

# Pick of the Trade

**"THERE'S NO BUSINESS  
LIKE OUR BUSINESS!"**

AS WE GO TO PRESS there is talk of peace. There is imminent hope for an armistice in Korea. There is doubt as to the depth of adjustment to be made by industry. There is prophecy of recession, some say minor, some say crippling. The majority think that late-1953 and early 1954 will see a change.

What will this do to our industry of electronics with its million people employed?

The picture of the overall economy need show little if any reflection. These factors can prevent the electronics industry adjusting down on the same curve of the overall economic adjustment.

1. Armament. Reduction in armament appropriations will affect electronics probably less than any other industry. Aircraft production is more and more an electronic dollar. Guided missiles are more and more an electronic dollar. Electronics more than any other art has the technological ability to make this nation the titan of the world in armament. The electronic circuit is approaching the point of controlling all phases of warfare.

2. Amusement. Television is going ahead as fast as production will permit. Out of the laboratories will come color, for an entirely new phase which will accelerate in public acceptance in proportion to the speed with which set prices come down. Prices come down? Watch what mechanized assembly, transistor circuits, miniaturization and simplification will do to prices of home electronic amusement devices in the near years ahead. Multiple TV-set homes? Sure.

3. Industry. The electronic circuit is being accepted in industry. The transistor, the magnetic amplifier, the quality component, the simplified and now mechanized assembly now permit of electronic controls as rugged and dependable as a lathe or a magnetic switch assembly with versatility impossible by other means.

Industry must accept electronics or industry will not go ahead. Industry must accept electronics because it can only increase progress by increasing efficiency. Developments in industrial electronics, both for control, and in communications will be consistent bordering on the spectacular.

Indications are that our business (electronics) will reflect less dip, if any, than the average—and it may experience no dip at all.

—W. B. Blood

*Electronic Markets, April, 1953*

**ABOUT THE COVER:** Pictured is the South Side Chicago Branch of Central Television Service. Central Television Service is the largest independent service company in the mid-west, with five branches; north and south sides of Chicago, Oak Park, Illinois, Des Moines, Iowa and Denver, Colorado.

Organized in 1947 by its founders, Phil Ban, General Manager, and Carl Korn, Chief Engineer, this company has a combined total of monthly service calls for all five branches exceeding 15,000 per month. The South Side Branch alone averages over 4,000 service calls per month, has its own garage servicing trucks.

Sid Reisberg, manager of this branch, (pictured at right) attributes its growth and successful operation, from the technical standpoint, to the use of skilled employees, simple but accurate record systems, dependable service information, and the intelligent selection and use of best equipment.

*No part of the PF INDEX or Technical Digest may be reproduced without written permission.*

# PF INDEX

## AND TECHNICAL DIGEST

VOL. 3 • NO. 4 • JULY - AUG., 1953

JAMES R. RONK, Editor

Editorial Staff: Robert B. Dunham • Ann W. Jones  
Glenna M. McRoan • Glen E. Slutz • Margaret Neff  
L. H. Nelson • C. P. Oliphant

Technical Director: W. William Hensler

Art Directors: Anthony M. Andreone • Pierre L. Crease

Photography: Robert W. Reed

Production: Archie E. Cutshall • Douglas Bolt

Printed by: The WALDEMAR Press; Joseph C. Collins, Mgr.

### CONTENTS

Shop Talk	5
Milton S. Kiver	
Servicing with the Scope	7
C. P. Oliphant	
Replacement Technique for Horizontal Output Transformers	11
Glen E. Slutz	
UHF (Circuits and Equipment for UHF Reception)	15
Merle E. Chaney	
A Small High Quality Amplifier	19
Robert B. Dunham	
Examining Design Features	23
Merle E. Chaney	
UHF Operational Survey	29
W. W. Hensler	
In the Interest of Quicker Servicing	33
Glen E. Slutz	
A Multiple Antenna Switching Device	41
Merle E. Chaney	
Testing Selenium Rectifiers	43
C. P. Oliphant	
Audio Facts	45
Robert B. Dunham	
Dollars and Sense Servicing	47
John Markus	
Photofact Cumulative Index	49
No. 39 Covering Photofact Sets	
Nos. 1-212 Inclusive	
Autronic Eye	108
C. P. Oliphant	
A Stock Guide for TV Tubes	123
+More or Less—	126



HOWARD W. SAMs, Publisher

COPYRIGHT 1953 • Howard W. Sams & Co., Inc.  
2201 East 46th Street • Indianapolis 5, Indiana

*No patent liability is assumed with respect to the use of information contained herein.*

The PF (PHOTOFACT) INDEX and Technical Digest is published every other month by Howard W. Sams & Co., Inc. at 2201 East 46th Street, Indianapolis 5, Indiana—and is included as a part of PHOTOFACT folders from PHOTOFACT Distributors without additional cost.

**SUBSCRIPTION DATA:** For those desiring the convenience of delivery to their homes or shops, Howard W. Sams & Co., Inc. will mail each issue of the INDEX direct, promptly upon publication. The subscription charge is \$2.00 for eight issues in the United States and U. S. possessions. Acceptance under Section 34.64 P. L. & R. authorized at Indianapolis, Indiana.

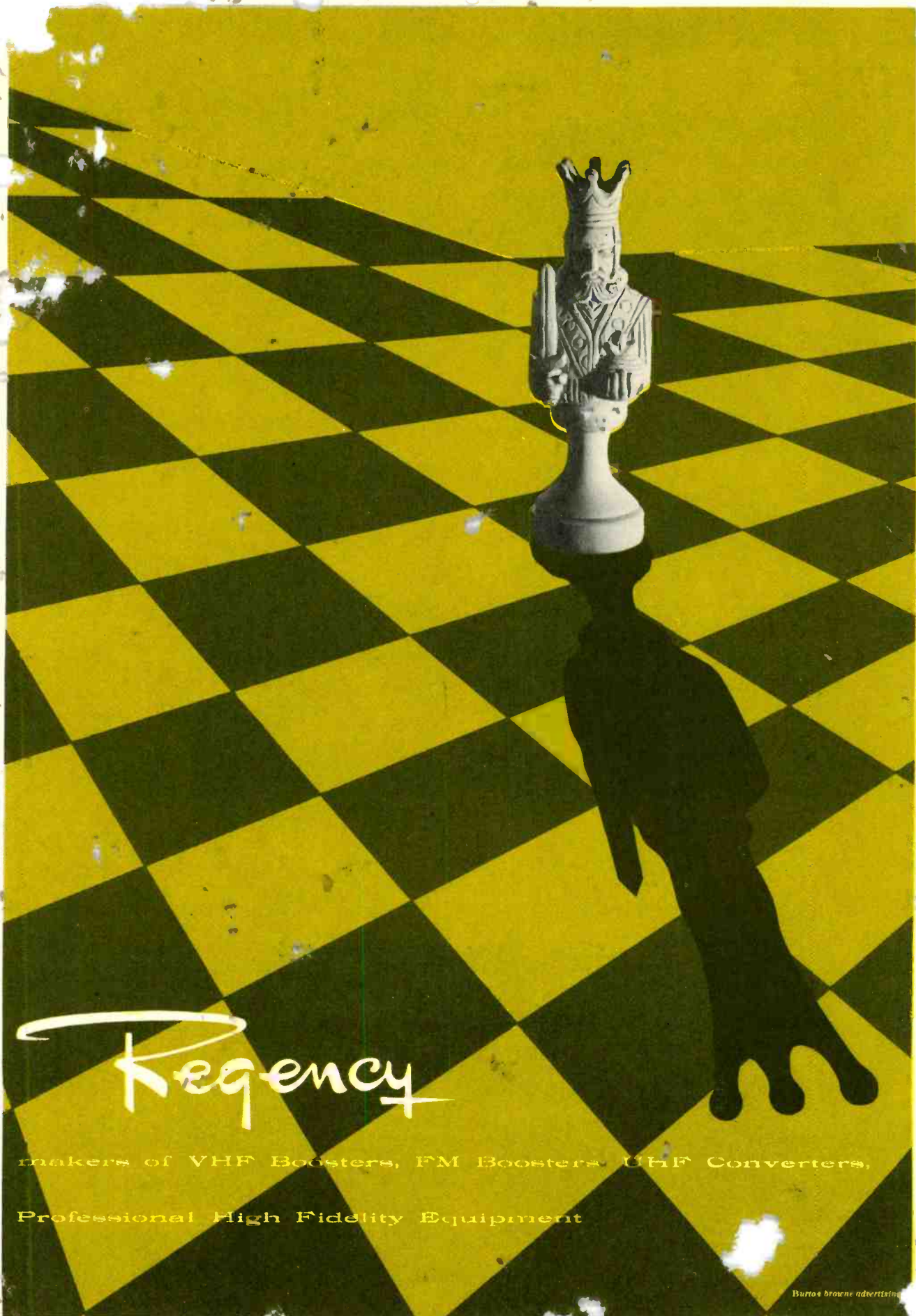

# Regency

makers of VHF Boosters, FM Boosters, UHF Converters,  
Professional High Fidelity Equipment

Burton Brown Advertising



# Shop Talk

**COLOR TELEVISION.** For some months now there have been very definite and persistent rumblings in the television industry concerning color television. At the recent I.R.E. convention held in New York City, no less than 10 papers were devoted to this subject. There is hardly a month that passes that some technical magazine does not carry an article on some aspect of color television. And those of us who are acquainted with the manufacturing end of this business know that considerable research is being devoted to color.

The question then is not "Will we have Color Television?", but rather, "How Soon?" The consensus of opinion seems to lean toward 18 months although one hears predictions of color sets this year while others feel that 4 to 5 years is the best we can hope for. Be that as it may, more and more will be heard of color television as time goes on and it behooves the serviceman to at least possess a reading familiarity with the more common color terms.

The situation as it exists today is this: There is one system, the CBS field sequential system, which has been officially approved for color broadcasting. However, because of its incompatibility with existing receivers, no major set manufacturer (aside from CBS) has been willing to go ahead with it. Instead, the industry, through the National Television System Committee (or NTSC), has been concentrating on a compatible system which is an outgrowth of a system originated by RCA. Its name, appropriately enough, is the NTSC color television system. Field testing of this system is now in progress and when sufficient data has been accumulated, petition will be made to the F.C.C. for official approval. The latter step is expected shortly.

In the meantime, the service technician need not stand still. For aside from the welter of strange circuits that he will eventually have to face, there is also a number of new concepts which he will have to

master first. So why not put the present formative period to good use learning these new ideas and becoming fully familiar with them?

Perhaps the best place to start is with the well-known black and white television system now in use. This is called a Monochrome system because it deals with one color. The television signal occupies a bandwidth of 6 megacycles (approx.) and this is all we need to form a high-quality picture.

Now, it might be felt that since we must have 6 mc to transmit a picture in one color, that we would require three times as much, or 18 mc, to broadcast a picture in three colors. The latter figure is chosen because colored images are produced through a combination of three primary colors (i.e., red, green, and blue). Actually, the first system which RCA presented before the F.C.C. required an overall bandwidth of 14.5 mc instead of 18 mc.\* See Figure 1. The reduction in bandwidth was achieved by taking advantage of the fact that the human eye can resolve considerably less detail in a blue image than it can in a green or red image. The inclusion of detail beyond that required by the observer is obviously a waste of valuable frequency space. Hence, the blue portion of the color video signal had its sideband reduced to approximately 1.3 mc.

A further reduction in signal bandwidth was made possible by the application of the so-called "mixed-highs" principle. This principle is

based on the physiological fact that the eye is not sensitive to color in fine detail. Thus, if you present a picture in which the large areas are in color and the fine detail is in black and white, your eye will see a complete color picture.

The first application of the "mixed-highs" principle to a color television system is shown in Figure 2. Each of the video color channels receives its signals from an appropriate color camera. However, the high video frequencies of each of the color chains are separated from the rest of their signals, combined with each other, and then transmitted over the green channel. The high video signals are those possessing frequencies above 2 mc. Frequencies from zero to 2 mc are considered as containing the larger detail of the image. The red and blue channels, devoid of the higher video currents, transmit only the low frequencies on narrow sidebands. The green carrier still maintained a full sideband, 3 mc, containing the green lows and the three mixed-high video frequencies.

At the receiver, the lows of each channel are received separa-

\*It is possible that an 18 mc color system was initially planned by RCA. However, it probably never progressed very far and is important only from a historical point of view.

\* \* Please turn to page 83 \* \*

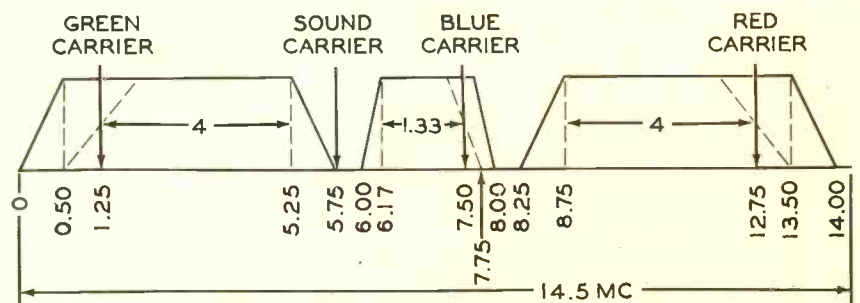

Figure 1. The first electronic color television presented by RCA required a bandwidth of 14.5 mc.

# RCA VoltOhmysts\*

*outsell all other  
VTVM'S*

RCA WV-97A  
SENIOR VoltOhmyst  
**\$6750** Suggested  
User Price



RCA WV-87A  
MASTER VoltOhmyst  
**\$11250** Suggested  
User Price

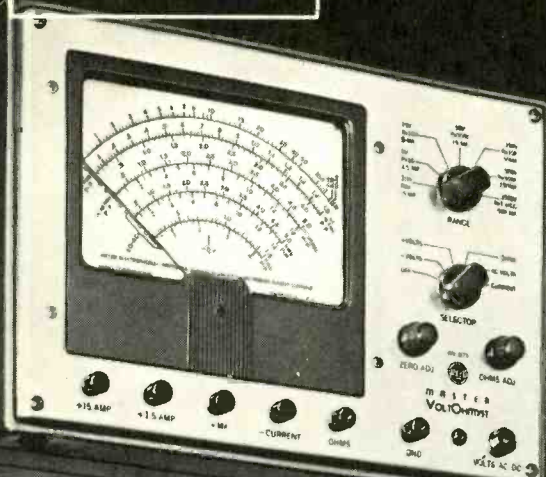

RCA WV-77A  
JUNIOR VoltOhmyst  
**\$4750** Suggested  
User Price

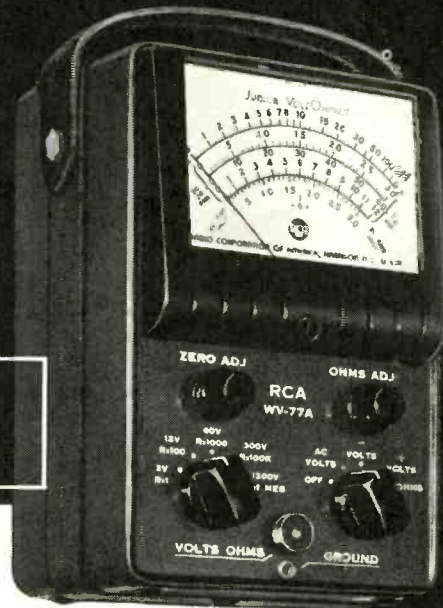

Because they're factory-calibrated under laboratory conditions... incorporate more features... have unusual accuracy and stability... in short, offer you more for your money—RCA VoltOhmysts outsell all other makes of vacuum-tube voltmeters.

All RCA VoltOhmysts employ a degenerative bridge circuit to compensate for line-voltage changes... a sturdy 200-microampere meter movement electronically protected against burn-out... large,

easy-to-read scales... metal shielding against external fields... and have an input resistance of 11 megohms on all dc ranges.

Before you buy a vacuum-tube voltmeter, be sure to get the full details on the RCA VoltOhmyst best suited to your needs. See your RCA Test Equipment Distributor today... or write RCA, Commercial Engineering, Section 67GX, Harrison, N. J.

\* Tmk ®



**RADIO CORPORATION of AMERICA**  
TEST EQUIPMENT

HARRISON, N. J.



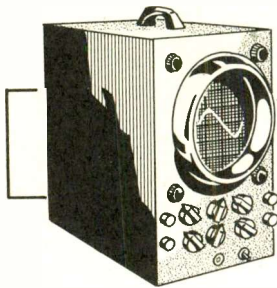

# SERVICING with the SCOPE

by C. P. Oliphant

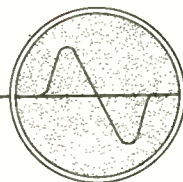

## Several Practical Procedures for Using the Scope to Enable Speedy, Efficient Radio Servicing.

The oscilloscope is a versatile testing unit that is widely used in the process of television servicing. The scope provides a means of visually checking the operation of the television circuit. When used systematically, it is considered to provide the most rapid method of localizing the component which is causing the difficulty. Other than being used for trouble shooting a television circuit, it is also used during the process of aligning receivers.

The above statement does not mean that the scope can be used in television servicing only. In fact, it can be employed in all phases of electronics. However, it is not employed very extensively in trouble shooting a radio circuit. Just as in the case of the television circuit, the scope could be put to great advantage in radio servicing.

Before the advent of television, the scope was not normally purchased for use in a service shop as a major tool for radio servicing. It was considered too costly an item for this use. The signal tracer was believed to be more advantageous for this type of work, with results of providing a good means of tracing the signal. However, with the service shop now set up for television servicing, it normally is equipped with a scope which can be used to provide an alternate means of signal tracing. For this reason it is believed that it would be helpful in time saved to the serviceman if the scope were employed for radio servicing also. It seems since the scope is in use so much during television servicing it would be wise to keep on using it whenever a radio receiver needed trouble shooting.

Other than providing a means of visual alignment of the receiver, the scope could very easily be used for the following during radio servicing.

1. Signal tracing.
2. Checking the overall performance of the receiver.
3. Checking for overloading and distortion and finding the cause of these conditions.
4. Discovering and finding the source of hum, oscillations, regeneration, and noise.

A method of trouble shooting a radiocircuit, which is straightforward and requires very little time, is presented in the following discussion. Since the use of the scope is incorporated in this procedure, it could be referred to as the visual means of trouble shooting a radio circuit as compared to the audio method. This method provides a means of visually checking the operation of each stage of the receiver.

The necessary test equipment to be used is a scope, and a signal generator to provide a modulated RF signal.

Starting with the assumption that the set to be checked is a weak or dead receiver, the recommended procedure is as follows:

The normal starting point in checking a receiver is the audio stage. It is felt that the conventional method of checking this section is a fast and sure way, that being the finger or screwdriver touch system. By point-to-point probing through the audio section an audible click or hum is heard in the speaker if this section is functioning. If the note is not heard, then a quick voltage or resistive check would soon detect the trouble.

With the audio section known to be all right, the scope can be used now as the means of tracing the signal. First, adjust the signal generator for a modulated 1000 kilocycle output. The RF Amplitude should be set at maximum gain. Loop-couple the output of the gener-

ator to the input of the receiver. Connect the ground terminal of the scope to ground or the B minus point of the receiver. Touch the vertical output probe of the scope to the plate of the IF tube. This is test point 1 as shown on the schematic of Figure 1. Tune the receiver through the mid-range and note whether a modulated pattern appears on the scope as is shown in Figure 2. Instead of tuning the receiver to tune in the generator signal, the receiver could be set at approximately mid-range and the frequency dial of the generator may be rocked back and forth until the correct conditions are met. If the signal is received at this point the trouble lies behind this test point, that is between test point 1 and the input of the audio stage.

If no signal, or a very weak signal, is seen on the scope at this point, the trouble lies in the IF stage or preceding stage or stages. If this is the case, move the scope probe to the plate of the converter stage (Test Point 2). Tune the receiver across mid-range or rock the frequency dial of the generator for an indication of the signal on the scope. If the signal appears at this point and was not present at the plate of the IF tube, move the scope probe to the grid of the IF stage (Test Point 3). If no signal appears at this point, the trouble is between test points 2 and 3. However, if the signal is present, check for bad IF tube or improper tube voltages.

If there was no signal at the converter plate, touch scope probe to the oscillator grid (Test Point 4) for a check to see if the oscillator is operating properly. An identifying pattern should appear on the scope as shown in Figure 3, which is an unmodulated carrier. This indicates that the oscillator stage is in operation. If the oscillator is functioning, move the scope probe to the converter signal grid. If the signal is present, check for bad converter tube or improper tube voltages. If signal is not present at test point 5, the trouble then lies ahead of this point.

# ANOTHER GREAT JFD FIRST

NEW JFD "GOLD SHIELD" UHF ANTENNAS ARE GUARANTEED AGAINST RUST FOR ONE FULL YEAR

Don't let antenna rust "eat away" your UHF profits with costly call backs. Only the spectacular new JFD "Gold Shield" UHF antennas are protected against rust and the serious damage rust causes to UHF pictures. JFD Bronzidite . . . the miracle anti-rust Army-Navy-Aercnautical "spec"

plating . . . safeguards your antenna installation and your reputation. Every nut, screw, bolt, washer and bracket is "Bronzidite" plated. Depend on the new JFD "Gold Shield" UHF antennas . . . your guaranteed line to surer profits. See them at your Jobber or write for brochure #218.

## BRONZIDITE



**JFD MFG. CO., INC.**  
BROOKLYN 4, N. Y.

Burton Browne advertising

WORLD'S LARGEST MANUFACTURER OF TV ANTENNAS AND ACCESSORIES



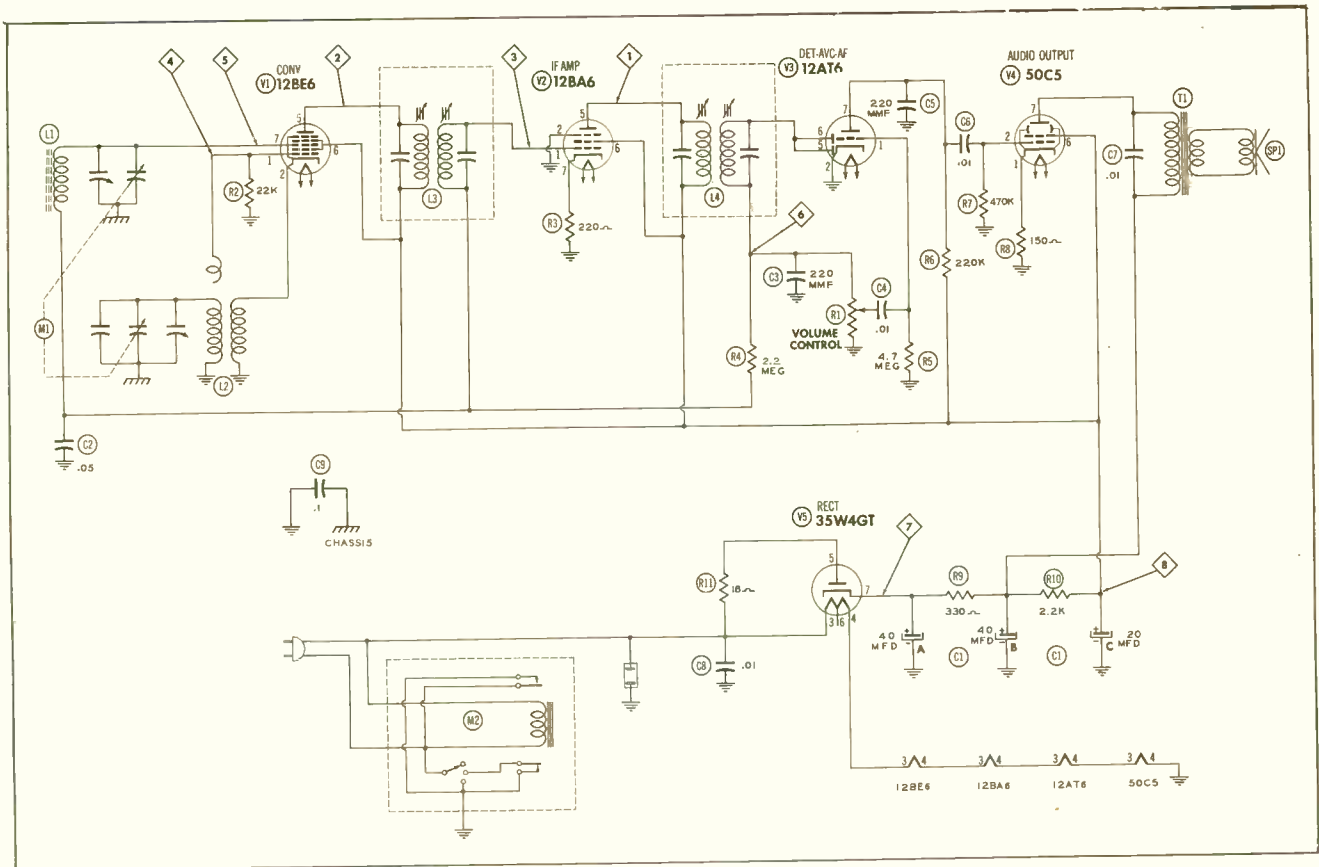

Figure 1. Circuit of a Typical AC-DC Receiver, Showing Test Points Discussed in Text.

This narrows the trouble down to the input circuit or to the RF stage if one is used. A resistance or voltage check of the input circuit should reveal the difficulty.

For a quick reference of the preceding discussion refer to Chart 1. When the scope probe is at a certain test point, the chart points out what steps should be taken under the conditions of no signal or signal present.

The scope used in the above discussion was of the wide band, high sensitivity type, which is normally used for television servicing. The vertical input lead of the scope was a normal, shielded lead. A properly shielded lead should be used so that hum will not be picked up and give a false indication. If the signal is weak in the receiver, a high impedance probe should be used so that the scope loads the receiver as little as possible.

If a wide band, high sensitivity scope is not available, a narrow band scope can be used. With this type of scope, however, a demodulator probe must be used if the IF and RF portions of the receiver are to be signal traced. The scope pattern will be in the form of a sine wave rather than a modulated carrier as obtained without the demodulator probe. It is interesting to note that the demodulator probe can be used in signal tracing any portion of the receiver, including the audio stage. This eliminates the need of connecting and disconnecting the demodulator probe in any signal tracing procedure.

When using a medium or low sensitivity scope, it may be impossible to obtain an indication at the grid of the converter or RF amplifier. This deficiency is not too serious, however, since the output of the signal generator can be coupled to the grid of the first stage, thus bypassing the input circuit. If this is necessary to obtain a signal, the trouble must lie in the input circuit. It must be remembered that when signal tracing the early stages of the receiver, the output of the signal generator must be kept at maximum setting in order to obtain a useable pattern on the scope.

	NO SIGNAL	SIGNAL PRESENT
Test Point 1.	Trouble in Preceding Stages Move to Test Point 2.	Trouble Behind - Check Circuit after this point. (See Figure 2 for Scope Pattern).
Test Point 2.	Trouble in Preceding Stages Move to Test Point 4.	Move to Test Point 3.
Test Point 3.	Check Circuit Between Points 2 and 3.	Check for bad IF Tube or Improper Tube Voltages.
Test Point 4.	Check Oscillator Section.	Move to Test Point 5. (See Figure 3 for Scope Pattern).
Test Point 5.	Check Preceding Parts or Stages.	Check for Bad Converter Tube or Improper Tube Voltages.

Chart 1. Trouble Shooting Chart

\* \* Please turn to page 104 \* \*

# UHF or VHF

there is an

**AMPHENOL**

antenna for every area

Whatever the location, whatever the problems presented by different areas, the expanded line of AMPHENOL antennas will provide top reception.

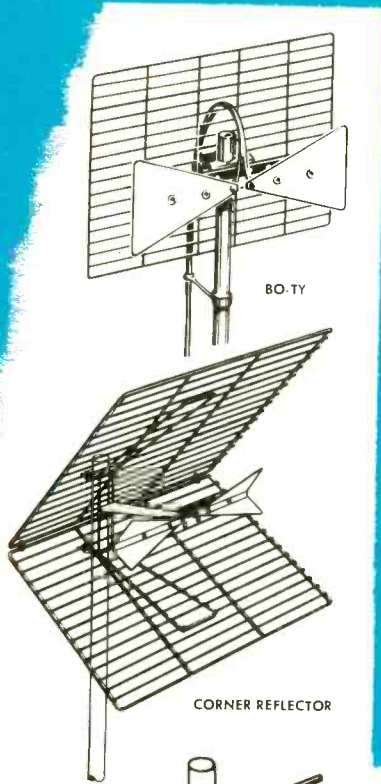

BO-TY

CORNER REFLECTOR

for VHF. For over four years the dependable INLINE has provided top viewing satisfaction to its users. With excellent gain and directional response, the INLINE is also available in a Stacked Array for additional gain in fringe areas and in a Piggy Back for multi-directional reception.

for UHF. Keeping pace with this expanding new market are a full line of AMPHENOL UHF antennas.

**BO-TY and Reflector.** With its rejection of unwanted signals off the back and sides, the BO-TY is excellent for major signal areas. Where additional gain is desired in fringe areas, two BO-TYs can be easily stacked.

**CORNER REFLECTOR.** The high ascending and strong forward radiation pattern of the new CORNER REFLECTOR make this AMPHENOL antenna ideal for fringe areas. Of exceptionally sturdy construction, the CORNER REFLECTOR also has the advantage of being mounted in front of the mast to insure no signal interference from the mast or accessories.

**RHOMBIC.** Another AMPHENOL antenna built to give the high gain needed for UHF in outlying districts. It also features rejection of ground reflections, an important consideration in UHF.

**YAGI.** There are 11 custom models of the YAGI for top reception across the entire UHF band. Each features extremely high gain on its assigned channels as well as a strong forward radiation pattern.

*The above listing should make the choosing of the right antenna an easy task. For UHF or VHF, AMPHENOL antennas assure top reception.*

AMERICAN PHENOLIC CORPORATION  
Chicago 50, Illinois

**AMPHENOL**

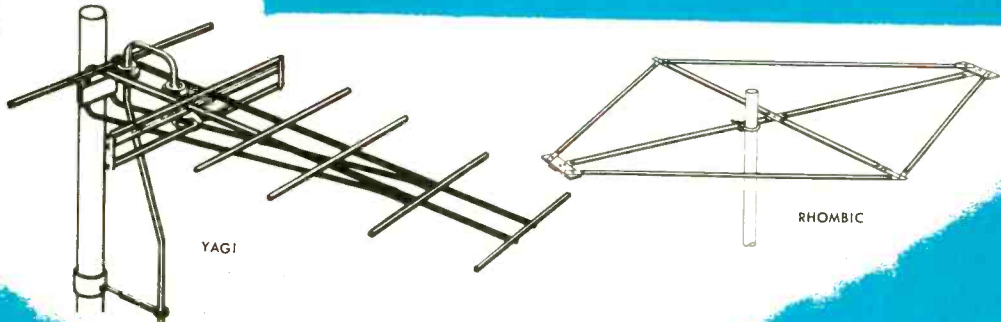

YAGI

RHOMBIC



# REPLACEMENT TECHNIQUE — for —

by Glen E. Slutz

Most service technicians will agree with this statement about television repair: a maximum of know-how and a good deal of patience are required in the task of replacing a horizontal output transformer and getting the set to function properly afterwards. The problem presents itself too frequently to pass it by, as evidenced by the number of questions which are being asked by service technicians everywhere concerning the subject. Therefore, if this report, based as it is on actual experience, contributes some worthwhile information on replacement technique, it will have served its purpose.

Horizontal output transformers in those television receivers which employ the flyback principle of high voltage generation are somewhat more complex than most other components. There are instances of replacements where upwards to fourteen distinct connections need to be made to the transformer itself. The physical aspects of positioning the unit and mounting it within the high voltage cage are considerations which must be carefully observed. Moreover, the presence of high voltage in the area calls for adherence to proper insulating practice in order to avoid arc-over or corona effects. Then, too, the electrical interdependency between the transformer and several other components, some of which are adjustable, limits severely the range of conditions under which the transformer will give satisfactory service.

Assuming that a horizontal output transformer is known to be defective, the first decision to be made is the choice of a suitable replacement unit. Here Photofact folders come to the aid of the technician, providing him with the manufacturer's part number of the exact replacement unit together with catalogue numbers of applicable transformers from the lines of various parts manufacturers. The latter units may be exact replacements for the defective transformer or they may be of the universal type designed for a broader field of use.

An exact replacement may be defined as one which corresponds physically and electrically with the original factory part as it was when new. Naturally the exact replacement is preferred usually over a universal transformer and is used when available. However, frequent occasions arise where the manufacturer's part is difficult or impossible to obtain, and in these instances a recommended, universal type is selected. Another well-founded advantage of choosing a universal transformer is that it obviates the necessity of stocking a large number of exact replacements. This is a point which appeals to inventory-wise shop managers.

Chart 1 is a list of universal horizontal output transformers with isolated secondaries made by five manufacturers of replacement parts. These units, although they differ in some respects with one another, are

CHART 1

Universal - Type Horizontal Output Transformers Having Isolated Secondaries.

Manufacturer	Transformer Part No.
Chicago	TFB-5
Merit	HVO-7 HVO-X7* HVO-10#
RCA	231T1
Stancor	A-8130
Triad	D-14

\* HVO-X7 differs from HVO-7 in having improved insulation.

# HVO-10 differs from HVO-7 in being adapted to low-inductance width coils.

## horizontal output transformers

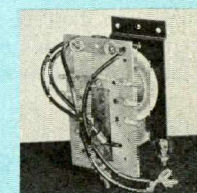
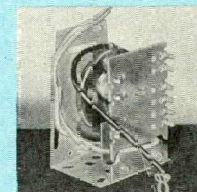
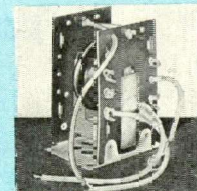
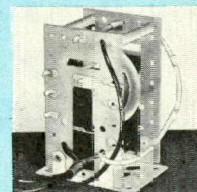

# Centralab Controls — always within reach . . . always right!

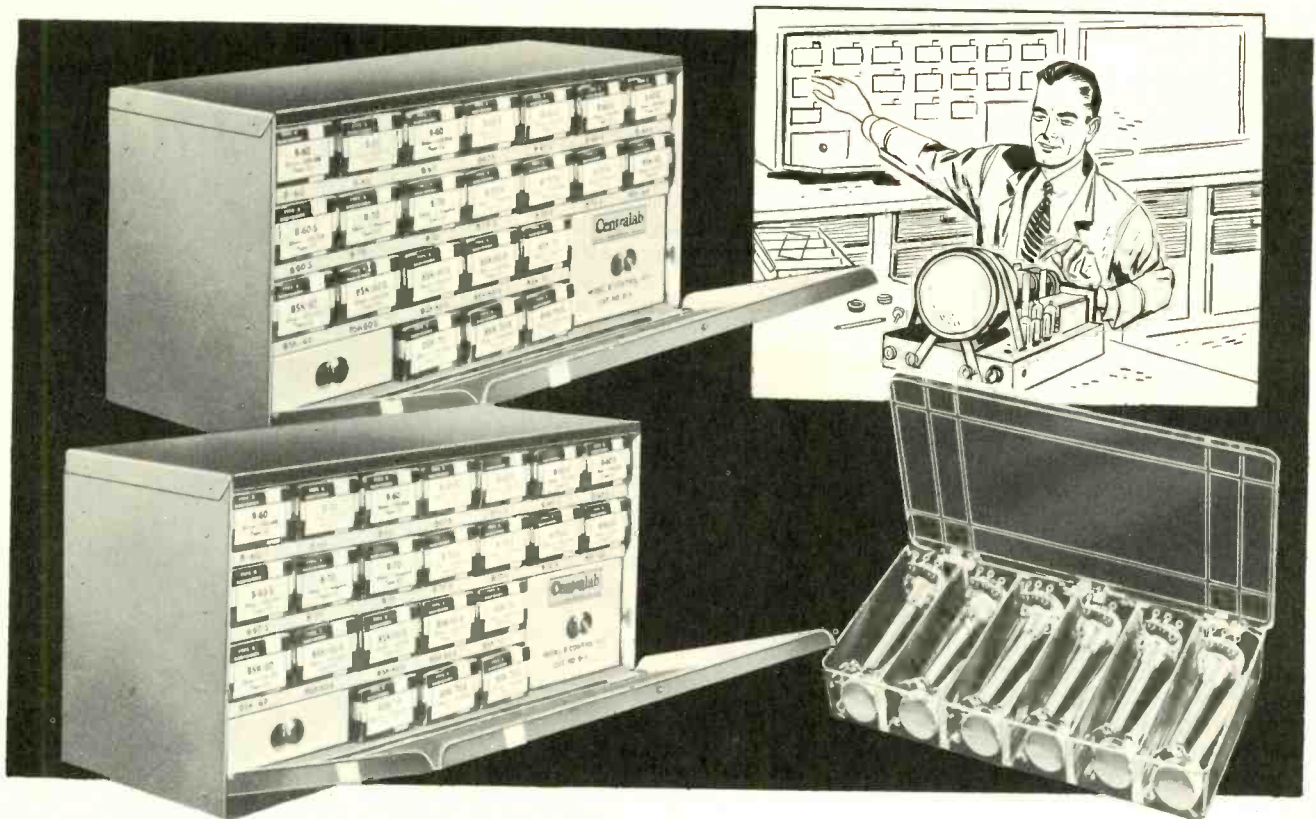

## These handy Blue Shaft<sup>\*</sup> Kits help take "parts hunting" out of repair service

If you're like thousands of other busy Service Engineers, you can't afford to sacrifice profit time — hunting for repair parts. The smart, sure way to faster service is to have your Centralab controls on hand when you need 'em — in these handy Blue Shaft Control Kits. Assortments contain values you use every day, in plain or switch types. Switches are factory attached and tested for immediate installation. Included are *exact* service replacements for popular radio and TV sets.

Three kit deals are available: B-A Kit contains 22 controls (8 types) in 1/2 and 1 megohm. All units C2 (audio) taper. Newest, revised Kit B-B has 22 controls (15 different types), plus 4 "Fastatch"<sup>\*</sup> type KB line switches. Ten handy Plasti-Pak Kits of 12 controls each also save time. You pay for parts only — no charge for containers.

You can count on your Centralab Distributor for exact Blue Shaft replacements to keep kits well stocked. So see him soon — he'll be glad to supply the kits you need.

# Centralab

A Division of Globe-Union Inc.

942 E. Keefe Avenue • Milwaukee 1, Wisconsin  
In Canada, 635 Queen Street East, Toronto, Ontario

### FAST MOVERS . . . NO "SLEEPERS"

**Kit Deal B-A** — 22 controls. 1/2 meg and 1 meg. B types have standard 3" shafts, full-length fluted mill. BSK types have 2 1/8" split-knurl shafts. In handy metal cabinet.

PLAIN TYPE				SWITCH TYPE			
3	B-60	1/2 meg.	C2	5	B-60-S	1/2 meg.	C2
2	B-70	1 meg.	C2	3	B-70-S	1 meg.	C2
2	BSK-60	1/2 meg.	C2	3	BSK-60-S	1/2 meg.	C2
2	BSK-70	1 meg.	C2	2	BSK-70-S	1 meg.	C2

Plus one metal cabinet

**Kit Deal B-B (Revised)** — 22 controls and 4 "Fastatch" switches. All have standard 3" shafts, full-length fluted mill. In handy metal cabinet.

PLAIN TYPE				SWITCH TYPE				"FASTATCH" SWITCHES		
1	B-5	1,000	C1	2	B-83	2.5 megs.	C1			2
1	B-10	5,000	C1	1	B-84	3 megs.	C1	1	KB-2	DPST
1	B-26	25,000	C1	1	B-87	5 megs.	C1	1	KB-3	SPDT
2	B-31	50,000	C1	3	B-60-S	1/2 meg.	C1			
2	B-40	100,000	C1	1	BSK-60-S	1/2 meg.	C2			
1	B-59	500,000	C1	2	B-70-S	1 meg.	C2			
2	B-69	1 meg.	C1	1	BT-80-S	2 megs.	C1			
1	B-75	2 megs.	C1	1	T-600K		C13			

Plus one metal cabinet

**Handy Plasti-Paks** — 12 controls. 10 individual kits, also B type. Plain and switch type. C2 (audio) taper. Split-knurl shafts. In useful plastic containers.

<sup>\*</sup>Trade Mark



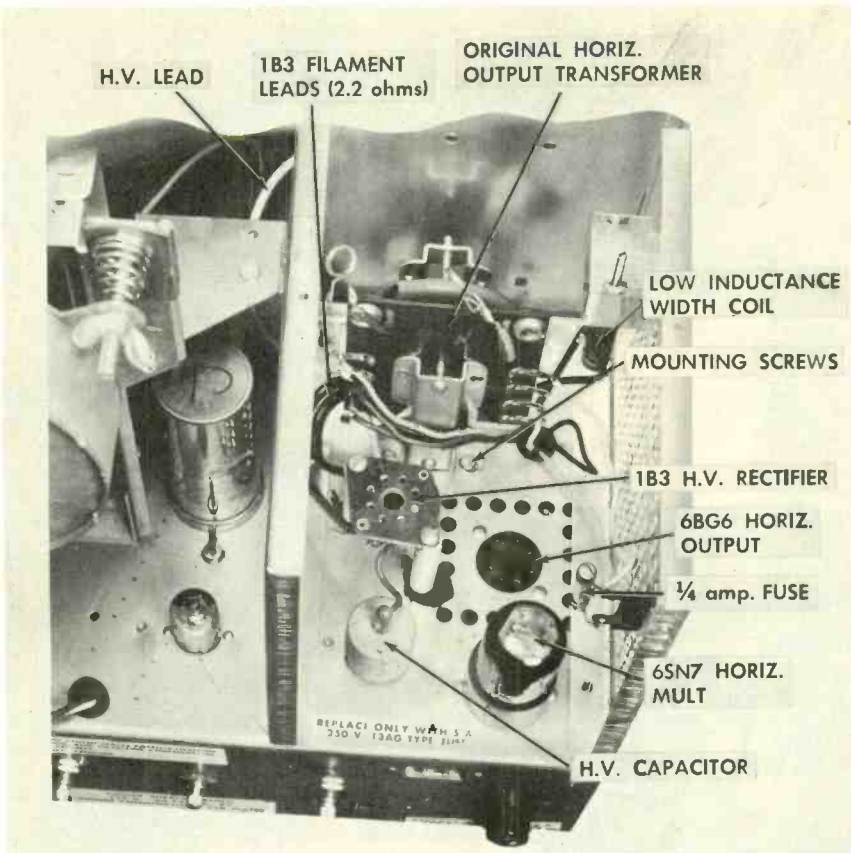

Figure 1. View of Original Horizontal Output Transformer Before Replacement (6BG6G and 1B3GT Tubes Removed for Photograph).

similar in basic construction and in application. The factual report which follows is an account of an actual replacement performed by a technician who was obliged to use one of these universal type transformers.

The Replacement Procedure -

The television receiver which needed the transformer replacement employed a 20 inch picture tube. A Stancor A-8130 transformer was selected as the replacement unit. (This unit is representative of the types shown in Chart 1. Any one of the others in the chart could have been used.)

Figure 1 is a picture showing the high voltage compartment of the receiver before the replacement was performed, and Figure 2 is a partial schematic of that portion of the receiver circuit involved in the change. The markings in script writing on the schematic are notations which were made from time to time by the technician during the course of the work. The X's indicate the breaks which were made in the circuit, and the colors identify the loose wires. (Identification of

\* \* Please turn to page 90 \* \*

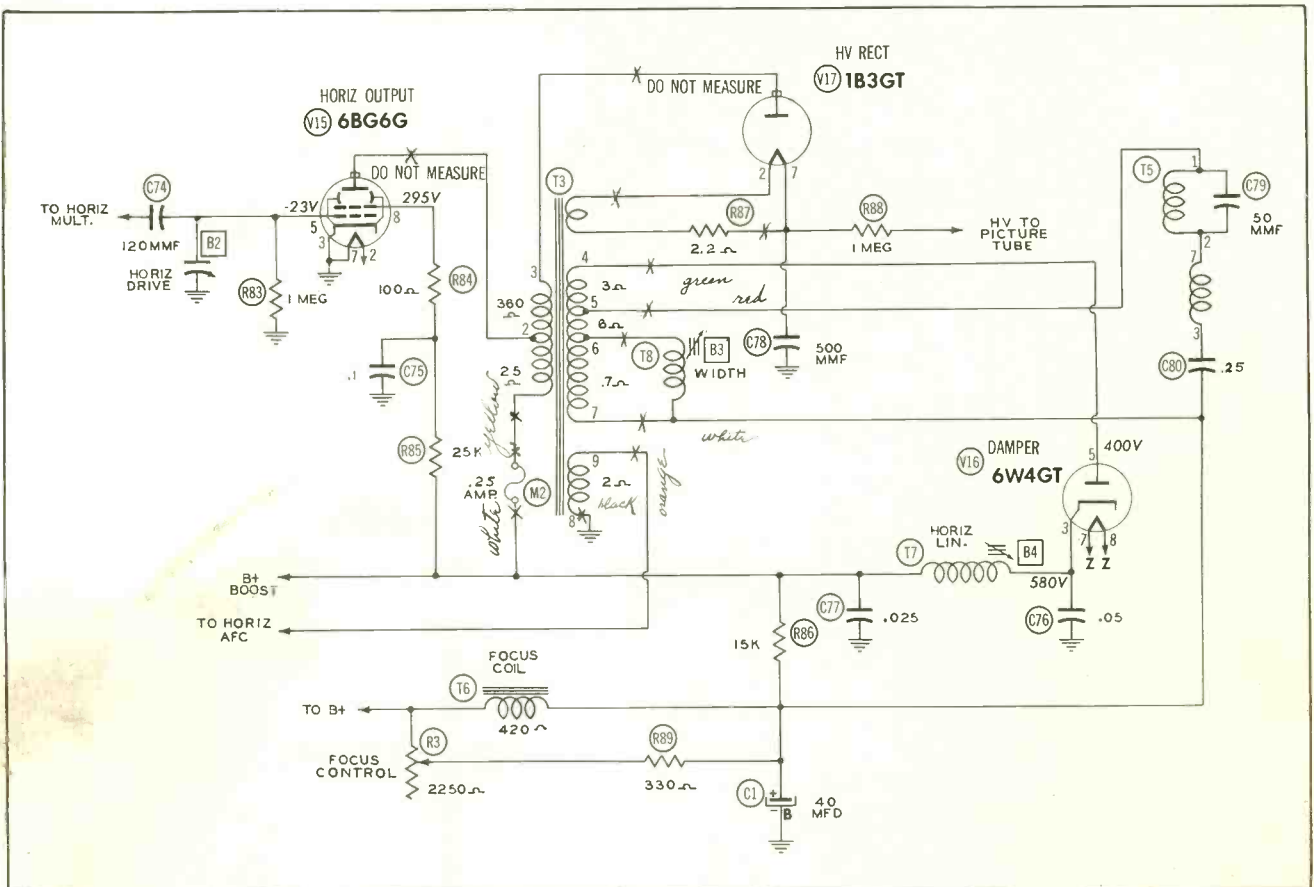

Figure 2. Partial Schematic of Horizontal Output Section of the Television Receiver Before Replacement.

**BEST ALL-AROUND TESTER ON THE MARKET**

**USE IT FOR:**

- TV SETS
- RADIOS
- TRANSMITTERS
- BROADCASTING EQUIPMENT
- HOME APPLIANCES
- TWO-WAY RADIO COMMUNICATIONS SYSTEMS
- PHONE LINES
- AIR CONDITIONING SYSTEMS
- STARTER CONTROLS
- AUTO IGNITIONS, GENERATORS, BATTERIES
- MOVIE EQUIPMENT
- PANEL INSTRUMENTS
- TV CAMERAS
- AUTO LIGHTING SYSTEMS
- GENERATORS
- VOLTAGE SOURCES
- "HAM" RADIO EQUIPMENT
- CABLES
- CONNECTORS
- AUDIO FREQUENCY SOUND CURRENTS

... and write for your complimentary copy of "1001" Uses for the Simpson Model 260"

**RANGES:**

20,000 OHMS PER VOLT DC  
 1,000 OHMS PER VOLT AC  
 VOLTS, AC AND DC: 2.5, 10, 50, 250, 1,000, 5,000  
 OUTPUT: 2.5, 10, 50, 250, 1,000  
 MILLIAMPERES, DC: 10, 100, 500  
 MICROAMPERES, DC: 100  
 AMPERES, DC: 10  
 DECIBELS (5 RANGES): -12 TO +55 DB  
 OHMS: 0-2000 (12 OHMS CENTER), 0-200,000 (1,200 OHMS CENTER), 0-20 MEGOHMS (120,000 OHMS CENTER)

**SIMPSON ELECTRIC COMPANY**

5200 W. Kinzie St., Chicago 44 • EStebrook 9-1121

In Canada: Bach-Simpson, Ltd., London, Ont.

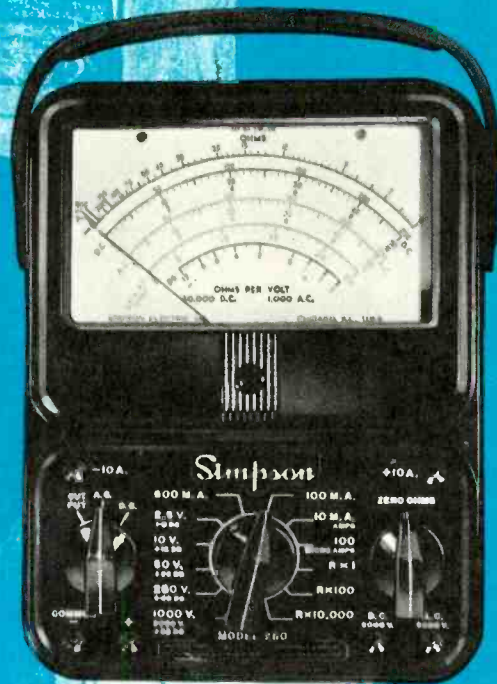

**Simpson**

**Model 260**

VOLT-OHM-MILLIAMMETER

Burton browne advertising



## A description of circuits and equipment for Ultra High Frequency reception.

by MERLE E. CHANEY

### RME UHF CONVERTERS

The RME Model 200 UHF Converter is designed for use with television receivers having tuning provisions to cover the VHF band from channels 2 through 13. The converter output is established at either the frequencies of channel 5 or 6 and therefore may be accepted by the tuner of a receiver when turned to these channels.

On the front of the cabinet are the selector switch and the tuning control. (Figure 1). Channel indication is provided by a slide rule type dial graduated with channel numbers between 14 and 83.

Employing but two tubes for its operation (a 6T4 or 6AF4 oscillator and a 6BC5 IF amplifier) rectification is obtained using a selenium rectifier. Figures 2 and 3 are top and bottom views respectively of the converter chassis with the tuner shields removed.

Other features of this unit are the AC receptacle on the rear of the chassis for providing AC power to the television receiver and an interesting tuning system. An explanation of the tuning system should aid in forming a clearer idea of the working of this unit.

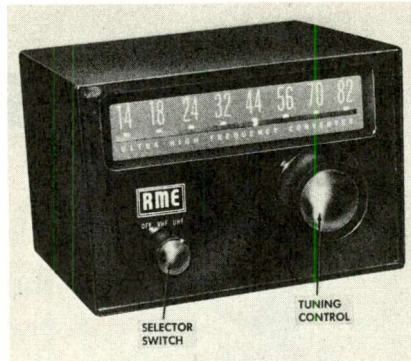

Figure 1. RME UHF Converter Model 200.

The tuner proper is completely incased in a copper-plated metal box, chassis, or enclosure. Under normal circumstances the tuning unit should not be disassembled. This reduces the possibility of accidentally damaging the components or altering the lead dress. There are however two inspection plates allowing access to the crystal mixer (Type 1N72, 1N82, or CK710) and to the components associated with the oscillator circuit.

The heart of the RME tuner lies in the tuning assembly which is shown in Figure 4. Parallel resonant lines are employed as the

tuning elements for the preselector and oscillator. These lines are formed by a plating process on a plastic base. Between the two pair of lines is a narrow strip of plated metal which is grounded and provides shielding between the two circuits. The plastic base, containing the parallel resonant lines, is supported in the tuning enclosure approximately one-half inch from the metallic sides.

Tuning of these lines is performed by two shorting bars which slide over the surface of the lines to either shorten or lengthen them. The shorting bars are attached to an insulated plate which in turn is mounted on a threaded tuning shaft. As the shaft is rotated the shorting bars either shorten or lengthen the effective length of the lines.

Tuning indication is achieved by a dial cord attached to the shorting bar strips and extended through the tuner chassis to the dial pointer. The dial pointer is maintained at the desired position through the use of a coil spring which takes up slack in the dial cord assuring a positive tuning indication.

The functioning of this converter unit may be seen by observing the schematic, Figure 5. L1 forms the preselector parallel resonant line-

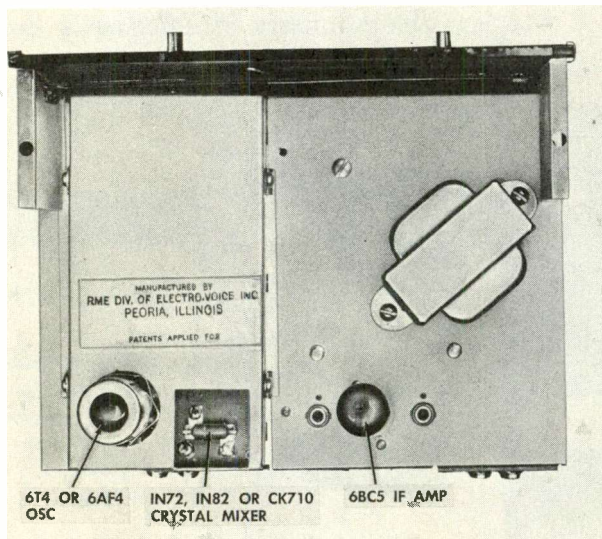

Figure 2. Top Chassis View of RME Converter.

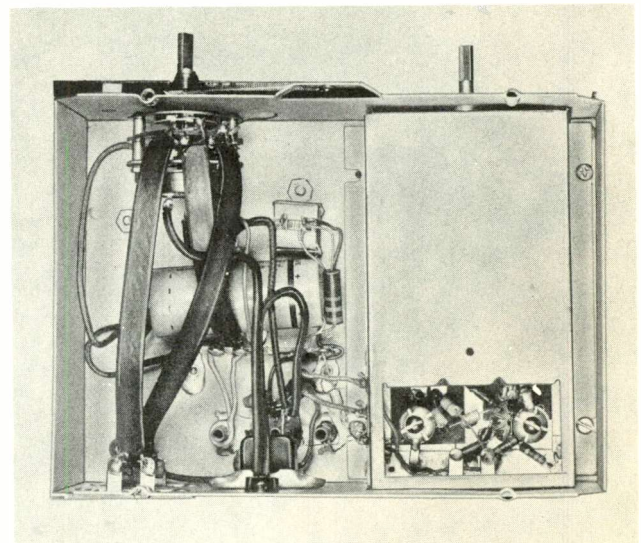

Figure 3. Bottom Chassis View of RME Converter.

# BUSS FUSES *Sell Easier-*

## STAY SOLD...

Yes, BUSS fuses sell easier because they are better known. You never have to spend valuable time selling the BUSS brand — your customers know the name BUSS because it has been the accepted standard of unquestioned quality in fuses for more than 37 years. Fuses for industrial, commercial, farm, automotive and home use.

And, BUSS fuses stay sold... because every BUSS fuse is of uniformly high quality... every fuse is electronically tested... every fuse is checked for physical dimensions. That's why there are no "kicks" or "comebacks" with BUSS fuses.

These important safeguards build customer goodwill and confidence in your company.

**Help  
You  
Make More  
Profit**

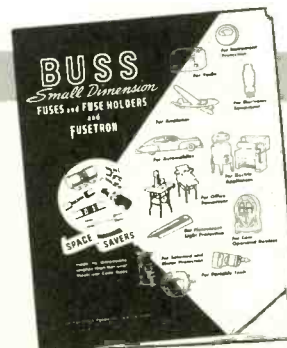

Bulletin SFB gives complete facts on BUSS SMALL DIMENSION FUSES  
If you'd like a copy, just write ...

**BUSSMANN MFG. CO.** University at Jefferson  
ST. LOUIS 7, MO. (Division McGraw Electric Co.)



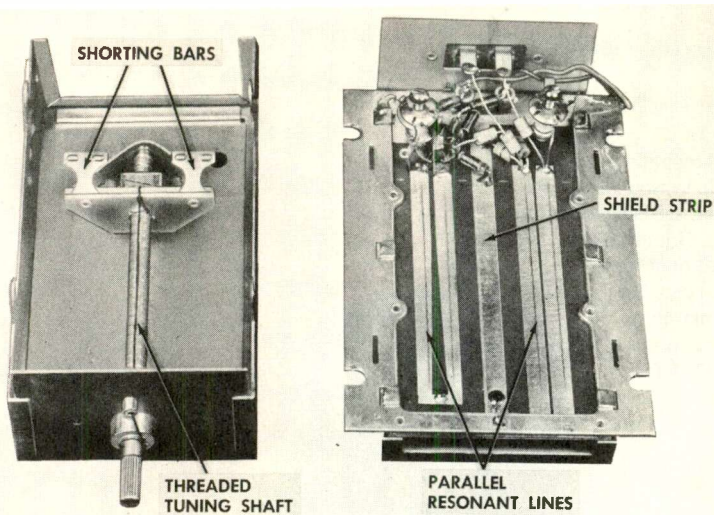

Figure 4. Tuning Unit Used in RME Converter Showing Parallel Tuned Lines & Shorting Bars.

with an accompanying shorting bar. The oscillator resonant line is made up of L2 and the shorting bar. The two shorting bars are ganged to effect a constant tracking of the pre-selector and oscillator tuned circuits. The oscillator frequency is established from 76 to 88 megacycles above that of an incoming signal. Beating the two frequencies at the crystal mixer yields the desired intermediate

frequency signal represented by channel 5 or 6.

A pentode tube, type 6BC5, functions in the amplifier stage. This stage of amplification provides a signal gain to compensate for losses in the mixer and RF circuits. Transformer coupling the output of the IF amplifier to the selector switch and then to the terminal strips provides a 300 ohm balanced output.

On the schematic, it is observed that the function switch is shown in "OFF" position. This setting of the switch grounds the VHF antenna lead and turns power off to the converter and to the TV receiver power receptacle.

In position 2 or VHF position, the VHF antenna lead is ungrounded and connected through the switch to the output terminal strip. At the same time, power is applied to the TV power receptacle and to the converter filaments. This position allows the television receiver to operate in the usual manner for VHF reception.

UHF position, position 3, again grounds the VHF antenna, connects the converter output to the output terminals, and applies B+ to the converter tubes. With the TV receiver set to receive channel 5 or 6 signals, depending upon which channel is not used in the area, the converter output is accepted by the tuner of the receiver and treated in the same manner as VHF signals. The converter tuning control is adjusted to receive best picture and sound from an available UHF signal. In some

\* \* Please turn to page 94 \* \*

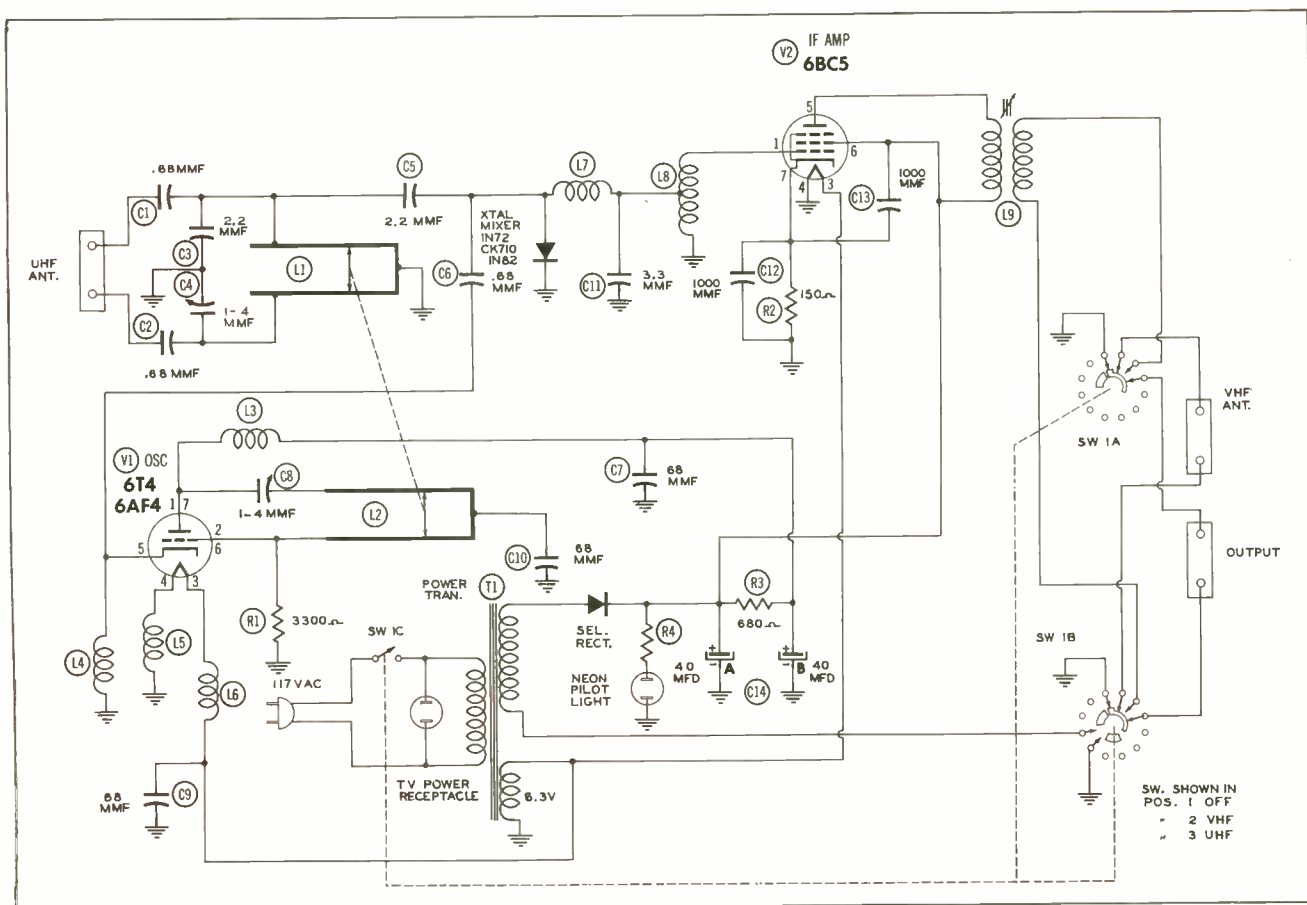

Figure 5. Schematic of RME Converter Model 200.

## A NEW CBS-HYTRON CTS-RATED\* TUBE

\*CTS-RATED: Rated for Continuous Television Service. In TV receivers, five tubes work . . . like transmitting tubes . . . *hard!* Account for almost 90% of your replacements. You know them: rectifiers, deflection amplifiers, damper diode. Larger-screen sets aggravate this problem. CBS-Hytron recognizes your need for huskier tubes for these sockets. Brand new designs, not just improved tubes. CTS-Rated 5AW4 . . . another CBS-Hytron first . . . is your answer for the low-voltage rectifier socket. It is CTS-Rated: (1) For heavier average (250 ma. max. d-c) and peak (750 ma. max. d-c) currents, (2) With big safety margins at these currents. You can depend upon the 5AW4 for continuous, trouble-free service. Yes, more CBS-Hytron CTS-Rated tubes are coming. Watch for them.

# CBS-HYTRON 5AW4

## NEW HEAVY-DUTY WORK HORSE CUTS 5U4G CALL-BACKS

Worried about slumping TV set performance, because of heavily loaded 5U4G's? Forget it. Use new CBS-Hytron CTS-Rated\* 5AW4. A replacement for the 5U4G, the 5AW4 recaptures . . . and keeps . . . that new-set sparkle. Maintains full voltage, despite heavy load. Minimizes burn-outs. Avoids filament shorts while testing chassis on side. Loafs on tough jobs. Gives long, long, trouble-free life. The 5AW4 will cut your call-backs. Boost your profits. See it . . . buy it . . . soon. At your CBS-Hytron jobber's.

†Patent applied for

### COMPLETE 5AW4 DATA FREE

See your CBS-Hytron jobber. Or write direct today.

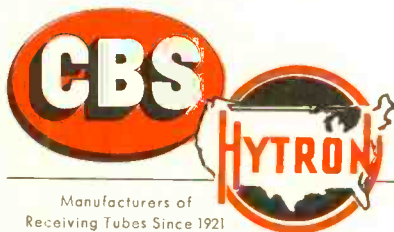

Manufacturers of  
Receiving Tubes Since 1921

CBS-HYTRON Main Office: Danvers, Massachusetts

A Division of Columbia Broadcasting System, Inc.



### MECHANICAL ADVANTAGES

**PLATE** — Note formed A-frame construction. Each plate of 5AW4 is formed into two cylinders containing the filament. Uniform filament-to-plate spacing and uniform filament performance avoid hot spots on filament, plate . . . and bulb. Over-size radiating fins and extra large surfaces between formed cylinders dissipate heat faster. Sturdy structure is rigidly supported at eight points.

**FILAMENT** — Massive, heavy-duty, 20-watt filament offers generous reserve of emission. Cuts burn-outs due to ionization attack and back emission. Transmitting-tube-type filament hook and spring suspension prevent sagging — yet reduce stresses on filament. Permit mounting 5AW4 in any position. Useful filament area is contained within formed cylinders of plate . . . to minimize internal voltage drop.

### New...Free DECAL

sells for you! *Sells* your magic ability to recapture new-set sparkle. Let this decal pull customers to you. Get it from your CBS-Hytron jobber today.



RECEIVING . . . TRANSMITTING . . . SPECIAL-PURPOSE AND TV PICTURE TUBES • GERMANIUM DIODES AND TRANSISTORS



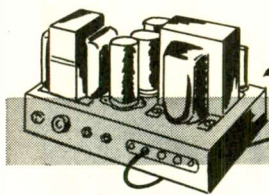

# A Small

# HIGH QUALITY AMPLIFIER



by ROBERT B. DUNHAM

Every part of a high-fidelity home music system is important, from the phonopickup and turntable, tape or wire playback equipment or tuner, through the pre-amplifier, power amplifier and loud speaker. The term home music system is used since most high-fidelity outfits are used chiefly for listening to recordings and radio or television programs in the home.

The room in which the listening is done is also important. And, incidentally, after a sound system has reached a high peak of perfection, the quality of the original program material takes on great importance, for it becomes more apparent if the quality of the recording or signal source is poor.

The power amplifier is important and always deserves a lot of consideration. At the present time a powerful amplifier is usually employed for several reasons. One is the high level peaks that must be amplified without distortion. Another is the fairly general idea that any powerful amplifier will have practically no distortion when operated at a low level. This can be true in the majority of cases but many have more distortion at

the usual low operating level than is found in a well-designed lower-powered amplifier.

A small, comparatively low-powered high-quality amplifier can be very satisfactory for home use, with actual listening tests, in direct comparison with more powerful outfits, being the proof. With an efficient speaker system, which is usually the case in high-quality systems, very little actual power is required to give more volume than can be tolerated in most homes. This moderate power requirement along with the advantages of a small unit makes the construction of the amplifier to be described a worthwhile project.

The choice of output tubes is one of the important considerations when designing a power amplifier. Their selection is determined to quite an extent by their ability to achieve the desired results without excessive demands in signal input or power supply requirements.

The dual triode 6BL7GT was selected for this application because of its many desired qualifications. It can be driven very easily to a fairly high output with low distortion,

which is not true with many low mu power triodes. Its small size and moderate power supply requirements result in a complete unit of small dimensions.

Since high-fidelity wide-range reproduction, with a minimum of distortion, is desired, only high quality output transformers are considered. Such transformers may be expensive but quality cannot be skimmed here without a definite loss in the final results. All those listed in the parts list have been tried in actual use and have given excellent performance.

The layout of parts can be seen in the illustrations (Figures 1, 2 and 3) of the complete amplifier. Mounted on a standard 7" x 9" x 2" chassis none of the parts are crowded. Actually the total number of parts is small enough to allow the amplifier to be constructed on a smaller chassis if it must be installed in a limited space.

The filter and decoupling capacitors C1 and C2 are mounted on insulating mounts and the meter jacks in the cathode circuits of the output stage must be insulated from the chassis. A ground bus (visible

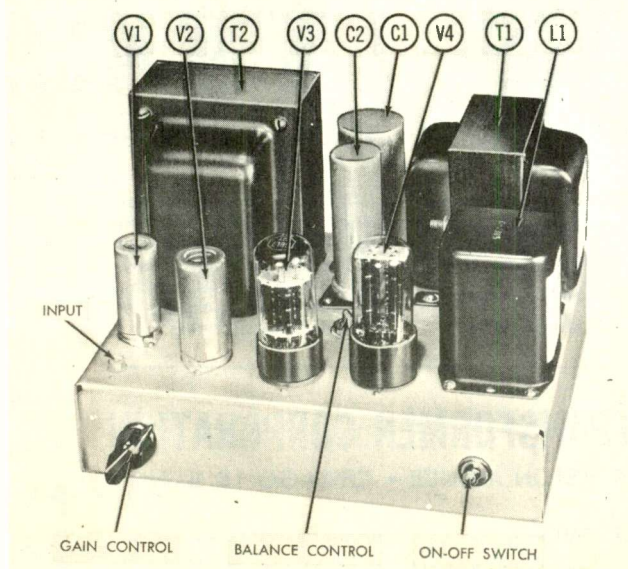

Figure 1. Amplifier Front View.

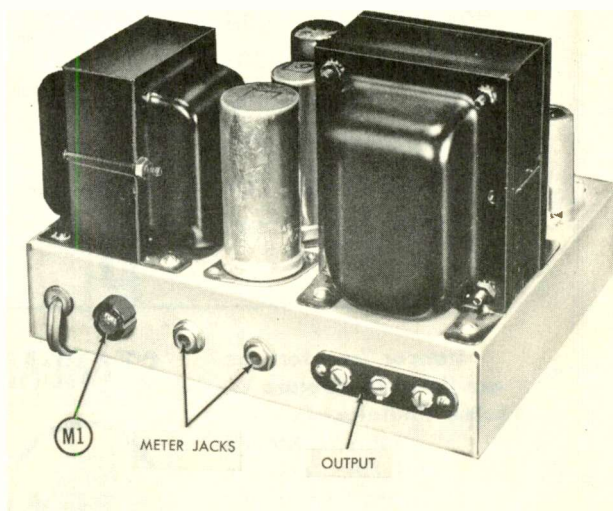
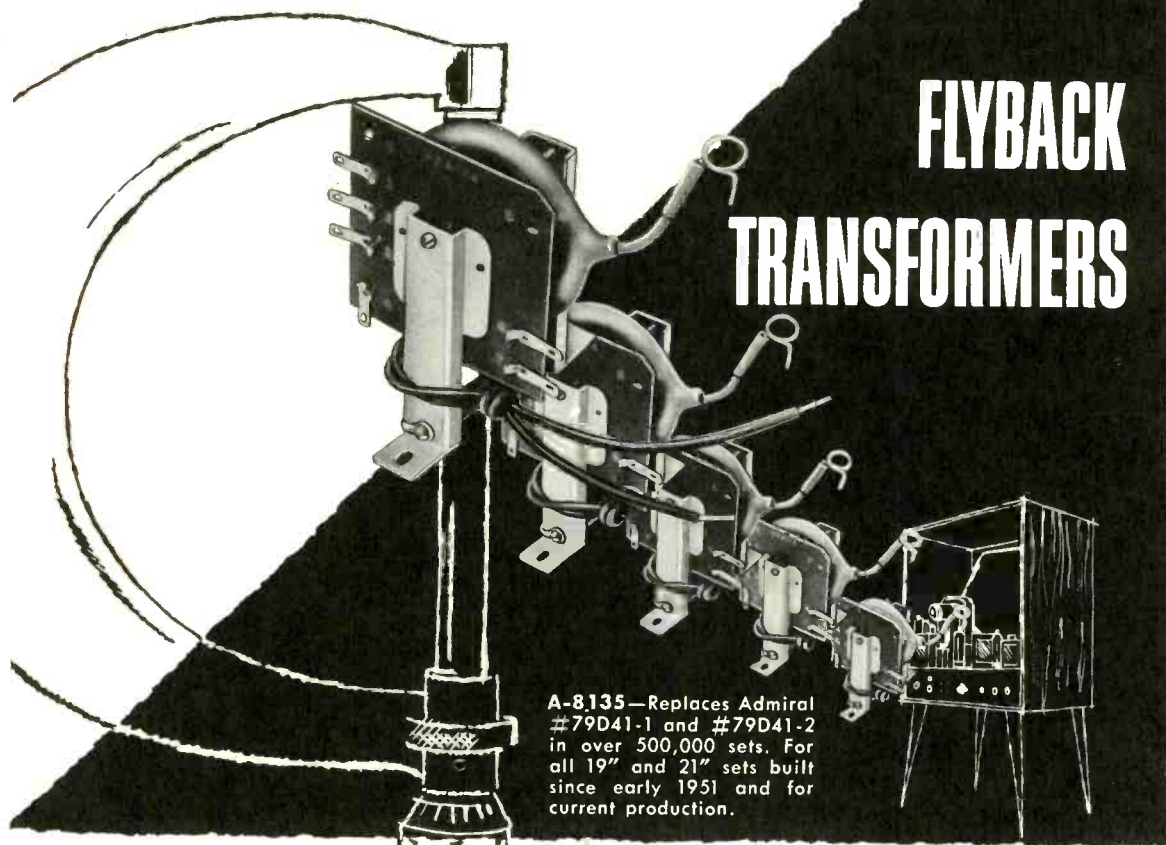

Figure 2. Amplifier Back View.

# STANCOR *Exact* REPLACEMENT

## FLYBACK TRANSFORMERS



**A-8135**—Replaces Admiral #79D41-1 and #79D41-2 in over 500,000 sets. For all 19" and 21" sets built since early 1951 and for current production.

Ask your distributor for Stancor bulletins 461 and 465, listing replacement applications of these transformers—or write directly to Stancor for your free copy.

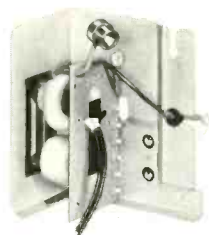

**A-8132**—Replaces Muntz #TO-0031; used in 1951 and 1952 production. Covers approximately 300,000 Muntz sets.

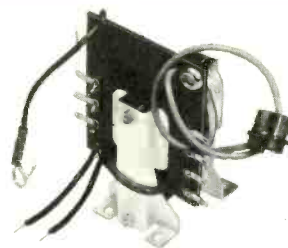

**A-8136**—Replaces Philharmonic #80-263, #80-265-2 and #80-265. Used in all sets built since early 1951 including AMC, Pathe, Silvertone, and other "private label" sets.

Stancor Transformers are listed in Howard W. Sams' Photofact Folders, John W. Rider's Tek-Files, and the Howard Company's Counterfacts.

## STANDARD TRANSFORMER CORPORATION

3594 ELSTON AVENUE • CHICAGO 18, ILLINOIS



EXPORT SALES—

Roburn Agencies, Inc., 39 Warren St., New York 7, N.Y.



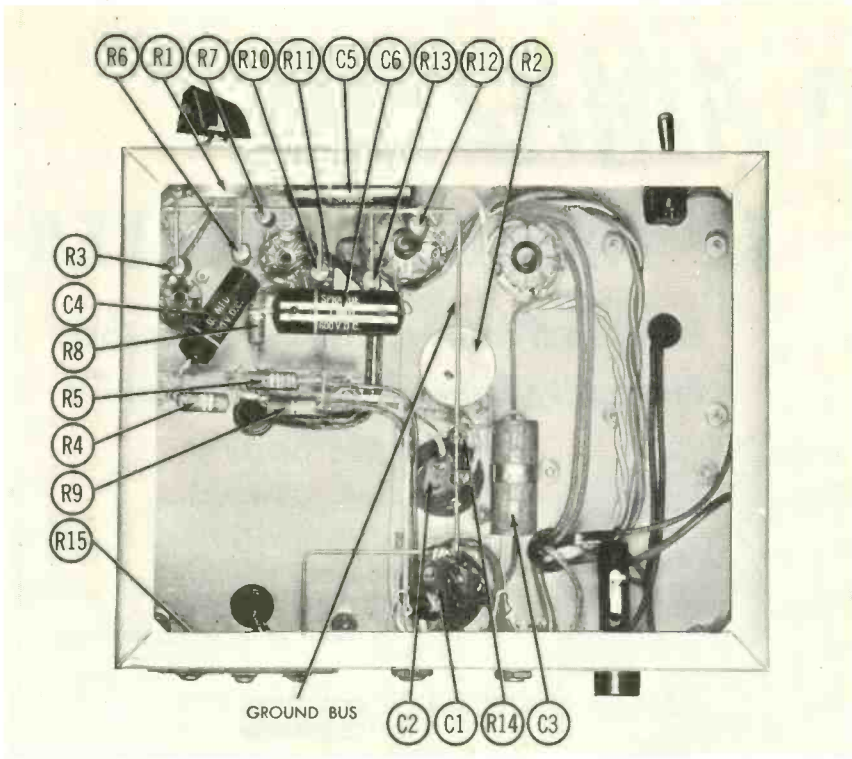

Figure 3. Amplifier Bottom View.

in bottom view, Figure 3), grounded to the chassis only at the input jack, is used for all circuit grounds to eliminate hum from ground loops.

The circuit (Figure 4) is conventional. No tone controls are included since the complete amplifier is included in the feedback loop and, also, it is intended to be used as most high-fidelity power amplifiers are used, set away in a well-ventilated location and remotely operated.

The gain control R1 is inserted in the input circuit for convenience in making adjustments. The first stage is conventionally resistance-coupled to the second which is direct-coupled to the split load phase inverter. Load resistors R10 and R11 should be a matched pair. R12 and R13 can also be matched to aid in signal balance.

The balance control R2 and the closed circuit jacks in the cathode circuits of the output stage are

\* \* Please turn to page 101 \* \*

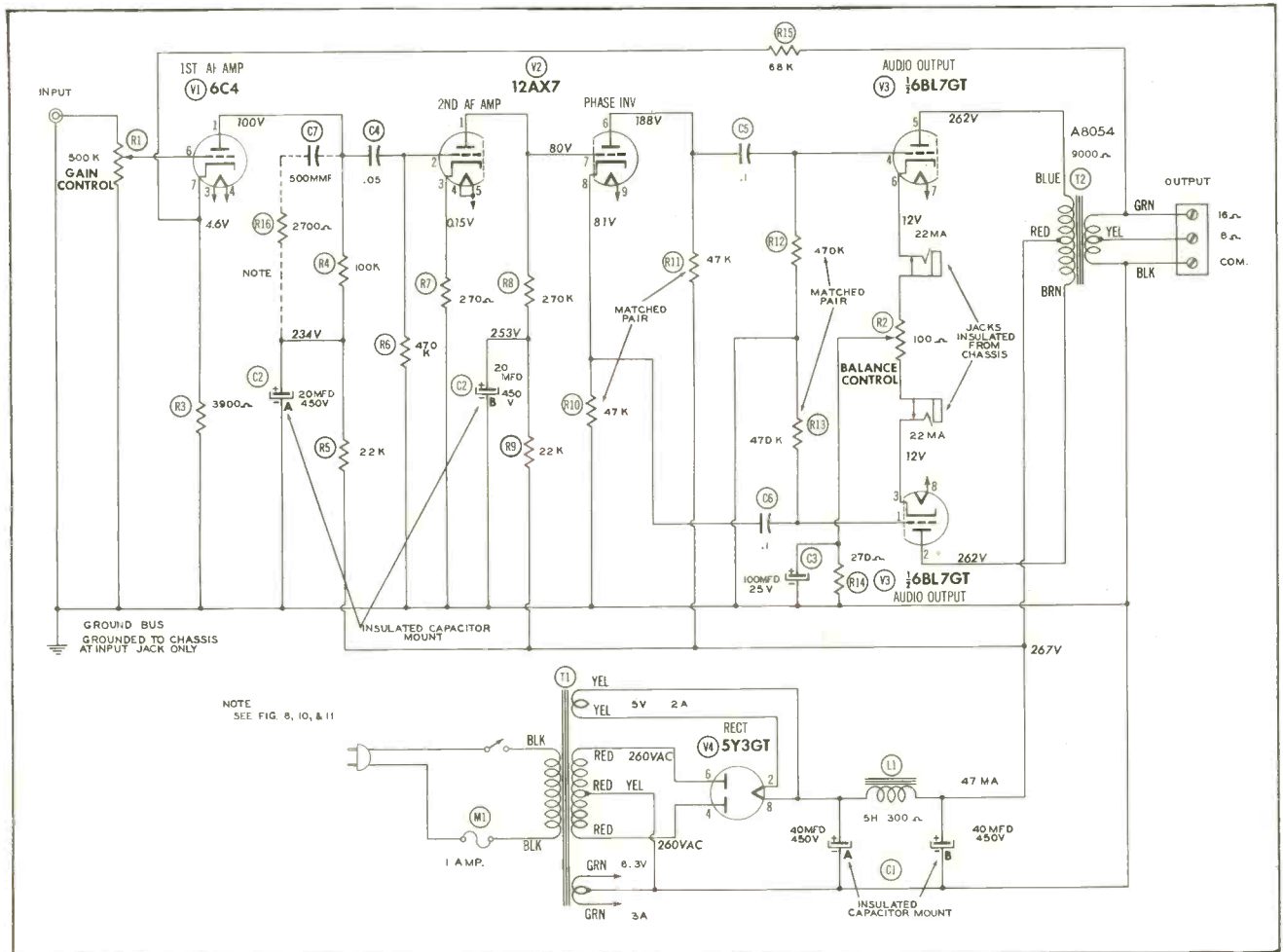

Figure 4. Schematic of Complete Amplifier.

# HICKOK

## MOST **AMAZING** TV TROUBLE SHOOTER

*Does in Minutes...Many Jobs that  
Normally Take Hours by Usual TV  
Service Methods*



- Crystal controlled all-purpose TV service instrument.
- Provides TV Pulses of 60; 900; 15,750 cycles and 315 KC.
- The only instrument to provide Horizontal and Vertical framing frequencies for fast servicing of deflection circuits. As well as provide drive for a monoscope or camera.
- RF output covers all channels and is calibrated in microvolts for sensitivity measurement.
- Can be used as a wire-connected TV transmitter to simultaneously transfer program to any number of TV receivers on any channel.
- Permits approximate field intensity measurement.
- Substitute video amplifier.
- Vertical, Horizontal sawtooth can be substituted for vert., horiz. oscillator in TV set.
- In addition to all these features the 650 also generates a bar and dot pattern.

### WHAT USERS SAY:

"Hickok Model 650 Generator is the most practical single piece of television test equipment offered to the TV serviceman. I like every feature about it, and have seen it used in every possible way."

Jack P. Moore, Service Mgr.  
Commonwealth Television Installation  
& Service Company

"The Hickok Model 650 is, without a doubt, one of the most useful instruments yet developed for the Television Servicing Technician."

Ray S. Guichard, Mgr. Svr. Trg.  
Capehart-Farnsworth Corporation

"My Hickok Model 650 Television Video Generator is the most time saving instrument I have ever used. Television Service companies who don't have this instrument should get one, and they could turn out three times as much work."

F. W. Gibbons, Oxford, Mississippi

"In my opinion, no self-respecting TV service organization should be without a 650. Mickok has again pioneered a quality piece of equipment at a price anyone can afford."

Donald T. Birch, Radio-TV Instr.  
The Lively Technical School

"I used to think I couldn't afford your testers, but after such a dynamic demonstration of dependability, I see now that no Radio or Television serviceman can afford to be without them."

R. L. Walton • Orwell Electric  
Orwell, Ohio

## MODEL 650

**THE HICKOK ELECTRICAL INSTRUMENT COMPANY**  
10566 Dupont Avenue • Cleveland 8, Ohio



# Examining

## DESIGN FEATURES

by MERLE E. CHANEY

### Fleetwood Model 600 Remote Control TV System -

Featured in the Fleetwood 600 receiver, manufactured by Conrac Inc. of California, is the provision for operation of the sweep chassis and picture tube up to distances of 40 feet. The receiver is especially designed for custom installations and consists of two separate chassis (Figure 1) each containing its own power supply. The tuner chassis (Figure 2) is made up of the RF tuner, video and sound IF stages,

and power supply including the volume and picture contrast control. It is connected by a 40 foot cable to the sweep chassis. The cable carries the detected video signal to the video amplifiers, picture tube, and sync circuits. It also carries the detected audio signal and includes a low voltage cable lead for actuating the power supply relay in the sweep chassis by the on-off switch in the tuner chassis. A bottom view of the tuner unit showing the layout of components is shown in Figure 3.

Since two power supplies are utilized in this system, high voltages and currents are not fed through the connecting cable. The low current requirements necessary to actuate the sweep chassis power supply relay are met by connecting the relay through the cable to the filament line in the RF chassis.

Although a long line is used to feed the video signal to the sweep chassis, the receiver system is designed with satisfactory operational characteristics. The video cable consists of a cathode-coupled coaxial line to effect low impedance coupling with correct termination of the line for efficient transfer of the video signal.

Contained on the sweep chassis, shown in Figure 4, are only those components associated with the sync and sweep generating circuits. When the receiving system is installed, the required adjustments are made at the sweep chassis. The operating controls on the tuner chassis are then used to establish correct picture and sound for the normal range of received signals. A bottom view of the sweep chassis is shown in Figure 5. Note the relay for turning on sweep chassis power.

Facilitating the operation of the tuner section is the use of dial lights to indicate each VHF channel

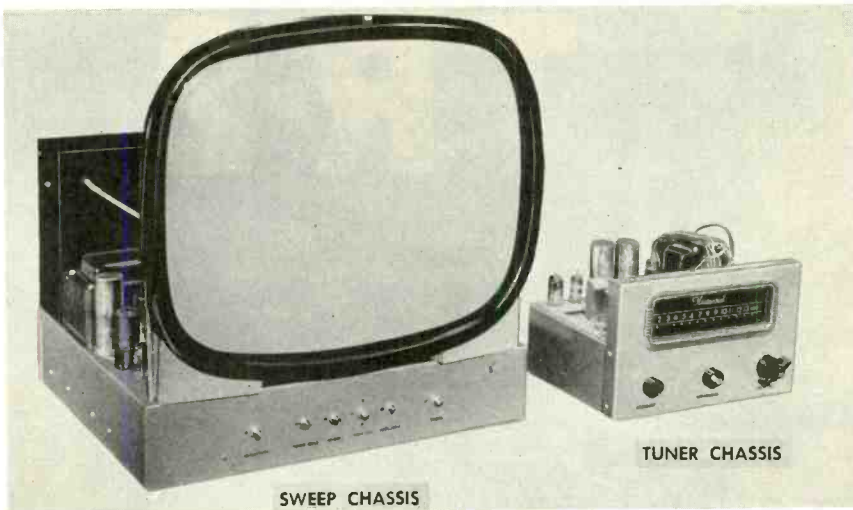

Figure 1. Tuner and Sweep Chassis Used in Fleetwood 600 Receiver System.

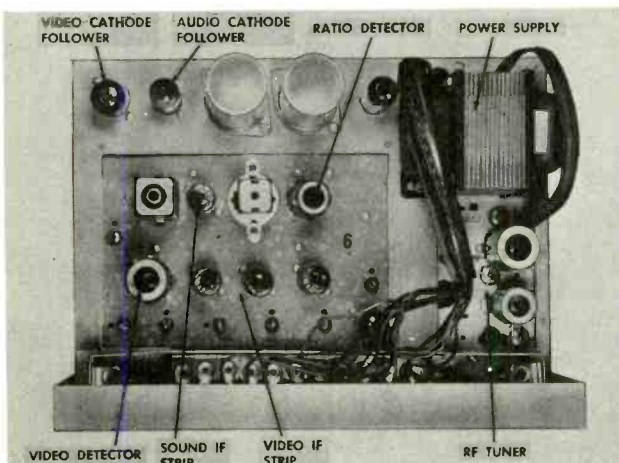

Figure 2. Tuner Chassis Unit in Fleetwood 600 Receiver.

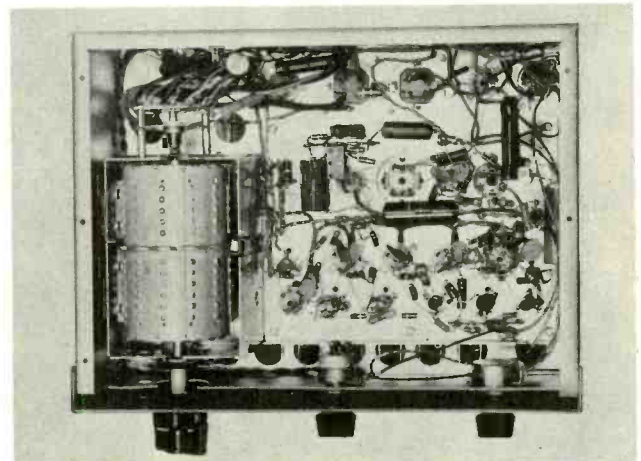
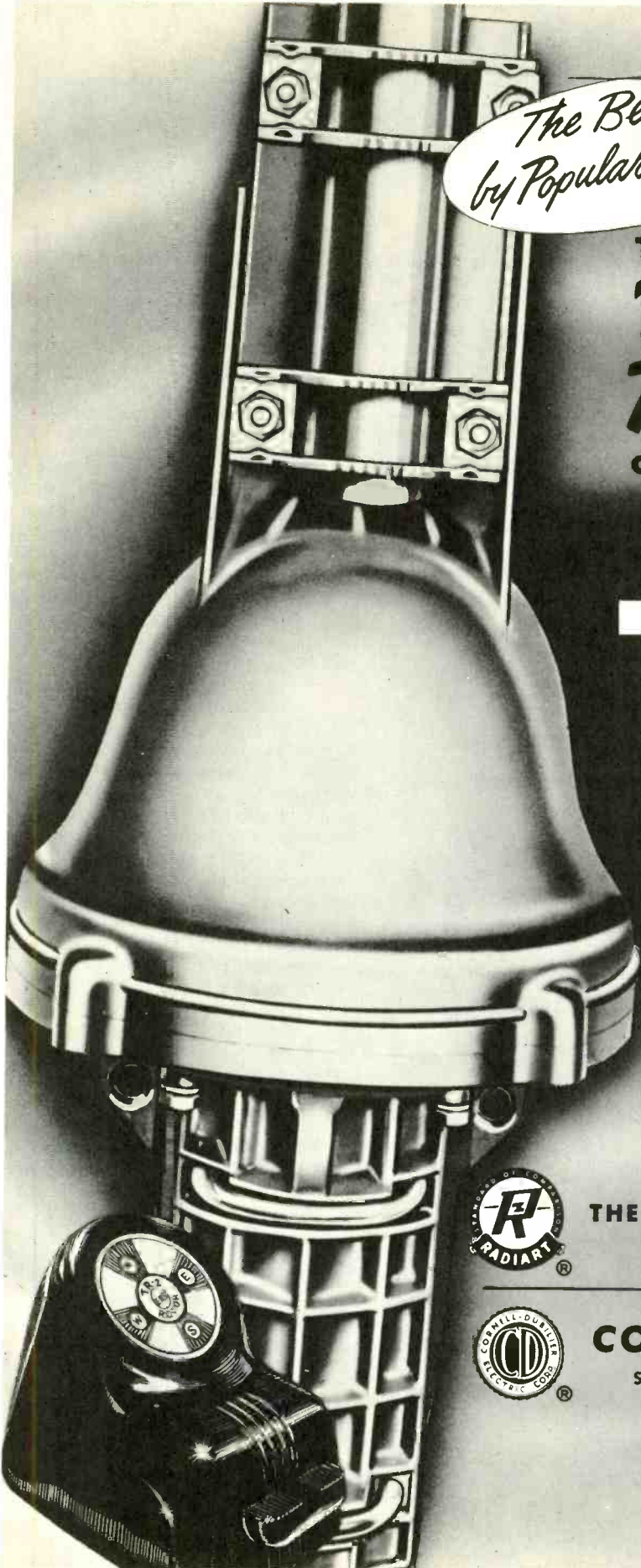

Figure 3. Bottom View of Tuner Chassis in Fleetwood 600 Receiver.



*The Best -  
by Popular Acclaim*

The most  
**Powerful  
TV ROTOR**  
on the market

# TR-2

Power When and Where You  
Need It . . . To Turn ANY TV  
Antenna Array Under All  
Weather Conditions -

Complete rotor with "COMPASS  
CONTROL" cabinet having illu-  
minated "perfect pattern" dial  
(uses 8 wire cable) . . . \$49.95



THE **RADIART** CORPORATION  
CLEVELAND 13, OHIO



**CORNELL-DUBILIER**  
SOUTH PLAINFIELD, NEW JERSEY



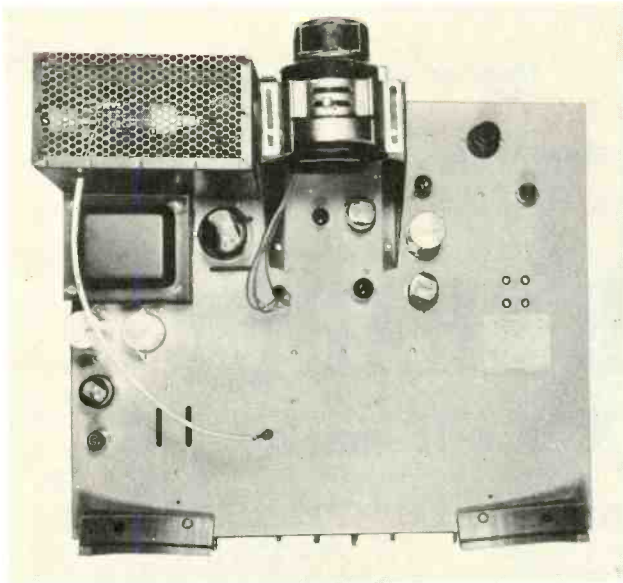

Figure 4. Fleetwood 600 Sweep Chassis.



Figure 5. Bottom View of Sweep Chassis in Fleetwood 600 Receiver.

setting. Although a turret type tuner is used, dial light switching is effected by a wafer switch mounted on the end of the tuner shaft.

Another feature incorporated in the 600 chassis is the provision for taking off the detected sound by means of a plug inserted in the sound detector output. Thus, high fidelity sound systems may be used to provide high quality sound reproduction where such installations are desired.

#### GE 415F -

Sub-assembly as employed in radio receiver construction is illustrated particularly well in the GE Model 415F. A top chassis view of this receiver is shown in Figure 6. The entire radio circuit with the exception of the speaker unit, volume control and filter capacitor is mounted on a narrow plastic strip which is

set in below the chassis as shown in Figure 7.

Tubes and IF transformers protrude through the top of the chassis and allow ready replacement. Dip soldering is employed to effect connections at the tube sockets on the sub-assembly while an additional process allows the IF transformers to be clipped into position. It is observed that only one soldering point is found at each of the IF transformers. Remaining connections are made by clip connections. On top of the chassis proper, the IF transformer is secured in position with a small bracket and metal screw. Quick replacement of these transformers can be made by unsoldering a single lead, removing one screw and lifting out the component.

Another kink employed in this receiver is a moving dial light which is attached to the tuner pulley and il-

luminates an area immediately behind the dial pointer at any setting. The dial scale is made of thin translucent plastic permitting the light to penetrate through in step with the movement of the dial pointer.

The sub-assembly in Figure 7 may be readily lifted free of the chassis by the use of a few preliminary steps. First remove all tubes from their sockets. Take out the IF transformers by first unsoldering one lead at each unit, and removing the single screw holding each transformer in position. The transformers may then be pulled out. The final step is to carefully pry out the line cord strain relief anchor which allows the sub-assembly to be lifted away from the remainder of the chassis. Connecting leads between the sub-assembly and components on the main chassis are sufficiently long to permit this procedure without additional unsoldering.

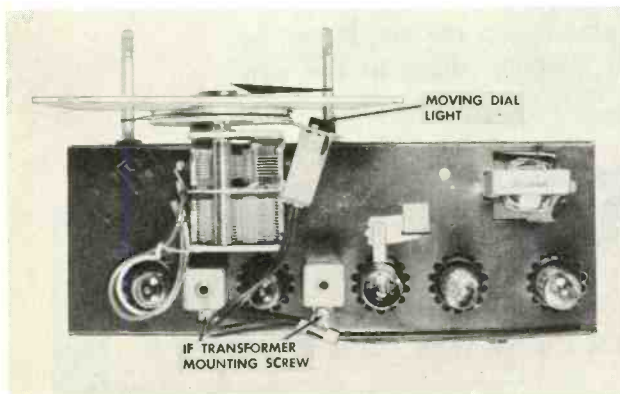

Figure 6. GE 415F Radio Receiver.

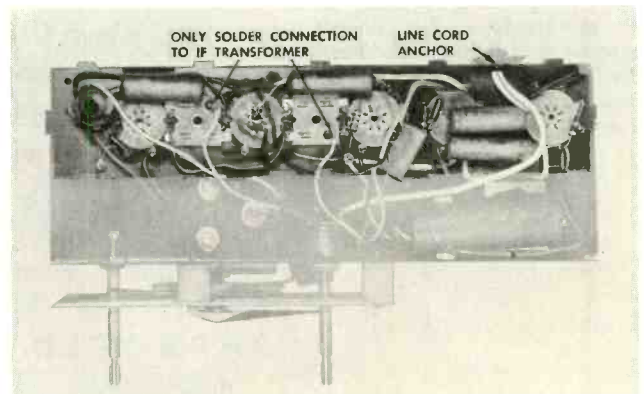

Figure 7. Bottom View of GE 415F Receiver showing Sub-assembly chassis.

Depend on Mallory  
for  
Approved Precision Quality

# GET A BIGGER SHARE

of the NEW UHF market  
with the Mallory UHF Converter



The new UHF market is a big one . . . and the Mallory UHF Converter is ready to help you make the most of it. Thousands of sets will need converting when UHF television goes on the air in your area . . . and the Mallory Converter can be your fastest moving item.

- The Mallory Converter adds *all* existing UHF channels to *any* TV set . . . without sacrificing reception of existing VHF channels.
- Mallory precision quality insures high quality picture definition . . . easy tuning.
- Your customers have nothing more to buy, no further adjustments to make . . . even if they move to another broadcast area.

*Ask* YOUR MALLORY DISTRIBUTOR

for complete details of the Mallory Converter. It has been a "best seller" in areas where UHF is already on the air. It can be your answer to a bigger share in the new UHF market.

### Installation is fast and EASY

All you need to do is connect the antenna lead and power lines from the Converter to the set. It can be done in your customers' homes in a matter of minutes.

P. R. MALLORY & CO. Inc.  
**MALLORY**

CAPACITORS • CONTROLS • VIBRATORS • SWITCHES • RESISTORS  
RECTIFIERS • POWER SUPPLIES • FILTERS • MERCURY BATTERIES  
**APPROVED PRECISION PRODUCTS**

P. R. MALLORY & CO. Inc., INDIANAPOLIS 6, INDIANA



Setchell-Carlson  
Unitized\* Chassis TV Receiver -

Those service technicians who have not had occasion as yet to check over a Setchell-Carlson TV set employing sub-assemblies throughout should be interested in learning about many of the features used to simplify the work of diagnosing and testing this receiver. The main features associated with the Model 152 and some of the previously produced Setchell-Carlson models, is that each circuit or group of circuits is contained on an individual chassis. These chassis units are provided with terminal jacks that plug into similarly spaced pin plugs on the main chassis. Found on each chassis are locating ears allowing the individual chassis units to mount onto the main chassis in the exact desired position. A top chassis view of the model is shown in Figure 8.

A factor contributing to the maintenance of these receivers in the field, is the possibility of performing most of the servicing work by removing the rear cover of the cabinet. When troubles seem to be localized to a certain stage of this receiver, two thumb screws are removed and any unit can be lifted out. Visual inspection and measurements can be made of the components contained in the sub-chassis suspected to be at fault and component replacement can often be effected without the necessity of removing the entire chassis. (Bottom view of Video IF sub-assembly unit is shown in Figure 9).

\* Trademark



Figure 9. Video IF Sub-Assembly Unit in Setchell-Carlson Showing Terminal Jacks and Locating Ears.

In those instances where stubborn difficulties do not allow ready diagnosis of the trouble, the entire chassis may be removed. Although each of the sub-assembly chassis units are plugged onto the top of the chassis, voltage measurements can be readily performed because large holes punched in the main chassis under each unit position give access to tube sockets and terminal connections, (See bottom view of main chassis in Figure 10).

Another feature found in the Model 152 receiver is the one employed to give additional protection in the horizontal output and high voltage stage. The horizontal output transformer, HV filter capacitor, and HV rectifier tube are mounted inside a hermetically sealed plastic container (Figures 11 and 12). This complete unit called the "Hermadome" (patent applied for) may be partially disassembled for testing by removing the dome shaped cover. A gasket forms an airtight seal between the two halves of the plastic contain-

er. Although the unit is airtight, the air trapped inside the case remains while circulation from the outside is prevented. The trapped air is dehumidified through the use of crystal granules held in the top of the dome. A paper disk observed through the semi-opaque plastic dome is chemically treated to indicate the presence of high moisture content, in which case the crystals should be replaced with a new or active supply. The protection thus afforded the horizontal output transformer and high voltage supply should provide added life by minimizing some of the possible difficulties to which this stage is frequently susceptible.

Westinghouse Radio  
Model H-381T5 -

An unusual type of chassis construction is observed in the Model H-381T5 Westinghouse radio re-

\* \* Please turn to page 121 \* \*

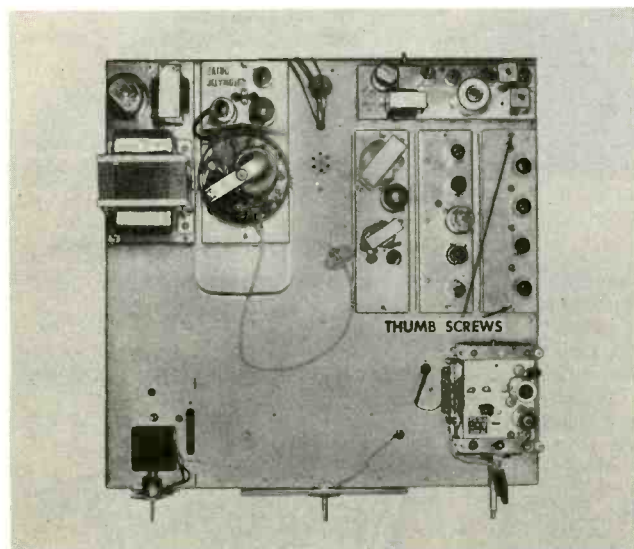

Figure 8. Top Chassis View of Setchell-Carlson Receiver Showing Sub-assemblies.

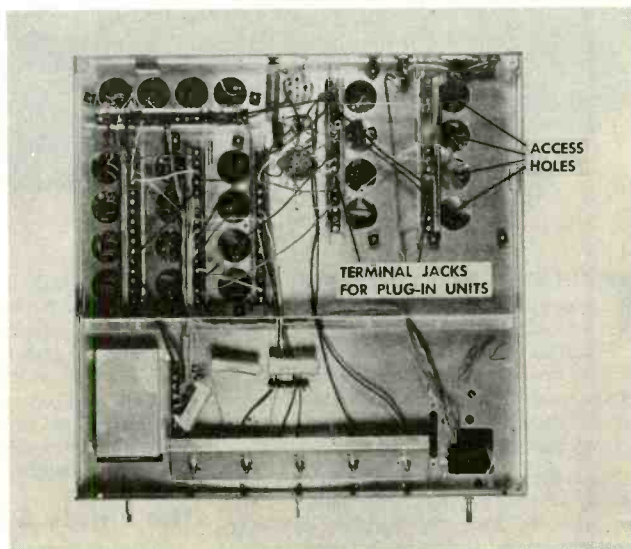

Figure 10. Bottom Chassis View of Main Chassis Showing Bus Leads Carrying Power and Continuity Between Sub-assembly Units in Setchell-Carlson Receiver.

# TRIPLETT 630 Volt-Ohm-Mil-Ammeter

## "speaks" for itself in any company



ing to desired circuit thru a single 2½" knob flush with the face panel. The molded switch itself embodies the most advanced engineering practices. Fully enclosed, the silvered contacts are kept permanently clean. Its rugged construction means stronger performance and longer life.

These two factors are but samples of the many ways in which on-the-job needs have been anticipated and provided for in a beautiful streamlined tester. It provides A.D-D.C. Volts, D.C. Micro-amperes, Milli-amperes, Amperes, Ohms, Megohms, Decibel and Out Put readings in a no-short design embodying interior construction with all direct connections; no harness cabling. Its fool-proof unit switch construction houses precision resistors in insulated recesses in direct connection with switch contacts.

Study the following Ranges and descriptions and compare them point by point with any similar instrument for conclusive proof that Triplett 630 "speaks" for itself in any company.

### Ranges

**D.C. Volts:** 0.3-12-60-300-1200—at 20,000 Ohms/Volt (For Greater Accuracy on TV and other High Resistance Circuits.)

**A.C. Volts:** 0.3-12-60-300-1200-6000—at 5,000 Ohms/Volt

(For Greater Accuracy in Audio and other High Impedance A.C. Circuits.)

**Decibels:** -30, +4, +16, +30, +44, +56, +70.

(For Direct Reading of Output Levels.)

**D.C. Microamperes:** 0-60—at 250 Millivolts.

**D.C. Milliampers:** 0-1.2-12-120—at 250 Millivolts.

**D.C. Amperes:** 0-12—at 4.44 at center scale.

**\*Ohms:** 0-1,000-10,000—(4.44 at center scale).

**\*Megohms:** 0-1-100—(4,400-440,000 center scale).

**Output:** Condenser in series with A.C. Volt ranges.

*\*Resistance ranges are compensated for greatest accuracy over wide battery voltage variations. Series Ohmmeter circuits for all ranges to eliminate possibility of battery drain when leaving switch in Ohms position.*

**T**RIPPLETT 630 Volt - Ohm - Mil - Ammeter has many significant advantages and features that make it stand distinctly apart from similar instruments in its price class. Actually in components, in engineering, in minutely accurate performance, Triplett 630 closely approaches laboratory standards.

Since the scales of any VOM comprise the means by which it makes its multiple services most valuable, the legibility and easy-read-ability are of prime importance. Triplett engineers have created in Triplett 630 the longest scales available in this size tester. (The upper arc by actual measurement is four and three-eighth inches.)

This long-scale factor accounts for the ease with which precise readings are easily made. Further legibility is gained by use of black and red scale markings. D.C. and D.B. are black and white. A.C. and Ohm markings are red on white. Ohms from one hundred million to one-tenth ohm mark the range of this amazing scale. On low ohms, center scale reading is 4.5 ohms.

### The Single Switch

Further indication of the practical skill and engineering "know-how" behind Triplett 630 is the Single Switch. Its simplicity of operation assures no burn-outs thru momentary memory lapses. There is instant switch-

Get a Triplett 630 into your own hands at your distributor.  
U.S.A. Dealer Net \$3950

TRIPPLETT ELECTRICAL INSTRUMENT COMPANY  
BLUFFTON, OHIO



OPERATIONAL  
SURVEY

by W. WILLIAM HENSLER



One of the most valuable assets in any venture is experience. This is most certainly true in the radio and television servicing business. Mistakes are to be expected when entering into a new field. One can accept these mistakes as just a part of the price for gaining that experience. Sometimes the price is rather expensive. An alternative is that of profiting from the experience of others. With this in mind we have prepared the following report relating the experiences of others in the field of UHF.

In order to present factual data, we conducted a series of surveys in three UHF areas in the south during the week of May 16th. The areas selected were Mobile, Ala., Baton Rouge, La., and Jackson, Miss. These three areas represent three different types of operation as far as UHF television coverage is concerned. In Mobile, there is a VHF station as well as a UHF station. In Baton Rouge, there is a VHF station in the fringe area. In Jackson, there is no television reception from other than the local UHF station. We were able to talk to several dealers in each of these areas. Each of them was most cooperative and we sincerely hope that some of their experiences related in this report will be helpful to you.

## Baton Rouge, Louisiana

In April of 1953, station WAFB-TV, Channel 28, commenced operation in Baton Rouge, Louisiana. This station provided reception for the owners of an estimated 20,000 receivers. These sets had been installed to operate on the channel 6 station in New Orleans some 65 to 70 miles distance. Thus, in addition to the sale of receivers equipped for UHF reception, there was the need of converting the existing receivers so that they could receive the local television station.

This conversion process was done in several ways. Those receivers which were equipped with

turret type tuners were converted in most instances by means of UHF strips. Others were converted through the use of external converters. Often times it was possible to employ the existing VHF antenna installation to provide satisfactory UHF pickup. This situation could not be positively forecast, however, and the adaptability of the VHF antenna could be determined only after actual tests. If the VHF antenna did not provide satisfactory reception, a UHF antenna was installed which often could be mounted on the existing mast. If satisfactory signal pickup could not be obtained at any point on the mast, a separate installation was required.

In order to fully grasp the magnitude of the conversion job which confronted many of the dealers in this area, it might be well to point out the technique employed by one specific dealer. This dealer had nearly 3,000 sets which had been sold prior to the inauguration of the local UHF station. These sets had been sold and installations made to provide reception from New Orleans on channel 6. In most cases, the antenna had been installed without a rotator. After the channel assignment had been made to Baton Rouge and the station had announced their proposed starting date, this dealer began installing UHF strips in those receivers which would accommodate this type of conversion. It was felt that sets which were located near the transmitting antenna might operate satisfactorily using the VHF antenna for signal pickup. In those instances no UHF antenna installations were made. It was explained, however, to the customer that a UHF antenna might be required, which could be determined after the station came on the air. In those locations at a greater distance from the transmitter, a UHF antenna was installed on the existing mast, with the antenna aimed as accurately to the customer that final positioning of the antenna could not be made until the station commenced operation.

The dealer was successful in converting approximately three-fourths of all the sets which he had previously sold for VHF reception before the UHF station came on the air. During this process of conversion, however, many sets were sold which were intended to receive the local UHF station only. Since many current receivers are now employing some form of built-in UHF antenna, no antenna installation was made for those sets which were installed near the transmitting antenna. The customer was made fully aware of the fact, however, that should the built-in antenna not work satisfactorily in that specific location, an external antenna would need be installed after the station came on the air. The dealers there found that several of these sets did operate satisfactorily using the built-in antenna only. The distance from the transmitting antenna was not the deciding factor, however, as to whether the built-in antenna would provide satisfactory operation. Surrounding terrain, the type of buildings, and the construction of the buildings in which the receivers were installed were a deciding factors as to the success of operation, and as we know from our experience in VHF reception, the positioning of the receiver itself is of great importance.

The indeterminate factor on the use of the built-in antenna is; what constitutes satisfactory reception? In many VHF installations satisfactory reception is also claimed from built-in or indoor antennas. Even then there may be certain disadvantages to this type of operation. Moving vehicles near the home or even people moving about in the room sometimes affect reception. In view of this, care should be taken not to guarantee results from the built-in antenna. The dealers in this area have adopted a policy of "we can try the built-in antenna in your location". If the reception is satisfactory to the customer then no external antenna need be installed. Of all the UHF areas which we have visited, more built-in antennas are

# RUGGED

## *Fiberglas* HELPS MAKE VEE-D-X UHF ANTENNAS THE WORLD'S STRONGEST

The sensationally strong Fiberglas boom used in the construction of VEE-D-X UHF antennas has the highest strength ratio to weight of any material known, and its bright red color makes it easy to identify as a genuine VEE-D-X antenna.

**TV SERVICE MEN EVERYWHERE VOTE VEE-D-X UHF ANTENNAS FIRST FOR CONSTRUCTION — PERFORMANCE — EASE OF INSTALLATION.**

Besides the rugged Fiberglas boom, VEE-D-X UHF antennas are designed with strong, yet light weight solid aluminum elements (to prevent ice loading) and (a VEE-D-X exclusive) Flex-Clamp on the Bow-Tie and Corner Reflector, for positive vise-like grip and ease of installation.

And every VEE-D-X UHF antenna is engineered for powerful performance in all areas! No wonder TV service men are saying, "These VEE-D-X UHF antennas are Power-FULL in both performance and construction."

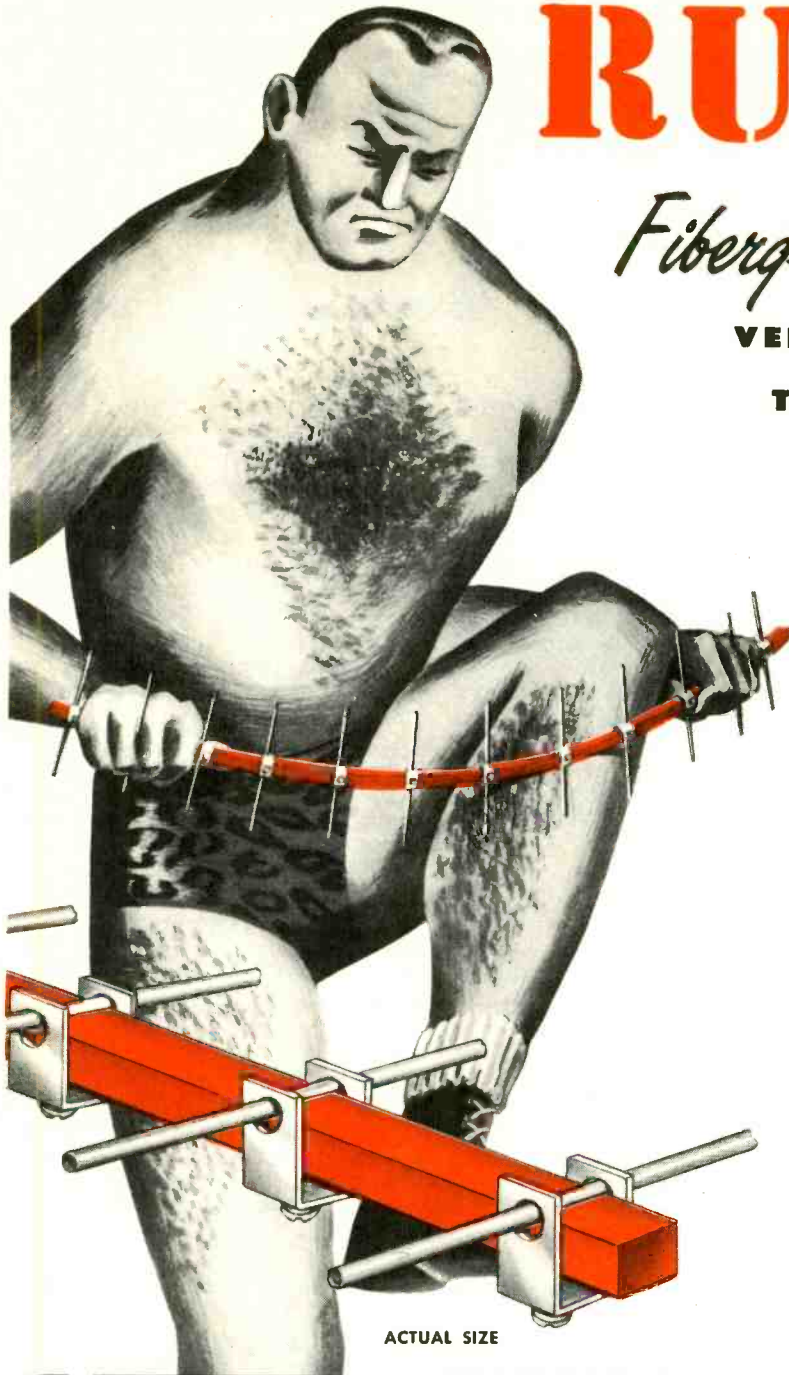

ACTUAL SIZE



THE WORLD'S FINEST UHF ANTENNAS

*LaPointe* ELECTRONICS INC.  
ROCKVILLE, CONNECTICUT

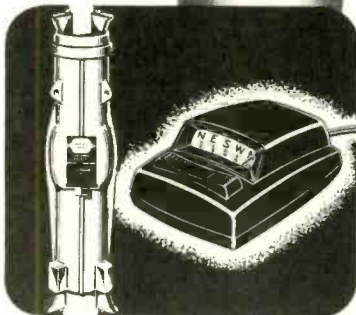

### ROTATOR

Finest in design, construction and performance. Produced in collaboration with three world famous manufacturers. Designed to perform with pin-point accuracy. Beautifully styled control console operates with convenient downward pressure. Choice of two colors.

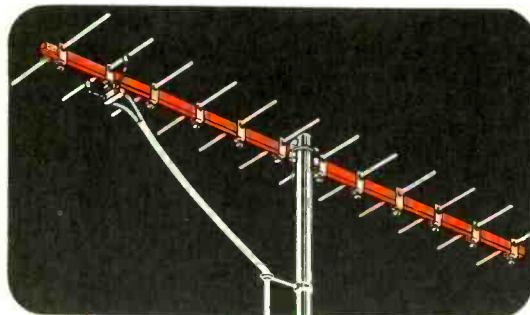

### LONG LONG JOHN

This 12-element yagi is engineered for grand slam power in fringe areas. It is the highest gain single channel antenna ever developed. Rugged Fiberglas boom construction. Strong, light in weight and factory pre-assembled construction for ease of installation. Model LJ-U.

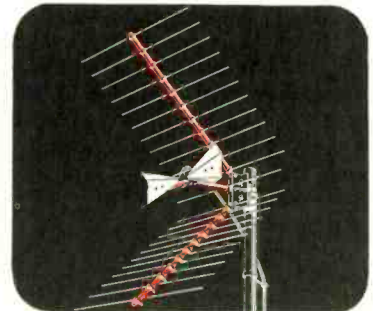

### CORNER REFLECTOR

This is the power-full all-channel VEE-D-X antenna that minimizes probing. Also the answer for UHF fringe and areas where noise or reflection problems exist. Rugged Fiberglas boom construction. Ready for installation in less than 30 seconds. Model COR-U.



being used in the Baton Rouge area than in any of the others. Keep in mind, however, that we are talking about a very small percentage of the total installations. We mention it to point out that in this area, built-in antenna systems are being used with some degree of success. As you will note, from this report, reception conditions in some of the other areas are not so well suited for this type of operation.

After the station came on the air, there existed the problem of adjusting the local oscillators on all these sets which had been installed prior to the time that the station had commenced operation. For instance, the dealer just previously mentioned was faced with the problems of adjusting the oscillators on approximately 2,000 sets which had been converted for UHF reception. Realizing the importance of getting the job done quickly, a plan was set up whereby the city was divided into various areas with each area having a given number of receivers requiring adjustment. All available technicians were assigned to these areas making it a sort of mass operation. In this way the entire job was completed within four days. It could have been done in even less time if it were not necessary to make callbacks in those instances where the customer was not at home at the time of the original call, or in those cases requiring a new antenna installation, or the repositioning of an antenna which had previously been installed. There was a certain percentage of installations which did work satisfactorily at the position where they were originally placed. The dealer felt that the time required in repositioning antennas which were installed before the station started operation was not lost entirely. The thinking behind this was, even though several of the antenna installations would need to be changed, there would be hundreds of them that would require no further attention. In this way it was possible to have all of the installations operating properly as quickly as possible after the station started operation.

The reason for pointing out the experiences of this particular dealer is to cite a case where antenna installation prior to the on-the-air date of the transmitter might be an advantage. You may recall in our previous writings we have recommended that the antenna not be installed until an actual on-the-air check can be made. This definitely is the case in areas where rough terrain is encountered, since in some

instances it might be that no signal at all may be received in a specific location. If an installation is made under these conditions prior to an actual on-the-air test, it may result in the loss of the sale of the receiver as well as the loss of labor on the antenna installation.

The sale of television receivers in the Baton Rouge area is following the same pattern that is being experienced in other areas. There seems to be a slow-up of sales, probably brought about by the potential customer adopting a "wait and see" attitude. The fact that the Baton Rouge station is not interconnected with the networks may also have some bearing on this situation. Of course, they can buy a receiver and have an elaborate external antenna installed for reception from New Orleans but since it is quite expensive, they choose to wait until such time as the local station can provide live programs.

This situation, of course, is not new. Many potential customers have used the same excuse in almost all areas where network programming is not provided. Another thing which might contribute to this feeling is that some of the stations come on with only a few hours of telecasting a day. After their on-the-air time is increased, there is more interest in their programming.

Fortunately, the Baton Rouge station was not one of those which came on the air with reduced power as an interim mode of operation. Experience has shown that this type of operation leads to confusion on the part of the viewer as to what can be expected from UHF reception and needless to say, presents terrific problems on the part of the dealer and installer.

Generally speaking, the dealers in Baton Rouge are pleased with the operation of the station and are happy that operational difficulties on the part of equipment that is associated with UHF is at a minimum. The dealers and installers in this area are to be commended for the part which they played in converting the thousands of VHF receivers in that area for UHF reception, as well as the part which they played in making the necessary UHF antenna installations.

Jackson, Mississippi

Prior to the start of operation of UHF station WJTV on channel 25, it is estimated that there were less

than 200 sets in Jackson, Mississippi. Thus, the dealers and installers were not confronted with the conversion job that existed in Baton Rouge. They could, in effect, start with a clean slate selling receivers which were converted, prior to the sale, for UHF reception. This being a new television area it would be expected that there would be a "buying spree" for television receivers. When we talked with several of the dealers in Jackson, they pointed out that the sales were of a gradual nature. This had one advantage in that it did not overburden the installation crews at a time when experience in UHF techniques was in demand. Some operational difficulty from UHF equipment was, or is, being experienced in this area. There were a few "bugs" that showed up in certain types of receivers which required special handling by the respective companies. As is the case with any new equipment, such things are likely to occur and only through actual operation of equipment will they be detected. Then it is only a matter of correcting the difficulty in existing equipment, as well as making the change on the equipment that is being produced.

The Jackson station commenced operation in January of 1953 and one of the things of importance that has been detected since that time is the effect of foliage on UHF reception. In January and February some of the installations were in such a position that the signal had to pass through trees. After the trees had leaved out, considerable attenuation was experienced, so much in some instances that the antenna location had to be changed. One dealer related a rather unusual experience in this connection. He found that the leaves had attenuated the signal so greatly that a satisfactory picture could not be obtained. The home was located such that the signal had to go through or over a small forest, made up of very tall trees. It would have been necessary to install a 50 or 60' mast on top of the house to clear the top of the trees. More by accident than anything else, he chose to try to mount an antenna near the ground and allow the signal to go under the trees. To his surprise, the results were quite good. Since satisfactory reception could be obtained at this point, no attempt was made to make the elaborate installation which would be required to clear the trees. If such a situation is encountered, it might be well to try to operate

\* \* Please turn to page 112 \* \*

# See YOUR ANSWER

WITH THE  
**PRECISION ES-500A**  
HIGH SENSITIVITY — WIDE RANGE  
**5" OSCILLOSCOPE**  
PUSH-PULL VERTICAL AND HORIZONTAL AMPLIFIERS  
20 MV PER INCH "V" SENSITIVITY — 150 MV PER INCH "H" SENSITIVITY

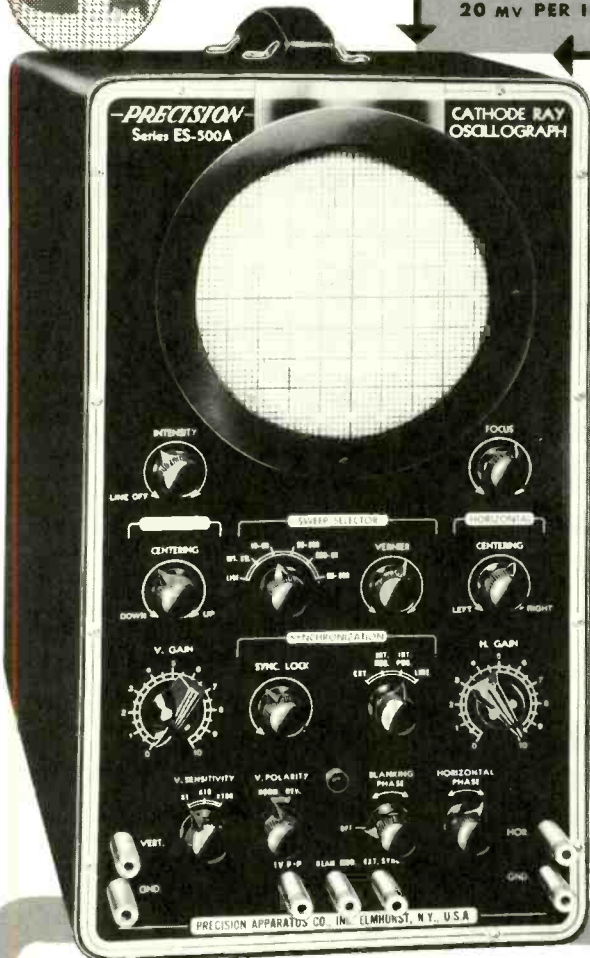

SERIES ES-500-A affords the ultimate in performance, visibility and operational flexibility at moderate cost. **PRECISION** engineers have incorporated every necessary feature which they found to be required to meet the needs of the rapidly advancing art of electronics, A.M., F.M., and TV.

### SUMMARY OF IMPORTANT FEATURES

- ★ Push-Pull Vertical Amplifier — High Sensitivity, Wide Range, Voltage Regulated. 20 millivolts (.02v.) per inch deflection sensitivity. 10 cycles to 1 MC. response. 2 megohms input resistance. Approx. 22 mmf. input capacity.
- ★ Compensated Vertical Input Step Attenuator—X1, X10, X100.
- ★ Direct Peak to Peak Voltage Checks thru use of internal, semi-square wave, regulated voltage calibrator.
- ★ Vertical Phase-Reversing Switch. Non-frequency discriminating.
- ★ Push-Pull, Extended Range, Horizontal Amplifier—150 Millivolts (.15 v.) per inch deflection sensitivity. 10 cycles to 1 MC response at full gain. 1/2 megohm, approx. 20 mmf. input.
- ★ Linear Multi-Vibrator Sweep Circuit—10 cycles to 30 KC.
- ★ Amplitude Controlled, Four Way Synch. Selection: Internal Positive, Internal Negative, External and Line.
- ★ "Z" Axis Modulation input facility for blanking, timing, etc.
- ★ Internal, Phasable 60 cycle Beam Blanking for elimination of alignment retrace; clean display of synch. pulses, etc.
- ★ Sweep Phasing Control for sinusoidal line sweep usage.
- ★ Direct Horizontal and Vertical Plate Connections.
- ★ High Intensity CR Patterns through use of adequate high voltage power supply with separate 2X2 rectifier.
- ★ The Circuit and Tube Complement: 6C4 "V" cathode follower, 6CB6 "V" amplifier, 6C4 "V" inverter, Push-Pull 6J6's "V" driver, 7N7 "H" amplifier and inverter, Push-Pull 6AU6's "H" driver, 7N7 Multi-vibrator, linear sweep oscillator, 5Y3 low voltage rectifier, 2X2 high potential rectifier, VR-150 regulator, SCP1/A CR Tube.
- ★ Four-Way, Lab-Type Input Terminals—Take banana plugs, phone tips, bare wire or spade lugs. Matches SP-5 Probe Set cable connector.
- ★ Light Shield and cross-ruled Mask, removable and rotatable.
- ★ Extra Heavy-Duty Construction and components.
- ★ Heavy Gauge, Etched-Anodized, No-Glare, Aluminum Panel.
- ★ Fully Licensed under Western Electric Co. patents.

**Series ES-500A:** In louvered, black-ripple, heavy gauge steel case. Size 8 1/4" x 14 1/2" x 18". Complete with light shield, calibrating mask and comprehensive instruction manual. **NET PRICE \$173.70**

### Series SP-5 — OSCILLOSCOPE TEST PROBE SET

FOR TV SIGNAL TRACING, ALIGNMENT,  
TROUBLE SHOOTING AND WAVEFORM ANALYSIS

- ★ Specifically engineered for use with **PRECISION** Cathode Ray Oscilloscopes, Series ES-500 and ES-500A.
- ★ Includes four of the most important test probes for general purpose, as well as specialized use:
  1. HIGH IMPEDANCE—LOW CAPACITY PROBE
  2. SIGNAL TRACING—CRYSTAL PROBE
  3. RESISTIVE—ISOLATING PROBE
  4. SHIELDED—DIRECT PROBE
- ★ Each probe is specifically engineered for efficient application to the special test problems requiring its use.
- ★ Distinctively colored heads and individual labelling permit positive identification of each probe.
- ★ A single, universal, coaxial cable accommodates each probe through a quick-change, self-shielding connector.
- ★ A specially-designed, shielded plug provides for positive cable attachment to the ES-500 and ES-500A Vertical input posts.
- ★ Each probe head terminates in a patented clip-on tip which frees both hands of the operator.



**Series SP-5,** in custom-designed, vinyl-plastic, carrying case, complete with four probe heads, universal coaxial cable, and detailed operating instructions. **NET PRICE \$23.50**

TV • AM • FM • TV • AM • FM

## PRECISION APPARATUS COMPANY, INC.

92-27 HORACE HARDING BLVD. • ELMHURST, L. I., N. Y.

EXPORT DIVISION: 458 BROADWAY, NEW YORK CITY U.S.A. • CABLES—MORHANEX  
CANADIAN SALES DIVISION: ATLAS RADIO CORP. LTD., 360 KING ST. W. TORONTO 28, ONTARIO

See the ES-500A Oscilloscope and the Series SP-5 Test Probe Set at leading Radio Parts & Equipment Distributors.



In the Interest of . . .

# Quicker Servicing

by GLEN E. SLUTZ

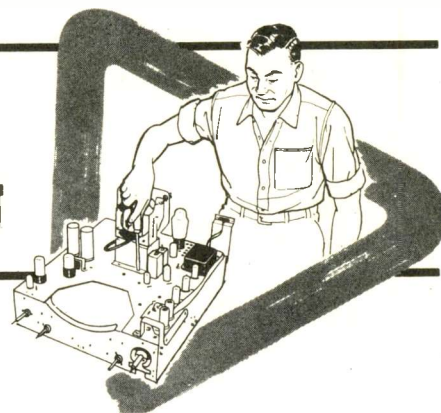

## Disposal Methods for Picture Tube

There are numerous types of picture tubes which have some salvage value even after they have gone bad and been replaced. Distributors have lists of such tubes furnished them by the various tube manufacturers. These lists give the accepted types and the amount of allowance on each type. Tubes which are not on the lists - and there are several - are worthless and eligible only for the trash heap. In connection with this point, however, a potential source of trouble for the service shop owner exists.

A cathode ray tube encloses a very high vacuum and the pressure of the surrounding air on the glass of the tube adds up to several thousands of pounds. Consequently, the sudden release of this great amount of energy, such as might be brought about by the tube breaking, is a violent occurrence. Implosions of picture tubes can send jagged pieces of glass flying with the speed of bullets. A high vacuum picture tube resting on a heap of rubble might be likened to an ocean mine washed up on a deserted beach somewhere;

it may lie for a long time undisturbed but finally someone comes along with an inquisitive nature and - blooey! - disaster strikes! Law suits are possible aftermaths of such incidents.

The best way to avoid trouble is to deprive the picture tube of its dangerous vacuum by puncturing it under controlled conditions prior to its disposal. Different methods of making this puncture are recommended by various authorities. CAUTION: With every method, protective goggles and gloves should be worn by the operator.

General Electric Co., manufacturer of picture tubes, has this to say: "Don't leave any picture tubes lying around. There are two safe ways of disposing of used tubes: (a) Place the old tube in a shipping carton properly sealed, and then drive a crowbar or similar instrument through the closed top of the container. (b) An alternative method in the disposing of more than one tube is to use a metal ash can with a plunger operated through the closed top."\*

\*G.E. Techni-Talk, Oct.-Nov., 1949

Another tube manufacturer, Sylvania Electric Products, Inc., recommends a method for picture tube puncture in their booklet entitled Servicing TV Receivers, Volume II. Quoting from the chapter on safety precautions - - -

"Before disposing of a defective cathode ray tube, it must be rendered harmless. To do this, wrap the tube with cloth and place in the cardboard shipping container with the socket upper-most. Using pliers, twist the key from the bottom of the socket. Then, using a small file inserted in the hole left when the key is removed, break the glass exhaust tip. This permits air to enter the bulb and renders it safe for disposal. During this operation, wear glasses and gloves."#

A variation of this method calls for drilling a small hole down through the center post on the base of the tube. Then a nail is inserted

---  
#Servicing TV Receivers, Vol. II, published by Sylvania, 1951, Page 127

\* \* Please turn to page 37 \* \*

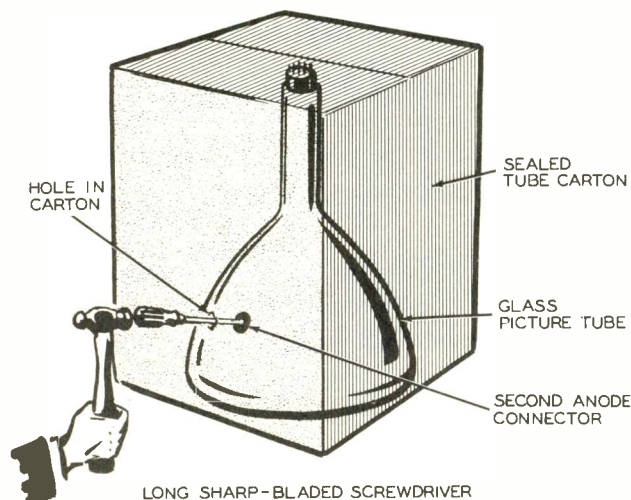

Figure 1. Method of Picture Tube Puncture with a Screwdriver Through the Anode Connector.

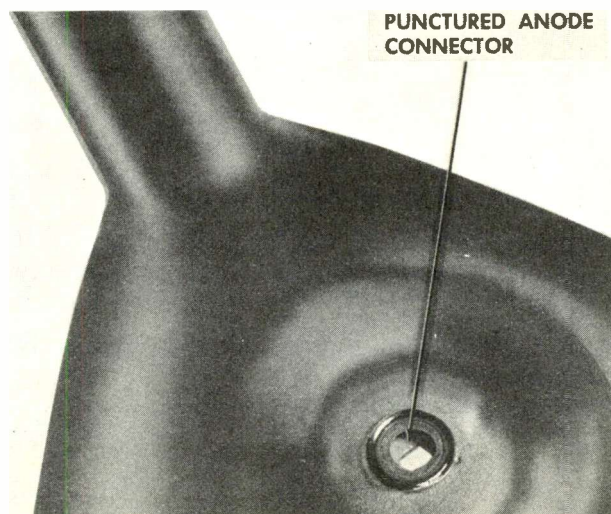

Figure 2. Close-up of a Picture Tube Showing Anode Connector After Puncture.

*Quality  
conscious dealers  
want the  
Nepco Line*

**E**xperience is a great teacher.  
And experience has taught more  
and more TV installers and service  
men they can't afford to risk their  
reputations on inferior materials.

**T**hat's why so many demand the  
NEPCO LINE—television's "Master  
of the Elements." They've found  
that National Electric's complete  
line of TV Antennas, Mounting  
Accessories, and Wire provides  
built-in ruggedness . . . meets the  
test of time and weather—and  
*assures their reputation in both  
the new and replacement markets.*



## EXAMINE THE NEPCO LINE—

**Quality materials  
with the strength to  
stay on the job . . .**

- \* Extra heavy zinc galvanizing on all parts.
- \* Baked on "Shera-solution" for *extra* corrosion protection.
- \* Rigid heavy gauge steel used in all mounts ( $1\frac{3}{4}'' \times 1\frac{1}{8}''$ ).
- \* Two 15' *stainless steel* chimney bands,  $\frac{5}{16}''$  eye bolts, and 4 heavy gauge banding clips with patented imbedding screws available with each chimney mount.
- \* All hardware corrosion-protected in the same complete manner as the mounts.

\* Every item in the NEPCO Line is engineered, tested and field proved to assure long service on the job.

**Plus features  
for fast, easy installation  
and handling**

- \* Unique adjustable mast clamp with one bolt mounting.
- \* Exclusive antenna mast clamp with positive alignment in all planes.
- \* Patented imbedding type screw for positive electrical and mechanical locking.
- \* Versatile mounts that accommodate all types of installations.

# National



ANTENNAS—UHF



CORNER ARRAY

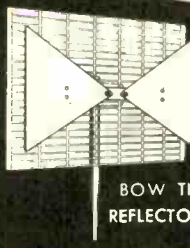

BOW TIE REFLECTOR

- DOUBLE DIPOLE REFLECTOR
- STACKED DIPOLE REFLECTOR
- YAGI TYPE
- BOW TIE
- CONICAL TYPE

ANTENNAS—VHF

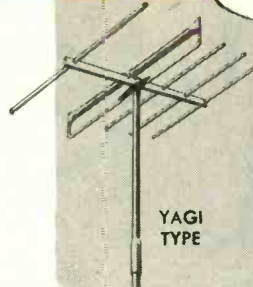

YAGI TYPE

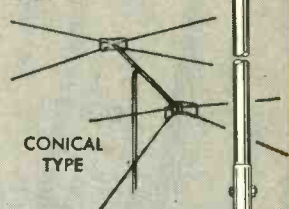

CONICAL TYPE

THE COMPLETE LINE  
FOR A FAST  
PERMANENT INSTALLATION

MASTING

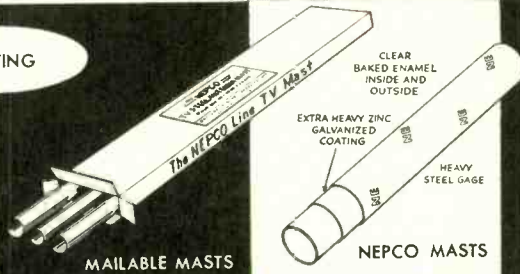

MAILABLE MASTS

CLEAR BAKED ENAMEL INSIDE AND OUTSIDE

EXTRA HEAVY ZINC GALVANIZED COATING

HEAVY STEEL GAGE

NEPCO MASTS

TELESCOPING MASTS

MOUNTS

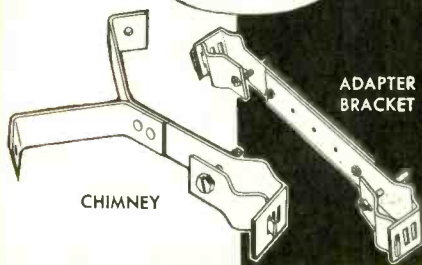

CHIMNEY

ADAPTER BRACKET

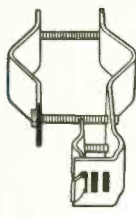

VENT

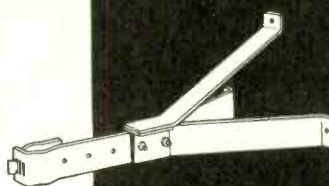

ADJUSTABLE WALL

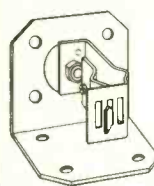

ROOF

WIRES

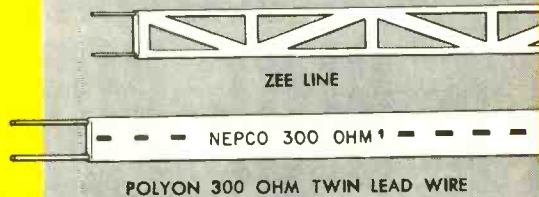

ZEE LINE

POLYON 300 OHM TWIN LEAD WIRE

YOU'LL FIND...

- \* A line designed with your handling problems in mind . . . strong compact boxes easy to move and stack.
- \* Large easy-to-read illustrated package labels.

In addition . . .

Brand recognition has been gained for the NEPCO Line through superior service on the job, and a national advertising and promotional program has created acceptance for this quality line.

The NEPCO Line is priced right for your customers.

Write, wire or phone for the name of your nearest representative today

Plus

- Wall Brackets
- Guy Rings
- Chimney Banding
- Banding and Mast Clamps

THE  
**NEPCO**  
LINE

**Electric Products**

Radio & Television Department, Pittsburgh, Pa.

# NEW



**TIGHTEST SEAL**  
LOCKS IN PERFORMANCE

**TOUGHEST SHELL**  
LOCKS OUT TROUBLE



**ATTRACTIVE YELLOW MOLDED PLASTIC SHELL**

Non-inflammable. Will not burn or melt under soldering iron or flame.

**BONDED SEAL**

Positive, heat resistant, non-inflammable bond seals leads and shell, locks out humidity.

**FIRMLY SECURED LEAD**  
Can't be pulled out, even under soldering iron heat.



PATENT PENDING

**ASTRON**  
**BLUE-POINT**<sup>†</sup>  
MOLDED PLASTIC PAPER  
*Capacitors*

THE NEWEST ADDITION  
TO THE **SM**<sup>†</sup> LINE

Yes, the **ASTRON BLUE-POINT**'s *tighter seal* and *tougher shell* give you heat and moisture protection to a degree never before possible—providing a longer life and greater dependability than has ever been achieved in a molded plastic capacitor! **BLUE-POINT** is a capacitor you can rely on *completely*, under every condition.

**BLUE-POINT** is suitable for continuous operation at 85°C. The bonded seal uses a special thermo-setting, heat-resistant, non-inflammable bonding agent—*positive* protection

against moisture. Solder leads as close to the capacitor as you like—they *won't* pull out! Every **BLUE-POINT** is clearly marked with voltage and capacitance, bears outside foil identification. Every **BLUE-POINT** is *tested* and *guaranteed*. Look for the **ASTRON BLUE-POINT** when you buy capacitors from your jobber, or if he doesn't carry it, send us his name. Insist on **ASTRON BLUE-POINT**, the capacitor you *know* you can depend on. Order a supply today.

For complete performance characteristics, specifications and listings, write for Bulletin AB-20A

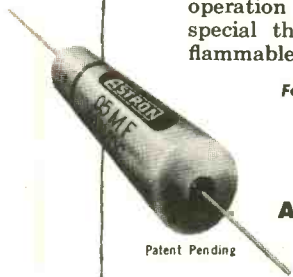

Patent Pending

DEPEND ON—INSIST ON

**ASTRON CORPORATION**



255 Grant Ave., E. Newark, N. J.

†Trade Mark

Safety Margin capacitors for every radio, television and electronic use.



IN THE INTEREST OF QUICKER  
SERVICING (Cont'd. from page 33)

and moved about so that it breaks off the exhaust tip on the glass envelope. This allows air to enter the tube rather slowly so that in many cases the phosphor screen material is undisturbed by the incoming air stream. This feature is desirable when the tube is to be kept for counter or window display of some kind. One detail to observe in preserving the phosphor is to position the neck and gun of the tube so that they are not directly above the screen face at the time the exhaust tip is broken. We experienced some flake deposit from the gun down onto the screen of a 16GP4 recently because this was not done.

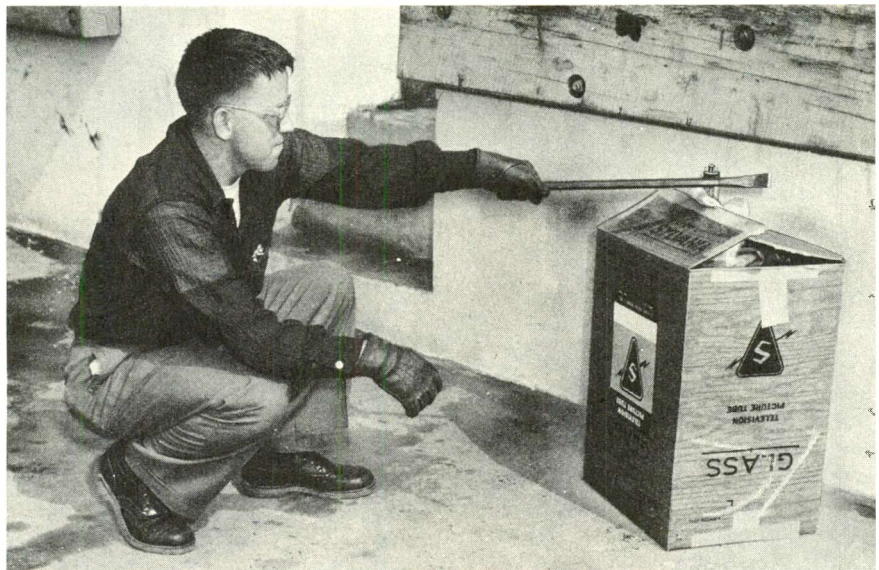

Figure 3. Breaking the Neck of a Picture Tube.

Still another method of tube puncture was given several trials in our laboratory with marked success. The tubes used were glass-shelled tubes (10BP4's) having the characteristic second anode connector recessed in the bulb wall. Figure 1 illustrates the set-up employed. The tube was positioned in a picture tube carton so that the second anode connector lay opposite a small hole punched through the wall of the carton. Then a long, sharp-bladed screw-driver was inserted through the hole and fitted into the anode connector. The carton was sealed shut, and a sharp blow on the screw-driver was enough to drive the blade through the metal anode cap of the tube. No violent implosion occurred in any of the trials we conducted using this method. If implosion had occurred, the walls of the tube carton were there to absorb the shock. As it was, the tubes were visibly unchanged except for the clean hole in each anode connector (Figure 2, and a portion of each screen blown clean of phosphor.

This last method can be used only with glass tubes, of course. With metal tubes it is necessary to use other means. We speedily dispatched a metal tube (16GP4) not long ago by a method which is worth mentioning. The tube was set face-downward in a tube carton with padding placed below it to raise the neck a few inches over the top of the carton. A heavy cloth was wrapped about the neck at its juncture with the flared cone, and the flaps of the carton were closed down around the neck. Safety goggles and gloves were donned and the neck of the tube was broken off with a long-handled

tool, See Figure 3. Only the neck of the metal 16GP4 broke, the cone and face of the tube remained completely intact. There was no flying glass as a result of the broken neck.

Before leaving the subject of picture tube disposal, it is well to re-emphasize the care which should go into such an operation. A respect for a tube's destructive potentialities should be kept in mind and rough handling prior to the actual puncture avoided.

"Trouble Shooting Aids"

Beginning with Photofact Set No. 200, a new service has been incorporated with the folders covering television receivers. This service is designed to furnish the service technician with a form of check sheet to aid in the rapid location of troubles in a specific television receiver.

The list of ailments is grouped according to the portion of the receiver affected; for example, horizontal sweep, vertical sweep, hori-

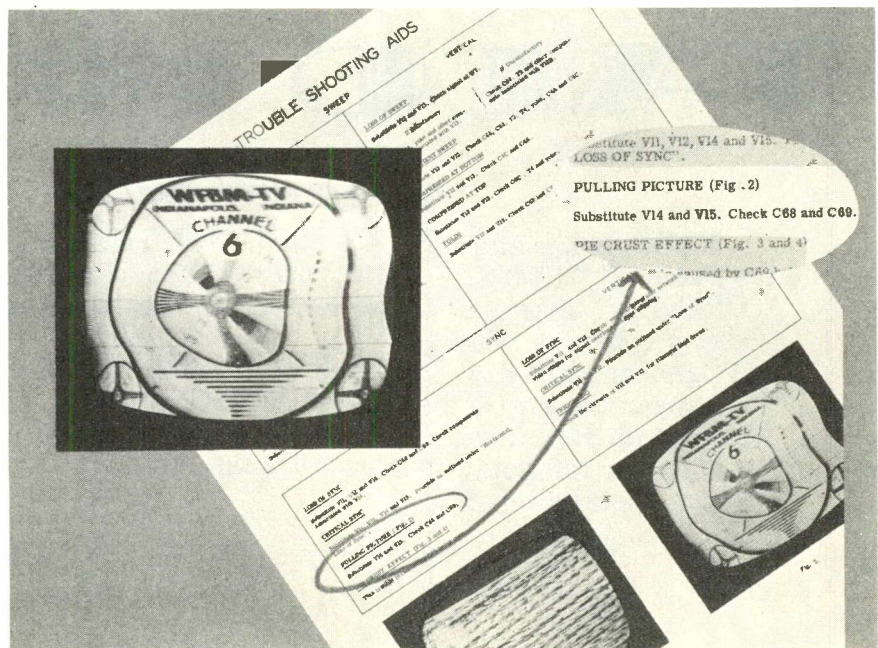
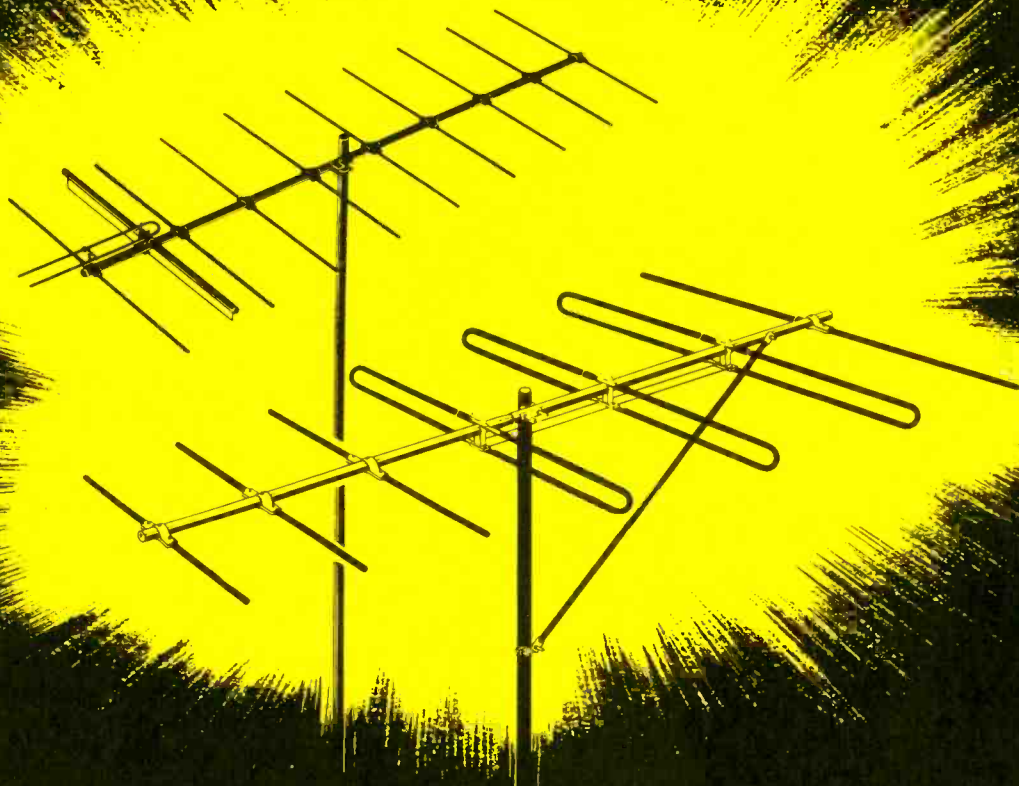

Figure 4. Using "Trouble Shooting Aids."





# THE INCOMPARABLE

*truly broad band*

## TACO VHF YAGIS

TACO, originator of the patented "TWIN-DRIVEN" antenna principle brings you broad band antennas to cover the entire VHF band. Here are the answers for your fringe installations.

### TACO INTRODUCES:

The TRI-TUNED 7-element Model 1840. TRIPLE-DRIVEN low band yagi with an unbelievable directivity pattern, and highest gain on Low-Band channels 2 thru 6 inclusive.

The SILVER STREAK BAZOOKA Model 1860, utilizing eleven working elements each contributing to an ideal directivity pattern with highest gain *across the band* from channel 7 thru 13.

**TECHNICAL APPLIANCE CORPORATION, SHERBURNE, NEW YORK**

in Canada: Hackbusch Electronics, Ltd., Toronto 4, Ontario



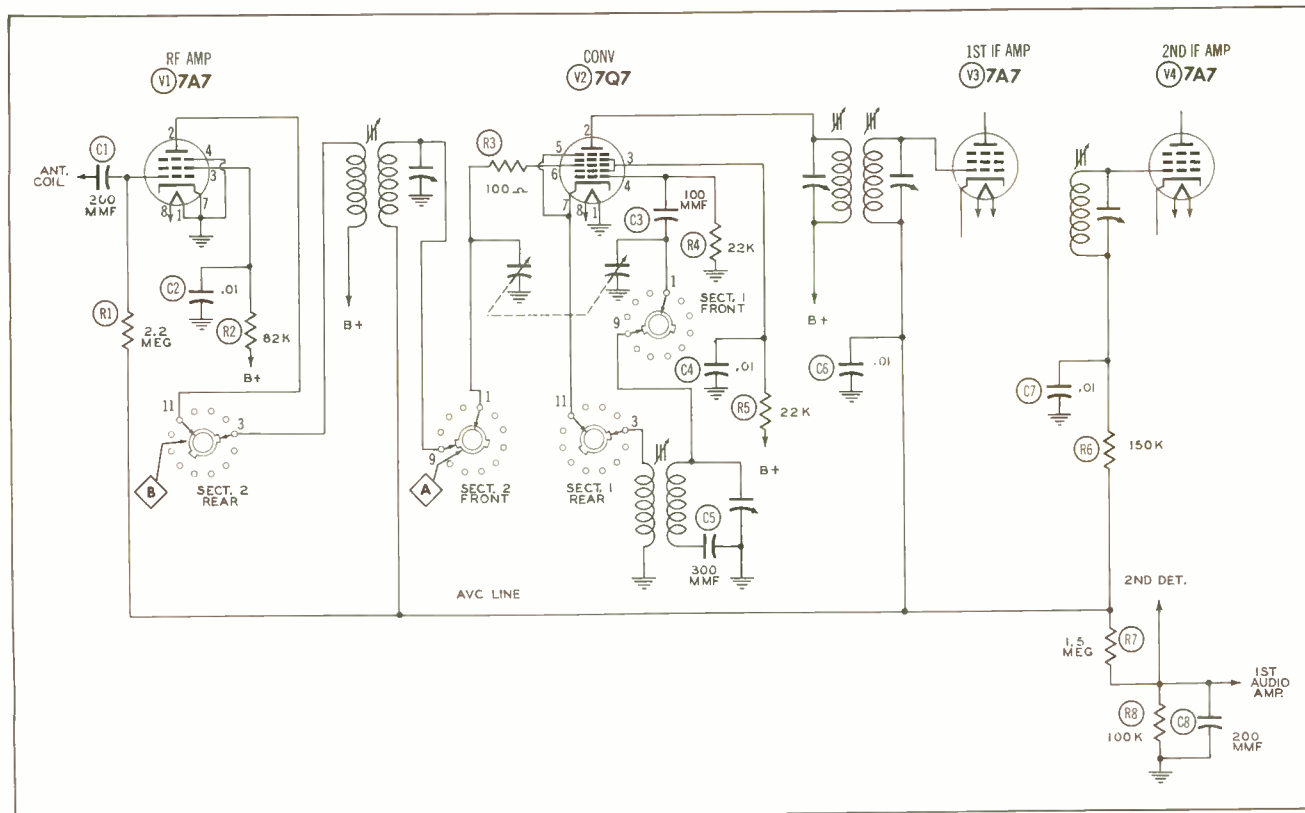

Figure 5. Partial Schematic of AM-FM Radio Showing AVC Circuit and Wafer Switches.

zontal sync, vertical sync, video, audio, high voltage, etc. Some of the troubles may be further identified by actual photographs taken of the picture screen and reproduced with the chart, see Figure 4. In some instances, defects which may be peculiar to certain sets are pinned down to failures of single components which may or may not be located in the receiver section seemingly involved.

"Trouble Shooting Aids", as this service has been named, are especially intended for use by the service technician who has a good electronic background but who may be a relative newcomer to the specific field of television servicing. It is hoped that the "old hands" in TV will also benefit from the new service since it offers a trouble shooting outline tailored to the specific receiver make and model.

#### Problem with an AM-FM Multiband Radio

This is the record of a tricky service experience which probably has been and will be repeated frequently enough to earn a mention in this column. The subject was an AM-FM multiband radio of conventional design with the exception that the converter was biased from the AVC line. The complaint was distorted sound on AM only when tuned

to a strong local station. This was indicative right away that the trouble very likely lay in the AM section of the set ahead of the second detector. The fact that the FM operation of the set was satisfactory eliminated the FM portion of the set together with the audio amplifying section which functioned for both AM and FM reception.

Figure 5 is a partial schematic of the AM section of the receiver together with the AVC circuit and the wafer switches involved in band switching. The symptoms being what they were, the first component to be suspected, after tube substitution proved fruitless, was the AVC filter capacitor, C6. If this were leaky or shorted, the AVC voltage would be too low and the resulting overload in the IF amplifiers would cause the distortion on strong signals. However, both C6 and C7 proved to be in good condition when checked. Measurements of the grid voltage on the converter tube (pin 6) with a vacuum tube voltmeter showed nearly zero volts. Yet considerable negative voltage appeared to be available across the second detector load R8.

The wafer switch was investigated next. The rear portion of the second section of this switch was located in the plate circuit of the converter. When the connections to

points 9 and 1 on the front side of the wafer section were removed and joined externally, the distortion trouble was found to disappear and the set functioned normally. In this way the defect was definitely found to be an insulation leakage between the front and rear portions, A and B, of the wafer switch section. The wafer switch was replaced with a new unit and set operation was restored to normal.

#### Knob Retaining Springs

The flat springs which hold front panel knobs securely in place are prone to turn up missing at the very time a set is being reinstalled in the customer's living room. Be prepared for such an eventuality. Watchmakers and jewelers frequently have broken mainsprings from clocks which they readily supply upon request. The springs come in various widths; two or three of these in the technician's tool kit will enable him to replace a knob spring with only a snip of his diagonal cutters. The cut should be made so that the piece of spring steel is very slightly longer than the slot in the knob. This will cause it to flex a little when it is set in position and hence hold the knob firmly on its shaft.

GLEN E. SLUTZ

**RCA VICTOR  
SERVICE PARTS**

*Made to play together...*

*... the only crystals and jewel sapphires specifically designed for the RCA "45"*

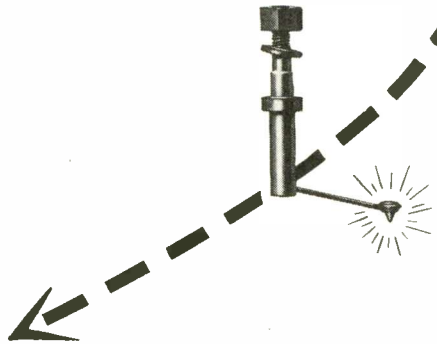
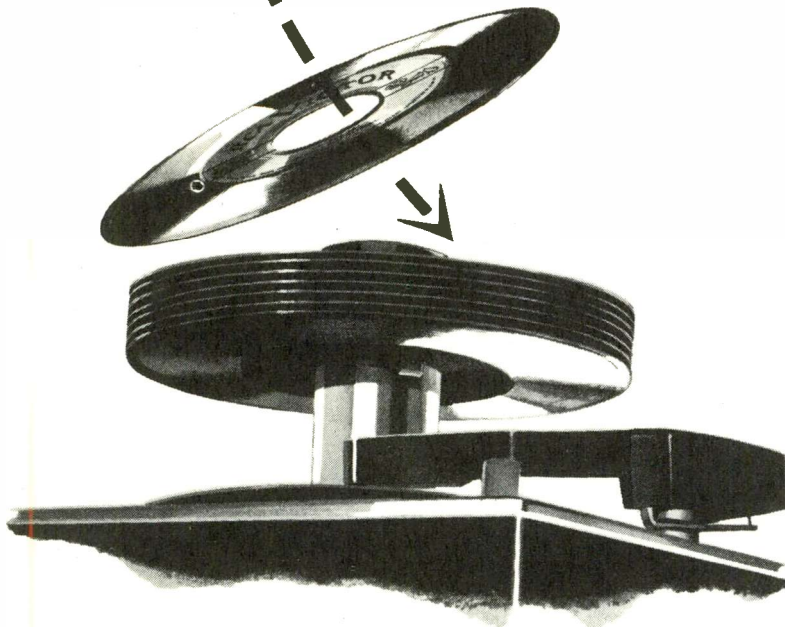
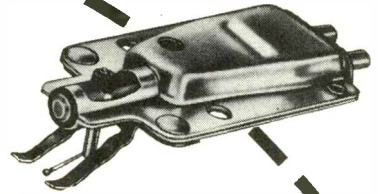

**RCA Crystal Cartridges in RCA "45" record players have the precise weight for proper tracking**

RCA Crystal Cartridges are designed specifically for RCA "45" pick-up arms. Together, they provide the correct weight for proper tracking—optimum lateral stylus compliance to minimize record-wear. Exact dimensions make them easy to install in any RCA Victor "45" record changer.

There's an "original" RCA Crystal Cartridge specially designed for every model RCA Victor record changer made. Use *genuine* RCA Crystal Cartridges and avoid replacement problems.



**Jewel-polished RCA Sapphire Styli are microscopically shaped for "45" grooves**



RCA jewel sapphires are rouge-polished to a superfine finish, and have the proper tip radius for "45" records. Record and stylus are designed to play together.

*Genuine* RCA jewel Sapphire Styli, with correct tip radius, are available for replacement in all type RCA Crystal Cartridges designed for RCA Victor 45, 78, 78-33, and 3-speed changers.

**RCA Crystals and Styli are made better—cost no more**



Because they're mass-produced by precision methods, RCA Crystal Cartridges and Styli meet the highest quality standards, yet cost no more. Smart packaging makes them easy to sell... handy dispensers make them easy to display.

Remember... customers count on you to return their RCA Victor record changers to their *original* high performance standards... by using *genuine* RCA Crystal Cartridges and Styli. Order a model inventory today from your *RCA Parts Distributor*.

**Genuine RCA Victor Service Parts are readily available from your RCA Parts Distributor**



**RADIO CORPORATION of AMERICA**  
**ELECTRONIC COMPONENTS**

**HARRISON, N. J.**



# A multiple Antenna

by Merle E. Chaney

# Switching

# DEVICE

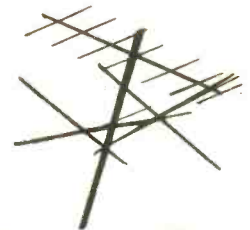

A large number of reception areas are so located that multiple type antenna systems are desirable. In these instances it is found that satisfactory reception from a number of stations is feasible, using separate high gain antennas oriented and selected for specific channels. This is particularly true because of the rapid influx of UHF television in the commercial broadcasting field, and the antenna problems peculiar to the use of this frequency spectrum.

The use of more than one antenna presents a certain problem, namely that a separate lead-in must be provided from each antenna with provisions at the receiver site for connecting each lead to the receiver. To overcome this obstacle, the Leader Electronics Company has designed an antenna switching device known as the "Tenna Switch". Produced in two models, one model accommodates up to four separate antennas while the other model operates with up to seven antennas. Several features are associated with this method of antenna selection. Probably the main

one is the fact that a single lead-in is used to couple the signal from any one antenna to the television receiver by means of a direct connection through the switch.

The "Tenna Switch" consists of two separate units, the control box and the selector switch box. For convenience the control box is located on or near the television receiver while the selector switch box may be mounted on the antenna mast, or centrally positioned to effect the switching of several antennas mounted on separate masts. A cable is employed between the two units to effect the switching.

A number of methods are recommended for mounting the control box at the location of the television receiver. Supplied with the unit is a mounting bracket to aid in the permanent positioning of the control box. Some of the possible ways for mounting the control box are to screw the case on to the wall or to the back of the receiver or on the table supporting the television receiver. Channel numbers or call letters may

be placed on the face of the control box correlating the switch positions with the desired antenna selected for a specific channel. Figure 1 shows the control box and the selector switch box. Components found inside the control box are the manually operated selector switch and the power transformer. The power transformer is a step-down type delivering 18 volts at the secondary. This supplies the power to actuate the motor device in the selector switch box. The motive power for the switch is provided through a vibrator and latching gear arrangement. The vibrator is connected in series with one of the switch sections so that in the normal off position the slot in the shorting wafer is lined up with the position selected by the control box. When a new position is selected on the control box, 18 volts is applied to the vibrator which actuates the gear drive for the selector switch until the slot in the shorting wafer is lined up with the new position, turning off the power to the vibrator. A schematic of the "Tenna Switch" is shown in Figure 2. It is observed that the selector switch box is merely a remotely controlled device actuated by a manually operated control box.

There are several practical applications for the "Tenna Switch" in addition to the use of the device for connecting several antennas to the receiver by means of a single transmission line. It can be used by dealers for demonstrating several television receivers. This method is accomplished by working the switch in reverse. The termination of the transmission line is connected to what is normally the output. Several receivers can then be operated by connecting to what normally would be the input connections. With this the dealer can make the necessary antenna connection to the receiver by manipulating the control switch. Of course, the same thing can be done with a single switch, but for purposes of maintaining neatness it might be necessary to mount the

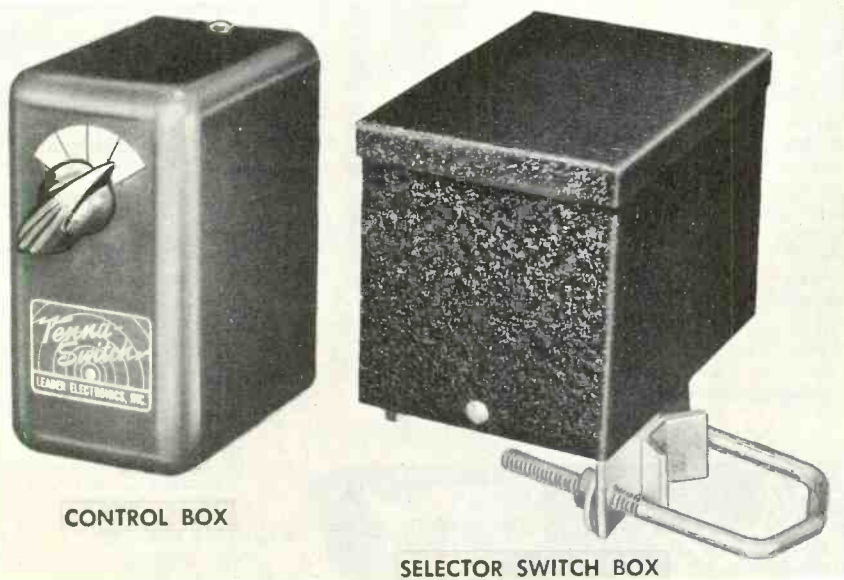

Figure 1. Control Box and Selector Switch Box, Components of the "Tenna Switch," Model TS-1A, manufactured by the Leader Electronics Co.



**NOW! EVERY CHANNEL-**

**2 to 83, with one antenna - one transmission line**

THE *telrex*

**DUO-BAND "CONICAL-V-BEAM"\***

\*REGISTERED TRADEMARK

**BETTER BY DESIGN... RAIN OR SHINE!**

*telrex*

**UHF STACKED "CONICAL-V-BEAM" WITH PARABOLIC TUNED SPLINE REFLECTOR**

Full-wave, Stacked "Conical-V-Beam" Dipoles with Parabolic Reflector. Stacked Broad-Band "Perfect Match" Conical-V-Beam Dipoles with tuned spline parabolic reflector for clean, ghost-free low angle, long distance, reception "Rain or Shine." The "Ultimate" in UHF arrays. Gain - Better than 15.9 db. Front-to-Back Ratio in excess of 28 db.



"CONICAL-V-BEAMS" ARE PRODUCED UNDER RE-ISSUE PATENT NUMBER 23,346 and SOLD ONLY THRU AUTHORIZED DISTRIBUTORS

- **DUO-BAND "CONICAL-V-BEAM"** - The TELREX "DUO-BAND" extends the "Conical-V-Beam" principle with the addition of two supplementary V splines which compact and add in-phase the higher frequency signals.
- **TRANSITION FROM VHF to UHF is AUTOMATIC and PERFECT!** (No "lossy" filter or isolation networks.) VHF and UHF signals are picked up at same cone apex.
- **NOW! WITH A SINGLE TRANSMISSION LINE!** Uniformly high gain with one major lobe. Channels 2 to 83. Actually improves reception on Channels 7 to 13 over standard "Conical-V-Beam."
- **EXCELLENT DIRECTIVITY ON VHF-UHF** - A clean, uni-directional pattern, assures high signal-to-noise ratio and freedom from "ghosts." The perfect array for reception near or far. Rugged design—light weight—low wind resistance—stacked models for increased sensitivity.
- **MODIFYING EXISTING "CONICAL-V-BEAMS" WITH TELREX KITS** - Existing "Conical-V-Beams" can be modified to operate efficiently on Channels 2 to 83 by means of the new TELREX Modification Kit.

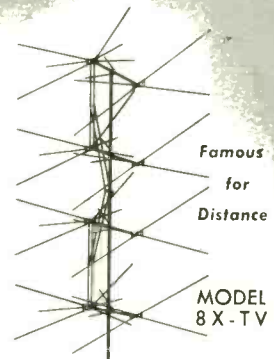

The ultimate in long distance arrays. Guaranteed to out-perform any antenna or combination of cut-to-frequency antennas. When used with Duo-Band splines it comprises the ultimate in reception on Channels 2 to 83. If the Telrex 8X-TV does not produce a usable signal TV reception is either impossible or impractical!



ASBURY PARK 10, NEW JERSEY



Originators and Manufacturers of "CONICAL-V-BEAMS" - insist on the Original!





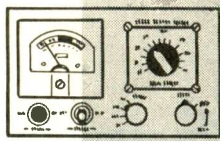

# TESTING SELENIUM RECTIFIERS



C. P. Oliphant

The selenium rectifier has always been regarded as an efficient and economical means of converting alternating current to direct current. It has been employed in various industrial applications and in the last few years has expanded in use to be included in radio and television design. It is a versatile unit which has considerably changed the design of the DC power supply. This change can be contributed to a number of factors which are classified as to its small size, light weight, high efficiency, cool operation, power handling capabilities, long life, and the fact that it requires no heater or filament voltage.

The construction of the selenium rectifier consists basically of three parts; a base plate, a layer of selenium, and a layer of an alloy. Refer to Figure 1 for enlarged sketch of a selenium rectifier plate.

The base plate is made either of iron or aluminum metal. Aluminum is being used more than iron for the base plate. The base plate is nickel-plated by chemically etching and electroplating with a very thin layer of nickel. The etching serves as a mechanical means for the selenium to adhere to the base plate.

After being nickel-plated, the base plate is covered with a very thin layer of selenium. High purity selenium, on the order of 100 per cent pure, is used. Impurities of the selenium are measured in parts-per-million. If the difference of impurities is between 7 and 10 parts-per-million, it may result in poor operation by the rectifier. The process of applying the selenium is a very critical and difficult process.

The thin barrier layer on the selenium is formed when the rectifier is heat treated. During the time the barrier layer is formed, the selenium is completely converted to a metallic form and the crystals are arranged in the order of rectification. A low-melting alloy is then sprayed on the selenium after the barrier layer has been formed.

The base plate of the rectifier is the negative electrode while the alloy acts as the positive electrode. Current flows readily from the base plate to the alloy but encounters a high resistance in the reverse direction. As a result of this action, effective rectification of an alternating input current results. The efficiency of the rectifier is dependent, to some extent, on the ratio of the resistance in the conducting direction to that of the blocking direction.

As considered by the manufacturer, the selenium rectifier is a rugged component and should last for the lifetime of the apparatus in which it is being used. However, failures do occur, especially under severe operating conditions. These failures are usually caused by the breakdown of some other component in the circuit or by placing the rectifier in a high heat area. The failures of selenium rectifiers may be classified as follows:

- a. Shorted Rectifier - the result of excessive current drain, high heat, or mechanical abuse.
- b. High forward resistance accompanied by reduced output voltage - usually caused by operating the selenium rectifier beyond rated capacity for extended periods.

- c. Reduced rectification capabilities accompanied by reduced current capacity - caused by excessive heating for long periods, or an abnormal increase of forward current for an extended period of time.

In the past, testing of a selenium rectifier that is suspected of being bad has been done without too much accuracy. The surest method of testing has been to replace the unit with a new one that is known to be in good operating condition. However, it is not always convenient to do this because it would oblige the serviceman to have in stock all the different size rectifiers that are employed in radio and television chassis. If this stock is not available, a special trip to the parts distributor has to be made. This is time consuming and, on occasions would be time wasted, especially if the selenium rectifier is not the part that is causing the trouble in the receiver.

A method of making tests with the ohmmeter has been used; however, this method does not always produce an accurate answer. The readings obtained on the ohmmeter are worthless in both the forward and reverse directions. The resistance of a rectifier in either direction is dependent on the voltage across it; therefore, the static characteristic resistance reading depends on the voltage and scale of the ohmmeter. Since the internal resistance of a selenium rectifier is non-linear, erroneous readings are obtained on the ohmmeter.

The Jackson Electrical Instrument Company has recently introduced to the trade a testing unit called a Selenium Rectifier Tester. (See Figure 2). This unit, Model 710, is for testing selenium rectifiers rated from 25 to 300 volts with currents from 20 milliamperes to 650 milliamperes. With the use of this test instrument an accurate rating of the selenium rectifier under test can be had. A dynamic test rather than a static test is

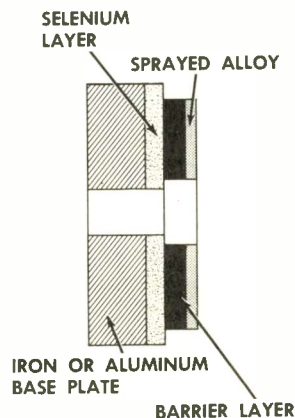
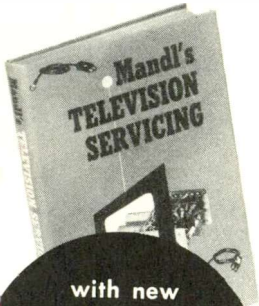

Figure 1. Cross Section of a Selenium Rectifier Plate.

turn to page 115 \* \*

# Mandl's new

## TELEVISION SERVICING



with new data on transistors cascode tuners automatically focused tubes and other recent developments

- ▶ pinpoints the trouble for you
- ▶ shows you exactly how to correct it

### YOU'LL EASILY LEARN FROM THIS BOOK

THE NEW REPRINT of this book includes the latest innovations and circuits. You'll find, for instance, explanation of the proposed color systems, the principles of the cascode ("Golden Grid") tuner and the latest technical data on this and on automatically focused tubes; the servicing of UHF-VHF receivers and of new types of high-frequency I.F. systems; the cause and cure of pulling and weaving; the functions, applications, and servicing of transistors; and the assigned frequencies of carrier and sound for UHF stations.

It is written in the clearest, simplest, most practical terms by a man who is nationally known for his helpful articles on radio and TV servicing. From these step-by-step explanations and illustrations you'll clearly understand just how each unit in the TV receiver functions, how it is set up by the various manufacturers, what flaws may occur in it, what points in the circuitry cause these flaws, how they affect the other components in the unit, and how they show up on the TV screen. All faults likely to occur, including those hard-to-find troubles are fully dealt with. And you won't be confused by unnecessary theory. Only the essentials actually needed for practical servicing are given, in clear, easy-to-follow terms.

### HUNDREDS OF HELPFUL ILLUSTRATIONS

Original photographs, especially made for this book, show you what appears on the screen when there is a defective picture tube, diathemy interference and dozens of other causes of imperfect pictures. Scores of scope patterns aid you in signal tracing and analysis of circuit performance. Hundreds of large, clear schematics, many from the major manufacturers, show you every detail of circuit arrangement.

### You'll learn—

simple signal tracing procedures • how to improve reception in fringe areas • How to use the oscilloscope and other test equipment • How to troubleshoot keyed A.G.C. and synchroguide circuits; align I.F. stages • And many trade tricks for diagnosing troubles in minimum time

### A COMPLETE MASTER TROUBLE INDEX

makes it easy for you to locate the source of trouble quickly. In the form of a handy chart it lists the various hums, sound distortions, streaks, bars, focus defects and 100 other trouble symptoms in sound and picture together with the possible causes of each and the page on which servicing instructions are given. **\$5.50**

## Men on the job recommend these top-ranking aids

### Television for Radiomen

by Edward M. Noll

"By the time you are through with this book you'll have a GOOD foundation in TV," writes a radio and TV engineer. "You'll discover that the author has treated a much written-about subject in a refreshingly original manner." Written by a man nationally known for his many helpful articles on TV operation and servicing, this book explains VERY fully and clearly the construction, function, and operating principles of EVERY circuit and element in TV reception, the principles of transmission, and the techniques of installing, aligning, and adjusting today's TV receivers. From this book you'll find it easy to acquire the fundamental knowledge you MUST have to qualify for the many good jobs now waiting for you in television. **\$7.75**

### Television and FM Antenna Guide

by E. M. Noll and M. Mandl

A basic course on antenna theory combined with a complete handbook on all types of antennas, including all commercial models, high-gain antennas for fringe areas, antennas for special locations and for the proposed UHF allocations. Shows you exactly how to determine, quickly and accurately, the best type of antenna for the site and the best position for it; how to minimize standing waves, noise, etc. on the transmission line; how to overcome special kinds of interference, and all other techniques for getting the most out of the antenna system. Based on extensive testing done by the authors. **\$5.25**

### Radio and Television Mathematics

by Bernard Fischer

"By far the best book for preparation for FCC exams," writes one radioman, echoing the opinion of countless others, "A book for the place of honor beside its natural partner, the slide rule," says *Radio-Electronics*. Here are step-by-step solutions not only for every question requiring mathematics in the FCC study guide, but also for hundreds of other circuit problems in radio, TV, and industrial electronics. You'll find, conveniently arranged under radio topics such as antenna power, plate-to-plate voltage and 400 others, the formulas to use, the numerical values to substitute, and the step-by-step solutions to 721 problems. Whatever YOUR problem, whether it is how to correct the power factor of a motor, convert polar to j-notation in a matter of seconds, find the impedance and length of a matching stub between a TV antenna and its transmission line, or any of hundreds of other problems you're apt to encounter, here is the clear and exact solution. **\$6.75**

### An Introduction to Practical Radio

by D. J. Tucker

One of the best "fundamentals" book ever published, widely praised by authorities. "The chapter on Kirchhoff's laws is a model," writes the reviewer in *Electronics*. "Also goes further into the use of vectors for solving a-c circuit problems—a must for today's radio technicians."

Here are ALL the basic how's and why's of radio, in terms you can EASILY understand and apply. The necessary mathematics is explained at the points where it is used. Each principle is accompanied by many examples of its use in the construction and operation of radio apparatus. "This book is everything you say it is," says one of the thousands of satisfied users. You'll find it admirable for a solid foundation in radio or for a brush-up on points you may have forgotten. **\$5.00**

Do you know enough about hearing aids?

### Hearing Aids

By Matthew Mandl

A rapidly increasing number of the 15,000,000 hard-of-hearing people in this country are turning to hearing aids and THEY ALL REQUIRE SERVICING! This book explains the operation of modern hearing aids, the differences between the various types of earpieces, amplifiers, batteries, etc.; what may go wrong with them; how to locate trouble, and how to make adjustments and replacements. **\$3.50**

From your distributor or

The Macmillan Company 60 FIFTH AVENUE, NEW YORK 11, N. Y.



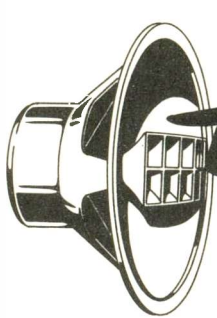

# Audio-Facts

by ROBERT B. DUNHAM



## Intermodulation -

When a new amplifier, manufactured or home built, is installed and turned on for the first time, probably the first reaction to receive the most attention is if it will make a sound and if it is loud. This soon changes to how it sounds. And this, how it sounds, is the important thing no matter how far advanced we go into the subject of high quality sound equipment.

Most high fidelity sound systems are used primarily for the reproduction of music for enjoyment. If the music as heard from the speaker does not sound the same as it did originally, due to distortion in the sound system, full enjoyment cannot be achieved. Consequently distortion, which can develop in any part of the system, must be kept down to a minimum.

This is a problem usually of greatest concern during the design and development of the equipment. But an understanding of why and how this distortion does originate, how to measure it, and how to reduce it is necessary for satisfactorily installing and servicing high quality sound equipment.

No doubt all of us, as we listened to music from a loud speaker, have wondered where the extra odd sounds and noises come from and why. If we tried to describe them

we could only come up with such things, as rattle, broken up, noisy, split, muddy and, upon occasion, some unprintable terms. These distortions have been analyzed and made the subject of much research and discussion. The result has been their reduction in many high quality systems to a negligible amount.

One type of distortion which has received much attention recently is that due to intermodulation. There are several very good reasons for this wide spread interest. One is that its measure corresponds very closely to the amount of ear disturbing qualities present in the signal.

The following definition of intermodulation distortion is found in the Standards of Radio Receivers, Institute of Radio Engineers - - "The production, in a nonlinear circuit element, of frequencies corresponding to the sums and differences of the fundamentals and harmonics of two or more frequencies which are transmitted through that element."

In other words intermodulation is the result of modulating a high frequency by a low frequency if non-linearity is present in the circuit handling the signal. The non-linearity producing this effect can be present in any part of the sound system, including the human ear.

Since this distortion is the beating of all the fundamentals and

all harmonics in all combinations, the result is a conglomeration of noise in no way musical. With music being made up of complex tones, consisting of many fundamentals and harmonics, it is easy to understand how a non-linear circuit will produce a multitude of beats which will be heard as annoying, noisy distortion in the reproduced music.

Any of the convenient methods of measurements will reveal the percentage of intermodulation present. If excessive, the necessary steps can be taken to reduce non-linearity, thereby reducing the distortion. A reduction in non-linearity will also reduce harmonic distortion since it is also due to this defect.

In an amplifier one of the common causes of non-linearity is the operating characteristics of the tubes. So the simple changing of a tube or the adjusting of bias can reduce intermodulation distortion an appreciable amount.

Various pieces of equipment, varying from moderately priced kits to laboratory apparatus, are available for measuring intermodulation. Fairly easy methods can be used to make comparative measurements as the basic principles are simple.

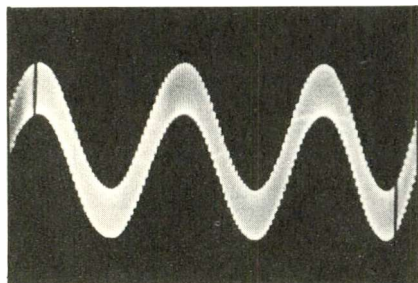

Figure 1. 60 CPS and 3000 CPS with 0.5% intermodulation.

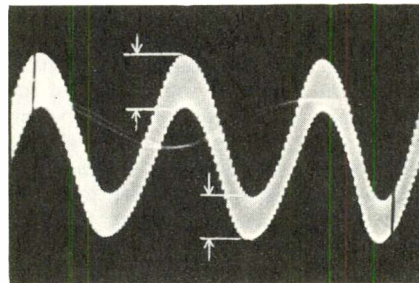

Figure 2. 60 CPS and 3000 CPS with 12% intermodulation indicated as difference in upper and lower portions.

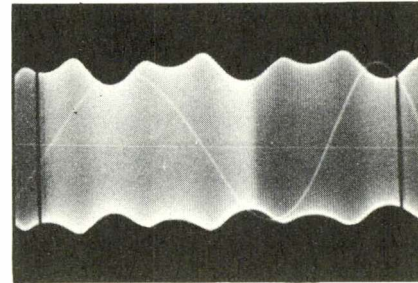

Figure 3. 3000 CPS carrier with 12% intermodulation.

Two signals, one usually between 40 and 100 cps the other 2000 and 12000 cps, are fed into the input of the equipment under test. Normally these are mixed with the low frequency having four times the amplitude of the high frequency. If non-linearity exists in the circuit tested, the high frequency, called the carrier, will be modulated by the low frequency. The intermodulation in the output can be viewed on the screen of an oscilloscope, how well depends upon the amount and the method employed.

In Figure 1, 60 cps and 3000 cps are combined at a ratio of 4 to 1. These are fed into the input of an amplifier and this waveform is obtained on the oscilloscope connected to the output. The 0.5% of intermodulation in this signal is not perceptible.

The waveform in Figure 2, is obtained in the same way but with

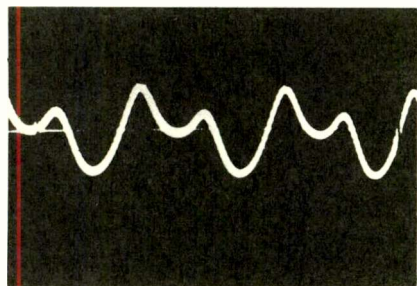

Figure 4. 12% intermodulation after removal of both 60 CPS and 3000 CPS components.

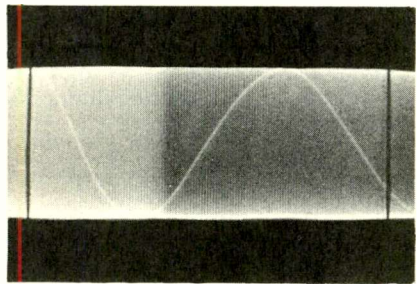

Figure 5. 3000 CPS carrier with 0.5% intermodulation.

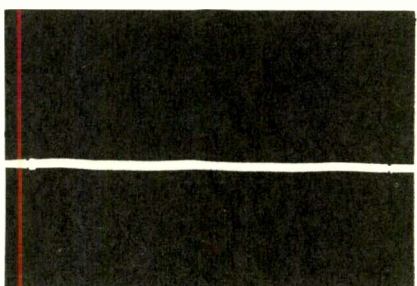

Figure 6. 0.5% intermodulation after removal of 3000 CPS carrier and 60 CPS component.

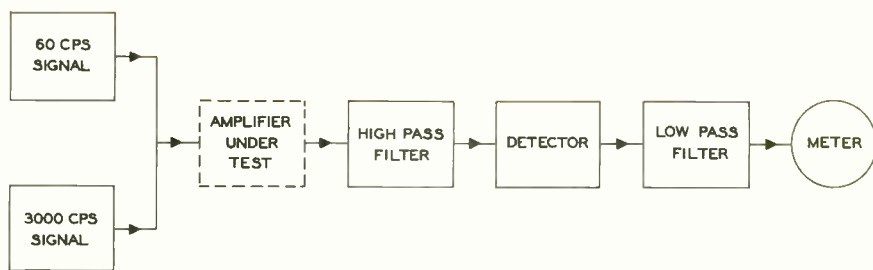

Figure 7. Block diagram of Intermodulation Meter.

12% intermodulation developed with - in the amplifier. It is now visible as a difference in the upper and lower portions of the waveform as indicated.

Now, if this combined signal at the output of the amplifier is passed through a filter and the 60 cps portion removed, the 3000 cps signal, or carrier, only remains as shown in Figure 3. Now 12% intermodulation is much more apparent.

If the signal in Figure 3 is rectified and passed through a filter to remove the 3000 cps carrier, only the intermodulation distortion remains. The 12% distortion is shown in Figure 4.

When the 60 cps portion of the signal in Figure 1 is removed by the high pass filter as shown in Figure 5 the 0.5% intermodulation is hardly visible. In Figure 6 with the 3000 cps carrier rectified and removed the 0.5% distortion is still not so apparent to the eye.

Waveforms such as these give some idea of how comparative checks can be made. But to actually read directly in percentage and with accuracy, an intermodulation distortion meter or wave analyzer is needed.

The waveforms shown were made in conjunction with a Measurements Corporation Model 31 Intermodulation Meter. Its basic form is given in the block diagram in Figure 7.

In this instrument 60 cps and 3000 cps are combined at a ratio of 4 to 1 and fed into the input of the equipment to be tested. The output of the amplifier (if that is the equipment being checked) is connected to the input of the analyzer section. The signal then passes through the high pass filter to remove the 60 cps component; then it is rectified in the detector section and passed on through the low pass filter to remove the 3000 cps carrier. By simply

setting the level controls and switches, the percentage of intermodulation distortion is read directly on the meter.

As mentioned before a test for intermodulation distortion is a very convenient and comparatively simple method of checking the operation of equipment such as an amplifier. For instance some quick checks with the Model 31 Intermodulation Meter were instrumental in improving the operation of a small power amplifier constructed in our laboratories. Frequency response and power measurements were very satisfactory as also were checks made with square waves. But some tests for intermodulation disclosed that a reduction in resistance of the cathode resistor in the output circuit, and the addition of a cathode bypass capacitor, reduced the intermodulation distortion at a high operating level from a value of 5.5% to less than 1%. There was a corresponding reduction of distortion at all levels with more efficient operation, resulting in what we were striving for - - better sound.

ROBERT B. DUNHAM

AUDIO FACTS CORRECTION NOTE:

The diagram below indicates a correction to Figure 7B, on page 112 of PF INDEX and Technical Digest No. 38 for May-June 1953.

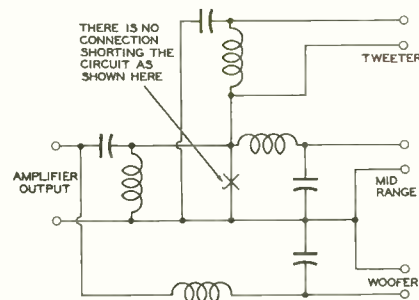

Additional data on preamplifier and control unit described in Audio Facts (PF INDEX No. 33) may be found on page 119.



# Dollar and Sense Servicing

**DETECTIVE ASSIGNMENT.** Not uncommon today among servicemen is a customer request for equipment that will record verbal or telephone conversations without the knowledge of the speakers. There are often the added specifications that the recording be acceptable in court as evidence, that all equipment be concealed, and that the equipment be voice-activated so it will operate unattended.

Research on one such assignment turned up a recorder that will meet practically all detective specs. It's a self-powered unit weighing only 8 lb ready for use, small enough to fit into a briefcase, and produces permanent unalterable recordings that have been accepted in some courts already as evidence. A voice-activated self-start-stop accessory is available at about \$20 additional cost.

Both sides of a telephone conversation can be picked up and the start-stop device actuated by a small coil wound unobtrusively around telephone wires. Recording is by embossing on endless plastic belts costing about 25¢. Both sides of the belt can be used. The unit also serves for playback, having its own loudspeaker as well as manual and remote foot controls for start-stop and back-spacing during transcribing of recordings.

Battery cost is about 1¢ per operating hour. A power pack is available for AC operation if desired. Cost of the instrument depends on sensitivity; a model having a microphone pickup range of 4 feet and a 1-1/2 hour recording capacity on each side of the plastic belt sells for around \$350. A similar model with 6 foot sensitivity costs around a hundred dollars more. Longer recording capacity boosts the cost higher yet. The manufacturer is Miles Reproducer Co., Inc., 812 Broadway, New York, N. Y.

The microphone may be concealed up to 60 feet away from the recorder unit. When used for telephoning recording, dial clicks are clearly recorded, and can be counted

to determine what numbers are called. Counting can be done more readily by playing back at slower speed.

The legality aspects of telephone recording should of course be discussed with the customer and checked before making an installation; your local telephone company can provide this information. Many telephone companies will also rent similar recording equipment; this is generally not suitable for detective work, however, because it intentionally produces sounds that tell the calling parties they are being recorded.

Magnetic tape is not acceptable as evidence because it can easily be altered. Words or entire sentences can be erased or cut out. New words or sentences, spoken by a good mimicking actor, can be spliced into the tape at any point and a re-recording made to eliminate the splices. So far, no one has figured out how to change embossed lateral recordings as easily.

**UHF HEADACHES.** Not always does the debut of a UHF station bring on a TV boom. In quite a few cases, UHF converters and sets sell good until the station goes on the air, then peter out. A TV Digest analysis of this situation presents five possible major causes of public disillusionment.

(1) The station gave widespread publicity to its coming-on-the air date, then missed it by a month or more, or operated with annoying intermittency during its first few weeks on the air.

(2) The station and/or set dealers failed to let the public know that separate outdoor UHF antenna installations would be needed in most cases.

(3) Dealers didn't bother to install the necessary equipment to give good demonstrations in their own stores. This neglected the old axiom that "you can't sell it unless you show it."

(4) Servicemen were not prepared to make adequate UHF installations, which require special transmission line and much more care in placement and orientation of the outdoor antenna.

(5) The new station carried none or few good network programs. This is the vicious circle that VHF television had to and did lick, wherein a station cannot attract sponsors until it has an audience, and a potential audience won't buy UHF equipment until it can see top-notch shows.

Fortunately the first four conditions are less prevalent in recently added UHF cities than in the pioneering localities, proving once again the value of actual experience with a new development.

**WORK.** When burdens grow too heavy, you can only do one of two things--throw off part of the load for others to carry, or unearth within yourself some new reservoir of strength or new inspiration to carry on. If you're over forty and irritability is one of the accompanying symptoms, see your family doctor before hiring that hard-to-find extra man; oftentimes doc can prescribe tonic, pills or injections that will change your whole outlook on life and boost your working efficiency tremendously. Try it; it's worth gambling one or two day's salary of that new man.

**MULTI-DIALER.** Cute trick in meter-making is a rack-and-gear arrangement that simultaneously slides the meter scale and switches appropriate range circuitry in new Marion meters. Whereas Simpson mounts its Roto-Ranger scales on a multi-faced cylinder giving a choice of 18 different scales, this newest development has five scales printed on a flat face that slides up or down. Such is the newest solution to the bio-mechanical problem of reading the wrong scale on a multimeter.

\* \* Please turn to page 122 \* \*

**WE BELIEVE** Norman Foster's recent advertisement in the Chicago "TV Guide" is of interest to the entire television and radio industry. Consequently, with Mr. Foster's permission, we are reprinting it here as a public service for every television and radio service technician in America.

*Harry Kalker*  
(HARRY KALKER, President)

**SPRAGUE PRODUCTS COMPANY**  
(Distributors' Division of the Sprague Electric Company)  
North Adams, Massachusetts



NORMAN FOSTER

UNFORTUNATELY

*Because of the Greed of a Few,*

THE ENTIRE TV SERVICE INDUSTRY MUST SUFFER

**HERE IS WHAT I HAVE DONE TO GUARANTEE YOU HONEST TV SERVICE**

1. The name, Foster Television is not taken from a street, a deck of cards, or a country, and it is not an adjective. It comes from the name of its sole owner, Norman Foster. I have spent 22 years in the Radio, Electronics and Television service business, and in these years I have worked for just about every type of Operator, good, bad and indifferent. When the time came that I could open my own business, I decided that because of the reputation that the Radio and Television repair business has always had, a company operating so honestly that they could invite their customers into the shop to watch their work being done could be a success. The volume of business we did last year proves I was right.

2. The reason that a service man would attempt to sell you something you do not need is because he had something to gain personally. Many Television service operators hire men, driving their own cars, on a percentage basis. This is advantageous because the service company can be in business with practically no investment. Under these conditions if this man needs money, it's only human nature that he is going to want to do the thing to your television set that will make him the most money—whether it be 5 tubes or haul it to the shop.

3. Every man that I have, works by the hour and punches a time clock. He drives a company owned new truck bearing my name and his equipment and uniforms are furnished to him without charge. He has orders to repair your set in your home whenever possible. He receives the same amount of money whether he repairs 1 set or 10, and whether he charges \$1 or \$10. His rate of pay and his advancement are based on the number of sets he can repair in the home.

4. Our service call price is a flat \$3 and covers all labor necessary to make any repair possible in your home except cleaning a screen, for which we charge \$1 extra. It is evident that on this basis we do not make money on every job, but with the large volume of business we do, it has averaged out to a modest profit at the end of the year. You can bring your set into our shop and not only save this service charge, but also see it repaired while you wait. There is no minimum charge on this service. You pay only for the actual time spent on your set.

5. How fast can service be? I have a large fleet of trucks operating throughout Chicago from 9:30 A.M. to 11:00 P.M. I do not advertise one hour service and I do not believe that anything but a coincidence could give such fast service. Because it is impossible to predict in advance how long each job will take a man, the best we can do is to offer same day service. Occasionally at this time of the year, bad weather causing slow driving, makes it necessary to postpone calls received late, until the next day.

6. Quality of parts. I use only nationally advertised tubes and parts. Every tube I sell is new, fresh and cartoned, bearing a name and a date, and is coded by the manufacturer to indicate that it is a tube manufactured and guaranteed for replacement use. I do not use bulk or surplus tubes. Every picture tube I sell bears a serial number and has a factory registration certificate to guarantee that it is a new first quality tube. I do not sell rebuilt or rejuvenated picture tubes. I use only Sprague plastic sealed condensers, which are far superior to the parts used in many TV sets.

7. I guarantee every part I replace for 90 days. If a part or tube I have replaced fails, it is replaced at absolutely no charge to you. Our guarantee is further underwritten by the American Mutual Liability Insurance Co. by arrangement with the Raytheon Manufacturing Co.

8. I have not satisfied everybody and I do not claim to. I cannot repair a set that needs a new picture tube for \$3 and I cannot give a \$60 service contract with each call. Nothing less would satisfy certain people. However, if you hear a complaint against Foster Television, that same person will generally have one against the plumber, the auto mechanic, the dentist and nearly everyone else who is unfortunate enough to do business with him. I need and value your patronage and I will sincerely respect it.

*Norman Foster*

Open 9:30 am-8:30 pm

• Home Service to 11 pm

• Sundays 11 am-3 pm

• H U M B O L D T 9 - 0 9 1 1



YOU CAN DEPEND ON

**FOSTER TV**

2922 MILWAUKEE AVENUE

CHICAGO

PF INDEX - July-August, 1953



# INDEX TO PHOTOFAC

RADIO AND TELEVISION SERVICE DATA FOLDERS

# No. 39

Covering Folder Sets Nos. 1 thru 212

## HOW TO USE THIS INDEX

To find the PHOTOFAC Folder you need, first look for the name of the receiver (listed alphabetically below), and then find the required model number. Opposite the model, you will find the number of the PHOTOFAC Set in which the required Folder appears, and the number of that Folder. The PHOTOFAC Set number is shown in bold-face type; the Folder number is in the regular light-face type.

**IMPORTANT—1.** The letter "A" following a Set number in the Index listing, indicates a "Preliminary Data Folder." These Folders are designed to provide you *immediately* with preliminary basic data on TV receivers pending their complete coverage in the standard, uniform PHOTOFAC Folder Set presentation.

**2.** Models marked by an asterisk (\*) have not yet been covered in a standard Folder. However, regular PHOTOFAC Subscribers may obtain Schematic, Alignment Data or other required information on these models without charge by supplying make, model or chassis number and serial number. (When requesting such data, mention the name of the Parts Distributor who supplies you with your PHOTOFAC Folder Sets.)

**3.** Production Change Bulletins contain data supplementary to certain models covered in previously issued PHOTOFAC Folders, and are listed in this Index immediately following the listing of the original coverage of the model or chassis. These Bulletins should be filed with the Folders covering the models to which the changes apply.

Set Folder No. No.	Set Folder No. No.	Set Folder No. No.	Set Folder No. No.	Set Folder No. No.
<b>ADAPTOL</b>	<b>ADMIRAL—Cont.</b>	<b>ADMIRAL—Cont.</b>	<b>ADMIRAL—Cont.</b>	<b>ADMIRAL—Cont.</b>
CT-1 ..... 48—1	Chassis 2011 Tel. Rec. [Also see Prod. Chge. Bul. 15—Set 126-1 and Bul. 26—Set 146-1]... 117—2	Chassis 24D1, 24E1, 24F1, 24G1, 24H1 Tel. Rec. [Also see Prod. Chge. Bul. 9—Set 114-1]... 103—2	Models 4H167A, B, C, CN Tel. Rec. [See Ch. 20B1]	Models 6RT41, 6RT42, 6RT43 [See Ch. 5B1 Photo]
<b>ADMIRAL (Also see Record Changer Listing)</b>	Chassis 20V1 Tel. Rec. Also See Prod. Chge. Bul. 15—Set 126-1 and Prod. Chge. Bul. 26—Set 146-1]... 117—2	Chassis 30A1 Tel. Rec. 57—2	Models 4H167S, SN Tel. Rec. [See Ch. 30B1]	Model 6RT43A [See Ch. 5B1A]
Chassis UL5K1 ..... 30—1	Chassis 20X1, 20Y1 Tel. Rec. .... 100—1	Chassis 30B1, 30C1, 30D1 Tel. Rec. .... 71—2	Models 4R11, 4R12 [See Ch. 4R1]	Model 6RT44 [See Ch. 7B1]
Chassis UL7C1 ..... 25—2	Chassis 20Z1 [Also See Prod. Chge. Bul. 7—Set 110-1]... 100—1	Model 4D11, 4D12, 4D13 [See Ch. 4D1]	Model 4T11 [See Ch. 4T1]	Models 6S11, 6S12 [See Ch. 6S1]
Chassis 3A1 ..... 2—24	Chassis 21A1 Tel. Rec. [Also See Prod. Chge. Bul. 23—Set 140-1]... 77—1	Models 4H15, 4H16, 4H17 [A or B] Tel. Rec. [See Ch. 20A1]	Models 4W19, 4W19 [See Ch. 4W1]	Model 6T02, 6T04 ..... 1—20
Chassis 3C1 [Also See Prod. Chge. Bul. 15—Set 126-1]... 117—2	Chassis 21B1, 21C1, 21D1 Tel. Rec. [Also See Prod. Chge. Bul. 25—Set 144-1]... 118—2	Models 4H18, 4H19 [C or CN] Tel. Rec. [See Ch. 20B1]	Models 5A32/12, 5A32/15, 5A33/12, 5A33/15, 5A33/16 [See Ch. 5A3]	Model 6T05 ..... 1—19
Chassis 4A1 ..... 3—31	Chassis 21E1 [See Chassis 21D1—Set 118-2 and Prod. Chge. Bul. 25—Set 144-1]... 135—2	Models 4H115, 4H116, 4H117 [S or SN] Tel. Rec. [See Ch. 30B1]	Models 5E21, 5E22, 5E23 [See Ch. 5E2]	Model 6T06, 6T07 [See Ch. 4A1]
Chassis 4B1 ..... 24—1	Chassis 21F1, 21G1 Tel. Rec. [Also see Prod. Chge. Bul. 30—Set 156-2 and Prod. Chge. Bul. 46—Set 180-1]... 135—2	Models 4H126A, B, C, CN Tel. Rec. [See Ch. 21A1]	Models 5F11, 5F12 [See Ch. 5F1]	Model 6T11 [See Model 6T02—Set 1-20]
Chassis 4D1 ..... 49—1	Chassis 21H1, 21I1 Tel. Rec. [Also see Prod. Chge. Bul. 30—Set 156-2 and Prod. Chge. Bul. 46—Set 180-1]... 135—2	Model 4H126 [S or SN] Tel. Rec. [See Ch. 30B1]	Models 5G21, 5G21/15, 5G22, 5G22/15, 5G23, 5G23/15 [See Ch. 5G2]	Model 6T12 [See Ch. 4A1]
Chassis 4H1 ..... 71—2	Chassis 21J1, 21K1 Tel. Rec. [Also see Prod. Chge. Bul. 30—Set 156-2 and Prod. Chge. Bul. 46—Set 180-1]... 135—2	Models 4H137A, B Tel. Rec. [See Ch. 21A1]	Models 5J21, 5J22, 5J23 [See Ch. 5J2]	Model 6T14A [See Ch. 7B1]
Chassis 4J1, 4K1 ..... 77—7	Chassis 21L1, 21M1 Tel. Rec. [Also see Prod. Chge. Bul. 30—Set 156-2 and Prod. Chge. Bul. 46—Set 180-1]... 135—2	Model 4H137 [S or SN] Tel. Rec. [See Ch. 30B1]	Models 5K11, 5K12, 5K13, 5K14 [See Ch. 5K1]	Models 6V11, 6V12 [See Ch. 6V1]
Chassis 4L1 ..... 100—1	Chassis 21N1, 21O1 Tel. Rec. [Also see Prod. Chge. Bul. 30—Set 156-2 and Prod. Chge. Bul. 46—Set 180-1]... 135—2	Models 4H145A, B, C, CN Tel. Rec. [See Ch. 20B1]	Models 5L21, 5L22, 5L23 [See Ch. 5L2]	Models 6W11, 6W12 [See Chassis 6W1]
Chassis 4M1 ..... 49—1	Chassis 21P1, 21Q1 Tel. Rec. [Also see Prod. Chge. Bul. 30—Set 156-2 and Prod. Chge. Bul. 46—Set 180-1]... 135—2	Models 4H145S, SN Tel. Rec. [See Ch. 30B1]	Models 5M21, 5M22 [See Chassis 5M2]	Models 6Y18, 6Y19 [See Chassis 6Y19]
Chassis 4N1 ..... 143—2	Chassis 21R1, 21S1 Tel. Rec. [Also see Prod. Chge. Bul. 30—Set 156-2 and Prod. Chge. Bul. 46—Set 180-1]... 135—2	Models 4H146A, B, C Tel. Rec. [See Ch. 20B1]	Models 5R11, 5R12, 5R13, 5R14 [See Ch. 5R1]	Model 6Z60M, 6Z60M, 6Z60W [See Ch. 6B1]
Chassis 4O1 ..... 143—2	Chassis 21T1, 21U1 Tel. Rec. [Also see Prod. Chge. Bul. 30—Set 156-2 and Prod. Chge. Bul. 46—Set 180-1]... 135—2	Models 4H146S, SN Tel. Rec. [See Ch. 30B1]	Model 5S21AN [See Ch. 5C3]	Models 7C61, 7C62, 7C62UL [See Ch. 6M1]
Chassis 4P1 ..... 191—2	Chassis 21V1 Tel. Rec. 177—2	Models 4H147A, B Tel. Rec. [See Ch. 20B1]	Model 5S22AN [See Ch. 5C3]	Model 7C62A [See Ch. 6M1]
Chassis 5A1 [See Model 6T02—Set 1-20]..... 4—24	Chassis 21W1 Tel. Rec. 177—2	Models 4H147S, SN Tel. Rec. [See Ch. 30B1]	Model 5S23AN [See Ch. 5C3]	Model 7C63-UL [See Ch. 7C1]
Chassis 5B1A ..... 18—1	Chassis 21X1, 21Y1 Tel. Rec. [Also see Prod. Chge. Bul. 62—Set 196-1 and Ch. 21W1—Set 177-2]... 177—2	Models 4H155A, B Tel. Rec. [See Ch. 20B1]	Model 5T12AN [See Ch. 5T1]	Model 7C63A [See Ch. 7C1]
Chassis 5B2 ..... 100—1	Chassis 21Z1, 21A1A Tel. Rec. .... 177—2	Models 4H155S, SN Tel. Rec. [See Ch. 30B1]	Models 5W11, 5W12 [See Ch. 5W1]	Models 7C65M, 7C65M, 7C65W [See Ch. 7E1]
Chassis 5C3 ..... 197—2	Chassis 22A1, 22A2A Tel. Rec. .... 180—2	Models 4H157A, B Tel. Rec. [See Ch. 20B1]	Models 5X11, 5X12, 5X13, 5X14 [See Ch. 5X1]	Model 7C73 [See Ch. 9A1]
Chassis 5D2 ..... 119—2	Chassis 22B1 Tel. Rec. 201—2	Models 4H157A, B Tel. Rec. [See Ch. 20B1]	Models 5Y21, 5Y22, 5Y23 [See Ch. 5Y2]	Models 7G11, 7G12, 7G14, 7G15, 7G16 [See Ch. 7G1]
Chassis 5E2 ..... 139—2	Chassis 22C1 Tel. Rec. 201—2	Models 4H157S, SN Tel. Rec. [See Ch. 30B1]	Models 6A21, 6A22, 6A23 [See Ch. 6A2]	Models 7P32, 7P33, 7P34, 7P35 [See Ch. 5H1]
Chassis 5F1 ..... 137—2	Chassis 22D1 Tel. Rec. 201—2	Models 4H165A, B Tel. Rec. [See Ch. 20B1]	Model 6C11 [See Ch. 6C1]	Model 7R141, 7R142, 7R143 [See Ch. 6L1]
Chassis 5G2 ..... 26—1	Chassis 22E1 Tel. Rec. 201—2	Models 4H165S, SN Tel. Rec. [See Ch. 30B1]	Model 6C71 [See Ch. 10A1]	Models 7T01, 7T01M-UL, 7T04, 7T04-UL [See Ch. 5N1]
Chassis 5H1 ..... 136—2	Chassis 22F1 Tel. Rec. 201—2	Models 4H166A, B, C, CN Tel. Rec. [See Ch. 20B1]	Models 6J21, 6J22 [See Ch. 6J2]	Model 7T06 [See Ch. 4B1]
Chassis 5J2 ..... 136—2	Chassis 22G1 Tel. Rec. 201—2	Models 4H166S, SN Tel. Rec. [See Ch. 30B1]	Model 6M22 [See Ch. 6M2]	Model 7T10 [See Ch. 5K1]
Chassis 5K1 ..... 30—1	Chassis 22H1 Tel. Rec. 201—2	Models 4H167A, B, C, CN Tel. Rec. [See Ch. 20B1]	Models 6N25, 6N26, 6N27 [See Ch. 5R2]	Models 7T14, 7T15 [See Ch. 5K1]
Chassis 5L2 ..... 160—1	Chassis 22I1 Tel. Rec. 180—2	Models 4H167S, SN Tel. Rec. [See Ch. 30B1]	Model 6P32 [See Ch. 6E1, 6E1N]	Models 8C11, 8C12, 8C13 Tel. Rec. [See Ch. 30A] and Ch. 8C1]
Chassis 5M2 ..... 157—2	Chassis 22J1 Tel. Rec. 180—2	Models 4H168A, B, C, CN Tel. Rec. [See Ch. 20B1]	Models 6Q11, 6Q12, 6Q13, 6Q14 [See Ch. 6Q1]	Models 8C14, 8C15, 8C16, 8C17 [See Ch. 8C1]
Chassis 5N1 ..... 31—1	Chassis 22K1 Tel. Rec. 180—2	Models 4H168S, SN Tel. Rec. [See Ch. 30B1]	Model 6R11 [See Ch. 6R1]	Models 8D15, 8D16 [See Ch. 8D1]
Chassis 5R1 ..... 59—1	Chassis 22L1 Tel. Rec. 180—2	Models 4H169A, B, C, CN Tel. Rec. [See Ch. 20B1]	Model 6R48, 6R49, 6R50 [See Ch. 3A1]	Model 8R46 [See Chassis 3A1]
Chassis 5R2 ..... 165—3	Chassis 22M1 Tel. Rec. 180—2	Models 4H169S, SN Tel. Rec. [See Ch. 30B1]		Models 9B14, 9B15, 9B16 [See Ch. 9B1]
Chassis 5T1 ..... 68—2	Chassis 22N1 Tel. Rec. 180—2			Models 9E15, 9E16, 9E17 [See Ch. 9E1]
Chassis 5W1 ..... 79—2	Chassis 22O1 Tel. Rec. 180—2			Models 12X11, 12X12 Tel. Rec. [See Ch. 20Z1]
Chassis 5X1 ..... 76—3	Chassis 22P1 Tel. Rec. 180—2			Models 14R11, 14R12 Tel. Rec. [See Ch. 20T1]
Chassis 5Y2 ..... 204—2	Chassis 22Q1 Tel. Rec. 180—2			Model 14R16 [See Ch. 20T1]
Chassis 5Y2 ..... 188—2	Chassis 22R1 Tel. Rec. 180—2			Model 15K21 Tel. Rec. [See Ch. 20T1]
Chassis 6A1 [See Model 6T01—Set 1-19]..... 103—1	Chassis 22S1 Tel. Rec. 201—2			Model 16M12 Tel. Rec. [See Ch. 21X1]
Chassis 6B1 ..... 48—2	Chassis 22T1 Tel. Rec. 201—2			Models 16R11, 16R12 Tel. Rec. [See Ch. 20T1]
Chassis 6C1 ..... 53—1	Chassis 22U1 Tel. Rec. 201—2			Models 17DX10, 17DX11, 17DX12 Tel. Rec. [See Ch. 19B1]
Chassis 6E1, 6E1N ..... 140—2	Chassis 22V1 Tel. Rec. 201—2			Models 17K11, 17K12 Tel. Rec. [See Ch. 21F1]
Chassis 6J2 ..... 26—2	Chassis 22W1 Tel. Rec. 201—2			Model 17K21, 17K22 Tel. Rec. [See Ch. 21F1]
Chassis 6L1 ..... 24—2	Chassis 22X1 Tel. Rec. 201—2			Models 17M15, 17M16, 17M17 Tel. Rec. [See Ch. 21F1]
Chassis 6M1 ..... 25—1	Chassis 22Y1 Tel. Rec. 201—2			Models 19A11S, SN, 19A12S, SN Tel. Rec. [See Ch. 19A1]
Chassis 6M2 [See Ch. 6J2—Set 140-2]..... 78—1	Chassis 22Z1 Tel. Rec. 201—2			Models 19A15S, SN Tel. Rec. [See Ch. 19A1]
Chassis 6R1 ..... 54—1	Chassis 23A1 Tel. Rec. 211—2			Models 20X11, 20X12 Tel. Rec. [See Ch. 20X1]
Chassis 6S1 ..... 107—1				
Chassis 6V1 ..... 62—1				
Chassis 6W1 ..... 71—1				
Chassis 6Y1 ..... 75—1				
Chassis 7B1 ..... 18—2				
Chassis 7C1 ..... 25—2				
Chassis 7E1 ..... 36—1				
Chassis 7G1 ..... 54—2				
Chassis 8C1 [See Ch. 8D1—Set 67-1]..... 67—1				
Chassis 8D1 ..... 67—1				
Chassis 9A1 ..... 32—1				
Chassis 9B1 ..... 49—2				
Chassis 9E1 [See Ch. 6E2]..... 68—2				
Chassis 10A1 ..... 3—30				
Chassis 19A1 Tel. Rec. [Also see Prod. Chge. Bul. 5—Set 106-1]... 59—2				
Chassis 19B1, 19C1 Tel. Rec. .... 210—2				
Chassis 19E1 Tel. Rec. .... 203—2				
Chassis 19F1, 19F1A Tel. Rec. .... 210—2				
Chassis 19G1 [See Ch. 19E1—Set 203-2]..... 210—2				
Chassis 19H1, 19K1 Tel. Rec. .... 210—2				
Chassis 19N1 [See Ch. 19E1—Set 203-2]..... 210—2				
Chassis 20A1, 20B1 Tel. Rec. [Also see Prod. Chge. Bul. 23, Set 140-1]... 77—1				

## IMPORTANT PHOTOFAC INFORMATION

We want you to receive maximum benefits through your use of this Index and of PHOTOFAC Folders. To keep you fully informed about PHOTOFAC, we have prepared the table of informative subjects listed below. Be sure to read each item carefully.

Subject	Page No.
1. Explanation of letter "A," asterisk (*), and Prod. Changes	49
2. How to obtain a sample PHOTOFAC Folder	58
3. How to file PHOTOFAC Folders easily and quickly	62
4. How to obtain Service Data on Pre-War Models	66

get out  
ahead in **uhf**

THESE PRACTICAL BOOKS  
GIVE YOU THE "KNOW-HOW"

## "UHF ANTENNAS, CONVERTERS AND TUNERS"



Milton S. Kiver gives you  
all the answers on:

**UHF Antennas:** Full analysis of each UHF type—design, operation, directional characteristics, input impedance, gain—tells you type best suited for any given location and conditions.

**Transmission Lines, Matching Networks:** tells how to select proper line to deliver maximum signal to receiver.

**Installation Practices:** Practical advice on proper antenna location and routing of line to set; tells how to check for antenna mismatch, how to determine whether system is properly installed.

**UHF Converters:** Full analysis of all existing self-contained types, including turret tuner strips.

**UHF Tuners:** Covers tuner design and operation, ranging from parallel-wire to "butterfly" types—tells how they work.

This book keeps you ahead in TV, makes you a UHF expert, for extra profits. Get your copy today.

ORDER UHF-1 Only ..... \$1.50

## "UHF CONVERTERS"

**Covers 21 Models**  
Be among the first to understand the design and operation of the new UHF converters and tuners. This book describes all the popular units and tells how they work with present VHF sets. Covers the following makes:

Arvin, Crosley, Dumont, G.E., Mallory, Motorola, RCA, Raytheon, Regency, Sarks-Tarzian, Standard Coil, Stromberg, Sutco, Sylvania. To stay ahead in TV, you'll want this essential book.

ORDER UC-1. Only ..... \$1.00



ORDER THESE BOOKS TODAY!

HOWARD W. SAMS & CO., INC.

ORDER THESE OUTSTANDING  
**TV BOOKS**  
FROM YOUR  
**PHOTOFACT DISTRIBUTOR**

## Howard W. Sams PHOTOFACT Publications

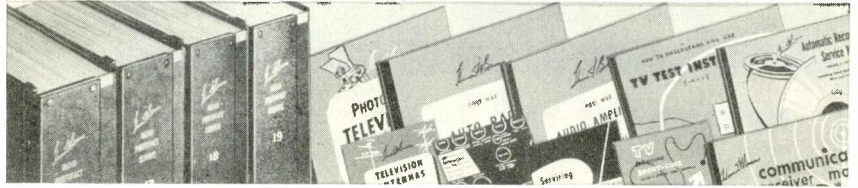

### PHOTOFACT SERVICE MANUALS

Here's the radio-TV service data that saves time and helps you earn more! Preferred and used daily by thousands of Radio and TV Service Technicians. Complete, accurate—based on analysis of the actual equipment. Uniform treatment for each model. Includes Standard Notation Schematics; full chassis photo coverage; complete circuit analysis and replacement parts data; wave forms, alignment data; record changer analysis—everything you need for quick, profitable servicing. Each volume in deluxe binding.

- VOL. 1—Post-war models to Jan. 1, 1947
- VOL. 2—Jan. 1, 1947—July 1, 1947
- VOL. 3—July 1, 1947—Jan. 1, 1948
- VOL. 4—Jan. 1, 1948—July 1, 1948
- VOL. 5—July 1, 1948—Dec. 1, 1948
- VOL. 6—Dec. 1, 1948—May 1, 1949
- VOL. 7—May 1, 1949—Oct. 1, 1949
- VOL. 8—Oct. 1, 1949—Dec. 1, 1949
- VOL. 9—Dec. 1, 1949—Mar. 31, 1950
- VOL. 10—Mar. 31, 1950—July 31, 1950
- VOL. 11—July 31, 1950—Oct. 31, 1950
- VOL. 12—Oct. 31, 1950—Jan. 1, 1951
- VOL. 13—Jan. 1, 1951—Apr. 30, 1951
- VOL. 14—Apr. 30, 1951—Aug. 1, 1951
- VOL. 15—Aug. 1, 1951—Oct. 31, 1951
- VOL. 16—Oct. 31, 1951—Jan. 31, 1952
- VOL. 17—Jan. 31, 1952—Apr. 30, 1952
- VOL. 18—Apr. 30, 1952—July 31, 1952
- VOL. 19—July 31, 1952—Nov. 30, 1952
- VOL. 20—Nov. 30, 1952—Feb. 28, 1953
- VOL. 21—Feb. 28, 1953—May 31, 1953
- VOL. 22—May 31, 1953—Sept. 15, 1953
- VOL. 23—Sept. 15, 1953—Dec. 15, 1953

② Each Volume in Deluxe Binder. . \$21.00

### PHOTOFACT FOLDER SETS

The easiest way to own the world's finest TV-Radio Service Data. Issued three sets per month—put in your standing order for them.

① Per PHOTOFACT Set ..... \$1.75

### PHOTOFACT SERVICE DATA ITEMS

- ② Deluxe Photofact Binder, Each ..... \$3.50
- ② PF INDEX Binder (holds 12 issues) ... 2.50
- ① Index Tabs for Sets 1-10 ..... .40
- ① Index Tabs for Sets 11-20 ..... .40
- ① Volume Labels for Vols. 1-10 ..... .25
- ① Volume Labels for Vols. 11-20 ..... .25
- ① Volume Labels for Vols. 21-30 ..... .25
- ① Index Cards, Sets 1-100 ... \$2.50 per set
- ① Index Cards, Sets 101-200 ... 2.50 per set
- ① Index Cards, Sets 201-300 ... 2.50 per set
- ① Mailing envelopes ..... 2.70 per 100

**EASY-PAY PLAN:** Ask your Parts Distributor for details on our attractive Time Payment terms that enable you to own and use the PHOTOFACT Service Data Library on a convenient pay-as-you-earn basis.

### AUTO RADIO SERVICE MANUALS

Vol. 3. Full service data on 47 chassis (80 models) used in 1950, 1951 and 1952 auto radio receivers. 288 pages, 8½ x 11". Order AR-3 ..... \$3.00

Vol. 2. Covers 60 chassis (90 models) used in 1948, 1949 and 1950 auto radios. 288 pages, 8½ x 11". Order AR-2 ..... \$3.00

Vol. 1. Covers 100 auto radio models made from 1946 to 1949 by 24 manufacturers. 396 pages, 8½ x 11". Order AR-1 ..... \$4.95

### HANDY SERVICE GUIDES

**Dial Cord Stringing Guide, Vol. 2:** Shows correct way to string dial cords in radio receivers made from 1947 through 1949. 96 pages, 5½ x 8½". Order DC-2 ..... \$1.00

Vol. 1: Covers receivers produced from 1938 through 1946. 112 pages, 5½ x 8½". Order DC-1 ..... \$1.00

**Radio Receiver Tube Replacement Guide.** Shows where to replace each tube in 5500 receivers made from 1938 to 1948. 196 pages, 5½ x 8½". Order TP-1 ..... \$1.25

### INVALUABLE TELEVISION BOOKS

**Photofact Television Course.** Gives a clear, complete understanding of TV principles, operation and practice. 208 pages, 8½ x 11". Order TV-1 ..... \$3.00

**TV Servicing Short-Cuts.** Describes actual TV service case histories; shows how to solve similar troubles in any receiver. 100 pages, 5½ x 8½". Order TK-1 ..... \$1.50

**TV Test Instruments.** Tells how to operate each test instrument used in TV service work. 148 pages, 8½ x 11". Order TN-1 ..... \$3.00

**UHF Converters.** Describes 21 popular converters; shows how they work. 44 pages, 8½ x 11". Order UC-1 ..... \$1.00

**UHF Antennas, Converters & Tuners.** Covers all antenna types, transmission lines and matching networks, UHF converters and tuners. 136 pages, 5½ x 8½". Order UHF-1 ..... \$1.50

**Television Antennas, 2nd Edition.** Tells how to select, install and service antennas. 224 pages, 5½ x 8½". Order TAG-1 ..... \$2.00

**Servicing TV in the Customer's Home.** Short-cut methods for repairs in the field; helps eliminate chassis removal. 96 pages, 5½ x 8½". Order TC-1 ..... \$1.50

**Making Money in TV Servicing.** Tells how to set up and operate a profitable TV service business. 136 pages, 5½ x 8½". Order MM-1 ..... \$1.25

**TV Tube Location Guides: Vol. 3.** Shows tube positions and functions in hundreds of TV receivers. Helps quickly locate faulty tube. 192 pages, 5½ x 8½". Order TGL-3 ..... \$2.00

Vol. 2. Covers receivers not included in Vols. 1 and 3. 208 pages, 5½ x 8½". Order TGL-2. \$2.00

Vol. 1. Covers hundreds of sets made by 56 mfgs. 208 pages, 5½ x 8½". Order TGL-1. \$1.50

### AUDIO PUBLICATIONS

**Recording & Reproduction of Sound.** Oliver Read's biggest selling volume on all aspects of Audio; fully covers recording and amplifying methods and equipment. Authoritative, complete. 810 pages, 6 x 9". Order RR-2 ..... \$7.95

**Audio Amplifiers, Vol. 3.** Full analysis of 50 audio amplifiers and 22 tuners made during 1950. 352 pages, 8½ x 11". Order AA-3 ..... \$3.95

Vol. 2. Covers 104 amplifiers and 12 tuners produced during 1949. 368 pages, 8½ x 11". Order AA-2 ..... \$3.95

Vol. 1. Covers 102 amplifiers and tuners produced from 1946-1948. 352 pages, 8½ x 11". Order AA-1 ..... \$3.95

### RECORD CHANGER MANUALS

Vol. 4. Full service data on 38 changers and recorders made during 1951. 288 pages, 8½ x 11". Order CM-4 ..... \$3.00

Vol. 3. Covers 44 changers and tuners made in 1949 and 1950. 288 pages, 8½ x 11". Order CM-3 ..... \$3.00

Vol. 2. Covers 45 models made in 1948 and early 1949. 432 pages, 8½ x 11". Order CM-2 ..... \$4.95

Vol. 1. Covers 41 post-war models made up to 1948. 396 pages, 8½ x 11". Order CM-1 ..... \$3.95

### COMMUNICATIONS RECEIVERS

Vol. 2. Full analysis of 26 popular communications receivers made during recent years. 190 pages, 8½ x 11". Order CR-2 ..... \$3.00

Vol. 1. Covers 50 well-known models produced from 1946 to 1948. 264 pages, 8½ x 11". Order CR-1 ..... \$3.00

Get these PHOTOFACT Publications  
at your Parts Distributor



ADMIRAL-Cont.

Model 20X122 Tel. Rec. (See Ch. 20X1)
Model 20X136 Tel. Rec. (See Ch. 20X1)
Models 20X145, 20X146, 20X147 Tel. Rec. (See Ch. 20Y1)
Model 22X12 Tel. Rec. (See Ch. 20Z1)
Models 22X25, 22X26, 22X27 Tel. Rec. (See Ch. 20Z1)
Models 24A11, 24A12 Tel. Rec. (See Ch. 20A1)
Model 24A125 Tel. Rec. (See Ch. 20A1)
Model 24A125AN Tel. Rec. (See Ch. 20X1)
Models 24A126, 24A127 Tel. Rec. (See Ch. 20A1)
Models 24C15, 24C16, 24C17 Tel. Rec. (See Ch. 20B1)
Models 24R11, 24R12 Tel. Rec. (See Ch. 20B1)
Models 24X15, S, 24X16, S, 24X17S Tel. Rec. (See Ch. 20X1)
Models 25A15, 25A16, 25A17 Tel. Rec. (See Ch. 20A1)
Models 26R11, 26R12 Tel. Rec. (See Ch. 21B1)
Model 26R25 Tel. Rec. (See Ch. 24H1)
Model 26R25A Tel. Rec. (See Ch. 21B1)
Model 26R26 Tel. Rec. (See Ch. 24H1)
Model 26R26A Tel. Rec. (See Ch. 21B1)
Model 26R35 Tel. Rec. (See Ch. 24H1)
Model 26R35A Tel. Rec. (See Ch. 21B1)
Model 26R36 Tel. Rec. (See Ch. 24H1)
Model 26R36A Tel. Rec. (See Ch. 21B1)
Model 26R37 Tel. Rec. (See Ch. 24H1)
Model 26R37A Tel. Rec. (See Ch. 21B1)
Models 26X35, 26X36 Tel. Rec. (See Ch. 24D1)
Model 26X36AS, S Tel. Rec. (See Ch. 21E1)
Model 26X37 Tel. Rec. (See Ch. 24H1)
Models 26X45, 26X46 Tel. Rec. (See Ch. 24H1)
Models 26X55, 26X56, 26X57 Tel. Rec. (See Ch. 24D1)
Models 26X55A, 26X56A, 26X57A Tel. Rec. (See Ch. 21D1)
Models 26X65, 26X66, 26X67 Tel. Rec. (See Ch. 24D1)
Models 26X65A, 26X66A, 26X67A Tel. Rec. (See Ch. 21D1)
Models 26X75, 26X76 Tel. Rec. (See Ch. 24D1)
Models 26X75A, 26X76A Tel. Rec. (See Ch. 21D1)
Model 26X77 Tel. Rec. (See Ch. 21F1)
Models 27K15, A, B, 27K16, A, B, 27K17, A, B Tel. Rec. (See Ch. 21F1)
Models 27K25, A, B, 27K26, A, B Tel. Rec. (See Ch. 21F1)
Models 27K35, A, B, 27K36, A, B Tel. Rec. (See Ch. 21F1)
Models 27K46, A, B Tel. Rec. (See Ch. 21F1)
Models 27K85, 27K86, 27K87 Tel. Rec. (See Ch. 21F1)
Model 27M12 Tel. Rec. (See Ch. 21F1)
Models 27M26, 27M27 Tel. Rec. (See Ch. 21F1)
Models 27M35, 27M36 Tel. Rec. (See Ch. 21F1)
Models 29X15, 29X16, 29X17 Tel. Rec. (See Ch. 24F1)
Model 29X25 Tel. Rec. (See Ch. 24F1)
Model 29X25A Tel. Rec. (See Ch. 21H1)
Model 29X26 Tel. Rec. (See Ch. 24F1)
Model 29X26A Tel. Rec. (See Ch. 21H1)
Model 29X27 Tel. Rec. (See Ch. 24F1)
Models 30A12, 30A13 (S or SN) Tel. Rec. (See Ch. 30A1)
Models 30A14, 30A15, 30A16 Tel. Rec. (See Ch. 30A1)
Models 30B15S, SN, 30B16S, SN, 30B17S, SN Tel. Rec. (See Ch. 30B1)
Models 30C15S, SN, 30C16S, SN, 30C17S, SN Tel. Rec. (See Ch. 30C1)
Models 30F15, A, 30F16, A, 30F17, A Tel. Rec. (See Ch. 20A1)
Models 32X15, 32X16 Tel. Rec. (See Ch. 20Z1)
Models 32X26, 32X27 Tel. Rec. (See Ch. 20Z1)
Models 32X35, 32X36 Tel. Rec. (See Ch. 20Z1)

ADMIRAL-Cont.

Models 34R15, A, 34R16, A Tel. Rec. (See Ch. 20V1)
Model 36K37 Tel. Rec. (See Ch. 21K1)
Models 36R45, 36R46 Tel. Rec. (See Ch. 21C1)
Models 36X35, 36X36, 36X37 Tel. Rec. (See Ch. 24E1 and Ch. 5B2)
Models 36X35A, 37X36A, 36X37A Tel. Rec. (See Ch. 24E1 and Ch. 5D2)
Models 37F15, A, B, 37F16, A, B Tel. Rec. (See Ch. 21G1 or Ch. 21Q1 and Ch. 5D2)
Models 37F27, A, B, 37F28, A, B Tel. Rec. (See Ch. 21G1 or 21Q1 and Ch. 5D2)
Models 37F35, A, B, 37F36, A, B Tel. Rec. (See Ch. 21G1 or 21Q1 and Ch. 5D2)
Models 37F55, 37F56, 37F67 Tel. Rec. (See Ch. 21G1 or 21Q1 and Ch. 5D2)
Models 37K15, A, B, 37K16, A, B Tel. Rec. (See Ch. 21G1 or 21Q1 and Ch. 3C1)
Models 37K27, A, B, 37K28, A, B Tel. Rec. (See Ch. 21G1 or 21Q1 and Ch. 3C1)
Models 37K35, A, B, 37K36, A, B Tel. Rec. (See Ch. 21G1 or 21Q1 and Ch. 3C1)
Models 37K55, 37K56, 37K57 Tel. Rec. (See Ch. 21G1 or 21Q1 and Ch. 3C1)
Models 37M15, 37M16 and Ch. 5D2)
Models 37M15, 37M16 or 21Q1 and Ch. 3C1)
Models 37M25, 37M26, 37M27 Tel. Rec. (See Ch. 21Z1)
Models 39X16, A, 39X17A Tel. Rec. (See Ch. 24G1 and Ch. 5B2)
Models 39X16B, 39X17B Tel. Rec. (See Ch. 24G1 and Ch. 5D2)
Model 39X17C Tel. Rec. (See Ch. 21J1)
Models 39X25, 39X26 Tel. Rec. (See Ch. 24F1 and Ch. 5D2)
Models 39X25A, 39X26A Tel. Rec. (See Ch. 21J1)
Models 39X35, 39X36, 39X37 Tel. Rec. (See Ch. 21J1 and Ch. 3C1)
Models 47M15, A, 47M16, 47M17 Tel. Rec. (See Ch. 21W1)
Models 47M35, 47M36, 47M37 Tel. Rec. (See Ch. 21Z1)
Models 52M15, 52M16, 52M17 Tel. Rec. (See Ch. 21Y1)
Models 57M10, 57M11, 57M12 Tel. Rec. (See Ch. 21Z1A)
Model 121DX10 Tel. Rec. (See Ch. 19C1)
Model 121DX11 Tel. Rec. (See Ch. 19F1A)
Model 121DX12 Tel. Rec. (See Ch. 19C1)
Model 121DX12A Tel. Rec. (See Ch. 19C1 or 19F1)
Model 121DX16 Tel. Rec. (See Ch. 19C1)
Model 121DX16A Tel. Rec. (See Ch. 19C1 or 19F1)
Model 121DX16L Tel. Rec. (See Ch. 19K1)
Model 121DX17 Tel. Rec. (See Ch. 19C1)
Model 121DX17A Tel. Rec. (See Ch. 19C1 or 19F1)
Model 121DX17L Tel. Rec. (See Ch. 19K1)
Models 121K15, 121K16, 121K17A Tel. Rec. (See Ch. 22M1)
Model 121M10 Tel. Rec. (See Ch. 22M1)
Models 121M11, 121M12 Tel. Rec. (See Ch. 21M1)
Models 121M11A, 121M12A Tel. Rec. (See Ch. 22M1)
Model 122DX15 Tel. Rec. (See Ch. 19C1)
Model 122DX15A Tel. Rec. (See Ch. 19C1 or 19F1)
Model 122DX15L Tel. Rec. (See Ch. 19K1)
Model 122DX16 Tel. Rec. (See Ch. 19C1)
Models 122DX16A Tel. Rec. (See Ch. 19C1 or 19F1)
Model 122DX17 Tel. Rec. (See Ch. 19C1)
Model 122DX17A Tel. Rec. (See Ch. 19C1 or 19F1)
Model 122DX17L Tel. Rec. (See Ch. 19K1)
Model 122DX26 Tel. Rec. (See Ch. 19C1)
Model 122DX26L Tel. Rec. (See Ch. 19K1)
Model 122DX38 Tel. Rec. (See Ch. 19C1)

ADMIRAL-Cont.

Model 221DX38A Tel. Rec. (See Ch. 19C1 or 19F1)
Models 221K16, A Tel. Rec. (See Ch. 21K1)
Model 221K26 Tel. Rec. (See Ch. 21K1)
Model 221K28 Tel. Rec. (See Ch. 21K1)
Models 221K35, 221K36 Tel. Rec. (See Ch. 21K1)
Models 221K45, 221K46, 221K47 Tel. Rec. (See Ch. 21M1)
Models 221K45A, 221K46A, 221K47A Tel. Rec. (See Ch. 22M1)
Models 221M26, 221M27 Tel. Rec. (See Ch. 21K1)
Model 222DX15 Tel. Rec. (See Ch. 19H1)
Model 222DX15S Tel. Rec. (See Ch. 22C2)
Models 222DX16, 222DX17 Tel. Rec. (See Ch. 22C2)
Model 222DX26, 222DX27 Tel. Rec. (See Ch. 22C2)
Models 222DX48, 222DX49 Tel. Rec. (See Ch. 22C2)
Models 228DX16, 228DX17 Tel. Rec. (See Ch. 23A1)
Model 320R17 Tel. Rec. (See Ch. 21J1)
Models 320R25, 320R27 Tel. Rec. (See Ch. 21J1)
Models 321DX15, 321DX16, 321DX17 Tel. Rec. (See Ch. 19E1)
Models 321DX16A, 321DX17A Tel. Rec. (See Ch. 19E1 or Ch. 19G1)
Models 321DX15L, 321DX16L, 321DX17L Tel. Rec. (See Ch. 19N1)
Model 321DX16L Tel. Rec. (See Ch. 19E1 or Ch. 19G1)
Model 321DX26 Tel. Rec. (See Ch. 19E1)
Model 321DX26B Tel. Rec. (See Ch. 19E1 or Ch. 19G1)
Model 321DX27B Tel. Rec. (See Ch. 19E1 or Ch. 19G1)
Models 321F15, 321F16 Tel. Rec. (See Ch. 21L1 and Ch. 5D2)
Model 321F18 Tel. Rec. (See Ch. 21L1 and Ch. 5D2)
Model 321F27 Tel. Rec. (See Ch. 21L1 and Ch. 5D2)
Models 321F35, 321F36 Tel. Rec. (See Ch. 21L1 and Ch. 5D2)
Models 321F46, 321F47 Tel. Rec. (See Ch. 21L1 and Ch. 5D2)
Model 321F49 Tel. Rec. (See Ch. 21L1 and Ch. 5D2)
Models 321F65, 321F66, 321F67 Tel. Rec. (See Ch. 21W1 and Ch. 5D2)
Models 321K15, 321K16 Tel. Rec. (See Ch. 21L1 and Ch. 3C1)
Model 321K18 Tel. Rec. (See Ch. 21L1 and Ch. 3C1)
Model 321K27 Tel. Rec. (See Ch. 21L1 and Ch. 3C1)
Model 321K35, 321K36 Tel. Rec. (See Ch. 21L1 and Ch. 3C1)
Models 321K46, 321K47 Tel. Rec. (See Ch. 21L1 and Ch. 3C1)
Model 321K49 Tel. Rec. (See Ch. 21L1 and Ch. 3C1)
Models 321K65, 321K66, 321K67 Tel. Rec. (See Ch. 21N1 and Ch. 3C1)
Models 321M25, 321M26, 321M27 Tel. Rec. (See Ch. 21Y1)
Models 321M25A, 321M26A, 321M27A Tel. Rec. (See Ch. 22Y1)
Model 322DX16 Tel. Rec. (See Ch. 22E2)
Models 421M15, 421M16 Tel. Rec. (See Ch. 21Y1)
Models 421M15A, 421M16A Tel. Rec. (See Ch. 22Y1)
Models 421M35, 421M36, 421M37 Tel. Rec. (See Ch. 22Y1)
Models 520M11, 520M12 Tel. Rec. (See Ch. 22A2)
Models 520M15, 520M16, 520M17 Tel. Rec. (See Ch. 22A2)
Models 521M15, 521M16, 52M17 Tel. Rec. (See Ch. 21Y1)
Models 521M15A, 521M16A, 521M17A Tel. Rec. (See Ch. 22Y1)
AERMOVIE
181-AD ..... 12-1
AERO (See Record Changer Listing)
AIMCEE (See AMC)
AIRADIO
SU-410 ..... 11-1
SU-52A, B, C (Receiver) ..... 13-2
TRA-1A, B, C (Transmitter) ..... 37-1
3100 ..... 37-1

AIRCASLE

C-300 ..... 136-3
DM-700 ..... 85-1
EV-760 ..... 85
G-516, G-518 ..... 48-3
G-521 ..... 54-3
G-724 ..... 52-25
G-725 ..... 50-1
K1 ..... 93-1
P-20 ..... 71-3
P-22 ..... 87-1
PAM-1 ..... 101-1
PC-8, PC-358 ..... 99-1
PM-7 ..... 100-2
PM-358 ..... 98-1
PX ..... 13-35
REV248 ..... 127-2
RZU248 (See Model REV248-Set 127-2)
SC-448 ..... 62-3
TD-6 ..... 103-3
WEU-262 ..... 91-1
WRA-1A ..... 47-1
WRA-4M ..... 60-1
XB702, XB703 Tel. Rec. .... 93A-1
X1750, XP775 Tel. Rec. .... 93A-1
OA-358-VM (See Model 358VM-Set 127-3)
06-F, 06-L ..... 135-3
78 ..... 52-1
9 ..... 50-2
10C, 10T Tel. Rec. (See Model 14C-Set 140-3)
12C, 12T Tel. Rec. (See Model 14C-Set 140-3)
14C, 14T Tel. Rec. .... 140-3
15 ..... 67-2
16C, 16T Tel. Rec. (See Model 14C-Set 140-3)
17C, 17T Tel. Rec. .... 140-3
20XUT Tel. Rec. .... 185-3
79A ..... 137-3
88, 88W ..... 142-2
101 ..... 86-1
102B ..... 98-2
105B ..... 13-3
150, 153 ..... 126-2
171, 172 ..... 96-1
198 ..... 83-1
200 ..... 139-3
201 ..... 81-1
212 ..... 65-1
213 ..... 63-1
2271, 227W ..... 84-1
312 Tel. Rec. (See Model 14C-Set 140-3)
316 Tel. Rec. (See Model 14C-Set 140-3)
350 ..... 136-4
358VM ..... 127-3
412 Tel. Rec. (See Model 14C-Set 140-3)
416 Tel. Rec. (See Model 14C-Set 140-3)
472, JP24, 472, JP25 (See Model 472,MP25-Set 168-1)
472,MP24 (See Model 472,MP25-Set 168-1)
472,MP25 ..... 168-1
472,053VM ..... 163-2
472,17XUT, 472,17XUT.1, 472, XUT.2, 472, XUT.3 (Ch. 217B) Tel. Rec. (See Model 20XUT-Set 185-3)
472,20XUC (Ch. 220B) Tel. Rec. (See Model 20XUT-Set 185-3)
472,20XUT, 472,20XUT.1, 472,20XUT.2 (Ch. 220B) 20XUT-Set 185-3)
568 ..... 14-1
568,205 ..... 141-2
568,205-1 (See Model 200-Set 139-3)
568,305 ..... 141-2
572 ..... 55-1
594,935 (See Model 935-Set 128-2)
602,1R2144 ..... 114-2
603,PR-81 ..... 133-2
604 ..... 53-2
606,400WB ..... 119-2
607,299 ..... 177-3
607,314, 607,315 ..... 122-2
607,316, -1, 607,317, -1 ..... 138-2
610,C351 ..... 174-2
610,CL152B, ..... 208-1
610,D200 ..... 142-3
610,F100 ..... 138-3
610,F151 ..... 172-2
610,H400 ..... 178-2
610,P-651.1 ..... 179-2
610,S500 ..... 184-2
621 (Ch. FJ-91) ..... 14-2
626 ..... 18-3
641 ..... 17-1
651 ..... 15-1
652,A25, 652,A35 ..... 169-2
652,6T1E, V ..... 205-2
652,32E5A ..... 210-3
652,4875 ..... 211-3
652,505 ..... 168-2
659,511, 659,513 ..... 167-2
659,520E, I ..... 185-4
9151, W ..... 129-2
935 ..... 128-2
9651, 965K1, W (See Model 9511-Set 129-2)
1400C, 1400T Tel. Rec. .... 140-3
1700C, 1700T Tel. Rec. .... 140-3
2000C Tel. Rec. .... 140-3
3170 Tel. Rec. (For TV Ch. See Set 140-3, For Radio Ch. See Model 150-Set 126-2)
4170 Tel. Rec. (For TV Ch. See Set 140-3, For Radio Ch. See Model 350-Set 136-4)
5000, 5001 ..... 16-2
5002 ..... 19-1
5003, 5004, 5005, 5006 ..... 20-1
5008, 5009 ..... 46-1

AIRCASLE-Cont.

5010, 5011, 5012 (Ch. 110) ..... 13-4
5015-1 ..... 118-3
5020 ..... 16-3
5022 ..... 123-2
5024 ..... 45-1
5025 ..... 24-2
5027 ..... 49-3
5028 ..... 44-1
5029 ..... 51-1
5035 ..... 46-2
5036 ..... 72-2
5044 ..... 121-2
5050 ..... 48-4
5052 ..... 45-2
5056-A ..... 120-2
6042 ..... 61-1
6050 ..... 74-1
6053 ..... 97-1
6541 ..... 18-4
6541 ..... 17-2
6544 (See Model 6541-Set 17-2)
6547 ..... 17-2
6611, 6612, 6613, 6630, 6631, 6632, 6634, 6635 ..... 15-2
7000, 7001 ..... 14-3
7004 ..... 19-2
7014, 7015 ..... 57-3
7015 Early ..... 47-2
7008B, 9008B ..... 99-2
90091, 9009W ..... 97-2
9101, 9012W ..... 94-1
10002 ..... 54-1
10003-1 ..... 46-2
10005 ..... 62-3
10021-1, 10022-1 ..... 59-3
10023 ..... 58-1
10024-1 ..... 58-2
108014, 108504 ..... 57-4
121104 ..... 73-4
12112 ..... 61-2
127084 ..... 55-2
131504 ..... 60-2
132564 ..... 69-1
138104 ..... 54-3
138124 ..... 64-1
139114 (See Model 139144-Set 59-4)
147114 ..... 56-3
149654 ..... 71-4
150084 ..... 71-4
159144 (See Model 139144-Set 59-4)
AIR CHIEF (See Firestone)
AIR KING
A-400 (Ch. 470) ..... 23-1
A-403 ..... 20-2
A-410 ..... 34-1
A-410 (Revised) ..... 40-1
A-426 ..... 43-1
A-501, A-502 (Ch. 465-4) ..... 31-3
A-510 ..... 24-3
A-511, A-512 ..... 30-2
A-520 ..... 49-4
A-600 ..... 26-3
A-604 ..... 81-2
A-625 ..... 50-3
A-650 ..... 45-4
A-1000, A-1001 Tel. Rec. .... 58-3
A1001A Tel. Rec. .... 75-2
A1016 Tel. Rec. .... 91-2
A2000, A2001 Tel. Rec. .... 75-2
A2002 Tel. Rec. (See Model A2000-Set 75-2)
A2010 Tel. Rec. .... 75-2
A2012 Tel. Rec. (See Model A1001A-Set 75-2)
12C1 Tel. Rec. (See Model 16C1-Set 121-3)
12T1, 12T2 Tel. Rec. (See Model 16C1-Set 121-3)
14T1 Tel. Rec. (See Model 16C1-Set 121-3)
16C1, 16C2, 16CS Tel. Rec. .... 121-3
16M1 Tel. Rec. .... 121-3
16T1 Tel. Rec. .... 121-3
16T18 Tel. Rec. (See Model 16C1-Set 121-3)
17C2 (Ch. 700-96) Tel. Rec. .... 151-2
17C5, B (Ch. 700-96) Tel. Rec. .... 151-2
17C7 (Ch. 700-96) Tel. Rec. .... 151-2
17K1 (Ch. 700-96) Tel. Rec. .... 151-2
17K1C (Ch. 700,110, 700,130) Tel. Rec. .... 150-2
17M1 (Ch. 700-96) Tel. Rec. .... 151-2
17T1 (Ch. 700-96) Tel. Rec. .... 151-2
19C1 Tel. Rec. .... 121-3
20C1, 20C2 (Ch. 700-93) Tel. Rec. .... 151-2
20K1 (Ch. 700-95) Tel. Rec. .... 151-2
20M1 (Ch. 700-93) Tel. Rec. .... 151-2
718R Tel. Rec. .... 121-3
800 ..... 66-1
2017R Tel. Rec. .... 111-2
4609-Set 11-2)
4603 ..... 3-26
4604 ..... 4-25
4704D (See Model 4604-Set 4-25)
4607, 4608 ..... 3-1
4609, 4610 (Early (See Model 4607-Set 3-1)
4609, 4610 (Late) ..... 11-2
4625 ..... 13-8
4700 ..... 39-1
4704 ..... 12-2
4705, 4706 ..... 9-1
4708 (See Model 4704-Set 12-2)







**BENDIX—CORONADO**

**BENDIX—Cont.**

3051 Tel. Rec. (Also see Prod. Chge. Bul. 16—Set 126-1) ..... 111-3

6001 Tel. Rec. (Also see Prod. Chge. Bul. 16—Set 126-1) ..... 111-3

6002 Tel. Rec. .... 99-5

6003 Tel. Rec. (Also see Prod. Chge. Bul. 16—Set 126-1) ..... 111-3

6090 Tel. Rec. .... 111-3

6100 Tel. Rec. (Also see Prod. Chge. Bul. 16—Set 126-1) ..... 111-3

6920 Tel. Rec. .... 111-3

6990 Tel. Rec. .... 111-3

7001 Tel. Rec. (See Prod. Chge. Bul. 16—Set 126-1 and Model 2051—Set 111-3) Ch. C-19 (See Model 753F) (See David Bogen)

**BREWSTER**

9-1084, 9-1085, 9-1086... 2-13

**BROCRINER**

A10CP ..... 198-2

CA-2 ..... 200-3

**BROOK ELECTRONICS INC.**

38 (Issue 2), 3C ..... 184-4

10C ..... 41-4

10C2-A ..... 43-7

10C3 ..... 72-5

10D ..... 41-4

12A ..... 89-3

12A2, 12A3 (See Model 12A—Set 89-3 and Model 3C—Set 184-4)

**BROOKS ELECTRONIC LABS.**

ST-14A ..... 183-3

ST-10 ..... 195-5

**BROWNING**

PF-12, RJ12 ..... 47-4

RJ-12A ..... 56-6

RJ-12B ..... 146-4

RJ-14A ..... 56-6

RJ-20 ..... 67-5

RJ-20A ..... 132-3

RJ-22 ..... 67-5

RV-10 ..... 46-6

RV-10A ..... 131-3

RV-11 ..... 46-6

RV-31 ..... 198-3

**BRUNSWICK**

BJ-6836 "Tuscany" ..... 28-4

C-3300 "Darryl" ..... 28-4

D-1000, D-1100 ..... 56-7

D-6876 "Buckingham" ..... 29-5

T-4000, T-4000½ "Buckingham" ..... 29-5

T-4400, T-4400½ ..... 61-4

T-6000, S, S3, S4, S5, S6, S7, S8, S9, S10, S11, S12, S13, S14, S15, S16, S17, S18, S19, S20, S21, S22, S23, S24, S25, S26, S27, S28, S29, S30, S31, S32, S33, S34, S35, S36, S37, S38, S39, S40, S41, S42, S43, S44, S45, S46, S47, S48, S49, S50, S51, S52, S53, S54, S55, S56, S57, S58, S59, S60, S61, S62, S63, S64, S65, S66, S67, S68, S69, S70, S71, S72, S73, S74, S75, S76, S77, S78, S79, S80, S81, S82, S83, S84, S85, S86, S87, S88, S89, S90, S91, S92, S93, S94, S95, S96, S97, S98, S99, S100, S101, S102, S103, S104, S105, S106, S107, S108, S109, S110, S111, S112, S113, S114, S115, S116, S117, S118, S119, S120, S121, S122, S123, S124, S125, S126, S127, S128, S129, S130, S131, S132, S133, S134, S135, S136, S137, S138, S139, S140, S141, S142, S143, S144, S145, S146, S147, S148, S149, S150, S151, S152, S153, S154, S155, S156, S157, S158, S159, S160, S161, S162, S163, S164, S165, S166, S167, S168, S169, S170, S171, S172, S173, S174, S175, S176, S177, S178, S179, S180, S181, S182, S183, S184, S185, S186, S187, S188, S189, S190, S191, S192, S193, S194, S195, S196, S197, S198, S199, S200, S201, S202, S203, S204, S205, S206, S207, S208, S209, S210, S211, S212, S213, S214, S215, S216, S217, S218, S219, S220, S221, S222, S223, S224, S225, S226, S227, S228, S229, S230, S231, S232, S233, S234, S235, S236, S237, S238, S239, S240, S241, S242, S243, S244, S245, S246, S247, S248, S249, S250, S251, S252, S253, S254, S255, S256, S257, S258, S259, S260, S261, S262, S263, S264, S265, S266, S267, S268, S269, S270, S271, S272, S273, S274, S275, S276, S277, S278, S279, S280, S281, S282, S283, S284, S285, S286, S287, S288, S289, S290, S291, S292, S293, S294, S295, S296, S297, S298, S299, S300, S301, S302, S303, S304, S305, S306, S307, S308, S309, S310, S311, S312, S313, S314, S315, S316, S317, S318, S319, S320, S321, S322, S323, S324, S325, S326, S327, S328, S329, S330, S331, S332, S333, S334, S335, S336, S337, S338, S339, S340, S341, S342, S343, S344, S345, S346, S347, S348, S349, S350, S351, S352, S353, S354, S355, S356, S357, S358, S359, S360, S361, S362, S363, S364, S365, S366, S367, S368, S369, S370, S371, S372, S373, S374, S375, S376, S377, S378, S379, S380, S381, S382, S383, S384, S385, S386, S387, S388, S389, S390, S391, S392, S393, S394, S395, S396, S397, S398, S399, S400, S401, S402, S403, S404, S405, S406, S407, S408, S409, S410, S411, S412, S413, S414, S415, S416, S417, S418, S419, S420, S421, S422, S423, S424, S425, S426, S427, S428, S429, S430, S431, S432, S433, S434, S435, S436, S437, S438, S439, S440, S441, S442, S443, S444, S445, S446, S447, S448, S449, S450, S451, S452, S453, S454, S455, S456, S457, S458, S459, S460, S461, S462, S463, S464, S465, S466, S467, S468, S469, S470, S471, S472, S473, S474, S475, S476, S477, S478, S479, S480, S481, S482, S483, S484, S485, S486, S487, S488, S489, S490, S491, S492, S493, S494, S495, S496, S497, S498, S499, S500, S501, S502, S503, S504, S505, S506, S507, S508, S509, S510, S511, S512, S513, S514, S515, S516, S517, S518, S519, S520, S521, S522, S523, S524, S525, S526, S527, S528, S529, S530, S531, S532, S533, S534, S535, S536, S537, S538, S539, S540, S541, S542, S543, S544, S545, S546, S547, S548, S549, S550, S551, S552, S553, S554, S555, S556, S557, S558, S559, S560, S561, S562, S563, S564, S565, S566, S567, S568, S569, S570, S571, S572, S573, S574, S575, S576, S577, S578, S579, S580, S581, S582, S583, S584, S585, S586, S587, S588, S589, S590, S591, S592, S593, S594, S595, S596, S597, S598, S599, S600, S601, S602, S603, S604, S605, S606, S607, S608, S609, S610, S611, S612, S613, S614, S615, S616, S617, S618, S619, S620, S621, S622, S623, S624, S625, S626, S627, S628, S629, S630, S631, S632, S633, S634, S635, S636, S637, S638, S639, S640, S641, S642, S643, S644, S645, S646, S647, S648, S649, S650, S651, S652, S653, S654, S655, S656, S657, S658, S659, S660, S661, S662, S663, S664, S665, S666, S667, S668, S669, S670, S671, S672, S673, S674, S675, S676, S677, S678, S679, S680, S681, S682, S683, S684, S685, S686, S687, S688, S689, S690, S691, S692, S693, S694, S695, S696, S697, S698, S699, S700, S701, S702, S703, S704, S705, S706, S707, S708, S709, S710, S711, S712, S713, S714, S715, S716, S717, S718, S719, S720, S721, S722, S723, S724, S725, S726, S727, S728, S729, S730, S731, S732, S733, S734, S735, S736, S737, S738, S739, S740, S741, S742, S743, S744, S745, S746, S747, S748, S749, S750, S751, S752, S753, S754, S755, S756, S757, S758, S759, S760, S761, S762, S763, S764, S765, S766, S767, S768, S769, S770, S771, S772, S773, S774, S775, S776, S777, S778, S779, S780, S781, S782, S783, S784, S785, S786, S787, S788, S789, S790, S791, S792, S793, S794, S795, S796, S797, S798, S799, S800, S801, S802, S803, S804, S805, S806, S807, S808, S809, S810, S811, S812, S813, S814, S815, S816, S817, S818, S819, S820, S821, S822, S823, S824, S825, S826, S827, S828, S829, S830, S831, S832, S833, S834, S835, S836, S837, S838, S839, S840, S841, S842, S843, S844, S845, S846, S847, S848, S849, S850, S851, S852, S853, S854, S855, S856, S857, S858, S859, S860, S861, S862, S863, S864, S865, S866, S867, S868, S869, S870, S871, S872, S873, S874, S875, S876, S877, S878, S879, S880, S881, S882, S883, S884, S885, S886, S887, S888, S889, S890, S891, S892, S893, S894, S895, S896, S897, S898, S899, S900, S901, S902, S903, S904, S905, S906, S907, S908, S909, S910, S911, S912, S913, S914, S915, S916, S917, S918, S919, S920, S921, S922, S923, S924, S925, S926, S927, S928, S929, S930, S931, S932, S933, S934, S935, S936, S937, S938, S939, S940, S941, S942, S943, S944, S945, S946, S947, S948, S949, S950, S951, S952, S953, S954, S955, S956, S957, S958, S959, S960, S961, S962, S963, S964, S965, S966, S967, S968, S969, S970, S971, S972, S973, S974, S975, S976, S977, S978, S979, S980, S981, S982, S983, S984, S985, S986, S987, S988, S989, S990, S991, S992, S993, S994, S995, S996, S997, S998, S999, S1000, S1001, S1002, S1003, S1004, S1005, S1006, S1007, S1008, S1009, S1010, S1011, S1012, S1013, S1014, S1015, S1016, S1017, S1018, S1019, S1020, S1021, S1022, S1023, S1024, S1025, S1026, S1027, S1028, S1029, S1030, S1031, S1032, S1033, S1034, S1035, S1036, S1037, S1038, S1039, S1040, S1041, S1042, S1043, S1044, S1045, S1046, S1047, S1048, S1049, S1050, S1051, S1052, S1053, S1054, S1055, S1056, S1057, S1058, S1059, S1060, S1061, S1062, S1063, S1064, S1065, S1066, S1067, S1068, S1069, S1070, S1071, S1072, S1073, S1074, S1075, S1076, S1077, S1078, S1079, S1080, S1081, S1082, S1083, S1084, S1085, S1086, S1087, S1088, S1089, S1090, S1091, S1092, S1093, S1094, S1095, S1096, S1097, S1098, S1099, S1100, S1101, S1102, S1103, S1104, S1105, S1106, S1107, S1108, S1109, S1110, S1111, S1112, S1113, S1114, S1115, S1116, S1117, S1118, S1119, S1120, S1121, S1122, S1123, S1124, S1125, S1126, S1127, S1128, S1129, S1130, S1131, S1132, S1133, S1134, S1135, S1136, S1137, S1138, S1139, S1140, S1141, S1142, S1143, S1144, S1145, S1146, S1147, S1148, S1149, S1150, S1151, S1152, S1153, S1154, S1155, S1156, S1157, S1158, S1159, S1160, S1161, S1162, S1163, S1164, S1165, S1166, S1167, S1168, S1169, S1170, S1171, S1172, S1173, S1174, S1175, S1176, S1177, S1178, S1179, S1180, S1181, S1182, S1183, S1184, S1185, S1186, S1187, S1188, S1189, S1190, S1191, S1192, S1193, S1194, S1195, S1196, S1197, S1198, S1199, S1200, S1201, S1202, S1203, S1204, S1205, S1206, S1207, S1208, S1209, S1210, S1211, S1212, S1213, S1214, S1215, S1216, S1217, S1218, S1219, S1220, S1221, S1222, S1223, S1224, S1225, S1226, S1227, S1228, S1229, S1230, S1231, S1232, S1233, S1234, S1235, S1236, S1237, S1238, S1239, S1240, S1241, S1242, S1243, S1244, S1245, S1246, S1247, S1248, S1249, S1250, S1251, S1252, S1253, S1254, S1255, S1256, S1257, S1258, S1259, S1260, S1261, S1262, S1263, S1264, S1265, S1266, S1267, S1268, S1269, S1270, S1271, S1272, S1273, S1274, S1275, S1276, S1277, S1278, S1279, S1280, S1281, S1282, S1283, S1284, S1285, S1286, S1287, S1288, S1289, S1290, S1291, S1292, S1293, S1294, S1295, S1296, S1297, S1298, S1299, S1300, S1301, S1302, S1303, S1304, S1305, S1306, S1307, S1308, S1309, S1310, S1311, S1312, S1313, S1314, S1315, S1316, S1317, S1318, S1319, S1320, S1321, S1322, S1323, S1324, S1325, S1326, S1327, S1328, S1329, S1330, S1331, S1332, S1333, S1334, S1335, S1336, S1337, S1338, S1339, S1340, S1341, S1342, S1343, S1344, S1345, S1346, S1347, S1348, S1349, S1350, S1351, S1352, S1353, S1354, S1355, S1356, S1357, S1358, S1359, S1360, S1361, S1362, S1363, S1364, S1365, S1366, S1367, S1368, S1369, S1370, S1371, S1372, S1373, S1374, S1375, S1376, S1377, S1378, S1379, S1380, S1381, S1382, S1383, S1384, S1385, S1386, S1387, S1388, S1389, S1390, S1391, S1392, S1393, S1394, S1395, S1396, S1397, S1398, S1399, S1400, S1401, S1402, S1403, S1404, S1405, S1406, S1407, S1408, S1409, S1410, S1411, S1412, S1413, S1414, S1415, S1416, S1417, S1418, S1419, S1420, S1421, S1422, S1423, S1424, S1425, S1426, S1427, S1428, S1429, S1430, S1431, S1432, S1433, S1434, S1435, S1436, S1437, S1438, S1439, S1440, S1441, S1442, S1443, S1444, S1445, S1446, S1447, S1448, S1449, S1450, S1451, S1452, S1453, S1454, S1455, S1456, S1457, S1458, S1459, S1460, S1461, S1462, S1463, S1464, S1465, S1466, S1467, S1468, S1469, S1470, S1471, S1472, S1473, S1474, S1475, S1476, S1477, S1478, S1479, S1480, S1481, S1482, S1483, S1484, S1485, S1486, S1487, S1488, S1489, S1490, S1491, S1492, S1493, S1494, S1495, S1496, S1497, S1498, S1499, S1500, S1501, S1502, S1503, S1504, S1505, S1506, S1507, S1508, S1509, S1510, S1511, S1512, S1513, S1514, S1515, S1516, S1517, S1518, S1519, S1520, S1521, S1522, S1523, S1524, S1525, S1526, S1527, S1528, S1529, S1530, S1531, S1532, S1533, S1534, S1535, S1536, S1537, S1538, S1539, S1540, S1541, S1542, S1543, S1544, S1545, S1546, S1547, S1548, S1549, S1550, S1551, S1552, S1553, S1554, S1555, S1556, S1557, S1558, S1559, S1560, S1561, S1562, S1563, S1564, S1565, S1566, S1567, S1568, S1569, S1570, S1571, S1572, S1573, S1574, S1575, S1576, S1577, S1578, S1579, S1580, S1581, S1582, S1583, S1584, S1585, S1586, S1587, S1588, S1589, S1590, S1591, S1592, S1593, S1594, S1595, S1596, S1597, S1598, S1599, S1600, S1601, S1602, S1603, S1604, S1605, S1606, S1607, S1608, S1609, S1610, S1611, S1612, S1613, S1614, S1615, S1616, S1617, S1618, S1619, S1620, S1621, S1622, S1623, S1624, S1625, S1626, S1627, S1628, S1629, S1630, S1631, S1632, S1633, S1634, S1635, S1636, S1637, S1638, S1639, S1640, S1641, S1642, S1643, S1644, S1645, S1646, S1647, S1648, S1649, S1650, S1651, S1652, S1653, S1654, S1655, S1656, S1657, S1658, S1659, S1660, S1661, S1662, S1663, S1664, S1665, S1666, S1667, S1668, S1669, S1670, S1671, S1672, S1673, S1674, S1675, S1676, S1677, S1678, S1679, S1680, S1681, S1682, S1683, S1684, S1685, S1686, S1687, S1688, S1689, S1690, S1691, S1692, S1693, S1694, S1695, S1696, S1697, S1698, S1699, S1700, S1701, S1702, S1703, S1704, S1705, S1706, S1707, S1708, S1709, S1710, S1711, S1712, S1713, S1714, S1715, S1716, S1717, S1718, S1719, S1720, S1721, S1722, S1723, S1724, S1725, S1726, S1727, S1728, S1729, S1730, S1731, S1732, S1733, S1734, S1735, S1736, S1737, S1738, S1739, S1740, S1741, S1742, S1743, S1744, S1745, S1746, S1747, S1748, S1749, S1750, S1751, S1752, S1753, S1754, S1755, S1756, S1757, S1758, S1759, S1760, S1761, S1762, S1763, S1764, S1765, S1766, S1767, S1768, S1769, S1770, S1771, S1772, S1773, S1774, S1775, S1776, S1777, S1778, S1779, S1780, S1781, S1782, S1783, S1784, S1785, S1786, S1787, S1788, S1789, S1790, S1791, S1792, S1793, S1794, S1795, S1796, S1797, S1798, S1799, S1800, S1801, S1802, S1803, S1804, S1805, S1806, S1807, S1808, S1809, S1810, S1811, S1812, S1813, S1814, S1815, S1816, S1817, S1818, S1819, S1820, S1821, S1822, S1823, S1824, S1825, S1826, S1827, S1828, S1829, S1830, S1831, S1832, S1833, S1834, S1835, S1836, S1837, S1838, S1839, S1840, S1841, S1842, S1843, S1844, S1845, S1846, S1847, S1848, S1849, S1850, S1851, S1852, S1853, S1854, S1855, S1856, S1857, S1858, S1859, S1860, S1861, S1862, S1863, S1864, S1865, S1866, S1867, S1868, S1869, S1870, S1871, S1872, S1873, S1874, S1875, S1876, S1877, S1878, S1879, S1880, S1881, S1882, S1883, S1884, S1885, S1886, S1887, S1888, S1889, S1890, S1891, S1892, S1893, S1894, S1895, S1896, S1897, S1898, S1899, S1900, S1901, S1902, S1903, S1904, S1905, S1906, S1907, S1908, S1909, S1910, S1911, S1912, S1913, S1914, S1915, S1916, S1917, S1918, S1919, S1920, S1921, S1922, S1923, S1924, S1925, S1926, S1927, S1928, S1929, S1930, S1931, S1932, S1933, S1934, S1935, S1936, S1937, S1938, S1939, S1940, S1941, S1942, S1943, S1944, S1945, S1946, S1947, S1948, S1949, S1950, S1951, S1952, S1953, S1954, S1955, S1956, S1957, S1958, S1959, S1960, S1961, S1962, S1963, S1964, S1965, S1966, S1967, S1968, S1969, S1970, S1971, S1972, S1973, S1974, S1975, S1976, S1977, S1978, S1979, S1980, S1981, S1982, S1983, S1984, S1985, S1986, S1987, S1988, S1989, S1990, S1991, S1992, S1993, S1994, S1995, S1996, S1997, S1998, S1999, S2000, S2001, S2002, S2003, S2004, S2005, S2006, S2007, S2008, S2009, S2010, S2011, S2012, S2013, S2014, S2015, S2016, S2017, S2018, S2019, S2020, S2021, S2022, S2023, S2024, S2025, S2026, S2027, S2028, S2029, S2030, S2031, S2032, S2033, S2034, S2035, S2036, S2037, S2038, S2039, S2040, S2041, S2042, S2043, S2044, S2045, S2046, S2047, S2048, S2049, S2050, S2051, S2052, S2053, S2054, S2055, S2056, S2057, S2058, S2059, S2060, S2061, S2062, S2063, S2064, S2065, S2066, S2067, S2068



**CORONADO-Cont.**

15TV2-43-9012A, 15TV2-43-9013A Tel. Rec. 144-3  
 15TV2-43-9025A, B, 15TV2-43-9026A, B Tel. Rec. 152-4  
 15TV2-43-9101A, 15TV2-43-9102A Tel. Rec. 152-4  
 15TV4-43-8948A, 15TV4-43-8949A Tel. Rec. 175-7  
 25TV2-43-9022A Tel. Rec. 183-4  
 25TV2-43-9022B Tel. Rec. 183-4  
 (See Prod. Chge. Bul. 65—Set 202-1 and Model 25TV2-43-9022A—Set 183-4)  
 25TV2-43-9022C Tel. Rec. (See Prod. Chge. Bul. 65—Set 202-1, Prod. Chge. Bul. 72—Set 212-1 and Model 25TV2-43-9022A—Set 183-4)  
 25TV2-43-9045A, B Tel. Rec. 199-5  
 25TV2-43-9045C Tel. Rec. (See Prod. Chge. Bul. 68—Set 205-1 and Model 25TV2-43-9045A—Set 199-5)  
 25TV2-43-9060A Tel. Rec. 199-5  
 25TV2-43-9060B Tel. Rec. (See Prod. Chge. Bul. 68—Set 205-1 and Model 25TV2-43-9060A—Set 199-5)  
 35TV2-43-9022C Tel. Rec. (See Prod. Chge. Bul. 65—Set 202-1, Prod. Chge. Bul. 72—Set 212-1 and Model 25TV2-43-9022A—Set 183-4)  
 35TV2-43-9045D Tel. Rec. (See Prod. Chge. Bul. 68—Set 205-1, Prod. Chge. Bul. 71—Set 211-1 and Model 25TV2-43-9045B—Set 199-5)  
 35TV2-43-9060C Tel. Rec. (See Prod. Chge. Bul. 66—Set 205-1, Prod. Chge. Bul. 71—Set 211-1 and Model 25TV2-43-9060A—Set 199-5)  
 43-2027 11-3  
 43-5005 28-36  
 43-6301 7-4  
 43-6451 10-10  
 43-6485 46-9  
 43-6730 (See Model 94RA31-43-8115A—Set 11-4)  
 43-7601 (See Model 43-7601B—Set 10-11)  
 43-7602 (See Model 43-7601B—Set 10-11)  
 43-7651 9-7  
 43-7652 (See Model 43-7651—Set 9-7)  
 43-7851 47-5  
 43-8101 (See Model 94RA31-43-8115A—Set 8-5)  
 43-8130C, 43-8131C (See Model 94RA33-43-8130C—Set 82-3)  
 43-8160 12-7  
 43-8177 (See Model 43-8178—Set 21-8)  
 43-8178 21-8  
 43-8180 10-12  
 43-8190 19-11  
 43-8201 (See Model 43-8178—Set 21-8)  
 43-8213 7-5  
 43-8240, 43-8241 12-8  
 43-8305 8-3  
 43-8312A 8-4  
 43-8330 19-12  
 43-8351, 43-8352 12-9  
 43-8353, 43-8354 28-7  
 43-8420 24-13  
 43-8421 8-3  
 43-8471 8-4  
 43-8576B 9-8  
 43-8685 11-4  
 43-8965 Tel. Rec. 86-3  
 43-9030 Tel. Rec. 182-3  
 43-9031 Tel. Rec. 182-3  
 43-9041 Tel. Rec. 182-3  
 43-9196 14-35  
 43-9201 24-14  
 94RA1-43-6945A 69-6  
 94RA1-43-7605A 65-5  
 94RA1-43-7650A, 94RA1-43-7651A 73-2  
 94RA1-43-7751A 87-3  
 94RA1-43-8510A, 94RA1-43-8511A 71-7  
 94RA1-43-8510B, 94RA1-43-8511B 75-6  
 94RA2-43-8230A 162-3  
 94RA4-43-8129A, 94RA4-43-8130A, 94RA4-43-8130B, 94RA4-43-8131A, 94RA4-43-8131B 62-10  
 94RA31-43-8115A, B, 94RA31-43-8116A 81-5  
 94RA31-43-9841A 79-3  
 94RA33-43-8130C, 94RA33-43-8131C 82-3  
 94TV1-43-8900A Tel. Rec. \*  
 94TV1-43-9002A Tel. Rec. \*  
 94TV2-43-8970A, 94TV2-43-8971A, 94TV2-43-8972A, 94TV2-43-8973A, 94TV2-43-8974A, 94TV2-43-8975A, 94TV2-43-8976A, 94TV2-43-8977A, 94TV2-43-8978A, 94TV2-43-8979A, 94TV2-43-8980A, 94TV2-43-8981A, 94TV2-43-8982A, 94TV2-43-8983A, 94TV2-43-8984A, 94TV2-43-8985A Tel. Rec. 78-4  
 94TV6-43-8953A Tel. Rec. 106-3

**CORONADO-Cont.**

165 (See Model 94RA31-43-8115A—Set 81-5)  
 197, U (See Model 94RA31-43-8115A—Set 81-5)  
 2027 (See Model 43-2027—Set 11-3)  
 5005 (See Model 43-5005—Set 28-36)  
 6301 (See Model 43-6301—Set 7-4)  
 641 (See Model 43-6451—Set 10-10)  
 6485 (See Model 43-6485—Set 46-9)  
 6730 (See Model 43-6685—Set 11-4)  
 6945A (See Model 94RA1-43-6945A—Set 69-6)  
 7601, B, 7602 (See Model 43-7601B—Set 10-11)  
 7605A (See Model 94RA1-43-7605A—Set 65-5)  
 7651, 7652 (See Model 43-7651—Set 9-7)  
 7654A, 7654B (See Model 15RA1-43-7654A—Set 147-3)  
 7656A, 7657A (See Model 94RA1-43-7656A—Set 73-2)  
 7751 (See Model 94RA1-43-7751A—Set 87-3)  
 7755A, B (See Model 05RA1-43-7755A—Set 101-2)  
 7851 (See Model 43-7851—Set 47-5)  
 7901A, 7901B (See Model 05RA1-43-7901A—Set 115-2)  
 7902A (See Model 15RA1-43-7902A—Set 134-6)  
 8101 (See Model 94RA31-43-8115A—Set 81-5)  
 8115A, B, 8116A (See Model 94RA31-43-8115A—Set 81-5)  
 8120A (See Model 05RA33-43-8120A—Set 110-6)  
 8129A, 8130A, B, 8131A, B (See Model 94RA4-43-8129A—Set 62-10)  
 8130C, 8131C (See Model 94RA33-43-8130C—Set 82-3)  
 8160 (See Model 43-8160—Set 12-7)  
 8177, 8178 (See Model 43-8177—Set 21-8)  
 8180 (See Model 43-8180—Set 10-12)  
 8190 (See Model 43-8190—Set 19-11)  
 8201 (See Model 43-8178—Set 21-8)  
 8213 (See Model 43-8213—Set 7-5)  
 8230A (See Model 05RA2-43-8230A—Set 162-3)  
 8240, 8241 (See Model 43-8240—Set 12-8)  
 8245A, 8246A (See Model 15RA33-43-8245A—Set 174-5)  
 8305 (See Model 43-8305—Set 8-3)  
 8312A (See Model 43-8312A—Set 8-4)  
 8330 (See Model 43-8330—Set 19-12)  
 8351, 8352 (See Model 43-8351—Set 12-9)  
 8353, 8354 (See Model 43-8353—Set 28-7)  
 8360A (See Model 05RA33-43-8360A—Set 102-3)  
 8365 (See Model 15RA33-43-8365—Set 169-4)  
 8420 (See Model 43-8420—Set 24-13)  
 8470 (See Model 43-8470—Set 8-3)  
 8510A, 8511A (See Model 94RA1-43-8510A—Set 71-7)  
 8510B, 8511B (See Model 94RA1-43-8510B—Set 75-6)  
 8515 (See Model 05RA2-43-8515A—Set 110-5)  
 8576B (See Model 43-8576B—Set 9-8)  
 8685 (See Model 43-8685—Set 11-4)  
 8908 Tel. Rec. \*  
 8940A Tel. Rec. \*  
 8945A Tel. Rec. (See Model 05TV1-43-8945A—Set 145-5)  
 8948A, 8949A Tel. Rec. (See Model 15TV4-43-8948A—Set 175-7)  
 8950A Tel. Rec. (See Model 05TV2-43-9010A—Set 146-5)  
 8953A Tel. Rec. (See Model 94TV6-43-8953A—Set 106-3)  
 8957A Tel. Rec. (See Model 15TV1-43-8957A—Set 62-4)  
 8958A, B Tel. Rec. (See Prod. Chge. Bul. 34—Set 162-1 and Model 15TV1-43-8958A—Set 161-3)  
 8960 Tel. Rec. \*  
 8965 Tel. Rec. (See Model 43-8965—Set 86-3)  
 8966 Tel. Rec. \*  
 8970A, 8971A, 8972A, 8973A Tel. Rec. (See Model 94TV2-43-8970A—Set 78-4)

**CORONADO-Cont.**

8985A, 8986A, 8987A Tel. Rec. (See Model 94TV2-43-8970A—Set 78-4)  
 8993A, 8994A, 8995A Tel. Rec. (See Model 94TV2-43-8970A—Set 78-4)  
 9002A Tel. Rec. \*  
 9005A, 9006A Tel. Rec. (See Model 05TV1-43-8945A—Set 145-5)  
 9008A Tel. Rec. \*  
 9010A Tel. Rec. (See Model 05TV2-43-9010A—Set 146-5)  
 9010B Tel. Rec. (See Model 05TV2-43-9010B—Set 153-2)  
 9012A, 9013A Tel. Rec. \*  
 9014A Tel. Rec. (See Model 05TV1-43-9014A—Set 128-4)  
 9015A, B, 9016A, B Tel. Rec. (See Model 15TV1-43-8957A—Set 62-4)  
 9020A, B, 9021A, B Tel. Rec. (See Prod. Chge. Bul. 34—Set 162-1 and Model 15TV1-43-8958A—Set 161-3)  
 9022A Tel. Rec. (See Model 25TV2-43-9022A—Set 183-4)  
 9025A, B, 9026A, B Tel. Rec. (See Model 15TV2-43-9025A—Set 144-3)  
 9030 Tel. Rec. (See Model K-731 [43-9031]—Set 182-3)  
 9031 Tel. Rec. (See Model K-72 [43-9031]—Set 182-3)  
 9041 (See Model K-21 [43-9041]—Set 182-1)  
 9101A, 9102A Tel. Rec. (See Model 15TV2-43-9101A—Set 152-4)  
 9169 (See Model 43-9196—Set 14-35)  
 9201 (See Model 43-9201—Set 24-14)  
 9230A (See Model 15RA37-43-9230A—Set 173-5)  
 9841A (See Model 94RA31-43-9841A—Set 79-3)  
 9876A (See Model 05RA4-43-9876A—Set 103-7)

**CROSLEY-Cont.**

EU-21 COMU, COBU, CDMU, CDBU, CDNU, Tel. Rec. \*  
 EU-21COS, EU-21COSB (Ch. 387) Tel. Rec. (See Model EU-21COLBe—Set 193-3)  
 EU-21PDBU, EU-21PDMU (Ch. 392, UHF Ch. 391 and Radio Ch. 362-1) Tel. Rec. \*  
 EU-21TOL, TOLB (Ch. 386) Tel. Rec. 193-3  
 E10BE, CF, RD, WE (Ch. 10E, 10E-1) 203-6  
 E15BE, CE, SL, TN, WE (Ch. 15-20E) 201-3  
 E20GN, GY, MN, TN (Ch. 15-20E) 201-3  
 E30BE, GN, MN, TN (Ch. 30E, 30E-1) 206-3  
 S11-442MU, S11-444MU, S11-453MU (Ch. 331-4) Tel. Rec. 153-3  
 S11-459MU (Ch. 321-4) Tel. Rec. 153-3  
 S11-472BU, S11-474BU (Ch. 331-4) Tel. Rec. 153-3  
 S17CDB, S17CDB2, S17CDB3, S17CDB4 (Ch. 331-4) Tel. Rec. 153-3  
 S17COC1, S17COC2, S17COC3 (Ch. 331-4) Tel. Rec. 153-3  
 S20CDB1, S20CDB2, S20CDB3 (Ch. 323-6) Tel. Rec. \*  
 9-101 58-8  
 9-102 50-4  
 9-103, 9-104W 60-10  
 9-105, 9-106W 59-7  
 9-113, 9-114W 53-9  
 9-117 51-5  
 9-118W 50-4  
 9-119, 9-120W 50-5  
 9-121, 9-122W 54-8  
 9-201, 9-202M, 9-203B 52-5  
 9-204, 9-205M 63-5  
 9-207M 57-6  
 9-209, 9-212M 53-10  
 9-213B (See Model 9-209—Set 53-10)  
 9-214M, 9-214ML 65-6  
 9-302 47-6  
 9-403M, 9-403M-2 79-4  
 9-404M Tel. Rec. 79-4  
 9-407, 9-407M-1, 9-407M-2 Tel. Rec. 66-6  
 9-409M3 Tel. Rec. 94-3  
 9-413B, 9-413B-2, 9-414B Tel. Rec. 79-4  
 9-419M1, 9-419M1-LD, 9-419M2, 9-419M3, 9-419M3-LD Tel. Rec. 94-3  
 9-420M Tel. Rec. 79-4  
 9-422M, 9-422MA Tel. Rec. 81-6  
 9-423M Tel. Rec. 79-4  
 9-424B Tel. Rec. 79-4  
 9-425 Tel. Rec. 95A-2  
 10-135, 10-136E, 10-137, 10-138, 10-139, 10-140 (Ch. 285) 93-3  
 10-307M, 10-308, 10-309 80-4  
 10-401 Tel. Rec. 95-2  
 10-404MU, 10-404MUU Tel. Rec. 114-3  
 10-412MU Tel. Rec. 114-3  
 10-414MU Tel. Rec. 116-4  
 10-414M1 (Ch. 292) Tel. Rec. (See Model 10-414MU—Set 116-4)  
 10-416MU Tel. Rec. 116-4  
 10-416M1, 10-416M-U (Ch. 292) Tel. Rec. (See Model 10-414MU—Set 116-4)  
 10-418MU Tel. Rec. 114-3  
 10-419MU Tel. Rec. 104-6  
 10-420MU Tel. Rec. 114-3  
 10-421MU Tel. Rec. 106-4  
 10-422MU Tel. Rec. 125-1A  
 10-428MU Tel. Rec. 129-5  
 10-429M (Ch. 292) Tel. Rec. (See Model 10-414MU—Set 116-4)  
 10-429MU Tel. Rec. 116-4  
 11-100U, 11-101U, 11-102U, 11-103U, 11-104U, 11-105U (Ch. 301) 127-5  
 11-106U, 11-107U, 11-108U, 11-109U (Ch. 302) 155-5  
 11-114U, 11-115U, 11-116U, 11-117U, 11-118U, 11-119U (Ch. 330) 135-5  
 11-126U, 11-127U, 11-128U, 11-129U (Ch. 312) 125-5  
 11-207MU, 11-208BU (Ch. 333) 142-6  
 11-301U, 11-302U, 11-303U, 11-304U, 11-305U (Ch. 303) 124-3  
 11-441MU (Ch. 320) Tel. Rec. 147-4  
 11-442MU (Ch. 331) Tel. Rec. 126-4  
 11-443MU Tel. Rec. (See Prod. Chge. Bul. 22—Set 138-1 and Model 11-442—Set 126-4)  
 11-445MU (Ch. 321, -1, -2) Tel. Rec. 126-4  
 11-446MU (Ch. 325) Tel. Rec. 126-4  
 11-477BU (Ch. 321, -1, -2) Tel. Rec. 126-4  
 11-483BU (Ch. 331) Tel. Rec. 126-4  
 11-550MU (Ch. 337) 139-5  
 11-560BU (Ch. 337) 139-5  
 17CDB1, 17CDB2, 17CDB3, 17CDB4 (Ch. 331, -1, -2) Tel. Rec. (See Model 11-442—Set 126-4)  
 17COC1, 17COC2, 17COC3 (Ch. 331, -1) Tel. Rec. (See Model 11-442—Set 126-4)  
 20CDB1, 20CDB2, 20CDB3 (Ch. 323-3, 323-4) Tel. Rec. \*  
 46FA, 46FB 15-5  
 56FA, 56FB, 56FC 31-7  
 56FA, 56PB 10-9  
 56TA-L, 56TC-L 4-9  
 56TD 21-9  
 56TG 4-3  
 56TJ 3-14  
 56TN-L, 56TW-L 8-5  
 56TP 4-9  
 56TZ 33-2  
 56TR, 56TS 17-11  
 56TU 10-13  
 57TQ (See Model 56TQ—Set 33-2) 36-4  
 58TA 58TC (See Model 58TW—Set 38-2) 34-5  
 58TL 36-4  
 58TW 38-2  
 66CA, CP, CQ (See Model 66CS—Set 18-14) 8-14  
 66CS, 66CSM 5-15  
 66TA, 66TC, 66TW 37-5  
 66CB, 66CR 40-4  
 66TA, 66TB 40-4  
 66CR, 66CS (Revised) 12-10  
 67CO, 67CQ 36-5  
 68CR (See Model 87CO—Set 36-5) 38-3  
 88TA, 88TC (Revised) (See Set 43-8 and Model 88TA—Set 38-3) 7-6  
 106CP, 106CS 25-10  
 146CS 42-6  
 148CP, 148CQ 42-6  
 148CR (See Model 148CP—Set 42-6) \*  
 307TA Tel. Rec. \*  
 348CP-TR1, 348CP-TR2, 348CP-TR3 Tel. Rec. \*  
 154927 Tel. UHF Conv. 211-5  
 Ch. 10E, 10E-1 (See Model E10BE) Ch. 15-20E  
 (See Model E15BE) Ch. 30E, 30E-1  
 (See Model E30BE) Ch. 292 Tel. Rec. (See Model 10-414MU) Ch. 301  
 (See Model 11-100U) Ch. 301  
 (See Model 11-106U) Ch. 303  
 (See Model 11-301U) Ch. 311, -1 (See Model D-25BE) Ch. 312  
 (See Model 11-126U) Ch. 320  
 (See Model 11-441MU) Ch. 321, 321-1, 321-2 (See Model 11-445MU) Ch. 323  
 (See Model 11-442MU) Ch. 323-6  
 (See Model 20CDB1) Ch. 323-6  
 (See Model S20CDB1) Ch. 323-2  
 (See Model 11-446MU) Ch. 330  
 (See Model 11-114U) Ch. 331, -1, -2 (See Model 11-442) Ch. 331-4 Tel. Rec. (See Model 11-442MU) Ch. 333  
 (See Model 11-207MU) Ch. 337  
 (See Model 11-550MU) Ch. 356-1, 356-2 (See Model DU-17CDB) Ch. 356-3, 356-4 (See Model DU-17CDB) Ch. 357 Tel. Rec. (See Model DU-20CDB) Ch. 357-1 (See Model DU-21CDN1) Ch. 359 Tel. Rec. (See Model DU-17PDM) Ch. 360, 361 Tel. Rec. (See Model DU-17PDB)

**CROSLEY-Cont.**

8985A, 8986A, 8987A Tel. Rec. (See Model 94TV2-43-8970A—Set 78-4)  
 8993A, 8994A, 8995A Tel. Rec. (See Model 94TV2-43-8970A—Set 78-4)  
 9002A Tel. Rec. \*  
 9005A, 9006A Tel. Rec. (See Model 05TV1-43-8945A—Set 145-5)  
 9008A Tel. Rec. \*  
 9010A Tel. Rec. (See Model 05TV2-43-9010A—Set 146-5)  
 9010B Tel. Rec. (See Model 05TV2-43-9010B—Set 153-2)  
 9012A, 9013A Tel. Rec. \*  
 9014A Tel. Rec. (See Model 05TV1-43-9014A—Set 128-4)  
 9015A, B, 9016A, B Tel. Rec. (See Model 15TV1-43-8957A—Set 62-4)  
 9020A, B, 9021A, B Tel. Rec. (See Prod. Chge. Bul. 34—Set 162-1 and Model 15TV1-43-8958A—Set 161-3)  
 9022A Tel. Rec. (See Model 25TV2-43-9022A—Set 183-4)  
 9025A, B, 9026A, B Tel. Rec. (See Model 15TV2-43-9025A—Set 144-3)  
 9030 Tel. Rec. (See Model K-731 [43-9031]—Set 182-3)  
 9031 Tel. Rec. (See Model K-72 [43-9031]—Set 182-3)  
 9041 (See Model K-21 [43-9041]—Set 182-1)  
 9101A, 9102A Tel. Rec. (See Model 15TV2-43-9101A—Set 152-4)  
 9169 (See Model 43-9196—Set 14-35)  
 9201 (See Model 43-9201—Set 24-14)  
 9230A (See Model 15RA37-43-9230A—Set 173-5)  
 9841A (See Model 94RA31-43-9841A—Set 79-3)  
 9876A (See Model 05RA4-43-9876A—Set 103-7)

**CORONET**

C2 6-8

**CRESCENT (Also see Changer and Recorder Listings)**

H-16A1 76-8

**CRESTWOOD (See Recorder Listing)**

CROMWELL (Mercantile Stores) 8B-2  
 1010 89-5

**CROSLEY**

DU-17CDB, CDM, CHB, CHM, CHN (Ch. 356-1, -2) Tel. Rec. 168-6  
 DU-17CDB, CD, CH, CHM, CHN (Ch. 356-3, -4) Tel. Rec. (See Prod. Chge. Bul. 58—Set 192-1 and Model DU-17CDB—Set 168-6)  
 DU-17CHN1 (Ch. 356, -1, -2, -3, -4) Tel. Rec. (See Prod. Chge. Bul. 58—Set 192-1 and Model DU-17CDB—Set 168-6)  
 DU-17CDB, PDM, PHB, PHM, PHN, PHN1 (Ch. 359 and Radio Ch. 360, 361) Tel. Rec. 163-4  
 DU-17TOB, TOL (Ch. 356-1, -2) Tel. Rec. 168-6  
 DU-17TOL1 (Ch. 356-1, -2) Tel. Rec. (See Model DU-17TOL—Set 168-6)  
 DU-17TOM (Ch. 356-1, -2) Tel. Rec. 168-6  
 DU-20CDM, CHB, CHM, COB, COM (Ch. 357) 175-8  
 DU-21CDM1, CDM, CHM, COB, COL, COLB, COM (Ch. 357-1) Tel. Rec. 175-8  
 D-25BE, CE, GN, MN, TN, WE (Ch. 311, 311-1) 202-2  
 (See Prod. Chge. Bul. 34—Set 162-1 and Model DU-17CDB—Set 168-6)  
 DU-17CDB, PDM, PHB, PHM, PHN, PHN1 (Ch. 359 and Radio Ch. 360, 361) Tel. Rec. 163-4  
 DU-17TOB, TOL (Ch. 356-1, -2) Tel. Rec. 168-6  
 DU-17TOL1 (Ch. 356-1, -2) Tel. Rec. (See Model DU-17TOL—Set 168-6)  
 DU-17TOM (Ch. 356-1, -2) Tel. Rec. 168-6  
 DU-20CDM, CHB, CHM, COB, COM (Ch. 357) 175-8  
 DU-21CDM1, CDM, CHM, COB, COL, COLB, COM (Ch. 357-1) Tel. Rec. 175-8  
 D-25BE, CE, GN, MN, TN, WE (Ch. 311, 311-1) 202-2  
 (See Prod. Chge. Bul. 34—Set 162-1 and Model DU-17CDB—Set 168-6)  
 DU-17CDB, PDM, PHB, PHM, PHN, PHN1 (Ch. 359 and Radio Ch. 360, 361) Tel. Rec. 163-4  
 DU-17TOB, TOL (Ch. 356-1, -2) Tel. Rec. 168-6  
 DU-17TOL1 (Ch. 356-1, -2) Tel. Rec. (See Model DU-17TOL—Set 168-6)  
 DU-17TOM (Ch. 356-1, -2) Tel. Rec. 168-6  
 DU-20CDM, CHB, CHM, COB, COM (Ch. 357) 175-8  
 DU-21CDM1, CDM, CHM, COB, COL, COLB, COM (Ch. 357-1) Tel. Rec. 175-8  
 D-25BE, CE, GN, MN, TN, WE (Ch. 311, 311-1) 202-2  
 (See Prod. Chge. Bul. 34—Set 162-1 and Model DU-17CDB—Set 168-6)  
 DU-17CDB, PDM, PHB, PHM, PHN, PHN1 (Ch. 359 and Radio Ch. 360, 361) Tel. Rec. 163-4  
 DU-17TOB, TOL (Ch. 356-1, -2) Tel. Rec. 168-6  
 DU-17TOL1 (Ch. 356-1, -2) Tel. Rec. (See Model DU-17TOL—Set 168-6)  
 DU-17TOM (Ch. 356-1, -2) Tel. Rec. 168-6  
 DU-20CDM, CHB, CHM, COB, COM (Ch. 357) 175-8  
 DU-21CDM1, CDM, CHM, COB, COL, COLB, COM (Ch. 357-1) Tel. Rec. 175-8  
 D-25BE, CE, GN, MN, TN, WE (Ch. 311, 311-1) 202-2  
 (See Prod. Chge. Bul. 34—Set 162-1 and Model DU-17CDB—Set 168-6)  
 DU-17CDB, PDM, PHB, PHM, PHN, PHN1 (Ch. 359 and Radio Ch. 360, 361) Tel. Rec. 163-4  
 DU-17TOB, TOL (Ch. 356-1, -2) Tel. Rec. 168-6  
 DU-17TOL1 (Ch. 356-1, -2) Tel. Rec. (See Model DU-17TOL—Set 16

**CROSLY-EMERSON**

**CROSLY-Cont.**  
 Ch. 380  
 (See Model EU-17COM)  
 Ch. 381 (See Model EU-21CDB)  
 Ch. 383  
 (See Model EU-17COM)  
 Ch. 384  
 (See Model EU-21CDB)  
 Ch. 385, 386, 387  
 (See Model EU-17COL)  
 Ch. 386 (See Model EU-21COLBd)  
 Ch. 387 (See Model EU-21COLBe)  
 Ch. 390 Tel. Rec. (See Model EU-21COMUa)  
 Ch. 392 (See Model EU-21PDBU)

**CROYDON**  
 C17FM Tel. Rec. (Also see Prod. Chge. Bul. 57—Set 191-1) 186-4  
 C21FM, C21FTM (Also see Prod. Chge. Bul. 57—Set 191-1) 186-4

**CRYSTAL PRODUCTS (See Coronet)**

**DALBAR**  
 Barcombo Jr.  
 Barcomba Sr. 10-14  
 M8 "Tonometric" 8-34  
 100-1000 Series 10-15  
 400 9-9

**DAVID BOGEN**  
 AM901 195-6  
 DB-10 102-4  
 DP-16 166-8  
 E66 85-4  
 E75 83-2  
 EK-326 76-9  
 FM801 198-4  
 G-50 30-6  
 GO-50 26-9  
 GO-125 22-12  
 GX50 25-11  
 H15 80-6  
 H30 79-5  
 H50, HL50, H2150 78-6  
 HE23 71-8  
 HE-10 154-3  
 HOH, HOL 80-5  
 HO10 183-5  
 HO50 84-5  
 HO125 87-4  
 HX30 82-4  
 HX50 75-7  
 HX-632 169-5  
 LOH, LOL 80-5  
 LP16 86-4  
 PH10 73-3  
 PK 183-5  
 PX10 68-5  
 PX15 72-7  
 RX 183-5  
 R501 33-3  
 R602 67-8  
 R-604 175-9  
 UP16 86-4  
 2AR, 2RS 28-8  
 11D 77-5  
 11U 76-10  
 11X 74-2  
 21D 77-5  
 21U 76-10  
 21X 74-2

**DEARBORN**  
 100 22-13

**DECCA**  
 DP11 24-15  
 DP29 19-13  
 PT-10 25-12

**DELCO**  
 R-705 42-7  
 R-1227, R-1228, R-1229-1 15-6  
 R-1230-A, R-1231-A, R-1232-A 14-33  
 R-1233 42-8  
 R-1234, R-1235 7-7  
 R-1236, R-1237 29-7  
 R-1238 38-4  
 R-1241 62-11  
 R-1242 32-4  
 R-1243 31-8  
 R-1244, R-1245, R-1246 52-6  
 R-1248, R-1249, R-1250 66-7  
 R-1251, R-1252 21-10  
 R-1253, R-1254, R-1255 47-7  
 R-1408, R-1409 15-7  
 TV-71, TV-71A Tel. Rec. 99A-3  
 TV-101 (See Model TV-102—Set 88-3)  
 TV-102 Tel. Rec. 88-3  
 TV-160 Tel. Rec. 85-5  
 TV-201 Tel. Rec. 59-8

**DeSoto (See Mopar)**

**DETROIT**  
 554-1-61A (See Aria Model 554-1-61A—Set 67-2)  
 558-1-49A 7-8  
 568-13-221D 9-10  
 571, 571A, 571B, 571L, 571AL, 571BL 10-16  
 571X, 571AX, 571BX 9-11  
 572-220-226A 8-6  
 572-1-6A 8-7  
 579 7-9  
 579-2-58B (See Model 579—Set 7-9)  
 582 19-14  
 610-A 55-8  
 611-A 50-6  
 626 Series 11-5  
 7156 48-6  
 7270 16-8

**DEWALD**  
 A500 4-22  
 A5001 (See Model A500—Set 4-22)  
 A500W (See Model A500—Set 4-22)  
 A501, A502, A503 4-22  
 A504, A505 16-9  
 A-507 26-10  
 A-509 31-9  
 A-514 27-6  
 A602, A605 16-10  
 A608 (See Model A602—Set 16-10)  
 B-400 35-3  
 B-401 34-6  
 B-402 45-8  
 B-403 52-7  
 B-504 43-9  
 B-510 38-5  
 B-512 35-4  
 B-515 63-6  
 B-612 42-9  
 B-614 56-9  
 BT-100, BT-101 Tel. Rec. 79-6  
 C-511 64-4  
 C-800 69-7  
 CT-101 Tel. Rec. 79-6  
 CT-102, CT-103, CT-104 Tel. Rec. 82-5  
 D-E517A 167-5  
 D-508 106-5  
 D-517 131-4  
 D-518 100-5  
 D519 (See Model B-506—Set 38-5)  
 D-616 102-5  
 DT-120, DT-122 Tel. Rec. 100-6  
 DT-60 Tel. Rec. 82-5  
 DT-161 Tel. Rec. 100-6  
 DT-162, DT-163 Tel. Rec. 118-5  
 DT-162R, DT-163A, R Tel. Rec. (Also see Prod. Chge. Bul. 58—Set 192-1) 136-7  
 DT-190D Tel. Rec. (Also see Prod. Chge. Bul. 58—Set 192-1) 136-7  
 DT-1020, DT-1020A Tel. Rec. 100-6  
 DT-1030, DT-1030A Tel. Rec. 100-6  
 DT-X-60 Tel. Rec. 100-6  
 E-20 128-5  
 E-22 141-5  
 ET-140, ET-141 Tel. Rec. 118-5  
 ET-140R, ET-141R Tel. Rec. (Also see Prod. Chge. Bul. 58—Set 192-1) 136-7  
 E-170, ET-171 Tel. Rec. (Also see Prod. Chge. Bul. 58—Set 192-1) 136-7  
 ET-190D, R Tel. Rec. (Also see Prod. Chge. Bul. 58—Set 192-1) 136-7  
 ET-190D (Revised) Tel. Rec. 208-3  
 FT-200 Tel. Rec. (See Prod. Chge. Bul. 58—Set 192-1 and Model DT-162R—Set 136-7)  
 FT-200 (Revised) Tel. Rec. 208-3  
 FT-201 Tel. Rec. (See Prod. Chge. Bul. 58—Set 192-1 and Model DT-162R—Set 136-7)  
 F-404 181-5  
 F-405 198-5  
 F-523 170-5  
 G-174 Tel. Rec. 208-3  
 G-201 Tel. Rec. 208-3  
 G-210, G-211 Tel. Rec. 208-3  
 511 71-9

**DODGE (See Mopar)**

**DORN'S (See Bell Air)**

**DREXEL (Mutual Buying Syndicate)**  
 17CG1, 17TW Tel. Rec. (Similar to Chassis) 149-13

**DUKANE**  
 1A45-A 184-5  
 1A300 189-6  
 1U325 185-6  
 4A100 186-5  
 4B100 (See Model 4A100—Set 186-5)  
 4C25 Flexiphone 187-4  
 4C100 200-4

**DUMONT**  
 RA-101 Tel. Rec. \*  
 RA-102B1, RA-102B2, RA-102B3 Tel. Rec. \*  
 RA-103 Tel. Rec. (Also see Prod. Chge. Bul. 5—Set 108-1) 90-3  
 RA-103D Tel. Rec. (Also see Prod. Chge. Bul. 9—Set 114-1) 93-4  
 RA-104A Tel. Rec. (Also see Prod. Chge. Bul. 9—Set 114-1) 93-4  
 RA-105 Tel. Rec. (Also see Prod. Chge. Bul. 6—Set 108-1) 72-8  
 RA-105B Tel. Rec. 95-3  
 RA-107 Tel. Rec. (Supp. to RA-105, Set 72) (Also see Prod. Chge. Bul. 6—Set 108-1) 99A-4  
 RA-108A Tel. Rec. 95-3  
 RA-109A-FAS Tel. Rec. (See Prod. Chge. Bul. 54—Set 188-1 and Model RA-109—Set 110-7)

**DUMONT-Cont.**  
 RA-109-A1, -A2, -A3, -A5, -A6, -A7 Tel. Rec. (Also see Prod. Chge. Bul. 14—Set 124-1) 110-7  
 RA-110A Tel. Rec. (Also see Prod. Chge. Bul. 9—Set 114-1) 93-4  
 RA-111-A1, -A2, -A4, -A5 Tel. Rec. 106-6  
 RA-112-A1, -A2, -A3, -A4, -A5, -A6 Tel. Rec. (Also see Prod. Chge. Bul. 38—Set 170-1) 119-5  
 RA-113-B1, -B2, -B3, -B4, -B5, -B6, -B7, -B8 Tel. Rec. (Also see Prod. Chge. Bul. 38—Set 170-1) 119-5  
 RA-116A Tel. Rec. RA-117-A1, -A3, -A5, -A6, -A7 Tel. Rec. 131-5  
 RA-119A Tel. Rec. 156-5  
 RA-120 Tel. Rec. (See Prod. Chge. Bul. 51—Set 185-1 and Model RA-113—Set 119-5)  
 RA-130A Tel. Rec. (See Prod. Chge. Bul. 54—Set 188-1 and Model RA-109—Set 110-7)  
 RA-147A Tel. Rec. (See Prod. Chge. Bul. 49—Set 183-1 and Model RA-117A—Set 131-5)  
 RA-160, -A1 Tel. Rec. (Also see Prod. Chge. Bul. 55—Set 189-1) 179-4  
 RA-162, -B1, -B4, -B5, -B6, -B7, -B21 through 26 Tel. Rec. (Also see Prod. Chge. Bul. 55—Set 189-1) 179-4  
 RA-164, -A1 Tel. Rec. (Also see Prod. Chge. Bul. 70—Set 194-1 and Prod. Chge. Bul. 69—Set 206-1) 189-7  
 RA-165, -B1, -B2, -B3, -B6, -B7, -B2 through 826 Tel. Rec. (Also see Prod. Chge. Bul. 60—Set 194-1 and Prod. Chge. Bul. 69—Set 206-1) 189-7  
 Andover Model RA-117A-A6 (See Model RA-117A)  
 Andover (See Model RA-147A)  
 Ardmore Model RA-112-A1, -A4 (See Model RA-112A)  
 Banbury Model RA-162-B4 (See Model RA-162)  
 Banbury Model RA-162-B21 through B26 (See Model RA-162)  
 Beverly Model RA-165-B2 (See Model RA-165)  
 Bradford (See Model RA-108A)  
 Brookville Model RA-113-B1, -B2 (See Model RA-113)  
 Burlington Model RA-113-B5, -B6 (See Model RA-113)  
 Carlton Model RA-117-A3 (See Model RA-117A)  
 Chatham (See Model RA-103)  
 Chester (See Model RA-147A)  
 Clifton (See Model RA-102)  
 Clinton Model RA-164-A1 (See Model RA-164)  
 Club 20 (See Model RA-106A)  
 Colony (See Model RA-105A)  
 Devon Model RA-160-A1 (See Model RA-160)  
 Devonshire (See Model RA-101)  
 Dynasty (See Model RA-162)  
 Fairfield (See Model RA-110A)  
 Flanders Model RA-162-B5 (See Model RA-162)  
 Guilford Model RA-111-A2, -A5 (See Model RA-111A)  
 Hanover Model RA-109A-A2, -A6 (See Model RA-109A-FAS)  
 Hanover (See Model RA-109A-FAS)  
 (See Model RA-104A)  
 Manchu (See Model RA-106A)  
 Mansfield (See Model RA-108A)  
 Meadowbrook II (See Model RA-147A)  
 Milford Model RA-165-B1 (See Model RA-165)  
 Mt. Vernon Model RA-112-A3, -A6 (See Model RA-112A)  
 Newbury (See Model RA-162)  
 Park Lane Model RA-117-A7 (See Model RA-117A)  
 Parklans (See Model RA-147A)  
 Putnam Model RA-111-A1, -A4 Tel. Rec. (See Model RA-111A)  
 Reverse (See Model RA-101)  
 Reverse II Model RA-113-B3, -B4 (See Model RA-113)  
 Ridgewood Model RA-165-B4 (See Model RA-165)  
 Royal Sovereign (See Model RA-119A)  
 Rumson (See Model RA-103D)  
 Savoy (See Model RA-103)

**DUMONT-Cont.**  
 Sheffield (See Model RA-103D)  
 Shelburne Model RA-165-B5 (See Model RA-165)  
 Sherbrooke Model RA-109-A3, -A7 (See Model RA-109A-FAS)  
 Sherbrooke (See Model RA-109A-FAS)  
 Sherbrooke II (See Model RA-130A)  
 Somerset (See Model RA-162)  
 Stratford (See Model RA-105A)  
 Strathmore Model RA-117-A5 (See Model RA-117A)  
 Sumter Model RA-117-A1 (See Model RA-117A)  
 Sussex (See Model RA-105B)  
 Tarrytown (See Model RA-120)  
 Tarrytown Models RA-113, B7, B8 (See Model RA-113)  
 Wakefield Model RA-165-B3 (See Model RA-164)  
 Wellington (See Model RA-104A)  
 Westerly Model RA-112-A2, -A5 (See Model RA-112A)  
 Westbury (See Model RA-105A)  
 Westbury II (See Model RA-109A-FAS)  
 Westwood (See Model RA-110A)  
 Whitehall (See Model RA-105A)  
 Whitehall II (See Model RA-130A)  
 Whitehall II Model RA-162-B7 (See Model RA-162)  
 Wilford Model RA-162-B1 (See Model RA-162)  
 Wimbledon Model RA-162-B6 (See Model RA-162)  
 Winslow (See Model RA-109A-FAS)  
 Winslow Model RA-109-A1, -A5 (See Model RA-109A)

**DUOSONIC**  
 K1, K2 19-15  
 K3, K4 19-16

**DYNAVOX**  
 AP-514 (Ch. AT) 28-9  
 M-510 15-8  
 Swingmaster 27-7  
 3-P-801 36-3

**ECA**  
 101 (Ch. AA) 1-25  
 102 14-7  
 104 13-14  
 105 16-11  
 106 7-10  
 108 3-6  
 121 13-15  
 131 16-12  
 132 45-9  
 201 15-9  
 204 32-5

**ECHOPHONE (Also see Hallcrafters)**  
 EC-1A \*  
 EC-113 3-13  
 EC-306 14-8  
 EC-403, EC-404 22-14  
 EC-102, EX-103 4-18  
 EC-306 (See Model EC-306—Set 14-8)

**EDWARDS**  
 Fidelotuner 33-4  
 15 135-6

**EKOTAPE (See Recorder Listing)**

**ELCAR**  
 602 5-19

**ELECTONE**  
 T5T53 12-34

**ELECTRO**  
 B20 14-9

**ELECTROMATIC**  
 APH301-A, APH301-C 7-11  
 606A, 607A 5-32

**ELECTRO-TONE**  
 555 13-17  
 706, 712 (See Model 555—Set 13-16)

**ELECTRONIC CORP. OF AMERICA (See ECA)**

**ELECTRONIC SPECIALTY CO. (See Ranger)**

**E/L (ELECTRONIC LABS.)**  
 75 (Sub-Station) 20-6  
 76E, K, M, W (See Model 2701—Set 4-28)  
 76RU ("Radio-Utiliphone") 20-6  
 710B, 710M, 710T, 710W, Orthosonic (Ch. 2875) 20-7  
 710PB, 710PC Orthosonic (Ch. 2887) 24-16  
 2660 "Master Utiliphone" 8-9  
 2701 4-28  
 3000 Orthosonic 31-10

**EMERSON**  
 501, 502 (Ch. 120000, 120029) 2-1  
 503 (Ch. 120000, 120029) 1-18  
 504 (Ch. 120000, 120029) 2-1

**EMERSON-Cont.**  
 505 (Ch. 120002) 8-9  
 505 (Ch. 120041) (See Model 523—Set 5-27)  
 506 6-9  
 507 8-10  
 508 (Ch. 120008) 7-12  
 509 8-10  
 510, 510A (Ch. 120000, 120029) 5-36  
 511 (Ch. 120010) 8-10  
 511 (See Model RA-120) (See Model 541—Set 16-23)  
 512 (Ch. 120006) 9-12  
 512 (Ch. 120056) 26-11  
 514 (Ch. 120007) 27-8  
 515, 516 12-11  
 517 (Ch. 120010) 26-11  
 517 (See Model RA-105B) (See Model 541—Set 16-13)  
 518 8-10  
 519 (Ch. 120030) 30-7  
 520 (Ch. 120000, 120029) 2-1  
 521 (Ch. 120013, 120031) 7-13  
 522 5-37  
 523 8-10  
 524 17-12  
 525 20-8  
 527 (Ch. 120019) Tel. Rec. \*  
 528 (Ch. 120038) 21-13  
 529, 529-9 (Ch. 120028) 18-15  
 530 (Ch. 120006) 32-6  
 531, 532, 533 11-6  
 534 (Ch. 120007) 27-8  
 535 20-9  
 536 (Ch. 120036) 21-14  
 536A 24-17  
 537 23-7  
 538 (Ch. 120051) (See Model 549—Set 26-12)  
 539 9-13  
 540A (Ch. 120042) 20-10  
 541 16-13  
 542 (See Model 542—Set 7-13)  
 543, 544 (Ch. 120046) 19-30  
 545 (Ch. 120047) Tel. Rec. Photofact Servicer 82  
 546 (Ch. 120049) 21-15  
 547A (Ch. 120050) 25-13  
 548 (Ch. 120051) 30-8  
 549 (Ch. 120051) 26-12  
 550 (Ch. 120006) (See Model 512—Set 9-12)  
 550 (Ch. 120056) 26-11  
 551A 24-17  
 552 20-8  
 553A 24-17  
 556, 557 (Ch. 120018B) 70-7  
 557B (Ch. 120048B) 43-10  
 558 (Ch. 120058) 31-11  
 559A (Ch. 120059) 31-12  
 560 (Ch. 120016) 25-14  
 561 (Ch. 120017) 63-7  
 563 (Ch. 120063B) 73-4  
 564 (Ch. 120027) (See Model 540A—Set 20-10)  
 565 (Ch. 120018B) 70-4  
 566 (Ch. 120051) (See Model 545—Set 26-12)  
 567 (Ch. 120015) (See Model 560—Set 25-14)  
 567 (Ch. 120042) (See Model 540A—Set 20-10)  
 568A (Ch. 120070A) 58-9  
 569A (Ch. 120062A) 42-10  
 570 (Ch. 120064) 97-3  
 571 (Ch. 120060) Tel. Rec. 46-25  
 571 (Ch. 120066B) \*  
 571 (Ch. 120086B) 76-11  
 572 (Ch. 120065) (See Model 540A—Set 20-10)  
 573B (Ch. 120039B) 42-11  
 574 (Ch. 120064) 97-3  
 575 (Ch. 120068A, 120068B) 85-6  
 576A (Ch. 120069A) 40-5  
 577B (Ch. 120012B) 41-6  
 578 (Ch. 120050) (See Model 547A—Set 25-13)  
 579A (Ch. 120034A) 61-6  
 580 (Ch. 120064) 97-3  
 581 (Ch. 120014A, B) 68-7  
 582 (See Model 548—Set 30-8)  
 583 (See Model 573B—Set 42-11)  
 584 (See Model 558—Set 31-11)  
 585 (Ch. 120025B) Tel. Rec. 61-7  
 585 (Ch. 120088B, 120090B, 120090D) Tel. Rec. \*  
 586 (Ch. 120023B, 120083B) 72-9  
 587 (Ch. 120033A, B) 71-10  
 588 (See Model 547A—Set 25-13)  
 590 (Ch. 120101A, B) 87-5  
 591 (Ch. 120055A) 67-9  
 593 (Ch. 120063B) 73-4  
 594, 595 (Ch. 120071A) 68-7  
 596 61-6  
 597 (Ch. 120073B) 90-5  
 599 (Ch. 120075B) 69-8  
 600 (Ch. 120103-B) Tel. Rec. (Also see Prod. Chge. Bul. 9—Set 114-1) 87-6  
 601 (Ch. 120075B) 69-8  
 602 (Ch. 120072A, 120082A) 56-10  
 603 (Ch. 120063B) 73-4  
 604A (See Model 576A—Set 40-5)  
 605 (Ch. 120076B) 66-8  
 606 (Ch. 120066) Tel. Rec. 46-25  
 606 (Ch. 120066B) \*  
 606 (Ch. 120086B-D) Tel. Rec. \*  
 606 (Ch. 120086B) 76-11  
 606 (Ch. 120086B) Tel. Rec. 76-11



EMERSON—Cont.

607 (Ch. 120074A)..... 90—5  
608A (Ch. 120089B)..... 84—6  
609 (Ch. 120084-B)..... 90—6  
610 (Ch. 120100A, B)..... 71—10  
611, 612 (Ch. 120087B-D)..... 76—11  
613A (Ch. 120085A, B)..... 79—7  
614, B, BC, C (Ch. 120101, B, BC, C) Tel. Rec. .... 97—4  
614D (Ch. 120095-B)..... 95A-3  
615 (Ch. 120001B)..... 63—7  
616 (Ch. 120100A, B)..... 71—10  
618 (Ch. 120090B, D)..... \*  
619 (Ch. 120092D)..... 76—11  
620 (Ch. 120091D-QD)..... 76—11  
621 (Ch. 120098B)..... 108—5  
622 (Ch. 120098P)..... 108—5  
623 (Ch. 120101A, B)..... 87—5  
624 (Ch. 120087B-D)..... 76—11  
625 (Ch. 120105B)..... 103—8  
626 (Ch. 120104B, 120104B) Tel. Rec. .... 84—6  
627 (Ch. 120107B)..... 76—11  
628 (Ch. 120098B)..... 108—5  
629 (Ch. 120114B) Tel. Rec. (See Model 631—Set 93A.6)..... 93A-6  
629B, 629C (Ch. 120120) Tel. Rec. .... 119—6  
629D (Ch. 120124B)..... 116—5  
630 (Ch. 120099B)..... 108—5  
631 (Ch. 120109)..... 93A-6  
632 (Ch. 120096B)..... 93A-7  
633 (Ch. 120114)..... 93A-6  
634B (Ch. 120097B)..... 111—4  
635 (Ch. 120108)..... 92—1  
636A (Ch. 120106A)..... 99—7  
637, B, BC, C (Ch. 120110, B, BC, C) Tel. Rec. .... 97—4  
637A (Ch. 120095-B)..... 95A-3  
638 (Ch. 120087D) Tel. Rec. (See Model 571—Set 76-11)..... 571-11  
639 (Ch. 120103B) Tel. Rec. (Also see Prod. Chge. Bul. 9—Set 114-1)..... 87—6  
640 (Ch. 120112)..... 93—5  
641B (Ch. 120125B)..... 120—5  
642 (Ch. 120117A)..... 98—3  
643A (Ch. 120111A)..... 91—4  
644, B, BC, C (Ch. 120113, B, BC, C) Tel. Rec. .... 97—4  
645 (Ch. 120115)..... 94—4  
646A (Ch. 120121A)..... 102—6  
646B (Ch. 120121B)..... 102—6  
647, B, BC, C (Ch. 120113, B, BC, C) Tel. Rec. .... 97—4  
648B (Ch. 120110E)..... 97—4  
648B (Ch. 120134B, G, H) Tel. Rec. (See Prod. Chge. Bul. 48—Set 182-1 and Model 661B—Set 137-4)..... 137-4  
649A (Ch. 120094A)..... 106—7  
650 (Ch. 120113C) Tel. Rec. (See Model 614—Set 97-4)..... 97-4  
650 (Ch. 120118B)..... 113—2  
650B (Ch. 120118B) Tel. Rec. (See Model 650—Set 113-2)..... 113-2  
650D (Ch. 120123-B) Tel. Rec. (Also see Prod. Chge. Bul. 48—Set 182-1)..... 109—3  
650F (Ch. 120138-B)..... 133-1A  
651B (Ch. 120120)..... 119—6  
651C (Ch. 120109)..... 93A-6  
651C (Ch. 120124)..... 116—5  
651D (Ch. 120124, B)..... 116—5  
652 (Ch. 120032B)..... 98—3  
653 (Ch. 120090B)..... 98—3  
653B (Ch. 120136-B)..... 159—5  
654 (Ch. 120118B)..... 113—2  
654B (Ch. 120118B) Tel. Rec. (See Model 654—Set 113-2)..... 113-2  
654D (Ch. 120123B) Tel. Rec. (Also see Prod. Chge. Bul. 48—Set 182-1)..... 109—3  
654F (Ch. 120138-B)..... 133-1A  
655B (Ch. 120123-B)..... 109—3  
655D (Ch. 120123B) Tel. Rec. (See Model 650D—Set 109-3)..... 109-3  
655F (Ch. 120138-B)..... 133-1A  
656B, 657B (Ch. 120122B) 111—5  
658B (Ch. 120124, B)..... 116—5  
658C (Ch. 120124) Tel. Rec. (See Model 629D—Set 116-5)..... 116-5  
658D (Ch. 120124B)..... \*

EMERSON—Cont.

660B (Ch. 120133B)..... 131—6  
661B (Ch. 120134B, G, H) Tel. Rec. (Also see Prod. Chge. Bul. 48—Set 182-1)..... 137—4  
662B (Ch. 120127-B) Tel. Rec. (Also see Prod. Chge. Bul. 18—Set 130-1)..... 125—6  
663B (Ch. 120128-B) Tel. Rec. (Also see Prod. Chge. Bul. 18—Set 130-1)..... 125—6  
664B (Ch. 120133-B) Tel. Rec. (Also see Prod. Chge. Bul. 18—Set 130-1)..... 131—6  
665-B (Ch. 120131-B and Radio Ch. 120130-B) Tel. Rec. .... 146—6  
666B (Ch. 120135B, G, H and Radio Ch. 120132B) Tel. Rec. (Also see Prod. Chge. Bul. 27—Set 148-1)..... 133—5  
667B, 668B (Ch. 120134B, G, H) Tel. Rec. (Also see Prod. Chge. Bul. 48—Set 182-1)..... 137—4  
669B (Ch. 120129B, D) Tel. Rec. (Also see Prod. Chge. Bul. 24—Set 142-1 and Prod. Chge. Bul. 47—Set 181-1)..... 126—5  
669B (Ch. 120148-B)..... \*  
670 (Ch. 120137B)..... 118—6  
671D (Ch. 120137D) (See Model 671B—Set 118-6)..... 118-6  
672B (Ch. 120097-B)..... 131—7  
673B (Ch. 120133-B) Tel. Rec. .... 131—6  
674B (Ch. 120134B, G, H) Tel. Rec. (Also see Prod. Chge. Bul. 48—Set 182-1)..... 137—4  
675B (Ch. 120129B, D) Tel. Rec. (Also see Prod. Chge. Bul. 24—Set 142-1 and Prod. Chge. Bul. 47—Set 181-1)..... 126—5  
676B (Ch. 120140B) Tel. Rec. .... 128—6  
676D (Ch. 120144B, G, H) Tel. Rec. (Also see Prod. Chge. Bul. 48—Set 181-1)..... 138—4  
676F (Ch. 120143B) Tel. Rec. (Also see Prod. Chge. Bul. 50—Set 184-1)..... 148—6  
677B, 678B (Ch. 120134B, G, H) Tel. Rec. (Also see Prod. Chge. Bul. 48—Set 182-1)..... 137—4  
679B (Ch. 130116-B)..... 142—7  
680B (Ch. 120144-B, G, H) Tel. Rec. (Also see Prod. Chge. Bul. 48—Set 182-1)..... 138—4  
680D (Ch. 120140B)..... 128—6  
680D (Ch. 120144B, G, H) Tel. Rec. (See Prod. Chge. Bul. 48—Set 182-1 and Model 681F—Set 137-4)..... 137-4  
681F (Ch. 120143B, H) Tel. Rec. (Also see Prod. Chge. Bul. 50—Set 184-1)..... 148—6  
683B (Ch. 120141-B)..... \*  
684B, 685B (Ch. 120134B, G, H) Tel. Rec. .... 137—4  
686B (Ch. 120144B, G, H) Tel. Rec. (Also see Prod. Chge. Bul. 48—Set 182-1)..... 138—4  
686D (Ch. 120140B)..... 128—6  
686F (Ch. 120143B, H) Tel. Rec. (Also see Prod. Chge. Bul. 50—Set 184-1)..... 148—6  
688B, 689B, 690B (Ch. 120129B) Tel. Rec. (Also see Prod. Chge. Bul. 24—Set 142-1 and Prod. Chge. Bul. 47—Set 181-1)..... 126—5  
691B (Ch. 120145-B)..... 160—3  
692B, 693B, 694B (Ch. 120129B, D) Tel. Rec. (See Prod. Chge. Bul. 24—Set 142-1 and Prod. Chge. Bul. 47—Set 181-1)..... 126—5  
695B (Ch. 120146-B)..... 162—5

EMERSON—Cont.

696B (Ch. 120144B, G, H) Tel. Rec. (See Prod. Chge. Bul. 48—Set 182-1 and Model 676D—Set 138-4)..... 138-4  
696F (Ch. 120143B, H) Tel. Rec. (Also see Prod. Chge. Bul. 50—Set 184-1)..... 148—6  
696L (Ch. 120142B) Tel. Rec. (Also see Prod. Chge. Bul. 50—Set 184-1)..... 148—6  
697B (Ch. 120129B, D) Tel. Rec. (See Prod. Chge. Bul. 24—Set 142-B)..... 142-B  
697B (Ch. 120129B, D) Tel. Rec. (See Prod. Chge. Bul. 47—Set 181-1 and Model 669B—Set 126-5)..... 126-5  
698B (Ch. 120127B) Tel. Rec. (See Prod. Chge. Bul. 18—Set 130-1 and Model 672B—Set 125-6)..... 125-6  
699D (Ch. 120160-B)..... 165—1A  
700B (Ch. 120153-B)..... 169—6  
700D (Ch. 120158-B)..... 166—9  
701B (Ch. 120153-B)..... 169—6  
701D (Ch. 120158-B)..... 166—9  
701F (Ch. 120143B) Tel. Rec. (See Prod. Chge. Bul. 50—Set 184-1 and Model 672B—Set 148-6)..... 148-6  
702B (Ch. 120136-B)..... 159—5  
703B (Ch. 120097-B)..... 160—4  
704 (Ch. 120154-B)..... 184—6  
705A, B (Ch. 120155A, B) 208—4  
706B, 707B (Ch. 120156-B)..... 178—5  
708B (Ch. 120165-B) (See Model 706B—Set 178-5)..... 178-5  
709A (Ch. 120162-A)..... 167—6  
710B (Ch. 120146-B) (See Model 695B—Set 162-5)..... 162-5  
711B (Ch. 120164-B)..... 183—6  
711F (Ch. 120169-B)..... 206—4  
712B (Ch. 120164B)..... 183—6  
712F (Ch. 120169B)..... 206—4  
713B (Ch. 120156-B) (See Model 706B—Set 176-5)..... 176-5  
716D (Ch. 120163-D)..... 190—2  
716F (Ch. 120168-D) Tel. Rec. (See Prod. Chge. Bul. 61—Set 195-1 and Prod. Chge. Bul. 71—Set 211-1 and Model 716D—Set 190-2)..... 190-2  
717D (Ch. 120163-D)..... 190—2  
717F (Ch. 120168-D) Tel. Rec. (See Prod. Chge. Bul. 61—Set 195-1 and Prod. Chge. Bul. 71—Set 211-1 and Model 716D—Set 190-2)..... 190-2  
718B (Ch. 120150-B)..... 191—7  
719D (Ch. 120163-D)..... 190—2  
719F (Ch. 120168-D) Tel. Rec. (See Prod. Chge. Bul. 61—Set 195-1 and Prod. Chge. Bul. 71—Set 211-1 and Model 716D—Set 190-2)..... 190-2  
720B (Ch. 120164-B)..... 183—6  
720D (Ch. 120169B)..... 206—4  
720F (Ch. 120169-D)..... 206—4  
721D (Ch. 120166-D) Tel. Rec. (Also see Prod. Chge. Bul. 65—Set 202-1)..... 197—5  
722D (Ch. 120163-D)..... 190—2  
724B (Ch. 120151B)..... 208—5  
725A (Ch. 120149A)..... 209—2  
727D (Ch. 120168D) Tel. Rec. (See Prod. Chge. Bul. 61—Set 195-1 and Prod. Chge. Bul. 71—Set 211-1 and Model 716D—Set 190-2)..... 190-2  
728D (Ch. 120166-D) Tel. Rec. (Also see Prod. Chge. Bul. 65—Set 202-1)..... 197—5  
731D (Ch. 120167-D and Radio Ch. 120152-B) Tel. Rec. (See Prod. Chge. Bul. 65—Set 202-1 and Model 721D—Set 197-5)..... 197-5  
732B (Ch. 120169B)..... 206—4  
732D (Ch. 120164-B) Tel. Rec. (See Model 711B—Set 183-6)..... 183-6  
733F (Ch. 120169F and Radio Ch. 120152F) Tel. Rec. .... 206—4  
734B (Ch. 120169B)..... 206—4  
736B (Ch. 120171-B) Tel. Rec. (See Prod. Chge. Bul. 65—Set 202-1 and Model 721D—Set 197-5)..... 197-5  
737A, B (Ch. 120172A, B) 207—3  
738B (Ch. 120150-B) (See Model 718B—Set 191-7)..... 191-7

EMERSON—Cont.

741D (Ch. 120168-D) Tel. Rec. (See Prod. Chge. Bul. 61—Set 195-1, Prod. Chge. Bul. 71—Set 211-1 and Model 716D—Set 190-2)..... 190-2  
742B (Ch. 120169B)..... 206—4  
751D (Ch. 120168-D) Tel. Rec. (See Prod. Chge. Bul. 61—Set 195-1, Prod. Chge. Bul. 71—Set 211-1 and Model 716D—Set 190-2)..... 190-2  
1002..... 16—14  
1003 (See Model 1002—Set 16-14)..... 16-14  
Ch. 120019 (See Model 527)..... 527  
Ch. 120025B (See Model 585)..... 585  
Ch. 120047 (See Model 545)..... 545  
Ch. 120066 (See Model 571)..... 571  
Ch. 120066B (See Model 571)..... 571  
Ch. 120084B (See Model 609)..... 609  
Ch. 120086B (See Model 571)..... 571  
Ch. 120087B-D (See Model 606)..... 606  
Ch. 120088B (See Model 585)..... 585  
Ch. 120089B (See Model 608A)..... 608A  
Ch. 120090B, D (See Model 585)..... 585  
Ch. 120091D-QD (See Model 620)..... 620  
Ch. 120092D (See Model 619)..... 619  
Ch. 120094A (See Model 649A)..... 649A  
Ch. 120095-B (See Model 614D)..... 614D  
Ch. 120096B (See Model 632)..... 632  
Ch. 120098B (See Model 621)..... 621  
Ch. 120098P (See Model 622)..... 622  
Ch. 120099B (See Model 630)..... 630  
Ch. 120103B (See Model 600)..... 600  
Ch. 120104B, BJ (See Model 626)..... 626  
Ch. 120107B (See Model 627B)..... 627B  
Ch. 120110E (See Model 631)..... 631  
Ch. 120110I, B, BC, C (See Model 614, B, BC, C)..... 614, B, BC, C  
Ch. 120110E (See Model 648B)..... 648B  
Ch. 120113, B, BC, C (See Model 644, B, BC, C)..... 644, B, BC, C  
Ch. 120114 (See Model 633)..... 633  
Ch. 120114B (See Model 629)..... 629  
Ch. 120118B (See Model 650)..... 650  
Ch. 120120 (See Model 629B, C)..... 629B, C  
Ch. 120123B (See Model 650B)..... 650B  
Ch. 120124 (See Model 651C)..... 651C  
Ch. 120124B (See Model 651C)..... 651C  
Ch. 120124B, G, H (See Model 661B)..... 661B  
Ch. 120128-B (See Model 663B)..... 663B  
Ch. 120129-B (See Model 669B)..... 669B  
Ch. 120131-B (See Model 665B)..... 665B  
Ch. 120133B (See Model 660B)..... 660B  
Ch. 120134B, G, H (See Model 661B)..... 661B  
Ch. 120135B, G, H (See Model 666B)..... 666B  
Ch. 120136-B (See Model 653B)..... 653B  
Ch. 120138-B (See Model 650F)..... 650F  
Ch. 12040B (See Model 676B)..... 676B  
Ch. 120141-B (See Model 683B)..... 683B  
Ch. 120142B (See Model 686L)..... 686L  
Ch. 120143B, H (See Model 676F)..... 676F  
Ch. 120144B, G, H (See Model 676D)..... 676D  
Ch. 120148-B (See Model 669B)..... 669B  
Ch. 120149A (See Model 725A)..... 725A  
Ch. 120150-B (See Model 718B)..... 718B  
Ch. 120151-B (See Model 724B)..... 724B  
Ch. 120152-F (See Model 731D)..... 731D  
Ch. 120153-F (See Model 733F)..... 733F  
Ch. 120153-B (See Model 700B)..... 700B  
Ch. 120154-B (See Model 704)..... 704  
Ch. 120155A, B (See Model 705A, B)..... 705A, B  
Ch. 120158-B (See Model 700D)..... 700D  
Ch. 120160-B (See Model 699D)..... 699D  
Ch. 120162-A (See Model 709A)..... 709A

EMERSON—Cont.

Ch. 120163-D (See Model 716D)..... 716D  
Ch. 120164-B (See Model 711B)..... 711B  
Ch. 120166-D (See Model 721D)..... 721D  
Ch. 120167-D (See Model 731D)..... 731D  
Ch. 120168-D (See Model 716F)..... 716F  
Ch. 120169-B (See Model 711F)..... 711F  
Ch. 120169-D (See Model 720F)..... 720F  
Ch. 120169F (See Model 733F)..... 733F  
Ch. 120171-B (See Model 736B)..... 736B  
Ch. 120172A, B (See Model 737A, B)..... 737A, B

**EMPRESS**  
55, 56 ..... 7—14

**ESPEY (Also see Philharmonic)**  
RR13, RR13L ..... 13—17  
7B ..... 47—8  
7C ..... 153—4  
18 ..... 90—7  
31 ..... 103—9  
51C ..... 174—6  
512 ..... 68—8  
512B ..... 182—4  
513, 514 ..... 63—8  
524 ..... 90—7  
581 ..... 14—10  
581 ..... 10—17  
641, 642 ..... 8—11  
651 ..... 9—14  
652, 653 (See Model 651—Set 9-14)..... 9-14  
651 ..... 90—7  
6511, 6512, 6514, 6516, 6517, 6520, 6521, 6533 (Ch. FJ97) (See Model 651—Set 9-14)..... 9-14  
6540, 6541 ..... 8—12  
6542 (Ch. FJ97) (See Model 651—Set 9-14)..... 9-14  
6545 (Ch. FJ97) ..... 5—16  
6546 (Ch. FJ97) (See Model 651—Set 9-14)..... 9-14  
6547 ..... 8—12  
6560 (Ch. FJ97) (See Model 651—Set 9-14)..... 9-14  
6611, 6612, 6613, 6614, 6615, 6630, 6631, 6632, 6634, 6635 (Ch. 97A)..... 18—16  
7541 (Ch. FJ97) (See Model 651—Set 9-14)..... 9-14  
7552 ..... 90—2

**ESQUIRE**  
60-10, 65,4 ..... 14—11  
511 ..... 157—3  
517 (See Model 520—Set 163-5)..... 163—5  
520 ..... 177—6

**FADA**  
DL21T Tel. Rec. .... 200—5  
G-925 Tel. Rec. .... 89—6  
P80 ..... 27—9  
P82 ..... 21—16  
P100 (See Model 27—10)..... 27—10  
P111 (See Model 178—6)..... 178—6  
P130 Tel. Rec. .... 135—7  
P7C15, P7C25 Tel. Rec. .... 158—3  
R-1025 Tel. Rec. .... 114—4  
R-1050 Tel. Rec. .... 114—4  
S4C20 Tel. Rec. .... 142—8  
S4C40 Tel. Rec. .... 142—8  
S4T15 Tel. Rec. .... 142—8  
S4T30 Tel. Rec. .... 142—8  
S6C55 Tel. Rec. .... 134—7  
S6C70 Tel. Rec. .... 134—7  
S6T65 Tel. Rec. .... 134—7  
S7C20, S7C30 Tel. Rec. (See Model S6C55—Set 134-7)..... 134-7  
S7C70 Tel. Rec. .... 134—7  
S7T65 Tel. Rec. .... 134—7  
S9C10 Tel. Rec. .... 134—7  
S20T20 Tel. Rec. (See Model S6C55—Set 134-7)..... 134-7  
S1015 Tel. Rec. .... 109—4  
S1020 Tel. Rec. .... 109—4  
S1030 Tel. Rec. .... 109—4  
S1055, S1055X Tel. Rec. .... 134—7  
S1060 Tel. Rec. .... 134—7  
S1065 Tel. Rec. .... 134—7  
TV30 Tel. Rec. .... 74—3  
7C42 Tel. Rec. .... 179—5  
7C52 Tel. Rec. .... 179—5  
7T32 Tel. Rec. .... 177—7  
1776 Tel. Rec. .... 204—4  
1779 Tel. Rec. .... 204—4  
20C22 Tel. Rec. .... 180—3  
20T12 Tel. Rec. .... 180—3  
21C2 Tel. Rec. .... 200—5  
21T Tel. Rec. .... 200—5  
24T2 Tel. Rec. .... 200—5  
24T10 Tel. Rec. .... 180—3  
173T, 175C, 177CD Tel. Rec. .... 192—5  
215C Tel. Rec. .... 200—5  
602 ..... 14—12  
605, 606 Series ..... 1—13  
609, 610 Series ..... 1—15  
633 ..... 17—13  
637 ..... 17—14  
652 Series ..... 1—23  
700 ..... 32—7  
711 ..... 28—10  
720 Tel. Rec. .... 177—7  
721 Tel. Rec. (See Model 7132—Set 177-7)..... 177-7  
790 ..... 64—6  
795 ..... 36—7  
799 Tel. Rec. .... 74—3  
830 ..... 97—5  
845 ..... 97—6

**FADA—Cont.**

855	92-2
880 Tel. Rec.	95A-5
899 Tel. Rec.	74-3
925 Tel. Rec.	89-6
930, 940 Tel. Rec.	74-3
965 Tel. Rec.	89-6
1000 Series	17-15
1001	17-15

**FAIRMONT**

3071A-056 Tel. Rec.	4-87	
(Similar to Chassis)	119-3	
3871A-058 Tel. Rec.	(Similar to Chassis)	109-1
31773 Tel. Rec.	(Similar to Chassis)	72-4
31874 Tel. Rec.	(Similar to Chassis)	85-3
31874S Tel. Rec.	(Similar to Chassis)	85-3
31874-872 Tel. Rec.	(Similar to Chassis)	85-3
31876A Tel. Rec.	(Similar to Chassis)	85-3
31876A-950 Tel. Rec.	(Similar to Chassis)	85-3
31879A-900 Tel. Rec.	(Similar to Chassis)	78-4
51876A Tel. Rec.	(Similar to Chassis)	85-3
51879A-918 Tel. Rec.	(Similar to Chassis)	78-4
51879A-916 Tel. Rec.	(Similar to Chassis)	78-4
231876A-954 Tel. Rec.	(Similar to Chassis)	85-3
231879A-912 Tel. Rec.	(Similar to Chassis)	78-4

**FARNSWORTH (Also see Record Changer Listing)**

EC-260	7-15
EK-081, EK-082, EK-083	26-13
EK-262, EK-263BL, E-263WL, EK-264BL, EK-264WL, EK-265	7-15
EK-681	26-13
ET-060, ET-061, ET-063	6-11
ET-064, ET-065, ET-066	4-2
GK-100, GK-102	23-8
GK-103, GK-104	23-8
GK-111, GK-112	60-11
GK-114, GK-115	60-11
GK-140, GK-141, GK-142, GK-143, GK-144	24-18
GT-050, GT-051, GT-052, GT-060, GT-061, GT-064, GT-065	35-6
K-267, K-669 (See Model EC-260—Set 7-15)	
Ch. 150	(See Model ET-060)
Ch. 152, 153	(See Model EC-260)
Ch. 156, 157	(See Model EK-081)
Ch. 158, 159	(See Model ET-064)
Ch. 162	(See Model EC-260)
Ch. 170	(See Model GK-100)
Ch. 193	(See Model EK-081)
Ch. 194, 201, 216	(See Model GK-100)

**FEDERAL MFG. CO.**

104 (Select-A-Call)	18-17
135 (Select-A-Call)	11-7
<b>FEDERAL TEL. &amp; RADIO CORP.</b>	
1021 (See Model 1030T—Set 8-13)	
1030T	8-13
1031, 1032 (See Model 1030T—Set 8-13)	
1040T	23-9
1040TB (See Model 1040T—Set 23-9)	
1540T	8-13

**FERRAR**

C-81-B	17-16
T-618	39-4
WR-11	15-10

**FIRESTONE (AIR CHIEF)**

4-A-2 (Code No. 297-6-LMMU-143)	14-4
4-A-3 (Code No. 297-6-LMFU-134)	31-13
4-A-10 (Code No. 297-7-RN228)	28-11
4-A-11 (Code No. 188-8-4A11)	41-7
4-A-12 (Code No. 213-8-8370)	49-8
4-A-15 (Code 77-7-4A15)	36-7
4-A-17 (Code No. 213-7-7270)	35-7
4-A-20 (Code 5-5-9000-A)	15-11
4-A-21 (Code No. 5-5-9001A)	11-19
4-A-22X (Code No. 5-5-9001B)	11-19
4-A-23 (5-5-9003-A)	2-29
4-A-24 (Code 291-6-566)	13-5
4-A-25 (Code 291-6-572)	13-6
4-A-26 (Code 307-6-9030-A)	33-5
4-A-27	28-12
4-A-31 (Code No. 177-5-4A31)	11-20
4-A-37 (Code 177-5-4A37)	13-7
4-A-41 (Code 291-7-576)	52-8
4-A-42 (Code No. 177-7-4A42)	30-9
4-A-60 (Code No. 307-8-9047A)	38-6
4-A-61 (Code No. 332-8-13712T)	48-7
4-A-62, 4-A-63	67-10
4-A-64, 4-A-75	68-9
4-A-66 (Code No. 177-8-4A66)	74-4

**FIRESTONE—Cont.**

4-A-68 (Code No. 332-8-143653)	53-11
4-A-69 (Code No. 155-8-85)	61-8
4-A-70	136-8
4-A-71 (Code 291-8-628)	59-9
4-A-78, 4-A-79	117-5
4-A-85	118-7
4-A-86	129-6
4-A-86 (Late)	144-4
4-A-87	119-7
4-A-88	119-6
4-A-89	118-1
4-A-92	154-4
4-A-95	144-4
4-A-96 (See Model 4-A-87—Set 119-7)	
4-A-97, 4-A-98	147-5
4-A-101, 4-A-102	187-7
4-A-108 (Code 297-2-361)	191-8
4-A-112 (See Model 4-A-92—Set 154-4)	
4-B-1 (Code 7-6-PM15)	7-1
4-B-2 (Code 7-6-PM14)	18-18
4-B-6 (Code No. 177-7-PM18)	29-8
4-B-56	133-6
4-B-57	124-4
4-B-58	135-8
4-B-60	153-5
4-B-61	155-6
4-B-62	152-6
4-B-67 (Code 120-2-F152)	187-6
4-C-3	19-17
4-C-5 (Code 291-7-574)	33-6
4-C-6	19-17
4-C-13 (Code 332-8-140623)	66-9
4-C-16, 4-C-17	120-6
4-C-18	110-8
4-C-19, 4-C-20	170-7
4-C-21 Code 120-2-C51-U)	185-7
120-2-C31-U)	86-5
120-2-C31-U)	86-5
13-G-9 (Code 347-9-2498) Tel. Rec.	73-5
13-G-5 (Code 291-9-651) Tel. Rec.	83-3
13-G-33 Tel. Rec.	108-6
13-G-44, 13-G-45 Tel. Rec.	*
13-G-46, 13-G-47 Tel. Rec.	140-5
13-G-48 Tel. Rec.	143-6
13-G-49, 13-G-50 Tel. Rec.	*
13-G-51, 13-G-52 (Code 307-1-9202A, AA, B, BA) Tel. Rec.	193-4
13-G-53, 13-G-54, 13-G-55 Tel. Rec.	*
13-G-56 Tel. Rec.	152-7
13-G-57 Tel. Rec.	158-4
13-G-58, 13-G-59 Tel. Rec.	*
13-G-79 Tel. Rec.	*
13-G-107, 13-G-108 (Code 105-2-700140) Tel. Rec.	197-6
13-G-109, A (Code 105-2-700100, 105-2-700104) Tel. Rec.	197-6
13-G-110 (Code 334-2-MS29A) Tel. Rec.	180-4
13-G-110A (Code 334-2-MS31CA) Tel. Rec. (Also see Prod. Chge. Bul. 60—Set 194-1)	182-5
13-G-114, A (Code 105-2-8170) (Ch. 817) Tel. Rec.	198-6
13-G-115, 13-G-116 (Code 334-2-MS31CA) Tel. Rec. (Also see Prod. Chge. Bul. 60—Set 194-1)	182-5
13-G-117 (Code 105-2-8170) (Ch. 817) Tel. Rec.	198-6

**FIRESTONE—Cont.**

13-G-119, 13-G-120 (Code 334-2-MS31CA) Tel. Rec. (Also see Prod. Chge. Bul. 60—Set 194-1)	182-5
13-G-122 (Code 105-2-700140) Tel. Rec.	197-6
13-G-124 (Code 105-2-82000) Tel. Rec. (See Model 13-G-107—Set 197-6)	
13-G-125 (Code 105-2-81700) Tel. Rec. (See Model 13-G-107—Set 197-6)	
<b>FISHER</b>	
50-C, -CH	209-3
<b>FLEETWOOD</b>	
600 Tel. Rec.	209-4
<b>FLUSH WALL</b>	
5P	26-14
<b>FORD</b>	
GF890, E (OA-18805-B)	109-5
M-1 (OA-18805-A1)	46-4
M-1A (OA-18805-A1) (See Model M-1—Set 46-4)	
M-1A-1 (OA-18805-A1)	106-8
M-2 (IA-18805-A1)	132-7
M-4 (FAC-18805-A1)	184-7
M-4 (FAC-18805-C) (See Model M-4—Set 184-7)	
OB (OA-18805-A1) (See Model M-1A-1—Set 106-8)	
OCF751 (1A-18805-D)	157-4
OMF (OA-18805-A2)	135-9
OZ (OA-18805-B) (See Model M-2—Set 109-5)	
1BF (IA-18805-A1) (See Model M-2—Set 132-7)	
1CF743 (1A-18805-B)	133-7
1CF743-1 (1A-18805-B)	158-5
1CF751-2 (1A-18805-G)	157-4
1MF (1A-18805-A2)	131-8
2BF (1A-18805-A1) (See Model M-4—Set 184-7)	
2CF754 (FAC-18805-B)	167-7
2MF (FAC-18805-A)	175-10
3MF (FAD-18805-C)	206-5
3SF755 (FAD-18805-D)	208-6
6MF060 (51A-18805-A) (Ch. 6CA1) Tel. Rec.	10-18
6MF780 (51A-18805-A1)	62-12
6MF780-E (51AF-18805) (See Model 6MF780—Set 62-12)	
8MF880 (8A-18805B)	42-12
8MF881 (8C-18805B)	47-9
8MF880 (8A-18805B)	61-9
8MF883 (8A-18805B-1)	83-4
8MF883-E (8A-18805) (See Model 8MF881—Set 47-9)	
9BF (8A-18805-A1) (See Model M-1—Set 46-4)	
9DF (8A-18805-A2) (See Model 8072—Set 44-4)	
9MF (8A-18805-A3) (See Model 8072—Set 44-4)	
9ZF (8A-18805-B1) (See Model 8MF883—Set 83-4)	
7070 (51A-18805-B2)	45-10
8072 (8A-18805-A)	44-4
<b>FREED EISEMAN</b>	
46	11-8
54, 55, 56, 68 (Ch. 1620C) Tel. Rec.	113-1A
<b>GALVIN (See Motorola)</b>	
<b>GAMBLE-SKOOGMO (See Coronado)</b>	
<b>GAROD (Also see Majestic)</b>	
4A-1, 4A-2	29-9
4B-1	51-6

**GAROD—Cont.**

5A-1	22-15
(Code 334-2-MS31CA)	5-28
5A-3	44-5
5A-4	40-6
5A-11 "The Companion"	15-12
5D, 5D-2	22-12
5D-3, 5D-3A	22-16
5D-4, 5D-5	33-7
5RC-1	36-8
6A-2	28-13
6AU-1	5-29
6BU-1A "The Senator"	13-18
6DPS, 6DPS-A	12-13
10T21, 10T22, 10T23, 10T24, 10T25 Tel. Rec.	60-12
10T20, 10T21, 10T22, 10T23 Tel. Rec.	95A-4
11FMP	38-7
12T21, 12T22, 12T23, 12T24, 12T25, 12T26A, 12T27A, Tel. Rec.	60-12
12T22, 12T21, 12T22, 12T23 Tel. Rec.	95A-4
15T26, 15T27 Tel. Rec.	60-12
15T24, 15T25, 15T26, 15T27 Tel. Rec.	95A-4
16C74, 16C75 (97 Series) Tel. Rec.	97A-4
19C6, 19C7 (97 Series) Tel. Rec.	97A-4
62B	29-10
306	48-8
900TV, 910TV Tel. Rec.	50-7
100TV, 101TV Tel. Rec.	50-7
104G, 104G Tel. Rec.	93A-5
104T, 104T Tel. Rec.	93A-7
1100TVP, 1110TVP Tel. Rec.	50-7
1200TVP, 1210TVP Tel. Rec.	50-7
1244G, 1245G Tel. Rec.	99A-5
1244T, 1245T Tel. Rec.	99A-7
1546G, 1546G Tel. Rec.	99A-5
1546T, 1549T Tel. Rec.	93A-7
1548G, 1549G Tel. Rec.	99A-5
1671 (98 Series) Tel. Rec.	97A-3
1672, 1673, 1674, 1675 (97 Series) Tel. Rec.	97A-4
1974, 1975 (97 Series) Tel. Rec.	97A-4
2042T, 2043T Tel. Rec.	93A-7
2546T Tel. Rec.	93A-7
2549T Tel. Rec.	93A-7
3912 TVFMP, 3915 TVFMP Tel. Rec.	95A-6

**GARRARD (See Record Changer Listing)**

<b>GENERAL (Mutual Buying Syndicate)</b>	
17CG1, 17TV Tel. Rec.	149-13
(Similar to Chassis)	
<b>GENERAL ELECTRIC (Also see Record Changer Listing)</b>	
UHF-103 Tel. UHF Conv.	209-5
YRB-60-1, YRB-60-2, YRB-60-12	33-8
10C101, 10C102 Tel. Rec.	96-4
10T1 Tel. Rec.	96-4
10T4, 10T5, 10T6 Tel. Rec.	96-4
12C101, 12C102, 12C105 Tel. Rec.	96-4
12C107, 12C107B, 12C108, 12C108B, 12C109, 12C109B Tel. Rec.	125-7
12K1 Tel. Rec.	95A-6
12T1 Tel. Rec.	96-4
12T3, 12T3B, 12T4, 12T4B Tel. Rec.	125-7
12T7 Tel. Rec.	99A-5
14	35-8
14C102, 14C103 Tel. Rec.	123-4
14T2, 14T3 Tel. Rec.	123-4
16C103 Tel. Rec.	123-4
16C110, 16C111 Tel. Rec.	123-4
16C113 Tel. Rec.	123-4

**GENERAL ELECTRIC—Cont.**

16C115, 16C116, 16C117 Tel. Rec.	123-4	
16K1, 16K2 Tel. Rec.	161-1A	
16T1, 16T2, 16T3, 16T4, Tel. Rec.	123-4	
16T5 Tel. Rec. (See Model 16T1—Set 123-4)		
17C101, 17C101A Tel. Rec.	123-4	
17C103, 17C104, 17C105 Tel. Rec.	(Also see Prod. Chge. Bul. 32—Set 158-1)	141-6
17C107, 17C108, 17C109 Tel. Rec. (Also see Prod. Chge. Bul. 32—Set 158-1)		141-6
17C110, 17C111 (Early, "D," and "W" Versions) Tel. Rec.	180-5	
17C112 (See Prod. Chge. Bul. 32—Set 158-1) and Model 17C103—Set 141-6)		
17C113 Tel. Rec.	166-10	
17C114 Tel. Rec. (See Prod. Chge. 32—Set 158-1 and Model 17C103—Set 141-6)		
17C115 Tel. Rec.	166-10	
17C117 Tel. Rec. (See Model 17C113—Set 166-10)		
17C120 Tel. Rec.	166-10	
17C125 Tel. Rec. (See Prod. Chge. Bul. 64—Set 201-1) and Model 21C200—Set 194-2)		
1771, 1772, 1773 Tel. Rec. (Also see Prod. Chge. Bul. 32—Set 158-1)		141-6
1774, 1775, 1776 Tel. Rec. (See Prod. Chge. Bul. 32—Set 158-1) and Model 17C103—Set 141-6)		
1777 Tel. Rec. (See Model 17C113—Set 141-6)		
17710 Tel. Rec.	196-3	
19C101 Tel. Rec.	99A-6	
20C105, 20C106, 20C107 Tel. Rec. (See Prod. Chge. Bul. 64—Set 201-1) and Model 21C200—Set 194-2)		
20C107 Tel. Rec. (See Prod. Chge. Bul. 64—Set 201-1) and Model 21C200—Set 194-2)		
20C150, 20C151 Tel. Rec.	153-6	
20T2 Tel. Rec.	176-3	
21C200 Tel. Rec.	176-3	
21C201, 21C202 Tel. Rec. (Also see Prod. Chge. Bul. 64—Set 201-1)		194-2
21C204 Tel. Rec. (Also see Prod. Chge. Bul. 64—Set 201-1)		194-2
21C206 Tel. Rec. (Also see Prod. Chge. Bul. 64—Set 201-1)		194-2
21C208 Tel. Rec. (Also see Prod. Chge. Bul. 64—Set 201-1)		194-2
21C208-U Tel. Rec. (See Prod. Chge. Bul. 64—Set 201-1) and Model 21C208—Set 194-2)		
21C214 Tel. Rec. (Also see Prod. Chge. Bul. 64—Set 201-1)		194-2
2111 Tel. Rec. (Also see Prod. Chge. Bul. 64—Set 201-1)		194-2
2112 Tel. Rec. (See Model 2111—Set 194-2)		
2116 Tel. Rec. (See Model 2111—Set 194-2)		
24C101 Tel. Rec.	152-8	
41, 42, 43, 44, 45	32-8	
50	7-16	
60, 61, 62, 63, 64, 65	98-4	
66, 67	76-12	
100, 101	6-13	
102, 102W	41-8	
103, 105	6-13	
106	8-14	
107, 107W	41-8	
114, 114W, 115, 115W	41-8	
118, 119M, 119W	39-5	
123, 124	97-7	
131 (See Model 118—Set 39-5)		
135, 136	81-8	
140	30-10	
143	75-9	
145	60-13	
150	56-11	
160	56-12	
165	89-7	
180	20-11	
186-4	57-7	
200, 201, 202, 203, 205, 205M	8-15	
210, 211, 212	51-8	
218, 218 "H"	121-5	
219, 220, 221	4-1	
226	91-5	
230 (See Kaiser-Frazier Model 200001—Set 35-13)		
250	4-13	
254	32-9	
260	15-13	
28		



**GENERAL ELECTRIC—Cont.**

400, 401 118-8  
 404, 405 121-6  
 408 116-6  
 409 176-4  
 410 118-8  
 411 118-8  
 412 189-9  
 412F 211-6  
 414 175-11  
 414F 211-6  
 415 175-11  
 415F 211-6  
 416 175-11  
 416F 211-6  
 417 16-15  
 422, 423 154-5  
 430 175-11  
 500, 501 98-4  
 502 95-9  
 505, 506, 507, 508, 509 98-4  
 510, 511 120-7  
 510F, 511F, 512F, 513F 143-7  
 514 198-7  
 515F, 516F, 517F, 518F 143-7  
 521, 522 114-5  
 523, 524, 525, 526 143-7  
 530 98-4  
 535 151-7  
 542, 543 198-7  
 547, 547, 548, 549 191-9  
 551, 552 201-4  
 600 109-6  
 601, 603, 604 115-3  
 605, 606 145-6  
 607, 608 (See Model 605—  
 Set 145-6)  
 610, 611 147-7  
 614, 615 199-6  
 650 101-3  
 741 157-6  
 752, 753 123-5  
 754 167-8  
 755 130-6  
 756 167-8  
 757 (See Model 755—  
 Set 130-6)  
 800A, B, C, D Tel. Rec.  
 (See Model 805—  
 Set 78-7)  
 801 Tel. Rec.  
 (Phonofact Servicer) 78  
 802 Tel. Rec. 91A-7  
 803 Tel. Rec. 97A-4  
 805, 806, 807, 809  
 Series Tel. Rec. 78-7  
 810 Tel. Rec. 53-12  
 811 Tel. Rec. 63-9  
 814 Tel. Rec. 69-9  
 815 Tel. Rec. 97A-5  
 817 Tel. Rec. 78-7  
 818 Tel. Rec. 95A-7  
 820 Tel. Rec. \*  
 821 Tel. Rec. 78-7  
 830 Early Tel. Rec. 81-9  
 835 Early Tel. Rec. 81-9  
 840 Tel. Rec. 81-9  
 901 Tel. Rec. 97A-5  
 910 Tel. Rec. 97A-5

**GENERAL IMPLEMENT**  
 9A5 (See 37—7)

**GENERAL INDUSTRIES (See  
 Changer and Recorder  
 Listings)**

**GENERAL INSTRUMENT  
 (See Recorder Changer Listing)**

**GENERAL MOTORS CORP.  
 (GMC)**  
 223029 93-6

**GENERAL TELEVISION**  
 1A5, 2A5, 3A5, 5A5  
 Ch. 1-1 1-21  
 4B5 27-11  
 5R5G, 5B5Y 27-12  
 9A5 39-6  
 9B6P 36-10  
 14A4F 3-21  
 15A5 (Ch. 1-1) 1-21  
 17A5 5-22  
 19A5 (Ch. 1-1) 1-21  
 21A4 12-14  
 22A5C 13-19  
 23A6 14-14  
 24B6 37-8  
 25B5 26-15  
 26B5 29-11  
 27C5 36-11

**GILFILLAN**  
 56A, 56B 1-27  
 56BC1, 56BCR (See  
 Model 56A—Set 1-27)  
 56C, 56D 1-27  
 56E (See Model 56A—  
 Set 1-27)  
 58M, 58W 45-12  
 66A, 66AM 8-16  
 66B "The Overland" 8-17  
 66D, 66DM 8-16  
 66P, 66PM  
 "The El Dorado" 9-15  
 68B-D 46-10  
 68F 46-11  
 68-48 61-10  
 68C, 68P, 68U (86 Series) 26-16  
 108-48 59-10

**GLOBE**  
 5BP1 18-20  
 6AP1 20-12  
 6D1 20-13  
 6P1 20-12  
 6U1 20-13  
 7CP-1 28-14  
 51 19-18  
 62C 19-19  
 85 49-9  
 454 41-9  
 456 40-7  
 457 39-7  
 500 21-18

**GLOBE—Cont.**

517 21-17  
 551 16-16  
 552 27-13  
 553 28-15  
 559 50-8

**GODFREY**  
 6AD 28-17  
 6SM 28-17

**GON-SET**  
 3-30 Meter Converter 61-11  
 10-11 Meter Converter 37-9

**B. F. GOODRICH  
 (Also See Mantala)**  
 92-523, 92-524, 92-525,  
 92-526, 92-527  
 92-528 148-7

**GOODELL**  
 ATB-3 70-5  
 NSA-20 73-6

**GOTHAM**  
 319 Tel. Rec. 209-6

**W. T. GRANT (See Grantline)**

**GRANTLINE**  
 300 (Series B) 9-16  
 500, 501 (Series A) 9-17  
 501-7 35-10  
 504-7 21-19  
 508-7 34-8  
 510-A 24-19  
 605, 606 2-17  
 641 12-15  
 651 11-9  
 5610 35-11  
 6547 11-10

**GROMMES**  
 LJ-2 194-3  
 50PG, 51PG 163-6  
 50PG2 206-6  
 100BA 185-10  
 117PS, 210PA 190-3  
 205PA 191-10  
 215BA 198-8

**HALLICRAFTERS  
 (Also See Echophone)**  
 A-84 (Run 1) 209-7  
 CA-2, CA-2A 30-12  
 CA-4 36-13  
 S-38 3-7  
 S-38B 121-7  
 S-38C (Run 2) 190-4  
 S-40 39-8  
 S-40A 33-10  
 S-40B 122-4  
 S-41G, S-41W 10-19  
 S-47 46-12  
 S-51 40-8  
 S-52 48-9  
 S-53 39-8  
 S-53A, AU 171-5  
 S-55, S-56 55-9  
 S-58 57-8  
 S-59 58-10  
 S-72 82-6  
 S-72L 173-6  
 S-76, S-76U 143-9  
 S-77 146-7  
 S-78 124-5  
 S-78A (Run 1) 180-6  
 S-80 162-6  
 S-81 166-11  
 S-82 167-9  
 ST-74 125-8  
 SX-42 44-6  
 SX-43 45-13  
 SX-62 61-12  
 SX-71 111-6  
 T-54 (Early) Tel. Rec. 48-10  
 T-54 (Late) Tel. Rec. 91-6  
 T-60 Tel. Rec. 63-10  
 T-61, T-64, T-67 Tel. Rec.  
 (Also See Prod. Chge.  
 Bul. 32—Set 158-1) 65-7  
 T-68 (Tel. Rec.) 63-10  
 T-69 Tel. Rec. 130-7  
 SR10 155-7  
 SR10A 155-7  
 SR11, SR12, SR13, SR14 129-7  
 SR18, SR19, SR20, SR21,  
 SR22 (See Model SR11—  
 Set 129-7) 168-7  
 SR24 510 Tel. Rec. 168-7  
 SR20, A, SR31, A, SR32,  
 A, SR33, A, SR34, A 170-8  
 SR50, SR51, SR52 179-6  
 BR40, BR40C 181-7  
 400, 406, 409, 410, 411,  
 412 52-9  
 505 (Early) Tel. Rec. 48-10  
 505 (Late) (See  
 Model T-54 Late) 91-6  
 506 (Early) Tel. Rec. (See  
 Model 505 Early) 91-6  
 506 (Late) 91-6  
 509, 510 Tel. Rec.  
 (Also See Prod. Chge.  
 Bul. 32—Set 158-1) 65-7  
 511 Tel. Rec. 96-5  
 512C, 513 Tel. Rec. 80-7  
 514 Tel. Rec. 91-6  
 515 Tel. Rec. 80-7  
 518, 519, 520 Tel. Rec. 92-3  
 520E Tel. Rec. 80-7  
 521 Tel. Rec. 92-3  
 521E Tel. Rec. 80-7  
 524 Tel. Rec. 80-7  
 600, 601, 602, 603, 604  
 61 92-3  
 605, 606 Tel. Rec. 107-5  
 680, 681 Tel. Rec. 113-3  
 690 Tel. Rec. 113-3  
 715, A, Tel. Rec. 113-3  
 716 Tel. Rec. (See Model  
 715—Set 113-3)  
 730, 731 (Run 1) Tel. Rec.  
 (See Model 680—  
 Set 113-3)

**HALLICRAFTERS—Cont.**

732, 733 Tel. Rec. \*  
 740, 741 (Run 1) Tel. Rec.  
 (See Model 680—  
 Set 113-3)  
 745 Tel. Rec. 105-4  
 750, 751 Tel. Rec. 105-4  
 760, 761 Tel. Rec. 105-4  
 805, 806 Tel. Rec. 136-9  
 810 Tel. Rec. 136-9  
 810A, 811 Tel. Rec. 124-6  
 815 Tel. Rec. 124-6  
 818, 820 Tel. Rec. 124-6  
 821 Tel. Rec. (See  
 Model 810A—Set 124-6)  
 822 Tel. Rec. 124-6  
 832, 833 Tel. Rec. 121-1A  
 860, 861 Tel. Rec. 124-6  
 870, 871 Tel. Rec. (See  
 Model 810A—Set 124-6)  
 880 Tel. Rec. (See Model  
 810A—Set 124-6)  
 1000 (Ch. W1000D)  
 Tel. Rec. 180-7  
 1001 (Ch. F1100D) (See  
 Model 1002—Set 169-7)  
 1002, 1003, 1004 (Ch.  
 F1100D) Tel. Rec. 169-7  
 1005, 1006 (Ch. A1100D)  
 Tel. Rec. 177-8  
 1007 (Ch. F1100D)  
 Tel. Rec. 169-7  
 1008 (Ch. X1000D)  
 Tel. Rec. 180-7  
 1010P (Ch. A-1200D,  
 K1200D, W1200D)  
 Tel. Rec. 188-6  
 1012P (Ch. A-1200D,  
 K1200D, W1200D)  
 Tel. Rec. 188-6  
 1013C (Ch. F1200D)  
 Tel. Rec. 188-6  
 1015, 1016, 1017, 1018,  
 1019 (Ch. A1100D)  
 Tel. Rec. 177-8  
 1019 (Ch. Z1000D)  
 Tel. Rec. 180-7  
 1021P (Ch. D1200D,  
 L1200D, X1200D)  
 Tel. Rec. 188-6  
 1022C (Ch. G1200D)  
 Tel. Rec. 188-6  
 1025 (Ch. C1000D)  
 Tel. Rec. 172-4  
 1026P (Ch. D1200D,  
 L1200D, X1200D)  
 Tel. Rec. 188-6  
 1027C (Ch. G1200D)  
 Tel. Rec. 188-6  
 1050, A (Ch. A11200D)  
 Tel. Rec. 211-7  
 1072 (Ch. AG1200D)  
 Tel. Rec. 211-7  
 1072A (Ch. AR1200D)  
 Tel. Rec. 211-7  
 1074 (Ch. AG1200D)  
 Tel. Rec. 211-7  
 1074A (Ch. AR1200D)  
 Tel. Rec. 211-7  
 1074AT (Ch. AY1200D)  
 Tel. Rec. 211-7  
 1075 (Ch. AG1200D)  
 Tel. Rec. 211-7  
 1075A (Ch. AR1200D)  
 Tel. Rec. 211-7  
 1075AT (Ch. AY1200D)  
 Tel. Rec. 211-7  
 1077 (Ch. AH1200D)  
 Tel. Rec. 211-7  
 1078 (Ch. AG1200D)  
 Tel. Rec. 211-7  
 1078A (Ch. AR1200D)  
 Tel. Rec. 211-7  
 1078AT (Ch. AY1200D)  
 Tel. Rec. 211-7  
 1081, A (Ch. AJ1200D)  
 Tel. Rec. 211-7  
 1085, A (Ch. AJ1200D)  
 Tel. Rec. 211-7  
 1088, A (Ch. AJ1200D)  
 Tel. Rec. 211-7  
 1111P (Ch. A1200D)  
 Tel. Rec. 188-6  
 1113P (Ch. D1200D)  
 Tel. Rec. 188-6  
 14808 (Ch. R900D)  
 Tel. Rec. 167-10  
 17804C Tel. Rec. 155-8  
 17810M Tel. Rec. 152-9  
 17812, 17813, 17814,  
 17815-H Tel. Rec. 155-8  
 17816, 17817 Tel. Rec. 156-6  
 17819 Tel. Rec. 155-8  
 17824 Tel. Rec. 155-8  
 17824-A Tel. Rec. 156-6  
 17825 (See F1100D) Tel.  
 Rec. (See Model 1002—  
 Set 169-7)  
 17838 Tel. Rec. 155-8  
 17848, 17849, 17850  
 Tel. Rec. 155-8  
 17860-H, 17861-H  
 Tel. Rec. 156-6  
 17905 Tel. Rec. (See  
 Model 17810-M—  
 Set 152-9)  
 17906 Tel. Rec. 165-6  
 17930, 17931, 17932,  
 17933, 17934 Tel. Rec. 165-6  
 20823 (Ch. M900D)  
 Tel. Rec. 167-10  
 20283B (Ch. L900D)  
 Tel. Rec. 167-10  
 20823C Tel. Rec. 165-6  
 20872 Tel. Rec. 155-8  
 20882 Tel. Rec. 155-8  
 20990, 20990S, 20994  
 Tel. Rec. 154-6  
 21923 Tel. Rec. 165-6  
 21928 Tel. Rec. 165-6  
 21940 Tel. Rec. 165-6  
 21980 Tel. Rec. 165-6  
 Ch. A1100D (See  
 Model 1005)

**HALLICRAFTERS—Cont.**

Ch. A1200D (See  
 Model 1010P)  
 Ch. AG1200D  
 (See Model 1072)  
 Ch. AH1200D  
 (See Model 1077)  
 Ch. AJ1200D  
 (See Model 1081)  
 Ch. AL1200D  
 (See Model 1050)  
 Ch. AR1200D  
 (See Model 1072A)  
 Ch. AY1200D  
 (See Model 1074AT)  
 Ch. D1200D (See  
 Model 1021P)  
 Ch. F1200D (See  
 Model 1013C)  
 Ch. G1200D (See  
 Model 1022C)  
 Ch. K1200D (See  
 Model 1010P)  
 Ch. L1200D (See  
 Model 1021P)  
 Ch. W1000D (See  
 Model 1000)  
 Ch. W1200D (See  
 Model 1010P)  
 Ch. X1000D (See  
 Model 1008)  
 Ch. X1200D (See  
 Model 1021P)  
 Ch. Z1000D (See  
 Model 1019)

**HAMILTON ELECTRONICS**  
 H-15-S 16-17  
 H-50-2S 16-18

**HAMILTON RADIO CORP.  
 (See Olympic)**

**HAMMARLUND**  
 HQ-129-X 8-18  
 SP-400-X 10-20

**HARVEY-WELLS**  
 AT-38-6, AT-38-12 32-11  
 ATR-3-6, ATR-3-12 36-14

**HEATH**  
 HBR-5 24-20

**HOFFMAN**  
 A-200 (Ch. 103) 4-23  
 A-202 (Ch. 119) 11-11  
 A-300 4-41  
 A-309 (Ch. 119) 11-11  
 A-401 (Ch. 102) 11-12  
 A-500 (Ch. 107) 4-34  
 A-501 (Ch. 108ST) 3-35  
 A-700 (Ch. 110S) 12-16  
 B-400 17-17  
 B-1000 20-14  
 C-501 48-11  
 C-502 51-9  
 C-503 50-9  
 C-504 (Ch. 123) 47-10  
 C-506, C-507 49-9  
 C-511 48-11  
 C-512 51-9  
 C-513 50-9  
 C-514 47-10  
 C-518 61-13  
 C710 (Ch. 133) 54-9  
 C1006, C1007 \*  
 CT-801, CT-801, CT-900,  
 CT-901 (Tel. Rec.) 63-11  
 7B104 (Ch. 190, B)  
 Tel. Rec. 201-5  
 7B113 (Ch. 202) Tel. Rec. 205-5  
 7B113B (Ch. 212, M)  
 Tel. Rec. 194-4  
 7M103 (Ch. 190, B)  
 Tel. Rec. 201-5  
 7M109 (Ch. 200) Tel. Rec. 205-5  
 7M109B (Ch. 210, M)  
 Tel. Rec. 205-5  
 7M112 (Ch. 202) Tel. Rec. 205-5  
 7M112B (Ch. 212, M)  
 Tel. Rec. 194-4  
 7M302 (Ch. 190, B)  
 Tel. Rec. 201-5  
 7P105 (Ch. 190, B)  
 Tel. Rec. 201-5  
 7P111B (Ch. 210, M)  
 Tel. Rec. 205-5  
 7P114B (Ch. 212, M)  
 Tel. Rec. (See Model  
 7B113B—Set 194-1)  
 7P304 (Ch. 190, B)  
 Tel. Rec. 201-5  
 208102 (Ch. 183T)  
 Tel. Rec. 168-8  
 208102F (Ch. 183T)  
 Tel. Rec. 201-5  
 208501 (Ch. 183T)  
 Tel. Rec. 168-8  
 20M101 (Ch. 183T)  
 Tel. Rec. 168-8  
 20M101F (Ch. 194)  
 Tel. Rec. 201-5  
 20M500 (Ch. 183T)  
 Tel. Rec. 168-8  
 20P502 (Ch. 183T)  
 Tel. Rec. 168-8  
 21B107 (Ch. 191, B)  
 Tel. Rec. 201-5  
 21B116 (Ch. 196, M)  
 Tel. Rec. 195-8  
 21B122 (Ch. 211, M)  
 Tel. Rec. 194-4  
 21B301 (Ch. 191, B)  
 Tel. Rec. 201-5  
 21B306B (Ch. 211, M)  
 Tel. Rec. 194-4  
 21B309 (Ch. 196M, T)  
 Tel. Rec. 195-8  
 21B504 (Ch. 191, B)  
 Tel. Rec. 201-5  
 21B507 (Ch. 211, M)  
 Tel. Rec. 194-4

**HOFFMAN—Cont.**

21B701 (Ch. 191, B)  
 Tel. Rec. 201-5  
 21B701 (Ch. 196M, T)  
 Tel. Rec. 195-8  
 21B901 (Ch. 202)  
 Tel. Rec. (TV Ch. only) 201-5  
 21B904 (Ch. 213, M)  
 Tel. Rec. 211-8  
 21M106 (Ch. 191, B)  
 Tel. Rec. 201-5  
 21M115 (Ch. 196, M)  
 Tel. Rec. 195-8  
 21M121 (Ch. 211, M)  
 Tel. Rec. 194-4  
 21M300 (Ch. 191, B)  
 Tel. Rec. 201-5  
 21M305 (Ch. 201)  
 Tel. Rec. 205-5  
 21M305B (Ch. 211, M)  
 Tel. Rec. 194-4  
 21M308 (Ch. 196M, T)  
 Tel. Rec. 195-8  
 21M503 (Ch. 191, B)  
 Tel. Rec. 201-5  
 21M506 (Ch. 211, M)  
 Tel. Rec. 194-4  
 21M700 (Ch. 191, B)  
 Tel. Rec. 201-5  
 21M700 (Ch. 196M, T)  
 Tel. Rec. 195-8  
 21M900 (Ch. 192) Tel.  
 Rec. (TV Ch. only) 201-5  
 21M903 (Ch. 213, M)  
 Tel. Rec. 211-8  
 21P108 (Ch. 191, B)  
 Tel. Rec. 201-5  
 21P117 (Ch. 196, M)  
 Tel. Rec. 195-8  
 21P123 (Ch. 211, M)  
 Tel. Rec. 194-4  
 21P307B (Ch. 211, M)  
 Tel. Rec. 194-4  
 21P310 (Ch. 196M, T)  
 Tel. Rec. 195-8  
 21P505 (Ch. 191, B)  
 Tel. Rec. 201-5  
 21P508 (Ch. 211, M)  
 Tel. Rec. 194-4  
 21P702 (Ch. 191, B)  
 Tel. Rec. 201-5  
 21P702 (Ch. 196M, T)  
 Tel. Rec. 195-8  
 21P902 (Ch. 192) Tel.  
 Rec. 201-5  
 21P905 (Ch. 213, M)  
 Tel. Rec. 211-8  
 24B707 (Ch. 187, B, C)  
 Tel. Rec. 159-6  
 24M708 (Ch. 187, B, C)  
 Tel. Rec. 159-6  
 601 (Ch. 154) Tel. Rec. 95A-8  
 601 (Ch. 155) Tel. Rec. 95A-8  
 610 (Ch. 140) Tel. Rec. 97A-6  
 612 (Ch. 142) Tel. Rec. 97A-6  
 613 (Ch. 149) Tel. Rec. 97A-6  
 630, 631 (Ch. 159) \*  
 630, 631 (Ch. 170) \*  
 632, 633 (Ch. 160) \*  
 632, 633, 634, 635 (Ch.  
 171) Tel. Rec. 150-7  
 634A, 635A (Ch. 173) \*  
 636, 637 (Ch. 183) \*  
 636, 637B (Ch. 183 B)  
 Tel. Rec. 141-7  
 636B, 637B (Ch. 183 B)  
 Tel. Rec. 168-8  
 638, 639 (Ch. 180) \*  
 638, 639 (Ch. 180) \*  
 816, 817 (Ch. 145) \*  
 820, 821, 822 (Ch. 146) \*  
 826, 827, 828 (Ch. 143) \*  
 826, 827, 828 (Ch. 143) \*  
 830, 831 (Ch. 151) Tel. Rec. 97A-6  
 832 (Ch. 151) Tel. Rec. (See  
 Model 830—Set 97A-6)  
 836, 837 (Ch. 153) Tel. Rec. 93A-8  
 840 (Ch. 153) Tel. Rec. 93A-8  
 846 (Ch. 151) Tel. Rec. (See  
 Model 830—Set 97A-6)  
 847, 848, 849 (Ch. 156)  
 Tel. Rec. 97A-7  
 860, 861, 862 (Ch. 157)  
 Tel. Rec. 97A-7  
 866, A, 867, A, 868, A  
 (Ch. 173) Tel. Rec. 150-7  
 870, 871, 872 (Ch. 170)  
 Tel. Rec. 150-7  
 876, 877, 878 (Ch. 171)  
 Tel. Rec. 150-7  
 876A, 877A, 878A (Ch.  
 173) Tel. Rec. 150-7  
 880, 881, 882, 883, 884,  
 885, 886, 887 (Ch. 183)  
 Tel. Rec. 141-7  
 886B, 887B (Ch. 183B)  
 Tel. Rec. 168-8  
 890, 891, 892 (Ch. 175)  
 Tel. Rec. 150-7  
 893, 894, 895, 896, 897  
 (Ch. 185) Tel. Rec. 141-7  
 896B, 897B (Ch. 183T)  
 Tel. Rec. 168-8  
 902 (Ch. 141, Radio Ch.) \*  
 912, 913 (Ch. 147) \*  
 914, 915 (Ch. 150) \*  
 917, 918 (Ch. 152) \*  
 920 (Ch. 152) Tel. Rec. (See  
 Model 830—Set 97A-6)  
 946, 947, 948 (Ch. 164)  
 Tel. Rec. 97A-7  
 950, 951, 952 (Ch. 172),  
 950A, 951A, 952A  
 (Ch. 174) Tel. Rec. 127-6

HOFFMAN-MAJESTIC

HOFFMAN-Cont.

Table listing radio models and prices for the Hoffman-Cont. section, including items like 953, 954, 955 (Ch. 184) and 141-7.

Table listing radio models and prices for the Hoffman-Cont. section, including items like 172 (See Model 950) and 173 (See Model 624A).

HOWARD

Table listing radio models and prices for the Howard section, including items like 472AC, 472AF, 472C, 472F.

HUDSON (Auto Radio)

Table listing radio models and prices for the Hudson (Auto Radio) section, including items like DB47 (Fact. No. 6MH089).

HUDSON (Dept. Stores)

Table listing radio models and prices for the Hudson (Dept. Stores) section, including items like 30T14A-056 Tel. Rec.

HUDSON ELECTRONICS

Table listing radio models and prices for the Hudson Electronics section, including items like RFM-71, 3W, 11.

HYDE PARK

Table listing radio models and prices for the Hyde Park section, including items like AR14L Tel. Rec.

HYDE PARK-Cont.

Table listing radio models and prices for the Hyde Park-Cont. section, including items like 14TR, 16TR Tel. Rec.

INDUSTRIAL ELECTRONIC CORP.

Table listing radio models and prices for the Industrial Electronic Corp. section, including items like 1T-40R, IT-42R.

INTERNATIONAL ELECTRONICS

Table listing radio models and prices for the International Electronics section, including items like JP-51, DP-20.

JACKSON

Table listing radio models and prices for the Jackson section, including items like JP-50, JP-30.

KAY MUSICAL INSTRUMENT CO.

Table listing radio models and prices for the Kay Musical Instrument Co. section, including items like 77, 78.

JEFFERSON-TRAVIS

Table listing radio models and prices for the Jefferson-Travis section, including items like MR-28, MR3.

JEWEL

Table listing radio models and prices for the Jewel section, including items like 17C9, 17T9, 17TW7.

KAISER-FRAZER

Table listing radio models and prices for the Kaiser-Frazer section, including items like 100170, 100205.

KAPPLER

Table listing radio models and prices for the Kappler section, including items like 102T, 102TT.

KARADIO

Table listing radio models and prices for the Karadio section, including items like 80C, 1275, 1275A.

KAYE-HALBERT

Table listing radio models and prices for the Kaye-Halbert section, including items like 012 (Ch. 243) Tel. Rec.

KAYE-HALBERT

Table listing radio models and prices for the Kaye-Halbert section, including items like 146 (Ch. 253DX) Tel. Rec.

KAYE-HALBERT

Table listing radio models and prices for the Kaye-Halbert section, including items like 777 (Ch. 253) Tel. Rec.

KAYE-HALBERT

Table listing radio models and prices for the Kaye-Halbert section, including items like 77, 78.

KITCHENAIRE

Table listing radio models and prices for the Kitchenaire section, including items like 5 Tube Radio.

KNIGHT

Table listing radio models and prices for the Knight section, including items like 4D-450, 4G-420.

KNIGHT

Table listing radio models and prices for the Knight section, including items like 68-127, 68-127T.

KNIGHT-Cont.

Table listing radio models and prices for the Knight-Cont. section, including items like 11C-300, 11D-302.

LAFAYETTE

Table listing radio models and prices for the Lafayette section, including items like FA15W, FA15Y.

LAMCO

Table listing radio models and prices for the Lamco section, including items like 1000.

LEAK

Table listing radio models and prices for the Leak section, including items like TL/12.

LEAR

Table listing radio models and prices for the Lear section, including items like LEARADIO.

LEARADIO

Table listing radio models and prices for the Learadio section, including items like Chassis R-971.

LEE TONE

Table listing radio models and prices for the Lee Tone section, including items like AP-100.

LEWYT

Table listing radio models and prices for the Lewyt section, including items like 615A.

LEXINGTON

Table listing radio models and prices for the Lexington section, including items like 500B1, 500BW, 500D1.

LIBERTY

Table listing radio models and prices for the Liberty section, including items like A6K, A6P, 6K.

LINCOLN (Auto Radio)

Table listing radio models and prices for the Lincoln (Auto Radio) section, including items like 1CH748.

LINCOLN (Allied Radio Corp.)

Table listing radio models and prices for the Lincoln (Allied Radio Corp.) section, including items like 5A-110.

LINCOLN CORP.

Table listing radio models and prices for the Lincoln Corp. section, including items like LIPAN.

LULLABY

Table listing radio models and prices for the Lullaby section, including items like LYMAN.

LYRIC

Table listing radio models and prices for the Lyric section, including items like 546T, 546TV, 546TW.

MAGIC TONE

Table listing radio models and prices for the Magic Tone section, including items like 500, 501.

MAGNACORD

Table listing radio models and prices for the Magnacord section, including items like 504 (Bottle Receiver).

MAGNAYOX

Table listing radio models and prices for the Magnayox section, including items like 104 Series.

MAGNAYOX

Table listing radio models and prices for the Magnayox section, including items like 104 Series (Ch. CT301).

MAGNAYOX

Table listing radio models and prices for the Magnayox section, including items like 104 Series (Ch. CT301).

MAGNAYOX

Table listing radio models and prices for the Magnayox section, including items like 104 Series (Ch. CT301).

MAGNAYOX

Table listing radio models and prices for the Magnayox section, including items like 104 Series (Ch. CT301).

MAGNAYOX

Table listing radio models and prices for the Magnayox section, including items like 104 Series (Ch. CT301).

MAGNAYOX

Table listing radio models and prices for the Magnayox section, including items like 104 Series (Ch. CT301).



**MAJESTIC—Cont.**

8FM775 (Ch. 8808D) . . . 29—14  
 8FM776 (Ch. 8807D) . . . 54—12  
 8FM889 (Ch. 8C07D) . . . 47—11  
 8JL885 (Ch. 4810B) . . . 47—11  
 8S452, 8S473 (Ch. . . . .) 6—19  
 10FM891 (Ch. 10C23E) [See Model 10FM981—Set 65-8]  
 12CA, 12CS Tel. Rec. . . . . 108—7  
 12FM475, 12FM778, 12FM779 (Ch. 41201) . . . 28—20  
 12FM895 (Ch. 12C22E) . . . 59—11  
 12T2, 12T3 Tel. Rec. . . . . 108—7  
 12T6 Tel. Rec. (See Model 12CA—Set 108-7)  
 14CA Tel. Rec. (See Model 12CA—Set 108-7)  
 14CT4 Tel. Rec. . . . . 133—8  
 14T2 Tel. Rec. (See Model 12CA—Set 108-7)  
 16C4, 16C5 Tel. Rec. . . . . 108—7  
 16CT4, 16CT5 Tel. Rec. . . . . 133—8  
 16T2, 16T3 Tel. Rec. . . . . 108—7  
 17C62, 17C64, 17C65 (Series 106) Tel. Rec. (See Prod. Chge. Bul. 43—Set 177-1) and Model 70—Set 153-8  
 17GA (Ch. 101) Tel. Rec. . . . . 127—7  
 17GA, 17HA (Ch. 101) Tel. Rec. . . . . 127—7  
 17TA, 17TB (Series 106) Tel. Rec. (See Model 70—Set 153-8 and Prod. Chge. Bul. 43—Set 177-1)  
 17T62 (Series 106) Tel. Rec. (See Model 70—Set 153-8 and Prod. Chge. Bul. 43—Set 177-1)  
 19C6, 19C7 Tel. Rec. . . . . 133—8  
 20C82, 20C83, 20C84 (Series 108) Tel. Rec. (See Model 70—Set 153-8 and Prod. Chge. Bul. 43—Set 177-1)  
 20F88, 20F89 (Series 109) Tel. Rec. . . . . 170—10  
 20F82, 20F83 (Series 108) Tel. Rec. (See Model 70—Set 153-8 and Prod. Chge. Bul. 43—Set 177-1)  
 20F85, 20F86, 20F87 (Series 108) Tel. Rec. (See Model 70—Set 153-8 and Prod. Chge. Bul. 43—Set 177-1)  
 20F81 (Series 108) Tel. Rec. (See Model 70—Set 153-8 and Prod. Chge. Bul. 43—Set 177-1)  
 20T81 (Series 108) Tel. Rec. (See Model 70—Set 153-8 and Prod. Chge. Bul. 43—Set 177-1)  
 20T82, 20T83, 20T84 (Series 108) Tel. Rec. (See Model 70—Set 153-8 and Prod. Chge. Bul. 43—Set 177-1)  
 20T81 (Series 108) Tel. Rec. (See Model 70—Set 153-8 and Prod. Chge. Bul. 43—Set 177-1)  
 21D40, 21D41 (Series 108) Tel. Rec. (See Model 70—Set 153-8 and Prod. Chge. Bul. 43—Set 177-1)  
 21D50, 21D51 (Series 108) Tel. Rec. (See Model 70—Set 153-8 and Prod. Chge. Bul. 43—Set 177-1)  
 21F86, 21F87 (Series 108) Tel. Rec. (See Model 70—Set 153-8 and Prod. Chge. Bul. 43—Set 177-1)  
 21F88, 21F89 (Series 108.5) Tel. Rec. (See Model 70—Set 153-8 and Prod. Chge. Bul. 43—Set 177-1)  
 21T20, 21T21 (Series 108) Tel. Rec. (See Model 70—Set 153-8 and Prod. Chge. Bul. 43—Set 177-1)  
 22 Thru 35 (Series 106.5) Tel. Rec. (See Model 70—Set 153-8 and Prod. Chge. Bul. 43—Set 177-1)  
 70, 72, 73 (Series 106) Tel. Rec. (See Model 70—Set 153-8 and Prod. Chge. Bul. 43—Set 177-1)  
 80FMP2 (See Model 70—Set 153-8 and Prod. Chge. Bul. 43—Set 177-1)  
 120, 121, 121B (Ch. 99) Tel. Rec. (Also See Prod. Chge. Bul. 37—Set 166-2)  
 141, 141B (Ch. 100), 141C (Ch. 101), 142, 142B (Ch. 100) Tel. Rec. . . . . 127—7  
 143 Tel. Rec. (See Prod. Chge. Bul. 37—Set 166-2 and Model 17DA—Set 127-7)  
 160, 160B, 162, 163 (Ch. 101) Tel. Rec. . . . . 127—7  
 170 (Ch. 101) Tel. Rec. . . . . 127—7  
 173 Tel. Rec. (See Prod. Chge. Bul. 37—Set 166-2 and Model 17DA—Set 127-7)  
 700, 701 (Series 106) Tel. Rec. (Also See Prod. Chge. Bul. 43—Set 177-1)  
 712, 715, 717, 718, 719 (Series 106) Tel. Rec. (Also See Prod. Chge. Bul. 43—Set 177-1)  
 800, 801, 802, 803, 804 (Series 108) Tel. Rec. (Also See Prod. Chge. Bul. 43—Set 177-1)  
 902, 903 (Ch. 103) Tel. Rec. . . . . 127—7  
 910, 911 (Ch. 103) Tel. Rec. . . . . 127—7

**MAJESTIC—Cont.**

1042, G, GU, T Tel. Rec. (See Model 12CA—Set 108-7)  
 1043, G, GU, T Tel. Rec. (See Model 12CA—Set 108-7)  
 1142, 1143 Tel. Rec. (See Model 12CA—Set 108-7)  
 1244, G, GU, T, TX Tel. Rec. (See Model 12CA—Set 108-7)  
 1245, G, GU, T, TX Tel. Rec. (See Model 12CA—Set 108-7)  
 1348 Tel. Rec. (See Model 12CA—Set 108-7)  
 1400, B (Ch. 100) Tel. Rec. . . . . 127—5  
 1401 (Ch. 105) Tel. Rec. (Also See Prod. Chge. Bul. 37—Set 166-2)  
 1546, G, GU, T Tel. Rec. (See Model 12CA—Set 108-7)  
 1547, G, GU, T Tel. Rec. (See Model 12CA—Set 108-7)  
 1548, G, GU, T Tel. Rec. (See Model 12CA—Set 108-7)  
 1549, G, GU, T Tel. Rec. (See Model 12CA—Set 108-7)  
 1600, 1600B (Ch. 101) Tel. Rec. . . . . 127—7  
 1605, 1605B (Ch. 102) Tel. Rec. . . . . 127—7  
 1610, 1610B (Ch. 102) Tel. Rec. . . . . 127—7  
 1646, 1647, 1648, 1649 Tel. Rec. (See Model 12CA—Set 108-7)  
 1671, 1672, 1673, 1674, 1675 Tel. Rec. . . . . 133—8  
 1700C Tel. Rec. (See Prod. Chge. Bul. 37—Set 166-2 and Model 17DA—Set 127-7)  
 1710 (Ch. 101) Tel. Rec. . . . . 127—7  
 1710C (Ch. 101) Tel. Rec. (See Prod. Chge. Bul. 37—Set 166-2 and Model 17DA—Set 127-7)  
 1720, 1721 Tel. Rec. (See Prod. Chge. Bul. 37—Set 166-2 and Model 17DA—Set 127-7)  
 1900 Tel. Rec. . . . . 95A—10  
 1974, 1975 Tel. Rec. . . . . 133—8  
 2042T, 2043T Tel. Rec. (See Model 12CA—Set 108-7)  
 2546T, 2547T, 2549T Tel. Rec. (See Model 12CA—Set 108-7)  
 Ch. 5801A (See Model 5AK711)  
 Ch. 5805A (See Model 5AK731)  
 Ch. 6802D (See Model 6FM714)  
 Ch. 6811D (See Model 6FM773)  
 Ch. 7804A (See Model 7YR752)  
 Ch. 7809A (See Model 7YR772)  
 Ch. 7809A1 (See Model 7YR753)  
 Ch. 7C11D (See Model 7FM887)  
 Ch. 7C25A (See Model 7JL866)  
 Ch. 8806D (See Model 8FM744)  
 Ch. 8807D (See Model 8FM776)  
 Ch. 8808D (See Model 8FM775)  
 Ch. 8C07D (See Model 8FM889)  
 Ch. 10C23E [See Model 10FM891)  
 Ch. 12B26E (See Model 12FM475)  
 Ch. 12C22E (See Model 12FM895)  
 Ch. 18C90, 18C91 (See Model 7TV850)  
 Ch. 4501 (See Model 5A410)  
 Ch. 4504 (See Model 5A430)  
 Ch. 4506 (See Model 5A445)  
 Ch. 4702, 4703 (See Model 7S433)  
 Ch. 4705 (See Model 7P420)  
 Ch. 4706 (See Model 7C432)  
 Ch. 4707 (See Model 7C447)  
 Ch. 4708R (See Model 7JK777R)  
 Ch. 4810 (See Model 8S452)  
 Ch. 4810B (See Model 8JL885)  
 Ch. 41201 (See Model 12FM475)  
**MALLORY**  
 TV-101 (Below Serial No. 200,000) Tel. Rec. UHF Conv. . . . . 194—7  
 TV-101 (Serial No. 200,000 and Above) Tel. Rec. UHF Conv. . . . . 194—8

**MANTOLA (B. F. Goodrich Co.)**

R630-RP . . . . . 3—22  
 R643-PM (See Model R643W—Set 4-29)  
 R643W . . . . . 4—29  
 R652, R652N . . . . . 9—22  
 R654 PM, R654-PV . . . . . 3—5  
 R655W (Ch. No. 501APH) . . . . . 8—20  
 R662, R662N . . . . . 3—33  
 R664, R664-PV, R664-W . . . . . 23—13  
 R-743-W (See Model R643W—Set 4-29)  
 R-7543 . . . . . 18—23  
 R-75143 . . . . . 39—12  
 R-75152 . . . . . 38—10  
 R-75343 . . . . . 39—12  
 R-76143 (See Model 2486—Set 25-17)  
 R-76162 . . . . . 40—10  
 R76262 (Fact. No. 7160-17) . . . . . 51—12  
 R-78162 . . . . . 43—11  
 2486 . . . . . 25—17  
 92-502 (See Model R643W—Set 4-29)  
 92-503, 92-504 (See Model R654PM—Set 3-5)  
 92-505, 92-506 (See Model R664PM—Set 23-13)  
 92-520, 92-521, 92-522 . . . . . 68—11  
 92-529 . . . . . 150—8  
**MARKEL**  
 (See Record Changer Listing)  
**MARK SIMPSON** (See Masco)  
**MASCO**  
 (Also see Recorder Listing)  
 IM-5 . . . . . 41—13  
 IM-10 . . . . . 186—8  
 JMR . . . . . 31—17  
 JM-5 (Master Station), JR (Sub-Station) . . . . . 42—18  
 JM-10 . . . . . 187—8  
 JMP-6 . . . . . 147—7  
 JMP-12 . . . . . 147—7  
 MA-8N . . . . . 119—8  
 MA-10HF . . . . . 112—4  
 MA-10EX . . . . . 113—4  
 MA-12HF . . . . . 51—13  
 MA-17N . . . . . 14—32  
 MA-17N . . . . . 50—11  
 MA-17P . . . . . 14—32  
 MA-17PN . . . . . 50—11  
 MA-20HF . . . . . 28—21  
 MA-25EX . . . . . 16—24  
 MA-25H . . . . . 60—15  
 MA-25N . . . . . 54—13  
 MA-25N . . . . . 43—14  
 MA-25NR . . . . . 49—12  
 MA-25P . . . . . 16—24  
 MA-25PN (See Model MA-25N—Set 43-14)  
 MA-35 . . . . . 21—20  
 MA-35N . . . . . 44—11  
 MA-35RC . . . . . 21—20  
 MA-50 . . . . . 30—16  
 MA-50N (See Model MA-50N—Set 45-15)  
 MA-50NR . . . . . 53—14  
 MA-60 . . . . . 119—9  
 MA-75 . . . . . 28—22  
 MA-75N . . . . . 52—27  
 MA-77, MA-77R . . . . . 190—7  
 MA-121 . . . . . 24—21  
 MA-125 . . . . . 188—8  
 MA-808 . . . . . 26—18  
 MAP-15 . . . . . 26—19  
 MAP-18 . . . . . 59—12  
 MAP-105 . . . . . 25—18  
 MAP-105N . . . . . 52—12  
 MAP-120 . . . . . 21—21  
 MAP-120N . . . . . 46—15  
 MB-8N . . . . . 196—5  
 MB-50N . . . . . 58—12  
 MB-60 . . . . . 127—8  
 MB-60 (Late) . . . . . 148—10  
 MB-75 . . . . . 61—15  
 MB-77 . . . . . 206—8  
 MB-125 . . . . . 211—9  
 MC-10 . . . . . 47—12  
 MC-25, MC-25P . . . . . 17—21  
 MC-25N, MC-25PC . . . . . 57—11  
 MC-126, MC-126P . . . . . 111—8  
 MCR-5 . . . . . 15—18  
 ME-8 . . . . . 152—10  
 ME-18, ME-18P . . . . . 151—8  
 ME-27 . . . . . 155—11  
 ME-36, ME-36R . . . . . 154—7  
 ME-52 . . . . . 149—7  
 MHP-110 . . . . . 114—6  
 MHP-110X . . . . . 115—5  
 Midgetalk . . . . . 116—7  
 MP-27P . . . . . 153—9  
 MPA-3, MPT-4 . . . . . 16—25  
 MSD-16 . . . . . 150—9  
 MU-5 . . . . . 117—6  
 MU-17 . . . . . 185—8  
 RK-5 (Early) . . . . . 33—11  
 RK-5, RK-5L, RK-5M, RK-5SL, RK-5S1 . . . . . 168—11  
 RK-5SLR . . . . . 177—9  
 T-16 . . . . . 123—8  
 TD-16 . . . . . 120—8  
 TP-16A . . . . . 30—17  
 WF-1A . . . . . 209—8  
 76, 711 . . . . . 20—20  
 86, 811 . . . . . 2021

**McGOHAN (Don)**

R630-RP . . . . . 195—7  
 MG-108 . . . . . 190—8  
 MG-188 . . . . . 191—6  
 MG-20-B . . . . . 189—5  
 MG-30-B . . . . . 188—9  
**McGRADE**  
 M-100 . . . . . 16—27  
**MECK (Trail Blazer-Plymouth)**  
 CD-500 (PX-5CS-EW-19) . . . . . 33—12  
 CE-500 (5CS-P12) . . . . . 34—10  
 CM-500 (5D7-W18) . . . . . 34—11  
 CR-500 . . . . . 38—11  
 CW-500 . . . . . 40—11  
 CX-500 . . . . . 48—13  
 DA601, DB6021 . . . . . 81—10  
 EC720 Rec. (Also See Prod. Chge. Bul. 12—Set 120-1)  
 EF-730, EG-731 . . . . . 89—8  
 EV-760 . . . . . 104—7  
 JM717C, CU, T, TU (Ch. 9021), JM720C, CU, T, TU (Ch. 9021) Tel. Rec. . . . . 148—11  
 JM-717C, T (Ch. 9022), JM-721C, CD (Ch. 9032) Tel. Rec. . . . . 186—9  
 MMS10T, MMS12T, MMS16C, MMS16T, MMS16C, T (Ch. 9018) Tel. Rec. (Also See Prod. Chge. Bul. 12—Set 120-1)  
 MM-617C, T (Ch. 9032) Tel. Rec. (See Model JM-717C—Set 186-9)  
 MM619C (Ch. 9018) Tel. Rec. (Also See Prod. Chge. Bul. 12—Set 120-1)  
 MM-620C, T (Ch. 9032) Tel. Rec. (See Model JM-717C—Set 186-9)  
 M616C, T (Ch. 9023) Tel. Rec. (See Model M620C, T (Ch. 9023)  
 JM717C—Set 148-11)  
 PM-5CS-DW10 . . . . . 2—4  
 PM-5CS-PW10 . . . . . 12—19  
 RC-5CS-P . . . . . 1—9  
 RC-6A7-P6 . . . . . 31—19  
 SA-10, SA-20 . . . . . 101—4  
 XA-701 Tel. Rec. . . . . 61—16  
 XE-705 (See Model XA-701—Set 61-16)  
 XF-777 Tel. Rec. . . . . 101—5  
 XL750 Tel. Rec. . . . . 76—14  
 XN-752 Tel. Rec. . . . . 110—9  
 XOB-75 Tel. Rec. . . . . 101—5  
 XP-775 Tel. Rec. . . . . 110—9  
 XQA Tel. Rec. . . . . 110—9  
 XQA-776 Tel. Rec. . . . . 110—9  
 XQR Tel. Rec. . . . . 110—9  
 XQ-776 Tel. Rec. . . . . 101—5  
 XRA, XRT Tel. Rec. . . . . 101—5  
 XRB Tel. Rec. . . . . 110—9  
 XSA Tel. Rec. . . . . 110—9  
 XSB (Ch. 9018) Tel. Rec. (Also See Prod. Chge. Bul. 12—Set 120-1)  
 XSC, XSD (Ch. 9018) Tel. Rec. (See Model MM614C—Set 117-8 and Prod. Chge. Bul. 12—Set 120-1)  
 XSPT Tel. Rec. . . . . 110—9  
 XS-786 Tel. Rec. . . . . 101—5  
 XT4, XT6 Tel. Rec. . . . . 110—9  
 XT-785 Tel. Rec. . . . . 101—5  
 XX900 Tel. Rec. . . . . 110—9  
 487 . . . . . 35—14  
 5A7-P11, 5A7-PB11 . . . . . 31—18  
 5D7/WL18 . . . . . 21—22  
 6A6-WA . . . . . 16—26  
 514C, T (Ch. 9018) Tel. Rec. (See Model MM614C—Set 117-8 and Prod. Chge. Bul. 12—Set 120-1)  
 614C, 614TL (Ch. 9022) Tel. Rec. (See Model JM717C—Set 148-11)  
 616C, T (Ch. 9018) Tel. Rec. (See Model MM614C—Set 117-8 and Prod. Chge. Bul. 12—Set 120-1)  
 617C, 617TL (Ch. 9022) Tel. Rec. (See Model JM717C—Set 148-11)  
 619C, T (Ch. 9018) Tel. Rec. (See Model MM614C—Set 117-8 and Prod. Chge. Bul. 12—Set 120-1)  
**MEDCO** (See Teleonic)  
**MEISSNER**  
 TV-1 (Ch. 24TV) Tel. Rec. . . . . 56—15  
 4E . . . . . 172—5  
 5A (See Maguire Model 571—Set 44-10)  
 6H (See Maguire Model 661—Set 12-18)  
 8BT . . . . . 161—5  
 8C . . . . . 37—12  
 9A . . . . . 123—9  
 9-1065 . . . . . 3—15  
 9-1091A, 9-1091B . . . . . 35—15  
 9-1091C . . . . . 116—8  
 9-1093 . . . . . 55—13  
 17A . . . . . 105—6  
 24TV Tel. Rec. (See Model TV1—Set 56-15)  
 574 (See Maguire Model 571—Set 44-10)

**MEISSNER—Cont.**

661 (See Maguire Model 661—Set 12-18)  
 2891 Series . . . . . 27—19  
**MERCURY (Automobile)**  
 GM891 (OM-18805-A) (See Ford Model GF890—Set 109-5)  
 1CM747 (1M-18805) (See Ford Model 1CF743—Set 133-7)  
 1CM747-1 (1M-18805) . . . . . 158—5  
 2CM752 (FAB-18805-A) . . . . . 167—7  
 6MM790, E . . . . . 62—12  
 8MM890 (Ch. 8E90) . . . . . 49—13  
 (8M-18805-B) . . . . . 69—10  
 8MM990 (8M-18805-B) . . . . . 83—4  
 8MM991 (8M-18805-B) . . . . . 83—4  
**MERCURY (Pacific-Mercury)**  
 2013 (Ch. 150-2) Tel. Rec. (Also See Prod. Chge. Bul. 57—Set 190-1)  
 2080 (Ch. 150-2) Tel. Rec. (See Prod. Chge. Bul. 57—Set 190-1 and Model 2013—Set 172-6)  
 2081 (Ch. 150-4 and Radio Ch. 155) Tel. Rec. . . . . 198—11  
 2113, 2115 (Ch. 150-11, -81) Tel. Rec. (Also See Prod. Chge. Bul. 57—Set 190-1)  
 2116, 2217 (Ch. 150-81) Tel. Rec. (Also See Prod. Chge. Bul. 57—Set 190-1 and Model 2013—Set 172-6)  
 2181 (Ch. 150-31, -61 and Radio Ch. 155) Tel. Rec. . . . . 198—11  
 2192 (Ch. 150-10 and Radio Ch. 160) . . . . . \*  
 2401 (Ch. 150-5, -51) Tel. Rec. (Also See Prod. Chge. Bul. 57—Set 191-1)  
 4120 (Ch. 150-2) Tel. Rec. (Also See Prod. Chge. Bul. 57—Set 190-1)  
 4220 (Ch. 150) Tel. Rec. (Also See Prod. Chge. Bul. 57—Set 190-1)  
 4317 (Ch. 150-7, -12) Tel. Rec. . . . . \*  
 4317 (Ch. 150-9) Tel. Rec. . . . . 172—6  
 4320 (Ch. 150-2, -15) Tel. Rec. (Also See Prod. Chge. Bul. 57—Set 191-1)  
 4421 (Ch. 150-81) Tel. Rec. (See Model 2013—Set 172-6 and Prod. Chge. Bul. 57—Set 191-1)  
 4721 (Ch. 150-10 and Radio Ch. 160) . . . . . \*  
 Ch. 150-2 (See Model 2013)  
 Ch. 150-4 (See Model 2081)  
 Ch. 150-5 (See Model 2401)  
 Ch. 150-7 (See Model 4317)  
 Ch. 150-15 (See Model 4320)  
 Ch. 150-31 (See Model 2181)  
 Ch. 150-51 (See Model 2401)  
 Ch. 150-61 (See Model 2181)  
 Ch. 150-81 (See Model 2113)  
 Ch. 155 (See Model 2081)  
**MIDLAND**  
 M6B . . . . . 2—30  
**MIDWEST**  
 P6, PB-6 . . . . . 14—19  
 R-12, RG-12, RT-12 (Ch. RG-12) . . . . . 44—12  
 R-12, RG-12, RT-12 (Ch. RG-12) . . . . . 44—13  
 R-16, RG-16, RT-16 (Ch. RG-16) . . . . . 45—16  
 SB, ST-8 (Ch. STM-8) . . . . . 15—19  
 S-12, SG-12, ST-12 (Ch. SG-12) . . . . . 21—23  
 S-16, SG-16, ST-16 (Ch. SG-16) . . . . . 21—24  
 TM-8 (Ch. STM-8) . . . . . 15—19  
 716, A (See Model S-16—Set 21-24)  
**MILWAUKEE ERWOOD**  
 (See Record Changer Listing)  
**MINERVA**  
 L-702 . . . . . 12—20  
 L-728 . . . . . 11—15  
 W-117 Tropic Master . . . . . 6—17  
 W-117-3 . . . . . 11—14  
 W-702B . . . . . 12—20  
 W710, W710A (W191) . . . . . 5—25  
 W-728 . . . . . 11—15  
 410, 411 . . . . . 41—14  
 702H, 702H-1 . . . . . 30—18  
 729 (Portapak) . . . . . 23—14  
**MIRRORTONE** (Also see Meck)  
 14MTS Tel. Rec. . . . . 163—7  
 16MC, MT, 17MC, MT, MZ-C, MZ-T Tel. Rec. . . . . 163—7  
 17PC (See Model 903—Series "P") Tel. Rec. (See Model 20PC—Set 175-12)

**MIRRORTONE—MOTOROLA**

**MIRRORTONE—Cont.**

17PCSB, 17PCW Tel. Rec. 204—5  
 17PT (Ch. 9025) Series  
 ("P") Tel. Rec. (See Model 20PC—Set 175-12)  
 17PTE Tel. Rec. 204—5  
 20MC, MT, MZ-C, MZ-T Tel. Rec. 163—7  
 20PC Tel. Rec. 175—12  
 20PCSB, 20PCW Tel. Rec. 204—5  
 20PT Tel. Rec. (See Model 20PC—Set 175-12)  
 20PTE, 20PTS, 20PTSB, 20PTW Tel. Rec. 204—5  
 20TPRSB Tel. Rec. 204—5  
 21PCS Tel. Rec. 204—5  
 21QDCS Tel. Rec. 204—5  
 24QDCS Tel. Rec. 204—5

**MICHELL**

T16-B, -M, T16-2KB, T16-2KM, T17-B, -M Tel. Rec. 154—8  
 T17B, T-17M Tel. Rec. 189—11  
 T12-B, -M Tel. Rec. 190—9  
 1250, 1251 55—14  
 1252, 1253 155—12  
 1254, 1255 159—8  
 1256 156—8  
 1267 158—7  
 1268 127—9

**MOLDED INSULATION CO. (Also see Viz)**

MR-6 (Wiretone) 41—15

**MONITOR**

M-403 (Fact. No. 470-2) 22—20  
 M-500 (Fact. No. 475) 28—23  
 M-510 (Fact. No. 472) 23—15  
 M-3070 29—15  
 RA-50 24—23  
 TA56M, TW56M 6—18

**MONITORADIO (Radio Apparatus)**

AR-1 164—5  
 AR-3 175—13  
 M-51A 162—8  
 M-101 159—9

**MONTGOMERY WARD (See Airline)**

**MOPAR**

602 (671A) 19—20  
 603 65—9  
 604 106—9  
 606 133—9  
 607 170—11  
 608 207—4  
 609 201—6  
 602 (C-4608) 18—24  
 802 (C-4608) [Revised] 42—19  
 803 (PD-4908) 66—12  
 804 67—12  
 805 (C-4908) 71—11  
 806, 807 (See Model 803—Set 66-12)  
 808 107—6  
 809 (C-5009) (See Model 805—Set 71-11)  
 812 (P-3106) 139—8  
 813 (D5107) 139—8  
 814 137—7  
 815 (C-5109) 139—8  
 816 (C-5110) 139—8  
 817 (C-5111) 139—8  
 819, 820 202—3  
 821 204—6  
 824 202—3

**MOTOROLA (Also see Record Changer Listing)**

AR-96-23 (M-5) 11—16  
 BKQ-A (See Ch. 10A—Set 106-10)  
 BK2A (Ch. 2A and P6-2 or P8-2) 197—7  
 BK2M (Ch. 2M and P7-2 or P8-2) 197—7  
 BK-6 10—23  
 BK8, X (Ch. 8A—Set 46-16)  
 CR-6 20—24  
 CR-76 25—21  
 CTO (See Model CT-9—Set 82-8)  
 CT1 (See Ch. 1A—Set 134-8)  
 CT1M 143—11  
 CT2A (Ch. 2A and P6-2 or P8-2) 197—7  
 CT2M (Ch. 2M and P6-2 or P8-2) 197—7  
 CT-6 8—21  
 CT8 (See Ch. 8A—Set 46-16)  
 CT8-A (See Ch. 10A—Set 106-10)  
 CT9 82—8  
 FD-6 7—20  
 FD7 (See Model FD-6—Set 7-20)  
 FD8 (See Ch. 8A—Set 46-16)  
 GMOT (See Ch. 10A—Set 106-10)  
 GMT2A (Ch. 2A and P6-2 or P8-2) 197—7  
 GMT2M (Ch. 2M and P6-2 or P8-2) 197—7  
 GM9T (See Ch. 8A—Set 46-16)  
 GM9T-A (See Ch. 10A—Set 106-10)  
 HJ2A (Ch. 2A and P6-2 or P8-2) 197—7  
 HJ2M (Ch. 2M and P6-2 or P8-2) 197—7  
 HNC (See Ch. 10A—Set 106-10)  
 HN2A (Ch. 2A and

**MOTOROLA—Cont.**

P6-2 or P8-2) 197—7  
 HN2M (Ch. 2M and P6-2 or P8-2) 197—7  
 HNB, HN9 (See Ch. 8A—Set 46-16)  
 ILOTC (See Ch. 10—Set 106-10)  
 IL2TC (See Ch. 1A—Set 134-8)  
 IL2T2 (See Ch. 1A—Set 134-8)  
 KR1 (See Ch. 1A—Set 134-8)  
 KR2A (Ch. 2A and P6-2 or P8-2) 197—7  
 KR2M (Ch. 2M and P6-2 or P8-2) 197—7  
 KR8, KR9 (See Ch. 8A—Set 46-16)  
 KR9A (See Ch. 10A—Set 106-10)  
 NHIC 139—9  
 NH2AC (See Nash Model AC-152—Set 184-9)  
 NH6 9—24  
 NHB (See Ch. 8A—Set 46-16)  
 OEO (See Ch. 10A—Set 106-10)  
 OE2 (See Ch. 8A—Set 46-16)  
 OE2A (Ch. 2A and P6-2 or P8-2) 197—7  
 OE2M (Ch. 2M and P6-2 or P8-2) 197—7  
 OE6 8—21  
 OE8, OE9 (See Ch. 8A—Set 46-16)  
 PCO (See Ch. 10A—Set 106-10)  
 PC2 (See Ch. 8A—Set 46-16)  
 PC2A (Ch. 2A and P6-2 or P8-2) 197—7  
 PC2M (Ch. 2M and P6-2 or P8-2) 197—7  
 PC6 8—21  
 PC8, PC9 (See Ch. 8A—Set 46-16)  
 PC9-A (See Ch. 10A—Set 106-10)  
 PD2A (Ch. 2A and P6-2 or P8-2) 197—7  
 PD2M (Ch. 2M and P6-2 or P8-2) 197—7  
 SRO8 (Ch. 8A) 105—7  
 SR18 (See Ch. 1B—Set 136-11)  
 SR2A (Ch. 2A and P6-2 or P8-2) 197—7  
 SR2M (Ch. 2M and P6-2 or P8-2) 197—7  
 SR6, SR8, SR9 (See Ch. 8A—Set 46-16)  
 SK9A (See Ch. 10A—Set 106-10)  
 TK-101, B Tel. UHF Conv. 196—6  
 TK-17M, Tel. UHF Conv. 193—5

**MOTOROLA—Cont.**

TK19M Tel. UHF Conv. 193—5  
 TK-19ME Tel. UHF Conv. (See Model TK17M—Set 193-5)  
 TK-20M Tel. UHF Conv. 193—5  
 TK-22M Tel. UHF Conv. 193—5  
 TK-23M Tel. UHF Conv. 193—5  
 TK-24M Tel. UHF Conv. 193—5  
 TK-24ME Tel. UHF Conv. (See Model TK17M—Set 193-5)  
 TK-31M Tel. UHF Conv. (See Model TK17M—Set 193-5)  
 TK-33M Tel. UHF Conv. (See Model TK17M—Set 193-5)  
 VF102, A, C (Ch. TS-7 and Radio Ch. HS-317) Tel. Rec. 51—14  
 VF103, VF103M (Ch. TS-8) Tel. Rec. 73—8  
 VK101, B, M (Ch. TS-5 and Radio Ch. HS-108) Tel. Rec. 51—14  
 VK106 (Ch. TS-9D) Tel. Rec. Photofact Servicer 82  
 VK106, B, M (Ch. TS-9, A, B, C) Tel. Rec. 67—13  
 VK106, VK107 (Ch. TS-9E, TS-9E1) Tel. Rec. 77—6  
 VTK-17M, ME Tel. UHF Conv. (See Model TK17M—Set 193-5)  
 VT71B, M-A (Ch. 4B through J) Tel. Rec. 55—16  
 VT-73, VT-73A (Chassis TS-4J) Tel. Rec. 71—12  
 VT101 (Ch. TS-3) Tel. Rec. 51—14  
 VT105 (Ch. TS-9D) Tel. Rec. Photofact Servicer, 82  
 VT105, VT105M (Ch. TS-9, TS-9A, TS-9B, TS-9C) Tel. Rec. 67—13  
 VT107 (Ch. TS-9D) Tel. Rec. Photofact Servicer, 82  
 VT107, B, M (Ch. TS-9, A, B, C) Tel. Rec. 67—13  
 VT121 (Ch. TS-15) Tel. Rec. 91A—9  
 WR6 (Ch. HS-18) 5—2  
 WR7, WR8 (See Model WR6—Set 5-2)  
 WS1C (See Willys Model 677012—Set 156-14)  
 WS2C (See Willys Model 679517—Set 172-12)  
 2MF (See Ford Model 3MF—Set 175-10)  
 3MF (See Ford Model 3MF—Set 206-5)  
 5A1 (Ch. HS-6) 2—11  
 5A5 (Ch. HS-15) 3—11  
 5A7 (Ch. HS-62), 29—16  
 5C1 (Ch. HS-228) 116—9  
 5C2 (Ch. HS-258) 116—9  
 5C3 (Ch. HS-262) 116—9  
 5C4 (Ch. HS-270) 116—9

**MOTOROLA—Cont.**

5CS (Ch. HS-271) (See Model 5C1—Set 116-9)  
 5C6 (Ch. HS-272) (See Model 5C1—Set 116-9)  
 5H11U, 5H12U, 5H13U (Ch. HS-224) 117—9  
 5J1 (Ch. HS-250), 5J1U (Ch. HS-224) 100—7  
 5J2 (Ch. HS-250) (See Model 5J1—Set 100-7)  
 5J2U (Ch. HS-224) (See Model 5J1—Set 100-7)  
 5L1 (Ch. HS-250), 5L1U (Ch. HS-224) 100—7  
 5L2 (Ch. HS-250) (See Model 5J1—Set 100-7)  
 5M1, 5M1U, 5M2, 5M2U (Ch. HS-249, HS-223) 101—7  
 5R11A, 5R12A, 5R13A, 5R14A, 5R15A, 5R16A (Ch. HS-280) (See Model 5R11U—Set 115-6)  
 5R11U, 5R12U, 5R13U, 5R14U, 5R15U, 5R16U (Ch. HS-242) 115—6  
 5X11U, 5X12U, 5X13U (Ch. HS-242) 114—7  
 5X21U, 5X22U, 5X23U (Ch. HS-259) 120—9  
 6F11, 6F11B (Ch. HS-264) 117—10  
 6L1, 6L2 (Ch. HS-226) 102—7  
 6X11U, 6X12U (Ch. HS-245) 112—5  
 7F11, 7F11B (Ch. HS-265) 113—5  
 7VT1, 7VT2, 7VT5 (Ch. TS-18) Tel. Rec. 83—6  
 8FD1 (See Ch. 8A—Set 46-16)  
 8FM21, 8FM21B (Ch. HS-247) 121—9  
 8GMT (See Ch. 8A—Set 46-16)  
 9FM21, 9FM21B (Ch. HS-246) 114—8  
 9T1 (Ch. TS-18, A) Tel. Rec. (See Model 7VT1—Set 83-6)  
 9VT1, 9VT5 (Ch. TS-18, A) Tel. Rec. 83—6  
 10T2 (Ch. TS-14B) Tel. Rec. 92—4  
 10VK9 (Ch. TS-9E, TS-9E1) Tel. Rec. 77—6  
 10VK12 (Ch. TS14, A, B) Tel. Rec. 92—4  
 10VK22 (Ch. TS14, A, B) Tel. Rec. 92—4  
 10VT3 (Ch. TS-9E, TS-9E1) Tel. Rec. 77—6  
 10VT10 (Ch. TS14, A, B) Tel. Rec. 92—4  
 10VT24 (Ch. TS14, A, B) Tel. Rec. 92—4  
 12K1, B (Ch. TS23B) Tel. Rec. 92—4

**MOTOROLA—Cont.**

12K2, B (Ch. TS-23B) Tel. Rec. 92—4  
 12K2 (Ch. TS-53) Tel. Rec. 115—7  
 12T1, B (Ch. TS-23B) Tel. Rec. 92—4  
 12T3 (Ch. TS-53) Tel. Rec. 115—7  
 12VF4, A, R-C (Ch. TS-23, A and Radio Ch. HS-190) Tel. Rec. 92—4  
 12VF26B, B-C, R, R-C (Ch. TS-23A, B and Radio Ch. HS-190A) Tel. Rec. 92—4  
 12VK11 (Ch. TS-23, A, B) Tel. Rec. 92—4  
 12VK15 (Ch. TS-30, A) Tel. Rec. (Also Prod. Chge. Bul. 5—Set 106-1) 93—7  
 12VK18B, 12VK18C (Ch. TS-15C, TS-15C1) Tel. Rec. 77—6  
 12VT13 (Ch. TS-23, A, B) Tel. Rec. 92—4  
 12VT16, 12VT16B, 12VT16C (Ch. TS-15C, TS-15C1) Tel. Rec. 77—6  
 14K1, B (Ch. TS-88) Tel. Rec. 112—6  
 14K18B, 14K18C (Ch. TS-115) Tel. Rec. 121—10  
 14P18 (Ch. TS-216) Tel. Rec. (See Model 14T4—Set 158-8)  
 14P2, 14P2U (Ch. TS-275) Tel. Rec. 174—9  
 14T1, B (Ch. TS-88) Tel. Rec. 112—6  
 14T3 (Ch. TS-114) Tel. Rec. 121—10  
 14T3X1 (Ch. TS-114A) (See Model 14T3—Set 121-10)  
 14T4, B (Ch. TS-216) Tel. Rec. 158—8  
 16F1 (Ch. TS-60 and Radio Ch. HS-234) Tel. Rec. 102—8  
 16F18B, 16F18C (Ch. TS-89 and Radio Ch. HS-324) Tel. Rec. (For TV Ch. see Set 121-10. For Radio Ch. see Model 16F1—Set 102-8)  
 16K2L, L-B (Ch. TS-52) Tel. Rec. 93A-10  
 16K2 (Ch. TS-74) Tel. Rec. 102—8  
 16K28B, 16K28C (Ch. TS-94) Tel. Rec. 121—10  
 16T1 (Ch. TS-60) Tel. Rec. 102—8  
 16T18B, 16T18C (Ch. TS-89) Tel. Rec. 121—10  
 16VF8B, R (Ch. TS-16, A and Radio Ch. HS-211) Tel. Rec. (For TV Ch. see Set 93-7. For Radio Ch. see Model 9FM21R—Set 80-10)  
 16VK1 (Ch. TS-52) Tel. Rec. 93A-10  
 16VK7 (Ch. TS-6, A) Tel. Rec. (Also Prod. Chge. Bul. 5—Set 106-1) 93—7  
 17F1 (Ch. TS-118 and Radio Ch. HS-253) Tel. Rec. 121—10  
 17F1A (Ch. TS-89 and Radio Ch. HS-253) Tel. Rec. 121—10  
 17F1B (Ch. TS-118 and Radio Ch. HS-253) Tel. Rec. 121—10  
 17F1BA (Ch. TS-89 and Radio Ch. HS-253) Tel. Rec. 121—10  
 17F2W (Ch. TS-118 and Radio Ch. HS-253) Tel. Rec. 121—10  
 17F2WA (Ch. TS-89 and Radio Ch. HS-253) Tel. Rec. 121—10  
 17F3, B (Ch. TS-118 and Radio Ch. HS-253) Tel. Rec. 121—10  
 17F3BA (Ch. TS-89 and Radio Ch. HS-253) Tel. Rec. 121—10  
 17F4 (Ch. TS-118 and Radio Ch. HS-253) Tel. Rec. (See Model 14K18H) 121—10  
 17F4A (Ch. TS-89 and Radio Ch. HS-253) Tel. Rec. 121—10  
 17F5 (Ch. TS-118 and Radio Ch. HS-261) Tel. Rec. (See Model 14K18H) 121—10  
 17F5A, 17F5BA (Ch. TS-89 and Radio Ch. HS-261) Tel. Rec. 121—10  
 17F5B (Ch. TS-118 and Radio Ch. HS-261) Tel. Rec. 121—10  
 17F6, B (Ch. TS-118 and Radio Ch. HS-253) Tel. Rec. (See Model 14K18H—Set 121-10)  
 17F6B, C (Ch. TS-174 and Radio Ch. HS-253) Tel. Rec. (See Model 14K18H—Set 121-10)  
 17F7B (Ch. TS-118) Tel. Rec. (See Model 14K18H—Set 121-10)  
 17F7BC (Ch. TS-174 and Radio Ch. HS-253) Tel. Rec. (See Model 14K18H—Set 121-10)  
 17F8 (Ch. TS-118) Tel. Rec. (See Model 14K18H—Set 121-10)  
 17F8C (Ch. TS-174) Tel. Rec. (See Model 14K18H—Set 121-10)  
 17F9, B (Ch. TS-118) Tel. Rec. (See Model 14K18H—Set 121-10)

**IMPORTANT**

**Quick, Easy PHOTOFAC T Filing Method**

The preferred 30-Second method for filing PHOTOFAC T Folders

Your PHOTOFAC T Folder Sets come to you in convenient envelopes. When you remove a Set from its envelope, you will find the Folders already arranged in proper filing order, and preceded by an Index Separator. This Separator lists each receiver covered in the Set, and has an index tab showing the Set number. To file, here's all you do:



1. Remove the Index Separator and the Folders from the envelope. The Folders and manila TV Jackets are already arranged in proper numerical filing order except the TV folders, which are placed last in the Set.
2. Open your binder and place the entire contents, taken from the envelope, behind the preceding Set of folders, laying aside the TV folders.
3. Now, insert the TV folders in their respective manila jackets and your filing is complete.

To locate the folder you want, refer to instructions on the first page of this index listing.

**ALWAYS REFER TO THE PHOTOFAC T INDEX**



**MOTOROLA—Cont.**

17F98C, C (Ch. TS-174 and Radio Ch. HS-261) Tel. Rec. (See Model 14K1BH—Set 121-10)

17F11 (Ch. TS-228 and Radio Ch. HS-302) Tel. Rec. (See Model 165-7)

17F12, A, B, BA (Ch. TS-325, A, 326, A, and Radio Ch. HS-319) Tel. Rec. (See Model 171-8)

17F12D (Ch. TS-201) Tel. Rec. (For TV Ch. Only see Prod. Chge. Bul. 49—Set 183-1 and Model 21F1—Set 173-9)

17F13, B (Ch. TS-395A, 02 and Radio Ch. HS-319) (For TV Ch. see Set 192-6, For Radio Ch. see Model 17F12—Set 171-8)

17F13B (Ch. TS-408A and Radio Ch. HS-319) Tel. Rec. (For TV Ch. see Model 21C1—Set 191-13, for Radio Ch. see Model 17F12—Set 171-8)

17F13C (Ch. TS-408A and Radio Ch. HS-319) Tel. Rec. (For TV Ch. see Model 21C1—Set 191-13, for Radio Ch. see Model 17F12—Set 171-8)

17K1A, 17K1BA (Ch. TS-95) Tel. Rec. (See Model 121-10)

17K1BE, E (Ch. TS-172) Tel. Rec. (See Model 14K1BH—Set 121-10)

17K2BE, E (Ch. TS-172) Tel. Rec. (See Model 14K1BH—Set 121-10)

17K3, 17K3B (Ch. TS-118) Tel. Rec. (See Model 121-10)

17K3A, 17K3BA (Ch. TS-89) Tel. Rec. (See Model 121-10)

17K4A (Ch. TS-95) Tel. Rec. (See Model 121-10)

17K4E (Ch. TS-172 Tel. Rec. (See Model 14K1BH—Set 121-10)

17K5 (Ch. TS-118) Tel. Rec. (See Model 14K1BH—Set 121-10)

17K5C (Ch. TS-174) Tel. Rec. (See Model 14K1BH—Set 121-10)

17K5E (Ch. TS-221A) Tel. Rec. (See Model 159-10)

17K6 (Ch. TS-118) Tel. Rec. (See Model 14K1BH—Set 121-10)

17K6C (Ch. TS-174) Tel. Rec. (See Model 14K1BH—Set 121-10)

17K7, B (Ch. TS-118) Tel. Rec. (See Model 14K1BH—Set 121-10)

17K7B, C (Ch. TS-174) Tel. Rec. (See Model 14K1BH—Set 121-10)

17K8, B (Ch. TS-236) Tel. Rec. (See Model 152-4A)

17K8A, BA (Ch. TS-228) Tel. Rec. (See Model 165-7)

17K9, B (Ch. TS-220) Tel. Rec. (See Model 159-10)

17K9A, BA (Ch. TS-228) Tel. Rec. (See Model 165-7)

17K9B (Ch. TS-221, -A) Tel. Rec. (See Model 159-10)

17K10, M (Ch. TS-228) Tel. Rec. (See Model 165-7)

17K10A (Ch. TS-174) Tel. Rec. (See Model 14K1BH—Set 121-10)

17K10E (Ch. TS-314A, B) Tel. Rec. (See Model 167-13)

17K11, B, C (Ch. TS-236) Tel. Rec. (See Model 152-4A)

17K11A, BA (Ch. TS-228) Tel. Rec. (See Model 165-7)

17K12, A, B, BA, W, WA (Ch. TS-325, A, 326, A) Tel. Rec. (See Model 171-8)

17K13A (Ch. TS-326A, B) Tel. Rec. (See Model 17F12—Set 171-8)

17K13D (Ch. TS-401) Tel. Rec. (See Prod. Chge. Bul. 49—Set 183-1 and Model 21F1—Set 173-9)

17K14, A, B (Ch. TS-395, -02) Tel. Rec. (See Model 192-6)

17K14BC (Ch. TS-408A) Tel. Rec. (See Model 21C1—Set 191-13)

17K14C (Ch. TS-408A) Tel. Rec. (See Model 21C1—Set 191-13)

17K14W (Ch. TS-395, -02) Tel. Rec. (See Model 192-6)

17K14WC (Ch. TS-408A) Tel. Rec. (See Model 21C1—Set 191-13)

17K15, B (Ch. TS-395A, -02) Tel. Rec. (See Model 192-6)

17K15BC (Ch. TS-408A) Tel. Rec. (See Model 21C1—Set 191-13)

17K15C (Ch. TS-408A) Tel. Rec. (See Model 21C1—Set 191-13)

17K16 (Ch. TS-395A, -02) Tel. Rec. (See Model 192-6)

17K16C (Ch. TS-408A) Tel. Rec. (See Model 21C1—Set 191-13)

17K17, 17K17A (Ch. TS-89) Tel. Rec. (See Model 121-10)

17K17A, 17K17BA (Ch. TS-89) Tel. Rec. (See Model 121-10)

**MOTOROLA—Cont.**

17T2, 17T2B (Ch. TS-118) Tel. Rec. (See Model 121-10)

17T3 (Ch. TS-118) Tel. Rec. (See Model 121-10)

17T3A (Ch. TS-89) Tel. Rec. (See Model 121-10)

17T3G (Ch. TS-221, -A) Tel. Rec. (See Model 159-10)

17T3X (Ch. TS-118A, B) Tel. Rec. (See Model 14K1BH—Set 121-10)

17T4 (Ch. TS-118) Tel. Rec. (See Model 14K1BH—Set 121-10)

17T4C (Ch. TS-174) Tel. Rec. (See Model 14K1BH—Set 121-10)

17T4E (Ch. TS-221, -A) Tel. Rec. (See Model 159-10)

17T5A (Ch. TS-214) Tel. Rec. (See Model 165-7)

17T5C (Ch. TS-228) Tel. Rec. (See Model 165-7)

17T5D (Ch. TS-236) Tel. Rec. (See Model 152-4A)

17T5E, F (Ch. TS-314A, B, TS-315A, B) Tel. Rec. (See Model 167-13)

17T6BD, C, D (Ch. TS-226) Tel. Rec. (See Model 152-4A)

17T6BF, F (Ch. TS-228) Tel. Rec. (See Model 165-7)

17T6G (Ch. TS-314A, B) Tel. Rec. (See Model 167-13)

17T7, A (Ch. TS-325, -02) Tel. Rec. (See Model 171-8)

17T8, A, B, BA (Ch. TS-325, TS-326) Tel. Rec. (See Model 171-8)

17T9 (Ch. TS-325A, B) Tel. Rec. (See Model 17F12—Set 171-8)

17T9A (Ch. TS-326A, B) Tel. Rec. (See Model 17F12—Set 171-8)

17T9E (Ch. TS-401) Tel. Rec. (See Prod. Chge. Bul. 49—Set 183-1 and Model 21F1—Set 173-9)

17T10 (Ch. TS-325B) Tel. Rec. (See Model 17F12—Set 171-8)

17T10A (Ch. TS-326A, B) Tel. Rec. (See Model 17F12—Set 171-8)

17T10D (Ch. TS-401) Tel. Rec. (See Prod. Chge. Bul. 49—Set 183-1 and Model 21F1—Set 173-9)

17T11 (Ch. TS-395, -02) Tel. Rec. (See Model 192-6)

17T11C (Ch. TS-408A) Tel. Rec. (See Model 21C1—Set 191-13)

17T11E (Ch. TS-400A) Tel. Rec. (See Model 194-9)

17T11EC (Ch. TS-408A) Tel. Rec. (See Model 21C1—Set 191-13)

17T12, B (Ch. TS-395A, -02) Tel. Rec. (See Model 192-6)

17T12C (Ch. TS-408A) Tel. Rec. (See Model 21C1—Set 191-13)

17T12W (Ch. TS-395A, -02) Tel. Rec. (See Model 192-6)

17T12WC (Ch. TS-408A) Tel. Rec. (See Model 21C1—Set 191-13)

17T13 (Ch. TS-40A) Tel. Rec. (See Model 194-9)

17F1 (Ch. TS-67, A and Radio Ch. HS-230) Tel. Rec. (See Model 111-9)

19K1 (Ch. TS-67, A) Tel. Rec. (See Model 111-9)

19K2, 19K2B (Ch. TS-101) Tel. Rec. (See Model 122-5)

19K2E, BE (Ch. TS-119, A) Tel. Rec. (See Prod. Chge. Bul. 53—Set 187-1 and Model 19K2—Set 122-5)

19K3, 19K4, 19K4B (Ch. TS-101) Tel. Rec. (See Model 122-5)

20F1, B (Ch. TS-119, A and Radio Ch. HS-230) Tel. Rec. (Also See Prod. Chge. Bul. 53—Set 187-1) 122-5

20F2, B (Ch. TS-119B, C) Tel. Rec. (See Prod. Chge. Bul. 53—Set 187-1 and Model 19K2—Set 122-5)

20T1, B, 20T2 (Ch. TS-119B, C) Tel. Rec. (See Prod. Chge. Bul. 53—Set 187-1 and Model 19K2—Set 122-5)

20T2A, 20T2AB (Ch. TS-307) Tel. Rec. (See Model 183-9)

20T2B (Ch. TS-119B, C) Tel. Rec. (See Prod. Chge. Bul. 53—Set 187-1 and Model 19K2—Set 122-5)

20T3, 20T3B (Ch. TS-307) Tel. Rec. (See Model 183-9)

**MOTOROLA—Cont.**

21C1, B (Ch. TS-292A, B) Tel. Rec. (Also See Prod. Chge. Bul. 63—Set 197-1) 191-13

21F1, B (Ch. TS-351, A and Radio Ch. HS-316) Tel. Rec. (See Model 173-9)

21F2, B, 21F3, B (Ch. TS-292A, B and Radio Ch. HS-316) Tel. Rec. (For TV Ch. See Prod. Chge. Bul. 63—Set 197-1 and Set 191-13, For Radio Ch. See Model 21F1—Set 173-9)

21K1, B (Ch. TS-351) Tel. Rec. (See Model 173-9)

21K2, B (Ch. TS-351) Tel. Rec. (See Model 173-9)

21K3, B, W (Ch. TS-351B) Tel. Rec. (See Model 21F1—Set 173-9)

21K4, A, B, W (Ch. TS-292A, B) Tel. Rec. (Also See Prod. Chge. Bul. 63—Set 197-1) 191-13

21K5, B, 21K6, 21K7 (Ch. TS-292A, B) Tel. Rec. (Also See Prod. Chge. Bul. 63—Set 197-1) 191-13

21T1, B (Ch. TS-351) Tel. Rec. (See Model 173-9)

21T2, B (Ch. TS-351) Tel. Rec. (See Model 173-9)

21T3 (Ch. TS-501, B) Tel. Rec. (Also See Prod. Chge. Bul. 63—Set 197-1) 191-13

21T4A (Ch. TS-324A, B) Tel. Rec. (Also See Prod. Chge. Bul. 63—Set 197-1) 191-13

21T4AC, ACE (Ch. TS-292-B) (See Prod. Chge. Bul. 63—Set 197-1 and Model 21C1—Set 191-7)

21T4EA (Ch. TS-324A, B) Tel. Rec. (Also See Prod. Chge. Bul. 63—Set 197-1) 191-13

21T5A, BA (Ch. TS-324A, B) Tel. Rec. (Also See Prod. Chge. Bul. 63—Set 197-1) 191-13

42B1 (Ch. HS-306) 191-14

42C1 (Ch. HS-309) 9-23

47B11 (Ch. HS-72) 29-17

48L11 (Ch. HS-113) 47-13

49L11Q, 49L13Q (Ch. HS-183) 77-7

51C1, 51C2, 51C3, 51C4 (Ch. HS-288) (See Model 521—Set 16-9)

51L1U, 51L2U (Ch. HS-224) (See Model 511—Set 100-7)

51M1U, 51M2U (Ch. HS-283) 149-8

52B1U (Ch. HS-305) 190-10

52C1 (Ch. HS-309) 191-15

52C1A (Ch. HS-309) (See Model 52C1—Set 191-15)

52C6 (Ch. HS-310) 177-10

52C6A (Ch. HS-375) (See Model 52C6—Set 177-10)

52C7 (Ch. HS-310) 177-10

52C7A (Ch. HS-310) (See Model 52C7—Set 177-10)

52C8 (Ch. HS-310) 177-10

52C8A (Ch. HS-375) (See Model 52C8—Set 177-10)

52CW1, 52CW2, 52CW3, 52CW4 (Ch. HS-329) 198-10

52H11U, 52H12U, 52H13U, 52H14U (Ch. HS-313) 176-6

52L1, A, 52L2, A, 52L3, A (Ch. HS-327, HS-357) 190-11

52M1U, 52M2U, 52M3U (Ch. HS-300) 188-10

52R1, 52R2, 52R13, 52R14, 52R15, 52R16 (Ch. HS-289) 188-11

52R11, 52R12, 52R15, 52R16 (Ch. HS-289A) (See Model 5211—Set 188-11)

52R11A, 52R12A, 52R13A, 52R14A, 52R15A, 52R16A (Ch. HS-317) 178-7

52R11U, 52R12U, 52R13U, 52R14U, 52R15U, 52R16U (Ch. HS-315) 177-11

55F11 (Ch. HS-30) 4-14

55X11A, 55X12A, 55X13A, 56X11 (Ch. HS-94) 28-24

57X11, 57X12 (Ch. HS-60) 28-25

58A11, 58A12 (Ch. HS-158) 52-13

58C11, 58C12 (Ch. HS-160) 64-8

58L11 (Ch. HS-114) 45-17

58R11, 58R12, 58R13, 58R14, 58R15, 58R16 (Ch. HS-16) 49-14

58R11A, 58R12A, 58R13A, 58R14A, 58R15A, 58R16A (Ch. HS-18A) 69-11

58X11, 58X12 (Ch. HS-125) 53-15

59F11 (Ch. HS-188) 68-12

59H11U, 59H12U (Ch. HS-210) 97-9

59L11Q, 59L12Q, 59L14Q (Ch. HS-187) 78-10

59R11, 59R121, 59R13M, 59R14E, 59R15Z, 59R16Y (Ch. HS-167) 79-10

59X11, 59X12 (Ch. HS-180) 81-11

59X21U, 59X22U (Ch. HS-192) 98-6

**MOTOROLA—Cont.**

61L1, 61L2 (Ch. HS-226) (See Model 611—Set 102-7)

62C1 (Ch. HS-299) 189-12

62C1A (Ch. HS-299) (See Model 62C—Set 189-12)

62C2 (Ch. HS-299) 189-12

62C2A (Ch. HS-299) (See Model 62C2—Set 189-12)

62C3 (Ch. HS-299) 189-12

62C3A (Ch. HS-299) (See Model 62C3—Set 189-12)

62W21 (Ch. HS-324) 196-7

62L1U, 62L2U, 62L3U (Ch. HS-308) 183-10

62X11U, 62X12U, 62X13U (Ch. HS-314) 175-14

65F11 (Ch. HS-31) 6-19

65F12 (See Model 65F11—Set 6-19)

65F21 (Ch. HS-26) 4-12

65L11, 65L12 (Ch. HS-7) 8-22

65T21, 65T21B (Ch. HS-32) 1-1

65X11A, 65X12A, 65X13A, 65X14A, 65X14B (Ch. HS-2) 4-8

67F1, 67F11, 67F12B, 67F13 (Ch. HS-63) 31-20

67F14 (Ch. HS-122) 55-15

67F61BN (Ch. HS-69) 44-14

67L11 (Ch. HS-59) 31-21

67X11, 67X12, 67X13 (Ch. HS-58) 30-20

67X21 (Ch. HS-61) 32-14

68F11, 68F12, 68F14, 68F14B, 68F14M, 68L11 (Ch. HS-119) 45-18

68T11 (Ch. HS-144) 54-14

68X11, 68X12 (Ch. HS-127) 68X11A, 68X12A (Ch. HS-27A) 56-16

69L11 (Ch. HS-175) 76-15

69X11, 69X121 (Ch. HS-181) 82-9

72X2M1 (Ch. HS-303) 176-7

72X2M2 (See Model 72X2M1—Set 176-7)

75F21 (Ch. HS-91) 19-21

75F31 (Ch. HS-36) 75F31A, B (Ch. HS-36A), 76F31 (Ch. HS-98) 29-18

77F2M1 (Ch. HS-89) 77F2M2, 77F2M2M, 77F2M2WM, 77F2M23 (Ch. HS-97) 33-13

77X2M1, 77X2M2, 77X2M22B (Ch. HS-102) 34-12

78F11, 78F11M (Ch. HS-150), 78F12M (Ch. HS-155) 56-17

78F2M1, 78F2M1M (Ch. HS-132), 78F2M2M (Ch. HS-128) 59-13

79F2M1, 79F2M1B, 79F2M21R (Ch. HS-178) 88-7

79X2M1, 79X2M2 (Ch. HS-168) 85-9

85Z1 (Ch. HS-2) 6-20

85K21 (Ch. HS-52) 6-3

88F2M1 (Ch. HS-133) 54-15

91F2M1 (Ch. HS-230A) (See Model 19F1—Set 111-9)

92F2M1, A, B, BA (Ch. HS-316A) (See Model 21F1—Set 173-9)

95F31, 95F31B (Ch. HS-39) 95F33 (Ch. HS-38) 19-22

99F2M1R (Ch. HS-170) 80-10

107F31, 107F31B, 109 (Ch. HS-87) 33-14

309 63-14

400 99-10

401 131-12

401A 179-8

405 (Ch. AS-13) 3-8

405M (See Set 21-25 and Model 405—Set 3-8)

409 (See Model 408—Set 38-12)

500 98-7

501 133-10

501A 148-12

505 (Ch. AS-14) 4-37

509 (See Model 508—Set 39-13)

600 97-10

603 (See Mopar Model 604—Set 65-9)

604 (See Mopar Model 704—Set 106-9)

605 (Ch. AS-15) 5-1

606 (See Mopar Model 606—Set 133-9)

607 (See Mopar Model 607—Set 170-11)

608 39-14

608 (Mopar) (See Mopar Model 608—Set 207-4)

609 (See Model 608—Set 39-14)

700 100-8

701 137-8

702 (Ch. BT-2 and P6-2) 197-7

705 (Ch. AS-16) 7-19

708 40-12

709 (See Model 708—Set 40-12)

800 103-10

801 138-6

802 (Ch. BT-2 and P8-2) 197-7

804 (See Mopar Model 804—Set 67-12)

808 (See Mopar Model 808—Set 107-6)

814 (See Mopar Model 814—Set 37-11)

Ch. AS-13 (See Model 405)

Ch. AS-14 (See Model 505)

Ch. AS-15 (See Model 605)

Ch. AS-16 (See Model 705)

Ch. AS-22 (See Model BK-6)

**MOTOROLA—Cont.**

Ch. BT-2 197-7

Ch. HS-2 (See Model 65X11A)

Ch. HS-6 (See Model 5A1)

Ch. HS-7 (See Model 65L11)

Ch. HS-8 (See Model 45B12)

Ch. HS-15 (See Model 5A5)

Ch. HS-18 (See Model WR6)

Ch. HS-22 (See Model 65F21)

Ch. HS-26 (See Model 65F11)

Ch. HS-30 (See Model 65F11)

Ch. HS-31 (See Model 65F11)

Ch. HS-32 (See Model 65T21)

Ch. HS-36 (See Model 75F31)

Ch. HS-36A (See Model 75F31A)

Ch. HS-38 (See Model 5A2)

Ch. HS-39 (See Model 95F31)

Ch. HS-50 (See Model 55X11A)

Ch. HS-52 (See Model 85K21)

Ch. HS-58 (See Model 67X11)

Ch. HS-59 (See Model 67L11)

Ch. HS-60 (See Model 57X11)

Ch. HS-62 (See Model 5A7)

Ch. HS-62A (See Model 5A7A)

Ch. HS-63 (See Model 67F11)

Ch. HS-64 (See Model 67X2M1)

Ch. HS-69 (See Model 67F61BN)

Ch. HS-72 (See Model 47B11)

Ch. HS-87 (See Model 107F31)

Ch. HS-89 (See Model 77F2M1)

Ch. HS-91 (See Model 75F21)

Ch. HS-94 (See Model 56X11)

Ch. HS-97 (See Model 77F2M2)

Ch. HS-98 (See Model 76F31)

Ch. HS-102 (See Model 77X2M1)

Ch. HS-108 (See Model VK-10)

Ch. HS-113 (See Model 68L11)

Ch. HS-114 (See Model 58L11)

Ch. HS-116 (See Model 58R11)

Ch. HS-119 (See Model 68L11)

Ch. HS-122 (See Model 67F14)

Ch. HS-124 (See Model 78F11)

Ch. HS-125 (See Model 58X11)

Ch. HS-127 (See Model 68X11)

Ch. HS-127A (See Model 68X11A)

Ch. HS-128 (See Model 78F2M2M)

Ch. HS-132 (See Model 78F2M1)

Ch. HS-133 (See Model 88F2M1)

Ch. HS-137 (See Model VF102)

Ch. HS-144 (See Model 68L11)

Ch. HS-150 (See Model 78F11)

Ch. HS-155 (See Model 78F12M)

Ch. HS-158 (See Model 58A11)

Ch. HS-160 (See Model 58G11)

Ch. HS-167 (See Model 59R11)

Ch. HS-168 (See Model 79X2M1)

Ch. HS-170 (See Model 99F2M1R)

Ch. HS-175 (See Model 69L11)

Ch. HS-178 (See Model 79F2M1)

Ch. HS-180 (See Model 59X11)

Ch. HS-181 (See Model 69X11)

Ch. HS-183 (See Model 49L11Q)

Ch. HS-184 (See Model 58R11A)

Ch. HS-187 (See Model 59L11Q)

Ch. HS-188 (See Model 59F11)

Ch. HS-192 (See Model 59X21U)

Ch. HS-210 (See Model 59H11U)

Ch. HS-223 (See Model 5M1)

Ch. HS-224 (See Model 5J1U)

Ch. HS-226 (See Model 611)

# PHONOGRAPH SERVICE

through the **MAGIC of CERAMIC.**

Direct replacement of crystal cartridges\* with permanent ceramic in millions of record players is now feasible

**\*ELECTRO-VOICE NEW CERAMIC PHONO-CARTRIDGES ARE DIRECTLY INTERCHANGEABLE WITH SILENT-NEEDLE-TYPE CRYSTAL CARTRIDGES**

(cartridges that do not use a thumb screw)

Through the *Magic of Ceramic*, these new E-V Cartridges offer many important advantages:

- 1. Virtually Indestructible**—No worry about deterioration or performance, all year 'round.
- 2. Moisture Proof**—Ceramic generating element cannot be dissolved by moisture. Ideal for extremely humid or dry areas.
- 3. No Heat Problem**—Not dehydrated by high temperatures. Assures good reproduction in all climates, hot, temperate or cold.
- 4. High Compliance**—Typical of modern E-V cartridges. It means less needle pressure (tracking force) and greater ability to follow the grooves—makes records *last longer* and *sound better*.
- 5. Wide Range**—Low mass driving system allows wider response range due to the lighter weight of needle and mount.
- 6. High Output Voltage**—Equal to or better than crystal cartridges.
- 7. Long Life**—Without fear of deterioration, can be kept in the service kit and carried along on service calls for on-the-job replacement sales, or kept in stock on the shelf.
- 8. No Additional Cost**—E-V Ceramic Cartridges are priced at no more than crystal. This makes the replacement sale even easier!



MODEL 43 CERAMIC. For 78, 45 and 33 $\frac{1}{3}$  rpm. Plays all three speeds with a single 2.3 mil all-purpose needle-tip. Output is .7 to 1.0 volt.  
Model 43, with Osmium Tip.....List \$6.50  
Model 43-5, with Sapphire Tip.....List \$7.50



MODEL 44 CERAMIC. Superb replacement in 45 and 33 $\frac{1}{3}$  rpm record players. Uses 1-mil needle. Output .7 volt.  
Model 44, with Osmium Tip.....List \$6.50  
Model 44-5, with Sapphire Tip.....List \$7.50

MODERNIZE—REPLACE—WITH ALL-SEASON, ALL-CLIMATE E-V



# ING REVOLUTIONIZED

**PERFECT PERFORMANCE EVEN AT THE TEMPERATURE OF BOILING WATER**



ELECTRO-VOICE Ceramic Cartridges provide high output and superior compliance. Note that crystal cartridges are rated at optimum temperature of approximately 70° F. As room or equipment temperature rises, output of crystal cartridge falls. Ratings given for these ceramic cartridges are measured at 100° F. at which temperature output is actually higher than most Rochelle Salt crystals. Frequency response is not temperature-dependent as is the case with Rochelle Salt.

E-V low-mass driving system gives substantially less mechanical impedance. The result is *less record wear* and *less needle wear*. The needle is easily replaced and will always be identically positioned, automatically.

The 3 ceramic models shown below are part of the famous E-V Basic 6 Preferred Types that make over 92% of all cartridge replacements.

## REVOLUTIONIZED SERVICING BOOSTS SALES

Servicing is more convenient—installation is quick and easy—performance is more satisfying. With these 3 ceramic cartridges in the service kit, every serviceman is always prepared to make fast on-the-job replacement sales. Service-calls become more profitable.

AVAILABLE AT AUTHORIZED E-V DEALERS



MODEL 46-T CERAMIC TURNOVER. For 78, 45 and 33 $\frac{1}{3}$  rpm. Uses separate 3-mil Osmium and 1-mil Sapphire Tip needles. Output .7 volt. With simple, accurate E-V turnover mechanism. . . . . List \$10.00 Model 46. Without turnover mechanism. List \$9.00



## PACKAGED FOR EASIER SALES AND SERVICE

Each ELECTRO-VOICE cartridge comes like a jewel in a rich two-tone transparent and golden yellow, self-stacking plastic box. Protects the cartridge, attracts the eye, helps make the replacement sale.

## NEW HIGH FIDELITY CERAMIC CARTRIDGES

For Hi-Fi enthusiasts, broadcast and recording studios, ELECTRO-VOICE has developed new Ultra-Linear, Wide-Range, Constant Amplitude Ceramic Phono-Cartridges. Require no preamp, no costly equalizing networks. Complete information is available on request.

## FREE INTERCHANGEABILITY CHART

Write now for new free Phono-Cartridge Replacement Chart No. 170-A. Gives quick, handy, complete cross-reference of cartridge interchangeability. Includes E-V cartridge specification table.

# Electro-Voice

BUCHANAN, MICHIGAN  
Export: 13 East 40th St., New York 16, U.S.A. Cables: Arlab

Reprints of these two pages are available to you in reasonable quantity without charge, for your use in promoting replacement sales. Simply write to Electro-Voice, Buchanan, Mich.

CERAMIC CARTRIDGES

**MOTOROLA-OLYMPIC**

**MOTOROLA-Cont.**

Ch. HS-228 (See Model 5C1)  
 Ch. HS-230 (See Model 19F1)  
 Ch. HS-234 (See Model 16F1)  
 Ch. HS-242 (See Model 5R11U)  
 Ch. HS-243 (See Model 5X11U)  
 Ch. HS-244 (See Model 5H11U)  
 Ch. HS-245 (See Model 6X11U)  
 Ch. HS-246 (See Model 9FM21)  
 Ch. HS-247 (See Model 8FM21)  
 Ch. HS-249 (See Model 5M1)  
 Ch. HS-250 (See Model 511)  
 Ch. HS-253 (See Model 17F1)  
 Ch. HS-258 (See Model 5C2)  
 Ch. HS-259 (See Model 5X21U)  
 Ch. HS-261 (See Model 17F5)  
 Ch. HS-262 (See Model 5C3)  
 Ch. HS-264 (See Model 6F11)  
 Ch. HS-265 (See Model 7F11)  
 Ch. HS-270 (See Model 5C4)  
 Ch. HS-271 (See Model 5C5)  
 Ch. HS-272 (See Model 5C6)  
 Ch. HS-283 (See Model 51M1U)  
 Ch. HS-289, A (See Model 5Z811)  
 Ch. HS-299 (See Model 62C1)  
 Ch. HS-300 (See Model 5ZM1U)  
 Ch. HS-302 (See Model 17F11)  
 Ch. HS-303 (See Model 72X21)  
 Ch. HS-305 (See Model 5Z811U)  
 Ch. HS-306 (See Model 4Z81)  
 Ch. HS-308 (See Model 6211U)  
 Ch. HS-309 (See Model 52C1)  
 Ch. HS-310 (See Model 52C6)  
 Ch. HS-313 (See Model 5Z811U)  
 Ch. HS-314 (See Model 62X11U)  
 Ch. HS-315 (See Model 5Z811U)  
 Ch. HS-316 (See Model 21F1)  
 Ch. HS-317 (See Model 5Z811A)  
 Ch. HS-319 (See Model 17F12)  
 Ch. HS-324 (See Model 62CW1)  
 Ch. HS-327 (See Model 5Z11)  
 Ch. HS-329 (See Model 52CW1)  
 Ch. HS-357 (See Model 5Z11)  
 Ch. M-5 (See Model AR96-23)  
 Ch. OB (See Model SROB)  
 Ch. PB-2 (See Model 197-7)  
 Ch. PB-2 (See Model 197-7)  
 Ch. TS-3 (See Model VT-101)  
 Ch. TS-4B Thru J (See Model VT-71)  
 Ch. TS-4J Late (See Model VT-73)  
 Ch. TS-5 (See Model VK101)  
 Ch. TS-7 (See Model VF-102)  
 Ch. TS-8 (See Model VF103)  
 Ch. TS-9, TS-9A, TS-9B, TS-9C (See Model VT105)  
 Ch. TS-9D (See Model VT105)  
 Ch. TS-9E, TS-9E1 (See Model VK106)  
 Ch. TS-14, A, B, (See Model 10VK12)  
 Ch. TS-15 (See Model VT121)  
 Ch. TS-15C, TS-15C1 (See Model 12VK18B)  
 Ch. TS-16, A (See Model 16VFB8)  
 Ch. TS-18, A (See Model 7VT1)  
 Ch. TS-23, A, B (See Model 12VK11)  
 Ch. TS-30, A (See Model 12VK15)  
 Ch. TS-52 (See Model 16K2L)  
 Ch. TS-53 (See Model 12K2)  
 Ch. TS-60 (See Model 16F1)  
 Ch. TS-67 (See Model 19F1)  
 Ch. TS-74 (See Model 16K2)  
 Ch. TS-88 (See Model 14K1)  
 Ch. TS-89 (See Model 16F18H)

**MOTOROLA-Cont.**

Ch. TS-94 (See Model 16K2BH)  
 Ch. TS-95 (See Model 17K1A)  
 Ch. TS-101 (See Model 19K2)  
 Ch. TS-114 (See Model 14T3)  
 Ch. TS-114A (See Model 14T3X1)  
 Ch. TS-115 (See Model 14K18H)  
 Ch. TS-118 (See Model 17F1)  
 Ch. TS-118A, B (See Model 17T3X1)  
 Ch. TS-119, A (See Model 19K2E)  
 Ch. TS-119B (See Model 20F2)  
 Ch. TS-119C, C1, D (See Model 20K3)  
 Ch. TS-172 (See Model 17K18E)  
 Ch. TS-174 (See Model 17F6BC)  
 Ch. TS-214 (See Model 17T3A)  
 Ch. TS-216 (See Model 14T4)  
 Ch. TS-220 (See Model 17K9)  
 Ch. TS-221, -A, (See Model 17K5E)  
 Ch. TS-228 (See Model 17F11)  
 Ch. TS-236 (See Model 17K8)  
 Ch. TS-275 (See Model 14P2)  
 Ch. TS-292, A, B, (See Model 21C1)  
 Ch. TS-292Y (See Models 21C1 and TK-19M)  
 Ch. TS-307 (See Model 20K6)  
 Ch. TS-314A, B, TS-315A, B (See Model 17K10E)  
 Ch. TS-324, A, B (See Model 21T4A)  
 Ch. TS-324Y (See Models 17F12 and YTK-17M)  
 Ch. TS-351, A, B (See Model 21F1)  
 Ch. TS-395, -02 (See Model 17F13)  
 Ch. TS-400A (See Model 17T11E)  
 Ch. TS-401 (See Model 17F12D)  
 Ch. TS-408A (See Model 17F13C)  
 Ch. TS-408Y (See Models 17F13C and TK-19M)  
 Ch. TS-410A (See Model 17T13)  
 Ch. TS-410Y (See Models 17F13 and TK-20M)  
 Ch. TS-501A (See Model 21T3)  
 Ch. TS-501Y (See Models 21T3 and TK-24M)  
 Ch. 1A ..... 134-8  
 Ch. 1B ..... 136-11  
 Ch. 2A ..... 197-7  
 Ch. 2M ..... 197-7  
 Ch. 8A ..... 46-16  
 Ch. 10A ..... 106-10

**MUNTZ**  
 M30 (Ch. TV-16A1) Tel. Rec. .... 108-8  
 M31 (Ch. TV-16A2) Tel. Rec. .... 108-8  
 M31 (Ch. TV17A2) Tel. Rec. .... 116-10  
 M31R (Ch. TV17A3) Tel. Rec. (See Model M32 (Ch. TV17A3)-Set 116-10)  
 M31R, M32 (Ch. TV-16A3) Tel. Rec. .... 108-8  
 M32 (Ch. TV17A2) Tel. Rec. .... 116-10  
 M32, (Ch. TV17A3) Tel. Rec. .... 116-10  
 M32R (Ch. TV17A3) Tel. Rec. (See Model M32 (Ch. TV17A3)-Set 116-10)  
 M33 (Ch. TV17A4) Tel. Rec. .... 116-10

**MUNTZ-Cont.**

M34 (Ch. TV17A4) Tel. Rec. (For TV Ch. only Set Model M33-Set 116-10)  
 M41, M42 (Ch. TV17A3A) Tel. Rec. (See Model 1750)  
 M46 (Ch. TV17A7) Tel. Rec. (See Model 2053)  
 M49 (Ch. TV17A7) Tel. Rec. (See Model 2053)  
 M-158 Tel. Rec. .... 97A-10  
 M-159 Tel. Rec. .... 97A-10  
 M-159A, B Tel. Rec. .... 97A-10  
 M-169 Tel. Rec. .... 96-6  
 1750, 1751, 1752 (Ch. 17A3A) Tel. Rec. (See Prod. Chge. Bul. 33-Set 159-3 and Model M31-Set 116-10)  
 2053 (Ch. 17A7) Tel. Rec. (See Prod. Chge. Bul. 33-Set 159-3 and Model M31-Set 116-10)  
 2053-A (Ch. 17B1, 17B2) Tel. Rec. (See Ch. 17B1-Set 163-8)  
 2054 (Ch. 17A7) Tel. Rec. (See Prod. Chge. Bul. 33-Set 159-3 and Model M31-Set 116-10)  
 2054A (Ch. 17B1, 17B2) Tel. Rec. For TV Ch. only See Ch. 17B1-Set 163-8  
 2055 (Ch. 17A7) Tel. Rec. (See Prod. Chge. Bul. 33-Set 159-3 and Model M31-Set 116-10)  
 2055 (Ch. 17B2, Above Serial No. 369500 or Ch. 17B6, Above Serial No. 3619500) Tel. Rec. .... 207-5  
 2055-A (Ch. 17B1, 17B2) Tel. Rec. (See Ch. 17B1-Set 163-8)  
 2055A, AU (Ch. 17B2, Above Serial No. 369500 or Ch. 17B6, Above Serial No. 3619500) Tel. Rec. .... 207-5  
 2055-B (Ch. 17B2) Tel. Rec. (See Ch. 17B2-Set 163-8)  
 2055B (Ch. 17B2, Above Serial No. 369500 or Ch. 17B6, Above Serial No. 3619500) Tel. Rec. .... 207-5  
 2056 (Ch. 17A7) Tel. Rec. (See Prod. Chge. Bul. 33-Set 159-3 and Model M31-Set 116-10)  
 2056-A (Ch. 17B1, 17B2) Tel. Rec. (See Ch. 17B1-Set 163-8)  
 2056B (Ch. 17B2, Above Serial No. 369500 or Ch. 17B6, Above Serial No. 3619500) Tel. Rec. .... 164-6  
 2066 (Ch. 17B2, Above Serial No. 369500 or Ch. 17B6, Above Serial No. 3619500) Tel. Rec. .... 207-5  
 2158A (Ch. 17B2, Above Serial No. 369500 or Ch. 17B6, Above Serial No. 3619500) Tel. Rec. .... 207-5  
 2158-A (Ch. 17B5, 17B6) Tel. Rec. (See Ch. 17B5-Set 163-8)  
 2159A (Ch. 17B2, Above Serial No. 369500 or Ch. 17B6, Above Serial No. 3619500) Tel. Rec. .... 207-5  
 2159-A (Ch. 17B5, 17B6) Tel. Rec. (See Ch. 17B5-Set 163-8)  
 2162 (Ch. 17B2, Above Serial No. 369500 or Ch. 17B6, Above Serial No. 3619500) Tel. Rec. .... 207-5  
 2162-A (Ch. 17B5, 17B6) Tel. Rec. (See Ch. 17B5-Set 163-8)  
 2457-A (Ch. 17B3, 17B4) Tel. Rec. (See Ch. 17B3-Set 163-8)  
 2461-A (Ch. 17B3, 17B4) Tel. Rec. (See Ch. 17B3-Set 163-8)  
 2763A, 2764A, 2765A (Ch. 17B6, Above Serial No. 374500) Tel. Rec. .... 208-7  
 Ch. 17B1, 17B2, Tel. Rec. 163-8  
 Ch. 17B2 (Above Serial No. 369500) (See Model 2055)  
 Ch. 17B3, 17B4, 17B5, 17B6 Tel. Rec. .... 163-8  
 Ch. 17B6 (Above Serial No. 3619500) (See Model 2055)

**MUNTZ-Cont.**

Ch. 17B8 (Above Serial No. 374500) (See Model 2763A)  
**MURPHY**  
 113 ..... 2-2  
 122 (See Model 112-Set 2-15)  
**MUSITRON**  
 PT-10 ..... 15-20  
 PX ..... 16-28  
 SRC-3 ..... 13-21  
 101 "Piccola" ..... 15-21  
 103 "Piccola" ..... 21-26  
 105 ..... 21-26  
 202 ..... 21-27  
**MUTUAL BUYING SYNDICATE (See Drexel or General)**  
**NASH**  
 AC-152 (NH2AC) ..... 184-9  
 6MN082 ..... 9-25  
**NATIONAL CO.**  
 HFS ..... 62-14  
 HRO-7R, HRO-7T ..... 50-12  
 HRO-50 ..... 112-7  
 HRO-50R1, HRO-50T1 ..... 169-11  
 HRO-60 ..... 202-4  
 NC-TV2, NC-TV7M, 1-1 ..... 67-14  
 NC-TV7W Tel. Rec. .... 67-14  
 NC-TV10C, T, W Tel. Rec. (Also See Prod. Chge. Bul. 1-Set 103-19) ..... 94-5  
 NC-TV12C, W Tel. Rec. (Also See Prod. Chge. Bul. 1-Set 103-19) ..... 94-5  
 NC-TV1001 Tel. Rec. (Also See Prod. Chge. Bul. 1-Set 103-19) ..... 94-5  
 NC-TV1025 Tel. Rec. (Also See Prod. Chge. Bul. 1-Set 103-19) ..... 94-5  
 NC-TV1201, NC-TV1202 Tel. Rec. (Also See Prod. Chge. Bul. 1-Set 103-19) ..... 94-5  
 NC-TV1225, NC-TV1226 Tel. Rec. (Also See Prod. Chge. Bul. 1-Set 103-19) ..... 94-5  
 NC-240DR, NC-240DT ..... 41-16  
 NC-33 ..... 47-14  
 NC-46 ..... 9-26  
 NC-57 ..... 48-14  
 NC-108R, NC-108T ..... 47-15  
 NC-125 ..... 139-10  
 NC-173R, NC-173T ..... 40-13  
 NC-183R, NC-183T ..... 49-15  
 SW-54 ..... 141-9  
 TV-1201 Tel. Rec. .... 119-10  
 TV-1226 Tel. Rec. .... 119-10  
 TV-1601 Tel. Rec. .... 119-10  
 TV-1625 Tel. Rec. .... 119-10  
 TV-1701, TV-1702 ..... 145-7  
 TV-1725, TV-1727 Tel. Rec. .... 145-7  
 TV-1729, TV-1730, TV-1731, TV-1732 Tel. Rec. .... 145-7  
 TV-2029, TV-2030 Tel. Rec. .... 145-7  
**NATIONAL UNION**  
 G-613 "Commuter" ..... 19-23  
 G-619 ..... 11-35  
 571, 571A, 571B ..... 17-22  
**NEWCOMB**  
 A-104R ..... 196-8  
 H-10 ..... 14-20  
 H-14 ..... 15-22  
 KX-30 ..... 15-23  
**NOBLITT SPARKS (See Arvin)**  
**NORELO**  
 PT200, PT300 Tel. Rec. .... 155-13  
 588A Tel. Rec. .... 164-7  
 1200A Tel. Rec. (See Model 588A-Set 164-7)  
**OAK (See Record Changer Listing)**  
**OLDSMOBILE**  
 982375 ..... 20-25  
 982376 ..... 20-25  
 982399 ..... 59-14  
 982420 ..... 57-12  
 982421 ..... 87-7  
 982454 ..... 60-16  
 982455 ..... 157-7  
 982543 ..... 96-7  
 982544, 982573 ..... 96-7

**OLDSMOBILE-Cont.**

982579 ..... 157-7  
 982697, 982698 (See Model 982544-Set 96-7)  
 982699, 982700 ..... 150-10  
**OLYMPIC**  
 DX-214, DX-215, DX-216 Tel. Rec. .... 106-11  
 DX-619, DX-620, DX-621, DX-622 Tel. Rec. .... 106-11  
 DX-931, DX-932 Tel. Rec. .... 106-11  
 DX-950 Tel. Rec. .... 106-11  
 RTU-3H (Duplicator) ..... 62-15  
 TV-104, TV-105 Tel. Rec. .... 67-15  
 TV-106, TV-107, TV-108 Tel. Rec. (See Model TV-104-Set 67-15)  
 TV-922 Tel. Rec. .... 58-14  
 TV-922L Tel. Rec. .... 67-15  
 TV-928 Tel. Rec. (See Model TV-922-Set 67-15)  
 TV-944, TV-945 Tel. Rec. .... 67-15  
 TV-946 Tel. Rec. (See Model TV-104-Set 67-15)  
 TV-947 Tel. Rec. .... 85-10  
 TV-948 Tel. Rec. (See Model TV-104-Set 67-15)  
 TV-949, TV-950 Tel. Rec. .... 85-10  
 XL-210, XL-211 Tel. Rec. .... 109-8  
 XL-612, XL-613 Tel. Rec. .... 109-8  
 6-501, 6-502, 6-502-P, 6-503 ..... 4-10  
 6-501V-U (See Model 6-501W-U-Set 3-20) ..... 3-20  
 6-501W-U, 6-502-U ..... 3-20  
 6-504, 6-504L ..... 8-24  
 6-601W, 6-601V, 6-602 ..... 22-21  
 6-604 Series ..... 6-604V-220, 6-604W-110, 6-604W-150, 6-604-220 (See Model 6-604 Series-Set 22-21) ..... 4-36  
 6-606 ..... 11-17  
 6-606-U ..... 11-18  
 6-717 ..... 4-7  
 6-617U (See Model 6-617-Set 4-7) ..... 57-13  
 7-421V, 7-421W, 7-421X, 7-435V, 7-435W ..... 34-13  
 7-526 ..... 30-21  
 7-532W, 7-532Z ..... 32-15  
 7-537 ..... 37-13  
 7-622, 7-638 ..... 34-14  
 7-724 ..... 29-19  
 7-728 (See Model 7-724-Set 29-19) ..... 7-939, 7-936, 7-939 ..... 31-22  
 8-451 ..... 48-15  
 8-533V, 8-533W ..... 57-14  
 8-618 ..... 35-16  
 8-925, 8-934, 8-936 ..... 45-19  
 9-435V, 9-435W ..... 152-11  
 17C (See Model 752-Set 126-8)  
 17C24, Tel. Rec. .... 182-7  
 17C44 (Ch. TK17) Tel. Rec. .... 196-9  
 17D Tel. Rec. (See Model 752-Set 126-8)  
 17K31, 17K32 Tel. Rec. .... 182-6  
 17K41, 17K42 (Ch. TK17) Tel. Rec. .... 196-9  
 17K50 (Ch. TK17) Tel. Rec. .... 196-9  
 17T20, Tel. Rec. .... 182-6  
 17T33, Tel. Rec. .... 182-6  
 17T40 (Ch. TK17) Tel. Rec. .... 196-9  
 17T48 (Ch. TK17) Tel. Rec. .... 196-9  
 20C45 (Ch. TL20) Tel. Rec. .... 196-9  
 20C52, 20C53 (Ch. TL20) Tel. Rec. .... 196-9  
 20D49 (Ch. TL20) Tel. Rec. .... 196-9  
 20K43 (Ch. TL20) Tel. Rec. .... 196-9  
 20K51 (Ch. TL20) Tel. Rec. .... 196-9  
 20T46, 20T47, (Ch. TL20) Tel. Rec. .... 196-9  
 21C28 Tel. Rec. .... 182-7  
 21D29 Tel. Rec. .... 182-7  
 21K26 Tel. Rec. .... 182-7  
 21T27 Tel. Rec. .... 182-7  
 51-421W ..... 151-9  
 489 ..... 154-9  
 51-435-V (See Model 9-435V-Set 152-11)  
 752, 752U, 753, 753U, Tel. Rec. .... 126-8  
 754 Tel. Rec. (See Model 752-Set 126-8)  
 755, 755U Tel. Rec. .... 126-8  
 757 Tel. Rec. (See Model 752-Set 126-8)  
 758 Tel. Rec. (See Model 752-Set 126-8)  
 762 Tel. Rec. .... 139-11  
 764, 764U Tel. Rec. .... 126-8  
 765, 766, Tel. Rec. (See Model 752-Set 126-8)  
 767 Tel. Rec. .... 126-8  
 768, 769, 773 Tel. Rec. (See Model 752-Set 126-8)  
 783 Tel. Rec. .... 139-11  
 785 Tel. Rec. (See Model 762-Set 139-11)  
 791, 792 Tel. Rec. (See Model 752-Set 126-8)  
 967, 968, 970 Tel. Rec. .... 139-11  
 Ch. TK17 (See Model 17T40)  
 Ch. TL20 (See Model 20C45)

**IMPORTANT**

**How to obtain Service Data on Pre-War Models**

Photo copies of schematics covering pre-war (prior to 1946) receivers can be obtained by regular PHOTOFACT subscribers at 50¢ each (our cost). Additional data can be supplied at a nominal cost per page. When requesting pre-war data, please mention the name of the Parts Distributor who supplies you with your PHOTOFACT Folder Sets.



OPERADIO

1A30 ..... 34-15
1A35 ..... 33-15
1A45 ..... 48-16
1A65 ..... 52-14
1A70-A ..... 47-16
1A140 ..... 46-17
4A25E ..... 101-9
4A30-A ..... 102-9
4A35 ..... 100-9
4A50-A, 4A51-A ..... 102-9
4A55 ..... 100-9
4M25C ..... 99-11
11A55 ..... 113-6
530, 531, 1035 ..... 37-14
"Soundcaster" .....

ORTHOSONIC (See Electronic Labs.)

PACIFIC MERCURY (See Mercury)

PACKARD

PA-382042 ..... 20-26
PA-393607 ..... 57-15
416387 ..... 160-7
416394 ..... 145-8
439279 (See Model 416387—Set 160-7)
439310 (See Model 416387—Set 160-7)

PACKARD-BELL

C1362 ..... 12-21
C1461 ..... 12-22
5DA ..... 16-29
5D8 ..... 44-15
5FF ..... 1-29
100 ..... 53-16
261 ..... 21-28
471 ..... 30-22
551 ..... 2-7
551-D (See Model 551—Set 2-7) ..... 2-35
563 (See Model 561—Set 2-35) ..... 57-6
576 (See Model 551—Set 2-7) ..... 19-24
578 (See Model 572—Set 22-22) ..... 22-22
581 (See Model 5D8—Set 44-15) .....

621 ..... 181-8
651 ..... 4-42
661 ..... 8-25
662 ..... 13-22
673A, 673B ..... 46-18
682 ..... 54-16
771 ..... 44-16
861 ..... 17-23
872 ..... 31-23
880, 880A ..... 46-16
881-A, 881-B ..... 47-17
884, 892 ..... 74-7
1052, 1052A ..... 8-26
1054B ..... 13-23
1063 ..... 18-25
1091 Tel. Rec. ....
1181, 1181A ..... 75-12
1273 ..... 46-19
1291TV Tel. Rec. ....
1472 ..... 48-17
2001TV, 2002TV Tel. Rec. ....
2091, 2092 Tel. Rec. ....
2101, 2102 Tel. Rec. ....
2105, 2105A Tel. Rec. ....
2115, 2116 (Ch. 2115-2) Tel. Rec. ....
2117 (Ch. 2117) Tel. Rec. ....
2118 Tel. Rec. ....
2202, 2204 Tel. Rec. ....
2291TV, 2292TV, 2293TV, 2294TV, 2295TV, 2296TV Tel. Rec. ....
2297-TV De Luxe, 2297-TV Standard Tel. Rec. ....
2298-TV Tel. Rec. ....
2301-TV Tel. Rec. ....
2302 Tel. Rec. (See Model 2301—Set 126-9)
2311 Tel. Rec. ....
2421, 2422, 2423 Tel. Rec. ....
2601-TV Tel. Rec. ....
2602 Tel. Rec. ....
2612 Tel. Rec. ....
2621, 2622 (Ch. 2621-2) Tel. Rec. ....
2692-TV De Luxe, 2697-TV Standard Tel. Rec. ....
2721, 2722 (Ch. 2720) Tel. Rec. ....
2723, 2724 (Ch. 2710) Tel. Rec. ....
2801-TV, 2801A-TV Tel. Rec. ....
2803TV Tel. Rec. ....
2811A Tel. Rec. ....
2991TV Tel. Rec. ....
3021 Tel. Rec. ....
3191, 3192 Tel. Rec. ....
3381 Tel. Rec. ....
4580 Tel. Rec. ....
4691TV Tel. Rec. ....
Ch. 2115-2 (See Model 2115)
Ch. 2117 (See Model 2117)
Ch. 2621-2 (See Model 2621)
Ch. 2710 (See Model 2723)
Ch. 2720 (See Model 2721)

PARKVIEW

17X Tel. Rec. .... 185-9

PATHE

17-N25, 17-RPC, 17-RPT (Ch. TAP) Tel. Rec. (Similar to chassis) ..... 127-12

PENTRON

(All see Recorder Listing)
AM-T ..... 183-11
F-100 ..... 184-10
MM4 ..... 178-8

PHILCO (Also see Record Changer Listing)

AT-1814 (Ch. 81, H1) (Code 123) Tel. Rec. (See Model 53-T1824—Set 201-7)
AT-1816, L (Ch. 81, H1) (Code 123) Tel. Rec. (See Model 53-T1824—Set 201-7)
AT-1817, -HM (Ch. 81, H1) (Code 123) Tel. Rec. (See Model 53-T1824—Set 201-7)
AT-1856, AT-1856-HM, AT-1856L (Ch. 81, H1) (Code 123) Tel. Rec. (See Model 53-T1824—Set 201-7)
AT-2230, L (Ch. 81, H1) (Code 123) Tel. Rec. (See Model 53-T1824—Set 201-7)
AT-2232 (Ch. 81, H1) (Code 123) Tel. Rec. (See Model 53-T1824—Set 201-7)
AT-2262 (Ch. 81, H1) (Code 123) Tel. Rec. (See Model 53-T1824—Set 201-7)
AT-2272, L (Ch. 81, H1) (Code 123) Tel. Rec. (See Model 53-T1824—Set 201-7)
AT-2279 (Ch. 81, H1) (Code 123) Tel. Rec. (See Model 53-T1824—Set 201-7)
AT-2288, -HM (Ch. 81, H1) (Code 123) Tel. Rec. (See Model 53-T1824—Set 201-7)
C-4608 (See Mopar Model 802—Set 18-24)
C-4608 (Revised) (See Mopar Model 802 Revised—Set 42-19)
C-4908 (See Mopar Model 805—Set 71-11)
C-5008 (See Mopar Model 809—Set 71-11)
C-5109 (See Mopar Model 815—Set 139-8)
C-5110 (See Mopar Model 816—Set 139-8)
C-5111 (See Mopar Model 817—Set 139-8)
CR-2 ..... 35-17
CR-4, CR-6 ..... 33-17
CR-8 ..... 38-13
CR-9 ..... 44-17
CR-12 ..... 39-16
CR-501 ..... 142-9
CR-503 ..... 128-10
CR-505 ..... 130-10
D-5107 (See Mopar Model 813—Set 139-8)
P-4635 (See Packard Model PA-382042—Set 20-26)
P-4735 (See Packard Model PA-393607—Set 57-15)
P-5106 (See Mopar Model 812—Set 139-8)
PD-4908 (See Mopar Model 803—Set 66-12)
S-4624, S-4625 (See Studebaker Model S-4624—Set 21-32)
S-4626, S-2627 (See Studebaker Model S-4627—Set 19-32)
S-5123 (See Studebaker Model AC2113—Set 172-11)
UN6-100 ..... 19-26
UN6-400 ..... 30-23
UN6-450 ..... 18-26
UN6-500 ..... 17-24
UN6-550 ..... 5-13
46-131 ..... 31-24
46-131 (Revised) ..... 32-16
46-132 ..... 4-20
46-142 ..... 36-16
46-200 Series ..... 1-24
46-200-1, 46-201, 46-202, 46-203 (See Model 46-200 Series—Set 1-24)
46-250, 26-250-1, 26-251 ..... 2-12
46-350 ..... 10-24
46-420, 46-420-1 ..... 6-22
46-421, 46-421-1 ..... 15-24
46-427 ..... 2-25
47-480 ..... 19-25
46-1201 ..... 4-35
46-1201 (Revised) ..... 29-21
46-1203 ..... 6-23
46-1209 ..... 13-24
46-1213 ..... 12-33
47-204, 47-205 ..... 33-18
47-1227 ..... 25-22
47-1230 ..... 22-23
48-141, 48-145 ..... 25-23
48-150 ..... 34-16
48-200, 48-200-1 ..... 33-19
48-206 ..... 37-16
48-214 ..... 33-19
48-225, 48-230 ..... 37-15
48-250, 48-250-1 ..... 32-17

PHILCO—Cont.

48-300 ..... 37-17
48-360 ..... 38-14
48-460, 48-460-1 ..... 34-17
48-461 ..... 38-15
48-464 ..... 26-20
48-472, 48-472-1 ..... 43-15
48-472 (Revised) ..... 48-18
48-475 ..... 40-14
48-482 ..... 30-24
48-485 ..... 47-19
48-700 Tel. Rec. .... 68-13
48-1000 (Code 121) .....
48-1000, 48-1000-5 (Code 122) Tel. Rec. .... 53-17
48-1000 (Code 125) Tel. Rec. ....
48-1001, 48-1001-5 (Code 121 and 122) Tel. Rec. .... 53-17
48-1050, 48-1050-5 (Code 122) Tel. Rec. .... 53-17
48-1200 ..... 29-20
48-1201 ..... 31-25
48-1253 ..... 36-17
48-1256 ..... 34-18
48-1260 ..... 31-25
48-1262 ..... 35-19
48-1263 ..... 32-18
48-1264 ..... 36-18
48-1266 ..... 39-15
48-1270 ..... 42-20
48-1274, 48-1276 ..... 41-17
48-1282 ..... 35-18
48-1283 (See Model 48-1282—Set 35-18)
48-1284 ..... 45-20
48-1286 ..... 51-15
48-1290 ..... 47-18
48-2500, 48-2500-5 Tel. Rec. (Codes 121 and 122) ..... 89-10
49-101 ..... 87-8
49-500, 49-500-1 ..... 48-19
49-501, 49-501-1 ..... 56-18
49-503 ..... 52-15
49-504, 49-504-1 ..... 54-17
49-505 ..... 51-18
49-506 ..... 48-19
49-601 ..... 42-21
49-602 ..... 41-18
49-603 ..... 59-15
49-605, 49-607 ..... 58-15
49-900-E, 49-900-1 ..... 49-16
49-901 ..... 56-19
49-902 ..... 51-16
49-904 ..... 58-16
49-905 ..... 52-16
49-906 ..... 57-16
49-909 ..... 55-17
49-1002 (Code 121) Tel. Rec. .... 91A-10
49-1040 (Code 121) Tel. Rec. .... 91A-10
49-1040 (Code 123) Tel. Rec. .... 92-5
49-1075 (Codes 121 and 122) Tel. Rec. .... 93A-11
49-1076 (Code 122) Tel. Rec. .... 93A-11
49-1076 (Code 123) Tel. Rec. .... 93A-11
49-1077 (Code 122) Tel. Rec. .... 92-5
49-1100 ..... 47-19
49-1101 ..... 55-17
49-1150 (Codes 121 & 122) Tel. Rec. .... 70-6
49-1150 (Codes 122, 124) Tel. Rec. .... 92-5
49-1175 (Codes 121 & 122) Tel. Rec. (Code 121) ..... 70-6
49-1175 (Codes 122, 124) Tel. Rec. .... 92-5
49-1240 (Codes 121, 123) Tel. Rec. .... 93A-11
49-1240 (Code 124) Tel. Rec. .... 92-5
49-1275 (Code 121) Tel. Rec. .... 93A-11
49-1278 (Code 122) Tel. Rec. .... 93A-11
49-1278 (Code 123) Tel. Rec. .... 92-5
49-1278 (Code 122) Tel. Rec. .... 92-5
49-1280 (Code 121) Tel. Rec. .... 92-5
49-1401 ..... 45-21
49-1404 (See Model 49-1405—Set 54-24)
49-1405 ..... 54-24
49-1450 (Codes 121A or B, 123A or B, 123T A, B, or B) Tel. Rec. .... 77-8
49-1475 (Codes 121A, B, 123A, B, 123T A, B) Tel. Rec. .... 77-8
49-1480 (Code 121A, B, 123A, B, 123T A, B) Tel. Rec. .... 77-8
49-1600 ..... 50-13
49-1601 (See Model 49-1600—Set 50-13)
49-1602, 49-1603 ..... 55-18
49-1604, 49-1605 ..... 53-19
49-1606, 49-1607 ..... 53-19
49-1609, 49-1611 (See Model 49-1606—Set 53-19)
49-1613 ..... 91-9
49-1615 ..... 64-9
50-1701 (Code 121) Tel. Rec. .... 140-7
50-1702 (Code 122) Tel. Rec. .... 140-7
50-11104 (Code 123) Tel. Rec. (Also see Prod. Chge. Bul. 29, Set 154-1) ..... 114-9
50-11105, 50-11106 .....
50-11400, 50-11401 .....
50-11402 (Code 121) Tel. Rec. (Also see Prod. Chge. Bul. 29, Set 154-1) ..... 114-9

PHILCO—Cont.

50-11403, 50-11404 (Codes 121 and 122) Tel. Rec. (See Prod. Chge. Bul. 29—Set 124-1 and Model 50-T1104—Set 114-9)
50-11403 (Code 125), 50-11404, 50-11406 (Codes 123, 124, 125) Tel. Rec. .... 115-8
50-11406 (Codes 121 and 122) Tel. Rec. (See Prod. Chge. Bul. 29—Set 154-1 and Model 50-T1104—Set 114-9)
50-11430 (Code 121) Tel. Rec. (Also see Prod. Chge. Bul. 29, Set 154-1) ..... 114-19
50-11432 (Code 122) (See Prod. Chge. Bul. 29—Set 154-1 and Model 50-T1104—Set 114-9)
50-11432 (Code 124) Tel. Rec. .... 115-8
50-11443 (Codes 122, 123) Tel. Rec. .... 94-7
50-11476, 50-11477 .....
50-11478, 50-11479 Tel. Rec. .... 128-11
50-11481, 50-11482 Tel. Rec. .... 128-11
50-11483 Tel. Rec. .... 93A-12
50-11484 Tel. Rec. .... 128-11
50-11485 (Code 121) Tel. Rec. .... 91A-10
50-11600 (Code 122) Tel. Rec. .... 110-10
50-11606 (Code 131) Tel. Rec. (See Model 50-T1600, Code 121—Set 91A-10)
50-11630 Tel. Rec. .... 99A-8
50-11632, 50-11633 (Code 122) Tel. Rec. .... 91A-10
50-11632, 50-11633 (Code 122) Tel. Rec. .... 110-10
50-520, 50-520-1 ..... 73-9
50-522, 50-522-1, 50-524 ..... 78-11
50-526 ..... 94-8
50-527, 50-527-1 ..... 80-11
50-620 ..... 85-11
50-621 ..... 89-11
50-920, 50-921, 50-922 ..... 88-8
50-925 (Code 123) 50-926 ..... 99-12
50-1420, 50-1421 ..... 97-11
50-1422, 50-1423 ..... 93-8
50-1720 ..... 93-8
50-1721, 50-1723, 50-1724 ..... 98-9
50-1725 ..... 93-8
50-1726 ..... 91-9
50-1727 ..... 86-7
51-11207, 51-PT1208 Tel. Rec. .... 136-12
51-PT1234 Tel. Rec. .... 136-12
51-PT1282 Tel. Rec. .... 136-12
51-T1443B, L, M, X, XL (Code 121) (Ch. 31, AP1) Tel. Rec. .... 123-11
51-T1601, T, 51-T1602 (Code 121) (Ch. 33, C1) Tel. Rec. .... 138-7
51-T1602, T, 51-T1603, PM, 51-T1443PW (Code 121) (Ch. 3P1, AP1) Tel. Rec. .... 123-11
51-T1601, T, 51-T1602 (Code 121) (Ch. 33, C1) Tel. Rec. .... 138-7
51-T1602, T, 51-T1603 (Code 122) (Ch. 32, C1) Tel. Rec. .... 138-7
51-T1604 (Code 121) (Ch. C, L) Tel. Rec. (See Prod. Chge. Bul. 20—Set 134-1 and Model 50-T1600—Set 110-10)
51-T1604 (Code 122) (Ch. B, L) Tel. Rec. (See Prod. Chge. Bul. 20—Set 134-1 and Model 50-T1600—Set 110-10)
51-T1606 (Code 131) Tel. Rec. (See Model 50-T1600, Code 121—Set 91A-10)
51-T1606 (Code 132) Tel. Rec. ....
51-T1607 (Code 121) (Ch. 33, C1) Tel. Rec. .... 138-7
51-T1607 (Code 122) (Ch. 32, C1) Tel. Rec. .... 138-7
51-T1634 (Code 121) (Ch. C, L) Tel. Rec. (See Prod. Chge. Bul. 20—Set 134-1 and Model 50-T1600—Set 110-10)
51-T1634 (Code 122) (Ch. B, L) Tel. Rec. (See Prod. Chge. Bul. 20—Set 134-1 and Model 50-T1600—Set 110-10)
51-T1634 (Code 123) (Ch. 33, C1) Tel. Rec. .... 138-7
51-T1634 (Code 124) (Ch. 32, C1) Tel. Rec. .... 138-7
51-T1800 (Code 121) (Ch. 33, C2) Tel. Rec. .... 148-13
51-T1800 (Code 122) (Ch. 32, C2) Tel. Rec. .... 148-13
51-T1800 (Code 123) (Ch. 33, C2) Tel. Rec. .... 148-13
51-T1800 (Code 124) (Ch. 32, C2) Tel. Rec. .... 148-13
51-T1839 (Code 121) (Ch. 41, D1, D1A) Tel. Rec. (See Prod. Chge. Bul. 56—Set 190-1 and Model 52-T2106—Set 171-9)
51-T1839 (Code 122) (Ch. 33, C2) Tel. Rec. (See Model 51-T1800—Set 148-13)
51-T1839 (Code 123) (Ch. 41, D1, D1A) Tel. Rec. (See Prod. Chge. Bul. 56—Set 190-1 and Model 52-T2106—Set 171-9)
51-T1841 (Code 121) (Ch. 41, D1, D1A) Tel. Rec. (See Prod. Chge. Bul. 56—Set 190-1 and Model 52-T2106—Set 171-9)
51-T1841 (Code 122) (Ch. 33, C2) Tel. Rec. (See Model 51-T1800—Set 148-13)
51-T1841 (Code 123) (Ch. 41, D1, D1A) Tel. Rec. (See Prod. Chge. Bul. 56—Set 190-1 and Model 52-T2106—Set 171-9)
51-T1841 (Code 124) (Ch. 33, C2) Tel. Rec. (See Model 51-T1800—Set 148-13)

PHILCO—Cont.

51-T1838 (Code 124) Ch. 3R2, CR3) Tel. Rec. .... 135-10
51-T1870 (Code 121) (Ch. 3P1, CP1) Tel. Rec. .... 135-10
51-T1871, 51-T1872 (Code 121) (Ch. 3P1, CP1) Tel. Rec. .... 135-10
51-T1871, 51-T1872 (Code 122) (Ch. 35, CP1) Tel. Rec. .... 135-10
51-T1874, L, 51-T1875, 51-T1876 (Code 121) (Ch. 3P1, CP1) Tel. Rec. .... 135-10
51-T2102 (Code 122) (Ch. 35, F2) Tel. Rec. .... 132-10
51-T2130 (Code 121) (Ch. 35, F2) Tel. Rec. .... 132-10
51-T2132 (Code 121) (Ch. 35, F2) Tel. Rec. .... 132-10
51-T2133 (Code 121) (Ch. 3R2, FR2) Tel. Rec. .... 132-10
51-T2134 (Code 124) (Ch. 35, F2) Tel. Rec. .... 132-10
51-T2136 (Code 124) (Ch. 35, F2) Tel. Rec. .... 132-10
51-T2138 (Code 121) (Ch. 3R2, FR2) Tel. Rec. .... 132-10
51-T2170 (Code 121) (Ch. 35, F2) Tel. Rec. (See Model 51-T2102—Set 132-10)
51-T2175, 51-T2176 (Code 124) (Ch. 35, F2) Tel. Rec. .... 132-10
51-530 ..... 122-7
51-532 ..... 122-7
51-534 ..... 122-7
51-537, 51-5371 ..... 126-10
51-629 ..... 106-12
51-631 ..... 106-12
51-632 ..... 136-13
51-930, 51-931, 51-932 ..... 153-11
51-934 ..... 102-10
51-1330 ..... 130-18
51-1730, 51-1730 (L) ..... 140-8
51-1731, 51-1732 ..... 124-7
51-1733, 51-1733 (L) ..... 137-9
51-1734 ..... 137-9
52-T1610 (Code 122) (Ch. 32, C1) Tel. Rec. (See Model 51-T1601, Code 122—Set 138-7)
52-T1612 (Code 122) (Ch. 32, C1) Tel. Rec. (See Model 51-T1601, Code 122—Set 138-7)
52-T1802 (Code 123) (Ch. 37, C2) Tel. Rec. (See Model 51-T1800—Set 148-13)
52-T1803 (Code 124) (Ch. 37, G1, G1) Tel. Rec. (Also see Prod. Chge. Bul. 57—Set 191-1) ..... 179-9
52-T1804 (Code 122) (Ch. 32, C2) Tel. Rec. (See Model 51-T1800—Set 148-13)
52-T1808 (Code 123) (Ch. 37, C2) Tel. Rec. (See Model 51-T1800—Set 148-13)
52-T1810 (Code 122) (Ch. 41, D1, D1A) Tel. Rec. (See Prod. Chge. Bul. 56—Set 190-1 and Model 52-T2106—Set 171-9)
52-T1808 (Code 122) (Ch. 33, C2) Tel. Rec. (See Model 51-T1800—Set 148-13)
52-T1810 (Code 122) (Ch. 33, C2) Tel. Rec. (See Model 51-T1800—Set 148-13)
52-T1812 (Code 121) (Ch. 32, C2) Tel. Rec. .... 148-13
52-T1812 (Code 122) (Ch. 32, C2) Tel. Rec. .... 148-13
52-T1812 (Code 123) (Ch. 32, C2) Tel. Rec. .... 148-13
52-T1820 (Code 121) (Ch. 41, D1, D1A) Tel. Rec. (See Prod. Chge. Bul. 56—Set 190-1 and Model 52-T2106—Set 171-9)
52-T1821, 52-T1822 (Code 124) (Ch. 71, G1) Tel. Rec. (Also see Prod. Chge. Bul. 57—Set 191-1) ..... 179-9
52-T1831 (Code 122) (Ch. 33, C2) Tel. Rec. (See Model 51-T1800—Set 148-13)
52-T1839 (Code 121) (Ch. 41, D1, D1A) Tel. Rec. (See Prod. Chge. Bul. 56—Set 190-1 and Model 52-T2106—Set 171-9)
52-T1840 (Code 121) (Ch. 41, D1, D1A) Tel. Rec. (See Prod. Chge. Bul. 56—Set 190-1 and Model 52-T2106—Set 171-9)
52-T1840 (Code 122) (Ch. 33, C2) Tel. Rec. .... 148-13
52-T1840 (Code 123) (Ch. 37, C2) Tel. Rec. .... 148-13
52-T1841 (Code 121) (Ch. 41, D1, D1A) Tel. Rec. (See Prod. Chge. Bul. 56—Set 190-1 and Model 52-T2106—Set 171-9)
52-T1841 (Code 122) (Ch. 33, C2) Tel. Rec. (See Model 51-T1800—Set 148-13)
52-T1841 (Code 123) (Ch. 41, D1, D1A) Tel. Rec. (See Prod. Chge. Bul. 56—Set 190-1 and Model 52-T2106—Set 171-9)
52-T1841 (Code 124) (Ch. 33, C2) Tel. Rec. (See Model 51-T1800—Set 148-13)





RCA VICTOR—Cont.

8PCS41, B, C (Ch. KCS24B-1, KR520A-1, KRK1A-1, KCS24C-1, KRK4, KRK2A, KR521A-1, RS123C) Tel. Rec. 90-9  
 8R72 (Ch. RC-1060A) 53-20  
 8R74, 8R75, 8R76 (Ch. RC-1060, A) 53-20  
 8T241, 8T243, 8T244 (Ch. KCS28) Tel. Rec. 74-8  
 8T270 (Ch. KCS29, KCS29A) Tel. Rec. 85-13  
 8TC270, 8TC271 (Ch. KCS29, KCS29A) 85-13  
 8TK29 (Ch. KCS32A, C and Radio Ch. RK135, A) Tel. Rec. 88-9  
 8TK320 (Ch. KCS33A-1) (Radio Ch. RK-135A-1) Tel. Rec. 85-13  
 8TR29 (Ch. KCS32, B and Radio Ch. RK135, A) Tel. Rec. 88-9  
 8TS30 (Ch. KCS201-1) Tel. Rec. 54-18  
 8TV41 (Ch. KCS25D-1, KCS25E-2, RK117A, RS-123A) Tel. Rec. 8TV221, B, 8TV223, B (Ch. KCS30-1 and Radio Ch. RC-616B, C, J, K) Tel. Rec. 74-8  
 8V7 (Ch. RC-615) (See Model 77V1—Set 38-18)  
 8V90 (Ch. RC-618, RC-618A), 8V91 (Ch. RC-616A, RC-616B) 56-20  
 8V111, 8V112 (Ch. RC-616) 58-18  
 8V151 61-17  
 8X53 (Ch. RC-1064) 39-17  
 8X71, 8X72 (RC-1070) 63-15  
 8X521 (Ch. RC-1066), 8X522 (RC-1066A) 52-17  
 8X541, 8X542 (Ch. RC-1065, RC-1065A) 59-16  
 8X544, 8X545, 8X546 (See Model 8X541—Set 59-16)  
 8X547, 8X548 (Ch. RC-1061) 65-10  
 9BX5 (Ch. RC-1059B, C) (See Model 8BX5—Set 46-20)  
 9BX56 (Ch. RC-1068) 79-13  
 9EY3 (Ch. RS-132) 158-10  
 9EY31, 9EY32 98-10  
 9PC41A, B, C (Ch. KCS24C-1, D, KRK-4, KR520B-1, KR521A-1, RS-123A) Tel. Rec. 90-9  
 9T57 (Ch. KCS49, T) Tel. Rec. 122-8  
 9T77 (Ch. KCS49A, AT) Tel. Rec. 122-8  
 9T79 (Ch. KCS49, AT, T) Tel. Rec. 122-8  
 9T89 (Ch. KCS60, T and Radio Ch. RC1092) Tel. Rec. 122-8  
 9T105 (Ch. KCS49B) Tel. Rec. 134-9  
 9T126 (Ch. KCS49C) Tel. Rec. 134-9  
 9T128 (Ch. KCS49C) Tel. Rec. 134-9  
 9T147 (Ch. KCS 60A and Radio Ch. RC1092) Tel. Rec. (For TV Ch. See Set 134-9, For Radio Ch. See Model 9T89—Set 122-8)  
 9T240 (Ch. KCS28, A) Tel. Rec. 74-8  
 9T246 (Ch. KCS28C) 74-8  
 9T246 (Ch. KCS38) 93-9  
 9T256 (Ch. KCS38C) 93-9  
 9T270 (Ch. KCS29) Tel. Rec. 85-13  
 9T240 (Ch. KCS28B) Tel. Rec. 74-8  
 9T245 (Ch. KCS34B) 93-9  
 9T247 (Ch. KCS34, B) Tel. Rec. 93-9  
 9T249 (Ch. KCS34, B) Tel. Rec. 93-9  
 9T272, 9T275 (Ch. KCS29C) Tel. Rec. 85-13  
 9TW309 (Ch. KCS 41-1 and Radio Ch. RK 135C) Tel. Rec. (For TV Ch. See Model 8TK29—Set 88-9, For Radio Ch. See Set 95A-11)  
 9TW333 (Ch. KCS30-1, Radio Ch. RC616N) Tel. Rec. 74-8  
 9TW390 (Ch. KCS31-1, RC617A) Tel. Rec. 91A-11  
 9W101, 9W102, 9W103 (Ch. RC-618B), 9W105 (Ch. RC-622) 97-12  
 9W106 (Ch. RC-622) 97-12  
 9X561 (Ch. RC-1079B) 9X562 (Ch. RC-1079C) 101-9  
 9X571 (Ch. RC-1079), 9X572 (Ch. RC-1079A) 107-7  
 9X641 (Ch. RC-1080), 9X642 (Ch. RC-1080A) 87-9  
 9X651 (Ch. RC-1085), 9X652 (Ch. RC-1085A) 104-9  
 9Y7 (Ch. 1057B) 75-13  
 9Y51 (Ch. RC-1077) 98-11  
 9Y510 (Ch. RC1077A), 9Y511 (Ch. RC1077B) 131-13  
 16T152 (Ch. KCS47E) Tel. Rec. 160-10  
 17T150, 17T151 (Ch. KCS66C) Tel. Rec. 169-13  
 17T153 (Ch. KCS66) Tel. Rec. 158-11

RCA VICTOR—Cont.

17T154 (Ch. KCS66) Tel. Rec. (See Model 17T153—Set 158-11)  
 17T155 (Ch. KCS66) Tel. Rec. 158-11  
 17T160 (Ch. KCS66) Tel. Rec. 158-11  
 17T162 (Ch. KCS66A) Tel. Rec. (See Model 17T153—Set 158-11)  
 17T163 (Ch. KCS66C) Tel. Rec. 169-13  
 17T172, 17T173 (Ch. KCS66A) Tel. Rec. (See Model 17T153—Set 158-11)  
 17T172K, 17T173K, 17T174K (Ch. KCS66D) Tel. Rec. 169-13  
 17T174 (Ch. KCS66A) Tel. Rec. 158-11  
 17T200, 17T201, 17T202 (Ch. KCS72) Tel. Rec. (Also See Prod. Chge. Bul. 59—Set 193-1) 184-12  
 17T211 (Ch. KCS72) Tel. Rec. (Also See Prod. Chge. Bul. 59—Set 193-1) 184-12  
 17T220 (Ch. KCS72) Tel. Rec. (Also See Prod. Chge. Bul. 59—Set 193-1) 184-12  
 17T250DE (Ch. KCS74) Tel. Rec. 193-8  
 17T261DE (Ch. KCS74) Tel. Rec. 193-8  
 17T301, U, 17T302, U (Ch. KCS78, B) Tel. Rec. 206-10  
 17T310, U (Ch. KCS78, B) Tel. Rec. 206-10  
 21D305, U (Ch. KCS81, B) Tel. Rec. 208-8  
 21D317, U (Ch. KCS81, B) Tel. Rec. 208-8  
 21D326, U, 21D327, U, 21D328, U, 21D329, U, 21D330, U (Ch. KCS81, B) Tel. Rec. 208-8  
 21T159 (Ch. KCS68C, E) Tel. Rec. (See Prod. Chge. Bul. 56—Set 190-1 and Model 21T176—Set 157-8)  
 21T159DE (Ch. KCS68F) Tel. Rec. 197-9  
 21T165 (Ch. KCS68C, E) Tel. Rec. (See Prod. Chge. Bul. 56—Set 190-1 and Model 21T176—Set 157-8)  
 21T166DE (Ch. KCS68F) Tel. Rec. (See Model 21T159DE—Set 197-9)  
 21T174DE (Ch. KCS68F) Tel. Rec. 197-9  
 21T175DE (Ch. KCS68F) Tel. Rec. (See Model 21T159DE—Set 197-9)  
 21T176, 21T177, 21T178, 21T179 (Ch. KCS68C) Tel. Rec. (Also See Prod. Chge. Bul. 56—Set 190-1) 157-8  
 21T178DE (Ch. KCS68F) Tel. Rec. 197-9  
 21T179 (Ch. KCS68C) Tel. Rec. (Also See Prod. Chge. Bul. 56—Set 190-1) 157-8  
 21T179DE (Ch. KCS68F) Tel. Rec. 197-9  
 21T197DE (Ch. KCS68A, Radio Ch. RC1111A and Audio Ch. RS141A) Tel. Rec. 209-10  
 21T207, G (Ch. KCS72A) Tel. Rec. (See Prod. Chge. Bul. 59—Set 193-1 and Model 17T200—Set 184-12)  
 21T208 (Ch. KCS72A) Tel. Rec. (Also See Prod. Chge. Bul. 59—Set 193-1) 184-12  
 21T217, 21T218 (Ch. KCS72A) Tel. Rec. (Also See Prod. Chge. Bul. 59—Set 193-1) 184-12  
 21T227, 21T228, 21T229 (Ch. KCS72A) Tel. Rec. (Also See Prod. Chge. Bul. 59—Set 193-1) 184-12  
 21T244 (Ch. KCS72D-1 and Radio Ch. RC1117B) Tel. Rec. 202-6  
 21T244 (Ch. KCS72D-2, Radio Ch. RC1111B, and Audio Ch. RS141C) Tel. Rec. 202-6  
 21T303, U (Ch. KCS82, B) Tel. Rec. 207-7  
 21T313, U, 21T314, U, 21T315, U, 21T316, U (Ch. KCS82, B) Tel. Rec. 207-7  
 21T322, U, 21T323, U, 21T324, U (Ch. KCS382, B) Tel. Rec. 207-7  
 45EY-1 (Ch. RS-132H) 135-11  
 45-EY-2 (Ch. RS-138, A, H) 165-9  
 45-EY-3 126-11  
 45-EY-4 (Ch. RS140) 173-11  
 45EY15 (Ch. RS-132H) 135-11  
 45-EY-26 (Ch. RS-138, H) 197-10  
 45-W-10 (Ch. RC1096A) 138-8  
 54B1, 54B1-N, 54B2, 54B3 (Ch. KCS89) 7-22  
 54B5 (Ch. RC1047) 17-25  
 55AU (Ch. RC1017) 2-16  
 55U (Ch. RC1017) 2-16  
 55F (Ch. RC104E) 4-6  
 55FA (See Model 55F—Set 4-6)  
 56X, 56X2, 56X3 (See Model 1011) 1-16

RCA VICTOR—Cont.

56X5 (See Model 56X10—Set 1-16)  
 56X10 (Ch. RC-1023B) 1-12  
 58AV, 58V (Ch. RC-604) 1-32  
 59AV1, 59V1 (Ch. RC-605) 6-25  
 6R7E (Ch. RS-127) 28-28  
 64F7, 64F2 (Ch. RC1037), 64F3 (Ch. RC1037A) 4-16  
 65BR9 (Ch. RC-045) 23-16  
 65F (See Model 55F—Set 4-6)  
 65AU, 65U (Ch. RC-1017A) 14-23  
 65U-1 (See Model 65AU—Set 14-23)  
 65X1, 65X2 (Ch. RC-1034) 4-30  
 65X1, 65X2 (Ch. RC-1064) 31-26  
 65X8, 65X9 (See Model 65X1—Set 4-30)  
 66B8 (Ch. RC-1040, RC-1040A) 14-24  
 66E (Ch. RS-126) 17-26  
 66X1, 66X2, 67X3, 66X4, 66X7, 66X8 (See Model 66X1—Set 7-23)  
 66X9 7-23  
 66X11 (Ch. RC-1046A), 66X12 (Ch. RC-1046), 66X13, 66X14, 66X15 (Ch. RC-1046B) 27-20  
 67V1, 67AV1 (Ch. RC-606) 9-27  
 68R1, 68R2, 68R3, 68R4 (Ch. RC-608) 23-17  
 75X11, 75X12 (Ch. RC-1050) 33-21  
 75X14, 75X15 (Ch. RC-1050) 33-21  
 75X16, 75X17, 75X18, 75X19 (Ch. RC-1050B) (See Model 75X11—Set 33-21)  
 77V1 (Ch. RC-1057A) 38-17  
 77V1 (Ch. RC-615) 38-18  
 77V2 (Ch. RC-606-C) 39-18  
 610V1 (Ch. RC-610C) 610V2 (Ch. RC-610) 31-27  
 612V1, 612V2, 612V3 (Ch. RC-121, RS-123) 17-27  
 612V4 (See Model 612V1—Set 17-27)  
 621TS (Ch. KCS21-1) Tel. Rec. (Servicer) 78  
 630TCS (Ch. KCS20B) Tel. Rec. 54-18  
 630TS (Ch. KCS20A) Tel. Rec. 54-18  
 641TV (Ch. KCS25A1-1, KCS25C-2, RK117A, RS-123A) Tel. Rec. 91A-11  
 648PTK (Ch. KCS24-1, KP1-1, KR520-1, KR521A-1, RK-121A, RS-123A) Tel. Rec. 90-9  
 648PV (Ch. KCS24A-1, KRK-1A, KR520-1, KR521A-1, RK-121A, RS-123B) Tel. Rec. 90-9  
 710V2 (Ch. RC-613A) 40-15  
 711V1 (See Model 711V2—Set 22-24)  
 711V2, 711V3 (Ch. RK-117 and RS-123) 22-24  
 711V3 (See Model 711V2—Set 22-24)  
 721TCS (Ch. KCS26A-1, -2) Tel. Rec. (See Similar Model 730TV1—Set 70-7)  
 721TS (Ch. KCS26-1, -2) Tel. Rec. (See Similar Model 730TV1—Set 70-7)  
 730TV1 (Ch. KCS27-1, -2 and Radio Ch. RC610A) Tel. Rec. 70-7  
 730TV2 (Ch. KCS27-1, -2 and Radio Ch. RC610B) Tel. Rec. 70-7  
 741PCS (Ch. KCS24B-1, KRK1A-1, KR520A-1, KR521A-1, RS-123C) Tel. Rec. 90-9  
 Ch. KCS20A (See Model 630TS)  
 Ch. KCS20B-1 (See Model 630TCS)  
 Ch. KCS20-1 (See Model 8T530)  
 Ch. KCS21-1 (See Model 621TS)  
 Ch. KCS24-1 (See Model 648PTK)  
 Ch. KCS24A-1 (See Model 648PV)  
 Ch. KCS24B-1 (See Model 8PCS41)  
 Ch. KCS24C-1 (See Model 8PCS41)  
 Ch. KCS24D (See Model 9PC41A)  
 Ch. KCS25A-1 (See Model 641TV)  
 Ch. KCS25-1 (See Model 641TV)  
 Ch. KCS25D-1 (See Model 8TV41)  
 Ch. KCS25E-2 (See Model 8TV41)  
 Ch. KCS26-1, -2 (See Model 721TS)  
 Ch. KCS27 (See Model 730TV1)  
 Ch. KCS28, A, B, C (See Model 8T241)  
 Ch. KCS29, KCS29A (See Model 8T270)  
 Ch. KCS29C (See Model 9TC272)  
 Ch. KCS30-1 (See Model 8TV241)  
 Ch. KCS31 (See Model 8TV241)  
 Ch. KCS32, KCS32A, KCS32B, KCS32C (See Model 8TK29)

RCA VICTOR—Cont.

Ch. KCS33A-1 (See Model 8TK320)  
 Ch. KCS34, B, C (See Model 1120)  
 Ch. KCS-38-C (See Model 1100)  
 Ch. KCS40, A, B (See Model 1164)  
 Ch. KCS41A-1 (See Model TA-129)  
 Ch. KCS42A (See Model TA-128)  
 Ch. KCS43 (See Model TA169)  
 Ch. KCS45, A (See Model 2T51)  
 Ch. KCS47, A, AT, T (See Model 6T54)  
 Ch. KCS47B, C (See Model 7T103)  
 Ch. KCS47D (See Model 7T132)  
 Ch. KCS47E 7T132  
 Ch. KCS47F (See Model 16T152)  
 Ch. KCS47G-2 (See Model 7T111B)  
 Ch. KCS48 (See Model 6T84)  
 Ch. KCS48A (See Model 7T143)  
 Ch. KCS49, A, AT, T (See Model 9T57)  
 Ch. KCS49B, C (See Model 9T105)  
 Ch. KCS49F (See Model 9T105)  
 Ch. KCS49CF (See Model 9T105)  
 Ch. KCS60, T (See Model 9T89)  
 Ch. KCS60A (See Model 9T147)  
 Ch. KCS61 (See Model 4T101)  
 Ch. KCS62 (See Model 4T141)  
 Ch. KCS66, A (See Model 17T153)  
 Ch. KCS66C (See Model 17T150)  
 Ch. KCS66D (See Model 17T172K)  
 Ch. KCS68A (See Model 21T197DE)  
 Ch. KCS68C, CB (See Model 21T176)  
 Ch. KCS68E (See Model 21T159)  
 Ch. KCS68F (See Model 21T159DE)  
 Ch. KCS70 (See Model U70)  
 Ch. KCS72 (See Model 17T200)  
 Ch. KCS72A (See Model 21T208)  
 Ch. KCS72D-1 (See Model 21T242)  
 Ch. KCS72D-2 (See Model 21T244)  
 Ch. KCS74 (See Model 17T250DE)  
 Ch. KCS78, B (See Model 17T301, U)  
 Ch. KCS79 (See Model U2)  
 Ch. KCS81, B (See Model 21D305, U)  
 Ch. KCS82, B (See Model 21T303, U)  
 Ch. KRK-1A (See Model 648PTK)  
 Ch. KRK1-1 (See Model 8PCS41)  
 Ch. KRK1A-1 (See Model 8PCS41)  
 Ch. KRK4 (See Model 9PC41A)  
 Ch. KRK-19, A (See Model U1A)  
 Ch. KR520-1 (See Model 628PTK)  
 Ch. KR520A-1 (See Model 8PCS41)  
 Ch. KR520B-1 (See Model 9PC41A)  
 Ch. KR521A-1 (See Model 8PCS41)  
 Ch. RC-589 (See Model 54B1)  
 Ch. RC-604 (See Model 58AV)  
 Ch. RC-605 (See Model 59AV1)  
 Ch. RC-606 (See Model 67V1)  
 Ch. RC-606C (See Model 77V2)  
 Ch. RC-608 (See Model 68R1)  
 Ch. RC-610 (See Model 610V1)  
 Ch. RC610A, RC610B (See Model 730TV1)  
 Ch. RC610C (See Model 610V1)  
 Ch. RC-613A (See Model 710V2)  
 Ch. RC-615 (See Model 77V1)  
 Ch. RC-616 (See Model 8V111)  
 Ch. RC-616A, RC-616H (See Model 8V91)  
 Ch. RC-616B, C, J, K (See Model 8TV321)  
 Ch. RC-616N (See Model 9TW333)  
 Ch. RC617A, B (See Model S1000)  
 Ch. RC-618, RC-618A (See Model 8V90)  
 Ch. RC-618, B, C (See Model 9W101)

RCA VICTOR—Cont.

Ch. RC-622 (See Model A106)  
 Ch. RC-1004E (See Model 55F)  
 Ch. RC-1011 (See Model 56X)  
 Ch. RC-1017 (See Model 55AU)  
 Ch. RC-1017A (See Model 65AU)  
 Ch. RC-1023B (See Model 56X10)  
 Ch. RC-1034 (See Model 65X1)  
 Ch. RC-1037, RC-1037A (See Model 64F1)  
 Ch. RC-1037B (See Model 8F43)  
 Ch. RC-1038, RC-1038A (See Model 66X1)  
 Ch. RC-1040, RC-1040A (See Model 66X8)  
 Ch. RC-1040C (See Model 8BX6)  
 Ch. RC-1045 (See Model 65BR9)  
 Ch. RC-1046, A, B (See Model 66X11)  
 Ch. RC-1047 (See Model 54B5)  
 Ch. RC-1050, RC-1050B (See Model 75X11)  
 Ch. RC-1057A (See Model 77U)  
 Ch. RC-1057B (See Model 9Y7)  
 Ch. RC-1059 (See Model 8BX5)  
 Ch. RC-1059B, RC-1059C (See Model 9BX5)  
 Ch. RC-1060 (See Model 8R71)  
 Ch. RC-1060A (See Model 8R72)  
 Ch. RC-1061 (See Model 8X681)  
 Ch. RC-1064 (See Model 8X53)  
 Ch. RC-1064 (See Model 65X1)  
 Ch. RC-1065, RC-1065A (See Model 8X541)  
 Ch. RC-1066 (See Model 8X521)  
 Ch. RC-1066A (See Model 8X522)  
 Ch. RC-1068 (See Model 9BX56)  
 Ch. RC-1069A, B (See Model 8B41)  
 Ch. RC-1070 (See Model 8X71)  
 Ch. RC-1070A (See Model X711)  
 Ch. RC-1077 (See Model 9Y51)  
 Ch. RC1077A, B (See Model 9Y510)  
 Ch. RC-1079, A (See Model 9X571)  
 Ch. RC-1079B, RC-1079C (See Model 9X561)  
 Ch. RC1079K, L (See Model 1X591)  
 Ch. RC-1080C (See Model 2X61)  
 Ch. RC-1080D (See Model 2X62)  
 Ch. RC-1082 (See Model 8X6)  
 Ch. RC-1085, B (See Model RC-1085A)  
 Ch. RC-1085B (See Model 2X621)  
 Ch. RC-1087 (See Model A55)  
 Ch. RC-1088 (See Model RC1088A)  
 Ch. RC1089B, C (See Model X551)  
 Ch. RC1090 (See Model 4T141)  
 Ch. RC-1092 (See Model 9T89)  
 Ch. RC1094 (See Model A-82)  
 Ch. RC1096 (See Model A-108)  
 Ch. RC1096A (See Model 45-W-10)  
 Ch. RC1098 (See Model 8411)  
 Ch. RC1098A (See Model B-411)  
 Ch. RC-1102 (See Model 1R81)  
 Ch. RC-1104, -1, A, A-1, B, B-1, C, D, E (See Model 1X51)  
 Ch. RC-1110 (See Model PX600)  
 Ch. RC1111 (See Model 2510)  
 Ch. RC1111A (See Model 21T197DE)  
 Ch. RC-1114 (See Model 2B400)  
 Ch. RC-1115 (See Model 2BX63)  
 Ch. RC-1117 (See Model 2US7)  
 Ch. RC-1117B (See Model 21T242)  
 Ch. RC-1117C (See Model 2U57)  
 Ch. RC1118, A, B, C (See Model 2C511)  
 Ch. RC1119 (See Model 2R51)  
 Ch. RC-1120, A (See Model 2C521)  
 Ch. RC-1121 (See Model 2XF91)  
 Ch. RC1121A (See Model 2XF911)

**RCA VICTOR—Cont.**

Ch. RK-117  
Ch. RK-117A (See Model 711V2)  
Ch. RK-117A (See Model 8TV41)  
Ch. RK-121 (See Model 612V1)  
Ch. RK-121A (See Model 648PTK)  
Ch. RK-121C (See Model RV151)  
Ch. RK-135, RK-135A (See Model 8TK29)  
Ch. RK-135A-1 (See Model 8TK320)  
Ch. RK135C (See Model 9TW309)  
Ch. RK135D (See Model TA169)  
Ch. RS-123 (See Model 612V1)  
Ch. RS-123A (See Model 9PC41A)  
Ch. RS-123B (See Model 648PV)  
Ch. RS-123C (See Model 8RCS41)  
Ch. RS-123D (See Model RV151)  
Ch. RS-126 (See Model 66E)  
Ch. RS-127 (See Model 63E)  
Ch. RS-132 (See Model 9EY3)  
Ch. RS-132F, H (See Model 45EY1)  
Ch. RS-132H (See Model 45-EY-15)  
Ch. RS-138, A, H (See Model 45-EY-2)  
Ch. RS-138L, M (See Model 45-EY-26)  
Ch. RS140 (See Model 45-EY-4)  
Ch. RS141 (See Model 2S10)  
Ch. RS141A (See Model 21T197DE)  
Ch. RS141C (See Model 21T244)  
Ch. RS142 (See Model 253)  
Bentley (See Model 4T101)  
Benton (See Model 21T175DE)  
Bristol (See Model 17T153)  
Cabot (See Model 21D305, U)  
Caldwell (See Model 17T162)  
Calhoun (See Model 17T173, 17T173K)  
Clarendon (See Model 21T179)  
Clermont (See Model 21D330, U)  
Covington (See Model 17T172, 17T172K)  
Cumberland (See Model 2T60)  
Deauville (See Model 21T315, U)  
Dobson (See Model 21T322, U)  
Donley (See Model 21T177)  
Fairfax (See Model 6T84)  
Fairfield (See Model 6T71, 6T72, 7T122, 7T122B)  
Farmington (See Model 21T166DE)  
Glendale (See Model 17T302)  
Hampton (See Model 17T160)  
Hanley (See Model 17T310)  
Hartford (See Model 6T87)  
Haywood (See Model 7T118)  
Highland (See Model 6T65, 7T112, 7T112B)  
Hillsdale (See Model 9T77, 9T126)  
Hilton (See Model 21T316, U)  
Jeffrey (See Model 21T313, U)  
Kenbridge (See Model 21D328, U)  
Kendall (See Model 17T174, 17T174K)  
Kent (See Model 6T54, 7T104, 7T104B)  
Kingsbury (See Model 6T64)  
Kirby (See Model 21T303, U)  
Lexington (See Model 21T323, U)  
Merritt (See Model 21D317, U)  
Modern (See Model 6T75, 7T124)  
New Port (See Models 6T53, 7T103, 7T103B)  
Northampton (See Model 9T79)  
Penfield (See Model 21T244)  
Prenfiss (See Model 21T314, U)  
Preston (See Model 17T155)  
Provincial (See Model 6T76, 7T125B, 9T128)  
Regency (See Model 6T74, 7T123, 7T123B)  
Rockingham (See Model 21T178)  
Rutland (See Model 6T86, 7T143)  
Sedgwick (See Model 9T89, 9T147)  
Shelby (See Model 2T51)  
Somerville (See Model 2T81, 4T14)  
Southbridge (See Model 21D329, U)  
Staunton (See Model 21D326, U)  
Stockton (See Model 21T324, U)  
Sunderland (See Model 21T197DE)

**RCA VICTOR—Cont.**

Suffolk (See Model 21T176)  
Talbot (See Model 16T152)  
Wayne (See Model 17T301)  
Westland (See Model 21T242)  
Whitfield (See Model 17T154)  
Winston (See Model 7T132)  
York (See Model 9T57, 9T105)  
Yorktown (See Model 21D327, U)

**RME**  
DB-22A ..... 50-14  
HF10-20 ..... 49-17  
VHF 2-11 ..... 79-14  
VHF-152A ..... 51-18  
45 ..... 13-25  
84 ..... 14-13

**RADIOLA**  
61-1, 61-2, 61-3 (Ch. RC-1011) ..... 14-25  
61-5 (Ch. RC-1023) ..... 12-25  
61-8, 61-9 (Ch. RC-1034) ..... 27-21  
61-10 (Ch. RC-1023B) ..... 12-35  
62-2 (See RCA Model 65U-1—Set 14-23)  
75ZU (Ch. RC-1063A) ..... 36-19  
76Z11, 76Z12 (Ch. RC-1058, RC-1058A) ..... 36-20  
Ch. RC-1011 (See Model 61-1)  
Ch. RC-1023, RC-1023B (See Model 61-5)  
Ch. RC-1023B (See Model 61-10)  
Ch. RC-1034 (See Model 61-8)  
Ch. RC-1058, RC-1058A (See Model 76Z11)  
Ch. RC-1063A (See Model 75ZU)

**RADIO CRAFTSMEN**  
C400 ..... 186-11  
RC-1 (Tuner) ..... 39-19  
RC-2 (Audio Amp.) "Kitchenaire" ..... 6-14  
RC-8 ..... 66-13  
RC-10 ..... 110-12  
RC100 Tel. Rec. ..... 96-9  
RC-100A Tel. Rec. (Also See Prod. Chg. Bul. 39—Set 170-2) ..... 117-11  
RC101 Tel. Rec. ..... 142-10  
RC200 Tel. Rec. (Also See Prod. Chg. Bul. 40—Set 172-1) ..... 140-9  
RC201 Tel. Rec. ..... 151-10  
2 ..... 176-8  
10 ..... 176-9  
202 Tel. Rec. ..... 184-13  
500 ..... 164-8  
800 ..... 204-8

**RADIO DEVELOPMENT & RESEARCH CO. (See Magic-Tone)**

**RADIOETTE** ..... 50-15

**RADIONIC (Also See Chancellor)**  
Y62W, Y728 ..... 26-22

**RANGER**  
118 ..... 28-27

**RADIO MFG. ENGINEERS (See RME)**

**RADIO WIRE TELEVISION (See Lafayette)**

**RAULAND**  
BAU21 ..... 211-10  
BA21 ..... 87-10  
W-819-A ..... 43-16  
1810 ..... 170-10  
1814 ..... 99-13  
1820 ..... 100-10  
1821, 1822 ..... 59-17  
1825 ..... 97-14  
1835 ..... 60-17  
1841 ..... 58-19  
1904 ..... 140-10  
1932 ..... 148-14  
1960 ..... 208-9  
1961 ..... 212-4  
2100 (Sub-station) ..... 39-20  
2101-A (Master Station) ..... 39-20  
2105 (Master Station) ..... 36-21  
2206, 2206H, 2212, 2212H, 2218, 2218H, 2224, 2224H ..... 80-13  
2306, 2312, 2324 ..... 87-10  
2400 Series ..... 33-12  
3406, H ..... 210-6  
3412, H ..... 210-6  
3424, H ..... 210-6

**RAY ENERGY**  
AD ..... 7-24  
AD4 ..... 7-25  
SRB-1X ..... 13-26

**RAYTHEON (Also See Belmont)**  
A-7DX22 Tel. Rec. (See Model 7DX21—Set 81-31)  
A-10DX24, B-10DX22 Tel. Rec. (Also See Prod. Chg. Bul. 1—Set 103-19) ..... 75-14  
CR-41, A, CR-42, A, CR-43, A (Ch. 4D16-A) ..... 212-5  
C1102 (Ch. 12AX22) Tel. Rec. (Also See Prod. Chg. Bul. 3—Set 105-1) ..... 94-8  
C1104 (Ch. 12AX22) Tel. Rec. (Also See Prod. Chg. Bul. 3—Set 105-1) ..... 94-8  
C-1104B (Ch. 12AX26, 12AX27) Tel. Rec. ..... 141-11

**RAYTHEON—Cont.**

C-1401 (Ch. 14AX21) Tel. Rec. (See Prod. Chg. Bul. 19—Set 132-1 and Model M-1711B—Set 124-8) ..... 99-14  
C-1602, Series 2 (Ch. 16AX29) Tel. Rec. (See Prod. Chg. Bul. 16—Set 126-1 and Model C-1602—Set 99-14) ..... 99-14  
C-1614A (Ch. 16AY21) Tel. Rec. (See Prod. Chg. Bul. 19—Set 132-1 and Model C-1615A—Set 124-8) ..... 124-8  
C-1614B (Ch. 16AY28) Tel. Rec. (Also See Prod. Chg. Bul. 19—Set 132-1 and Model C-1615A (Ch. 16AY21), C-1615B (Ch. 16AY28) Tel. Rec. (Also See Prod. Chg. Bul. 19—Set 132-1) ..... 124-8  
C-1615A (Ch. 16AY21), C-1615B (Ch. 16AY28) Tel. Rec. (Also See Prod. Chg. Bul. 19—Set 132-1) ..... 124-8  
C-1715A (Ch. 17AY21) Tel. Rec. (Also See Prod. Chg. Bul. 19—Set 132-1) ..... 124-8  
C-1715B (Ch. 17AY21) Tel. Rec. (Also See Prod. Chg. Bul. 19—Set 132-1) ..... 124-8  
C-1716A (Ch. 17AY24) Tel. Rec. (Also See Prod. Chg. Bul. 19—Set 132-1) ..... 124-8  
C-1716B (Ch. 17AY21) Tel. Rec. (Also See Prod. Chg. Bul. 19—Set 132-1) ..... 124-8  
C-1717A (Ch. 17AY21) Tel. Rec. (Also See Prod. Chg. Bul. 19—Set 132-1) ..... 124-8  
C-1717B (Ch. 17AY21) Tel. Rec. (Also See Prod. Chg. Bul. 19—Set 132-1) ..... 124-8  
C-1718A (Ch. 17AY24) Tel. Rec. (Also See Prod. Chg. Bul. 19—Set 132-1) ..... 124-8  
C-1718B (Ch. 17AY21) Tel. Rec. (Also See Prod. Chg. Bul. 19—Set 132-1) ..... 124-8  
C-1719A (Ch. 17AY24) Tel. Rec. (Also See Prod. Chg. Bul. 19—Set 132-1) ..... 124-8  
C-1719B (Ch. 17AY21) Tel. Rec. (Also See Prod. Chg. Bul. 19—Set 132-1) ..... 124-8  
C-1720A (Ch. 17AY27) Tel. Rec. (Also See Prod. Chg. Bul. 19—Set 132-1) ..... 147-9  
C-2005A (Ch. 20AY21) Tel. Rec. (Also See Prod. Chg. Bul. 43—Set 177-1) ..... 149-9  
C-2103A, C-2105A (Ch. 21AY21) Tel. Rec. 173-1A  
C-2108 (Ch. 21T1) Tel. Rec. ..... 189-14  
C-2109A (Ch. 21T2) Tel. Rec. ..... 202-7  
C-2109A, C-2111A (Ch. 21T1) Tel. Rec. ..... 189-14  
C-2112A (Ch. 21T3) Tel. Rec. ..... 202-7  
C-2113A (Ch. 21T3) Tel. Rec. ..... 202-7  
C-2114A (Ch. 21T3) Tel. Rec. ..... 202-7  
C-2115A (Ch. 21T3) Tel. Rec. ..... 202-7  
C-2116A (Ch. 21T3) Tel. Rec. ..... 202-7  
C-2118A (Ch. 21T3) Tel. Rec. ..... 202-7  
M701 (Ch. 21T3) Tel. Rec. (Also See Prod. Chg. Bul. 3—Set 105-1) ..... 94-8  
M1101, M1103, M1105 (Ch. 12AX22) Tel. Rec. (Also See Prod. Chg. Bul. 2—Set 105-1) ..... 94-8  
M1105B, M-1106, M-1107 (Ch. 12AX26, 12AX27) Tel. Rec. ..... 141-11  
M-1402, M-1403, M-1404 (Ch. 14AX21) Tel. Rec. 123-12  
M-160 (Ch. 16AX23, 25, 26) Tel. Rec. ..... 99-14  
M-161A (Ch. 16AY21), M-161B (Ch. 16AY28) Tel. Rec. (Also See Prod. Chg. Bul. 19—Set 132-1) ..... 124-8  
M-1612A (Ch. 16AY21), M-1612B (Ch. 16AY28) Tel. Rec. (Also See Prod. Chg. Bul. 19—Set 132-1) ..... 124-8  
M-1613A (Ch. 16AY21), M-1613B (Ch. 16AY28) Tel. Rec. (Also See Prod. Chg. Bul. 19—Set 132-1) ..... 124-8  
M-1626 (Ch. 16AY21) Tel. Rec. ..... 165-2A  
M-1711A (Ch. 17AY24), M-1711B (Ch. 17AY21) Tel. Rec. (Also See Prod. Chg. Bul. 19—Set 132-1) ..... 124-8  
M-1712A (Ch. 17AY24), M-1712B (Ch. 17AY21) Tel. Rec. (Also See Prod. Chg. Bul. 19—Set 132-1) ..... 124-8  
M-1713A (Ch. 17AY24), M-1713B (Ch. 17AY21) Tel. Rec. (Also See Prod. Chg. Bul. 19—Set 132-1) ..... 124-8

**RAYTHEON—Cont.**

M1725A (Ch. 17AY21) Tel. Rec. (See Prod. Chg. Bul. 19—Set 132-1 and Model M-1711B—Set 124-8) ..... 99-14  
M-1726 (Ch. 17AY21), Tel. Rec. (See Prod. Chg. Bul. 19—Set 132-1 and Model M-1711B—Set 124-8) ..... 176-10  
M-1726A, M-1728A (Ch. 17AY21A) Tel. Rec. ..... 176-10  
M-1733A (Ch. 17T1) Tel. Rec. ..... 189-14  
M-1734A (Ch. 17T2) Tel. Rec. ..... \*  
M-2007A, M-2008A (Ch. 20AY21) Tel. Rec. (See Prod. Chg. Bul. 43—Set 177-1 and Model C-2001A—Set 149-9) ..... \*  
M-2101A (Ch. 21AY21) Tel. Rec. (See Model C-2103A) ..... 173-1A  
M-2107A (Ch. 21T1) Tel. Rec. ..... 189-14  
P-201 Tel. Rec. (See Model 7DX21—Set 81-13)  
RC-1405 (Ch. 14AX21) Tel. Rec. (For TV Ch. Only See Model C-1401—Set 123-12)  
RC-1618A (Ch. 16AY21), RC-1618B (Ch. 16AY28) Tel. Rec. (Also See Prod. Chg. Bul. 19—Set 132-1) ..... 124-8  
RC-1619A (Ch. 16AY21), RC-1619B (Ch. 16AY28) Tel. Rec. (Also See Prod. Chg. Bul. 19—Set 132-1) ..... 124-8  
RC-1718A (Ch. 17AY24) Tel. Rec. (See Prod. Chg. Bul. 19—Set 132-1 and Model M-1711A—Set 124-8)  
RC-1718B (Ch. 17AY21) Tel. Rec. (Also See Prod. Chg. Bul. 19—Set 132-1) ..... 124-8  
RC-1719A (Ch. 17AY24) Tel. Rec. (See Prod. Chg. Bul. 19—Set 132-1 and Model M-1711A—Set 124-8)  
RC-1719B (Ch. 17AY21) Tel. Rec. (Also See Prod. Chg. Bul. 19—Set 132-1) ..... 124-8  
RC-1720A (Ch. 17AY27) Tel. Rec. (Also See Prod. Chg. Bul. 19—Set 132-1) ..... 147-9  
RC-2005A (Ch. 20AY21) Tel. Rec. (Also See Prod. Chg. Bul. 43—Set 177-1 and Model C-2001A—Set 149-9)  
RC-2117A (Ch. 21T3) Tel. Rec. ..... 202-7  
UHF-100 (UHF Tuner) ..... 207-8  
7DX21, 7DX22 Tel. Rec. (Also See Prod. Chg. Bul. 3—Set 105-1) ..... 75-14  
10AXF44 Tel. Rec. (See Model C-1102—Set 94-8 and Model A-10DX24—Set 75-14)  
10DX21, 10DX22 Tel. Rec. (Also See Prod. Chg. Bul. 3—Set 105-1) ..... 75-14  
10DX24 Tel. Rec. (See Model A-10DX24—Set 75-14)  
18DX21A Tel. Rec. ..... 81-13  
5501 (See Model C-1104B)  
Ch. 14AX21 Tel. Rec. (See Model C-1401)  
Ch. 16AX23, 25, 26 (See Model C-1602)  
Ch. 16AY28 (See Model C-1615B)  
Ch. 16AY211 (See Model C-1615A) (Also See Prod. Chg. Bul. 19—Set 132-1)  
Ch. 16AY212 (See Model M-1626)  
Ch. 17AY21 (See Model C-1714B)  
Ch. 17AY21A (See Model C-1729)  
Ch. 17AY24 (See Model C-1715A)  
Ch. 17AY27 (See Model RC-1720A)  
Ch. 17T1 (See Model C-1735A)  
Ch. 17T2 (See Model C-2109A)  
Ch. 20AY21 (See Model C-2001A)  
Ch. 21AY21 (See Model C-2103A)  
Ch. 21T1 (See Model C-2108)  
Ch. 21T2 (See Model C-2109A)  
Ch. 21T3 (See Model C-2112A)

**RECORDIO—Cont.**

1J10 (Ch. 1J1) ..... 128-12  
2A10 ..... 163-10  
6A10, 6A20 (Ch. 6A) ..... 10-27  
6B10, 6B20, 6B30, 6B32 ..... 8-27  
7D42, 7D44 (Ch. 7D1) ..... 52-18  
7E40, 7E44 ..... 47-20  
8J10, 8J50 ..... 62-17  
9G10 ..... 91-10  
9G40M, 9G42 ..... 86-9  
9H40B ..... 89-13  
Ch. 1J1 (See Model 1J10)  
Ch. 6A (See Model 6A10)  
Ch. 7D1 (See Model 7D42)

**REELEST (See Recorder Listing)**

**REGAL (TOK-FONE)**  
Tok-Fone (20-watt Amp.) ..... 13-27  
AP40, ARP400, ARP450 ..... 15-26  
BP48 ..... 49-18  
C-52 ..... 182-9  
CD31 Tel. Rec. (See Model 16T31—Set 80-14)  
CD36 Tel. Rec. ..... \*  
CR761 ..... 50-16  
CR762 ..... 195-11  
FM78 ..... 68-14  
P-201 Tel. Rec. (See Model 7DX21—Set 81-13)  
P-175 ..... 183-12  
W700 (See Model W800—Set 14-26)  
W800, W801 ..... 14-26  
W900, W901 ..... 13-28  
16T31 Tel. Rec. ..... 80-14  
16T36 Tel. Rec. ..... \*  
17HD31, 17HD36, Tel. Rec. ..... 147-10  
17T22, 17T22DX Tel. Rec. 143-13  
19C31, 19C36 Tel. Rec. 147-10  
19D31, 19D36 Tel. Rec. 147-10  
20C22, 20C22DX Tel. Rec. 143-13  
20C31, 20C36 Tel. Rec. 147-10  
20D22, 20D22DX Tel. Rec. 143-13  
20D31, 20D36 Tel. Rec. 147-10  
20HD31, 20HD36 Tel. Rec. 147-10  
20T22, 20T22DX Tel. Rec. 143-13  
22D17, 22D17DX, 22D19, 22D19DX Tel. Rec. 143-13  
205 ..... 26-23  
208 (See Model W800—Set 14-26)  
271 ..... 210-7  
575 ..... 210-8  
747 ..... 27-22  
777 ..... 53-21  
1007 Tel. Rec. ..... 83-9  
1030, 1031 Tel. Rec. ..... 80-14  
1049 ..... 17-28  
1107 ..... 41-19  
1207, 1208 Tel. Rec. ..... 83-9  
1230 Tel. Rec. ..... 80-14  
1500 ..... 38-19  
1607 Tel. Rec. ..... 83-9  
1708, 1708DX Tel. Rec. 143-13  
1749 ..... 28-29  
1877 ..... 182-10  
2217, 2217DX, 2219, 2219DX Tel. Rec. 143-13  
7152 ..... 70-8  
7162 ..... 69-12  
7163 ..... 66-14  
7251 ..... 40-16

**REGENCY**  
RC-600 Tel. UHF Conv. .... 200-8

**REMBRANDT**  
721, 1606, 1606-15, 1950 Tel. Rec. ..... 65-11

**REMLER**  
MP5-5-3 ..... 8-28  
5300B, 5300B1, 53001 ..... 23-18  
5310 ..... 40-17  
5400, 5410 ..... 44-19  
5500 "Scottie Pup" ..... 27-23  
5505 "Scottie Pup" (See Model 5500—Set 27-23)  
5515 "Scottie Pup" (See Model 5500—Set 27-23)  
5520, 5530 "Scottie Junior" ..... 27-23  
6000 ..... 77-9

**RENRAD**  
L-1A, PT-1A, 185T-1 ..... 9-28

**REVERE (See Recorder Listing)**

**ROLAND**  
5T1E ..... 205-8  
5T1V ..... 208-10  
5T2M ..... 204-9  
8XF1, 8XF2 ..... 211-11

**ROYAL (Lee)**  
AN150, AN160 ..... 179-11  
20CP, 20TW Tel. Rec. (Similar to Chassis) ..... 149-13

**SCOTT (E. H.)**  
Musical ..... 44-20  
Music Control, Dynamic Noise Suppressor ..... 46-21  
"Ravenwood" Tel. Rec. 150-11  
6T11, 6T11A Tel. Rec. (Also See Prod. Chg. Bul. 4—Set 105-2) ..... 52-19  
13A Tel. Rec. ..... \*  
16A ..... 40-18  
300 Tel. Rec. ..... 154-11  
310 ..... 400 Tel. Rec. (See Prod. Chg. Bul. 4—Set 105-2 and Model 6T11—Set 52-19)  
510 ..... 103-14  
515 ..... 165-11  
710, 710A, 710X Tel. Rec. 150-11  
720 Tel. Rec. ..... \*  
800-8 ..... 14-27



**SCOTT (E. H.)—Cont.**

800BT Tel. Rec. (For TV Ch. See Prod. Chge. Bul. 4—Set 52-19, For Radio Ch. See Model 800—Set 14-27)  
 817C, 817CU Tel. Rec. (See Model 820C—Set 178-9)  
 817T, 817TU (See Model 820C—Set 178-9)  
 820C Tel. Rec. 178-9  
 820CU Tel. Rec. 178-9  
 820CU (See Model 820C—Set 178-9)  
 820T, 820TU Tel. Rec. (See Model 820C—Set 178-9)  
 910 Tel. Rec. 150-11  
 920 Tel. Rec. 150-11  
 924W Tel. Rec. 176-11  
 1000 180-8  
 1510 181-11

**SCOTT (H. H.)**

111-B 143-14  
 112-B 144-8  
 120-A 183-13  
 210-A 79-15  
 210-B 145-9  
 211-A 81-14  
 214- (120-A, 220-A) 183-13  
 220-A 183-13

**SEARS-ROEBUCK (See Silvertone)**

**SEEBURG (See Record Changer Listing)**

**SENTINEL**

1U-284GA 22-25  
 1U-284I, 1U-284NA, 1U-284NI, 1U-284W 1-2  
 1U-285P 6-27  
 1U-293CT 29-29  
 1U-293I, 1U-293T, 1U-293W 1-14  
 1U-294I, 1U-294N, 1U-294T 1-11  
 1U312PG, 1U312PW 103-15  
 1U-313I, 1U-313W 39-21  
 1U-314E, 1U-314-I, 1U-314-W 38-21  
 1U-315-I, 1U-315-W 40-19  
 1U-316PM, 1U-316PT 48-22  
 1U-335PG, PI, PM, PW 105-9  
 1U338-I, 1U338-R, 1U338-W 122-9  
 1U339-K 111-12  
 1U340-C 129-10  
 1U-343 212-6  
 1U-344 211-12  
 1U345P 183-14  
 1U-346 209-11  
 1U416 Tel. Rec. 117-12  
 1U419, 1U420 Tel. Rec. 115-9  
 1U420B Tel. Rec. 124-9  
 1U421, 1U422 (Series "YA") Tel. Rec. (See Prod. Chge. Bul. 16—Set 126-1 and Model 412—Set 100-11)  
 1U423 Tel. Rec. (Also See Prod. Chge. Bul. 19—Set 132-11)  
 1U423B, 1U423-T Tel. Rec. (See Prod. Chge. Bul. 19—Set 132-1 and Model 1U423B—Set 124-9)  
 1U424 Tel. Rec. (Also See Prod. Chge. Bul. 19—Set 132-1 and Model 1U424—Set 124-9)  
 1U-425—Tel. Rec. 127-10  
 1U428 Tel. Rec. (See Model 1U425) 127-10  
 1U429, 1U430, 1U431 Tel. Rec. (See Prod. Chge. Bul. 25—Set 144-1 and Model 1U428—Set 124-9)  
 1U-432 Tel. Rec. (Also See Prod. Chge. Bul. 21—Set 136-1 and Model 1U425—Set 127-10)  
 1U438, 1U439, 1U440, 1U441, 1U443, 1U444 (Series "XD, XDD, 2XD") Tel. Rec. 157-9  
 1U446, 1U447 (Series "XD, XDD, 2XD") Tel. Rec. (See Model 1U438—Set 157-9)  
 1U447-A, 1U448-A, 1U449-A, 1U450-A, 1U451-A Tel. Rec. 178-10  
 1U-448, 1U-449, 1U-450 (Series "XD, XDD, 2XD") Tel. Rec. (See Model 1U-438—Set 157-9)  
 1U-454, 1U-455, 1U-456, 1U-457 Tel. Rec. (Also See Prod. Chge. Bul. 63—Set 197-1)  
 1U-458, 1U-459, 1U-460, 1U-461 Tel. Rec. 199-10  
 1U462, 1U463 (Ch. 2WA) Tel. Rec. 205-9  
 L-284I, L-284NA, L-284NI, L-284NR, L-284W 23-19  
 284GA 22-25  
 284I 1-2  
 284NA, 284NI 1-2  
 285P 6-27  
 286P, 286PR 23-20  
 289T 6-28  
 292K 16-30  
 293 Series 1-14  
 293-CT 29-22  
 293-T, 293T, 293W 1-14

**SENTINEL—Cont.**

294 Series 1-11  
 294I, 294N, 294T 1-11  
 295-T 22-26  
 296B, 296M 46-22  
 302-1, 302-T, 302-W 33-23  
 305-1, 305-1-3, 305-W, 305-X 33-24  
 309-1, 309-N, 309-R, 309-W 28-30  
 312PG, 312PW 103-15  
 313-I, 313-W 39-21  
 314-E, 314-I, 314-W 38-21  
 315-1, 315-W 40-19  
 316PM, 316PT 48-22  
 332 (See Model 313—Set 39-21)  
 333 (See Model 315—Set 40-19)  
 335PG, PI, PM, PW 105-9  
 338-I, 338-R, 338-W 122-9  
 339-K 111-12  
 340-C 129-10  
 342K 155-14  
 343 212-6  
 344 211-12  
 345P 183-14  
 346 209-11  
 400TV Tel. Rec. 73-11  
 401 Tel. Rec. 70-9  
 405VM Tel. Rec. 73-11  
 405 Series Tel. Rec. 70-9  
 406 Series Tel. Rec. 70-9  
 407 Series Tel. Rec. \*  
 409 Series Tel. Rec. \*  
 411 Series Tel. Rec. (See Model 401 Series—Set 70-9)  
 412, 413, 414, 415 Series YA, YB, YC, YD, YE, YF Tel. Rec. (Also See Prod. Chge. Bul. 4—Set 105-2)  
 416 Tel. Rec. 117-12  
 419, 420 Tel. Rec. 115-9  
 420B Tel. Rec. 124-9  
 421, 422 Tel. Rec. (See Prod. Chge. Bul. 16—Set 126-1 and Model 412—Set 100-11)  
 423, 424 Tel. Rec. (Also See Prod. Chge. Bul. 19—Set 132-1) 124-9  
 423B, 423-T Tel. Rec. (See Prod. Chge. Bul. 19—Set 132-1 and Model 423—Set 124-9)  
 424 Tel. Rec. (Also See Prod. Chge. Bul. 19—Set 132-1) 124-9  
 424-T Tel. Rec. (See Prod. Chge. Bul. 19—Set 132-1 and Model 424—Set 124-9)  
 425 Tel. Rec. 127-10  
 428 Tel. Rec. 127-10  
 429, 430, 431 Tel. Rec. (See Prod. Chge. Bul. 25—Set 144-1 and Model 1U428—Set 124-9)  
 432 Tel. Rec. (Also See Prod. Chge. Bul. 21—Set 136-1 and Model 425—Set 124-9)  
 435 Tel. Rec. (See Prod. Chge. Bul. 21—Set 136-1 and Model 425—Set 124-9)  
 438, 439, 440, 441, 443, 444 (Series "XD, XDD, 2XD") Tel. Rec. 157-9  
 446 (Series "XD, XDD, 2XD") Tel. Rec. (See Model 438—Set 157-9)  
 452, 453 Tel. Rec. (See Model 1U-447-A—Set 178-10)  
 454, 455, 456, 457, Tel. Rec. (Also See Prod. Chge. Bul. 63—Set 191-17)  
 458, 459, 460, 461 Tel. Rec. (See Model 1U-458—Set 199-10)  
 462, 463 (Ch. 2WA) Tel. Rec. 205-9  
 464, 465, 466 (See Model 1U-454—Set 191-17)  
 Ch. 2WA (See Model 462)

**SETCHELL-CARLSON**

53 (Ch. 152) Tel. Rec. 209-12  
 150 Tel. Rec. 144-9  
 151-A17, 151-A17-LR, 151-B17, 151-B17-LR, 151-B20, 151-B20-LR, 151-C20, 151-C20-LR Tel. Rec. 155-15  
 416 2-14  
 427 21-29  
 437 39-22  
 447 40-20  
 458-RD 106-13  
 469 9-15  
 531 (Ch. 152) Tel. Rec. 209-12  
 570 97-15  
 2500, 2500LP Tel. Rec. 144-9  
 5301, 5302 (Ch. 122) Tel. Rec. 209-12  
 Ch. 152 (See Model 53)

**SHAW**

Ch. 224 (Runs 301, 302, 303, 304, 304-1, 2, 305, 305-2) Tel. Rec. 202-8

**SHERATON**

C-26B, M (Ch. 260-C) Tel. Rec. \*  
 C-26B, M (Ch. 260-C) Tel. Rec. \*  
 C-26M24 (Ch. 260-C) Tel. Rec. \*  
 C30B, M Tel. Rec. 176-13  
 C30B24, C30M24

**SHERATON—Cont.**

Tel. Rec. 176-13  
 T-26M, B (Ch. 260-C) Tel. Rec. \*  
 T30M Tel. Rec. 176-13  
 17MT20 (Ch. 530DX Series) Tel. Rec. 210-9  
 21MT100, 21MT110 (Ch. 530DX Series) Tel. Rec. 210-9  
 21MC10, 21MD10 (Ch. 530DX Series) Tel. Rec. 210-9  
 21MT100 (Ch. 530DX Series) Tel. Rec. 210-9  
 Chassis 270-C (See Model C-26B)  
 Ch. 530DX (See Model 17MT20)  
**SHERIDAN ELECTRONICS (See Vogue)**  
**SIGNAL**  
 AF252 37-19  
 141 44-21  
 241 33-25  
 341-A 39-23  
 341-T 25-25

**SILVERTONE—Cont.**

151-16, 151-17 (Ch. 528.630-1) Tel. Rec. \*  
 152-16, 16A (Ch. 549.102, 549.102-2) Tel. Rec. \*  
 159 (Ch. 478.309) 115-11  
 160-12 (Ch. 549.100-4) Tel. Rec. 97A-12  
 161-16 (Ch. 100.112) Tel. Rec. 99A-10  
 162-17 (Ch. 110.700-10) Tel. Rec. 139-13  
 163-16 (Ch. 478.319) 157-10  
 164-14 (Ch. 478.313) Tel. Rec. 144-12  
 165-16 (Ch. 100.120) Tel. Rec. 166-16 (Ch. 478.339) Tel. Rec. \*  
 116-17 (Ch. 478.339-A) Tel. Rec. \*  
 167-16, 167-16A (Ch. 549.101, -1) Tel. Rec. \*  
 168-16 (Ch. 549.100-3) Tel. Rec. 161-9  
 169-16 (Ch. 549.102, 549.102A) Tel. Rec. \*  
 170-16 (Ch. 549.102, 549.102A) Tel. Rec. \*  
 173-16 (Ch. 110.700-10) Tel. Rec. 139-13  
 175-16, A (Ch. 549.105, -6, -7, -8, -9) Tel. Rec. 161-9  
 176-19 (Ch. 549.100-6) Tel. Rec. 161-9  
 177-19 (Ch. 110.700-40) Tel. Rec. 139-13  
 179-16, 180-16 (Ch. 132.890) Tel. Rec. 130-12  
 185-16 (Ch. 549.101-2) Tel. Rec. \*  
 186-19 (Ch. 549.101-3) Tel. Rec. \*  
 187-16, 188-16 (Ch. 110.700-10) Tel. Rec. \*  
 189-16 (Ch. 549.100-1) Tel. Rec. 139-13  
 191-16 (Ch. 110.700-50) Tel. Rec. \*  
 194-16, 195-16 (Ch. 132.890) Tel. Rec. 130-12  
 197-16 (Ch. 132.880) 109-12  
 215 (Ch. 528.174) 117-13  
 217, 218 (Ch. 528.174) (See Model 215—Set 117-13)  
 220 (Ch. 528.173) 110-13  
 222, 223, 224 (Ch. 528.173) (See Model 220—Set 110-13)  
 225 (Ch. 528.171-1) 107-8  
 237 (Ch. 488.237) 145-10  
 238 (Ch. 548.360-1, 548.361) (See Model 239—Set 152-9)  
 239 (Ch. 548.360-1, 548.361) 115-12  
 245 (Ch. 548.358-1) 107-9  
 246 (Ch. 137.906) 111-14  
 249 (Ch. 548.360-1, 548.361) 115-12  
 107I, 1018 (Ch. 528.210, -1, -2) 183-11  
 1032 (Ch. 528.196) 183-15  
 1040, 1045 (Ch. 528.194) 181-12  
 1040A (Ch. 528.194-1) (See Model 1040—Set 181-12)  
 1045A (Ch. 528.194-1) (See Model 1040—Set 181-12)  
 1052 (Ch. 132.011) 174-10  
 1052A (Ch. 132.011-1) (See Model 1052—Set 174-10)  
 1053 (Ch. 132.011) 174-10  
 1053A (Ch. 132.011-1) (See Model 1053—Set 174-10)  
 1054 (Ch. 132.012) 173-12  
 1054A (Ch. 132.012-1) (See Model 1054—Set 173-12)  
 1055 (Ch. 132.012) 173-12  
 1055A (Ch. 132.012-1) (See Model 1055—Set 173-12)  
 1058, 1059 (Ch. 101.860) 162-11  
 1062, 1063 (Ch. 101.860) 162-11  
 1066 (Ch. 100.202) 162-10  
 1116-16 (Ch. 110.700-90), 1117-17 (Ch. 110.700-96) Tel. Rec. \*  
 1117-17 (Ch. 110.700-100, -104) Tel. Rec. 201-8  
 1130-17 (Ch. 110.700-96) Tel. Rec. \*  
 1130-17, 1130A-17 (Ch. 110.700-100, -104) Tel. Rec. 201-8  
 1135-17 (Ch. 110.700-96) Tel. Rec. \*  
 1141-20 (Ch. 110.700-93) Tel. Rec. \*  
 1141-20 (Ch. 110.700-120) Tel. Rec. 201-8  
 1145-20 (Ch. 110.700-140) Tel. Rec. 201-8  
 1150-14 (Ch. 478.361, A) Tel. Rec. \*  
 1161-17 (Ch. 110.702-10) Tel. Rec. 205-10  
 1162-16 (Ch. 110.700-90) Tel. Rec. \*  
 1162-17 (Ch. 110.700-96) Tel. Rec. \*  
 1162-17 (Ch. 110.700-100, -104) Tel. Rec. 201-8  
 1166-17 (Ch. 478.339-B) Tel. Rec. \*  
 1171-17 (Ch. 110.702-10, -50) Tel. Rec. 205-10

**SILVERTONE—Cont.**

1172-17 (Ch. 110.700-100, -104) Tel. Rec. 201-8  
 1173-20 (Ch. 110.700-140) Tel. Rec. 201-8  
 1176-21 (Ch. 100.208) Tel. Rec. 165-12  
 1181-20 (Ch. 110.700-120) Tel. Rec. 201-8  
 1183-21 (Ch. 110.700-150) Tel. Rec. 201-8  
 1184-20 (Ch. 528.631, -1) Tel. Rec. 181-13  
 1186A (Ch. 100.208) Tel. Rec. 165-12  
 1188-20 (Ch. 110.700-140) Tel. Rec. 201-8  
 1191-17 (Ch. 110.700.97) Tel. Rec. \*  
 1260 (Ch. 456.150, -2) Tel. Rec. \*  
 1261 (Ch. 456.150-2) Tel. Rec. \*  
 1266 (Ch. 456.150, -2) Tel. Rec. \*  
 1268-21 (Ch. 456.150-1) Tel. Rec. \*  
 1270-21 (Ch. 456.150-1) Tel. Rec. \*  
 1271-21 (Ch. 456.150-1) Tel. Rec. \*  
 1272-21 (Ch. 456.150-1) Tel. Rec. \*  
 1273-21 (Ch. 456.150-1) Tel. Rec. \*  
 1274-21 (Ch. 456.150-1) Tel. Rec. \*  
 1275-21 (Ch. 456.150-1) Tel. Rec. \*  
 1300 (Ch. 319.200) Tel. Rec. \*  
 1300-1 (Ch. 319.200-1) 90-10  
 1301 (Ch. 319.190) 91-11  
 2001, 2002 (Ch. 132.878) (See Model 1—Set 101-10)  
 2003, 2004, 2005, 2006 (Ch. 757.110) 211-13  
 2007 (Ch. 757.110) 198-12  
 2009, 2010, 2011, 2012, 2013 (Ch. 132.022) 196-14  
 2014, 2015, 2016 (Ch. 132.021) 196-15  
 2022 (Ch. 132.027) 197-11  
 2023, 2024, 2025, 2026, 2027 (Ch. 132.896-1) (See Model 10—Set 144-11)  
 2028 (Ch. 528.230) 203-8  
 2041 (Ch. 528.235) 208-11  
 2056 (Ch. 132.026-3) 207-9  
 2060, 2061 (Ch. 101.860) 203-9  
 2063, 2064 (Ch. 101.860, -1) (See Model 1058—Set 162-11)  
 2100 (Ch. 110.700-100, -104) Tel. Rec. 201-8  
 2101 (Ch. 647.023) Tel. Rec. \*  
 2105 (Ch. 132.024, -1, -2) Tel. Rec. 198-13  
 2105A (Ch. 132.024-3, -31) Tel. Rec. 198-13  
 2110A, 2111A (Ch. 528.631, -1, -2, -3, -4, -5) Tel. Rec. 212-7  
 2115B (Ch. 528.631, -1, -2, -3, -4, -5) Tel. Rec. 212-7  
 2130 (Ch. 100.210, -1, -3) Tel. Rec. 207-10  
 2145 (Ch. 132.024, -1, -2) Tel. Rec. 198-13  
 2145A (Ch. 132.024-3, -31) Tel. Rec. 198-13  
 2150 (Ch. 32.024-4) Tel. Rec. 198-13  
 2150 (Ch. 110.700-140) Tel. Rec. 201-8  
 2150B (Ch. 528.631, -1, -2, -3, -4, -5) Tel. Rec. 212-7  
 2160, 2162 (Ch. 528.631, -1, -2, -3, -4, -5) Tel. Rec. 212-7  
 2170-C (Ch. 100.209) Tel. Rec. 193-10  
 2170-D, E (Ch. 100.210, -1, -3) Tel. Rec. 207-10  
 2172 (Ch. 100.210, -1, -3) Tel. Rec. 207-10  
 2174 (Ch. 132.035) Tel. Rec. \*  
 2195-21 (Ch. 100.208-1 and Radio Ch. 100.202-1) Tel. Rec. (See Prod. Chge. Bul. 59—Set 193-1 and Model 1176-21—Set 165-12 For TV Ch. and Model 1066—Set 162-10 for Radio Ch.)  
 2200, 2202, 2203 (Ch. 528.229) 201-8  
 2210 (Ch. 132.880) (See Model 210—Set 109-12)  
 2225 (Ch. 528.233) 208-12  
 3105 (Ch. 132.024-5, -6) Tel. Rec. 198-13  
 3106 (Ch. 132.045, -1) Tel. Rec. 199-11  
 3127 (Ch. 100.210, -1, -3) Tel. Rec. 207-10  
 3145 (Ch. 132.024-5, -6) Tel. Rec. 198-13  
 3170 (Ch. 528.239) Tel. Rec. \*  
 3170-B (Ch. 100.210, -1, -3) Tel. Rec. 207-10  
 3174 (Ch. 132.035-2) Tel. Rec. 206-11



After-WARD You'll Install no Others.

WARD will give you the "HI" in sales — the "HI" in profits you seek . . . WARD Antennas always create greater customer satisfaction. Remember, WARD will keep your inventory lower and cut your "call backs" . . .

Ask Your Distributor for the new Ward Ultra Hi-Line and Signaline Catalog.

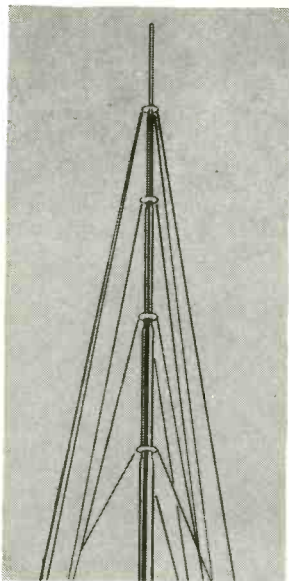

**ZIP-HI MAST** — Corrosion-proof 16 gauge permastube . . . easily assembled . . . in 2, 3, 4, 5 section models.

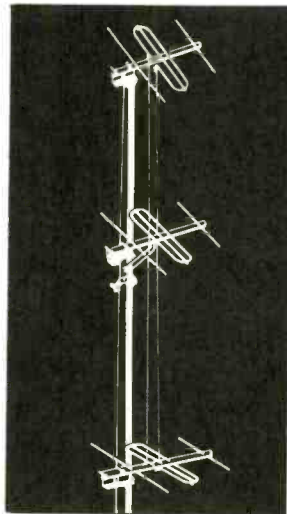

**3 X 3** — Original development for UHF band composed of 3 stacked 3 element beams. Full wave spacing between bays . . . clean cut pattern with sharp forward lobe and no side lobes . . . cut to frequency . . . unsurpassed for near fringe and fringe areas.

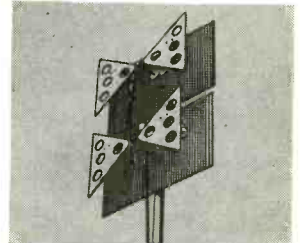

**BOW TIE** — Peak-A-Bow design with the only adjustable screen on the market . . . Available in single and stacked models.

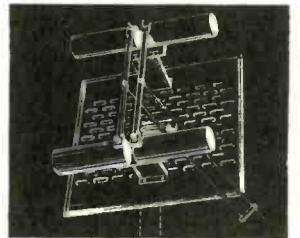

**CAN-CAN** — New lazy H design for entire UHF band . . . uni-directional pattern . . . sturdy compact unit . . . field tested and thoroughly proven.

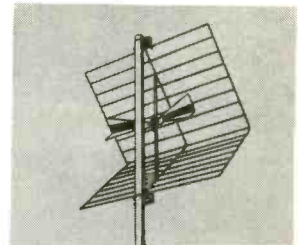

**CORNER REFLECTOR** — For semi-fringe areas . . . ruggedly designed to eliminate ghosts and vibration.

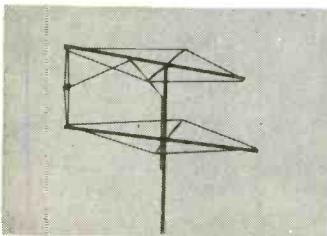

**RHOMBIC** — Highest gain of all UHF antennas . . . for fringe and super fringe areas.

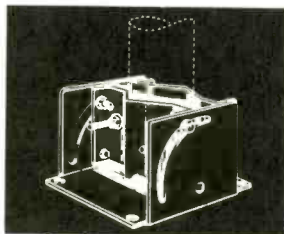

**HEAVY DUTY BASE** — Ruggedly constructed to fit all masts from 1 1/4" to 2 1/4" O.D.

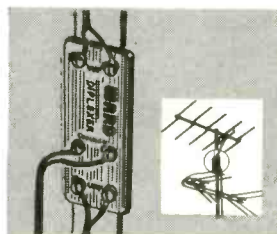

**DIPLEXER** — For separate UHF-VHF antennas . . . or for set and converters with separate UHF-VHF terminals . . . Foolproof . . . easily installed.

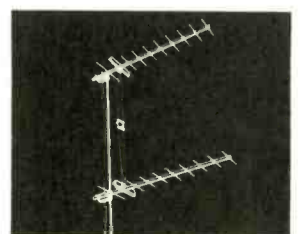

**10 ELEMENT YAGI** — Multi-channel series of 10 element UHF Yagis . . . Excellent for fringe areas . . . very directional . . . completely pre-assembled — single and stacked models.



# THE WARD PRODUCTS CORP.

DIVISION OF THE GABRIEL COMPANY

1148 Euclid Avenue • Cleveland 15, Ohio • in Canada: Atlas Radio Co., Ltd.



## SILVERTONE—Cont.

3175 (Ch. 132.044)	
Tel. Rec. ....	203-10
3177 (Ch. 100.210)	
-1-3) Tel. Rec. ....	207-10
3187 (Ch. 100.210)	
-1-3) Tel. Rec. ....	207-10
3200 (Ch. 528.259) (See	
Model 2200—	201-9
3202, 3203 (Ch. 528.259)	
(See Model 2200—	
Set 201-9)	
4120 (Ch. 456.150, -2)	
Tel. Rec. ....	*
6002 (Ch. 132.818)	5-35
6011 (Ch. 132.816)	
6012 (Ch. 132.816A)	15-27
6016 (Ch. 132.820)	27-24
6050 (Ch. 132.825-4)	15-28
6051 (Ch. 110.451)	
6052 (Ch. 110.452)	13-29
6071 (Ch. 132.826-1)	15-29
6072 (Ch. 110.454)	13-30
6092 (Ch. 101.672-1B)	
6093 (Ch. 101.672-1A)	10-728
6100 (Ch. 101.660-1A)	6-29
6104 (Ch. 101.662-2D)	
(See Model 6105—	
Set 7-26)	
6105 (Ch. 101.622-2B)	7-26
6106A (Ch. 101.662-4E)	29-23
6111 (Ch. 101.662-3C)	7-26
6111A (Ch. 101.662-5F)	29-23
6200A (Ch. 101.800-3)	65-12
6200A (Ch. 101.800-1)	9-29
6203 (Ch. 101.800A)	
(See Model 6200A—	
Set 9-29)	
6220, 6220A (Ch.	
101.801, 101.801-1A)	9-30
6230 (Ch. 101.802)	11-21
6230A (Ch. 101.802-1)	11-21
6285A (Ch. 101.664-1B)	20-28
6286 (Ch. 528.6286)	
-1, -3) ....	185-12
6287 (Ch. 528.6287)	
-1, -3) ....	185-12
6290 (Ch. 101.677-B)	20-29
6293 (Ch. 528.6293-2)	9-16
6295 (Ch. 528.6295)	98-12
6685 (Ch. 139.150)	
Ch. 139.150-1)	
Power Shifter ....	15-30
7020 (See Model 7021—	
Set 16-31)	
7021 (Ch. 101.807)	
101.807A) ....	16-31
7025 (Ch. 132.807-2)	29-24
7054 (Ch. 101.808)	15-31
7070 (Ch. 101.817)	30-26
7080 (Ch. 101.809)	16-32
7080, 7080A (Ch.	
101.809-2) ....	58-20
7085 (Ch. 101.814)	30-27
7086 (Ch. 110.466)	27-25
7090 (Ch. 101.810)	15-32
7095 (Ch. 101.826)	
(See Model 7115—	
Set 16-33)	
7100 (Ch. 101.811)	17-29
7102 (Ch. 101.814-1A)	30-27
7103 (Ch. 110.466-1)	27-25
7111 (Ch. 434.140)	30-28
7115 (Ch. 101.825)	
7116 (Ch. 101.825-1A)	
7117 (Ch. 101.825-1B)	16-33
7119 (Ch. 101.825-2C)	62-18
7145 (Ch. 436.200)	23-21
7148 (Ch. 431.188)	
7148A (Ch. 431.188-1)	23-22
7152 (Ch. 109.626)	25-26
7153 (Ch. 109.627)	26-30
7165 (Ch. 101.823-A, 1A)	10-29
7166 (Ch. 101.823)	
101.823-1)	10-29
7210 (Ch. 101.820)	32-20
7220 (Ch. 101.801-2C)	
(See Model 6220—	
Set 9-30)	
7226 (Ch. 101.819A)	31-28
7230 (Ch. 101.802-2A)	
(See Model 6230—	
Set 11-21)	
7300 (Ch. 435.240)	45-22
7350 (Ch. 435.410)	38-22
7353 (See Model 7350—	
Set 38-22)	
8000 (Ch. 132.838)	31-29
8003 (Ch. 132.818-1)	53-22
8004 (See Model 8003—	
Set 53-22)	
8005 (Ch. 132.839)	33-26
8010 (Ch. 132.840)	40-21
8011 (See Model 8010—	
Set 40-21)	
8020 (Ch. 132.841)	43-17
8021 (Ch. 132.868)	70-10
8024, 8025 (Ch.	
475.206-1) ....	80-15
8050 (Ch. 101.813)	33-27
8051 (Ch. 101.839)	49-19
8052 (Ch. 101.808-1C)	68-15
8053 (Ch. 101.808-1D)	
(See Model 8052—	
Set 68-15)	
8070 (Ch. 101.817-1A)	
(See Model 7070—	
Set 30-26)	
8072 (Ch. 101.834)	34-19
8073 (Ch. 135.243)	84-9
8080 (Ch. 101.852)	52-20
8083, 8083A (Ch.	
101.809-1A) ....	58-20
8084, 8084A (Ch.	
101.809-1B) ....	58-20
8086 (Ch. 101.814-5C)	61-18
8086A, 8086B (Ch.	
101.814-6) ....	61-18
8090 (Ch. 101.821)	49-20
8097A (Ch. 101.825-4)	62-18
8100 (Ch. 101.829)	51-19
8101, 8101A, 8101B,	
8101C (Ch.	
101.809-3C) ....	58-20
8102 (Ch. 101.814-2B)	61-18
8102A (Ch. 101.814-3B)	61-18

## SILVERTONE—Cont.

8102B (Ch. 101.814-2B)	61-18
8103 (Ch. 110.473)	56-21
8104 (See Model 8086—	
Set 61-18)	
8105, 8105A	
(Ch. 101.833) ....	35-20
8106, A (Ch. 101.833-1A)	
(See Model 8105—	
Set 35-20)	
8107A, 8108, 8108A (Ch.	
101.851), 8109 (Ch.	
101.851-1) ....	64-10
8112, 8113 (See Model	
8115—Set 62-18)	
8115 (Ch. 101.825-3D)	62-18
8115 A, B, C (Ch.	
101.825-4) ....	62-18
8117 (Ch. 101.825-3E)	62-18
8117 (Ch. 101.825-3E)	62-18
8118 (Ch. 101.825-3F)	62-18
8118 A, B, C (Ch.	
101.825-4) ....	62-18
8124, 8125, 8126,	
(Ch. 101.831A,	
101.831-1) (See Model	
8127—Set 41-20)	
8127, A, B, C (Ch.	
101.831A), 8128, A, B,	
C (Ch. 101.831), Wire	
Recorder Amp. (Ch.	
101.773) ....	41-20
8130 Tel. Rec. ....	49-21
8132 (Ch. 101.854)	
Tel. Rec. ....	66-15
8132 (Ch. 101.829-1, Ch.	
101.846) Tel. Rec. ....	66-15
8144 (Ch. 431.199)	32-21
8145 (Ch. 109.631)	45-23
8148 (Ch. 109.632)	44-22
8149 (Ch. 109.633)	48-23
8150 (Ch. 109.634)	32-22
8152 (Ch. 109.635)	
(See Model 8153—	
Set 42-22)	
8153 (Ch. 109.635)	
8153A (Ch. 109.635-1)	42-22
8155 (Ch. 463.155)	57-17
8157 (Ch. 109.636A)	50-17
8168 (Ch. 109.638)	46-23
8169 (Ch. 109.638)	
(See Model 8168—	
Set 46-23)	
8200 (Ch. 101.800-2B)	
(See Model 6200A—	
Set 65-12)	
8201 (See Model 6200A—	
Set 65-12)	
8210 (Ch. 101.820-1A)	71-13
8220, 8221 (Ch. 101.801-3D)	
(See Model 6220—	
Set 9-30)	
8222 (See Model 6220—	
Set 9-30)	
8230 (Ch. 101.835) ....	59-18
8231 (See Model 8230—	
Set 59-18)	
8260 (Ch. 101.823-2B)	
(See Model 7165—	
Set 10-29)	
8270 (Ch. 101.822)	
8270A (Ch. 101.822A)	57-18
9000 (Ch. 132.857)	65-13
9005, 9006 (Ch. 132.858)	72-11
9022 (Ch. 132.871)	76-17
9054 (Ch. 101.849)	63-16
9073, 9073A (Ch.	
135.244), 9073B	
(Ch. 135.244-1) ....	83-10
9073C (Ch. 135.243-1)	
(See Model 9073—	
Set 83-10)	
9082 (Ch. 135.245) ....	101-11
9101 (Ch. 101.809-3C)	
(See Model 7080—	
Set 58-20)	
9102 (See Model 7080—	
Set 58-20)	
9105 (Ch. 132.875) ....	89-14
9107A (Ch. 101.851-1)	
(See Model 8107A—	
Set 64-10)	
9111 (Ch. 110.499) Tel.	
Rec. (See Model 9123—	
Set 79-16)	
9112 (Ch. 110.499-1) Tel.	
Rec. (See Model 9124—	
Set 79-16)	
9113 (Ch. 110.499) Tel.	
Rec. (See Model 9123—	
Set 79-16)	
9114 (Ch. 110.499-1) Tel.	
Rec. (See Model 9124—	
Set 79-16)	
9115 (Ch. 478.224), 9116	
(Ch. 478.221) Tel. Rec. ....	97-16
9116 (Ch. 478.221)	
Tel. Rec. ....	97-16
9119, 9120 (Ch.	
101.865) Tel. Rec. ....	*
9120A (Ch. 101.862-1)	
Tel. Rec. ....	*
9121 (Ch. 101.867)	
Tel. Rec. ....	*
9122 (Ch. 101.864)	
(See Model 8132—	
Set 66-15)	
9122A (Ch. 101.868)	
Tel. Rec. ....	*
9123 (Ch. 110.499)	
Tel. Rec. ....	79-16
9124 (Ch. 110.499-1)	
Tel. Rec. ....	79-16
9125 (Ch. 478.252)	
Tel. Rec. ....	*
9125A (Ch. 478.253)	
Tel. Rec. ....	104-10
9125B (Ch. 478.253-1)	
Tel. Rec. ....	*
9126 (Ch. 110.499-2)	
Tel. Rec. ....	79-16
9127 (Ch. 100.499-2)	
Tel. Rec. (See Model	
9126—Set 79-16)	
9128A (Ch. 101.868)	
Tel. Rec. ....	*

## SILVERTONE—Cont.

9129 (Ch. 110.499) Tel.	
Rec. (See Model 9123—	
Set 79-16)	
9130 (Ch. 110.499-1) Tel.	
Rec. (See Model 9124—	
Set 79-16)	
9131 (Ch. 478.210)	
Tel. Rec. ....	84-10
9132 (Ch. 110.499-1) Tel.	
Rec. (See Model 9124—	
Set 79-16)	
9133, 9134 (Ch. 101.866,	
Radio Ch. 101.859)	
Tel. Rec. ....	95-5
9139, 9140 (Ch. 110.499-1)	
Tel. Rec. (See Model	
9124—Set 79-16)	
9153 (Ch. 435.417) ....	67-16
9161 (Ch. 548.358) ....	88-10
9270 (Ch. 547.245) ....	51-20
9280 (Ch. 528.168) ....	94-9
Ch. 100.043	
(See Model 133)	
Ch. 100.107	
(See Model 133)	
Ch. 100.107-1	
(See Model 149)	
Ch. 100.111	
(See Model 143A)	
Ch. 100.112	
(See Model 161-16)	
Ch. 100.115	
(See Model 142)	
Ch. 100.120	
(See Model 165-16)	
Ch. 100.201	
(See Model 69)	
Ch. 100.202	
(See Model 1066)	
Ch. 100.209	
(See Model 2195-21)	
Ch. 100.208	
(See Model 1176-21)	
Ch. 100.208-1	
(See Model 2195-21)	
Ch. 100.209	
(See Model 2170-C)	
Ch. 100.210, -1, -3	
(See Model 2130)	
Ch. 100.959	
(See Model 142)	
Ch. 101.660-1A	
(See Model 6100)	
Ch. 101.662-2B,	
(See Model 6105)	
Ch. 101.662-2C	
(See Model 6105)	
Ch. 101.662-3C	
(See Model 6111)	
Ch. 101.662-4E	
(See Model 6106A)	
Ch. 101.662-5F	
(See Model 6111A)	
Ch. 101.666-1B	
(See Model 6285A)	
Ch. 101.672-1A	
(See Model 6093)	
Ch. 101.672-1B	
(See Model 6092)	
Ch. 101.677B	
(See Model 6290)	
Ch. 101.773	
(See Model 8127)	
Ch. 101.800-1, -1A	
(See Model 6200A,	
Ch. 101.800-1, -1A)	
Ch. 101.800-3 (See Model	
6200A, Ch. 101.800-3)	
Ch. 101.801, -1A	
(See Model 6230)	
Ch. 101.802, -1	
(See Model 6230)	
101.807, A (See Model	
7021)	
Ch. 101.808	
(See Model 7054)	
Ch. 101.808-1C	
(See Model 8052)	
Ch. 101.808-1D	
(See Model 8053)	
Ch. 101.809 (See	
Model 7080,	
Ch. 101.809)	
Ch. 101.809-1A	
(See Model 8083)	
Ch. 101.809-1B	
(See Model 8084)	
Ch. 101.809-2, 8080	
(Ch. 101.809-2)	
Ch. 101.809-3C	
(See Model 8101)	
Ch. 101.810	
(See Model 7090)	
Ch. 101.811	
(See Model 7100)	
Ch. 101.813	
(See Model 8050)	
Ch. 101.814	
(See Model 7085)	
Ch. 101.814-1A	
(See Model 7102)	
Ch. 101.814-2B	
(See Model 8102)	
Ch. 101.814-3B	
(See Model 8102A)	
Ch. 101.814-5C	
(See Model 8086)	
Ch. 101.814-6C	
(See Model 8086A)	
Ch. 101.817	
(See Model 7070)	
Ch. 101.819A	
(See Model 7226)	
Ch. 101.820	
(See Model 7210)	
Ch. 101.821	
(See Model 8090)	
Ch. 101.822	
(See Model 8270)	
Ch. 101.822A	
(See Model 8270A)	
Ch. 101.823, -1	
(See Model 7166)	

## SILVERTONE—Cont.

Ch. 101.823-A, -1A	
(See Model 7165)	
Ch. 101.825	
(See Model 7115)	
Ch. 101.825-1A	
(See Model 7116)	
Ch. 101.825-1B	
(See Model 7117)	
Ch. 101.825-2C	
(See Model 7119)	
Ch. 101.825-3D	
(See Model 8115)	
Ch. 101.825-3E	
(See Model 8117)	
Ch. 101.825-3F	
(See Model 8118)	
Ch. 101.825-4	
(See Model 8097A)	
Ch. 101.829	
(See Model 8100)	
Ch. 101.829-1	
(See Model 8133)	
Ch. 101.831	
(See Model 8128)	
Ch. 101.831A	
(See Model 8127)	
Ch. 101.831-1	
(See Model 8124)	
Ch. 101.833	
(See Model 8105)	
Ch. 101.834	
(See Model 8072)	

SILVERTONE-STARK

SILVERTONE-Cont.

Ch. 435.417 (See Model 9153)  
 Ch. 436.200 (See Model 7145)  
 Ch. 456.150 (See Model 1260)  
 Ch. 465.150-1 (See Model 1268-21)  
 Ch. 456.150-2 (See Model 1260)  
 Ch. 463.155 (See Model 8155)  
 Ch. 478.206-1 (See Model 8024)  
 Ch. 478.210 (See Model 9131)  
 Ch. 478.221 (See Model 9116)  
 Ch. 478.224 (See Model 9115)  
 Ch. 478.238 (See Model 25)  
 Ch. 478.240 (See Model 144)  
 Ch. 478.252 (See Model 9125)  
 Ch. 478.253 (See Model 9125A)  
 Ch. 478.253-1 (See Model 9125B)  
 Ch. 478.257 (See Model 125)  
 Ch. 478.257-1 (See Model 125B)  
 Ch. 478.289 (See Model 112)  
 Ch. 478.302 (See Model 114)  
 Ch. 478.303, A (See Model 110)  
 Ch. 478.309 (See Model 159)  
 Ch. 478.311 (See Model 120)  
 Ch. 478.312 (See Model 144)  
 Ch. 478.313 (See Model 164-14)  
 Ch. 478.319 (See Model 163-16)  
 Ch. 478.338 (See Model 150-14)  
 Ch. 478.339 (See Model 166-16)  
 Ch. 478.339-A (See Model 166-17)  
 Ch. 478.339-B (See Model 1166-17)  
 Ch. 478.361, A (See Model 1150-14)  
 Ch. 488.237 (See Model 237)  
 Ch. 528.168 (See Model 9280)  
 Ch. 528.171-1 (See Model 225)  
 Ch. 528.173 (See Model 220)  
 Ch. 528.174 (See Model 215)  
 Ch. 528.194 (See Model 1040)  
 Ch. 528.196 (See Model 1032)  
 Ch. 528.210, -1 (See Model 1017)  
 Ch. 528.229 (See Model 2200)  
 Ch. 528.230 (See Model 2028)  
 Ch. 528.233 (See Model 2225)  
 Ch. 528.235 (See Model 2041)  
 Ch. 528.239 (See Model 3170)  
 Ch. 528.259 (See Model 3200)  
 Ch. 528.630, -1 (See Model 151-16)  
 Ch. 528.631 (See Model 1184-20)  
 Ch. 528.631, -1 (See Model 2110A)  
 Ch. 528.632, -1, -2, -3, -4, -5 (See Model 2110A)  
 Ch. 528.632A, -1, -2, -3, -4, -5 (See Model 2110A)  
 Ch. 528.628, -1, -3 (See Model 6286)  
 Ch. 528.6287, -1, -3 (See Model 6287)  
 Ch. 528.6293-2 (See Model 6293)  
 Ch. 528.6295 (See Model 6295)  
 Ch. 547.245 (See Model 9270)  
 Ch. 548.358 (See Model 9161)  
 Ch. 548.358-1 (See Model 245)  
 Ch. 548.360-1 (See Model 239)  
 Ch. 548.361 (See Model 239)  
 Ch. 548.363 (See Model 33)  
 Ch. 549.100 (See Model 101)  
 Ch. 549.100-1 (See Model 101A)  
 Ch. 549.100-3 (See Model 102A)  
 Ch. 549.100-4 (See Model 160-12)  
 Ch. 549.100-5, -6, -7, -8, -9 (See Model 175-16)  
 Ch. 549.102, -2 (See Model 169-16)  
 Ch. 757.100 (See Model 2007)  
 Ch. 757.110 (See Model 2003)

SIMPLON

CA-5 ..... 22-27  
 WV2 ..... 17-30  
**SKY KNIGHT (See Air Knight)**  
**SKYRIDER (See Hallcrafters)**  
**SKYROVER**  
 N5-RD-250 (9022-N) .....  
 N5-RD-251 (9022-H) ..... 6-31  
 N5-RD295 (Ch. 5A7) ..... 21-30  
**SKY WEIGHT**  
 81 ..... 20-30  
 82 ..... 13-13  
**SONOGRAPH**  
 BL100 (See Model 122-10)  
 BL100-Set 122-10)  
**SONORA**  
 RBU-176 ..... 5-31  
 RB-207 (See Model RBU-176-Set 5-31)  
 RCU-208 ..... 5-30  
 RDU-209 ..... 3-29  
 RET-210 ..... 24-24  
 RGMF-212, RGMF-230 ..... 27-26  
 RKRU-215 (Ch. RKRU) ..... 9-31  
 RMR-219 ..... 19-28  
 RMR-220, RMR-245 (See Model RMR-219-Set 19-28)  
 RQU-222 ..... 8-23  
 RWFU-238 ..... 23-24  
 RK-223 ..... 19-29  
 WAU-243 ..... 27-27  
 WBRU-239 ..... 32-23  
 WCU-246 ..... 36-22  
 WDU-233 ..... 25-27  
 WDU-249 ..... 37-20  
 WEU-262 ..... 33-28  
 WGFU-241, WGFU-242 ..... 24-25  
 WJU-252 ..... 36-23  
 WKRU-254A ..... 34-20  
 WLRU-219A ..... 37-21  
 WLRU-220A (See Model WLRU-219A-Set 37-21)  
 WLRU-245A (See Model WLRU-219A-Set 37-21)  
 YB-299 ..... 112-9  
 100 ..... 41-21  
 101 ..... 48-24  
 102 ..... 53-23  
 171 (See Model 171-Set 109-13)  
 302, 303 Tel. Rec. ..... 97A-13  
 305, Tel. Rec. ..... 174-11  
 306 ..... 108-11  
 323, 324, 325 ..... 174-11  
 332 Tel. Rec. ..... 174-11  
 350, 351 Tel. Rec. ..... 173-13  
 352 Tel. Rec. ..... 182-12  
 401 ..... 47-21  
 402A (See Model RMR-219-Set 19-28)  
 402F (See Model WLRU-219A-Set 37-21)  
**SOUND, INC.**  
 "Interstund" ..... 7-27  
 MB6P3, MB6P6, MB6P30, MB6R4 ..... 35-21  
 MB7E3 ..... 28-31  
 MB7E8 ..... 26-24  
 582 ..... 28-32  
**SPARKS-WITHINGTON (See Sparton)**  
**SPARTON (Also see Record Changer Listing)**  
 4AW17 (Ch. 417) ..... 50-18  
 4AW17-A (Ch. 417A) ..... 49-22  
 5AH06, 5A106 (See Model 5AW06-Set 4-17)  
 5A115 (Ch. 5-16) ..... 30-29  
 5AM26-P5 (Ch. 5-26-P5) ..... 5-17  
 5AW06 (Ch. 5-06) ..... 4-17  
 5AW16 (Ch. 5-16) ..... 30-29  
 6AM06 (Ch. 6-06) ..... 34-21  
 6AM26 (See Model 6AW26PA-Set 15-33)  
 6AW26PA (Ch. PCS-6-26) ..... 15-33  
 6-66A (Ch. 6-66A) ..... 51-21  
 7AM46 (Ch. 7-46) ..... 1-31  
 7AM46PA, 7BM46PA, 7BW46PA (See Model 7AM46-Set 1-31)  
 8AM46 (Ch. 8-46) ..... 1-31  
 10AB76-PA, 10AM76-PA, 10BM76-PA (See Model 10BW76-PA-Set 15-34)  
 10BW76-PA (Ch. 10-76PA) ..... 15-34  
 100, 101 (Ch. 5A7) ..... 38-23  
 102, 103, 104 (See Model 100-Set 38-23)  
 121 (Ch. 819) ..... 57-19  
 122 (See Model 121-Set 57-19)  
 130, 132, 135, 139 (Ch. 5A10) ..... 94-10  
 141 (See Model 121-Set 57-19)  
 141A (Ch. 8110) ..... 92-6  
 141XX, 142XX (Ch. 8W10) ..... 126-12  
 142 (See Model 121-Set 57-19)  
 150, 151, 152, 155 (Ch. 4E10) ..... 91-12  
 230 (Ch. 5A10, A) ..... 210-10  
 232 (Ch. 5A10, A) ..... 210-10  
 239 (Ch. 5A10, A) ..... 210-10  
 350, 351 (Ch. 613) ..... 197-12  
 1000, 1001, 1003 (Ch. 1217) ..... 60-18  
 1005, 1006, 1007, 1008 (Ch. 8-57) ..... 29-25  
 1010 (Ch. 717) ..... 35-22  
 1015 (See Model 10BW76PA-Set 15-34)  
 1020, 1021, 1023, 1030, 1030A (Ch. 618) ..... 60-18  
 37-22

SPARTON-Cont.

1031, A (See Model 1030-Set 37-22)  
 1035, 1035A, 1036, 1036A, 1037, 1037A, 1039, 1040, 1041 (Ch. 918) ..... 62-19  
 1040XX, 1041XX (Ch. 8W10) ..... 126-12  
 1051, 1052 (Ch. 689) ..... 58-21  
 1058, 1059, 1060, 1061, 1064 (Ch. 819) ..... 57-19  
 1071 (See Model 121-Set 57-19)  
 1072 (Ch. 819) ..... 57-19  
 1080 (Ch. 918A) (See Model 4900TV-Set 64-11)  
 1080A (Ch. 8110) (See Model 141A-Set 92-6)  
 1081 (Ch. 918A) (See Model 4900TV-Set 64-11)  
 1081A (Ch. 8110) (See Model 141A-Set 92-6)  
 1085, 1086, (Ch. 8W10), 126-12  
 1090, 1091, (Ch. 8W10), 126-12  
 1210, 1211 (Ch. 8W10) (See Model 141XX-Set 126-12)  
 1300, 1301 (Ch. 613) ..... 197-12  
 4900TV (Ch. 24TV9C, 3TV9C, 918A) Tel. Rec. 64-11  
 4916, 4917, 4918 (Ch. 24T110, 3T110, 6510) Tel. Rec. ..... 164-9  
 4920, 4921, 4922 (Ch. 24T101) Tel. Rec. ..... 164-9  
 4935 (Ch. 23T10C) Tel. Rec. ..... 133-1A  
 4939TV, 4940TV, 4941TV (Ch. 24TV9, 3TV9) Tel. Rec. ..... 64-11  
 4942 (Ch. 23T10C) Tel. Rec. ..... 133-1A  
 4944, 4945 (Ch. 3T810, 24T810) Tel. Rec. ..... 86-10  
 4951, 4952 (See Model 4900TV-Set 64-11)  
 4954 (Ch. 23T10C) Tel. Rec. ..... 133-1A  
 4960 (Ch. 23T10C) Tel. Rec. ..... 133-1A  
 4964, 4965 (Ch. 23T810) Tel. Rec. ..... 157-11  
 4970, 4971, 4972 (Ch. 8510) ..... 92-6  
 5002, 5003 (Ch. 23T10) Tel. Rec. ..... 102-13  
 5006, 5007 (Ch. 23T10) Tel. Rec. ..... 102-13  
 500X (Ch. 25TK10A) Tel. Rec. ..... 121-13  
 5007X (Ch. 25TK10A) Tel. Rec. ..... 121-13  
 5010, 5011 (Ch. 19T510, A) Tel. Rec. ..... 104-11  
 5014, 5015 (Ch. 19T510, A) Tel. Rec. ..... 104-11  
 5025 (Ch. 265S160) Tel. Rec. ..... 128-13  
 5025BA Tel. Rec. (See Prod. Chge. Bul. 22-Set 138-1 and Model 5025-Set 128-13)  
 5026 Tel. Rec. ..... 128-13  
 5029, 5030 (Ch. 26SD160) Tel. Rec. ..... 128-13  
 5035, 5036, 5037 (Ch. 265S160) Tel. Rec. ..... 128-13  
 5052 (Ch. 24T810, 3T810) Tel. Rec. ..... 97A-13  
 5056, 5057 (Ch. 19T510, A) Tel. Rec. ..... 104-11  
 5064, 5065 (Ch. 23T810) Tel. Rec. ..... 157-11  
 5068, 5069 (Ch. 24TV9C) Tel. Rec. (See Model 4900TV-Set 64-11)  
 5071, 5072 (Ch. 19T510, A) Tel. Rec. ..... 104-11  
 5075BA Tel. Rec. (See Prod. Chge. Bul. 22-Set 138-1 and Model 5075-Set 128-13)  
 5076 (Ch. 265S160, B) Tel. Rec. ..... 128-13  
 5076BA Tel. Rec. (See Prod. Chge. Bul. 22-Set 138-1 and Model 5076-Set 128-13)  
 5076BB Tel. Rec. ..... 128-13  
 5077 Tel. Rec. ..... 128-13  
 5077BA Tel. Rec. (See Prod. Chge. Bul. 22-Set 138-1 and Model 5077-Set 128-13)  
 5078 Tel. Rec. ..... 128-13  
 5079 Tel. Rec. ..... 128-13  
 5079B Tel. Rec. (See Prod. Chge. Bul. 22-Set 138-1 and Model 5079-Set 128-13)  
 5080 Tel. Rec. ..... 128-13  
 5080BC Tel. Rec. (See Prod. Chge. Bul. 22-Set 138-1 and Model 5080-Set 128-13)  
 5082, 5083 (Ch. 26SD160, 26SD170) Tel. Rec. (For TV Ch. See Set 128-13, For Radio Ch. See Model 141XX-Set 126-12)  
 5082, 5083 (Ch. 26SD170X, XP) Tel. Rec. (For TV Ch. See Prod. Chge. Bul. 22-Set 138-1 and Model 5082-Set 128-13, For Radio Ch. See Model 141XX-Set 126-12)  
 5085, 5086 (Ch. 2RD190, 25RD190) Tel. Rec. ..... 139-14

SPARTON-Cont.

5088, 5089, 5090 (Ch. 26SD160, 26SD170 and Radio Ch. 8W10) (For TV Ch. See Set 128-13, For Radio Ch. See Model 141XX-Set 126-12)  
 5101, 5102, 5103 (Ch. 265S170, P) Tel. Rec. (See Prod. Chge. Bul. 22-Set 138-1 and Model 5025-Set 128-13)  
 5104, 5105 (Ch. 265S170D, P) Tel. Rec. (See Prod. Chge. Bul. 22-Set 138-1 and Model 5025-Set 128-13)  
 5107, 5108 (Ch. 265S170D, 265S170DD) Tel. Rec. ..... 5107X (Ch. 265S171) Tel. Rec. ....  
 5110 (Ch. 265S170D, 265S170DD) Tel. Rec. ....  
 5125 (Ch. 275S170D, 265S170DD) Tel. Rec. ....  
 5152, 5153, 5154 (Ch. 265S170, P) Tel. Rec. (5025-Set 128-13)  
 5155, 5156, 5157 (Ch. 26SD170X, XP) Tel. Rec. (See Prod. Chge. Bul. 22-Set 138-1 and Model 5025-Set 128-13)  
 5158 (Ch. 26SD170, P) Tel. Rec. (See Prod. Chge. Bul. 22-Set 138-1 and Model 5025-Set 128-13)  
 5162X, 5163X (Ch. 265S171A) Tel. Rec. ....  
 5165X, 5166X (Ch. 26SD171) Tel. Rec. .... 166-13  
 5170, 5171 (Ch. 25SD201, 25SD201) Tel. Rec. .... 147-11  
 5175X (Ch. 26SD171) Tel. Rec. .... 166-13  
 5178X (Ch. 26SD171) Tel. Rec. .... 166-13  
 5182, 5183, 5188, 5189 (Ch. 26SD170, P and Radio Ch. 8W10) Tel. Rec. (For TV Ch. See Prod. Chge. Bul. 22-Set 138-1 and Model 5025-Set 128-13, For Radio Ch. See Model 141XX-Set 126-12)  
 5191, 5192 (Ch. 25SD201, 25SD201) Tel. Rec. (See Model 5170-Set 147-11)  
 5207, 5208 (Ch. 265S172, A) Tel. Rec. .... 167-14  
 5207A (Ch. 255172) Tel. Rec. ....  
 5210 (Ch. 265S172B) Tel. Rec. .... 167-14  
 5212 (Ch. 215172) Tel. Rec. .... 174-12  
 5220 (Ch. 26SD172C) Tel. Rec. .... 167-14  
 5225, 5226 (Ch. 26SD172C) Tel. Rec. .... 167-14  
 5240, 5241 (Ch. 215212) Tel. Rec. .... 201-10  
 5250, 5252, 5253 (Ch. 215172) Tel. Rec. 174-12  
 5262, 5263 (Ch. 265S172, A) Tel. Rec. .... 167-14  
 5265 (Ch. 26SD172, A) Tel. Rec. .... 167-14  
 5267, 5268 (Ch. 26SD172, A) Tel. Rec. .... 167-14  
 5270 (Ch. 26SD172C) Tel. Rec. .... 167-14  
 5271 (Ch. 26SD172C) Tel. Rec. See Model 5207-Set 167-14  
 5272, 5273 (Ch. 26SD172C) Tel. Rec. .... 167-14  
 5280, 5281 (Ch. 215212) Tel. Rec. .... 201-10  
 5288, 5289 (Ch. 25CD202) Tel. Rec. .... 178-11  
 5290 (Ch. 25SD202) Tel. Rec. ....  
 5291, 5292, 5293, 5294, 5295 (Ch. 25CD202) Tel. Rec. .... 178-11  
 5296A, 5297A (Ch. 25CD202) Tel. Rec. .... 178-11  
 5298, 5299 (Ch. 25CD202) Tel. Rec. (See Model 5298-Set 178-11)  
 5301 (Ch. 215173-D) Tel. Rec. .... 201-10  
 5340, 5341 (Ch. 215213) Tel. Rec. .... 201-10  
 5342 (Ch. 25D213) Tel. Rec. ....  
 5342A (Ch. 27D213) Tel. Rec. .... 210-11  
 5343 (Ch. 25D213) Tel. Rec. ....  
 5343A (Ch. 27D213) Tel. Rec. .... 210-11  
 5380, 5381 (Ch. 215213) Tel. Rec. .... 201-10  
 5382A (Ch. 27D213) Tel. Rec. .... 210-11  
 5382B (Ch. 27D213-A) Tel. Rec. .... 210-11  
 5383A (Ch. 27D213) Tel. Rec. .... 210-11  
 5384A (Ch. 27D213) Tel. Rec. .... 210-11  
 5386A (Ch. 27D213) Tel. Rec. .... 210-11  
 10352, 10353 (Ch. 27D213) Tel. Rec. .... 210-11

SPARTON-Cont.

Ch. PC-5-6-26 (See Model 6AW26PA)  
 Ch. 2RD190 (See Model 5085)  
 Ch. 25D201 (See Model 5170)  
 Ch. 3T810 (See Model 4944)  
 Ch. 3TR10 (See Model 5052)  
 Ch. 3TV9, 3TV9C (See Model 4900TV)  
 Ch. 4E10 (See Model 150)  
 Ch. 5A7 (See Model 100)  
 Ch. 5-06 (See Model 3AW06)  
 Ch. 5A10 (See Model 130)  
 Ch. 5A10, A (See Model 230)  
 Ch. 5-16 (See Model 5A116)  
 Ch. 5-29PS (See Model 5AM26PS)  
 Ch. 689 (See Model 1051)  
 Ch. 613 (See Model 350)  
 Ch. 618 (See Model 1030)  
 Ch. 6-06 (See Model 6AM06)  
 Ch. 717 (See Model 1010)  
 Ch. 7-46 (See Model 7AM46)  
 Ch. 819 (See Model 121)  
 Ch. 8110 (See Model 141A)  
 Ch. 8510 (See Model 4970)  
 Ch. 8W10 (See Model 141XX)  
 Ch. 8-46 (See Model 8AM46)  
 Ch. 8-57 (See Model 1005)  
 Ch. 918 (See Model 1035)  
 Ch. 918A (See Model 4900TV)  
 Ch. 10-77PA (See Model 10BW76PA)  
 Ch. 1217 (See Model 1000)  
 Ch. 19T510, 19T510A (See Model 5010)  
 Ch. 215172 (See Model 5212)  
 Ch. 215173-D (See Model 5301)  
 Ch. 215212 (See Model 5240)  
 Ch. 215213 (See Model 5340)  
 Ch. 23T810 (See Model 4964)  
 Ch. 23T10C (See Model 4935)  
 Ch. 23T10D (See Model 5002)  
 Ch. 24T810 (See Model 4944)  
 Ch. 24T110 (See Model 4916)  
 Ch. 24T10 (See Model 4920)  
 Ch. 24TR10 (See Model 5052)  
 Ch. 24TV9 (See Model 4939TV)  
 Ch. 24TV9C (See Model 4900TV)  
 Ch. 25CD202 (See Model 5288)  
 Ch. 25D213 (See Model 5342)  
 Ch. 25RD190 (See Model 5085)  
 Ch. 255172 (See Model 5207A)  
 Ch. 25SD201 (See Model 5170)  
 Ch. 25SD202 (See Model 5290)  
 Ch. 25TK10A (See Model 5006X)  
 Ch. 26SD160 (See Model 5025)  
 Ch. 26SD170 (See Model 5082)  
 Ch. 26SD170P (See Model 5182)  
 Ch. 26SD170X, XP (See Model 5082)  
 Ch. 26SD171 (See Model 5165X)  
 Ch. 26SD172, A (See Model 5267)  
 Ch. 26SD172C (See Model 5220)  
 Ch. 265S160, B (See Model 5076)  
 Ch. 265S160L (See Model 5035)  
 Ch. 265S170 (See Model 5101)  
 Ch. 265S170 D (See Model 5104)  
 Ch. 265S170DD (See Model 5107)  
 Ch. 265S170 P (See Model 5104)  
 Ch. 265S171, A (See Model 5107X)  
 Ch. 265S172, A, B (See Model 5207)  
 Ch. 27D213 (See Model 5342A)  
 Ch. 27D213-A (See Model 5382B)  
 Ch. 417 (See Model 4AW17)  
 Ch. 417A (See Model 5AW17A)  
 Ch. 666A (See Model 6-66A)  
**SPIEGEL (See Aircraft)**  
**STARK**  
 410 ..... 40-22  
 1010 ..... 88-2  
 1020 ..... 89-5



**STARRETT**

Gotham Tel. Rec. .... 101-12  
 Henry Hudson, Henry Parks  
 Tel. Rec. .... 92-7  
 John Hancock Tel. Rec. .... 96-10  
 Nathan Hale Tel. Rec. .... 87-12  
 Robert E. Lee Tel. Rec. .... 92-7  
 A17CG-1 (Ch. 1751)  
 Tel. Rec. (See Ch. 1751)  
 1751-Set 165-2A)  
 A17TG-1 (Ch. 1751)  
 Tel. Rec. (See Ch. 1751)  
 1751-Set 165-2A)  
 A20C-2 (Ch. 1851)  
 Tel. Rec. (See Ch. 1851)  
 1851-Set 165-2A)  
 A20CD-1 (Ch. 1851)  
 Tel. Rec. (See Ch. 1851)  
 1851-Set 165-2A)  
 A20TG (Ch. 1851)  
 Tel. Rec. (See Ch. 1851)  
 1851-Set 165-2A)  
 178M1 (Ch. 1251)  
 Tel. Rec. .... 149-13  
 208M1 (Ch. 1551)  
 Tel. Rec. .... 149-13  
 278M1 (Ch. 1251)  
 Tel. Rec. .... 149-13  
 29AM1 (Ch. 1451)  
 Tel. Rec. .... 149-13  
 308M1 (Ch. 1551)  
 Tel. Rec. .... 149-13  
 378B1 (Ch. 1251)  
 Tel. Rec. .... 149-13  
 39AM1 (Ch. 1451)  
 Tel. Rec. .... 149-13  
 Ch. 1251 (See Model 178M1)  
 Ch. 1451 (See Model 29AM1)  
 Ch. 1551 (See Model 208M1)  
 Ch. 1751 ..... 165-2A  
 Ch. 1851 ..... 165-2A

**STEELMAN**

AF1100 ..... 180-9  
 3D2 ..... 211-14  
 3RP1 ..... 210-12  
 102 ..... 184-14  
 107 ..... 178-12  
 200 ..... 23-25  
 215 ..... 165-13  
 303 ..... 19-31  
 327 ..... 182-13  
 330 ..... 186-12  
 350, 351 ..... 21-31  
 357 ..... 178-13  
 450, 451 ..... 178-14  
 487 ..... 182-14  
 517 ..... 179-12  
 595 ..... 164-10  
 597 ..... 183-16  
 601 ..... 177-12  
 602 ..... 185-13  
 6000 ..... 186-13  
 5101 ..... 162-12  
 6000 ..... 163-11

**STEWART-WARNER**

AVCI (Code 9054B), AVC2  
 (Code 9054A) Tel. Rec. 64-12  
 A51T1 (Code 9020-A)  
 A-51T2 (Code 9020-B)  
 A-51T3 (Code 9020-C)  
 A-51T4 (Code 9020-D) ..... 17-32  
 A61CR1 (Code 9034-C)  
 A61CR2 (Code 9034-B)  
 A61CR3 (Code 9034-E)  
 A61CR4 (Code 9034-F) ..... 39-25  
 A61P1 (Code 9036-A)  
 A61P2 (Code 9036-B)  
 A61P3 (Code 9036-C) ..... 42-23  
 A72T1 (Code 9026-A)  
 A72T2 (Code 9026-B)  
 A72T3 (Code 9026-C) ..... 32-24  
 A72T4 (Code 9026-D)  
 A92CR3, A92CR5  
 (Code 9028-C), A92CR6,  
 A92CR7 (Code 9028-F) ..... 29-26  
 B51T1, B51T2, B51T3  
 (Code 9044A, B, C) ..... 58-22  
 B61T1, B61T2 (Code  
 9046A, B) ..... 59-19  
 B72CR1 (Code No. 9038A) ..... 47-22  
 B92CR1, B92CR2, B92CR3,  
 B92CR4, B92CR5,  
 B92CR6, B92CR7  
 (Codes 9043A, B, C, D,  
 K, L, M) ..... 65-14  
 C51T1 (Code 9054-A),  
 C51T2 (Code 9054-B) ..... 41-22  
 T-711 (Code 9031-A)  
 Tel. Rec. .... 95A-12  
 T-711M (Code 9031-AM)  
 Tel. Rec. .... 95A-12  
 T-712 (Code 9031-B)  
 Tel. Rec. .... 95A-12  
 TRC-721 (Code 9037-A)  
 Tel. Rec. .... 95A-12  
 21C-9210C (Series "A, B,  
 C, D, E, F, G) ..... 192-8  
 21C-9211D, E, F, G (Series  
 A, B, C) Tel. Rec. .... 200-9  
 21T-9210A (Series "A, B,  
 C, D, E") Tel. Rec. .... 192-8  
 21T-9211B (Series A, B)  
 Tel. Rec. .... 200-9  
 21T-9211C (Series A, B, C)  
 Tel. Rec. .... 200-9  
 27C-9212A (Series A, B, C)  
 Tel. Rec. .... 211-15  
 51T46 (Code 9028-B)  
 51T56 (Code 9028-C) ..... 39-24  
 51T126 (Code 9018-C),  
 51T136 (Code 9018-F),  
 51T146 (Code 9018-H),  
 51T176 (Code 9018-B) ..... 15-35  
 61T16 (Code 9022-A),  
 61T26 (Code 9022-B) ..... 1-6  
 62T16 (Code 9023-C),  
 62T16 (Code 9023-D),  
 62T26 (Code 9023-E),  
 62T36 (Code 9023-F) ..... 2-21  
 72CR16, 72CR26 ..... 18-28  
 9000-B ..... 11-22  
 9001-C, D, E, F ..... 8-29

**STEWART-WARNER-Cont.**

9002-A, 9002-B, 9002-P,  
 9002-R ..... 38-24  
 9005-A, B ..... 13-31  
 9007-A, F, G ..... 10-30  
 9100A, 9100B, 9100E,  
 9100F, 9100G, 9100H  
 Tel. Rec. .... 75-15  
 9103-B, C, 9104-A, B, C  
 Tel. Rec. .... 105-10  
 9106A, B Tel. Rec. .... 118-10  
 9108A, B, 9109A, B  
 Tel. Rec. .... 118-10  
 9110-A, B ..... 118-10  
 9120-A, B, C, D, E, F  
 Tel. Rec. .... 137-11  
 9121-A, 9121-B, 9122-A  
 Tel. Rec. .... 138-9  
 9126-A, -B Tel. Rec. (See  
 Prod. Chge. Bul. 51-  
 Set 185-1 and Model  
 9120-A-Set 137-11)  
 9127-A Tel. Rec. .... 162-13  
 9132-A Tel. Rec. .... 190-13  
 9150-B, 9150-D, 9150-DZ  
 140-12  
 9151-A, -B, C ..... 106-14  
 9152-A, -B, C ..... 102-14  
 9153-A, -B, C ..... 108-12  
 9154-C, 9154-CZ ..... 142-13  
 9160 AU, BU, CU, .....  
 DU, EU ..... 171-10  
 9161A, B, C ..... 110-12  
 9162A, B ..... 168-13  
 9164-A, -B (See Model  
 9162-A, -B) ..... 168-13  
 9165A, -B ..... 193-11  
 9200-A, -C, -D, -FA,  
 -G Tel. Rec. .... 132-13  
 9202-A, -B (Thru Series  
 "B") Tel. Rec. (See  
 Model 9202-C (Series "B"  
 -Set 158-12))  
 9202-A, -B (Thru Series  
 "H") Tel. Rec. .... 172-9  
 9202-A, -B (Series "M")  
 Tel. Rec. (See Prod.  
 Chge. Bul. 60-Set  
 194-1 and Model 9202-A  
 (Series "H")-Set 172-9)  
 9202-C, -DA, -DB, -DD,  
 -E, -F (Thru Series "B")  
 Tel. Rec. .... 158-12  
 9202-C, -DA, -DB, -DD,  
 -DDA, -E, -F (Thru Series  
 "H") Tel. Rec. .... 172-9  
 9202-C, -DA, -DB, -DD,  
 -DDA, -E, -F (Series  
 "M") Tel. Rec. (See  
 Prod. Chge. Bul. 60-  
 Set 194-1 and Model  
 9202-A (Series "H")-  
 Set 172-9)  
 9202-FA (Thru Series "B")  
 Tel. Rec. (See Model  
 9202-C (Series "B")-  
 Set 158-12)  
 9202-FA (Thru Series "H")  
 Tel. Rec. .... 172-9  
 9202-FA (Series "M")  
 Tel. Rec. (See Prod.  
 Chge. Bul. 60-Set  
 194-1 and Model 9202-A  
 Series "H")-Set 172-9)  
 9203A Tel. Rec. .... 166-14  
 9204-A Tel. Rec. .... 164-11  
 9209-A, AW, B, C, D  
 (Series A, B, C, D, E)  
 Tel. Rec. .... 181-14  
 9210-C (Series "A, B,  
 C, D, E") Tel. Rec. .... 192-8

**ST. GEORGE**

(See Recorder Listing)

**STRATOVOK**

579-58A ..... 6-32

**STRONBERG-CARLSON**

AM-43 ..... 129-11  
 AM-48, AM-49 ..... 131-14  
 AP-50 ..... 130-13  
 AR-37A ..... 128-14  
 AR-37A ..... 173-5  
 AR-40 ..... 194-12  
 AR-425 ..... 199-12  
 AU-29 ..... 125-11  
 AU-32 ..... 133-12  
 AU-33 ..... 134-10  
 AU-34 ..... 128-5  
 AU-35 ..... 138-10  
 AU-36 ..... 132-14  
 AU-42 ..... 137-12  
 AV-38, AV-39 ..... 126-13  
 C-1 ..... 153-14  
 SR-401 ..... 191-18  
 TC-10 Tel. Rec. (Also See  
 Prod. Chge. Bul. 1-Set  
 103-19) ..... 79-17  
 TC-19 Tel. Rec. .... 97-17  
 TC-125 Tel. Rec. .... 95A-13  
 TS-15, TS-16, TS-125  
 Series Tel. Rec. .... 72-12  
 TV-101, TV-101W (112020)  
 Tel. Rec. .... \*  
 TV-10PM, TV-10PY (112025,  
 112022) Tel. Rec. .... \*  
 TV-12 (See Model TV-125-  
 Set 68-16)  
 TV-12 PGM (For TV Ch.  
 Only See Model TV-125-  
 Set 68-16)  
 TV-12M5M (For TV Ch.  
 Only See Model TV-125-  
 Set 68-16)  
 TV-12LM (See Model  
 TV-125-Set 68-16)  
 TV-125 (Ch. 12)  
 Tel. Rec. .... 68-16  
 16 Series Tel. Rec. .... 135-12  
 17 Series Tel. Rec. .... 135-12  
 24 Series Tel. Rec. .... 138-11  
 32 ..... 11-23  
 116 Series Tel. Rec. .... 135-12  
 117 Series Tel. Rec. (See  
 Model 119CDM-Set  
 130-14)

**STRONBERG-CARLSON-Cont.**

119C Tel. Rec. (See Prod.  
 Chge. Bul. 43-Set  
 177-1 and Model 119CDM  
 -Set 130-14)  
 119CDM, 119CDM ..... 130-14  
 119M5A, D, G, I, M, R  
 Tel. Rec. .... 130-14  
 119 RPM2 Tel. Rec. .... 130-14  
 317RPM, 317TM Tel. Rec. 146-10  
 321CD2M, 321CD2O,  
 321CF, 321CD2M Tel.  
 Rec. .... 165-14  
 324CDM, 324CSM .....  
 (Series 324) Tel. Rec. 172-10  
 417C5-M, 417C5-O, 417C5-  
 Dec. 417TX (Series 417)  
 Tel. Rec. .... 178-15  
 421CDM, CM, TX Tel.  
 Rec. (Also See Prod.  
 Chge. Bul. 47-Set  
 181-1) ..... 170-13  
 421 Series (Revised)  
 Tel. Rec. .... 198-14  
 1020 (See Model 1220  
 Series-Set 50-19)  
 1100-H, 1100-HI ..... 20-31  
 1101-H, 1101-HI .....  
 (Ch. 112002), 1101-HM,  
 1101-HW, 1101-HY  
 (Ch. 112001) ..... 2-9  
 1101-HM, -HW, -HY  
 (Ch. 112001) ..... 2-9  
 1101HPW, 1101HPW ..... 41-23  
 1105 (Series 10) ..... 18-29  
 1110-HW, 1110-PTW  
 (Series 10) ..... 18-30  
 1120 (See Model 1220  
 Series-Set 50-19)  
 1121-HW, LW, MI-O  
 M2-HW, M2-Y, PSM, PFW,  
 PGM, PGW, PLM, PLW,  
 PSM (Series 10-11-12) ..... 10-31  
 1135-PLM, 1135-PLM,  
 1135-PLW (Series 10-11) 23-26  
 1200 ..... 57-20  
 1202 (Series 10) ..... 55-21  
 204 (Ch. 112021) ..... 34-22  
 1210M2-Y, 1210M2-W,  
 1210PLM, 1210PGW  
 (Series 10-11) ..... 37-23  
 1220 Series ..... 50-19  
 1235 Series ..... 49-23  
 1400 ..... 57-20  
 1407PFM, 1407PLM ..... 58-23  
 1409M2-M, 1409M2-Y,  
 1409M2-W, 1409M3-A,  
 1409M3-M, 1409PG-M,  
 1409PG-W ..... 62-20  
 1500 ..... 132-15  
 1507 ..... 133-13  
 1608 ..... 150-12

**STUDEBAKER**

AC2111 (S5127) ..... 166-15  
 AC2113 (S5123) ..... 172-11  
 S-4624, S-4625 ..... 21-32  
 S-4626, S-4627 ..... 19-32

**SUPREME (Lipan)**

711 ..... 68-17  
 7125 ..... 63-17  
 733 ..... 60-19  
 738 ..... 64-13  
 750 ..... 55-22

**SUTCO (Suffon)**

21-A Tel. UHF Conv. .... 201-11

**SWANK**

5 Tube Radio-phon  
 (DU101) ..... 5-21  
 ER61 ..... 17-33

**SYLVANIA**

C33M Tel. UHF Conv. .... 199-13  
 1-075 (Ch. 1-139) Tel.  
 Rec. (Also See Prod.  
 Chge. Bul. 48-Set  
 182-1) ..... 92-8  
 1-076 (Ch. 1-108) Tel.  
 Rec. (Also See Prod.  
 Chge. Bul. 2-Set  
 103-20 and Prod. Chge.  
 Bul. 49-Set 183-1) ..... 96-11  
 1-090 (Ch. 1-168) Tel.  
 Rec. (Also See Prod.  
 Chge. Bul. 49-Set  
 183-1) ..... 99-17  
 (Also See Prod. Chge.  
 Bul. 48-Set 182-1) ..... 92-8  
 1-125-1 (Ch. 1-186) Tel.  
 Rec. (Also See Prod.  
 Chge. Bul. 48-Set  
 183-1) ..... 113-9  
 1-128 (Ch. 1-108) Tel.  
 Rec. (Also See Prod.  
 Chge. Bul. 2-Set 103-20  
 and Prod. Chge. Bul.  
 49-Set 183-1) ..... 96-11  
 1-177 (Ch. 1-186) Tel. Rec.  
 (Also See Prod. Chge.  
 Bul. 48-Set 182-1) ..... 92-8  
 1-197 (Ch. 1-139) Tel. Rec.  
 (See Prod. Chge. Bul.  
 48-Set 182-1 and Model  
 1-075-Set 92-8)  
 1-197A (Ch. 1-186)  
 Tel. Rec. (Also See  
 Prod. Chge. Bul. 49-  
 Set 183-1) ..... 113-9  
 1-210 (Ch. 1-139) Tel.  
 Rec. (See Prod. Chge.  
 Bul. 48-Set 182-1 and  
 Model 1-075-Set 92-8)  
 1-245, 1-246 (Ch. 1-139)  
 Tel. Rec. (See Prod.  
 Chge. Bul. 48-Set  
 182-1 and Model 1-075-  
 Set 92-8)

**SYLVANIA-Cont.**

1-245-1, 1-246-1  
 (Ch. 1-186) Tel. Rec.  
 (Also See Prod. Chge.  
 Bul. 49-Set 183-1) ..... 113-9  
 1-247 (Ch. 1-168) Tel.  
 Rec. (Also See Prod.  
 Chge. Bul. 48-Set  
 183-1) ..... 99-17  
 1-247-1 (Ch. 1-231)  
 Tel. Rec. .... \*  
 1-250, 1-251, 1-252  
 (Ch. 1-215) ..... 103-16  
 228-11 (Ch. 1-507-1)  
 Tel. Rec. .... 174-13  
 22M (Ch. 1-387) Tel. Rec.  
 (See Model 2221M-  
 Set 137-13)  
 22M-1, -2 (Ch. 1-387-1)  
 Tel. Rec. (Also See  
 Prod. Chge. Bul. 41-  
 Set 174-1) ..... 154-12  
 22M-11 (Ch. 1-507-1)  
 Tel. Rec. .... 174-13  
 23B, B-1, M, M-1,  
 (Ch. 1-387-1) Tel. Rec.  
 (Also See Prod. Chge.  
 Bul. 41-Set 174-1) ..... 154-12  
 238-11 (Ch. 1-507-1)  
 Tel. Rec. .... 174-13  
 23M-11 (Ch. 1-507-1)  
 Tel. Rec. .... 174-13  
 24M (Ch. 1-462-1)  
 Tel. Rec. .... 154-12  
 24M-1 (Ch. 1-387-1)  
 Tel. Rec. (Also See  
 Prod. Chge. Bul. 41-  
 Set 174-1) ..... 154-12  
 24M-3 (Ch. 1-387-1)  
 Tel. Rec. (See Prod.  
 Chge. Bul. 41-Set 174-1  
 and Model 24M-1-Set  
 154-12)  
 25M, 25M-1 (Ch. 1-387-1  
 and Radio Ch. 1-603)  
 Tel. Rec. (For TV Ch. See  
 Prod. Chge. Bul. 41-  
 Set 174-1 and Model  
 22M-1-Set 154-12, For  
 Radio Ch. See Model  
 178B-Set 192-9)  
 71M (Ch. 1-441) Tel. Rec.  
 (See Model 710XB)  
 71M-1 (Ch. 1-502-1) Tel.  
 Rec. (Also See Prod.  
 Chge. Bul. 42-Set  
 176-1) ..... 163-12  
 728 (Ch. 1-366) Tel. Rec.  
 (See Prod. Chge. Bul.  
 55-Set 189-1 and Model  
 710X-Set 124-10)  
 728-1 (Ch. 1-502-1) Tel.  
 Rec. (Also See Prod.  
 Chge. Bul. 42-Set  
 176-1) ..... 163-12  
 728-11 (Ch. 1-502-3) Tel.  
 Rec. (See Prod. Chge.  
 Bul. 42-Set 176-1 and  
 Model 71M-1-Set  
 163-12)  
 72M (Ch. 1-366) Tel. Rec.  
 (See Prod. Chge. Bul.  
 55-Set 189-1 and Model  
 710X-Set 124-10)  
 72M-1 (Ch. 1-502-1) Tel.  
 Rec. (Also See Prod.  
 Chge. Bul. 42-Set  
 176-1) ..... 163-12  
 72M-2 (Ch. 1-437-3) Tel.  
 Rec. (See Model 738-5)  
 72M-11 (Ch. 1-502-3) Tel.  
 Rec. (See Prod. Chge.  
 Bul. 42-Set 176-1 and  
 Model 71M-1-Set  
 163-12)  
 738 (Ch. 1-366) Tel. Rec.  
 (See Prod. Chge. Bul.  
 55-Set 189-1 and Model  
 710X-Set 124-10)  
 738-5 (Ch. 1-437-3) Tel.  
 Rec. (See Prod. Chge.  
 Bul. 41-Set 174-1 and  
 Model 7140MA-  
 Set 131-15)  
 738-11 (Ch. 1-502-3) Tel.  
 Rec. (See Prod. Chge.  
 Bul. 42-Set 176-1 and  
 Model 71M-1-Set 163-12)  
 73M (Ch. 1-366) Tel. Rec.  
 (See Prod. Chge. Bul.  
 55-Set 189-1 and Model  
 710X-Set 124-10)  
 73M-1, 73M-2 (Ch.  
 1-502-2) Tel. Rec.  
 (Also See Prod. Chge.  
 Bul. 42-Set 176-1)  
 73M-3, -5, -6 (Ch. 1-437-3)  
 Tel. Rec. (See Prod.  
 Chge. Bul. 41-Set  
 174-1 and Model 7140MA  
 -Set 131-15)  
 73M-11 (Ch. 1-502-3)  
 Tel. Rec. (See Prod.  
 Chge. Bul. 42-Set 176-1  
 and Model 71M-1-Set  
 163-12)  
 748 (Ch. 1-356) Tel. Rec.  
 (See Prod. Chge. Bul.  
 55-Set 189-1 and Model  
 6140M-Set 120-10)  
 748-1 (Ch. 1-437-1) Tel.  
 Rec. (See Prod. Chge. Bul.  
 41-Set 174-1 and Model  
 7140MA-Set 131-15)  
 748-2 (Ch. 1-437-2) Tel.  
 Rec. (See Prod. Chge.  
 Bul. 41-Set 174-1 and  
 Model 7140MA-Set  
 131-15)  
 74M (Ch. 1-356) Tel. Rec.  
 (See Prod. Chge. Bul.  
 55-Set 189-1 and Model  
 6140 M-Set 120-10)

**SYLVANIA-Cont.**

74M-1 (Ch. 1-437-1) Tel.  
 Rec. (See Prod. Chge.  
 Bul. 41-Set 174-1 and  
 Model 7140MA-Set  
 131-15)  
 74M-2 (Ch. 1-437-2) Tel.  
 Rec. (See Prod. Chge.  
 Bul. 41-Set 174-1 and  
 Model 7140 MA-Set  
 131-15)  
 74M-3 (Ch. 1-437-2) Tel.  
 Rec. (See Model 74M-2)  
 75B, M, M-1 (Ch. 1-437-1  
 and Radio Ch. 1-603-1)  
 Tel. Rec. (For TV Ch.  
 See Model 5150M-Set  
 131, For Radio Ch. See  
 Model 178B-Set 192-9)  
 1058 (Ch. 1-504-1)  
 Tel. Rec. .... 212-8  
 1058U (Ch. 1-504-2, -4)  
 Tel. Rec. .... 212-8  
 105M (Ch. 1-504-1)  
 Tel. Rec. .... 212-8  
 102MU (Ch. 1-504-2, -4)  
 Tel. Rec. .... 212-8  
 1206 (Ch. 1-510-1)  
 Tel. Rec. .... 212-8  
 1208U (Ch. 1-510-2, -4)  
 Tel. Rec. .... 212-8  
 120M (Ch. 1-510-1)  
 Tel. Rec. .... 212-8  
 120MU (Ch. 1-510-2, -4)  
 Tel. Rec. .... 212-8  
 1268 (Ch. 1-510-1)  
 Tel. Rec. .... 212-8  
 1268U (Ch. 1-510-2, -4)  
 Tel. Rec. .... 212-8  
 126L (Ch. 1-510-1)  
 Tel. Rec. .... 212-8  
 126LU (Ch. 1-510-2, -4)  
 Tel. Rec. .... 212-8  
 126M (Ch. 1-510-1)  
 Tel. Rec. .... 212-8  
 126MU (Ch. 1-510-2, -4)  
 Tel. Rec. .... 212-8  
 150A, L (Ch. 1-510-3)  
 (Codes CO6 and up)  
 Tel. Rec. .... 187-11  
 155A, L, M (Ch. 1-437-3)  
 (Codes CO6 and up) ..... 187-11  
 172K (Ch. 1-508-1, -3)  
 Tel. Rec. (Also See Prod.  
 Chge. Bul. 70) ..... 192-9  
 172KU (Ch. 1-508-2)  
 Tel. Rec. (Also See Prod.  
 Chge. Bul. 70) ..... 192-9  
 172M (Ch. 1-508-1, -3)  
 Tel. Rec. (Also See Prod.  
 Chge. Bul. 70) ..... 192-9  
 172MU (Ch. 1-208-2)  
 Tel. Rec. (Also See Prod.  
 Chge. Bul. 70) ..... 192-9  
 172N (Ch. 1-508-1, -3)  
 Tel. Rec. (Also See Prod.  
 Chge. Bul. 70) ..... 192-9  
 175B (Ch. 1-508-1, -3)  
 Tel. Rec. (Also See Prod.  
 Chge. Bul. 70) ..... 192-9  
 175BU (Ch. 1-508-2)  
 Tel. Rec. (Also See Prod.  
 Chge. Bul. 70) ..... 192-9  
 176L (Ch. 1-508-1, -3)  
 Tel. Rec. (Also See Prod.  
 Chge. Bul. 70) ..... 192-9  
 175MU (Ch. 1-508-2)  
 Tel. Rec. (Also See Prod.  
 Chge. Bul. 70) ..... 192-9  
 1768 (Ch. 1-508-1, -3)  
 Tel. Rec. (Also See Prod.  
 Chge. Bul. 70) ..... 192-9  
 1768U (Ch. 1-508-2)  
 Tel. Rec. (Also See Prod.  
 Chge. Bul. 70) ..... 192-9  
 1778 (Ch. 1-508-1, -3)  
 Tel. Rec. (Also See Prod.  
 Chge. Bul. 70) ..... 192-9  
 1778U (Ch. 1-508-2)  
 Tel. Rec. (Also See Prod.  
 Chge. Bul. 70) ..... 192-9  
 177M (Ch. 1-508-1, -3)  
 Tel. Rec. (Also See Prod.  
 Chge. Bul. 70) ..... 192-9  
 177MU (Ch. 1-508-2)  
 Tel. Rec. (Also See Prod.  
 Chge. Bul. 70) ..... 192-9  
 1788 (Ch. 1-508-1, -3 and  
 Radio Ch. 1-603-1)  
 Tel. Rec. (Also See Prod.  
 Chge. Bul. 70) ..... 192-9  
 1788U (Ch. 1-508-2 and  
 Radio Ch. 1-603-1)  
 Tel. Rec. (Also See Prod.  
 Chge. Bul. 70) ..... 192-9  
 178MU (Ch. 1-508-2





**TEMPLE—Cont.**

G-4108 (See Model G-418—Set 26-25)  
 G-7205 (See Model G-722—Set 24-27)  
 H-411 (See Model H-521—Set 28-33)  
 H-521 (See Model G-521—Set 28-33)  
 H-622 (See Model H-727—Set 34-23)  
 TV-1775, TV-1777, TV-1778, TV-1779  
 Tel. Rec. 66-16

**TEMPOTONE**

500 E Series 2-8

**TEMPLETON (See Temple)**

**THORDARSON**

T-30W08A 8-31  
 T-31W10A 30-30  
 T-31W10-AX 57-22  
 T-31W25A 9-33  
 T-31W50A 20-34  
 T-32W00, T-32W10 76-18

**THORENS (See Record Changer Listing)**

**TRAD**

AC8HF 24-28  
 C-2020, C-2420, CD2020  
 Tel. Rec. 173-14  
 T-20, A Tel. Rec. 133-14  
 T-20-E Tel. Rec. 165-17A  
 T-1720 Tel. Rec. 173-14  
 T-1853, A, Tel. Rec. 200-10

**TRANSVISION**

Ch. Model A Tel. Rec. 107-11  
 Ch. A-3 Tel. Rec. 130-15  
 Ch. A-4 Tel. Rec. 192-10  
 WRS-3 Tel. Rec. 112-10

**TRANSVUE**

17XC, 17XT Tel. Rec. (Similar to Chassis) 132-8  
 20XC, 20XT Tel. Rec. (Similar to Chassis) 132-8  
 160-L (Ch. 12AX21) Tel. Rec. 601 (Ch. 16AX23, 25, 26) Tel. Rec. (Similar to Chassis) 99-14  
 710 (Ch. 16AX23, 25, 26) Tel. Rec. (Similar to Chassis) 99-14  
 1400T Tel. Rec. (Similar to Chassis) 132-8  
 1700C, T Tel. Rec. (Similar to Chassis) 132-8  
 2000C Tel. Rec. (Similar to Chassis) 132-8  
 12AX21

**TRAV-LER (Also see Record Changer Listing)**

10T Tel. Rec. 86-11  
 12150, A Tel. Rec. 108-13  
 121 Tel. Rec. 86-11  
 14850, A, 14C50, A Tel. Rec. 108-13  
 16C50A Tel. Rec. 108-13  
 16R50A, 16T50A Tel. Rec. 108-13  
 16T Tel. Rec. (Also see Prod. Chge. Bul. 31, Set 156-3) 86-11  
 20A50 Tel. Rec. 146-11  
 62R50, 63R50 Tel. Rec. 150-13  
 64R50, 64R50-1, 64R50-2 Tel. Rec. 146-11  
 65G50, -1, -2 Tel. Rec. (See Model 20A50—Set 146-11) 146-11  
 75A50, 75A50-1, 75A50-2 Tel. Rec. 146-11  
 114-1A, -2 (Ch. 32A1) Tel. Rec. 150-13  
 117-3, -4, -6 (Ch. 32A1) Tel. Rec. 150-13  
 119-5 (Ch. 32A1) Tel. Rec. 150-13  
 217, -10, -11, -12, -14 (Ch. 32A2) Tel. Rec. 171-11  
 217-15, 217-16 (Ch. 34A2) Tel. Rec. 170-14  
 217-25 (Ch. 34A2) Tel. Rec. (See Model 217-15—Set 170-14)  
 219-8A, 219-8B (Ch. 11A2) Tel. Rec. 162-14  
 220-9, -9A, -9B (Ch. 33A2) Tel. Rec. 171-11  
 220-22, -23, -24, -27 (Ch. 34A2) Tel. Rec. (See Model 217-15—Set 170-14)  
 5000 (See Model 5000I—Set 11-27)  
 5000I 11-27  
 5002 Series (Ch. 109) 12-28  
 5007, 5008, 5009 (Ch. 104) 1-36  
 5010, 5011, 5012 (Ch. 105) 2-5  
 5015 36-25  
 5019 23-30  
 5020 (Ch. 800) 11-28  
 5021 43-20  
 5022 101-14  
 5027 31-30  
 5028 34-24  
 5029 33-29  
 5030, 5031 32-25  
 5036 54-19  
 5049 45-24  
 5051 32-26  
 5054 36-26  
 5056-A 90-12  
 5060, 5061 116-11  
 5065 42-24  
 5170 163-13

**TRAV-LER—Cont.**

6040 49-25  
 6050 56-23  
 7000, 7001 59-21  
 7003 (Ch. 501) 12-29  
 7014 59-21  
 7016, 7017 84-11  
 7023 83-13  
 7036 112-11  
 Ch. 11A2 (See Model 219-8A)  
 Ch. 32A1 (See Model 62R50)  
 Ch. 33A2 (See Model 217-15)  
 Ch. 34A2 (See Model 217-15)  
 Ch. 104 (See Model 5007)  
 Ch. 105 (See Model 5010)  
 Ch. 109 (See Model 5002)  
 Ch. 501 (See Model 7003)  
 Ch. 800 (See Model 5021)

**TRELA**

HW301 14-28

**TRUETONE**

D1034A, B, C (See Model D1046A—Set 102-15)  
 D1046A 102-15  
 D1046B, C, D (See Model D1046A—Set 102-15)  
 D1092 Tel. Rec. (Similar to Chassis) 108-7  
 D1234A, B 189-15  
 D1240A 187-12  
 D1612 28-34  
 D1644 12-30  
 D1645 Factory 2647-6509 6-33  
 D1747, D1748 32-27  
 D1752 (Factory 7901-14) 34-25  
 D1835 (Factory Model 25A86-856) 44-25  
 D1836, D1836A (Factory 26A85-856) 45-25  
 D1840A (Ch. 138PCM) 46-24  
 D1845 31-31  
 D1846A, B, C 40-23  
 D1850 (Series A) 51-23  
 D1949 60-20  
 D1950, D1951 (See Model D1850—Set 51-23)  
 D1952 (See Model D1949—Set 60-20)  
 D1990 (Factory No. 7AF22) Tel. Rec. 69-13  
 D1991, B Tel. Rec. 77-11  
 D1992 (Factory No. 7AF22) Tel. Rec. 69-13  
 D1993, B Tel. Rec. 77-11  
 D1994 Tel. Rec. 77-11  
 D1996 Tel. Rec. (See Model D2983—Set 68-18)  
 D1997A Tel. Rec. \*  
 D18189 Tel. Rec. (Ch. 20A21) 101-15  
 D2020 106-15  
 D2025A (Fact. Mod. 26A95-906) 83-14  
 D2027A 97-18  
 D2050A Tel. Rec. 200-11  
 D-2102A, B 200-11  
 D-2103A, B 200-11  
 D-2108A, D-2109A 199-14  
 D2145 197-13  
 D-2205 201-12  
 D-2214A 204-10  
 D2226 196-16  
 D2237A 182-15  
 D2255 197-14  
 D2263 190-14  
 D2270 211-16  
 D2325-A 205-11  
 D-2383 205-11  
 D2403 (Factory No. 461) 13-33  
 D2604 13-34  
 D2605 (Factory Model 2AW2) 9-34  
 D2606 65-15  
 D2612 (Code SW-9022-G) 3-9  
 D2613 13-37  
 D2615 (Factory Model 6D110) 2-18  
 D2616 (Factory Model 6D117) 10-32  
 D2616-B 31-32  
 D2619 (Factory No. 2701) 27-29  
 D2620 1-28  
 D2621 4-32  
 D2622 14-30  
 D2623 11-29  
 D2624 (Factory 27D14-600) 2-6  
 D2626 (Fact. No. 457-2) 52-22  
 D2630 (Factory 27D14-602 issue A) 1-10  
 D2634 12-31  
 D2640 (Factory No. 459) 43-21  
 D2642 12-32  
 D2644 (Factory No. 101C) 11-30  
 D2645 4-39  
 D2646 (Factory No. 919) 2-23  
 D2663 (Ch. 4C1) 11-31  
 D2665 (Factory 48114 Series A) 22-31  
 D2692 39-28  
 D2709 (Factory No. 470) 27-30  
 D2710 (Factory No. 2402-6308) 23-31  
 D2718 (Factory No. 227D14-6381U) 23-32  
 D2743 25-29  
 D2745 (See Model D1645—Set 6-33)  
 D2748 (Ch. 7156) 26-27  
 D2806, D2807 (Factory Model 181) 44-26  
 D2810 (Factory No. 24D24-7308B) 36-27

**TRUETONE—Cont.**

D2815 48-25  
 D2819 (Factory No. 26A82-738) 35-24  
 D2851 38-28  
 D2906 (Factory No. 189) 69-14  
 D2907 69-14  
 D2910 65-16  
 D2919 (Fact. No. 6DF21) 59-22  
 D2963 73-13  
 D2982 Tel. Rec. 68-18  
 D2985 Tel. Rec. 70-11  
 D2987 Tel. Rec. 69-13  
 D2988, D2989 Tel. Rec. \*  
 D2990 Tel. Rec. 203-12  
 D-3120A, B 203-13  
 D3210A 190-15  
 D3265A 189-16  
 D3615 (Factory 25BD2-606) 18-32  
 D3619 (Factory 5P110) 10-33  
 D3630, D3630N 19-33  
 D3720 24-29  
 D3721 (Factory 1108X) 32-28  
 D3722 (Fact. No. 472) 51-24  
 D3809 (Factory No. 178) 43-22  
 D3810 39-27  
 D3811 (Fact. No. 1148XH) 47-24  
 D3840 49-26  
 D-3130A (Fact. Model 140611) 74-10  
 D-4118, B 200-12  
 D4142A 142-14  
 D4620 (Factory No. 5C12) 26-28  
 D4730 (Factory 26C19-61) 7-28  
 D4818 (Fact. No. 134DX) 45-26  
 D4932 (Fact. No. 25C22-82) 47-25  
 D4842 (Fact. No. 26C21-81) 50-21  
 2D1088A Tel. Rec. 105-11  
 2D1088B Tel. Rec. 145-1A  
 2D1089A Tel. Rec. 113-10  
 2D1089B Tel. Rec. 136-14  
 2D1091 Tel. Rec. 161-10  
 2D1093A, 2D1094A Tel. Rec. 119-12  
 2D1095 (Ch. 16AX27) Tel. Rec. 134-11  
 2D1095A Tel. Rec. (See Model 2D1185B—Set 154-13)  
 2D1185B Tel. Rec. (See Prod. Chge. Bul. 43—Set 177-1 and Model 2D1185B—Set 154-13)  
 2D1185E Tel. Rec. (See Prod. Chge. Bul. 43—Set 177-1 and Model 2D1185B—Set 154-13)  
 2D1190A, B Tel. Rec. 147-12  
 2D1191A (Ch. BRC20AY22) Tel. Rec. 151-11  
 2D1194A (Ch. 16AX216) Tel. Rec. (Ch. 20AY21) \*  
 2D1225A (Ch. 21AY21A) Tel. Rec. 24-31  
 2D-1228A (Ch. 20AY21) Tel. Rec. (See Model 2D-1224A) \*  
 2D1230B Tel. Rec. (Also See Prod. Chge. Bul. 59—Set 193-1) 185-14  
 2D1235A (Ch. 17MS345) Tel. Rec. 188-13  
 2D1235B, C, D, E Tel. Rec. 207-11  
 2D1315A Tel. Rec. 204-11  
 2D1325A Tel. Rec. 204-11  
 2D1344A, B (Ch. 21MS36C) Tel. Rec. 210-13  
 2D-1354A (Ch. 9210P) Tel. Rec. 194-13  
 2D2043A Tel. Rec. 161-10  
 2D2047B Tel. Rec. 161-10  
 2D2049A (Ch. 16AY210) Tel. Rec. 134-11  
 2D2052 Tel. Rec. 134-11  
 2D2052A, B (Ch. 16AY210) Tel. Rec. 207-12  
 2D2052C (Ch. 17AY23) Tel. Rec. \*  
 2D2052D, E (Ch. 17AY28) Tel. Rec. 120-11  
 2D2149A (Ch. 17AY212) Tel. Rec. 177-14  
 2D2152A (Ch. 17AY26) Tel. Rec. \*  
 2D2215A (Ch. 21AY21A) Tel. Rec. 179-13  
 2D2219A Tel. Rec. (Ch. 21AY21A) \*  
 2D231A Tel. Rec. 204-11  
 2D2314A Tel. Rec. 204-11  
 2D2321A Tel. Rec. 204-11  
 2D2322A, B Tel. Rec. 203-14  
 2D2335A, B Tel. Rec. 4-21

**ULTRADYNE**

L-46 4-21

**UNITED MOTORS SERVICE (See Delco or Buick, Chevrolet, Oldsmobile and Pontiac)**

**U. S. TELEVISION**

C16030 Tel. Rec. 99A-12  
 C19031 Tel. Rec. 99A-12  
 T-10823 Tel. Rec. 89-5  
 T16030 Tel. Rec. 99A-12  
 T19031 Tel. Rec. 99A-12  
 5A16, 5B16, 5C16 (See Model 5C66—Set 17-9)

**U. S. TELEVISION—Cont.**

5A66, 5B66, 5C66, 5066MPA 24-30  
 5C66 Early 17-9  
 8-16M (Dumbarton) 26-29

**UNITONE**

88 5-26

**UNIVERSAL CAMERA (See Record Changer Listing)**

**UTAH (See Record Changer Listing)**

**V-M (Also see Record Changer Listing)**

110 191-19  
 150 139-15  
 160 187-13  
 970 159-15  
 972 203-15  
 975 165-16  
 980 138-12  
 985 166-16  
 1001-A 10-34

**VAN-CAMP**

576-1-6A 7-29

**VIDEO CORP. OF AMERICA (See Videofax)**

**VIDEODYNE**

10FM, 10TV, 12FM, 12TV Tel. Rec. 69-15

**VIDEOLA**

VS-160, VS-161 Tel. Rec. 92-9  
 VS-165, VS-166, VS-167, VS-168 Tel. Rec. 92-9

**VIDEO PRODUCTS**

630-DXC Tel. Rec. 176-13  
 630-DX2C Tel. Rec. 176-13  
 630-K3C Tel. Rec. 176-13  
 630-K24C Tel. Rec. 176-13

**VIEWTONE**

RC-201A, RRC-201 11-32

**VISION MASTER**

14MC, AT Tel. Rec. (Similar to Chassis) 117-8  
 16MC, 16MT, 16MXC, 16MXCS, 16MXT, 16MXTS Tel. Rec. (Similar to Chassis) 117-8  
 17MC, 17MT, 17MXC, 17MXCS, 17MXT, 17MXTS Tel. Rec. (Similar to Chassis) 117-8

**VIZ**

RS-1 (Ch. V-2132) 14-31

**VOGUE**

532 A-P 11-33  
 Ch. Models 533R, 554R 8-32

**WARWICK (See Clarion)**

**WATTERSON**

ARC-4591A 16-36  
 PA-4585, APA-4587 3-2  
 RC-4581 16-35  
 4581 3-32  
 4582 6-34  
 4782 24-31  
 4790 16-34  
 4800 43-23

**WAVEFORMS**

A-20 191-20  
 C-5 191-20

**WECOR (See Webster-Chicago)**

**WEBSTER-CHICAGO (Also see Changer and Recorder Listings)**

B-123-1 204-12  
 B-124-1 203-16  
 B-134-1 217-14  
 B-135-1 210-14  
 B-136-1 207-12  
 F-123-1 204-12  
 F-134-1 205-12  
 F-136-1 207-12  
 F-136-1 207-12  
 66-1A 34-26  
 100-608 121-14  
 100-621 113-11  
 130 119-13  
 161-1 55-23  
 166 159-16  
 288 117-14  
 342 105-12  
 760 112-12  
 762 105-12  
 2D219A Tel. Rec. 179-13  
 2D222A (Ch. 21AY21A) Tel. Rec. \*  
 2D231A Tel. Rec. 204-11  
 2D2314A Tel. Rec. 204-11  
 2D2321A Tel. Rec. 204-11  
 2D2322A, B Tel. Rec. 203-14  
 2D2335A, B Tel. Rec. 4-21

**WEBSTER ELECTRIC (Also see Recorder Listing)**

81-15, 81-15A 142-15  
 82-25, 82-25A, 83-25, 143-15 (See Model H-217B—Set 91-14)  
 84-25 145-12  
 85-25 144-14

**WEBSTER (Telehome)**

W606M 56-24  
 604M 57-23

**WELLS-GARDNER**

317G334C-218 Tel. Rec. 195-12  
 317G334C-220 Tel. Rec. 195-12  
 317G334C-278 Tel. Rec. 195-12  
 321MS31C-222, -224 Tel. Rec. 194-14  
 321MS31C-272, -274, -276 Tel. Rec. 194-14  
 321MS31C-280, -282, -284 Tel. Rec. 194-14  
 321MS31C-296 Tel. Rec. 194-14

**WESTERN AUTO (See Truettone)**

**WESTINGHOUSE (Also see Record Changer Listing)**

H-104, H-105 4-11  
 H-104A, H-105A, H-107A, H-108A (See Set 21-36 and Model H-104—Set 4-11)  
 H-107, H-108, H-110, H-111 4-19  
 H-113, H-114, H-116 (See Model H2117—Set 11-34)  
 H-117, H-119 11-34  
 H-122 6-35  
 H-122A, B (See Model H-122—Set 6-35)  
 H-125, H-126 3-19  
 H-130 6-35  
 H-133 14-34  
 H-137 (See Model H-138—Set 6-36)  
 H-138 6-36  
 H-147 31-33  
 H-148 15-37  
 H-148A (See Model H-148—Set 15-37)  
 H-153, H-153A (Ch. V-2103) 35-25  
 H-154 (See Set 21-36 and Model H-104—Set 4-11)  
 H-155 35-25  
 H-156 (See Model H-153—Set 35-25)  
 H-157 (Ch. V-2122) 33-31  
 H-161 (Ch. V-2118) 34-27  
 H-162 (See Model H-117—Set 11-34)  
 H-164 (Ch. V-2119-1) 36-28  
 H-165 (See Model H-168—Set 34-27)  
 H-166, H-167 (See Model H-164) 36-28  
 H-168, H-168A, H-168B (Ch. V-2118) (See Model H-161) 34-27  
 H-168B (Ch. V-2118) (See Model H-168—Set 34-27)  
 H-169 (Ch. V-2124-1) 37-24  
 H-171 (Ch. V-2103) 35-25  
 H-171A, C (Ch. V-2103) (See Model H-153—Set 35-25)  
 H-178 (Ch. V-2123) 35-26  
 H-181 Tel. Rec. \*  
 H-182 (Ch. V-2128) (Ch. V-2128-1) 53-25  
 H-183, H-183A 48-26  
 H-184 (See Model H-153—Set 35-25)  
 H-185 (Ch. V-2131, V-2131-1) 54-20  
 H-186M, H-187 (Ch. V-2132) 60-21  
 H-188 (Ch. V-2133) 51-25  
 H-190, H-191, H-191A (Ch. V-2134) 59-23  
 H-192 Tel. Rec. 54-20  
 H-196 Tel. Rec. 65-17  
 H-196A (Ch. V-2130-1) Tel. Rec. (See Model H-197—Set 65-17)  
 H-196A (DX) (Ch. V-2130-1DX or V-2130-2DX) Tel. Rec. 84-13  
 H-198 (Ch. V-2137-2) 73-15  
 H-199 (Ch. V-2137-1) 69-16  
 H-202 (Ch. V-2128-2) 50-22  
 H-203 (Ch. V-2137) 62-21  
 H-204 50-22  
 H-207A (Ch. V-2130-1, V-2137) Tel. Rec. 65-17  
 H207A (DX) (Ch. V-2130-1DX or V-2130-2DX and Radio Ch. V-2137) Tel. Rec. 84-13  
 H207B (DX) (Ch. V-2130-1DX or V-2130-2DX and Radio Ch. V-2137) Tel. Rec. 84-13  
 H-210, H-211 (Ch. V-2144, V-2144-1) 61-20  
 H-212 (Ch. V-2137) 62-21  
 H-213 (Ch. V-2103-1) 75-16  
 H-216, H-216A (Ch. V-2146-05, V-2146-45, V-2149-1) Tel. Rec. 97A-14  
 H-217, A (Ch. V-2146-11DX, V-2137, V-2149) Tel. Rec. (See Set 99A-14 and Model H-217B—Set 9

WESTINGHOUSE—

WESTINGHOUSE—Cont.

H-31075, H-31075U, H-31175, H-31175U (Ch. V-2161, V-2161U) 99—18  
 H-31294, H-31294U, H-31394, H-31394U, H-31494, H-31494U, H-31594, H-31594U (Ch. V-2153-1) 98—13  
 H-316C7 (Ch. V-2136-1) 112—13  
 H-317C7 (Ch. V-2136-1) (See Model H-316C7—Set 112-13)  
 H-31875, U (Ch. V-2157, U) 117—15  
 H-32075, U (Ch. V-2157, U) 117—15  
 H-32175, U, H-32275, U (Ch. V-2157-1, U) 117—15  
 H-32375, U (Ch. V-2157-2, U) 117—15  
 H-32471, H-32571, U (Ch. V-2136-2) 113—13  
 H-326C7 (See Model H-316C7—Set 112-13)  
 H-32716U (Ch. V-2157-3U) 126—14  
 H-328C7, U (Ch. V-2136-4) 137—15  
 H-33194, U (Ch. V-2164, U) (Also see Prod. Chge. Bul. 52—Set 186-1) 171—12  
 H-33294 (See Model H-33194U—Set 171-12)  
 H-33394, U (Ch. V-2164, U) (Also see Prod. Chge. Bul. 52—Set 187-1) 171—12  
 H-33471U, H-33571U (Ch. V-2136-5U) 142—16  
 H-33717UR (Ch. V-2136-5R) 149—14  
 H-33675U, H-33775U (Ch. V-2157U) 134—12  
 H-33875U (Ch. V-2157-4U) 140—13  
 H-34175U (Ch. V-2157-4U) 140—13  
 H-34295U, H-34395U (Ch. V-2156-1U) 138—13  
 H-34575, H-34675 (Ch. V-2157-4U) (See Model H-33875U—Set 140-13)  
 H-34895, H-34995 (Ch. V-2156-1U) (See Model H-34295U—Set 138-13)  
 H-35077, H-35177 (Ch. V-2180-1) (Also see Prod. Chge. Bul. 52—Set 186-1) 154—14  
 H-354C7 (Ch. V-2180-2) 158—13  
 H-35575, H-35675 (Ch. V-2157-5) 161—11  
 H-357C10 (Ch. V-2180-5) 161—12  
 H-35975, H-36075 (Ch. V-2157-6) 191—21  
 H-36176 (Ch. V-2181-1) 186—15  
 H-36575, H-36675 (Ch. V-2157-7) 185—15  
 H-36775 (Ch. V-2157-8) 189—17  
 H-36895, H-36995 (Ch. V-2156-1U) (See Model H-34295U—Set 138-13)  
 H-37077, H-37177 (Ch. V-2180-8) 186—16  
 H-37294, H-37394, Ch. V-2182-1 and H-377 Optional Pwr. Supply 188—14  
 H-37475, H-37575 (Ch. V-2157-9) 189—17  
 H-37694 (Ch. V-2182-1 and H-377 Optional Power Supply) 188—14  
 H-37875, H-37975 (Ch. V-2181-1) 211—17  
 H-38075, H-38175 (Ch. V-2184-1) 211—17  
 H-38575, H-38675 (Ch. V-2157-11) 204—13  
 H-38775 (Ch. V-2157-11) (See Model H-38575—Set 204-13)  
 H-39376 (Ch. V-2182-2) 210—15  
 H-40094, H-40194, H-40294, H-40394 (Ch. V-2164-2) 205—13  
 H-600T16 (Ch. V-2150-61, A, B) Tel. Rec. 98—14  
 H-601K12, H-602K12 (Ch. V-2150-41) Tel. Rec. 98—14  
 H-603C12 (Ch. V-2151-01 and V-2149-3) Tel. Rec. 100—14  
 H-604T10, A (Ch. V-2150-91A, -94, -94A) Tel. Rec. (See Set 99A-14 and Model H-609T10—Set 95-7)  
 H-605T12 (Ch. V-2150-101) Tel. Rec. 97—19  
 H-606K12 (Ch. V-2150-111, A) Tel. Rec. 120—12  
 H-607K12 (Ch. V-2150-111, A) Tel. Rec. 120—12  
 H-608C12 (Ch. V-2152-01, V-2149-3) Tel. Rec. (See Model H-603C12—Set 100-14)  
 H-609T10 (Ch. V-2150-94C) Tel. Rec. 95—7  
 H-610T12 (Ch. V-2150-136) Tel. Rec. 105—13  
 H-611C12 (Ch. V-2152-16) Tel. Rec. 112—14  
 H-613K16 (Ch. V-2150-146) Tel. Rec. 107—12  
 H-614T12 (Ch. V-2150-136) Tel. Rec. 105—13  
 H-615C12 (Ch. V-2152-16) Tel. Rec. 112—14  
 H-617T12 (Ch. V-2150-176, U, -177U) Tel. Rec. (Also see Prod. Chge. Bul. 10—Set 116-1) 103—17

WESTINGHOUSE—Cont.

H-618T16 (Ch. V-2150-186, A, C, CA) Tel. Rec. (Also See Prod. Chge. Bul. 10—Set 116-1) 103—17  
 H-619T12, U (Ch. V-2150-176, U, -177U) Tel. Rec. (Also See Prod. Chge. Bul. 10—Set 116-1) 103—17  
 H-620K16 (Ch. V-2150-186, A, C, CA) Tel. Rec. (Also See Prod. Chge. Bul. 10—Set 116-1) 103—17  
 H-622K16 (Ch. V-2150-186, A, C, CA) Tel. Rec. (See Prod. Chge. Bul. 10—Set 116-1 and Model H-617T12—Set 103-17)  
 H-625T12 (Ch. V-2150-197) Tel. Rec. 114—11  
 H-626T16 (Ch. V-2172) Tel. Rec. 116—13  
 H-627K16 (Ch. V-2171) Tel. Rec. 116—13  
 H-628K16, H-629K16 (Ch. V-2171) Tel. Rec. 116—13  
 H-630T16 (Ch. V-2176) Tel. Rec. 116—13  
 H-633C17, H-634C17 (Ch. V-2173) Tel. Rec. 122—11  
 H-636T17 (Ch. V-2175) Tel. Rec. 116—13  
 H-637T14 (Ch. V-2177) Tel. Rec. 116—13  
 H-638K20 (Ch. V-2178) Tel. Rec. 129—13  
 H-639T17 (Ch. V-2192, -1) Tel. Rec. 133—15  
 H-640T17 (Ch. V-2175-3, 4), H-640T17A (Ch. V-2192, -1, -2, -3, -4, -5, -6) Tel. Rec. (Also See Prod. Chge. Bul. 28—Set 150-1) 133—15  
 H-641K17 (Ch. V-2175-1, -5), H-641K17A (Ch. V-2192, -1, -2, -3, -4, -5, -6) Tel. Rec. (Also See Prod. Chge. Bul. 28—Set 150-1) 133—15  
 H-642K20 (Ch. V-2178-1, -3) Tel. Rec. 129—13  
 H-642K20A (Ch. V-2194, V-2194A, V-2194-1) Tel. Rec. 137—16  
 H-643K16 (Ch. V-2179, V-2179-1) Tel. Rec. 127—13  
 H-646K17 (Ch. V-2192) Tel. Rec. 133—15  
 H-647K17 (Ch. V-2175-3, 4) Tel. Rec. 133—15  
 H-648T20 (Ch. V-2201-1) Tel. Rec. (Also See Prod. Chge. Bul. 42—Set 176-1) 154—15  
 H-649T17 (Ch. V-2200-1) Tel. Rec. (Also See Prod. Chge. Bul. 42—Set 176-1) 154—15  
 H-649T17 (Ch. V-2192-4) Tel. Rec. (See Model H-639T17—Set 133-15)  
 H-650K21 (Ch. V-2192-4) Tel. Rec. (See Model H-639T17—Set 133-15)  
 H-651T17 (Ch. V-2200-1) Tel. Rec. (Also See Prod. Chge. Bul. 42—Set 176-1) 154—15  
 H-651K17 (Ch. V-2192) Tel. Rec. (See Model H-639T17—Set 133-15)  
 H-651K17 (Ch. V-2200-1) Tel. Rec. (Also See Prod. Chge. Bul. 42—Set 176-1) 154—15  
 H-652K20 (Ch. V-2194-2, -3) Tel. Rec. (See Prod. Chge. Bul. 31—Set 157-3 and Model H-642K20A—Set 137-16)  
 H-652K20 (Ch. V-2201-1) Tel. Rec. (Also See Prod. Chge. Bul. 42—Set 176-1) 154—15  
 H-653K24 (Ch. V-2202-2, V-2201-1) Tel. Rec. (Also See Prod. Chge. Bul. 35—Set 164-1) 160—13  
 H-654T17 (Ch. V-2175-3, -4, V-2192, -1) Tel. Rec. 133—15  
 H-655K17, H-656K17, H-657K17 (Ch. V-2200-1) Tel. Rec. (Also See Prod. Chge. Bul. 42—Set 176-1) 154—15  
 H-657K17 (Ch. V-2192-4, -5, -6) Tel. Rec. (See Prod. Chge. Bul. 28—Set 150-1 and Model H-639T17—Set 133-15)  
 H-658T17 (Ch. V-2192, -1) Tel. Rec. (See Prod. Chge. Bul. 28—Set 150-1 and Model H-639T17—Set 133-15)  
 H-659T17 (Ch. V-2204-1) Tel. Rec. (Also See Prod. Chge. Bul. 42—Set 176-1) 154—15  
 H-660C17, H-661C17 (Ch. V-2203-1 and Radio Ch. V-2180-3) Tel. Rec. (Also See Prod. Chge. Bul. 46—Set 180-1) 157—12  
 H-662K20 (Ch. V-2201-1) Tel. Rec. (Also See Prod. Chge. Bul. 42—Set 176-1) 154—15

WESTINGHOUSE—Cont.

H-663T17 (Ch. V-2192-2) Tel. Rec. (See Prod. Chge. Bul. 28—Set 150-1 and Model H-639T17—Set 133-15)  
 H-663T17 (Ch. V-2204) Tel. Rec. (Also See Prod. Chge. Bul. 42—Set 177-1) 154—15  
 H-664K17 (Ch. V-2200-1) Tel. Rec. (Also See Prod. Chge. Bul. 42—Set 176-1) 154—15  
 H-665T16 (Ch. V-2206-1) Tel. Rec. (See Prod. Chge. Bul. 42—Set 176-1 and Model H-648T20—Set 154-15)  
 H-667T17, H-668T17 (Ch. V-2216) Tel. Rec. (Also See Prod. Chge. Bul. 40—Set 172-1, Prod. Chge. Bul. 43—Set 177-1, Prod. Chge. Bul. 52—Set 186-1 and Model H-667T17—Set 167-15)  
 H-673K21 (Ch. V-2217-1) Tel. Rec. (See Model H-667T17—Set 167-15)  
 H-676T21 (Ch. V-2217-1) Tel. Rec. (See Model H-667T17—Set 167-15)  
 H-678K17, H-679K17 (Ch. V-2216-1, -2, -3) Tel. Rec. (Also See Prod. Chge. Bul. 40—Set 172-1, Prod. Chge. Bul. 43—Set 177-1, Prod. Chge. Bul. 52—Set 186-1 and Model H-667T17—Set 167-15)  
 H-681T17 (Ch. V-2215-1) Tel. Rec. (See Prod. Chge. Bul. 45—Set 179-1, Prod. Chge. Bul. 52—Set 186-1 and Model H-667T17—Set 167-15)  
 H-688K24 (Ch. V-2219-1) (Also See Prod. Chge. Bul. 52—Set 186-1) 174—14  
 H-689T16 (Ch. V-2214-1) (See Prod. Chge. Bul. 40—Set 172-1, Prod. Chge. Bul. 58—Set 192-1 and Model H-667T17—Set 167-15)  
 H-690K21, H-691K21 (Ch. V-2217-1) Tel. Rec. (See Model H-667T17—Set 167-15)  
 H-692T21 (Ch. V-2217-2, -3) Tel. Rec. (See Prod. Chge. Bul. 43—Set 177-1, Prod. Chge. Bul. 52—Set 186-1 and Model H-667T17—Set 167-15)  
 H-695K21 (Ch. V-2217-2, -3) Tel. Rec. (See Prod. Chge. Bul. 43—Set 177-1, Prod. Chge. Bul. 52—Set 186-1 and Model H-667T17—Set 167-15)  
 H-699K17 (Ch. V-2216-2, -3) Tel. Rec. (See Prod. Chge. Bul. 40—Set 172-1, Prod. Chge. Bul. 45—Set 179-1, Prod. Chge. Bul. 52—Set 186-1 and Model H-667T17—Set 167-15)  
 H-700T17, H-701T17 (Ch. V-2216-2, -3) Tel. Rec. (See Prod. Chge. Bul. 40—Set 172-1, Prod. Chge. Bul. 45—Set 179-1, Prod. Chge. Bul. 52—Set 186-1 and Model H-667T17—Set 167-15)  
 H-701K21 (Ch. V-2217-2) Tel. Rec. (See Prod. Chge. Bul. 40—Set 172-1, Prod. Chge. Bul. 45—Set 179-1, Prod. Chge. Bul. 52—Set 186-1 and Model H-667T17—Set 167-15)  
 H-704T17 (Ch. V-2216-2) Tel. Rec. (See Prod. Chge. Bul. 40—Set 172-1, Prod. Chge. Bul. 45—Set 179-1, Prod. Chge. Bul. 52—Set 186-1 and Model H-667T17—Set 167-15)  
 H-705K17 (Ch. V-2216-2, -3) Tel. Rec. (See Prod. Chge. Bul. 40—Set 172-1, Prod. Chge. Bul. 45—Set 179-1, Prod. Chge. Bul. 52—Set 186-1 and Model H-667T17—Set 167-15)  
 H-706T16 (Ch. V-2207-1) Tel. Rec. 193—12  
 H-708T20 (Ch. V-2220-1, -3, -11) Tel. Rec. 193—12  
 H-710T21 (Ch. V-2217-2, -3) Tel. Rec. (See Prod. Chge. Bul. 40—Set 172-1, Prod. Chge. Bul. 43—Set 177-1, Prod. Chge. Bul. 52—Set 186-1 and Model H-667T17—Set 167-15)  
 H-710T21 (Ch. V-2217-4, -5) Tel. Rec. 202—10

WESTINGHOUSE—Cont.

H-711T21 (Ch. V-2217-2, -3) Tel. Rec. (See Prod. Chge. Bul. 40—Set 172-1, Prod. Chge. Bul. 43—Set 177-1, Prod. Chge. Bul. 52—Set 186-1 and Model H-667T17—Set 167-15)  
 H-711T21 (Ch. V-2217-4, -5) Tel. Rec. 202—10  
 H-713K21 (Ch. V-2217-2, -3) Tel. Rec. (See Prod. Chge. Bul. 40—Set 172-1, Prod. Chge. Bul. 43—Set 177-1, Prod. Chge. Bul. 52—Set 186-1 and Model H-667T17—Set 167-15)  
 H-714K21 (Ch. V-2217-2, -3) Tel. Rec. (See Prod. Chge. Bul. 40—Set 172-1, Prod. Chge. Bul. 43—Set 177-1, Prod. Chge. Bul. 52—Set 186-1 and Model H-667T17—Set 167-15)  
 H-715K21 (Ch. V-2217-2, -3) Tel. Rec. (See Prod. Chge. Bul. 40—Set 172-1, Prod. Chge. Bul. 43—Set 177-1, Prod. Chge. Bul. 52—Set 186-1 and Model H-667T17—Set 167-15)  
 H-715K21 (Ch. V-2217-4, -5) Tel. Rec. 202—10  
 H-718K20 (Ch. V-2220-2) Tel. Rec. 193—12  
 H-720K21 (Ch. V-2217-2, -3) Tel. Rec. (See Prod. Chge. Bul. 40—Set 172-1, Prod. Chge. Bul. 43—Set 177-1, Prod. Chge. Bul. 52—Set 186-1 and Model H-667T17—Set 167-15)  
 H-720K21 (Ch. V-2217-4, -5) Tel. Rec. 202—10  
 H-721K21 (Ch. V-2217-2, -3) Tel. Rec. (See Prod. Chge. Bul. 40—Set 172-1, Prod. Chge. Bul. 43—Set 177-1, Prod. Chge. Bul. 52—Set 186-1 and Model H-667T17—Set 167-15)  
 H-722K21 (Ch. V-2217-4, -5) Tel. Rec. 202—10  
 H-723K21 (Ch. V-2217-5) Tel. Rec. 202—10  
 H-724T20, H-725T20 (Ch. V-2220-2) Tel. Rec. 193—12  
 H-730C21 (Ch. V-2218-1 and Radio Ch. V-2180-9) 190—16  
 H-730C21 (Ch. V-2218-2 and Radio Ch. V-2180-9, -10) Tel. Rec. (Also See Prod. Chge. Bul. 59—Set 193-1 and Radio Ch. V-2180-9) 190—16  
 H-730C21 (Ch. V-2218-1 and Radio Ch. V-2180-9, -10) Tel. Rec. (Also See Prod. Chge. Bul. 59—Set 193-1) 190—16  
 H-732C21 (Ch. V-2218-1 and Radio Ch. V-2180-9, -10) Tel. Rec. 190—16  
 H-732C21 (Ch. V-2218-1 and Radio Ch. V-2180-9, -10) Tel. Rec. (Also See Prod. Chge. Bul. 59—Set 193-1) 190—16  
 H-733C21 (Ch. V-2218-1 and Radio Ch. V-2180-9, -10) Tel. Rec. 190—16  
 H-733C21 (Ch. V-2218-11 and Radio Ch. V-2180-9, -10) Tel. Rec. (Also See Prod. Chge. Bul. 59—Set 193-1) 190—16  
 H-737T17 (Ch. V-2232-2) Tel. Rec. 212—9  
 H-740T21, H-742K21, H-743K21 (Ch. V-2233-1) Tel. Rec. 212—9  
 H-750T21 (Ch. V-2221-1) Tel. Rec. 212—9  
 H-750T21 (Ch. V-2233-3) Tel. Rec. 212—9  
 H-751T21 (Ch. V-2217-4, -5) Tel. Rec. 202—10  
 H-751T21 (Ch. V-2233-2) Tel. Rec. 212—9  
 H-752T21 (Ch. V-2217-4, -5) Tel. Rec. 202—10  
 H-752T21 (Ch. V-2233-2) Tel. Rec. 212—9  
 H-753K21 (Ch. V-2221-1) Tel. Rec. 212—9  
 H-753K21 (Ch. V-2233-3) Tel. Rec. 212—9  
 H-754K21 (Ch. V-2217-4, -5) Tel. Rec. 202—10  
 H-754K21 (Ch. V-2233-2) Tel. Rec. 212—9  
 H-755K21 (Ch. V-2233-2) Tel. Rec. 212—9  
 H-756K21 (Ch. V-2217-4, -5) Tel. Rec. 202—10

WESTINGHOUSE—Cont.

H-756K21 (Ch. V-2233-2) Tel. Rec. 212—9  
 H-757K21 (Ch. V-2217-4, -5) Tel. Rec. 202—10  
 H-757K21 (Ch. V-2233-2) Tel. Rec. 212—9  
 H-758K21 (Ch. V-2217-4, -5) Tel. Rec. 202—10  
 H-758K21 (Ch. V-2233-2) Tel. Rec. 212—9  
 H-759K21 (Ch. V-2217-4, -5) Tel. Rec. 202—10  
 H-759K21 (Ch. V-2233-2) Tel. Rec. 212—9  
 H-760T21 (Ch. V-2233-2) Tel. Rec. 212—9  
 H-760T21 (Ch. V-2233-2) Tel. Rec. 212—9  
 H-761T21 (Ch. V-2233-2) Tel. Rec. 212—9  
 H-761T21 (Ch. V-2233-2) Tel. Rec. 212—9  
 H-802 (Ch. V-1190-1, -2, -3, -4, -5, V-11213) Tel. Rec. UHF Conv. 209—13  
 H-1251 Ch. V-2102 (See Model H-104) Ch. V-2102-1 (See Model H-138)  
 Ch. V-2103 (See Model H-153)  
 Ch. V-2103-3 (See Model H-214) Ch. V-2107 (See Model H-133) Ch. V-2118 (See Model H-161) Ch. V-2119-1 (See Model H-164) Ch. V-2120 (See Model H-165) Ch. V-2122 (See Model H-157) Ch. V-2123 (See Model H-178) Ch. V-2124-1 (See Model H-169) Ch. V-2127 (See Model H-183) Ch. V-2128, V-2128-1 (See Model H-182) Ch. V-2128-2 (See Model H-202) Ch. V-2130-1 (See Model H-196) Ch. V-2130-11DX, -12DX (See Model H-196A [DX]) Ch. V-2130-21DX, -22DX (See Model H-207A [DX]) Ch. V-2130-31DX, -32DX (See Model H-225 [DX]) Ch. V-2131, V-2131-1 (See Model H-185) Ch. V-2132 (See Model H-186M) Ch. V-2133 (See Model H-188) Ch. V-2134 (See Model H-190) Ch. V-2136 (See Model H-307T20) Ch. V-2136-11DX (See Model H-316C7) Ch. V-2136-2 (See Model H-324T7) Ch. V-2136-4 (See Model H-328C7) Ch. V-2136-5R (See Model H-334T7UR) Ch. V-2137-5U (See Model H-334T7U) Ch. V-2137 (See Model H-203) Ch. V-2137-1 (See Model H-199) Ch. V-2137-2 (See Model H-198) Ch. V-2137-3, V-2137-3S (See Model H-231) Ch. V-2144, V-2144-1 (See Model H-210) Ch. V-2146-05 (See Model H-216) Ch. V-2146-11DX (See Model H-217) Ch. V-2146-21DX, -22DX (See Model H-226) Ch. V-2146-35DX (See Model H-2178) Ch. V-2146-45 (See Model H-216) Ch. V-2148 (See Model H-300T5) Ch. V-2149 (See Model H-2178) Ch. V-2149-1 (See Model H-216) Ch. V-2149-3 (See Model H-603C12) Ch. V-2150-01, V-2150-02 (See Model H-223) Ch. V-2150-31 (See Model H-242) Ch. V-2150-41 (See Model H-601K12) Ch. V-2150-51 (See Model H-231) Ch. V-2150-61, A, B (See Model H-600T16) Ch. V-2150-81, -82, -84 (See Model H-251) Ch. V-2150-91A (See Model H-604T10) Ch. V-2150-94C (See Model H-609T10) Ch. V-2150-101 (See Model H-605T12) Ch. V-2150-111, A (See Model H-606K12)



**WESTINGHOUSE—Cont.**

Ch. V-2150-136  
 (See Model H-610T12)  
 Ch. V-2150-141 (See  
 Model H-613K16)  
 Ch. V-2150-176, U  
 (See Model H-617T12)  
 Ch. V-2150-177U (See  
 Model H-617T12)  
 Ch. V-2150-186, A, C, CA  
 (See Model H-618T16)  
 Ch. V-2150-197  
 (See Model H-625T12)  
 Ch. V-2151-1  
 (See Model H-302P5)  
 Ch. V-2152-01 (See  
 Model H-603C12)  
 Ch. V-2152-16  
 (See Model H-611C12)  
 Ch. V-2153  
 (See Model H303P4)  
 Ch. V-2153-1 (See  
 Model H-312P4)  
 Ch. V-2156  
 (See Model H-309P5)  
 Ch. V-2156-1U  
 (See Model H-342P5U)  
 Ch. V-2157, U  
 (See Model H-318T5)  
 Ch. V-2157-1, -1U  
 (See Model H-321T5)  
 Ch. V-2157-2, -2U  
 (See Model H-323T5)  
 Ch. V-2157-3U (See  
 Model H-327T6U)  
 Ch. V-2157-4U  
 (See Model H338T5U)  
 Ch. V-2157-5  
 (See Model H-355T5)  
 Ch. V-2157-6  
 (See Model H-359T5)  
 Ch. V-2157-8  
 (See Model H-367T5)  
 Ch. V-2157-9  
 (See Model H-374T5)  
 Ch. V-2157-11  
 (See Model H-385T5)  
 Ch. V-2161, U-2161U  
 (See Model H-310T5)  
 Ch. V-2164, U (See  
 Model H-331P4)  
 Ch. V-2164-2  
 (See Model H-400P4)  
 Ch. V-2171 (See  
 Model H-627K16)  
 Ch. V-2172 (See  
 Model H-626T16)  
 Ch. V-2173  
 (See Model H-633C17)  
 Ch. V-2175 (See  
 Model H-636T17)  
 Ch. V-2175-1  
 (See Model H-641K17)  
 Ch. V-2175-3, -4  
 (See Model H-640T17)  
 Ch. V-2175-5  
 (See Model H-641K17)  
 Ch. V-2176  
 (See Model H-630T14)  
 Ch. V-2177  
 (See Model H-637T14)  
 Ch. V-2178, -1, -3 (See  
 Model H-638K20)  
 Ch. V-2180-1  
 (See Model H350T7)  
 Ch. V-2180-2  
 (See Model H-354C7)  
 Ch. V-2180-3  
 (See Model H-660C17)  
 Ch. V-2180-5  
 (See Model H-357C10)  
 Ch. V-2180-8 (See  
 Model H-370T7)  
 Ch. V-2180-9, -10  
 (See Model H-730C21)  
 Ch. V-2181-1 (See  
 Model H-361T6)  
 Ch. V-2182-2  
 (See Model H-393T6)  
 Ch. V-2184-1  
 (See Model H-378T5)  
 Ch. V-2192  
 (See Model H-639T17)  
 Ch. V-2192, -3, -4, -5, -6  
 (See Model H-640T17A)  
 Ch. V-2194, V-2194A,  
 V-2194-1 (See  
 Model H-642K20A)  
 Ch. V-2194-2, -3 (See  
 Model H-652K20)  
 Ch. V-2200-1 (See  
 Model H-651K17)  
 Ch. V-2201-1 (See  
 Model H-652K20)  
 Ch. V-2202-2 (See  
 Model H-653K24)  
 Ch. V-2203-1 (See  
 Model H-660C17)  
 Ch. V-2204-1 (See  
 Model H-659T17)  
 Ch. V-2206-1 (See  
 Model H-665T16)  
 Ch. V-2207-1  
 (See Model H-706T16)  
 Ch. V-2208-1 (See  
 Model H-716T17)  
 Ch. V-2210-1 (See  
 Model H-653K24)  
 Ch. V-2214-1  
 (See Model H-689T16)  
 Ch. V-2215-1 (See  
 Model H-681T17)  
 Ch. V-2216-1  
 (See Model H-667T17)  
 Ch. V-2216-2, -3 (See  
 Model H-678K17)  
 Ch. V-2216-4, -5  
 (See Model H-704T17)  
 Ch. V-2217-1  
 (See Model H-673K21)  
 Ch. V-2217-2, -3 (See  
 Model H-692T17)  
 Ch. V-2217-4, -5 (See  
 Model H-710T12)  
 Ch. V-2218, -1, -11  
 (See Model H-730C21)

**WESTINGHOUSE—Cont.**

Ch. V-2219-1  
 (See Model H-688K24)  
 Ch. V-2220-1 (See  
 Model H-708T20)  
 Ch. V-2220-2 (See  
 Model H-718K20)  
 Ch. V-2220-3, -11  
 (See Model H-708T20)  
 Ch. V-2221-1  
 (See Model H-750T21)  
 Ch. V-2232-2  
 (See Model H-737T17)  
 Ch. V-2233-1  
 (See Model H-740T21)  
 Ch. V-2233-2  
 (See Model H-751T21)  
 Ch. V-2233-3  
 (See Model H-750T21)  
 Ch. V-11213  
 (See Model H-802)  
 Ch. V-11900-1, -2, -3, -4,  
 -5 (See Model H-802)

**WILCOX-GAY**  
 (Also see Majestic)  
 (Also see Recordio)  
 G-306, G-402, G-403,  
 G-404 Tel. Rec. (See  
 Majestic Model 1272—  
 Set 108-7)  
 G-414 Tel. Rec. (See  
 Majestic Model G-414—  
 Set 133-8)  
 G-426, G-427 Tel. Rec.  
 (See Majestic Model  
 1272—Set 108-7)  
 G-614, G-624 Tel. Rec.  
 (See Majestic Model  
 G-414—Set 133-8)  
 G-914 Tel. Rec. (See  
 Majestic Model G-414—  
 Set 133-8)  
 OD-446M (OD Series)  
 Tel. Rec. 101—17  
 OF439-1-C (Ch. OF Series)  
 Tel. Rec. 98—15  
 OD Series  
 (See Model OD-446M)  
 OL Series Tel. Rec. \*  
 9D Series Tel. Rec. \*  
 9W Series Tel. Rec. \*

**WILLYS-OVERLAND**  
 8030 (670777) 50—23  
 670777 (See Model  
 8030—Set 50-23)  
 677012 156—14  
 679517 172—12

**WILMAK**  
 W-446 "DENChum" 21—11

**WIRE RECORDING CORP.**  
 (See Recorder Listing)

**WOOLROC**  
 3-1A (Ch. 6-9022-K) 6—37  
 3-2A (Code 7-9003-D) 6—38  
 3-5A 22—32  
 3-6A/5 24—32  
 3-9A, 3-10A 7—30  
 3-11A (Ch. 56A76) 8—33  
 3-12/3 23—33  
 3-13A, 3-14A, 3-15A, 34—28  
 3-17A, 3-18A 34—29  
 3-20A 24—33  
 3-29A 7—31  
 3-61A (See Model  
 3-71A—Set 36-29)  
 3-70A 31—34  
 3-71A 36—29

**ZENITH (Also see  
 Record Changer Listing)**  
 G500 (Ch. 5G40) 83—16  
 G503 (Ch. 5G41) 99—19  
 G510, G510V, (Ch.  
 5G02) 84—14  
 G511, G511W, G511Y  
 (Ch. 5G01) 85—14  
 G516 (Ch. 5G03) 109—15  
 G615, G615W, G615Y  
 (Ch. 6G05) 86—14  
 G622, G663, G665  
 (Ch. 6G01) 96—12  
 G723 (Ch. 7G04) 104—13  
 G724 (Ch. 7G02) 103—18  
 G725 (Ch. 7G01) 101—18  
 G881, G882, G883, G884,  
 G885 (Ch. 8G20) 98—16  
 G-2322 (Ch. 23G22)  
 Tel. Rec. 98—17  
 G-2322Z (Ch. 23G24)  
 Tel. Rec. (See Ch.  
 23G24—Set 91A-13)  
 G2322Z1 (Ch. 23G24T1)  
 Tel. Rec. (See Ch.  
 23G24—Set 91A-13)  
 G2340Z1, G2340Z2 (Ch.  
 23G24T1) Tel. Rec. (See  
 Ch. 23G24—Set 91A-13)  
 G2346R (Ch. 23G22)  
 Tel. Rec. 98—17  
 G2350RZ, Z (Ch. 23G24)  
 Tel. Rec. (See Ch.  
 23G24—Set 91A-13)  
 G2353EZ (Ch. 23G24)  
 Tel. Rec. (See Ch.  
 23G24—Set 91A-13)  
 G2353EZ1 (Ch. 23G24T1)  
 Tel. Rec. (See Ch.  
 23G24—Set 91A-13)  
 G2356EZ (Ch. 23G24)  
 Tel. Rec. (See Ch.  
 23G24—Set 91A-13)

**ZENITH—Cont.**

G2420E (Ch. 24G20)  
 Tel. Rec. 93—11  
 G2420-EOX (Ch. 24G20-  
 OX) Tel. Rec. 93—11  
 G2420R (Ch. 24G20)  
 Tel. Rec. 93—11  
 G2420-ROX (Ch.  
 24G20-OX) Tel. Rec. 93—11  
 G2437RZ, G2438RZ, Z,  
 G2439RZ (Ch. 24G26)  
 Tel. Rec. (See Ch.  
 24G26—Set 91A-12)  
 G2441 (Ch. 24G24)  
 Tel. Rec. 98—17  
 G2441R (Ch. 24G22/24)  
 Tel. Rec. 98—17  
 G2441RZ, Z (Ch. 24G26)  
 Tel. Rec. (See Ch.  
 24G26—Set 91A-12)  
 G2441Z1, G2441RZ1 (Ch.  
 24G26Z1) Tel. Rec. (See  
 Ch. 24G26—Set 91A-12)  
 G2442E, Z (Ch. 24G22/24)  
 Tel. Rec. 98—17  
 G2442RZ (Ch. 24G26)  
 Tel. Rec. (See Ch.  
 24G26—Set 91A-12)  
 G2442EZ1, G2442RZ1 (Ch.  
 24G26Z1) Tel. Rec. (See  
 Ch. 24G26—Set 91A-12)  
 G2448R (Ch. 24G22/24)  
 Tel. Rec. 98—17  
 G2448RZ (Ch. 24G26)  
 Tel. Rec. (See Ch.  
 24G26—Set 91A-12)  
 G2448RZ1 (Ch. 24G26Z1)  
 Tel. Rec. (See Ch.  
 24G26—Set 91A-12)  
 G2454R (Ch. 24G21)  
 Tel. Rec. 93—11  
 G-2454-ROX (Ch.  
 24G21-OX) Tel. Rec. 93—11  
 G2854R-OX (Ch.  
 28F20) Tel. Rec. (See  
 Model H-28F960—  
 Set 64-15)  
 G2951, R, OX, ROX,  
 G2952, R, ROX (Ch.  
 29G20, -OX) Tel. Rec. 95—8  
 G2957, R (Ch. 23G23 and  
 Radio Ch. 6G20) 98—17  
 G2958R (Ch. 23G23 and  
 Radio Ch. 6G20)  
 Tel. Rec. 98—17  
 G-3059R (Ch. 24G23/25 and  
 Radio Ch. 6G20) 98—17  
 G-3062 (Ch. 24G23/25 and  
 Radio Ch. 6G20)  
 Tel. Rec. 98—17  
 G3157RZ, Z (Ch. 23G24 and  
 Radio Ch. 8G20/22) Tel.  
 Rec. (See Ch. 23G24  
 and Ch. 8G20/22—  
 Set 91A-13)  
 G3157RZ1, G3157RZ2 (Ch.  
 23G24T1 and Radio Ch.  
 8G22) Tel. Rec. (See  
 Ch. 23G24 and Ch.  
 8G20/22—Set 91A-13)  
 G3158RZ1 (Ch. 23G24 and  
 Radio Ch. 8G22)  
 Tel. Rec. (See  
 Ch. 23G24 and Ch.  
 8G20/22—Set 91A-13)  
 G3173RZ, Z, G-3174RZ  
 (Ch. 23G24 and Radio  
 Ch. 8G20/22) Tel. Rec.  
 (See Ch. 23G24 and  
 Ch. 8G20/22—Set  
 91A-13)  
 G3259RZ (Ch. 24G26 and  
 Radio Ch. 8G20/22) Tel.  
 Rec. (For TV Ch. See  
 Ch. 24G26—Set 91A-12,  
 For Radio Ch. See  
 Ch. 8G20/22—Set  
 91A-13)  
 G3259RZ1 (Ch. 24G26T1  
 and Radio Ch. 8G22)  
 Tel. Rec. (For TV Ch. See  
 Ch. 24G26—Set 91A-12,  
 For Radio Ch. See  
 Ch. 8G20/22—Set  
 91A-13)  
 G3259RZ2 (Ch. 24G26T2  
 and Radio Ch. 8G22) Tel.  
 Rec. (For TV Ch. See  
 Ch. 24G26—Set 91A-12,  
 For Radio Ch. See  
 Ch. 8G20/22—Set  
 91A-13)  
 G3262Z (Ch. 24G26 and  
 Radio Ch. 8G20/22) Tel.  
 Rec. (For TV Ch. See  
 Ch. 24G26—Set 91A-12,  
 For Radio Ch. See  
 Ch. 8G20/22—Set  
 91A-13)  
 G3262Z1 (Ch. 24G26T1 and  
 Radio Ch. 8G22) Tel. Rec.  
 (For TV Ch. See Ch.  
 24G26—Set 91A-12, For  
 Radio Ch. See Ch.  
 8G20/22—Set 91A-13)  
 G3275RZ (Ch. 24G26 and  
 Radio Ch. 8G20/22) Tel.  
 Rec. (For TV Ch. See  
 Ch. 24G26—Set  
 91A-12, For Radio Ch.  
 See Ch. 8G20/22—Set  
 91A-13)  
 H-401, G (Ch. 4H40) 156—15  
 H500 (Ch. 5H40) 152—12  
 H-503, Y (Ch. 5H41) 151—12  
 H511, H511W, H511Y  
 (Ch. 5H01) 147—13  
 H615 (Ch. 6G05) 140—14  
 H615E1 (Ch. 6G05E1) 178—16  
 H661E, H661R  
 (Ch. 6H01) 125—13

**ZENITH—Cont.**

H664 (Ch. 6H02) 149—15  
 H665, R, RZ, Z  
 (Ch. 6H01) 125—13  
 H723 (Ch. 7H04) 122—12  
 H723Z (Ch. 7H04Z) 134—14  
 H723Z1 (Ch. 7H04Z1)  
 (See Model H724Z1—  
 Set 163-14)  
 H723Z2 (Ch. 7H04Z2) 178—17  
 H724 (Ch. 7H04) 126—15  
 H724Z (Ch. 7H02Z) (See  
 Model H723Z—  
 Set 134-14)  
 H-724Z1 (Ch. 7H02Z1) 163—14  
 H724Z2 (Ch. 7H02Z2) 178—17  
 H725 (Ch. 7G01Z) 135—15  
 H808, H808R  
 (Ch. 8H20 Revised) 127—14  
 H880RZ (Ch. 8H20) 114—12  
 H1083E (Ch. 10H20) (See  
 Model H3467R—  
 Set 120-13)  
 H1086R, H-1087R (Ch.  
 10H20) (See Model  
 H3467R—Set 120-13)  
 H2029R, H2030E, H2030R  
 (Ch. 20H20) Tel. Rec. 144—15  
 H2041R (Ch. 20H20)  
 Tel. Rec. 144—15  
 H-2052R, H2053E (Ch.  
 20H20) Tel. Rec. 144—15  
 H2226E, R, H2227E,  
 H2227R (Ch. 22H20)  
 Tel. Rec. 114—13  
 H2229R, H2230E, R  
 (Ch. 22H21) Tel. Rec. 151—13  
 H2241R (Ch. 22H21)  
 Tel. Rec. 151—13  
 H2242E, R (Ch. 22H22)  
 Tel. Rec. 151—13  
 H2250R (Ch. 22H20)  
 Tel. Rec. 114—13  
 H2252R, H2253E (Ch.  
 22H21) Tel. Rec. 151—13  
 H2254R (Ch. 22H22)  
 Tel. Rec. 151—13  
 H2255E (Ch. 22H20)  
 Tel. Rec. 114—13  
 H2328E, EZ, R, RZ (Ch.  
 23H22, Z) Tel. Rec. 118—11  
 H2329R, RZ (Ch. 23H22,  
 Z) Tel. Rec. (See Model  
 H2328E—Set 118-11)  
 H2330E, R (Ch. 23H22)  
 Tel. Rec. (See Model  
 H2328E—Set 118-11)  
 H2330E, RZ (Ch. 23H22,  
 Z) Tel. Rec. (See Model  
 H2328E—Set 118-11)  
 H2335RZ, RZ, H2335SE, EZ  
 Ch. 23H22, Z) 118—11  
 H2436Q (Ch. 24H21)  
 Tel. Rec. (See Model  
 H3477R—Set 120-13)  
 H-2437E, H-2438R,  
 H-2439R (Ch. 24H20)  
 Tel. Rec. 120—13  
 H2443R (Ch. 24H20)  
 Tel. Rec. (See Model  
 H2437E—Set 120-13)  
 H2445R (Ch. 24H21)  
 Tel. Rec. 120—13  
 H2447R (Ch. 24H21)  
 Tel. Rec. 120—13  
 H2449E (Ch. 24H20)  
 Tel. Rec. 120—13  
 H2868 (Ch. 20H20 and  
 Radio Ch. 8H20Z) Tel.  
 Rec. (For TV Ch. See  
 Model H2029R—Set 144-15,  
 For Radio Ch. See  
 Model H880RZ—Set 114-12)  
 H3068R (Ch. 22H21 and  
 Radio Ch. 8H20Z) Tel.  
 Rec. (For TV Ch. See  
 Model H2229R—Set  
 151-13, For Radio Ch.  
 See Model H880RZ—  
 Set 168-14)  
 H-3074 (Ch. 20H20 and  
 Radio Ch. 10H20Z)  
 Tel. Rec. (For TV Ch. See  
 Model H2029R—  
 Set 144-15, For Radio  
 Ch. See Model H2229R—  
 Set 151-13)  
 H3168R (Ch. 23H22 and  
 Radio Ch. 8H20) Tel. Rec. (For  
 TV Ch. See Model  
 H2328E—Set 118-11,  
 For Radio Ch. See  
 Model H880RZ—Set  
 114-12)  
 H3257, R (Ch. 24H20 and  
 Radio Ch. 8H20) Tel.  
 Rec. (For TV Ch. See  
 Set 120-13, For Radio  
 Ch. See Model H800RZ—  
 Set 114-12)  
 H3273E, H3274R (Ch.  
 22H21 and Radio Ch.  
 10H20Z) Tel. Rec. 151—13  
 H3284R (Ch. 22H22 and  
 Radio Ch. 10H20Z) Tel.  
 Rec. 151—13  
 H3467R (Ch. 24H20 and  
 Radio Ch. 10H20)  
 Tel. Rec. 120—13  
 H3469E (Ch. 24H20 and  
 Radio Ch. 10H20) Tel.  
 Rec. (See Model  
 H3467R—Set 120-13)  
 H3475R (Ch. 24H20 and  
 Radio Ch. 10H20)  
 Tel. Rec. 120—13  
 H3477R (Ch. 24H21 and  
 Radio Ch. 10H20)  
 Tel. Rec. 120—13  
 H3478E (Ch. 24H21 and  
 Radio Ch. 10H20)  
 Tel. Rec. 120—13

**ZENITH—Cont.**

H3490EQ (Ch. 24H21 and  
 Radio Ch. 10H20Z) Tel.  
 Rec. (For TV Ch. See  
 Model H2445R—Set  
 120-13, For Radio Ch.  
 See Model H3273E—  
 Set 151-13)  
 J402 (Ch. 4J40) 178—18  
 J420F (Ch. 4J0T) 185—16  
 J514 (Ch. 5J03) 176—14  
 J615, F, G, W, Y  
 (Ch. 6J05) 182—16  
 J616 (Ch. 6J03) 179—14  
 J644, J665E, R  
 (Ch. 6J02) 172—13  
 J733, G, R, Y (Ch. 7J03) 186—17  
 J880, J880R (Ch. 8H20Z) 168—14  
 H1083E, EZ (Ch. 10H20Z)  
 (See Model H3273E—  
 Set 151-13)  
 J1086, R, RZ (Ch. 10H20Z)  
 (See Model H3273E—  
 Set 151-13)  
 J1087, Z (Ch. 10H20Z)  
 (See Model H3273E—  
 Set 151-13)  
 J2026R (Ch. 20J21)  
 Tel. Rec. 159—18  
 J2027E, R, J2029E, R  
 J2030E, R (Ch. 20J21)  
 Tel. Rec. 159—18  
 J2031R (Ch. 20J21) Tel.  
 Rec. (See Model J2026R  
 —Set 159-18)  
 J2032R (Ch. 20J22) Tel.  
 Rec. (See Model J2051E  
 —Set 159-18)  
 J2040E, J2042R, J2043R,  
 J2044E, R (Ch. 20J21)  
 Tel. Rec. 159—18  
 J2049R (Ch. 20J21) Tel.  
 Rec. (See Model J2027E  
 —Set 159-18)  
 J2050R (Ch. 20J21) Tel.  
 Rec. (See Model J2027E  
 —Set 159-18)  
 J2051E, J2053R, J2054R,  
 J2055R (Ch. 20J22)  
 Tel. Rec. 159—18  
 J2125R (Ch. 21J21)  
 Tel. Rec. 159—18  
 J2127E, R, J2129E, R,  
 J2130E, R (Ch. 21J20)  
 Tel. Rec. 159—18  
 J2140E, J2142R, J2143R,  
 J2144E, R (Ch. 21J20)  
 Tel. Rec. 159—18  
 J2151E, J2153R, J2154R,  
 J2155R (Ch. 21J21)  
 Tel. Rec. 159—18  
 J2868R (Ch. 20J21 and  
 Radio Ch. 8H20Z) Tel. Rec.  
 (For TV Ch. See Set  
 159-18, For Radio Ch.  
 See Model J880—  
 Set 168-14)  
 J2968R (Ch. 21J20 and  
 Radio Ch. 8H20Z) Tel.  
 Rec. (For TV Ch. See  
 Set 159-18, For Radio  
 Ch. See Model J880—  
 Set 168-14)  
 J3069E (Ch. 20J21 and  
 Radio Ch. 10H20Z)  
 Tel. Rec. (For TV  
 Ch. See Set 159-18,  
 For Radio Ch. See  
 Model H3273E—Set  
 151-13)  
 J3169E (Ch. 21J20 and  
 Radio Ch. 10H20Z)  
 Tel. Rec. (For TV Ch.  
 See Set 159-18, For  
 Radio Ch. See Model  
 H3273E—Set 151-13)  
 K412G, R, W, Y  
 (Ch. 4K01) 195—13  
 K510, K510W, K510Y,  
 (Ch. 5K02) 181—15  
 K515 (Ch. 5K03) (See  
 Model J514—Set 176-14)  
 K518 (Ch. 5J03) (See  
 Model J514—Set 176-14)  
 K622, F, G, W (Ch. 6K03) 203—18  
 K666R (Ch. 6K02) 203—18  
 K725, F, G (Ch. 7K01) 212—10  
 K772E, R (Ch. 7K20) 190—17  
 K1127R (Ch. 19K22)  
 Tel. Rec. 184—15  
 K1815E, R (Ch. 19K20)  
 Tel. Rec. 184—15  
 K1820E, R (Ch. 19K20)  
 Tel. Rec. 184—15  
 K1846E, R (Ch. 19K20)  
 Tel. Rec. 184—15  
 K1850E, R (Ch. 19K20)  
 Tel. Rec. 184—15  
 K1880R (Ch. 19K20)  
 Tel. Rec. 184—15  
 K2229E (Ch. 19K24) Tel.  
 Rec. (See Model  
 K1812E—Set 184-15)  
 K2229R (Ch. 19K23)  
 Tel. Rec. 184—15  
 K2230E, R (Ch. 21K20)  
 Tel. Rec. 187—14  
 K2235E, R (Ch. 19K23)  
 Tel. Rec. (See Model  
 K1812E—Set 184-15)  
 K2240E, R (Ch. 21K20)  
 Tel. Rec. 184—14  
 K2258E (Ch. 19K23) Tel.  
 Rec. (See Model  
 K2258R—Set 184-15)  
 K2258R (Ch. 19K23)  
 Tel. Rec. 184—15  
 K2260R (Ch. 21K20)  
 Tel. Rec. 187—14  
 K2262R (Ch. 19K23) Tel.  
 Rec. (See Model  
 K2229E—Set 184-15)  
 K2263E (Ch. 21K20)  
 Tel. Rec. 187—14  
 K2266, R (Ch. 21K20)  
 Tel. Rec. 187—14

## ZENITH—Cont.

K2267E (Ch. 21K20)	
Tel. Rec.	187-14
K2268R (Ch. 21K20)	
Tel. Rec.	187-14
K2270H, R (Ch. 21K20)	
Tel. Rec.	187-14
K2271H (Ch. 21K20) Tel. Rec. [See Model K2230E—Set 187-14]	
K2286R (Ch. 19K23)	
Tel. Rec.	184-15
K2287R (Ch. 21K20 and Radio Ch. 8H20Z) Tel. Rec. [For TV Ch. See Set 187-14, For Radio Ch. See Model J880—Set 168-14]	
K2288E (Ch. 19K23)	
Tel. Rec.	184-15
K2290R, K2291E (Ch. 21K20 and Radio Ch. 10H20Z) Tel. Rec. [For TV Ch. See Set 187-14, For Radio Ch. See Model H3273E—Set 151-13]	
4G800 (Ch. 4E41)	35-27
4G800WZ, 4G800YZ, 4G800Z (Ch. 4E41Z)	52-23
4G903, 4G903Y (Ch. 4F40)	76-20
4K016 (Ch. 4C52)	6-39
4K035 (Ch. 4C53)	6-40
5D011, 5D027 (Ch. 5C01, 5C01Z)	3-17
5D810 (Ch. 5E02)	54-21
5G003 (Ch. 5C40)	17-35
5G003Z (Ch. 5C40Z)	30-31
5G036 (Ch. 5C51)	30-32
5R080-5R086 (Ch. 5C02, 5C04)	4-4
6D014, 6D014W, 6D029, 6D029G (Ch. 6C01)	9-35
6D015, 6D015Y, 6D030 (Ch. 6C05, 6C05Z)	3-24
6D815, 6D815W, 6D815Y (Ch. 6E05)	55-24
6G001, 6G001Y (Ch. 6C40)	3-14
6G001YZ [See Model 6G001—Set 3-14]	
6G004Y (Ch. 6C41)	20-35
6G038 (Ch. 6C50)	32-30
6G801 (Ch. 6E40)	53-26
6R084 (Ch. 6C21)	20-36
6R087 (Ch. 6C22)	7-32
7R886 (Ch. 6E02)	34-30
7H820, 7H820W (Ch. 7E01)	43-24
7H822 (Ch. 7E02), 7H822WZ, 7H822Z (Ch. 7E02Z)	55-25
7M918 (Ch. 7F03)	75-18
7H920, 7H920W (Ch. 7F01)	77-13
7H921 (Ch. 7F04)	73-16
7H922 (Ch. 7F02)	87-15
7R070 (Ch. 6C06)	37-25
7R887 (Ch. 7E21)	54-22
8G005Y (Ch. 8C40)	7-33
8G005YT [Z1] (Ch. 8C40T [Z1]), 8G005YT [Z2] (Ch. 8C40T [Z2])	53-27
8H023 (Ch. 8C01)	4-40
8H032, 8H033 (Ch. 8C20)	1-33
8H034	4-20
8H050, 8H051, 8H052, 8H061	1-33

## ZENITH—Cont.

8H832, 8H861 (Ch. 8E20)	52-24
9H079, 9H079E, 9H079R, 9H081, 9H082R, 9H085R, 9H088R (Ch. 8C21)	7-34
9H881, 9H882R, 9H885, 9H888R (Ch. 9E21)	43-25
9H984, 9H984LP (Ch. 9F22)	64-14
9H995 (Ch. 9E21Z)	74-12
12H090, 12H091, 12H092, 12H093, 12H094 (Ch. 11C21)	2-20
14H789 (Ch. 13D22)	41-24
271965R (Ch. 27F20) Tel. Rec.	
281925 E, R (Ch. 28F22)	95-8
281926 R (Ch. 28F25)	64-15
Tel. Rec. [See Model 281925—Set 64-15]	
281960E (Ch. 28F20) Tel. Rec. [See Model 281960E—Set 64-15]	
281960E-Z (Ch. 28F20Z) Tel. Rec. [See Model 281960E—Set 64-15]	
281960-GO, 281960K (Ch. 28F20) Tel. Rec. [See Model 281960—Set 64-15]	
281961 Z (Ch. 28F21) Tel. Rec. [See Model 281961—Set 64-15]	
281962R (Ch. 28F20) Tel. Rec. [See Model 281962—Set 64-15]	
281962R-LP (Ch. 28F20Z) Tel. Rec. [See Model 281962—Set 64-15]	
281963 (Ch. 28F21) Tel. Rec. [See Model 281963—Set 64-15]	
281964R (Ch. 28F23) Tel. Rec.	64-15
371998RIP (Ch. 28F23 and Radio Ch. 9E21Z) Tel. Rec. [For TV Ch. See Model 42T999RIP—Set 74-13, For Radio Ch. See Model 9H995—Set 74-12]	74-13
37T998RIPU (Ch. 28F20 and Radio Ch. 9E21Z) Tel. Rec. [For TV Ch. See Model 281960—Set 64-15, For Radio Ch. See Model 9H995—Set 74-12]	
42T999RIP (Ch. 28F23, Radio Ch. 13D22) Tel. Rec. [See Model 281964R]	
Ch. 4C52 [See Model 4K016]	
Ch. 4C53 [See Model 4K035]	
Ch. 4E41 [See Model 4G800]	
Ch. 4E41Z [See Model 4G800Z]	
Ch. 4F40 [See Model 4G903]	
Ch. 4H40 [See Model H-401]	
Ch. 4J40 [See Model J402]	
Ch. 4J60T [See Model J420T]	
Ch. 4K01 [See Model K412G]	

## ZENITH—Cont.

Ch. 5C01, 5C01Z [See Model 5D011]	
Ch. 5C02, 5C02Z [See Model 5R080]	
Ch. 5C40 [See Model 5R080]	
Ch. 5C40 [See Model 5G003]	
Ch. 5C40Z [See Model 5G003Z]	
Ch. 5C40ZZ [See Model 5G003ZZ]	
Ch. 5C51 [See Model 5G036]	
Ch. 5E02 [See Model 5D810]	
Ch. 5G01 [See Model G511]	
Ch. 5G02 [See Model G510]	
Ch. 5G03 [See Model G516]	
Ch. 5G40 [See Model G500]	
Ch. 5G41 [See Model G503]	
Ch. 5H01 [See Model H511]	
Ch. 5H40 [See Model H500]	
Ch. 5H41 [See Model H503]	
Ch. 5J03 [See Model J514]	
Ch. 5K02 [See Model K510]	
Ch. 5K03 [See Model K518]	
Ch. 6C01 [See Model 6D014]	
Ch. 6C05, Z [See Model 6D015]	
Ch. 6C06 [See Model 7R070]	
Ch. 6C21 [See Model 6R084]	
Ch. 6C22 [See Model 6R087]	
Ch. 6C40 [See Model 6G001]	
Ch. 6C41 [See Model 6G004Y]	
Ch. 6C50 [See Model 6G038]	
Ch. 6E02 [See Model 6R886]	
Ch. 6E05 [See Model 6D815]	
Ch. 6E40 [See Model 6C801]	
Ch. 6G01 [See Model G660]	
Ch. 6G05 [See Model G615]	
Ch. 6G05Z1 [See Model H615Z1]	
Ch. 6G20 [See Model G2957]	
Ch. 6H01 [See Model H61E]	
Ch. 6H02 [See Model H644]	
Ch. 6J02 [See Model J644]	
Ch. 6J03 [See Model J616]	
Ch. 6J05 [See Model J615]	

## ZENITH—Cont.

Ch. 6K02 [See Model K666R]	
Ch. 6K03 [See Model K622]	
Ch. 7E01 [See Model 7H820]	
Ch. 7E02 [See Model 7H822]	
Ch. 7E02Z [See Model 7H822WZ]	
Ch. 7E22 [See Model 7R887]	
Ch. 7F01 [See Model 7H920]	
Ch. 7F02 [See Model 7H922]	
Ch. 7F03 [See Model 7H918]	
Ch. 7F04 [See Model 7H921]	
Ch. 7G01 [See Model G725]	
Ch. 7G01Z [See Model H725]	
Ch. 7G02 [See Model G724]	
Ch. 7G04 [See Model G723]	
Ch. 7H02 [See Model H724]	
Ch. 7H02Z [See Model H724Z]	
Ch. 7H02Z1 [See Model H724Z1]	
Ch. 7H02Z2 [See Model H724Z2]	
Ch. 7H04 [See Model H723]	
Ch. 7H04Z [See Model H723Z]	
Ch. 7H04Z1 [See Model H723Z1]	
Ch. 7H04Z2 [See Model H723Z2]	
Ch. 7J03 [See Model J733]	
Ch. 7K01 [See Model K725]	
Ch. 7K20 [See Model K777E]	
Ch. 8C01 [See Model 8H023]	
Ch. 8C20 [See Model 8H032]	
Ch. 8C21 [See Model 9H079]	
Ch. 8C40 [See Model 8G005Y]	
Ch. 8C40T [Z1] [See Model 8G005YT [Z1]]	
Ch. 8C40T [Z2] [See Model 8G005YT [Z2]]	
Ch. 8E20 [See Model 8H832]	
Ch. 8G20 [See Model G881]	
Ch. 8G20/22	91A-13
Ch. 8H20 [See Model H880RZ]	
Ch. 8H20 Revised [See Model H880]	
Ch. 8H20Z [See Model J880]	
Ch. 9E21 [See Model 9H881]	
Ch. 9E21Z [See Model 9H995]	
Ch. 9F22 [See Model 9H984]	

## ZENITH—Cont.

Ch. 10H20 [See Model H3467R]	
Ch. 10H20Z [See Model H3273E]	
Ch. 11C21 [See Model 12H090]	
Ch. 13D22 [See Model 14H789]	
Ch. 19K20 [See Model K1815E]	
Ch. 19K22 [See Model K1812E]	
Ch. 19K23 [See Model K2229R]	
Ch. 20H20 [See Model H2029R]	
Ch. 20J21 [See Model J2027E]	
Ch. 20J22 [See Model J2026R]	
Ch. 21J20 [See Model J2127E]	
Ch. 21J21 [See Model J2127R]	
Ch. 21K20 [See Model K-2230E]	
Ch. 22H20 [See Model H2226R]	
Ch. 22H21 [See Model H2229R]	
Ch. 22H22 [See Model H2242E]	
Ch. 23G22 [See Model G2322] Tel. Rec.	
Ch. 23G23 [See Model G2957]	
Ch. 23G24	91A-13
Ch. 23G24Z1 [See Model G2322Z1]	
Ch. 23H22, 23H22Z [See Model H-2328E]	
Ch. 24G20-OX [See Model G2420-EOX]	
Ch. 24G21 [See Model G2454R]	
Ch. 24G21-OX [See Model G2454-ROX]	
Ch. 24G22/24 [See Model G2441R]	
Ch. 24G23/25 [See Model G3059R]	
Ch. 24G24 [See Model G2441]	
Ch. 24G26	91A-12
Ch. 24G26Z1 [See Model G2441Z1]	
Ch. 24H20 [See Model H2437E]	
Ch. 24H21 [See Model H2245R]	
Ch. 27F20 [See Model 27T965R]	
Ch. 28F20 [See Model 28T960E-Z]	
Ch. 28F20Z [See Model 28T960E-Z]	
Ch. 28F21 [See Model 28T961E]	
Ch. 28F22 [See Model 28T925E]	
Ch. 28F23 [See Model 28T964R]	
Ch. 28F25 [See Model 28T926E]	
Ch. 29G20 [See Model G2951]	

## RECORD CHANGERS

(CM-1) indicates service data also available in Howard W. Sams 1947 Record Changer Manual. (CM-2) indicates service data available in Howard W. Sams 1948 Record Changer Manual. (CM-3) indicates service data available in Howard W. Sams 1949, 1950 Record Changer Manual. (CM-4) indicates service data available in Howard W. Sams 1951, 1952 Record Changer Manual.

## ADMIRAL

RC-150	(CM-1) 26-31
RC160, RC160A, RC161, RC-161A [See Model RC200—Set 9 and Model RC-160—Set 21-37]	
RC-170, RC-170A	(CM-1) 31-2
RC-180, RC-181	(CM-2) 76-1
RC-182 [See Model RC-181—Set 76-1 and Supplement—Set 76-2] (CM-2)	
RC-200	(CM-1) 9
RC-210, RC211, RC212	(CM-3) 72
RC-220, RC-221, RC-222, RC-320, RC-321, RC-322 [See Set 79-1 and Changes in Set 108-2 (CM-3)]	
RC400	(CM-4) 104-1
RC500	(CM-4) 132-2
RC-550 [See Model RC-500—Set 132-2 (CM-4) and Model RC-550—Set 185-2]	

## AERO

46A	(CM-1) 19-34
47A	(CM-2) 77-2

## AVIOLA

100	(CM-1) 33-32
-----	--------------

## BELMONT

C-9	(CM-2) 34-31
-----	--------------

## COLLARO

RC-521, RC-522	205-4
3RC-521, 3RC-522	205-4

## COLUMBIA

104	124-2
-----	-------

## CRESCENT

C-200	(CM-1) 20-37
6 Series	(CM-3) 89-4
250 Series	(CM-2) 78-5
350 Series	(CM-2) 80-4
500 Series	197-4

## FARNSWORTH

P-51, P56	(CM-1) 13-36
P-72, P73	(CM-2) 75-8

## GARRARD

RC-60	(CM-2) 81-7
RC80	(CM-4) 157-5

## GENERAL ELECTRIC

P6	(CM-2) 79-8
----	-------------

## GENERAL INDUSTRIES

RC130L	(CM-1) 22-33
--------	--------------

## GENERAL INSTRUMENT

204	(CM-1) 23-34
205	(CM-1) 10

## LEAR

PC-206A	(CM-1) 18-33
---------	--------------

## MAGUIRE

ARC-1	(CM-1) 7
-------	----------

## MARKEL

70, 71	(CM-2) 84-8
74, 75 [See Set 91-7] (CM-3) and Supplement—Set 131-11]	

## MILWAUKEE ERWOOD

10700	(CM-1) 16-37
11200	(CM-2) 86-6
11600	(CM-3) 73-7
12300	(CM-4) 138-5

## MOTOROLA

B24RC, B25RC, B27RC, B28RC	(CM-1) 12-35
RC30	(CM-2) 80-9
RC36, A	(CM-4) 147-8
RC36C [See Model RC36—Set 147-8]	
RC37	(CM-4) 141-8
RC40 [See Model RC37—Set 141-8 (CM-4)]	
OAK 6666	(CM-1) 19-35
9201	(CM-3) 111-10

## PHILCO

D10, D10A	(CM-1) 14-21
M-4	(CM-1) 25-30
M-7	(CM-1) 28-35
M-8	(CM-2) 83-7
M-9C	(CM-2) 74-7
M-12C	(CM-3) 109-9
M-20	(CM-3) 103-11
M22	(CM-4) 140-6

## RCA

RP148	(CM-3) 72-10
RP-176	(CM-1) 25-31
RP-177	(SM-2) 44-27
RP-178	(CM-2) 79-12
RP190 Series	(CM-4) 144-7

## SEEBURG

K	(CM-1) 11-36
L	(CM-1) 24-34
M	(CM-1) 32-19
S, SQ	(CM-2) 78-12

## SILVERTONE

101.761-2	(CM-2) 77-10
101.761-3	(CM-2) 83-11
101.762-3	(CM-2) 83-11
101.763	(CM-2) 88-11

## SPARTON

C48	(CM-2) 87-11
-----	--------------

## THORENS

CD-40	(CM-1) 39-29
-------	--------------

## TRAV-LER

A	(CM-3) 72-13
---	--------------

## UNIVERSAL CAMERA

100	(CM-1) 36-30
-----	--------------

## UTAH

550	(CM-1) 8
650	(CM-1) 22-34
7000	(CM-1) 27-31
7001	(CM-2) 83-15

## W-M

200-B	(CM-1) 15-36
400	(CM-1) 26-33
400 (Lite)	(CM-2) 90-13
402, 400C	(CM-2) 82-12
402D, 400D	(CM-2) 87-14
404 [See Model 405—Set 73-14 (CM-3)]	

405	(CM-3) 73-14
406, 407	(CM-3) 73-14
800	(CM-1) 21-38
800-D	(CM-2) 84-12



## RECORDERS

<p><b>AMPRO</b> 730 .....(CM-4) 133—4 731 (For electrical unit see Folder 166-5; for mechanical unit see Folder 133-4) 731-R (See Model 731)</p> <p><b>BRUSH SOUND MIRROR</b> BK-401 .....(CM-1) 42—25 BK-403 .....(CM-2) 78—3 BK-416 .....(CM-2) 81—4 BK-437, S-BK-439, BK-441, BK-442, BK-443P .....164—3</p> <p><b>BRUSH MAIL-A-VOICE</b> BK-501, BK-502, BK-503 .....(CM-1)</p> <p><b>CONCERTONE</b> 1401 (401) .....(CM-4) 155—4</p> <p><b>CRESCENT</b> H-1A .....(CM-4) 130—5 H-2A1 Series .....(CM-3) 119—4 H-19 Series "Steno" .....(CM-4) 122—3</p>	<p><b>CRESCENT—Cont.</b> H-22A1 .....125—4 M2000 Series .....(CM-4) 120—4 M-2001 Series .....120—4 M-2500 Series .....120—4 M-3000 Series .....120—4 M-3001 Series .....120—4 M-3500 Series .....120—4 1000 Series .....(CM-2) 1000 Series Revised(CM-3) 77—4</p> <p><b>CRESTWOOD</b> CP-201 .....(CM-3) 118—4</p> <p><b>DUKANE</b> 11A55FF, 11B55 .....187—5</p> <p><b>EICOR</b> 1000 .....(CM-3) 90—4</p> <p><b>EKOTAPE</b> 101-4, 5, 102-4, 5, 103-4, 5, 104-4, 5 .....(CM-3) 116—12 101-8, 101-9, 102-9, 103-8 .....107—6 109, 110, 111, 112 .....(CM-4) 152—5 114, 115, 116, 117 .....189—8</p>	<p><b>GENERAL INDUSTRIES</b> R70, R90 .....(CM-1) 35—28 250 .....(CM-4) 143—8</p> <p><b>INTERNATIONAL ELECTRONICS</b> PT3 .....(CM-2) 88—4</p> <p><b>KNIGHT</b> 96-144 (CM-4) .....158—6 96-485 .....183—8 97-499 (CM-4) .....158—6</p> <p><b>LEAR DYNAPORT</b> WC-311-D .....(CM-2) 80—8</p> <p><b>MAGNECORD AUDIAD</b> AD-1R .....(CM-2) 84—7 PT6-A, AH, AHX, AX .....190—6 PT63-A, AH, AHX, AX .....190—6</p> <p><b>MASCO</b> DC37R (CM-4) .....148—9 D37 (CM-4) .....148—9 D37R .....(CM-4) 148—9 LD37, LD37R .....(CM-4) 148—9 375 .....(CM-3) 117—7</p>	<p><b>PENTRON</b> PB A2, PB-1 .....184—11 9T 3 .....(CM-4) 153—10 9T 3C .....(CM-4) 162—9</p> <p><b>RCA</b> MI-12875 .....(CM-2) 85—12</p> <p><b>RECORDIO (See Wilcox Gay)</b></p> <p><b>RELEST</b> CIA .....(CM-4) 123—13</p> <p><b>REVERE</b> T-100 .....(CM-4) 149—11 TR-200 (For electrical unit see Folder 165-10; for mechanical unit see Folder 149-11) T-70153, T-70157, T-70163, T-70167, T-70235, T-70257, T-70263, T-70267, T-77153, T-77157, T-77163, T-77167, T-77253, T-77257, T-77263, T-77267 .....193—9</p>	<p><b>SILVERTONE</b> 70 (Ch. 567, 230, 577, 231) .....(CM-4) 121—11 771 .....(CM-1) 26—32 101.774-2, 101.774-4 .....(CM-3) 114—10</p> <p><b>ST. GEORGE</b> 1100 Series .....(CM-1) 40—24</p> <p><b>TAPE MASTER</b> PT-121 .....186—14 PT-125 .....198—15</p> <p><b>WEBSTER-CHICAGO</b> 79-80 .....(CM-1) 37—26 178 .....(CM-3) 113—12 210 .....(CM-4) 159—17 228 .....(CM-4) 156—13</p> <p><b>WEBSTER ELECTRIC (See Ekotape)</b></p> <p><b>WILCOX GAY</b> 2A10, 2A10B, 2A11, 2A11B .....180—10 3A10, 3A11 .....200—13</p> <p><b>WIRE RECORDING CORP.</b> WP .....(CM-2) 76—19</p>
--	--	---	--	---

## ADDITIONAL PHOTOFACIT BENEFITS

From time to time, PHOTOFACIT Folder Sets include valuable "bonus" aids, as well as useful data of a special nature. The fol-

lowing materials are extra benefits incorporated in the PHOTOFACIT Folder Sets indicated, at no additional cost.

Set No.	Set No.	Set No.
1—RTMA Production Source Code (Jan. 1, 1952) .....168	8—Replacement of Disc & Plate Type Ceramic Capacitors ..... 58	13—CR Tube Dimension Chart .....112
2—TRADE DIRECTORY—Parts Manufacturers ..... 12	9—Certificate entitling subscriber to PHOTOFACIT Volume Labels for Vols. 1-10 ..... 62	14—CR (Electromagnetic) Tube Characteristics Chart .....112
3—National Electrical Code on Antennas ..... 88	10—Certificate entitling subscriber to PHOTOFACIT Volume Labels for Vols. 11-20 .....102	15—CR Tube Interchangeability Chart .....112
4—Record Changer Cross Reference by Manufacturer and Model .....118	11—Certificate entitling subscriber to 100 Door Knob Hangers ..... 80	16—NPA maintenance and repair information .....130
5—Mica Capacitor Color Codes ..... 48	12—Photofact Television Course appearing serially in .....38-51, 54	17—Proposed Television channel allocation .....132
6—Ion Trap Alignment ..... 62		18—General Electric Clock Data .....160
7—"Let's Look at the Sync Pulses" ..... 64		

# QUAM

QUAM  
**FOCALIZER**  
UNIT  
TRADE MARK

*Tru-Match*  
**OUTPUT**  
**TRANSFORMERS**

**QUAM**  
**ION TRAPS**

*Adjust-a-Cone*® **SPEAKERS**

ELECTRO-DYNAMIC SPEAKERS  
PERMANENT MAGNET SPEAKERS  
HIGH FIDELITY SPEAKERS  
OUTDOOR THEATRE SPEAKERS  
REAR SEAT AUTO SPEAKERS  
TELEVISION SPEAKERS  
INTER-COM SPEAKERS  
CO-AXIAL SPEAKERS

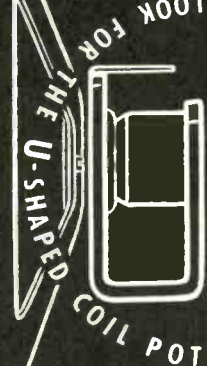

**QUAM-NICHOLS CO. 33rd Place and Cottage Grove, Chicago 16, Ill.**

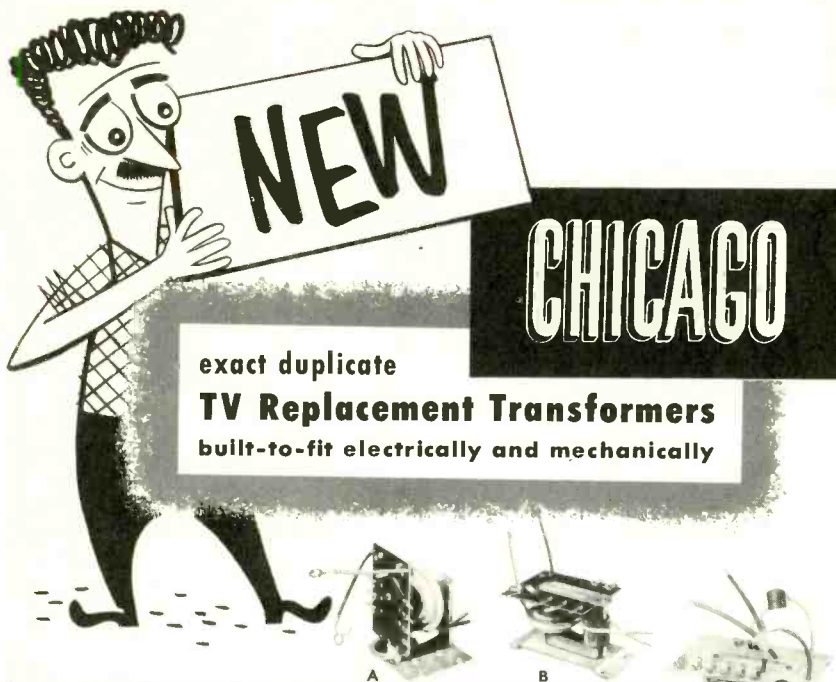

**FIVE NEW HORIZONTAL OUTPUT TRANSFORMERS (70°)**

CAT. No.	KV OUTPUT	MTG. TYPE	BOOST VOLTAGE	DIRECT REPLACEMENT AND DESCRIPTION	WT. LBS.	LIST PRICE
TFB-18	16.0	A	475	RCA 225T1, Dumont, Hallicrafters, Hoffman, Arvin, Keye-Halbert, Packard Bell, and others	1	\$10.00
TFB-19	14.0	B	510	CBS 10136, Silvertone, Crosley, and others	1	10.50
TFB-20	16.0	C	500	Muntz TO-0031	1	10.00
TFB-21	13.0	D	500	Trav-ler TVX 104, TVX 106	1	9.00
TFB-22	13.00	D	500	Trav-ler TVX 108	1	9.00

**TWO NEW DEFLECTION YOKES (70°)**

CAT. No.	INDUCTANCE		DC RESISTANCE		WT. LBS.	LIST PRICE
	HORIZ.	VERT.	HORIZ.	VERT.		
TY-9	25 mh.	50 mh.	27 ohms	60 ohms	1	\$10.00
TY-10	25 mh.	3.3 mh.	27 ohms	4 ohms	1	10.50

**FIVE NEW WIDTH AND LINEARITY COILS**

CAT. No.	TYPE	INDUCTANCE	RESISTANCE	LIST PRICE
TW-4	Width	.05—.5 mh.	.53 ohms	\$1.00
TW-5	Width	.5—3.5 mh.	2.3 ohms	1.25
TW-6	Width with AGC	Pri. 2.6—7.5 mh. Sec. 4.0—28 mh.	1.2 ohms 32.0 ohms	1.75
TW-7	Width	1.0—10.0 mh.	8.0 ohms	1.50
TL-4	Linearity	5.0—40.0 mh.	32.0 ohms	1.25



**FREE! TV Replacement Catalog**

Write for your copy of CHICAGO'S latest Exact Duplicate TV Transformer Catalog—get acquainted with your complete guide to every replacement requirement. Do every job right—ask your distributor for CHICAGO built-to-fit replacements.

**CHICAGO TRANSFORMER**

DIVISION OF ESSEX WIRE CORPORATION  
3501 ADDISON STREET, CHICAGO 18, ILL.



**MOTOROLA-DETROIT CO.**

one of the country's largest distributors of television sets and appliances

SAYS



**IS A PROFITABLE ITEM TO STOCK FOR 2 REASONS**

**1. TV SERVICEMEN BUY IT**



"Our customers use Krylon and plenty of it," reports Motorola-Detroit parts manager, Paul Wallace. "The spray nozzle makes it easy to insulate the complete chassis in a matter of minutes." Because of its high dielectric strength, Krylon helps prevent corona.

**2. WE USE IT OURSELVES**



Indoor service chief, John Workman, reports, "We use Krylon clear plastic coating to spray the bell part of metal picture tubes. Krylon stops dust from adhering to the tube and prevents arcing. We find Krylon is a must in television service operations."

**— ALSO —**

"Our appliance division uses White Krylon to touch up any white goods that become chipped. We're sold on White Krylon for one big reason — it won't turn yellow."

*S. Charles T. Weyoff*  
Service Manager  
Motorola-Detroit Co.

In U.S.A. and CANADA  
SEE YOUR JOBBER  
Or Write For Information  
Department 2507



**KRYLON, Inc.**

2038 Washington Ave., Philadelphia 46, Pa.



SHOP TALK

(Continued from page 5)

tely, whereas the highs of the green channel are distributed in equal measure to each receiving system. The signal of each color then actuates its own particular cathode-ray tube and the light from the three tubes are combined for the final image.

Consider carefully what happens to the highs. Each cathode-ray tube will produce the same fine detail on its screen and the combination of these three colors in the final image will produce either white, black, or intermediate shades of gray. This is true because the combination of the three primary colors, in equal amount, will produce white or its equivalent. Thus, in the "mixed-highs" systems, the fine detail of the image will appear in monochrome, and the larger objects will be in color.

The use of the "mixed-highs" principle, as described above, enabled RCA to reduce the bandpass of their color signal to 12.5 mc, as shown in Figure 3. This was in 1946.

While all this color television work was being carried on, black

and white television was in commercial operation and growing at a phenomenal rate. The expansion was so rapid, in fact, that it did not take long to realize that if and when color television was authorized, it would have to confine itself to the same 6 mc channel now utilized by black-and-white television. This was officially enunciated by the Federal Communications Commission in 1948.

Efforts to compress the 12.5 mc color signal of Figure 3 into a 6 mc channel proved fruitless and so an entirely new approach was developed. This turned out to be the dot sequential system which, after a number of changes, led to the present NTSC system. Some of the changes were wrought by RCA and some by other firms who were interested in evolving the best and most practical color system possible.

The name of dot sequential which was originally chosen by RCA is misleading since the system is basically a simultaneous one. At first, this latter feature went unrecognized. However, as a deeper insight into its operation was gained, and as refinements were added, its true simultaneous nature became

apparent. Today, the name of dot sequential is no longer heard; the system is either referred to as the NTSC system or as the "band-shared simultaneous color television" system.

In the NTSC system, the full television signal (sound and video) is contained in a 6 mc channel. The system still makes use of the "mixed-highs" principle. It also contains the full black-and-white television signal and, in addition incorporates a color carrier and its sidebands.

The first question that comes to mind then, is: "How can all this be compressed into a 6 mc band-pass?" After all, it required 12.5 mc in the previous system and here 6 mc is enough. Where is the color signal placed?

The secret lies in the fact that a television signal does not occupy every "cycle" of the 6 mc band assigned to it. It was discovered as far back as 1929 (and then apparently forgotten) that the energy in a video signal is not uniformly spread over the 6 mc band but rather, that it appears in the form of bundles located near harmonics of the 15,750 cycle line scanning frequency. The energy is clustered around these points, leaving relatively wide gaps in-between. Since these empty gaps are not being used, there is no reason why they cannot be utilized for the transmission of additional information and this is specifically where the color information for the NTSC color television signal is placed. See Figure 4.

Thus, as matters stand now, we have a black-and-white television signal which is essentially identical to that transmitted by present television stations. This signal is transmitted in black and white and is received in black and white. It is called the luminance signal and contains all the information that your present set receives.

To this is added the chrominance signal and this possesses all the color information of the picture. The energy for this signal is placed midway between the clusters of energy of the luminance signal. This is carried out in the following manner. A color subcarrier is

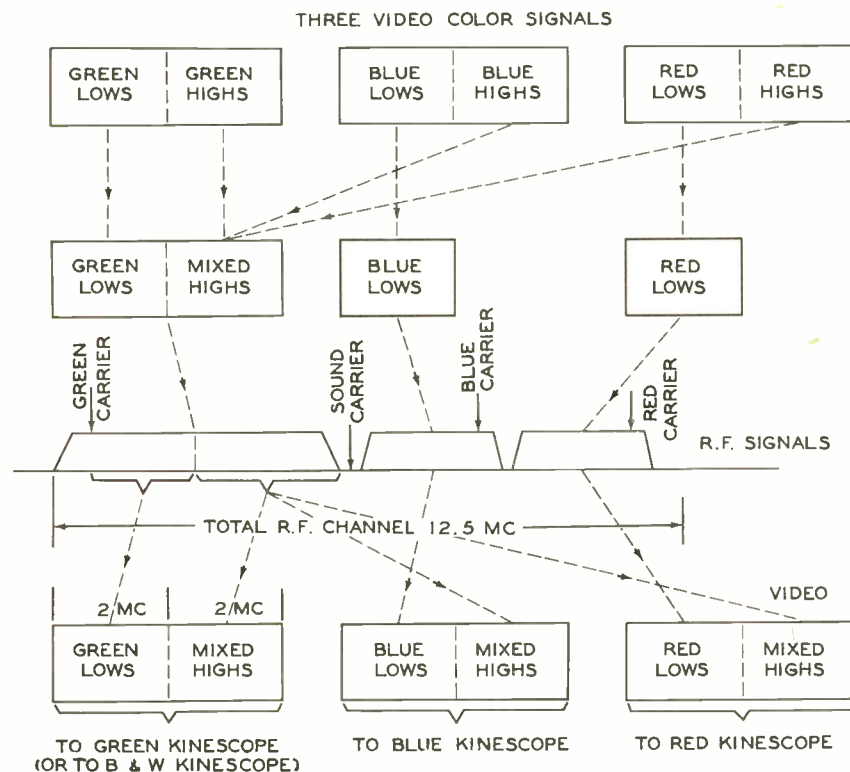
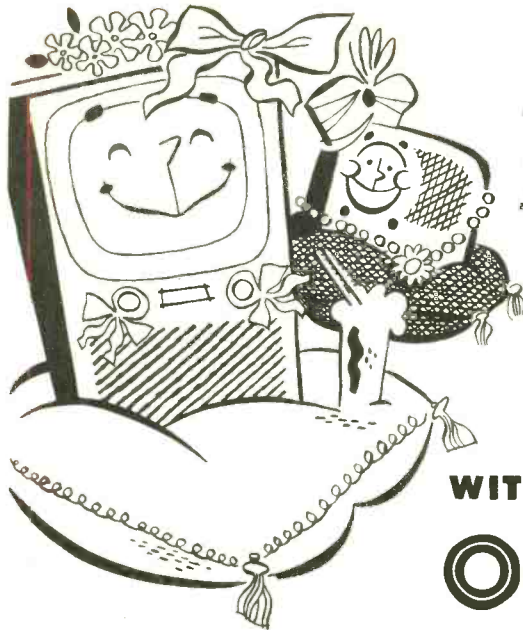

Figure 2. Application of the "mixed-highs" principle to a color television system.



# PAMPER

YOUR TV  
AND

**RADIO SETS**

WITH DEPENDABLE

# OHMITE®

REPLACEMENTS

## Little Devil® COMPOSITION RESISTORS



Tiny, yes . . . but what dependability, ruggedness, and stability! And they provide an *extra* margin of safety—being rated at 70C rather than 40C. Completely sealed and insulated by molded plastic, they meet all JAN-R-11 requirements . . . are available in 1/2, 1, and 2-watt sizes in all RTMA values.

### TYPE AB NOISE-FREE POTENTIOMETERS

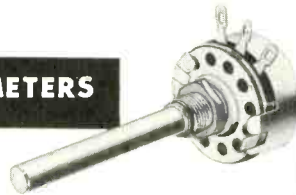

Because the resistance material in these units is solid-molded—not sprayed or painted on—continued use has practically no effect on the resistance. Often, the noise-level *decreases* with use . . . and they provide exceptionally long, trouble-free service. Rated at 2 watts, with a good safety factor.

### BROWN DEVIL® AND DIVIDOHM® RESISTORS

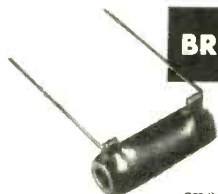

BROWN DEVIL fixed resistors and DIVIDOHM adjustable resistors are favorite vitreous-enameled units! DIVIDOHM resistors are available in 10 to 200-watt sizes; BROWN DEVILS in 5, 10, and 20-watt sizes.

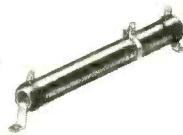

WRITE FOR  
STOCK  
CATALOG

OHMITE MFG. CO.  
4872 Flournoy St.  
Chicago 44, Ill.

Be Right With . . .

# OHMITE

RHEOSTATS • RESISTORS • TAP SWITCHES

EASIEST USING,  
EASIEST READING  
VACUUM TUBE  
VOLT-OHM METER



Model 709

New  
**TELE-VOLTER**  
by Jackson

The **BIGGEST** little  
instrument of its kind

The 7"-square meter, with hair-line pointer, provides all the voltage (AC-DC) and ohm ranges you could possibly want or need. Meter is electronically protected against overload.

Controls consist of on-off circuit switch, zero adjust, ohms adjust, besides switches built into probes for changing from DC to AC or ohms.

High voltage accessory probe gives readings to 30,000 volts DC.

**Dealer net price . . . \$95.00**

Ask your electronics distributor  
for information, or write us.

# JACKSON

**ELECTRICAL INSTRUMENT CO**

"Service Engineered"  
Test Equipment

**DAYTON 2, OHIO**

In Canada:  
The Canadian Marconi Co.



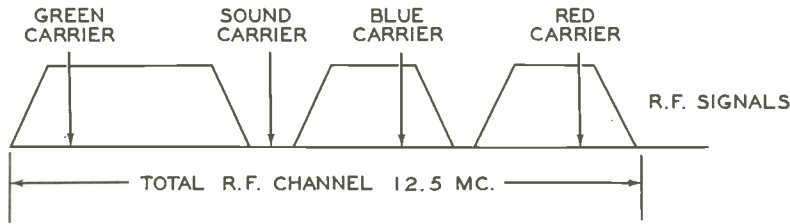

Figure 3. By using the "mixed-highs" principle, the bandwidth of the color signal could be reduced to 12.5 mc. Compare this with Figure 1.

chosen which (at the present time) possesses a frequency of 3.583125 mc. This represents a figure which is the product of 7875 multiplied by 455. Now 7875 is one half of 15,750 and if we use an odd multiple of 7875 as a carrier, then it will fall between two harmonics of 15,750 cycles. If we used even multiples of 7875, we would end up with 15,750 or one of its harmonics and this would place our second signal at the same points (throughout the band) as those occupied by the black-and-white signal. However, by taking an odd multiple of 7875, we have this second signal fall in-between the bundles of energy produced by the first signal and the two do not interfere.

The color subcarrier with a frequency of 3.583125 mc is an odd multiple (the 455th) of 7875 and so the energy contained in the subcarrier and its sidebands fall in-between the bundles of energy of the monochrome signal. Technically, this is known as interleaving.

A complete color television signal, then, contains a black and white signal in conjunction with a color signal. The bandwidth of the color signal is considerably less than the black and white signal because only the larger objects in a picture are "colored"; the detail in a color picture is still presented in monochrome. This, of course, is the mixed-highs principle.

When the two interleaved signals are received by a black-and-white receiver, the regular 0-4 mc video signal produces a full picture. But the color subcarrier and its energy, falling at harmonics of the half-line frequency, produce patterns on successive pictures or frames which cancel out. In a color television receiver, the subcarrier is transferred to a desampler where its low frequency color signals are reobtained and then these signals

are fed either to separate color tubes or to a single 3-gun color tube.

In the foregoing discussion we have introduced (and explained) several new terms and concepts. The luminance signal, we know, is the name given to our regular black-and-white television signal. In a color television receiver, the luminance channel would thus carry this black-and-white signal. Also, if you consider carefully what our present black-and-white signal does you will see that it possesses the brightness information of the picture. After all, every monochrome video signal contains nothing but the variations in amplitude of the picture signal and these amplitude variations, at the picture tube, produce changes in light intensity at the screen. Thus, we could also call the black-and-white signal a "brightness" signal and this is another name which is synonymous with luminance.

The color signal is called the chrominance signal and the circuits through which it passes are known as the chrominance channel. There are two other quantities that are sometimes employed in connection with the color signal and these are

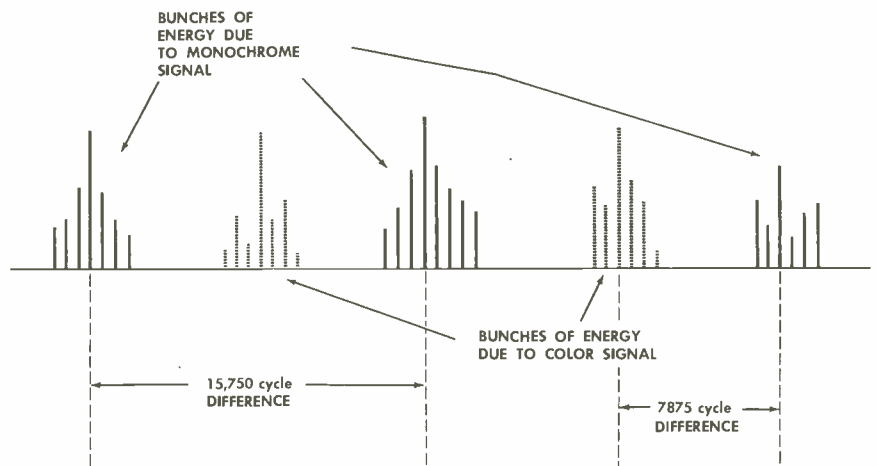

Figure 4. In the NTSC system, the color signal is interleaved with the black-and-white signal, enabling both to appear in the same 6-mc channel.

hue and saturation. Hue is what the layman calls color, that is red, green, yellow, blue, etc. Saturation is concerned with the depth or richness of particular hue or color, that is, how blue and how red it is. A color that is highly saturated is said to have a deep hue, as deep red, deep green, etc. Light red or pale green are less saturated or conversely, are diluted by white light.

It has been said, and rightly so, that the present system could be called "colored" television since to the full black and white picture we add our color. The black-and-white (i.e., brightness or luminance) signal is called the main or primary carrier whereas the color (or chrominance) signal is cast in the role of subcarrier. It is interesting to note that the system has been so designed that the color signal does not appreciably affect the picture brightness. For this reason the phrase color-minus-brightness is frequently seen.

The ideas that have been so briefly presented here are quite new and it will take some time to digest them. But a start has been made and before long we will be speaking of hue and saturation with the same familiarity that we now use for contrast and brightness.

REVIEW. Although much has been written about UHF antennas and converters, relatively little attention has been paid to the more fundamental aspects of circuit operation at these extremely high frequencies. Yet, for his immediate needs, knowledge of basic circuit behavior is of greater importance to the serviceman. This is because converter repair or antenna erection is more directly concerned with the

**Free!**  
to servicemen

Reduces  
service time  
•  
Eliminates  
"call-backs"

New Phonograph  
Pickup Cartridge

# Replacement Manual

and Magnetic Recording Head Listing



LISTS OVER 1,900 PHONOGRAPHS

and phonograph combinations which are equipped with, or which can effectively use Shure Crystal and Ceramic Pickup Cartridges. Shure Cartridges are superior or equivalent to the units they replace. This Replacement Manual covers the period from 1938 through 1952—and lists models by over 125 Manufacturers. The Magnetic Tape and Wire Recording Head listing indicates the Shure Tape Heads used in original equipment. It also illustrates Tape and Wire Recording Heads—and shows typical operating data for the Tape Recording Heads.

Ask your  
SHURE  
DISTRIBUTOR  
for Manual  
No. 66A

**SHURE**

SHURE BROTHERS, Inc., Dept. P ★ Manufacturers of Microphones and Acoustic Devices

225 WEST HURON STREET, CHICAGO 10, ILLINOIS • Cable Address: SHUREMICRO

COMPACT  
DEPENDABLE  
EFFICIENT  
*Rotary Power*  
by Carter



THE NEW

*Custom*

### DC-AC CONVERTER

These latest of all Carter DC to AC Converters are specially engineered for professional and commercial applications requiring a high capacity source of 60 cycle AC from a DC power supply. Operates from storage batteries, or from DC line voltage. Three "Custom" models, delivering 300, 400, or 500 watts 115 or 220 V. AC. Wide range of input voltage, 12, 24, 32, 64, 110 or 230 V. DC. Unequaled capacity for operating professional recording, sound movie equipment and large screen TV receivers. Available with or without manual frequency control feature.

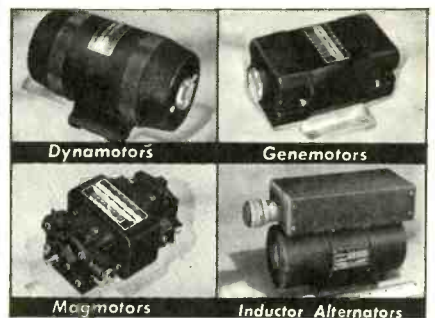

### WRITE TODAY FOR CATALOG

Carter Rotary Power Supplies are made in a wide variety of types and capacities for communications, laboratory and industrial applications. Used in aircraft, marine, and mobile radio, geophysical instruments, ignition, timing, etc. WRITE TODAY for complete Dynamotor and Converter Catalogs, with specifications and performance charts on the complete line.

**Carter MOTOR CO.**  
2651 N. Maplewood Ave.  
Chicago 47





effect of too long a piece of wire, or too large a component than it is with the overall operation of these units.

An analysis of UHF circuit behavior was recently given in an article entitled "Explanation of UHF Characteristics" which appeared in the February, 1953 issue of the Philco Service Supervisor. Another article, also very helpful, appeared in the May, 1949 issue of the C-D Capacitor. This was labeled, "Inductive and Reactive Effects of Leads at Ultra-High Frequencies." Both articles will be reviewed below.

The Philco Service Supervisor is published by the Philco Corporation and is sent directly to authorized members of Philco Factory, Supervised Service. The Capacitor is published monthly by the Cornell-Dubilier Electric Corporation, Hamilton Boulevard, South Plainfield, N. J. There is no charge for this bulletin. Simply contact the company and indicate that you want your name added to the Capacitor mailing list.

**Resistance:** In AM radio work, we have always considered reasonably short lengths of connecting wire as possessing a negligible amount of resistance. That the same length of wire might also possess inductance is perhaps realized but regarded even more lightly than its resistance. Certainly these factors seldom if ever influence circuit operation, so why be concerned with them.

But when we raise the frequency of the currents flowing through the wire, we find that something happens which forces us to pay more and more attention to the same resistance and inductance that we could formerly ignore. Why is this so?

The reason for the change in wire resistance can best be understood if we consider what occurs within a length of wire when current flows through it. It is common know-

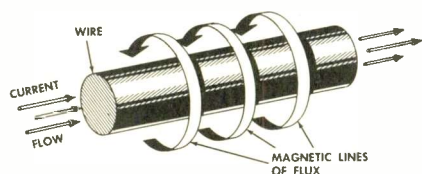

Figure 5. A small section of wire carrying a current.

ledge that current flow has associated with it, a magnetic field in the form of lines of flux which are everywhere encircling the current. The definition of inductance depends upon these flux linkages and is given by the formula:

Inductance (Henries) =

$$\frac{\text{Flux linkages encircling connector}}{\text{Current producing these linkages}} \text{ (in amps.)} \times 10^{-8}$$

Consider now the end view of a small round section of wire that has current flowing through it. See Figure 5. Each small section of current traveling through this wire has magnetic lines of flux encircling it, but the sections of current at the outer surface of the wire have fewer lines of flux around them than the currents at the center of the wire. This is because the flux produced inside the wire by the central currents does not encircle the outer currents and so cannot influence their flow. However, the flux produced by the currents at the surface of the wire does encircle the currents at the center and hence exerts an influence upon them. From the foregoing definition of inductance, it is seen that, since there are more flux linkages encircling the center of the wire than the outer surface of this wire, the inductance will be greater at the center than at the surface.

As the frequency of the currents increase, the inductance at the center of the wire will present more opposition (reactance) than the outer sections of the wire where less inductance exists. The RF current, seeking the path of "least resistance", will tend to concentrate more at the surface (or skin) of the conductor. Hence, the current, which formerly spread uniformly throughout the entire area, is now concentrated near the surface. In effect, this has reduced the useful cross-section area of the conductor and the resistance, due to this decrease in effective area, will rise. If the wire is used as a resistor, its overall resistance will change as the frequency varies, becoming greater as the frequency increases.

The total resistance of a wire, at high frequencies, is thus seen to consist of the normal DC resistance plus an additional amount which is dependent upon frequency. At frequencies above 300 mc, this latter factor becomes predominant and, at sufficiently high frequencies, is often many times the DC resistance.

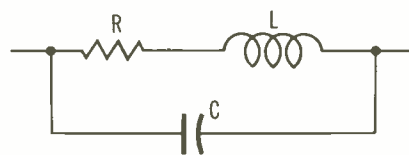

Figure 6. Equivalent circuit of an ordinary resistor at the ultra-high frequencies.

In this respect, a large conductor, because of its increased surface area, shows lower high frequency resistance than a smaller sized one. Low values of high-frequency resistance are exhibited by tubular conductors in which the wall is thin as compared to the diameter of the tubing. The same is true of strip conductor and of completely-braided wire and strip.

**Inductance:** Consider, too, the effect that the inductance in the foregoing piece of wire might have on a circuit. For a straight round wire of non-ferrous metal such as copper, the inductance formula is:

$$L(\mu h) = .00508 S(2.3 \log_{10} \frac{4S}{d} - 0.75)$$

where

S = length of wire in inches

d = diameter of the wire in inches.

Using the formula for a length of No. 20 wire, three inches long, we obtain an inductance of approximately .08 microhenries. At 1000 cycles, the impedance presented by this inductance is:

$$\begin{aligned} X_L &= 2\pi fL \\ &= 2 \times 3.14 \times 1000 \times .08 \times 10^{-6} \\ &= .00050 \text{ ohms} \end{aligned}$$

At 100 mc, the impedance becomes 50 ohms and, at 1000 mc 500 ohms. At this latter high frequency, then, a small 3 inch length of wire has a complex impedance consisting of an appreciable amount of resistance and inductance.

Another interesting example is the inductance and reactance of the pigtail leads of a conventional mica capacitor. In the postage-stamp-size molded capacitor, these leads are made of No. 20 round wire. Even when the capacitor is mounted into a circuit with 1/2 inch of each pigtail, the total lead inductance is .021 microrhenry. This

# HERE IT IS!

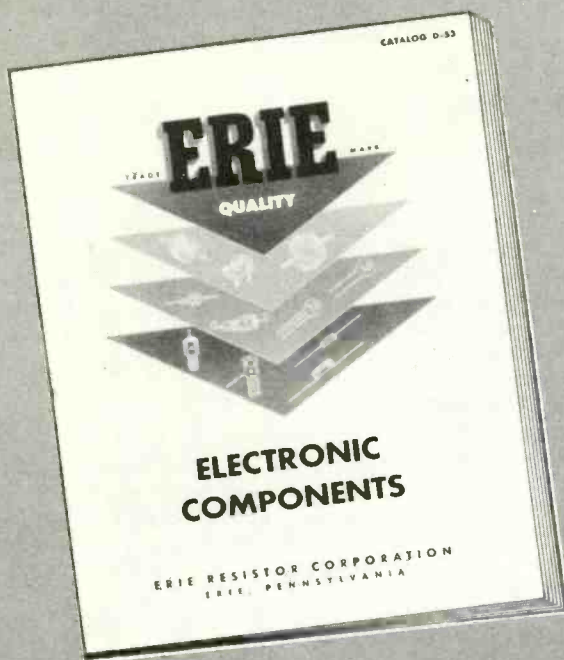

*Ready for YOU*

Complete, up-to-date listings, illustrations, and descriptions of ERIE Electronic components are contained in the new ERIE CATALOG D-53.

This catalog assembles all the new items introduced since publication of our last catalog together with the long-time standard numbers.

Ask for it at your Distributors, or write Dept. D for your copy.



ERIE RESISTOR CORPORATION . . . . . ELECTRONICS DIVISION

Main Offices: ERIE, PA.

Sales Offices: Cliffside, N. J. • Philadelphia, Pa. • Buffalo, N. Y. • Chicago, Ill. • Detroit, Mich. • Cincinnati, Ohio • Los Angeles, Calif.

Factories: ERIE, PA. • LONDON, ENGLAND • TORONTO, CANADA

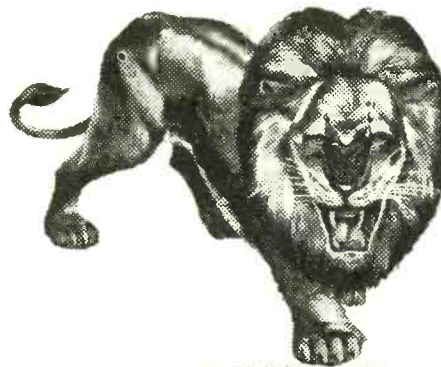

You'll get the **LION'S SHARE OF THE MARKET** with . . .

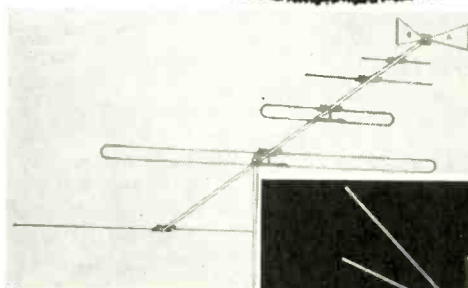

Phoenix PAR-105. New UHF-VHF all-channel 2-83.

Phoenix PAR-103 UHF-VHF All-channel, one antenna; one transmission line for coverage over channels 2-83.

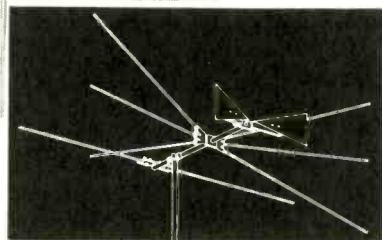

Phoenix PAR-108 ULTRA HI-V for channels 14-83, all aluminum . . . maximum gain . . . 300 ohm impedance.

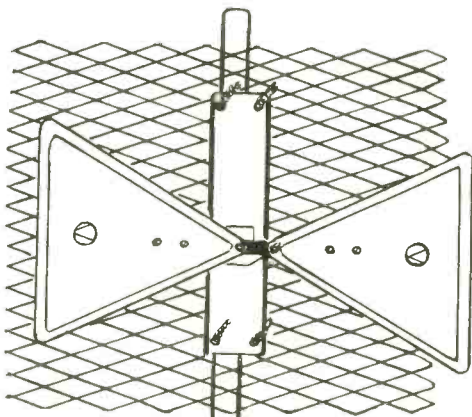
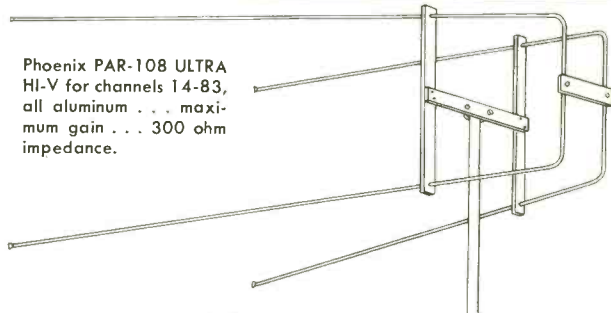

Phoenix PAR-102 ULTRA HI-BOW with screen reflector channels 14-83 300 ohm impedance . . . ribbed dipoles for double protection. 2 U-balls assure rigid installation.

Write for full information and prices.

**PHOENIX ELECTRONICS, INC. LAWRENCE, MASS.**



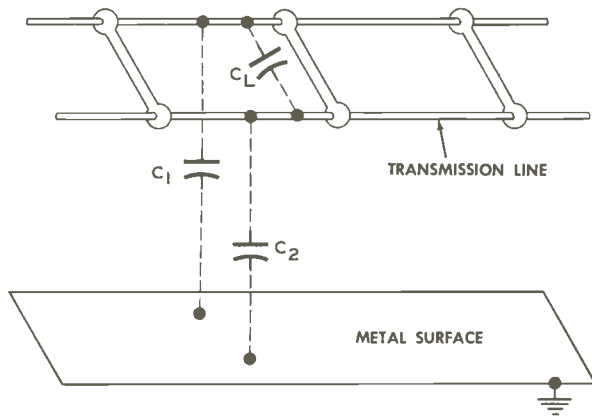

Figure 7. What happens when an open-wire (or otherwise unshielded) transmission line is run near a metal surface.

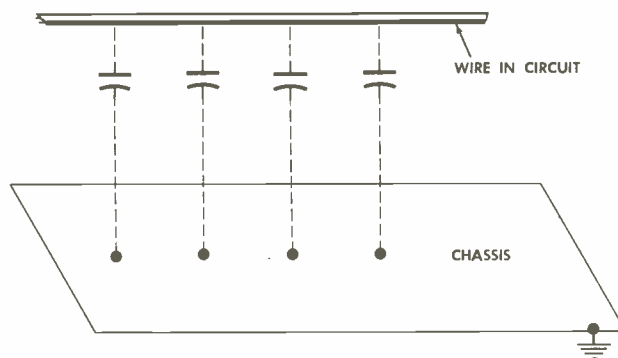

Figure 8. Stray capacitance existing between a wire and the nearby chassis.

pigtail inductance is sufficient to resonate an .01-mfd capacitor to 11 megacycles. Thus, at this frequency we have, instead of a simple capacitor, a tuned circuit. At lower frequencies, we have a capacitor, and at high frequencies the circuit acts as an inductor!

Or, consider a common resistor. At the low frequencies this presents only resistance; at the high frequencies inductance and shunting capacitance enter the picture, too. See Figure 6. In a carefully constructed resistor, the inductance arises solely from the inductance in the connecting leads. The shunting capacitance across the resistor is primarily the capacitance between these two leads. At sufficiently high frequencies, the shunting capacitance reduces the effective impedance of this circuit to relatively low values. Furthermore, due to the presence of the inductance and capacitance, the impedance is complex and not simply resistive any more.

**Capacitance:** The capacitance of any circuit may change because of stray couplings that might arise between adjacent wires, a wire and ground, points between which there exists a difference of potential, and in almost innumerable other ways that never were considered important before.

An admonition, often given, is to keep transmission lines away from metallic surfaces. Suppose we forget to do this, what happens? Simply this. A transmission line consists of distributed inductance, resistance, and capacitance. These go to make up the characteristic impedance of the line and a change in

any one of these components will have a very definite effect on the line impedance.

Consider now the capacitance when the line is run near a metallic surface. See Figure 7. The normal capacitance across the line is augmented by the stray capacities  $C_1$  and  $C_2$ . In effect,  $C_1$  and  $C_2$  add to  $C_L$ , the normal line capacitance, and thereby increase the total capacitance at this point in the line. Result: A decrease in characteristic impedance, leading to mismatching, standing waves, and loss of power.

We are also told that when a transmission line (of the unshielded type) becomes wet, its attenuation goes up. Why is this so? The equation for the attenuation constant of an open wire line is given by:

$$\text{Attenuation} = \frac{R}{2Z_0} + \frac{G Z_0}{2}$$

where

$R$  = the resistance of the line, created largely by skin effect.

$Z_0$  = characteristic impedance of line.

$G$  = the leakage across the line, determined by the dielectric.

When a line becomes wet, the leakage increases because wet insulators or a wet dielectric become more conductive. In the above equation, the leakage factor "G" is in the numerator of the fraction and

increased leakage will result in a higher attenuation factor.

In a UHF chassis, the capacity shunting effect also enters into the picture in a number of ways. Capacitance exists between any two conductors separated by a dielectric. In the present instance, one conductor would be a wire in the circuit, while the other conductor might be the chassis itself. See Figure 8. The dielectric here is air. The extent of this capacitance is determined by the size of the wire and its distance from the chassis. Since the wire is quite small, the resultant capacitance is likewise small. At DC or low frequency AC this capacitance is negligible. However, capacitive reactance decreases with frequency rise (i.e.,  $X_c = \frac{1}{2\pi fC}$ )

and at UHF the impedance of this shunting path can be very low. With this condition existing, the placement and physical size of components becomes very important. If a component is replaced by one of different size, physically, or repositioned, or if the dressing of the wire is changed, the distributed capacitance existing between these components and nearby components on the chassis will be altered. This, in turn, will change the characteristics (perhaps the tuning) of the system. Even the warping of a chassis can cause a change in the capacitive (and inductive, too) components of the circuit. So the precaution to proceed with care is one of the most important that you can observe whenever any work is done in UHF circuits.

MILTON S. KIVER

## HORIZONTAL OUTPUT TRANSFORMERS

(Continued from page 13)

the wires in some manner is a good practice because of the high number of disconnections required. It saves circuit tracing later on. If a color code is not employed in the original circuit, or the colors are not distinguishable one from another, the wires may be marked in some other fashion, for example, with small tags and cellophane tape.)

Before the high voltage cage could be removed, it was necessary to remove the width coil from its bracket. This was done without too much trouble by releasing the snap catches which held it in place and allowing it to fall down out of the bracket. Next, the two wires to the fuse were unsoldered and their colors noted on the work sheet (Figure 2). The three tubes in the cage were removed for reasons of accessibility, and then the cage itself was dismounted and set out of the way. In

order to do this, the high voltage lead to the picture tube was detached from the tube's anode socket and fed back through the insulated opening in the cage wall to provide sufficient slack.

The width coil was disconnected from terminals 6 and 7 on the transformer and then all the other connections to the transformer were removed and the wires identified. Four self-tapping screws held the transformer to the chassis; these were taken out and the original transformer was set aside. The replacement transformer had mounting holes spaced differently than the other unit. Consequently, the replacement unit was placed as shown in Figure 3 and three new mounting holes were drilled in the chassis bed with a No. 35 drill. Then the new transformer was mounted in position using the original four self-tapping screws.

There were two reasons for using a new width coil rather than

the original. First, the instructions with the replacement transformer called for a width coil having a relatively high inductance (4-39 mh). The original width coil was the low inductance type as determined by the ohmic resistance of that portion of the original transformer secondary across which the width coil was connected. This resistance was given in the Photofact folder as 0.7 ohm (refer to Figure 2); or if necessary it could have been found by actual measurement with an ohmmeter. As a general rule if the resistance of this tapped portion of the original transformer secondary is under 3 ohms, the width coil in the set is of the low inductance type. If the resistance is greater than 3 ohms, the width coil may be considered in the high inductance bracket. To serve as an additional basis of physical comparison, Figure 4 shows examples of the two types of width coils. Figure 4A is a high inductance width coil, while Figure 4B depicts a low inductance type of width coil. If, by mistake, the low inductance width coil were used in an application demanding the higher inductance unit, insufficient width would result in the picture and the excessive current through the width coil would probably burn it out.

The second reason for using a width coil other than the original in the television receiver was that an AFC feedback voltage was needed as indicated in the schematic of Figure 2. The replacement transformer had no extra winding for this function; therefore a width coil having a secondary winding to furnish AFC feedback voltage had to be chosen to replace the original coil. The Stancor WC-5, which is of the high inductance type and has the secondary winding, was selected. Since this unit had a coil form of larger diameter than the original part, the hole in the bracket mounting on the high voltage cage wall had to be enlarged by reaming.\* Before the new width coil was snapped into position, however, the necessary connections to it were made.

To serve as a guide for making connections to the new horizontal output transformer and to the new width coil, an instruction sheet consisting of five schematic diagrams and various notes is packed with the

\*Stancor has recently announced a reduced diameter coil form for the WC-5; the use of this unit would have made the reaming operation unnecessary.

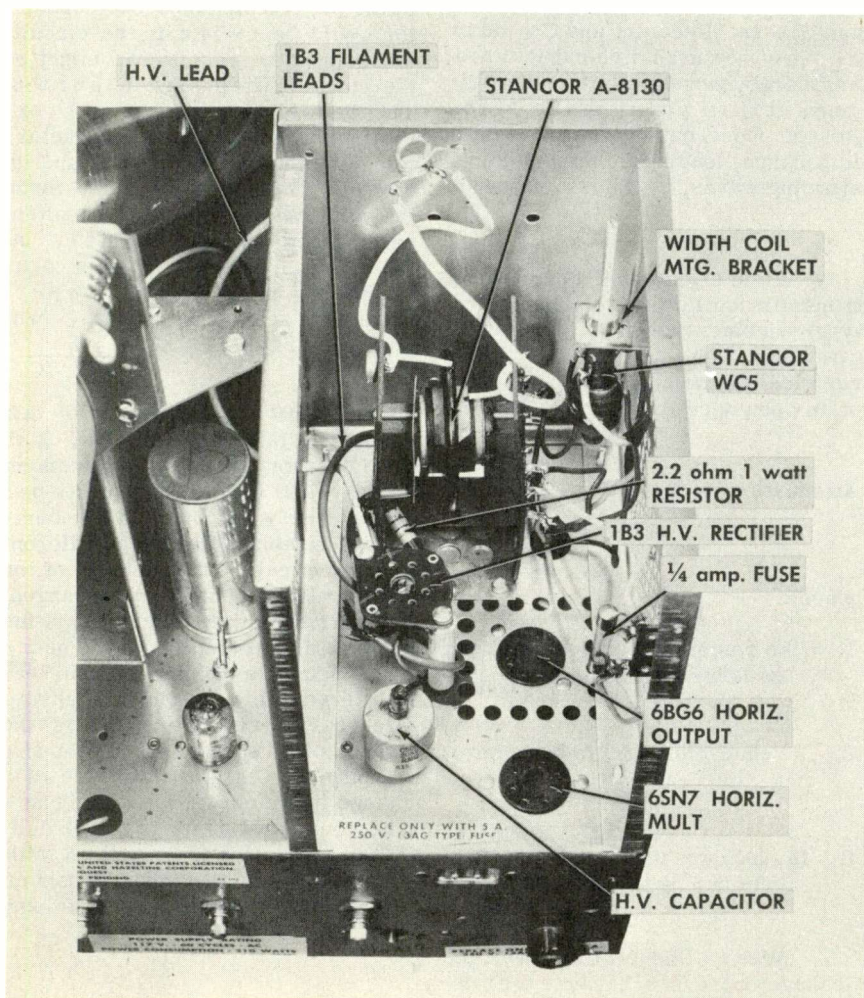

Figure 3. View of New Stancor A-8130 Horizontal Output Transformer Mounted with Final Connections Completed (Tubes Removed for Photograph).



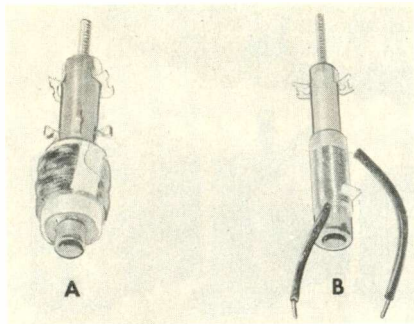

Figure 4. Two Types of Width Coils, (A) High Inductance Type, (B) Low Inductance Type.

A-8130. Schematics No. 1 and No. 5A were selected as being applicable to the case at hand. These schematics have been reproduced in Figure 5.

A problem was encountered in connecting the 1B3GT rectifier filament. In the original set-up the 2.2 ohms resistance was an intrinsic part of the filament lead itself. Therefore, with the new transformer it was necessary to add a 2.2 ohm, 1 watt resistor in series with the filament circuit. This resistor can be seen in Figure 3; one end was connected directly to a socket terminal of the 1B3GT, the other end was held rigid by using an opening in the transformer's rear terminal board. (Once the details of the filament circuit have been permanently adopted the leads may be dressed considerably shorter than those shown in Figure 3.)

Proceeding according to the schematics of Figure 5, the technician made the following tentative connections:

**TRANSFORMER**

Terminal No.	Lead
4	Green to damper plate
5	Red to deflection coils
6	White to C80
1	Yellow to fuse

On the new width coil, connections were made as follows:

**WIDTH COIL**

Terminal	Lead
----------	------

**Primary**

- Blue dot - To transformer terminal 8
- Red dot - To transformer terminal 5

**Secondary**

Orange dot - Orange lead to Horizontal AFC

Black dot - Black lead to ground

Tube cap clips were transferred from the old to the new transformer to accommodate the 6BG6G and 1B3GT tube caps. Then the connections were completed to the fuse, the high voltage cage was set in place, the width coil snapped in position, and the set was turned on.

**Securing Satisfactory Operation -**

A picture was obtained, but it was immediately obvious that something was not right. Vertical synchronization was satisfactory, but horizontally the picture appeared split in half down its center by the

horizontal blanking bar. The right side of the image appeared on the left side of the screen while the left portion appeared at the right. This phenomenon indicated that the polarity of the AFC feedback voltage was the reverse of what it should have been. To remedy this trouble, the technician interchanged the connections to the primary of the width coil; in other words, the blue dot terminal on the width coil was connected to transformer terminal 5 and the red dot, to transformer terminal 8. When the set was returned to operation, the horizontal displacement of the picture was found to have been corrected.

The next check on operation was performed with a voltmeter and a high voltage probe. The measurement was taken at the high voltage filter capacitor, and the voltage was

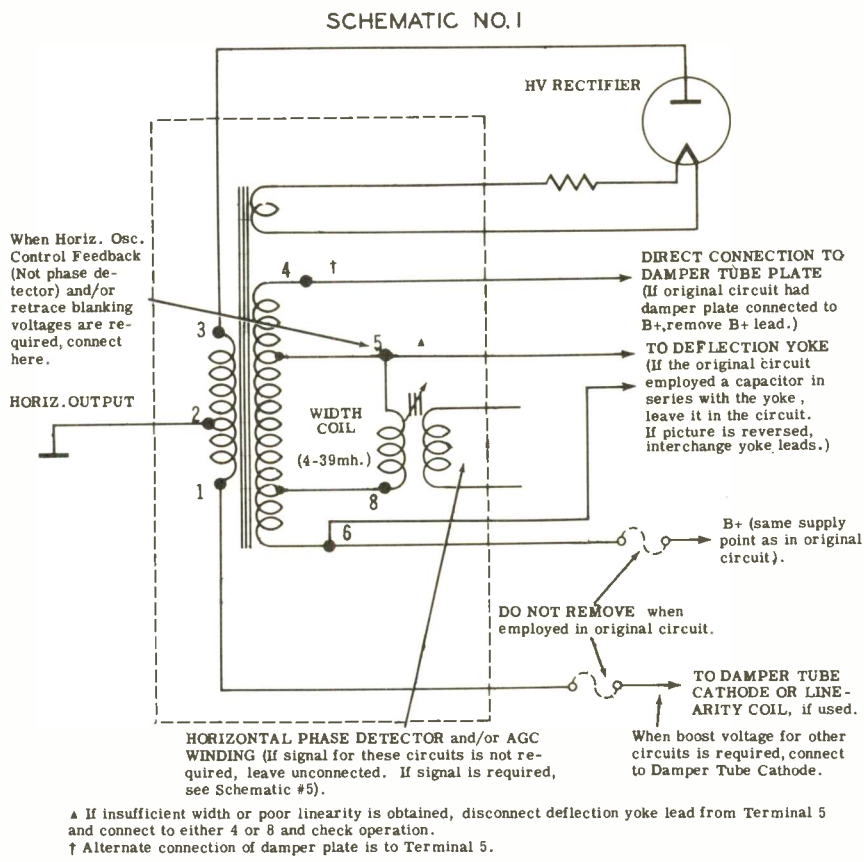

▲ If insufficient width or poor linearity is obtained, disconnect deflection yoke lead from Terminal 5 and connect to either 4 or 8 and check operation.  
 † Alternate connection of damper plate is to Terminal 5.

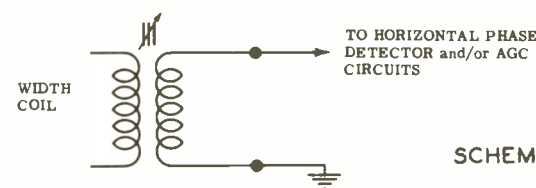

(Note: If polarity is reversed, interchange connections to width coil secondary.)

Figure 5. Schematics No. 1 and No. 5A on the Instruction Sheet Packed with the Stancor A-8130 Horizontal Output Transformer.



MILLIONS OF "SAFE CENTER" SELETRON RECTIFIERS  
IN USE IN RADIO AND TV!



Reg. Trade Mark

## SELENIUM RECTIFIERS

When you specify SELETRON "Safe Center" Selenium Rectifiers you eliminate arc-over danger, short circuits and heating at the center contact point. Assembly pressure, or pressure applied in mounting the rectifier cannot affect its performance—a SELETRON feature accomplished by deactivating the area of the plate under the contact washer.

The millions of SELETRON Selenium Rectifiers in satisfactory service as original equipment in the products of leading manufacturers are millions of reasons why you can specify SELETRON and be safe!

Consult your local jobber!

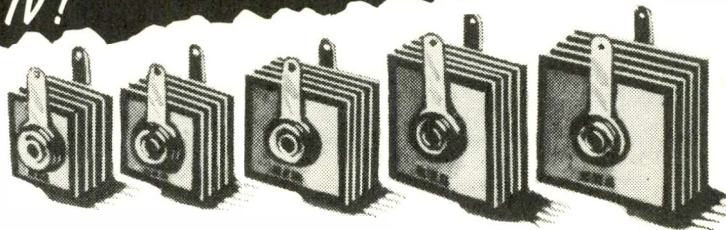

MODEL NO.	PLATE SIZE	STACK THICKNESS	MAX. INPUT VOLTAGE R.M.S.	MAX. PEAK INVERSE VOLTAGE	MAX. D.C. OUTPUT CURRENT
1M1	1" sq.	3/8"	25	75	100 MA
8Y1	1/2" sq.	1/8"	130	380	20 MA*
16Y1	1/2" sq.	1/8"	260	760	20 MA*
8J1	1 1/8" sq.	1/8"	130	380	65 MA
5M4	1" sq.	1/8"	130	380	75 MA
5M1	1" sq.	3/8"	130	380	100 MA
5P1	1 3/8" sq.	3/8"	130	380	150 MA
6P2	1 3/8" sq.	1 3/8"	156	456	150 MA
5R1	1 1/2" x 1 1/4"	3/8"	130	380	200 MA
5Q1	1 1/2" sq.	1 1/8"	130	380	250 MA
6Q1	1 1/2" sq.	1 1/8"	156	456	250 MA
6Q2	1 1/2" sq.	1 3/8"	156	456	250 MA
6Q4 (+)	1 1/2" sq.	1 3/8"	130	380	300 MA
5Q51	1 1/2" x 2"	1 1/8"	130	380	350 MA
6QS2	1 1/2" x 2"	1 1/4"	156	456	350 MA
5S1	2" sq.	1 1/8"	130	380	500 MA
6S2	2" sq.	1 3/8"	156	456	500 MA

\* This rectifier is rated at 25 MA when used with a 47 ohm series resistor.  
(+) Stud mounted—overall: 2"

**RR SELETRON DIVISION RR**  
**RADIO RECEPTOR COMPANY, INC.**  
Since 1922 in Radio and Electronics

Sales Department: 251 West 19th St., New York 11, N. Y.  
Factory: 84 North 9th St., Brooklyn 11, N. Y.

**XCELITE Hand Tools**  
PREFERRED BY THE EXPERTS

TEMPER-SAVING TIP!

## USE THIS "BORROW"-PROOF XCELITE Nut Driver Set

- Color-coded handles
- Lockable wall holder

Each of the seven husky, man-sized handles has its own color, telling you the size instantly. Deep sockets handle two nuts. Precision-formed for good grip without slip! In lockable wall holder, only \$7.85.

Or buy XCELITE nut drivers separately — stubby to 6" shanks, for all nut sizes.

The handiest tools in your shop!

See your XCELITE DEALER TODAY!

## XCELITE, INCORPORATED

(Formerly Park Metalware Co., Inc.)

DEPT. Q  
ORCHARD PARK, N. Y.

For Originality  
LOOK TO XCELITE

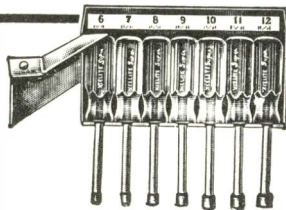

No. 127 Set

AND NOW . . .



the  
**Navarre**  
\$39.50

## All Channel UHF CONVERTER by Videon

Proudly, we present the Navarre—the UHF Converter designed and produced by the manufacturers of the popular Videon Boosters. Try it. Compare it with ALL others.

### FEATURES:

SINGLE KNOB TUNING . . . ALL CHANNEL COVERAGE, 14 thru 83 . . . ENTIRELY SELF-POWERED . . . NO INSIDE CONNECTIONS . . . SIMPLE TO ATTACH . . . COMPLETELY SHIELDED CONSTRUCTION . . . PRESSED STEEL CABINET BEAUTIFULLY FINISHED IN MAROON ENAMEL . . . and the price is especially appealing.

Write for further information  
and name of your distributor



**ELECTRONIC CORPORATION**

222 East Ohio Street · Indianapolis, Indiana



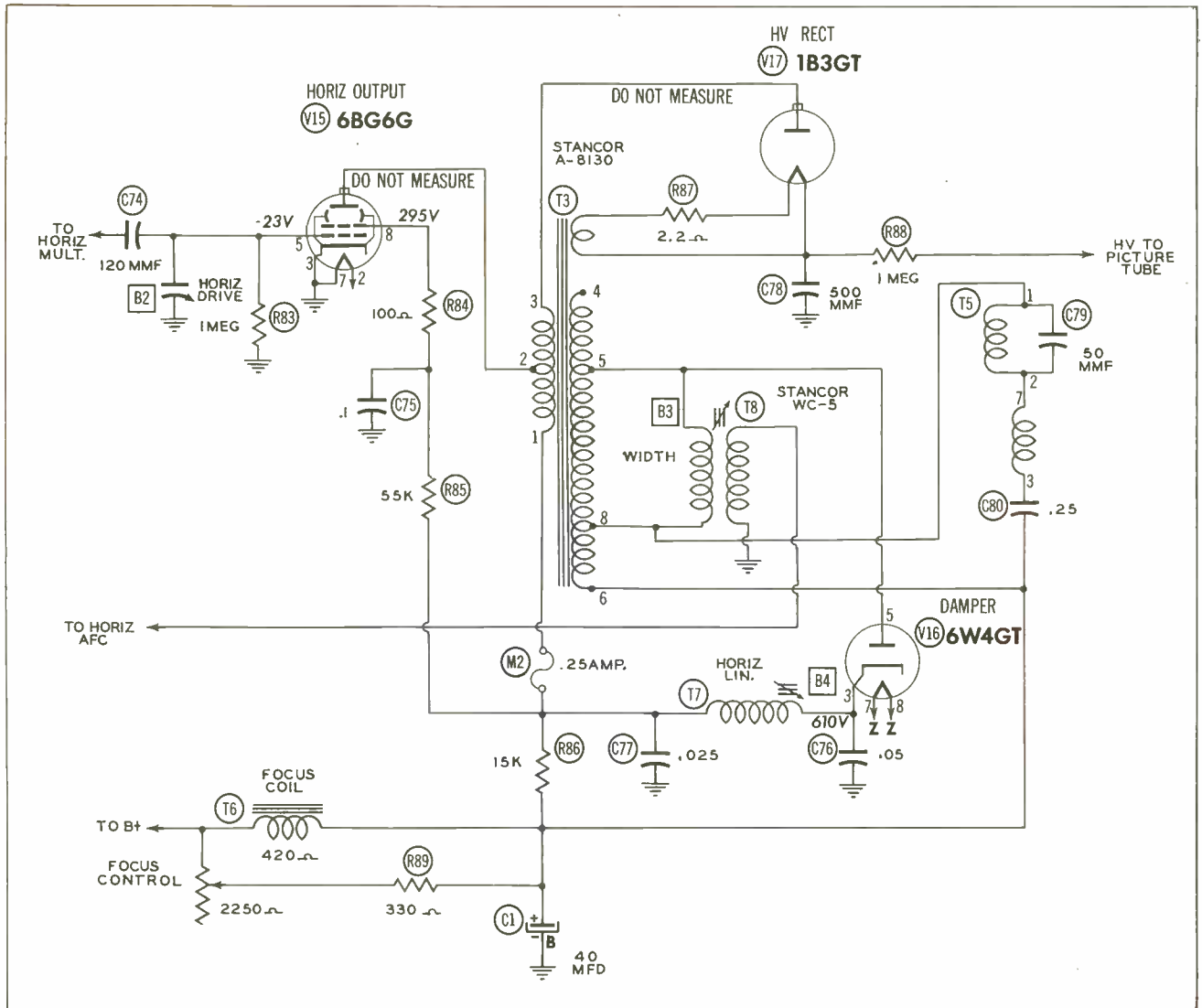

Figure 6. Partial Schematic of Horizontal Output Section After Replacement of Horizontal Output Transformer.

found to be 11.5 kilovolts with minimum setting of the brightness control. (Note: All high voltage measurements to follow were taken at the high voltage capacitor with minimum picture brightness.) The width of the picture, at the same time, was considerably too great; when this was reduced by means of the width coil slug adjustment, it was found that the high voltage fell to 10 kilovolts. Blooming of the picture with increase in brightness was very apparent.

A check was made of the screen voltage on the 6BG6G horizontal output tube. This measurement showed the presence of 360 volts on the screen, which was too high for proper operation of the tube. Consequently, the technician proceeded to increase the resistance of the screen dropping resistor, R85, until at a figure of 55K ohms the screen voltage amounted to a near normal 300 volts. At the same time,

however, the high voltage output of the system dropped off even farther, to 9 kilovolts.

It seemed likely that a mismatch existed between the secondary of the horizontal output transformer and the horizontal deflection coils. Proceeding on this assumption, the technician changed the red lead to the deflection coils from terminal 5 on the transformer to terminal 8. This move brought about a marked reduction in the width of the picture and the high voltage was not high enough to properly operate the picture tube. A dim and blooming picture continued to prevail. Also, a resistance of 75K ohms was needed in the screen circuit of the 6BG6G in order to drop the screen voltage to the 295 volt level.

As a check on the boost voltage, a voltmeter measurement was taken at the cathode of the 6W4 damper tube. A reading of 660 volts at that

point confirmed the fact that the boost voltage was indeed excessive; it should have been only 580 volts according to the schematic (Figure 2). In order to correct this situation, another change was made in the connections to the horizontal output transformer secondary. The green lead to the damper plate was shifted from transformer terminal 4 to terminal 5. This move seemed to solve most of the troubles in the operation of the circuit. The voltage at the damper cathode was measured and found to be a permissible 610 volts. However, a 55K ohm resistor was required in the screen circuit of the 6BG6G to bring the screen voltage down to 295 volts. After slight adjustments of the width control and the horizontal drive a very good picture was obtained with only slight blooming at increased brightness settings. The high voltage was found to be 13 kilovolts which, while not optimum, was sufficient to operate the picture tube normally.

At this point in the operation, about one kilovolt drop in high voltage was suddenly experienced. At the same time the telltale sputter of corona discharge was heard in the general area of the high voltage cage. Under reduced lighting, the technician tried to see the corona spark but was not successful. However, after turning off the set and discharging the residual high voltage with a screwdriver, he applied corona dope to various points on the 1B3GT socket terminals and to both ends of the 2.2 ohm filament resistor. This operation must have reached the seat

of the trouble since the corona was not present thereafter.

The final circuit connections are shown in the schematic of Figure 6. Actually the only component changes other than the transformer and width coil were the 55K ohm screen resistor, R85, and the addition of the 2.2 ohm filament resistor, R87.

By way of summary, it can be stated that replacing a horizontal output transformer of the type dealt with in this report requires more than ordinary servicing ability. Yet by following the instructions which

are normally packed with the units and trying the various alternate connections suggested in these instructions, the service technician can perform a very satisfactory and lasting replacement. In many cases far fewer changes and trials are required for proper operation than were needed in the job described in this report. It is hoped that the material presented here may help to smooth out one of those rough spots in the path to efficient television servicing.

GLEN E. SLUTZ

## UHF

(Continued from page 17)

instances improvement in tuning may be gained by adjustment of the fine tuning on the VHF tuner.

One important point must be observed when servicing this instrument. If the oscillator tube is removed, or replaced, the tube shield contactor must be put back in place to avoid tube failure.

## SYLVANIA UHF CONVERTER

### Sylvania Models C32M and C33M UHF Converters -

Sylvania Models C32M and C33M are UHF converters which are very similar in design, therefore this description will be confined to the C33M unit. Sylvania Model C33M is a UHF converter that is continuously tunable over the full seventy-channel UHF band. It is designed to

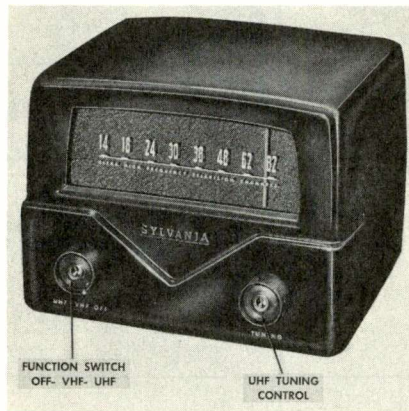

Figure 6. The Sylvania C33M UHF Converter.

operate with any television receiver capable of receiving channels 5 and 6. A cabinet view of this unit is shown in Figure 6. Two front panel controls are employed. On the left, the function switch uses three positions: OFF, VHF, and UHF. The tuning control at the right operates the concentric-line type tuning ele-

ment. Tuning is indicated on a slide-rule type dial graduated with channel indications.

To facilitate the installation of the converter in areas where strong UHF signals are present, the unit is supplied with a built-in UHF antenna. Where obstructions exist such as trees, buildings, and in low signal areas, it may be necessary to employ an external UHF antenna. This can be determined at the time of installation.

With the converter installed and ready for operation, the converter unit is turned to UHF position and the television receiver is tuned to channel 5 or 6. (If a strong signal is normally received on one of these channels, the tuner should be tuned to the other channel.) Tuning in a UHF station is accomplished with the UHF converter tuning control.

A top chassis view of the converter is shown in Figure 7.

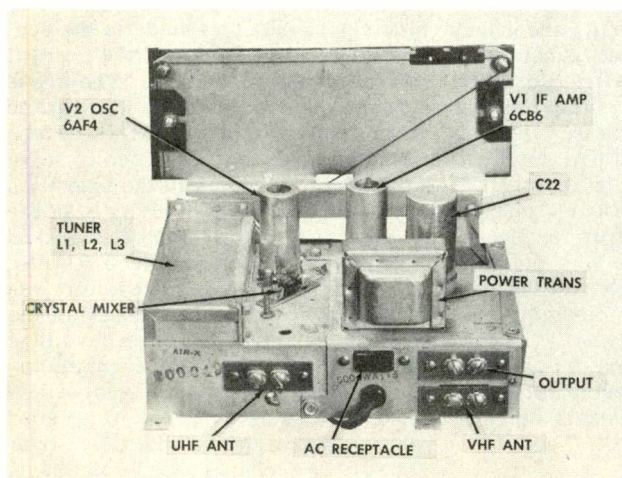

Figure 7. Top Chassis View of Sylvania C33M UHF Converter.

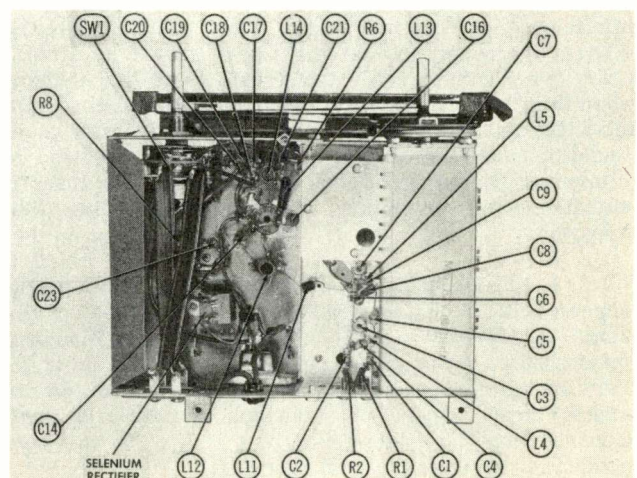

Figure 8. Bottom Chassis View of Sylvania C33M UHF Converter.



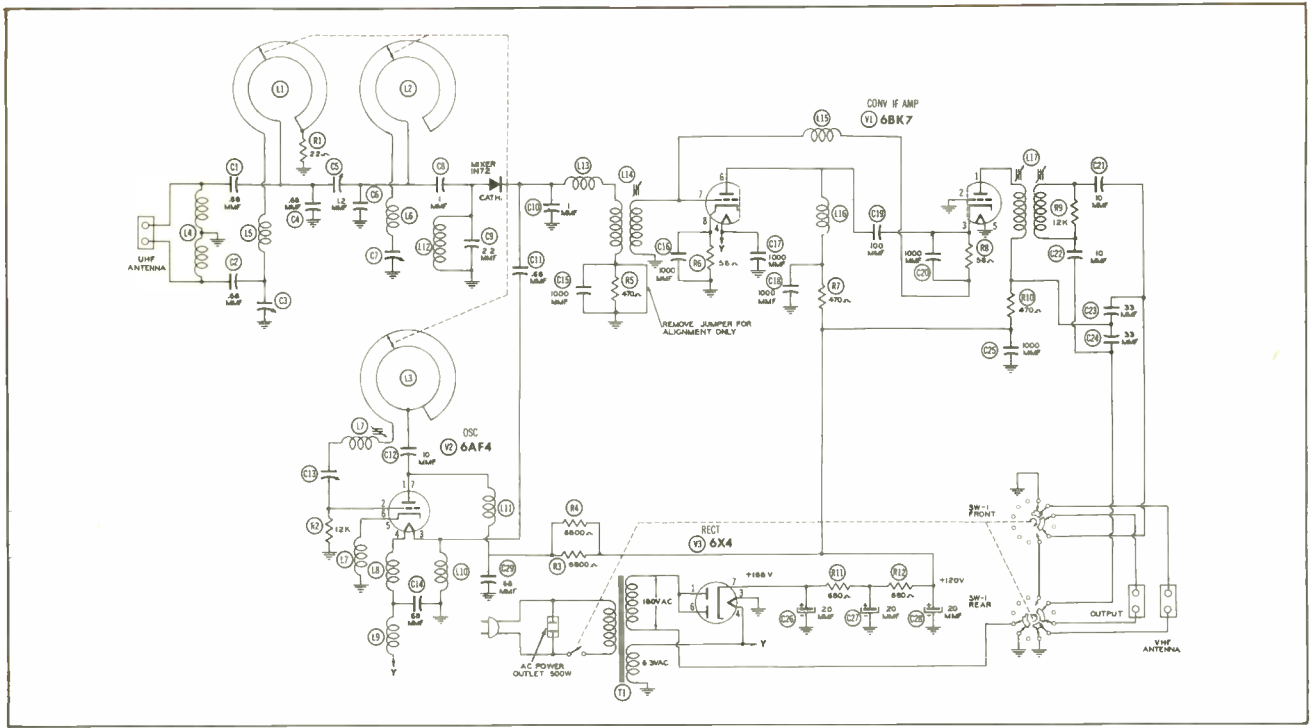

Figure 9A. Schematic of the Sylvania C32M UHF Converter.

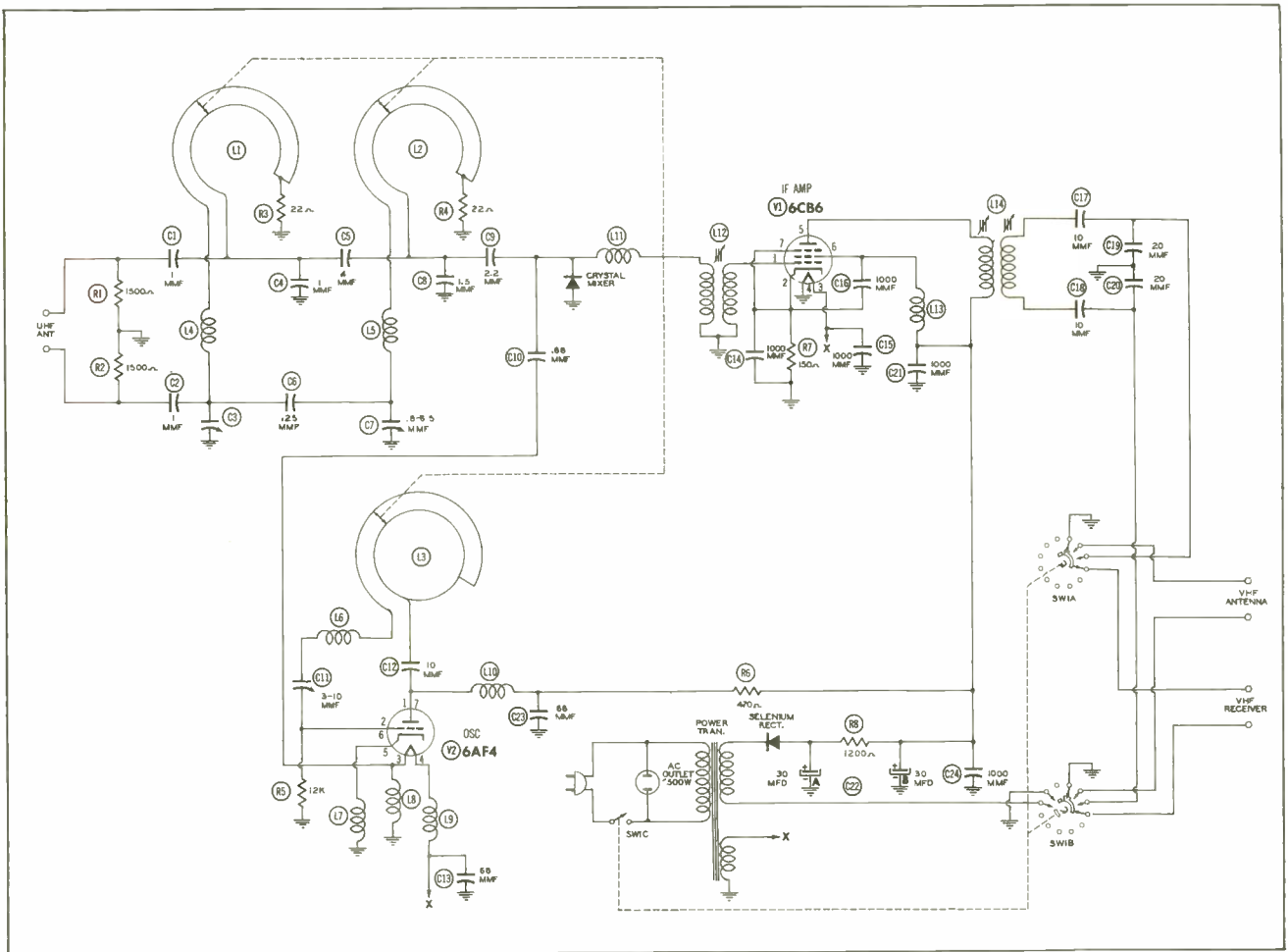

Figure 9B. Schematic of the Sylvania C33M UHF Converter.

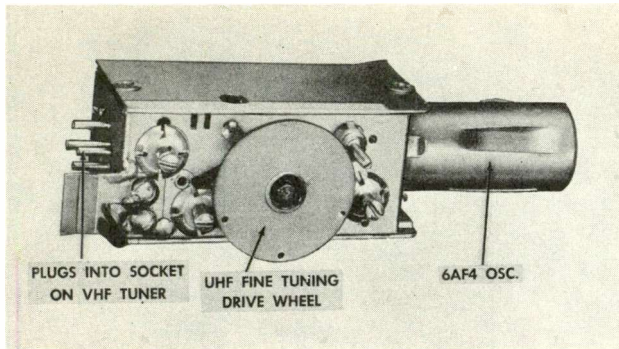

Figure 10. Westinghouse UHF Plug-in Receptor (H-802).

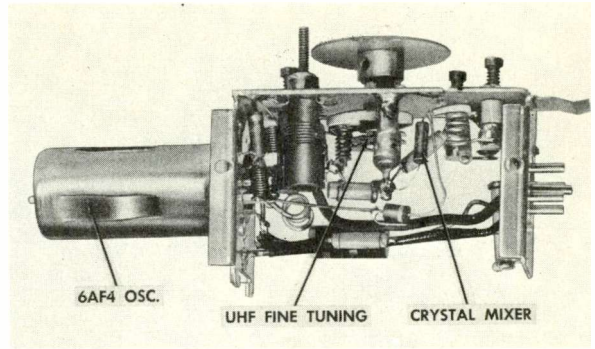

Figure 11. Westinghouse H-802 Receptor With Cover Removed.

Critical lead dress and wiring arrangement is illustrated in Figure 8. For best operation, disturbance of the lead dress should be avoided.

Figure 9A is a schematic for Model C32M converter and Figure 9B a schematic for Model C33M. Since the only major difference between the two units is the incorporation of a different IF amplifier tube, a description of Model C33M should serve to illustrate the functioning of both units.

An examination of the converter circuits shows it to contain a three element tuning unit of the concentric-line type. L1 and L2 are the variable tuning inductors forming a double-tuned preselector circuit while the third inductor L3 is in the oscillator section. The preselector circuit is designed for maximum selectivity consistent with broad bandpass requirements. The local UHF oscillator employing a 6AF4 tube operates below the frequency of the incoming signal to provide the correct relationship between video and sound frequencies applied to the VHF tuner in the television receiver. Note in the schematic of Figure 9B that the oscillator signal is taken from the filament of the oscillator tube. In this instance, the interelectrode capacity existing between the cathode and filament (about 2.7 mmf) forms the coupling device for the signal. This method achieves a minimum of loading and interaction between the mixer and oscillator circuits, thus permitting more stable oscillator performance.

Signals from the UHF oscillator and from the preselector circuits are fed to the crystal mixer type 1N82, resulting in a new frequency at the mixer output. This intermediate frequency is coupled by the input transformer, L12, to the IF amplifier stage employing a 6CB6 tube.

The output circuit of the amplifier stage is designed for either a

300 ohm or 72 ohm impedance load, and is connected through the function switch to the UHF output terminals.

On the back of the converter is an AC receptacle. Its purpose is to supply power to the television receiver. When using this outlet, the receiver's On/Off switch may be left in "On" position permanently, and power to both units is controlled by the converter unit function switch. If desired, the receiver's power cord may be inserted in a wall socket allowing power to both units to be controlled individually.

The function switch on the converter performs the following operations:

1. OFF Position. Power to the converter and to the AC receptacle is off.

2. VHF Position. Power to the converter and to the AC receptacle is turned on. The converter

filaments are on but the B+ is removed from the IF amplifier and oscillator tubes. The VHF antenna is connected through the switching arrangement to the converter output terminals and to the TV receiver for normal VHF reception.

3. UHF Position. In this position, both filament and B+ voltages are applied to the converter tubes, the VHF antenna is grounded, and the converter output signal is connected through the function switch contacts to the output terminals and to the antenna input terminals.

The converter power supply employs a selenium rectifier, power transformer and an RC filter network. One winding on the power transformer provides power to the converter filaments.

WESTINGHOUSE -

A variety of UHF tuner units are supplied for Westinghouse tele-

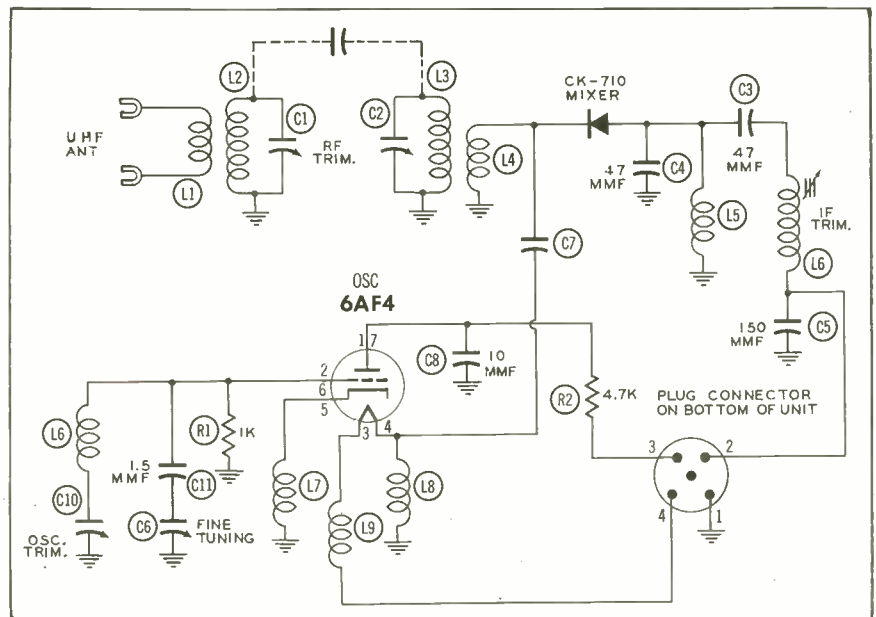
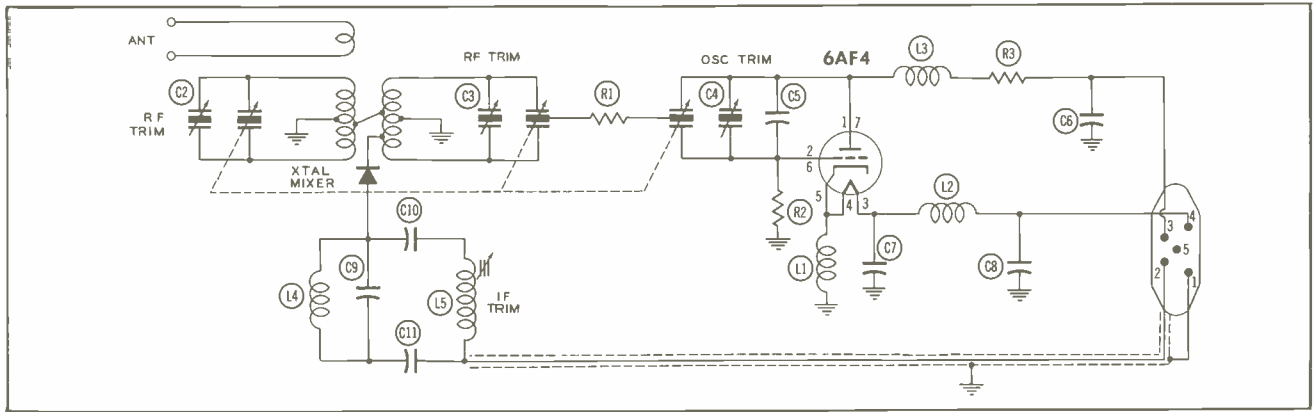
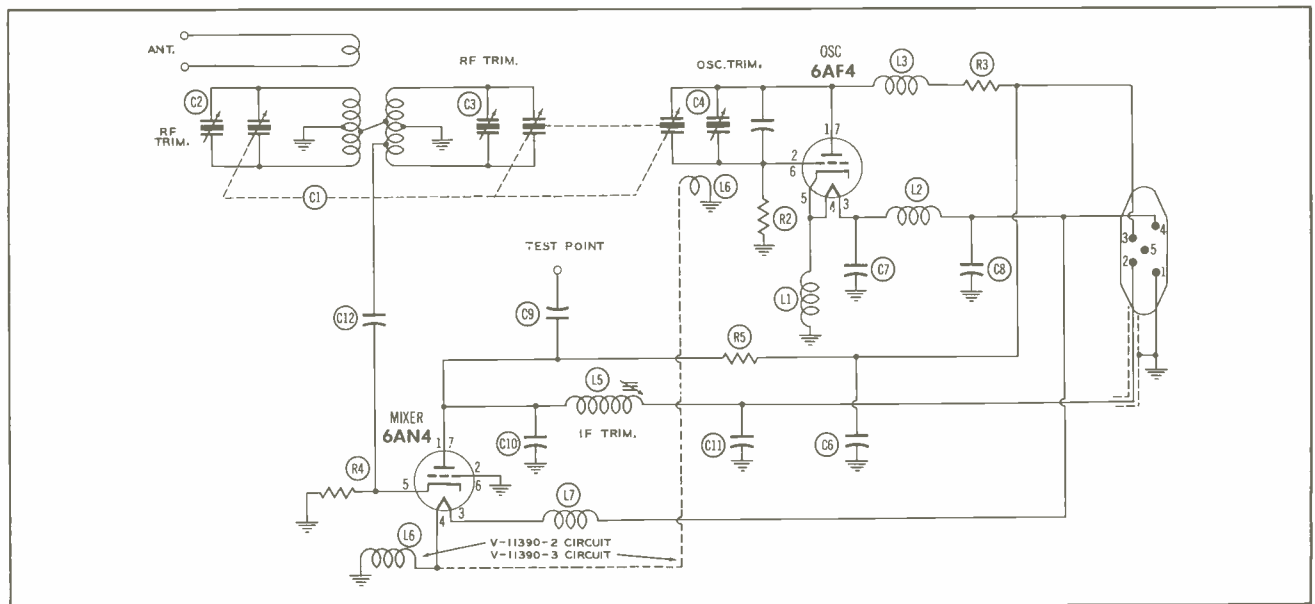

Figure 12. Schematic of Westinghouse H-802 UHF Receptor.





(A) Type V-11390-1;



(B) Types V-11390-2, and -3;

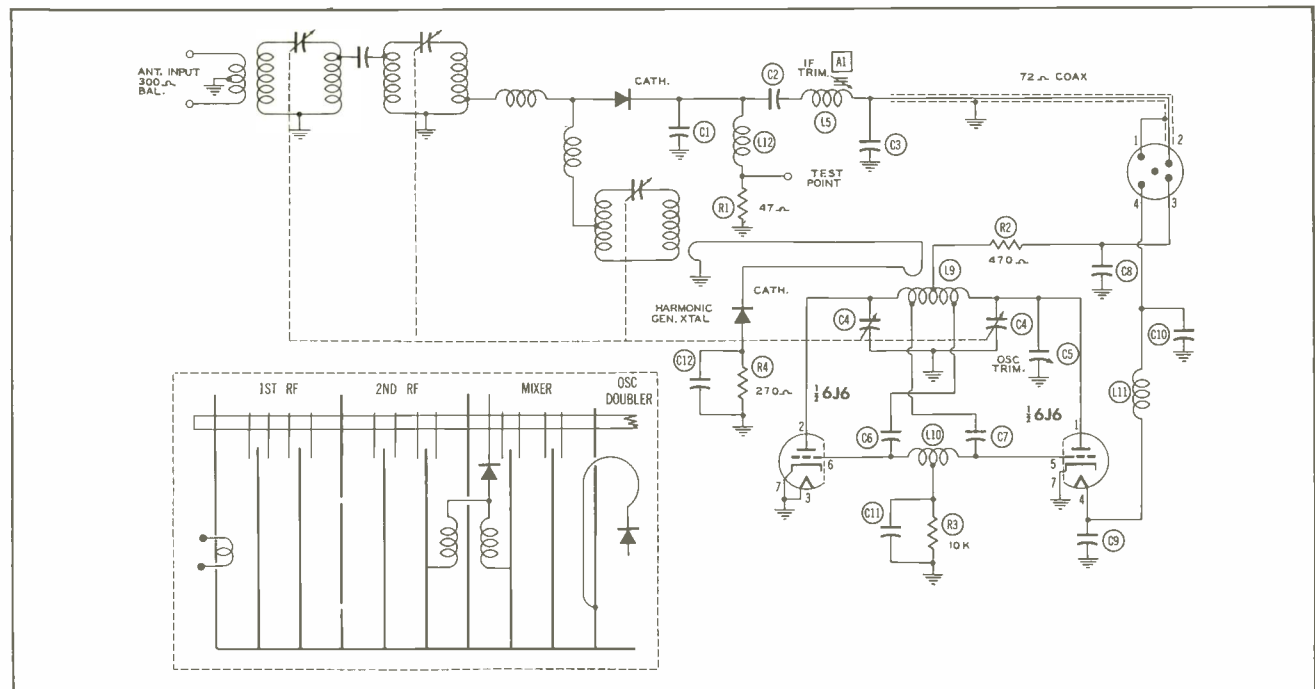

(C) Type V-11613-1.

Figure 13. Schematics of Three Westinghouse All-Channel Tuners.



Burton Brown advertising

**this TV set IMPROVES WITH AGE**

Five years old next week—and now better than ever. When the original tube wore out it was replaced with a Rauland. Now pictures are brighter, sharper, clearer. Another Rauland success story—your cue to sell *improvement* through *replacement* with Rauland—and chalk up plus business.

THE RAULAND CORPORATION 4245 NORTH KNOX AVENUE  
CHICAGO 41, ILLINOIS • MULBERRY 5-5000  
ZENITH SUBSIDIARY



vision receivers to provide UHF TV reception. The receivers in which the tuners can be installed are only those which contain provisions to accommodate these units. Covering a number of applications, these tuners are available as either single channel pre-tuned, plug-in receptors or as all-channel continuously tunable type. Since most of the receivers are equipped with provisions for plugging in two of the single channel receptors, it is possible to incorporate the more economical units individually as UHF stations go on the air within the receiving area.

The all UHF channel converter is available for those installations where this type unit is preferred. In those locations where several UHF stations are expected within a reasonable time, the all-channel units would provide the most useful service.

To facilitate the installation of any of these units there are a number of variations built into the tuners. The Model H-802 is the single channel, pre-tuned receptor unit and is shown in Figure 10. The channel number is stamped on the end of the carton. This indicates the channel to which the unit is aligned at the factory. Since the Model H-802 can be preset within a limited range of UHF channels, the unit is supplied in six versions to cover the entire UHF television band. These various units are stamped with a part number illustrated in Table I, which indicates the tuning range of each unit. A photo and schematic of the Model H-802

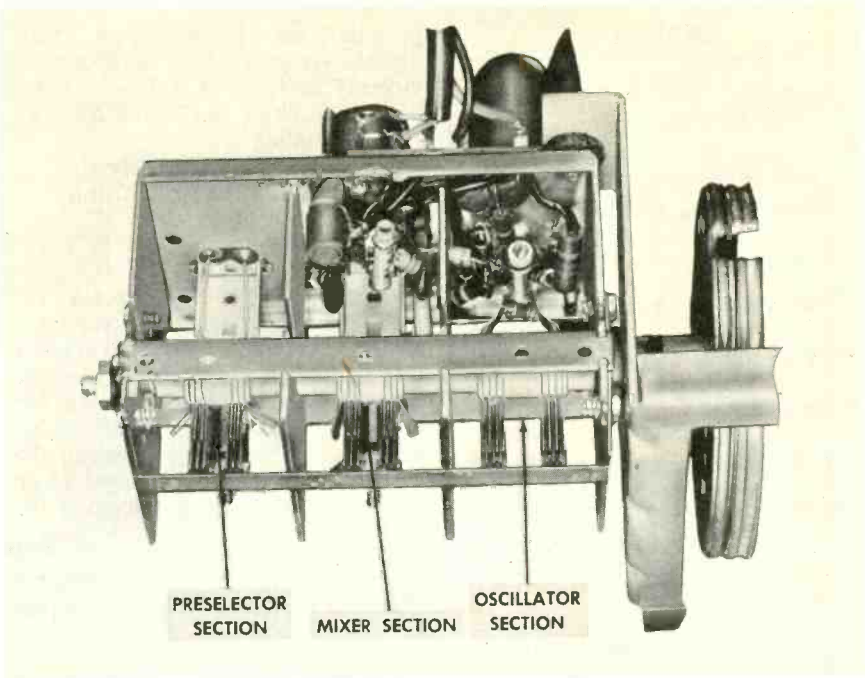

Figure 15. Internal View of Westinghouse H-803-1 Tuner.

with the cover shield removed are shown in Figures 11 and 12 respectively.

For the all UHF channel tuner, the variations are shown by the schematics in Figure 13. It is observed that there are three basic types of the all-channel UHF units. The correct tuner unit to obtain for a specific Westinghouse Receiver is given in Table II. To aid in obtaining the desired tuner, the carton is stamped with a suffix to the model number. The photo in Figure 14

shows the Model H-803-1 using tuner part number V-11390-2,-3. Figure 15 shows a view inside this tuner. Model H-803-4 using the V-11613 tuner is shown in Figure 16.

The V-11390-1 tuner employs a 6AF4 oscillator tube and a crystal mixer to provide the desired IF signal to the VHF tuner unit. V-11390-2 and -3 use similar circuitry except that a 6AN4 tube is employed as the mixer. The V-11613-1 tuner has a 6J6 twin triode tube functioning as a push-pull oscillator. In addition it

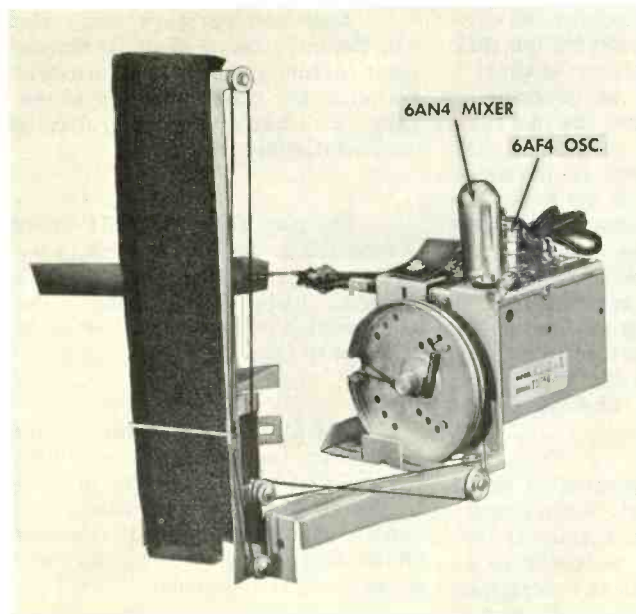

Figure 14. Westinghouse All-Channel UHF Tuner Model H-803-1.

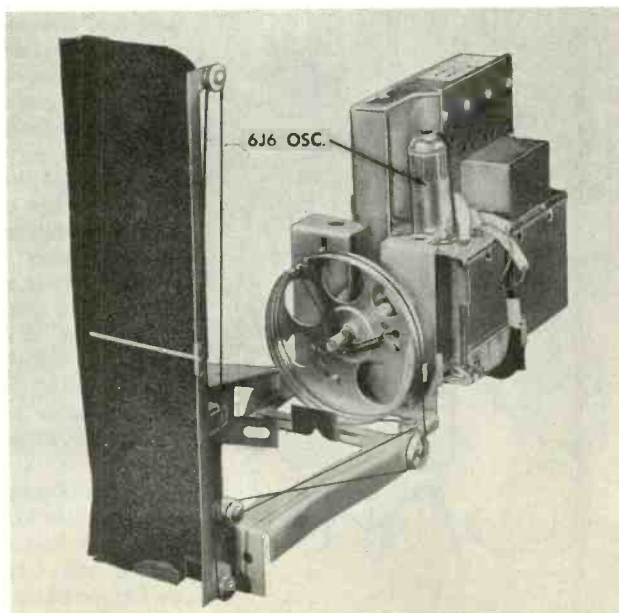

Figure 16. Westinghouse All-Channel UHF Tuner Model H-803-4.

TABLE I

Frequency Ranges of Westinghouse H-802 Receptors.	
Receptors Marked	Can be Tuned to Channels
V-11900-1	14 through 29
V-11900-2	28 through 43
V-11900-3	43 through 58
V-11900-4	58 through 73
V-11900-5	73 through 83

uses a crystal in the oscillator doubler circuitry and a crystal as the mixer.

Although the electrical circuitry and components used in these tuners are different, their function is the same. In each instance, the UHF tuner by a single conversion process provides a 44 mc IF signal in the output. Signal gain is achieved by feeding this signal to the VHF tuner which in UHF position functions as a 44mc 2 stage amplifier. To do this, the VHF local oscillator is disabled enabling the mixer tube to

become a straight amplifier. Thus signals are provided to the receiver's video IF circuits of a level comparable to that presented during VHF reception.

Installation of WESTINGHOUSE Single Channel Receptor Model H-802 -

To install the receptor, remove the rear cover from the television receiver. Plug the receptor into one of the two sockets at the back of the VHF tuner. If the receptor is plugged into the socket nearer the side of the chassis, the UHF position nearer channel 13 on the dial is employed. Plugging the

receptors are supplied pre-tuned, only slight adjustment of the trimmer should be required. Additional adjustments of the unit, if required, are given in the instructions supplied at the time of purchase.

Installation of WESTINGHOUSE All UHF Channel Tuner -

The installation of the all channel tuner in Westinghouse receivers is made with the chassis removed from the cabinet. Detailed installation instructions are supplied with the units and if carefully followed should provide an efficiently operating tuning system.

TABLE II

Receiver Models in Which Westinghouse All-Channel UHF Tuners May Be Used.

Marking on outside of carton	Tuner Type	Receiver in which assembly may be used
H-803-1	V-11390-1,-2, or -3	21" models
H-803-2	V-11390-1,-2 or -3	17" models except those with plastic cabinets
H-803-3	V-11390-1,-2, or -3	17" models with plastic cabinets
H-803-4	V-11613-1	21" models
H-803-5	V-11613-1	17" models except those with plastic cabinets
H-803-6	V-11613-1	17" models with plastic cabinets

unit into the socket nearer the center of the chassis activates the UHF channel position next to channel 2 on the dial. When the receptor is plugged into the socket, the fine tuning drive wheel on the receptor must engage the wheel on the drive shaft, and the slots in the top of the receptor engage the top of the VHF tuner bracket. In the event that the center tongue on the tuner bracket is bent too far toward the back of the cabinet, it should be bent sufficiently to allow insertion of the receptor and to permit the sharp bend on the center tongue to bear on the top of the receptor.

The receptor is supplied tuned to a specified channel. When checking a new installation rotate the fine tuning wheel on the receptor to its center position. This is determined when the center hole in the rim is straight up. Touch up tuning, if required, by adjusting the oscillator trimmer on the receptor. Since the

Most of the work associated with the installation of an all-channel tuner is chiefly mechanical in nature. No soldering operations are necessary which aids in acceleration of the installation detail.

The plug from the UHF tuner is inserted in the socket back of the VHF tuner nearer the center of the chassis. This corresponds to the UHF position on the channel selector adjacent to channel 2.

The all-channel tuners are shipped pre-adjusted to receive UHF channels 14 through 83. In some instances, however, it may prove beneficial to adjust the IF trimmer on the all-channel tuner for best picture detail and sound.

MERLE E. CHANEY



*"I'm not complaining. Just wanted to compliment you on the quality of the music since you got the JENSEN NEEDLE!"*



**A SMALL, HIGH QUALITY AMPLIFIER**  
(Continued from page 21)

important. If a minimum of distortion is to be had, a convenient method of balancing and checking the current drain of the output tubes is necessary. This is especially true when a high quality output transformer is used, for direct current unbalance in the primary must be held to a minimum. By means of a standard phone plug a milliammeter can be plugged into each jack in turn while adjusting the balance control to check for

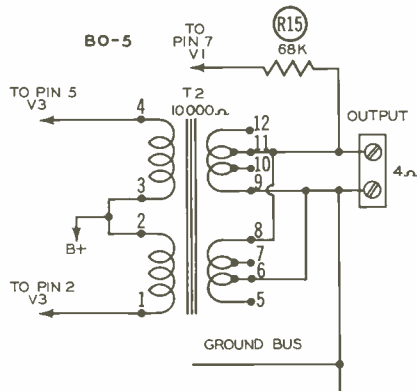

Figure 5. Output Section Chicago BO-5, 4 ohm.

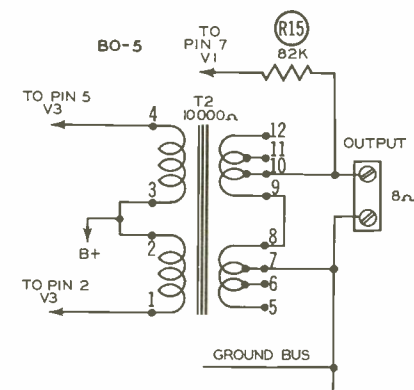

Figure 6. Output Section Chicago BO-5, 8 ohm.

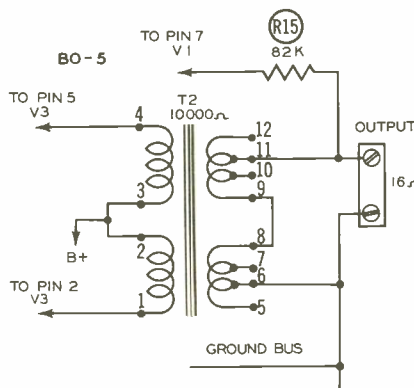

Figure 7. Output Section Chicago BO-5, 16 ohm.

correct balance whenever necessary. Aging of the 6BL7GT can make this check worth while and it is a necessity when installing and selecting a new 6BL7GT.

The schematic in Figure 4 gives the correct connections for the Stancor A-8054 High Fidelity Output Transformer. If the socket connections and color-coded transformer leads are connected as shown the feedback loop will be correctly phased.

Figures 5, 6, and 7 show the connections of the Chicago BO-5 Full Frequency Range Output Transformer for outputs of 4, 8, and 16 ohms with the value of R15 changed to 82K in 8 and 16 ohm output connections.

With the Chicago PSO-150 or PCO-150 PA Range Output Transformer installed the circuit in Figure 8 was followed. The PSO-150 has numbered terminals and the PCO-150 has color-coded leads, as shown. A 500 mmf. capacitor, C7, and the 2700 ohm resistor, R16, were connected from Pins 1 and 5 of V1 to the junction of C2A and R5 to increase stability at high frequencies.

Figure 9 illustrates the connections used with the Merit A-3101 High Fidelity Output Transformer. The plate (red) primary leads of this transformer are not coded so phasing will have to be found by trial connection of these red leads. If these leads are reversed, making the feedback positive, a terrific oscillation will be set up which could tear up a loudspeaker, so care must be taken when first turning on the amplifier for this check. The green primary leads are not used in this application and should be insulated and secured to protect against accidental shorts.

Figure 10 is the output circuit used with the Triad HSM-89 Hermetically Sealed Output Transform-

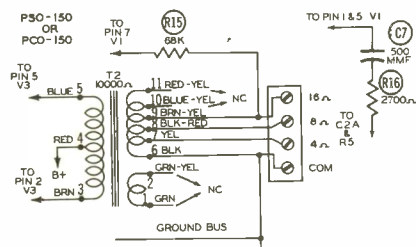

Figure 8. Output Section Chicago PSO-150 and PCO-150.

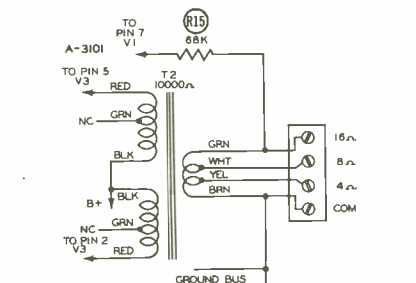

Figure 9. Output Section Merit A-3101.

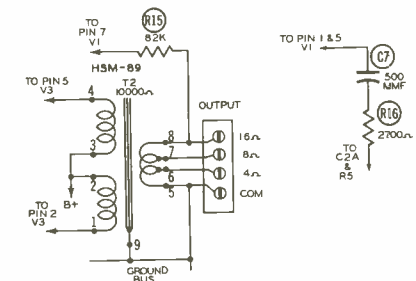

Figure 10. Output Section Triad HSM-89.

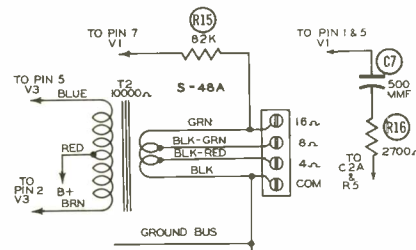

Figure 11. Output Section Triad S-48A.

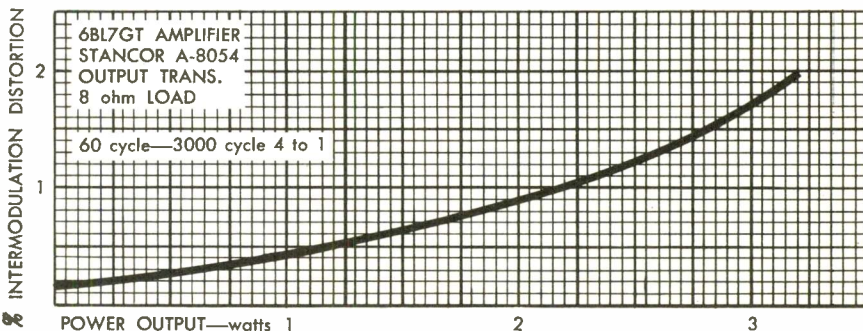
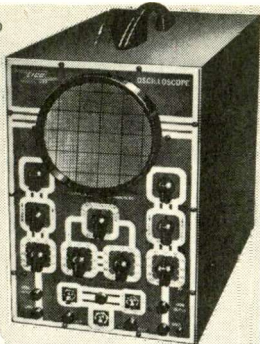

Figure 12. Intermodulation Distortion Graph.

536K Multimeter Kit \$12.90  
Wired \$14.90  
1000 ohms/volt



425K 5" Scope  
Kit \$44.95,  
Wired \$79.95.



**YOU BUILD**

**EICO**

**KITS  
IN ONE  
EVENING-  
but they  
last a lifetime...  
and you save  
50%!**

**22 Kits and 24 Instruments —  
the Industry's most complete  
line of MATCHED  
TEST INSTRUMENTS!**

Over 1/4-million EICO Instruments are now in use the world over! That's the proof of EICO's leadership in Value to the Serviceman!

For latest precision engineering, finest components, smart professional appearance, lifetime performance and rock-bottom economy — see and compare the EICO line at your jobber's today before you buy any higher-priced equipment! You'll agree with over 100,000 others that only EICO Kits and Instruments — no other — give you the industry's greatest values at lowest cost.

Write NOW for  
FREE latest Catalog  
PF-7



221K VTVM Kit \$25.95,  
Wired \$49.95.



565K Multimeter Kit \$24.95,  
Wired \$29.95,  
20,000 ohms/volt.

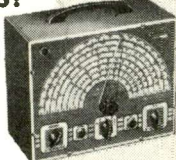

320K Sig. Gen.  
Kit \$19.95, Wired \$29.95.



360K Sweep Gen.  
Kit \$34.95, Wired \$49.95.



1040K Battery Elim.  
Kit \$25.95, Wired \$34.95.

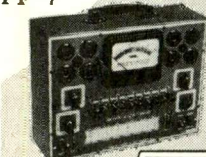

625K Tube Tester  
Kit \$34.95,  
Wired \$49.95.

**Laboratory  
Precision  
at Lowest Cost**

Prices 5% higher on West Coast.

**EICO**

INSTRUMENTS & KITS

ELECTRONIC INSTRUMENT CO., Inc.  
84 Withers Street, Brooklyn 11, N. Y.

er and Figure 11 that used with the Triad S-48A High Fidelity Output Transformer. In each case the value of R15 is 82K and C7 and R16 were connected as shown for increased stability.

The power transformer shown in the schematic and illustrations is actually larger than necessary since the high-voltage secondary is rated at 90 milliamperes and the total plate current drain of the amplifier is only slightly more than half that amount. Installed while developing the amplifier, it will continue to be used since such under-running is an advantage. Conservative operation of all components contributes to continued stable operation of a unit such as this.

Some of the filter chokes in the parts list are potted, similar to the one in the illustrations, while others are shielded or open-frame construction. The various styles and models of chokes and transformers are listed since availability and personal preference are to be considered in their selection. All are satisfactory and their use will result in consistent stable operation.

A milliammeter should be plugged into the meter jacks, by means of a standard phone plug, to read the plate current of one and then the other section of the output tube V3, while adjusting the balance control R2 for identical readings in each section. It may be necessary to select another 6BL7GT if balance cannot be reached. Push-pull output tubes, in this case both in one envelope, should always be selected for balance, which is not as difficult as it might appear.

A signal input of less than one volt peak-to-peak is sufficient to drive the amplifier to a full power output in excess of three watts. This is good clean output essentially flat from 20 to 50,000 cps. The percentage of inter-modulation distortion, measured with a Measurements Corporation Model 31 Intermodulation Meter, is given in Figure 12.

The qualifications of this amplifier are such that it fulfills the oft-times heard, "Wish I had a really good small amplifier."

See Page 103 for Parts List

ROBERT B. DUNHAM

## New, Improved DAVIS SUPER VISION TELEVISION ANTENNA

**WIND-TESTED  
and WEATHERIZED**

**DAVIS**  
**SUPER - VISION**  
Trade Mark Reg.

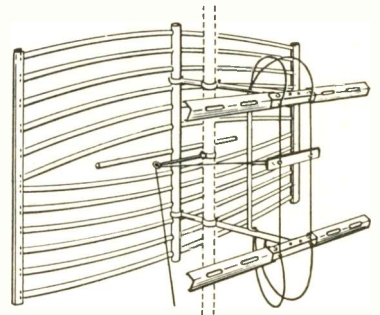

**"THE ORIGINAL ANTENNA SOLD WITH  
A MONEY-BACK GUARANTEE"**  
**UNBEATABLE FOR FRINGE AREA OR DX**

1. EXCELLENT FOR FRINGE AREA and DX RECEIVING—and broad band receiving with high gain on all channels—2 through 13.
2. CLEARER PICTURES UP TO 125 MILES OR MORE—from the station.
3. GHOST PROBLEMS REDUCED or eliminated due to excellent pattern.
4. PROVIDES 10 DB OR MORE GAIN ON HIGH CHANNELS where gain is needed most.
5. EXCELLENT FRONT TO BACK RATIO on all channels. No co-channel interference.
6. MINIMIZES INTERFERENCE: Airplane Flutter — Diathermy and Ignition — F. M. — Neon Signs — X-Ray — Industrial — Etc.
7. ELIMINATES DOUBLE STACKED ARRAYS, and out-performs 2 bay yagis on low band and 4 bay yagis on high channels.
8. ONLY ONE TRANSMISSION LINE NECESSARY.
9. NO WORRY OVER POSSIBLE CHANNEL CHANGES on either high or low channels.
10. CAN BE TIPPED WITHOUT TILTING MAST to take advantage of horizontal wave lengths.
11. Can be used with ANTENNA ROTOR.

**WRITE FOR NEW LITERATURE  
& TECHNICAL DATA SHEETS**

**ASK YOUR JOBBER —  
"The Backbone Of Your Industry"  
FOR COMPLETE INFORMATION**

**DAVIS ELECTRONICS**

AMERICA'S FASTEST GROWING  
ANTENNA MANUFACTURER

BOX 1247 BURBANK, CALIFORNIA



PARTS LIST

TUBES								POWER TRANSFORMER Cont.										
V1	6C4			V3	6BL7GT			Triad										
V2	12AX7			V4	5Y3GT			R-10A	117V AC	525V CT	.09A	5V	2A	6.3V	5A			
								R-8A	117V AC	500V CT	.075A	5V	2A	6.3V	2.5A			
								Merit										
								P-3154	117V AC	550V CT	.05A	5V	2A	6.3V	2.6A			
CONTROLS								OUTPUT TRANSFORMER										
R1	Resistance	Watts	IRC	Clarostat	Centralab	Mallory		T2	Stancor	Primary Impedance	Secondary Impedance							
R2	500K		Q13-133	AG-60-Z RS2	B60	U-48			A-8054	9000Ω CT	8, 16Ω							
	100Ω	2	W100	43-100	VK-121	C100P			Chicago									
									BO-5	10000Ω CT	8, 16, 600Ω CT and 4,150Ω							
RESISTORS									PCO-150	10000Ω CT	4, 8, 16, 150, 600Ω							
R3	Resistance	Watts	IRC						PSO-150	10000Ω CT	4, 8, 16, 150, 600Ω							
R4	3900Ω	1	BTA-3900						Triad									
R5	100K	1	BTA-100K						HSM-89	10000Ω CT	4, 8, 16Ω							
R6	22K	1	BTA-22K						S-48A	10000Ω CT	4, 8, 16Ω							
R7	470K	1	BTA-470K						Merit									
R8	270Ω	1	BTA-270						A-3101	10000Ω CT	4, 8, 16Ω							
R9	270K	1	BTA-270K															
R10	22K	1	BTA-22K															
R11	47K	1	BTA-47K) Matched Pair															
R12	47K	1	BTA-47K) Matched Pair															
R13	470K	1	BTA-470K) Matched Pair															
R14	270Ω	1	BTA-270															
R15	68K	1	BTA-68K See Figure 6, 7, 10 and 11															
R16	2700Ω	1	BTA-2700															
FUSE								FILTER CHOKE										
M1	Type	Rating	Littelfuse	Buss				L1	Stancor	DC	DC Resistance	Inductance						
	3AG	1A	Fuse	Holder	Fuse	Holder			C-2305	.1A	300Ω	5H	Potted					
			312001.	341001	AGC1	HKP			C-1420	.08A	360Ω	16H	Shielded					
									C-1355	.065A	290Ω	8H	Open Frame					
									Chicago									
									RC-1585	.085A	285Ω	15H	Potted					
									RS-1585	.085A	285Ω	15H	Potted					
									R-885	.085A	250Ω	8H	Open Frame					
									Triad									
									HSM-305	.07A	300Ω	15H	Potted					
									C-6X	.065A	300Ω	5H	Open Frame					
									Merit									
									C-3192	.085A	325Ω	15H	Shielded					
									C-2990	.075A	400Ω	15H	Open Frame					
POWER TRANSFORMER								MISCELLANEOUS										
T1	Stancor	PRI	Section 1	Section 2	Section 3			1	Toggle Switch									
	PC-8404	117V AC	520V CT .09A	5V 2A	6.3V 3A			2	Octal Tube Sockets									
	PC-8403	117V AC	500V CT .07A	5V 2A	6.3V 2.5A			1	9-Pin Noval Tube Socket									
	Chicago							1	7-Pin Miniature Tube Socket									
	PCC-55	117V AC	540V CT .055A	5V 2A	6.3V 2A			2	Closed Circuit Jacks									
	PV-60	117V AC	500V CT .06A	5V 2A	6.3V 2A			1	Phono Jack									
								1	AC Power Cord									
								1	7" x 9" x 2" Chassis									
									Terminal Strips, Miscellaneous Hardware, etc.									

OF COURSE IT'S

**AEROVOX**

FOR ALL TYPES  
OF MICAS!

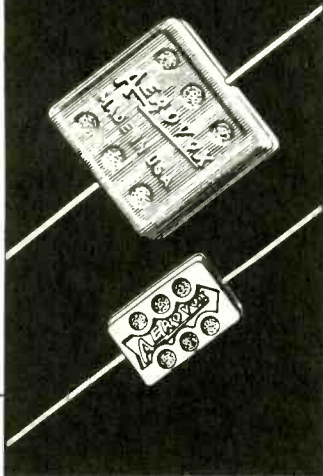

Yes sir, it's still the most complete line. Including types that meet JAN specs. Pick just the right mica capacitor from over two dozen different types.

Postage-stamp or tiny wafer types; high-voltage heavy-duty types in different terminals and mountings; silver micas; porcelain-cased types; etc. Choice of tolerances.

Don't fumble, fuss or fume! Let Aerovox micas fit your particular needs.

Ask your distributor for Aerovox mica capacitors — the outstanding selection of types.



FOR RADIO-ELECTRONIC &  
INDUSTRIAL APPLICATIONS

AEROVOX CORPORATION  
NEW BEDFORD, MASS., U. S. A.

In Canada: AEROVOX CANADA LTD., Hamilton, Ont.  
Export: 41 E. 42nd St., New York 17, N. Y.

## SERVICING WITH THE SCOPE

(Continued from page 9)

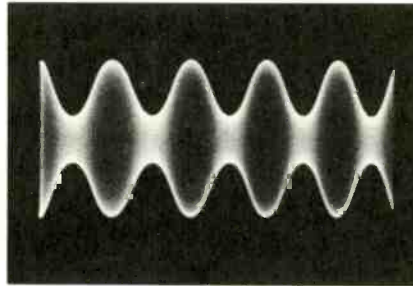

Figure 2. Modulated Signal at the Plate of the IF Tube (Test Point 1).

A test procedure for checking the operation of the AVC circuit can, at times, be very helpful. When using the scope in checking the operation of the AVC circuit, two important facts can be determined pertaining to the AVC operation. By visual examination, it can be seen whether the AVC "takes hold" as it should for proper operation, and any distortion present in the AVC circuit can be detected on the scope.

The procedure for checking the AVC operation is similar to the setup as was employed in the foregoing trouble shooting procedure. The signal generator is set at 1000 kilocycles but is now set to provide a medium signal output. That is, set the step attenuator switch (or RF Attenuator switch) and RF control (or RF Amplitude) at mid-position range. As before, this signal is loop-coupled to the input of the receiver. Tune the receiver to the same frequency of the signal generator. With the scope set for approximately 100 cycles, connect the vertical input lead of the scope to the high side of the detector load (the volume control in many receivers).

The pattern on the scope should be in the form of a sine wave. If the waveform is of irregular shape, the operation of the AVC circuit is improper and the circuit should be

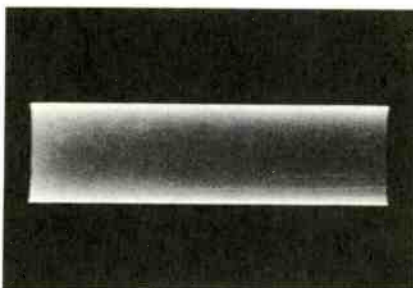
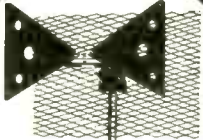

Figure 3. Unmodulated Carrier at the Oscillator Stage (Test Point 4).

# GO TESCO!

for **UHF**

For greater gain in UHF



**ULTRA BOW-TENNA** Model 704



**ULTRA V-TENNA** Model 703

Stronger reception  
Ruggedly built



Covers Channels 2 thru 83  
**VHF-UHF ULTRA-ROCKETENNA** PRL-742

Tesco engineers developed the ULTRA-TENNA series for VHF-UHF, or UHF alone, to solve all antenna problems. Write now for complete information.

it's the cats whiskers... and just as sensitive!

# TESCO

TV PRODUCTS CO. SPRINGFIELD GARDENS  
NEW YORK, 13, N. Y.  
NEW YORK TO 'FRISCO, ... IT'S TESCO



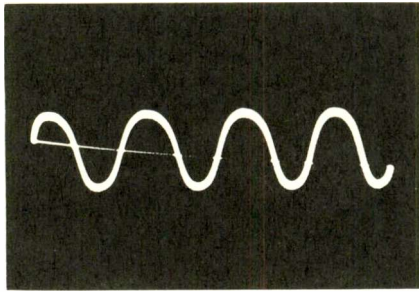

Figure 4A. Operation of the AVC Circuit with Medium Signal Input.

checked for a leaky or open capacitor or a bad resistor. However, if the signal generator is not producing an output of a true sine wave, the scope pattern will be distorted and might be misinterpreted as being improper operation of the AVC circuit. Therefore, it must be determined if the output of the generator is a true sine wave. The operation of the AVC circuit can be checked even though this condition is present.

The pattern on the scope should appear as is shown in Figure 4A. This is under the condition of medium output of the signal generator.

To check the operation of the AVC circuit, increase the output of the generator by first changing the step attenuator step-by-step. On each successive position of the attenuator, the sine wave should increase in amplitude without being distorted. There will be only a slight increase in amplitude due to the controlling action of the AVC circuit, if operating properly. Next, gradually increase the RF control of the signal generator. The amplitude of the pattern should increase slightly. If the pattern is still not distorted at maximum setting of the RF control, the AVC circuit can be considered to be operating properly. Figure 4B represents proper operation of the AVC circuit with maximum signal input.

If a receiver is producing a loud squeal in the output, the trouble may be in the AVC circuit. A quick

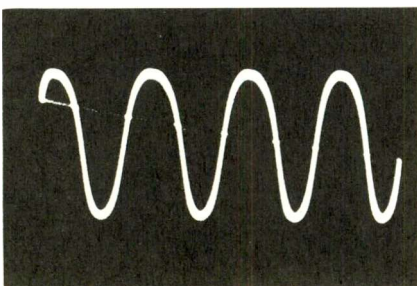

Figure 4B. Operation of the AVC Circuit with Maximum Signal Input.

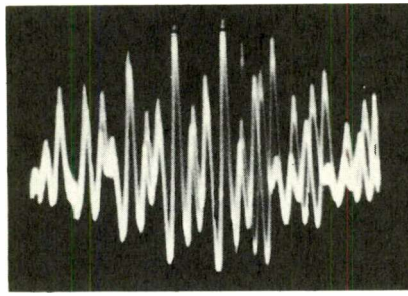

Figure 5. Condition Due to an Open Filter Capacitor in the AVC Circuit.

check of this circuit can be made by connecting the vertical input of the scope to the AVC line. If the condition that is shown in Figure 5 appears on the scope, look for an open filter capacitor in the AVC circuit. If no signal is obtained at this point, a resistance check should be made to see if the AVC filter capacitor is shorted.

Another frequently encountered trouble is that of a defective power supply filter network. If it is suspected of poor filtering, the network can be checked with the aid of the scope. To make this check, set the scope for a frequency of approximately 20 cycles. To protect the scope from being damaged by high DC voltage, use a .25 mfd., 600 volt, capacitor in series with the vertical input lead. Connect the capacitor to the input of the power supply filter network (Test Point 7). Adjust the scope for a stationary pattern. Figure 6 shows the waveform present at the input of the filter network.

To determine the efficiency of the power supply filter, transfer the vertical input lead of the scope to the output of the filter network (Test Point 8). If the filtering network is functioning properly, nearly all the input ripple will be smoothed out and a fairly straight horizontal line will appear on the screen of the scope. Figure 7 shows the output of the filter network used in the receiver shown in Figure 1. Comparing Figure 6 with Figure 7, note that the input ripple has been smoothed out

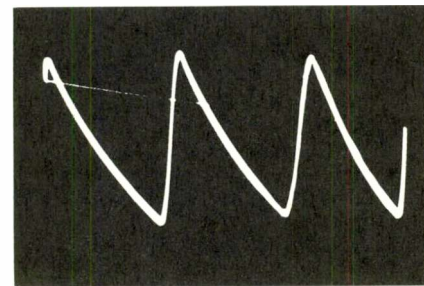

Figure 6. Input of Power Supply Filter (Test Point 7 in Figure 1).

considerably. If the ripple is still prominent in the output of the filter network, each section of the network should be checked for a bad component.

A percentage of ripple of 1 per cent is considered passable in receivers of the AC-DC type in most cases. However, on the AC or higher quality receivers, the percentage of ripple should be .25 percent or better. The percentage of ripple can be calculated by use of the following formula.

$$\text{Per cent } E_r = \frac{E_r}{E_{dc}} \times 35.7$$

Where:

$E_r$  = peak-to-peak ripple voltage.

$E_{dc}$  = output voltage of power supply.

The 35.7 value is obtained from the ratio of 100 divided by 2.8. The 2.8 factor changes the peak-to-peak ripple voltage to the RMS value.

The amount of ripple in a power supply varies from receiver to receiver. The ripple factor is

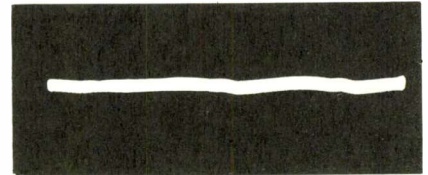

Figure 7. Output of Power Supply Filter (Test Point 8 in Figure 1).

dependent upon the design of the receiver and the condition of the component parts of the filter network.

It must be remembered that the type of radio circuit used for presenting the foregoing trouble shooting procedures was a basic five tube AC-DC receiver. This type of receiver can be serviced quickly without too much difficulty. However, in servicing more complex receivers, trouble shooting becomes more difficult because of the greater number of stages and component parts. The procedure of trouble shooting these sets with the scope follows the same pattern but more steps are involved in localizing the exact stage in which the trouble is located. If the procedure is followed along the same lines as has been presented here, trouble shooting of any type radio receiver can be accomplished without too much difficulty.

C. P. OLIPHANT



*Presents*

the World's FIRST  
Completely NEW  
High Fidelity  
Record Changer!

specifically designed  
to meet the  
exacting standards  
of  
Hi-Fi enthusiasts!



*trio*matic®  
**935HF**  
record changer

**OFFERS**

more Exclusive  
Hi-Fi Features...  
more Record  
Protecting Features...  
more Convenient Record  
Handling Features...  
**THAN ANY COMPETITIVE CHANGER!**





All New

# triomatic® 935HF record changer

"Custom-Precision" quality for the discriminating buyer

The V-M 935HF is a top quality high fidelity record changer throughout! Its many exclusive features will have tremendous appeal to ALL of your customers interested in life-like reproduction of recorded music.

**MANUAL OPERATION**—Allow changer to shut off automatically, place record on turntable and set speed, turn Control Knob to "ON" and place needle in lead-in groove.

- 1 LAMINATED TURNTABLE WITH PRECISION-FORMED CONCENTRICITY**, (exclusive in this price range) is weighted and balanced to assure constant-speed operation. New motor mount and close-tolerance drive completely eliminate wow. Extra heavy flocking silences and cushions record drop. Turntable is mounted on a selected three-ball thrust bearing, with mirror-finished surfaces, for silent rumble-free performance.
- 2 GENTLE TRI-O-MATIC SPINDLE** protects records, eliminates record holders that grip the grooves. Records are moved at the center (point of perfect control) . . . are lowered, NOT dropped, to spindle shelf and flat, air-cushion dropped to turntable.
- 3 DIE CAST TONE ARM** of aluminum, is rigid and resonance-free! Is balanced for easy, exact adjustment to needle pressures specified by needle or cartridge manufacturers.
- 4 TWO PLUG-IN TONE ARM HEADS** (1 gold, 1 red, less cartridges) are included. Precision-fitted cast aluminum construction. Adaptable to: GE "turn-about" RPX050, GE RPX040, GE RPX041, Pickering single-play and turnover, and Clarkstan cartridges.\*
- 5 A MINIMUM OF LATERAL PRESSURE** is required to track and trip the friction-free V-M 935HF changer. Cartridges requiring down to 5 grams needle pressure can be used with excellent results.
- 6 MUTING SWITCH** for absolute quiet during change cycle.
- 7 V-M 45 SPINDLE** is included. Permits automatic play of up to fourteen large center-hole records.
- 8 EXCLUSIVE FOUR-POLE, FOUR-COIL MOTOR** with surplus power for silent, constant-speed service, eliminates the source of electronic hum and rumble.  
\*Pre-amplification stage required.

### ADDITIONAL FEATURES:

Gold base plate, burgundy accessories; complete, automatic shut-off; plays all speed, size records automatically; completely jamproof mechanism.



V-M 935 Mounting Board Pre-Cut.  
Measures 3/4" x 16 1/4" x 17 1/4"

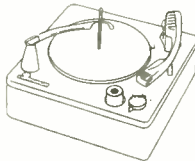

V-M 936HF Changer Attachment on metal pan has 6' AC cord, 4' phono cord with plugs. Underwriters' Approved.

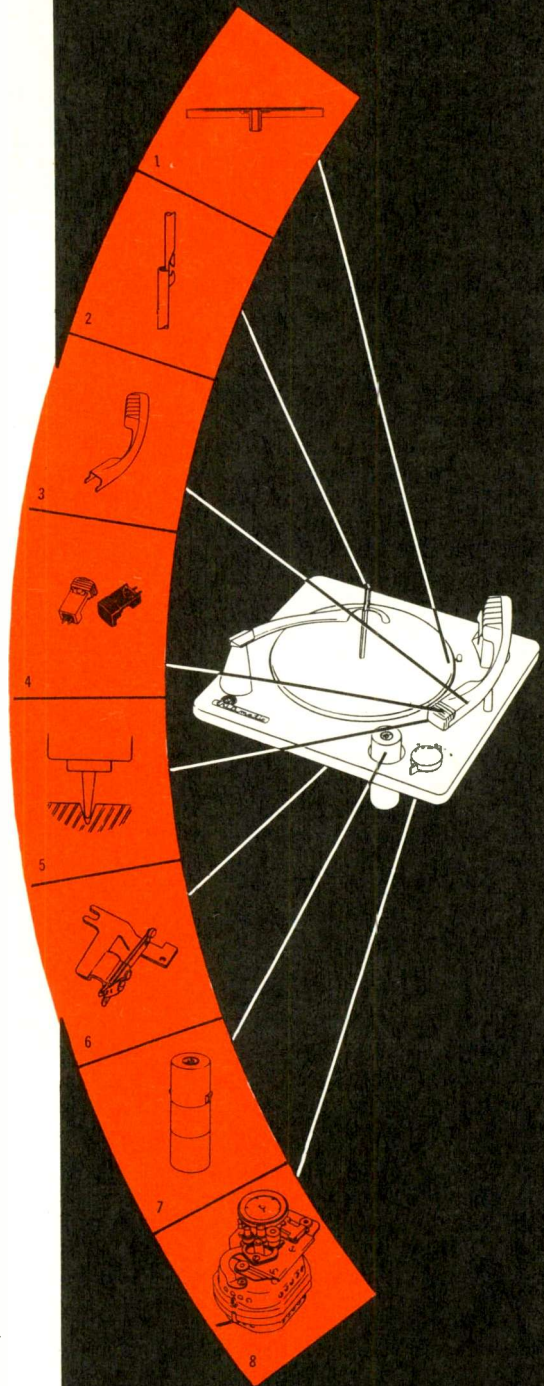

## CORPORATION

BENTON HARBOR, MICHIGAN

WORLD'S LARGEST MANUFACTURER OF PHONOGRAPHS  
AND RECORD CHANGERS EXCLUSIVELY

**V-M CORPORATION**  
BENTON HARBOR 7, MICHIGAN

Write for illustrated literature telling ALL about the new V-M 935HF high fidelity changer.

# the Autronic-Eye

by C. P. Oliphant

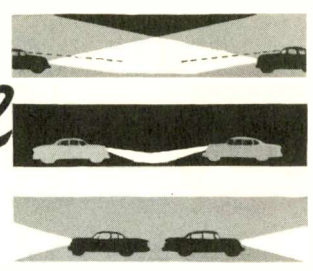

Until the time the Autronic Eye was introduced to the automobile industry, the radio had been the only electronic item used in the car. Should the acceptance of the Autronic Eye continue to grow, it is very probable that the radio-television technician may be called upon to service these units. For this reason, the following discussion is presented to give the service technician a working knowledge of the operation of the Autronic Eye.

The Autronic Eye performs three basic functions during night driving which are:

1. The headlight beams of the car on which the Autronic Eye is installed are automatically changed from upper to lower position when the lights from an approaching car fall within range of the phototube.
2. The headlight beams are held in this position until all cars have passed.

3. The headlight beams are automatically returned to the upper beam position as soon as all approaching cars have passed.

By performing these three functions automatically, the selection of the proper beam is accomplished without human error.

With the use of the Autronic Eye safety, comfort, and courtesy are three resulting factors. Safety is achieved because headlights are quickly dimmed and the driver of an approaching car is not blinded by bright lights. Since the driver is relieved of the responsibility of switching the headlights, night driving is less strenuous, which adds to the driver's comfort. This also adds to the efficiency of the driver. Courtesy is evident to other drivers since the headlights are dimmed quickly when a car approaches. This tends to cause the driver of the approaching car to respond rapidly in dimming his headlights.

Actually, the main resulting factor from the use of the Autronic Eye is safety.

The Autronic Eye consists of four components; phototube unit, amplifier unit, power relay, and auxiliary foot switch (see Figure 1). The primary function of each unit is as follows:

**Phototube Unit.** This unit consists of a photo-multiplier stage and an optical lens system. See Figure 2 for side view of phototube unit with cover removed. The lens farthest from the phototube is a light-gathering lens (condenser); while the one nearest the phototube is a filtering lens. The color of the filtering lens depends upon the tint of the windshield behind which the phototube unit is to be installed.

The photo-multiplier unit receives the incoming light rays and converts them into electrical impulses which, in turn, control the

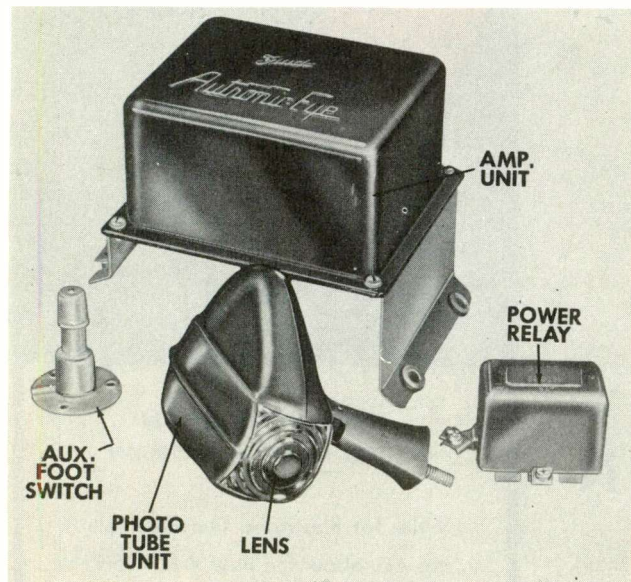

Figure 1. Composite Photograph Showing the Four Units of the Autronic Eye.

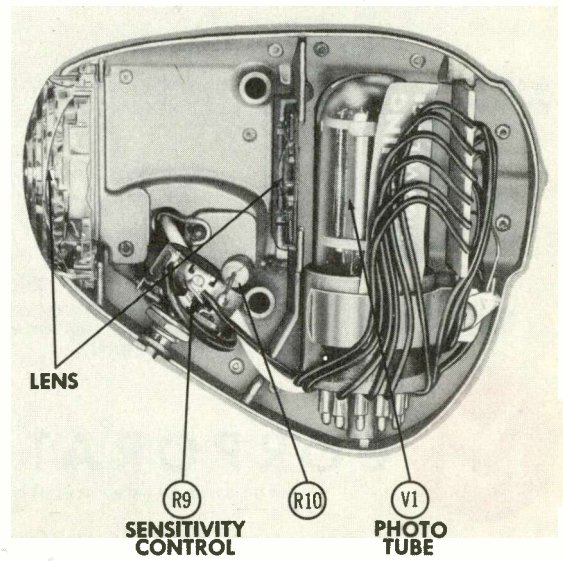

Figure 2. Side View of Phototube Unit with Cover Removed.



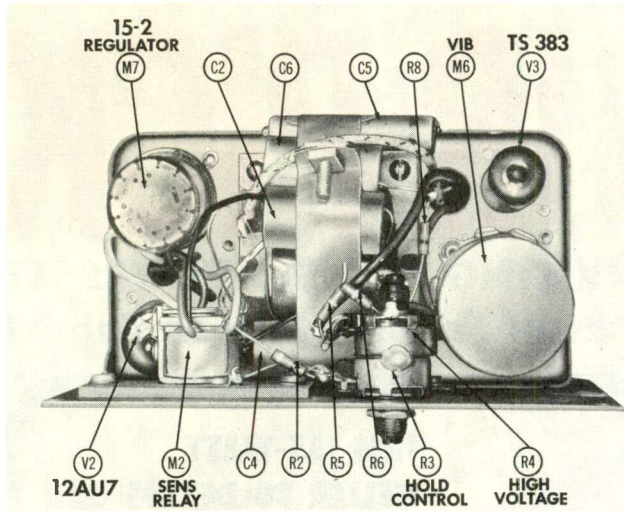

Figure 3. Top View of Amplifier Unit Chassis.

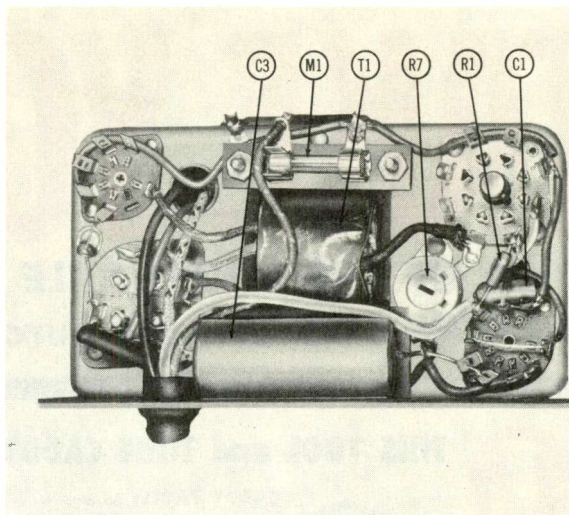

Figure 4. Underneath View of Amplifier Unit Chassis.

headlight beams. It is mounted directly behind the windshield in the lower left-hand corner.

**Amplifier Unit.** This unit contains a control tube stage, a sensitive plate-circuit relay, and a vibrator type power supply that furnishes operating voltages for the phototube, the control tube, and the power relay. Refer to Figure 3 for top view of amplifier unit chassis. Figure 4 shows the underneath view of the chassis. The amplifier unit is installed under the hood in the engine compartment.

**Power Relay.** This unit is a heavy duty sealed relay that is energized by the operation of the amplifier unit. This, in turn, selects the proper beam position. The power relay unit is mounted near the amplifier unit in the engine compartment.

**Auxiliary Foot Switch.** This switch is a momentary contact, plunger type control which provides a means of obtaining the upper beam for purposes of signaling, or when the situation warrants more lighting. Under normal operation, this switch is in the open position and when closed it over-rides the control unit. When this switch is depressed, the headlights remain in the upper beam position regardless of the amount of light entering the phototube.

This unit is mounted on the floor just above the standard foot dimmer switch.

Figure 5 shows the cabling layout of the component units of the Autronic eye plus the headlight switch and foot dimmer switch which

are recabled in the circuit. The foot dimmer switch is electrically reconnected in the Autronic Eye circuit for two purposes; (1) to provide a means of manually obtaining the lower beam position, and (2) to allow the automatic operation of the Autronic Eye when the switch is in the second position.

The operation of the circuit, which is shown in Figure 6, is as follows: The phototube V1 operates with a negative cathode potential of approximately 1000 volts DC. The plate load of V1 is R1, R2, and R3. These three resistances are also the grid return for the triode section of the control tube V2. For purposes of reference, assume that the circuit has been placed in operation and the headlights are in the upper beam position. At this time, no light is being admitted to the cathode of the phototube, which means that no current will flow from its plate. With no plate current flowing through the grid return of V2 there is a negligible voltage drop across R1 which places the grid of V2 practically at the same potential as its cathode. Consequently, the triode section of V2 conducts heavily. While V2 is conducting, the relay M2 is held closed, placing a short across R2 and R3. At the same time, the power relay M3 is de-energized, placing the headlights in the upper beam position.

When light strikes the cathode of the phototube, plate current begins to flow from V1 and varies in accordance with the intensity of the light. The magnitude of the final plate current is greatly increased from that of the original cathode emission by the action of the electron multiplier. The purpose of the

electron multiplier is to receive a small amount of current and increase it in multiples to a usable value. This process begins when light strikes the cathode of the phototube causing electrons to be emitted. These electrons are then picked up by the first dynode of the multiplier section. Secondary emission occurs from the first dynode to the second dynode, with the secondary electrons greatly outnumbering the primary electrons. This process is continued for each succeeding dynode, with the result that the secondary electrons are increased in multiples.

The flow of plate current from V1 causes a voltage drop across R1 which places a negative potential on the grid of V2. With the grid negative, plate current flow from V2 decreases. It decreases to the point where relay M2 is allowed to open, removing the short from across R2 and R3. The removal of this short provides a higher value of plate load for V1, with the result of driving the grid of V2 further negative. This insures V2 being held at cutoff and M2 remaining

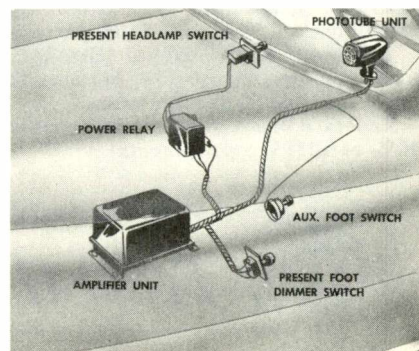

Figure 5. Cabling Layout of the Component Units of the Autronic Eye.

# TAKE YOUR PICK

**EITHER OF THESE VALUABLE SERVICING ITEMS...YOURS AT NO EXTRA COST...with purchases of Federal Picture Tubes!**

**1**

## THIS TOOL and TUBE CADDY or...



**CADDY FACTS:** An attractive convenience—for tools and tubes—you'll be proud to carry on all service calls. Sturdy wood construction... covered with simulated alligator leather (blue). Over-all size: 18½ inches long, 13¼ inches high, 9 inches wide. Brass-finished lock, hinges, catches and corner guards. Compartments hold approximately 75 receiving tubes of various sizes. Opens into three separate, easily-accessible sections. \$9.50 value! (A \$14.95 list value).

**2**

## THIS 135-WATT WELLER SOLDERING GUN



**GUN FACTS:** Weller Model WD-135 (135 watts). Ideal for all types of soldering and dozens of household jobs. Instant heating. Dual heat increases tip life. High or low heat as desired. Exclusive tip-fastening feature—full, constant heat. Low-cost, replaceable tips. Pre-focused spotlight. Longer reach—perfect balance. Shatter-proof plastic housing. \$10.95 value! (A \$14.90 list value).

We want you to know the Quality, Long-Life Performance and Replacement Profits in

**Federal PICTURE TUBES**



## How to get your choice—

With every purchase of a Federal "Best-in-Sight" Picture Tube, your participating Federal Distributor gives you one Federal Certificate. There are no restrictions on type of tube. You may buy one tube at a time, or as many as you need.

As soon as you have accumulated 10 certificates, deliver them to the distributor from whom you purchased your Federal Picture Tubes and he will exchange them for the Combination Tool and Tube Servicing Caddy OR the Weller Soldering Gun. (If you wish, both Caddy and Soldering Gun will be given in exchange for 20 Federal Certificates.)

TV SET MANUFACTURER TEST SHOWS OVER

**99% HIT THE BULL'S-EYE FOR QUALITY!**

Here's proof that it pays to replace with Federal. Here's assurance of customer satisfaction... of less time wasted on call-backs... of more dollars of profit.

Join the trend to Federal "Best-in-Sight" Picture Tubes... outstanding for quality, because they are made by a world leader in broadcast tubes.

Federal's line of popular-size tubes will take care of over 90% of all TV replacements!



**See your Federal DISTRIBUTOR For Federal Tubes and Certificates!**

This offer is void wherever prohibited or wherever any tax, license or other restriction is imposed.

(This offer expires August 31, 1953)



Start Ordering Federal Picture Tubes—Start Saving Federal Certificates!

**Federal Telephone and Radio Corporation**

VACUUM TUBE DIVISION • 100 KINGSLAND ROAD, CLIFTON, N. J.

In Canada: Federal Electric Manufacturing Company Ltd., Montreal, P. Q.  
Export Distributors: International Standard Electric Corp., 67 Broad St., N. Y.



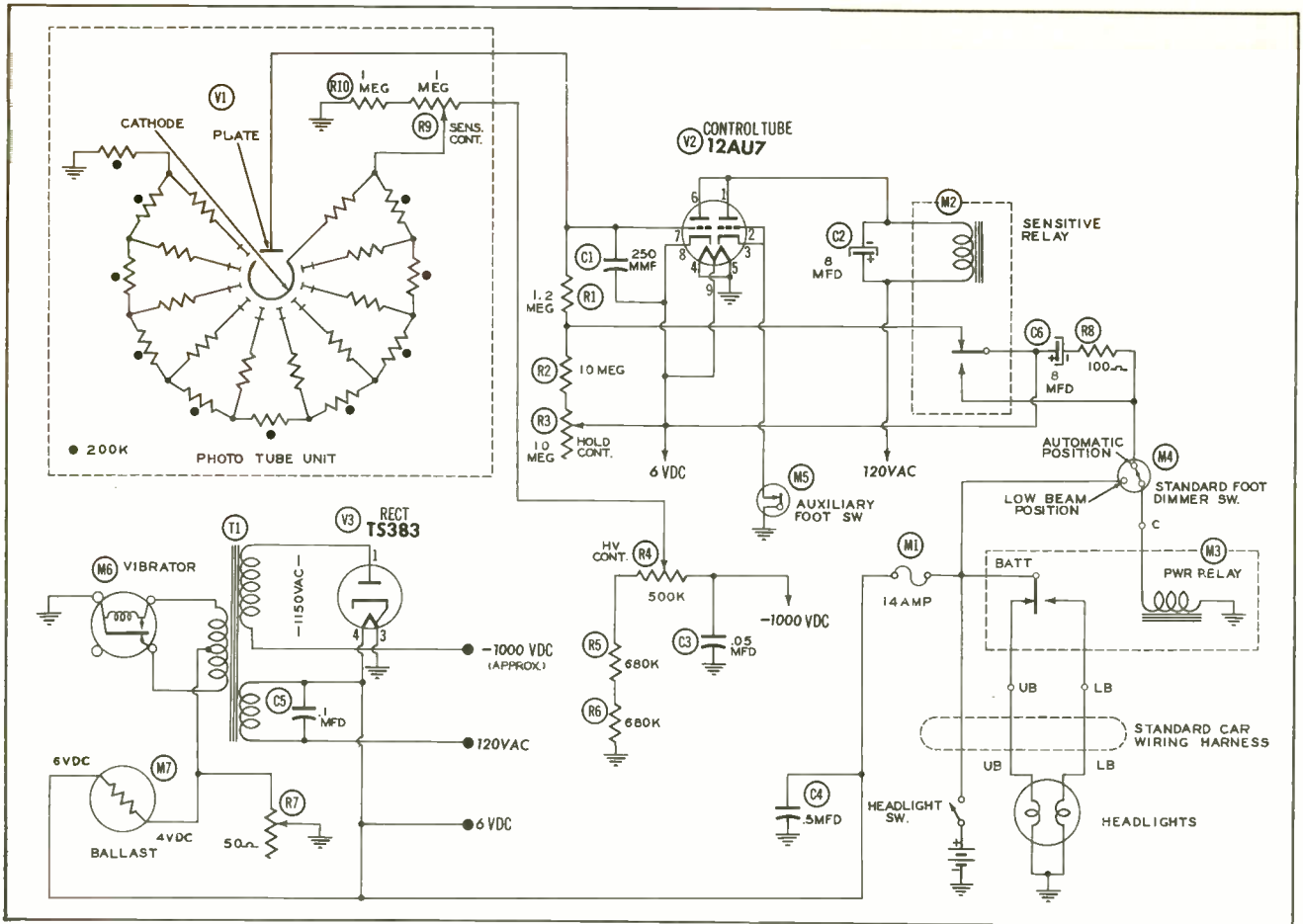

Figure 6. Circuit of Autronic Eye Complete from Phototube Unit to Car Headlights.

open as long as any light strikes the cathode of the phototube. The phototube is also protected from excessive plate current drain with the increase of plate load. When relay M2 opens, relay M3 closes, placing the headlights in the lower beam position. The headlights will

remain in this position as long as light strikes the cathode of the phototube or until the auxiliary foot switch is used.

The function of the auxiliary foot switch M5 is to provide a means of obtaining the upper beam when it

is desired to signal an approaching driver. When the switch is depressed, the cathode circuit of the diode section of V2 is completed to ground and the second half of V2 conducts, causing plate current flow through

\* \* Please turn to page 120 \* \*



*the secret is in the LIPS!*

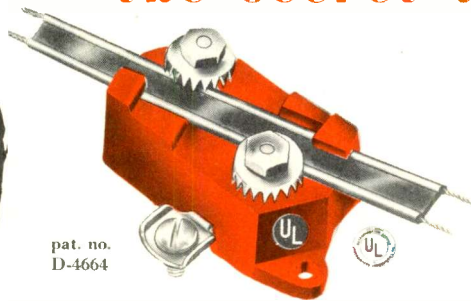

pat. no. D-4664

the only lightning arresters with the strain relief lips are made by JFD. A patent is its proof!

JFD MANUFACTURING CO., INC. BROOKLYN 4, N.Y.  
World's largest manufacturer of TV antennas and accessories



## "Little Giant" LIGHTNING ARRESTER

for flat and oval jumbo twin lead  
No. AT105 (with hardware for wall or window sill mounting) . . . . . \$1.25 list  
No. AT105S (with stainless steel strap for universal mounting) . . . . . \$1.50 list

Barton Broome advertising

# Walco

## REPLACEMENT NEEDLES

**BECAUSE YOU'RE IN  
BUSINESS TO MAKE MONEY!**

*and you make real money when*

you install Walco diamond-tipped replacement needles because your profit runs as high as \$10.00 per needle and more. You do a good turn for your customer, too, because, play for play, he pays less and he preserves his precious records as well. Walco replacement needles cost you as much as 40% less than other brands because Walco manufactures needles. Many leading manufacturers use Walco-made needles as original equipment. You'll be ahead all-ways with Walco.

### Walco

TRADE NAME OF

## ELECTROVOX CO., INC.

60 FRANKLIN ST., EAST ORANGE, N. J.

**A TWO-FISTED WAY  
TO BEAT  
T. V. I.**



LF-601



HF-600

Television interference can be caused by amateur radio transmitting stations, diathermy equipment, X-Ray equipment, automotive ignition noises, etc. The basic problem of eliminating this interference is that of rejection of the signals received from these sources.

When interference is caused by harmonics from a transmitter, it can be greatly reduced or eliminated at the transmitter by use of a Bud LF-601 Low Pass Filter.

If interference is caused by any of the other sources of interference mentioned above, it can be eliminated by use of a Bud HF-600 High Pass Filter at the receiver.

Almost any one can make a television interference filter, but it takes real "know how" and experience to produce a unit that will do an efficient job. Bud Filters are the result of intensive research and development in this field. Wide acceptance of these products is proof of their exceptionally high quality.

LF-601 \$23.30 List

HF-600 \$5.00 List

See them at your distributor. Name of your nearest Bud distributor and informative literature will be furnished upon request.



### BUD RADIO, Inc.

2118 EAST 55th ST., CLEVELAND 3, OHIO  
DEPT. X

#### UHF OPERATIONAL SURVEY

(Continued from page 31)

under the trees and should it prove successful it will result in a tremendous saving for your customer. Also you will agree the work involved in mounting an antenna two or three feet from the ground is considerably different than mounting a 50 to 60' mast.

The dealers that we contacted stated that they had no success with built-in antennas. This may be due to the fact that the transmitting tower is not in the city itself but is located to the southwest. Thus, no homes in Jackson proper are within the shadow of the antenna tower. There are several other factors which may contribute to this condition, such as surrounding terrain, as well as the electrical and/or mechanical tilt of the transmitting antenna.

Many of the dealers have UHF installations which are 50 to 60 miles distant from the tower. A popular antenna for this type of installation is a 4 stacked 12 element Yagi cut for the specific channel of operation. Other antennas which are used successfully at this distance or slightly

less are the corner reflector, colinear, stacked bow-tie, conical with parabolic reflector and 4 bay conical with screen reflector. The terrain surrounding Jackson is by no means flat but it cannot be compared with the type of terrain that is encountered in UHF areas in the east or in Portland, Oregon. There is some shading of certain areas behind hills in and around Jackson, but it is not as serious as that experienced in other UHF areas. The Jackson TV station is connected on the network so that it can provide live programming. Their signal quality is good and for the most part has been so since they came on the air last January. The main concern of the dealers in this area is that of slow sales. Perhaps since this is a new TV area, the sales will have a "snow ball" effect and sales will be at their expected level shortly.

Mobile, Alabama

In December, 1952, WKAB-TV channel 48 commenced operation in Mobile, Alabama using a 100 watt driver as interim equipment. They plan to go on full power as soon as their final 12 KW amplifier is delivered in its entirety. This was one of the first UHF stations to come on

the air with such low power. The results obtained were far from gratifying.

Several thousand receivers had been installed in this area for VHF reception from the channel 6 station in New Orleans or any other station which might be received under certain atmospheric conditions. Since the New Orleans station is about 125 miles distant, good reception could not be had at all times. The consumers were fully aware of this situation and had learned to live with it. They rightfully expected that their days of looking at a snow filled picture would come to an end with the inauguration of local TV service. To their dismay it was found in many instances that reception from the local UHF station was not as good as that experienced from New Orleans. Only those locations within two or three miles of the transmitter could be assured of satisfactory reception. There were some installations at a greater distance that would receive a fair signal due to their particular locations. This condition led to skepticism on the part of the potential television buyer. The average consumer expected that the quality of reception could be likened to their experiences



with AM reception. They had learned to expect that distant reception cannot always be had but that a local, station, even a low power 250 watt, should provide good reception in the immediate vicinity. The technician who is fully aware of the limitations of television reception can easily see why a range as small as that mentioned above is experienced. Unfortunately, this is not common knowledge on the part of the average consumer and a state of confusion has resulted.

Prior to the time of the starting date of the UHF station, the sale of television receivers was at a rapid pace. After the station came on the air and the buyers found what poor reception they were getting, the word was soon passed and television sales dropped practically to zero. The dealers were not only faced with the prospect of no sales but they had to appease their buyers of the receivers that had already been sold. In some cases this was an impossible task since UHF reception was guaranteed at the time of the sale.

The VHF station in Mobile, WLAL-TV operating on channel 10, came on the air about three weeks after the UHF station. This, too, proved to be a premature start, since the station came on the air using only a temporary antenna. The station was also plagued with failure of temporary equipment which they had put into service in order to commence operation at this time. With two stations operating in Mobile and neither of them providing satisfactory reception in some parts of the city and vicinity, the general public was even more confused. Realizing that the problems confronting the dealers was for the most part caused by the operation of the stations at reduced power, the management of both stations jointly sponsored an ad in the local newspaper stating the conditions under which they were operating. In this way it was hoped that much of the pressure which was put on the dealers and installers could be relieved. It was instrumental in doing this to a certain extent but many of the television set owners must wait until full power operation can be started before good reception can be had. We contacted the dealers in Mobile on May 11th and 12th and at that time the permanent 12 bay antenna was nearing completion, and it was expected that it could be put into operation no later than May 15th. This undoubtedly will eliminate many of the reception problems existing in Mobile. The UHF station, we

were told, has their final 12 KW amplifier and needs only one klystron to complete the installation. When this comes to pass, Mobile will be supplied with two full power television stations.

Since the reception conditions in Mobile were far different from those experienced in other areas, the techniques which were used could not be considered as the rule for other installations. Locations only a few miles distant from the transmitter were found to be in the fringe area, while under normal circumstances this same location would be in the primary service area. This required the installation of high gain antennas and it is of great concern as to what might happen with these installations after the station comes on with full power. It is hoped that no serious effect will be noted. In some cases, it might be necessary for the dealer to change the type of antenna and/or change its position, which will cause him added expense.

Needless to say, the dealers in Mobile are far from happy about the situation which existed there. They have tried to make installations which would provide satisfactory reception for their customers but have been forced to do so under a terrific handicap. Perhaps the Mobile operation will serve one purpose. It might discourage future telecasters from using similar "flea power" operation. It is very probable that by the time this report is in print, the Mobile UHF station will be on full power. This should help the situation immeasurably.

#### Antennas and Lead-Ins

The most frequently used antenna in the primary areas of the above cities is the bow-tie type. Where there is an existing installation it is usually possible to mount the bow tie somewhere on the existing mast. Of course when this is not possible, a separate mast must be used. The secondary area brought into use some bow ties, but usually a higher gain antenna was preferred; such as stacked bow ties, colinear arrays, and two and four bay conicals with reflectors. The fringe area bought into use the corner reflector, conical with parabolic reflector, some colinear arrays and four bay conicals, and for extreme sensitivity some dealers are four stacking 12 element Yagis. We talked with no dealers who related that they had tried any rhombic antennas. No

specific reason was given for this other than most dealers felt that they were getting satisfactory results with the antennas that they were using and felt that no experimentation with rhombics was needed. At both Jackson and Baton Rouge dealers pointed out that they have several installations from 50 to 60 miles from the station. For the most part though, the dealers are concentrating on sales in the primary and secondary areas.

Three types of lead-in are being used almost exclusively by the dealers in these areas. These are the tubular, oval and open wire. Dealers who had used both tubular and oval types said that they could not tell too much difference in the operation of the two. The type which they preferred was often decided by what type the jobber had on hand or by the preference of the individual installers. Some dealers stated that they were using no open wire, even in the very fringe areas, while one dealer we talked to is using open wire exclusively, even on primary area installations. So it seems to be a matter of individual preference as to the type used. Our experiences in the testing of these types of lines showed that all three types are suitable for use at UHF frequencies. It was found, however, that the open wire type affords less attenuation and is recommended for use in fringe areas. One important consideration in the use of this line is that of proper impedance matching. Several of the open wire manufacturers are now offering 300 ohm open wire line, which presents no more matching problem than the other types.

We sincerely hope that this report will be successful in making your work easier by pointing out some of the experiences of dealers now engaged in making UHF installations. Should you at any time have any data concerning UHF installations that might be helpful to our readers, we would be pleased to hear from you.

Our thanks go out to those dealers and distributors who were so kind to spend the time with us to answer our many questions. Their cooperation has made this report possible.

W. W. HENSLER

# The TARZIAN UTP1 (Single Channel) Translator for

# UHF



**Works on ANY  
TV Receiver**

- Self-powered.
- Two units may be attached to receiver to receive two UHF channels.
- Input alignable to any UHF station (470-890 mc)
- Output into balanced 300 ohms, channels 2-6 inclusive
- Requires NO internal wiring changes.
- Easily attached.

**COMPLETE RANGE OF FREQUENCIES AND ANTENNA SWITCHING POSSIBILITIES MAKE THE RECEPTOR**

## Completely Universal in Application

● The UTP1 is the answer to set owners anywhere within the range of one or two UHF stations.

Adaptable to any type receiver, the UTP1 brings in the UHF station through one of the unused low channels, 2 to 6. None of the 12 VHF channels is sacrificed.

The same high standards of engineering quality . . . design . . . and development which have made the TARZIAN Tuners famous—are embodied in the UTP1 Receptor.

Moderately-priced to appeal to millions of present-day set owners. See your set dealer or service man or write for detailed information.

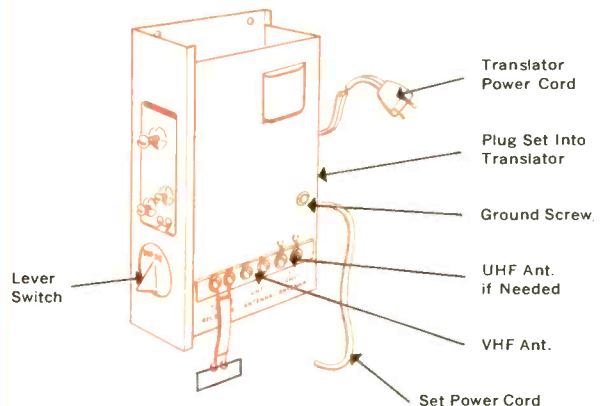

**SARKES TARZIAN, INC., TUNER DIVISION**  
BLOOMINGTON, INDIANA



## A SELENIUM RECTIFIER TESTER (Continued from page 43)

made because this unit employs AC voltages and tests the rectifier under its rated current load.

The tester consists of two parts - the testing unit itself and an associated unit called the Sele-Rater.

The Sele-Rater (see Figure 3) provides a means of determining the ratings of a selenium rectifier even though the manufacturer's ratings have not been placed on the unit or the markings have been obliterated. The Sele-Rater provides a means of determining the appropriate test settings for the testing unit.

It is a very simple procedure to use the Sele-Rater. Figure 4 (A and B) show the Sele-Rater being used. In Figure 4A, the correct space gauge is being determined. The correct procedure for doing this, as given by the manufacturer, is as follows:

Place the rectifier on the Sele-Rater in a manner that will permit you to see the space gauges between any two plates. When the gauge that corresponds to the air space between any two plates of a regularly spaced rectifier has been located you will note the two lines leading from the space gauge to the edge of the Sele-Rater. Note that one of these lines is marked 6-plate the other 8-plate. These lines are the zero lines for rectifiers with that spacing. In the case of rectifiers with little or no spacing, use the solid white space marking as the guide.

To determine the zero line that is to be used, count the number of cells or plates between the ter-

minals of the rectifier. The 6-plate zero line is to be used when the rectifier contains six plates and the 8-plate zero line when the unit has 8 plates. All single plate rectifiers will use the line marked "single plate zero line". It is well to note that when testing bridge or doubler rectifier stacks, each section is to be tested separately. When determining the zero line, count only the number of plates in each section.

After the zero line has been determined, the width of one plate is measured to determine the approximate current carrying capacity of the rectifier. (See Figure 4B). To measure the width of the plate, place the rectifier on the Sele-Rater with one edge of the plate at the correct zero line as determined above. Reading the number at the opposite edge of the plate will give the MA load setting to be used on the testing unit.

It is important to note at this point that the current rating as determined by the Sele-Rater may differ slightly from the actual manufacturer's rating, but will be sufficiently accurate for a quality test on the tester unit. This is because the current rating of selenium rectifiers depends on the actual surface area of the plates. The surface area of a 200 milliamperere rectifier made by one manufacturer may differ from one made by another manufacturer. This could be due to the center contact of one rectifier covering less space than that of a different make rectifier. Or one manufacturer may rate his rectifier more conservatively than another manufacturer. When this is the case, the reading given by the Sele-Rater will be different. It is recommended, however, that when a rectifier reads above 150 milliamperes on the Sele-

Rater but below the 200 milliamperere mark, the MA load pointer on the tester should be set at the 200 point. The rectifier should be considered as having a current rating of 200 milliamperes. This would also be true of readings between 250 and 300, 350 and 400, 450 and 500. This discrepancy of different readings becomes more noticeable at lower ratings of rectifiers. Such is the case of the 65 and 75 milliamperere rectifiers. These rectifiers are designed by most manufacturers with nearly the same specifications, however, they are rated with a difference of 10 milliamperes. Again, it is believed that it wouldn't make any difference if the rectifier tester is set at either 65 or 75 milliamperes when making a test since they are rated so closely together.

The Jackson Model 710 Tester operates on 110-125 volt, 60 cycle, AC. The unit is considered small and compact. The measurements of the unit are 7" x 4-1/2" x 3". The unit has four pre-set controls and a test switch. The pre-set controls are the on-off and line adjustment switch, the MA load, the range switch, and the voltage switch.

The on-off and line adjustment switch turns the power on and off and is a variable means of obtaining the correct transformer primary tap for the available line voltage. This variable switch is adjusted until the meter pointer falls at the center of the "line" marker on the dial of the meter.

The MA load control is a variable resistance that is set on the value that corresponds to the rating found on the rectifier, or to the rating that was obtained from the use of the Sele-Rater. The scale of this



Figure 2. The Jackson Model 710 Selenium Rectifier Tester.

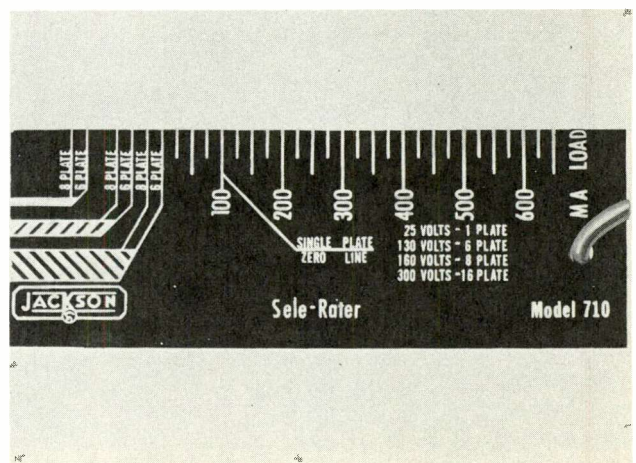

Figure 3. The Sele-Rater Used to Determine the Unknown Ratings of a Selenium Rectifier.

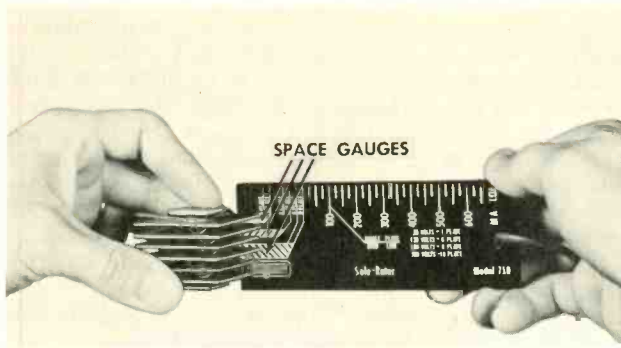

Figure 4A. Selecting the Space Gauge Between two Plates.

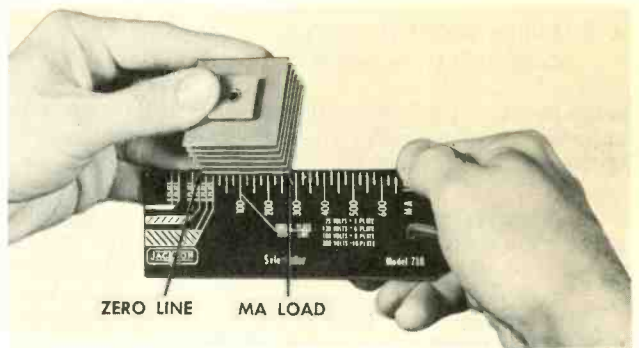

Figure 4B. Determining the Current Rating.

control ranges from 20 to 150 milliamperes. The MA load control is used in conjunction with the range switch.

The range switch has two positions, one marked X1 and the other X10. When the range switch is in the position X1 the tester will handle rectifiers rated from 20 to 150 milliamperes. When in the X10 position, the scale of the MA load is multiplied by 10. This changes the range of the MA load from 200 to 1500 milliamperes. However, it is recommended by the manufacturer that 650 milliamperes be the maximum rating of a rectifier tested on this instrument. The accuracy of the tester takes a decided drop above the setting of 650 milliamperes.

The voltage switch is a variable control that is used to set the tester at the proper voltage rating of the rectifier to be tested. It obtains four different settings; namely, 25, 130, 160, and 300 volts. The voltage switch is to be set at the position nearest the rated value of the rectifier. If the rated voltage is not known, a listing for different ratings according to the number of plates is given on the Sele-Rater.

The unit contains two test leads with alligator clips for attaching to the terminals of the rectifiers. One lead is red and the other black. The red lead is placed on the positive or cathode terminal of the rectifier and the black lead on the negative terminal during a test. Correct polarity must be observed to avoid damage to the instrument. Figure 5 shows a test setup of a selenium rectifier out of the circuit.

If a rectifier is to be tested while it is still in the chassis, the positive (cathode) side of the rectifier must be disconnected from the circuit. Since the rectifier is disconnected when making a current drain test on the set the rectifier can very easily be tested at the same time. However, make sure the line voltage to the receiver is off during the time of performing the test. Figure 6 represents a test setup when the rectifier is in the chassis. Note the disconnected positive lead of the rectifier.

For protection of the instrument, it is important to remember not to allow the alligator clips to touch each other while the instrument is turned on. When a metal bench

top is being used, remember that both test leads should not be placed on the metal top at the same time. A direct short would permanently damage the meter.

A momentary contact toggle switch is provided for the test switch. After the tester is set up according to the rating of the rectifier, this switch is pressed which places the meter in the testing circuit. From direct reading of this meter the condition of the rectifier under test can be determined.

The dial of the meter has a scale graduated in units of five from 0 to 50. There are three major divisions; 0 to 10 - bad, 10 to 50 - good, and 30 to 50 - peak. (See Figure 7).

If the reading of the meter is 10 or above, the rectifier is considered to be satisfactory. If the reading is below 10, the rectifier is considered bad. The area of the scale above 30 indicates rectifiers which have not gone through the aging process. This does not mean that a rectifier that produces a reading in this area is much better than one that produces a reading in the



Figure 5. Test Setup of a Selenium Rectifier out of the Circuit.

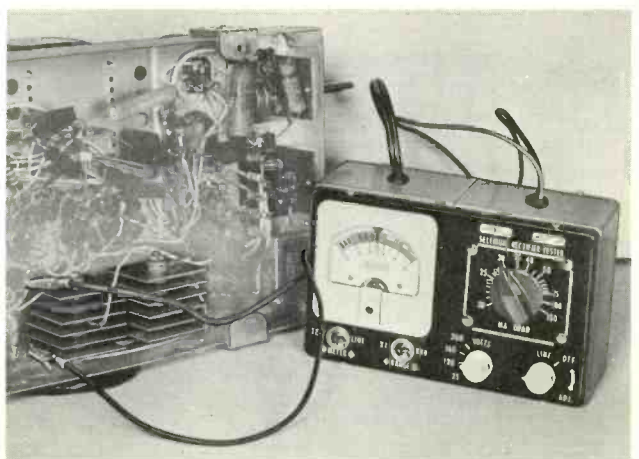

Figure 6. Test Setup of a Selenium Rectifier When the Rectifier is in the Chassis.



area between 10 and 30. Because of the difference in rating systems used by different manufacturers, the maximum reading of various rectifiers are different.

The indication of a shorted rectifier is vigorous vibration of the meter pointer at any place on the scale. The pointer may be in the area designated as good but if the pointer is vibrating, the rectifier is shorted. When this is the case, the test switch should be released instantly.

When a rectifier is open, the meter pointer will drop down to zero when the test switch is depressed and will remain there until the test switch is released.

Usually before an electrical test of a selenium rectifier a visual examination of the unit is made. A number of factors concerning the condition of the rectifier can be determined from this visual check.

A condition of "sparking" is sometimes encountered. This condition is accompanied by a crackling, popping sound. The sparking consists of blue-white sparks on the surface of the selenium alloy, which are caused by a much higher than rated inverse voltage appearing across the rectifier. If this surge of excessive voltage lasts for a

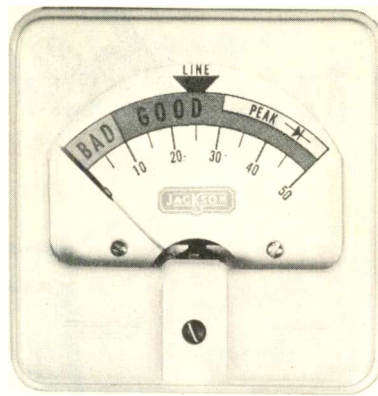

Figure 7. Meter of Selenium Rectifier Tester Showing the Reference Scale.

short period of time, the rectifier will not be permanently damaged. Round, black spots will appear on the alloy as a result of the sparking. These spots are self healing and will not short out the rectifier unit. If the sparking has been severe for a long period of time, the effective rectification area will be reduced. With further use during sparking the rectification area will be reduced to a point where the rectifier will become inoperative.

When the rectifier has been subjected to several times its normal forward current, the temperature rises above the melting point

of the alloy. This causes the alloy to soften and run, which is accompanied by decoloration of the surface of the plate. When this condition is found, the rectifier unit is considered useless for further operation.

Whenever a unit is found that has been decolorized and is spotted as the result of sparking, it is considered to have been completely destroyed.

It is well to keep in mind that the rectifier itself is not always the unit that is causing the trouble, but is usually another part in the circuit. Even if the Selenium Rectifier Tester does indicate a bad rectifier, the circuit should always be checked for possible troubles that could render the rectifier bad.

This Selenium Rectifier Tester should fill a longtime need of the service technician for a means of easily and quickly checking selenium rectifiers. It makes possible a positive check on the condition of the rectifier thus eliminating that helpless feeling of not knowing whether the selenium rectifier is at fault or whether some other component failure is causing excessive current drain.

C. P. OLIPHANT

#### A MULTIPLE ANTENNA SWITCHING DEVICE (Continued from page 41)

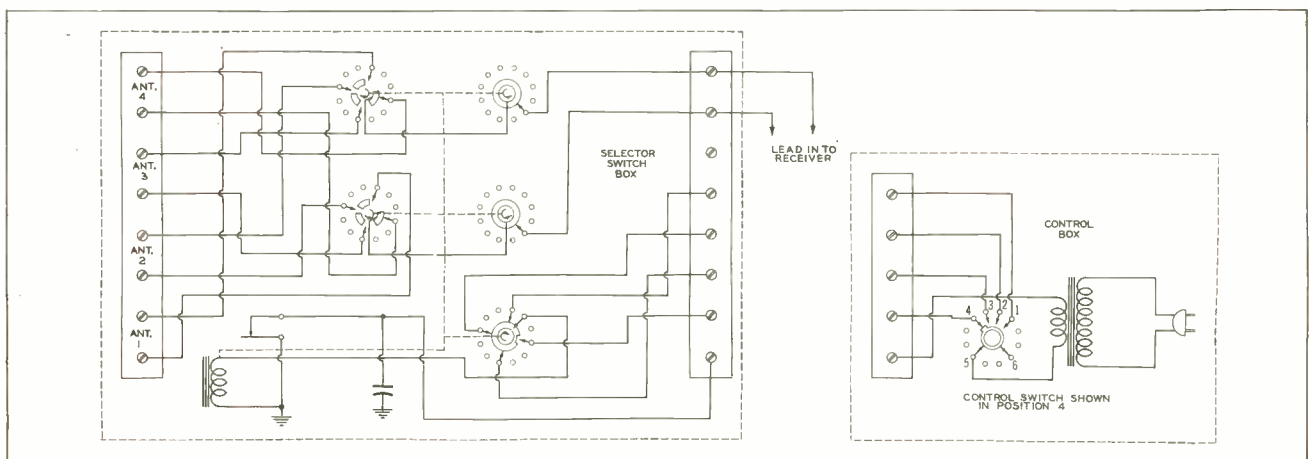

Figure 2. Schematic Diagram of "Tenna Switch," Model TS-1A.

switch in an out-of-the-way place. With the "Tenna Switch" the control box can be positioned at a convenient point so that the antenna switching can be accomplished without leaving the potential customer.

As another example of its use, it may be necessary to make an installation where it is desired to pick up three stations, each of them in different directions. It may be that two or three of them are quite dis-

tant, meaning that a high gain antenna must be used. In such a case, three high gain antennas (such as Yagis cut for the respective channels) could be installed. The "Tenna Switch" will then make possible the selection of the proper antenna which has been correctly orientated toward the station. Such an installation has two definite advantages. (1) It permits the use of high gain antennas for each of the three channels. (2)

It allows the viewer to, make almost instantaneous selection of the proper antenna.

Since the switch mechanism is mounted on the mast, subjecting it to all weather conditions, it is enclosed in a weatherproof box. Ceramic switch wafers and silver-plated contacts are employed to insure long life operation.

MERLE E. CHANEY

You wanted it... *here it is*

**THE RCA**  
**"SERVI-CHEST"**

the truly portable "workshop"  
 you'll be proud to take into the home

**YOURS FOR JUST 30**  **RCA SILVER TOKENS!**

Look at these features!

- 1** GIANT SERVICE MIRROR—Top-quality glass. 11" x 16" working surface. Removable hinges for flexibility of use. Wedges provided for adjustment of mirror angle.
- 2** SOLDERING GUN COMPARTMENT—Will accommodate all popular makes of soldering guns or irons.
- 3** UTILITY DRAWER—Roomy enough for tools, flashlight, large capacitors, high-voltage probes, etc.
- 4** RESISTOR DRAWER—Will hold large assortment of popular resistor sizes.
- 5** CAPACITOR DRAWER—Plenty of space for working supply of radio and TV types.
- 6** SPARE PARTS DRAWER—Suitable for small components and tools.
- 7** VOLTMETER COMPARTMENT—Designed to accommodate the popular RCA "Volt-Ohmyst"®. Instrument can be operated without removal from compartment.
- 8** UTILITY COMPARTMENT—Suitable for socket wrench kit, drop cloth, carrying strap, etc.



DELUXE CONSTRUCTION  
 Measures 13 1/4" high,  
 9" deep, 18 1/4" wide.

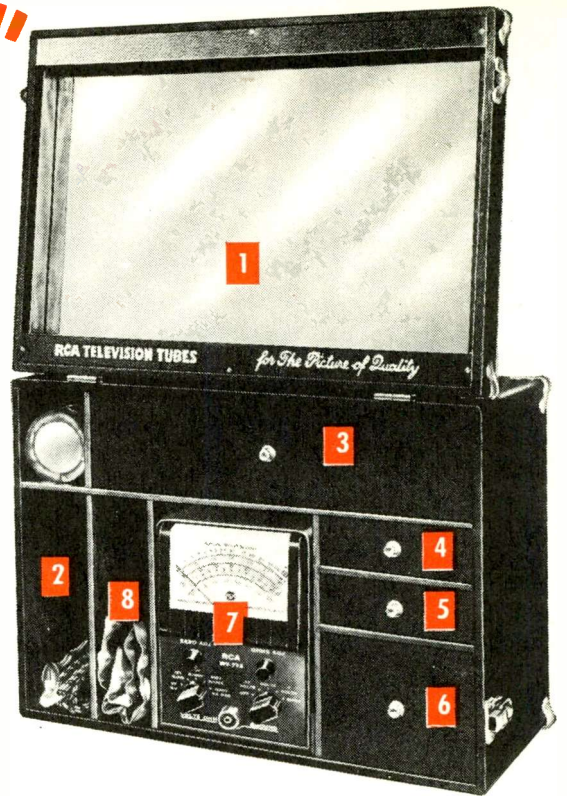

**PLUS THIS BIG BONUS**

With every RCA "SERVI-CHEST" you earn, you get these seven RCA Technical Publications.

1. "Service Parts Directory for RCA Victor Radios."
2. "This Business of Radio and TV Servicing."
3. "RCA Receiving Tubes" booklet.
4. "RCA TV Replacement Guide."
5. "TV Servicing Supplement."
6. "RCA Kinescopes" booklet.
7. "TV Servicing."



**How to get your RCA "SERVI-CHEST"**

IT TOOK SIX MONTHS TESTING in the field to develop just the right kind of carry-all case for you . . . the RCA "SERVI-CHEST." It's the "little black bag" that identifies you as a "professional" Radio and Television Service Technician. The "SERVI-CHEST" is just what you asked for . . . and you can get yours *without cost.*

During the next three months, you will receive one RCA Silver Token from your *RCA Tube Distributor* for each RCA Kinescope or for each 25 RCA Receiving Tubes you purchase. When you have collected 30 Silver Tokens, present them to your *RCA Tube Distributor* and receive, *without cost*, the complete RCA "SERVI-CHEST." Start earning yours today.

Now you can earn an RCA Drop Cloth and Carrying Strap

For only 3 Silver Tokens each, you can earn these two valuable servicing aids. See your RCA Tube Distributor.



Now available from your RCA Tube Distributor . . . The famous RCA "TREASURE CHEST" a perfect companion piece to the RCA "SERVI-CHEST"

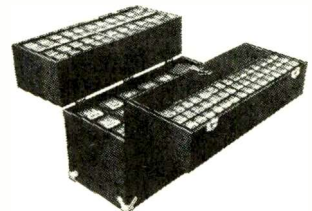

See your RCA Tube Distributor today for full details



**RADIO CORPORATION of AMERICA**  
 ELECTRON TUBES  
 HARRISON, N. J.



# Additional Data on Preamplifier and Control Unit

Due to many requests for the layout of components for the preamplifier and control unit, described in Audio Facts in PF Index and Technical Digest No. 33, we have prepared an underside view of the chassis with call outs. This, with the photos in the original article, should answer most of the questions concerning the placement of parts.

The preamplifier section is located in one corner of the chassis away from the rest of the circuit to reduce the possibility of feed back.

All leads from the input jacks and to the crossover-rolloff and channel selector switches are shield-

ed, with the shields grounded only at one end.

Resistors R8, R9, R10 and R11 with capacitors C4, C5, C6, C8, C9 and C10 are mounted above the chassis directly on the crossover and rolloff switch.

Heater leads are twisted and dressed close to the chassis.

The ground bus, grounded only at the input jack, is important.

When using a magnetic phono cartridge, the resistor or resistor and capacitor combination, recommended by the manufacturer of the

cartridge, should be installed in the input circuit for correct loading and balanced response. For example - a 22K ohm resistor, connected in parallel with R6, has given very good results with a GE variable reluctance cartridge.

Note the correction previously made in PF Index and Technical Digest No. 35. There is no connection from the bottom of R2B and the top of R2C of the IRC LC1 Loudness Control.

Also, on the schematic, C8 should be .005 mfd and C9, .004 mfd. The correct values appear in the parts list.

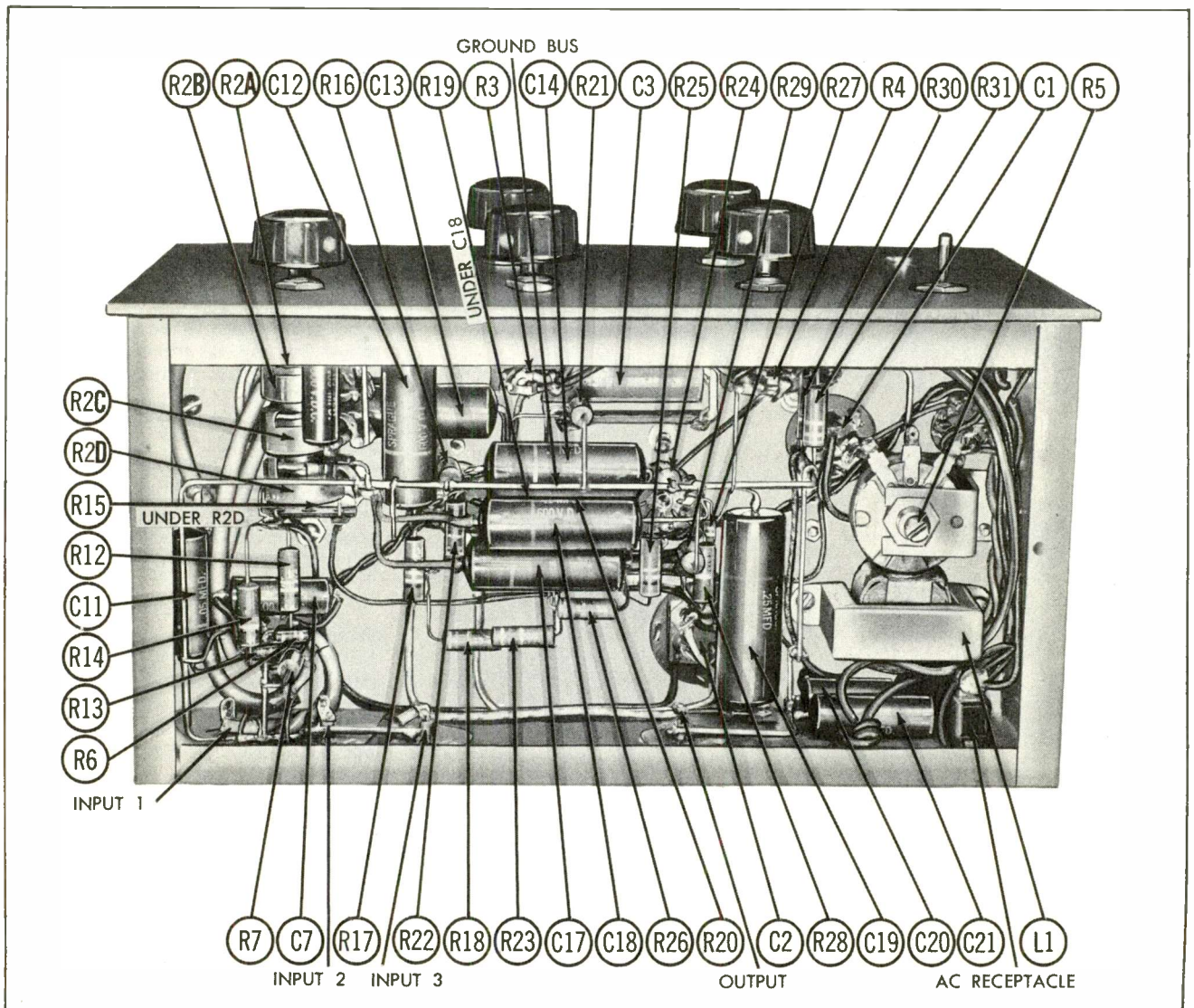

# Mr. Electronic Service Technician

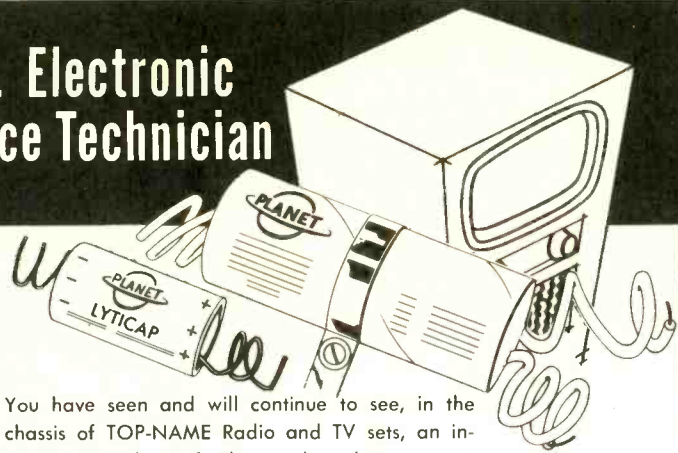

You have seen and will continue to see, in the chassis of TOP-NAME Radio and TV sets, an increasing number of Planet electrolytic capacitors — conspicuous because of their shiny red cardboard jackets. They are in those quality sets because components engineers have proven for themselves that PLANET condensers are "ENGINEERED FOR QUALITY".

You can take advantage of their findings by purchasing from your distributor Planet universal replacement types of the same high standard of quality. Ask for PLANET by name.

**"ENGINEERED FOR QUALITY"**

Write now for latest FREE catalog 6-A

**PLANET MANUFACTURING CORPORATION**

225 BELLEVILLE AVENUE  
BLOOMFIELD, N. J.

1 year service guarantee



## AUTRONIC EYE

(Continued from page 111)

the sensitive relay M2. This current energizes the relay and closes the contacts. This removes the energy from relay M3 which allows it to open, completing the circuit to the upper beam position. The circuit remains in this state until the auxiliary foot switch is released.

Capacitor C6 and Resistor R8 are incorporated to protect the contacts of relay M2 when the relay is opened and closed. Capacitor C1 is used to filter out power supply ripple.

The power supply is a non-synchronous vibrator type operating from a 4-volt supply. The 6 volts present at the battery are reduced to 4 volts by the ballast M7. At the center tap of the primary of T1 there are 4 volts. This voltage is adjusted to exactly 4 volts by the variable resistance R7. There are two secondary windings of T1. One furnishes a high-amplitude voltage which, after being rectified by V3, provides a negative 1000 volts DC to the cathode circuit of the phototube and the other winding furnishes 120 volts AC to the plate of the control tube V2. The .1 microfarad capacitor (C5) is a buffer capacitor.

There are three controls that are manually set when the Autronic Eye is installed in the car. These are the sensitivity control, R9, located in the phototube unit; the hold control, R3, located in the amplifier unit; and the high voltage control, R4, also located in the amplifier unit. These controls are accessible from outside the cover of their respective units.

The sensitivity control changes the amount of current in the voltage divider of the phototube unit. This, in turn, varies the response of the phototube. The hold control varies the load of the phototube and assures V2 being held at cutoff until there is no light on the cathode of the phototube. The high voltage control is adjusted for correct operating voltage for the cathode of the phototube.

Current in the phototube unit flows from the high voltage supply to ground by two paths. One path is through potentiometer R9 and re-

## ONLY TELCO UHF ANTENNAS HAVE THE "WISHBONE"

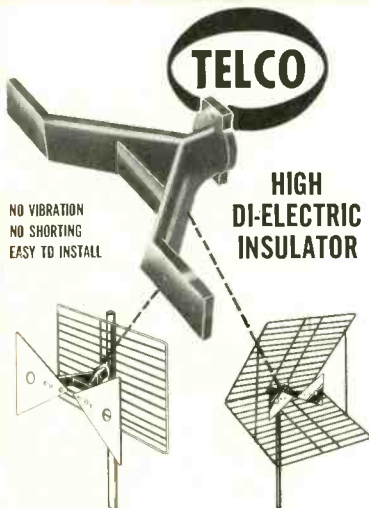

NO VIBRATION  
NO SHORTING  
EASY TO INSTALL

No. 8965 Butterfly Wishbone Antenna List \$7.50

No. 8984 Wishbone Corner Reflector List \$14.50

SEE these new antennas at your distributor.



TELEVISION HARDWARE MFG. CO.  
Division of General Cement Mfg. Co.

903 Taylor Avenue • Rockford, Illinois

## AUDIO MEN

Be sure to read this new 3-way approach to high-fidelity!



128 Pages

Over 100 Illustrations

**\$1.50**

### JUST OFF THE PRESS

This unique new Gernsback Library Book discusses high-fidelity problems from three viewpoints. DESIGN includes audio waveform analysis, intermodulation distortion tests, crossover design, constant voltage lines, etc. CONSTRUCTION covers various types of amplifiers (including the Williamson). MEASUREMENTS goes into detail on modern audio measurement techniques.

Buy a copy at your parts distributor today.

This book is an excellent companion volume to HIGH-FIDELITY TECHNIQUES, by James R. Langham. Gernsback Library Book 42, \$1.00

Gernsback Publications, Inc.

Publishers of

**RADIO-ELECTRONICS**



sistor R10. The other path is through potentiometer R9 and through the voltage dividing network. The voltage for each dynode of the phototube is divided evenly by the 200,000 ohm resistors. A small series resistor protects each dynode.

The rectifier and ballast tubes were especially developed for use in

this particular power supply. The type of phototube being used was not released by the manufacturer, probably because it was felt that replacement with factory-run tubes might tend to affect the operation of the circuit.

At the present, most servicing of the Autronic Eye is being done by

the installing company. It is felt, however, that as this unit becomes more and more accepted, the radio-television technician will be called upon for service. As a result, an added source of income for the technician is available.

C. P. OLIPHANT

## EXAMINING DESIGN FEATURES

(Continued from page 27)

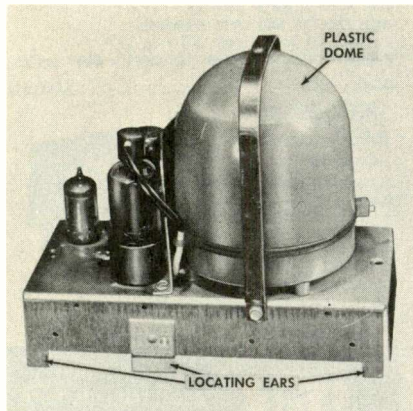

Figure 11. Horiz. Output Transformer and High Voltage Assembly Unit in Setchell-Carlson. Observe Hermetically Sealed Plastic Dome.

ceiver (See Figures 13 and 14). The most distinctive element noted in the construction of the receiver is the use of a plastic chassis instead of the usual metal type. Aside from certain advantages which may be exhibited in this method of chassis construction, the electrical circuitry is the same as that of previously produced models.

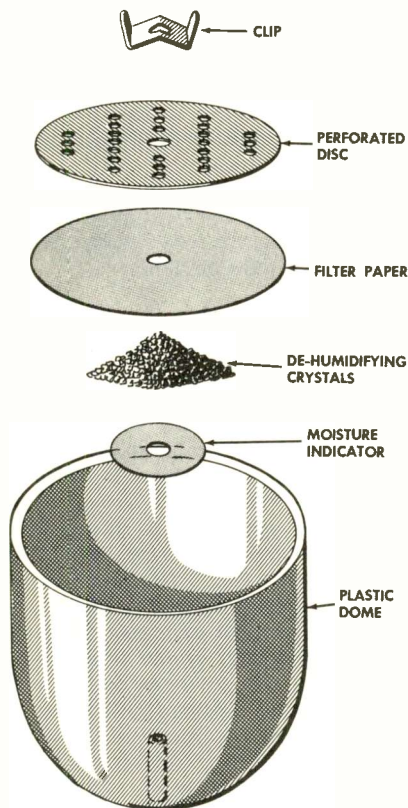

Figure 12. Dehumidifying Elements Employed in Plastic Dome of Figure 11.

It is interesting to observe the variations which are possible in the construction technique, such as extensive molding of compartments, shelves, and tie points designed to facilitate the assembly procedure. Although metal chassis material could employ similar design in fabrication, the workability and economics of the use of plastic lend to its practicability.

A point in favor of a molded plastic chassis is that extensive insulating procedures are not required since the molded channels, etc., provide their own insulation.

Since this unit is an AC/DC transformerless receiver, a floating ground is used. A bare wire, threaded about the chassis, provides this ground continuity. Posts molded onto the chassis are used to anchor connecting leads against movement from vibration and to insure that the leads will not cause shorts.

MERLE E. CHANEY

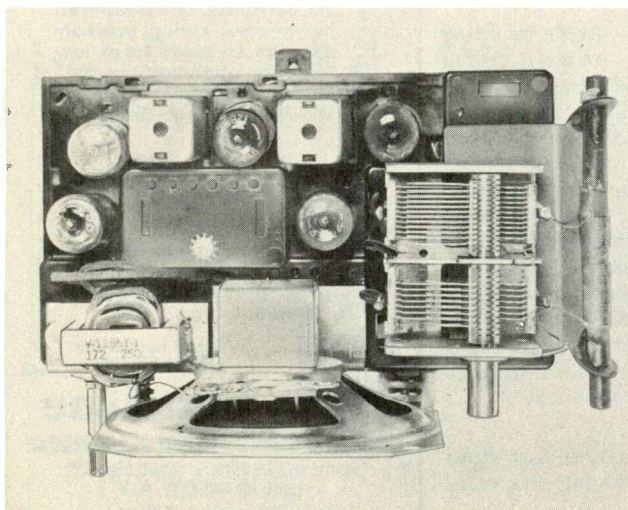

Figure 13. Westinghouse H-381T5 Radio Using Plastic Chassis (Top View).

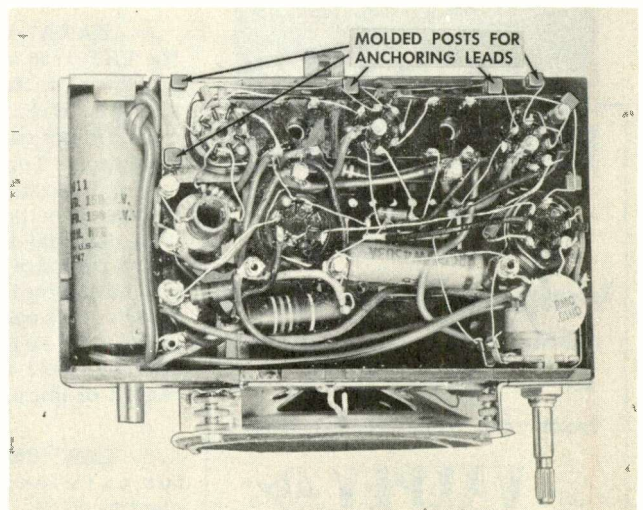

Figure 14. Bottom View of Westinghouse Plastic Chassis Showing Parts Layout.



# AUDEL'S TV SERVICE MANUAL TELLS HOW TO SOLVE TV TROUBLES AND ANSWERS TV QUESTIONS

AUDEL'S TELEVISION SERVICE MANUAL covers T.V. information at your finger ends. Shows good receiver adjustment and How to Get Sharp, Clear Pictures, How to Install Aerials—Avoid Blurs, Smears, Interference and How to Test. Explains Color Systems and Methods of Conversion. IT PAYS TO KNOW! Over 380 PAGES & 225 ILLUSTRATIONS explaining operating principles of Modern Television Receivers.

Just Out!



**\$2 POST PAID**

Shooting—Color Television—Television Terms. **7 DAYS FREE TRIAL** GET THIS PRACTICAL ASSISTANCE FOR YOURSELF

AUDEL, Publishers, 49 W. 23rd St., N. Y. Mail me postpaid for 7 Days examination AUDEL'S TELEVISION SERVICE MANUAL (Price \$2). If D.K. I will mail you \$2, otherwise I will return book.

**1001 FACTS**  
**19 CHAPTERS**  
Placement of Television Receivers—Receiver Controls; Test Patterns & Adjustments—Television Interference—Interference Traps—Television Antennas & Transmission Lines—Master Antenna Systems—Antenna Installation Procedure—Television Broadcasting—Television Receiver Fundamentals—Circuit Description of Typical Receiver—Television Picture Tubes—Projection Type Receivers—Television Testing Instruments—Television Servicing—Trouble Shooting—Television Terms.

## DOLLARS & SENSE

(Continued from page 47)

**BELL TROUBLE.** Early one morning the big bell in the spire of St. Joseph's Roman Catholic Church in Troy, N.Y. started tolling, and kept it up for an hour. Continued tolling at an odd hour is generally the solemn signal of a priest's death, but Father Nolan assured telephoning parishioners that he was alive and well. An electrician was called. Climbing the bell tower to the relay control box, he found a bird's nest built right on top of the relay. The weight of the nest had moved the contacts enough to close the circuit and start the bell ringing.

A permanent cure of the trouble was achieved by removing the nest and blocking the birdhole entrance with wire screen.

**THE WINNER.** To aid track judges in calling the close ones at horse races, a special television system employing a long-persistence picture tube has been developed by New York City engineer Nelson J. Waterbury. A light beam is directed across the track just ahead of the finish line. When this is interrupted by the lead horse, the television camera at the finish line is unbiased just long enough to get a picture of the winning horse crossing the line. The image of this scene is retained for ten or more seconds on the picture tube being watched by the judges, enabling them to announce the winner without waiting for photos to be developed. The special long-persistence phosphor is the type used in radar cathode-ray tubes. First use of the system is expected to be made at the Laurel, Md. race track, according to Radio Daily.

**HAWAIIAN TV.** After boosting its VHF transmitter power from 25,000 watts to 47,000 watts, KNBH atop Mt. Wilson, California has received many reports of long-distance reception. Topping them all is one from Honolulu reporting consistent reception of both picture and sound with a standard receiving installation over a period of two weeks. Engineers now have logical explanations for such seasonal DX on over-water paths, but for the televiewer it's still a thrill to see so far without benefit of microwave or coax.

**LAW.** The penalty in any state for careless servicing may be electrocution.

(Continued on next page)



### EMC MODEL 206

Mutual Conductance Tube Tester

- Uses lever type switches
- Checks mutual conductance on calibrated microhm scale
- Detects both shorted and open elements
- Tests all tubes from .75 v to 117 filament volts
- Built-in roll chart • 4 1/2" meter.

Model 206P

### MODEL 204

Tube-Battery-Ohm Capacity Tester

- Tests all tubes including Noval and sub-miniature
- Tests resistance to 4 megohms
- Tests condensers from .01 to 1 mfd.
- Tests all batteries under rated load.

Model 204 (oak case) . . . \$55.90

Write Dept't. PF-7 for latest FREE catalog.



## For Easier Servicing

**Easier, Faster,  
Exact Alignment with  
Valpey Type CM5**  
4.5Mc., 5.0Mc. and 10.7Mc.  
All ± .01% at \$3.95 each  
from your nearest distributor

**VALPEY**  
*Crystal* CORPORATION

HIGHLAND ST., HOLLISTON, MASS.

## MOBILE COMMUNICATION ANTENNAS

**"WHIP"**  
Ruggedly built for police, fire, ambulance, amateur use. **MULTI-ANGLE BASE** and **SPRING**. Mast can be locked in vertical position despite car contours. Oil-tempered heavy steel spring prevents damage to mast from low hanging obstructions. 96" long. Resists 90 degree bends. Weather resistant finish.

**ROOF TOP**  
2-meter, covering the VHF spectrum (144 to 174 mc). Installed from outside. Suitable for taxis, police, fire, amateur, etc. Rubber gasket with lock nut affords waterproof protection. Includes 11 ft. antenna cable.

Send for Catalog No. A-53-2

**insuline**  
**CORPORATION OF AMERICA**  
INSULINE BUILDING • 36-02 35th AVE.  
LONG ISLAND CITY, N. Y.  
West Coast Branch and Warehouse:  
1335 South Flower Street, Los Angeles, Calif.  
Exclusive Canadian Sales Agents:  
CANADIAN MARCONI COMPANY, Toronto



# A STOCK GUIDE FOR TV TUBES

The figures in the chart below have been revised to include production of TV receivers since the compilation of the chart which appeared in the last issue of the PF INDEX and Technical Digest. The chart represents the number of tubes of any given type that are now in service in TV receivers as compared to the total number of tubes in service. The figures are based on a total of 1,000 units.

Note that two columns are included in the chart. The left column headed "46-53 Models" takes into

account all post-war TV receivers. The right hand headed "52-53 Models" is based on these recent TV models only. Tubes having a rating of less than one (except the indicated new types) are left out of the chart. Moreover, all ratings have been adjusted to the nearest whole number.

For additional information on the method of compilation and the recommended use of this chart for maintaining adequate tube stocks, refer to the PF INDEX and Technical Digest for May-June, 1953.

46-53 Models		52 & 53 Models		46-53 Models		52 & 53 Models		46-53 Models		52 & 53 Models	
1B3GT	39	43	6AU5GT	4	5	6BZ7	2	3	6X5GT	2	1
1V2	1	-	6AU6	139	127	6C4	11	10	6X8	2	4
1X2	6	2	6AV5GT	2	4	6CB6	87	138	6Y6G	4	1
1X2A	4	6	6AV6	14	16	6CD6G	7	8	7C5	1	-
5U4G	45	46	6AX5GT	2	3	6CL6*	-	-	7N7	3	1
5V4G	8	-	6AX4	2	-	6J5	3	3	12AT7	15	15
5Y3GT	3	1	6BA6	16	11	6J5GT	2	1	12AU6	1	-
6AB4	3	3	6BC5	11	8	6J6	35	31	12AU7	45	26
6AC7	9	9	6BE6	4	6	6K6GT	18	10	12AV7	4	5
6AF4#	-	-	6BF5	-	1	6S4	8	10	12AX4	2	4
6AG5	40	11	6BF6*	-	-	6SH7	1	-	12AX7	4	5
6AG7	3	4	6BG6G	15	6	6SL7GT	4	3	12AZ7	-	1
6AH4GT	1	2	6BH6	9	-	6SN7GT	80	90	12BH7	7	12
6AH6	7	10	6BJ6	2	-	6SQ7	3	3	12BX7*	-	-
6AK5	5	5	6BK5	-	1	6T8	15	15	12BY7	-	2
6AL5	80	80	6BK7	3	6	6U8	3	7	12SN7GT	7	5
6AQ5	13	13	6BL7GT	5	9	6V3	2	3	25BQ6GT	3	5
6AQ7GT	-	2	6BN6	2	2	6V6GT	23	21	25L6GT	6	6
6AS5	2	2	6BQ6GT	16	25	6W4GT	33	35	25W4GT	2	2
6AT6	4	3	6BQ7	6	15	6W6GT	7	12	25Z6	1	-
									5642	2	3

# A stock of these tubes should be maintained in UHF areas.

\* New tubes recently introduced.

## DOLLARS & SENSE (Continued from page 122)

**MAGNETICS.** Average weight of the Alnico slugs that will go into an estimated 22,500,000 loudspeakers in 1953 is 1-1/2 ounces, according to RTMA. Contrast this with the 10-1/2 pound Alnico magnet that Stromberg-Carlson is putting into its newest speaker for the high-fi trade.

Motorola has turned its loudspeaker design inside out, so that the magnet and associated parts are within the cone; this makes it possible to use a 7-inch speaker in their newest portable radios, whereas the older design had a 4-inch speaker.

If production predictions hold true, about 7 million speakers will go into TV sets, 8 million into radios, and the rest will be split up among hi-fi, industrial, military and replacement markets.

**ERAS.** Do you remember when 7-inch screens were all the vogue, way back in '48 and '49? 10-inchers had their heyday a bit longer, going back into '47 and up into '50. The 12-inchers lasted from mid-1949 to mid-1951. The 14-inchers had the shortest life span of all, from 1951 to fall 1952 for its peak sales. Still going today, however, are the 16-17 inchers that started in early 1950 and the 20-21 inchers that took off near the end of 1950.

These figures along with price trends for cheapest table-model sets in each size, make interesting graphs in a recent issue of Electronics. A downward swoop in the price curve foretells the demise of each small set in turn. Conversely, a leveling-off price curves for the 17 and 21-inch sets would seem to indicate that they are to be with us for a few more years.

JOHN MARKUS

Save time...effort...  
and equipment with  
**Equipto**  
Electronic Chassis  
and  
Equipment Stand



Here's an ideal unit for transporting television sets, chassis, or other heavy equipment or for use as a portable stand to hold heavy testing equipment and television sets. It has a rugged all-steel construction and is the right height for full working convenience. It rolls noiselessly on big 2 1/2" rubber wheels. Finished in olive green, polymerized, shock-resistant enamel. Available without wheels, if desired.

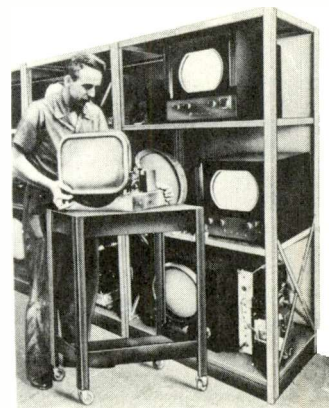

**Equipto**

Division of Aurora Equipment Company  
830 Prairie Avenue, Aurora, Illinois  
Steel Shelving...Parts Bins...Drawer Units

# WALSCO

HAS THE ONLY UHF  
ANTENNAS WITH  
AMAZING  
**X-77**  
INSULATOR

Hollow, unbreakable X-77  
Insulator used exclusively on  
Walsco Corner Reflector and  
Reflecto-Fan.

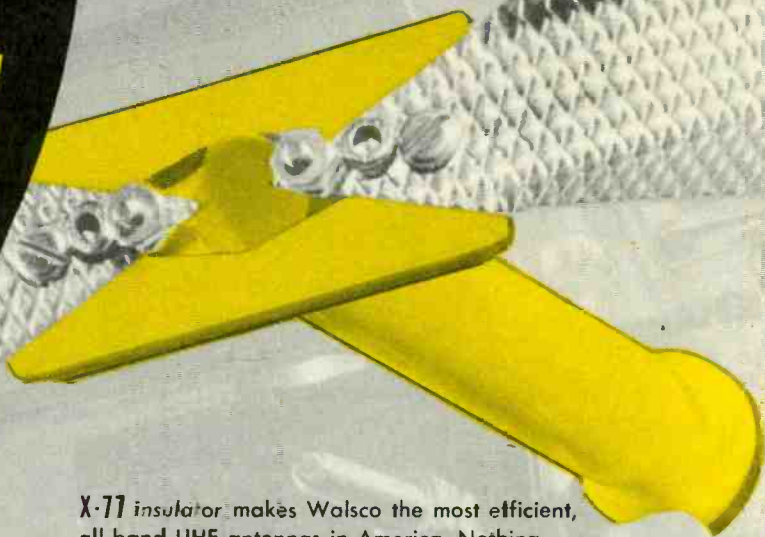

X-77 insulator makes Walsco the most efficient, all-band UHF antennas in America. Nothing compares with it!

X-77 is hollow, allowing lead-in wire to pass through the center. Wire is kept completely out of field pattern. It eliminates broken wires caused by strain of wire on antenna terminals.

X-77 can't break . . . ever! It's 5 times stronger than polystyrene. Silicone treated to shed dust and moisture . . . not affected by extreme heat, cold or wind.

X-77 is non-hygroscopic. Outstanding insulating qualities will last indefinitely.

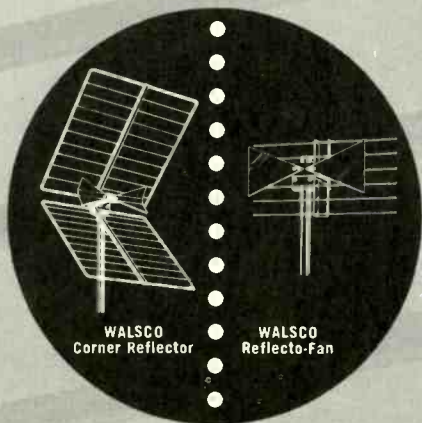

Largest in demand everywhere

Catalog No.	Description	Avg. Gain (db)	List Price
Reflecto-Fan 4400	Single Bay	7.0	\$ 6.75
*4402	Dual Stack	11.0	14.25
*4404	4 Bay Stack	14.5	35.00
Corner Reflector 4450	Single Bay	11.2	14.50
*4452	Dual Stack	16.4	32.00

**WALSCO**

Walter L. Schott Co.  
Los Angeles 18, Calif.  
Chicago 6, Ill.

\* Supplied with complete stacking kit.  
Most not included in prices.

Overseas Representative: Ad Auriema, Inc., 89 Broad St., New York 4, N.Y.



# TV SUPPLEMENTARY SHEET NO. 4

MODEL & CHASSIS	PART #	CATALOG #	FUNCTION	DESCRIPTION	LIST PRICE	MODEL & CHASSIS	PART #	CATALOG #	FUNCTION	DESCRIPTION	LIST PRICE	
KAYE-HALBER 012	M-106-A	AG-83-5 KSS-3	Height	2 Meg. $\Omega$ carbon	\$1.25		VC-12121C	AG-84-5 FKS-1/4	Height	2.5 Meg. $\Omega$ carbon	\$1.25	
	M-106-A	AG-83-5 KSS-3	Vert. Hold	2 Meg. $\Omega$ carbon	\$1.25		VC-12127B	RTV-297	Contrast/ Vol./Sw.	750 Tap 500/250K $\Omega$ Conc. Dual carbon SPST,	\$4.30	
	CHASSIS 243	M-110	AG-19-5 KSS-3	Vert. Lin.	5000 $\Omega$ carbon	\$1.25		VC-12131C	AG-44-5 KSS-3	Hor. Hold	50K $\Omega$ carbon	\$1.25
		M-116	RTV-293	Contrast/ Vol./Sw.	2000/500K $\Omega$ Conc. Dual carbon--SPST	\$3.70		VC-12132C	AG-83-5 KSS-3	Vert. Hold	1.5 Meg. carbon	\$1.25
		M-120	AG-58-5 KSS-3	Bright.	500K $\Omega$ carbon	\$1.25						
114DX CHASSIS DX253	M-106-A	AG-83-5 KSS-3	Height	2 Meg. $\Omega$ carbon	\$1.25	MOTOROLA	14P2 14P2U	1X711613	Order From MFR.	Hor. Cent.	50 $\Omega$ 1W-W.W.	
	M-106-A	AG-83-5 KSS-3	Vert. Hold	2 Meg. $\Omega$ carbon	\$1.25		18A702441	AG-85-5 RS-2	Bright.	5 Meg. $\Omega$ carbon	\$1.25	
	M-110	AG-19-5 KSS-3	Vert. Lin.	5000 $\Omega$ carbon	\$1.25	CHASSIS TS-275	18A702443	AG-85-5 RS-2	Height	5 Meg. $\Omega$ carbon	\$1.25	
	M-112	RTV-319	Focus	2250 $\Omega$ 4W-W.W.	\$1.85		18A702444	RTV-343	Contrast/ Vol./Sw.	2500 Top 2000/ 1 Meg. Tap 300K $\Omega$ Conc. Dual carbon--SPST	\$4.90	
	M-116	RTV-293	Contrast/ Vol./Sw.	2000/500K $\Omega$ Conc. Dual carbon--SPST	\$3.70		18A702468	AG-49-5 RS-2	Hor. Hold	100K $\Omega$ carbon	\$1.25	
	M-120	AG-58-5 KSS-3	Bright.	500K $\Omega$ carbon	\$1.25		18A702475	AG-8-5 RS-2	Vert. Lin.	750 $\Omega$ carbon	\$1.25	
	M-128	A10-25K KSS-3	Hor. Drive	25K $\Omega$ 4W-W.W.	\$2.20		18A711225	AG-61-5 KSS-3	Focus	1 Meg. $\Omega$ carbon	\$1.25	
	M-130	A10-400 KSS-3	Width	350 $\Omega$ 4W-W.W.	\$1.85		18A711999	AG-61-5 RS-2	Tone	1 Meg. $\Omega$ carbon	\$1.25	
MAJECTIC 20FP88 20FP89	C-8.206-6	AG-19-5 FKS-1/4	Vert. Lin.	5000 $\Omega$ carbon	\$1.25		18K711278	Order From MFR.	Vert. Hold	850K $\Omega$ carbon		
	C-8.219-5	AG-84-5 FKS-1/4	Height	2.5 Meg. $\Omega$ carbon	\$1.25		21F1,B 21K1,B 21K2,B 21T1,B 21T2,B	1X711613	Order From MFR.	Hor. Cent.	50 $\Omega$ 1W-W.W.	
	C-8.221	A43-2500 FKS-1/4	Focus	2250 $\Omega$ 2W-W.W.	\$1.25		18A702441	AG-85-5 RS-2	Bright.	5 Meg. $\Omega$ carbon	\$1.25	
	C-8.229-7	AG-46-Z RS-2	Hor. Hold	50K $\Omega$ carbon	\$1.25		18A702443	AG-85-5 RS-2	Height	5 Meg. $\Omega$ carbon	\$1.25	
	C-8.229-8	AG-63-Z RS-2	Vert. Hold	1 Meg. $\Omega$ carbon	\$1.25		18A702468	AG-49-5 RS-2	Hor. Hold	100K $\Omega$ carbon	\$1.25	
	C-8.229-9	AG-49-5 RS-2	Bright.	100K $\Omega$ carbon	\$1.25	CHASSIS TS-351,A	18A702475	AG-8-5 RS-2	Vert. Lin	750 $\Omega$ carbon	\$1.25	
	C-8.230-1	RTV-323	Contrast/ Vol./Sw.	1500/1 Meg. Conc. Dual carbon--SPST	\$4.30		18A711225	AG-61-5 KSS-3	Focus	1 Meg. $\Omega$ carbon	\$1.25	
	MERCURY 2013 2113 2115 2401 4120 4220 4317 4320	PMA-48016	AG-19-5 FKS-1/4	Vert. Lin.	5000 $\Omega$ carbon	\$1.25	*RADIO CHASSIS	18A711999	AG-61-5 RS-2	Tone	1 Meg. $\Omega$ carbon	\$1.25
PMB-48014-1		AG-44-5 RS-2	Hor. Drive	50K $\Omega$ carbon	\$1.25	HS-316	18K702864	RTV-344	Contrast/ Vol./Sw.	2500 Top 2000/1 Meg. Tap 300K $\Omega$ Conc. Dual carbon--SPST	\$4.90	
PMB-48014-2		AG-49-5 FKS-1/4	Bright.	100K $\Omega$ carbon	\$1.25		18K711278	Order From MFR.	Vert. Hold	850K $\Omega$ carbon		
PMB-48014-3		AG-55-5 FKS-1/4	Noise Bal.	250K $\Omega$ carbon	\$1.25		18A600974	AT-115 KSS-3 SWA	Vol./Sw.	2 Meg. Tap 500K $\Omega$ carbon--SPST	\$1.85 .60	
PMB-48014-5		AG-84-5 FKS-1/4	Height	2.5 Meg. $\Omega$ carbon	\$1.25		18K77399	AG-61-5 KSS-3	Tone	1 Meg. $\Omega$ carbon	\$1.25	
PMB-48014-7		AG-61-5 RS-2	Vert. Hold	1 Meg. $\Omega$ carbon	\$1.25							
PMB-48015		RTV-247	Contrast/ Vol./Sw.	750/500K $\Omega$ Conc. Dual carbon--SPST	\$3.70							
MIRRORTONE 20PC		VC-12120B	AG-19-5 FKS-1/4	Vert. Lin.	5000 $\Omega$ carbon	\$1.25						

Form No. 751838010-5M-11/52



This supplementary sheet is for use as an up-to-the-minute addition to your Clarostat RTV Manual. Manuals are available through your distributor or directly from Clarostat. Price \$1.00.

**CLAROSTAT MFG. CO., INC.**  
**DOVER, NEW HAMPSHIRE**

### INDEX TO ADVERTISERS

July-August 1953 Issue

Advertiser	Page No.
Aerovox Corp.	104
American Phenolic Corp.	10
Astron Corp.	36
Theo. Audel & Co.	122
Bud Radio, Inc.	112
Bussmann Mfg. Co.	16
Carter Motor Co.	86
Centralab (Div. Globe-Union, Inc.)	12
Chicago Transformer Co.	82
Clarostat Mfg. Co., Inc.	125
Davis Electronics	102
Electro-Voice, Inc.	Center Spread
Electronic Instrument Co., Inc. (EICO)	102
Electronic Measurements Corp.	122
Electrovox Company, Inc.	112
Equipto	123
Erie Resistor Corp.	88
Federal Telephone & Radio Corp.	110
General Cement Mfg. Co.	120
Hickok Electrical Instr. Co.	22
CBS-Hytron	18
Insuline Corp. of America	122
International Resistance Co.	2nd Cover
Jackson Electrical Instrument Co.	84
Jensen Industries	100
JFD Manufacturing Co.	8, 111
Krylon, Inc.	82
LaPointe Electronics, Inc.	30
Littelfuse, Inc.	4th Cover
The Macmillan Co.	44
P. R. Mallory & Co., Inc.	26
National Electric Products Corp.	34-35
Ohmite Mfg. Co.	84
Phoenix Electronics, Inc.	88
Planet Manufacturing Corp.	120
Precision Apparatus Co., Inc.	32
Quam-Nichols Company	81
Radiart Corporation	24
Radio Corp. of America	6, 40, 118
Radio Electronics	120
Radio Receptor Company, Inc.	92
Rauland Corporation, The	98
Regency Div., I. D. E. A., Inc.	4
Sams & Co., Inc., Howard W.	50
Walter L. Schott Co. (Walsco)	124
Shure Bros., Inc.	86
Simpson Electric Co.	14
Sprague Products Company	48
Standard Transformer Corp.	20
Sylvania Electric Products, Inc.	3rd Cover
Sarkes Tarzian, Inc.	114
Technical Appliance Corp.	38
Telrex, Inc.	42
Triplett Electrical Instrument Co.	28
T-V Products Company	104
Valpey Crystals Corp.	122
Videon Electronic Corp.	92
V-M Corporation	106-107
Ward Products Corp.	72
Xcelite, Inc.	92

While every precaution is taken to insure accuracy, we cannot guarantee against the possibility of an occasional change or omission in the preparation of this Index.

# + More or Less -

Elsewhere in this issue is a report on UHF operations in Baton Rouge, La., Jackson, Miss. and Mobile, Ala. One thing which should be apparent in this report is the difference in feeling on the part of the dealers and television owners in Mobile as compared to those in Baton Rouge and Jackson. The stations in the latter cities are operating with considerably more power than the station in Mobile. This additional power has made it possible for the dealers there to make a great many more satisfactory installations than is possible in the Mobile area.

So, fewer installations can be made in Mobile. Is that bad? Won't it be possible to make an even greater number of installations in Mobile after the station comes on with full power? The answer to the latter question will undoubtedly be yes. What then is wrong with operating temporarily on "flea power"? Is this not a service to those few who can enjoy the programming at the present time? Again the answer to the last question is yes. But what of those people who have purchased receivers only to find that the reception is very poor. Where do they go with their troubles? To the dealer, of course. After all was it not the dealer who pointed out all the features of the receiver? How could the dealer convince the buyer that because of the low power of the transmitter, his reception is poor but that it would be much better after the power of the transmitter is increased? The dealer has already promised something that he could not produce so it is human nature to be skeptical about any further promises, even though there is nothing wrong with the receiver. It is the weak signal which it is called upon to receive that is the cause of the trouble.

Is this the dealer's fault? Did he oversell? Anyone who has been in an area where a television station is about to come on the air knows of the promotional job that is done by the station. Almost daily, ads are run telling of the progress (or sometimes the lack of progress) of the construction and pointing out all of the programs which will be carried on the station. How then can the dealer be criticized for doing something which is a part of the plans of the station? Our thinking is that they cannot.

This situation is extremely bad when it is extended to UHF. The public knows that UHF is something new. He has found out that he cannot receive the new signal on his twelve channel receiver without spending some additional money. Is he wrong in expecting results? Again we think not. The public rightfully expects that any new system should be completely tried and proved, but begins to wonder when he sees the poor results which are obtained.

Several of the dealers that we contacted in Mobile had lost money on many of the UHF installations which they had made. They had bitter experience with some of their customers because of the low signal strength of the station. It would appear that if a dealer cannot be sure of results he would shy away from making installations. That is exactly what many of them are doing. Remember it is rather difficult to explain to Mr. John Q. Public why you can get better reception from a station 125 miles away than you can from one only 10 miles away.

The connecting link between the telecaster and the viewer is the television dealer. The dealer is in business to make a profit through the sale of his merchandise and services. This can be carried on through a long period of time only through maintaining satisfied customers. When the dealer is confronted with a situation like the one in Mobile, it taxes him to the utmost to do this. He is eager to increase his sales. This means more profit but only when he can maintain satisfied customers and make the installations without unnecessary expenses and call-backs. The situation in Mobile should be used as a guide showing future telecasters what not to do.

W.W.H.