

The
Indiana
Historical
Radio Society



BULLETIN

Volume 41

December 2012

Number 4

In this issue:

- ◇ Dave's Service Bench and "Happy Listening To You"
- ◇ Restoring a Zenith 6G501 Portable Receiver
- ◇ Radios With No Schematics, No Capacitor Values,
What Do I Use?



The BULLETIN
A PUBLICATION OF THE INDIANA
HISTORICAL RADIO SOCIETY
FORTY-ONE YEARS OF
DOCUMENTING EARLY RADIO

The Indiana Historical Radio Society Bulletin

December 2013

◇ Contents:	page
◇ IHRS Winter Meet – Lawrence Park	3
◇ Dave’s Service Bench—David Mantor	4
◇ Honomu Radio Service - F Prohl	9
◇ A Radio Candy box for Ruth—Fred Prohl	11
◇ From the IHRS Officer’s Notebook—editor	10
◇ IHRS Fall Meet Radio Display	14
◇ Restoring a Zenith 6G501—Bob Pote	16
◇ Radio With No Schematics, No Capacitor Values, What Do I Use?	
◇ Ed Dupart	18
◇ Radio Ads	26
◇ The Mystic Radio Bug - Bob White	pages 13, 15, and 28

The cover—Santa has in his bag a Stewart Warner radio borrowed from an advertising piece.

Congratulations to Dave Mantor, Michael Feldt, and Herman Gross with their selection as 2013 IHRS Officers. And a thank you to Joe Farkas and Alex Whitaker for their leadership during the past year.

In this issue Dave Mantor leads us into 2013 as IHRS President with Dave’s Service Bench, Bob Pote takes on the task of recovering and restoring a Zenith portable receiver, and Ed Dupart, always the instructor, guides us through identifying defective capacitors in receivers.

IHRS members should note that three meets are scheduled for 2013. The officers agreed that with the all the vintage radio opportunities in surrounding states during the summer we prefer to support them in their meet activity and look forward to successful Fall, Winter, and Spring IHRS Meets.

Fred Prohl, Bulletin Editor



**IHRS Winter Meeting – Lawrence Park Community Center,
Lawrence, Indiana - Saturday February 23, 2013
Meet at the Lawrence Park Community Center,
5301 N Franklin Road, Lawrence (North East Indianapolis)**

The Lawrence Park Community Center is located just outside the North East segment of I465, Indianapolis. Exit I465 at 56th Street East or Pendleton Pike (US36) East. From 56th Street turn South on Franklin Road to the Community Center – From Pendleton Pike turn North to the Community Center.

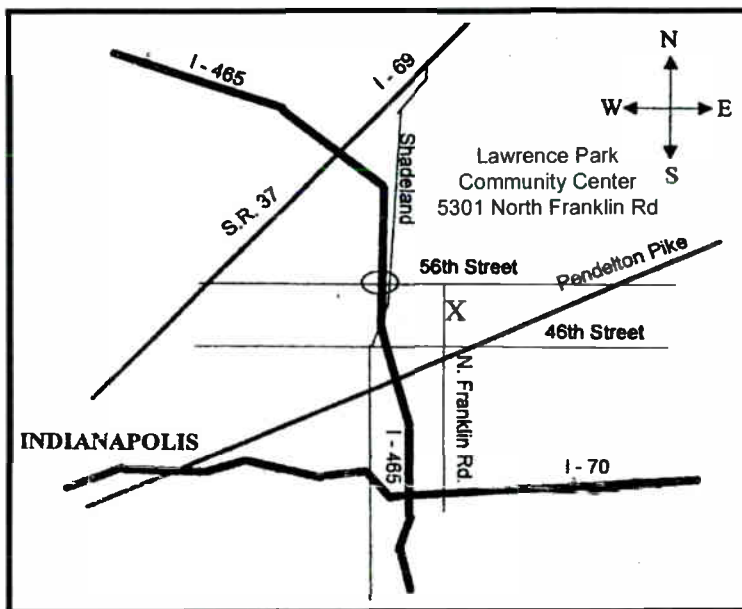

The IHRS Winter Meet is a **Swap N Sell indoor meet**. The doors to the Center will open at 8:00 AM for setup and Swap N Sell.

Old Equipment "Popular Vote" Contest is open to all entries of vintage radio and radio related equipment. Tables for the display of vintage/unique electronic equipment will be available.

CONTEST CATEGORIES:

1. Pre WWII Multiband radios
2. Post WWII Multiband Radios

Registration fees: Registration fee \$5.00 per family. Swap table rental: IHRS members - registration fee plus \$10.00 for each table; non-IHRS members – registration fee plus \$15.00 for each table. Tables are rectangular.

Meet contacts: Fred Prohl, 812-988-1761 and Ed Taylor, 317-638-1641

Greetings from *Dave's Keyboard.*

Thank you for the confidence that has been placed in me to carry on the tradition of the president's office. In the 41 years and counting of this organization, each member who has served in any of the offices has given of their time and has helped this club to move forward. 40+ years is, I'm sure, well above the average for any membership unit to survive. I commend each and every person who has served, and my sincere wish is that I will also serve in the same spirit as those before me. On a personal note, I owe my very presence here to my father-in-law, the late CE Strand, for getting me interested in *IHRS*. I think my first meet that I attended was Auburn. Because of a strenuous work schedule in those days, I couldn't attend many meets, but I believe the next one was the Valparaiso meet. Looking back, I believe I really enjoyed the Valpo gathering the best at the time partly due to its location at the technical school campus. At that meet, I purchased a Christmas decoration from one of the member's wives, a decoration that we still display for the Christmas season. However (isn't there always a "however" in anyone's opening statements for anything?), we all have work to do to generate fresh



interest not only in antique radios but particularly in *Indiana Historical Radio Society*. The only way we'll be able to continue and hopefully grow will be to invite others to attend. Sons, daughters, grandchildren, friends, folks walking by, advertisements, anything to get the name and banner of *IHRS* out and before the public. Perhaps a community event that we can all join in together and help. Community service? Displays in malls? I think the possibilities are endless...we just need to use our imaginations and try some new venues. As I mentioned at Greenfield, my email / post office box / cell phone number is open. Please contact me with your ideas and suggestions. Many thanks. See you all at the next meet.

"Happy listening to you" from the duo that brought us Happy Trails. Doubtful there are any who are reading this edition of the *IHRS Bulletin* who aren't already familiar with the name of Roy Rogers. He, being an original from the Buckeye state, followed his dream to Southern California and became the rider on the golden palomino and to eventually share in the Roy Rogers and Dale Evans movie, television and singing fame. Roy Rogers was a childhood hero of mine. Okay, I'll say it like it is...he's always been my hero. With this background, I've collected his movies and pictures for

years. The picture of Roy here is one that came to my attention recently.



Although it is a super interesting picture of Roy on the stairs in his home that he shared with Arline, his wife, what caught my attention was the console radio at the bottom of the stairs. My recognition of some radios is not as good as it might be, so, I turned to a favorite source of mine – *DDRFD*. That's my acronym for "Dupart Doing Research For Dave." All kidding aside, Friend Ed came through for me when I needed to know what the radio was. The console pictured is a 10-tube Zenith, model 155 (1937). The closest my Roy friends can get as to when the picture was taken is in the early '40s time-frame. Arline died in October, 1946 just a few days

Dave's Service Bench (continued)

after Roy's son, Dusty, was born. I've sent a query to several Rogers family members about the possibility of this radio being still in existence – no replies as yet. Stay tuned.



A nice photo of an early session of radio entertainment. The names of the two ladies are unknown.

The Radio Heritage of the University of Pennsylvania. The internet is especially fun when you're able to spend some time cruising through the countless websites that are dedicated to whatever subject you're looking for. Recently I was spending some time looking for subject material on old radio stations. There's a lot to look at, and it's very easy to become overwhelmed by the sheer amount of information. Of the particular instance I'm referring to, I had navigated to a web forum that I've been a member of for 14 years. It deals primarily with tube-type ham radio equipment and appropriate discussions. It posted a link to another web forum of which I've just recently

joined. There, a gentleman by the name of *Russ Miller, WA3FRP*, posted a picture of a 1910 radio station. Mr. Miller is the alumni club president and was very accommodating when I emailed a request to him asking if I could share a few details here within *The Bulletin* of the wireless association's very early beginnings. The following is a brief clipping of the history of this association. And if that information isn't enough to warm the heart of any antique radio enthusiast, just think of this: the club is still active, recently celebrating its 100th year in 2009 followed by activity that included completion of a new amateur radio station this year (2012) and making a contact with another amateur station using their original call sign of W3KZ.



University of Pennsylvania
Wireless Club—1910

The Wireless Club of the University of Pennsylvania was founded on October 4, 1909 by a group of enthusiastic wireless operators led by Julian S. Simsohn (College 1911). The Pennsylvanian carried regular reports about the Club as it

organized, installed its equipment and began receiving and then started transmitting from campus. The Club quickly attracted fifty members with a wireless station located on the first floor of Houston Hall in the west alcove next to the present day Bodek Lounge using an antenna stretching between the tops of Houston and Logan Halls. Two Philadelphia newspapers also reported early Wireless Club activities: The Philadelphia Bulletin reported that "...messages have been sent from the Hampton Club a distance of 250 miles, while aerograms have been received from points 500 miles away. Cape Cod is heard every night..." The Public Ledger reported "...the Wireless Club is one of the strongest organizations at Pennsylvania. It is in constant communication with five universities and with the Philadelphia Navy Yard. Frequently it sends messages to ships at sea..." (The above quote is used here by permission)

Congratulations are in order to the club members, past and present, who have worked hard to retain the tenure, vision and integrity of the club. I highly recommend that anyone with an internet connection go to the following URL and read for yourself. However, please allow yourself plenty of time as there's lots of material to read, and it's great stuff!! <http://www.seas.upenn.edu/~uparc/history.html>

It's always a pleasure for me to see and visit with Glenn Fitch at the

club meets. I consider Glenn to be a treasure trove of experience, and I can say I've learned a lot from him. Well, he did it again. Imagine my surprise at the Greenfield meet when he handed me a 3-ring binder with a collection of newspaper clippings of some of Phil Hatfield's accomplishments as senior engineer at the General Electric plant in Owensboro, Kentucky. Some of the years covered in these clippings range roughly from 1940 to 1980; there's an announcement of Hatfield's passing the test for his private pilot's license; his lectures on the University of Evansville's overseas campus in Grantham, England; even his co-authoring, along with L.G. Mumford, a chapter in the highly recognized book Amplifier Handbook. The more I find out about Phil Hatfield, the more I regret not having the privilege to have met the man. His accomplishments seem endless.

One day in the very near future, I'd like to share with you pictures of a 20-40 meter ham amplifier that he designed and built. Again, one can see the preciseness of his ability to design and construct radio gear. I've owned it about 17-18 years. Where did I get it? You guessed it - Glenn Fitch.

Lum and Abner - Mark Trail - Archie - Roy Rogers - The Great Gildersleeve - The Green Hornet. These are just a few of the many old radio programs

that could be heard on a regular basis quite a number years ago. Now there seems to be considerable growth of enthusiasm for *Old Time Radio* programs, commonly known as *OTR*. I'm happy to report of this growth because I remember listening to Lum and Abner with my dad and those special times. Obviously, it wasn't referred to as "old time radio" back when it was in the prime time slots of radio's initial scheduling. However, because of today's technical and very precise digital re-recording, we now have a plethora of programs that we can listen to. Many of them are complete with the original advertisements. Each generation makes the claim that those living in the earlier times before had it easier and lived a simpler lifestyle. I must agree in part; when I listen to a characteristic recording of Gildersleeve or Lum and Abner, I have to believe that the folks listening in the '30s and '40s, by today's standards, lived simpler lives. Folks living in that day certainly worked hard, but there were not the distractions of computers, cell phones and television. I daydream a little bit when I sit in front of my console radio listening to a present day program. As I listen, visions of old radio

...I have to believe that the folks listening in the 30's and 40's, by today's standards, lived simpler lives.

days bring new life to my ears. And add to that scenario, the program coming from a radio with glowing vacuum tubes, well...I guess I could go on and on. I would recommend for "your listening pleasure" that you obtain a collection of old programs. I have quite a few, and I would be happy to record onto a CD for anyone interested some of the happy sounds of *The Great Gildersleeve*, *The Roy Rogers Radio Program*, *Mark Trail* or *Archie*.

I have some projects that are patiently waiting for me to share within these pages. Reminiscing is sure fun, but then I'd better get back to business with some radio servicing from my bench. Stick

around – let's light some filaments.

Well, that about does it for this edition of Dave's Service Bench. My email Inbox remains open for anyone to add their comments about Phil Hatfield, John T. Frye, info on the Henry Fields Shenandoah Five or if you'd just like to share some of your radio experiences. You can reach me at merrjoy@yaho.com or PO Box 1, Fairmount, IN 46928-0001. (Please note my new email address)

One final comment, one that is so very important to us all... *Veteran's Day*. By the time this is-

sue of *The Bulletin* is published and into the hands of the members, this year's special day, commemorating those who were willing to serve our country, will be a memory. However, the privilege that each of us has is to be able to say "thanks" to each veteran. A handshake, a note of praise, words of encouragement, sharing a cup of coffee with a vet, all of these are just a few ways we can show our appreciation. Our veterans' contribution is immense when one thinks about the freedoms we enjoy and the price that was paid. A special thanks to any IHRS member who served in the armed forces. We appreciate you, and we thank you for your commitment!!



**Raising the flag over Iwo Jima
February 23, 1944**

So, until the next *Bulletin*, enjoy the old radios. Lord willing, I'll see you at the next meet. And remember, your smile may help someone have a great day.

Dave Mantor w9ocm

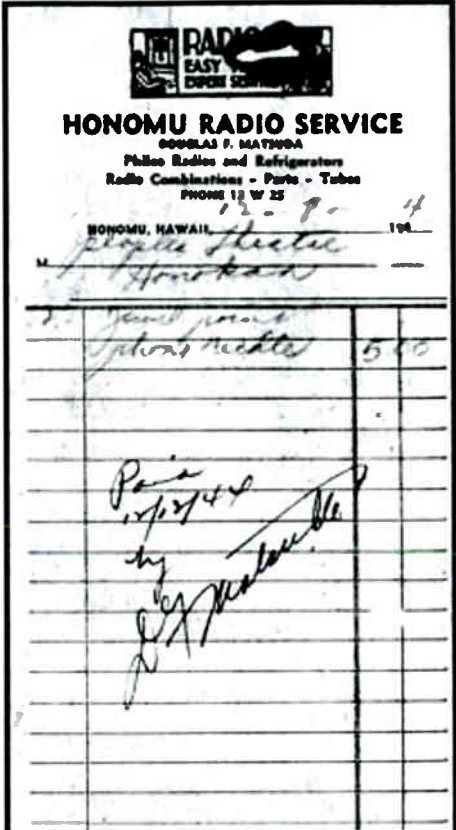

Honomu Radio Service
by Fred Prohl
While on a family trip to Hawaii several years ago we visited the town of Honomu, and yes, there was a small antique shop. I felt a bit guilty separating a part of the town's history with my purchase of the above "Honomu Radio Service" receipt, but my interest and curiosity won. Purchased on 12-8-1944 were 2 jewel point phono needles by the Peoples Theater, Honokaa, for \$5.00.
(continued on page 10)

(Honoumū—continued from page 9)

Why the keen interest?

- ◇ The receipt date is 3 years and 1 day following the attack on Pearl Harbor.
- ◇ The shop owner's last name is Matsuda, apparently of Japanese decent.
- ◇ On the date of the receipt the United States was at war with Japan.
- ◇ This was a Radio Shop!

Recognizing we are a multicultural society (my parents spoke fluent German) the possibility Mr. Matsuda was of Japanese decent only fuels the wish to have met him

to understand the scrutiny he must have experienced as a radio shop owner in Hawaii during WWII

So what was his radio shop like—on the Island of Hawaii, 1944? What model Philco was available then?

A book could be written based on this receipt!

Fred Prohl December 7, 2012

BTW — PBS has an interesting search for the first pocket transistor radio on the History Detectives, season 10 (2012) episode 1007. It is about a quest to find the lowest serial numbered Regency TR-1

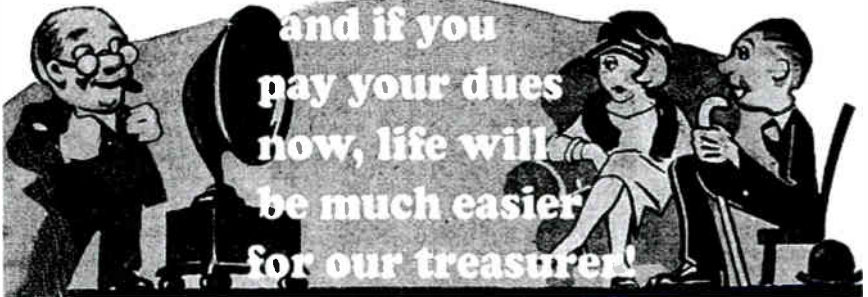

Renew your membership for 2013 now!

If the date on your mailing envelope for this issue of the Indiana Historical Radio Society Bulletin is 12/12 or earlier, it is time to renew your membership. Send your check payable to the *Indiana Historical Radio Society*

in the amount of \$15.00 per year. Send your payment to:
Herman Gross, IHRS, 1705 Gordon Drive Kokomo, IN 46902.

Include your current mailing address, if not on your check,
and your email address, if you have one.

Membership questions? Contact Herman at w9itt@comcast.net
or call him at (765) 459-8308.

2013— 2013—2013— 2013—2013— 2013
Indiana Historical Radio Society Meeting Schedule
 ——— Winter Meet—February 23 ———
 Lawrence Park Community Center, Lawrence
 ——— Spring Meet—May 3 and 4 ———
 Quality Inn, Kokomo
 ——— Fall Meet—October 12 ———
 Riley Park Shelter, Greenfield

A Radio Candy Box for Ruth

If there is no rattle when a candy box is shaken, it's safe to say there is no treat inside. Not so with the (1 ½ x 1 ½ x 3") radio candy box shown below. Months after my purchase the box was opened yielding a treat—a note – a Christmas note to Ruth.

Once read, the question will be – was the candy box accompanied by an operating radio for Harley and Ruth to "listen in" on those nights they could not go to a picture show? *Fred Prohl*

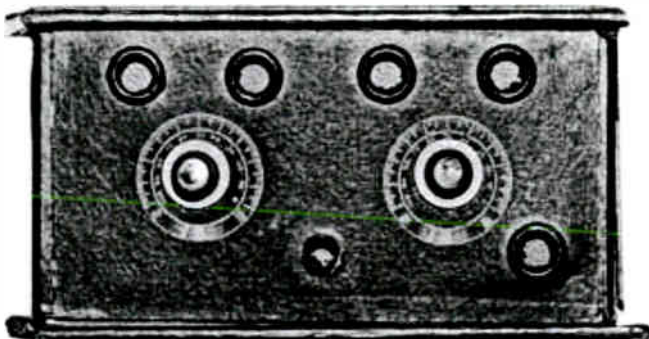

RUTH

One of Santa's helpers whose name is Raditot
 Used his little magnifying glass upon Ruth's
 knot
 He danced with joy and said to the other elfs
 around
 The very thing that Ruth would want for Xmas
 I have found
 On rainy nights when Harley and Ruth can't
 go to a show
 A radio would be just the thing to keep them
 amused - you know.

- 2013 Regional Vintage Radio -

Mid-South Antique Radio Club

MSARC Meet information contact: layvinrad@insightbb.com

Antique Radio Club of Illinois www.antique-radios.org

Feb 10 and April 14 - American Legion Hall, Carol Stream

RadioFest—August 1-2-3 Willowbrook Holiday Inn

Michigan Antique Radio Club www.michiganantiqueradio.org

Jan 18, Farmington Hills, MI

Extravaganza—June 28-29

Antique Radio Club (SPARK), Dayton, OH

June 1, Gerhart Civic Center, (details in IHRS Spring Bulletin)

AWA-Antique Wireless Association www.antiqwiresless.org

The original and largest historical radio group. The AWA publishes a quarterly

AWA Journal. Membership is \$25 per year. Write to: Antique Wireless

Association, Inc. Box 421, Bloomfield, NY 14469

See you at the IHRS Winter Meet at the

Lawrence Park Community Center February 23 !!

From the IHRS Officer's Notebook:

IHRS Annual Meeting, Greenfield September 29

Elected to office for the year 2013 - Dave Mantor, President; Michael Feldt, Vice President; and Herman Gross, Treasurer/Secretary. A vote of thanks was given to Joe Farkas and Alex Whitaker for their service as an IHRS officer.

Officers Meeting, November 17

Treasurer's Report—each of the IHRS meets in 2012 did not meet expenses.

Current IHRS account balance is just over \$5000.

Regarding 2012 meets—the Columbus (summer) meet was the most disappointing.

Discussed—IHRS radios at the Ligonier Museum. The IHRS officers will schedule a meeting with Ligonier Museum administrators to discuss the future of the IHRS display.

IHRS Meets in 2013—Three meets will be scheduled in 2013. 1) Winter meet, February 23, at the Lawrence Park Community Center, 2) Spring Meet at the Quality Inn Kokomo, May 3&4, and 3) the Fall Meet at Greenfield, October 12. The Summer meet was dropped in favor of supporting Vintage Radio Meets in the states adjoining Indiana and AWA occurring during the summer.

Meet Fees—For all meets; \$5.00 family registration (including vendors), \$10 IHRS vendors and \$15 for non IHRS vendors.

Dave Mantor, Michael Felt, Herman Gross, Fred Prohl

"MYSTIC" RADIO SET

THE ORIGINAL

BUG

A Big Hit!

Ornamental
Practical
Useful

For the
Home
Office
Club
Etc.

Try
It,
Then
Tell
Your
Friends

Patents
Applied For

Full Directions
On the Back
Of This Card

DELIGHTFUL
RADIO RECEPTION

Combined With a
Beautiful Piece of

FINE ART POTTERY

You'll
Be
Proud
To
Show
"The
Bug"
To
Your
Friends



No. 102 - "MYSTIC BUG"

Finely Modeled
Wonderfully Colored

HIGHLY GLAZED ALL OVER

A Genuine Novelty

Fine
For
Gift,
Prize or
Trophy
Can Be
Mailed
Any
Where
In Our
Carton

All the Rage!

Gets Local
Stations
Loud and Clear

No
Batteries

No
Tubes

No
Wear
Out

Any
One
Can
Work
This
Set

Tan for All

Model 102 is a complete radio set for home or office use. It is a genuine novelty and is highly recommended. Price, \$10.00. Made in U.S.A. Patent applied for. Copyright, 1935, by Radio Shack and Company, Inc., New York, N.Y.

SEND YOUR 'FAN' FRIEND A 'BUG'

More about the "Mystic Radio Bug" on pages 15 and 28.

On Display—2012 Fall Meet, Greenfield



Glen Fitch placed a number items on display at the Greenfield Meet.

Above:

An Atwater Kent three tube breadboard and an Atwater Kent 10A with a Sears Roebuck power supply.

A collection of detector circuits, some adjustable others fixed.

A Grommes Monaural Tube Amplifier

Below:

Additional equipment constructed by Philip Hatfield (see the IHRS March 2012 Bulletin.)

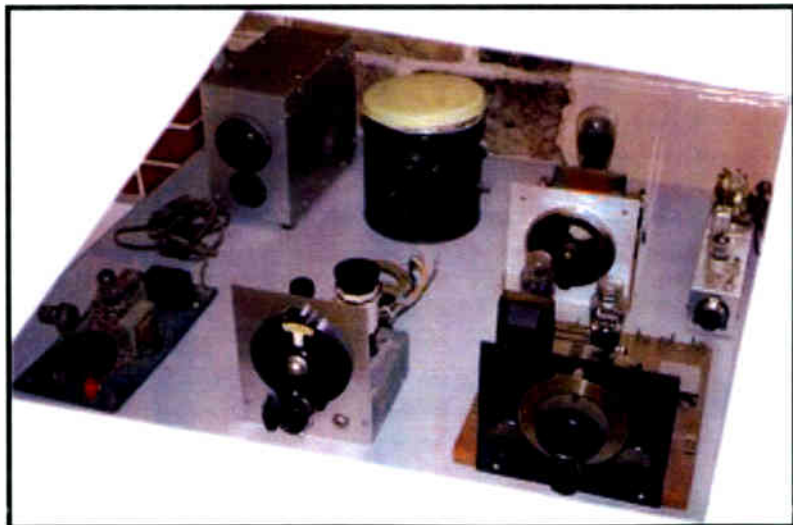



Restoration transition of a Zenith 6G501 – see next page for Bob Pote's article.

Above: Another beautifully finished Emerson – shown by Dan Sperry (see page 32, December 2011 Bulletin.)

Below: The underside of Bob White's Mystic Radio "Bug". Note the fixed detector. More pictures on pages 13 and 28



Restoring a Zenith 6G501 Portable Receiver—Bob Pote

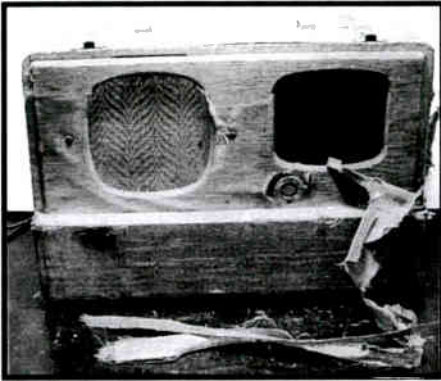

I recently attended an auction and purchased this radio for \$5.00 fully intending to use it as a parts set. When my wife saw it she said why don't you try to restore it instead? So I told her I would give it a try. This is the radio as I got it. The cloth covering was in tatters and the front cover was missing. Removing the cloth was fairly easy but a damp sponge makes removal a lot easier.

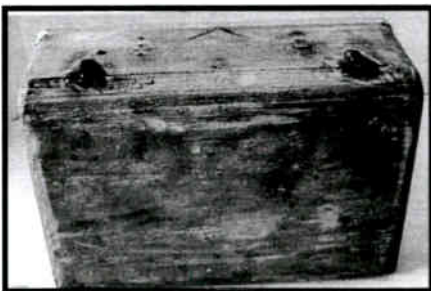

Here is the cabinet with all the cloth removed, I also removed the hinge hardware on the front of the radio because the front cover was missing. I did a lot of sanding,

filling holes with wood filler and gluing loose corners in the cabinet.

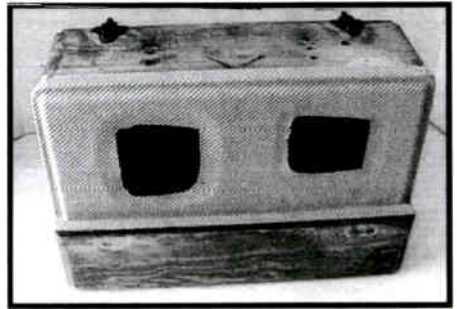

Here is the front of the cabinet showing application of cloth. So I removed the hinge clips and filled in the holes with wood filler. I did additional sanding the entire cabinet to remove all traces of glue and cloth fibers. The rear cover hinges had to be left in place as they were riveted to the cover and it was impossible for me to remove them with out damage to the cover.



This is a rear view of the cabinet after installing a new dial cover

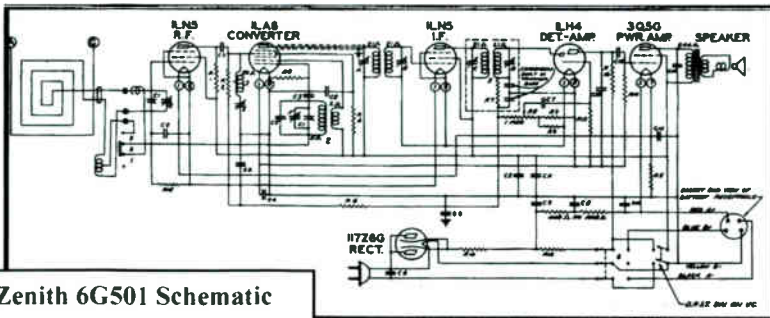

Zenith 6G501 Schematic

and lining the battery compartment and rear cover interior with black vinyl. Please note the asbestos sheet on the top of the battery compartment. I didn't want to disturb it because of health reasons, so I gave it a coat of Quick Drying Polyurethane varnish, safely encapsulating the asbestos fibers.

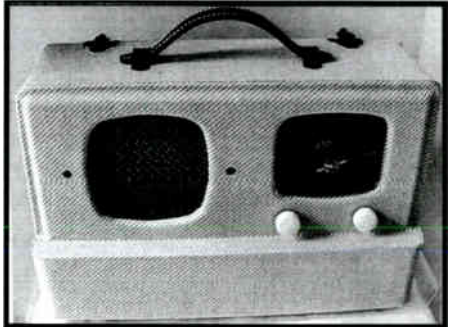

This is the finished product. I reused the handle hardware and I was able to locate a new leather handle from Antique Electronic Supply that is almost a carbon copy of the original. Sharp eyed readers will notice that the material that I used is the same material that is used on old amplifiers. The entire project took me about two weeks to complete.

List of supplies I used:

- ◇ Cloth fabric and handle – Antique Electronic Supply
- ◇ Dial Cover – Mark PalmQuist
- ◇ Black Vinyl – Jo Ann Fabrics
- ◇ Electrolytics – D. H. Distributors
- ◇ Capacitors and Line cord – Bob's Antique Radio
- ◇ Battery Box and Battery Power Supply – Jim Potivent
- ◇ Elbow Grease – me – *Bob*

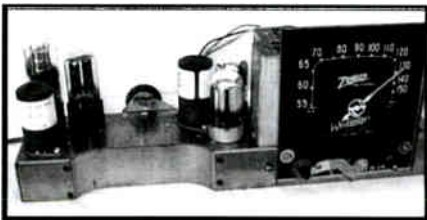

The chassis wasn't neglected during the restoration. I replaced all capacitors and both electrolytics. Much rubber coated wire was replaced and a new battery harness was made using plastic insulated wire, adhering to the same color code as the old harness. I also purchased a power supply from Jim Potivent that uses ten D cells and gives about 60 hours of playing time. I might add that the radio plays great and is very sensitive.

Restoring a Zenith and Bob Pote (continued)

"The crackle of static drifted through the speakers of the 1940 Zenith radio. Bob Pote slowly turned the dial, searching for signal. The Greenwood resident often comes to his "radio room," surrounded by antiques of all colors and sizes, to play with electronics he's unearthed over the years. Finally, after a minute of searching, an Indianapolis signal burst through, sounding crisp and clear. "These may look old, but they still work pretty good. You just have to know how to work them," he said."

So begins an article written by Ryan Trares for Greenwood's *Daily Journal*, published in December of last year.

"Pote became fascinated with radio while in high school in Chicago. One of his assignments in shop class was to make a crystal radio using a diode and copper wire. His collection includes the first radio he was given, a Motorola model that his grandmother bought for him. Since then, he's added dozens of others through auctions, garage sales and trading with other collectors."

Bob Pote has been an IHRS member since the 1970's. He has been collecting radios for most of his life with an emphasis on Zenith. Like many IHRS members, Bob can go back to his teens when he was introduced to crystal radio construction and station reception. Significant to his early experience,

Bob's enthusiasm includes radio restoration and DXing. "I look at the history. I think about everything that's come over those speakers," he said in the Daily Journal Article. "Someone sat in front of these radios and may have heard the Japanese attack Pearl Harbor or Charles Lindbergh complete his flight across the Atlantic." Bob is a member of the National Radio Club and is a regular at tuning in and identifying distant radio signals.

ONLY ZENITH HAS THIS!

U. S. PATENT NO. 2164251



\$29.95

Wholesale Prices
Shipped Regularly
in Airplane Cases
(EXCLUDING SLATS)

The ONLY PORTABLE RADIO Guaranteed to Play Where Other Portables Fail... or Your Money Back

At Home or Away—the Year 'Round Companion

Engineers of the Zenith Radio Corporation again give you a most remarkable invention... the Patented Movable Wavemagnet in a portable radio which you can carry in one hand, self-powered with a light, one-piece battery pack. Under all ordinary circumstances it works without outside aerial... without outside wires or ground.

LISTEN WHILE YOU TRAVEL... PLAY... OR WORK

Take this wonder portable where ordinary portables will not work efficiently: in a train, airplane, bus, ship, tent or any windowed building where aerial construction keeps and reception. The secret of why it works while others fail is in the Patented Movable Wavemagnet, which is exclusive to Zenith.

Check up on your own radio trip. See just how many Zeniths are being used... and how many other makes fail to do so. Your money back if Zenith fails.

WORKS ON LIGHT SOCKET OR BATTERY

At home, in the office, in hotels, if you want to save one battery, plug into any light socket... 110 volt AC or DC. That's 110-volt AC electrically disconnect your battery and save its for outdoors or travel.

PHONE OR WRITE FOR THE NAME OF YOUR NEAREST ZENITH DEALER

Headquarters: Wheelock Street, Boston
 COLLEGE-BUILDING CO., Inc., 387 Fourth St. • Phone 628-2800 3-2123 • New York City



The shape and size of
this lightweight beauty of
the portable radio.

The Lowly Million in genuine work... priced slightly higher than regular complete radio.



ZENITH RADIO
AGAIN A YEAR AHEAD
AMERICA'S OLDEST MANUFACTURER OF FINE RADIOS FOR THE HOME

RADIOS with NO SCHEMATICS

NO CAPACITOR VALUES

WHAT DO I USE?

by Edward Dupart

Ed rewrote his Bulletin article of June 2001 related to capacitors in AM radios.

Most of us at one time or another have run across a radio that needed new capacitors, but we didn't have a schematic and there were no values on the capacitors for one reason or another. Mice, rats, roaches or a Philco. What values do we use? After years of working on old radios, I have found certain values are common to their particular application. What I have listed in the following table are approximations, and you may find some exceptions. Also, these are for vacuum tube circuits, not transistor circuits. Transistor circuits use much larger value capacitors because of the lower impedance's encountered with bipolar transistors. Listed in the table are some of the common values I have found and what I use.

For voltage ratings of non-electrolytic capacitors, 400 to 600 volt capacitors will work fine for transformer operated radios and 150 to 200 volt capacitors will work fine for AC/DC operated radios. The electrolytic filter capacitors in power supplies should be a 450 volt rating for transformer operated radios and at least 150 volts for AC/DC operated radios with-

out voltage doubler circuits, which aren't very common. If you have a voltage doubler circuit, use 350 volt capacitors throughout the circuit. To replace a low voltage electrolytic with a high voltage electrolytic will result in the high voltage electrolytic not being formed properly, but I have done this and haven't had any problems. An example would be replacing a 20 volt electrolytic with a 250 volt electrolytic.

Your AVC and cathode bypass capacitors operate at very low voltages, and so you can use 100volt capacitors safely in those applications. Some of the audio coupling capacitors operate at very low voltages, especially the one connected to the volume control. Use a meter and measure the voltages across the capacitor to be sure.

Capacitors are not as critical in capacity value as what some people might say, EXCEPT in AVC, tuning and other resonant circuits, so you can alter the value of coupling and bypass capacitors to a degree and the radio will still play OK. I find it better to go higher in capacity value rather than lower

Radios with No Schematics (continued)

and the math proves it. I condensed this article and left the math proofs out of it. If you are interested in seeing the complete article with all the math, please e-mail or write to me and I will send you the entire article.

I have done a lot of experimenting and the following are the results of those experiments. Some texts also back up my findings.

You can double and triple the capacity value of power supply filters without any adverse effect, other than when you turn off the radio it may play for a few seconds while the caps are discharging.

To radically increase the value of audio coupling capacitors, say going to a .5:f, might cause a multi-stage amplifier to oscillate, but if you stay within the values listed in

the table you won't have any problems.

Putting in too large an AVC capacitor at the mixer/RF section, say a .1:f, can cause the radio to take a long time to adjust to the proper volume level.

Putting in too large an AVC capacitor at the volume control can cause a loss of audio, because the audio gets filtered to ground rather than going to the 1st AF amplifier. The object of the 250pf capacitor is to fill in the RF valleys and make a smoother AF signal.

References:

Electronics Communication, 4th edition, Shrader, McGraw Hill Book Co., Pgs 288-289

Commercial Radio Operator Theory Course, Schwartz, Martin, AMECO Publishing Corp., Pg 160

Types of capacitors and their applications			
Capacitor Type - general description, lots of exceptions	Application	Approximate Capacity Range :f means microfarad	Reliability
Paper – tubular shape	Coupling, bypass	.001-1:f	Poor
Plastic – mylar, polystyrene, etc.	Coupling, bypass	.001-1:f	Good
Ceramic-flat coin look	Coupling, bypass, tuning	1 pf - .1:f	Excellent
Mica-rectangular stop light look or tear drop shape	Coupling, bypass, tuning	1 pf - .1:f	Excellent
Air - variable	Tuning	5 pf – 1000 pf	Excellent
Electrolytics			
Aluminum – large size-can shape	Coupling, bypass	1 – 100k:f	Poor
Tantalum–small size–tear drop shape	Coupling, bypass	.1 - 50:f	Good

CAPACITOR APPLICATIONS OTHER THAN POWER SUPPLIES:		
Application :f means microfarad	Range I See	What I use
First audio amplifier coupling capacitor:	.005:f - .01:f	.01:f
Second audio amplifier coupling capacitor:	.005:f - .05:f .01:f typical	.01:f
Screen and plate bypass capacitor AM & Shortwave radios:	.01:f - .1:f .05:f typical	.1:f
Screen and plate bypass capacitor Longwave, AM & Shortwave radios:	.1:f - .2:f	.22:f
AVC capacitor at the volume control: These rarely ever go bad!	100pf - 250 pf	250pf
AVC capacitor at the mixer & RF stages:	.01:f - .05:f .05:f typical	.05:f
Cathode bypass capacitor in audio circuits:	.05:f - 50:f 4:f typical	20:f AF Out .05:f 1 st AF
Cathode bypass capacitor in radio frequency circuits:	.01:f - .1:f	.05:f
Capacitor in series with single tone control:	.005:f - .05:f .01:f typical	.01:f
Capacitors across audio output transformers:	.005:f - .03:f 600v or higher	.005:f
POWER SUPPLY FILTER CAPACITORS:		
Late 1920's radios:	1:f - 4:f	10:f
1930's and up with full wave rectifier, 80, 5Y3, 5Z3, etc.:	8:f - 20:f	20:f
1930's to 1940's with ½ wave rectifier, 25Z5, 25Z6, 35Y4, 35Z5, etc. with field coil speaker:	10:f - 20:f	20:f
1940's to 1960's with ½ wave rectifier. 35Z5, 35W4, etc. without field coil speaker:	50:f 1st filter 30:f 2nd filter	50:f 50:f

Common Capacitors in AM radio circuits—Function and Problems

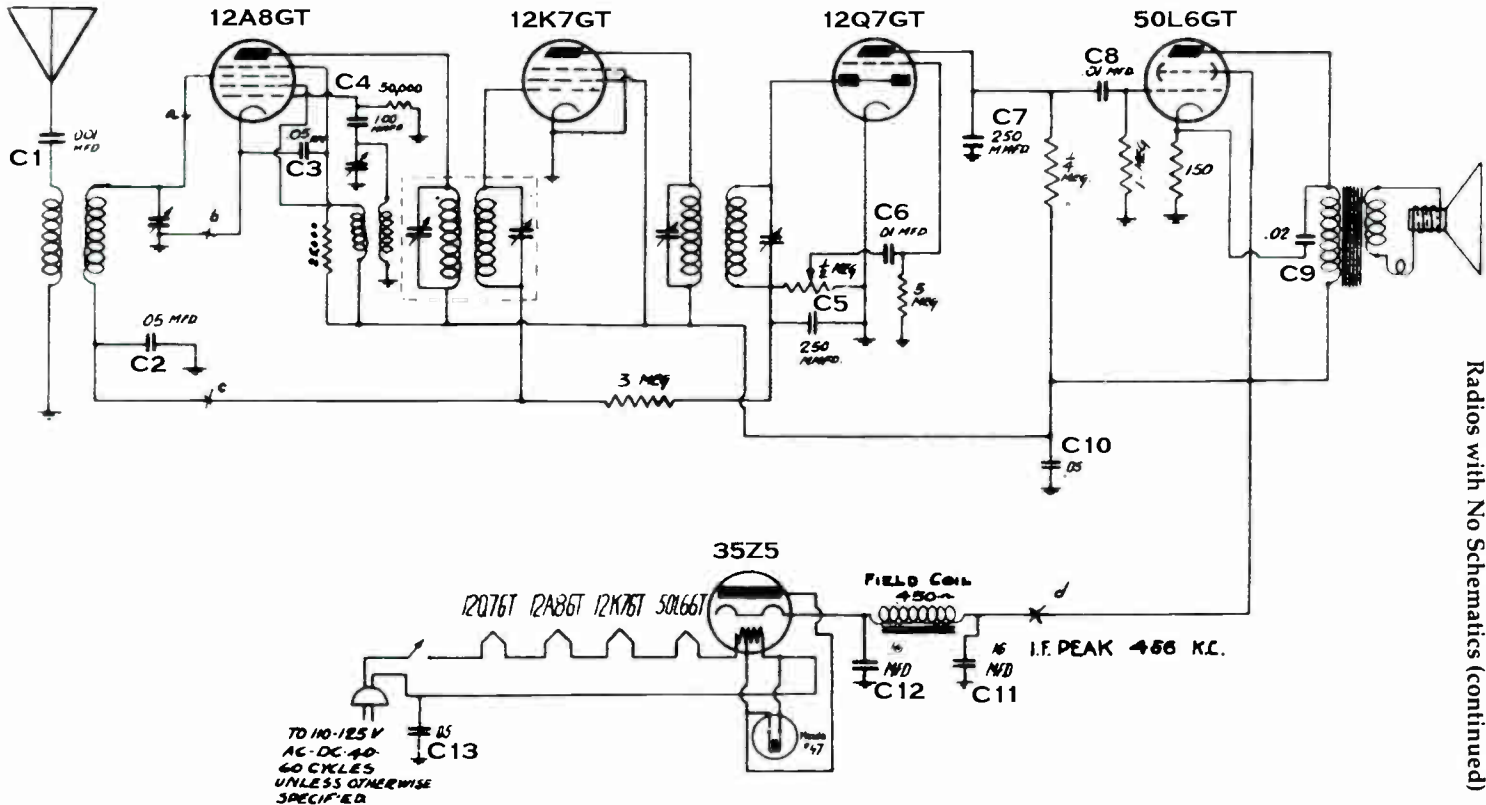

Radios with No Schematics (continued)

I decided to show a typical 5 tube schematic representative of radios from the 1930's to the end of vacuum tube radios in the early 1970's. Obviously, there are changes over the decades, mainly in tube types and the lack of field coils and improved capacitors in later years. This schematic is of a Fada from 1939 and it's interesting to see a mistake they made in the schematic that no one caught decades ago in that there is no line going from the junction of the switch and the filament of the 12Q7GT to ground. I left the mistake in there to show that schematics are not infallible. The given table is for this radio giving common names and functions for each capacitor and the kinds of typical problems that capacitor creates. With the limited space, detailed descriptions and functions are very brief and there are exceptions. I hope this will aid the new radio enthusiast in trouble shooting their radios. *Ed Dupart*

Cap ID	Cap Function	Short	Open	Leaky	Type of Cap-typical	Reliability
C1	Antenna coupling	Nothing unless it touches a hot AC line, then the ant coil smokes.	Maybe a loss of sensitivity	About like a short	Paper	Poor
C2	AVC filter. Filters audio voltage to produce a smooth negative feedback voltage	Overloads on strong stations	Poor reception-sensitivity Possible motorboating	May overload on just one or two strong stations.	Paper	Poor
C3	Screen grid by-pass	No reception. Screen resistor overheats	Squeals or howls, especially when tuning a station	Screen resistor may overheat.	Paper	Poor
C4	Oscillator grid coupling	No reception.	No reception	May not oscillate at upper end. Pick up stations at low end of dial but not at the top end of the dial	Mica	Good rarely goes bad

24 C5	AVC filter. Filters out RF from AF voltage.	No volume	Slight distortion	Some loss in volume	Normaly Mica, but sometimes paper	Mica-good Paper -usually still good
C6	1st audio coupling	distortion-erratic volume control function	Low to no volume	Similar to shorted condition	Paper	Poor & one of the first capacitors I change
C7	Filters RF from the Audio(AF)	No volume, plate resistor may run warm and may open up	Sound may not be as clear as it could be and sometimes causes squeals	Low volume	Normaly Mica, but sometimes paper	Mica-good Paper -usually still good
C8	Audio coupling	No volume, AF output tube runs hot-plate may glow red as well as grids.	Low to no volume	Distorted sound at low levels, sounds better when volume is turned up. AF output tube runs warm and will go prematurely bad over time.	Paper	Poor and is the very first paper capacitor I change in a radio. This capacitor seems to go bad first.
C9	Protects AF output transformer and output tube. Filters some high frequencies to ground for more bass sound	No volume, burns up AF output transformer and AF output cathode resistor.	No real effect at first, but AF output transformer and output tube may go bad. More pronounced high frequency sound. Some radios may squeal or howl.	Low volume, AF output cathode resistor runs hot.	Paper	Poor

C10	Screen grid bypass	No volume, can burn up field coil and 35Z5	Squeals or howls, especially when tuning a station, in some cases no reception	Field coil runs hot and poor reception due to reduced screen and plate voltages-low B+	Paper	Poor and this is the 3rd paper capacitor I would change in a radio.
C11	Power supply filter capacitor	No volume, can burn up field coil and 35Z5	Loud 60 cps hum and possible to still pick up a station or two	Field coil runs hot and poor reception due to reduced screen and plate voltages-low B+	Electrolytic	Poor and I check & change the filter capacitors first.
C12	Power supply filter capacitor	No volume and usually burns up the 35Z5	Loud 60 cps hum and possible to still pick up a station or two	Poor reception due to reduced screen and plate voltages-low B+	Electrolytic	Poor and I check & change the filter capacitors first.
C13	Noise filter-filters out motor noise	Depending on the grounding in the radio, can make the chassis hot-shock hazard. Can blow house fuse. Sometimes creates unwanted hum.	No effect	Depending on the grounding in the radio, can make the chassis hot-shock hazard. Sometimes creates unwanted hum.	Paper	Poor- it's not a real trouble maker, but I do change them. Can be a safety hazard.

A good resource: Elements of Radio Servicing, 2nd edition by Marcus and Levy, McGraw Hill 1955

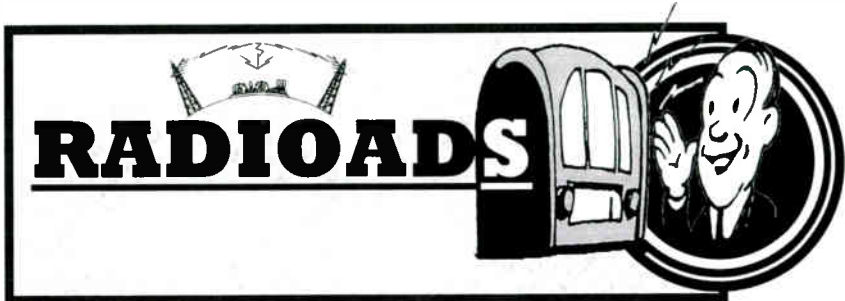

Submit your "FREE TO CURRENT MEMBER" RadioAd by the 15th of February, May, August, or November in time for the Bulletin issue that follows.

Wanted: Information or pictures of band switch linkage that moves the band indicator on the dial for Silvertone console model 1968. Lou Dvorak 937-845-9595 12/12

Wanted: Tempo 1 Power Supply (Ham). Dave Mantor, PO Box 1, Fairmount, IN 46928-0001 (765)618.8342 Email - merrijoym@yahoo.com Thank you 8/12

For Sale the following consoles , Stromberg Carlson model 440-M , \$ 200 , Midwest model D-17 , \$375 , American Bosch model 28 with matching speaker cabinet , \$150 , and Philco model 190 X , \$125 , also code practice key with oscillator \$50 . Bob Pote, 317-881-5721 , Greenwood, IND. or contact me via e-mail mrzenith41@aol.com 3/12

Wanted: McMurdo-Silver Model 802 Superhet Rcvr & Model 701 Xmtr. B&W Junior Coils, 5 pin, horizontal, No's 21XX or Freq stamped on their unglazed white porcelain base. William Ross W9WR, 300 Oxford Road, Kenilworth, IL 60043-1167, 847-251-7447, william.ross@comcast.net.6/12

For Sale: REPRODUCTION RADIO BATTERIES: I've developed replica battery solutions for most tube and transistor radios--batteries that have not been available for nearly thirty years. They look, they feel and they work--just like the originals! Plus, they are a reusable resource. Inside are holders for AA, C, D and 9-volt batteries. When the batteries wear out, simply remove them and install new ones. Contact Bill Morris at batterymaker@gmail.com or at 317-895-1334. 3/12

For Sale: Reproduction cabinet parts (wood). In stock parts; front panels, rear arch supports, base molding, for Philco models 20,21,70,90 (others per sample). Philco Colonial Clock top trim including finials, Grandfather Clock finials for Philco 570, GE H-91, Crosley 124 (others per sample). Almost any wood part available per sample, any make or model (per quote) (tooling charge may apply). Dick Oliver c/o Antique Radio Service, 1725 Juniper Place #310, Goshen, In. 46526. Ph. (574) 537-3747, e-mail- dolivears@aol.com 3/12



2013 Officers

Responsibilities

David Mantor, President

P. O. Box 1
 Fairmount, Indiana 46928
 (765) 618-8342 before 7pm Indiana time
 email merrijoym@yahoo.com

Activities, Business,
 Administration, & Publicity

Michael Feldt, Vice President

12035 Somerset Way, East
 Carmel, Indiana 46033
 (317) 844-0635 email: feldtm@msn.com

Sites and Dates of Meets

Herman Gross, Treasurer/Secretary

1705 Gordon Dr.
 Kokomo, Indiana 46902
 (765) 459-8308
 email: hw144ihrs@comcast.net

NOTE

Applications and correspondence
Dues, Financial, and address
 change. Please notify
immediately of change of address.

Editor Fred Prohl

3129 Lanam Ridge Road
 Nashville, IN 47448
 (812) 988-1761 email inhistradio@gmail.com

News Articles, Radio Ads, Photos
 for Bulletin publication
 Maintain indianahistoricalradio.org

Dr. Ed Taylor, Historian

245 North Oakland Avenue
 Indianapolis, Indiana 46201-3360
 (317) 638-1641

Donations & Scrapbook Material

Bulletin Deadlines: News, Articles & Radio Ads, 2/15, 5/15, 8/15, 11/15

IHRS Web site address: www.indianahistoricalradio.org

The INDIANA HISTORICAL RADIO SOCIETY is a non-profit organization founded in 1971. Annual membership dues of \$15.00 includes the quarterly IHRS "BULLETIN." Radio-Ads are free to all members. Please include an S.A.S.E.

The BULLETIN

**A publication of the Indiana Historical Radio Society
 Forty-one years of documenting early radio.**

MYSTIC RADIO SET
THE ORIGINAL
BUG



A new, old stock Mystic Radio "Bug" - a fantastic find by Bob White. See pages 13 and 15.

www.mysticradio.com