

**BULLETIN**  
*Indiana Historical Radio Society*  
PRESERVATION FOR POSTERITY

Vol. 30

Winter, 2001

No 4



Santa's Coming!



## Officers

(revised 12/4/01)

### Terry Garl, President

54980 Drive  
Osceola, Indiana 46902  
(219) 679-4280 e-mail: teg53oscin@aol.com

### Bill Morris, Vice President

3545 Rock Maple Drive  
Indianapolis, Indiana 46235  
(317) 895-1334 e-mail: bmorris@mw.net

### Fred Prohl, Secretary, Treasurer

3129 L. anam Ridge Road  
Nashville, Indiana 47448  
(812) 988-1761  
e-mail: indianahistoricalradio@att.net

### Edward Dupart, Editor

1441 N. Church St. – Cadiz  
New Castle, Indiana 47362-9172  
(765) 533-6272 e-mail: edupart3@hrtc.net

### Dr. Ed Taylor, Historian

245 North Oakland Avenue  
Indianapolis, Indiana 46201-3360  
(317) 638-1641

### Fred Schultz

1246 Lincolnway South  
Ligonier, Indiana 46767  
(219) 894-3092 e-mail: olradio@ligtel.com

## Responsibilities

Activities, Business,  
Administration, & Publicity

Sites and Dates of Meets

NOTE

→ Applications and Correspondence  
Dues, Financial, and Address  
Change. Please Notify  
Immediately of Change of Address.

News, Articles, Photos,  
Radio-Ads

Donations & Scrapbook Material

IHRS Museum Curator

**Bulletin Deadlines:** News, Articles & Radio Ads, 2/15, 5/15, 8/15, 11/15

**IHRS e-mail Web site address:** [www.indianahistoricalradio.org](http://www.indianahistoricalradio.org)

The INDIANA HISTORICAL RADIO SOCIETY is a non-profit organization founded in 1971. Annual membership dues are \$15.00/year or 2 years/\$25.00, which includes the quarterly IHRS "BULLETIN". Radio-Ads are free to all members. Please include a S.A.S.E. when requesting information. Send applicatins for membership and renewals to Fred Prohl, our treasurer as noted above.

## IHRS ACTIVITIES for 2001. our 30<sup>th</sup> YEAR

### IHRS WINTER 2002 MEET - FEBRUARY 16, 2002

**INDIANAPOLIS** at the **HOLIDAY INN SOUTHEAST**, 5120

Victory Drive, 1-465 at EMERSON ROAD, EXIT 52.

All activities are inside. Set up, 6-8 PM Friday. Registration 7 AM Saturday.  
\$5.00 per member/family. Table rental \$5.00 each. Tables can be reserved in advance by preregistering with treasurer Fred Prohl, 3129 Lanam Ridge Road, Nashville, IN 47448.

Two contest categories: Pocket Transistor Radios and 1, 2, 3 volt filament portable tube radios.

Lodging: Holiday Inn, 317-359-5341, (ask for IHRS special rate), Red Roof Inn, (across from the Holiday Inn) 317-788-9551 or 800-733-7663, Super 8, 4530 S. Emerson Ave, 317-788-0955, or 800-800-8000.

Plan on attending a lunch/business meeting at 12:15, Ponderosa Steak House, 5005 S. Emerson, about 1/2 mile south of the Holiday Inn.

Info: Fred Prohl 812-988-1761 or Dr. Ed Taylor, 317-638-1641.

---

### **MSARC ACTIVITIES**

**13-April MSARC Spring Meet, Henderson, KY**

Info: Joe Zahnen, 423-690-5833, zahnenj@esper.com

Days Inn Motel. Info: Jim Church, (812) 867-0721.

Contest categories:

Home-brew Sets & Kits (tube)

Transistor battery sets (non-novelty)

Table Sets, wood, tube (AC-AC/DC) (non-cathedral/tombstone)

Consoles (AC-AC/DC)

Speakers

Radio MFG & Broadcasters in MSARC Area

Ugly Radio

Miscellaneous

**20-July MSARC Summer Meet, Louisville, KY. Derby City Antique Mall.**

Info: Allan Ferris, (502) 543-8233. Contest categories:

Crystal Sets (home brew)

Cathedral Sets, wood (AC-AC/DC)

Table sets, plastic or metal, tube (AC-AC/DC) (no catalin or wood)

Phonographs (no wind-up) & tape/wire recorders (tube, pre 1966)

Accessories

Radio MFG & Broadcasters in MSARC Area

Ugly Radio

Miscellaneous

**11-Nov. MSARC Fall Meet, Lexington, KY**  
Central Kentucky Vocational Technical School  
Info: Joe Vittow, (502) 839-5444. Contest categories:  
Battery sets pre-1931 (all styles)  
Table sets, Repwood, tube (AC-AC/DC)  
Television sets, tube or transistor  
Novelty sets, tube or transistor  
Microphones  
Radio MFG & Broadcasters in MSARC Area ~Ugly Radio  
Miscellaneous

### **NARC ACTIVITIES -2001**

For NARC meet info contact: Jim Thompson, 612-822-4000 or Kip Wallace,  
612-544-2547, [KipWallace@dl-inc.com](mailto:KipWallace@dl-inc.com)

### **ARCI ACTIVITIES - 2001**

**All meets at Elgin, IL, RAMADA INN, 345 River Rd. 847-695-5000. DEC 16,**  
Swap meets.

**Info: Tom Klienschmidt 847-255-8128 or Art Bilski 630-739-1060,**  
[OLDRADIO@NTSOURCE.COM](mailto:OLDRADIO@NTSOURCE.COM)

## **FROM THE PAST PRESIDENT**

Herman & Shirley Gross

Congratulations to the new officers for year 2002....our 31ST year. IHRS is in good hands. Shirley and I wish to express our gratitude to all the wonderful people we've worked with these past years. In retrospect, it's been fun, and we look forward to seeing all of you at our coming meets. I hope to have more time to work on radios and perhaps even enter one of my "gems" in a contest, something I've never had time for in the past.

We really enjoyed the Fall Foliage meet in Greenfield. The weather was superb as was the setting. Too bad many people got scared off due to the threat of rain. The business meeting, the last one I had to conduct, went well enough considering I had to "wing" it since I left my briefcase at home with the nicely printed meeting agenda in it!

I want to thank everyone who expressed their concern about my condition after my recent heart surgery with your prayers, cards, phone calls, e-mails and flowers. They meant a lot to me and were especially soothing during my first week or so of recuperation. I'm happy to report that I'm walking 1.5 miles each day and my breathing problem is diminishing daily.

Shirley and I won't fade into the woodwork. You'll find us at every meet we can possibly make. Our IHRS friends are golden.

## Comments from the Editor

Ed Dupart

I thank Herman Gross and George Freeman for all the time and energy and great things they have done for the IHRS and I look forward to seeing them at future meets!

Enclosed are some fine articles that represent a lot of hard work.

I will welcome all suggestions for improving the Bulletin.

Please use e-mail or regular postal mail for sending articles and information to me. If you want to send me articles on a 3 ½ or 5 ¼ floppy, that's great, too. I can work with virtually any word-processing program for DOS or windows designed for IBM compatibles. Please send computerized pictures in a BMP, JPEG or TIFF format. Sorry, I'm not set up for Mac or Apple. Typewritten articles are fine, too, because I can scan those into my computer. I will be looking for pictures of unusual radios from inexpensive to expensive radios that you normally don't see at shows for a picture gallery in the Bulletin, plus your favorite photos.

If I make a mistake, please forgive me, but please let me know so I can correct it.

Ed Dupart

### 2002 DUES NOTICE!

Your Indiana Historical Radio Society membership is now due if your mailing label reads 12/01.

Please send a check payable to the *Indiana Historical Radio Society* in the amount of \$15.00 for a one year membership or \$25.00 for a two year membership.

Send your payment to:

Fred Prohl, IHRS  
3129 Lanam Ridge Road  
Nashville, IN 47448

Please include your current mailing address, if not on your check, and your email address, if you have one.

Questions concerning your membership should be directed to Fred at [fpohl@att.net](mailto:fpohl@att.net) or call him at 812 988 1761.

## **IHRS Business Meeting Minutes – October 13, 2001**

IHRS President, Herman Gross, opened the meeting at 11:50am. The minutes of the IHRS Elkhart meeting were read and approved. The treasurer's report was read as follows:

Account balance reported 6/23/01 was \$6008.61

Debits since include postage	- \$167.65
5yr internet ID	- \$125.00
Insurance	- \$377.00
Envelopes, labels, name tags etc.	-\$96.18
Bulletin, postage	-\$518.41
Credits (membership dues)	+\$125.00
IHRS account balance as of 10/07/01 is	\$4849.37

The Elkhart and Noblesville meet expense/income are not included in this report.

Under old business a motion was made and passed to place the results of the Davey estate gift in the IHRS account. The gift consisted of radio and test equipment items from Mr. Davey's collection, sold at Elkhart meet silent auction.

*Discussion:* The Bulletin, publishing schedule, and color versus black and white pictures.

*Discussion:* Not all members have picked up their free IHRS 30 year commemorative coffee cup. The secretary will have the cups available at the Indianapolis Winter meeting with the hope that most members will receive their cup with out having to consider mailing. (Meeting follow-up note. Cups will be mailed to members wishing to receive the cup before the end of the year. The cost will be \$5.00 for the mailing. Contact Fred Prohl.)

*Discussion:* Four or five IHRS meetings in 2001? Herman Gross reported unanimous response for only four meets per year. Also discussed was the operating radio contest. Strong support was stated for continuing the contest. Placing the contest in the Spring meet had support from the attending members. The Greenfield contest results were given by George Freeman.

The IHRS 2002 officer candidate list was presented.

Nominations were requested from the members. No additional nominations were presented, a motion was made and passed to close the nominations. A motion was made and passed to unanimously accept the candidates as presented.

The 2002 IHRS officers are:

President – Terry Garl

Vice President – Bill Morris

Secretary/Treasurer – Fred Prohl

Editor – Ed Dupart

Historian – Dr. Ed Taylor

Museum Curator – Fred Schultz, Marcella Schultz

A thank you was given and applauded for the service of President Herman Gross and Vice President George Freeman. A special thanks (in his absence) was given to Bob O’Friel for his years of service to the organization as the Bulletin editor. (Bob and Carol were not able to attend the meeting; Bob is recovering from a fall.)

A thank you was given to those who provided the great “pitch in food.”

The meeting was adjourned at 12:30pm.

Submitted by Fred Prohl, IHRS Secretary

**Coffee cup, FREE** to all IHRS members. Initially presented to attendees at the Spring IHRS meeting, this attractive coffee cup commemorates the Society’s 30 years of celebrating Radio History.

Not able to pick up your free cup? Would like to have the gift before Christmas? Send a check payable to Indiana Historical Radio Society in the amount of \$5.00 (for postage) to Fred Prohl, IHRS, 3129 Lanam Ridge Road, Nashville, IN 47448. Fred will send you a cup.

A second cup can be purchased for \$5.00 plus \$5.00 shipping (\$10.00 total)

Cups will also be available at the Indianapolis winter meeting!

### In Memory of:

**Marshall Howenstein**, 100 years old, a resident of Westminster Village died at 2:45 PM Thursday, Nov 29, 2001. This is all the information that was sent to me. Marshall was one of the founding fathers of the IHRS.

**WILLIAM H. HUNTLEY Sr.**, 85. Coatesville, died Oct. 9. He was the owner 40 years of Huntley’s Bait & Tackle, New Winchester. He also had been a mechanic 25 years for Hedge’s Pontiac. Mr. Huntley was a member of Groveland (Ind.) Masonic Lodge. Memorial contributions may be made to Riley Hospital for Children. Bill Huntley was active in the IHRS during the 1970’s and 1980’s. His amateur call was K9YKF.

### News from the Museum

By: Fred Schultz

The Indiana Historic Radio Museum is happy to report that we’ve had a very successful year and as of the first of November we end our summer hours and return to our Saturday only winter hours. We have had another great summer



season with October, as usual, being our busiest month. We have been fortunate enough to have received many rare radios from the Ross Smith collection, including early Deforest items. Serge Krauss has been a great help in adding to our crystal set and light bulb displays. The museum has now been open for 6 years, (where has the time gone?) we have had visitors from every state in the union plus over a dozen foreign countries. We now feel it is time to make some major changes, therefore we will be closed during the months of January and February to completely reorganize the display. Anyone wishing to contribute items for the display, now is a good time to do so.

If you have not visited the IHRS Museum you have missed something special. In the 6 years we have been open thousands have passed through the museum. During this period of time we have not received one negative comment in our guest register. If you are planning a trip, stop by and visit us. There's so much more to see in Northeastern Indiana. It is the center of Indiana tourism, located within 20 miles of five of the six longest highways in the US. US20, US6, US30, I90, and I80 in that order. The Museum is located in Noble County which contains over one hundred lakes, more than any other county in the state. We are in the heart of Amish Country with the single largest Amish population in the USA being 14 miles to the north. Shipshewana has the states largest Flea Market, with over 30,000 visitors coming every Tuesday and Wednesday, May through November, many of them stopping by to see the Radio Museum. 20 miles to the west is Nappanee, home of the largest Antique Mall in the US. 28 miles to the east is Auburn, home of the world famous Auburn-Cord-Duesenberg car museum, also located in Auburn is the National Truck Museum of the United States, the IHRS has several radios on loan there. When in the area, the Das Dutchman's Essen Haus Amish restaurant is the place to eat, seating over 1,400. It is the second largest restaurant in the USA attracting visitors from around the world. These are just a few of the many attractions that make for a great vacation, so keep us in mind if you are coming to our neck of the woods. For Museum information, contact me at 219-894-3092 or 3779. [Olradio@ligtel.com](mailto:Olradio@ligtel.com)  
Fred Schultz, IHRS Curator

## Articles

### **“One Of A Kind” Trav-Ler Radio**

by Fred Prohl

Visit the Lawrence County court house in Bedford, Indiana and you'll discover a small museum in the court house basement. And, as I did, you will see a display of several radios. Like many community museums the items on display are from the region. So I inquired why an unusual looking Trav-Ler clock radio was on display. I was told it belonged to John Bridges, a Bedford resident, who at one time worked at the Trav-Ler radio assembly plant in Orleans, Indiana.



The radio, as the picture indicates, has a marbled plastic case with a Telechron clock in the center. I called John and scheduled a time to talk about his experience at Trav-Ler.

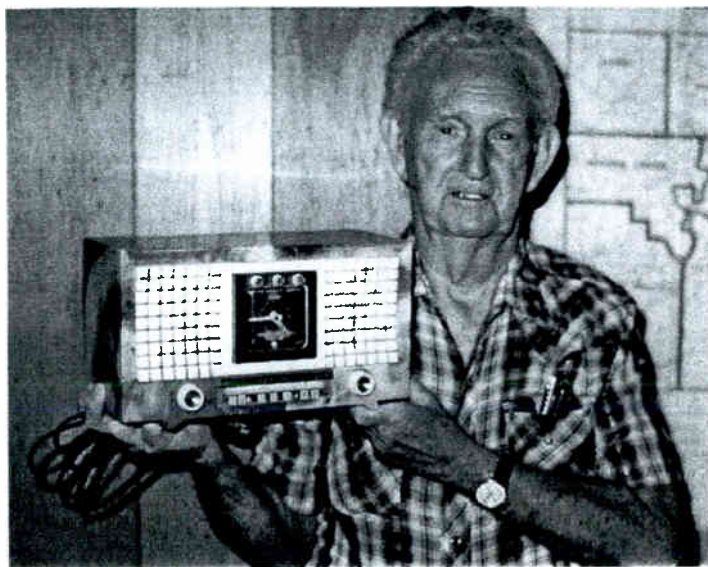

**John Bridges in the Lawrence County Museum**

John's career in radio began in 1932 at an appliance store. His boss got him started in a home study National Radio Institute course so John could repair radios sold at the store. As his career progressed he worked for the International Radio Corporation, Ann Arbor, Michigan, responsible for assembly testing. International Radio Corporation stopped radio production in 1939 to concentrate on producing the Argus Camera. (There is an International Radio Corporation radio on display at the Bedford museum.) In 1941, following two years of operating a radio and camera shop, John joined RCA in Bloomington, Indiana as an electronics trouble shooter where he quickly advanced to a production line foreman position. His experience at RCA during World War II included working with Chief Engineer Sarks Tarzan on production projects and developing a wartime program for training women in radio electronics.

In 1945, Joe Freedman opened a Keith radio assembly facility in Bedford, Indiana. (A 1950 Polks Directory listing identifies the company at Keith Radio Products, 1604 K Street, Bedford.) The building is now a furniture store. John said the name "Keith" may have been after Joe Keith, a coil winding foreman. Keith Radio assembled products primarily for Trav-Ler Manufacturing Corporation, Chicago. Employees were considered Trav-Ler employees (wore

Trav-Ler badges). John Bridges joined Trav-Ler Radio Products in 1946 as foreman in charge of production.

In 1946, Keith Radio Products moved most of its production to a facility in Orleans, Indiana (about 15 minutes south of Bedford.) At the new location, the company assembled radios, televisions, and phonographs for Trav-Ler, and other brand names like Sears and Montgomery Ward. The Orleans facility eventually contained about 10 acres of space.



**Keith building in Bedford**

Engineering and product development for Trav-Ler remained in Chicago. John indicated as production manager he would receive the current circuit and chassis design from Chicago engineering and the responsibility for producing the new design was placed in his hands. The Orleans plant did not have production or industrial engineering support. The assembly department did it themselves. None of the radios produced in Indiana have an Indiana production identification. All the Trav-Ler products (all that I have seen) have a Chicago production tag. John told me that all Trav-Ler radios, record players and televisions were made in Orleans. The exception was for about one year, during 1948, when some production was completed in Los Angeles. The LA facility was shut down in 1949 and parts were shipped to the Orleans plant.

In the early 1960's it was a shipment of radio cases for the model 56C45 Trav-Ler clock radio that contained a strange appearing marbled plastic case. Evidently the supplier's molding operation tossed a mixture of colored plastic in the hopper – resulting in something very different from normal. An assembly line employee was about to throw it away when John rescued the case and instructed the line to assemble the radio. John saved the “one of a kind” radio

and eventually gave it to the Lawrence County museum for display as a memento of Trav-Ler production in southern Indiana.

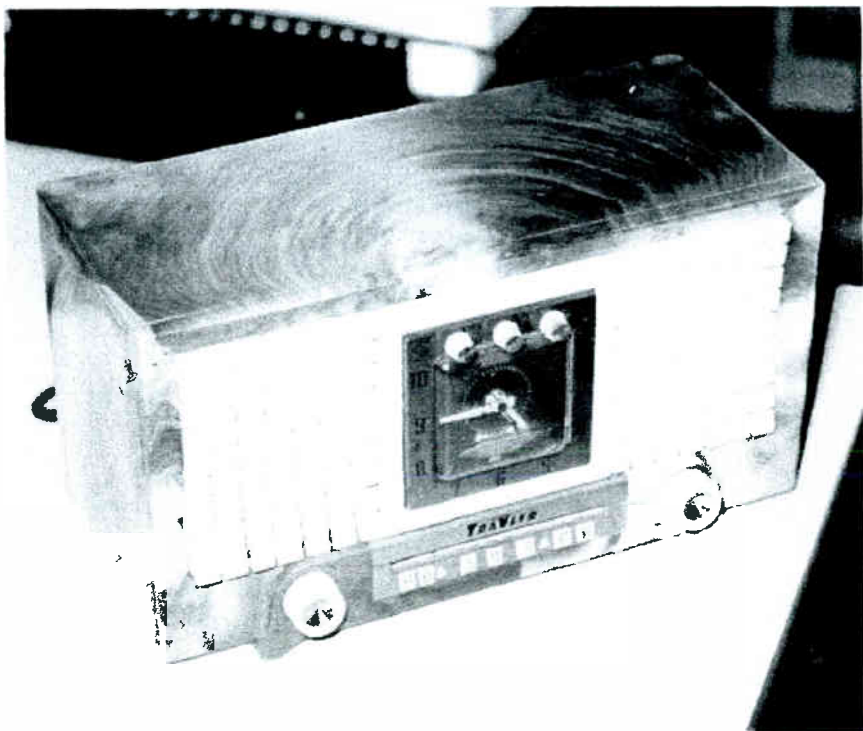

**The "One of a kind" Trav-Ler radio**

Production in Orleans continued through the transition from tube circuitry to transistor circuits until 1974 when the plant shut down. In the late 1960's and early 70's the production plant experienced a series of new owners beginning with Hoffman Products Corporation, Cortron Industries in 1972, and finally the Admiral Corporation. Admiral closed the plant in 1974.

Firmly planted in southern Indiana, John Bridges developed a second career (18 years) as owner and producer of the "Kozy Fireplace."

Consistent with our throwaway society there is very little left that documents the Keith Radio Corporation and its association with Trav-Ler. The ESSEX corporation now owns the Orleans facility.

Following a remodeling project ESSEX saved a front step board as an artifact. Mounted on the step board is a brass plaque that reads as follows:

## A PIECE OF HISTORY

THIS STEP, PART OF THE ORIGINAL BUILDING BUILT ABOUT 1900, WAS REMOVED FOR EXPANSION OF OUR WIRE MILL IN MAY, 1993. ORIGINALLY BUILT AS A FURNITURE FACTORY, IT BECAME A MAJOR SOURCE OF RADIOS, TV'S, AND PHONOGRAPHS FOR MONTGOMERY-WARD, WESTERN AUTO AND DISCOUNT DEPARTMENT STORES. A QUARTER OF A CENTURY AGO, ADMIRAL CORP. EMPLOYED 2500 EMPLOYEES IN THIS BUILDING ON ONE SHIFT.

DECEMBER 1, 1993

### Trav-Ler Notes:

Bunis 3<sup>rd</sup> edition

Douglas III pg 215

Douglas III pg 208

Trav-Ler Karenola Radio&Television Corp.  
571 West Jackson Boulevard  
Chicago, IL  
1928 Trav-Ler Portable  
Trav-Ler Manufacturing Corporation  
Dept K 3401 North Halsted Street  
Chicago, IL  
Operadio Sold patent to Trav-Ler  
Trav-Ler, maker of portables since 1926

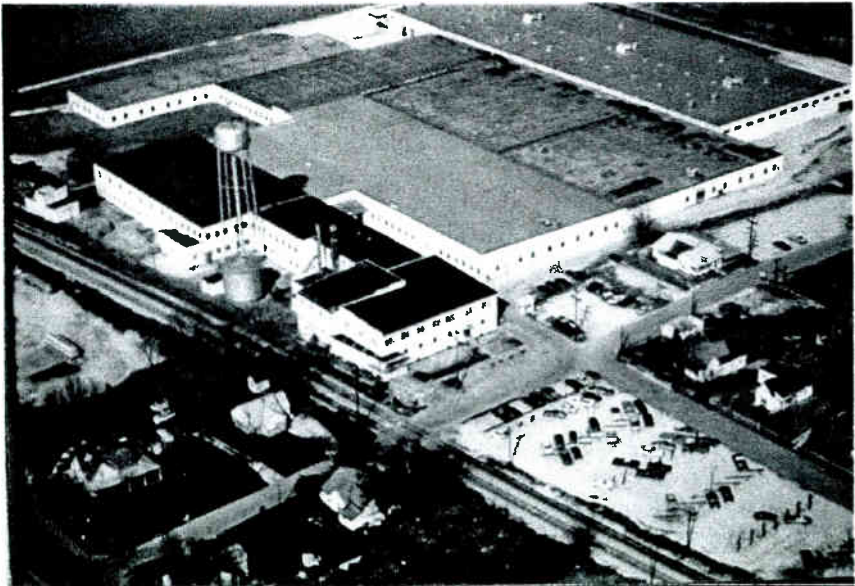

Trav-Ler facility in Orleans



## Photo Gallery

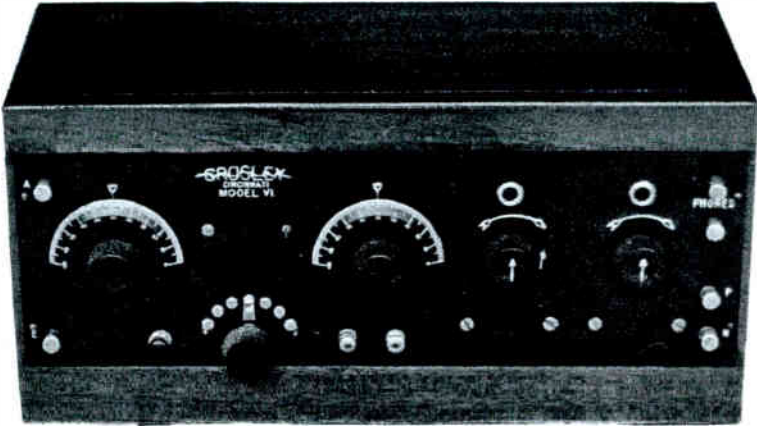

Crosley VI in a Mahogany cabinet with room for batteries. 1923 vintage.



Crosley V 1923 Notice the 7 tap band switch.

The pictured Crosley's have ceramic tube sockets, wood book condensers and cylinder/solenoid coils, while the 1924 versions have bakelite sockets and flat spiderweb coils. The pictured Crosley V has a hole in the top to allow the use of a tall tube. At a later date, and if members want, I will write a more in depth article on early Crosleys with schematics.

## Articles

### A Self-Contained “67.5 volt B Battery” for Portables by Tony Maher

Here's an article for you. I have permission from Tony Maher to reproduce it for our bulletin. I would add this note to the article— I have bought three complete kits from Mr. Maher. They are fairly easy to assemble and, if the instructions are followed carefully, will work the first time power is applied. Bill Morris

Not only will this unit work with the standard 467 battery packs, but can be adapted for A-B combination packs used in Zenith Trans Oceanics.

Complete kits including instructions, parts and circuit board can be obtained from Mr. Maher. Either contact him via email or his home address.

This article describes the construction of an AA battery powered 67 1/2 volt “battery”. This new rechargeable “B battery” is slightly smaller than the original Eveready 467 battery and is the same weight. The substitute battery can be made in different voltages and can be powered from a wide variety of sources.

***Warning:** this unit generates voltages which can in some circumstances be lethal. Take all precautions.*

The immediate forerunner of today's transistor portable was the Personal Portable of the late 1940's and early 1950's.

Many of these were very attractive sets. They used miniature 7 pin valves and were powered by small Eveready 67 1/2 volt batteries, but they were expensive to buy and to run.

With the advent of the transistor radio in the late 1950's they disappeared from common usage and sight.

Today the small 67 1/2 volt batteries that powered these sets are no longer available and the collector has the choice of soldering together seven or eight 9 volt batteries or making a mains powered power supply.

Neither choice is a good one.

The first at about \$30 to \$40 a time is expensive, and the second takes away the portability which was one of the major attractions of these, the smallest valve receivers ever made.



A year ago, during a visit to the hills around Melbourne, the writer obtained a small cream AWA Personal Portable Model 450-P made in 1948. This radio uses two D flashlight cells for its filament supply and a small 67 1/2 volt Eveready 467 battery for the B supply. D batteries are, of course, readily available but not so the B battery. This focused the author's mind on a suitable B battery replacement. I sought out on the internet a suitable design. I found many mains powered battery eliminator designs and a few suitable battery powered ones for portable use, but none that fitted inside the set in the place occupied by the original battery. The final effort was to design my own. This was not a simple task. I wanted a simple solution that did not involve metalwork or shielding, that was easy to make, cheap to build and run, and could of course happily coexist with and within a small valve portable radio. Switching regulators could be used but the author's experience of these in the past had shown him they were a potent source of Radio Frequency Interference (RFI). Cast aluminium boxes, filter chokes and miniature metalwork loomed on the horizon. Luckily the space requirement ruled out this approach.



Once the switching regulator approach had been discarded a 50 hertz inverter was considered. The lower frequency would make RFI problems much more manageable and ordinary power transformers could possibly be used.

Serendipity then entered the scene in the form of a magazine advertisement for "on special" IOVA toroidal power transformers . These were cheap at \$10 and they had two 6 volt, and two 120 volt, windings. Toroids are efficient, small, and have very low external fields. I ordered two. Oh how I wish I'd ordered more....the price has now more than doubled....

This transformer forms the basis of the final design. Power is supplied from 4 or more AA NiMH batteries, depending on the output voltage required.

Other power sources that can be, and have been, used include AA alkaline batteries, AA NiCad batteries, lead acid batteries, non regulated voltage adjustable power packs, and regulated voltage adjustable power packs.

Personal Portable radios were designed to operate over a wide B battery voltage range. Batteries were expensive and the radios were designed to extract the maximum amount from the battery before it was discarded. Typically radios were designed to continue operating with B battery voltages 30% or more below their nominal voltage.

This unit will continue to operate when the individual AA cells are below 1.0 volt. This corresponds to an output voltage of 40 volts.

A set of four AA NiMH 1 600maH rechargeable batteries will supply the B battery needs of the authors AWA 450-P Personal Portable (67 1/2 volts at 8.Oma) for nearly 10 hours at a B battery cost approaching zero (assuming of course you already have the batteries).

The unit will give 15 hours or more of operation from a \$2.50 set of Chinese made AA Alkaline batteries. The unit can be used with extra AAs as a 90 volt battery or as a 108 volt supply. With a switchable 1 amp plug pack it can be used as a variable bench supply.

Note 1: An Eveready Type 467 MiniMax 67 1/2 volt battery is 94 x 71 x 35mm. An Eveready Type 482 MiniMax 45 volt battery is 140 x 89 x 44mm.

#### **Circuit operation.**

2 parts of a Cmos 4011 quad nand gate U1a and U1b are used as a square wave oscillator. The frequency of the oscillator is not critical and is set by the capacitor C1 and the resistor R1. Another nand gate U1c is used as a buffer between the oscillator and the gate of a Mosfet Q2. The last nand gate of the 4011 U1d is used to supply an inverted signal to the gate of another Mosfet Q1. When its gate is driven positive by the buffered output of the oscillator each Mosfet in turn passes current through it's portion of the primary of transformer T1. The transformer steps up the voltage and supplies it to a bridge rectifier D1- D4 and

filter capacitor C2. Because the voltage from the transformer is a square wave, with only a small time between each half cycle, there is little ripple on the output and only a small filter capacitor C1 is required. R4 discharges the capacitor C1 in the event of there being no load connected.

The toroidal transformer has two 6 volt windings which are connected in series. These are driven by the Mosfets.

It also has two 120 volt windings which are connected in parallel. Resistors R2 and R3 perform a number of roles and should be located as close as possible to the gates of their respective Mosfets. Their first role is ensure that one Mosfet is off before the other turns on. They do this in conjunction with the gate to source capacitance of each Mosfet by slowing the rise and fall times of the square wave which is fed to each Mosfet. They also minimize the amount of RFI generated and prevent high frequency oscillations from occurring in the gate circuit. Resistor R5 prevents destruction of the 4011 I.C. in the event of the battery being connected the wrong way around. R6 and D6 provide a Power on light for the unit. Q3 acts as an on/off switch. It enables the unit to be turned on and off by a small current. A normal toggle switch can be used in its place but it is often desirable to have switching performed by small low current contacts. Low current reed switches can be fitted to doors lids etc. so that the unit turns on automatically when a door or lid is opened. Reed switches would stick if used to directly switch the current required by the unit. D5 and R7 are used to protect the gate of the Mosfet from being damaged by static.

Experienced readers will have noted that this circuit is very similar to that of the Vibrator power supplies long used for battery operated radios and car radios. The plugin vibrator unit is replaced by the 4011 and the two Mosfets.

The 4011 oscillator acts as a replacement for the vibrator's reed and the 2 Mosfets act as the vibrator's contacts.

The author is currently adapting this design to act as a plugin vibrator replacement.

### **Mechanical construction**

The unit is built around the toroidal power transformer. The power transformer is designed for printed circuit mounting and advantage is taken of this to mount a small fibreglass matrix or printed circuit board to the pins of the transformer.

All components are in turn mounted on this board. The battery pack is fastened to the flat side of the transformer with double sided carpet tape or Scotch VHB tape or similar.

Clear 1.6mm thick polycarbonate plastic is cold folded into a U to create the correct size envelope for the "battery" and to provide insulation.

This envelope is held in place with a 3/16' countersunk screw which passes into the central mounting hole of the transformer. Please refer to the photo and layout drawing.

## **Assembly**

A printed circuit board has been designed for the unit. This is a small board and the tracks on it are likewise small.

You will need a suitable soldering iron with a suitable tip. A Scope or similar high wattage soldering iron will not do. A 25 watt or temperature controlled iron with a small tip is required. Insert components in the position shown on the drawing. Insert Mosfets last. Leave Mosfet leads at maximum length. Refer to the photo as necessary. All diodes and all resistors are mounted vertically because of limited space. Observe the way each component is fitted in the photo and copy.

Test pins are fitted on the perimeter of the board and the input, output and switch leads are soldered to these pins.

Note: One switch lead shares a common pin with the + input lead.

There are four wire links on the board. One link runs along the top of the IC.

The other three links are on the copper side of the printed circuit board.

Join pads labeled A to A, B to B, C to C and D to D.

## **Testing**

Warning~ this unit generates voltages which can in some circumstances be lethal. Take all precautions.

Care should be taken with the wiring to ensure it is as per the circuit diagram.

Great care should be taken to avoid shorts and dry joints.

Buy new glasses if necessary. Visually check and check again.

Is the polarity of the electrolytic capacitor correct? Is the IC or one of the Mosfets around the wrong way?

Note the Mosfets. One is reversed in orientation to the others.

Are the 4 diodes the correct way around? Does the bar on the zener go to the outer edge of the board?

Do you have the correct resistors in the correct places?

Check your colour codes.

Make sure the transformer is the right way around. 6 volt windings should be near the Mosfets. Make sure each individual AA cell is correctly inserted in the battery holder.

Make sure the battery pack is connected with the correct polarity.

The unit will withstand polarity reversals of short duration but don't leave the battery reversed for minutes rather than seconds.

The author has constructed 6 units and all worked first up so it's not too hard.

The good news is that it's pretty difficult to permanently damage any of the parts... but... stand by for the emails from those who "succeed". If you have a voltmeter or DVM select the 200 volt range and connect it across the output. Fit the batteries and briefly touch the battery connector to the battery pack terminals. Voltage should immediately appear. If not inspect and inspect again.

**WARNING:** If you are fitting the unit to a battery powered portable take great care with the battery plugs particularly if you do not have the original batteries. Many portables had combined A and B batteries, others had separate plugs. Colour codes on battery plugs can be different to what one would expect.

Using a DVM on ohms range check the battery plug and locate the filaments. If the filaments are in a series chain remove a valve to confirm you have the right leads. If in doubt don't connect the unit but trace the wiring instead.

The polarity of the A battery is important. If no sound is heard, or if only a brief burst is heard, try reversing the two A battery leads. My hope is that by using this design and future ones we can wake these beautiful little sets from their long sleep and once again freely use them as the portables their designers intended, and at a running cost much lower than ever before possible.

**all correspondence will be entered into.....** email to [tmaher@ detection.com.au](mailto:tmaher@ detection.com.au) or send a stamped self addressed envelope to: Tony Maher  
31 Barossa Ave, Vermont South Vic, Australia 3133

*Editors note: This article first appeared in the April 2001 issue of "Radio Waves" ~ the official publication of The Historical Radio Society of Australia and is reprinted here in it's original form with the author's permission. It came at a time when our club President, Frank Simonsen, and I were both struggling with this problem and offers an entirely new solution. I hope you have enjoyed it as I have.*

*K Allison – editor of Radio Waves*

## PARTS LIST

- C1 Capacitor 330nfd MKT type
- C2 Capacitor 100mfd 160 volt small or Capacitor 47mfd 250 volt small
- D1 - D4 Diode 1N4007
- D5 Zener Diode 1N965 15 volt
- D6 5mm Red led of reasonable brightness
- Q1 - Q3 Mosfet MPT3O55E
- R1 Resistor 15k ohm 1/4 watt
- R2 - R3 Resistor 100k ohm 1/4 watt
- R4 Resistor 470k ohm 1/4 watt
- R5 Resistor 100 ohm 1/4 watt
- R6 Resistor 1k ohm 1/4 watt
- R7 Resistor 10k ohm 1/4 watt

SWI Reed switch normally closed type. This is used as an on off switch for the unit. A small Dip or microswitch can also be used. An existing B battery switch on the radio can also be rewired to perform the function.

The existing B battery wire from the switch should be directly connected to the +ve output of the unit. **WARNING.** Take care when rewiring an existing switch. Do not under any circumstances connect the output of the unit to the A battery or filament circuit. Valves will be destroyed if this occurs.

Ti Toroidal Transformer I OVA Powertran M43 12 Two 6 volt windings plus two 120 volt windings. Available from Altronics Perth or Elstronics Christchurch.

U1IC Cmos 4011BP

Also the following hardware:

Battery holder suitable for 4 AA batteries (or more if higher voltages are required.)

Doublesided tape or suitable glue for mounting the battery holder to the transformer.

Polycarbonate or similar insulating material for forming into a U shape to insulate and protect unit.

3/16" screw for mounting same to transformer Suitable Nickel Metal Hydride, alkaline, Nicad or lead acid batteries.

A printed circuit board for the unit has been designed and is available from the author.

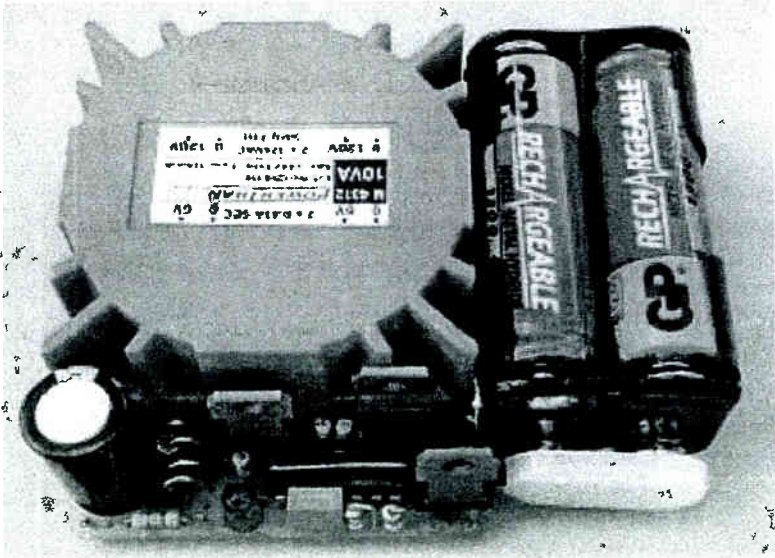

CIRCUIT OF THE 'B' BATTERY

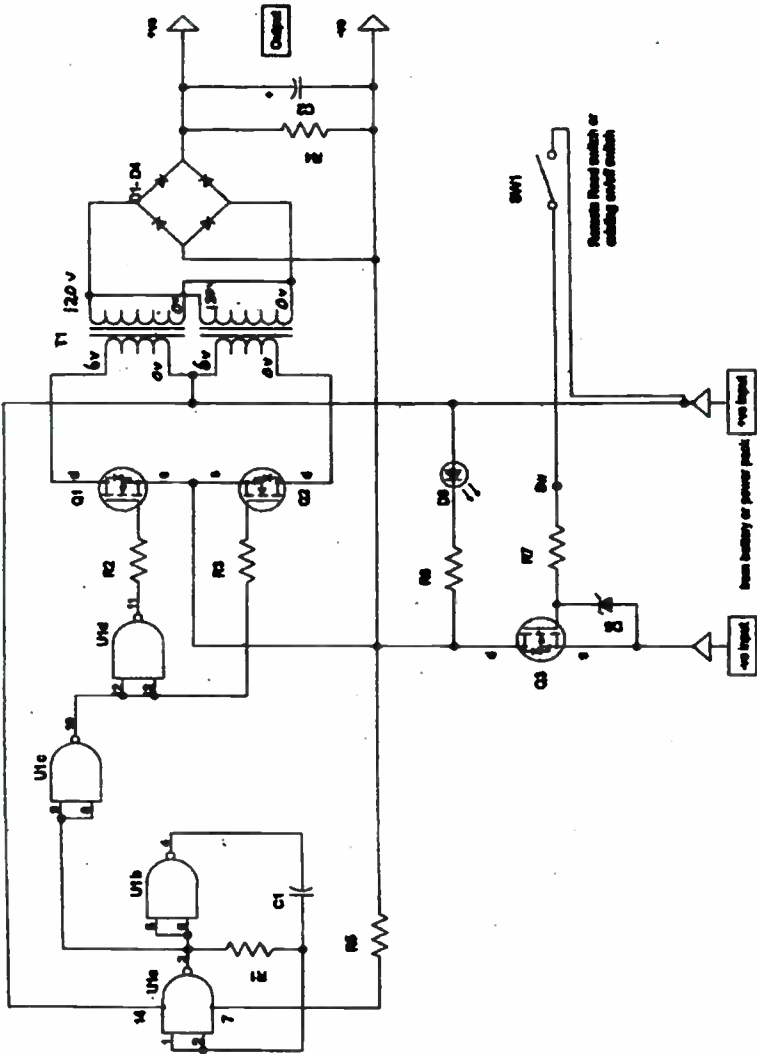

Schematic of the 67.5 volt B-battery for Portable Radios

## “EV-RA-LAB”, Evansville, IN; A Collaboration

by George A. Freeman

(Editor’s Note: This article appeared in the last Bulletin, minus the pictures. I really wanted to keep the pictures and the article together.)

This is a story of collaboration. (to cooperate, to work together toward a common end).

Collaboration between a 19th century born father and his 16 year old twentieth century son.

Collaboration in the 21st century between three Hoosiers, a Buckeye, and a Kentuckian; members of two different regional vintage radio clubs.

### The early 1920’s Collaboration:

W. E. “Jack” Martin was a telegraph operator, and dispatcher at L&N Railroad from 1889 until he retired in 1938, a period of 49 years. He was 53 years old in 1921 when his 16 year old son, George F. Martin, must have been completely immersed in the new “thing”, radio! Jack spent a great deal of quality time with the boy, learning of the potential of this toy for something more important than play. Perhaps Jack had heard of Marconi experiments employing radio waves as communication devices for trains. Perhaps the father envisioned wireless having potential for elimination of his own job. The son was able to communicate his enthusiasm and a degree of what seemed sophisticated knowledge of the new medium to his dad. The father opened his mind to the boy’s obsession. Mutual enthusiasm of the father and the son lead to a business venture, “EV-RA-LAB”, shortened version of “Evansville Radio Laboratories” named for the town to which they had just moved, Evansville, Indiana. So committed was the father to the venture that he risked serious portions of his telegrapher’s paychecks to the early manufacturing and marketing of radio sets and components.

Note, in Figure #1, EV-RA-LAB makes or markets the filament control. The complete unit including cabinet costs \$12.00. In Figure #2 two months later, the Rheostat is made by Paragon and the cabinet is priced an additional \$3.00, a 25% price increase! A first blush of optimism is implied in the appeal to dealers and the added production that could result. And, note the addition of an amplifier unit A-2, priced at three times the Type “D”. By March the only component made or marketed exclusively by EV-RA-LAB is the switch arm, not as difficult a process as the filament control.

Did the collaboration bear fruit? Young George did not find a job in radio manufacturing. But he did work all his life in the printing business. We venture this possibility. The same ads you see may well have become part of a dossier the boy used to secure his job in the printing business. Was the banner headline, WATTS THE YOOSE” young George’s idea? Copy in a January, 1921 QST ad claims, “The EV-RA-LAB Type ‘D’ is a neat and highly efficient instrument



with its price within the range of all. Has a seven point switch for varying the high voltage battery. This is absolutely necessary when soft or receiving tubes are used. This detector may be used with any type of tube on the market." Were some of these the boy's words? It's reasonable to assume that some of the ad layouts manifested George's thought processes, that his prospective employer was impressed, and the boy won his job in what we know turned out to be a lifetime career. The father/son collaboration provided abundant fruit.

### The 21st century Collaboration:

The author, during the 1990s, came across a coverless March, 1921 Radio News at a vintage radio meet and bought it for perhaps \$3.00. Inside was the ad beginning "WATT'S THE YOOSE.." (Figure #2) Earlier, Indiana Historical Radio Society (IHRS) co-founder, Jim Fred of Cutler, IN, well known vintage radio writer and entrepreneur as "Antique Radio Laboratories" paid a Californian an above-average price for a coverless 1921 QST. The reason Jim overpaid was because of a long letter he received sometime between 1970 and 1980. The writer told Jim about his boyhood days as a 16-year-old radio manufacturer. The correspondent revealed EV-RA-LAB bought ads in QST magazine in 1921. The man, whom Jim and the author are now assuming was George F. Martin, did not go into radio, but instead "went to work for a printing company". Jim may have lost the letter but he recalls clearly many salient facts which he relayed to the writer in a note dated June 27, 2000. Jim was responding to an ad placed by the writer in the June "Antique Radio Classified" for an EV-RA-LAB artifact. Jim has one. It was sent to him by George Martin. It's a rubber stamp for EV-RA-LAB.

As soon as last year's Mid South Antique Radio Collectors (MSARC) meet was over at Henderson, KY last year, the writer drove across the river to Evansville and spent two days at the city's two libraries researching EV-RA-LAB. We found the address listed for the firm, (a) learned that many city street names, and addresses had been altered in 1929, and photographed the old home sites with the new street names. We did not find any reference to EV-RA-LAB even being in existence. Could it be that Jack's enterprise would be construed as moonlighting by the railroad? Ergo an employee serving two masters. If so, publicity would be avoided to protect the income funding this speculative radio enterprise.

We did find Jack's obituary in the Evansville Courier dated March 23, 1952. He died at the age of 84. His wife of 53 years, Cora, died three months later. Survivors included a daughter, Mrs. W.A. Herron and a son, George F. Martin. And, among the notes of the author, the fact that George lived most of his life at Newburgh, IN (near Evansville), and "worked for a printer".

The writer visited the Evansville address in the 1923 QST and Radio News EV-RA-LAB ads, 1103 South Third St. The building is no longer in existence. Judging by adjacent and nearby properties the home of EV-RA-LAB probably was in the basement of a small private residence between Blackford and

Washington Avenue. The post 1929 address would have been 955 Southeast Third St. This space is occupied today by one end of the Stratford Apartments which face Washington Avenue.

In 1925 the Martins moved to 21 Oa Mulberry Street. (b) They moved again in 1926 to 2426 Riverside Avenue, corner of Linwood Avenue where Jack and Cora lived out the rest of their lives.(c) (Figure #3)

Jack Martin was a member of the E.T. Turner Masonic Lodge at Earlington, KY for 50 years and was a member of the Knights Tempter Commandery at Madisonville, KY. Learning this the author called on fellow Madisonville, KY MSARC member Wally Watts for help. We needed a picture of the low-profile entrepreneur!

Wally was in the shower weeks later when the lightbulb lit. He remembered he had saved a reprint of a Dec. 3,1903 "Special Coal and Railroad Number", a magazine section of the "Eartington Bee" newspaper. Earlington had been a leading coal and rail center. Wally found the paper, and Bingo!, learned that Jack Martin had been transferred from Evansville by L&N RR to Earlington in 1900. Then was transferred back to Evansville in the 1920 to 21 period. Thus EV-RA-LAB may have sported a Kentucky name but for a job switch and a few months. And, for our article, Wally found the accompanying picture of Jack sporting his bowler and handlebar mustache. (Figure #4)

Our thanks to Bob Sands, IHRS member/MSARC officer, who patiently explained to the writer the EV-RA-LAB components and their function and manufacturing complexity.

The collaboration continues. MSARC vice president, Jim Church has attempted several contacts to family members, all so far to no avail. You get few "bingos" among the many tries in research. Each blind alley can help eliminate possibilities.

And that brings us to you. George Martin told Jim Fred he donated the only EV-RA-LAB radio he owned to a museum. Next time you visit a museum keep your eyes open. The folks at the museum may not know they have it let alone that it's a radio artifact. So gaze at the pictures, burn them into your brain, and join the collaboration as we search for a real EV-RA-LAB. Flea markets, meets, antique and collectible stores, you know the drill. Thanks in advance to you, and to Wally Watts, Jim Fred, Bob Sands, and Jim Church for their efforts.

(a) 1920 Evansville City Directory.

(b) 1926 Evansville City Directory.

(c) (In 1929 this address was re-assigned the designation 738 East Riverside Drive.) 1929 Bennett's Evansville City Directory. © RALOGEUM 2001

## THE LATEST AUDION CONTROL UNIT

A neat and highly efficient instrument which sells at a price within the reach of all.

Price  
\$ **12.00**



The  
**EV-RA-LAB  
AUDION  
CONTROL  
UNIT**  
**TYPE "D"**

### Specifications:

**Panel:** Bakelite XX Dilecto. Size 8 x 9 x 1/2 inches. Handsomely engraved and filled with brilliant white.

**Filament Control:** EV-RA-LAB Standard six ohm rheostat, which provides single turn adjustment.

**Binding Posts:** Nickered with hard rubber tops. Four extra posts are mounted on the Panel so that it may be used with Audio-Trons.

**Vacuum Tube Sockets:** Standard four prong type with Phosphor-Bronze Contactors.

**Miscellaneous:** A seven point switch is provided for varying the plate voltage. A single Gang Pull Switch is used for an off and on switch. May be used with any type of tube on the market today.

*Order from ad or send 4 cents for bulletins describing our Detector and Amplifier Units.*

### EVANSVILLE RADIO LABORATORY

1103 South Third St.

Evansville, Indiana



Type "D"

The EV-RA-LAB Type D Audion Control Unit may be used with any type tube on the market and has a seven point switch for varying the high voltage battery. This feature alone makes this Unit the one for your station. For batteries and tubes see list below.

Price without cabinet, \$12.00

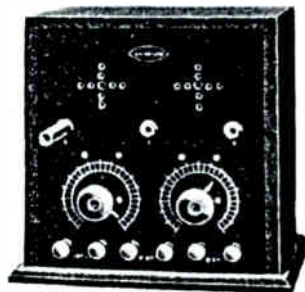

Type A-2

The EV-RA-LAB Type A-2 is a neat and highly efficient instrument, made of the finest materials and workmanship. Give maximum amplification without any interfering noises. The coils have the correct impedance value for modern amplifying tubes. One plug included. For batteries and tubes see list below.

Price without cabinet, \$35.00

The following parts used in the construction of Audion Control Apparatus in stock ready for immediate shipment, PREPAID.

Cabinet, Oak, for above Units.....	\$3.00	EV-RA-LAB Switch Arms .....	.50
A-F Electra Relay .....	5.75	Fermion Panels 5 x 9 x 1/2 .....	.75
A-F Amplifier-Oscillator .....	5.75	Paragon Rheostat .....	1.75
Eveready tapped batteries, 45 volts.....	4.50	Federal Plugs .....	1.00
Burgess, large, 45 V.....	7.00	Federal Jacks .....	.05
Burgess, small, 45 V.....	6.50	Switch Points, per dozen .....	.40
Acme Amplifying Coils, UM.....	4.25	Binding Posts, hard rubber .....	.125
Single Gang Pull Switches.....	.30	20,000 Meter Coils .....	5.75
Marconi Knobs, 1 1/2 in.....	.10	Murdock VT Bases .....	1.00

*Dealers—we have an attractive proposition for you.*

**EVANSVILLE RADIO LABORATORY, 1103 South Third St., Evansville, Indiana**



fig 3



W. E. MARTIN.

fig 4

## New Old Stock (NOS) Parts

By Edward Dupart

At the June meet, Pete Yanczer brought up an experience he had concerning brand new resistors that were 50 or more years old. They didn't check good and were out of tolerance. Not all of them, but enough of them that he checks all resistors before he puts them into a circuit. I have always had the habit of checking capacitors, especially electrolytics before using them, but haven't been too concerned about resistors. We tend to think if it's new, regardless of the age, it's OK. What we don't realize is that there is an internal chemistry that can make NOS parts break down on the shelf or in the drawer. Check those new old stock parts before going to all the trouble of putting them into a circuit.

## Greenfield Meet October 13, 2001

The weather held out and a lot of interesting radios showed up. This is one of my favorite meets because of the location and the weather is cooler. I like the park and the shelter house and many people bring great food to eat. What else could a radio person ask for? Great food, good weather and nifty radios to see buy, sell and swap. The editor.

The following contest results are courtesy of George Freeman:

There were six entries; three in each of the two announced contest categories.

### **Reflex radios:**

First place to Janet and George Freeman for a 1925 Air-Ola JUsT-riTE (Yes, this is the correct spelling! They spelled it this way as a marketing strategy.) of Huntington, WV. The display featured a narrative history of the company.

Second place to George Hausske for his 1925 Harkness Counterflex. Accompanying was a feature article on the radio from a "Radio Call Book".

### **Tombstone radios:**

First place to Dr. Ed Taylor and his 1933 Majestic model 49 "Duo Modern" display. The display included World's Fair context from the period.

Second place to Mike Feldt for his Indiana-made Arvin model 617. 1936c.



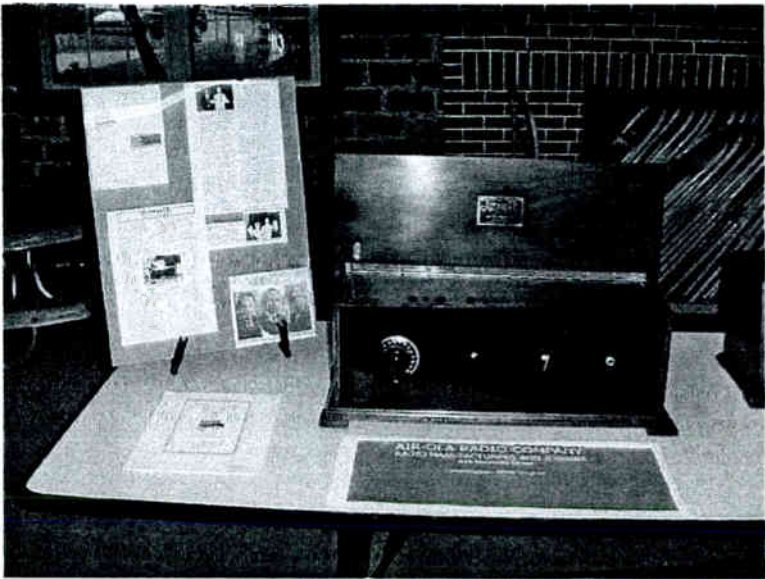

First place to Janet and George Freeman for a 1925 Air-Ola JUst-rITE



Second place to George Hauske for his 1925 Harkness Counterflex





First place to Dr. Ed Taylor and his 1933 Majestic model 49 "Duo Modern" display.

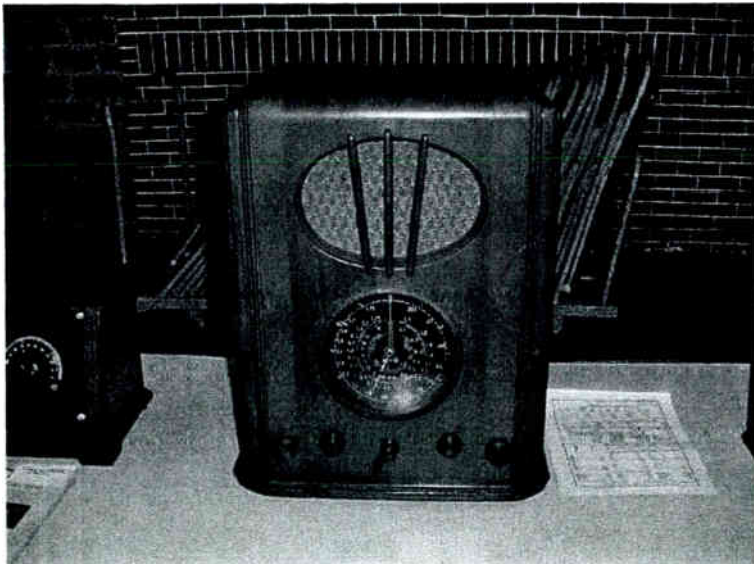

Second place to Mike Feldt for his Indiana-made Arvin model 617. 1936c.

## Noblesville Meet September 15, 2001

The Noblesville meet occurred shortly after the September 11 tragedy and consequently, not too many people showed up, but enough showed up that we went ahead and had the working radio set up. This was a chance for many of us to try out radios that we never had a chance to hear in operation, especially the 1920's vintage variety. It was hard for many of us to concentrate on radios when the recent events were still going through our hearts and minds, but the meet did give us a chance to have a break from all the sad news.

There were two contest categories: Pre-1930 radios and post-1930 radios.

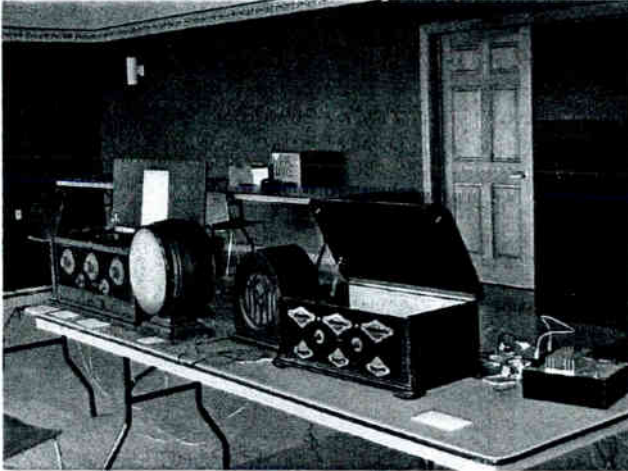

This Grebe won 1<sup>st</sup> place in the pre-1930 radios and belongs to John Howard



This AK won 2<sup>nd</sup> place in the pre-1930 category and belongs to Kelsey Howard, John's daughter.

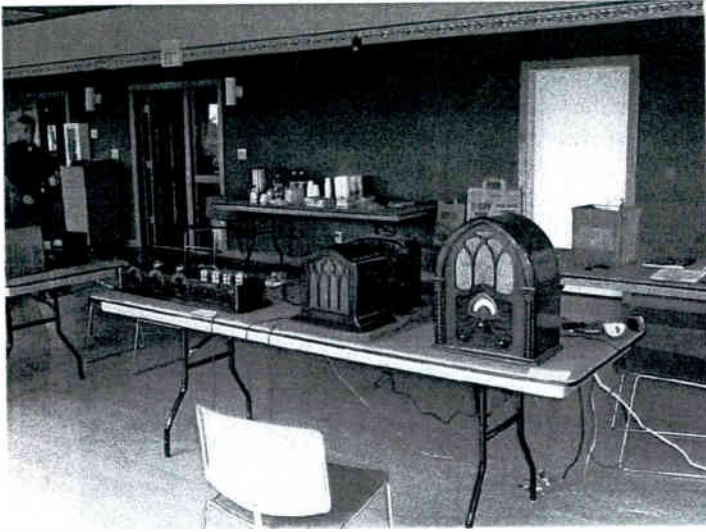

A battery operated AK 82Q cathedral owned by Mike Feldt won 1<sup>st</sup> place for radios 1930 and newer. Too bad this isn't in color, because that Neutrodyne was a pretty blue! They both sounded pretty good, too!

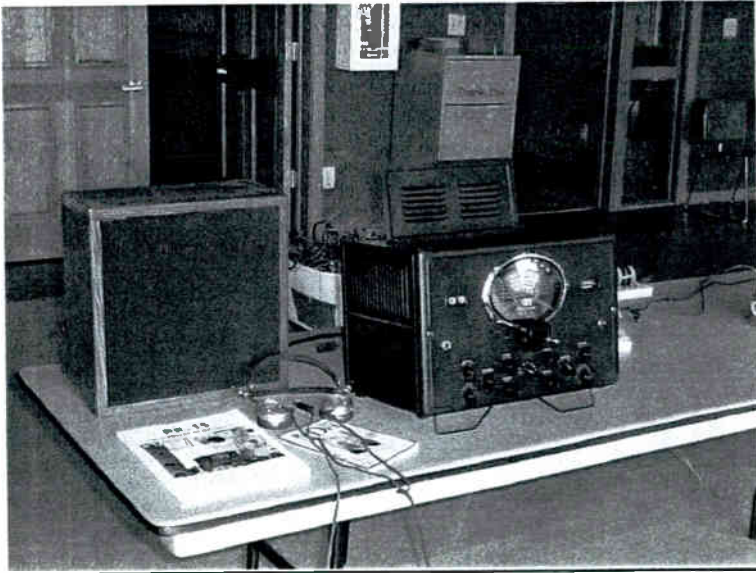

Steven Starr owns this 1937 Patterson PR-15 that won 2<sup>nd</sup> place in the 1930 and newer radios.



A Crosley 51 SD was driving this unusual horn using headphones for a driver. In a quiet room this works well, but in this room it was too noisy and could not be heard well. This was my setup-the editor.



An IHRS member carefully tuning a 1920's vintage receiver





This gives you an idea how many radios were lined up, ready to try out.

---

## RADIOADS

---

**These ads are free to IHRS members. Please limit them to 100 words. Unless we are advised otherwise, we will run ads for two issues. The exception would be where services, etc. are being listed. Please send your ads to the editor at the address shown on page 2.**

**For Sale:** 1947 Silvertone am/fm console radio with wire recorder and 78 rpm record player. Good condition, must pick up, cannot ship. \$75.  
George B. Clemans, 851 West Wooster St., Bowling Green, OH 43402.  
(419) 352-7198. [clemans@bgnet.bgsu.edu](mailto:clemans@bgnet.bgsu.edu).

**For Sale:** Airline 62-97, \$110.00; 1946 Airline, \$35.00; 1935 Clinton, \$50.00; Crosley 10-136E, Black, \$95.00; Crosley 645, \$115.00; 1934 Emerson 36 \$115.00; Brown bakelite Emerson, \$40.00; 1948 Firestone 4-A-61, White, \$55.00; G.E. 51SF clock radio, Brown, \$30.00; G.E. 408, Brown, (not playing), \$15.00; 1931 Gloritone 26, \$175.00; 1935 Grunow 470, \$100.00; 1940 Motorola 40-60W, \$55.00; Maroon Motorola SRI, \$30.00; 1930 Philco 20, \$235.00; 1931 Philco 70, \$315.00; 1936 Philco 84, \$150.00; 1942 RCA 6X2, White, \$50.00; 1946 Ultradyne L-43, \$45.00; 1936 Varsity, \$50.00; 1946 Zenith S-0-0 11, Brown, \$45.00. All radios are in nice condition and in good working order unless otherwise specified. Call for descriptions or can deliver to Indianapolis show in February.

Bill Arnold, Washington, Indiana. Ph 812-254-1702 or Email: [barnoldworld.com](mailto:barnoldworld.com)

**For Sale:** Book: "From Crystal to Color", the History of Radio/TV Station WFBM, Indianapolis (1924 to 1964) by George S. Madden & Burk Friedersdorf. First edition 1964 published by WFBM. Has 190 pages and is in excellent condition complete with dust jacket. Price, \$25.00

Novelty radio, solid maple wall telephone, excellent condition--  
\$30.00

Harry Blesy N9CQX,  
95740 Clarendon Hills Rd.  
Hinsdale, IL 60521

Phone/FAX (630) 789-1793

**For Sale:** Near mint copy of the AWA Review for 1998--\$20.00 postpaid.  
James Fred, 5355 S. 275 W., Cutler, IN 46920, phone (765) 268-2214.

**FOR SALE:** Reproduction Philco cathedral cabinet parts and reproduction cabinets for model 20, 21, 70, 90. Grandfather clock finials: Philco 570, GE H-91, Crosley 124. Philco Colonial Clock top trim and finials. Rider's Radio Index, 1 through 23 -\$20.00 ppd. Books, SASE for list. All plus shipping. Philco cabinets, front panels, see page 22 in Volume 29, #4 the Winter edition. Other parts, inquire. Call or e-mail for details. Note new phone # and address. Dick Oliver c/o Antique Radio Service, 1725 Juniper Place, #3 10, Goshen IN 46526. New phone # (219) 537-3747, e-mail dolivears@aol.com

**FOR SALE:** Coke Machine, Cavalier Model CSS 173. Refrigeration works and it's all there including the key. Holds a lot of 12oz. (or smaller bottles). \$250.00 The coke machine may be seen by appointment, but bring money.  
Mike Clark, 6484 East 350 North, Franklin, IN 46131.  
Tel. # (317) 738-4649, e-mail ripmaclark@aol.com

**FOR SALE:** Photocopies: Hallicrafters 8-22, Zenith 1000-1, Radiola III, 18, 60, 100A, 103, Majestic 52, and other radio, tube, and Test Equipment manuals. Also some Novelty radios. LSASE for list. N.I.B. Western Electric 421A-\$55 postpaid.

**WANTED:** Speaker/output xfmr. assembly for RCA 5T1. Herman Gross, 1705 Gordon Dr. Kokomo, IN 46902. (765) 459-8308, e-mail = w9itt@mindspring.com

**FOR SALE:** Novelty radios, N.I.B.: Pekinese Dog - \$20.00, Computer Mouse FM - \$15.00; Pepsi machine, old style-\$20.00. Shipping extra. Steve Whited, 3637 W. 71st Street, Indianapolis, IN, 46268. (317) 298-9967.

**WANTED:**Philco 512 Mandarin Red radio w/212 Red speaker or 514 Nile Green radio with 214 Green speaker or 513 Labrador Grey metal radio with 213 matching grey speaker. I prefer the Red model.  
Bob O'Friel, 7631 Cape Cod Circle, Indianapolis, IN 46250-1844 Phone, (317) 849.4028

**WANTED:** For Zenith model 6G601M portable. The knobs, front cover and Wave Magnet. Also need Wave Magnet for 7G605 Transoceanic, I could possibly adapt one from a 8G005Y if available.

Robert C. Pote, 1181 Crestwood Dr.

Greenwood, IN 46143, phone (317) 881-4521 e-mail = mrzenith41@aol.com

**Interested in TV history?** Want to see how it started? Try this Web site. You'll be amazed how far we've come.

<http://pyanczer.home.mindspring.com/Tour> Note: all lower case except the upper case "T" in tour.

Pete Yanczer, 635 Bricken Place, Warson Woods, MO 63122-1613

**FOR SALE:** Remler infradine amplifier, type 700, panel mounted on copper box, excellent condition less tubes--\$100.00 plus shipping. 3 used 2O1As--\$45 plus shipping. AK Model 49, includes battery cable, no tubes--\$ 100.00 plus shipping. James Fred, 5355 S. 275W, Cutler. IN, 46920, phone (765) 268-2214.

**FOR SALE:** Book, "The Story of Kolster Radio", 1928, HC. 46pgs 8 1/2" x 11", color and b & w with silver borders, company history and product line, beautiful blue and gold book showing some cover wear otherwise excellent--\$50.00. Harry Blesy, N9CQX, 95740 Clarendon Hills Rd.. Hinsdale IL 60521, ph (630) 789-1793