



VOL. 22

JUNE 1993

NO. 2



OKAY GRAND DEPENDABLE FIVE
Manufactured by the Okay Radio Corporation
22½ West National Avenue, Brazil, Indiana.



Indiana Historical Radio Society
BULLETIN

OFFICERS

Marilyn B. Johnston, President
R. 1, Box 218A
Windfall IN 46076-9706
317/945-7735

Vice President

Paul S. Gregg, Secretary
725 College Way
Carmel IN 46032-2041
317/846-3094

Glenna Sanders, Treasurer
15 Todd Drive
Terre Haute IN 47803
812/877-2643

Dr. Ed Taylor, Historian
245 North Oakland Avenue
Indianapolis IN 46201-3360
317/638-1641

James A. Fred, Editor
R. 1, Box 41
Cutler IN 46920
317/268-2214

IHRS Responsibility

Business,
Activities,
Publicity

Sites and Dates
of Meetings

Correspondence,
Applications

Dues,
Financial,
Change of
Address

Donations,
Scrapbook
Material

News,
Articles,
Radioads

Bulletin Deadlines

News and Articles - 2/15, 5/15, 8/15, 11/15
Radioads - 3/1, 6/1, 9/1, 12/1

BOARD of DIRECTORS

Glenn Fitch
James A. Fred
Paul S. Gregg
Frank J. Heathcote
Don K. Johnston
Marilyn B. Johnston
Fred C. Prohl

Eric Sanders
Glenna Sanders
Walter J. Sanders
Robert Shuck
Ross A. Smith
Dr. Ed Taylor
James Thomas
Eric VonGrimmenstein

The *Indiana Historical Radio Society* is a non-profit organization founded in 1971. Annual membership dues are \$10.00, which includes the quarterly *IHRS Bulletin*. Radioads are free to all members. Please include a S.A.S.E. when requesting information.



Saturday, Aug. 28, 1993 at the HIGH DIVE Park Pavilion, Elkhart, IN

REGISTRATION \$2.00 at the door, includes spouse and family.

8:30 AM - Swap and Sell. Coffee & Doughnuts for Early Birds.

9:30 AM - Enter Items in Contest. Most Popular Vote.

- | | | |
|------------|-------------------------|--------------------------------|
| Categories | 1. Radios of the 1920's | 4. Radios of the 40's, Wood |
| | 2. Radios of the 1930's | 5. Radios of the 50's, Plastic |
| | Wooden Cabinets | 6. TV Sets 10" or smaller, |
| | 3. Radios of the 1930's | up to 1960. |
| | Plastic Cabinets | 7. Novelty Radios, any type. |

10:00 AM - Place Items for "SILENT AUCTION"

11:30 AM - Close of "SILENT AUCTION". 10% Donation Expected for I.H.R.S. Expenses.

12:00 Noon - Carry-in Dinner. Vote for One Item Each in the Seven Contest Categories.

1:00 PM - I.H.R.S. Business Meeting.

2:00 - 3:00 PM - Swap Meet Continued.

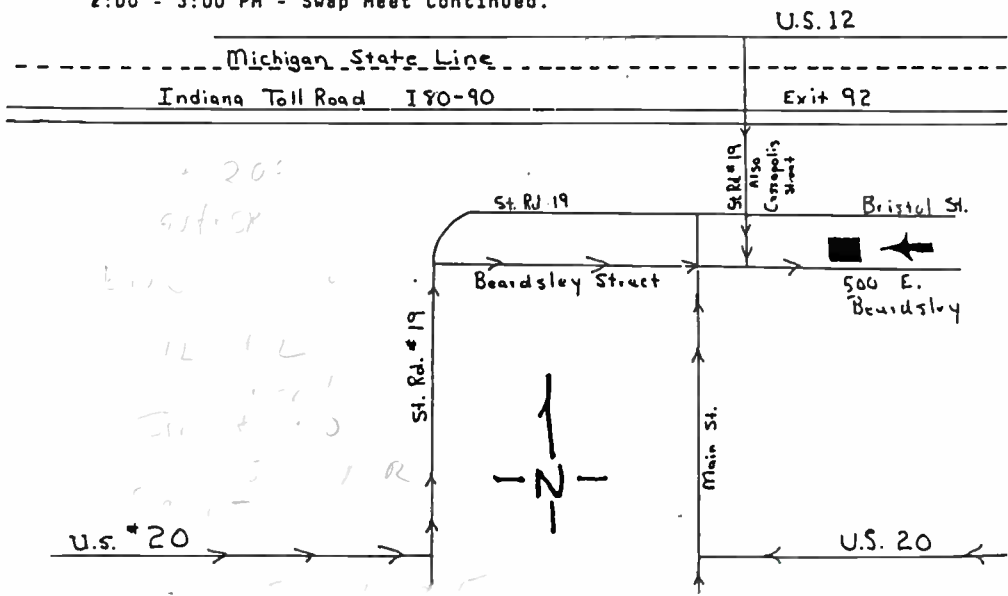

CALENDAR

Saturday, August 28, 1993
 High Dive Park, Elkhart, Indiana
 Contact: Ross A. Smith - 219/295-7770

Saturday, October 9, 1993
 Riley Park, Greenfield, Indiana
 Contact: Glenn Fitch - 317/565-6911

June 1993

Dear IHRS Members,

If you missed the May 1993 IHRS Twenty-Second Regional Radio Festival, you missed a very, very good meeting. Your officers and chairmen of the meeting have been receiving favorable notes and 'phone calls about how much the meeting was enjoyed. We have also received worthwhile feedback with timely and constructive criticism, which will be shared at the SATURDAY, AUGUST 28, 1993 MEETING IN ELKHART. Please be sure and read the notice of the summer meeting elsewhere in the Bulletin. And then PLAN TO ATTEND.

Did you enjoy reading the IHRS MEMBER RECOGNITION article in the March Bulletin? Of course you did. I received no feedback--not even from the Member himself. But, never mind! The second IHRS Member Recognition article is printed herein and features our Dr. E. E. Taylor--Ed to his friends. Please submit your Member Recognition article about a member from any state or country; someone you have always wanted to recognize because of his influence on your hobby, or for his contributions to wireless and radio collecting, or for a deserving individual that the rest of IHRS would enjoy hearing about, or for someone you want to recognize for personal reasons. Don't be concerned about your handwriting; I can read almost anyone's writing--I worked for two doctors before retiring.

Your Vice President, John E. Kellar, wrote to me in April. As I read John's letter, the tears welled up. This was my prerogative as a female President and I exercised it. It was a pleasure to serve on the Board with you John. Although your term in office was not long, you were very energetic and productive while you served. The diverse regional meeting sites that you planned and scheduled for 1993 reflect your concern for providing the best for IHRS. The Chairmen you enlisted for the May Meeting were excellent choices. We know you would have been a fine President for IHRS, but your health comes first. IHRS will reap the fruits of your work for a long time. Thanks for serving your club. (John's letter follows my notes.)

Here's something for you to do between now and when I see you in Elkhart. Use the enclosed application form to encourage the growth of INDIANA HISTORICAL RADIO SOCIETY and sign up a fellow collector and friend. Remember, the new member can prorate his first year's dues: \$10.00/year with four Bulletins; or, \$7.50 for membership with the June, September and December Bulletins. Membership is \$5.00--for one-half year with two Bulletins and \$2.50 for a quarter-year membership. And then, after you get him signed up as a member, bring your new IHRS Member/Friend and your family to the August 28 Family Meeting.

Thanks for your support in the past, for the present, and in the future.

Marilyn

IHRS President

INDIANA HIST. RADIO SOC.
MRS. MARILYN JOHNSTON (PRES)
R# 1 BOX 218 A
WINDFALL INDIANA

2202 ROCKNE DRIVE
S. BEND, IND. 46615

APRIL 14, 1993

DEAR MARILYN

IT IS WITH REGRET THAT I AM COMPOSING THIS TO THE IHRS AND YOU, BUT, THE TIME HAS COME FOR ME TO TAKE A POSITIVE ACTION ON A MATTER THAT IS OF GREAT CONDERN TO ME.

DUE TO A CERTAIN REOCCURRING PERSONAL PROBLEM I HAVE FOUND IT NOT TO BE IN MY BEST INTEREST TO TRY TO PURSUE AN ACTIVE ROLE IN THE IHRS. FROM THIS WRITING ON I WILL CONTINUE WITH THE IHRS IN A INACTIVE POSTURE ONLY.

THANKS FOR THE OPPORTUNITY TO HAVE SERVED WITH THE IHRS.

RESPECTFULLY YOURS,
s/John E. Kellar

Brazil's newest industry which has been quietly in operation for several weeks on a small scale is already blossoming out and increasing its capacity. This new industry is the Okay Radio Corporation which is now operating in the four rooms over the Mohr Service station in the Thomas block on East National Avenue.

The founders of this new industry are Will Tilley, who has been experimenting with radios for deveral years, and John G. H. KLINGLER, MANAGER OF THE Citizens Telephone Company, who is also a radio enthusiast. The company is now in process of reorganization as others have become financially interested and articles of incorporation are to be filed soon.

The company is putting on the market a radio outfit known as the Okay Grand Tuned Radio Frequency set in two models. The set is a five tube outfit which has met with a ready reception on the market in competition with many higher priced outfits. The company has interested several of the largest jobbers in the business and have had no difficulty in placing their entire output with excellent prospects for increased demand.

The set has been tested alongside of larger and more expensive units and was found to be fully as effecient and in several cases much better than the more costly sets.

The Brazil company has developed a set which has been highly praised by experienced radio men. It is constructed of highest quality low loss parts and has an economy of

operation in battery consumption which is surprising. The new set uses but five and six ma. which is a heavy drain on the batteries. In the new set is used a specially wound R F coil which is made for the Okay people. The audio frequency coil and other parts are made to harmonize and the outfit is one of the most efficient that has been developed. Some of the features of the new set are that it is non-squealing and non-radiating, is quiet and will not interfere with near by radios. It has a splendid tone that is making it a rapid seller.

An unusual feature in a set at this price is its remarkable selectivity, being able to select any station the owner may desire even where powerful stations are in close proximity.

The set is being put up in two models, the smaller retailing at \$65 and the larger at \$85 which compares with other sets selling at \$125 and \$150. The cabinets are made at the Bell Bros. factory in this city and the complete job is very artistic. The fronts of the sets are etched in gold in the varichrome process and the marking for the dials are very distinct.

The plant is in charge of Roy Daly who is a radio expert of extensive experience. The plant has been turning out about 25 sets a day, but some improvements are being made and the company expects to have a production of at least 50 sets a day in a short time and are confident that their business will continue to grow until it reaches much larger proportions.

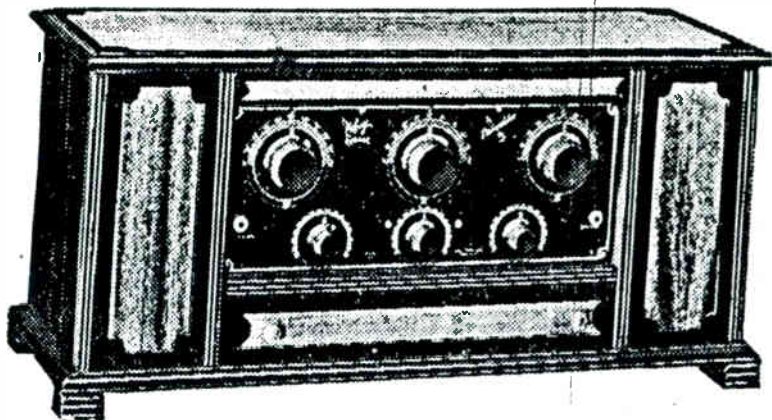

There's Satisfaction in Every OKAY Dependable 5 RADIO

Every owner of an OKAY radio (and there are many of them) has reported that extraordinarily fine reception has resulted from the use of the set. They're all satisfied.

Behind every set is Fischer's factory guarantee. The set is manufactured close to here and receives factory service. Its name, the Okay Dependable Five, is an assurance of its reliability.

FISCHER AUTO SALES

EVERYTHING YOUR AUTO NEEDS

Ninth and Wabash Avenue

Fisher Auto Sales of Terre Haute, IN offered the Okay Grand Dependable five radio in two table model cabinets and one console cabinet.

The lower priced cabinet is featured on the front cover and the higher priced table cabinet is pictured in the above advertisement.

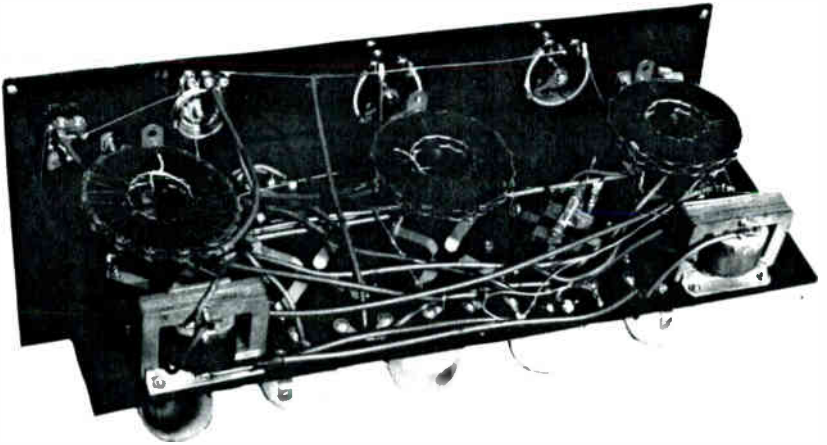
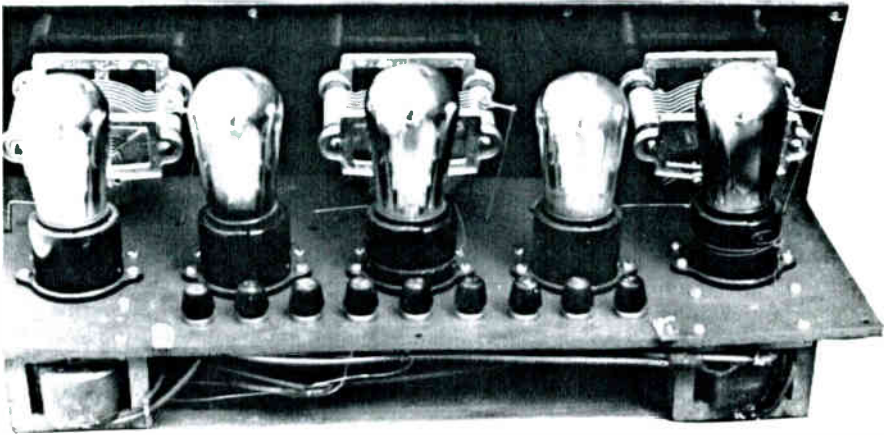

Top and bottom view of the chassis

RADIOS!

Let me build that radio set to fit your ideas and pocketbook. Special receivers and installations taken care of at minimum cost. Call 4666 at 6 p. m. or personally at
**OKAY RADIO CORP.
FACTORY.
Rov Daily.**

The Brazil Daily Times
December 17, 1925
Page 5



The set pictured on the front cover was found in the summer of 1986 in a tool shed on a farm just north of Brownsburg, IN.

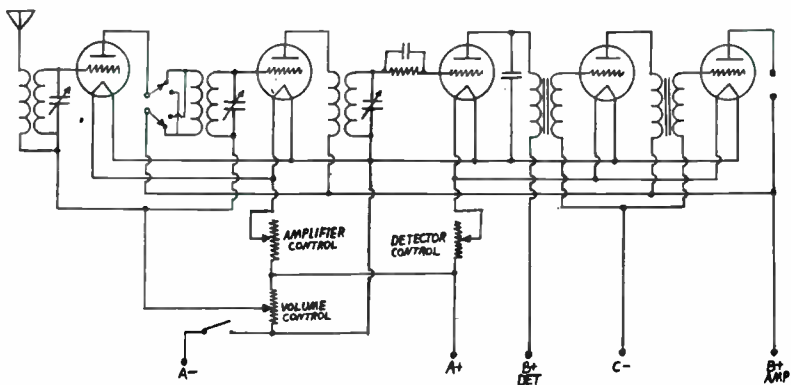

This is the schematic diagram to the Okay Grand Dependable Five. Notice that the primary of the second RF coil can be either in a forward or reverse polarity for best reception.

RADIO

Okay 5-Tube Set, this is a wonder set for pure reception. We consider this one of the perfections in Radio. We have it in three style cabinet and console.

The Saturday Spectator
 December 19, 1925
 Page 23
 Fisher Auto Sales ad

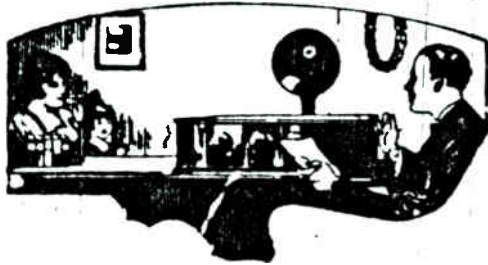

Fischer's For Radio

Two things are responsible for us re-entering the radio business:

FIRST—Many of our customers who have depended upon this store for their auto accessories urged upon us to furnish them also with radio.

SECOND—We had our golden opportunity of obtaining the distribution of a line of radio that has passed the censorship of three of the best Electrical laboratories. It has been passed as perfect, is made right here close to home by a corporation that has plenty of capital to carry on a large volume of business. The cabinets for this set are made adjacent to the radio factory by furniture manufacturers who know how to build them.

What do you get of this—satisfactory service where we can give you direct factory guarantee and service.

OKAY DEPENDABLE 5

Sold on Payments.

FISCHER AUTO SALES

NINTH AND WABASH

The Saturday Spectator, Nov. 7, 1925.

The Brazil Daily Times
July 27, 1925

Nestled up in the residential section of the northeast part of the city a new industry for Brazil has been quietly but steadily operating for the past few months. It is turning out a product that ranks in quality along with the Stout bedroom suites or Brazil Wood Products Breakfast sets. The factory is that of Bell Bros., in charge of Paul Bell, for years foreman of the Stout Furniture Company plant in this city.

Mr. Bell, associated with his brother Omer, who has made a splendid success of the engraving business in Terre Haute, built their factory building for the purpose of manufacturing special furniture of such types

that the larger factories could not produce without quantity production on a large scale, but for which the demand does not justify a large quantity. The plant had not been completed before the management landed an order for Radio cabinets which has kept the plant busy up to this time.

The factory is a brick building about 30 by 70 feet, one story high, located on a lot at the rear of Mr. Bell's property on East Cole Street. A Times representative today found the five craftsmen working on radio cabinets of various sizes, but mostly for the smaller sets. These were being made of mahogany, walnut, and other hard woods. The workmanship on these cabinets bears the most careful inspection.

At the north end of the factory a Ford engine has been mounted to furnish power for the various machines, transmitted through the whole length of the building. The little engine is so built that a continual stream of water passes through the water chamber from a good sized tank above it and the air cooled feature is done away with. Should the little engine get sluggish or over ambitious an automatic governor regulates its speed. The 22 horse power developed is sufficient to propel a good sized planer, a sticker, a shaper, a trim saw or variety saw, band saw, belt sander, grinder, and an air compressor. The latter supplies air for the varnish sprayers in the finishing room, which is set off near the front of the building. Here an exhaust fan takes away the fine spray of shellac or varnish that misses its mark on the furniture that is being finished.

Mr. Bell says that the little factory is equipped to make all kinds of furniture, restore antiques, and to make other articles from wood. A stock of rough mahogany, poplar, oak, and other hardwoods is kept on hand.

Mr. Bell, who serves as superintendent, is one of those craftsmen who loves a piece of wood and fondles a piece of native quarter sawn oak with the same affection that a mother bestows on her offspring. With the soul of an artist and craftsman he watches the furniture from the rough lumber to the highly polished product.

Incidentally, while Mr. Bell is making radio cabinets, up in some back rooms over a downtown store another set of mechanics are making radios, which are said to be as good as the nationally advertised instruments.

A LAWRENCE WELK STORY

Russ Rennaker, W9CRC

In the early 1930s there was a dance ballroom out on the north side of Chicago known as the Aragon. This was the era of the big bands and every band you can name played there at one time or another. All of the major networks broadcast from the ballroom on a weekly schedule.

In 1938 a little-known orchestra, directed by a chap named Lawrence Welk, was booked into the Aragon and scheduled to do a half-hour program over the CBS network. I was assigned to the program as audio engineer and Jack McCormack was the announcer.

Fresh from one-night stands in the midwest, Mr. Welk was possessed of a distinct accent, traced directly to his German ancestry. This fact was well-known by the "brass" in the Wrigley Building and the word had come down that under no circumstances was Mr. Welk to get on the microphone, although he protested that he had always announced his band's selections in other ballrooms where they had played. "Not on CBS", came back the answer, and that was that.

One night Jack McCormack, for some reason that was never actually determined, did not show up for the broadcast. Announcers were notably late for their appearances and I didn't worry much until we had less than five minutes before air time. Even then, I envisioned Jack dashing up the stairs just in time to read the introduction. The minute hand hit zero. I heard the studio announcer say, "And now we take you to the Aragon Ballroom for the soothing strains of Lawrence Welk and his champagne music." No Jack McCormack.

Without any introduction, the band swung into the theme while I frantically shouted into the talk circuit, "Back to the control room." When I explained that we had no announcer, a sleepy voice at the other end said simply, "Well let the band director do it." I discovered later that particular engineer had never heard of the edict.

I felt that I had no alternative; I waved to Lawrence and pointed at the microphone. For thirty minutes Lawrence introduced each number in what was destined to become a very familiar voice over the champagne music.

It turned out that from the moment his voice came out of loudspeakers all over the country, the CBS switchboard lit up and stayed lit up for the duration of the program. It seemed that that distinctive accent--which some bigwig had banned--had caught the fancy of the female listeners throughout radioland.

So far as I know, no announcer was ever assigned to do the Lawrence Welk Show again; at least not on CBS.

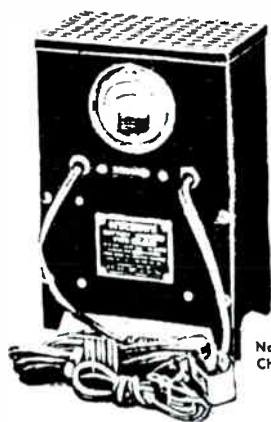

No. 107
Charger

No. 5535B
Charger

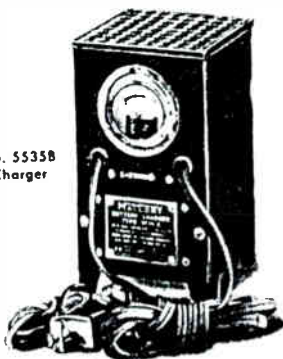

No. 3C
Booster



MALLORY

Approved **PRECISION PRODUCTS**

HAVE YOU READ?

by Ed Taylor D.Sc.E.E.

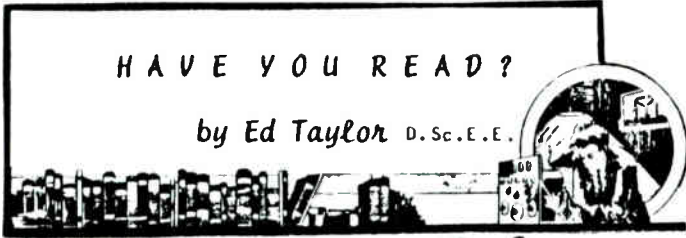

**THE HISTORY of
SARKES TARZIAN, INC.
Delbert C. Miller 1993**

This spiral bound volume, of 156 pages, traces the story of Sarkes and Mary Tarzian and the industrial company which they built.

The author has Xeroxed a scrapbook collection of papers, news articles, trade journal clippings, and photographs. Much of this material is made up of copies of copies and the result is now of very poor pictorial quality.

This is a true "Horatio Alger" story of how an immigrant from Armenia came to America when he was seven years old. After college he became Chief Product Engineer of the Atwater Kent Radio Company, Chief Engineer for the RCA Argentina plant, and later founding his own manufacturing facility in Bloomington, Indiana. Included are biographies of the Tarzians, information on the Tuner, Semiconductor, Air Trimmer, and Broadcast Equipment divisions of their company and the founding of radio stations W9XHZ, WTTS, and WTTV.

This volume deserves a B+ for literary content, but only D- for the slovenly copy-machine presentation. Available from the Monroe County Museum, 202 E. Sixth Street, Bloomington, IN 47408 for \$12.00 postpaid.



BOOK REVIEW

“A Radio Journal 1912 - 1940”

The early days of radio must have been a wondrous time for the pioneers of this new form of communications. "A Radio Journal 1912 -1940" is aptly titled as it recounts with heartfelt nostalgia the excitement of a young boy's first experiences with wireless radio and his subsequent explorations into ham and commercial radio.

The author, Russ Rennaker, has spent almost eighty years working in the radio field and shares his recollections of the trials and tribulations of the burgeoning industry. From his first inventive spark-gap transmitter wireless station at age 10, to his exploits as a young radio broadcasting engineer with CBS in the '20s, '30s and '40s, Mr. Rennaker relates his series of airwave stories with obvious relish in an easy and informal manner.

"A Radio Journal 1912 - 1940" should hold a special allure for all radio buffs, and it's full of pictures of radio equipment and personalities from that era. Old timers will enjoy the memories and the younger generation will be inspired by Mr. Rennaker's electronic ingenuity and candid accounts of pranks among the various radio newscasters and crew, as well as recounts of war related experiences.

This book is available from R & R Press, 1011 Linda Drive, Kokomo, Indiana 46902. The retail price is \$9.00 plus \$.90 postage.



Paul Gregg with the pause that refreshes, waiting for a customer in the flea market.



Our smiling receptionists at the registration table greet an IHRS member.



Dr. Ed Taylor, Russ and Ruth Rennaker, and Pax Kirby look on as Durward auto-graphs another book.



Ruth Clark (Dr. Clark's Mother) waits while Durward signs one of his books.

IHRS Member Recognition

Ed Taylor

Author, doctor, engineer, hobbyist:

A reading on this meter tells a lot about one of the founders of our society

By Vic Johnston

Who's who in the Midwest says the esteemed doctor is a metrologist. That's no weatherman. It means he knows the study of measurement, a subdivision of science that underlies and assists all others.

Through his writings and his willingness to share his knowledge, he also assists all others.

Besides being very familiar with meters, he also knows his motors, toasters, televisions, telephones and of course radios.

A radio 'fan' since his youth, he still has several crystal radios among his collection, including one his parents gave him one Christmas.

Anyone who has had the privilege to see this Hoosier's museum can't help but be impressed. There is a lot more to see than radios that aren't plugged in. How do those things work anyhow?

He would be glad to tell you. Compressed in the carriage house behind his Indianapolis home is one of the tidiest, yet most compleat collections of antique radios in the United States, but more on that later.

Not content to just accumulate, Dr. Taylor is also an avid author, historian and restorer.

His most significant book is *Taylorvision* and was published in 1983. He received the prestigious

Antique Wireless Association's Taylor Award in 1987 for his work in this field.

He also received the Ron Scranton Memorial Award in 1985 from the Antique Radio Club of Illinois for his work in the preservation of antique communications equipment.

He regularly enters IHRS contests and wins with his unique and characteristically liliputian contributions.

His work with television goes back at least as far as when he was employed by the Farnsworth TV corporation in Marion from 1942 to '43 as an electronic inspector. From there the young man went to work for RCA as a radio facsimile developer from 1943 to '44.

Ed was the electrical metrologist for the P. R. Mallory Company, components group of Indianapolis from 1944 until his retirement in 1989. While at Mallory he was well-known as the company historian.

His primary duties centered on the calibration of electrical instruments and equipment for timers and capacitors.

He received two patents in the electrical testing and alarm fields during his stay with Mallory.

Ed became Doctor in 1983 when he was awarded a Doctor of Science in Electrical Engineering degree by

“ *Wherever I go, I look. I've bought radios in Denmark and England and shipped them back . Once I found an old electric motor in New Orleans being used as a door stop...*

*Dr. Ed Taylor
IHRS*



the Sussex College of Technology (England).

Many IHRS members are glad for his research, but a visit to the Ed Taylor Radio Museum is a real treat.

From the ball aerial outside to the display cases inside, the Taylor museum is well-displayed and labeled.

Hundreds of radios and over 2,000 books are housed in this inner-sanctum of wireless goodies.

Some of the antique technical apparatus on display includes a slant towards the child in all of us. A Crosley Pup, Radio Rex, and at least three bookshelves of Radio Boys and their related ilk.

Not to be missed is the unique antique toaster that ingeniously flips the bread, the meter collection, old carbon-filament light bulbs, shocking devices and even a complete set of Radio Orphan Annie's decoder pins. Lots of malt-flavored drink was consumed to get those now sought after trinkets.

His favorite radios remain the tiny crystal sets like the one from his parents, "They're interesting, small,

and don't take up a lot of space. I also enjoy collecting one and two tube sets."

Thanks Ed. Thanks for finding these pieces of history, writing about them, fixing them and showing them off.

Dr. Taylor's other memberships:

Instrument Society of America

Society of Inventors

Antique Wireless Association

Tesla Coil Builders Association

Indianapolis Radio Club

American Guild of Organists

Theatre Organ Society

Indiana Jaguar Club

Indianapolis Technical Instrument Society

President M.B.J. asked for a few comments on the subject of how I got started in radio.

It all started in November, in the midst of the great depression, when I was nine years old. One of my childhood duties was to walk to the post office every day to pick up the family mail. Along the way I would go by the local hardware store and in the window was a Crosley 52 Radio. It had a price of two dollars, which included an RCA horn and a set of headphones. I was fascinated by the prospect of having my own radio but the two dollars was out of the question at the time. I checked the window every day. Much to my disappointment, the radio suddenly vanished from the store window. Inquiries only revealed that "the set is sold".

Imagine the thrill and delight when on Christmas morning the little Crosley, with my name on it, appeared under the tree. I still remember the radio aroma when the lid was raised. It was a combination of coil lacquer, bakelite, tar, and varnish. Three silvery 01-A tubes added to the mystique.

I had been bitten by the radio bug and have had a lifelong interest.

"Doc" Taylor

UP TO \$50 TRADE-IN **30 DAYS TRIAL** **EASY TERMS** **UP TO 16-TUBES**

... on Many 1942 Models

Write today for big, **FREE** catalog, featuring many beautiful 1942 factory-to-you radio chassis and console values—from 5 to 16 tubes—including Automatic Record-Changing Radio - Phonographs, Home - Recorder, etc.—from \$12.95 to \$212.50.

MIDWEST RADIO CORPORATION
CINCINNATI, OHIO

FILL IN COUPON AND MAIL TODAY OR JUST SEND YOUR NAME AND ADDRESS ON 4¢ POSTCARD

MIDWEST *factory-to-you* **RADIOS**
MANUFACTURERS OF QUALITY RADIOS SINCE 1920

Midwest Radio Corporation
Cincinnati, Ohio, U.S.A.
Dept. 59-G

Name.....

Send me your new **FREE** Catalog, complete details of your liberal 30-day Trial offer and factory-to-you prices.

Address.....

Town..... State.....

User-Agents Make Easy Extra Money. Check here () for details.

PT. 59-G

DID YOU RECEIVE FOUR BULLETINS IN 1992?

The above query was tucked inside your March 1993 Bulletin and I received a variety of nice answers--except for one.

Some of the replies were brief--some were chatty notes. I received: "thanks for checking; yes; I don't remember, but I enjoy the Bulletin too much not to renew; got all issues--see you in Kokomo; Yes, I did; Sorry I'm late sending my dues; thanks;" etc. Also, I accomplished what I needed to know in order that missing issues could be mailed. Some of you had missed only one copy and two members had missed two copies in 1992.

No one was upset and seemed to realize that I had had their best interest at heart--except for ONE. His comment really surprised me. It read, "Being sarcastic? My late dues was an oversight."

In trying to do the best job that I'm able to do, some members may misunderstand me. The total of friendly, amicable, appreciative replies far offset the one in a category by itself. I want all members to receive everything they expect and have paid for.

Your constructive ideas, support, and encouragement are wanted. The 'vibes' so far have been fantastic.

Marilyn B. Johnston

The John Meck Ind - Scott Radio Labs Reunion was held on Saturday, June 5, 1993 at the Plymouth Holiday Inn. IHRS asked for a review of this reunion but we do not have anything to give you. If this organization does interest you, please contact Donald E. Myers, 201 Dickson Street, Plymouth IN 46563.

IHRS/AWA 22ND SPRING REGIONAL MEETING

We wished for 'no rain' and beautiful weather for the meeting--and that's exactly what we had. We did not want weather quite that cool but the IHRS radio collectors came prepared with jackets, sweaters, and Leo Gibbs even brought his gloves.

There were several early birds on Wednesday but the Flea Market action really got rolling on Thursday with lots of tailgaters. Many, many interesting vintage and collectible memorabilia were available. The number of sellers varied from day to day, naturally, but on Thursday there were 63 at one time and Friday's count was 75. Some closed up shop only to be replaced by new arrivals. The indoor tables were particularly popular with sellers of paper and small items. There was no charge for the outdoor spaces; this accounts for the indefinite number of sellers.

Glenna Sanders was in charge of the count for the ladies' luncheon and the banquet, names for the conducted tour, renewals, new applications, the daily registrations; all of the time she was smiling, answering questions, locating and directing guests, and taking care of all the behind the scenes activities of our Treasurer. She had a fantastic volunteer crew for each day. Our thanks go to Edna Yanczer, Wava Smith, Lucy Anne Miller, Janet LaVelle, Shirley Hausske, Sandy Freed, Marjorie Fitzpatrick, and Nadine Bryant for being terrific hostesses and for welcoming the guests. Walt and Glenna's daughter-in-law and Eric's wife--Kacey--was missed at the welcome station this year. Glenna, we sure hope we haven't overlooked anyone on your team. Thanks again for an excellent job on the registration desk.

The conducted tour of one of the world's largest manufacturers of stained glass for churches was very enjoyable and educational. The members who visited the Kokomo Opalescent Factory on Thursday learned about annealing, and how the glass is packed for shipping. The majority of shipments go overseas. No one learned the secret recipes--some are over a

hundred years old and go back to when the factory was started. Was the best part seeing the young men running with the ladles full of molten glass? Seeing the skill required to blend the colors? Or seeing it rolled? Or just being behind the scenes of an ancient skill and trade? This factory, like many in the Nineteenth Century, came to Howard County because of the availability of natural gas; that is why they are still here. We browsed in the OP Gift Shop before and after the tour.

Thursday Evening's Hospitality was Chaired by Peter Yanczer and John Jones; they emceed the W. C. Fields' and Our Gang movies, and the musical shorts of Lucille Ball, Ted Lewis, and Laurel & Hardy. Don and I had to miss the hospitality and fun. It was our loss. Thanks to 'Old Faithful' (Edna Yanczer) for being such a very gracious and pleasant hostess with the "mostest". She held up the tradition of IHRS Hospitality that was initiated back in our early days in Auburn IN at the Star-Lite Motel. Haven't we moved along "a fer piece"? Edna reports that the popcorn was a big hit with the movie goers. She also shared the popcorn with the Ramada's registration desk personnel. Isn't that just like Edna? She is definitely one of IHRS' assets. Some members are just unsung heriones, that's for sure.

Elder-Beerman, Kokomo's largest department store, gleaned quite a volume of business from some of our lady shoppers. Oh, the bargains that Dorothy Barnett, Nadine Bryant, Edna Yanczer and Jean Stinger reaped! There went your Flea Market moola Ralph, Carl, Pete and Charles!! Really, E. Beerman should have donated door prizes to IHRS! Another customer (D. Kirby) tried his best to buy a summer belt--but with no luck.

Sorry to report--no information was received from the two Friday morning Seminar presenters.

The program for IHRS' Ladies' Second Annual Dutch Luncheon received 'rave reviews'. Nancy and Gary Snyder from Russiaville shared just one of their numerous hobbies--Button Collecting. Nancy had her

displays framed and organized by ilk, form, style, rarity, content, etc. The ladies benefited from Nancy's hands-on teaching method she uses in the Western School System. The IHRS' Ladies' Third Annual Dutch Luncheon program is going to have a hard act to follow. (Some of the local public who attended the 2:30 p.m. program heard about the Button Program and were disappointed that they had not been invited to attend Nancy's program.)

Even before the February IHRS Meeting, Herman Gross, Contest Chairman, had his act in gear and submitted the contest categories well in advance of the printing of the flier re the meeting. He planned his table layouts, signs, forms, and asked Jim Fred, George Hausske, Don Johnston and Eric Sanders to serve as Judges. It seemed as if everything was "all systems go"--but IHRS did not have a contest room. Herman was going to have "to make do" with a Ramada guest room for the IHRS Contest Room. The Ramada, as usual, did not let IHRS down. The Seiberling Room became available and it was ideal--better than we have ever had for a Contest Room in the past.

Open Class

- 1st, James Thomas (Kokomo IN) 1924 Flex-0-Dyne w/Metro Electric Speaker
- 2nd, Charles J. Stinger (Hamilton OH) 1916 Crystalol Detector

Metal Cased

- 1st, Fred M. Schultz (Ligonier IN) Apex Model 36

USA Transistor

- 1st, Tom Williams (Dunlap IL) GE 908

Kits and Homebrew

- 1st, John W. Haught (Aliquippa PA) 2-tube receiver
- 2nd, Peter F. Yanczer (St. Louis MO) Scanning Disc TV Kit

Speakers

- 1st, Peter F. Yanczer, Ornate French Speaker

Tube-Type Novelty

1st, Dr. E. E. Taylor (Indianapolis IN) Empress Swiss
Chalet

Made in Kokomo

1st, James A. Fred (Cutler IN) Phillips Radio
by B-W Manufacturing

2nd, Wanda Waters (Batavia OH) Delco Radio 1229

BEST OF SHOW

A few words of explanation re IHRS' Best of Show Trophy are in order. (See Vol. X, No. 1) The donors, Glen E. Rogers (Lafayette IN) and Ron Scranton (Hoopeston IL) established this prestigious program "to recognize a radio article that has won a first place in its class at the IHRS Spring Meeting. The radio article may be a one time winner only; the owner may be eligible for future awards with another item." The thirteen recipients of the Trophy are:

- 1981 - Walter Sanders (Terre Haute IN)
- 1982 - Delbert Barrett (Fort Wayne IN)
- 1983 - Don K. Johnston (Windfall IN)
- 1984 - Delbert Barrett (Fort Wayne IN)
- 1985 - Jim and Felecia Kreuzer
- 1986 - Raymond O. Hill (Beaver Falls PA)
- 1987 - Ross A. Smith (Elkhart IN)
- 1988 - Joe Koester (Laurel MD)
- 1989 - Robert E. Lozier Jr. (Monroe NC)
- 1990 - John Case (Columbus OH)
- 1991 - Joe Stafford (Delaware OH)
- 1992 - George A. Freeman (Madison IN)
- 1993 - James Thomas (Kokomo IN)

The Ron Scranton Trophy, A. H. Grebe Memorial Award, for 1993 was announced Friday evening at the Awards Banquet by Chairman Gross.

Congratulations to all of the past winners and to our newest recipient of the Best of Show Trophy. It is a well-known fact that the trophy means a lot to each of you. The large trophy with all of the names of the winners is on display in Dr. Taylor's Museum.

1993 is the last year for this Memorial Award. A new award program is being considered.

On Wednesday, February 17, I wrote to Mr. Durward Kirby, an IHRS member of several years, and invited him to be the IHRS' May 21 Banquet Speaker. He lost no time in replying. When we came home on Friday, February 19, Mr. Kirby's voice was on the answering machine. He was accepting the invitation! This pending highlight for our May meeting was not mentioned to you at the Indianapolis meeting the next day. Mr. Kirby asked for certain contingencies in connection with his acceptance. These requirements were not completed until March.

Durward's Friday afternoon presentation was open to the general public by invitation. Durward was accompanied by his wife, Pax, and his eldest son, Randy. Randy played straight man for his Father and also operated the video camera. It was exciting to hear Durward--a famous radio and television personality--speaking in person to IHRS' Hoosiers and guests. It was an hour's entertainment that will not be forgotten. After the talk, Durward and Pax autographed their books with personal messages.

MY LIFE . . . THOSE WONDERFUL YEARS! was the fuel for the afternoon presentation. Friday evening Durward again spoke for over an hour without repeating any of the earlier program. He shared personal stories of his life in the very early days of radio and during the birth pangs of television; he didn't omit the bloopers. We remembered some of them. He brought to life again many submerged memories of a kinder and gentler television fare than we are able to enjoy in the '90s.

The day and evening of May 21 will remain with all of us who enjoy good, clean, unadulterated entertainment. We felt especially pleased and privileged that the three Kirbys came to Kokomo, Indiana. If you missed either or both of Durward's performances, it is regrettable. It is a pity.

IHRS/AWA 22ND SPRING REGIONAL MEETING (continued)

Several months ago Hal Hunt got in touch and offered to donate a considerable amount of desirable items to IHRS for the Saturday auction; Hal delivered the van load to Clif Bolton's excellent storage facility, where everything was safe until the auction. Thanks to both of you for all of the lifting, loading, unloading, and the special attention you gave for the benefit of your club. All of those items found new homes AND Hal's donation was a great boost to the IHRS Treasury.

Auctioneer Harry Blesy, assisted by Toni, did a Class-A Act. They are new members of IHRS from North Riverside IL. Already they have more than proven themselves to be assets. There were less than 150 lots sold with some of the donated items going for \$1.00/box but IHRS had the unusual treat of having a donated item bring over \$250.00. The average sale was \$12.00+. We had 52 bidders. Ty Gregory, Chairman of the Auction, lined up some very competent workers: Terry E. Garl, Dr. Ed Taylor, Fred Prohl, Robert Shuck, Paul Gregg, Pete Yanczer, Walt and Glenna Sanders.

The above information was contributed by many IHRS Members, the Chairmen, and attenders. The support group for this meeting was fantastic! We truly hope we have not overlooked any of the special members who made the meeting so successful. There were enough duties and volunteer workers to go around.

We were especially pleased with the way you policed up the Flea Market area. We always go out and check to see if anyone has forgotten to load a Scott, and to pick up the boxes and coke cans. You didn't leave us any trash. Three jackets were left in the Ramada. Two have been claimed. Check your closet.

While the meeting is over for most of us, it is just the beginning (in a way) for the Treasurer. She balances out the auction and registration monies. She pays the sellers and commercial invoices after she gets back home in Terre Haute. Thanks for your help in making it a "GOOD SHOO", Glenna. And a BIG THANKS to all members and their families for your support.

We sincerely hope you enjoyed the Spring Meeting.

*Thy prayers and
thine alms are come up for
a memorial before God.*

Acts 10:4

Date May 31, 1993

A gift of \$ 30.⁰⁰ Check

to the glory of God
and in memory of

Abe Miller

has been given to

Abe Miller Memorial Scholarship
Fund - Keene United Methodist Church
by Indiana Historical Radio

Marilyn B Johnston

Thank you--God used your expression of
sympathy to bring comfort and encouragement.

Dear Marilyn,

Bob and I wish to thank you and the IHRS for your gift to the Scholarship Fund in Abe's memory. We were able to give checks to four graduating seniors this year and plan to do the same for at least a few more years. It is comforting to us to know young people are being helped in his memory and I know Abe is pleased. Thank you for your gift and for your caring.

Lucy Anne and Bob

(The above thank you and cards were received from the parents of Abe Miller; he died 3/5/93--thirteen days after all 3 members had attended the Indianapolis Meet.)

Again, your IHRS friends extend their deepest sympathy for your loss and ours. We weep in our hearts, too.

Carl E. Strand, 86, loved by family and friends, passed away on Thursday, May 27, 1993 at the home of his daughter, Mary Joy Mantor, in Anderson, Indiana. He is survived by his wife, Ruth, three daughters, one son, one brother, two sisters, and several grandchildren. One son died in 1984.

Carl pastored several churches in North Dakota and Minnesota. The family moved to Indiana in 1966.

Carl was an enthusiastic collector of Atwater Kent and Crosley radios. He worked at several radio repair shops in North Dakota in the 1930s and was in command of a vast knowledge of the earlier sets. He continued his collecting into the years of raising a family. Carl loved the radio meets, the discussions, the buying and the selling. But, most of all, to you--his friends and fellow IHRS Members--he loved the people. The family hopes the club will always exemplify the friendliness that Dad looked forward to at each meet.

Interment was June 3 in Fairmount, Indiana.

Dave Mantor
son-in-law

(IHRS made a memorial contribution to the Liberty Baptist Church, Sweetser, Indiana.)

Johnnie F. Anderson, 89, North Vernon, passed away recently. He was a former southern Indiana IHRS Member.

He was with the State Board of Accounts agency from 1946 to 1969 and was Jennings County Auditor from 1938 to 1945. He was past president of the Jennings County School Board and taught at Rabbit Plains, Rush Branch, and San Jacinto schools. He also served as the President of the County Waterworks and was a charter member of Jennings County Chamber of Commerce. He was a member of First Methodist Church, North Vernon, to which memorial contributions may be made.

Anderson is survived by his wife, Mary, one daughter, two grandchildren and two great-grandchildren.

IHRS Friends extend belated condolences to the family.



WANTED: Faradon variable condenser model UC-1820 for restoration of my model AG-1380 loop antenna. Cash or trade. Ross Smith, 1133 Strong St., Elkhart, IN 46514, Ph. 219-295-7770.

FOR SALE: Conn Strobotuner model ST-6. Perfect condition, complete with microphone and instruction manual, \$75.00. Dr. Ed Taylor, 245 N. Oakland Ave., Indianapolis, IN 46201, Ph. 317-638-1641.

WANTED: past issues of "IHRS BULLETIN". I need Volumes 1 thru Volume 21. Harry Blesy, 2409 Northgate, North Riverside, IL 60546, Ph. 708-442-8855.

FOR SALE: ARRL and "RADIO" handbooks, 30's, 40's, 70's, and 80's. SASE please. Paul Gregg, 725 College Way, Carmel, IN 46032, Ph. 317-846-3094.

WANTED: clean and unaltered Collins 310B-1/-2/-3 Exciter and RME 99 Receiver. Martin Piepenburg, R 1, Box 56B, Monterey, IN 46960, Ph. 219-542-2591.

FOR SALE: good, clean, working All American Mohawk Lyric chassis, model S-6 complete with tubes, slightly patched speaker and 4 original knobs, \$30.00, Thordarson N.O.S., R-190 boxed audio autotransfer, (its supposed to improve bass response) \$10.00; 2 good type 50 tubes, \$25.00 each; good 71A, 6A3, 6E5, & BH at \$5.00 each, add UPS. Will bring to Elkhart meet. WANTED: a 3 prong socket assembly for AK-30 plus a vernier knob. George Hausske, 1922 E. Indiana St., Wheaton, IL 60187, Ph. 708-668-3845.

WANTED: HELP! I want a date--any date--that might possibly conflict with IHRS Members' attendance at upcoming meetings. I need Hamfest dates, Radio Clubs' meeting dates, and potentially conflicting dates for our meetings. Please help your Officers with their 1994 planning. M. B. Johnston, R 1, Box 218A, Windfall, IN 46076-9706, PH. 317-945-7735.

FOR SALE or TRADE: 15 console TV's from 1950's and 60's, \$10.00 for pick-up truck load. Heathkit/Packard Bell transistor kit color TV with books and diagrams, was working, also tube type kit TV chassis, both \$20.00. Glenn Fitch, Ph. 317-565-6911.

WANTED: speaker for Zenith model 52 console radio, call evenings. Terry Ernsberger, 15655 CR40. Goshen, IN 46526, Ph. 219-642-3300.

FOR SALE: Radiola 17 with speaker, \$185.00; RCA Victor table top model X-551, \$55.00; National Union table model, 571-210-1522, \$55.00, all very clean and in good working condition. Joseph Stevens, 223 W. Wiley St., Bluffton, IN 46714, Ph. 219-824-9514.

BUY-SELL-TRADE: When at the Shiphewana Flea Market go 12 miles south on SR5 to Ligonier, IN. Hundreds of radios and related items in a section of the Radio Shack building, large private collection. Fred Schultz, 1246 Lincoln Way South, Ligonier, IN 46767, Ph. 219-894-3779.

WANTED: Radiola 44, Tower Sailing ship/Pirate speakers, Radiola 17 and 18, RCA 100A speakers and horn speakers. Joe Stevens 223 W. Wiley St., Bluffton, IN 46714, Ph. 219-824-9514.

FOR SALE or TRADE: 15 console radios from 1930 to 1955, most are untested and may need work, \$20.00 if you buy all. Also small town Western Electric Telephone switch board in good condition, \$100.00. Large telephone power supply, looks like new, \$20.00. Glenn Fitch, Ph. 317-565-6911.

A LIST will be forthcoming of the collection of C. E. Strand, which will be sold for the benefit of Ruth, Carl's wife. I estimate the radio count to be 200 plus vast quantities of horn speakers, literature, and tubes. If you have any specific wants, write me. All inquiries will be answered. Thank you. Dave Mantor, W9OCM, 2308 So. Fairlawn Way, Anderson, IN 46011.

WANTED: buy or trade novelty radios. Will buy one radio or total collection. Leo Hall, 16222 Fifteen Mile Road, Fraser, MI 48026, Ph. 313-294-7526.

WANTED: 1920's Indiana manufactured radios such as: Aladyne, Amaco, American, Apcodyne, Cardinold, Case, Diamond "T", Elmco, Future, Gram Built, Hancock, Hatfield, Indiana Hyperdyne, King Cole, LePilote, Lyradion, Melody, Midland, Nicholson, Okay, Queen Quality, Showers, Sinclare, Skylark, Slagle, Star Raider, Starr, Tilman, Vizo, and Washburn Burner. Also looking for any E.H.Scott, McMurdo Silver, Lincoln, Norden Hauck, and Leutz radios, literature, junk chassis, and parts. Michael Feldt, 12035 Somerset Way E., Carmel, IN 46033, Ph. 317-844-0635.

FOR SALE by NON-MEMBER: estate of radio and TV collector, radio sets, parts, tubes, Test Equipment, etc. Mrs. Ralph Kaelin, 70 Owens Cemetary Rd., Rockholds, KY 40759, Ph. 606-549-9896.

I HAVE BEEN IN BUSINESS (radio-electronic) repairing radios and amplifiers since 1935. A 26 page color catalog of products I manufacture and items for sale is available for \$2.00 postpaid. I have 5000 new and tested used, boxed, vacuum tubes. I have approximately $\frac{1}{2}$ ton of good new and used transformers. Send SASE with inquiries to James Fred, R 1, Box 41, Cutler, IN 46920, Ph. 317-268-2214.

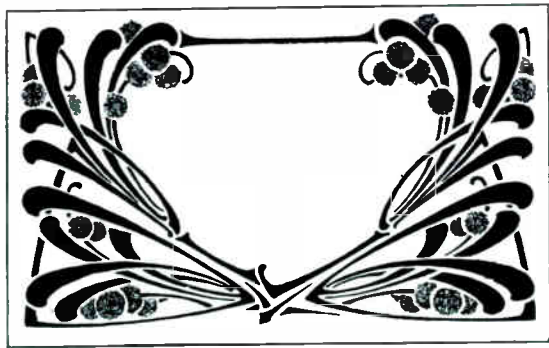



For 60 years this transom hung over the double door entryway to the room that once housed the Okay Radio Corporation.



This is the factory site as it looks today. It is on the S. E. corner of West National Avenue and Franklin Street. The room that once housed the Okay Radio Corporation is located upstairs in the left rear corner of the building.