

The *Call Letter*

December, 2010
Vol. 36 — No. 12



Celebrating **35** years in print!

The Northwest Vintage Radio Society

Post Office Box 82379
Portland, Oregon 97282-0379

The Northwest Vintage Radio Society is a non-profit historical society incorporated in the State of Oregon. Since 1974 the Society has been dedicated to the preservation and enjoyment of "Vintage radio" and wireless equipment.

Membership in the Society is open to all who are actively interested in historic preservation. The dues are \$25.00 for domestic membership, due on January 1st of each year (prorated quarterly).

The *Call Letter* has been a monthly publication since 1974. It was originated with the founder, Bob Bilbie, and our first president, Harley Perkins. Through several editors and with the assistance of numerous society members, the *Call Letter* has continued to be a publication that informs members of the society's business and that supports the hobby of collecting, preserving, and restoring vintage radios.

Society meetings are held the second Saturday of each month at the Abernethy Grange Hall at 15745 S. Harley Ave. in Oregon City, Oregon. They convene at or about 10 AM for the purpose of displaying radios, conducting Society business, and exchanging information. Guests are welcome at all Society meetings and functions (except board meetings).

Other Society functions include guest speakers, auctions, radio shows, and radio sales which are advertised in the *Call Letter* and are held in and around Portland.

With each issue of the *Call Letter*, we remember Jim Mason, a charter member of the society who remained active until his death in 1998. A generous bequest from Jim's estate ensures the vitality of the Northwest Vintage Radio Society, and continued publication of the *Call Letter*.

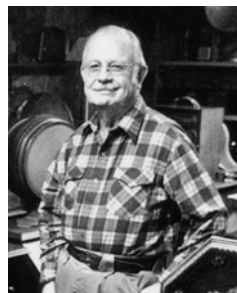

Society Officers for 2010:

President	Dick Bixler	(503) 690-2557 rf2af@comcast.net
Vice-President	Tony Hauser	(503) 397-0074 abhauser@aol.com
Treasurer	Cliff Tuttle	(503) 666-7005 kiptuttle@comcast.net
Recording Secretary	Liles Garcia	(503) 649-9288 landn2@frontier.com
Corresponding Secretary	Mike McCrow	(503) 730-4639 tranny53@comcast.net
Board member at large	George Kirkwood	(503) 648-4809 radiogeo@hevanet.com
<i>Call Letter</i> Editor	Rick Walton	(503) 656-4104 rwalton@easystreet.net
Librarian	John Bucholtz	(360) 693-7135 Bucholtz3049@comcast.net

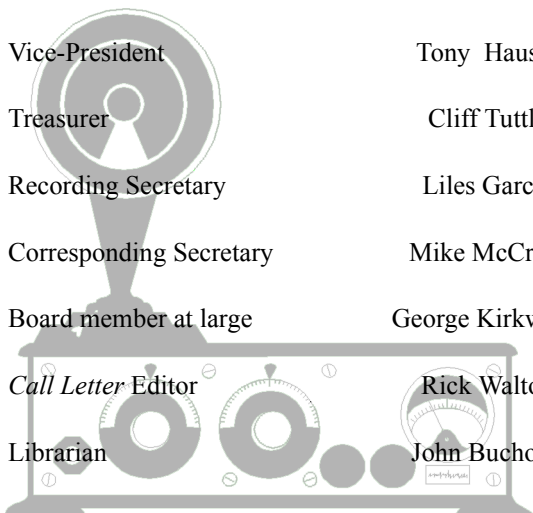

December 2010

Table of Contents

From the Editor2

From the President3

Annual Holiday Party3

NWVRS Meeting Minutes.....4

A Thank You Note5

Articles of Incorporation Amendment.....5

NWVRS Calendar of Events6

Photo Display.....7

NWVRS Radio Archives9

Roster Update10

Loop Antenna & Amplifier Project11

Voilà ...new and recent finds by NVRS members13

Swap Shop14

New Caps & Shirts!15

On the cover: From deep in the *Call Letter* archives comes this photo of a Christmas advertising sign for Eveready. This sign belongs to member Brian Toon. Your editor took this photo in September, 2007.

The next meeting is December 11, 2010.

**Annual Holiday Potluck and
Election of Officers for 2011.**

**No Monthly Feature for December.
January’s Monthly Feature: Kit Radios**

Visit our web site at <http://nwvrs.org>.

Next *Call Letter* Deadline: December 30, 2010.

The *Call Letter* is the official publication of the Northwest Vintage Radio Society. Circulation is limited to the membership and guests of the Society. The Society is not responsible for the material contributed for publication, nor the quality, timeliness, or accuracy of the items or services offered for sale in the SWAP SHOP. By common agreement of the board of directors, the buyer assumes all responsibility for the satisfaction of any transaction.

From the Editor

by Call Letter Editor, Rick Walton

As you can tell from the table of contents, this is a full issue — again! On page 3 is a message from President Dick Bixler and a reminder that the annual holiday potluck takes place following our *short* business meeting on December 11. On page 5 is a nice thank you note from the Killeby family, and details about the proposed amendment to the society’s Articles of Incorporation filed with the State of Oregon.

At the November meeting, Sid Saul displayed his loop antenna built in a cardboard box. In this issue, Sid describes how he built the loop and the one-transistor amplifier he uses with it.

The rest of this issue is full of photographs from last month’s display, one Voilá item, and Mark Moore’s report on the latest in our quickly expanding archives.

As pointed out in the meeting minutes, if you are interested in receiving the *Call Letter* electronically only, please let me know so that I can make the change in the mailing list for the *Call Letter*. Remember, you can both view the *Call Letter* online and receive a paper copy if you wish.

Have a Happy Holiday, one and all!

Always sunny & warm.

*For a refreshing change,
check it out!*



Sunny 1550 KKAD

	Herb Alpert - Tony Bennett - Michael Buble - Carpenters
	Nat King Cole - Perry Como - Neil Diamond - Diana Krall
	Barry Manilow - Johnny Mathis - Platters - Carly Simon
	Elvis - Frank Sinatra - Babara Streisand - Andy Williams

From the President

by Dick Bixler

Merry Christmas... Happy New Year... and good wishes to all. May your stockings be filled with AK breadboards and other radio exotica.

As we approach our annual Christmas party I would like to thank all whose efforts at Christmas as well as the rest of the year, make us the great member directed group that we are. We can look back thankfully to the completion of another success-filled year for our NWVRS.

Our membership numbers increase as we welcome new faces, ideas and techniques. We have enjoyed a number of informative programs courtesy of outside experts as well as tech talks by our own engineering oriented brethren. We can look forward to more of the same in our upcoming meetings.

Our ever-energetic VP, Tony Hauser, has outfitted us in super new caps to replace the old tattered ones as well as some great new NWVRS activity shirts. As interest develops, we'll have the chance to get some attractive, dressier and more general wear blue jackets.

We recognize and deeply regret the passing of our members from previous years as well as 2010. As the saying goes, our organization "stands on the shoulders of giants". We have an obligation to validate their efforts by more of our own.

Our Library is growing for our individual education, entertainment and edification. We greatly appreciate that our individual historic radio items are donated and under the supervision and preservation of our Society historian.

In addition to our Christmas dinner, we will be voting, not only for 2011 Society officers but also on the necessary bylaw changes as outlined in the November meeting by our Treasurer, Cliff Tuttle. Please see the minutes from the November meeting for details.

Best Holiday Wishes Dick

Annual Holiday Party

You are reminded that our December Society meeting is the occasion for our annual Holiday Party. Following a brief business meeting, the feast begins. As always, the event is pot luck. Bring your favorite salad, side dish, or dessert. Guests are welcome.

NWVRS Meeting Minutes

President Dick Bixler called the November 13, 2010 meeting of the NorthWest Vintage Radio Society to order at 9:50 AM. Liles Garcia read the minutes of the September meeting; the minutes were approved as printed in the October Call Letter. Cliff Tuttle gave the Treasurer's Report, and it was approved as provided by cliff. Members present voted to give Cliff the authority to work with the State of Oregon to define our Society's corporate status. Our Society gained three new members at our Swap Meet last month. Brian Snawder is one of our new members; the group gave Brian a round of applause. John Bucholtz said that the library is doing well. Mark Moore showed the group some of the items that he has in the Society archives. Fellow member Dennis Killeby recently passed away. Dick expressed the group's sympathy to his family. There were 57 people at our meeting today.

Old Business

Swap Meet--Brian Toon said that we sold 31 tables at our Swap Meet. See him if you would like to have a table at our May Swap Meet.

NWVRS Clothing--Tony Hauser has both hats and shirts for sale.

Electronic Copy Of Call Letter--Please let Rick Walton know if you would like to receive the Call Letter by e-mail.

New Business

Christmas Party--Our Society's Annual Christmas Party will be at our December meeting. The Party will be a potluck lunch.

Nomination Of Officers--Members present voted to nominate the current officers for next year.

Leads and Needs

Dave Wise needs a cabinet for a General Dynamics R-1051. John Cushing needs to look at a Zenith 12S245 to see the wood rails around the speaker. Del Dixon needs two Zenith ivory top hat knobs. Damon Vandehey needs a tube tester that tests compactrons and other newer tubes. Ed Tompkins needs three wood knobs for a Kolster K-100 tombstone radio.

"WHAT IS THIS?" Contest from November Call Letter: George Kirkwood won the \$7.00 for his description of the mystery item. See the November Call Letter for more information.

Program Topic

The Program Topic for today is “Before And After Projects”. Members showed and discussed the approximately four items that they brought. The Program Topic for January will be “Kit Radios”.

Sid Saul brought a loop antenna that he made for a crystal set. He showed the group a one transistor amplifier that he added to the crystal set.

The meeting was adjourned.

A Thank You Note

The family of Dennis Killeby would like to thank you for the Silent Key tribute in last month's issue. Dennis loved being a member of NWVRS; he had found a kindred group. You spoke his language, and he loved you for it. It was always his greatest pleasure to spend the second Saturday of the month and the swap meets with you. Please know that we will keep his membership active because you are very special to our family. We will see you in the Spring.

With great love and appreciation, Sylvia Killeby and family

Articles of Incorporation Amendment

by Cliff Tuttle

Proposal to amend our ‘Articles of Incorporation’ with the State of Oregon

After talking with Rhonda Powell of the Department of Justice – Charitable Activities Section, it seems both necessary and appropriate that we amend our Articles of Incorporation as filed with the state. To do this, we need to post this proposed change in our *Call Letter*, propose a motion to execute this change at the following meeting, and vote on that motion. Our intent is to have this vote at our December 11th meeting.

The proposed amendment would change Article II, subsection 2 as follows:

Currently it reads “To preserve the literature and history of radio apparatus for the benefit of its members;”

Propose to change it to read “To preserve the literature and history of radio apparatus for public benefit;”

See you on the 11th

NWVRS Calendar of Events

Most of the hamfest and ham swap meet information comes from: PNW Hamfair web page at www.n7cfo.com/amradio/hf/hf.htm

December 11 NWVRS monthly meeting and annual Holiday Party 10 am. Election of officers for 2011.

2011

January 8 NWVRS monthly meeting 10 am; tailgate swap 8:30.

February 12 NWVRS monthly meeting 10 am; tailgate swap 8:30.

February 19 Salem Hamfair & Computer/Electronics Swapmeet. Rickreall, Oregon at the Polk County Fairgrounds. <http://www.w7sra.com>.

March 12 NWVRS monthly meeting 10 am; tailgate swap 8:30.

March 12 Mike & Key Swap Meet. Puyallup fairgrounds exhibition hall, Puyallup, WA. For information, contact dmdink@yahoo.com or n7wa@arrl.net. <http://www.mikeandkey.org/flea.htm>.

April 9 NWVRS monthly meeting 10 am; tailgate swap 8:30.

April 22-24 Idaho State Convention. Garden City, ID, Voice of Idaho ARC. ARRL sanctioned. Info, Lynn Rasmussen, W7RAZ, (208)550-7710, w7raz24@gmail.com. <http://www.idahostateconvention.com/>

May 14 NWVRS Spring Swap/Sale at Aurora American Legion Hall, Aurora, Oregon.

May 14 Stanwood Camano Amateur Radio Club Hamfest, Stanwood Middle School, Stanwood, WA. Always the second Saturday in May. Contact Vic, N7KRE (360)387-7705) nwecop@tgi.net <http://www.scarcwa.org/>

June 3-5 Sea-Pac Hamfest. Seaside Convention Center, Seaside, Oregon. ARRL sanctioned. ai9q@arrl.net www.seapac.org/

June 10, 11, 12 Wenatchee Hamfest 2011. Apple City ARC. Dryden Gun Club. Dryden, WA. Contact Jim, W7JBP at shultzjims@aol.com or Judy, at ka7zna@msn.com for information. <http://www.qsl.net/w7td/>

Photo Display

Photos by Dick Bixler, Esteban Mendoza, Dave Wise, and Rick Walton

Only four members displayed items in November, but they displayed good ones. Esteban Mendoza, who showed the beautifully restored Coca Cola vending box radio, and the very cleverly restored Crosley, asked that I add this statement to his explanation of his radios: "If not for Blake's teaching, showing, and his instructions, his knowledge and patience, the Crosley cabinet wouldn't have come out as it did. Thank you Blake for all your help."



Above: Crosley 148 in Austin cabinet
Left: Coca Cola radio with before photo.
Both restored and presented by Esteban Mendoza.

Below: Channel Master 6515A
Restored and presented by Dave Wise.





Restoration of Eveready "B" batteries.
Restored and photographed by
Dick Bixler.



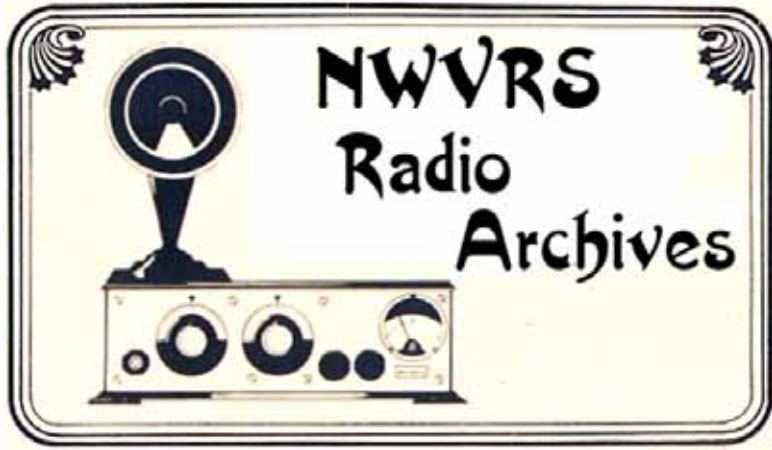

by Mark Moore, NWVRS Archivist

At our November meeting, I received several items for the NWVRS Archives including a 16-inch radio transcription disc and accompanying CD; a Notice of Secrecy Law poster dated 1912 for posting in all radio stations, a writing tablet with a Radio cover and three Radio Quiz Master Stunt Games.

The transcription disc was recorded at KEX in 1932 and it contains a recording of Mildred Bedell of Bedell's Clothing Store reading the news on KEX. Local shop owners were invited to read the news on air as compensation for sponsorship of their broadcasts. George Kirkwood made a CD recording of the news broadcast for future generations to hear.

Thanks to Dick Bixler for continuing to find items for our archives. The writing tablet was found in Don Iverson's collection and it features a *Radio Magazine* cover showing radio's young inventors. The Quiz Master Games from 1944 are very colorful and they are a nice addition to our archives.

Thanks also to radio historian and honorary member of the NWVRS Craig Adams for researching the history of *The Cinnamon Bear* radio program which first aired in November 1937. He found a number of newspaper ads for *The Cinnamon Bear* as well. I have added the ads and information to my PdxHistory.com website.

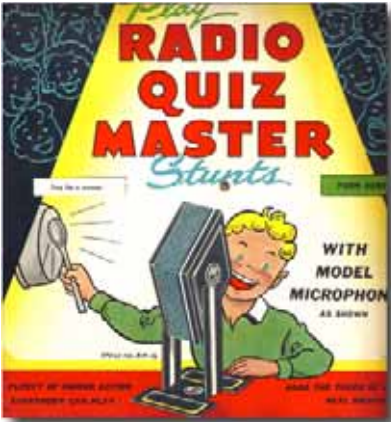

Roster Update

Cliff Tuttle, our treasurer, reports that as of November 24, twenty-seven members have paid their 2011 dues, including this new member:

Gibson, Brian R
 4450 SW 96th Ave #4
 Beaverton, OR 97005
 (503) 469-0113
 Musical Instrument Tube Amplifiers
gbgibson@earthlink.net

Loop Antenna & Amplifier Project

by Sid Saul saulsidney@gmail.com



Here are the links for the loop calculator and transistor amplifier used to build the loop antenna and amplifier shown at our Nov 2010 NWVRS meeting:

Loop Calculator <http://www.angelfire.com/mb/amandx/loop.html>

Transistor Amplifier <http://www.sentex.ca/~mec1995/circ/activant.html>

The loop numbers for my project were 19.5 inches tall, 15.5 inches wide, and 7 inches deep: This just happened to be the first old cardboard box I grabbed and not scientific at all. 19 turns spaced .25 inches apart. I used a 0-365 pF variable capacitor in series with the loop. With added capacity from the loop, I plugged in 18-380 pF on the calculator. I used 110 feet of #26 stranded insulated wire.

Use whatever size box you have. Run the numbers from the calculator to make sure the capacitor covers the broadcast band as equally as possible from your variable capacitor. My numbers calculated a loop inductance of about 533uH. My calculated frequencies were .35 to 1.6 MHz. Very close to actually measured.

I used only 1 turn of wire separate from the main coil spaced .25 inch from the main coil to make the pickup coil that feeds into the amplifier input or directly to the radio's antenna terminal without using the amplifier.

I just taped the loose unused end of this 1 turn pickup loop to my cardboard box to keep from unraveling. I cut .25 inch spaced grooves with a hack saw in all four corners of the box to keep the spacing under control, and covered the finished coils with paper to prevent future damage to the windings.

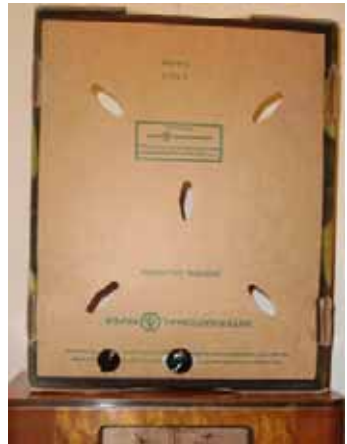



This simple 1 transistor amplifier, substituting the 18 inch wire antenna shown on the schematic with my loop, seemed to more than double long distance performance. I hope to check the actual increase in the near future and may add a second identical amplifier in series with the first.

I initially used a 9 volt rechargeable battery for power and later used a 9 volt wall - wart putting out almost 14 volts unloaded. I placed the negative DC voltage at the point on the schematic shown as common ground connection. I didn't use a shielded antenna plug going to the radio. Instead ran one lead from this common ground to my radio's 'G' terminal on the radio's antenna strip. As long as this wire goes to the radio's chassis is all that matters.

AM-FM-SW Active Antenna

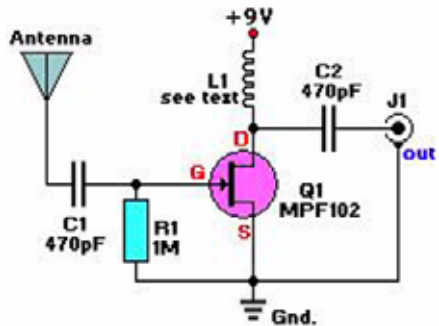

The lead from C2 on the schematic went to the radio's 'A' antenna terminal. I added a rotary selector switch on the front of my box that allows me to bypass the loop and amplifier for using another antenna for shortwave. Doing this required placing a 150 to 270 pF capacitor in series between the common ground on the schematic and the connection to my radio's ground screw-chassis. This got rid of all the interference and frequency shifting from the added capacity of the selector switch and associated wiring. This capacitor is not installed or needed without the optional selector switch. I also ran a water pipe ground to my radio's G terminal, as this got rid of noise with or without a loop, as I have a lot of mains noise in my apartment building. Special thanks to George Kirkwood for his suggestion to use 300 ohm flat TV lead-in wire from the amplifier to the radio to help prevent the rare squeal occurring when the wires from the amplifier to the radio got tangled up turning the loop for maximum signal. This antenna has a very sharp null when turned broadside to the station.

Norvac electronics and Fry's both carry the NTE 451 JFET transistor for around a buck. L1 needs to be around 470 uH for best results for the AM band. I placed 4 smaller inductors in series to get close and without

problems. Trying more than 500 uH lowered performance. This little project costing but a few dollars has given my '39 RCA K1 6 tuber a new lease on it's AM DX life.

Follow-Up: Here is the signal strength comparison from the loop with and without the amplifier. I used the AVC circuit on my RCA for this comparison as this relies on incoming signal strength. I placed my digital voltmeter across the capacitor that stores negative DC voltage coming from the 2nd detector AVC tube and sends it to the control grids of the 1st detector and IF tubes.

On average there was a 50 percent increase in signal voltage using the onboard amplifier as compared to the loop alone. The range was a low of 13 percent increase on the blow torch station nearby, to a high of 79 percent increase with a low power night time local station. I hope you enjoyed reading about my first experience with loop antennas and building this simple amplifier.

Voilà

...new and recent finds by NVRS members

Compiled by Jay Johnston

Rudy Zvarich—I got a receiver I have “drooled” a life time for at the Rickreall swap meet, a Hallicrafters SX-28, It is in excellent original condition. It will be a winter project to tune it back to original specs.

10% DISCOUNT

To all members in good standing of the
Northwest Vintage Radio Society
 for any purchase from



NORVAC
 ELECTRONICS, INC.

BEAVERTON (503) 644-1025
 7940 SW Nimbus Ave.

SALEM (503) 583-9810
 1545 Commercial St. NE

EUGENE (541) 345-2904
 960 Conger St.

Please show your current
 NVRS membership card
 to receive discount.

Swap Shop

FOR SALE: Thousands of tubes, hundreds of radio parts, panels, meters, surplus, etc. R5-D3 electronic surplus, Bob Lee, 9770 S.E. Stanley Ave., Milwaukie, OR 97222, (503) 513-0410

FOR SALE: Mister Resistor has thousands of resistors plus over a thousand tubes all at LOW LOW prices. If you need either contact John Bucholtz at 360-693-7135 or e-mail at Bucholtz3049@comcast.net.

FOR SALE: *Hickok 288X signal generator, Hickok 600A tuber tester, Eico 7 1/2" Tube type VTVM, Eico solid state signal tracer, Mallory vibrator tester, Radio Shack 22-215 VOM with half scale, MFJ 2035MV 0-15 VDC 30 amp continuous power supply. THANK Robert Campbell

Radio Service

These members have indicated they are willing to perform radio repairs:

Roger Brown – (503) 693-6089

Bruce Baur - (503)-708-4537, brucebaur@comcast.net

Blake Dietze – (360) 944-7172, wb6jhj@ix.netcom.com

Jack Doyle – (503) 305-8097

Pat Hickman – (503) 887-9015 Web: www.classictubeaudio.com

Email: phickman@comcast.net

Todd Ommert – (503) 246-4141 Web: www.burlingame-radio.com

Email: burltv@msn.com

Tony Ranft – (360) 944-8489 or walterranft@hotmail.com – General repairs.

Dave Wise – (503) 648-0897, david_wise@phoenix.com

If you are willing to repair radios, give your name, phone and/or e-mail, and any comments to the *Call Letter* editor.

The Northwest Vintage Radio Society is not responsible in any disputes arising from services provided by members listed here. By common agreement of the board of directors, the buyer assumes all responsibility for the satisfaction of any transaction.

Leads and Needs

Questions about restoration of vintage radio? Visit Radiolaguy's web site often for this information plus lots of other interesting displays, photos, virtual museum plus lots of other information on vintage radio and television. Oh, yes, there are items for sale as well and NVRS members get a substantial discount on most of these items. Thank You, Sonny the Radiola Guy
Visit my vintage radio web site: <http://www.radiolaguy.com>

New Caps & Shirts!

New caps and new shirts are available. Caps are \$10, and shirts are \$22 for M & L sizes, \$24 for XL. Contact Tony Hauser for more information.



Radio Fans



**Here Is a Winner
Armstrong
Regenerative Set
Receiving
Radius
600 Miles
\$23²⁵**

Order Direct From
This Advertisement.

HERE is a money saving Radio Outfit that will bring the news of the world—concerts, lectures and stock reports—into your home. And complete with loud set, tubes, batteries, aerial and ground wires, for only **\$23.25!** Connections simple and plainly marked. Easy to tune. Order NOW! Shipping weight, 12 pounds. Shipped from CHICAGO or PHILADELPHIA store.

\$7PR9366.....\$23.25

Save on All Radio Supplies.
Save money on your radio supplies, and get guaranteed quality! Our big **FREE Book** shows hundreds of bargains in complete sets and parts. Many new booklets, complete list of broadcasting stations. Contains "How to Build an Aerial." Mail coupon!



**FREE
Radio
Catalog!**

Sears, Roebuck and Co.
Chicago - Philadelphia

Mail coupon today to store nearest you for free Radio Catalog.

Send me FREE Radio Catalog No. 89171.....

Name.....

P. O. State.....

Rural Route..... Box No.....

Street and No.....

Licensed under the Armstrong Patent No. 1113149 for amateur experimental and scientific uses only.

Sears, Roebuck and Co.

The World's Biggest Mail Order House

The Back Page

The December, 1922 issue of *Radio Age* magazine.
“Happy Christmas to all, and to all a Good Night!”

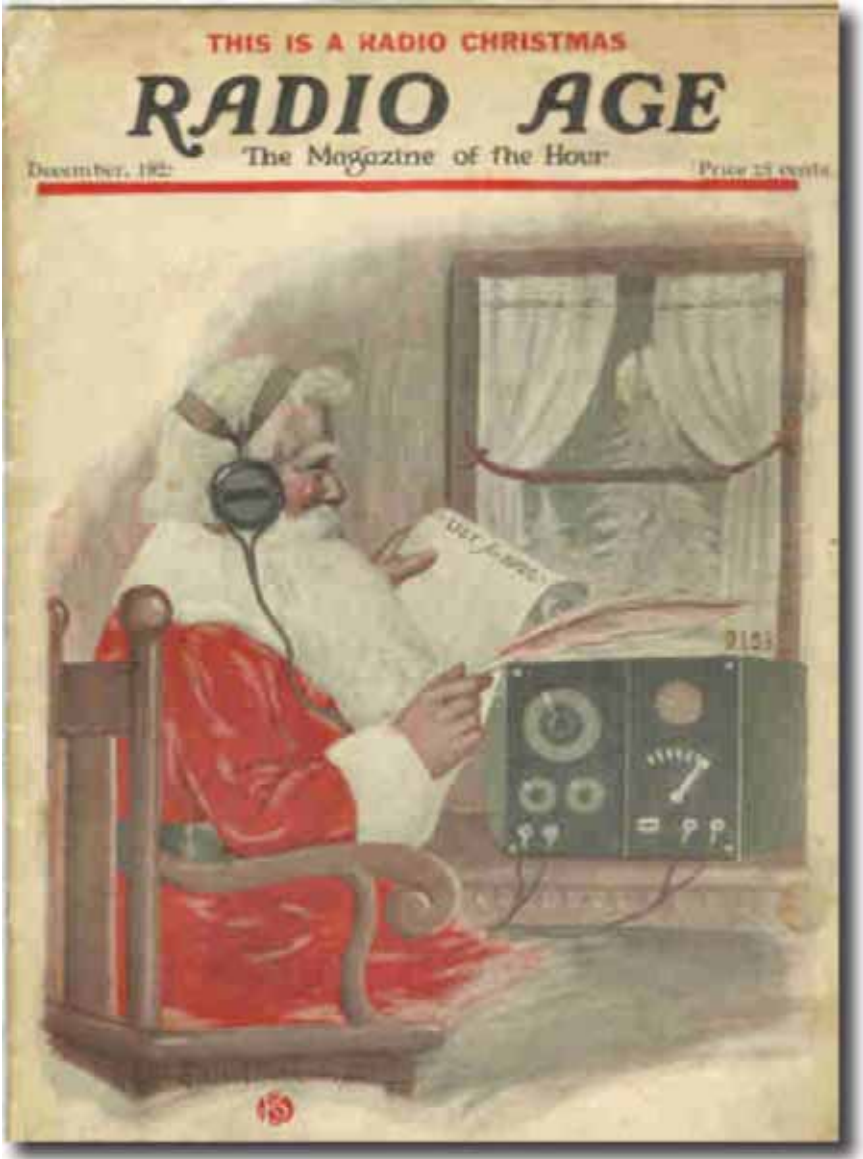

Officer's Roles

The President

The President shall preside at all regular and special meetings of the membership and the Board of Directors. The President shall set the time and the place of Board of Directors' Meetings. The President has the power to appoint members of committees as appropriate to enhance the activities of the society.

The Vice President

The Vice President shall be responsible for planning and arranging technical and entertaining activities associated with the society's meetings. He serves as chairman of the program committee if such a committee is appointed. He acts as presiding officer at meetings if the President is unavailable.

The Recording Secretary

The Recording Secretary shall be responsible for recording the minutes of every business meeting.

The Corresponding Secretary

The Corresponding Secretary shall be responsible for all of the society's networking and correspondence tasks.

The Treasurer

The Treasurer shall be accountable for all funds received and disbursed by the society and shall report all monetary transactions and treasury balance at each regular meeting of the society. The Treasurer shall prepare a list of members in good standing for distribution at the next regular meeting following the annual meeting of the society.

The Board of Directors

The Board of Directors shall consist of the current elected officers of the society plus the immediate past president of the society. The Board of Directors shall direct the care and expenditure of the funds of the society. The Board shall determine a suitable time and place for regular society business meetings.