

NORTHWEST
VINTAGE RADIO
SOCIETY

VOL
3

NO.
2

January 25th, 1977

"THE CALL LETTER"

Written & edited by Bob Bilbie, Mailed by Bobbie Kibler, Contributing writers-Tom James and Mark Moore. Mailing labels by Doug Eggert. This newsletter is written each month for the enjoyment of our members and all materials submitted for publication should be mailed to Bob Bilbie, 295 S. Knott St., Canby, Ore., 97013 BEFORE the 25th of the month to make deadline.

WE TELL IT LIKE IT IS!

#####

FURTHER INFO ON SALEM

As you all know by now the Salem Show & Flea Market is just around the corner and we hope that as in the past, it too, is a success. Those wishing to sell should contact Frank or Elizabeth Haley (Ph. 393-2897) for reservations on tables. Rates are \$6 per table. Those not wishing to sell but only display their radios for public view can go to the State Fairgrounds in Salem at 4 PM, Saturday evening and help set up the NWVRS Display. We hope you all accept this challenge as you have in the past, for if it is successful it be an annual event. Those of you who don't know where the Fairgrounds are located we include the address: I7th & Silverton Rd., between Lancaster Drive & H'way 99E

Get down there on Saturday evening, Feb. 12th with your display or sale items between the hours of 4pm to 6:30pm and be able to set up early. (You get to view some of the merchandise early that way!) O.K., NWVRS, lets get it on and make Mr. Haleys' efforts worth while, you'll enjoy it and the hunting is not going to be better anywher else on that given day!! Big day is Feb. 13th, 1977 at 10 am for buyers.

AN URGENT NOTE

This is from a letter I received from member Don Hunker:

I am helping a friend at Rodgers restore a Model I80 Majestic Receiver. It has a beautiful walnut cabinet with a 78 RPM record player in the top. He is a finish shop man and has done a fantastic job of refinishing and restoring the cabinet but ALAS!, no POWER SUPPLY! So Don needs Grigsby/Grunow Majestic POWER UNIT # 8P6 & 8P3 for Model I80 chassis (MUST WORK) Can any member out there help in this project??

Call Don at 357-2495 or write to this address: Don Hunker, Rt. 2, Box 401-M

Forest Grove, Ore., 97116

HE'LL APPRECIATE ANY INFORMATION

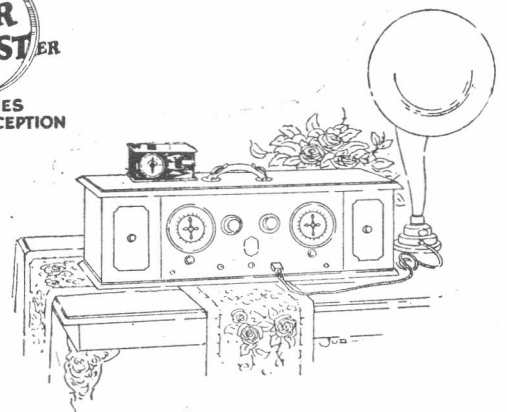

Super-Booster Distributing Co.

2528 W. 7th St. Los Angeles Tel. DU. 0878

MARKS MEMO

With the many new members we have just enrolled have come many gracious and encouraging letters. For many of these new members we owe thanks to James Fred of "Elementary Electronics", for his mention of us in his Antique Radio Corner as well as Brent Dingman of Historical Radio Services. I think all of us could learn a lesson from Brent and his more than helpful attitude for radio collectors everywhere.

Among many of the letters that come my way is the feeling of praise for our little "newspaper", The Call Letter. I want to pass along this praise to the ones who deserve it, Bob & Sandy. We also look forward to a year of active growth with Bob as president.

Before we list our many new members, I want to pass along a thank you to Dave Wright of Bethesda, Maryland, who is in his second year as a member, for his kind letter. We hope someday to meet all of our members who are now separated by restrictive miles.

Since this is the beginning of the year we have had an unusual amount of new members. Of course, this does make it easier at renewal time as all dues are to be paid during January if possible. WE WELCOME:

Tim Austin, Raleigh, N.C., Bob Avey, Portland, In., Rick Caruso, York, Pa., Larry Chambers, Nashville, Tenn., A.R. Fremstad, Calgary, Can., Ron Hayhurst, Milw., Ore., Michael Henderson, Charleston, W.Va., Jerry & Nina Irwin (Chapter Members-not confirmed) who have moved to Ontario, N.Y. to be closer to Kodak, Jerrys employer--we all miss you Jerry & Nina! Ed.) Ray Kresek, Spokane, Wn., Harold Leeder, Victoria B.C., Canada, Norm Moore, Portland, Ore., Bill & Susie Mueller, Pitts., Pa. (the editors daughter & son-in-law who finally decided that collecting radios weren't so bad after all!! Ed.) Vard Nelson, Junction City, Ore., Edward Short, Middletown, Ct., F.A. Smith, Vanc., B.C., Frank Vaillancourt, Hinsdale, NH, Andrew Wall, Terminal Island, Ca., Harry Weinborn, Portland, Ore., ANTIQUE WIRELESS ASSOC., Holcomb, NY, Bill Craven, Williston, ND., Dick Deaux, St. Paul, Minn., Louis Myers, Alva, OK, Jerry Ridenour, Wabash, In, Dan Kraft, Ramsay, ME., and Glen Stamwitz, Hoquiam. WELCOME FROM ALL OUR MEMBERS!

In order to put all members on an annual basis for paying their dues, we ask those who joined in the middle of the year to renew NOW in order to save a lot of extra work later on. Also, dues may be going up in the year so NOW is the time! It has been the policy of the NWVRS from the beginning to have dues paid in January, since it is easier for everyone concerned.

ONE LAST NOTE:

KEX will be running OLD RADIO SHOWS every evening at 8:05 from Jan., 24th thru Feb. 4th, Monday thru Friday. Listen in!

Secretary of the NWVRS
Mark Moore

OF INTEREST TO MEMBERS

Your editor has come across the following "brand new" instruction MANUALS on the following Radiolas, III, IIIA, IV, Bal Amp for Rad III, X, 20, 26, 28, Super Het (att. Harley Perkins) Borgia, RCA Duo-Rectron Batt Elim. (Mod. AP-937), Radiola 25, Model Iø4 Speaker and Radiola "Grand" type Rg, also catalogs, 1st and second, 1921 and '22. Catalog containing pictures of very rare Radiolas #I, RS, Mod. 5 and Radiola II. Any member having one of these radios but not a MANUAL is welcome to COPY one for his own use. There is no charge for the use of the originals, however would appreciate discretion in the handling of these very precious bits of radio history.



"This guy said he'd paid half--so we compromised!"

AN IMAGINARY LOOK INTO THE FUTURE!

Portland(UP)Northwest Vintage Radio Society, founded a scant ten years ago and dedicated to the resoration and preservation of antique radio has just opened their new museum, covering two acres at the corner of Bennet & Hammersly in downtown Philcoville. Over 1000 radios and many associated exhibits are on view to the public on a donation basis, and of special interest is the new DE FOREST HALL containing rare specimens of De Forests early experiments in wireless. The members of the NWVRS had this dream years ago and thru their diligent efforts have caused this to become a reality. As well as the display area they have a large meeting hall, a workshop for refinishing & restoring antique radio cabinets, a fully equipped electronic workshop, a very large library full of books dealing with every phase of radio, a cafeteria which serves a special "AK Burger" which they claim is unique since it is cooked over a smoking radio! They claim an enrollment of over 10,000 members all over the U.S. & overseas. Other activities carried on by the club are seminars of all sorts dealing with every aspect of antique radio, work with the local school systems, shows put on in different cities in the land to bring the magic of early day radio before the public and helping in many ways to further the interst in antique radio. A future plan is to donate to our Smithsonian Institution a group of surplus old sets with which they can establish a national museum room of antique radio for all United States citizens to enjoy. We congratulate this group for their very worthy efforts in providing a needed and most interesting museum for the perpetuation of one of Americas bits of nostalgia, Antique Radio.



SOUND LIKE A "FAR-FETCHED" DREAM, FELLAS?? think about it a while and feel the pride well up in you in having this become a reality.....we can do it a step at a time by drawing up plans NOW and working like hell for the NORTHWEST VINTAGE RADIO SOCIETY and not just our own little world of collecting!

This is just an idea but maybe it could work like this on a timetable sort of plan.....

- 1st...Incorporation-1 year
- 2nd...Land purchase, paid by club activities-2 years to accomplish
- 3rd...Foundation laid, by monies made thru club ventures-2 yrs.
- 4th...Building put up in same manner, small at first but designed in such a manner as to be able to add to later-3 yrs
- 5th..Installing permanent displays most of which is available right now (Editor would donate ALL my collection to a worthy cause like this)
- 6th..On to even bigger & better things!

Remember how many things were just a "dream" before they were a reality, including our own little club which started only as an idea in the back of Sandy Bilbies mind...as a matter of fact...most of us back in the "founding days" of the NWVRS laughed at her saying that we felt that it could not be done! (We started with 5 interested parties and a month later had 35 CHARTER MEMBERS!! Yes, fellas this could become a reality.....give it some thought and we'll talk about it at one of our meetings.....Editor & Pres., Bob Bilbie

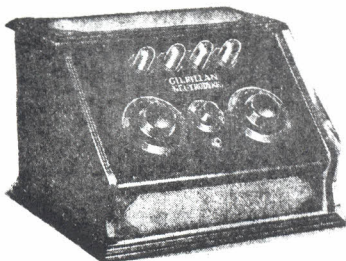

The Best Buy in Radio Today!

GILFILLAN NEUTRODYNE

The 4-tube, Dry Cell Set of Unsurpassed Tone Quality. Low in Price—Big in Results!

\$65



"ATMOSPHERICS"
by TOM JAMES
Poet & Veep!

"CAMPBELLS' ALPHABET SOUP"

A is for Auburger, a super Maryland cat,
B is for Bilbie, we know where he's at,
C is for Campbell, also Coors and Cheese,
D is for Don, we have several of these.
E is for Eggert, Doug the first name,
F is for Fizzle and Fortune & Fame.
G is for Gonshorowski, R & G make two,
H stands for Hunker, one here will do.
I represents Irwin, stern Charter stuff,
J is for Joncas, a Cornelius buff.
K stands for Knott, a kinky feat,
L is for Maurice, M is for Leete
N is for Novak, Jerry but not Dick,
O is for O'Brien, staunch Irish Mick
(None on our roster, that I could detect)
P is for Perkins, Phormer President elect.
Q is for Quincy, also not on our map,
R stands for Raynor, A Canadian chap,
S stands for Shadduck, a shy sort of man,
T is for Tomkins, does the best he can.
U is for Useless, likewise so is V
W is for Wood, a local northwest devotee.
X is for the line you sign your name,
Y stands for Young, of dial cleaning fame
Z is temporarily not on the list,
Use it for others quite obviously missed!

"Cornell-Dubilier sales just hit a new high"

THE WORLD'S MOST COMPLETE CONDENSER LINE
WET & DRY ELECTROLYTICS
MICA • PAPER • DYKANOL

CORNELL-DUBILIER CORPORATION
1014 Hamilton Blvd., So. Plainfield, N. J.

CORNELL DUBILIER

"SNEAKY PETE STRIKES AGAIN"

With a tip of a find in La Bonne,
I jumped in my car at the dawn,
But, pity my plight.....
The previous night
Old sneaky had been there and gone!

"JUNK or GEM"

A vintage radio is a precious thing,
From an era unparalelled in time,
But the appearance or performance
of same,
Is not necessarily worth a dime.

RADIOS **SAVE UP TO 50%**

ALL NEW 1937 MODELS

A penny post card brings you our new, full-color 16-page BARGAIN CATALOG free. Many models to choose from: 4 to 19 tubes; AC-DC, All-Wave and new Farm sets that operate like city radios! Send post card or coupon below for full details of 30-day no-risk trial and Agent-User proposition. Write now!

30-DAY NO-RISK TRIAL

\$6.98

MAIL COUPON *Free Catalog*

GOLDENTONE RADIO CO., Dept. B, DEARBORN, MICH. Without obligation, send me new 1937 Catalog and 30-day trial plan. Name _____ Address _____

"A PERFECT FIT"

I had a drinking friend,
Whose set can gone to pot.
He said the tubes lit good,
But they got beastly hot!

Poor old vintage radio...

A laugh or two for me...

It had 80's in the sockets,
Where OI-A's should be!

Dealers:—MARWOL 5-Tube
Tuned Radio Frequency

BABY GRAND—\$45.00 List	A-1—\$60.00 List
MADERA All Wood Loud Speaker	TELEVOCAL TUBES No. 199—No. 201-A Bakelite Base
	AERIAL BOOTERS

HERBERT H. HORN
WHOLESALE ONLY
1629 S. Hill St. WESTmore 1713 LOS ANGELES

"ATMOSPHERICS", continued...

"CAVEAT EMPTOR"

He said, "How d'ya do", normal enough,
And, "I'm sure pleased to meetcher",
But I found out this character was
A strange and coniving creature.

He had some old radios put away
In a careful, and tidy fashion;
He loved each one in a different way,
With a deep paternal passion.

I knew I was in trouble here, sure,
If I expected a bargain here;
I wondered if he'd someone to leave them to,
When he shucked this mortal sphere.

He reluctantly sold a METEOR,
For an astronomic sum,
And I left the weeping old codger,
Ashamed of the cad I'd become!

But I'm now all over my grief,
Since I learned the truth from a friend,
That SHYSTER had bought all those radios,
At a FLEA-MARKET over in Bend!!

It is our hope that we can get our extra-ordinary poet, Tommy James, to compile a booklet of his unique limericks on early day radio and have it available to our club members at a price helpful to both him and the NWVRS. These little items are one of the best sections of our newsletter and everyone looks forward to them each month.....keep it up Tom, we love 'em!

The next regularly scheduled meeting of the Northwest Vintage Radio Society will be Feb. 12th, 1977 at 10 am. Buena Vista Clubhouse, 16th & Jackson, Oregon City, Ore. Plan to attend for we always need your active participation to keep our little club "healthy".

FINDS

By Bob Bilbie-Hallicrafters SX-28 and matching speaker in very good condition. Works, too. National NC-200 and the matching speaker, manuals, AND the original wood crate it was packed in. This radio deserves special mention for the condition it's in-LIKE NEW! It is playing beautifully, with all it's original tubes. This radio can be seen in "FLICK of the SWITCH" on page 239 Also Amer. Bosch Mod. #5A, Philco cathedral, Mod. #60 and Red Lion Writing Desk Cabinet holding a Model 40 A.K. "tin-box"

By Alan Shadduck. A rare FALCK "tombstone" using screen grid tubes, Zenith Trans-Oceanic needing only one tube to make it work (Excellent condition)
By Joe Tomkins-RCA Radiola Model 20 and others too numerous to mention!

\$16.00

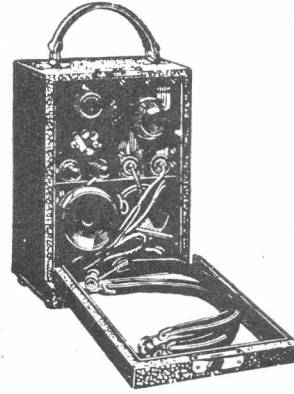

1-Tube Kodak

\$22.50

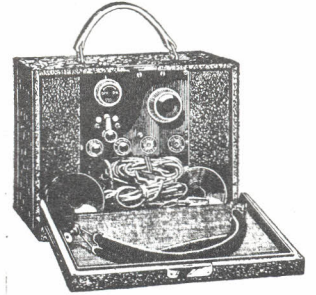

2-Tube Kodak

No matter where your vacation takes you, this wonderful receiver will be your companion.

\$37.50

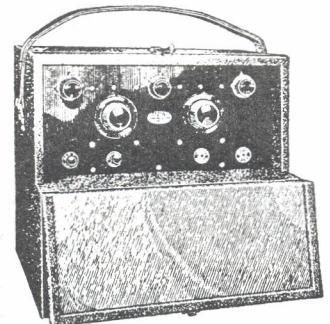

4-Tube Kodak

Surely you can choose yours from this wonderful assortment.

Approved by Radio News and KNX Testing Laboratories

KEY TO STATION CALLS

Horizontal:

Location of Stations	Wave-Length
1. Tacoma, Wash.	250
2. Los Angeles, Calif.	468.5
3. Yankton, S. D.	244
5. Harrison, Ohio	422.3
6. Oakland, Calif.	240
8. Los Angeles, Calif.	336.9
9. Dallas, Tex.	475.9
11. Chicago, Ill.	447.5
12. Everett, Wash.	224
13. New York, N.Y.	405.2
14. Portland, Ore.	491.5
15. Toledo, Ohio	252
16. Baltimore, Md.	246
17. Yellow Springs, Ohio	263
18. Cedar Rapids, Iowa	278
19. Fall River, Mass.	266
20. Lawrenceburg, Tenn.	282.8
22. Harrisburg, Pa.	275
23. Minneapolis, Minn.	416.4
25. Chicago, Ill.	226
26. El Paso, Texas	267.7
27. Des Moines, Iowa	526
28. Dallas, Texas	246
29. Stevens Point, Wis.	278
30. Denver, Colo.	322.4
31. New York, N. Y.	360
32. Spokane, Wash.	273
34. New York, N. Y.	240
35. Chicago, Ill.	447.5
36. Indianapolis, Ind.	268
37. St. Louis, Mo.	248
38. Springfield, Mass.	331.1

KEY TO STATION CALLS

Vertical:

Location of Stations	Wave-Length
1. Lacey, Wash.	246
2. Oakland, Calif.	508.2
3. Toledo, Ohio	252
4. Arlington, Va.	434.5
5. Newark, N. J.	252
6. Everett, Wash.	224
7. Salt Lake City, Utah	246
8. San Jose, Calif.	231
9. Lincoln, Nebraska	275
10. Providence, R. I.	305.9
11. Chicago, Ill.	302.8
12. Oakland, Calif.	240
13. Chicago, Ill.	266
14. Clarinda, Iowa	242
15. Escanaba, Mich.	256.3
16. Houghton, Mich.	263
17. Cleveland, Ohio	389.4
18. Omaha, Neb.	258
19. Rossville, N. Y.	273
20. Northfield, Minn.	336.9
21. Philadelphia, Pa.	508.2
22. Birmingham, Ala	248
23. Winter Park, Fla.	240
24. Madison, Wis.	535.4
25. Richmond Hill, N. Y.	212.6
26. Louisville, Ky.	275
27. Kansas City, Mo.	278
29. Miami, Fla.	263
30. Los Angeles, Calif.	405.2
31. Kansas City, Mo.	365.6
32. San Jose, Calif.	231
33. New York, N. Y.	454.3

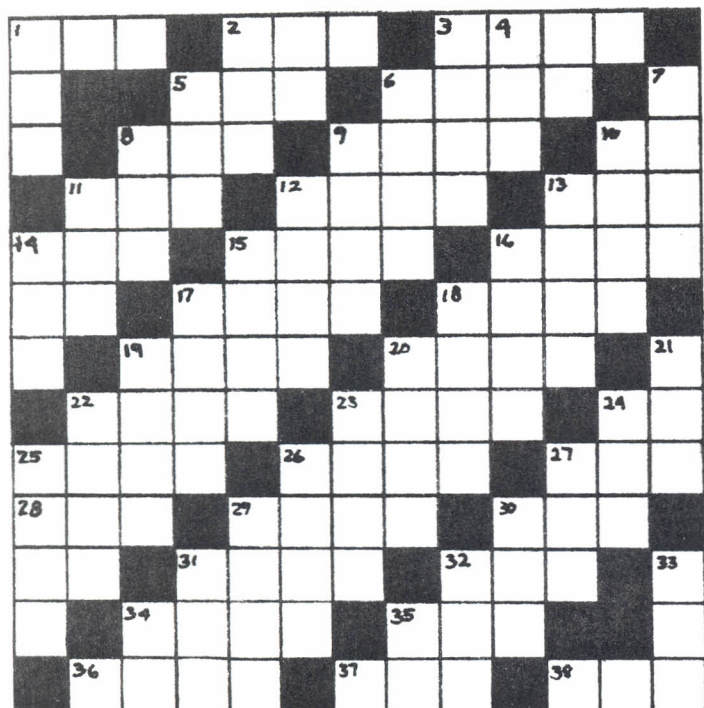

(Answer will be in next months newsletter)

WANT AD

WANTED - Plastic dial scale, 2 Band for 1937 Philco. Would prefer entire variable tuning condenser assembly. WANT-3, #7F8 Loktal tubes. (new only) R.C. (Bob) Campbell 2175 SE Pine, Hillsboro, Oregon, 97123 Ph. 648-7331

Cross-word puzzle from 1926 Radio News

It took Bob Campbell 5 hours to reference stations and draw the puzzle and it will be a "toughy" for who try it!

The newsletter appreciates items like these and is looking forward to some more! (Now if we can get the rest of the "inactive" members to participate, we'll have it made!!)

Since schematics for old test gear seems to be more scarce than those for our radios we will try to include each month, a couple of the more popular pieces of test gear and if you have any you would like to see in print, write and we will see if we can publish them for you.

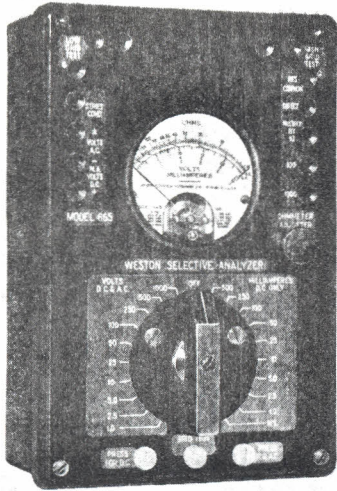

The Weston Model 665, Type I, Selective Analyzer.

The schematic diagram of the Weston Model 665, Type I, Selective Analyzer.

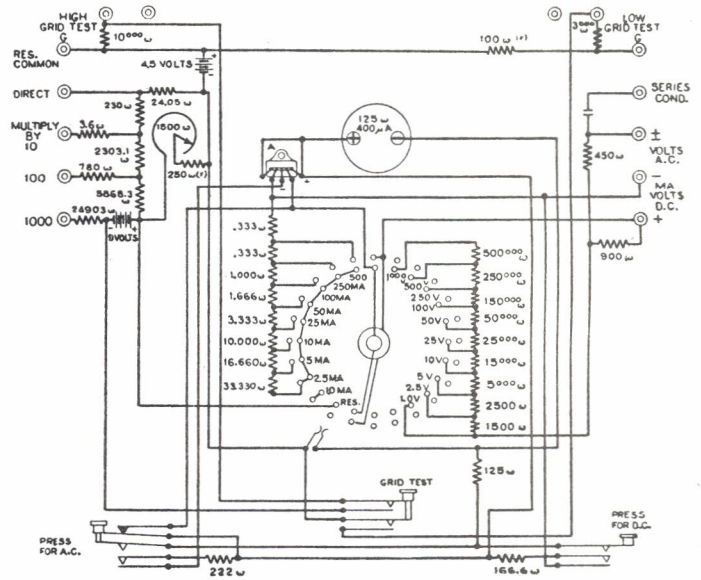

FEBRUARY, 1935 •

These were re-printed from "SERVICE", a magazine devoted to the professional trade of radio serviceman. From Feb., 1935

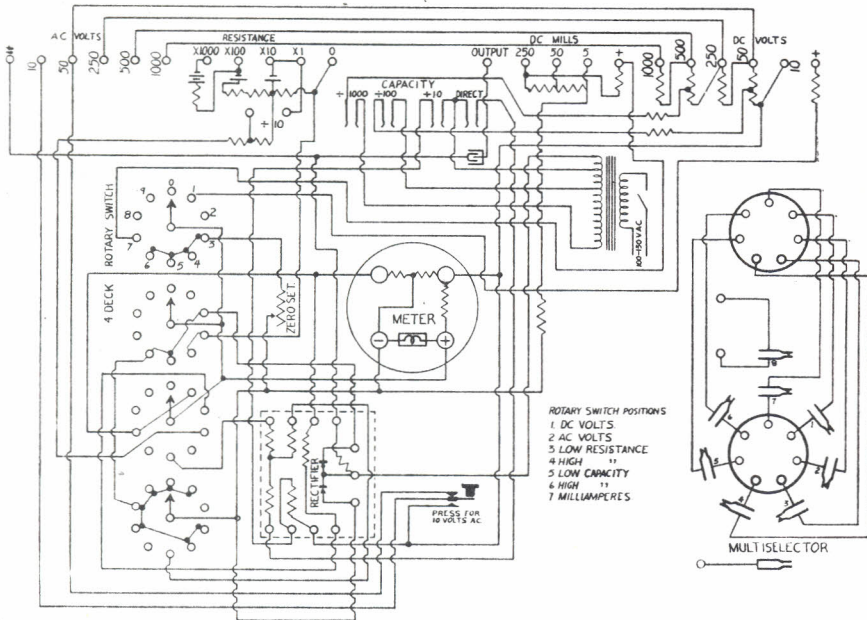

The schematic diagram of the Hickok Model SG-4800 Radio Set Tester. The switch positions are indicated in the diagram.

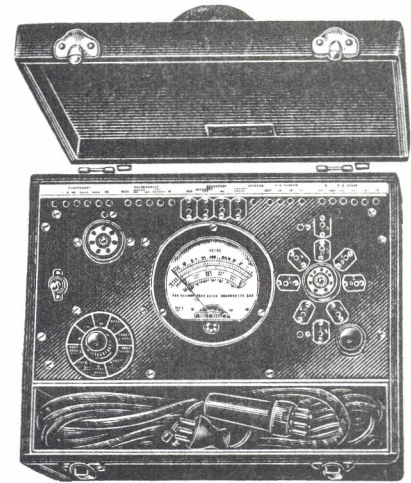

The Hickok Model SG-4800 Radio Set Tester.

A NOTE TO THE GALS OF NWVRS
The gals held there first ever meeting of the NWVRS Aux. and discussed among other things their plans for serving our ref-

reshments at the club meetings as well as any future events concerning our society. It is great to see this active interest by other members to help further the growth of our club. The next meeting will be held at Kathy Hay's house, 5225 S.E. Brookside Drive, Milw., Ore. For more info call 659-8566. Hey, fellas, don't you wish WE had this much drive??

SO LONG FOR THIS TIME....SEE YOU ALL NEXT MONTH AT YOUR LOCAL MAILBOX.....73