

National RADIO-TV NEWS



*Merry Christmas
From N. R. N.*

IN THIS ISSUE

Analyzing a Typical AC-DC Receiver
A Simple Electronic Organ
Alumni Association News

Dec.-Jan.
1954-1955

VOL. 16
No. 6



IT gives me great pleasure once again to have the opportunity to extend cordial season's greetings to each and every one of our Students and Graduates.

It was Dickens who said "There seems a magic in the very name of Christmas." We greet our friends and neighbors with the warm feeling that Christmas always brings. Yes, magic and joy, good fellowship, understanding. If only we could carry the spirit of Christmas with us throughout the whole year.

May the deep joy of the holiday season be with you. And may the good cheer that this season brings remain to brighten each day during the coming year. On behalf of myself and the entire staff at NRI we wish you Good Luck, Good Health, Good Fortune.

J. E. SMITH, *President.*

Analyzing a Typical Five-Tube AC-DC Superheterodyne Receiver

By J. B. STRAUGHN

Technical Editor, National Radio-TV News



J. B. Straughn

General Description

THE Emerson Model 547A is a five tube, ac-dc operated, single band superheterodyne receiver. The schematic diagram appears on page four. Miniature tubes are employed throughout. It uses a 12BE6 as the mixer oscillator, a 12BA6 remote cut-off rf pentode as the i-f amplifier, a 12AT6 as the second detector, avc and first audio tube, a 50B5 power output tube and in the power supply a 35W4 half-wave rectifier.

The circuits employed in this receiver are typical of those found in practically all five tube ac-dc superheterodynes. There is nothing at all unusual in the receiver with the possible exception of the use of the oscillator grid voltage as starting bias on the 12BE6 and 12BA6 tubes. This will be discussed later.

Signal Circuits

This receiver uses a self-contained loop antenna which operates at maximum efficiency when its position is at right angles to the broadcasting source. It is important, therefore, once the station is tuned in, to rotate the cabinet back and forth through a quarter of a circle (90 degrees), leaving it at the position where the station is received with maximum volume.

You will notice that the loop is tuned by rf tuning condenser 33 and its parallel trimmer A6. AVC by-pass condenser 11 is also in this tuned circuit although, due its relatively large capacity and low reactance, it has no effect on the resonant frequency of this circuit.

All passing radio waves will induce voltages into the loop. Only the signal which is tuned-in will undergo resonance step-up and develop a large voltage. This signal voltage is applied to the control grid, pin 7, and the cathode, pin 2, of the 12BE6 tube. The cathode connection is through by-pass condenser 11 and the tapped section of the oscillator coil.

The oscillator is a conventional Hartley. The cathode current of the tube flows through the lower section of the coil to the cathode. In doing so, a voltage is induced into the balance of the coil. Since the coil is tuned, a circulating rf current is set up whose frequency is determined by the coil inductance and the capacity of the tuning condenser and trimmer A5. The voltage developed across the coil is transferred through capacity coupling, by means of the small turn of wire adjacent to the coil, to the oscillator grid, pin 1. The wiring forming this capacity is called a gimmick. Therefore variations in oscillator grid voltage cause further variations in cathode current and oscillation is sustained.

When the oscillator grid is driven positive, electrons flow from the cathode, to the grid and back to the cathode through bias resistor 16. In doing so a dc voltage is developed across this resistor which makes the oscillator grid negative with respect to the cathode. This is the oscillator bias, an important voltage from the serviceman's viewpoint.

Since the electron stream, travelling from the cathode to the plate, is modulated at both the frequency of the station which is tuned in and

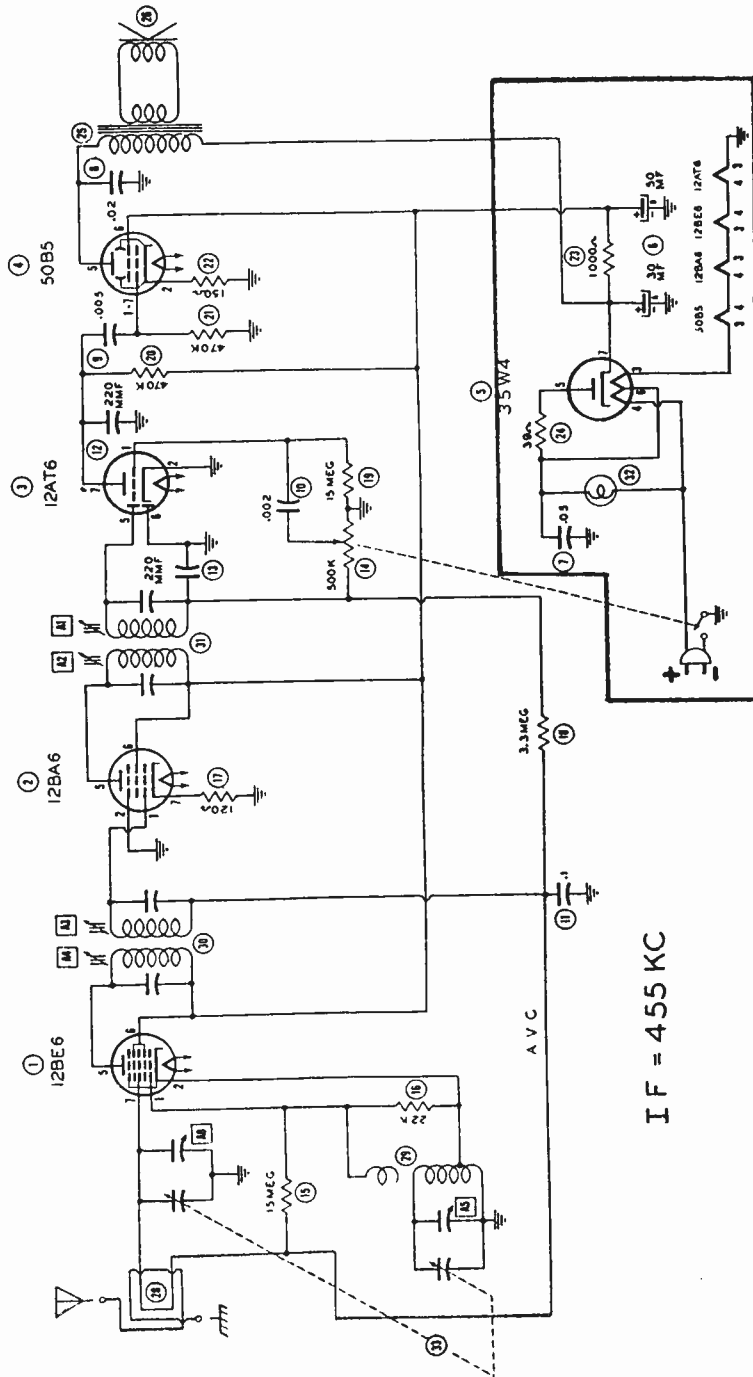

Schematic diagram of EMERSON Model 547A Superheterodyne receiver.

Voltage and Resistance Reading Instructions

1. Voltage readings are in volts and resistance readings in ohms unless otherwise specified.
2. D-C voltage measurements are at 20,000 ohms per volt; a-c voltage measured at 1,000 ohms per volt.
3. Socket connections are shown as bottom views.
4. Measured values are from socket pin to common negative.
5. Line voltage maintained at 117 volts for voltage readings.
6. Nominal tolerance on component values makes possible a variation of $\pm 15\%$ in voltage and resistance readings.
7. Volume control at maximum, no signal applied for voltage measurements.

Alignment

To set pointer, turn variable condenser fully closed and set pointer at mark near left end of dial backplate. Use isolation transformer if available. If not, connect a 0.1 mfd. condenser in series with low side of signal generator and chassis. Volume control should be at maximum position; output of signal generator should be no higher than necessary to obtain an output reading. Use an insulated alignment screwdriver for adjusting.

	DUMMY ANTENNA	SIGNAL GENERATOR COUPLING	SIGNAL GENERATOR FREQUENCY	RADIO DIAL SETTING	METER OUTPUT	ADJUST	REMARKS
1	0.1 mfd.	High side to stator of rear section of tuning condenser. Low side to chassis.	455 kc	Variable condenser fully open.	Across voice coil.	A1, A2, A3, A4	Adjust for maximum output. If isolation transformer is not used, reduce dummy antenna to 0.001 mfd. to reduce hum modulation.
2	200 mmfd.	High side to external antenna lead. Low side to external ground lead.	1620 kc	Variable condenser fully open.	Across voice coil	A5	Adjust for maximum output.
3	200 mmfd.	High side to external antenna lead. Low side to external ground lead.	1400 kc	Tune for maximum output.	Across voice coil.	A6	Adjust for maximum output.

Voltage Readings

Symbol	TUBE	PIN 1	PIN 2	PIN 3	PIN 4	PIN 5	PIN 6	PIN 7
1	12BE6	*-6.7 DC	0	25 AC	12 AC	92 DC	92 DC	-0.1 DC
2	12BA6	-0.1 DC	0	25 AC	38 AC	92 DC	92 DC	0.8 DC
3	12AT6	-0.65 DC	0	0	12 AC	-0.3 DC	0	42 DC
4	50B5	0	5.7 DC	85 AC	38 AC	107 DC	92 DC	0
5	35W4	0	0	85 AC	117 AC	110 AC	112 AC	112 DC

*Oscillator Grid Voltages Are Measured By Vacuum-Tube Voltmeter.

Resistance Readings

Symbol	TUBE	PIN 1	PIN 2	PIN 3	PIN 4	PIN 5	PIN 6	PIN 7
1	12BE6	24,000	0.6	26	13	700,000	700,000	3.5 meg.
2	12BA6	3.5 meg.	0	26	38	700,000	700,000	118
3	12AT6	15 meg.	0	0	13	500,000	0	1.2 meg.
4	50B5	480,000	150	90	38	700,000	700,000	480,000
5	35W4	inf.	inf.	90	120	150	118	700,000

the frequency of the oscillator signal, mixing takes place. In the plate circuit, we have a new signal, modulated with the same audio as appeared on the station carrier. The frequency of this signal lies at a point intermediate between the audio and rf station carrier. Hence it is called the intermediate frequency and is referred to as the i-f. Like other signals, formed by beating together two signals, its frequency is equal to the difference in frequency between the orig-

inal signals—in this case, 455 kc. Another beat equal to the sum of the oscillator and station frequencies is formed but this signal does not affect the resonant circuit in the plate of the 12BE6 tube. The primary of the i-f transformer is tuned to 455 kc and presents a high reactance only to the i-f signal. At all other frequencies the reactance is low and practically no undesired signal voltages exist across the primary. The large 455 kc signal, circulating in the primary, induces

a voltage into the secondary where the signal undergoes resonance step-up. The secondary voltage is applied to the control grid, pin 1, of the 12BA6 and through by-pass condenser 11 and cathode bias resistor 17 to the cathode of the 12BA6. Amplification occurs in the tube and a much larger signal at the i-f frequency appears across the primary of the second i-f transformer. This signal in turn appears across the secondary of the transformer and is applied to diode plate 5 and cathode pin 2 of the 12AT6. The path to the cathode is through rf by-pass condenser 13. The second i-f transformer, acting in the same manner as the first, provides additional rejection of undesired signals.

When the applied signal makes diode plate 5 positive we have electron flow from the cathode, to diode plate 5, through the secondary of the second i-f transformer, and through volume control 14, back to the cathode. When the applied signal reverses in polarity diode plate 5 is negative with respect to the cathode and there is no flow of current through the circuit. Thus we have detection of the i-f signal and the audio portion of this signal appears across the volume control.

Most of the i-f signal is by-passed out of the volume control circuit by means of by-pass condenser 13. Some, however, is applied through coupling condenser 10, along with the audio signal, to the control grid of the 12AT6.

Because both the audio and a portion of the i-f signal is applied to the grid-cathode of the 12AT6 there will be a variation in the plate current at an i-f rate and also at an audio rate. Due to the high value of plate load resistor (470,000 ohms) a large audio signal will be developed across this resistor. However, the circuit impedance at the i-f frequency is quite low due to the presence of plate by-pass condenser 12. Therefore, we essentially only have the audio signal across the plate load.

The audio is transferred to the grid-cathode of the 50B-5 tube through coupling condenser 9, the 50 mfd output filter condenser and cathode bias resistor 22. Amplification again occurs at the audio frequency and we have a large signal voltage developed across the primary of the output transformer.

Some of the higher frequencies are by-passed by plate to ground condenser No. 8. The main purpose of this condenser, however, is to prevent oscillation in the 50B5 tube. By making the plate circuit capacitive at the higher frequencies oscillation is avoided.

The signal currents flowing through the primary of the output transformer induced a voltage into the secondary and we have an audio signal flowing in the secondary and through the loud-speaker voice coil. This causes the voice coil to

move back and forth, since it is in the field of the permanent magnet with which this speaker is equipped. The cone is rigidly attached to the voice coil and follows its movements. This movement of the cone sets up the sound waves which we hear.

Undesired signals produced through distortion in the 50B5 tube exist in the plate circuit and produce across cathode bias resistor 22 a voltage which, being out of phase with the grid signal voltage, cuts down the undesired signal by degeneration. The desired signal is also partially weakened, but its original strength is sufficient to permit the use of degeneration. Distortion is reduced by degeneration, for undesired harmonics of the signal are greatly attenuated.

Noise signals coming over the line are by-passed by condenser 7 and do not get into the power supply and the receiver output.

Tracing Supply Circuits

Those items encircled in the lower right-hand portion of the diagram are in the power supply. Here the cathode of the rectifier, pin 7, and the set side of the On-Off switch, which connects to the chassis, serve as the high voltage dc source for all positive tube electrodes in the receiving circuit.

The 35W4 is a half-wave rectifier tube. Electrons flow only from the cathode to the plate through this tube. For a dc outlet the plug must be inserted in the wall socket so the plug marked + is in the + terminal of the wall outlet. The other prong is then in the — as indicated.

Note that during dc operation the chassis is connected through the On-Off switch to the negative terminal of the source, and the plate of the rectifier tube is connected to the positive terminal through resistor 24 and the parallel circuit consisting of the pilot lamp and the tapped portion of the rectifier filament. The terminals of the plate and screen supply receiving circuits will thus be positive with respect to the chassis.

Some voltage of course is dropped in the pilot lamp, resistor 24 and between the plate and cathode of the rectifier tube. Most of the voltage, however, is applied to the receiver circuits, which may be considered a load connected to the cathode of the rectifier and the chassis.

Pin 7 of the 35W4 being nearer the positive terminal of the source, is the positive terminal of the power supply. As you trace from the rectifier cathode through the receiver circuits (for example, through the primary of the output transformer, through the plate-cathode of the 50B5 tube, and through resistor 22 to the chassis), the positive potential with respect to chassis dimin-

ishes. Socket pin 5 of the 50B5 is therefore positive with respect to socket pin 2, a condition essential for operation of the tube.

If you insert the plug incorrectly into the outlet of a dc source, the plate of the 35W4 will be negative with respect to the chassis, hence the plate will be negative with respect to the cathode, and electrons will not flow through the rectifier tube. The pilot lamp and the tubes glow, but the receiver will be "dead"; reversing the plug remedies this condition.

With an ac power source, the plate of the 35W4 is alternatively positive and negative with respect to the chassis. During the half cycle that the plate is positive, the 35W4 tube is conductive and is furnishing the receiver with a high dc voltage. During the other half cycle, the tube is not conductive.

Most of the ripple in the resulting rectified current is eliminated by filter resistor 23 and by the two electrolytic filter condensers marked 6.

Note that the filter resistor is not in the plate supply circuit of the 50B5 tube. An ac ripple voltage is applied through the primary of the output transformer to the plate of this tube, and as a result some ripple current flows in the plate circuit. However, the ripple current is slight because the plate current is rather insensitive to variations in plate voltage. Any ripple current flow develops an ac ripple voltage across the cathode bias resistor. Being in the control grid circuit, degeneration occurs, and the ripple current in the primary of the output transformer is held to a negligible amount and abnormal hum does not occur.

Starting with the 12BE6 tube let us trace the dc supply circuit through the tubes in the receiver. Imagine, of course, that the tubes are operating, and hence conducting.

The cathode current of the 12BE6 comes from the set side of the On-Off switch, flows through the chassis to the grounded end of the oscillator coil, through the oscillator coil tap to the cathode of the 12BE6 and out into the tube envelope. Here the electron stream divides, some electrons going to the screen, pin 6, and the balance to the plate, pin 5. The electrons in the plate circuit flow through the primary of the first i-f transformer where they join with the electrons which went to the screen. The recombined electrons now travel through the circuit to filter resistor 23, and through it to the cathode of the rectifier, which is the B+ supply source.

Exactly the same action occurs in the case of the cathode current of the 12BA6, this time, however, the electron stream being through the chassis and cathode bias resistor 17 to the cathode of the 12BA6.

The cathode current of the 12A7U flows from B- to the cathode of this tube, across to the plate, through plate load resistor No. 20, filter resistor 23 and to the rectifier cathode.

In the case of the 50B5 tube, the cathode current flows from B-, through bias resistor 22, to the cathode and out into the tube envelope. Here some of the electrons flow to the screen and the balance, which is the majority, flow to the plate. The plate current electrons pass through the primary of the output transformer and return to the cathode of the rectifier. The electrons which make up the screen current flow from the screen, through filter resistor 23 and to the rectifier cathode.

Now that we have considered the plate and screen currents of the various tubes let us see how bias is developed. We have already considered the oscillator bias developed across grid resistor 15 in the oscillator circuit. The grid end of resistor 16 is negative with respect to the cathode of the 12BE6. Note that 15 meg resistor No. 15 connects to the negative end of resistor 16 and to the control grid of the 12BE6 through the loop. Thus the voltage across resistor 16 is also applied to the control grid of the 12BE6. Any rf present across resistor 16 is filtered out by means of resistor 15 and by-pass condenser 11. This by-pass condenser, being quite large, is a short as far as rf is concerned, all of the rf being dropped across resistor 15. Therefore, pure dc is available for application to the control grid of the 12BE6. This same voltage, as you will note, is applied to the control grid of the 12BA6. When no signal is received this serves to set the minimum bias voltage for both the 12BE6 and 12BA6 tubes.

When a signal is received the dc component of the audio signal developed across diode load resistor 14 (the volume control) is filtered by resistor 18 and avc by-pass condenser 11. It is applied to the control grids of the 12BE6 and 12BA6 type tubes. On a signal of reasonable strength the avc voltage is the bias for the 12BE6 and 12BA6 tubes, being much greater than the starting voltage from the oscillator grid circuit. For practical purposes there is no interaction between these two voltages, due to the high value of resistors 15 and 18. In other words the oscillator grid voltage is not appreciably changed by the avc and little or no voltage is transferred from the oscillator circuit to the volume control.

You will see that a small resistor, having a value of 120 ohms, is connected between the cathode of the 12BA6 tube and the chassis. Only a very slight dc voltage is developed across this resistor and its presence at this point is not for the bias voltage developed across it. Rather it is to provide degeneration which will eliminate any tendency toward oscillation in the 12BA6 circuit. Note that the condenser is not by-passed. A by-

pass condenser would prevent out-of-phase i-f voltages from building up across the resistor and would thus prevent degeneration.

The control grid of the 12AT6 tube is connected through grid resistor 19 to the tube cathode. Thus we have what is known as conduction bias. Here is the usual explanation for conduction bias: Some of the electrons which would normally go to the plate of the 12AT6 strike the control grid. Since the control grid cannot emit these electrons they must travel back to the cathode through grid resistor 19. As you know, the end of a resistor at which electrons enter is always negative with respect to the end at which they leave. Therefore, the grid end of resistor 19 becomes negative with respect to its cathode and this voltage is the bias for the 12AT6 type tube. Actually, here is what happens: When the cathode is heated electrons are boiled out of it. These form a cloud around the cathode and since electrons are negative particles the cloud is negative with respect to the cathode. Thus we have a voltage source between the cloud and cathode. This voltage divides between the cloud and control grid and between the control grid and cathode. By making the control grid to cathode path outside the tube high in resistance, most of the voltage appears across resistor 19. The grid to cathode voltage across resistor 19 biases the tube. This method of biasing can only be used where a very small voltage is required. The potential between the electron cloud and cathode of the 50B5, for example, is insufficient to bias this tube.

The 50B5 tube is biased in the conventional manner, by means of the cathode current of the tube flowing through bias resistor No. 22. The plate supply voltage, of course, divides between the primary of the output transformer, the plate cathode path in the tube and the bias resistor. The latter, being small, has the least amount of voltage across it. The polarity of this voltage is easily determined. As we have previously said, the end of a resistor at which electrons enter is negative with respect to the end at which they leave. It follows that the grounded end of 22 is negative with respect to the cathode. The control grid is essentially at ground potential so, it too, is negative with respect to the cathode. The audio signal across resistor 21 is simply in series with the fixed bias voltage, making the grid first more negative and then less negative.

Since resistor 22 is not by-passed, degeneration occurs in the output circuit, as was previously described.

All of the filaments are connected in series across the 117 volt line supply and will function with either ac or dc power. Let us trace the filament circuit by starting at the (+) terminal of the power cord plug. From here we go to prong 4 of the 35W4 and also to the pilot lamp

and through it to prong 6 of the 35W4. Therefore, the current divides, a portion of it flowing through the pilot lamp and a portion through the filament tap (pins 4 and 6 of the 35W4). From here the current flow is from pin 6 to pin 3 of the 35W4 to pin 3 of the 50B5. The current flows from pin 4 of the 50B5 to pin 4 of the 12BA6 and from pin 3 of this tube to pin 3 of the 12BE6. Pin 4 of the 12BE6 joins pin 4 of the 12AT6 and the current flows through the filament of the 12AT6 to the chassis and back through the On-Off switch to the - of the power cord plug.

The total voltage required for the filaments is $35 + 50 + 12 + 12 + 12$ or 121 volts. The average power line voltage is 117 volts which means that each of the tubes will receive slightly less than normal voltage. As a matter of fact they will work satisfactorily on any voltage between 105 and 125 volts.

You will note that the plate of the 35W4 connects through resistor 24 to pin 6 of the tube. Therefore, the cathode current of the rectifier tube also flows through the pilot lamp and through the filament tap (pins 4 and 6). When the set is first turned on the resistance of all the tube filaments is rather low and the pilot lamp will light up quite brightly. As the tubes reach normal filament temperature their resistance goes up and the pilot light becomes dim. Then, when the cathode of the rectifier heats up to operating temperature the plate current of the rectifier flowing through the pilot lamp will cause it to light to normal brilliancy. As a matter of fact, variations in audio signal, due to the fact that the 50B5 is not quite linear, will cause variations in the plate current of the 35W4 and the pilot lamp will often blink in time with changes in audio signal strength. This is a normal condition and does not indicate a defect.

The 39 ohm resistor No. 24 is used to limit the plate current of the rectifier. If the set is turned off, the 30 mfd input filter condenser quickly discharges, and if the switch is then suddenly turned back on, the plate may be highly positive due to portion of its cycle occupied at that instant by the line voltage. In this condition the cathode which is still hot enough to emit electrons is effectively connected to B- and a very large amount of current can flow from the cathode to the plate until the 30 mfd input filter condenser charges up. However, the 39 ohm resistor limits this flow of current; otherwise the cathode connection inside the tube might open or melt due to the heat produced by an excess current flow.

Alignment

Alignment data is given in chart form just as it appears in the manufacturer's factory manual. The chart is self-explanatory although a short description of some of the points of interest is

given. (See pages four and five.)

When a receiver is completely out of alignment this means that its dial pointer does not indicate the proper frequencies when the tuning condenser is turned through its range. The first thing to do is to set the pointer as described in the alignment instructions.

The suggestion to use an isolation transformer is a good one and where such a transformer is available should be used in servicing ac-dc receivers. You will note that the line plug of the receiver can be inserted in the wall outlet in such a way that the chassis of the receiver can connect to the ungrounded side of the power line. If you stand on a ground, such as a concrete floor, and touch the chassis you will be shocked. An isolation transformer is a power transformer which has a 1-to-1 turns ratio. That means if 117 volts are applied to the primary of the transformer there will be 117 volts across the secondary, for operation of a receiver or a piece of equipment. However, there will be no dc path between the primary and secondary and in such a case you can stand on ground and touch the chassis of the receiver without getting shocked regardless of the manner in which the line plug is inserted into the outlet socket of the isolation transformer.

Of course, servicemen are careful about touching the chassis of a receiver when it is plugged directly into the lower line. However, if the ground lead of the signal generator is connected to the receiver chassis you could get a shock on touching the generator and it is often necessary to touch the signal generator when making adjustments on the attenuator, on-off switch or tuning control. The presence of a .01 mfd condenser in series with the low side of the signal generator and the receiver chassis will tend to limit the severity of such a shock. Actually, there is little danger of a shock if you stand on a good insulator such as a board on a concrete floor or sit on a wooden chair. Most servicemen take such precautions and seldom, if ever, get shocked.

The use of dummy antennas has previously been discussed on other receivers. You can align a set without using a dummy antenna but if the capacitors are available you should employ them, as it will permit a somewhat better alignment job on the rf trimmer.

It is essential that a condenser be in series with the hot signal generator lead when you connect the signal generator from the control grid (pin 7) of the 12BE6 to the chassis. Note that the instructions say to make the connection of the signal generator hot lead (high side) to the stator of the rear section of the tuning condenser. Of course, pin 7 connects to this point so you are actually connecting to the control grid of the 12BE6. If there is no condenser in the circuit the

output of the signal generator, if it has a conductive path, may short out the bias voltage on the 12BE6, thus upsetting the circuit operation. The better grade signal generators such as the NRI Professional have a built-in series condenser. You can check yours with an ohmmeter by connecting the ohmmeter test probes between the hot and ground leads of the signal generator. You should not obtain any reading. Lack of reading indicates the presence of a condenser in the circuit. If a reading is obtained then an external condenser as suggested in these alignment instructions should be employed.

You will also notice that in aligning the i-f amplifier it is suggested that the variable condenser be fully open. When this is done the tuned circuit at the input of the 12BE6 will act as a load on the signal generator, reducing its output. However, sufficient output voltage should be available in any case. The purpose of tuning the receiver to a high frequency (variable condenser fully opened) is to prevent a beat between the signal generator and the oscillator in the receiver. This can be avoided by shorting the oscillator tuning condenser with clip leads, with a screwdriver or simply by placing your finger across the stator and rotor plates of the oscillator condenser. When this is done you can tune the receiver to the low frequency end of the dial and have a somewhat greater signal available at the input of the 12BE6 for i-f alignment. As a matter of fact it is, in most instances, unimportant where the radio dial is set for i-f alignment, as long as a squeal, which varies with the dial setting, is not heard in the speaker and as long as the output of the signal generator is great enough to force a signal through the i-f amplifier.

You will note that an output meter connected across the voice coil is recommended. This is a low range ac voltmeter, which will measure the modulation of the signal generator. Such a method of alignment is entirely satisfactory but the monotone coming from the speaker can be annoying to the person doing the alignment and to anyone nearby.

This may be avoided by connecting a dc voltmeter across the diode load (volume control 14) with the positive lead of the voltmeter connected to the grounded end of the control. The control can then be adjusted for minimum sound from the loudspeaker and the meter will indicate the rectified signal voltage across the volume control. In this case all adjustments are made for maximum voltage, just as they are if the output meter is connected across the voice coil. Any meter range which will give a deflection that may be noticed can be used. Remember you are not measuring any particular voltage; you are just making the adjustments for maximum movement of the meter needle to the right of the scale.

In step 2 of the alignment instructions, trimmer

A5 is adjusted. This is the oscillator trimmer. In the next step the rf trimmer—A6—is adjusted and it is suggested that when making the adjustment you first tune the receiver for maximum output. This insures better tracking between the oscillator and the rf circuit. Once, however, you have tuned the receiver for maximum output at 1400 kc you do not touch the dial again—just adjust A6 for greatest output. This completes the alignment as the diagram shows no low frequency padder. From this we know that the oscillator has specially cut plates, so that it will always be 455 kc higher in frequency than the rf circuit which it tracks (follows).

When making adjustment Nos. 2 and 3 you will notice that the signal generator leads are to connect to the external aerial and ground leads of the receiver. These leads are attached to a single turn of wire around the loop. *Precaution:* When operating the receiver in very low signal areas these loop leads may be connected to an external antenna and ground. Never connect a ground to this receiver chassis as such a connection might blow the line fuse.

Voltage and Resistance Readings

The chart immediately below the alignment data gives the voltage and resistance readings to be expected between the tube pins indicated and the common negative terminal which is the chassis of the receiver.

In the *voltage and resistance reading instructions* (page four) it is suggested that the dc voltmeter have a resistance of 20,000 ohms per volt while the ac voltmeter have a resistance of 1000 ohms per volt. Actually the ohms-per-volt rating of the ac meter is of no importance even though most of them happen to be 1000 ohms per volt. DC meters may be anywhere between 1000 ohms per volt and 20,000 ohms per volt. Again the exact resistance of the meter is not too important. If it is below 20,000 ohms per volt the measured voltages will be somewhat lower than normal where there are high values of resistance in the circuit. If you have such a meter, you will soon become used to these variations from recommended values and will not be confused.

If a vacuum tube voltmeter is employed your readings will be somewhat higher than those given in the chart, where there are large values of resistance in the circuit. This would be the case when measuring the control grid to cathode voltage of any of the tubes.

Directly under the voltage chart it is indicated that the oscillator grid voltage is measured only with a vacuum tube voltmeter. This is not necessarily true and you can measure dc voltage across resistor 16, which is the oscillator grid resistor, with a 20,000 ohms per volt meter or one having even less sensitivity. Your voltage will be slightly

lower than the value in the chart but you can definitely see if the oscillator is functioning. If you measure a dc voltage across this resistor temporarily stop the oscillator by touching the rotor and stator plates of the oscillator tuning condenser with your finger. If there is no change in the measured voltage it was not due to oscillator grid current and the oscillator is not working. If, however, there is a drop in the measured voltage then the voltage was due to the oscillator signal and the oscillator was functioning.

In making resistance readings the actual resistance between those tube filaments receiving a positive potential and the chassis will depend upon the condition of the electrolytic condensers. As long as these condensers have a combined resistance of greater than 100,000 ohms they may be considered satisfactory, as far as leakage is concerned.

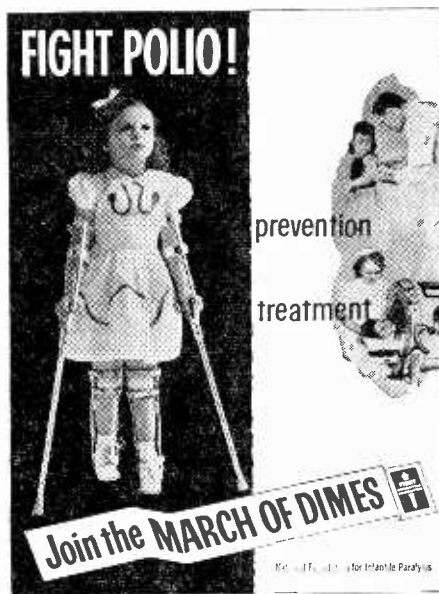

The receiver must of course be turned off when making ohmmeter measurements. A point to bear in mind, however, is that the receiver must be turned off long enough for the tube cathodes to become cold. An ohmmeter essentially consists of a battery in series with a meter and limiting resistor. When the test leads are connected to a circuit the battery in the ohmmeter sends current through the limiting resistor, the meter, and through any external resistance between the leads. Therefore voltage exists across the ohmmeter test probes. If the cathode of the 12AT6 in this receiver is hot you could connect the ohmmeter test probes between the control grid and cathode, with such a polarity that the grid is made positive. Then there would be a flow of

electrons from the ohmmeter battery to the tube cathode, and across to the grid instead of through grid resistor 19. You might measure a very low resistance and come to the conclusion that resistor 19 was at fault. If you get such a low resistance, and the tube filaments are hot, simply reverse your ohmmeter test probes. This will make the control grid negative and there will be no conduction through the tube. Better still, wait a minute until the tube cathodes have cooled off before making ohmmeter measurements.

In the resistance chart you will notice that the resistance between pin 6 of the 50B5 and the chassis is given as 700,000 ohms. As stated previously this depends upon the leakage resistance of the electrolytic condensers. A reading here of 100,000 ohms would be acceptable as would be a reading over 1 megohm.

The reading from pins 1 and 2 of the 35W4 to the chassis are marked Inf. This means an infinite resistance exists between these points and you should not get a noticeable reading on your ohmmeter—in other words, the reading should be so high that you cannot tell the difference with the probes connected to the circuit or disconnected from the circuit.

Expected Performance

With a receiver of this type you can expect excellent selectivity and good sensitivity. The amount of pickup depends upon your location if the loop is used or upon your antenna system if an outside antenna is employed. Acceptable tone quality may also be expected although the single-ended amplifier (one which does not use a push-pull circuit) may be troubled to some extent by audio distortion, particularly if the volume control is advanced too much. Also, one would expect a receiver using this circuit to be a table model and employ a fairly small loudspeaker. A larger loudspeaker—10 to 15 inches—would give more acceptable tone quality, particularly better reproduction of low notes. It can be said, however, from the examination of the wiring diagram, that the receiver has good selectivity, good sensitivity and reasonable tone quality—an all around good performer.

Service Hints

The Lessons in your course cover most of the difficulties that will be encountered in ac-dc receivers. However, distortion, which may be puzzling, sometimes occurs in these circuits. As you know distortion may be due to gas in the 50B5 or leakage in coupling condenser 9. This may be checked with a dc voltmeter connected between pins 1 or 7 of the 50B5 and the chassis (pins 1 and 7 are connected internally in the tube). If you clear up any leakage or gas trouble here you may notice that distortion still occurs, particular-

ly when the volume is advanced. You may also notice that this distortion is not due to overloading of the tubes by excess signal strength. Actually it is caused by leakage in coupling condenser No. 10. Frequently both coupling condensers 9 and 10 become leaky so if you clear up the trouble at 9 and still notice distortion when the volume control is advanced, coupling condenser 10 should be replaced. Distortion occurs in this case because of the rectified voltage developed across the volume control. As the volume is turned up, an increasingly negative voltage is applied, through leaky coupling condenser 10, to the control grid of the 12AT6. This soon overbiases the tube and distortion becomes quite noticeable.

At times you may encounter a dead receiver and may notice when you tune to a station that the pilot lamp flickers in a normal manner, due to variations in the plate current of the 50B5. This is definite proof that everything is all right up to and including the plate circuit of the 50B5. There is nothing left to suspect but an open in the loudspeaker voice coil. Infrequently the voice coils open up at the point where they are attached to the speaker cone. The connection is usually covered with a sealing compound resembling pitch. If a hot soldering iron is applied and the sealing compound gently wiped away, as it melts, you can sometimes find the open and splice the connection. If this is not possible a new speaker should be installed.

You will often get a complaint that pilot lights burn out as soon as they are installed. Invariably this is due to an open between pins 4 and 6 of the 35W4. Generally, the receiver tubes will not light but sometimes the connection simply opens at pin 6 inside the tube and continuity exists between pins 4 and 3. In such a case the tube filaments will light up although the receiver will not operate since no voltage is applied to the plate of the tube. A check on all three filament pins with an ohmmeter while the tube is removed will disclose such trouble.

At other times resistor No. 39 may burn out, the tap on the filament may be burned out and the pilot light may also burn out. This definitely indicates excess rectifier plate current and the first thing to do is to check the electrolytic filter condensers with an ohmmeter. One lead of each condenser should be disconnected from the circuit when measuring the condenser leakage resistance. If the condensers are in good condition disconnect and check plate by-pass condenser No. 8 of the 50B5 tube.

Should you find no shorts in the circuit with your ohmmeter the trouble is evidently due to excess plate current, drawn by the 50B5. This could be caused by gas in the tube or leakage in coupling condenser 9 and should be checked in the manual
(Page fifteen, please)

A SIMPLE ELECTRONIC ORGAN

By LEO M. CONNER

NRI Consultant

SOME readers have expressed a desire to build a simple electronic organ but have been discouraged when they see the complicated circuits for some of these devices.

Most electronic organs have a large number of oscillators, some have two oscillators which beat against each other with the difference in beat note being fed on to amplifiers, some have tone wheels which produce the sound and some of the earlier types had vibrating reeds which produced the audio voltage.

One of the simplest forms of audio oscillators is the relaxation type. The output from this type of oscillator is saw-tooth in shape but it is still acceptable as a source of tone.

This type of oscillator feeding a simple pentode amplifier was selected. By using resistors to control the pitch, a very wide range frequency can be obtained.

The complete circuit is shown in Fig. 1. Note that there are two jacks shown as J1 and J2 on the diagram. J2 was incorporated into the circuit for two purposes—it was felt that some might like to use the oscillator for code practice. By plugging a key into J2 and the desired resistance into J1 the oscillator can be used for this purpose. When used as a "musical instrument" a jumper is inserted in J2 and the resistance bank plugged into J1.

The oscillator, amplifier, loudspeaker and power supply are all assembled on a 5" x 10" x 3" chassis which is equipped with a bottom plate.

Fig. 2 shows the resistor values which give a range of approximately 1 octave with halftones at the proper points. The musical frequencies are

Page Twelve

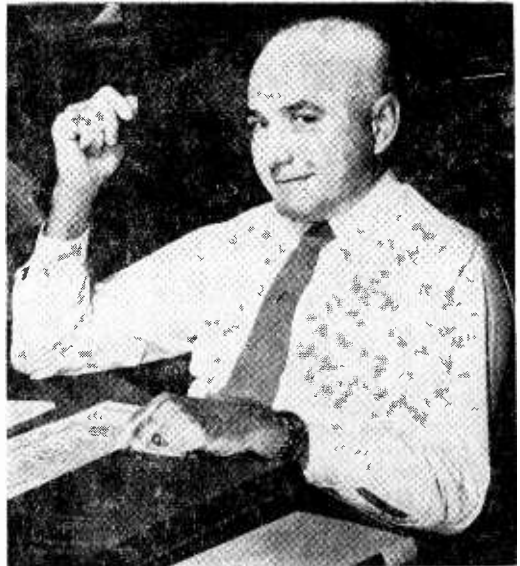

Leo M. Conner

approximate only and if you wish to obtain the exact frequency it would be necessary to use series and parallel combination resistors to get the exact result or else use 500,000 ohm potentiometers at each position and then carefully adjust the amount of resistance until you obtained the desired tone.

You can "play" this device by touching a test lead to the ends of the resistor terminals. However, it is better if the contact is made by means of a "key" similar to those used on a piano. Some thought has been given to the purchase of a used piano in order to obtain the complete keyboard and then building the resistor arrangements into the piano cabinet.

Bear in mind that this unit is a "solo" device and that you cannot play chords with it.

NRI cannot furnish any of the parts for these instruments but you should be able to find all of them at your regular radio wholesalers.

Increasing the resistance which is plugged into J1 will lower the tone while decreasing the resistance will raise the pitch. Decreasing the capacity of the .00025 mfd. condenser connected between pins 1 and 5 of the 6BA6 oscillator tube will also increase the frequency. In using the resistor values which are given in Fig. 2, remember that resistors have tolerance and that the other parts in the circuit have tolerances. This is immaterial since you can "juggle" the resistors to obtain the desired pitch.

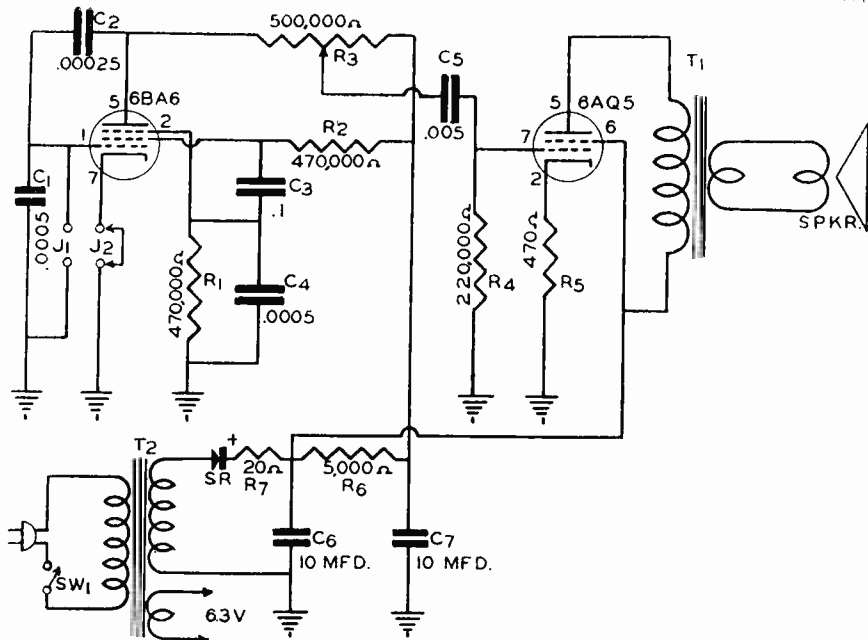

Figure 1

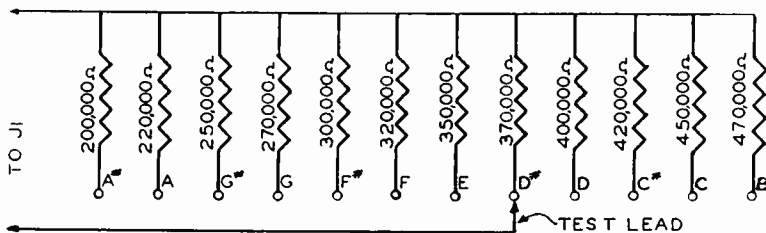

Figure 2

Parts List

R1 470,000 ohm, 1/2 watt
 R2 470,000 ohm, 1/2 watt
 R3 .5 meg volume control
 R4 220,000 ohm, 1/2 watt
 R5 470 ohm, 1 watt
 R6 5000 ohm, 5 watt
 R7 20 ohm, 1/2 watt

C1 .0005 mfd mica
 C2 .00025 mfd mica
 C3 .1 mfd paper
 C4 .0005 mfd mica
 C5 .005 mfd paper
 C6 10 mfd, 150V electrolytic
 C7 10 mfd, 150V electrolytic

T1 Output transformer
 T2 Power transformer, 130V at 40 ma
 6.3V at 1.2 amp
 SR Selenium rectifier—65 ma
 SW₁ Single pole—toggle switch
 2 Miniature sockets
 TUBES: 1—6BA6 and 1—6AQ5
 1 EACH Resistors in Figure 2
 SPKR PM Dynamic
 CHASSIS 5"×10"×3" with bottom plate
 5' power cord and plug
 J1-J2 Two-jack terminal strip

Technical Ramblings

By B. VAN SUTPHIN
NRI Consultant

VOLTAGE DROPS

What is the meaning of voltage drop and why is it important?

The term voltage drop should never have been coined, since it results in many false conclusions on the part of beginners. In ordinary conversation, we may speak of dropping a person from a club, or a person being dropped from a class. The same meaning does not apply to a voltage drop. We are not discarding an undesired voltage nor are we throwing it away.

When we have a simple circuit as shown in Fig. 1 the battery is the voltage source and causes current to flow through the resistor and connecting wires. For this current to flow, the source voltage must be applied to the resistor and act on its free

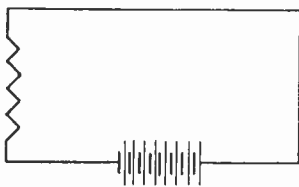

Figure 1

electrons. A meter connected across the resistor will show that the voltage is present.

As you know, the voltage will be equal to the resistance in ohms multiplied by the current in amperes.

Now suppose we break the resistor in half and join the broken ends together to give us two resistors as shown in Fig. 2.

Again a voltmeter would show that the source voltage is applied across the two resistors at A and C causing a flow of current.

However, suppose that we connect our voltmeter from A to B. Will we measure voltage? Of course. Well, will voltage be present across B and C? Again the answer is yes.

Now will the voltage across AB equal the entire source voltage across A and C? It will not, since the rest of the source voltage is engaged in making current flow from B to C.

How much voltage is present across A and B? Just enough to force the right amount of current through this resistor. The voltage is equal to the resistance in ohms between A and B multiplied by the current in amperes through the resistor. Since that part of the source voltage not engaged in acting on the resistor between A and B is forcing current through B and C the entire source voltage is being put to work. This is always true in any circuit. Because of this, the voltages acting on various parts of the circuit must always add up to the source voltage.

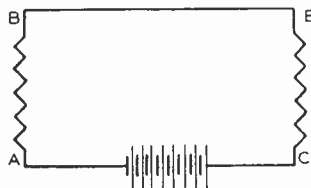

Figure 2

Since neither of the voltages across AB and BC are equal to the source voltage, we cannot call them the source voltage when referring to them.

Perhaps, because of early water analogies, the source voltage was called the voltage rise. It was natural, therefore, to call those portions of the source voltage acting on the various parts of the circuits voltage drops.

Voltage drops are extremely important in radio work. For example, we apply signal *voltage* to a tube and get a change in plate *current* which duplicates the variations in the grid voltage. Now if further amplification is necessary—what are we going to do? Signal *voltage* not signal *current* is required to operate the grid of the next tube.

All that we need to do is put a resistor or other

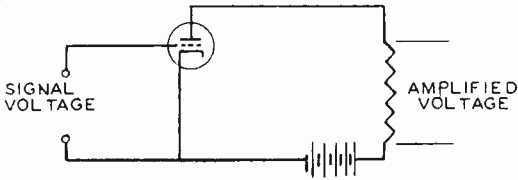

Figure 3

load in the plate circuit of the tube. Then the B supply voltage will divide between the plate-cathode of the tube and the load as shown in Fig. 3. The signal *current* variations result in a *voltage* variation across the plate load and we again have a voltage which we can amplify.

Without going too far afield, remember that a voltage drop is always accompanied by a current flow. For convenience sake alone radio men say that the current flowing through the part creates a voltage drop across it. This is not true but the statement serves the purposes and makes it unnecessary to trace the origin of the voltage drop to the source voltage. Also, they know that the voltage drop will be equal to the resistance in ohms multiplied by the current in amperes. This statement is important, not because a serviceman

ordinarily figures out the value of a voltage drop, but because it tells him that an increase in the load resistance results in more voltage drop across it, that a decrease in the load resistance results in less voltage drop across it, that an increase in the current through the circuit results in more voltage drop across the load while a decrease in the current through the circuit results in less voltage drop across the load.

Frequently it is desirable to know the polarity of a voltage drop. Here is a rule you should remember—the end of a resistor or other part at which electrons enter, is always negative with respect to the end at which they leave. Thus if you connect a negative terminal of a voltmeter to the end of a part at which electrons enter and the positive lead to the end at which the electrons leave, the meter will read upscale. This isn't so important in making voltage measurements, because it is easy to reverse your test probes. However, the polarity of voltages are often important where they are used to act on the grid of a tube and to understand the circuit operation you need to know, by looking at a diagram, the polarities of the various voltage drops in the circuits.

This little discussion should clear up any of the difficulties encountered by beginners when they first hear of voltage drops.



Five-Tube AC-DC Receiver (Continued from page eleven)

ner previously described.

A cathode to heater short in the 50B5 will change the bias on the tube and could raise its plate current to the point where damage occurs. Usually, however, cathode to heater leakage in this tube will simply result in hum, since this would permit an ac voltage to be applied to the control grid-cathode circuit.

Cathode to heater leakage in the 12AT6 is not so likely to cause trouble since the cathode is grounded. A cathode to heater short, between pin 4 of the filament and the cathode, would not introduce any ac voltage in the grid circuit. Such a short, however, could prevent the filament of the 12AT6 from lighting because as you can see the other filament pin, No. 3, is grounded. Thus we would have one filament of a filament string not lighting and a dead receiver on our hands. Similar difficulty is encountered in the 12BE6 and in such a case neither the 12AT6 or 12BE6 filaments would light.

Let us know if you like circuit analysis articles of this type and if you find the information helped. This will aid us in bringing you the kind of information you want.



Jobs As Motion Picture Service Men

"Motion Picture Service Men. Army & Air Force Motion Picture Service, Engineering Depot, Building 207-C, 4300 Goodfellow Boulevard, St. Louis 20, Missouri, expects openings for 35mm motion picture service men in this country and Europe, starting at \$5500 per year. Experience not required if engineering graduate or if experienced in similar field." NRI men who are interested should send details of experience and background to the above address.



New Products Available from NRI Supply Division

- NEW Weller Junior Soldering GunSee page 17
- NEW NRI De Luxe Tube CaddySee page 18
- NEW NRI AM-FM-TV Signal Generator
and MarkerSee page 22
- NEW NRI TV Oscilloscope and Probe SetSee page 23

BE SURE TO PLACE ORDERS EARLY
FOR CHRISTMAS DELIVERY

CHRISTMAS SUGGESTIONS FOR RADIO & TELEVISION TECHNICIANS

EACH year at this time we receive many letters from students and graduates, members of their families and even friends inquiring about the NRI Professional Test Instruments, and other NRI services, with a view of purchasing them for Christmas presents. For your convenience we give, in the following several pages, condensed information about these items. Note that test instruments and parts kits are available on monthly terms.

We urge our readers, who are prepared to send orders to do so very promptly. For those who must wait until nearer Christmas, we promise to try to make shipments within one day of receiving order. That means Monday's orders, for example, are shipped Tuesday. Tuesday's orders are shipped Wednesday, etc., but Friday's orders are shipped Monday. The Institute is closed on Saturdays.

Mail moves slower at this season. A letter may take a day or two longer to reach us. Likewise, shipments move slower, too. We will do everything we can to rush shipments but please help us avoid impossible situations. Every year we receive orders within a few days of Christmas marked "Christmas present, please rush" or "Must get here before Christmas," with not enough time for the shipment to get there. That leads to disappointments.

One more important point. A father, mother, wife, sweetheart or friend may purchase these items for a student or graduate, but we should have the student's name and student number as part of our record. To keep the present secret from the student, the shipment may be sent to any address designated.

So, mail your orders early. We'll extend every possible cooperation to help make the lucky recipient of the shipment have a Merry Christmas. An order blank is found on page 25.



NRI Professional Tool Kit INCLUDES ROLL-UP CARRYING CASE

A kit of fourteen carefully selected, good quality tools, complete with roll-up carrying case. You will be proud to own this fine kit of tools. They are just what NRI recommends for doing your experiments. Will last well into your professional Radio and Television Servicing career.

This is a real money-saving value. If bought at dealer's net prices, it would cost you about \$10.50. Yet NRI's price is only \$8.95, including the strong canvas carrying case. The items included in the kit are as follows:

1. Long nose pliers. Professional grade, precision made, of tool steel. Polished head. Smooth handles.
2. Diagonal cutters. Precision made from tool steel. Professional quality.
3. Metal cutting saw. Removable, four position blade. Light, but very sturdy.
4. Eight inch file. An indispensable item.
5. Slip joint pliers. For general utility.
6. Double blade neutralizing tool. Designed for new miniature i.f. transformers.
7. Four-in-one bone fibre neutralizing tool. Necessary for aligning receivers.
8. Small screwdriver. Slender four-inch blade.
9. Nut driver. For five-sixteenths inch hex nuts. Good quality, plastic handle.
10. Nut driver. Same as above, for one-fourth inch hex nuts.
11. Phillips screwdriver. For Phillips screws widely used in Radio and TV. Plastic handle.
12. General utility screw driver. Good quality.
13. Plastic long nose pliers. Shock proof. Used to move "hot" wires in Radio and Television sets.
14. Volume control wrench. Correct size for tightening volume controls and toggle switches.

Only \$8.95

Tool kit shipped, complete with carrying case, by parcel post, prepaid. Individual tools or carrying case not sold separately. Order blank page 25.

The Newest Soldering Tool on the Market!

WELLER JUNIOR SOLDERING GUN

You will solder faster, easier and better with a Weller JUNIOR gun . . . Ideal for NRI Students



New Compact Design. Less length from grip to tip for better balance and precision control. Handsome, gloss-black housing is rugged plastic. Streamlined design slides easily into tight, difficult places.

Over 100 Watts. Conservative rating of more than 100 watts gives ample power for all general soldering. 120 volts, 60 cycle, AC only.

Instant Heat. Heats in 5 seconds; no waiting, and heat is uniform at the tip. No loss of time or current.

Trigger Switch Control. Heat is instantly on— instant off with fingertip control. Eliminates danger of a hot, idle iron.

Dual Spot Lights. Prefocused spotlights illuminate your work, do away with shadows.



ONLY
\$595
POSTPAID

Replaceable Tips. Standard Wellertips, long-life and easy to replace are used with the Weller JUNIOR GUN. Weller Soldering Tips require no retinning!

Guaranteed. Each Weller JUNIOR Gun is registered and guaranteed for one year. U'L approved.

Low Price. No other soldering tool—iron or gun gives this combination of professional craftsman quality and practical features for ONLY \$7.95 list. **NRI PRICE JUST \$5.95, postpaid.**

WELLER ALL-PURPOSE DUAL-HEAT SOLDERING GUNS

Dual-Position Trigger Switch Selects Heat Desired

The Weller Model D-440 which is rated at 100-150 watts is recommended for ordinary Radio-TV work. List price is \$14.90. **NRI's price is only \$10.73, postpaid.**

The Weller Model D-550 is rated at 200-250 watts. It is for heavy duty work as well as Radio-TV. List price is \$16.25. **NRI's price only \$11.71, postpaid.**



A soldering gun is the ideal tool for the Radio and Television serviceman. It makes a perfect Christmas gift. Eliminates those tedious minutes of waiting for your soldering iron to heat.



Trigger controlled dual heat gives you low heat for circuit connections and high heat for chassis soldering. Dual spotlights light work.

All guns are fully guaranteed. Tips are easily and economically replaced. Shipped by parcel post, prepaid. Order Blank is found on page 25.

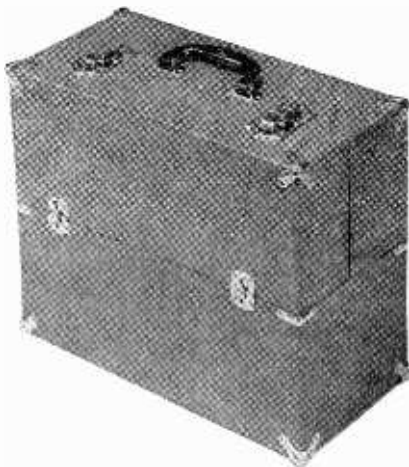

**NRI Deluxe Tube Caddy
Only \$12.95**

NRI looked long and hard to find the right tube and tool carrier for NRI men. We sincerely believe that this is a real value. One-fourth inch plywood construction. All points of wear protected by metal hardware. Outside is covered with attractive, wear-resistant, luggage type fabric.

Opens from the center, giving immediate access to roomy compartments for tubes, small parts, tools, soldering gun, Multitester, etc. A tube caddy is truly the professional way to carry tubes and tools on service jobs.

Dimensions: 16½ inches long, 8 inches deep, and 13½ inches high. Shipped to you by parcel post, prepaid. **Only \$12.95.**



**A Professional-Appearing Metal
Cabinet for the 2-E and 2-CK NRI
Electronic Multitester**

NRI students and graduates are justly proud of the performance and appearance of the NRI Electronic Multitesters which they build. Now you can give your NRI Electronic Multitester a professional look by installing it in this beautiful cabinet. This cabinet has a Marine gray ripple finish. The color harmonizes perfectly with the front panel included with your Electronic Multitester kit. It is made of high-grade cabinet steel sturdy enough to take rough handling. A swell job! Something which every NRI student and grad would be proud to have for his Electronic Multitester.

**Cabinet Protects Your Tester
Makes It Easy To Carry**

An attractive black and red moulded bakelite handle makes carrying your service tester easy. You will be pleased and your service customers surprised, because of its professional appearance. This cabinet is made to fit your tester exactly. In addition to improving the tester's appearance, it protects the tester from dust and damage. The installation requires but a few minutes. All necessary screws and hardware are included.

It is important to note that this cabinet cannot be used with the old 2RK NRI Tester. It is available only for the newer 2-E and 2-CK NRI Electronic Multitesters, which have a slanting front panel.

Only \$3.75

Shipped by parcel post, prepaid. Order blank on page 25.

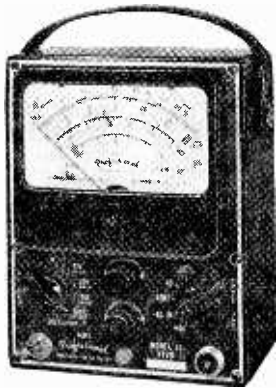

MODEL 11

NRI Professional Vacuum Tube Voltmeter

IDEAL FOR RADIO OR TELEVISION WORK

This VTVM is a top performer among moderate priced instruments. It's accurate, good looking, and easy to operate. Especially good for beginners, since meter movement is electronically protected against reasonable overloads. Five basic types of measurements are provided.

1. **D.C. volts**—six ranges, maximum 1200 volts.
2. **A.C. volts**—six ranges, maximum 1200 volts.
3. **Ohms**—six ranges, maximum 2,000 megs.
4. **D.C. Zero Center Scale**—for FM alignment.
5. **Output Measurements**—includes d.c. blocking condenser.

Specifications

Panel: Black enamelled etched characters.

Case: Black molded bakelite; 7½" x 5½" x 3".

Meter: 200 micro-ampere, double-jewelled, large 4½" x 4¼" meter scale—easy to read.

Input Resistance: 11 megohms.

Tubes: One 12AU7; one 6X4; and selenium rectifier.

Includes: Operating instructions; AC-DC-ohms cable with d.c. isolating probe and detachable alligator clip.

Power Required: 50-60 cycle, 110-120 volts a.c.

Actual Weight: 4 lbs. **Shipping Weight:** 6 lbs.

Warranty: Standard 90 day RETMA warranty. Shipped express charges collect. Use order blank on page 25.

Only \$38.50

Optional Accessories for Model 11

High Voltage TV Probe. Extends d.c. volts range to 30,000 volts. \$8.00, postpaid.

Crystal Detector HF Probe. Reads positive peak sine-wave voltages up to 250 mcs., \$6.65, postpaid.

Custom Leather Case. Top grain cowhide. Has tool compartment. Water-proof, lined suede interior, \$9.50, postpaid. (Also for Mod. 46, right.)



MODEL 46

NRI Professional Volt-Ohm Milliammeter

20,000 OHMS PER VOLT SENSITIVITY
COMPLETELY PORTABLE
NO EXTERNAL POWER NECESSARY*

The Model 46 NRI Professional Volt-Ohm-Milliammeter has been designed to fill the need for an inexpensive, fully portable radio and television servicing instrument. A wide range of measurements is provided.

1. **DC volts**—five ranges, maximum 1200 volts.
2. **AC volts**—five ranges, maximum 1200 volts.
3. **Ohms**—three ranges, maximum 60 megohms.
4. **Microamperes**—0-120.
5. **Milliamperes**—four ranges, maximum 1200 milliamperes.
6. **Output measurements**—dc blocking condenser and special output jack. Also, dc voltmeter has plenty of sensitivity for avc or agc measurements.
7. **Decibels**—five ranges.

Specifications

Panel: Black enamelled; etched characters.

Case: Black bakelite; 7½" x 5½" x 3".

Meter: 50 microampere, double-jewelled, large 4½" x 4¼" meter scale.

High quality components: ±1% resistors used throughout.

Actual weight: 3½ lbs. **Shipping weight:** 5 lbs.

Includes: Complete operating instructions, test leads, clips and ohmmeter batteries.

Warranty: Standard 90 day RETMA warranty.

Only \$33.50

Optional Accessories for Model 46: **High Voltage TV Probe.** Extends dc volts range to 30,000 volts. \$8, postpaid. Order Blank page 25.

Custom Leather Case. \$9.50, postpaid. Same as for Model 11 VTVM described at left.

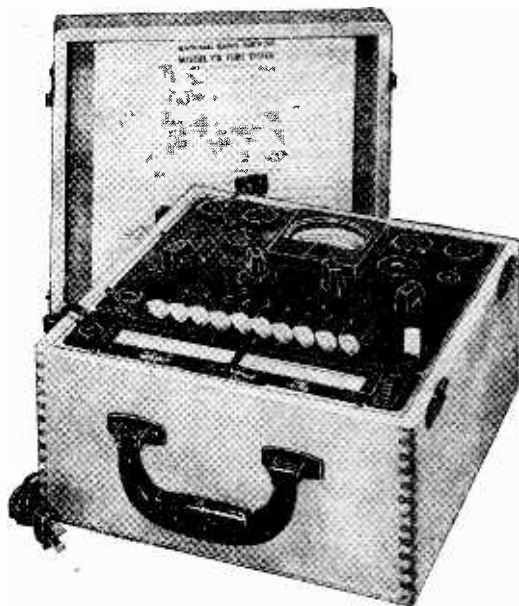

MODEL 70

NRI Professional Tube Tester

WITH BUILT-IN ROLL CHART

Designed to test the latest Radio and Television tubes. Convenient, built-in roll chart. Comes complete with detailed instruction manual. Approved RETMA emission circuit keeps the possibility of obsolescence at the very minimum. Specifications:

1. **Employs Standardized RETMA Emission Test Circuit**—Ten separate four-position tube element switches make tube prong connections flexible—take care of future electrode connections.
2. **Eight Tube Test Sockets**—Tests 4, 5, 6, 7, and 7L prong tubes; plus octal, loctal, 7-prong miniature; and 9-prong miniature tubes.
3. **Fifteen filament Voltage Taps**—0.75, 1.5, 2, 2.5, 3.3, 5, 6.3, 7.5, 12.6, 18.9, 25, 35, 50, 70, and 110 volts; filament voltages for all receiving tubes.
4. **Filament Continuity Test and Open Element Test.**
5. **Handsome Professional Looking Hardwood Case**—Beautiful natural grain, clear lacquer finish. Size: 10 $\frac{3}{4}$ " x 10 $\frac{3}{4}$ " x 6 $\frac{1}{4}$ ".
6. **Actual Weight**—11 pounds. Shipping Weight, 13 pounds. Shipped express charges collect.
7. **Power Requirements**—50-60 cycle, 110-120 volts A.C. required.
8. **High Speed, Double Window Roll Chart.**
9. **Standard 90 day RETMA Warranty.**

Price \$49.75

Our newest model tube tester has been engineered and priced exclusively for NRI men. It is a truly professional test instrument—one which will give your customers confidence in your work. Ideal for beginners or "old hands."

Page Twenty

TV Picture Tube Adapter



May be used with all NRI Professional Tube Testers, Models 66 through 70. (Not usable with NRI Model 1185.) This Adapter enables you to test a Television picture tube in a receiver, or in the original factory carton. The test includes a cathode emission check and a check for shorts between the various elements in the tube. Manufacturers do not claim that a Television Picture Tube Adapter is a fool-proof means of testing Television picture tubes. There are certain comparatively infrequent troubles in picture tubes which an Adapter will not detect. It is, nevertheless, a popular and useful accessory.

Only \$4.98

Complete with instructions. Shipped parcel post, prepaid. Order blank on page 25.



Speedex

FULLY AUTOMATIC

WIRE STRIPPER

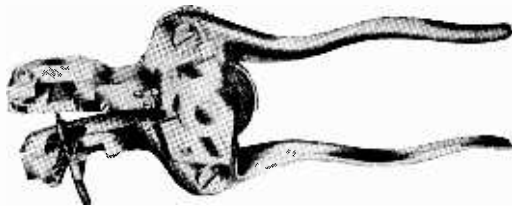

**WILL NOT CRUSH
STRANDED WIRES**

Here's the completely new "766" series Speedex "Speed-O-Matic" wire stripper. Fully automatic with "delayed return action" to prevent crushing of fine stranded wires. Sturdy, easy to use with narrow easy grip handles for easy handling. Interchangeable hardened steel blades that can be purchased separately to meet all wire stripping requirements. For #10, 12, 14, 16, 18, 20, 22 wire. List price \$8.25. **NRI price \$4.95.** Shipped post-paid. Order blank page 25.

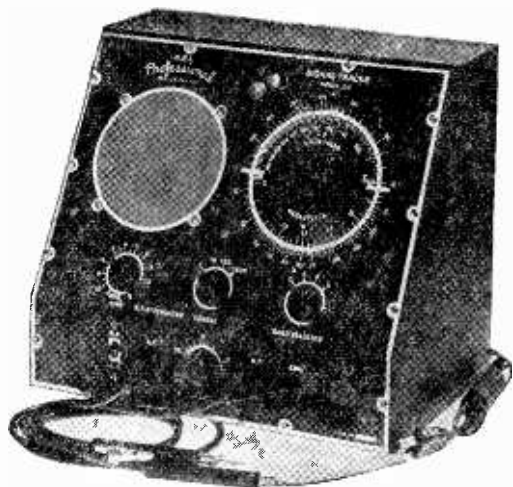

MODEL 34

NRI Professional Signal Tracer

TUNED CIRCUITS—GIVE HIGH PERFORMANCE

Signals can be traced from antenna to loudspeaker. Trouble is quickly localized in dead receivers. Greatly assists beginners or experienced serviceman in finding stubborn cases of hum, noise, or distortion. Sources of oscillation in r.f. or i.f. stages can be quickly isolated. Two separate inputs make the instrument ideal for tracing down intermittent trouble.

One special use for this instrument is in measuring the "gain-per-stage." Also, because this instrument uses two stages of tuned radio frequency amplification, it can readily be used for alignment purposes. A Signal Generator is not essential. The actual broadcast station signal is used instead. The instrument is practically fool proof—anyone can safely use it. Detailed instruction manual is included. Specifications:

1. Power requirements—50 to 60 cycle, 110-120 volts a.c., only.
2. Sturdy maroon crackle finish case—12" x 8¼" x 10¼". Handsomely etched aluminum panel.
3. Tubes included: 2—6BA6; 1—6SQ7; 1—6K6-G; 1—6E5; and 1—5Y3-G.
4. Frequency coverage is 170 kc. to 11.6 mc. in four bands.
5. Five inch dynamic loudspeaker provides audio output. Also has visual output indicator.
6. Standard 90-day RETMA Warranty.

Price \$57.50

Actual weight—15 lbs. Shipping weight—18 lbs. Shipped by express, collect. Please use order blank on page 25.

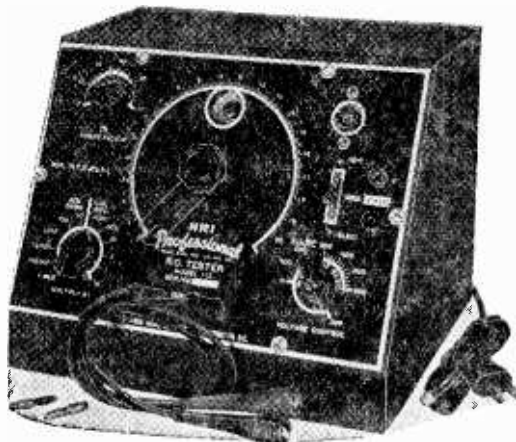

MODEL 112

NRI Professional R-C Tester

No Radio and Television service shop is complete without a reliable resistor-condenser tester. Such an instrument speeds up your service work, enabling you to increase your profits and your customer goodwill.

Here's what you can do with this instrument:
 (1) Measure power factor of electrolytic condensers. (2) Measure capacity of all types of condensers. (3) Check all types of condensers for leakage or break-down by applying actual d.c. working voltage. (4) Accurately measure resistor values in ohms and megohms. Specifications:

1. Capacity ranges: Directly calibrated from .0001 microfarad to 200 microfarad, in six ranges. Will measure down to 10 mmfd.
2. Resistance Ranges: 10 ohms to 20 megohms, in six ranges.
3. Bridge Type Circuit, linear calibrated main scale.
4. D.C. voltage up to 600 volts for leakage test.
5. Complete with four tubes: 1-V, 6Y6G, 6SL7, and 6E5.
6. Power requirements: 110 to 120 volts, 50-60 cycle a.c. only.
7. Maroon colored, crackle finish cabinet. Measures 10 inches by 8 inches by 7½ inches.
8. Actual weight 9 pounds. Shipping weight, 11 pounds.
9. Complete with instruction manual, rubber covered test leads, and special test plugs.
10. Standard 90-day RETMA Warranty.

Only \$36.50

Shipped by express, collect.

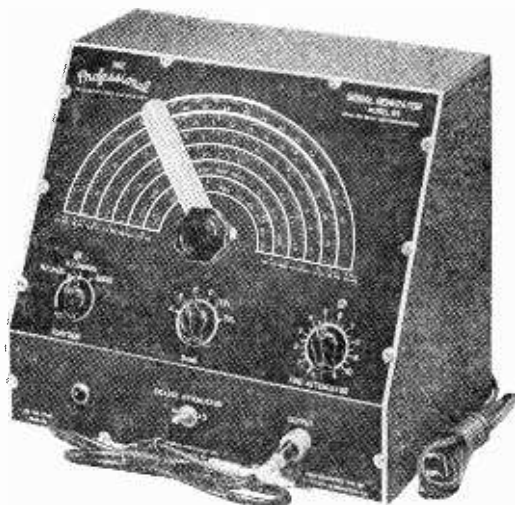

MODEL 89

NRI Professional AM-FM-TV Signal Generator and Marker

170 Kc. to 60 Mc. on fundamentals

This is a new, improved version of the NRI Professional Signal Generator which has been popular with NRI men for a number of years. We have greatly improved the accuracy of the instrument, and added special calibration points for FM and TV. Strong harmonics and accurate calibration make the instrument useful up to 120 megacycles.

A stable Hartley Electron-Coupled oscillator circuit is used with cathode follower output. This gives excellent frequency stability. A single output jack with detachable coaxial lead is used. A 400 cycle pure sine wave audio output is available.

1. **Fundamental frequency coverage:** 170 kc. to 60 mc. in six carefully selected bands. Frequency control vernier ratio 6:1.
2. **Guaranteed accuracy:** $\pm 1\%$ on all six bands. (even better accuracy at certain critical frequencies due to spot calibration.)
3. **Tubes:** 1-6BE6; 1-6SN7; 1-5Y3.
4. **Handsome maroon crackle finish case with black etched aluminum panel.** 12" x 8 $\frac{3}{4}$ " x 10 $\frac{3}{4}$ ".
5. Actual weight 12 pounds. Shipping weight 15 pounds. Detailed instruction manual.

Price Only \$45.00

Shipped by Railway Express, collect. Please use order form on page 25.

Page Twenty-two



"A" Battery Eliminator For Testing Auto Radios

PROVIDES 6 VOLTS & 12 VOLTS D.C.
WILL TEST NEW 1955
12-VOLT AUTO RADIOS

Specifications

TYPE 610C-ELID—Rated output 6 volts at 10 amperes continuous or 12 volts at 6 amperes continuous. Either output obtainable by means of simple output terminal switching arrangement.

Equipped with Full-Wave Dry Disc Selenium Rectifier, Assuring Noiseless, Interference-Free Operation and Extreme Long Life and Reliability. Can also be used as a battery charger.

On-Off Switch, 8-Position Voltage Control, Meters, Fuse Protection, Rubber Mounting Feet, 6-ft. All-Rubber Cord Set, and Cabinet of heavy gauge metal having attractive grey-hammerloid finish. Size 6 $\frac{1}{2}$ " x 9 $\frac{1}{8}$ " x 8 $\frac{1}{2}$ ".

Only \$39.95

Shipping weight, 22 lbs. By Express, collect. Instructions and warranty included.

Announcing the NEW NRI Professional TV Oscilloscope

A Sensational, Wide-Band 5-inch Television Oscilloscope
Designed Especially to Meet the Latest Demands of
Black and White and Color Television Servicing.

Also Ideal for AM-FM and
Industrial Uses

This instrument represents one of NRI's greatest values. It is designed and built to our specifications. A *wide-band* oscilloscope, such as our new Model 56, is necessary for color TV servicing. The frequency response of the vertical amplifier is flat up to 4.5 megacycles. At the present time we know of no other oscilloscope costing less than twice the price of our Model 56 that achieves this standard. And in addition, sensitivity, sweep range, and other important specifications are also outstanding in this instrument.

A convenient time payment plan is available spreading the cost of the instrument over a period of six months. Write NRI for particulars.

Specifications

High sensitivity—1-inch deflection with a signal voltage of only .014 volts (RMS).

Wide-band response — ± 3 db from 5 cycles to 4.5 megacycles at any setting of the vertical attenuator control.

Push-pull deflection amplifiers — used in both horizontal and verticle circuits.

Wide range linear sweep—10 CPS to 100,000 CPS in four separate overlapping ranges.

Voltage-regulated power supply for maximum stability.

High impedance input—to minimize loading of critical circuits under observation. Input resistance 2 megohms, average input capacity 25 micro-microfarads.

Stable sync circuit—single polarity-reversing control—will sync when either positive or negative pulses are observed.

Frequency compensated four-step attenuator.

Vertical attenuator calibrated. Reads peak-to-peak volts directly—no calculations necessary.

Calibration test signal of 2 volts on front panel.

Intensity modulation and return trace blanking.

Twelve modern tubes including 5UP1.



MODEL 56

Power—50-60 cycle, 110-120 volts ac.

Detailed instruction manual—includes plan for building accessory probes similar to those listed below.

Only \$147.50

Shipped by Express, Collect. Order blank on page 25.

Professional Oscilloscope Probe Kit: For use with Model 55 or Model 56 NRI Oscilloscopes. Consists of four probes: high impedance-low ca-

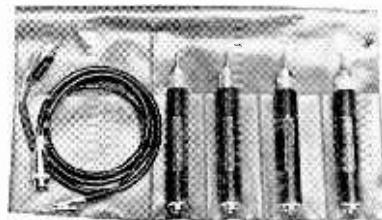

capacity probe; crystal demodulator probe; resistive isolating probe; shielded direct probe; plus detachable shielded cable, plastic case, and complete instructions. **Only \$14.95, postpaid.**

Page Twenty-three



Radio Replacement Parts Kit

INCLUDES STURDY STEEL TOOL BOX

Commonly needed Radio replacement parts. Ideal for the man who wants to get an inexpensive start. Also just the thing for a man already doing Radio and TV service work. If this kit were bought from a Radio parts distributor, it would cost approximately \$40. We offer it for only \$21.75. The parts are standard, fresh, first-quality—they are not surplus. Made by well-known manufacturers. Many parts packed in manufacturer's cartons. Here is what the kit includes:

1. Sturdy steel tool box, 16 inches by 7 inches by 7 inches, with pop-up tray.
2. Two 456 kc. i.f. transformers, one standard size, and one miniature size.
3. A matched set of 2 r.f. replacement coils for r.t.f. receivers.
4. Two 25 ft. rolls of flexible indoor antenna wire, wound on antenna hanks.
5. One antenna coil and one oscillator coil (matched) for either a.c.-d.c. or a.c. sets.
6. Box containing 10 assorted pilot lamps.
7. Dial cord and belt replacement kit, including springs, fasteners, and other hardware.
8. Paper tubular condensers—twenty-five most popular sizes, rated at 600 volts.
9. Fixed resistors—one hundred popular sizes and wattage ratings.
10. Electrolytic condensers—eight widely used types for a.c. and a.c.-d.c. receivers.
11. Two high-grade plastic line cords.
12. One universal output transformer for either single-ended or push-pull output.
13. One A.C.-D.C. output transformer.
14. Scratch filler, for hiding cabinet scratches.
15. One tube of speaker cement and one bottle of solvent.
16. Volume control kit—six popular volume controls, four switches, eight assorted shafts.
17. Two popular types of selenium rectifiers.
18. Two jars full of standard radio hardware.

Only \$21.75

Shipping weight is 15 pounds. All Replacement Parts Kits are shipped express, collect. Please use order form on next page.

Page Twenty-four

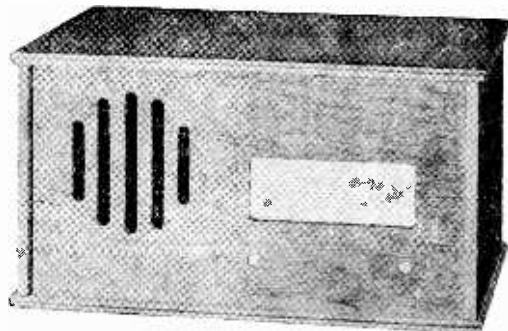

A Beautiful Cabinet For Your NRI Radio

The cabinet is well seasoned natural wood, unpainted. You can, if you wish, give it two or three coats of clear lacquer, or paint it your favorite color to match the room. Four neat rubber bumpers prevent scratching or marring furniture on which you may set your Radio.

The sides, top, and bottom are made of 3/8 inch 5 ply White Gum sanded to a smooth finish. The front panel is attractive Philippine Mahogany. The grille cloth is rich green, harmonizes with the color of the dial scale. The back is open.

Mailed knocked down. Easy to assemble.

Notice the cabinet will come to you knocked down. That is to avoid possible damage in shipment. The sides, top and bottom are rabbeted. Everything slips perfectly and securely into place. It's fun to assemble—a very easy job. No dirt, no fuss. No nails or screws. You simply apply a bit of glue into the grooves, use a little hand pressure and your cabinet is complete.

Slipping your Radio into the cabinet is a two minute job. You'll notice a big improvement in the tone immediately. You'll have an attractive Radio for your den, living room or bedroom.

Sent parcel post, prepaid. Read important note below. Please use Order Blank at right.

Only \$4.95

Be sure to check whether you have the NRI Radio built from parts supplied with Kit 7RK or from Kit 7E. This is important because there is a slight difference in size in the two cabinets.

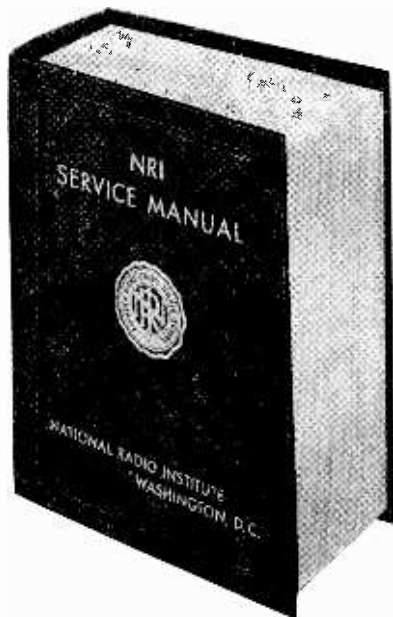

NRI Service Manual, Vol. I Saves You Time and Money

If you are one of the many technicians who are in an area where you get a lot of servicing jobs on receivers built previous to 1946 you will want to order our NRI Service Manual, Volume I. Especially when we tell you our stock is running low.

More than 10,000 of these volumes have been sold to our students and graduates. We would like to re-stock this popular manual but manufacturing costs have gone up about 25% since we placed our last order. We would need to price this manual at about \$19 or \$20. That's quite a jump. We decided not to re-order.

More than 1400 Most Used Radio Diagrams
(5150 Models) of Sets Built Before 1946

The manual contains 1566 pages of diagrams and service information, plus 34 pages devoted to Alignment procedure. Many diagrams include trimmer location and parts layout. Over sixty leading makes of receivers are covered. Actual cost per diagram is hardly more than a penny!

\$15.95 Each

Sent parcel post, prepaid. Please use order blank at right.

Use Order Blank Below

All test instruments and the NRI Parts Kit are shipped by Railway Express, charges collect. Tool Kits, Soldering Guns, Diagram Manual, Radio Cabinets, Tube Caddies, and Accessories are shipped by parcel post, prepaid.

ORDER BLANK

National Radio Institute, Supply Division,
16th and U Streets, N.W.,
Washington 9, D. C.

I enclose \$_____ (money order, check or bank draft). Send me the following material:

- NRI Professional Tool Kit. Price \$8.95.
- 100-watt Weller "Junior" Soldering Gun. Price \$5.95.
- 100-150 watt dual-heat Weller Soldering Gun. Price \$10.73.
- 200-275 watt dual-heat Weller Soldering Gun. Price \$11.71.
- NRI DeLuxe Tube Caddy. Price \$12.95.
- 2-E and 2-CK Steel Cabinet. Price \$3.75.
- Model 11 NRI Professional Vacuum Tube Voltmeter. Price \$38.50.
- High Voltage Television Probe for Model 11. Price \$8.
- Crystal Detector Probe for Model 11. Price \$6.65.
- Leather Case for Model 11 or Model 46. Price \$9.50.
- Model 46 NRI Professional Volt-Ohm-Milliammeter. Price \$33.50.
- High Voltage Television Probe for Model 46. Price \$8.
- Model 70 NRI Professional Tube Tester. Price \$49.75.
- TV Picture Tube Adapter. Price \$4.98.
- Automatic Wire Stripper. Price \$4.95.
- Model 34 NRI Professional Signal Tracer. Price \$57.50.
- Model 112 NRI Professional Resistor-Condenser Tester. Price \$36.50.
- Model 89 NRI Professional AM-FM-TV Signal Generator and Marker. Price \$45.
- "A" Battery Eliminator. Price \$39.95.
- Model 56 NRI Professional TV Oscilloscope. Price \$147.50.
- NRI Oscilloscope Probe Kit. Price \$14.95.
- NRI Professional Replacement Parts Kit. Price \$21.75.
- 7RK Radio cabinet, shipped unassembled. Price \$4.95.
- 7E Radio cabinet, shipped unassembled. Price \$4.95.
- NRI Service Manual, Volume I. Price \$15.95.
- Please send information concerning time payments.

Name Student No.

Address

City Zone State

Express Office

If you live in Washington, D. C., add 2% for D. C. Sales Tax.

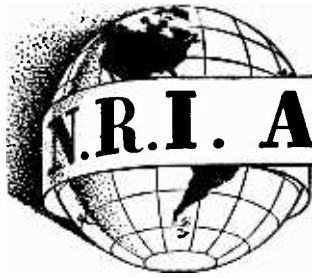

N.R.I. ALUMNI NEWS

Oliver B. Hill	President
F. Earl Oliver	Vice Pres
Harvey W. Morris	Vice Pres.
Louis E. Crossman	Vice Pres.
Thomas Hull, Jr.	Vice Pres.
Louis L. Menne	Executive Secretary

Thomas Hull, Jr., of New York, is President-elect of the NRIAA

F. Earl Oliver of Detroit, Elmer E. Shue of Baltimore, Louis E. Grossman of New Orleans and Herbert Garvin of Los Angeles are Vice Presidents.

AT the close of the polls on October 25 the final tally shows Thomas Hull, Jr., of New York City, elected president to serve the NRI Alumni Association during the year 1955. Tommy Hull has served several terms as vice president. He is vice chairman of our New York Chapter where he is extremely popular because of the fine lectures he delivers to the members. Tommy Hull is the type of fellow who plans his work. He is always well prepared to give his best. He will make an excellent president.

Charles C. Mead, Chairman of our Chicago Chapter, ran against Tommy Hull and made a very fine showing considering that this is his first attempt to win a National office. Mr. Mead is sure to again come forward in some future election.

F. Earl Oliver, one of our old reliables, was re-elected a vice president. Mr. Oliver never misses a meeting in Detroit and has always taken an interest in chapter activities in the Central States.

Mr. Louis E. Grossman of New Orleans has

been re-elected a vice president. He is a true gentleman of the South and is highly regarded by our members in those areas.

Two newcomers complete our roster. Mr. Elmer E. Shue, long a prominent and active member of Baltimore Chapter, has been elected a vice president. This is a deserving compliment to a very loyal member. Mr. Herbert Garvin of Los Angeles has been elected a vice president. Mr. Garvin had no chapter support but drew many votes from members in the Western States. We are very pleased to welcome Mr. Garvin as a vice president of the NRI Alumni Association.

Speaking of the West Coast a tip of the hat to Mr. Oliver B. Hill, of Burbank, California, who served us so well during 1954 and who will relinquish his office to Mr. Thomas Hull, Jr. on January 1. We are proud of the fine men who serve our chapter in an official capacity and, under our new slate of leaders, we look forward to greater expansion of our membership which now numbers more than 15,000.

Chapter Chatter

Detroit Chapter is off to a wonderful start for what is planned to be a very active winter season. At the first meeting of the new Fall season Max Ludtke made a fine talk on the Printed Circuit. Mr. Ludtke also demonstrated a set in which the printed circuit had been used. The following meeting Harry Stephens gave a talk and demonstration on the use of the Chanalyst for troubleshooting. This, too, was a fine talk, well received by the members. The Chapter's RCA dynamic demonstrator was also used in these demonstrations.

The semi-annual stag party held at the Cry-Moto Club in Windsor was a complete success, as usual. The members always look forward to these strictly social gatherings.

Immediate future meetings call for a talk on servicing high fidelity sound equipment by John Nagy, a talk by Floyd Buehler on the repair of public address systems and, as this report is written, a visit is scheduled for WWJ-TV Studios, one of the most modern and best equipped studios in the country.

Just for the fun of it a drill kit was raffled off and was won by Mr. Stanley Szafran. There is a sad note too. The chapter received late news of the death of one of our members, Mr. Stanley G. Hasler, Marine City, Michigan. Mr. Hasler was highly regarded by all. Vice President F. Earl Oliver points out the need of keeping officers posted regarding illness or misfortune that may befall upon any of our members. The belated passing of Mr. Hasler came as a distinct shock.

Election of officers for 1955 will be held on December 10th. All members are urged to turn out in order that we may have a truly representative vote of the wishes of the chapter. Refreshments will be served following the election. There is no meeting scheduled for December 24.

Looking forward to 1955, plans have already been made for a representative of the Michigan Bell Telephone Company to give a talk on the latest developments in the transistor field. This talk is scheduled for one of the January meetings.

Meetings are held on the second and fourth Friday of each month at St. Andrews Society Hall, 431 E. Congress, beginning at 8:00 P.M.

New York Chapter in full swing with some wonderful talks, for example, Tommy Hull on Radio AVC, Phil Spampinato on Photo Flash Circuits, and William Fox on Field Experiences.

Chairman Bert Wappler, extremely busy in his expanding business in Long Island City, nevertheless plans his time so as to give full attention

to the activities of New York Chapter. In this he is aided by other members of the executive committee including Secretary Lou Kunert, Tommy Hull, Frank Zimmer and Alex Remer.

Meetings are held on the first and third Thursday of each month at St. Mark's Community Center, 12 St. Mark's Place, between Second and Third Avenues in New York City.

Pittsburgh Chapter, in a letter from Secretary K. J. Shipley, wishes us to mention a tour made by the members to the studios and transmitter stations of WENS. Because of the large number of members who wished to make this tour they were divided in two groups on different nights. Our thanks are extended to Mr. Heisel and Mr. Layton of the WENS staff for the attention they gave our members and for their patient answers to our many questions on UHF transmitters.

Mr. Bert Bregenzer, Vice President, Penna TV Service Federation, gave a very excellent talk on the oscilloscope. At another meeting our own Vice Chairman, Mr. T. D. Schnader gave a servicing demonstration on a 16-inch Olympic TV set.

It should be mentioned that Pittsburgh Chapter held a basket picnic for its members at Bregenzer's Ranch, north of Pittsburgh. There were approximately ninety people in attendance, including children. Races were held for the children and prizes awarded to the winners. A door prize was awarded to one of the ladies. Liquid refreshments were distributed to all and there was plenty of ice cream for the children.

A tip of the hat to Chairman Frank Skolnik and to Secretary Ken J. Shipley for an excellent job in keeping headquarters posted regarding Pittsburgh activities. Meetings are held on the first Thursday of each month at 134 Market Place.

St. Paul-Minneapolis Chapter now holds meetings at its regular location, St. Paul Midway YMCA.

Mr. Charles Narin of General Electric Company addressed the chapter on vacuum tubes and defects. Apparently some prizes were distributed because the report is that Mr. Olson of our chapter won ten of the new service type GE tubes. Mr. Babcock, Mr. Berbee and Mr. Balkus won GE service signs. A door prize, consisting of a wire stripper was won by George Reil. Mr. Reil had just returned from his vacation during which he visited NRI in Washington. He made a nice report of this visit to the chapter members.

Our door prizes are getting to be quite a thing. We had so many at a recent meeting we held some over for the next meeting. Some of the members went to the dealers in St. Paul and came up with some dandy prizes. George Thell won a power transformer, Al Danielson, Harold

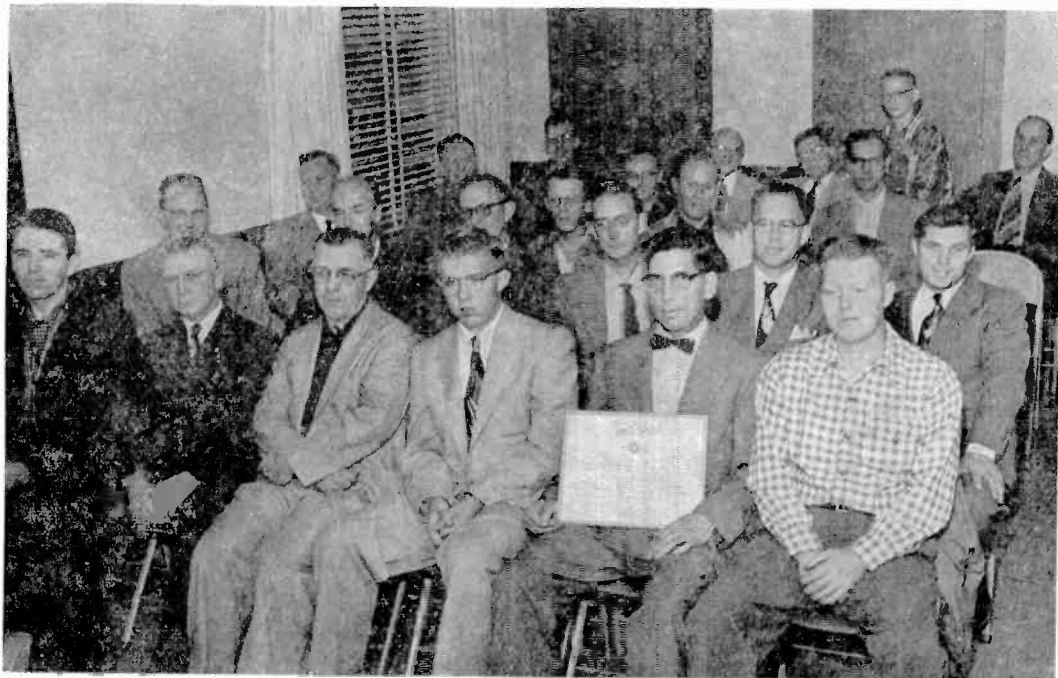

St. Paul-Minneapolis Chapter members, proud of their charter, are shown at their comfortable place of meeting, in the Midway Y.M.C.A. in St. Paul.

Holtz and R. W. Linde each won a Philco foot control switch. (At the next meeting the boys want to know what use they made of them.) All this! Donated by our service dealer friends in St. Paul.

At one of our meetings Mr. Mike Kuschill, head service technician, Roycraft, Inc., Philco Distributors, spoke to us on TV servicing. It was a talk that will long be remembered. He was delighted that such an organization as ours exists and told us that he will come back again. The members were so impressed with the fine spirit of co-operation extended by Mr. Kuschill he was made an honorary member of our chapter. We look forward to his next visit knowing that we again will be greatly benefited.

We now stand forty-six strong. There has been a change in our official family. Our Chairman, Mr. Warren A. Schulze has accepted a position as director of sales, Terwilliger TV Mast Company of Pontiac, Illinois. Naturally it was necessary for him to resign as Chairman. We shall miss him very much and our best wishes go with him. He was voted a life

membership in our Chapter. An election was held and John Berka was elected chairman in a close race with Ray Olson. Mr. Berka is a very popular member and will receive the full support of those in our chapter.

A guest speaker for a forthcoming meeting will be a Service Engineer from Setchell-Carlson Television. Within the next month or two we will arrange a visit through studios KSTP-TV.



Executive Committee of St. Paul-Minneapolis Chapter. Left to right, R. E. Olson, Planning Committee; Walter Berbee, Treasurer; Warren Schulze, Retiring Chairman; and John t. Babcock, Secretary.

Meetings are planned into February. The officers have arranged some excellent meetings and all students and graduates in the St. Paul-Minneapolis area are invited to attend. Much credit to the untiring and enthusiastic efforts of Secretary John I. Babcock who can be reached at 3157 32nd Ave. South, in Minneapolis.

Baltimore Chapter is very happily located at 100 N. Paca St., our meeting place during the past several months. Mr. A. J. Rathbun has been greatly complimented by our members for his devotion to the needs of our chapter members. At every meeting he conducts a question and answer forum relative to Radio and TV problems encountered by the members during the month. These talks lead to lively discussions which are beneficial to all who participate.

The dinner meeting held a few months ago was so well attended it is planned to hold another some time during the month of December, the date to be announced by notice to all of the members. Arrangements are also being made to visit television station WHAM-TV.

Meetings are held on the second Tuesday of each month at the O.U.A.M. Hall, 100 N. Paca St., in Baltimore. Secretary Joseph M. Nardi, 4157 Eierman Avenue, Baltimore 6, Maryland will be glad to supply information to all who are interested.

Milwaukee Chapter, like so many groups, visited Station WTMJ and WTMJ-TV. Mr. Brauer, audio supervisor for these stations gave our members a very interesting talk which was followed by a demonstration of color TV at the station. This tour consumed three hours all of which was immensely enjoyed by the members. Our thanks to Mr. Brauer and to the officials of WTMJ-TV for their courtesies to us, the opportunity to visit the studios while programs were in progress. Our members were very much impressed with the new color installations.

On October 18 the chapter celebrated its first anniversary. Mr. J. B. Straughn and Mr. L. L. Menne of headquarters were present on this occasion. Mr. Straughn spoke on AC-DC receiver diagnosis. The members followed Mr. Straughn's discussion by means of diagrams which were supplied. Following this good talk a buffet luncheon was served.

Chairman S. K. Petrich, Secretary Robert Krause and Treasurer E. V. Bettencourt spoke in turn, each contributing something in review of the chapters first year of activity. Other members who took part in this discussion were Phillip Rinke, John Edgerton and Walter Smith. Mr. Menne congratulated the officers and members on the progress made during the first year and, based upon the enthusiasm of the members, predicted a long and pleasant association of NRI

students and graduates through our Milwaukee Chapter. Chairman Petrich admonished the members to give serious thought to nominees for officers for the year 1955. A number of very important points, previously discussed by the executive committee, were taken up with the members for disposal at a future meeting.

Meetings are held on the third Monday of each month at 2249 N. Humboldt Avenue, corner East North Avenue. The Secretary is Robert Krauss, 135 E. Keefe Ave., Milwaukee.

Chicago Chapter, meeting in the tower space, American Furniture Mart Bldg., 666 Lakeshore Drive, continue to go along serenely meeting twice a month on the second and fourth Wednesday. Visitors to the chapter are reminded to use the West Door entrance.

Secretary Edward Shapel reports some very interesting meetings including a very fine demonstration by Walter Nicely on a TV set that has blacked out.

The notices sent out by Chairman Charles C. Mead and Secretary Shapel are in themselves inspiring.

Philadelphia-Camden Chapter, a bee-hive of activity, sends a full schedule of meetings for the next several months. Meetings are held on the second and fourth Monday of each month at the Knights of Columbus Hall, Tulip and Tyson Sts., Philadelphia. Meetings begin at 8:15 P.M.

A recent guest speaker was Mr. M. E. Heath, Service Supervisor of the Westinghouse TV Company. His subject was "A black and white service Clinic." For this he used a visualcast presentation in conjunction with a dynamic demonstrator chassis. Copies of the Westinghouse television manuals and schematics were distributed to members present. Westinghouse went to a lot of trouble to bring this demonstration to our members. This was a terrific lecture, in the words of the secretary's report, and arrangements have already been made to have Mr. Heath return in the very near future. Members were also supplied with pens and cigaret holders, the compliments of Westinghouse. As a closing remark Mr. Heath promised to talk on color television the next time he visits the chapter.

As this report is written arrangements have been made to visit WCAU Sky Tower Transmitting Center in Philadelphia. On December 15 the chapter will hold a social at which time L. L. Menne will install the new officers for the coming year. The social this year has been moved up so as not to conflict with the Christmas holidays. All members are urged to attend and visitors are cordially invited.



Mr. Morris E. Heath, Service Supervisor, Westinghouse, Philadelphia Office, and part of his audience, at a meeting of Phila-Camden Chapter.

The effervescent secretary of Philadelphia-Camden chapter is Mr. Jules Cohen, 7124 Souder St., Philadelphia, 24, Pa., who will be glad to give information regarding chapter activities by letter or telephone to all who wish to contact him.

Springfield, Mass. Chapter, one of the youngest in our group, is growing very rapidly. They average close to forty present at each meeting and the programs are excellent. Spirit is running very high in this group due very much to the fine work of Chairman Howard Smith, Secretary A. L. Brosseau, Vice Chairman Ray Nystrom and Treasurer L. Lyman Brown.

This chapter, like several others, just before cool weather set in, held a picnic which was attended by thirty-four adults and nine children. Chairman Smith particularly wishes to congratulate the ladies for their fine contributions, their spirit of good fellowship and the manner in which they entered into the activities. Special mention goes to Mr. Frank Seavey, who prepared the chicken and did a wonderful job of it. Mr. Brown also is

extended a compliment for the fine cooperation he gave to the committee on arrangements. Incidentally, Mr. Brown has been one of our chief lecturers. His wide experience as a radio and TV consultant qualifies him as an expert and members look forward to his talks.

Chairman Howard Smith is interested in identification badges to be worn by each member so that we can become better acquainted. Mr. Smith will be glad to have suggestions from other chapter officers. His address is 53 Bangor St., Springfield 8, Massachusetts.

Mr. Brown, Mr. Bruso and Mr. Smith are working on a demonstration TV set for use at chapter meetings. This promises to be something super and is not to be revealed until the proper time at some future meeting. Therefore no more on that subject. Secretary A. L. Brosseau, 56 Gardner St., or Chairman Howard B. Smith, 53 Bangor St., Springfield, will be glad to supply information to any NRI students or graduates in this area who would like to attend meetings.

New Orleans Chapter, under the careful planning of Chairman Louis E. Grossman, at each meeting goes through two of the experiments of the NRI courses. Diagrams are drawn on the blackboard and all members have an opportunity

to participate in the discussions. Some mighty good work by Secretary Anthony H. Buckley, too. The chapter has settled down to a fine group of loyal members who attend meetings quite regularly. As this is written a visit by L. L. Menne, of headquarters, is anticipated.

The Chairman is Louis E. Grossman, 2229 Napoleon Ave., and the Secretary is Anthony H. Buckley, 2817 Burgundy Street in New Orleans, either of whom will be glad to supply information regarding forthcoming meetings.

Flint, Mich. Chapter, has not submitted a report, as this is written, but very likely it will follow within a few days just too late to be given mention in this issue. Nevertheless, our information is that Flint Chapter is meeting regularly and that the members are greatly enjoying their association. The chairman is George Rashead, 338 S. Marengo Avenue, Flint 5, Michigan. The Secretary is David J. Nagel, 3135 E. Mt. Morris Road, Mt. Morris, Michigan.



Here And There Among Alumni Members

Lucien LeBlanc, of Drummondville, P.Q., Canada, says business is good. Has more TV and Radio work than he can handle. Sales good, too.

— n r i —

William F. Kline, of Cincinnati, Ohio, is now the owner of the

Fessenden Appliance Co., a firm established 25 years ago. He employs four people, and recently received a write-up in ELECTRICAL SERVICE NEWS in connection with his efficient Radio-TV and Appliance Service Department. Graduate Kline serviced Radios and TV for 14 years in spare time before going on his own about a year and a half ago.

— n r i —

Nick Hannon, a retired Sergeant of the Police Department in Philadelphia, and a staunch member of Philadelphia Chapter, has been made Plant Security Officer for the Chevrolet Division.

— n r i —

George W. Brenner, of Lewiston, Montana, sent a copy of his QSL card with a picture of the ham rig he constructed. His call letters are W7WSE.

— n r i —

Graduate Ray Fontenet is at present a Radar Technician for the U. S. Army, at Ocean View Station, Norfolk 3, Va.

— n r i —

George J. Gottsche, Jr., of Saratoga Springs, N. Y., has just obtained his 2nd class radio-telephone license.

— n r i —

James Wiggins, of Toronto, Ont., Canada, visited NRI recently while he and his wife were vacationing. Graduate Wiggins is employed by the Canadian Exposition in Toronto.

— n r i —

Sylvania News, in its October issue, shows a photo of NRI Graduate E. K. James, of Chesham, New Hampshire. Nice story about his experience and his many connections in the field of Radio and Television. A boost for NRI, too, for which, thanks.

— n r i —

Raymond D. Arnold, of Providence, Rhode Island, is now Chief Engineer of Station WARA.

— n r i —

James R. Farris, of Cedar Rapids, Iowa, is employed by Collins Radio Co. as a Supervisor of Inspection.

S. G. Petrich, who is in the Radio-TV sales and servicing business at 5901 W. Villet St. in Milwaukee, says business is booming. His wife, Ann, is a great help to him in the store.

— n r i —

Graduate Gene Blackburn, of Louisa, Ky., writes that his Television business is great. Would like to get in touch with another NRI Grad as he is in need of another bench man.

— n r i —

Emerson A. Breda, of Tacoma, Washington, operates the Defiance Radio TV Service and is doing extremely well. About 80% of his work is TV.

— n r i —

Graduate H. S. Moody, of Ruston, Louisiana, says NRI training is paying off in his job with Southern Bell Tel. & Tel. Co. Expects to take advanced training.

— n r i —

Lloyd Bohling, of Watertown, Wisconsin, wishes all to know he is doing a "rushing business." He is mighty pleased with the number of new customers he received as a result of a small announcement in his local newspaper.

— n r i —

Congratulations to Mark Green, who now operates his own Radio and TV Service in Pleasant Plain, Ohio.

— n r i —

Warren Eye, of Salina, Kansas, has specialized as an Admiral TV Technician with a large TV dealer. Says \$100 a week is not hard to get for the properly trained man.

— n r i —

Ralph L. White, member of our Springfield Massachusetts Alumni Chapter, recently won first prize of \$100 in the Cisin TV book naming contest. His suggestion for the title of their new book on pix tubes was "CRT from A2Z."

— n r i —

Oscar C. Hill of Houston, Texas, who was a candidate for Vice President in the election just held, ran a very good race. We'll hear more about him, in future years.

— n r i —

John J. Janega, of Sydney, N.S., Canada writes a very enthusiastic letter about his work with the Canadian Marconi Company as an electronic technician. He represents the company in Sydney on a good salary, and is his own boss. Services marine electronic equipment, including Radar, Loran, Echo Sounders. Says work is very interesting.

NATIONAL RADIO-TV NEWS

16th & U Sts., N.W.

Washington 9, D. C.

Forwarding Postage Guaranteed

For:

Mr. Francis H. Fingado
611 17th St.
Denver 2, Colo.

25236-G

4

Sec. 34.66, P. L. & R.
U. S. POSTAGE
1½c PAID
Washington, D. C.
Permit No. 7052

National **RADIO-TV NEWS**

Vol. 16 December-January 1954-1955 No. 6

Published every other month in the interest of the students
and Alumni Association of the

NATIONAL RADIO INSTITUTE
Washington 9, D. C.

The Official Organ of the NRI Alumni Association.
Editorial and Business Office, 16th & You Sts., N. W.,
Washington 9, D. C.

L. L. MENNE, EDITOR
H. L. EMERSON, ASSOCIATE EDITOR
J. B. STRAUGHN, TECHNICAL EDITOR

NATIONAL RADIO-TV NEWS accepts no paid advertising. Articles referring to products of manufacturers, wholesalers, etc., are included for readers' information only, and we assume no responsibility for these companies or their products.

Index

Article	Page
Analyzing a Typical Five-Tube AC-DC Superheterodyne Receiver	3
A Simple Electronic Organ	12
Technical Ramblings	14
Christmas Suggestions—NRI Test Equipment	16
New Model 56 TV Oscilloscope	23
NRI Alumni Association Election Results ..	26
Chapter Chatter	27
Here and There Among Alumni Members ..	31

Printed in U.S.A.