

National RADIO-TV NEWS

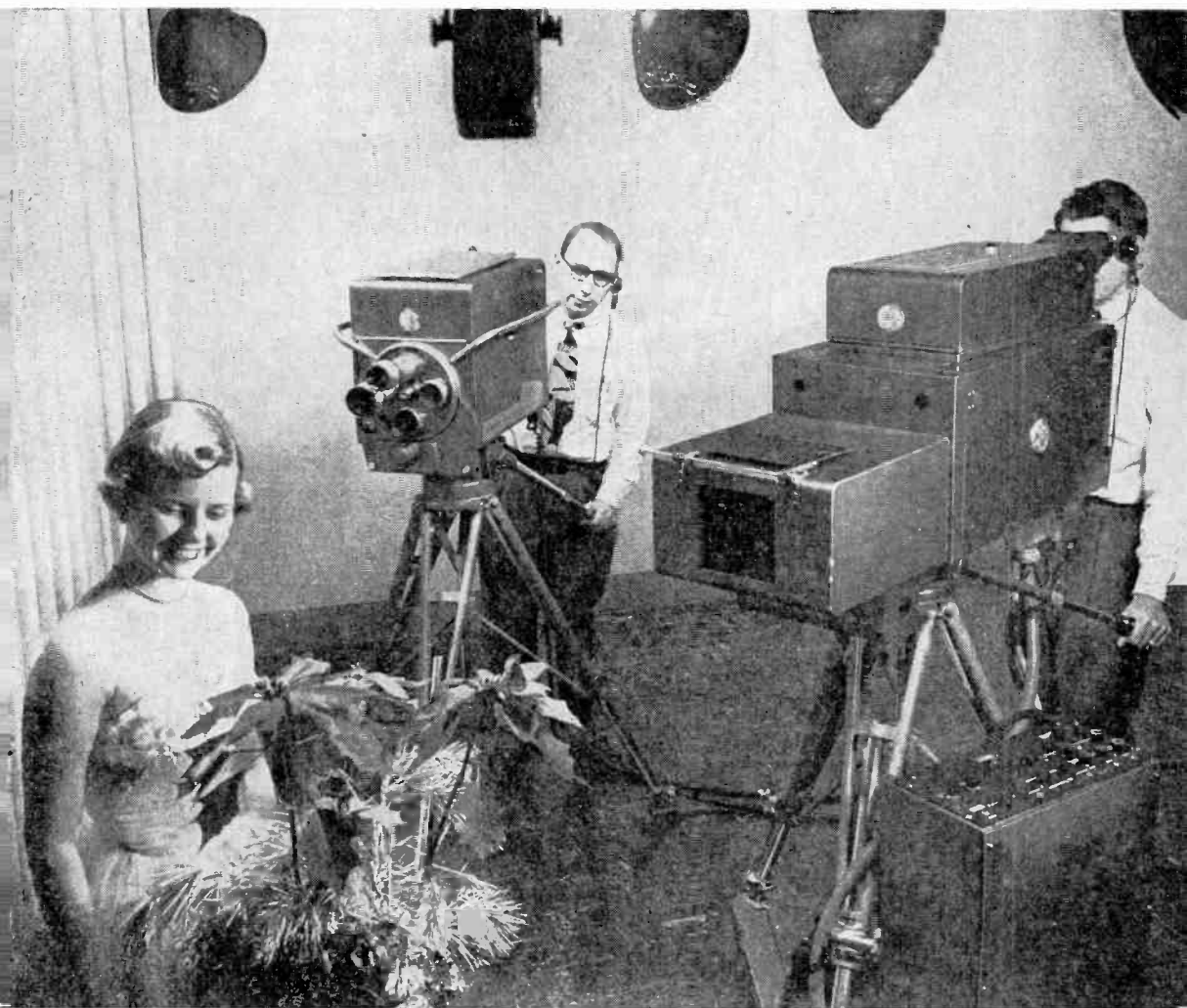

IN THIS ISSUE

Opportunities in the Radio-TV Industry
How to Build an Inter-Com
Alumni Association News

April-May
1954

VOL. 16
No. 2



Control Yourself

One reason some men never get anywhere is because they spend all their lives fighting difficulties of their own making.

For example, consider the man who is ready to argue at the drop of a hat, at any time and on any subject. He may out-talk other people and win his arguments, but in so doing he loses the friendship, respect and cooperation which are essentials of success. An argument won by noise and command merely shows that reason is weak.

Another example is a man who cannot recognize that anyone else could possibly be correct. Unwillingness to consider the other man's viewpoint is a serious handicap in any business where success depends on cooperation with others—and that covers just about every business in existence today.

Consider the words of the Roman philosopher Seneca: "*Most powerful is he who has himself in his own power.*" And Milton had the same basic thought when he wrote, "*He who best governs himself is best fitted to govern others.*"

In other words, if you let common-sense reason rule your own feelings, fears, desires and pride—if you control yourself—you'll soon find people fighting with you, not against you, for your success in Radio and Television.

J. E. SMITH, *President.*

OPPORTUNITIES IN THE RADIO AND TELEVISION INDUSTRY

By **GEORGE W. RAMER**
NRI Consultant



George W. Ramer

MANY people are so impressed with the rapidly increasing number of opportunities for profitable employment in the repair and maintenance of radio and television receivers and transmitters that they often overlook the ever increasing number of opportunities in the production of electronic equipment. No one need be reminded of the vast number of radio and television sets being produced today, but we frequently overlook the many other electronic devices being produced.

Electronics is rapidly becoming the major control method in our daily lives. With radar, instrument landing systems, and the automatic pilot we control the flight of aircraft. Electronic navigational aids control ships at sea, while newly developed rockets are also controlled by electronics. Electronic devices are a major source of control in nuclear energy research. Advances in the field of medicine demand more and more electronic devices. And daily new applications are being found for electronics in the control of industrial processes. We may indeed be witnessing the beginning of a new era which will be known to historians as the age of electronics.

In view of its many applications we can see that expansion in almost any industry today opens up new opportunities in the field of electronics. Industry today is hard put to find the personnel to keep pace with the advance of science in electronics, consequently the man who is familiar with radio and television electronics is in an excellent position to secure a good job in industry.

It is true that working in a factory may not be as profitable as operating your own radio and television repair business, and you will not have

the degree of independence you would have if self-employed. But, on the other hand you do not need any capital invested in your job, nor do you have any of the cares and responsibility of operating a business of your own, and you can use a job in industry to gain experience while being well paid for it. Some experience working in the production of electronic equipment would certainly be of benefit to a man who wishes to open his own shop. To some people a job in industry offers experience prior to going into business for themselves and to others it offers a career, but in any event it is an opportunity well worth looking into.

The Factory Today. Fifty years ago the factory was not considered a very desirable place to work, nor a very desirable institution to have in one's neighborhood. However phenomenal improvement has been made in the past five decades in improving working conditions and plant facilities. Not only have the factories changed but there has been a change in the public attitude toward the factories and those who work in them. The social barrier between the white collar worker and the man who works with his hands has been broken down. Today, many factory workers look upon the once exalted white collar worker with pity.

Let us take a look at a modern factory engaged in the production of electronic equipment. As we approach it we are apt to ride through a neighborhood of neat, well kept, middle-class homes. The factory building will be architecturally pleasing to the eye with well kept lawns and hedges surrounding it. We park our car in a large well-paved parking lot adjacent to the plant (there will be almost as many cars in this lot

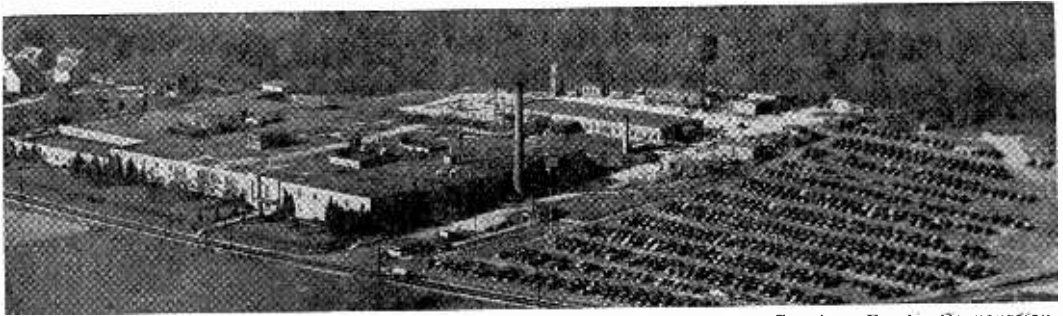

Courtesy Bendix Corporation

Here is an aerial view of the Bendix Corporation's modern plant. Note the ample parking facilities and the pleasant suburban atmosphere.

as there are employees in the plant). When we enter the building we find the working spaces well lighted and large enough to allow every employee to work with ease and efficiency. We find large, modern, well-kept wash-rooms and locker rooms. There is usually an infirmary with a full-time registered nurse. There is also a large, modern cafeteria in which hot meals are served economically to the employees. Very likely we will find that the whole plant is air conditioned for the employees' health and comfort as well as efficiency.

If we stop to talk to one of the employees we are apt to find that he is pretty well satisfied. He has to work hard because of increased demands for production. He frequently works over-time, for which he receives extra pay. But the company does not make excessive demands upon him. Nobody minds when he takes several coffee breaks a day, and the over-time comes in mighty handy to pay for that new car or to swell that savings account. The company helps provide him and his family with health and accident insurance. He may tell us that tonight he is going to participate in some company sponsored recreational activity.

The modern factory at which we have just looked is, of course, the ideal, but it is the ideal which industry is constantly striving for, and it has been achieved by many companies. Industrial management has found that the key to good production is healthy and happy employees.

In plants engaged in the production of electronic equipment there are generally four departments in which a man with a knowledge of electronics may find employment. These departments are: Production, Supply, Inspection or Quality Control, and Engineering. In each of these departments there are jobs that require varying degrees of knowledge of electronics, and skill in the electronics art. There are jobs which demand only a fundamental knowledge of electricity and the ability to make or recognize a

good soldered connection, but at the other extreme there are jobs which require a highly skilled technician. Today all of these positions pay well for the degree of skill and knowledge which they demand. Let's look at the jobs in the various departments and see what they offer and what they demand.

Production

All of the jobs in production require that the worker be time and efficiency minded. Industrial plants hire high-priced efficiency experts to develop methods which will give them the most production at the least cost, but in the final analysis the best efficiency expert for a given job is a conscientious worker on that job. A good production worker will be constantly thinking of ways to do his job more efficiently. Attention to detail is most important in this phase of industry. If the worker can, for instance, devise a method of making a solder connection in which he picks up his soldering iron in less time than he formerly did, he may in the course of an eight hour day save an hour's time. This in terms of work produced is the equivalent of his working a nine hour day instead of eight. Management appreciates the fact that the production worker can do this. For this reason you will find suggestion boxes in most plants and awards given employees for time saving suggestions.

The Assembler. The assembler is on the bottom rung of the ladder in the production department. He may be required to simply mount parts on a chassis, or wire simple circuits from models or pictorial diagrams. Practically no knowledge of electronic theory is required for this job, but it does require a degree of mechanical dexterity and the ability to make good solder joints quickly. There are usually several grades within this classification and the assembler will advance as he becomes more efficient and experienced. For light assembly such as under chassis wiring, most plants have found it economical to employ women, but the jobs in this classification which

require heavier work, steadier attendance, and more knowledge of electronics generally go to men. The supervision of an assembly line is usually a man's job. The top grade in the assembler's classification is not a dead end. He may go on to become a wire man.

The Wireman. This job requires a little more skill and more knowledge than that of the assembler. The wireman frequently must work from wiring diagrams and schematics. Often the wireman begins work where the assembler stops. That is, the assembler wires sub-assemblies from models or pictorial diagrams. Then the wireman connects these sub-assemblies together making the complete unit. The wireman's work is rarely done on an assembly line basis. It often involves planning cable runs and clamping and lacing cables in place. The wireman must have a knowledge of the over-all operation of the equipment on which he works, which is not required of the assembler. Valuable knowledge of electronic systems and experience in wiring them may be gained in the wireman's position. Just as in the assembly category, there are several grades within the wireman classification. Top wiremen are, today, earning up to \$2 an hour plus time and a half for overtime.

The top grade in the wireman's classification is no more a dead end than that of the assemblers. Rapid expansion in the production of electronics equipment creates a constant need for qualified personnel in the supervision of wiremen and assemblers. This is the next step for the top wiremen.

The Foreman. This job not only requires a thorough knowledge of electronic principles but also the ability to manage people well and to plan the activities of a production group. Usually some experience as a wireman is required of a foreman. It is his job to supervise the work of the wiremen and assemblers, to plan a production schedule, and see that production is kept up to that schedule. He must also coordinate the activities of his production unit with those of other units and other departments.

The foreman's job is generally a salaried position, and his salary is usually greater than the earnings of the highest paid worker under his supervision. However many top wiremen hesitate to accept supervisory positions because they generally pay less for over-time than an hourly rated employee's job. With the rapid expansion of the industry today a good foreman may be promoted up to the higher echelons of management.

Supply

The Supply Department offers some opportunity to the man with a knowledge of electronics. However they are usually not as good as the opportunities offered in the other departments. It does

offer a good opportunity for a person with very limited knowledge of electronics to get a foothold in the industry. Supply work can roughly be broken down into three general classifications: Stock, Expediting, and Procurement.

The Stock-Clerk. Very little is required of the stock clerk in the way of electronic knowhow. He need only be familiar with the various electronic components used in his plant and the procedures used in issuing them from his stockroom to the Production Department. This job offers a good opportunity for the beginner in electronics to learn the various components used. A stock clerk receives reasonably good pay and may advance to the position of chief stock clerk, but he will not acquire any great knowledge of

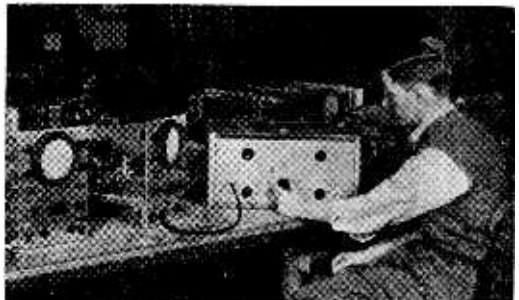

Courtesy General Electric

This man is engaged in the production testing of oscilloscopes for the General Electric Company.

electronics in the process. Knowledge acquired about the cost and storage of electronic components in this job may be valuable to the man who someday wishes to operate a repair business of his own.

The Expediter. The expeditor is a go-between for the supply and production departments. He must be familiar with the various electronic components in stock plus the work of production, so that he can see that the right material is at the right place at the right time. He must see that supply is not a bottle-neck for production. The status and pay of the expeditor varies greatly from one plant to another. In one plant his status may be that of a messenger or stock chaser, while in another his status may be equal to that of a foreman. The man in this job will learn more about the over-all operation of the factory than he will about the science and techniques of electronics. The expeditor is apt to learn some good material control methods that could be as easily applied to a large service business as they are to factory production.

Procurement. The procurement section of a large factory may be either a part of the supply de-

(Page eight, please)

These NRI Graduates are Succeeding In Industrial Radio-TV-Electronics



Factory
Radar
Work

"I cannot thank NRI enough for the start they have given me in the field of Radio and Television. I am now working in a factory on radar equipment and have a spare time Radio and TV business. Also operate my own amateur radio station, call W3PRN.

"The NRI course has been a great help to me. My advice to men interested in the field of radio and electronics is to enroll now at NRI."

FLOYD ZAWAKE
121 E. Locust St.
Scranton, Penna.



Now Transmitter
Tester, Former
Cotton Mill
Worker

"When I started taking your course in Radio I was working in a cotton mill at night making eighty cents per hour. I didn't know what a resistor was. Sometimes I look at my diploma and tears come to my eyes. It was worth two-thirds of my life, because it changed my living 75 per cent.

"I recently changed jobs with a nice increase. My position is Transmitter Tester with Federal Telephone and Radio Corporation. Thanks to NRI."

LEROY MUSSELWHITE
160 Midland Avenue
Kearney, N. J.

— n r i —

— n r i —



Has Good Job as Trouble Shooter In Television Factory

"When I started your course, I did not know a resistor from a condenser. I had only gone to the seventh grade in school.

The lessons were a little hard but I got through them. Started repairing radios on my tenth lesson, averaging \$10 to \$20 per week, spare time.

"I have a very good job at Capehart-Farnsworth Company, here in Fort Wayne, as a trouble

shooter on television. I also have a part time job as a TV serviceman.

"I believe Radio-TV is a most profitable profession. I shall always be proud that I chose the NRI course. NRI is always ready to help."

MARION R. LINDEMUTH
1727 High St.
Fort Wayne, Ind.



Television
Service Engineer
With Well-Known
Manufacturer

"During the past years, I have been very fortunate to have had several good jobs in Radio and Television. At present, I have an excellent position with Stromberg-Carlson Company as Television Service Engineer.

"Most of my success can be directly attributed to NRI's very excellent course and helpful aid after graduation. This has been the only formal training which I have had in this field."

J. M. TICKNOR
165 Woodside Ave.
Buffalo, N. Y.

— n r i —



Tester
for
Western
Electric

"I can truly thank NRI for the job which I now have at Western Electric in Winston-Salem, North Carolina. There are a number of people here at Western Electric who are NRI graduates. Everyone of them is very pleased with your course. My work is testing government equipment.

"I am always glad to boost NRI any time I have a chance."

JACK WAGNER
RFD 1
Lexington, N. C.

— n r i —

Former Cab Driver—Now Employed in the Test-Equipment Department of a Television Manufacturer

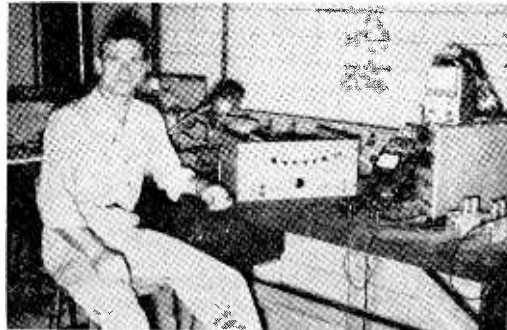

"Several years ago, I was a cab driver averaging \$35 to \$40 per week. Enrolling in your Radio and Television Servicing Course started me on the way up.

"I am now employed in the test-equipment department, tuner division, of Sarkes-Tarzian, Inc.,

of Bloomington, Indiana. Average \$80 to \$100 per week. Thanks to you for starting me on the right road."

JOHN H. SHEPHERD
726 W. Howe St.
Bloomington, Ind.

As space permits, from time to time, we plan to devote a page or two in NR-TV News to short success stories such as above. They are taken from testimonial letters we have on file. Photographs and letters of this kind are always greatly appreciated by us. We feel we should pass them on to our readers for the inspiration to be gained from a reading of them.

(Continued from page five)

partment or a part of the planning department. In either event, they need men with a reasonably good background in electronics and a thorough familiarity with the components used, their price, their sources, and the quality of material supplied by various sources. Jobs in this section are generally considered to be of the white collar variety, but they are usually rather well paid. A man with experience in procuring components for a large service shop or in the wholesale radio and television parts business is ideally suited for a job in this section of the factory. In addition to knowing the sources of supply for the most economical components of good quality, the man working in procurement must also know when to purchase material so that it will not be held in stock too long, tying up valuable storage space,

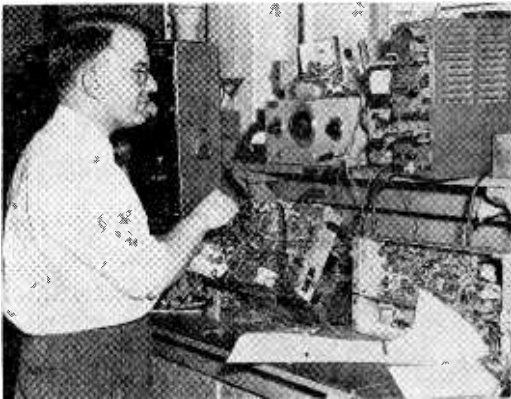

Courtesy Motorola, Inc.

An engineer at work in the laboratories of Motorola, Inc. He is working on the development of new and improved types of power line carrier communications equipment.

but on the other hand it must be in stock before it is needed, so that production will not be held up while waiting for parts. Work in procurement is interesting and very important but it does not require any skill in the electronic arts nor as much knowledge of electronic theory as many other jobs in the factory.

Inspection and Quality Control

The Inspection Department of a large factory is usually divided into two groups. One section is engaged in the inspection of incoming material purchased to go into the equipment manufactured at the factory. Their function is to see that material purchased by the company meets the requirements specified at the time of purchase, and is of good quality. If the plant is engaged in the production of electronics equipment for

the government they must see that incoming parts meet government specifications.

The production inspection department is in control of the quality of the product being manufactured. They must inspect the equipment at various stages of its assembly, and when it is finally assembled must inspect and test it to see that it meets the purchaser's specifications. Here again the requirements for jobs in these departments vary from very little knowledge in the field of electronics to very detailed and complex technical knowledge.

Incoming Inspection. In this section of inspection the inspector may be required merely to see that a certain part is properly labeled or is of the specified size or shape. On the other hand, he may be required to test material to see that it meets rigid mechanical and electrical specifications. He may use very complicated test equipment, but much of it will be familiar to the man who has had experience in the repair of radios for television. The incoming inspection department, of necessity, works in coordination with the supply department which procures these materials. In many cases it may be under the supervision of the supply department, but it is usually maintained in a separate inspection department. The incoming inspector is in a good position to learn much about electronic components, their design, and the specifications they must meet in order to be used in various applications. He will be well paid and may be advanced to more technical positions as he learns and gains experience in the department.

Production Inspection. The production inspector will be required to inspect the work done by assemblers and wiremen. His job generally carries a high degree of responsibility, because he must decide whether a given piece of equipment is to be accepted or rejected and reworked. He must make thorough inspection tests rapidly so that he does not delay production. He may be merely required to make simple continuity tests and visually inspect solder connections, or as he progresses he may eventually be required to conduct precise tests using electronic test equipment such as the oscilloscope, the vacuum tube voltmeter, the signal generator, and the resistance and capacity bridge. There are jobs in this department which require skill in electronics ranging from that of the novice to that of the expert technician, and the inspector is paid according to the requirements of his job. All inspectors should be able to read schematic and pictorial diagrams and mechanical blueprints. The pay scales in the inspection department are usually about parallel to those in production or slightly higher.

Work in the Inspection Department is of a semi-white collar variety. Pay may be either on a salary or hourly basis, and opportunities for



Courtesy Astatic Corp.

This technician is calibrating a microphone in the sound room at the Astatic Corporation Factory.

advancement are generally good. Opportunities for learning are restricted only by the equipment manufactured at the plant at which the inspector works.

Engineering

Probably the most desirable jobs offered by industry today are in the engineering department. This department is responsible for the development and research on new products, the final testing of units being produced, the general planning of new units to be produced, and the methods used to produce them. The most attractive opportunities in this department are probably in the research and development laboratory. There is an ever increasing demand for laboratory technicians to work on the development of new products. Also employed in the lab, there may be persons who would fall into the assembler and wiremen categories. Under the engineering department, many companies maintain a field service organization. Because of the increasing complexity of many electronic devices it is essential that the manufacturer supply the qualified technicians to maintain these devices after they have been sent to the consumer. In some plants the field service man has the status of a technician, while in others he is considered an engineer.

The Laboratory Technician. The laboratory technician will generally work with one or more engineers. He must have a thorough knowledge of electronic theory and also be an expert wireman. A variety of other talents may also be required of him. He may frequently be called upon to do design work when he needs equipment for a particular application. In small organizations he is frequently a jack of all trades. He may be called upon to be a wireman, a technician, an engineer, and a draftsman. He will find that although his job is demanding his work is very interesting and profitable. An engineer may give

the technician a very rough schematic of a piece of equipment, tell him what it is supposed to do, and tell him to build it and see if it will work. In this case much of the design of the equipment is left up to the technician. Also a large amount of testing is his responsibility plus all of the construction. Because of this interesting variation in the technician's work, to many people it is more attractive than that of the engineer for whom he works. The technician's pay is usually good, although slightly less than that of the engineer. He may be paid either on a salary basis or an hourly wage. Frequently, if he is employed on an hourly basis, he will make more money than some of the engineers, because he will receive more pay for the over-time that he works. Good assemblers and wiremen who work in the laboratory are frequently promoted to the position of laboratory technician. The opportunities for profitable experience in the laboratory are again limited only by the variety of the equipment being designed and developed there.

Field Service. To be a field service man one must become so thoroughly familiar with the equipment manufactured at the plant that he can rapidly trouble-shoot that equipment and repair it. He is apt to be one of the best paid men in the plant, but his job does involve some inconvenience. He must be free to travel wherever he is sent to service the equipment. And he frequently must travel on very short notice. But to compensate for this inconvenience, in addition to a generous salary, his transportation is paid and he usually receives a per diem allowance for living expenses when he is away from the plant. In some cases he may be required to service military equipment overseas.

In addition to the technical requirements for his job he must also act as a public relations representative. He is the representative of his company in the field, and must frequently entertain customers and in general encourage a feeling of good will toward the company he represents.

The educational opportunities in field service are of course limited by the variety of equipment produced by the company, but in many instances the equipment is so varied and complicated that a field serviceman will eventually gain some knowledge of practically every phase of electronics.

The Engineer. A few years ago it would have been impossible for a man without a college degree in electrical engineering to obtain a position as an engineer in a factory engaged in the design and development of electronic equipment, but today there is a dire shortage of graduate engineers and many factories are finding it profitable to promote their best wiremen and technicians to engineering positions. Some even offer them training at the company's expense.

Also in many factories technical school graduates are filling engineering or semi-engineering positions. The jobs the technician-engineer is required to work on are too many and too varied to enumerate here. He may work in planning, production engineering, or research and development. No matter what phase of the factory's work he is employed in, he will have most interesting work and be well paid for his efforts. In these days of expanding industry his opportunities for advancement are almost unlimited.

An employee is by no means held rigidly in any one of the departments mentioned here. There are many opportunities for a man of worth to advance from one department to another as positions are created or vacated. The rapid expansion of the electronics and other allied industries makes possible rapid advancement even for the man starting in the assembly or stock-clerk categories. Industry offers jobs for people with such a wide difference of degree of skill and knowledge that there is opportunity for everyone from the novice, who is just beginning to learn about electronics, to the experienced technician, who has a thorough knowledge of electronics and has developed a high degree of skill. A man who has just begun to study electronics may find it possible to get a foot-hold in the electronics industry and gain valuable experience along with his studies, while being paid a reasonable salary for his efforts. On the other hand a man who is an experienced technician may find that industry offers him a good job with excellent pay, and excellent opportunities for advancement.

Every day industry is opening new doors of opportunity to the man who has experience and training in electronics. It might be well when you see these open doors to pause and take a look inside, to see what possibilities the future holds for you.

— n r i —

Our Cover Photo

A new single-tube TV camera (left) to be made by General Electric promises a simple and economical method for colorcasting under the NTSC color system, according to the company. The new camera is contrasted with a more complicated three-tube camera (right).

G. E. will build the new color camera and associated equipment for TV stations under a patent license agreement with the Columbia Broadcasting System.

Picture was made in the color TV studio at the G. E. Electronics Laboratory in Syracuse, N. Y., where the company operates an experimental color TV transmitter and is concentrating its color development.

Page Ten



HEADQUARTERS 3D INFANTRY DIVISION CITATION BRONZE STAR MEDAL (MERITORIOUS)

WARRANT OFFICER JUNIOR GRADE STANLEY K. PHELPS, W2149677, 3d Signal Company, 2d Infantry Division, United States Army, is cited for meritorious service in connection with military operations against an armed enemy in Korea during the period 12 June, 1952 to 15 April, 1953. Warrant Officer Phelps, serving as Repair and Maintenance Officer, performed his duties in a superior manner. His untiring meticulous attention to detail, resourcefulness and technical proficiency greatly improved repair procedures within his company. He frequently and systematically inspected communication equipment throughout the command and its combat elements, and initiated an extensive preventive maintenance program which promoted the doctrines of cost consciousness and contributed materially to the efficient communication network of the Division. Warrant Officer Phelps' outstanding skill, initiative and sincere devotion to duty reflect great credit upon himself and the military service. Entered the Federal service from Michigan.

NRI is very proud to publish the above citation which has been awarded to Stanley K. Phelps, an NRI student, whose home address is 1025 Hamilton St., Jackson, Michigan. Our most sincere congratulations to Warrant Officer Phelps for his outstanding service to our country.

Servicing the 40-MC I-F Strip

Quoted from a letter by R. W. Felber, Service Manager, Stewart-Warner Electric.

The printed circuit I.F. strip currently used on Stewart-Warner VHF-UHF receivers can generally be serviced in the field in much the same manner as conventional chassis wiring. All resistors and condensers can be replaced provided that care is exercised. Do not apply excessive heat to any solder connection, since this could cause the printed circuit to lift from the board. Remove the components from their position gently to prevent damage to the board or the printed circuit. When replacing a condenser or resistor, be sure that the component leads are clean and properly dressed.

We have encountered several cases of broken solder connections at the point where the printed circuit and the I.F. transformers or traps are joined. This generally comes about through flexing of the entire strip when tubes are replaced in the sockets. Take care not to push these tubes too hard into their sockets.

If you should have occasion to service a receiver which appears to have a dead I.F. strip, closely inspect these solder connections. Open solder joints can be readily repaired by re-heating them with a small iron. Again, care should be exercised so as to prevent the application of excessive heat.

If you actually encounter a situation where the I.F. transformer or trap winding is open, the entire strip will have to be returned for replacement. These units cannot be successfully repaired in the field.

Exercise care in the removal of these strips since we will be unable to undertake adjustment of units that are damaged or show signs of abuse.

— n r i —

NRI Man Appointed Manager of New Wholesale Radio-TV Parts Outlet

Congratulations to Gerald Rehbein, 302 Grandview Parkway, Traverse City, Michigan, who has been appointed manager of the new Grand Traverse Branch of BELL-LOURIM ELECTRONICS, INC. Until his recent promotion, Jerry Rehbein had been working for this organization as a salesman, out of their Muskegon store. A good man and a well-deserved promotion! We're proud to send best wishes for continued success.

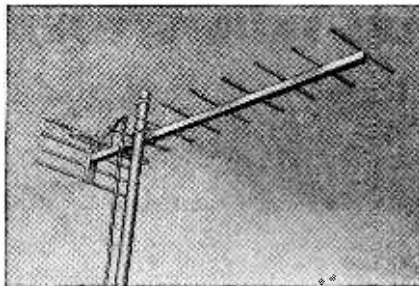

Taco UHF Yagi Incorporates Unique Assembly

A new concept in UHF antenna design is announced by Technical Appliance Corporation, Sherburne, N. Y., manufacturers of Taco antennas and accessories. Incorporating welding techniques used in production of antennas for the military and aviation industry, Taco's UHF Yagis have a Rigi-Channel frame to which aluminum driven and parasitic elements are welded—a new development in television antenna construction. This assembly method provides a perfect union between all elements driven and parasitic, thereby assuring FIRST DAY performance throughout the life of the installation.

In addition to outstanding mechanical design, the antenna utilizes the Taco Grid reflector. This grid assembly is similar to the screen-grid assembly used in the popular Taco UHF antennas to provide the greatest possible front-to-back ratio. The use of this grid results in a sharper picture and eliminates many performance problems prevalent with single rod reflectors. The grid reflector, in addition to improving the shielding from the rear, is combined with eight directors to build up the signal for highest signal-to-noise ratio.

Available in single, two and four stack models, shipped complete with phasing bars.

— n r i —

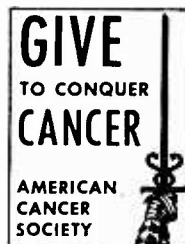

ELECTRONIC TUBE IS BRAIN OF AIRCRAFT

Reprinted through the Courtesy of
The Evening Star,
Washington, D. C.

In 1903 the Wright brothers put together some baling wire, cloth, shellac and a motor. Some fifty years ago their craft climbed into the air for 12 to 15 seconds and flew a full 120 feet—man's first powered flight and the birth of the airplane.

But in 1907 Lee De Forest, the famous inventor, put another kind of wire inside a vacuum tube. Science was given a new world of electronics to explore. Without this discovery today's complicated airplane would not be possible.

In this 50th year of powered flight an electronic tube is practically invisible compared with a 70,000-pound plane. But these tubes, many no bigger than a thumbnail, are the brains which actuate the airplane.

In a modern aircraft these tubes may number into hundreds, or thousands. The life of a pilot depends on them as he sweeps through the sky at a speed of more than 600 miles an hour.

Look to Outer Space

The tubes not only make flying safer but are pointing the way to scientists in their efforts to conquer space itself. But the transition from the "fly-by-the-seat-of-your-pants" era to today's "instrument landing" was not accomplished overnight.

When weather or darkness closed in, the pilots of the World War I era and the early 1920's frequently landed in farmers' fields. They needed more information than their senses could give them if they were to stay in the air after dark-

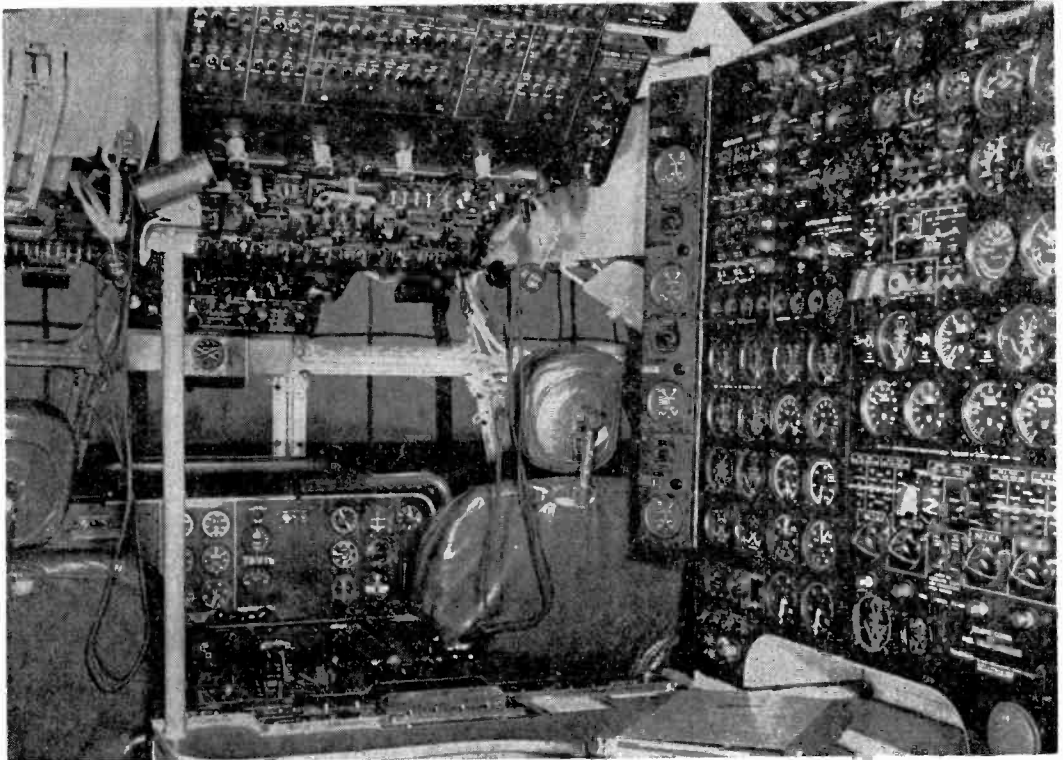

TODAY'S FLYERS FACE THIS—A flying electronics lab is necessary to fly today's airplane. This is a Pan American World Airways Boeing Stratocruiser's instrument panel.

ness or when the ground was obscured by clouds. They had to know if they were flying upside down or about to fly into the ground.

Little by little, the engineers turned out airspeed indicators, directional compasses, sensitive altimeters, bank-and-turn indicators, and a device which showed the rate of climb or descent of the airplane.

Guided by New Compass

The most striking demonstration of the new science of instrument flight came in May, 1927, before electronics entered the picture, when Charles A. Lindbergh flew his little Spirit of St. Louis alone non-stop across the Atlantic Ocean.

The dozen basic instruments in Col. Lindbergh's single-engined Ryan monoplane included a new-type precision compass designed especially for him by the Pioneer Instrument Co. This early company was one of the firms which, two years later, formed the Bendix Aviation Corp. Lindbergh's feat of long-range navigation was due in large part to this new compass and the plane's other instruments.

After that, radio in relation to flying was developed, and with it, electronics and its capability for "blind flight." Developed in the 1930's, the radio compass quickly became a basic device in guiding pilots. Today it gives the line of direction from the plane to any radio station. It led to development by the Federal Government of a network of airway radio beacons.

The plane and the electronic tube were linked even more tightly by the fast scientific developments of World War II. The laboratories produced the first all-electronic automatic pilot. As multi-engined planes were built by the thousands, all had their "little black boxes," as the airborne electronic gear became known. It was indispensable to bombing, communication, navigation and in coordinating multi-engined power.

Ordinary "radio tubes" just like those in a home radio set were the first vacuum tubes widely used in aviation. With limited electrical ability, they often failed in their tasks. An engineer pointed out the fallacy of entrusting a \$50,000 automatic pilot to a 50-cent tube. Early efforts to strengthen them fell far short of required performance standards.

Today's Tubes Rugged

Today's tubes really have to be tough. For instance, if 30 B-36H intercontinental bombers go on a standard mission, the tubes must operate



YESTERDAY'S PILOT HAD A SIMPLER TASK—Airplane pilots in 1918 flew with this instrument panel and by the seat of their pants.

for a total of 1.5 million hours, which, the Air Force says, is like running an average home radio set for 30 straight years. But the Air Force adds, considering bomber conditions, this same home radio also would have to be in a 200-degree oven and dropped on the floor every 10 minutes to simulate what today's tube is up against. No ordinary radio tube could stand it.

A number of special-purpose tubes to meet the needs of the new electronic world were developed by Bendix Aviation in 1946. To make sure they would operate under the most severe aviation usage, they were given some rugged tests. They were put in cold chambers of 65 degrees, below zero, in compartments generating 200 degrees of heat, and were given landing impact "shocks" every 10 seconds for 200 hours. These tubes, before they go into a military airplane, have a minimum life expectancy of 3,500 hours.

Jet fuel may be 65 degrees below zero but it still has to burn. It's like trying to light a match in a hurricane when they start the "fire" in the blast of a jet engine's air compressor, but electronics does it. A 24-volt power supply is transformed by electronics into a super spark of about 15,000 volts that ignites the fuel at the jet's plugs.

Even though jet fuel is gulped up in bucketfuls by multi-engined planes like the eight-jet Boeing XB-52 Stratofortress bomber, the little tubes keep track of the expenditure of the fuel. By "metering" it, they give the jets just the right quantities for top performance at any altitude.

— n r i —

People who straddle the fence never do any ploughing.

— n r i —

A road hog usually gets butchered.

—George E. Mayo.

How to Build an Inter-Com

By JOHN G. DODGSON
NRI Consultant

INTER-COMMUNICATIONS systems provide a convenient means of communication between two (or more) rooms in the home, office, or short distances out of doors—a sort of “private telephone.”

Although it is advisable for a serviceman to use commercial type inter-coms for professional installations, he may wish to build one for his own use. An inter-com can be very handy in TV antenna installations to provide “roof-to-receiver” communication or it can be used between the counter and bench in a service shop.

Besides the familiar inter-office use where they provide efficient and inexpensive service, inter-coms can be employed in various ways in the home.

tion is comprised of a loudspeaker only. Of course, a two-conductor transmission line is needed between these stations.

Fig. 1 is the master station of the inter-com. It has a basic two stage audio amplifier with loudspeaker, input transformer, and push-to-talk switch. The power supply is omitted, in Fig. 1, to avoid complicating the diagram. It is shown in Figure 2.

The switch in the diagram is shown in the “talk” position. When it is turned to the “listen” position and the loudspeaker at the remote station is spoken into, the resultant voltage appears across the primary winding of the input transformer T_1 and is transferred to the secondary winding by transformer action. This causes a

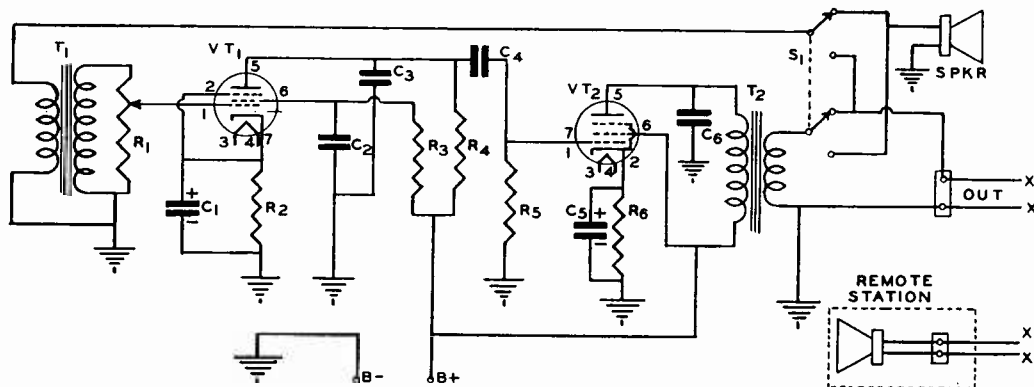

Fig. 1

Probably their most familiar use in the home is to furnish a convenient means of communication between the work shop, garage, or “ham shack” and the kitchen or some other central point of the home. Another application is to place a remote station outside the front door and to have the master station at some central location in the home. Inter-coms can also be used advantageously as “Electronic Nurses” by placing a remote station over the baby crib and the master station in the main bedroom.

A wired inter-communication system is a comparatively simple device. It consists of one master station and one remote station. The master station contains a loudspeaker (which is also used as a microphone), and an audio amplifier, with a special switching system. The remote sta-

tion is comprised of a loudspeaker only. Of course, a two-conductor transmission line is needed between these stations.

Fig. 1 is the master station of the inter-com. It has a basic two stage audio amplifier with loudspeaker, input transformer, and push-to-talk switch. The power supply is omitted, in Fig. 1, to avoid complicating the diagram. It is shown in Figure 2.

The switch in the diagram is shown in the “talk” position. When it is turned to the “listen” position and the loudspeaker at the remote station is spoken into, the resultant voltage appears across the primary winding of the input transformer T_1 and is transferred to the secondary winding by transformer action. This causes a

The 1000 ohm resistor R_2 provides the bias for the first audio stage. This cathode resistor is

by-passed by electrolytic condenser C_1 . The 300 ohm resistor R_6 provides bias for the output stage and is by-passed by electrolytic condenser C_5 . The .1 mfd. condenser C_2 is the screen by-pass condenser while the screen voltage is fed through the 470,000 ohm resistor R_3 . Plate by-pass condensers C_3 and C_6 are used to by-pass high audio frequencies to ground, thereby minimizing the possibility of "squealing."

The power supply is the common ac type illustrated in Fig. 2. The power supply and voltage amplifier can be easily built on a 7" x 7" x 2" chassis. The input transformer T_1 should be kept as far away from the power transformer as possible. A good method is to place them in opposite corners of the chassis. Aside from this, there are no other critical parts placement or wiring. The top-chassis layout used is shown in Figure 4.

The power supply should be assembled first. Before power is applied, it is advisable to check

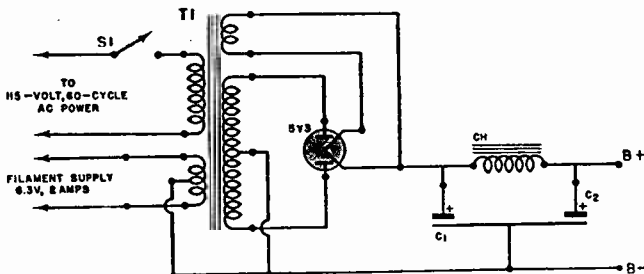

Fig. 2

Table II
AC Power Supply Parts List

- T_1 —Power transformer, 350—350 40 MA:
6.3V 3 amp.; 5V 2 amp.
Merit P-2965 or Stancor PM8407
- C_1, C_2 —10-10 mfd. upright dual elect. 450V
- CH—10 henry, 40 MA. Filter choke
- S_1 —Single-pole, single-throw, slide or toggle switch
- 5Y3 Fullwave Rectifier Tube
- One octal tube socket

The load, of course, will drop the voltage to between 250 and 350 volts—the actual dc output voltage is not critical. Also check the ac ripple voltage between B+ and B—. If your ac voltmeter does not have a dc blocking condenser in series with the input, use the output jacks or wrap one lead of a condenser (any value between .01-mfd. and .05-mfd., rated at 600 volts) around one of the test leads and use the other condenser lead as a probe. This is important because otherwise the high dc voltage at B+ would cause a false ac ripple reading. If an ac ripple

Table I
Inter-Com Parts List

- R_1 —1 meg. Potentiometer
- R_2 —1K, $\frac{1}{2}$ W
- R_3 —470K, $\frac{1}{2}$ W
- R_4 —220K, $\frac{1}{2}$ W
- R_5 —470K, $\frac{1}{2}$ W
- R_6 —300, 1 Watt
- C_1, C_5 —10 mfd., 25V, Elect.
- C_2 —.1 mfd., 400V
- C_3, C_6 —.005 mfd., 400V
- C_4 —.01 mfd., 400V
- T_1 —Input transformer, 4 ohms to grid
Stancor A-4744 or Merit A-2923
- T_2 —Output transformer, 7000 ohms to 4 ohm
40 ma. Merit A-3020
- SPKR—4 or 5 inch PM Loudspeakers
- VT_1 —6AU6 Tube
- VT_2 —6AQ5 Tube
- S_1 —Double-pole, double-throw switch-slide, spring action, or toggle
- Two 7-pin miniature tube sockets and miscellaneous hardware

from B+ to B— with an ohmmeter to be sure that there are no shorts in the supply due to incorrect assembly or to defective parts. A defective part or an unwanted ground could easily ruin the power transformer. If a reading below 100,000 ohms is obtained, C_1 and C_2 should be individually checked for leakage on an ohmmeter, with a condenser bridge or by substitution. If this check is good (or after any existing trouble is cleared up) apply power and check the output voltage between B+ and chassis. Any value between 300 and 400 volts is satisfactory.

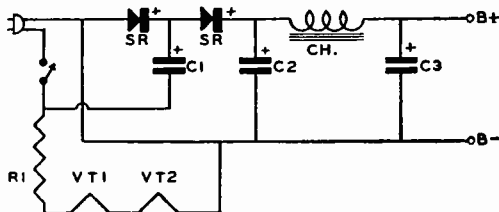

Fig. 3

Table III
Voltage Doubler Parts List

- SR—65 MA. selenium rectifier
- C_1 —20 mfd. 150V tubular Electrolytic
- C_2, C_3 —20-20 mfd. 450V dual upright or Tubular
- R_1 —390 ohm line-cord resistor or 360 to 390 ohm wire-wound, 20 watt resistor
- CH—10 henry, 40 ma. filter choke
- S_1 —single pole-single throw switch

voltage above .5 volts is obtained, check the electrolytic condensers for leakage, loss in capacity or high power factor. Also be sure the choke coil is not shorted and has the recommended value.

After the power supply is assembled and checked, the amplifier should be built. Before applying power, check with an ohmmeter to be sure the plate and screen by-pass condensers are good and that there are no grounds or shorts. Finally, apply power to the amplifier and check visually for any signs of trouble such as overheating resistors or wax melting from the power transformer. If any of these conditions are encountered, they can be cleared up by simple "trouble shooting" techniques.

The next step is to assemble the remote station and connect it to the master station. An ordinary wall loudspeaker baffle obtained from any wholesaler may be used to house the remote station.

TV twin lead or any other two-conductor wire can be used to inter-connect the units (the impedance of the line is unimportant). If the transmission line is to be run for long distances or out-of-doors, shielded wire should be used. Coax cable employed for TV lead-ins would be satisfactory for this purpose.

The last step is to check the system before it is permanently installed. Help is needed for this. One person should talk while the other listens and vice-versa. Do not place the units close together when checking or acoustical feedback will cause "howling." It is best to place them in different rooms. If squealing is encountered when the volume control is turned to maximum output, then back it up to the point where the squealing ceases. Measure the resistance between the center tap of the volume control and the ungrounded side of R_1 and insert a resistor of that value between the ungrounded side of R_1 and the input transformer. Careful dressing of the leads also will minimize the possibility of squealing or oscillation.

A transformer type power supply need not be used. A voltage-doubler system will work satisfactorily. Although the over-all gain of the system is slightly decreased, it is sufficient for most applications. If the Inter-Com is to be used for appreciably long distances, the power transformer type should be built. The author suggests building the power transformer-type. Its superior features are worth the extra cost (which is only about \$2).

The selenium rectifier voltage doubler in Fig. 3 is of the half-wave type. Although a full-wave voltage doubler gives better regulation and a higher output voltage, there is a voltage difference almost equal to the line voltage between the filaments and cathodes. This increases the possibility of heater-to-cathode leakage which is undesirable.

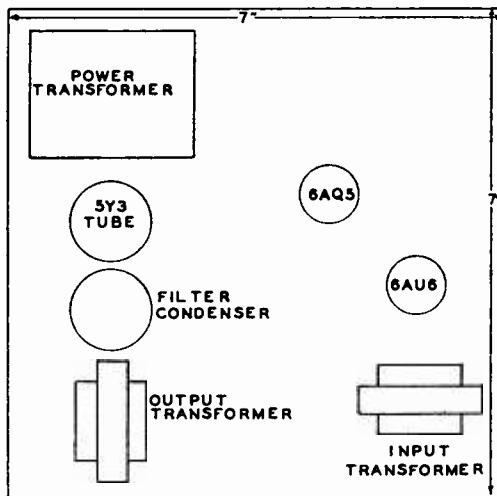

Fig. 4

In building the voltage doubler system, it is important not to connect B— to chassis. If B— were connected to the "hot" side of the power line, it would be 110 to 120 volts off ground and a dangerous shock would be obtained from touching the chassis. Instead of using the chassis as B—, a "ground bus" which is insulated from the chassis is used and all ground returns are made to it.

Since the filament voltage dropping resistor R_1 dissipates considerable power, it becomes quite hot. This could cause trouble in the other components, especially the selenium rectifiers, if placed near them. One solution is to use a linecord resistor. If an ordinary resistor is used, mount it on top of the chassis.

Changing to a voltage doubler power supply necessitates changing the tubes. A 12AU6 tube is substituted for the 6AU6 tube while a 50B5 tube is used in place of a 6AQ5 tube. There is only one circuit change. In Fig. 2 the socket pin numbers for the new tubes are changed. Of course, a smaller chassis can be used.

If desired, a tone control can be added to either type of Inter-Com. One of the simplest methods is to connect a .03 mfd. condenser from the plate of the output tube to one side of a 250,000 ohm or 500,000 ohm volume control. The center tap of the volume control should be connected to chassis.

A pilot lamp can also be added to the power transformer-type inter-com. Connect it to the 6.3 volt winding of the power transformer. A miniature screw base No. 40 or a bayonet base No. 47 can be used.

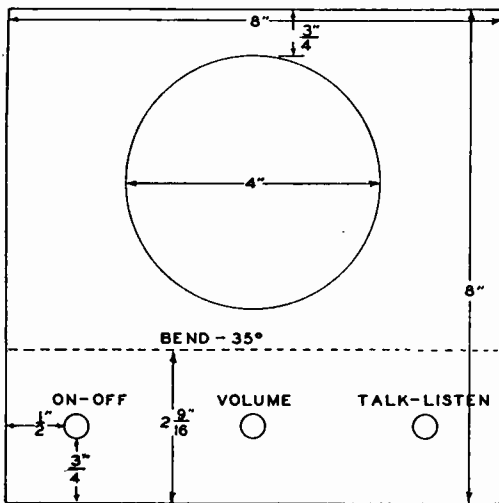

Fig. 5

A wooden cabinet is suitable for housing the master station. However, it should be made a little larger (about 2 inches) than the over-all dimension because the output tube dissipates quite a bit of heat which could damage the cabinet.

If a back panel is used on the cabinet, three or four holes between 1 and 2 inches in diameter should be drilled in it so that the heat can escape. Should you prefer a metal type cabinet, one can be obtained from any wholesaler or radio supply house. The author used the cabinet designed to house the NRI Electronic Multitester. A sloping panel was cut from an aluminum sheet. (See Figure 5.)

The Multitester cabinet can be purchased from the NRI Supply Division for \$3.75. All other components can be obtained at your radio wholesaler. They are not available from NRI.

————— n r i —————

If you are wearing out the seat of your pants before the sole of your shoes, you are making too many contacts in the wrong places.

————— n r i —————

"I enjoyed the Fortieth Anniversary Issue of NATIONAL RADIO-TV NEWS very much. It is nice to know the story of the NRI and other things that were in that issue.

I am proud to be a part of such a fine school. Will do my part to help keep the good name of NRI."

KENNETH R. BRAIK
1384 N.W. 29th Terrace
Miami 42, Fla.

Thanks For Your Greetings

For the many cards and letters sent to us by our students and graduates during the Holiday Season and now, to congratulate us on our fortieth anniversary, we want to give our sincere thanks.

These expressions of good will and loyalty to NRI are greatly appreciated.

J. E. SMITH

————— n r i —————

"May I extend to you my congratulations on the fortieth anniversary of the founding of the National Radio Institute. The story of the beginning and the growth of the school under your guidance is an inspiration to any ambitious person in this country and is an example of the opportunities open to everyone under our democratic form of government.

"My wishes to you for continued health, happiness and success."

GEORGE M. KRAUSE
Krause Radio & Television
321 Walnut Street
Roselle, N. J.

————— n r i —————

"I want to say Happy Birthday to NRI and NRI Alumni Association. And as a student of NRI and a member of NRI Alumni Association, am very proud of both. I hope they have many more Happy Birthdays."

JOSEPH H. RUFF, JR.
2407 Middle Ave.
Norfolk 4, Va.

————— n r i —————

"I wish to congratulate the National Radio Institute on its fortieth anniversary. I have watched the school grow for the past twenty-one years, and I believe the school owes a great deal to the National Radio-TV News for its continued growth.

"The 'News' is a great help to all of us graduates and also to the students.

"Your guidance has been an inspiration to many young men. I personally want to thank you for such an informing publication. I also want to thank the many others who have also helped to make our News so good."

ALFRED J. GIRARD
123 Clinton St.
Shrewsbury, Mass.

Color TV Picture Tubes

Rank Among Modern Miracles

SEVERAL companies have begun commercial manufacturing of color TV picture tubes. The process is, at present, very intricate and *very costly*. List price of the type 15GP22 is now about \$265. Undoubtedly this price will be reduced as production techniques improve.

Manufacturers are initially concentrating commercial production on the fifteen-inch round-glass tube, using three electron guns and shadow mask, or aperture plate, for color selection. The actual picture size is approximately twelve inches on the diagonal across the screen, or, about the size of present twelve-inch sets. Larger screen tubes are still in the experimental stage.

The accompanying photographs, furnished by RCA and GE, illustrate some of the production problems being solved by the industry today.

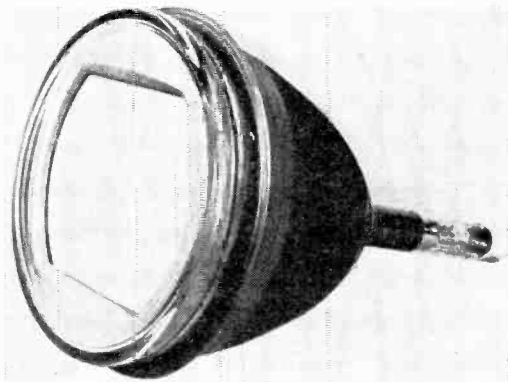

Courtesy RCA

First commercial RCA tricolor picture tube is this 15-inch type which produces both color and black-and-white pictures. Tube is built around tri-barrel electron gun; a shadow mask through which electron streams are projected; and a viewing screen. The tube utilizes electrostatic focusing and magnetic deflection.

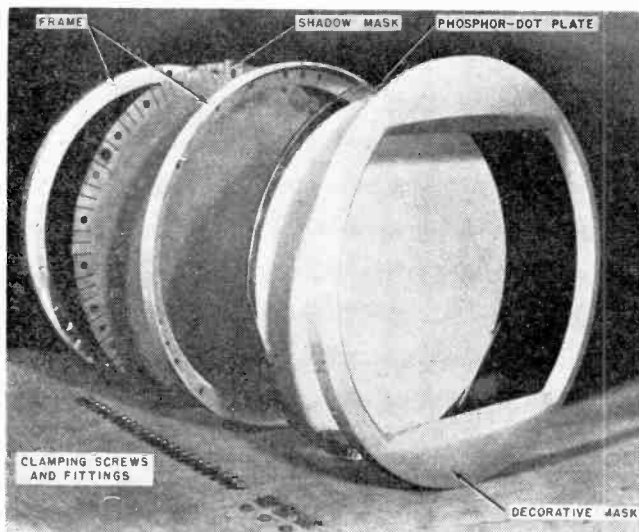

Courtesy RCA

Exploded view of RCA tricolor tube's viewing-screen assembly. The phosphor-dot plate, which serves as viewing screen, contains approximately 600,000 dots of phosphors. Dots are activated by electron beams, which are emitted by tube's three electron guns and projected through the nearly 200,000 tiny holes in the shadow mask. Each hole in the shadow mask is lined up with a triangular cluster of dots on the viewing screen—a red, a green, and a blue dot to each cluster. Each electron beam, with fantastic speed, passes through each of the shadow mask holes and strikes its proper dot in each triangular group.

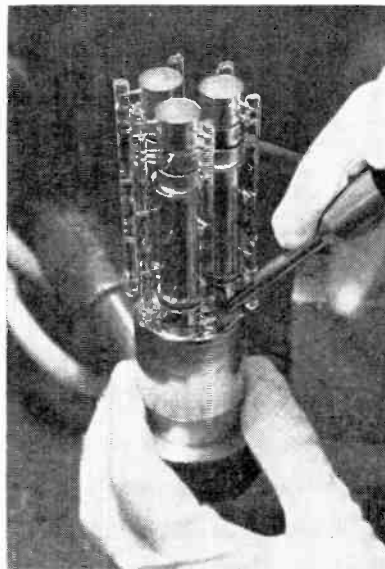

Courtesy General Electric

Three electron guns, arranged in circle 120 degrees apart, are welded together for a 15-inch color picture tube at the G-E color picture tube development laboratory. Each gun emits electron beams to excite one of the three primary phosphor colors (red, blue, green) on the picture screen.

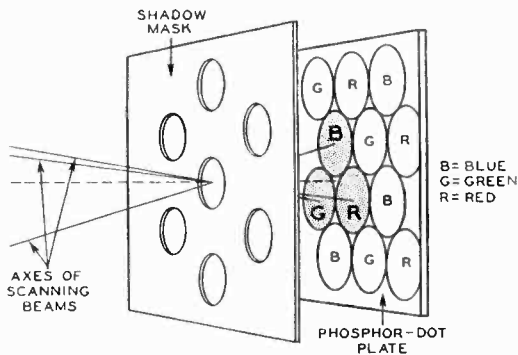

Courtesy RCA

Scanning action of RCA tricolor picture tube is so rapid that each of nearly 600,000 phosphor dots on tube's viewing screen is activated 30 times per second. As diagrammed above, electron streams from tube's three electron guns are projected through each of nearly 200,000 tiny holes in shadow mask. Beam from "blue" gun strikes proper "blue" phosphor dot in triangular cluster of red, green, and blue dots lined up with given hole in shadow mask. Simultaneously, electron beams from "red" and "green" guns strike and "light up" their respective dots in same triangular cluster.



Courtesy General Electric

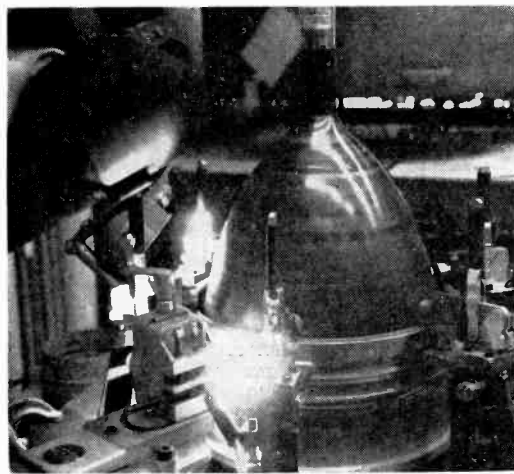

Courtesy General Electric

Glass faceplate or cap of color picture tube is carefully welded to the bulb cone at this station in G-E color picture tube development laboratory at Electronics Park, Syracuse, N. Y. Metal flanges on the faceplate and the bulb cone are joined to cover "color sandwich" which includes the shadow mask and phosphor plate. The metal surfaces of both flanges are machined under high pressure at this station before welding.

Alignment of color picture tube shadow mask or aperture plate and the phosphor screen is a precision operation at G-E color picture tube development laboratory. Each of the metal mask's 200,000 tiny holes must exactly match its corresponding cluster of three dots (red, blue, green) on the screen (under operator's left hand). At this "lighthouse" station, a concentrated arc light below platform simulates electron beam, to cast shadow of the aperture plate on the phosphor screen above it. Ultraviolet light in operator's right hand excites phosphor dots so aperture plate and phosphor plate can be aligned visually over the entire plate. Knob control at right on platform is one of three (others are obscured by operator's right hand and the equipment) which control vertical and horizontal alignment of the aperture plate and phosphor screen.

— n r i —

"All good things which exist are the fruits of originality."—John Stuart Mill.

— n r i —

Trouble is only opportunity in work clothes!

Page Nineteen

ION TRAP MAGNETS

By G. E. Fogg, Field Engineer
Sylvania Corporation,
Television Picture Tube Division

Reprinted through the courtesy of SYLVANIA
NEWS

ONE of the very important factors in servicing TV sets in use of the correct ion trap magnet and its proper adjustment.

The mere presence of raster on the tube is no indication that the magnet has been properly adjusted. Operation of the set for even a few seconds with the magnet incorrectly adjusted may permanently damage the picture tube. Hence, it is of the utmost importance that the magnet be correctly adjusted immediately.

There are two general classes of ion trap magnets — double and single field types (See Figure 1). Each type of magnet is used with a specific electron gun structure and in most instances, a particular tube type.

The physical construction of ion trap magnets varies considerably. The double field type always has two pairs of pole pieces or two ring magnets; the single field type has only one magnet.

The proper field strength of an ion trap magnet is dependent on several factors; the most important being the gun design and the high voltage (A_2 Voltage) on the picture tube.

In the case of a double field ion trap magnet, a field strength of 35 gauss in the main field will usually be satisfactory. For tube types requiring single field magnets, two strengths — 35 gauss and 45 gauss, will be adequate for practically all applications. In general, the higher operating voltages will require stronger magnets.

A good method of adjusting an ion trap magnet is as follows: Locate the ion trap magnet approximately at the slant cut or anode bend, which is visible through the neck (See Figure 2). In the case of double magnet ion traps, place the smaller (weaker) magnet toward the tube face. With the brightness and contrast controls turned to minimum, turn the set on and allow it to warm up for about a minute. Turn the con-



Figure 1. A Selection of Common Ion Traps, a Double Magnet Type in the Upper Left.

trast and brightness controls about half way on. Move the ion trap magnet back and forth along the neck and around it until the picture is brightest. Now, readjust the contrast and brightness controls for proper contrast and brightness level used by the customer. Readjust the ion trap magnet position for maximum brightness. The ion trap must never be used to center the picture on the tube.

In the case of the split-ring doublefield ion trap magnet, some rotational adjustment of the weaker magnet with respect to the stronger magnet may be required for pattern centering. After final adjustment, the ion trap magnet should be within $\frac{3}{4}$ " of the slant cut between second grid and anode or the bend in anode on guns having a

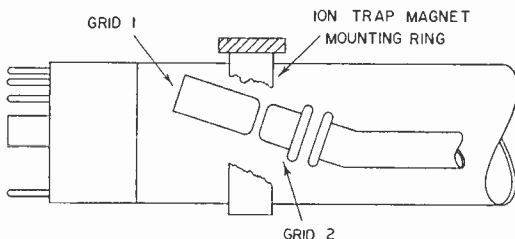

Figure 2. Approximate Placement of Ion Trap in Relation to Electron Gun.

bent anode structure. If the magnet is beyond this range, a magnet of different field strength should be used.

has been made, the magnet is too close to, or on the tube base, a magnet of lower field strength should be used. The reverse is true if the ion trap magnet is too close to the face end of the tube.

If, after the correct set up of the ion trap magnet

TABLE I

ION TRAP MAGNET TYPE

S-Single	D-Double	S-Single	D-Double	S-Single	D-Double
Tube Type	Trap	Tube Type	Trap	Tube Type	Trap
7DP4	D	16KP4/A	S	19DP4/A	S
7QP4	S	16LP4/A	D	19EP4	D
		16MP4/A	D	19FP4	D
8AP4	S	16QP4	D	19GP4	S
8AP4A	S	16RP4	S	19JP4	S
		16SP4	D	19QP4	S
10BP4/A	D	16TP4	S		
10MP4/A	D	16UP4	D	20CP4/A	S
		16VP4	S	20DP4/A	S
12LP4/A	D	16WP4/A	D	20FP4	S
12QP4/	S	16XP4	D	20GP4	S
12RP4/A	S	16YP4	S	20HP4	S
12TP4	D	16ZP4	D	20JP4	S
12UP4/A/B	D	16ABP4	S	20LP4	S
12VP4/A	D	16ACP4	S	20MP4	S
12WP4	S	16AEP4	S		
12YP4	S			21AP4	S
		17AP4	S	21DP4	S
14BP4/A	S	17BP4/A/B/C	S	21EP4/A	S
14CP4	S	17CP4/A	S	21FP4/A	S
14DP4	D	17FP4	S	21KP4	S
14EP4	S	17GP4	S	21MP4	S
14GP4	S	17HP4	S	21WP4	S
14HP4	S	17JP4	S		
		17KP4	S	22AP4/A	S
15CP4	D	17LP4	S		
15DP4	S	17QP4	S	24AP4/A	S
		17RP4	S	24BP4	S
16AP4/A	D	17SP4	S		
16CP4	D	17TP4	S	27AP4	S
16DP4/A	D	17UP4	S	27EP4	S
16EP4/A/B	D	17VP4	S	27GP4	S
16FP4	S	17YP4	S	27LP4	S
16GP4/A/B	S				
16HP4/A	D	19AP4/A/B/C/D	S	30BP4	S
16JP4/A	D				

Technical Ramblings

By B. VAN SUTPHIN

NRI Consultant

Question: What's new on Color TV?

Under the joint sponsorship of RCA and a number of the Washington area wholesalers, a color clinic was held here in Washington a few weeks ago.

At this clinic, the technical aspects of color television were discussed, and a color TV receiver was demonstrated—though no color programs were on the air at the time. The attending serviceman learned how a color TV receiver operates, how it is different from a black-and-white receiver, and how to adjust a color TV receiver. In addition, a question-and-answer session was held.

The complete topic of color television is much too broad to discuss in this column, but I believe that a great deal of information can be quickly covered by using the "question and answer" method. The following questions are some of those asked at the color clinic.

Question: Exactly what do you mean when you say that the new color TV system is compatible?

Answer: This means that if a color TV program is transmitted, you will receive a black-and-white picture if you have a black-and-white receiver, or a color picture if you have a color receiver. This means that receivers sold in the past will not become obsolete when wide scale color broadcasts start.

Question: Will color TV receivers be more difficult to service than black-and-white sets?

Answer: Yes. Additional circuit knowledge will be required to handle color television service problems effectively.

Question: Will the black-and-white pictures be as good as those obtained on a black-and-white set?

Answer: Yes. Incidentally, no adjustment of the TV set is necessary when the station switches from color to black-and-white transmission.

Question: How does the tube produce color?

Answer: The RCA Tri-color kinescope contains three separate electron guns; the screen has three different phosphors. Electrons from each of the separate guns strike different phosphors on the tube face, and produce separate colors: red, blue or green. By mixing these three primary colors, all colors can be obtained. When black-and-white reception is desired, all three electron guns are excited at the same time, and the three primary colors combine to produce white. By varying the intensity of the white, varying shades from gray to black are produced.

Question: How does the set determine when it is getting a color signal and when it is getting a black-and-white signal?

Answer: The color television signal contains a special "color burst" at the end of each horizontal sync pulse; the black and white signal does not contain this color burst. Color TV receivers contain a stage called a "color killer" which operates only when the color burst is present. The stage is cut off when a black-and-white signal is received, and the color circuits therefore do not operate.

Question: Can the service man still diagnose most troubles by viewing a picture on the screen?

Answer: Yes. If the service man knows what circuits are used in the receiver, and knows what each circuit does, he can often isolate the trouble by looking at the picture.

Question: Is the color range of the picture limited so that only certain colors can be reproduced?

Answer: No. The range of colors available on the screen of a color TV receiver is wider than the range of colors available in printer's ink. That is, you can obtain more colors, and more hues than you can obtain on the pages of a magazine.

Question: Can the failure of certain circuits cause just one color to disappear from the picture?

Answer: Yes. Also, failure of certain circuits can

cause two colors to disappear from the picture thereby giving a picture that contains only a single color in various shades.

Question: How many controls are necessary on a color TV receiver?

Answer: Present day color Television receivers have only five controls on the front panel: Off-On, Volume, Brightness, Channel Selector, Fine Tuning, Chroma (color control). Including the non-operating controls, however, there are thirty-six controls on the RCA color television receiver used for demonstration purposes.

Question: Is it practical to convert present day TV receivers for color reception?

Answer: No. Approximately thirty extra tubes are required for the color circuit, and the bandwidth of the video stages must be 4.1 megacycles. Very few present day television receivers are capable of such bandwidths. In addition, the cost of building and installing the color circuits makes such conversions impractical.

Question: How is the extra color information "squeezed in" the present 6-megacycle television channels?

Answer: Tests indicate that "holes" exist in the regular television channel when a black-and-white signal is transmitted. By correct placement of the video carrier and the color sub-carrier, the two signals can exist together without interference.

Question: I have heard that special types of antennas are required for color reception. Is this true?

Answer: No. Almost all standard designs of broad band antennas, such as dipole and fan types, have more than adequate bandwidths if properly installed. *It is essential that the antenna have sufficient bandwidth.* If the response is too sharp, the color information might be reduced in amplitude sufficiently to cause improper coloring.

Question: Will ghosts affect the color television picture?

Answer: Yes. But as the lecturer at the color clinic stated, the ghosts will appear in color—much prettier than black and white ghosts! Also, he mentioned that snow in a color picture will appear in color and probably be called confetti.

Question: Will enough color TV receivers be produced in 1954 to satisfy the demand?

Answer: No. Comparatively few color TV sets will appear on the market in 1954. All of them will be expensive—four or five times as costly as black-and-white receivers. In addition, the

screens will be small, generally 15-inch size. It will be at least two or three years before the price of color television receivers comes down enough for the average man to purchase one.

Question: Will color TV ever completely replace black-and-white TV?

Answer: It is doubtful. The problems of transmitting color are more complex than the problems of transmitting black-and-white. Consequently, it will be many years before all television stations are equipped to transmit color. In addition, some people just don't like color. You probably know some people who do not watch technicolor movies—they prefer black-and-white. The same situation will exist in the case of color TV.

Question: How will color TV production affect the price of black-and-white sets?

Answer: As the engineers seek new ways to reduce the price of color TV sets, they will undoubtedly find new ways to decrease the price of black-and-white sets. This means that the competition of new color TV receivers will decrease the price of black-and-white sets and allow more persons to have television receivers. This is, of course, a great boom for the TV serviceman.

Question: Are all existing TV stations able to transmit color at the present time?

Answer: No. To transmit color satisfactorily, changes must be made in the modulator circuits of the television transmitter. In addition, the TV station must be able to receive a color signal. If the TV station is coupled to the network with the new co-axial cable or by microwave link, it can receive the color signal. Therefore, only changes in the station equipment are required to transmit color. If the particular TV station is coupled to the network through the older cable, it will not be able to receive the color signal, and consequently cannot retransmit it.

Question: What should I do to prepare myself for the coming of color television?

Answer: Learn all you can about black-and-white television. Doing this will allow you to enter the field of color television with a head start. The basic facts of the two systems are the same. That is, the same type of sweep circuits are used in both color and black and white sets. The video amplifiers are basically the same. Thus knowledge of black-and-white television will simplify the problems of learning color.

Question: What is the most useful piece of servicing equipment for use with color TV?

Answer: *Knowledge.* Without knowledge, all

other pieces of test equipment are useless because you, as a serviceman, must be able to interpret the indications shown by your test equipment. (The oscilloscope will be the most useful piece of physical test equipment.)

Question: What value of high voltage is used in color TV receivers?

Answer: At the present time, approximately 20,000 volts are used on the second-anode of the picture tube. In the future, slightly higher voltages may be necessary. Also, a different type of picture tube requiring three separate high voltage power supplies of different voltage ratings may be used later.

Question: Will tube failure still be the most prevalent service problem?

Answer: Yes. The color TV receiver has more tubes than the black-and-white set, and this increases the chance of tube failure.

Question: Will fringe area reception of color TV signals be possible?

Answer: Yes. However, narrow band antennas—such as the Yagi—will not be satisfactory. Also, untuned boosters will probably prove more satisfactory than tuned boosters.

Question: Will color signals broadcast on UHF?

Answer: Yes. The installation of a color TV receiver for UHF reception will be a little more difficult because the impedance match between the set and the lead-in is very important. A mismatch would probably cause considerable signal loss and possible color changes.

Question: Will larger color tubes be available?

Answer: Yes. RCA has just announced a new 19 inch color tube.

Question: Will I be called upon to service a color TV receiver this year?

Answer: It is very doubtful. Most of the color TV receivers used at the present time are serviced by the set manufacturer. It will probably be some time before you are called upon to service a commercial color Television receiver.

Question: How can I determine whether color is to be broadcast in my area?

Answer: Contact your local TV station. They will tell you whether they have the equipment necessary to transmit color, whether they can receive the color signal from the network, and whether they plan to carry color telecasts.

Question: How soon will color TV receivers be

available at prices that the average home owner can afford?

Answer: It will probably be two years before the average home owner can go to his local dealer and purchase a color TV receiver at a price he can afford.

Question: The color carrier is broadcast on a frequency of 3.58 mcs. above the video carrier. Will local ham transmitters operating on 80-meter band (3.5 to 4.0 mcs.) interfere with a color TV receiver?

Answer: Yes. If the signal from the ham transmitter enters the receiver circuits, it is certain to upset color synchronization. Thorough shielding of color TV receivers, however, will prevent anything but the strongest signal from entering the set. Thus, they will be relatively free of interference from stations operating in the 80 meter amateur band.

————— n r i —————

HAMS — Dr. D. C. Nettleton, W8BQQ, Piper Hotel, P. O. Box 21, Manton, Mich., is anxious to work other NRI students who are amateurs.

————— n r i —————

The man who puts \$10,000 additional capital into an established business is pretty certain of increased returns; and in the same way, the man who puts additional capital into his brains—information, well-directed thought and study of possibilities—will as surely—yes, more surely—get increased returns. There is no capital and no increase in capital safer than that.

—Marshall Field.

————— n r i —————

Mental wrecks usually occur on one track minds.

————— n r i —————

The reason some women don't count is that they haven't the figures.

————— n r i —————

About the time we think we have the bull by the tail it turns out to be a bum steer.

————— n r i —————



THE ORIGIN AND USE OF THE DECIBEL

By GEORGE P. KEARSE

Reprinted through courtesy of AMPHENOL Engineering News
Copyright 1953 by American Phenolic Corporation

Widespread contacts with numerous TV Service Engineers have revealed that many of these highly qualified and vitally important members of our family are greatly confused by the decibel values used to evaluate the performance data of antennas and transmission lines. Therefore, we believe that a short discussion of the use of the decibel as a measuring unit would help to clear up some of this confusion.

ORIGIN. The decibel is one tenth of a bel, named after Alexander Graham Bell, and was originally developed by telephone companies to measure power levels in communication circuits associated with the normal logarithmic response of the human ear. It has been "borrowed" by other branches of electronics and today it is almost universally used in any application where it is necessary to compare two power levels even when these levels are measured in different terms, such as voltage or current.

LOGICAL CHOICE FOR ANTENNA MEASUREMENTS. It is a natural choice, therefore, to select the decibel as a measuring unit when comparing the power sensitivity (signal pickup) of an antenna with that of a folded dipole where pickup differences must be stated in relative units independent of the power level at which the measurements are made.

PECULIARITIES OF THE DECIBEL SCALE. Decibel values, being logarithmic quantities, can often become confusing and misleading unless one has been using these units regularly. For example, values of 10 db or 20 db correspond to a power ratio of 10 to 1 and 100 to 1, respectively, and values of 30 db, 50 db, and 100 db, while being relatively small numbers themselves, represent tremendous changes in power levels. Less confusion will result if one will remember that a 2 to 1 (or 1 to 2) power ratio represents approximately a 3 db change and that a 10 to 1 (or 1 to 10) power ratio represents a 10 db change. Points in between these two values may be "guesstimated" within a few per cent without too much trouble. The following table showing power ratios as db values compared to percentage changes vividly illustrates the difference be-

tween the two. It is based on a 1 to 1 ratio, or 0 db, as representing a 100% level.

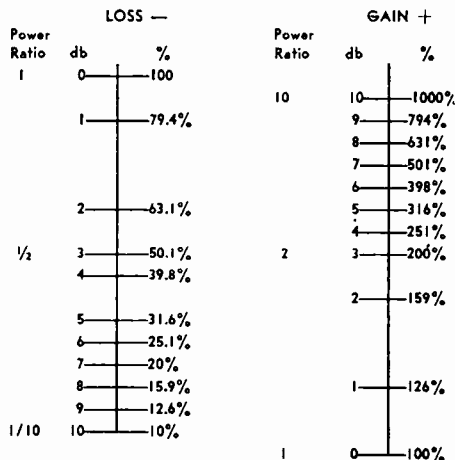

Examples of the Use of the Chart

1. An antenna with a gain of 3 db over a folded dipole would collect 200% or 2 times the power collected by a folded dipole.
2. A lightning arrester with an insertion loss of 1 db would permit 79.4% of the signal power to remain in the transmission line for reception purposes—20.6% being consumed by the unit itself.

The chart may be extended as needed, remembering that as the percentage values are multiplied or divided by 10, the decibel values add. For example:

A serviceman has the problem of determining how much gain a booster should have to overcome the loss in a 1000 ft. run of coaxial line from a hilltop antenna to an installation in the valley below. At the operating frequency the loss per hundred feet is 1.5 db. The total will be ten times 1.5 db, or 15 db. Therefore, the booster must raise the power level at the input to the cable 31.6 times or 3160% to compensate for the long cable run.

SCIENCE QUESTION BOX

By Scientists of the General Electric
Company

Q: What is the greatest age that a person has been known to live?

A: According to one authority on vital statistics, Dr. Louis I. Dublin, the greatest age attained in modern times for which the records seem reliable is that of a Dane named Christian Jacobsen Drakenberg. He was born Nov. 18, 1626, and died Oct. 9, 1772, so he almost completed 146 years. In 1737, at the age of 111, he married a 60-year-old widow, who died a few years later.

Q: Is a person safe from lightning inside a metal trailer?

A: A person inside a metal trailer should be quite safe from lightning, for if it struck it would jump over the rubber tires to the earth. It might also cause a short circuit in the trailer's electrical wiring, but proper fuses would take care of this. If there is a water supply to the trailer from a metal pipe, the pipe should be connected to the metal of the trailer by a copper wire. Special precautions should be taken in getting in and out during a thunderstorm, for if a stroke should occur when a person has one foot on the ground and the other on the trailer, he might get a severe shock. If one has to go in or out during a storm it is best to jump.

Q: What can I do for a humming noise in my radio that occurs when a light is turned on in the basement?

A: If the light in question is an incandescent lamp, interference of this type is generally caused by a loose connection in the socket, switch or contacts or a loose weld in the lamp. If changing the lamp does not eliminate the interference, check the electrical wiring connections. The very old incandescent lamps (20 years or more) may cause television interference and should be replaced. Fluorescent lamps can generate some radio interference and if it is objectionable, a special filter can be installed in the wires to the lamp and the fixture connected to the ground. This should eliminate the interference.

Q: Why is there so much talk about rocket trips to Mars? Isn't Venus closer to the Earth than Mars?

A: Yes, when Venus is closest to the Earth it is 26,000,000 miles away, while on the very rare occasions when Mars comes closest it is 34,500,000

miles from us. However, when Venus is nearest it is nearly in line with the Sun and cannot be observed, but when Mars is closest it is opposite the Sun, so that observations can easily be made. Perhaps the greater interest in Mars, as a possible destination for rocket travel, is that we can see its surface. Green areas, that may be some sort of vegetation, can be seen so that we can form some idea of conditions there. Venus is constantly covered with thick clouds, and we do not know what the surface conditions are underneath. Doubtless it would be much harder for us to survive on Venus than on Mars.

Q: Is there any scientific difference between a stone and a rock?

A: To a geologist the matter which forms the Earth's crust is called rock. Rocks may be composed of inorganic material, such as granite or slate, or they may be organic, such as coal. The layman, with justification from the dictionary, uses the terms rock and stone interchangeably, but the geologist seldom uses the word stone, except in conjunction with another qualifying word. Thus he may speak of sandstone or limestone; or crushed stone, such as is used for road building.

Q: How do flowers extract their delightful fragrances from the soil?

A: The fragrance of a flower is not extracted by the plant from fragrances already existing in the soil. The plant is a chemical factory which takes raw materials mainly in the form of hydrogen and oxygen from water, and carbon from the carbon dioxide in the air, and builds up various compounds by chemical reactions in the plant cells. All parts of the plant, such as the cellulose or woody parts, are formed in this way. It is the number and arrangement of the carbon, hydrogen and oxygen atoms making up the fragrant compounds that determine their odor.

Q: What is the principal difference between incandescent and fluorescent lighting?

A: In the incandescent lamp an electric current passes through a fine tungsten wire which offers considerable resistance, raising the wire to white heat. Thus it gives off light, as well as a considerable amount of heat. In the fluorescent lamp, the current passes through a tube containing mercury vapor at low pressure and causes it to glow with a faint bluish light. It also generates large quantities of invisible ultraviolet rays. These strike fluorescent powders called phosphors, coated on the inside of the tube. These powders convert the invisible rays into visible light, which can be used for illumination. This process is considerably more efficient, as a smaller proportion of the energy is lost as heat.



N.R.I. ALUMNI NEWS

Oliver B. Hill	President
F. Earl Oliver	Vice Pres.
Harvey W. Morris	Vice Pres.
Louis E. Grossman	Vice Pres.
Thomas Hull, Jr.	Vice Pres.
Louis L. Menne	Executive Secretary



New Orleans Chapter, NRI Alumni Association, pauses for a little celebration at the close of its first and very successful year.

Chapter Chatter

Philadelphia Chapter is pleased to announce the following new members: Walter Thomas, Raymond E. Dawes, Fred C. Herb, Clifford F. Sipes, Clyde C. Meadows, all of Philadelphia; Luther T. Brandt, Perkasia, Pa., and John Zanger, Maple Shade, New Jersey.

The members are looking forward to May 24 when they will celebrate the twentieth anniversary of the establishment of Philadelphia Chapter. This will be a big night and all members are urged to keep the date in mind.

Mr. Henry Lapinski, service manager, Philadelphia Branch of Motorola TV Company, and Mr. Al Fisher, Field Engineer for the same company went through the entire Motorola chassis describing the circuits and defects that occur in the set and how to go about servicing them. Much of the material was on film and went into great detail. This was one of the best meetings we've had in a long time. In addition to their splendid talks Mr. Lapinski and Mr. Fisher supplied each member with service data and schematics pertaining to the new Motorola sets.

The Chapter is arranging to get a Sweep Generator and Marker combination. Harvey Morris is going to give a series of talks on how to use these and other servicing instruments. At each meeting a different meter will be described and each member present will be given an opportunity to put the instrument to use. Philadelphia Chapter already has enough equipment to start a complete service shop. Attendance at these meetings is a splendid way to learn how to use this equipment.

Meetings are held on the second and fourth Monday of each month at the Knights of Columbus Hall, Tulip and Tyson Streets, in Philadelphia. Information concerning the chapter may be had by telephoning to Secretary Jules Cohen, FI 2-8094.

Pittsburgh Chapter has an attendance of fifty to fifty at each meeting. Mr. J. B. Straughn, Assistant Director of Education, NRI, at one meeting spoke to the members on Analyzing and Servicing AC-DC Receivers. At this same meeting Mr. Bert Bregenzler, owner, Penn Radio and TV, gave an excellent talk on color TV. Mr. L. L. Menne, of headquarters installed our new officers.

At another meeting Mr. W. R. Bookser, General Sales Manager, Tydings Company, spoke on antenna distribution and Mr. John R. Covert and Mr. George O. Tanner, representatives in Pittsburgh for Amphenol Corporation, showed a very interesting film on UHF antennas.

At another meeting Mr. Thomas Schnader, of our own chapter spoke on new test equipment and TV servicing.

Arrangements are being made for members to witness production of picture tubes being made in a local plant.

Information regarding meetings may be obtained by communicating with Secretary K. J. Shipley, 1009 St. Martin Street, Pittsburgh.

New Orleans Chapter is having a little housing problem. Until a permanent meeting place is located meetings are held at the home of Chairman Louis E. Grossman, 2229 Napoleon Avenue.

Mr. Grossman has arranged to hold these meetings in his spacious basement which is being properly equipped for this temporary use.



Three principal officers, New Orleans Chapter, are Octave Jumonville, Jr., Treasurer, V. J. Cornelius, Vice-Chairman and Louis E. Grossman, Chairman. Mr. A. H. Buckley, Secretary, was absent when this photo was taken.

Incidentally, Mr. Grossman is recovering from an appendectomy. He has the best wishes of all of the members for a speedy return to the best of good health.

New Orleans Chapter is experimenting with a new idea. The plan is to bring in an experienced instructor who is to be paid a nominal fee and who is to lead the group in solving common problems.

Mr. Michael Sucharik, Radio Engineer, was the speaker at one meeting. His demonstration covered servicing a TV receiver, a very popular subject right now. His interesting talk pointed out many short cuts to better servicing methods. He emphasized the importance of using only the very best of components for replacement purposes.

Secretary Anthony H. Buckley, 2817 Burgundy St., in New Orleans will be glad to furnish information regarding meetings to any NRI students or graduates who may be interested.

Baltimore Chapter had a most interesting meeting on March 9 at which time Mr. Straughn and Mr. Menne were guests. Mr. Straughn gave an interesting talk and as an added feature Mr. John J. Lucas, sales representative Amphenol Corporation, also made a very excellent talk and showed a very fine film.

At another meeting our own Mr. H. J. Rathbun spoke on TV Multivibrator circuits.

A dinner party is planned for the near future.

Baltimore Chapter is in need of some mimeograph equipment. It has been suggested that perhaps some Alumni member may have some duplicating or mimeograph equipment for which he has little or no use that he would sell at a reasonable cost. If any reader has such equipment please communicate with Secretary Joseph M. Nardi, 4157 Eierman Avenue, Baltimore 6, Maryland.

Milwaukee Chapter has a new vice chairman. Mr. Elwin Sowle, who did such good work in helping to get the chapter organized, is unable to attend meetings owing to conditions beyond his control. He therefore resigned and Mr. Erwin E. Kapheim was elected vice chairman. At the same time Mr. Clarence P. Kleier was elected alternate vice chairman.

There has also been a realignment of the finance committee to include Mr. Kapheim, Mr. Kleier along with Al A. Schroeder. The entertainment committee consists of Ralph E. Hanson, Harvey Otto, John M. Klis, with Clarence J. Keller and Cyril B. Schreiner, as alternates. Mr. Kapheim gave an excellent talk on the purpose of our chapter, what the chapter can do for the members and what the members can do for the chapter. Others who took part in an open discussion were Mr. Schreiner, Mr. Kleier, Mr. Joseph C. Reed, Mr. Adam Palton, Mr. Spark Hashimoto, and Mr. William Fells.

Chairman Petrich led an interesting discussion on interference affecting local TV programs. Chairman Petrich asked each member individually what he expected from attendance at meetings and most of the members felt that they would like to start with fundamentals of Radio and Television, see blackboard demonstrations and work up from scratch so as not to embarrass any of the members who may not be as well versed as others.

Mr. Kleier is providing a blackboard for the chapter. Mr. Petrich is providing a TV chassis. Mr. Keller, with vast army experience as an instructor, has contributed much to the success of our recent meetings.

The chapter meets on the third Monday of each



Oliver B. Hill of Burbank, California, President of the NRI Alumni Association, with Mrs. Hill, daughter, Diane, who is 14 and in 9th grade, Junior High, and Raymond, who is 19 and now in the Navy. We are proud to have the head of this fine family as President of our Alumni Association for 1954.

month at 8:00 P.M. at 2249 N. Humboldt Avenue in Milwaukee.

Chicago Chapter with Chairman Charles C. Mead and Secretary Frank Ziecina carrying the load, is anxious to contact an NRI graduate in the Chicago area who is available to instruct the group, many of whom are still students. Such a person would be most happily received by Chairman Mead.

Recent topics for discussions have been TV antennas, their percentage of efficiency, length computations, advantages of a reflector and servicing TV antenna troubles.

The plan of having members bring in a conventional radio chassis, in working condition, and then have picked lead men introduce defects for the members to find and adjust is proving very popular.

Meetings are held on the second Wednesday of each month in the tower space, 33rd Floor, American Furniture Mart Building, 666 Lake Shore Drive. Please use west entrance.

New York Chapter always has a full program. Capable speakers are assigned their subject in advance and come to meetings fully prepared. For example Mr. Frank Manz, spoke on Capacitors and AC Theory. Mr. Phillip Spampinato spoke on audio power supplies and Mr. Thomas Hull, Jr., conducted the radio clinic.

Mr. Alex Remer spoke on TV field technique, Mr. William Fox gave his usual interesting talk on his general servicing experiences and Mr. David Spitzer also spoke on his experiences. At all of these sessions members are invited to ask questions.

At still another meeting Thomas Hull, Jr., who, by the way, is a national vice president, spoke on power supplies. Mr. Ontie Crowe spoke on signal tracing and again, Mr. Phil Spampinato spoke on audio amplifiers and servicing by schematics. At our most recent meeting Ted Durante gave a fine talk on Business Ethics and Geo. Schalk, Jr. outlined the Raytheon Service plan.

Chairman Bert Wappler, Secretary Louis J. Kurnert and Assistant Secretary and Treasurer, Frank Zimmer always take an important part in all of our meetings. Attendance is excellent. Students and graduates in this area are invited to visit us at any time.

Meetings are held on the first and third Thursday of each month at St. Marks Community Center, 12 St. Marks Place, between 2nd and 3rd Avenues in New York City.

— n r i —



Detroit Chapter is going great under the leadership of Chairman John P. Kehoe, ably assisted by Secretary Robert M. Kinney. Detroit chapter is fortunate to have the capable advice of such long standing Alumni members as national vice president F. Earl Oliver, Harry R. Stephens and many other loyal members who have held office and who have a deep interest in the affairs of the chapter. Recent events were a tour through television station WXYZ-TV—a most interesting experience.

We wish to express our great appreciation for the courtesies shown to us by Mr. John Lee and Mr. Mason Weaver of this station. They extended themselves in showing every consideration to our members.

Earl Oliver gave a demonstration on the use of the oscilloscope, using an actual television chassis for the purpose. Harry Stephens did the commentary. Assisted by Chairman Kehoe these men did a lot of preparatory work for this demonstration and it certainly met all expectations.

At another meeting there was a demonstration of the TV bar generator recently described in National Radio-TV News. Tom Patterson brought in three professional bar generators for comparison. Earl Oliver brought in a unit he had built as did also John Kehoe who brought in a different type for comparisons.

Our most recent meeting was set aside as Gadget Night. Members and guests brought in useful gadgets and short cuts which helped them solve or make easier service or work shop problems. We were very happy to see some of the older members who have not been coming regularly and also to have a considerable number of guests.

Meetings for the immediate future will feature a presentation by the Detroit Edison Company titled "Radio and TV Interference Problems and Their Solution." At another meeting there will be a demonstration of the operation of microwave which will be presented by the Michigan Bell Telephone Company and at still another meeting we have scheduled a talk by a Sergeant of the Detroit Police Force who will speak on "The Detroit Police Radio System." Meetings are held on the second and fourth Friday of each month at St. Andrews Society Hall, 431 East Congress, beginning at 8:00 P.M.

— n r i —

"Many thanks for the very handsome lapel button. Highly appreciated." Daniel L. Green, Charleston, South Carolina.

— n r i —

"A most colorful and interesting pin. Nice to be remembered. You are looking after us." Oscar Guzman, New York, N. Y.



Here and There Among Alumni Members

Mr. Howard E. Smith, who operates Valley Electronics, 53 Bangor St., Springfield, Mass., is the guiding spirit in organizing a chapter in Springfield. Any interested graduates in the area of Springfield, Mass., are urged to get in touch with Mr. Howard E. Smith.

Joseph R. Hirt, of Dover, N. J., mentions that there are now five NRI men at his place of employment, Aircraft Radio, Boonton, N. J.

Spare time business is booming for Ray M. Dirba, of Wallis, Texas. He averages two to three hours per day, with a profit of over \$200 per month for the past few months.

James W. Hoskins, of Vallejo, Calif., says NRI training is helping considerably in his new job with the Pacific Gas and Electric Co.

Since his discharge from the Army, Alvin Pudello, of Snover, Mich., has purchased his own building and started a Radio and Television Sales and Service business. TV sales are going good.

Leroy J. Mack is now working full time at Radio and Television Station KVOA in Tucson, Arizona.

Matthew Magley, of Turtle Creek, Penna., has passed the milestone of more than 1000 Radio and TV sets serviced in spare time.

Graduate Herman Wiemer, of Gray, Okla., is employed as a communications maintenance man by the Natural Gas Pipeline Co. of America. Says that much of their two way mobile equipment will eventually be replaced by microwave equipment.

Grad Willie E. Marchessault, of Pawtucket, R. I. has started a full time Radio and TV Service. Says doing very good.

From Laredo, Texas, comes word that Graduate Arnulfo Leon is doing well in his own Radio-TV business. TV is still "fringe-area" there, but interest is growing.

Elmer Frewaldt is now on the Engineering staff of a new UHF-TV Station, KEDD, of Wichita, Kansas.

From the prairies of North Dakota comes word of the amateur activities of Gilbert H. Fiste, WONGK of Sharon, N. Dak. Running about 80 watts with a 6AG7 oscillator and single 1625 final, modulated with a pair of 6L6's.

Alumnus Richard E. O'Hara, of Gorham, N. H., is now co-owner of the White Mountain Radio and TV Shop in Berlin. Selling Motorola, and meeting plenty of queer fringe area service problems.

Charles Lepper, of Huntington Park, Calif., is now working at the South Gate Radio Center and getting along fine. Glad he enrolled with NRI.

Graduate Emil Capobianco, of Schenectady, N. Y., is now employed in the Technician Program of General Electric Co. His present work involves electronic control circuits in auto-pilots.

Vern Barr, of Toronto, Ohio, is now head benchman for Transvideonics TV Repair in Steubenville.

Robert E. Chapman, of Waco, Texas, has just acquired his second-class radiotelephone license. Also has amateur call W5BHX, and is now employed by his local Motorola 2-Way Service Station.

R. E. Brecheisen, of Kenosha, Wis., recently received a promotion to Electronic Mechanic with the U. S. Navy (civilian) Electronics Department—Instrument Repairing.

C. W. Tews, owner of Tews Radio and Television Service, Milwaukee, Wisc., says he is doing quite well. Says more work than he can handle, thanks to NRI, which sure pays off.

Chester W. Hume, of Youngstown, Ohio, a full-time TV serviceman, is interested in re-locating in the Virginia, District of Columbia, or Maryland area.

Looking back on the history of Radio, J. H. Unferfate, of Youngstown, Ohio, mentions building an Armstrong Superhet in 1920. Had 3-inch, hand wound coils. The tube had a spare filament. When one filament burned out, the spare was connected by switching to another terminal.

Mr. and Mrs. Gerald J. Macheak, of Cedar Falls, Iowa, visited NRI recently, as a part of a vacation trip to Bermuda and Nassau. The trip was received as a Special Award from RCA for the outstanding sales success of MACHEAK'S TV, in Cedar Falls. Congratulations!

James H. Wales, of Baltimore, Md., is now employed with a local Television Station.

Paul G. Miller, of Maumee, Ohio, is having great success with his Radio and Television Service business. He has been able to purchase his business building and a house.

NATIONAL RADIO-TV NEWS

16th & U Sts., N.W.

Washington 9, D. C.

Sec. 34.66, P. L. & R.
U. S. POSTAGE
1 1/2c PAID
Washington, D. C.
Permit No. 7052

Forwarding Postage Guaranteed

For:
 Mr. Francis H. Fingado
 611 17th St.
 Denver 2, Colo.

25236

4

POSTMASTER—FORM 3547 REQUESTED



Vol. 16

April-May, 1954

No. 2

Published every other month in the interest of the students and Alumni Association of the

NATIONAL RADIO INSTITUTE
Washington 9, D. C.

The Official Organ of the N R I Alumni Association.
Editorial and Business Office, 16th & You Sts., N. W.,
Washington 9, D. C.

L. L. MENNE, EDITOR
H. L. EMERSON, ASSOCIATE EDITOR
J. B. STRAUGHN, TECHNICAL EDITOR

NATIONAL RADIO-TV NEWS accepts no paid advertising. Articles referring to products of manufacturers, wholesalers, etc., are included for readers' information only, and we assume no responsibility for these companies or their products.

<i>Index</i>	
Article	Page
Editorial	2
Opportunities in the Radio and Television Industry	3
Our Cover Photo	10
Electronic Tube is Brain of Aircraft	12
How to Build an Inter-Com	14
Color TV Picture Tubes	18
Ion Trap Magnets	20
Technical Ramblings	22
Origin and Use of the Decibel	25
Science Question Box	26
NRI Alumni Association News	27
Chapter Chatter	28
Here and There Among Alumni Members ..	31

Printed in U.S.A.