



FEBRUARY - MARCH, 1936

Vol. 6 No. 12

IN THIS ISSUE:

Inexpensive Test Panel

Quality and Harmony

High Fidelity Broadcasting
Station

Final Alumni Election News

Etc.

NATIONAL RADIO NEWS

WASHINGTON, D.C.



Seventeen to Seventy

AT 17 this chap, and there are thousands like him today, hasn't a care in the world. High school is finished and he may or may not have landed his first job. He is looking at life through the rose colored glasses of youth—sees nothing ahead but good times and ultimate success as the natural course of events. Sometime within the next five years he will marry and settle down to await his big opportunity.

22 to 30

HE'S MARRIED now—has a family. Life still has a somewhat cheerful aspect, but some of its rough points are starting to show through and rub where it hurts. He has a job, but is waiting for *his big chance*. He has not found time to study nor has he seen the necessity for special preparation for that *big opportunity*.



31 to 45

HIS FAMILY is larger—the youngsters are growing up. He still has a job. Salary has increased, but not in proportion to expenses; seems impossible to quite make ends meet. The big break hasn't arrived. His ambition has rubbed mighty thin from his jolting contact with hard knocks. And he still hasn't learned that there is a sure-fire method to SUCCESS through study—specialized training.



46 to 69

THE CHILDREN are married—that's one expense out of the way. But he finds it harder to get and keep jobs—harder to break even. Income decreases. No more dreams of opportunity. Divides his time between worrying over expenses and talking about what he would do if he were a young man. Doesn't realize that other men have increased their earnings *even at his age* by study.



70 to ?

WRITE THIS last chapter yourself. You've seen enough of the tragedies of life to know the climax to this story. It is not pleasant. Any year in this man's life could have been the turning point. His mistake is the mistake of most unsuccessful men—failure to understand that the greater part of opportunity is within themselves—that one doesn't wait for opportunity but selects the proper field—one which pays big returns—then studies and works in it until his SUCCESS has been achieved.

J. E. SMITH,
President.



An Inexpensive Test Panel

... as described by Don B. Looney, N. R. I. Technical Staff, in cooperation with N. R. I. graduate Clifford Gilbert, of Columbus, Georgia. Mr. Gilbert suggested this article to N. R. I., supplied the layout and wiring diagrams, and much of the valuable information which appears on these pages.

N. R. I. students and graduates often feel the need of having a complete test panel on which practically all the equipment for modern Radio receiver servicing can be mounted. In most shops, testing equipment and associated apparatus with which a service man works may be found in several different places, and often much time is wasted in locating this equipment and getting it set up for a particular measurement.

With all test apparatus built on one panel and on one work-bench, the service man saves much time (and therefore money), besides having his workshop appear workmanlike and efficient. Space will be available on the bench or worktable for tools, receiver chassis, etc.

A modern test panel using high-resistance voltmeters and low-current milliammeters can be an expensive piece of shop equipment which the average service man cannot well afford, especially if he is just starting into business. The test panel described in this article has been designed to keep the cost as low as possible and at the same time give the Radio-Trician a test panel that will prove entirely satisfactory for all ordinary service work. Much of the material

used is included in the N. R. I. Laboratory Experimental Units, and after the student has completed his experiments he can use the parts in the test panel. The parts not included in the Experimental Units can probably be obtained from your Radio "junk-box," or from a nearby Radio dealer. This subject will be discussed in more detail later in this article.

The exact size and shape of the panel can be such that it will meet your own particular requirements.



Clifford Gilbert
Columbus, Ga.

The one being described is built on a 14" x 18" panel. If desired, it can be built in sections or units, building first those sections for which you have the most need. Each individual section should then be built on a panel 7" high and 6" long. By following this plan you can at

Don B. Looney



any time add new units that your work requires.

While the most essential test equipment is described in this article, you will doubtless see other valuable equipment described in your text-books and other Radio magazines which you may want to add. In fact, if readers of NATIONAL RADIO NEWS desire descriptions of additional units to the present test panel, the author will be glad to receive suggestions for further articles on this subject.

PANELS—Bakelite, Hard Rubber, Plyboard

Having decided upon the size of the panel you wish to use, the next question is the kind of material to use. Bakelite panels are used in practically all high-grade testing equipment, since they have a highly polished surface and high insulating qualities. However, Bakelite is very hard and brittle and it is rather difficult to cut and drill. Also it is rather expensive, and for this reason should not be used if you desire to keep costs to the very lowest figure. Hard rubber panels are slightly easier to cut and drill and have a very good appearance, but are also rather expensive.

If you want to keep the expense down as much as possible it is suggested that a piece of 3-ply plyboard be obtained from the local lumber dealer. This plyboard costs approximately five cents a square foot, depending upon the locality. It is suggested that you have the lumber company cut the panel to the exact size that you are going to use. There will probably be a small charge for this, but you will be sure of having it perfectly straight and square, which is essential for a good looking job. To finish the plyboard, obtain a small amount of aniline black dye in powdered form, and mix it with a small amount of alcohol. Give the panel two or three coats of this dye until the proper degree of black is obtained. Then give the panel
(Next page, please)

An Inexpensive Test Panel (Continued from page 3)

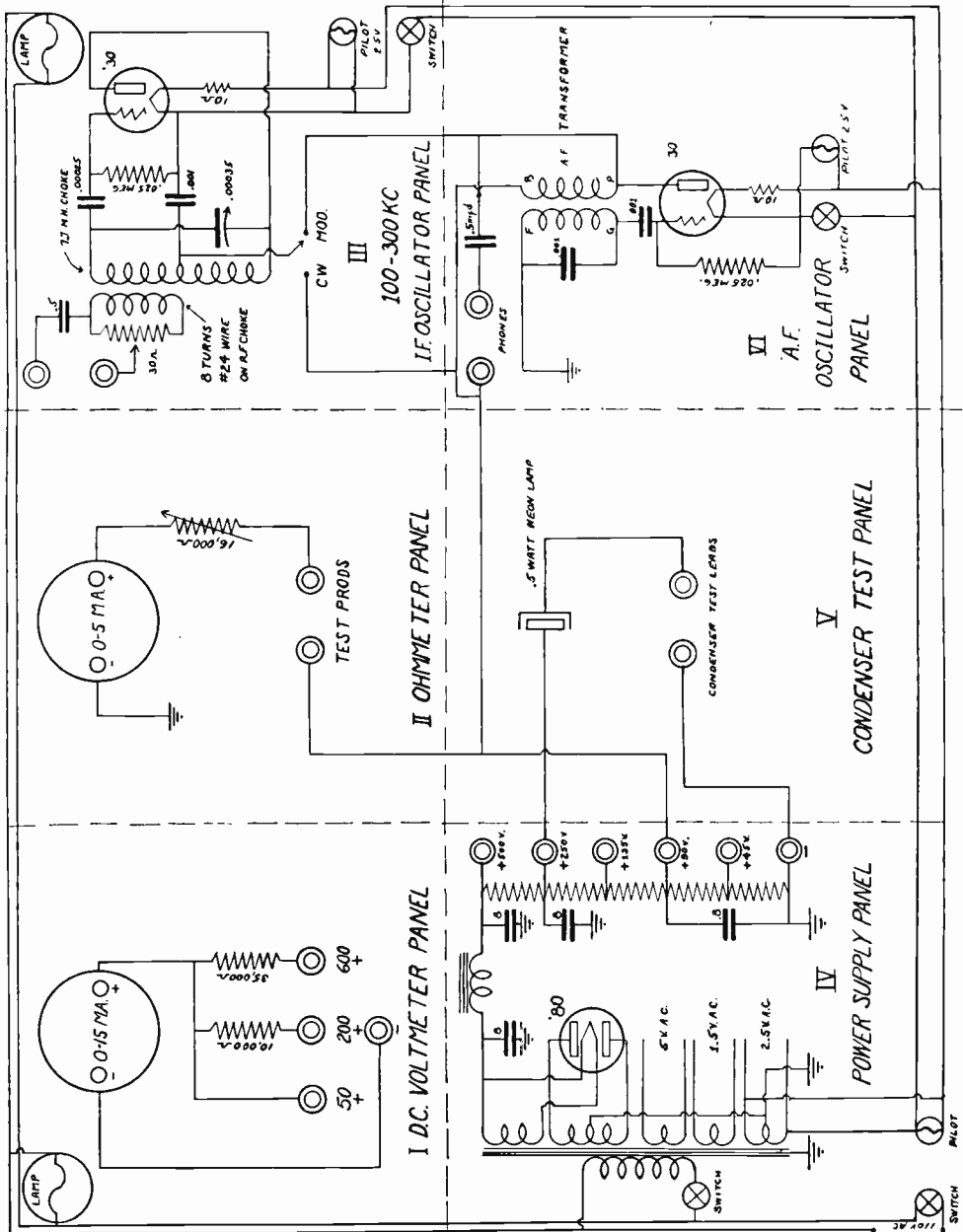

Figure 1, Wiring Diagram

(Page 8, please)

The Service Forum

Conducted by

J. B. Straughn, N. R. I. Service Consultant



MAJESTIC MODEL 20

DEAD

When no voltages can be measured on the plates of the first detector or I. F. tubes, the trouble is generally caused by a broken down .1 microfarad bypass condenser. These units are located inside the I. F. transformer. To repair, the transformers must be removed, the sealing compound melted out and a new condenser installed. The new condenser should be rated at 600 volts to prevent a repetition of the trouble. If you do not wish to go to this trouble of melting out the condenser, it will be satisfactory to insulate the transformer can from the chassis, connecting the can to the chassis with a 600 volt .1 microfarad condenser.

————— n r i —————

CROSLEY MODEL 608

INOPERATIVE

When all voltages check okay but set will not operate, look for an open .5 microfarad bypass condenser, part number 4919, shown in the diagram as being connected from the A. F. transformer to the chassis.

————— n r i —————

KOLSTER MODEL 6D

LOW OR NO VOLUME

Look for open grid suppressor resistors. As they are wrapped in paper, they are not readily visible and a continuity check should be made.

————— n r i —————

GENERAL MOTORS MODEL 120

HUM

If the reception seems to be otherwise normal, replace the .1 microfarad condenser located under the A. C. terminal strip. Use a 600 volt replacement condenser.

————— n r i —————

GENERAL ELECTRIC MODEL K-62

INTERMITTENT RECEPTION

Replace the 5 megohm and 1 megohm resistors in the grid circuit of the 27 AVC tube. A defect in these resistors may also cause motor-boating. Should the trouble continue, replace the two resistors used to shunt the speaker field.

GREBE MODEL SK-4

HUM

Replace the .1 microfarad condenser used in the detector circuit, if the filter condensers are okay.

————— n r i —————

GLORITONE MODEL 26

INTERMITTENT RECEPTION

This is generally caused by open screen grid or cathode R. F. bypass condensers. These are located in a single container under the R. F. coil shield. .25 microfarad 600 volt replacement condensers will prove satisfactory.

————— n r i —————

GENERAL ELECTRIC MODEL K-63

INOPERATIVE ON BROADCAST BAND

When you find it necessary to throw the wave band switch into the short-wave position and back before the set operates on the broadcast band, the trouble will generally be found in an intermittent contact in one of the coils. A visual inspection is necessary.

————— n r i —————

DEWALD MODEL 547 A. C.

GENERAL TROUBLES

Make sure that none of the filament socket prongs touch the chassis—bend so that this cannot occur. To prevent oscillation clean the contacts between the rotors of the tuning condensers and the chassis. It is often worth while to solder the wipers to the chassis.

————— n r i —————

KOLSTER MODEL K-131 and K-132

POOR SENSITIVITY

This complaint coupled with insufficient automatic volume control action is generally due to a change in value of some resistor associated with the AVC system. Check each resistor carefully with an ohmmeter.

(Page 10, please)

Electric Eye to Sort Mail for Uncle Sam in Railroad Terminals

THE photo-electric relay is the unerring eye of a robot railway mail sorter in the functioning of a new type of equipment developed by the Cleveland Electric Tramrail Division of the Cleveland Crane & Engineering Company, in collaboration with General Electric engineers. This equipment, designed to be of great help in railroad terminals, will automatically route sacks of mail to the proper railroad cars.

Each sack is loaded with mail for one city. When the sack is full, it is placed in a tray container which travels on an automatic conveyor system of the overhead monorail type. The containers are made up into "trains" pulled along at about five miles an hour by a motor-driven carrier, as many as 50 containers making up a train. The little mail train has for its destination a number of railway mail cars, each going to a different city. As the train goes by, the mail sacks are automatically sorted and dropped on the loading platform near the proper railway cars.

An ingenious arrangement of photo-electric relays is the basis of this sorting. On each mail bag tray conveyor is a photo-electric relay and solenoid mechanism which travels along the conveyor with the tray. The photo-electric tube, when actuated by a beam of light, causes the relay to release the mail sack by means of the solenoid mechanism.

In a demonstration arrangement in Cincinnati there were 34 possible destinations for the mail trays. The light source (which actuates the photo-electric relay) at each railway mail car, was arranged to shine its beam on a different plane from all the others, and at one or the other of two angles. In order to cause delivery of any given sack of mail at a particular destination, it is merely necessary to set the photo-electric tube on a suitable plane and at the proper angle to intercept a particular light

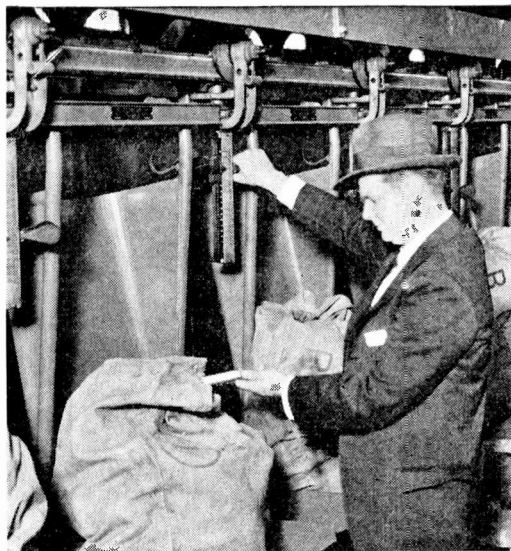

(Photo courtesy General Electric)

Photo-electric control equipment on conveyor built by Cleveland Crane & Engineering Company.

beam, and no other. Thus only those mail sacks whose photo-electric tubes are correctly set are delivered; if the tubes are set correctly, the mail is automatically delivered.

The setting of the photo-electric equipment takes place at the dispatching platform, immediately after loading. The dispatcher, as the mail passes him on the conveyor, inspects the destination tag on each sack and sets the relay equipment accordingly. In order to allow the operators plenty of time for loading and dispatching, an automatic arrangement of control slows down the conveyor at that point, speeding it up again after leaving.

— n r i —

Institute Celebrates 21st Anniversary

The men of the National Radio Institute's faculty and staff celebrated the twenty-first anniversary of the founding of the Institute on November 20, 1935, at a banquet held at Hotel Continental, Union Station Plaza, Washington, D. C. Interesting talks were given by President J. E. Smith, and Vice-President and Director E. R. Haas, founders of the Institute.

Page Six

Course Paying for Itself

"You will be interested to know that many of the payments I am sending you on the course are the result of my work in Radio. This course is certainly paying for itself, and I am not yet half finished."

DAVID OFFEY,
88 Grand Avenue,
Astoria, Oregon.

MAN WANTED

NATIONAL RADIO NEWS wishes to get in touch with a man who has the following qualifications:

1. Must be a student or graduate of the National Radio Institute.
2. Must have operated, successfully, his own Radio sales or service shop or store.
3. Must have used a system of book-keeping and business records which helped in the successful operation of the business.
4. Must have sufficient writing ability to describe the system used, and show why it was of value to his business.

Any readers of NATIONAL RADIO NEWS who have the above qualifications, should get in touch with your editor at once. We want a special article written, and a *cash award will be made* to the applicant who can do this job to our satisfaction. In addition, he will most likely receive some valuable national publicity in a very popular Radio magazine.

Write to P. J. Murray, Managing Editor, NATIONAL RADIO NEWS, 16th & U Streets, N. W., Washington, D. C., giving briefly your reasons for believing that you can do the job. Do not attempt to write the article until you have first communicated with this office and have found out exactly what is desired.

ALLIED RADIO CORPORATION, 833 W. Jackson Blvd., Chicago, Illinois, has just published a new 1936 catalog. N. R. I. students and N. R. I. Alumni who are now actively engaged in service work are invited to write for their copies. Their requests will be given preferred consideration. Of special interest in the new Allied catalog are the sections devoted to the latest type of test equipment as well as to new Radio merchandise such as metal tube receivers, new Public Address equipment, the latest set building kits, etc. Write to Allied direct for your catalog.

Allied Radio Corporation has just recently added more floor space and more Radio specialists to serve its customers better than ever before. They particularly invite N. R. I. men to visit their enlarged quarters and to inspect the new merchandise. The entire facilities of Allied's engineering staff are placed at the disposal of every N. R. I. man. Helpful personal service will make each visit to Allied invariably **instructive and profitable.**

Filtercons to Reduce Interference

Man-made static reduction is the object of seven new types of supply line filter devices developed by Continental Carbon Inc., 13900 Lorain Ave., Cleveland, Ohio.

Filters designated for use with small motors, heater pads, vibrators, and neon transformers are of the type which prevent radiation of high frequency impulses on the supply lines. Two designs are specifically for use between a Radio receiver and a power line, and are of the convenient plug-in type which can be quickly con-

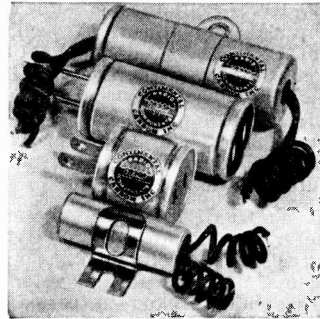

needed and demonstrated. For oil burner motors and noise-producing devices with grounded frames, two filters are provided with mounting straps to be attached directly to the apparatus. Five of the seven filters employ a combination network of inductances and condensers. The filters are rated to carry 5 amperes, A. C. or D. C.

The principle of the filters is to prevent radiation of interference by capacity, or capacity and inductance, and to block line noise from entering a receiver by diverting extraneous signals to ground, or shunting the r.f. component to the grounded side of the line.

List prices range from 40c to \$1.50. Distribution is through Continental Carbon jobbers and distributors.

— n r i —

There are approximately 66,221,784 Radio receiving sets in the world, according to statistics compiled by the Bureau of Foreign and Domestic Commerce.

North America's total is listed at 25,632,981; Europe's 22,897,981; Asia 2,555,396; Europe-Asia, 2,010,000; South America, 1,088,374; Oceania, 829,851; Africa, 209,201.

The United Kingdom has 7,055,464 receivers; Germany, 6,516,732; France, 2,763,123; Russia, 2,000,000; Japan, it is estimated, has 2,190,000 receivers.

An Inexpensive Test Panel (Continued from page 4)

two coats of white shellac. Allow each coat twenty-four hours to dry. Before applying the next coat rub down the panel with fine steel wool. Also rub the final coat of shellac lightly with the steel wool.

Wiring Diagram and Panel Arrangement

Inspecting the wiring diagram, Fig. 1, and the panel layout, Fig. 2, you will see that the test panel is divided into six distinct sections. These sections are: *I*, D. C. voltmeter; *II*, Ohmmeter; *III*, I. F. oscillator; *IV*, Power supply; *V*, Condenser tester; *VI*, A. F. oscillator. The panel layout and wiring diagram give general information concerning the construction of the test panel. The exact physical layout of the panel will, of course, depend upon the particular parts used. The following suggestions will be helpful in selecting and building the different units or sections.

I. D. C. VOLTMETER. The meter used in the voltmeter is a Readrite 50 V. D. C. meter having a resistance of 3,300 ohms and a current of 15 ma. at full-scale deflection. The use of a 10,000 ohm resistor in series with the meter increases the voltage range to 200, while

a 35,000 ohm resistor increases the range to 600 volts.

The use of a meter requiring a smaller current for full-scale deflection will give a more sensitive and accurate voltage reading. This will, of course, increase the cost of the panel. In case you have a different meter, then the necessary resistors to use can be determined by our old friend, Ohm's Law, using the formula $R + r = E \div I$, where R is the limiting resistor required, r the resistance of the meter, E is the voltage we wish to read at full-scale deflection of the meter, and I is the current in amperes for full-scale deflection. For instance, if we have a one milliamperer meter having a resistance of 20 ohms and wish to read 200 volts at full-scale deflection, our formula would read $R + 20 = 200 \div .001$, or $R = 200,000 - 20$, or 199,980 ohms. Of course it is impossible to obtain a resistance of this exact size and we would use a 200,000 ohm resistor. Likewise, when using the 50 V. D. C. Readrite meter for a 600 volt scale we find that the calculated resistance to use would be 36,700 ohms. However, this is not a standard size resistance and so the nearest size available is used, which is

(Page 21, please)

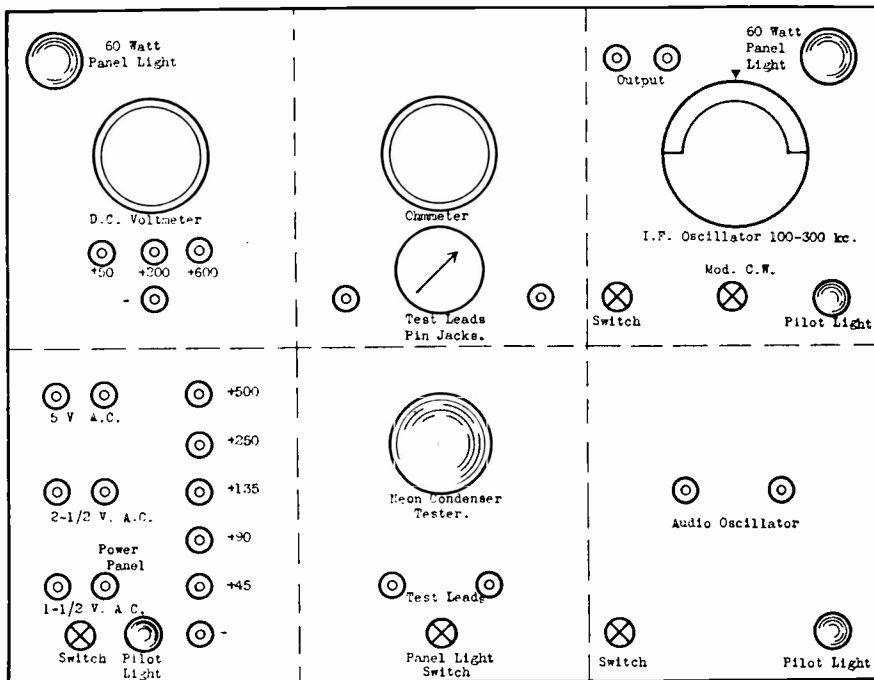

Figure 2—Panel Layout

HOW TO

GIVE YOUR CUSTOMERS QUALITY and HARMONY

AT A REASONABLE COST

"PAL, please cut off those hideous legs" (meaning the legs of the Radio cabinet).

"Joe, will you ever stop poking around that Radio? What's the idea of all those pads in the cabinet? You mess up the room." (I was trying to take out the "boom" by absorbing the sound in the cabinet with felt pads.)

Just a sample of the "back-seat" comments from my "better half" before I decided to take things in hand. "Pal" is her approach for something I might want to do; "Joe" is command. And a command, to a married man, is more than a request.

Readers of NATIONAL RADIO NEWS will remember the interesting series of articles written by Mr. Kaufman, sometime ago, regarding the use of the cathode ray oscillograph. In this article Mr. Kaufman tells also how the cathode ray oscillograph was used on his receiver.—Editor.

I solved the problem; a cabinet in harmony with the surroundings; a tone sufficiently rich in quality to satisfy the most exacting. What I did to build quality and harmony into my receiver will interest you and suggest many jobs that you can perform for extra money.

by JOSEPH KAUFMAN
N. R. I.
Director of Education



I had a Kolster K-80, a superheterodyne (1931) vintage) in a large, deep, box-type cabinet and mounted on four spindle legs. If you are well acquainted with this set, you will agree that it is a good receiver—has a real loud-speaker, oversized audio transformers and I. F. transformers that peak easily, indicating that the coils are set for critical coupling.

I decided that a special cabinet would satisfy Mrs. Kaufman, and a sketch of the proposed housing for the new Radio received her O. K. I was a little more critical in satisfying myself. Having decided that the audio amplifier was capable of handling higher frequencies, I turned my attention to the R. F. system. As I wanted high fidelity, I decided to band-pass the entire R. F. circuit by at least 14 kc. I have

(Page 11, please)

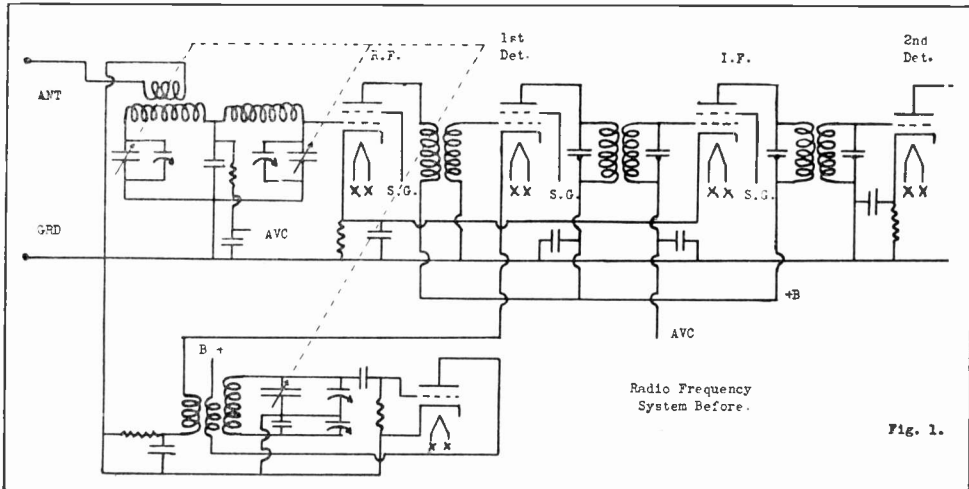

The Service Forum (Continued from page 5)

KENNEDY MODEL 20

HUM

To prevent hum, disconnect the wire from the filter condenser to the high voltage end of the voltage divider and connect it between the choke and speaker field windings. Then connect a 1 microfarad 600 volt paper condenser from the high voltage end of the divider to the chassis.

—————*n r i*—————

KOLSTER MODEL K-20 STARTING HOWL

Try a new 27 type tube. If the trouble continues connect a 100,000 ohm resistor across the secondary of the first audio transformer.

—————*n r i*—————

KOLSTER MODEL K-45 DISTORTION

When this set distorts at high volume levels the trouble is generally due to the voice coil rubbing against the field coil core.

—————*n r i*—————

RCA MODEL 17 OSCILLATIONS

No provisions were made on these receivers to balance out squeals. Increasing the size of the grid suppressors will stop oscillations but there is a much cheaper method. Simply take two pieces of bell wire with the insulation on them and solder one to the stator and the other to the rotor of the second tuning condenser. Twist the two wires together. A point will be reached where oscillation ceases due to the capacity between the wires, which serves to slightly detune the stage. You can make the twist about four inches long and then gradually clip it off with a pair of side-cutting pliers until best results are obtained.

—————*n r i*—————

RADIOLA MODEL 67

HUM

Try moving the chassis about in several positions. Also consider the moving of the speaker about one or two inches back from the front of the cabinet. Wads of felt wedged between the speaker cone and frame will generally prove just as satisfactory. The above cures are for hum not caused by a defect in the receiver—a resonance condition.

RCA VICTOR MODEL R-32

HUM

These receivers had a natural high hum level. To remedy remove the first A. F. tube socket located on the power supply unit base. This can be accomplished by cutting the bakelite socket strip between the 26 and 45 tubes and lifting the socket which will break off at the cut mark. Remove the wires on the socket and tape the ends of the filament leads to prevent shorting. Remove the hum control mounted next to the tone control in the base of the amplifier. Install a five prong socket in place of the original and connect the heater terminals to the filament supply of the 45 tube. Reconnect the grid and plate leads to their respective terminals. Connect a 2,500 ohm 2 watt resistor from the cathode terminal to the chassis and bypass with a 2 microfarad condenser. A 27 type tube is to be used in the socket and a noticeable reduction in hum should occur.

—————*n r i*—————

EMERSON CHASSIS U6B LOW VOLUME OR INOPERATIVE

Check the .1 microfarad screen bypass condenser on the 6A7 type tube. This often breaks down. Should this condenser become open, oscillations will occur.

—————*n r i*—————

EMERSON MODEL 26 DISTORTION AND OSCILLATIONS

Replace the 15,000 ohm .25 watt resistor used as a bleeder for the screen of the 57 second detector. A 1 watt replacement unit should be employed.

—————*n r i*—————

ZENITH MODEL 462 INOPERATIVE AT (AUTO RADIO) ONE END OF DIAL

When this condition occurs, replace the oscillator tube and go over the connections in the oscillator circuit with a hot soldering iron.

—————*n r i*—————

ZENITH MODEL 25 REGENERATIVE NOISE

Connect a 50,000 ohm resistor from the grid of each 45 type tube to the chassis.

Quality and Harmony (Continued from page 9)

reproduced the original R. F. system in Fig. 1. As you will observe, the pre-selector consists of a band-pass input, followed by a fixed R. F. stage of amplification. The fixed R. F. stage I considered undesirable, as I knew I could not get flat response over the entire tuning range if it was retained. Changing it to a tuned R. F. stage was too much of a job, for I would need a four-gang variable condenser and an R. F. transformer to match the band-pass coils. That procedure was ruled out, so I decided to remove the R. F. preselector amplifier and convert the stage to I. F. amplification as shown in Fig. 2.* Now I could band-pass all circuits. Observe that one I. F. transformer

from vibrating, I decided that a combination Radio and book case would answer the purpose. The cabinet, see Fig. 3, will hold about thirty books, and believe me thirty books on Radio, electrical engineering and mathematics are "heavy." Now let us turn to some of the details.

The Cabinet was built from regular shelving board, that you can buy at any mill. I used 14" board—about 1" thick. I am giving no detail dimensions, as they will depend on the chassis you use. The loudspeaker compartment in my receiver is 18" wide and 28" high. The baffle-board was an 18" by 28½" three-ply board, 5/8" thick. The side compartments are

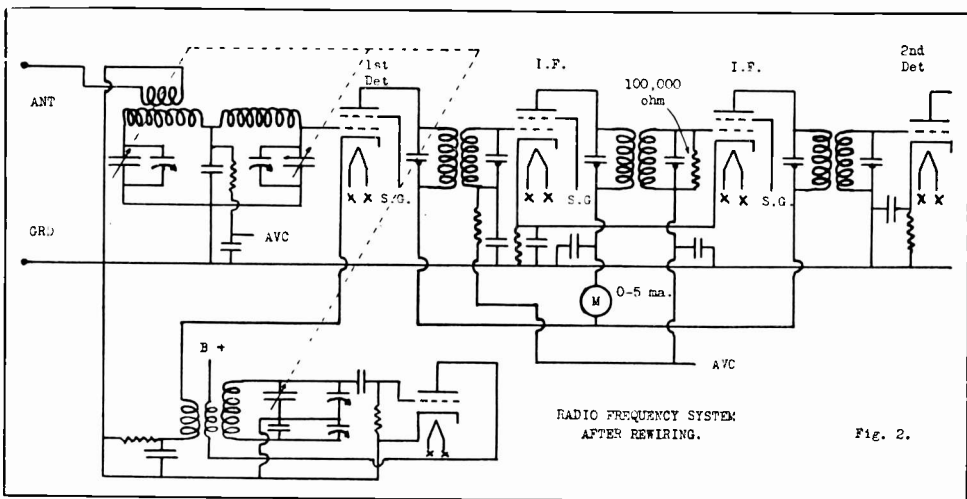

secondary is shunted by a 100,000 ohm resistor. I found this necessary to prevent excessive gain and oscillation.

I wanted a visual tuning indicator, as the other members of the family could never tune a station in properly. This is shown in Fig. 2, in the plate circuit of the first I. F. stage.

Knowing that the loudspeaker would not reproduce above 5,000 c.p.s. (in fact this is a high value) I decided to add a tweeter. I selected a Brush crystal loudspeaker, which starts to amplify about 3,000 kc., reaching its maximum at 5,000 and holding constant output far above any frequency that would be fed to it. I wanted the cabinet shallow so I could avoid cabinet resonance. And to prevent the whole cabinet

10" wide. The top is about 1" longer and 2" taller than the chassis. You can get the mill to cut all large boards to size, ready for assembly with finishing nails. After the boards are assembled you can add the trim. All you need is a back saw and inexpensive mitre box. The trim is attached with finishing nails. Drive all nails below the surface of the wood with a nail set and fill in with plastic wood.

The back of the loudspeaker and chassis compartments must remain open. The rear of the book compartments are covered with ply boards. Note that the sounding board inclines away from the top, to keep the high frequency sound off the floor, and towards the listener when the latter is located about fifteen feet away.

I went over the entire cabinet with steel wool, gave the cabinet two coats of flat white paint, allowed each coat forty-eight hours to dry and smoothed down with steel wool. Then

*I do not recommend changing a Radio circuit unless you thoroughly understand what you are doing. This is a job for an expert graduate Radio-Trician. Any of the other suggestions in this article will help improve fidelity, even if changing the circuit is not attempted.

The Service Forum (Continued from page 10)

ZENITH MODEL 70

HUM

Connect a 2 microfarad 200 volt bypass condenser from the detector cathode to the chassis. This should be in addition to the one already employed.

————— *n r i* —————

PHILCO MODEL 21 and 21A OSCILLATIONS

Connect a 4 microfarad high voltage electrolytic condenser between the yellow terminal of the condenser block which goes from the high voltage tap of the voltage divider and the chassis. Be sure to observe the polarity marking. If a paper condenser is used, it should be rated at 600 volts.

————— *n r i* —————

PHILCO MODEL 73

HUM

Connect a 250,000 ohm resistor between the grids of the 45 type tube. Also try twisting the plate leads of the tubes together. This is especially effective on receivers operating from a 25 cycle source.

————— *n r i* —————

PHILCO MODEL 511

HUM

Try shielding the detector and ground the shield. Hum is often induced directly into the detector tube elements by nearby parts.

————— *n r i* —————

BOSCH MODEL 60 POOR SENSITIVITY

Adjust the antenna compensating condenser which will be found directly above the antenna and ground binding posts. This condenser has a black knob and should be adjusted when the receiver is tuned to a station at approximately 1,000 kilocycles.

————— *n r i* —————

BOSCH MODEL 48

HUM

If a check of the various components usually causing hum does not result in elimination of the trouble, connect a 2 microfarad 600 volt condenser from one side of the speaker field to the chassis. Experiment will show which side of the field should be used as one connection will result in less hum than another.

BRUNSWICK MODEL 15 INTERMITTENT OPERATION

This is often found to be due to open .25 microfarad cathode bypass condensers. Pulling on the leads to these with the set operating will usually disclose the trouble.

————— *n r i* —————

BRUNSWICK MODEL 15

HUM

This is often caused by a short of the .14 microfarad condenser across the filter choke. A .1 microfarad condenser can be used for replacement purposes. Distortion in these sets is often caused by a short in the metal clad audio bias resistor. Lack of an 800 ohm reading on an ohmmeter from the 45 filament to the chassis indicates that the resistor in question is shorted. If a new resistor is installed it should be rated at 5 watts.

————— *n r i* —————

BOSCH MODELS 58 AND 60

DRIVE BELT REPLACEMENT

The condenser drive belt consists of a heavy stranded phosphor bronze cable having a small loop at each end. Correct tension is maintained by means of a spring, eliminating trouble ordinarily caused by excessive tightness or looseness in the drive. After replacing the belt it is necessary to reset the dial as described in "S" below.

1. Turn the condenser gang to the zero position. (Condensers fully open.)

2. Place the loop at one end of the drive cable over the pin at the top right hand side of the large drive drum.

3. Lead the belt along the groove and downward to the small grooved drum.

4. Turn the condenser gang to the "100" position. (Condensers fully engaged.)

5. Start the belt at the center groove of the small drum and wind on 6½ turns in a clockwise direction (to the right), winding toward the front of the receiver.

6. Bring the belt up and over the idler pulley.

7. Follow down the groove of the large drum and hook the loop over the drum tension spring. The spring can most easily be pulled into the correct position by looping a length of wire or strong cord around the spring hook.

8. Reset the dial as follows: Loosen the small gear on the knob shaft. Turn the shaft to the left as far as it will go. Set the dial against the stop at the "100" position. Retighten the small gear.



RADIO-TRICIAN

REG. U.S. PAT. OFF.

Service Sheet

Compiled Solely for Students and Graduates

NATIONAL RADIO INSTITUTE, WASHINGTON, D. C.

EMERSON MODEL 106, CASSIS U6B

(Serial Numbers Higher Than 636,900)

I. F. and Wave-Trap Alignment. The I. F. coils are located in cans on top of chassis. The second I. F. transformer is directly behind speaker. The four trimmers are located at tops of cans.

Turn wave-band switch to broadcast position, clockwise. Rotate variable condenser to minimum position and feed 456 kc. to grid of 6A7 tube. Adjust four I. F. trimmers for maximum response. Feed 456 kc. through antenna lead and adjust 456 kc. wave-trap trimmer for *minimum response*. Trimmer is on small wave-trap which is mounted on bracket extending from right-hand chassis wall.

Location of Coils. Broadcast and short-wave antenna coils are wound on one form, mounted on vertical bracket at right-hand side of chassis. Trimmers for these coils are on same assembly facing outward, and available through holes in bracket. Lower trimmer is for short-wave antenna coil; upper for broadcast antenna coil.

Broadcast and short-wave oscillator coils are wound on one form mounted below chassis deck. Trimmers are mounted on same assembly, facing outward, and accessible through holes in right-hand chassis wall. Front one is for short-wave oscillator coil and rear one for broadcast oscillator coil.

Dual padding condenser for oscillator coils is mounted inside of front chassis wall. Adjusting screws available through holes in front wall of chassis. Upper screw, broadcast padder; lower, short-wave padder.

Broadcast Alignment. Turn wave-band switch to clockwise position (broadcast), set dial to 600 (use center of speaker as reference point), and feed 600 kc. through antenna. Adjust broadcast oscillator padder for maximum response. Set dial to 1425; feed 1425 kc. through antenna. Adjust broadcast oscillator trimmer for maximum response and

adjust broadcast antenna trimmer for maximum response. Reset dial to 600 and rock variable condenser while realigning broadcast oscillator padder.

Short-Wave Alignment. Turn wave-band switch to counter-clockwise position (short-wave), set dial to 570; feed 1600 kc. through antenna. Adjust short-wave oscillator padder for maximum response. Set dial to 1280, feed 3600 kc. through antenna. Adjust short-wave oscillator trimmer for maximum response and then adjust short-wave antenna trimmer for maximum response. Reset dial to 570, feed 1600 kc. and rock variable condenser while readjusting short-wave oscillator padder.

GENERAL NOTES

1. On early production runs bias for the grid of the 6F5 is obtained by a small, one-volt battery (bias cell). Cell assembly is mounted on a bakelite strip inside of the left-hand chassis wall. Do not put a voltmeter across this bias cell. If the set distorts, check by temporarily replacing with a new cell, or other one-volt source. To remove bias cell simply pull up on the spring clip and lift the cell from its cap. On replacing, be sure clip makes good contact.

2. If adjustment of sliding scale dial is necessary, loosen two slotted hexagon-head guides at top edge of scale. Adjust guides by moving up or down in slotted holes in chassis. Do not bring them so far down that the pinion gear binds on rack. Scale should move freely—without appreciable vertical movement.

3. After replacing a dial scale take care to align it properly with variable condenser. Rotate variable condenser to maximum capacity, loosen set-screw on hub of pinion gear and slide scale so that extreme right-hand mark (near 55) is in line with center of speaker. Then tighten set-screw.

Readers who file Service Data in separate binders remove page carefully, trim on dotted line for same size as Data published heretofore.

Emerson Model 106, Chassis U6B (Serial Numbers Higher Than 636,900)

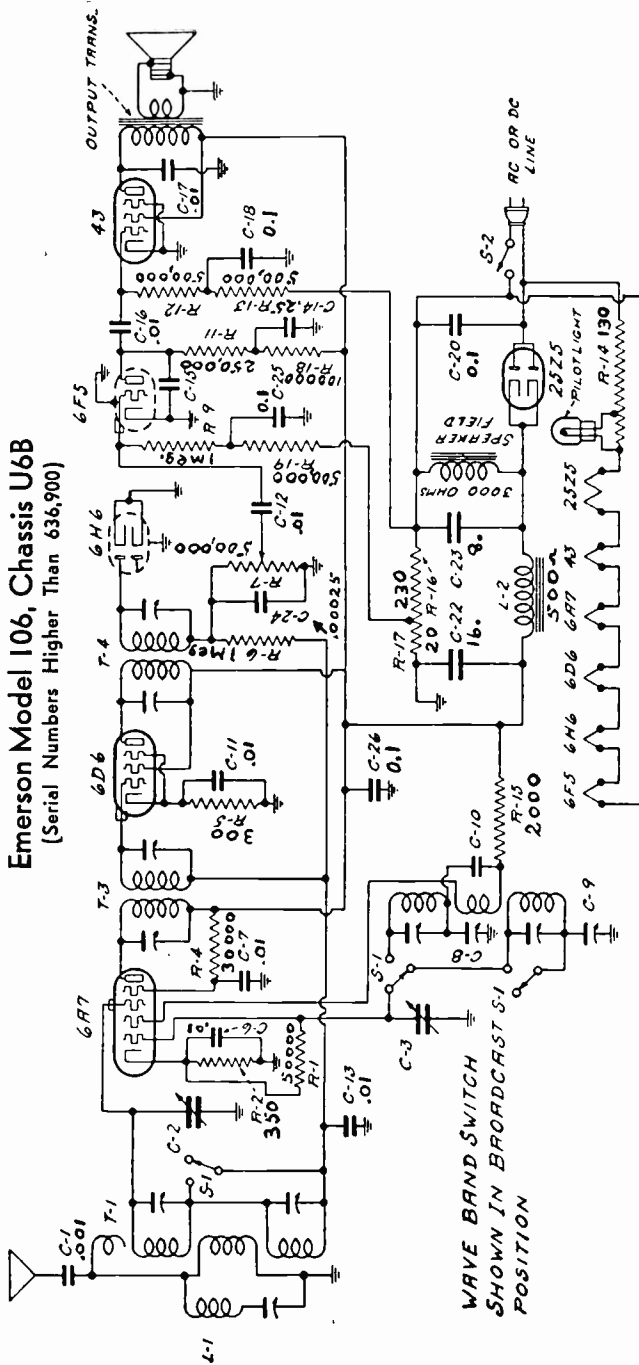

VOLTAGE ANALYSIS

Readings should be taken with a 1000 ohms-per-volt meter. Voltages listed below are from point indicated to 43 cathode (B minus). Line voltage for these readings was 117.5 volts, 60 cycles, a-c. Voltage across speaker field (25Z5 cathode to line switch—125 volts).

Tube	Plate	Screen	Cathode	Osc. Plate	File.
6A7	105	55	1.7	100	6 a-c
6D6	105	105	2.75	—	6 a-c
6H6	—	—	0	—	6 a-c
6F5	55	—	0	—	6 a-c
43	100	105	0	—	24 a-c

High Fidelity Broadcasting Station WTCN

Western Electric's new five kilowatt transmitter gives Twin Cities' listeners most modern development in Radio art.

listeners, possessing modern Radio receivers, virtually the same as they do in the studio.

The new location in rural Ramsey County, five miles from the Minneapolis City Hall and the same distance from the state capitol in St. Paul, is ideal for broadcasting purposes. This central spot equalizes the strength of the signal sent out over the air to both Minneapolis and St. Paul areas. As there are no nearby buildings to distort the transmitted wave, uniform coverage is assured to both cities.

Characteristics of the five kilowatt transmitter are of special interest, for the transmitter represents the newest developments in the family of Western Electric equipment. One hundred per cent modulation of the carrier is affected at low level by grid modulation. The purity of the signal is maintained in the processes of modulation and amplification; the distortion contribution of the transmitter being less than five per cent at 100 per cent modulation and less than two per cent at average program level.

The audio frequency characteristic is linear within \pm one db from 30 to 10,000 cycles. The noise level is at least 75 db below the signal at 100 per cent modulation as measured with a program noise meter. The carrier frequency stability is maintained to well within 50 cycles of the assigned frequency, and the harmonic radiation on any multiple of carrier frequency is at least 70 db below the carrier.

Major components of the new five kilowatt transmitter are assembled in compact, attractive cabinets which are easy to install. They occupy comparatively little floor space. There are five cabinets in all, each of which has doors which provide convenient access to the circuit components. These doors are grilled to provide full ventilation.

Complete modulating and Radio frequency units and part of the rectifying equipment are housed in the five cabinets. The first cabinet contains the crystal oscillator, buffer amplifiers and modulating amplifier together with their associated power supply equipment. The oscillator unit is calibrated at the factory and needs no further adjustment when installed. The vacuum tubes used in the oscillator and the two

buffer amplifier stages are of the equipotential type—271A. Resistance-capacity coupling is used from the oscillator to the first buffer and a band pass transformer from the first to second buffer. The second buffer stage uses two tubes in parallel. The amplifier is neutralized and is inductively coupled to the grid circuit of the modulating amplifier.

The modulating amplifier uses two 212E tubes in a push-pull circuit where modulation is accomplished by the grid method. The amplifier is neutralized and provides excitation for the intermediate amplifier contained in the next unit. Control of the Radio frequency grid excitation and consequently the power delivered to the antenna is obtained by potentiometer adjustment of the grid bias on the first buffer amplifier. The power supply apparatus for the first unit is contained in the cabinet.

In the second cabinet is the intermediate amplifier, a single stage amplifier using two 279A tubes in push-pull. It is a self-contained unit having rectifiers for grid and plate voltages. The output circuit is inductively coupled to a

load circuit providing grid excitation for the power amplifier.

The third cabinet contains the power amplifier tube unit. This consists of two 220B tubes in push-pull together with the load resistor and other apparatus associated with the grid and plate supply circuits. The input tuning is in the intermediate amplifier unit. The output tuned circuits are mounted in the power amplifier tuning unit. Grid and plate voltages are supplied by rectifiers external to this unit.

Tuning circuits of the power amplifier are contained in the fourth cabinet. The circuit



Single mast antenna and transmitter building, located equidistant between the Twin Cities.

TOWERING skyward, midway between the Twin Cities, stands WTCN's new antenna, symbolizing a new "voice" for the Northwest. The power behind this voice is a 5,000 watt transmitter which embodies the most recent improvements in high fidelity sound transmission and greatly widens the station's coverage. WTCN, owned and operated by the Minneapolis Tribune—St. Paul Press Dispatch, now ranks with the best equipped broadcasting stations in the country.

When the new system went on the air for the first time a few months ago Twin Cities Radio listeners accorded it a gala welcome. Crowds flocked to witness the dedication. The trim, buff colored brick structure which houses the transmitter became the center of attraction. Engineers on duty escorted the stream of enthusiastic visitors through the building explaining the workings of the intricate apparatus that performs the modern miracle of broadcasting today.

High fidelity in the reproduction of sound is an outstanding feature of WTCN's new transmitter. From it, programs go over the air with such life-like quality that the shadings and tones of voices and musical instruments are not lost in the process of transmission. As a result, speakers, vocalists and orchestras sound to

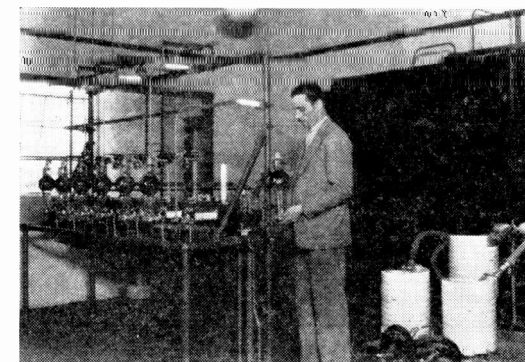

Rectifiers and rear of transmitter.

consists of two tuned meshes inductively coupled, the second mesh matching the input impedance of the transmission line and the first mesh offering the correct working impedance to the amplifier tube.

A monitoring rectifier is mounted in this unit and terminals are provided for connection to monitoring facilities in the speech input equipment to a monitoring loud speaking telephone and to oscillographic equipment.

The fifth unit may be mounted in the main transmitter line-up or separately. It contains time delay and control relays, rheostats, meters and the grid-bias rectifier. Twenty-four pilot lamps show when the important parts of the circuit are functioning properly and immediately indicate the location of any trouble that may arise. This enables tube replacements to be made in a comparatively short time.

(Page 18, please)

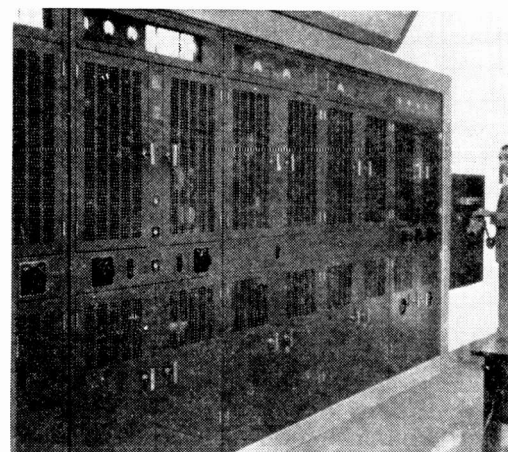

Impressive panel of the 5,000 watt high fidelity Western Electric transmitter.

(Continued from page 17)

A feature of the control circuit is the automatic restoring relay which returns the transmitter to operation in the event of momentary interruption of the power circuits or minor transmitter difficulty which requires the removal of the plate voltage from the vacuum tubes to clear. This feature insures a minimum loss of program time to the broadcaster from interruptions of this sort. Should more serious trouble occur, the power will be removed from the transmitter to prevent tube damage and a pilot light associated with the circuit in trouble will be extinguished in the control panel, thereby providing immediate indication to the station engineer of where to look for the difficulty. When this has been cleared the pilot light can be reset and the transmitter restarted immediately.

Meters for measuring the plate voltage, filament voltage, bias voltage, and the leakage current for the final amplifier are mounted on the front panel together with controls and adjustments. The leakage current is an indication of the conductivity of the cooling water. An hour counter provides means for checking the operation of the transmitter and tubes.

In addition to the five cabinets there are also an antenna coupling unit, high voltage rectifier equipment, and a water cooling system for the tubes in the final amplifier. The coupling unit is designed for use with a coaxial transmission line and is installed at the base of the antenna.

n r i

In the next issue of NATIONAL RADIO NEWS we are going to introduce you to two new members of the N. R. I. Staff who will be in positions to be of great help to every student and graduate. Watch for the next issue.

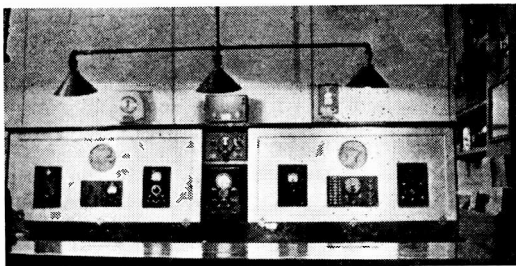

N. R. I. student Ralph E. Daniels, operating the Daniels Radio Service in San Luis Obispo, California, has just sent us this photograph of his test bench. Congratulations, Ralph, on a very neat, workmanlike job. Let's have some more pictures like this for NATIONAL RADIO NEWS.

G-E Radio and Automatic Phonograph Combination

A new eight tube Radio and automatic phonograph combination has been announced as an addition to the General Electric line.

Equipped with metal tubes exclusively, the unit has four bands covering weather reports and European long-wave, as well as standard broadcasts and short-wave reception.

Besides metal tubes, it incorporates the "sliding rule tuning scale," the "sentry box;" the "permaliner;" and the "stabilized dynamic loudspeaker."

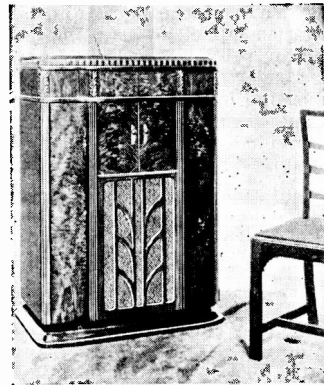

The automatic record changer accommodates nine 10-inch or eight 12-inch records. There is an intermission of only 4½ seconds between records.

n r i

Arcturus Introduces Metal Tube Line

The Arcturus Radio Tube Company, Newark, N. J., announces its "Coronet" Metal Tube line, utilizing a new and exclusive principle in receiving tube structure. It is claimed that the "Coronet" seal in these tubes enables the application of the manufacturing technique perfected by the industry over the past 28 years.

By using the tried and proved advantages of the vacuum tube art in the manufacture of "Coronet" metal tubes, the inherent weaknesses of the original metal tube are overcome. This special construction also results in a material reduction of the input and output capacities and makes possible uniformity in inter-element capacities. A special process has been developed to permit proper bombardment of the inner elements to the temperature necessary to dispense with residual gas troubles. The "Coronet" seal also precludes the possibility of shorts between wires and ground.

The types already in production are 5Z4, 6A8, 6C5, 6F5, 6F6, 6H6, 6J7, 6K7 and 6L7.

Quality and Harmony (Continued from page 11)



I applied two coats of *old ivory* enamel (to surfaces exposed to view). After the first coat dried, it was smoothed with fine steel wool. After the second coat dried (I waited 72 hours) I rubbed the entire surface with powdered pumice-stone. For flat surfaces I used a felt pad nailed to the side of a wood block; for curved surfaces I used a pad alone. The pad is dipped in water, then in pumice, and I rubbed along the length of each surface until smooth and velvety. Surplus pumice was washed off.

Aligning the Chassis. To introduce flat-top resonance into the R. F. system, I resorted to the cathode ray oscillograph and a wobbled signal generator. First the I. F. was peaked; the oscillator made to track the preselector dial; then the preselector was peaked. Next turning to the I. F., I band-passed this section to about 16 kc. width. I found the shunt resistor across the intermediate I. F. transformer helpful in getting wide response. The signal generator was connected to the input of the first detector, with the oscillator tube out.

Next the signal generator was connected to the input of the receiver and the receiver and generator tuned to each other at 1,400 kc. The oscillator of the receiver was peaked by adjusting the trimmer; the preselector trimmers were then adjusted for peak response. To band-pass the preselector one trimmer was advanced, the other turned out to restore band-pass response. The receiver was tuned so the first segment on the variable condensers meshed with stator, and in the same manner, but in this case bending the segments, the receiver was

band-passed. Of course, the signal generator was tuned to give peak output before any adjustment was made. The same procedure was continued until all segments were adjusted.

Introducing High Frequency Output. The tone control on the receiver was removed and a 50,000 ohm potentiometer used in its place. The end terminals were connected to the plates of the output tubes, each protected by a series .5 mfd. condenser, and connections were made to the tweeter loudspeaker as shown in Fig. 4. I fastened the tweeter to the center of the grill, right inside the regular loudspeaker, after cutting a small hole in its frame for the twisted connecting wires. Now I fastened the regular loudspeaker to a small tilted platform which I moved up until the felt of the loudspeaker just touched the inclined baffle. The platform was screwed to the cabinet, not the baffle.

I made a board 4" wide and 18" long; cut five strips of carpet 5" wide and 30" long; nailed one piece to the center of the board, the fuzzy side towards the rear of the loudspeaker. The other four pieces were nailed at a 45 degree angle. All fuzzy pieces were in the same direction. Then the board was screwed to the rear opening of the sounding box, so sound from the rear of the loudspeaker would be absorbed.

The chassis was slipped into its compartment. Holes were located for the controls and dial before they were cut. Before the receiver front panel was returned, the edge was covered with white adhesive tape, to prevent vibration. After the panel was locked in place, the chassis was inserted into its compartment, knobs attached and the loudspeaker cable connected.

After the receiver was connected to my noise-reducing antenna, I was convinced that I had a better Radio. Now when I want to hear the letters *s*, *t*, *k* and *d* pronounced by the performer or announcer, or hear their breathing, or the noise in the studio, or the high passages of symphonies, or that grand opera tenor show his "stuff," I advance the tweeter control.

"Pal," my wife said, "that's a fine Radio,"—indicating that the other half of the Kaufman partnership was satisfied.

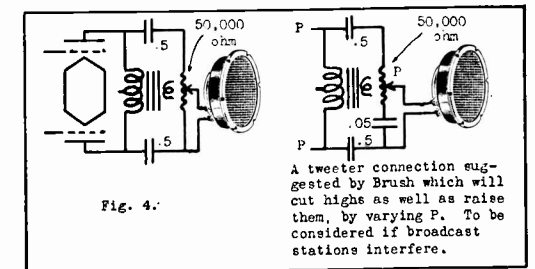

Fig. 4.

A tweeter connection suggested by Brush which will cut highs as well as raise them, by varying P. To be considered if broadcast stations interfere.



RADIO-TRICIAN

REG. U.S. PAT. OFF.

Service Sheet

Compiled Solely for Students and Graduates

NATIONAL RADIO INSTITUTE, WASHINGTON, D. C.

EMERSON MODEL 109, CHASSIS U4A

GENERAL NOTES

1. The filament dropping resistor (R13—see schematic) is a resistance wire built into the special line cord. The cord will, therefore, become warm under normal conditions. To insure good heat radiation stretch out the line cord to its full length. Do not attempt to shorten it by cutting.
2. One side of the power line is directly grounded to the chassis base. Under no circumstances, therefore, should a ground wire be permitted to come in contact with any metal part of this receiver.
3. If replacements are made or the wiring disturbed in the r-f section of the circuit the receiver should be realigned.
4. When replacing the oscillator coil, be sure to mount it in the correct position. The locating hole in the square fibre terminal strip should be nearest the rear of the chassis.

TUBE DATA

- 1—6A7—Pentagrid oscillator-modulator
- 1—6F7—Triode amplifier-pentode detector
- 1—43—Pentode power output
- 1—25Z5—Dual half-wave rectifier

VOLTAGE ANALYSIS

Voltage readings should be taken with a 1000 ohms-per-volt-meter. Voltages listed below are from point indicated to ground (chassis).

Tube	Plate	Screen	Cathode	Osc. Plate	Fil.
6A7	105	60	1.35	105	5.5
6F7	55	15	2.25	—	5.5
Triode					
43	98	105	14.4	—	23.0

Voltage across speaker field—115

Voltage across choke—10.5

ADJUSTMENTS

An oscillator with frequencies of 456 and 1425 kc should be used.

An output meter should be used across the voice coil or output transformer for observing maximum response.

Location of I-F's and Trimmers: The first i-f transformer, is in an oblong coil can, located on top of the chassis directly behind the speaker. The two trimmers for this i-f are accessible through holes in the top of the coil can.

The second i-f transformer, is in a round coil can located on top of the chassis to the left of the speaker. The single trimmer for this i-f is accessible through a hole in the top of the coil can.

The oscillator and antenna trimmers are located on the top of the variable condenser. The oscillator trimmer is on the rear section and the antenna trimmer is on the front section.

Alignment Procedure: 1. Rotate variable condenser to minimum.

2. Feed 456 kc to grid of 6A7 tube.

3. Adjust the three i-f trimmers, repeating for maximum response.

4. Set dial pointer to 1425 and feed 1425 kc through the antenna.

5. Adjust the oscillator (rear) trimmer for maximum response.

6. Adjust antenna trimmer for maximum response.

Readers who file Service Data in separate binders remove page carefully, trim on dotted line for same size as data published heretofore.

Emerson Model 109, Chassis U4A

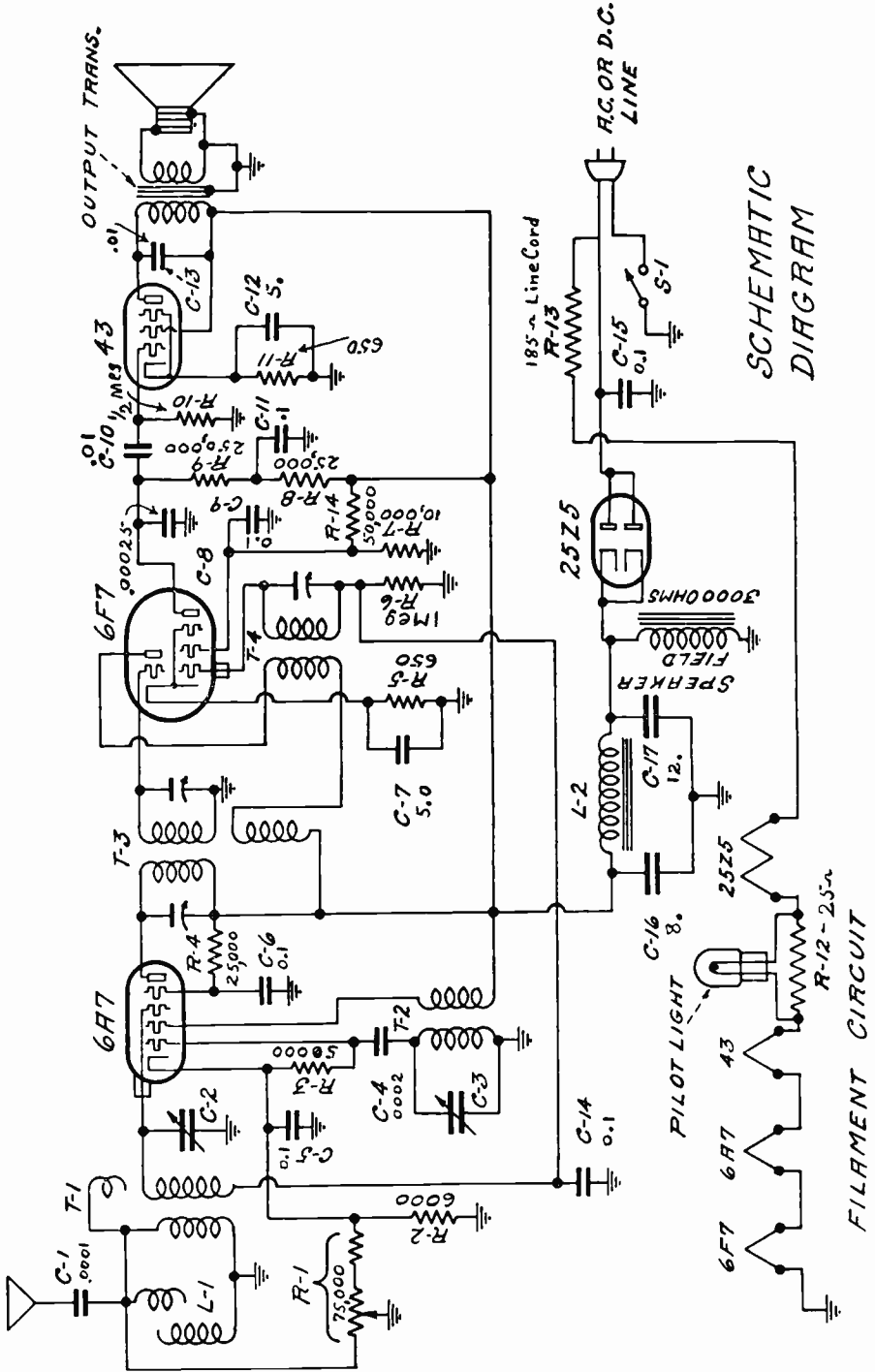

SCHMATIC DIAGRAM

An Inexpensive Test Panel (Continued from page 8)

35,000. The percentage of difference is so small that the error in the voltage measurements will be negligible.

II. OHMMETER AND CONTINUITY TESTER. The Readrite 0-5 milliammeter is used in constructing the ohmmeter. The 16,000 ohm resistor may be a variable resistor such as a 20,000 ohm volume control, or a 10,000 ohm fixed resistor in series with a 10,000 ohm resistor such as supplied with the Home Experimental Units. In adjusting the ohmmeter, a voltage supply of exactly 90 volts should be connected to the meter as shown, with *all the 20,000 ohms* resistance in the circuit and the test leads short-circuited. The variable resistance is then varied until exact full-scale deflection is obtained on the meter.

There are two ways of calibrating the ohmmeter for future use. One way is to measure the resistance of several resistors known to be correct and observe the reading obtained on the meter for the different resistors. These values and readings can be tabulated in the form of a table, or a curve can be plotted showing the various values.

Another method is to use the formula for determining the resistance in a series ohmmeter circuit,

$$R_x = \left(\frac{D_1}{D_2} - 1 \right) R_m$$

where R_x is the resistor being measured, D_1 the meter reading obtained without having R_x connected but test leads shorted, D_2 meter reading obtained when R_x is connected, R_m the resistance of the meter circuit, in this case 10,000 ohms. The values which are obtained from various calculations should, of course, be tabulated or put in a graph form for future use.

This ohmmeter also makes an excellent continuity tester and it will be found to be one of the most used instruments in the shop.

III. I. F. OSCILLATOR. Very little explanation is needed for the construction of the I. F. oscillator, as practically all of the details are given in the schematic diagram. The only part which cannot be found in practically any Radio shop is the 7.7 mh. choke coil, which is center tapped. This choke coil is now standard equipment in Home Experimental Unit No. 5, or it can be obtained from the Service Supply Division at a cost of twenty-five cents. With the switch in the "C. W." position the oscillator will produce continuous waves, while with the switch in "Mod." the oscillator will be modulated by the audio frequency produced by the A. F. oscillator. If it is not desired to build the A. F. oscillator then a modulated signal can be obtained by changing the grid leak from

25,000 to 2 megohms. Either 45 or 90 volts should be used on the plate of the tube, using the value that gives best results.

Any 3-element tube such as a 26, 71, 45, 31 or 27 can be used in place of the 30 tube shown in the diagram. Of course the proper socket and filament voltage should be used according to the tube selected.

The fundamental frequency of the oscillator is from approximately 100 kc. to 300 kc. However, any strong harmonic signal is equally useful as the fundamental. This modulated oscillator produces useful strong harmonics up to the fifteenth. That is, with the oscillator set at a fundamental of 100 kc., we can make use of the various harmonics, beginning with the sixth in a broadcast receiver to make adjustments at 600, 700, 800, 900, 1,000, 1,100, 1,200, 1,300, 1,400 or 1,500 kc. In fact, when we can hear signals at all of these adjustments, we know the oscillator is set so the fundamental frequency is 100 kc. because the difference between any two signals is 100 kc.

Mark an indicating line on the panel opposite the zero line at the dial for calibrating purposes. Then set a broadcast receiver to 550 kc. and slowly decrease the oscillator dial (near 39) until maximum signal is heard again. This is the 110 kc. setting of the oscillator made from the fifth harmonic of the fundamental. Make a notation of this dial reading for future resetting. Make similar recordings from the fifth harmonic for 120 kc. by setting the receiver to 600 kc. and again for 130 kc. by setting the receiver to 650 kc. and so on, advancing the receiver dial in steps of 50 kc. to record progressive changes of 10 kc. of the oscillator dial. This procedure allows you to mark the settings of the entire fundamental range up to 300 kc. without complicated calculations and trials but a final check at 300 kc. should be made, noting that when the signal is tuned in at 1,500 kc. then it is also possible to leave the oscillator set for 300 and again tune in the signal at 900 and 600 kc. on the broadcast receiver. Here the difference between the harmonic signals is 300 kc., proving that the fundamental is 300 kc.

The oscillator dial then can be quickly reset to any position for using a desired fundamental, such as 162, 175, or 242 kc., for testing or aligning a superheterodyne.

When you need a signal of 464 kc., set the oscillator to a position which you estimate to be 232 kc. A check of the fifth harmonic on a broadcast receiver set to 1,160 kc. will let you make this setting exactly.

IV. POWER SUPPLY PANEL. Very little will be said concerning the power panel, inasmuch as its construction will depend entirely upon the parts which the constructor may have

(Page 25, please)

They Also Help With Your Training

WE want you to be well acquainted with the members of the N. R. I. Staff—feel that you know, personally, the people who are responsible for bringing you your Radio education. It will make your studies—your association with the Institute much more pleasant and interesting.



For this reason we have, from time to time, through the columns of NATIONAL RADIO NEWS, brought you the history and interesting high lights on the various men in the N. R. I. organization.

It is high time, we think, that you should meet some of the ladies of the National Radio Institute Staff, and realize that they too play important parts in furthering the aims and ideals of N. R. I., and that they are extremely important in the educational program laid out for each student from the time he enrolls to the time of his graduation, and thereafter.

For instance, in picture Number 1, we have Margaret Starkey, whose chief interests are with the graduates of N. R. I. One-half of her time is devoted as an Assistant to the Manager of the Employment and Graduate Service Department; the balance as Assistant to the Executive Secretary of the N. R. I. Alumni Association. She was educated at Luray High School, Luray, Virginia, and Virginia Intermont College, Bristol, Virginia. She has been with N. R. I. over five years.

Number 2 pictures a young lady who serves you no end, though you scarcely, if ever, hear her name mentioned. Ida Soldano is Confidential Secretary to President Smith. Many of the letters you receive from Mr. Smith are through her hands. Since Mr. Smith follows his students' records very closely, Miss Soldano must, necessarily, be in very close touch with them. She was educated in Washington, and has been with the Institute for twelve years.

Mildred Alligood, the young lady pictured in Number 3, has only been with the Institute a short time, about two years, but her ability to handle a great volume of detail and her interest in matters pertaining to students and graduates, quickly won for her the position of Secretary to Mr. E. R. Haas, Vice-President and Director of the Institute. She, also, was educated in Washington.

Our picture Number 4 is Anne Gorman. She attended Business High School in Washington, and came with N. R. I. about ten years ago. While it is not usual for the fair sex to delve into the intricacies of Radio, this young lady showed such an interest in the subject that she was appointed Technical Librarian for the N. R. I. Instruction Department, the position she now holds. In this capacity, her service to students and graduates needs no explanation.

(Last page, please)

These Letters Tell Their Own Story

C. A. Drotleff of 1689 Mahoning Avenue, Youngstown, Ohio, enrolled for the N. R. I. Course in Radio, specializing in Servicing and Merchandising. At the time he was forty-six years old and engaged in the tailoring and dry cleaning business.

Read these letters he has written to N. R. I.
November 15, 1934

Dear Mr. Dowie:

I am somewhat behind with my lessons because I have been very busy servicing Radio sets this fall.

Mr. Dowie, I am very proud to say that with the experience I have gained from my lessons so far, I have been able to earn some extra money in spare time.

I want to let you in on a secret right here. Do you know that every dollar I have paid on my Course so far I have earned by doing Radio work?

I wish to state that I am very proud of being a student of the N. R. I.

You may rest assured that I will endeavor to catch up with my lessons in the very near future.

Very truly yours,

C. A. DROTLEFF.

May 24, 1935

Dear Mr. Smith:

I can say that I have been getting along pretty good with my spare time Radio work. I have serviced and repaired quite a few sets during the last summer and fall season, and I am happy to report to you that so far I have been quite successful.

Well, Mr. Smith, I can honestly say that your training I have so far, has done me a lot of good. I have made about twice as much money as my Course cost me, and I think it's the best training a fellow can get for the money he pays. Mr. Smith, I am proud of the N. R. I., and hope that every young man who likes Radio will take your Course, because it's the best he can get in the country, and before closing, let me wish you and the whole staff of N. R. I. the best of success.

Your student,

C. A. DROTLEFF.

June 10, 1935

Dear Mr. Smith:

In checking over my book, I find I have earned about \$354 in doing spare time Radio work since I started my Radio Course. That does not include two sets I have here now, which are one Edison and one Chevrolet auto Radio.

I am going to get \$4 for each. That is \$8 for both, so that will be \$362.00.

Sincerely yours,

C. A. DROTLEFF.

(Page 25, please)

Sprague "Tiny Mike" Condensers Announced

An unusually small dry electrolytic condenser of full capacity and 450-v working voltage has just been perfected and placed upon the market by Sprague Products Company, North Adams, Massachusetts. The condenser is called the Sprague "Tiny-Mike," Type TM.

Basing their size comparisons upon their own standard types, the makers of "Tiny-Mike" assert that this little fellow actually fits into one-half the space occupied by standard condensers of equal capacity. This makes an exceptionally compact unit—although one that is large

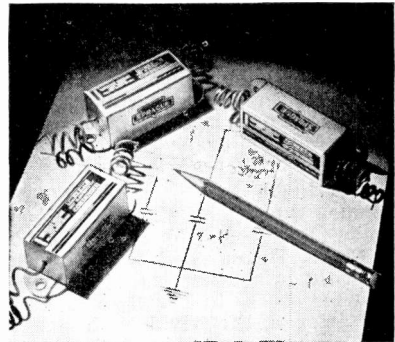

enough and so constructed as not to overheat. Like other Sprague Condensers, the TM units are guaranteed unconditionally when used on any voltage up to their rated capacity.

"Tiny-Mike" condensers are an ideal low cost replacement for any of the electrolytic condensers used in modern Radio sets, wet or dry. Where economy is a factor, "Tiny-Mikes" may be used to replace any cell in multiple units, and where exceptionally high capacity is wanted, two or more TM units may be combined in parallel.

"Tiny-Mike" condenser is fully described in the Sprague 1936 Catalog which will be sent upon request to the manufacturer.

— n r i —

Arcturus Issues Data Bulletin on "Coronet" Line

A four-page folder giving a general description of the new "Coronet" line has just been issued by the Arcturus Radio Tube Company, Newark, N. J. This bulletin also contains a complete chart of characteristics and a table giving pin connections and physical specifications. It will be sent free to dealers and servicemen requesting it on their letterhead.

Old Timer "Signs Off"

NATIONAL RADIO NEWS has just been informed by one of its Columbus, Ohio readers of the death of David N. Osyor, who claimed the distinction of firing the last shot in the Civil War, and of being the oldest N. R. I. student.

On April 17, 1865, during an engagement near Durham, N. C., Sergeant Osyor of Company F, Ninth Ohio Volunteer Cavalry, had the chevrons torn from his arm by the bullet of a Confederate sniper. Osyor, seeing the smoking barrel of a long rifle in an apple tree, fired at it, wounding the sniper in the leg. Almost simultaneously a truce was declared and the war ended.

In later years Osyor became a telegraph operator, but finding the work too tame, again joined the Army and took an active part in the Indian wars and became acquainted with Buffalo Bill, America's foremost frontier hero.

Mr. Osyor later became a mining engineer and showed a great interest in electrical subjects. Radio held a strange fascination for him and for a number of years he operated his own radio repair shop.

Those men who think they are "too old to learn new tricks," should take a page from Osyor's book. He enrolled with the National Radio Institute when he was 88 years old, and completed his course in less than a year.

At 94, after a life vivid with action, this grand old man leaves us, beloved and admired by his many friends and acquaintances.

— n r i —

This Is Your Day

There never was a time when we could say, "It is yesterday," and there never will be a time when we can say, "It is tomorrow"—forever and forever it is today. The past has ceased to be and the future has not been born. Therefore, whatever we hope to accomplish *must* be done in the *now*. The present is all we have and somewhere hidden away in the magic words "Today" and "Now" lies the secret of Success and Happiness.

— n r i —

It is always a puzzle to psychologists as to whether great men read detective stories for relaxation or because they were licked for doing it when kids.

— n r i —

Those who try to understand women usually succeed only in marrying them.

— n r i —

It is a man's unflinching ego that causes him to think his particular trouble is the most important thing in the world.

The Small Grid Bias Cells

Duo-diode triodes with high mu factors, such as the 75 and 2A6 are extensively used in modern receivers as a combination second detector, A. V. C. and first audio. The triode requires a low negative bias and has a low plate current. Furthermore the contact potential at the grid is unusually high for a new tube (about + .9 volt), gradually decreasing with age.

This introduces two difficulties. First, these tubes should operate at - 2 volts C bias. If the bias is originally set for - 3 volts to over-

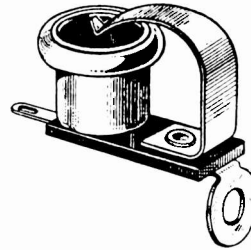

Fig. 1
Courtesy
P. R. Mallory & Co.,
Indianapolis, Ind.

come contact potential of + .9, eventually the tube will be over-biased. If the bias is produced automatically by a cathode resistance, the latter would have unusually high resistance for an audio tube. Unless extremely high capacity shunt condensers, which are expensive, are used, considerable A. F. degeneration (loss of signal strength) will occur.

Much of this difficulty is eliminated by the Mallory grid bias cell, shown in Fig. 1. This cell is acorn shaped, about $\frac{5}{8}$ " in diameter and $1\frac{1}{32}$ " deep. It is an electrolytic cell which originally has a no-current potential of 1 volt, and if charged by a current will have a potential not exceeding 2 volts. It holds its charged potential for about 48 hours, gradually dropping to normal.

A typical circuit to overcome the effects of degeneration and varying contact potential is shown in Fig. 2. For a new tube the cell which is in the grid circuit with a grid resistor cancels all the + contact potential leaving a net C bias of about - .1 volt. On a strong signal grid current flows momentarily, charges the cell to - 2 volts, and the net bias is (minus 2 + .9) = 1.1 volts. As long as the signal does not exceed this value normal action takes place. Momentary excessive grid signal only recharges the cell. As the tube ages its contact potential drops and more of the cell voltages are usable. Thus with aging of the tube, it will handle stronger signals.

Inasmuch as the cathode C bias resistor is
(Next page, please)



N. R. I. ALUMNI News

DUNN REELECTED

Popular Baltimorean Gets Second Term as President

THE *betting averages* were high this year in favor of P. J. Dunn for President of the Alumni Association. He did a splendid job during 1935, proving he was a good organizer—and had the interest of the Association at heart. You fellows showed you appreciated the fine work he has been doing in your interest. Just the same, his opponent in the election, Allen Arndt. (Chairman, New York Metropolitan Area Chapter) gave him a *good run for his money* in the early stages of balloting—but the finals told the tale.

“Pete” carried the State of Maryland, naturally, also those middle western states he visited last summer, while on tour in the interest of the Association. “Al” gave a good account of himself in New York State and various cities throughout the United States and Canada.

Both of these men were *presidential timber*—and a lot of the fellows are anxious to see what “Al” would do at the reins. There is another election next year—perhaps “Al” will be nominated again—who knows!

“Pete” has worked hard for the Alumni in the past, and he is going on to a new high in the coming year. Get behind the President—co-operate in every possible way to make 1936 a banner year for the N. R. I. Alumni Association.

— n r i —

THANKS FOR THE BOOST

“We recognize that N. R. I. graduates who have completed a valuable training can use, for their own business, the excellent goodwill of the N. R. I. by belonging to the National Radio Institute Alumni Association.”

DAN FAIRBANKS, *Sales Manager*,
International Resistance Co.,
Philadelphia, Pennsylvania.

INSTALL NEW OFFICERS

Three New Vice-Presidents—New Executive
Secretary Take Office

Merryman Retains Job

This year's election broke all records for being the most interesting and exciting. Only three National Officers of the Association were reelected—P. J. Dunn, Earl Bennett, and E. Merryman.

Edward J. Meyer, St. Louis, Missouri, a new Vice-President, proved his popularity from the start. “Ed” has built a lively Radio business in his home town, and wants to open an Alumni Association Chapter there. *We hope he makes the grade.*

For many years, National Alumni Officers were residents of the United States. Then in 1932, Alphy Blais, Thetford Mines, P. Q., Canada, changed all that by being elected to office. And now, the very popular Ed. Witherstone, Secretary-Treasurer of the Toronto Chapter and Editor of their magazine, the *Canadian Radio-Trician*, “crashed through” at the recent elections to become the second Canadian to be elected a Vice-President of the Alumni Association. Witherstone has certainly done a fine job for N. R. I. men, living on the other side of the border, if we are to take as an indication the large number of votes cast in his favor. “He stands ‘Ace High’ in Canada,” reports one enthusiastic voter from the Far North. Congratulations Witherstone!

The Philadelphia-Camden Chapter is mighty happy these days—Clarence Stokes of that Chapter was also elected Vice-President by a large majority. You have guessed it—voting was particularly heavy in the Pennsylvania and Jersey areas.

We don't know exactly what Earl Merryman, our Secretary, “has on the ball,” but he has the honor now of being the oldest officer of the Alumni Association. He has been Secretary since the Association was organized in 1929.

(Page 30, please)



Chicago Chapter

The race between Local Chapter editors for bigger and better bulletins is getting interesting. Mr. C. B. Morehead, Editor of the *Chicago Chapter Chatter*, turned out a bulletin last month that may cause no little envy in other Alumni circles. It was a swell job and showed evidence of careful thought and preparation. This fellow Morehead will bear watching!

Cupid recently paid a visit to one of the Chapter members. Mr. F. Wiktorski took the big step. The Mr. and Mrs. will make their home at 1423 Darrow Avenue, Evanston, Ill. The Association wishes them every happiness.

One of the highlights at the last meeting was the reappearance of several of the old timers, who have been missed at recent gatherings. There were also several new members present. The fellows who didn't get to the last meeting certainly missed hearing a fine Radio speaker. Mr. Lee gave a talk on "Analyzers and Testing Equipment." He described, also, some new rotary switches which have recently been placed on the market for use in analyzers, and promised to bring more samples for inspection by the members at the next meeting. As a prologue to his lecture, he passed several of them in the audience and illustrated their use by diagrams on the blackboard. To say the boys were interested is understating it.

Meetings will be continued on the regularly scheduled dates, the first and third Fridays of the month. Place: The Sherman Hotel (see bulletin board for room number): Time: 8:30 P. M.; Objectives: Education, association, reciprocity, recreation—and every N. R. I. man in the Chicago area is urged to pay a visit and see what is going on.

— n r i —

"Organizations now in existence have bettered the service man's position. They have obtained much needed recognition from Radio manufacturers. Furthermore, they have increased the Radio man's earning power, at the same time eliminating many unfair practices. All service men who believe in their future should belong to or support an organization devoted to their welfare."

B. E. JENKINS, *Manager*,
Electronic Division,
Weston Electrical Instrument Corp.,
Newark, New Jersey.

Technical Bulletin Service a Success

Thanks, fellows, for the overwhelming response you gave to our technical bulletin plan. The membership replied with hundreds of voting coupons, signifying they wanted National Headquarters to send them more technical bulletins, publications, instruction books, tube and Radio receiving set data—direct from the manufacturer.

We are very glad to be able to inaugurate this new service for N. R. I. Alumni members. As one fellow put it, "you never can have too much technical data in the Radio servicing business." We feel the same way about it. Contacts are continuing to be made with Radio manufacturers and other organizations for this purpose. Only material that has recognized Radio technical value will be selected. It is our desire to help in every possible way to make N. R. I. Alumni members better Radio men.

— n r i —

"Jim" Kearns Resigns

The New York Metropolitan Area Chapter announces "Jim" Kearns has resigned as Chairman. He had held this office since the Chapter was formed in April 1934.

"Jim" writes that he is going to attend meetings as usual—but circumstances prevent him from continuing as Chairman. A lot of the fellows will miss "Jim's" dynamic personality as *master of ceremonies*. We all wish him well.

— n r i —

"Ham" Convention

Alumni member H. A. Logsdon of Topeka, Kansas, was in charge of an exhibit at the tenth annual Kansas State Convention of Radio amateurs, Hotel Kansan, Topeka, a short time ago. The professional model 37-A, M. W. Airline 7 tube super was displayed by Mr. Logsdon, and attracted considerable attention among the "Hams."

C. W. Bourne, an Alumni member of Ainsworth, Nebraska, who also attended the convention, stated in a letter to National Headquarters, "If more N. R. I. men would associate themselves with the Alumni Association, these men would be more readily identified with taking an active part in the Radio industry."

— n r i —

It is estimated that the Automobile manufacturers will produce 4,000,000 cars this coming season. Somebody is going to sell a lot of automobile Radio receivers to this group.

New Mailing O. K'd

A short time ago, an Alumni member suggested that we mail new members' certificates, books, membership cards, etc., in a large flat manila envelope with cardboard backing, the idea being that the certificate would be in better condition for framing. The idea was tested and has proved successful. We have received a number of reports from men to whom this test mailing was made, notifying us the condition of the package when it was received. Here are a few of the reports:

Mr. Audrey Harris of Waco, Texas, says, "I received the package of books, membership card and certificate—all seemed to have arrived just as they were packed."

L. C. Goff of Los Angeles, California, reports, "The package which you mailed to me was received in excellent condition. It did not show any evidence of having been bent and the cardboard was unbroken."

Mr. L. J. Chavarry of Gardiner, Maine, reports, "Package arrived O. K. I think this is a good way to mail our certificate and other material."

In the future, the N. R. I. Alumni Association certificate as well as other material sent in the package will be mailed flat.

— n r i —

Directory of Chapters

In each issue of "THE NEWS" we publish a list of the Local Chapters, and the addresses of the officers to whom you may write for information on Chapter Programs. Here is the list:

Baltimore — I. A. Willett, Secretary, 2411 Arunah Ave., Baltimore, Md.

Philadelphia — Clarence Stokes, Secretary, 2947 Rutledge St., Philadelphia, Pa.

New York—Allen Arndt, Chairman, 183 Avenue C, Apt. 6, New York City.

Buffalo—T. J. Telaak, Chairman, 657 Broadway, Buffalo, N. Y.

Toronto—Ed Witherstone, Secretary, 363 Nairn Ave., Toronto, Ont., Canada.

Chicago—Samuel Juricek, Secretary, 4223 N. Oakley Ave., Chicago, Illinois.

Pittsburgh—Albert Maas, Secretary, 9 S. Howard Ave., Bellevue, Pa.

Detroit—F. E. Oliver, Secretary, 218 Alter Rd., Detroit, Mich.

— n r i —

Folks used to be willing to wait patiently for a slow moving stage-coach; but now they kick like the mischief if they miss one revolution of a revolving door.



New York Metropolitan Area Chapter

Mr. Allen Arndt was recently elected Chairman to succeed "Jim" Kearns. After sending in the final examination on his "public speaking course," he should be well prepared to give the boys some fine bits of oratory.

"Al," you know, made a real bid for National Presidency this year, and received a large number of votes. But—P. J. Dunn, National President for 1935 and Chairman of the Baltimore Chapter, had the edge on "Al" in the final balloting—piling up a large majority. "Pete" had done such a fine job during 1935, the members clearly indicated they wanted to give him another opportunity to "carry on" in 1936.

Word reaches National Headquarters that the New York Metropolitan Area Chapter desires to increase its membership by at least fifty in the next few months. A number of surprises are in store for the men who support Chapter officers, in their endeavor to build a bigger and finer Alumni Chapter.

N. R. I. graduates and students living in the New York Area are urged to get in touch with Mr. Allen Arndt, 183 Avenue C, Apt. 6, New York City, for complete information regarding meeting dates and Chapter plans for 1936.

— n r i —

A Member Says

Oliver B. Hill, Moscow, Idaho, writes: "While sending in my vote on your New Alumni service plan, I would like to add my congratulations and express my appreciation for the NATIONAL RADIO NEWS. It is a splendid publication from cover to cover. The department which discusses the new circuits and testing equipment and so on, such as the one covering the Cathode Ray Oscillograph, the data sheets, metal tubes, are always very valuable. In fact, I find everything in it very interesting, and I hope that Mr. Smith always has his page for us. I'd be completely lost without the NEWS."

— n r i —

Reports received by NATIONAL RADIO NEWS indicate that Philco has recently added 2,000 employees, and now has 10,000 on its factory payroll.

Baltimore Chapter

Four important and interesting speakers will make their appearance at the next three meetings of the Baltimore Chapter. They will speak in the following order. Mr. Walter R. Jones, Engineer, Hygrade Sylvania Corporation; Mr. John F. Rider, Publisher; Mr. H. P. Bridge, Editor *IRC Servicer*; and Mr. Dan Fairbanks, Sales Engineer, IRC. A large attendance is anticipated to hear these gentlemen, as they are in close touch with the Radio-Trician's problems.

The latest copy of the *Baltimore Bulletin* shows its Editor, Mr. Wilmer Giese, is continuing to hold his own despite the competition from other Chapter publications. The service tips and Radio articles would do credit to any large Radio magazine. More power to you, Giese.

Many of the Chapter members will be glad to learn that their former Advertising Manager, Mr. Charlie Hachemeister, is going to be back with them in Baltimore after a long sojourn in Shrewsbury, Pa. He will take over the advertising reigns—relieving Mr. Goswell who did a very creditable job while pinch-hitting for Mr. Hachemeister.

Word reaches National Headquarters that Mr. Charles Lottes is opening a Radio repair shop at 2233 Reisterstown Road. We all join in wishing him the best of success.

Considerable interest is being shown by the Chapter in holding a dance—repeating the very pleasant social affair of last year. In all probability, this dance will be arranged to take place in the New Howard Hotel, which may also become the new meeting headquarters of the Baltimore Chapter.

"Pete" Dunn announced that he will resign as chairman of the Baltimore Local to devote more of his time to his duties as National President of the Association. National Headquarters is keeping him quite busy with 1936 Association plans. Incidentally, "Pete" has been all smiles since it was announced he was re-elected.

— n r i —

"We have watched with great interest the progress being made by the National Radio Institute Alumni Association and are convinced that your organization is accomplishing a great deal of good for its members."

F. J. WESSNER, *General Manager*,
National Union Tube Corp.,
New York, New York.

— n r i —

Have you ever noticed that some people find it difficult to forgive their own vices in others?

Toronto Chapter



Mr. Ed Witherstone, Editor of the *Canadian Radio-Trician* and Secretary-Treasurer of the Toronto Chapter, covered Canada like a blanket, as candidate in the recent election of National officers. From every nook and corner votes poured into National Headquarters supporting Mr. Witherstone as Vice-President of the Association. Then, too, many votes came to him from men living right on this side of the border—"such popularity must be deserved." (Pardon us, Mr. Chesterfield.)

Mr. McLean, charter member of the Toronto Chapter, has accepted the job as advertising solicitor for the *Canadian Radio-Trician*. "By getting paid advertisements in our paper we hope to give a bigger publication," reports the Editor.

The following Local officers were elected to serve during 1936:

- A. Stollard, Chairman.
- D. Heath, Vice-Chairman.
- E. Witherstone, Secretary-Treasurer.
- V. Trowell, Librarian.
- H. McLean, Member of Executive Council.

Two of the former officers, W. Forward and E. Solomon declined nomination for office this year due to lack of time in both cases. The Toronto Chapter reports, "We are sorry to lose the benefits of having these two members serve us, but feel sure the state they have helped to bring the Local up to, will make it easier for those who have taken their places to carry on."

At a recent meeting, Mr. J. C. Wilson delivered a very interesting talk on the business side of Radio. "Don't ever," said Mr. Wilson, "under-rate yourself because of not knowing everything there is to know about Radio. It is far more important to learn to apply what you do know rather than limit yourself and your earning ability until you have everything mastered." There is a "wisdom in them thar words."

— n r i —

"We are very pleased to cooperate with your Alumni Association in your endeavor to elevate the ethical practices of the Radio servicing industry."

W. L. BOHLKE,
RCA Manufacturing Company, Inc.,
Camden, New Jersey.

Philadelphia-Camden Chapter

The Philcam Radio Sales and Service, 2433 Kensington Ave., Philadelphia—a local Alumni Association project—is proving a great success.

It certainly looks as if the Local officers of the Philcam Chapter have hit the bull's eye again when they developed their own service business. Meetings are held every Thursday night. The third Thursday being set aside for business meeting and the remaining Thursday nights for servicing instructions. This latter move is one of the most important made by the Local since its entry into the Association. It gives both students and graduates the opportunity for practical instruction that is bound to be profitable to all concerned. National Headquarters urges every student and graduate living in the Philadelphia-Camden area to investigate this Local Alumni shop plan.

Mr. Clarence Stokes, Local Secretary, was recently informed that he had been successful in the national election for officers. He is one of the four vice-presidents who will take part in Alumni activities for 1936. Congratulations.

Both Mr. Willett and Mr. Hornbrook are to be commended for the fine job they are doing with the Local Chapter publication, *Philcam Key*. This is a lively little magazine and should be in the hands of every N. R. I. man living in Philadelphia and vicinity. Readers will find within its pages many interesting editorials, technical discussions, service hints, personal notes on members. The slogan of the Philadelphia-Camden Chapter "Progressive Champs" is well justified.

— n r i —

"NATIONAL RADIO NEWS is a very complete publication, and should greatly enhance the value of your training to graduate members."

FLOYD FAUSETT, *Chief Engineer*,
Supreme Instruments Corp.,
Greenwood, Mississippi.

— n r i —

"I am glad to be able to join the N. R. I. Alumni Association as I think it more than well worth the money."

JOHN A. BROWN,
General Electric Company,
Payette, Idaho.

— n r i —

Mr. Joseph Kaufman, N. R. I. Director of Education discusses "The Philosophy of Radio Servicing" in the next issue of NATIONAL RADIO NEWS.

Detroit Chapter

Mr. Barlow, Chairman, reports to National Headquarters that the Detroit Chapter members are enthusiastic in having round-table discussions of Radio receiver troubles. A wealth of knowledge can be gained by individual members in this way, as they can see demonstrated the procedure of other Radio-Tricians in repair work. A cordial invitation is extended to N. R. I. students and graduates living in Detroit and vicinity to be present at these demonstrations. Full information can be secured by writing Mr. F. E. Oliver, Secretary, 218 Alter Road, Detroit.

A cathode ray oscillograph practical demonstration will be arranged shortly by Mr. Mills, former chairman. The speaker on this occasion will be Mr. Adams, well-known in Radio circles in the Detroit area. This type of equipment has excited considerable interest among servicemen. No student or graduate who is seriously interested in his future can afford not to keep pace with the many new developments that are finding their way into the Radio profession. There is no better way in which you can do this than by being present at every Local Chapter meeting.

— n r i —

New Officers

(Continued from page 26)

That is quite a record for any man to set up, don't you think? Samuel Juricek of Chicago gave him a real "tussel" for the job, you can be sure.

R. B. Murray, the new Executive Secretary, was voted into office by a large majority. We are looking forward to having him keep things "humming" during the year. P. J. Murray did not run for office, but we learn he is going to give as much time as possible to serving the Association. C. E. Lenhart of Edmond, Oklahoma, opposition to "Bob," put up a good fight—how those Oklahoma members did pull for their "home-town" talent.

Former Vice-Presidents L. J. Vanek, Frank Parkins and Fred Nichols, earned for themselves a well deserved rest. National Headquarters and the Alumni, thanks them for the real service they have performed in behalf of the Association.

W. Giese, Baltimore, and John Jacobs of San Francisco, gave a good account of their popularity—only a few more votes would have turned the tide.

— n r i —

Man calls fate to account for accidents but feels personally responsible when he makes a hole in one.



Praises Consultation Service

I certainly appreciate the mighty fine Consultation Service offered students and graduates of the National Radio Institute. I had been trying for a long time to get a circuit diagram on a certain receiver. Various companies, which make a specialty of supplying diagrams, could not furnish one for this model—in fact, the manufacturer, through his process of changing model numbers frequently, could not even identify the set. But when I asked N. R. I. about it—described the set to them and gave them what other information I had available on it, not only recognized the set, but supplied the diagram which I needed. That's real, worthwhile service.

Signed: Staff Sergeant B. B. MARCH,
Signal Corps, U. S. Army.

— n r i —

Hams Recently Reported

Since the last issue of NATIONAL RADIO NEWS the following N. R. I. Amateurs have reported their call letters to the Mailbag:

H. F. Hayes—W8ACD—Lapeer, Mich.
Henry Nitzel—W3FTT—Baltimore, Md.
William Ballard—W2EWE—Suffern, N. Y.
Earl C. Ward—W6ETX—Los Angeles, Calif.
Forrest Drew—W1BJP—Newport, Vermont

— n r i —

Thanks Bernard Valour

I'd like to thank Mr. Bernard Valour, of Sloatsburg, N. Y., for the idea advanced in "The Mailbag" of NATIONAL RADIO NEWS for August-September, 1935. He told of a service job on a Dewald Model 724 A. C. His tip certainly helped me on a recent job.

JULIUS TENCH,
Bedford, Ohio.

— n r i —

A Suggestion

I have read and re-read the last issue of the N. R. NEWS. It surely is a "dandy" Radio publication. It is full of useful as well as instructive and entertaining material, and I de-

rived a lot of pleasure from it. There is one point to which I would like to call your attention. I have quite a few copies of the News which I would like to bind, but to do so would have to sacrifice valuable data. For instance, on pages 16 and 17 of the last issue is a picture of Mr. Hollingsworth, and underneath a chart bearing on the subject discussed. To bind this copy would entail losing valuable information.

Could it not be arranged to have these splendid articles so printed that none of the material would be lost?

J. C. N. GOSLING,
Pointe Claire, P. Q., Canada.

We also have the problem of binding copies of NATIONAL RADIO NEWS for our Editorial Office use. Our solution is to use Gilmer Binders, similar to those that so many N. R. I. students use to bind their lesson texts. We find them ideal for the purpose.—Editor.

— n r i —

Stepping On It

If Radio service work keeps on coming in at the present rate, I'll have to quit my regular job in order to have enough time. In the past week I have had 1 Philco; 4 Simplex Midgets; 1 Silvertone; 2 Spartons; 1 A. C. Dayton; 1 RCA-Victor; 1 Crosley; 1 Echophone; 1 Majestic, and 1 Stewart Warner. Not bad for an old fellow, is it?

L. A. HORTON,
Plainwell, Mich.

— n r i —

Wants Advice

I've seen so much good advice from readers of "The Mailbag" in answer to questions, that I'd like to ask for some. I wonder if some of my fellow graduates will tell me what they think of the Radio serviceman having sidelines, such as repairing household electrical equipment, etc., also should the average serviceman try to sell receivers?

ALLEN HAYWORTH,
New York City.

Let's give Hayworth the benefit of our experiences. Send your answers to his questions to "The Editor, NATIONAL RADIO NEWS, 16th & You Streets, Washington, D. C."—Editor.

They Also Help

(Continued from page 22)

Miss Ella Diltz is pictured as Number 5. She is Secretary to the Office Manager and as such assists in the coordination work which is so important to the smooth operation of the National Radio Institute. This is extremely important to N. R. I. students and graduates. Miss Diltz received her early education in Siloam Springs, Arkansas, and attended college in Washington, D. C. She has been with N. R. I. for over six years.

The little lady with the big smile (Number 6), is Silvia Sachs. Born in New York, she attended high school in Washington, D. C. Miss Sachs is in the Student Service Department. She keeps a close watch on students' progress and knows more about your student records than you do yourself. She has been with the Institute nearly eight years.

Sarah Heigham, the young lady pictured in Number 7, is a native Washingtonian. She was educated in this city, and has been with the National Radio Institute for about eight years. Coming with N. R. I. as a typist she soon showed a keen interest in students' problems and was transferred to the Student Service Department. Just fail to send your lessons in on time, and this young lady will know about it even before Chief Instructor Dowie does. Her job, in a few words, is keeping N. R. I. students going forward rapidly toward success.

In length of service, Isabelle Fant (Number 8) is one of the oldest members of the Institute's Staff. She has been with N. R. I. since 1920. Also a native Washingtonian, she is a graduate of Eastern High School and Wood's Commercial College. Her work with the Institute is of utmost importance, as she is in entire charge of the Stenographic Department, where many of the letters written you by Mr. Smith, and members of the Staff, are typed.

Margaret Matthias, the young lady pictured in Number 9, is Secretary to the Publicity Director. Since the function of this department is to make N. R. I. Radio-Tricians better known throughout the world, the importance of her service to students and graduates is self-evident. Born and raised in Washington, she was graduated from Central High School, and Stewart's Business College. She has been with N. R. I. nearly nine years.

There are lots more ladies on the N. R. I. Staff we want you to meet. So if the Staff Photographer can keep his camera working, we'll tell you about some more of them and how they fit into the N. R. I. organization to serve you.

Page Thirty-two

NATIONAL RADIO NEWS

FROM N. R. I. TRAINING HEADQUARTERS

Vol. 6—No. 12

February-March, 1936

Published every other month in the interest of the students
and Alumni Association of the

NATIONAL RADIO INSTITUTE
Washington, D. C.

The Official Organ of the N. R. I. Alumni Association

Editorial and Business Office, 16th & You Sts., N. W.,
Washington, D. C.

P. J. MURRAY, MANAGING EDITOR

NATIONAL RADIO NEWS accepts no paid advertising. Articles referring to products of manufacturers, wholesalers, etc., are included for readers' information only, and we assume no responsibility for these companies or their products.

Index

Article	Page
Seventeen to Seventy	2
Inexpensive Test Panel	3
Service Forum	5
Electric Eye Sorts Mail	6
Man Wanted	7
Quality and Harmony	9
Data Sheet, Emerson Model 106	13-14
High Fidelity Station WTCN	16-17
Data Sheet, Emerson Model 109	19-20
They Also Help	22
Small Grid Bias Cells	24
Alumni News	26-27-28-29-30
Mailbag	31