



National **RADIO** News

Vol. 6—No. 7

WASHINGTON, D. C.

Apr.-May, 1935

IN THIS ISSUE

Which Road? . . . by E. R. Haas

New Use for Aviation-Radio

Broadcasting from a Bobsled

WOR's New Station

and a BIG, special article by
Frank Cook

ALL-WAVE ANTENNA
SYSTEMS

By J. E. Smith, President, N. R. I.



J. E. Smith

Sounds That Led to War Preserved in NBC Museum

AN echo of the early days of the World War is contained in the "peep-peep" of a wireless message sent 19 years ago, which was caught and preserved on a wax phonograph record just added to the NBC museum of Radio relics in the RCA Building, Radio City.

The historic cylinder, exhibited in the studio foyer, reproduces the dots and dashes sent by the German-owned wireless station at Sayville, L. I., in 1915, which were picked up by Charles Apgar of Westfield, N. J., on his home-made receiving set. The set itself, a crude affair compared with modern equipment, also is in the exhibit.

In the early days of the war it was suspected that messages transmitted to Europe via Sayville contained a secret code, in violation of this country's neutrality. Government stations at Arlington and Fire Island monitored the Sayville messages, without uncovering anything out of the way.

Finally Chief Flynn of the Secret Service personally requested Apgar, well-known "Radio detective," to check the Sayville signals. Each night for two weeks Apgar picked up every signal sent by Sayville.

The records were turned over to Flynn, and it was found that the wax had caught many significant details of the transmission which had escaped those who had listened to the signals. After investigation of Apgar's records, the Government refused to renew the station's license, and the plant was taken over by the Navy Department. Thus the Sayville incident was one of the first of the "overt acts" which led to America's declaration of war two years later.

Page Two

Apgar's famous records, 175 in all, were closely guarded in the Government archives several years. Recently they were acquired by the National Broadcasting Company for display in its large collection of history-making Radio equipment, and a sample record has been on exhibition at Radio City with the crude paratus used and donated by Charles Apgar. Even on the small, battered tin phonograph which Apgar used, the Sayville signals may be heard today as clearly as when the amateur sleuth recorded them 19 years ago.

The NBC museum includes many other famous relics, including the sending set on which Marconi made his celebrated letter S broadcast the original bunsen burner detector which inspired Dr. De Forest his idea for Radio tubes, Edison's first model of a phonograph, and hundreds of other original devices which had an important bearing on the development of voice recording and wireless transmission. The exhibits are shown to more than a thousand visitors each day who make the tour of the Radio City studio with trained NBC guides.

— n r i —

Beware of Panhandlers

I want to call the attention of every student and graduate of the National Radio Institute to a brand new racket, which seems to have sprung up in the last few months.

Some unscrupulous persons, who have secured the names and addresses of N.R.I. students and graduates from some of our literature, are writing these students and graduates soliciting funds. In the majority of cases they use the story that they are broke and want to take the N.R.I. Course of Training, and want N.R.I. students and graduates to contribute—to them out so that they can get their education.

They even go so far as to make elaborate promises regarding the return of the money, sometimes stating that they will pay high interest rates for the loan of this money.

Do not fall for these stories. Do not give these solicitors any money. Regardless of how deserving they may make their cases look, remember, it is a "racket." If you receive such letters, pay no attention to the request for financial help, but send the letter to the National Radio Institute. We'll take the necessary action from this end.

All-Wave Antenna Systems

By Frank Cook, N. R. I. Instruction Staff

THE Importance of a Good Antenna. If an all-wave antenna system is properly designed, connected and coupled to the all-wave set the results obtained will be a great increase in signal strength, and a decrease in the amount of noise picked up. There are many types and makes of all-wave antennas, some more desirable than others, but on the whole all superior to the usual straight-away broadcast antenna, if you install them according to the instructions furnished by their makers. In this article I will explain why these antennas are so different: that they all accomplish the same purpose.

In order to learn these facts, let us forget details for a while and investigate some of the properties of a wire, stretched in space.

Theory of the Antenna. A single wire has distributed throughout its length: inductance, capacity and resistance. Forgetting the resistance for a while, we have inductance and capacity remaining. It can readily be seen that the presence of these two factors will cause a condition of resonance to exist. In other words, the wire will tune to a certain frequency. That is, it will resonate to a definite frequency. Since the inductance and capacity are distributed, it is evident that the length of the wire is very important, determining the frequency to which it will resonate.

It has been found that the length bears a definite relation to the wavelength of the incoming signal. A wire will be resonant to a wave whose length in meters is very nearly the length of the wire in meters. In other words, the wave will "stand" on the aerial. In order to clearly understand this, refer to Fig. 1A. The cycle shown is called a fundamental wave. In the case of a radio frequency signal, the length of the wire in meters—to resonate to a definite radio frequency signal—may be determined by dividing 300,000 meters by the frequency in kilocycles.

If the total length of wire is equal to one-half the length of the fundamental wave, then a one-half wave will be standing upon it—yet still in resonance with the transmitted wave. Certain aerials are called half-wave aerials since they depend on this fact. However, this is not the only frequency to which the wire is resonant, which is fortunate; otherwise, we would find it necessary to erect many aerials in order to receive best results over the wide range of frequencies for which the modern radio is designed. This half-wave aerial will also respond to all harmonics of the fundamental signal. If a half-wave aerial is designed to work on a fundamental frequency of 10,000 kilocycles it will also respond to 20,000 and 30,000 kilocycles, etc. The current distribution is shown in Fig.

1B, for the second and third harmonics. Notice that there is very little current at the ends of the wire. Maximum voltage will, however, be present at these points.

Returning to our half-wave antenna, we find two facts of interest to study. First, the presence of the resistance has the same effect on resonance that it would have in any tuning circuit; that is, to broaden its resonant characteristic. Therefore, if we select the length of a wire so as to tune to a middle frequency in some wave band we still are able to obtain good results from signals in the adjacent frequency range. Of course, the farther away from the resonant frequency the signal that we wish to receive happens to be, the less will be the aerial voltage. Consequently a weaker signal is present. We cannot expect an aerial which really works best at one frequency to work as well at other values. Fortunately the radio receiver will amplify the weak signals.

The second point about this aerial is its impedance at various points along its length. If we were to measure the impedance between point C, the center, and any point such as 1, we would find that it increased from zero to a very large value as a point was selected near the ends of the wire. If we were to cut the half-wave antenna in two and measure the resonant resistance we would be astonished to find that it always has an impedance of about 75 ohms. This is of importance because of the

(Page 8, please)

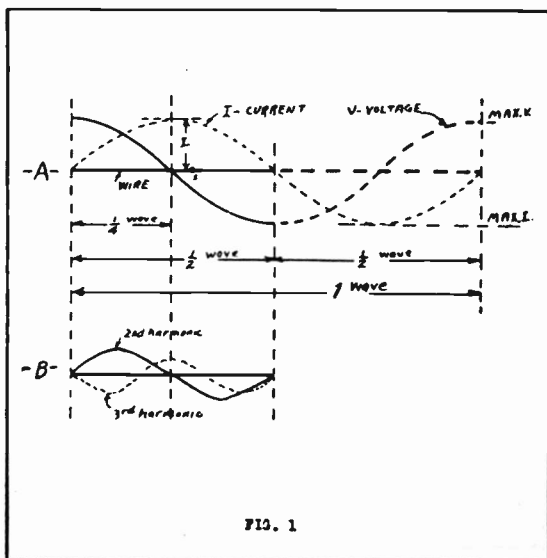

FIG. 1

Easy Measurement Charts

Simple formulas and charts for calculating values of combined resistances.



J. A. Dowie,
N. R. I. Chief
Instructor

THE amount of current which will flow in any given radio or electrical circuit can be calculated by the use of Ohm's Law, or simple charts as previously shown in article of December, 1934-January, 1935 NATIONAL RADIO NEWS.

The formula or equation for this law takes into consideration a single resistance or several resistances connected either in series or parallel.

When resistance units are connected together in series, the resultant resistance of the combination is the sum of the individual values according to the formula

(1) $R = R_1 + R_2 + R_3$ etc., which means, in other words, the total resistance R equals resistance No. 1 plus resistance No. 2 plus resistance No. 3, etc.

Thus if a resistance is found to be too small in value and the correct value of resistance is not available, the required additional resistance or resistances may be connected in series with it to give the correct value. For example, suppose a circuit required 10 ohms resistance in it to control the value of current and you did not have a 10 ohm resistor available, a 6 and

4 ohm resistor would give you 10 ohms, or a 4 plus 4 plus 2 ohm resistor would give you the correct value.

When a number of resistance units are connected in parallel, or shunt, an entirely different relation holds. The resultant resistance in this case is less than that of any one component. That is, the total resistance value of the parallel combination is lower than the lowest resistance taken singly.

When two equal resistances are connected in parallel, there are two paths through which the current can flow with equal ease, and therefore it is twice as easy for current to flow as if only one of the resistances were present. That is, the combined resistance of two equal resistances connected in parallel is only one-half the resistance of either one singly.

For example, the combined resistance of two 50 ohm resistors connected in parallel would be: Combined resistance equals $\frac{1}{2} \times 50$ equal 25 ohms. If three equal resistances are connected in parallel it will be three times as easy for the current to flow, therefore the combined resistance in this case is only one-third the value of any of the resistances taken singly. In the same way, we can easily find the combined resistance of any number of equal resistances connected in parallel.

When there are two unequal resistances in parallel the resultant resistance can be calculated by the following formula*:

(2)
$$R = \frac{R_1 \times R_2}{R_1 + R_2}$$

Where R equals the resultant resistance and R_1 and R_2 the unequal resistances connected in parallel. From the formula it can be seen that

*Of course, this formula may be used for equal resistances, although it is much simpler to divide by 2, 3, or 4 depending on whether 2, 3, or equal resistances are in parallel.

(Page 15, please)

Resistances in Parallel
(in ohms)

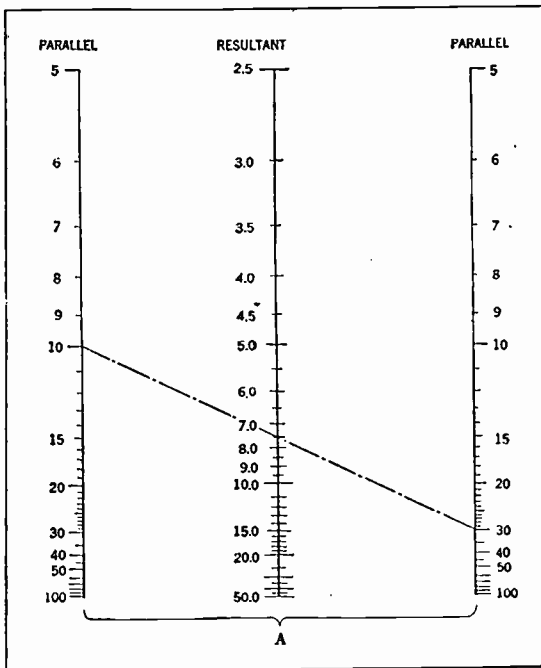

The Service Forum

CROSLEY MODELS 58 & 59

HUM

If the tubes, filter condensers, etc., test okay replace the 1 megohm resistor in the grid circuit of the 47 type tube. Oftentimes a defect in this resistor will result in hum.

— n r i —

ATWATER KENT INTERMITTENT MODEL 82

Oscillation and intermittent operation are often due to a defect in the R.F. trimmer condensers. The connections to the condensers should be checked and also the mica spacer should be examined. If found to be defective install a new piece of mica. The condenser is one of the two trimmers on top of the I.F. transformer, completely enclosed in the shield can.

— n r i —

GENERAL ELECTRIC INCREASING MODEL 831 SENSITIVITY

It has been found that the removal of the shield from the first I.F. transformer will result in an increase in sensitivity in this set.

— n r i —

LYRIC MODEL J DISTORTION

This is generally caused by an open in the 500,000 ohm center tapped resistor located near the power transformer. A replacement can be made with two 250,000 ohm 2 watt resistors connected in series.

— n r i —

SPARTON MODEL 99 DEAD

When the receiver is completely inoperative and there is no plate voltage on any of the R.F. tubes and the voltage on the power tubes is low, check for a primary to secondary short in the R.F. transformers. Very close coupling is obtained by winding the primary and the secondary leads together and they sometimes short. A replacement of the transformer is recommended, although the coil can be repaired by unwinding the entire bobbin and locating the shorted point.

— n r i —

SPARTON MODEL 931 REWIRING

An improvement can be made in this set by replacing the 182 type tubes with two 2A5 type tubes. The filaments of the two tubes must be wired in series and the hum control should be removed. The bias resistor should be replaced

with one having a value of 200 ohms and rated at 5 watts. The 80 tube may be replaced with a 5Z3 and if the output transformer is changed to one designed to work with 2A5's into a voice coil impedance of 9 or 10 ohms the result will quite justify the change.

— n r i —

SPARTON MODEL 930 HUM AND NOISY

This is often due to a poor connection between the electrolytic condenser can and the chassis. Cleaning the connection at this point will clear up the trouble.

— n r i —

PHILCO MODEL 19X HUM

Check the hum bucking coil, making sure the leads are not shorted. Try reversing the leads to the hum bucking coil.

— n r i —

KENNEDY, UNIVERSAL AUDIO HOWL MODEL

Check the volume control and see if one of its terminals is making intermittent contact to the speaker frame.

— n r i —

MAJESTIC MODEL 52 INTERMITTENT RECEPTION

Check the .04 microfarad condenser connected from the cathode of the first detector to the oscillator coil. This condenser sometimes breaks down intermittently thus causing the trouble.

— n r i —

CLARION MODEL 320 INTERMITTENT RECEPTION

The .0008 microfarad condenser in the detector-oscillator cathode circuit sometimes opens up, causing the trouble—replace the condenser with another of the same size.

— n r i —

MAJESTIC MODEL 500 DEAD

When a circuit disturbance test shows that nothing is coming through ahead of the 42 type tube the .05 microfarad coupling condenser between the 6F7 and the power tube is probably open.

— n r i —

RCA MODELS 44 & 46 DIFFICULTY IN ALIGNING

This is usually caused by a change in inductance in the first R.F. coil which is un-

(Page 11, please)

New Use for Aviation-Radio

NEWSPAPER offices in the sky—fleet news gatherers darting from one scene of events to another at 200 miles an hour, and broadcasting the news to the waiting millions far below. Fantastic? Not at all. It is now an accomplished fact, and one which shows promise of creating an additional demand for trained, capable Radio men.

Already the Detroit News has placed in service at Detroit's City Airport, a new Lockheed Airplane, especially designed for this work. The plane will carry four persons, or half a ton of newspapers. It flies more than 200 miles an hour.

Broadcasting Equipment

The plane's Radio equipment includes a new transmitter, which is to be an auxiliary of Radio Station WWJ, the Detroit News Radio Station, in broadcasting outdoor events of special public interest. The broadcasting installation was worked out by engineers of Station WWJ, American Airlines and the Trans-Continental and Western Air, Inc. The transmitter, which covers a range of 1,000 to 6,000 kilocycles, was built for the Detroit News by the Western Electric Company. As a pickup station for re-broadcasting through Station WWJ, the plane has been assigned call letters WKFB, and operates on a frequency of 2,150 kilocycles.

Airways Communications

The transmitter operates for both voice and code, and it can be controlled from either the pilot's seat or the passengers' cabin.

For airway communication covering the movement of the plane, the Federal Communications Commission has designated it as Station K11PMN. Such communications are transmitted on a frequency of 3,105 kilocycles.

Receiving Apparatus

The Radio receiving equipment covers a range of 195 to 6,000 kilocycles. A special receiver includes a navigator's directional loop, provisions for flying the airway range beacons and receiv-

ing the Department of Commerce weather broadcasts.

Photographic Equipment

Special equipment provides for the first time, a practical method of taking aerial news pictures with an automatic camera, directed and controlled by the pilot.

Three camera installations are included in the plane's equipment, making it possible to take pictures at any angle from the plane—forward, above or below. One camera is mounted on the left wing, eight feet from the cabin. It is installed in a fixed position, parallel to the line of flight, and enclosed in a streamline compartment. This camera is operated by an electric motor with controls leading through the wing

to the pilot's seat. A gun sight mounted on the pilot's windshield serves as his view finder. The pilot merely aims his plane until the view he desires is perfectly framed in the gun sight. Then he presses a switch in the plane control stick which puts the automatic camera in operation. Pictures can be taken at intervals of

two seconds and a total of 110 can be taken with one loading of the camera magazine.

Photos also are taken straight down from the plane through the floor. This installation can be operated manually from the passenger cabin or automatically from the pilot's seat.

The third camera installation is located in one of the paper-carrying compartments at the rear. It provides for manually operated cameras projected upward, sidewise and to the rear of the plane.

While the popular trend in aircraft design is to use metal construction, this special plane is made principally of wood to minimize camera vibration and background noise which would interfere with broadcasting.

The plane itself is of the low-wing monoplane type, outfitted as land or sea plane. Retractable wheels are interchangeable with floats for alighting on water. The wing spread is 43 feet. The plane has a fuel capacity for cruising 1,000 miles.

It is powered by a Pratt & Whitney engine

(Next page, please)

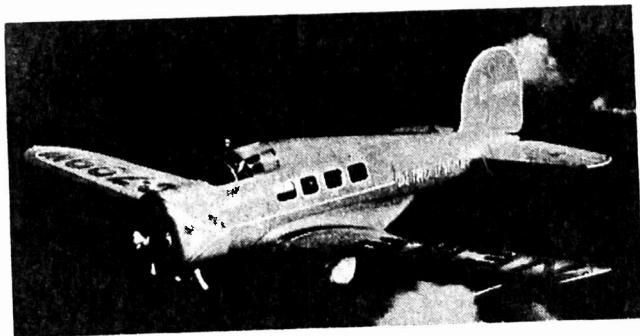

The "Early Bird," photographic and broadcasting plane of the Detroit News.



Walter R. Hoffman, Chief Engineer of Radio Station WWJ, operating the Western Electric Transmitter at the telegraph desk in the "Early Bird."

rated at 550 horsepower and a Hamilton controllable-pitch propeller. Special supercharging increases the power output as the plane climbs. Increasing the propeller pitch in the climb, much as one would shift gears in a car, makes full use of the power.

The engine drives two pumps governing the operation of the automatic controls, the propeller control and a Radio generator. It also heats the cabin.

Robot

The plane is equipped with a robot or automatic pilot, which serves to relieve the plane pilot while he is taking pictures, broadcasting news, writing or handling navigation problems.

Two small gyroscopes mounted in the airplane control panel are the brains of the mechanical pilot. Hydraulic pistons furnish the brawn to move the airplane controls. Air valves and spring pulleys furnish the co-ordinating nerves and muscles.

One unit controls the rudder and steers the plane. The other controls the ailerons and keeps the wing level. It also controls the elevator, keeping the fuselage level and regulating the angle of climb or descent.

Once the plane is off the ground and headed on its course, the aviator pulls a lever to en-

gage the automatic pilot. The gyroscopes are rotated by a vacuum pump at 12,000 rpm. Their speed tends to keep them in a fixed position.

When irregular air current tilts the nose or wing of the plane up or down, the gyro supporting frames open and close the air jets. They transmit corrective impulses to the airplane controls and the plane is brought back to the straight and level path.

Will Benefit Radio Industry

It is not hard to see the result to the Radio industry if the newspapers of America generally adopt the practice of utilizing aircraft for news gathering and broadcasting. Every transmitter and every receiver so installed must be manufactured by trained Radio men. In the merchandising and installation of this equipment, the Radio-Trician's services are again in demand. And then we come to the important job of operating the equipment. There must be operators in the planes, and at the pick-up stations on the ground.

It is difficult to predict what the outcome of this may be in the increased demand for Radio personnel, but we do know that this is another forward step in aviation, and since Radio furnishes the *eyes and ears*, for aircraft in flight, and consequently moves forward, step by step with the aviation industry, we can agree that this is also a large stride in the right direction for the Radio industry.

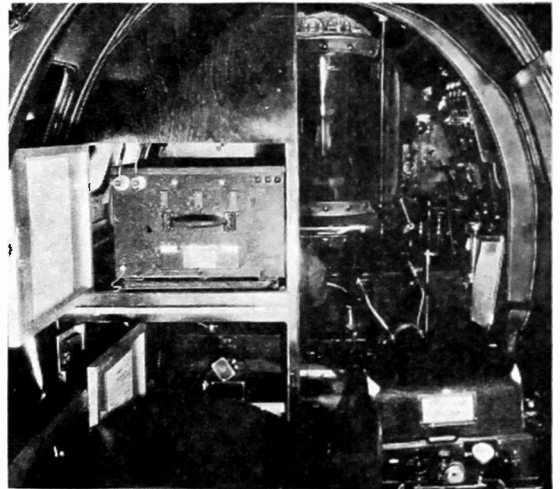

Interior of the "Early Bird," showing the Western Electric Radio transmitter and receiver.

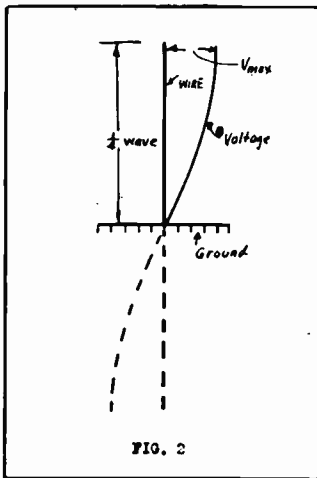

FIG. 2

effect on current flow in the aerial, since it is necessary to know this if proper matching or coupling is to be accomplished. This phase of all-wave antennas will be taken up a little later on.

The Different Types of Antennas. We are now ready to take up other antenna forms. Roughly, antennas may be divided into two systems, called the Marconi and the Hertz aeri-

als, named after their inventors. We will study the Marconi type first, since it is the most common system and one of the simplest.

The Marconi system uses a ground connection, while the Hertz type does not. In the Marconi system the ground has the property of doubling the wavelength in meters to which a given length of wire will resonate. The vertical wire is a quarter-wave aerial, as shown in Fig. 2. The dotted lines are purely imaginary and are included to show that we really have one-half of a one-half wave antenna.

This brings up another important point in regard to this type of aerial. Figure 3 shows the two most common methods of erecting this aerial, either as an inverted L or T type. The horizontal or the flat top portion is considered part of the aerial, while the vertical portion may be called the lead-in. Nevertheless it is to be included in the antenna itself. It forms part of the collecting system. Yet the length of the antenna is measured, as indicated by the dash-dash line, and should be one-quarter wave. A quarter-wave antenna performs equally as well on all harmonics.

The flat portion collects waves which are reflected from the sky, while the lead-in picks up local signals and waves arriving at a low angle. This ability of the lead-in is at once the blessing and the curse of this type of aerial.

Properly installed, the lead-in would provide a greater pickup for local signals. However, few service men know about this and they fail to realize that the aerial system includes not only the lead-in but the antenna coil of the set and the ground wire as well. You will find many cases in your service work where the lead-in is close to a metal roof, near water-spouts, along the side of a building for long distances,

or running parallel to the ground wire for great distances in order to conceal the lead-in. Where this is done, the lead-in actually loses some of the energy collected by the flat top and does not assist in collecting the desired signal but permits a possibility of noise pickup.

This last item, noise, is the greatest factor which forces us to choose other types of antenna systems. The lead-in comes down to the ground, passing through zones of the greatest man-made interference. The only possible solution is the location and elimination of the source of interference, or the use of some other type of antenna which employs a transmission line.

Summing up the outstanding factors of the Marconi system, we may use a shorter wire; and if made for the broadcast band it will be operated quite satisfactorily at its third, fifth, seventh, etc., harmonics. When properly installed, we find response very good. Faulty installations and noise are the chief offenders. In locations where man-made interference is low and where space permits proper installation, this antenna is still the favorite type.

It can be seen from this that if we can eliminate the lead-in from the flat top portion, the interference will decrease. Also, if we can erect the aerial properly outside of the noise zone and still connect it to the set, we will experience a further decrease in interference or noise. Remember, man-made interference is a greater problem on the shorter waves than on the broadcast band. For instance, automobiles radiate a large quantity of interference experienced on the high frequencies as their ignition systems are actually radio transmitters.

The Hertz antenna system has outstanding advantages and will now be discussed. This type of antenna does not rely on a ground connection for its operation and therefore must consist of one or any multiple of half wave lengths. The usual forms of Hertzian antennas are the horizontal, vertical and the bent forms as shown in Fig. 4. The vertical type does not

(Page 10, please)

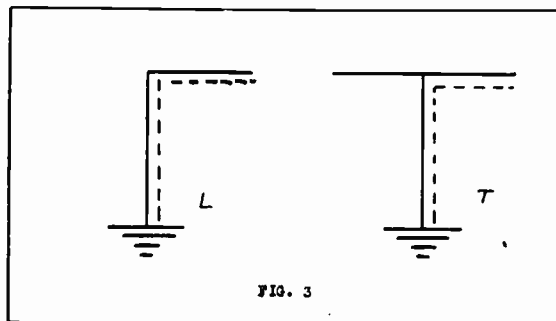

FIG. 3

World's First Broadcast From a Bobsled

SKIMMING over the ice on the dangerous Mt. Van Hoevenberg bobsled run at Lake Placid at a speed which at times reached 70 miles an hour, Eugene S. Darlington, a General Electric engineer, carrying a small portable Radio transmitter, broadcast a running description of the sensations experienced in this mile and a half dash, a feat never before done in the history of Radio. It required less than two minutes to make the trip, but in those two minutes were packed an exciting description of a harrowing experience such as few Radio announcers have ever had.

With Ed Tyrell, one of the most experienced drivers at the wheel, and the first man ever to drive the course, Jim Brown, another bobsledder of years' training in second position, and Harold Darrah at brake, Darlington, in third position on the bobsled made this epochal broadcast which was carried over General Electric's stations, WGY, and W2XAD, in Schenectady.

Firmly strapped to his back was a 25-pound pack set, atop of which was a five-foot antenna which more or less resembled a fish pole. Strapped to his chest was a special microphone, which was much like those used by a telephone switchboard operator. His hands were both occupied in holding himself to the sled.

Bobsledding was a new experience for him and his first words after "Well, here we come, we're leaving the top of the mountain," was a call to the man behind him to "take off the brakes." The first few yards of the run were smooth and easy sledding. The curves were easy up to this point. Then came his call, "we're coming to the first big curve. It's White Face. We're in it. Oh boy, was that a thrill." His voice was trembling a bit, but he didn't stop talking, not even when the sled went tearing through Zig-Zag, where the sled was high on one bank one instant and up on the opposite side the next. "We're coming to Zig-Zag," murmured Darlington into his microphone. "It looks like a two foot slit in a 30-foot ice wall. Will we—we did!" He didn't have time to finish his first thought.

"Was that exciting! Nothing but sky and ice all around. Thought I was—oh boy, here's another curve. I hope it's the one at the finish. We're in it and here's the finish line. What a ride!" And then as the sled went flying up the



Upper left: Bobsled team at starting line. Right: Engineer testing transmitter before start of broadcast. Lower: Broadcasting while going into a turn at 70 miles an hour.

finish incline with brakes dragging and covering the riders with a spray of snow. Darlington's last words were, "We finished. It was great. Most exciting and thrilling experience I have ever had, but I wouldn't mind doing it over again."

He did repeat the stunt later in the day with his Radio signal hooked up to the public address system along the course for the entertainment of the hundreds of spectators who witnessed the feat.

J. Jay O'Brien, Chairman of the American Olympic Bobsled Committee and former captain of the American Olympic team, who witnessed the broadcast, declared this was the first time such a feat had ever been done. He said it had been suggested in previous bobsled races, both at Lake Placid and in Europe, but that Radio Engineers said it could not be done.

The equipment used by Darlington was what is known as a small "pack set," operating on a wave-length of about 7 meters, with one watt of power. Under ordinary conditions such a signal will carry 4 or 5 miles. His signal was received by another engineer with similar equip-

(Page 18, please)

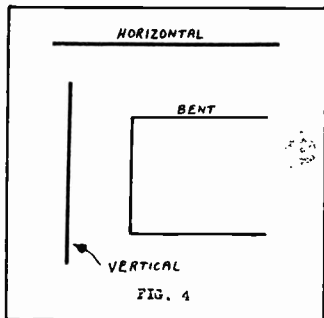

have directional characteristics. That is, uniform pickup is experienced about this antenna. Pickup is at a rather low angle, making it excellent for distant reception. However, it is excellent for local reception as well. The horizontal antenna is most commonly

used due to its simplicity in erection and efficiency. The maximum pickup is experienced at right angles in respect to the plane of the antenna. That is, if the antenna is running north and south the maximum pickup will be experienced from east and west directions. High angle pickup is also obtained due to the directive characteristics of the antenna. That is, maximum pickup is obtained 90° from the direction in which the antenna runs. It is therefore also extremely important to place the antenna at right angles in respect to power lines and other metallic objects to reduce interference pickup to a minimum.

You will remember that a single wire in space one-half wavelength long has very little voltage about it at its center and that the best connection to it is at a point of low impedance. This property makes it possible to couple to the type of antenna with a low impedance transmission line. It is further possible to place the antenna in the most effective position, that is, away from the interference as the transmission line does not assist in picking up the signal. It merely transfers the signal to the receiver with very little loss.

Transmission Lines. The study of lines used for the efficient transfer of power is extremely complicated, however, with a few known facts

we can understand some of their characteristics and behavior. As you should no doubt realize a line is something like an antenna wire in space as it has distributed resistance, inductance, capacity and leakage losses. Naturally the longer the line, the greater will be all of the other factors. It is therefore best to select a length—the shortest—which will give maximum efficiency in the transfer of energy fed to it. The antenna is the source, while the receiver is the load. Usually the method of coupling to the antenna determines the length of the line as it is the impedance of both the antenna and the line that must be matched for an efficient transfer. The coupling from the line to the receiver is easily matched by using a simple transformer. Its impedance may be varied by changing the number of turns on the transformer.

The length of transmission line for receiving purposes is generally given in wave-length similar to the antenna length.

There are several general kinds of lines as referred to by the experienced Radio-Trician. They are the current—any length or untuned length—and the voltage—specific length or tuned types. The current type is preferred as it is easiest to install and generally more flexible. This type of line is coupled to a current—low impedance—position on the half wave antenna and should be at least one-half wave length long. This is in respect to the wave-length of the antenna. Of course the voltage coupled types join the antenna at a voltage—high impedance—position. This type requires a transmission line of a specific length and one that has several inches of spacing. These types are generally odd multiples in length, that is, one-quarter wave length or 3, 5, 7 times as long. In Fig. 5a and 5b we find lines that are suitable for this type. The parallel and transposed types are shown. However, these lines will work as low impedance types as well. The twisted cord type shown in Fig. 5c will work

(Page 12, please)

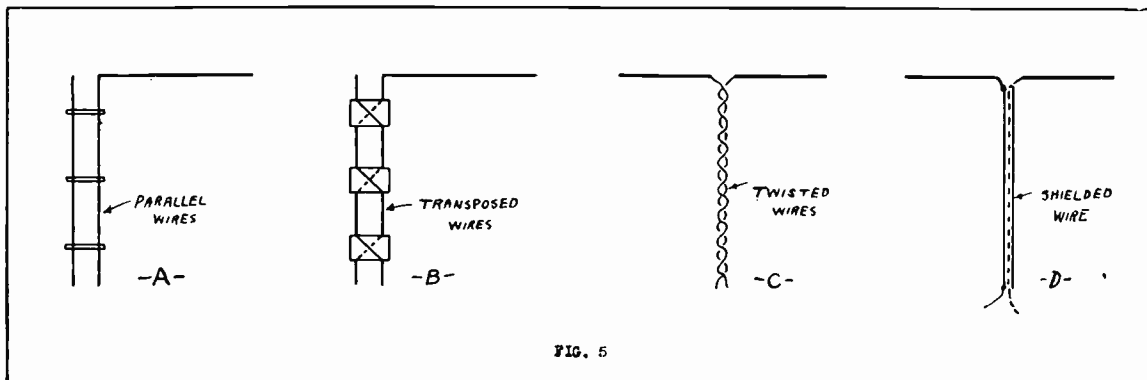

shielded. It is sometimes necessary to replace this coil, although a drying out process in a hot oven will often help. Also it is possible to bend the plates of the tuning condensers in these models and this should be tried if it is impossible to purchase a new coil locally.

—————n r i—————
RCA MODEL R27

**INTERMITTENT
RECEPTION**

Intermittent reception and distortion in this set is generally due to the armature of the magnetic speaker getting out of center. The three adjusting screws for armature alignment will be found on the side of the speaker and should be readjusted.

—————n r i—————
RCA MODEL M34

**INSENSITIVE AT
LOW FREQUENCIES**

Generally caused by improper adjustment of the low frequency padding condenser. The adjustment should be made at approximately 600 kilocycles, rocking the tuning condenser gang back and forth while the adjustment is being made.

—————n r i—————
**INTERNATIONAL,
KADETTE MODEL**

OSCILLATION

This is caused by improper location of the wire projecting from the control grid of the 36 detector. If it gets too close to the R.F. coil oscillations will occur. Experimenting with the position of the wire will enable you to stop oscillations.

—————n r i—————
**RCA VICTOR
MODELS R8, R12 & R20**

POPS WHEN TUNING

This difficulty is sometimes intermittent and usually occurs on locals. We have always found it to be caused by bad screen grid tubes. To remedy, substitute new screen grid tubes in all stages and replace old ones, one at a time, to find the offender.

—————n r i—————
RCA MODEL 78

HUM

Unbalanced type 56 tubes in the driver stage will result in hum. Tubes which test the same should be used. A heater to cathode short in one or both tubes will result in a very annoying hum.

**RCA VICTOR
MODEL 77**

FADING

Bridge across the bypass condensers in the R.F., I.F. and 1st detector stages with a .05 mfd. condenser in good condition. An open in any of these units will create the trouble.

—————n r i—————
**RCA VICTOR
MODEL RO-23**

INOPERATIVE

Check the band shift switch looking particularly for corroded contacts or loose wires. Apply a hot soldering iron to any joints of which you are suspicious.

—————n r i—————
**RCA VICTOR
MODEL R-27**

WEAK AND OSCILLATION

This is usually due to a defect in the dry electrolytic condenser. It is located in the bottom of the set. It consists of a 2 mfd. section for plate bypassing and a 4 mfd. unit for screen bypassing.

—————n r i—————
**RCA VICTOR
MODELS 17M, R17W**

WEAK AND OSCILLATION

This is usually due to a defect in the dry electrolytic condenser. It is located in the bottom of the set. It consists of a 2 mfd. section for plate bypassing and a 4 mfd. unit for screen bypassing.

—————n r i—————
**RCA VICTOR
MODEL R12**

OSCILLATION

Check the various bypass condensers in the set by bridging them with others. A 1 mfd. condenser will do for test purposes. A considerable amount of trouble has been encountered because of these condensers opening up. Replace the oscillator plate bypass condenser (4 mfd.). This also bypasses the screens of the 1st R.F., 1st detector, and I.F. tubes. If the condenser in question opens oscillation will result.

(Page 28, please)

All-Wave Antennas--Continued from page 10

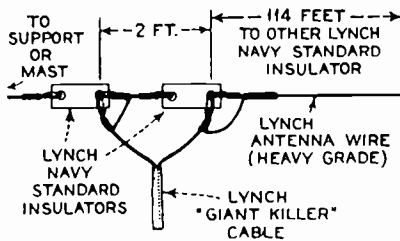

(Fig. 6)

best as a low impedance line due to the higher distributed capacity, presented to the load.

Modern all-wave antenna systems employ transmission lines in order to obtain the best pickup obtainable by the antenna, for the least amount of man-made interference. These lines like all transmission lines cause the cancellation of interference picked up near the lines themselves. That is, the two wires receive the same signal or interference at the same time, and at the same strength. Therefore, all being in phase, they will cancel out as they appear at the receiver pickup coil or the load end of the line. Consequently, merely the signal impressed upon the antenna is transferred to the receiver.

The efficiency of transmission lines is extremely high when properly matched. A drop of but 2 per cent for each wave length is generally experienced. Even if the line was but 50 per cent efficient, we will generally be able to appreciate the distinctive advantages as the antenna may be placed in a position where maximum signal exists and make up for the line loss. Unquestionably the man-made interference or local noises about the receiver will be reduced in respect to the desired signal.

Popular Types of All-Wave Antennas

Undoubtedly many Radio-Tricians will be interested in knowing more about the theory regarding the operation of some of the popular types of all-wave antennas used today. As manufacturers do not divulge the exact theoretical operation of the antennas that they make, the descriptions given here are based on their probable design. Therefore, only the outstanding characteristics will be disclosed of the several types.

The simplest all-wave aerial system consists of a flat top section and a transmission line. The Lynch Manufacturing Company has developed such an arrangement. The top or antenna section is 114 feet long. Coupling to the transmission line as shown in Fig. 6. Notice the arrangement of the wires at the end insulators. You will remember that maximum voltage is always at the ends of the antenna and when this system is employed, a high impedance line is desirable. However, if we obtain but 50 per

cent efficiency in the transfer we will still be far ahead of the conventional system. This combination does just that! An attempt—in a simple way—has been made to increase the terminal impedance of the line by employing a small loop formed around the right hand insulator shown in Fig. 6. Notice the insulators are 2 feet apart. Twisted or shielded lines may be used in this manner. This combination works nicely in the broadcast band giving maximum response to the high frequency end of that band. On the 6,000 kilocycle band it operates best, functioning as a full wave antenna with voltage at both ends and at the center. It will work very well on 3,000 kilocycles as a half wave antenna and likewise on 12,000 kilocycles on the fourth harmonic. A matching transformer is used at the receiver end to permit best coupling. It has several taps for best adjustment.

The Tobe model 34 kit contains a 75-foot aerial, a twisted wire transmission line, 50 feet long, a line to set matching transformer and a line to aerial coupling unit. This provides a match at both ends resulting in a very good signal transfer. The coils are made to mate in sections of 50-foot transmission line units. If less than 50 feet is needed, the excess cannot be cut off and must be coiled up in the set or at some point between the antenna and the receiver. In other words, the impedance of the line must be matched to the transformers employed. If more than 50 feet is needed, additional 50-foot sections must be purchased. The set transformer is tapped to permit some adjustment for maximum signal transfer.

One of the most interesting antennas for all wave purposes is the Philco combination. Indications are that it is not maximum efficient but minimum noise, in respect to the signal this is most desirable. A unique arrangement is obtained by the Philco combination as shown in Fig. 7. The horizontal portion is loosely coupled to the line by the inductive capacity combination. A few turns are placed on the ends of the transmission line to obtain pickup. This is believed to be a high impedance voltage coupled to the line at all times except upon the extremely high frequencies around 10 to 30 megacycles when the small distributed capacity between the coils become effective. Maximum response obtained at the natural frequency (6,000 kilocycles) of the half wave antenna represented by the total length which is about 60 feet plus the inductance presented by the coupling coils. By placing the antenna inductance off center pickup will usually be experienced on practically all frequencies even in the broadcast band. There will be sufficient difference in voltage drop to receive a signal free from the usual local noises to appreciate the all-wave feature.

(Page 21, please)

RADIO-TRICIAN SERVICE SHEET

REG. U. S. PAT. OFF.

COMPILED SOLELY FOR STUDENTS & GRADUATES

PHILCO RECEIVER MODEL 45 (also 29)

ADJUSTING COMPENSATING CONDENSERS

For adjustment of compensating (padding) condensers an accurately calibrated signal generator and a special insulated padding wrench are needed. Adjustments are made in the following order—

ADJUSTMENT OF THE INTERMEDIATE FREQUENCY — Remove the grid clip from the type 6A7 tube and connect the "ANT" output terminal of the signal generator to the grid cap of the tube. Connect the "GND" terminal of the signal generator to the "GND" terminal of the receiver chassis.

Connect the output meter to the primary terminals of the output transformer. Set the signal generator at 460 K.C. (the intermediate frequency) and with the receiver and signal generator turned on, the wave band switch at left and dial at 600 K.C., adjust each of the I.F. compensating condensers in turn, to give maximum response in the output of the receiver. The three pairs of I.F. compensating condensers are located one pair at the top of each of the three I.F. transformer shields. These are the three metal "cans" near the rear of the chassis. Each of the transformers has a dual compensating condenser mounted at its top, and accessible thru a hole in the top of the coil shield. In the dual compensators, the Primary circuit is adjusted by turning the screw; the Secondary circuit is adjusted by turning the hex-head nut.

ADJUSTMENT OF THE WAVE TRAP — Replace the grid clip upon the Detector-Oscillator tube (Type 6A7). Connect the output leads from the signal generator directly to the antenna and ground terminals of the receiver. Set the Wave-Band Switch of the receiver to the standard broadcast band (left hand position) and

the Station Selector at the low frequency (540 K.C.) end. Adjust the Wave Trap condenser to give MINIMUM response to a 460 K.C. signal from the signal generator. The Wave Trap is located at rear and underneath the chassis. It is reached from the rear of the chassis, by inserting the fibre wrench thru the hole near right-hand rear corner of chassis.

DETECTOR, AND OSCILLATOR "HIGH" AND "LOW" FREQUENCY ADJUSTMENTS—The "antenna" and "oscillator H.F." compensators are located on top of the tuning condenser assembly, reached from above.

Set the signal generator at 1500 K.C., tune in this signal on the set and adjust the antenna compensator (nearest tuning control) to give maximum reading in the output meter.

Next adjust the oscillator H.F. condenser (located on the other section of tuning condenser) to maximum reading.

Finally set the signal generator at 600, tune in this signal and adjust the oscillator "L.F. condenser," located underneath chassis to maximum reading. This adjustment is reached thru the hole in top of chassis, between the two electrolytic condensers (left hand end of chassis when facing rear).

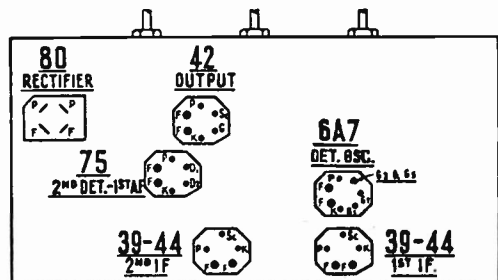

Tube layout (underside)

Readers who file Service Data on separate binders remove page carefully, trim on dotted line for same size as Data published heretofore.

PHILCO MODEL 45

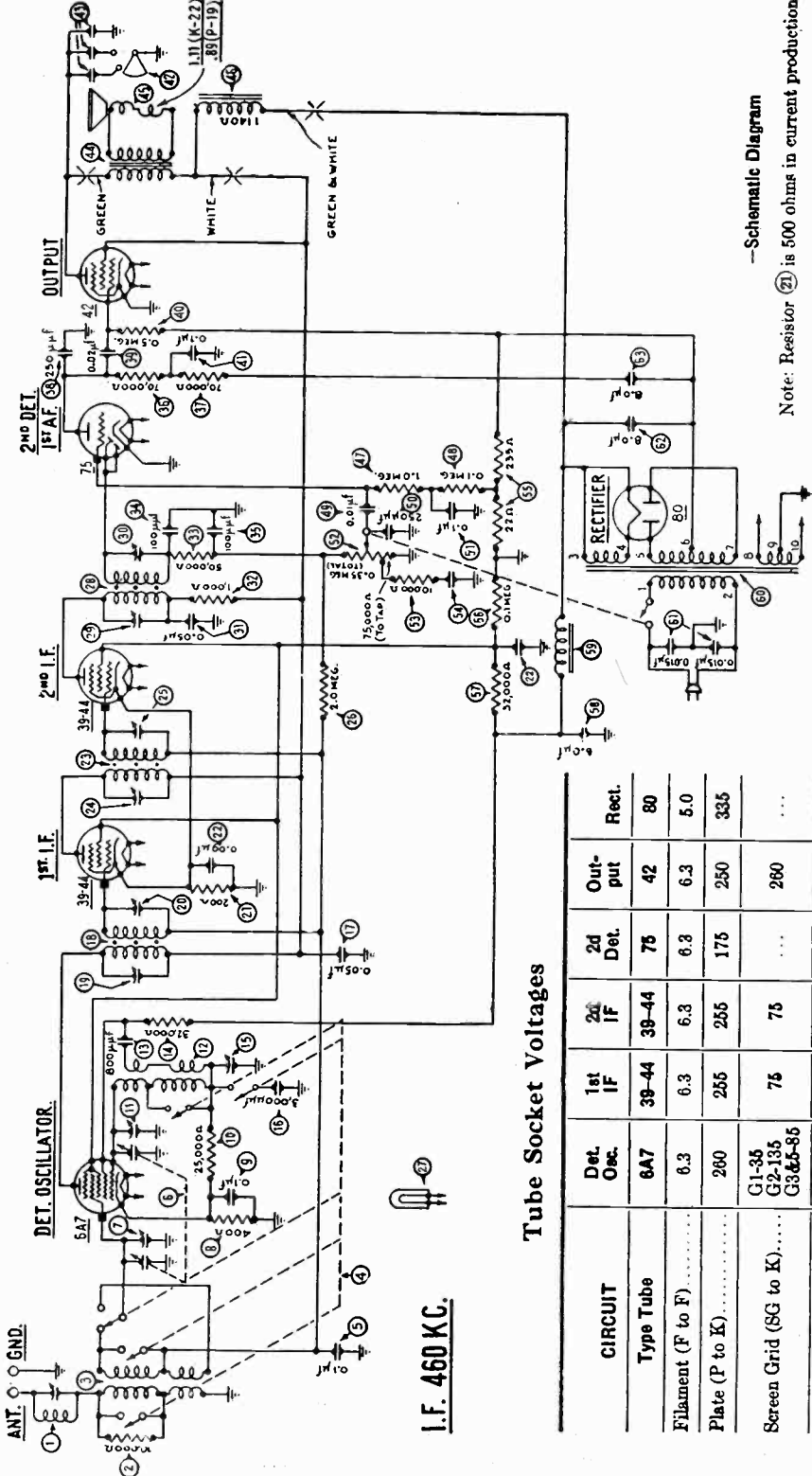

—Schematic Diagram

Note: Resistor (21) is 500 ohms in current production

Tube Socket Voltages

CIRCUIT	Det. Osc.	1st IF	2d IF	2d Det.	Out-put	Rect.
Type Tube	6A7	39-44	39-44	75	42	80
Filament (F to F).....	6.3	6.3	6.3	6.3	6.3	5.0
Plate (P to K).....	260	255	255	175	250	335
Screen Grid (SG to K).....	G1-35 G2-135 G3-65-85	75	75	...	280	...
Cathode (K to F).....	4.2	3.8	3.8	0	0	...

The above tests were made with an AC voltmeter for filament voltages and a high resistance DC voltmeter for all others. Dial at 550 KC, volume control at maximum. Test made with test prods applied to socket terminals underneath chassis. Line voltage 115.

a resistor may be reduced in value by connecting it in parallel with another resistor.

If more than two unequal resistances are connected in parallel, first find the joint resistance of two resistances, and considering this as a single resistance, combine it with a third resistance and so on.

By using the accompanying charts A and B for resistance in parallel, which is based on formula (2), total resistance values in parallel may be very easily solved.

All you need to do is to draw a straight line from one known resistance value picked out on the left hand scale to the value of the second resistance on the right hand scale and the resulting resistance value can be read off at the point where the line you have drawn intersects the center scale.

Chart A covers the range of 5 to 100 ohms. Chart B covers the range of 100 to 10,000 ohms.

The correct use and value of these two charts is best illustrated by working out two examples.

Assume that we have two resistances connected in parallel and the individual resistances are 10 ohms and 30 ohms respectively. To find the resultant or effective resistance of the two resistances connected in parallel we connect 10 on the left hand scale (Chart A) with 30 on the right hand scale and we find the resultant resistance would be 7.5 ($7\frac{1}{2}$) ohms in this case. If one resistance was 1,000 ohms and the other 500 ohms and these were connected in parallel the resultant resistance according to Chart B would be 330 ohms.

To find the resistance necessary to connect in parallel with an existing resistance to bring it down to any desired value draw a straight line from the known value on an outside scale to the desired resultant value on the center scale, and continue the line to intersect the other outside scale, reading the answer at this point.

The range of either of charts A and B may be extended by considering the values on each

of the three scales as multiplied by some constant. For example, if the values on Chart B are multiplied by 1,000, the range then will be from 100,000 to 10,000,000 ohms or 0.1 to 10 megohms. To take an example, the resultant resistance of a 500,000 ohm (0.5 megohm) and a 1,000,000 ohm (1.0 megohm) resistor in parallel may be found by drawing a line between 500 and 1,000 on the outside scales, the intersection with the center scale at 330 giving the answer as 330,000 ohms (0.33 megohm). In extending the range of these charts in this way, the student should be careful to use the same multiplier on all three scales.

To obtain the resultant resistance of a number of units some of which are connected in series and others in parallel in the same circuit, the resultant resistance of the parallel portions of the circuit are obtained separately by the use of the charts and these figures are added directly to the values of the resistance units which are connected in the circuit in series.

Resistances in Parallel
(in ohms)

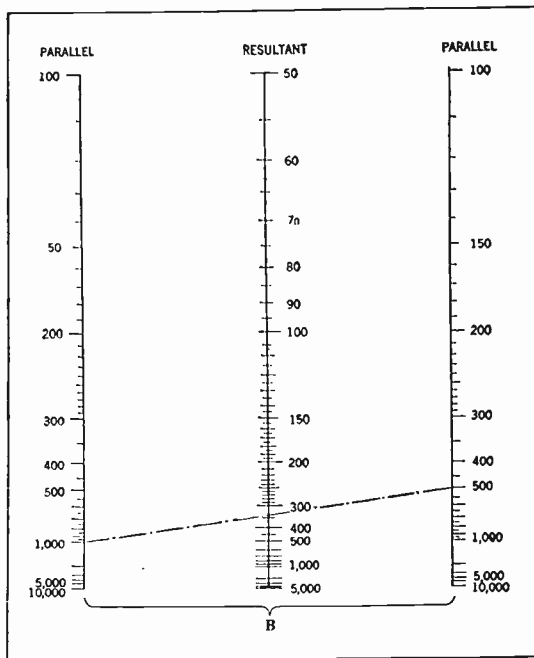

Numerous letters have been received by NATIONAL RADIO NEWS, commenting favorably upon this series of easy measurement charts which have been supplied by Chief Instructor Dowie. We are satisfied, therefore, that they have been valuable to our readers.

NATIONAL RADIO NEWS solicits letters of comment from its readers. We want to hear what you think of *your* magazine. We want to make it what you want it to be. If it suits you, if you find it valuable, then it serves the purpose intended for it. Your comments are our only method of deter-

mining if NATIONAL RADIO NEWS satisfies you. If you have faults to find—tell us. Maybe we can correct them. If you like "The News" we are human enough to want to hear your praise. So drop us a line occasionally addressed to "The Editor, NATIONAL RADIO NEWS."

WHICH ROAD? By E. R. H.

EVERY normal young man, and many men who are no longer young, has an underlying desire to succeed. He wants to climb—to advance in position for several very well-defined reasons.

The first of these is the desire for greater earning power—more money with which to buy those things that make life easier—happier—more comfortable. We all want to drive nice cars, have homes of our own.

Every one of us wants to provide well for someone, be it a wife, children, an aged father, mother, or other relative. We all want to lay aside something for the future, for that "rainy day" which is liable to come to any of us.

Another powerful motive which spurs men on to success is the desire for prestige. Where is the fellow who does not wish to show his family, his neighbors, his sweetheart, his former teachers, that he has the ability to step above the crowd—the ability to become *someone*? If there is a man who would not get a thrill out of that, I have never met him.

I know a gentleman, and you'd know him, too, if I would mention his name, who is the president of several corporations, director in several others, who has all that is necessary to make life worth living. This man derives one of his greatest pleasures from driving back to his old home town, in a fine big car, back to the town where many years ago, as a poor boy he got his start—where he took the right road and ended as a successful business man.

And why shouldn't he get a thrill from the experience? When he returns to that old town—the one he left with only one asset, his ambition, he probably meets men, who years ago scoffed at the success idea—he probably meets relatives who are proud to have him come back to them, successful. Maybe there is an old mother waiting for him—one of the few who predicted success for him when he first went away.

There is a fork in the road of life. Every man travels over this road and sooner or later comes to this fork. It is usually encountered shortly after the school days are over. Arriving at this fork in the road you have come to the most important point in your career. Which way to turn? That is the question. Your future depends upon your choice of the trail you will travel.

The two roads look very much alike—except that one may look a little easier at the start. Do not be deceived. The road that looks pleasant, that seems to offer a carefree journey, is very much harder, later on in life. There are bumps on both roads, and it is much more logical to climb over the rough spots while you are young and better able to stand the hard-

ships, than later on, when you are advanced in years and have less vitality.

At this point I want to correct an impression that so many young men have—a very false idea that they can start out on the easy road, take advantage of its pleasures for a while, and then make a short cut across to the road to success, when they have tired of the pleasures which the first trail seemed to offer.

The longer you travel the wrong road, the harder it is to break away. There are those who do it—who climb the almost impossible obstacles between the two roads and arrive safely on the path that leads to success. But it is dangerous to start out the wrong way. And it is foolish because the pleasures offered by the lower road are very thin—very temporary. We tire of them quickly—but usually when it is too late to start in the right direction.

The staff artist of NATIONAL RADIO NEWS has caught my idea well and has illustrated it for your convenience. You will notice that the roads start out at the end of elementary or high school training, and shortly thereafter comes that *all-important fork in the road*. It is too bad that in real life these roads are not marked with sign-posts. You are required to make your own decision as to which one you will travel.

The road to failure leads downward, through "too much play." Golf, shows, swimming, tennis, touring, leisure, are all well and good when taken in small doses, and not at the expense

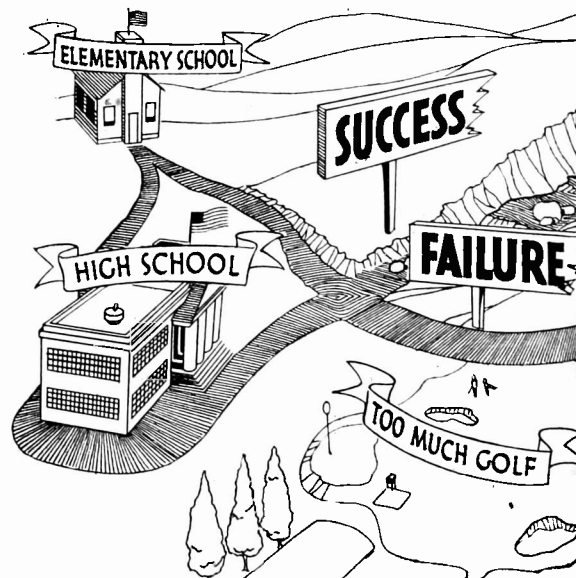

...s, N. R. I. Vice-President and Director

your future success. We must also be aware of the "no-future job" which offers temporary security, but nothing for the years to come.

This road will certainly and surely wind up NOWHERE. It will lead you to an old age of poverty, possibly dependent upon charity. Could you imagine anything more deplorable?

On the other hand, suppose we decide to travel the success road. It leads through N.R.I. Training. Shortly after this training period is started you can start making money in your spare time. While studying, and while still holding on to your regular job.

The training then carries you to a radio business of your own, or to a good

(Page 18, please)

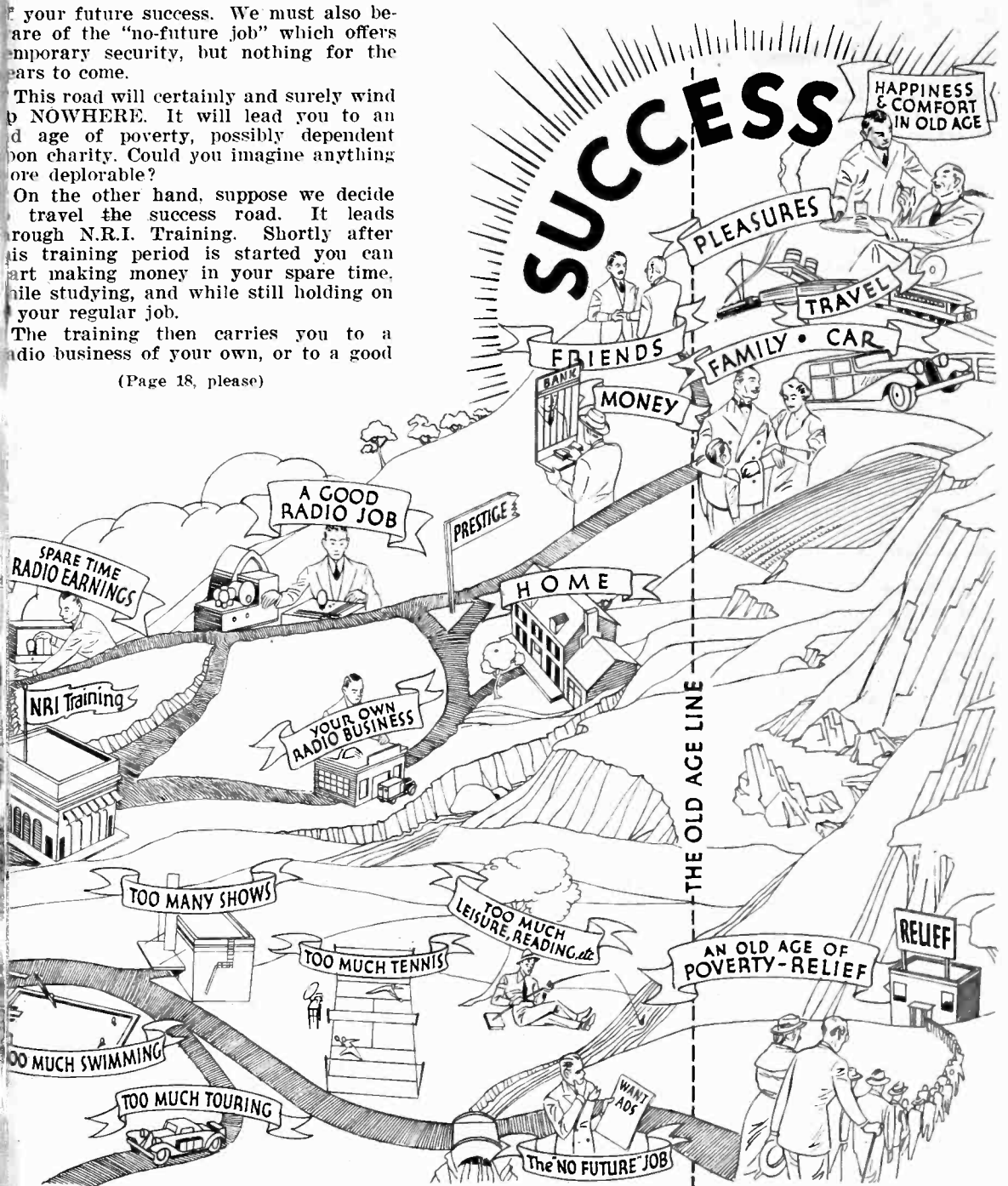

Which Road?

(Continued from page 17)

Radio job with a real future in the fastest growing industry of our day. This means that you have definitely entered the area of success. It leads to more money, fine friends, pleasures, a home for yourself and your family, good schools for the children, money and leisure for travel, the fine car you have always wanted.

But best of all, it gives you that sense of security, that feeling that *all is well*, that knowledge that you have done your job, that you have provided for yourself and for those who depend upon you. You will be looked up to as a successful man and will have the satisfaction of knowing that your old age of happiness is assured.

And now a parting word of warning. Spring is here—summer is well on the way. These are the danger seasons for you. It is with spring and summer that most of us come to the fork in the road. It is then that we must decide whether to turn to the road of study and success, or the road of "too much play" which leads downward to failure. Determine to use this summer profitably. Determine to study and advance yourself. Then with the fall you can be well along the road to success.

The fellow who chooses the other road will be wasting his time. Even if he does decide, this fall, to get back to the success road, he will have to overcome many obstacles, may even have to go back to the beginning and start all over. You will have a great lead on him, a great advantage in that you will arrive at your goal much ahead of him, and enjoy your success just that much sooner.

— n r i —

Broadcast from Bobsled

(Continued from page 9)

ment at the finish line of the bobsled run. The signal was relayed from this receiver by wire to another short-wave transmitter, operating on about 150 meters, which sent it through the ether to Lake Placid village, a distance of 6 miles, where it was fed into a telephone line to Schenectady and hooked into WGY and General Electric's short-wave transmitter, W2XAD, for re-broadcasting throughout the country. W2XAD is a regular broadcast relay station which has been heard in all parts of the world and is regularly received in European countries.

Page Eighteen

Inexpensive Tube Checker

Our laboratory has just had the opportunity to test, thoroughly, one of the *Tefft Tube Checkers* manufactured by an N. R. I. graduate and his associate, Mr. A. R. Tefft, of Plymouth, Michigan.

The price is low, to Radio Dealers and Servicemen, \$10.50 net, which includes delivery charges in the United States. Small in size it is easy to carry about, and requires little room to operate. Accurately tests over 150 tubes including all latest types. No adaptors required. Only one adjustment necessary for all tube testing. Individually tested and calibrated before leaving the factory. Tube chart and full instructions for operation with each checker.

For full details write direct to A. R. Tefft Co., Plymouth, Michigan.

— n r i —

Beam Velocity Microphone

Our attention has been called to the Beam Velocity Microphone produced by The Amperite Co., 561 Broadway, New York City, which they state permits 8 times more volume than an ordinary Velocity Microphone before it will feed back—and 20 times more than a diaphragm type microphone.

In using the Beam Velocity, it must be remembered that it is very much more directional than the regular Velocity and only to be used in those unusual places where the regular Velocity will feed back.



— n r i —

I am a member of the Alumni Association once again, after a year's absence. NATIONAL RADIO NEWS is better than ever. It is a great link between N. R. I. and the graduate.

The Mailbag in the last issue is not quite as good as it used to be. This particular page used to be my preference of the whole book. Is it that the Alumni Association has taken some of the color from the good old Mailbag.

George Moore.

We're sorry about the Mailbag, George. We'll try to do better.—EDITOR.

RADIO-TRICIAN SERVICE SHEET

REG. U.S. PAT. OFF.

COMPILED SOLELY FOR STUDENTS & GRADUATES



PHILCO MODEL 118

ADJUSTING COMPENSATING CONDENSERS

For adjusting compensating or padding condensers in Model 118, an accurately calibrated signal generator covering the broadcast range of frequencies is required and also a crystal controlled signal generator for the high frequency adjustments. For the former we suggest the Philco Model 024 Signal Generator and for the latter the Model 091, Crystal Controlled high frequency signal generator. The actual adjusting calls for a special insulated hex wrench and insulated screwdriver. Philco Part No. 3164 Fibre Wrench and No. 27-1159 Screwdriver are recommended. An output meter is also required, for connection to the receiver.

I.F. ADJUSTMENT—The I.F. (intermediate frequency) of Model 118 is 260 K.C.

Remove the grid clip from the top of the 6A7 tube and connect the shielded antenna lead from the Signal Generator to the cap of this tube. Connect the ground lead of the Signal Generator to the ground post of receiver. Connect the output meter to the primary terminals of the output transformer of receiver. Set the wave-band switch at the left position (standard broadcast).

Set the wave switch on the Signal Generator at 260 K.C., and the dial of the receiver at 550. Turn on the set (volume full on), and the Signal Generator. Now adjust the 1st I.F. Primary and Secondary condensers Nos. (30) and (32) and the 2d I.F. primary and secondary condensers (37) and (75) to give maximum reading on the output meter. The I.F. primary condenser is adjusted by turning the screw on top of the I.F. transformer and the secondary is adjusted by turning the nut. The I.F. transformers are in the smaller metal "cans." The screw and nut are reached through the hole in top. If the needle on the output meter goes off the scale, turn down the "attenuator" on the Signal Generator until a lower reading is obtained.

Note: In early production the 1st I.F. compensating condensers only are adjusted as described above. Part (75) is not used. The 2d I.F. primary (37) is an 04000A condenser reached and adjusted through hole in top of chassis near the 42 driver tube.

WAVE TRAP—Remove antenna lead from grip cap of 6A7 tube and attach it to antenna post on set. Replace cap on 6A7 tube. With Signal Generator still operating at 260 K.C., adjust wave-trap condenser (1) so as to get MINIMUM reading in output meter. This adjustment is made from underneath the chassis.

ANTENNA, DETECTOR AND OSCILLATOR H. F. (Broadcast)—These condensers Nos. (7), (14), and (21), are located on top of the tuning condenser gang, adjustment made by means of the fibre wrench. Set the signal generator at 1500 K.C., tune in the signal at 1500 on dial and adjust these condensers in the order given, to give maximum output reading. (7) is located on the section nearest the front and (14) on the center section.

OSCILLATOR—LOW FREQUENCY—This is condenser (28) located underneath chassis and accessible from underneath. Use the fibre wrench. Set signal generator switch at 600, tune in the signal at 600 on the dial and adjust condenser to maximum.

ANT. AND OSC. H. F.—SHORTWAVE—The crystal controlled signal generator is used for these adjustments. These are condensers (2) (Ant. H.F.) and (22) (Osc. H. F.) located underneath chassis, and adjusted from underneath. The fundamental frequency of the Philco Model 091 crystal controlled signal generator is 3600 K. C. or 3.6 megacycles. The third harmonic of this is 10.8 M.C. Turn the waveband switch of the set to the right and the dial to just below 11 M.C. The 10.8 harmonic should be picked up here and the two condensers should be adjusted to give maximum reading on the output meter, on this signal.

Readers who file Service Data on separate binders remove page carefully, trim on dotted line for same size as Data published heretofore.

PHILCO MODEL 118

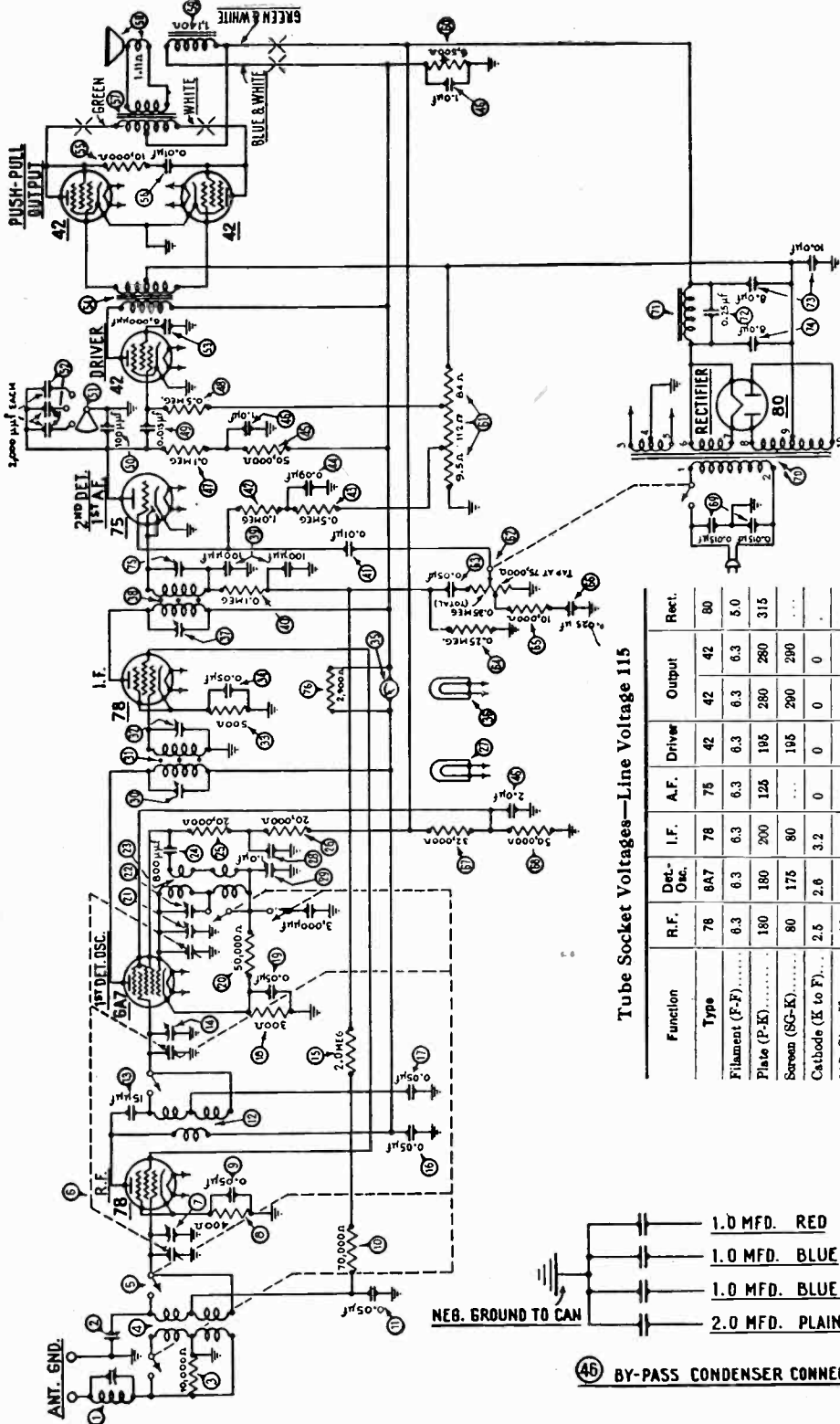

Tube Socket Voltages—Line Voltage 115

Function	R.F.	Det.-Osc.	I.F.	A.F.	Driver	Output	Rect.
Type	7B	6A7	7B	75	42	42	80
Filament (F-F).....	6.3	6.3	6.3	6.3	6.3	6.3	5.0
Plate (P-K).....	180	180	200	125	195	280	315
Borean (SG-K).....	80	175	80	...	195	290	290
Cathode (K to F)...	2.5	2.6	3.2	0	0	0	0
6A7: G1 to K.....	26						
6A7: G1 to K.....	150						

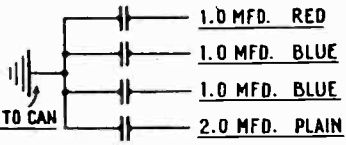

(46) BY-PASS CONDENSER CONNECTIONS

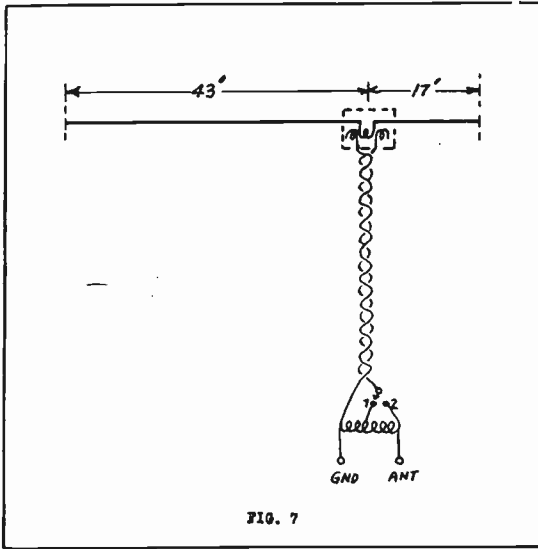

of the system. The receiver end of the transmission line employs a simple inductance. It is used as an auto transformer on the high frequency band. In the broadcast band the voltage drop across the inductance, shunted by the line, is coupled to the input of the receiver.

Several months ago the Engineering Staff of the Radio Corporation of America designed an all-wave antenna system to operate effectively from 550 kilocycles to 20,000 kilocycles. The system is known as the double doublet. In Fig. 8a we see the electrical arrangement of the antenna collectors.

An effective increase in signal strength will be obtained from 4,000 to 28,000 kilocycles over ordinary antenna combinations. However, the engineers claim the arrangement satisfactory

for the broadcast band as well. This combination does give relatively good response over most of the important parts of the short wave spectrum. Fig. 8b shows the response as experienced when using the double doublet antenna system. Curve A is the response for the horizontal portion of the antenna while curve B is that for the lower doublet. Naturally curve C is the overall response as it is experienced when using the complete antenna system.

When erecting this antenna, it is most important to have the correct spacing between the two half wave antennas and further to use the length of wire as specified. All guy wires are broken by insulators to prevent reflection as well as absorption of the wave received. The transmission line is of the twisted type and should be at least 110 feet long. This is one-half wave length long for the 6,000 kcs. band. A receiver transformer is used in order to obtain proper matching to the input of receivers now on the market.

The signal strength on any all-wave set will increase in respect to the noise level with the proper aerial installation. If for no other reason, a new aerial of any type will work better than one several years old which are corroded, dirty and having high leakage losses. The proper matching of a new resonant aerial and a low noise level are the main points on which to base your ideas about reception improvements. The increased signal strength in respect to the noise level are the main selling points of a noise reducing antenna.

Unfortunately, most set owners think any kind of reception indicates a good aerial, and frequently claim the set's ability does not measure up to their expectation while the root of the trouble is the antenna system employed. It is up to the service man to overcome this and it may take salesmanship to do it. You (Page 23, please)

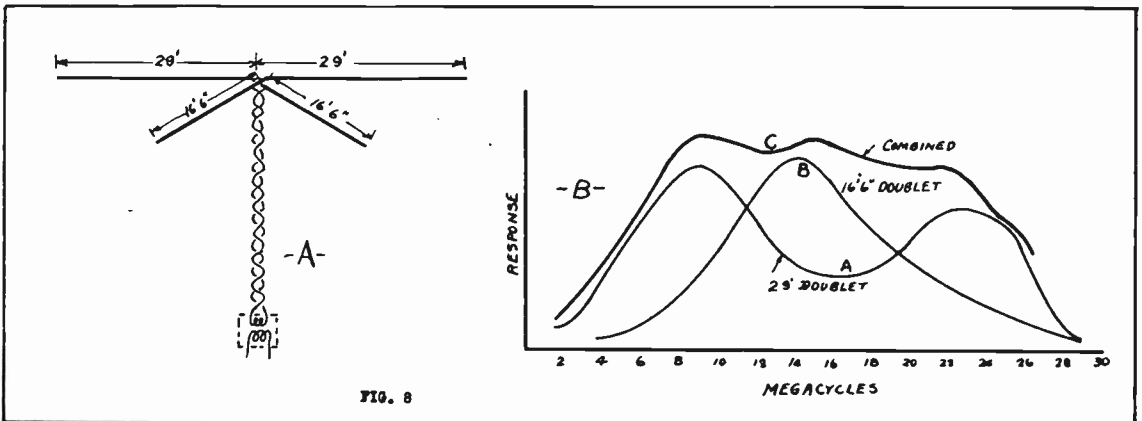

WOR's New Station

Two steel towers and a suspended cable emitting a pattern of Radio waves that will concentrate on New York, Philadelphia and other cities, uncannily diminish over the Pocono Mountains and other thinly settled areas and reoccur beyond, are among the features of WOR's new broadcasting station at Carteret, N. J.

This directional antenna system has been specially designed by Bell Telephone Laboratories to operate with the 50 kilowatt Western Electric transmitting equipment and to focus its power where the greatest number of listeners reside.

The importance of obtaining this focus of power lies in the fact that more electrical noises are produced in congested areas than in thinly populated sections. Electric trains, power lines, elevators, electrical appliances, all contribute to the "noise level" picked up by Radio sets. For consistent reception the signal of a broadcasting station must be far above the noise levels. Consequently, stronger signals are necessary in cities than in the suburbs or in the country.

In WOR's antenna system, the cable is suspended midway between the two towers, each 385 feet high and 790 feet apart. The three antennas are arrayed in a straight line and are spaced in accordance with wave length factors. Carteret itself is located on a line between New York and Philadelphia and the antennas run at right angles or broadside to this geographical line. Their broadside discharge of radiation is much more powerful than the lengthwise discharge.

Drawn on a map, the field of radiation takes the form of an hour glass, with Carteret and its surrounding communities falling within the neck of the glass, and with the bulbs enclosing the New York and Philadelphia areas.

The effect is obtained by the spacing of the antennas. This is calculated so that the waves they emit broadside are in step, the crests and troughs matching precisely and reinforcing each

other. The waves emitted lengthwise by two of the antennas, however, are out of step. They not only tend to neutralize each other in that direction, but, react to re-inforce further the power emitted broadside.

The design of the antenna also takes account of the effect of the sky waves, those emitted upward. At night these waves are reflected back to earth from a layer of ionized atmosphere at an approximate height of 60 miles. Where returning sky waves mingle with ground waves, interference occurs unless one predominates with an intensity at least four times as great as the other.

The arrangement of the antenna actually aims the sky waves at certain strategic angles. For more than 50 miles around the station, ground waves will over-ride them. The territory from Carteret to Morristown will receive ground waves. Beyond, sky waves will increase in relative strength so that at Wilkes-Barre and Scranton, they will clearly predominate. Philadelphia will lie within the pure ground wave area, while Baltimore and Washington beyond will receive clearly predominant sky waves.

The new broadcasting equipment will extend WOR's service over a much greater area than does its present 5 kilowatt equipment. Calculations indicate that at Miami, Florida, the station's power will be 24 times greater than now.

The broadcasting apparatus is connected with the antenna system by a concentric trans-

mission line consisting of one copper tube within another, the outer being 2 5/8 inches in diameter and the inner 1 1/16 inches in diameter. This line runs 600 feet from the transmitter building to a point mid-way between the two towers, being laid 5 feet underground. No wire leaves the transmission house above ground.

The transmission line divides in three branch lines of similar construction. One is coupled to the central cable antenna. The other two

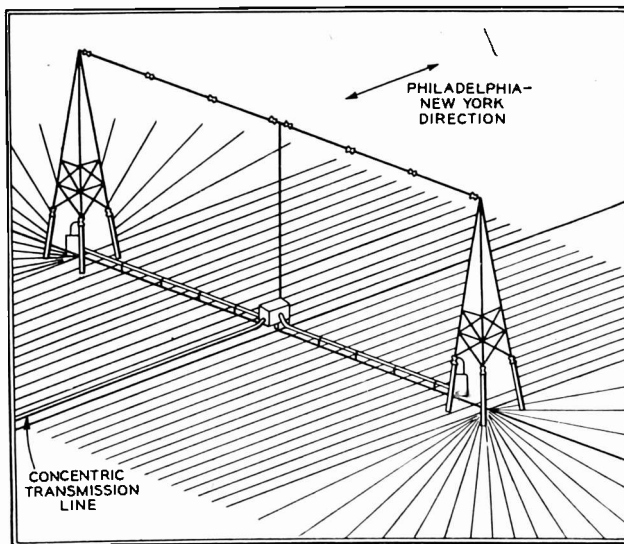

Directional Characteristics of WOR's New Station

(Next page, please)

extend 390 feet in opposite directions to the end towers.

The transmitter is on a swampy site. At high tide, a large area is under water. The transmitter is grounded in this soil by a system of underground conductors. There are 40 miles of No. 8 drawn copper wire underground, part running at right angles to the line of antennas, and another radiating out beneath the end towers.

The main ground bus, 1/16 inch thick by 6 inches wide, runs between the two towers and extends beyond them at either end. All lateral and radial ground wires are welded to the main bus and the north ends of the copper wires all terminate in the Rahway River. A length of 3/4 inch stranded cable of bare copper is laid along the bottom of a creek.

Within the transmitter house a novel arrangement eliminates all overhead conduit and high voltage busses. Motor generators and transformers are arranged in the basement directly beneath the transmitter so that all leads come up through the floor directly into the respective panels where they terminate.

The building itself has no ordinary heating plant, but is heated chiefly by the energy dissipated from the power tubes.

As planned and developed, WOR will be a mecca for sight-seers. The main control room is a virtual Radio-apparatus theater. With the control desk in the middle as the nerve center, the entire room is panelled with Radio equipment. In contrast to the ordinary straight line-up of apparatus, the first and last two panels of the 50 kilowatt transmitter have been offset at a 45 degree angle so that the control man is nearly equidistant from all panels and controls. The transmitter forms one whole wall.

The rear wall of the room will be panelled with the present 5 kilowatt transmitter for utility purposes. A glass partition, enclosing the speech input equipment, forms another side of the room. To the left of the entrance will be a Western Electric aircraft Radio beacon transmitter, the first to be operated by a commercial broadcasting station. Installed at the request of the Department of Commerce, this beacon will emit a special signal to warn aircraft of their presence in the vicinity of WOR.

A special room has been set aside in which will ultimately be installed a short-wave transmitter for re-broadcasting to foreign countries.

— n r i —

HE FOUND THEM

"When I was a little boy," sweetly piped the hard-boiled sergeant, "I had a set of wooden soldiers. One day I lost those soldiers and I cried very much but my mother said, 'Never mind, Johnny! Some day you will get your wooden soldiers back,' and believe me, you bunch of wooden-headed blockheads, that day has come!"

All-Wave Antennas

(Continued from page 21)

will have to go out and get orders. They won't come to you. The item of cost is of major consideration. Many systems are still rather expensive when compared to the older type. This adds another problem which you alone can iron out by studying the individual problems and installing the antenna which is most effective.

Any student selling sets or working for a dealer should see to it that the proper aerial goes to the home with each set sold. Not only is the customer more satisfied, but you can be more certain that the set will "stay sold." Also, proper installations are good advertisements, making others want a similar installation.

— n r i —

Mr. Joseph Kaufman, Educational Supervisor of the National Radio Institute has been asked by your editor to write a series of articles for NATIONAL RADIO NEWS on Oscillograph testing. There is a lot of interest in this equipment these days and we expect to have Mr. Kaufman's first installment ready for the next issue. Watch for it.

— n r i —

ERLA MODEL 224 A. C.

INTERMITTENT RECEPTION

Intermittent reception is often due to a defect in the local distance switch which selects the number of turns actually used in the primary of the 2nd R. F. transformer. To repair this switch put the contact in a tapered hole and center punch around the edge to retighten. This is a single pole double throw switch, and may be replaced if desired by any similar type which has the mechanical requirements to fit the receiver mounting.

— n r i —

COLUMBIA MODEL S. G. 8

INTERMITTENT RECEPTION

Carefully check the volume control. The fine wires on this unit sometimes break and may cause intermittent reception. The contact between the slider arm and resistance element must be tight. It is well to visually examine and to electrically check all the resistors.

— n r i —

"I think there has been a great improvement made in the 'RADIO NEWS.' The Service Forum sure does come in handy.

"The article on Ohmmeters by Mr. George Rohrich sure did give me a clear understanding about Ohmmeters and how to connect them."

PAUL H. STEHLE,
Marcus Hook, Pa.



ALUMNI

News

Introducing R. B. Murray

power lies in the fact that more electrical noises are produced in congested areas than in thinly populated sections. Electric trains, power lines, elevators, electrical appliances, all contribute to the "noise level" picked up by Radio sets. For consistent reception the signal of a broadcasting station must be far above the noise levels. Consequently, stronger signals are necessary in cities than in the suburbs or in the country.

In WOR's antenna system, the cable is suspended midway between the two towers, each 385 feet high and 790 feet apart. The three antennas are arrayed in a straight line and are spaced in accordance with wave length factors. Carteret itself is located on a line between New York and Philadelphia and the antennas run at right angles or broadside to this geographical line. Their broadside discharge of radiation is much more powerful than the lengthwise discharge.

Drawn on a map, the field of radiation takes the Marine Corps Institute.

Before very long we are going to have him write an article for NATIONAL RADIO NEWS, but he is right busy now getting settled in his new job and making plans. He will visit a number of the Local Chapters before many months roll around.

Here's wishing you the best of luck, Bob!

Page Twenty-four

The Wheels of Progress Are Oiled...

By P. J. Dunn, President

I consider my election the greatest honor ever bestowed upon me—to be selected as the leader of such a fine body of men. I thank you all from the bottom of my heart for the confidence you have shown in me.

You may rest assured that I will do my best to promote a closer relationship between the members of our Association, our Local Chapters, and National Headquarters, at Washington. I further promise that I will give the best that is in me to the welfare of our Association.

With the plans already formulated we are going to make this the biggest year in the history of the N. R. I. A. A. To accomplish this the National officers need the help of every member of the National Association, and every officer and member of the Local Chapters. Unity means progress—let's work together, boys—for the advancement of our great Association.

I intend to maintain close contact with the Local Chapters, and I'll visit as many Chapters as possible during the year. I'll work with the Chapters in any way possible. It will be a pleasure to help advance the good work which we are doing.

Speaking of unity and progress, there is no better way of accomplishing this than for every Chapter to have its own Paper or Bulletin. The Baltimore Chapter has been publishing "The Baltimore Bulletin," for nearly a year. It has been the greatest factor in building up that Local. Today this Chapter of our organization is classed as the biggest and strongest Radio Association in the State of Maryland.

Other Chapters can likewise come to promi-

(Page 26, please)

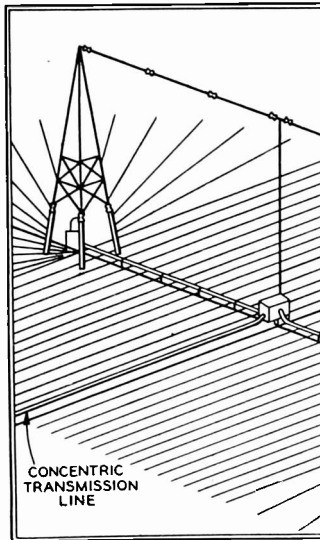

Directional Characteristics

extend 390 feet in opposite directions to the end towers.

The transmitter is on a swampy site. At high tide, a large area is under water. The transmitter is grounded in this soil by a system of underground conductors. There are 40 miles of No. 8 drawn copper wire underground, part running at right angles to the line of antennas, and another radiating out beneath the end towers.

The main ground bus, 1/16 inch thick by 6 inches wide, runs between the two towers and extends beyond them at either end. All lateral and radial ground wires are welded to the main bus and the north ends of the copper wires all terminate in the Rahway River. A length of 3/4 inch stranded cable of bare copper is laid along the bottom of a creek.

Within the transmitter house a novel arrangement eliminates all overhead conduit and high voltage busses. Motor generators and transformers are arranged in the basement directly beneath the transmitter so that all leads come up through the floor directly into the respective panels where they terminate.

The building itself has no ordinary heating plant, but is heated chiefly by the energy dissipated from the power tubes.

As planned and developed, WOR will be a mecca for sight-seers. The main control room is a virtual Radio-apparatus theater. With the control desk in the middle as the nerve center, the entire room is panelled with Radio equipment. In contrast to the ordinary straight line-up of apparatus, the first and last two panels of the 50 kilowatt transmitter have been offset at a 45 degree angle so that the control man is nearly equidistant from all panels and controls. The transmitter forms one whole wall.

The rear wall of the room will be panelled with the present 5 kilowatt transmitter for utility purposes. A glass partition, enclosing the speech input equipment, forms another side of the room. To the left of the entrance will be a Western Electric aircraft Radio beacon transmitter, the first to be operated by a commercial broadcasting station. Installed at the request of the Department of Commerce, this beacon will emit a special signal to warn aircraft of their presence in the vicinity of WOR.

A special room has been set aside in which will ultimately be installed a short-wave transmitter for re-broadcasting to foreign countries.

— n r i —

HE FOUND THEM

"When I was a little boy," sweetly piped the hard-boiled sergeant, "I had a set of wooden soldiers. One day I lost those soldiers and I cried very much but my mother said, 'Never mind, Johnny! Some day you will get your wooden soldiers back,' and believe me, you bunch of wooden-headed blockheads, that day has come!"

All-Wave Antennas

(Continued from page 21)

will have to go out and get orders. They won't come to you. The item of cost is of major consideration. Many systems are still rather expensive when compared to the older type. This adds another problem which you alone can iron out by studying the individual problems and installing the antenna which is most effective.

Any student selling sets or working for a dealer should see to it that the proper aerial goes to the home with each set sold. Not only is the customer more satisfied, but you can be more certain that the set will "stay sold." Also, proper installations are good advertisements, making others want a similar installation.

— n r i —

Mr. Joseph Kaufman, Educational Supervisor of the National Radio Institute has been asked by your editor to write a series of articles for NATIONAL RADIO NEWS on Oscillograph testing. There is a lot of interest in this equipment these days and we expect to have Mr. Kaufman's first installment ready for the next issue. Watch for it.

— n r i —

ERLA MODEL 224 A. C.

INTERMITTENT RECEPTION

Intermittent reception is often due to a defect in the local distance switch which selects the number of turns actually used in the primary of the 2nd R. F. transformer. To repair this switch put the contact in a tapered hole and center punch around the edge to retighten. This is a single pole double throw switch, and may be replaced if desired by any similar type which has the mechanical requirements to fit the receiver mounting.

— n r i —

COLUMBIA MODEL S. G. 8

INTERMITTENT RECEPTION

Carefully check the volume control. The fine wires on this unit sometimes break and may cause intermittent reception. The contact between the slider arm and resistance element must be tight. It is well to visually examine and to electrically check all the resistors.

— n r i —

"I think there has been a great improvement made in the 'Radio News.' The Service Forum sure does come in handy.

"The article on Ohmmeters by Mr. George Rohrich sure did give me a clear understanding about Ohmmeters and how to connect them."

PAUL H. STEHLE,
Marcus Hook, Pa.

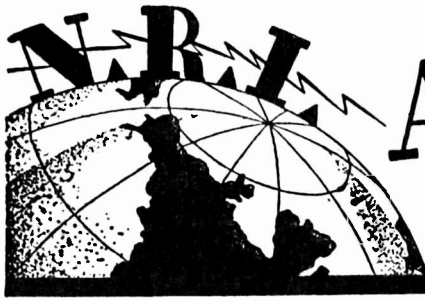

ALUMNI *News*

Introducing R. B. Murray



Handling Alumni Association activities at National Headquarters in Washington is no cinch. There is a lot of work connected with it.

With the increased size of NATIONAL RADIO NEWS, new services given members, and elaborate plans for the future, it was

found necessary to have more "man power." So we went "up on the carpet," and talked to Mr. Smith--and as usual he came to our rescue.

As the result we now have with us, R. B. (Bob) Murray, who has been appointed Assistant Executive Secretary. Looks like a case of *Clan Murray*, with P. J. as Executive Secretary and R. B. as Assistant, but really--they are not related in any way. (Phil is Irish and Bob is Scotch.)

R. B. Murray has been interested in Radio, Electrical and Sound Picture work since 1925, and has been with N. R. I. since 1930. He has traveled extensively in Canada, all parts of the United States, Mexico, Central and South America, and the West Indies. This has given him a wonderful opportunity to study Radio conditions and should be a great benefit to Alumni members whom he will serve in his new position.

Bob was born and raised in Dayton, Ohio; is 30 years old, an ex-U. S. Marine (this is a good one--P. J. Murray is an ex-Sailor) and spent a number of years as an instructor in the Marine Corps Institute.

Before very long we are going to have him write an article for NATIONAL RADIO NEWS, but he is right busy now getting settled in his new job and making plans. He will visit a number of the Local Chapters before many months roll around.

Here's wishing you the best of luck, Bob!

Page Twenty-four

The Wheels of Progress Are Oiled...

By P. J. Dunn, President



I consider my election the greatest honor ever bestowed upon me--to be selected as the leader of such a fine body of men. I thank you all from the bottom of my heart for the confidence you have shown in me.

You may rest assured that I will do my best to promote a closer relationship between the members of our Association, our Local Chapters, and National Headquarters, at Washington. I further promise that I will give the best that is in me to the welfare of our Association.

With the plans already formulated we are going to make this the biggest year in the history of the N. R. I. A. A. To accomplish this the National officers need the help of every member of the National Association, and every officer and member of the Local Chapters. Unity means progress--let's work together, boys--for the advancement of our great Association.

I intend to maintain close contact with the Local Chapters, and I'll visit as many Chapters as possible during the year. I'll work with the Chapters in any way possible. It will be a pleasure to help advance the good work which we are doing.

Speaking of unity and progress, there is no better way of accomplishing this than for every Chapter to have its own Paper or Bulletin. The Baltimore Chapter has been publishing "The Baltimore Bulletin," for nearly a year. It has been the greatest factor in building up that Local. Today this Chapter of our organization is classed as the biggest and strongest Radio Association in the State of Maryland.

Other Chapters can likewise come to promi-

(Page 26, please)

I Built Up a Profitable Radio Business

By EARL BENNETT, Vice-President N. R. I. Alumni Association

(Chairman, Chicago Chapter)

Some fellows going into the Radio business wonder why it is that no matter how hard they work—how many hours they put in—the business stays small. They see other fellows start businesses which seem to grow by leaps and bounds.

Well, the answer is simple. It isn't always the amount of work that you put into a business—the number of hours which you devote to its building up that regulates its size. Of course, you've got to work hard to put any Radio business across, but it is my contention that the size of the Radio business and the profits you take from it, are usually regulated more by the amount of preliminary thought—the amount of

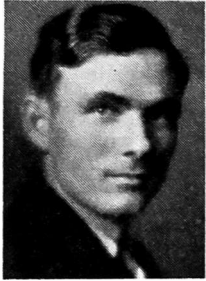

study you give to the proposition before you start the business than anything else.

Now I have built up a very profitable Radio business. It is located in Evanston, Ill., a town with a population of about 38,000, which might well be considered a suburb of Chicago. I could have been content with a small business—getting my Radio work only from individual set owners, but right from the start I decided that what I wanted was volume—and the best way to get volume was to do something besides merely contacting the individual set owners in my locality.

To further this plan I sat down and wrote a sales letter—a very personal sales letter—to the various department stores in the Chicago Metropolitan area. I did not try to sell my proposition in this letter—I merely tried to line up interviews with executives of the stores.

I told them in the letter that I could save them money on their Radio service work, particularly in certain localities. I got them interested—I got interviews—and as a result I sold my plan to a number of them.

When I was called in for an interview, I built my story around the idea that Radio customers of the store wanted prompt service. They didn't want to wait several days until a Radio man from the store could get around to them. Furthermore, I pointed out that it was expensive for the store to send men on long trips to service a single Radio—and then possi-

(Page 27, please)

New Secretary Appointed at Toronto

Due to the resignation of our Secretary, Mr. A. G. Ruse, who has held that office ever since this Chapter was organized, it was necessary to hold a special election to fill that office.

Our new secretary is Mr. Ed Witherstone, 362 Nairn Ave., Toronto, Ontario.

At a recent, very successful meeting, the Toronto Chapter adopted its own Constitution which will shortly be sent to National Headquarters, in Washington for approval.

Under the able guidance of our new secretary, we are continuing our drive for new members as it is our desire to build up the membership, and consequently the strength of this Chapter. Like other Chapters of this Association, we want to extend a welcome to N. R. I. students, as well as graduates, with the assurance that they can be greatly benefited by participating in the affairs of this organization.

It is planned to publish a Chapter Bulletin which will give especial attention to Canadian Radio problems and consequently be of great value to Canadian Alumni members. Toronto Chapter membership will be made available to all Canadian Association members so they may take advantage of this Bulletin and other services.

— n r i —

Vice-President Vanek Writes

... please let the gang know, through the pages of NATIONAL RADIO NEWS, that I thank them for the honor they have bestowed upon me in the recent Alumni Association elections—that of re-electing me to the Vice-Presidency. I hope that I can serve them to their satisfaction.

As you recall, we have been communicating with each other about the organization of a Local Chapter of the Alumni Association here in Cincinnati. I have been working on that proposition and have talked to a number of N. R. I. students and graduates about it. I am making a survey of the nearby towns—including Cincinnati, Covington, etc., and just as soon as I feel that we are in a position to have a good Local organization here, I will notify you and we can get started.

LAWRENCE J. VANEK,
113 W. University Ave.,
Cincinnati, Ohio.

Page Twenty-five



Holds Big Meeting

The officers of the Cleveland Chapter of the N. R. I. Alumni Association were particularly pleased with the way N. R. I. students and graduates turned out at a recent meeting of this Chapter. It was probably the largest gathering that Cleveland has had in over a year.

It was a special meeting, called for the purpose of discussing plans for the year 1935 with our Executive Secretary, from Washington, present.

The Cleveland Chairman, Mr. Charles Jesse, addressed the meeting and told of his plans for the year. There were numerous valuable suggestions from the members. It was decided at this meeting that the Chapter should elect new officers, particularly as Secretary Hannum had found it necessary to resign, due to accepting a position which took him out of town.

Chairman Jesse stated that he felt that possibly some of the boys from the East Side of Cleveland wanted a Chairman from their own section of the city, and in order to give them an opportunity to elect such a man to the Chairmanship, Jesse resigned. He was, however, promptly re-nominated, and since no other nominations were forthcoming, he was re-elected unanimously to the chair. Mr. Burton Bailey of Cleveland was elected Secretary, and Mr. James F. Obdrzalek was elected Assistant Secretary.

The members were then given first-hand information, from Washington, by Mr. Murray, on the progress that other Chapters had made during the past year, specifically pointing out that some of the successful plans had originated right in Cleveland.

The officers of the Cleveland Chapter wish to extend to every N. R. I. *student* and *graduate* in this area, a cordial invitation to attend our meetings. The officers, listed below with their addresses, will be only too glad to give full details regarding the date, place, and program of future meetings. A post card or a phone call will bring you the desired information:

Charles Jesse, Chairman, 3127 West 112th St., Cleveland Ohio.

Burton Bailey, Secretary, 2473 East 89th St., Cleveland, Ohio.

James Obdrzalek, Assistant Secretary, 3454 East 54th St., Cleveland, Ohio.

Page Twenty-six

nence—so let's get started with a Bulletin for every Chapter of our Association. Chicago, New York, and Philadelphia have started publications, and I wish them much success with their new papers. Let's get started Buffalo, Toronto, Detroit and Cleveland—a paper for each Local Chapter. Let's make this the first step of progress for 1935.

Let's all put our shoulders to the wheel, and push together and make 1935 the banner year of our Association. We can do this by attending our Chapter meetings regularly; by promoting meetings that will be helpful in the advancement of Radio knowledge, and by helping the other fellows get ahead.

Remember boys—the old depression's over. The wheels of progress have been oiled for a long period of prosperity. The smoke is again pouring from the smokestacks of mills and factories—men are going back to work again. New Radios will be bought and many of the old ones will need repairing. This will mean more work and more money for the members of our Association.

— n r i —

Pittsburgh

Pittsburgh claims the distinction of being the first Chapter of the N. R. I. Alumni Association to open a branch office. Our headquarters are in the Wilksburg section of Pittsburgh—but for the convenience of members we have opened our Supply Department in Bellevue.

Our members have gotten very much interested in five meter reception and transmission, and a number of them will have their amateur tickets before very long. Incidentally, Pittsburgh wants to be the first Local Chapter to have a real Short-Wave set-up between members.

Our Executive Secretary, from Washington, paid us a visit not so long ago, and a special meeting was called to give him an opportunity to address all of the Pittsburgh members. The meeting was held, as usual, in the Penn-Lincoln Hotel, and we had a fine turn-out.

— n r i —

St. Louis Grads Attention

Plans are underway for the organization of a Local Chapter of the N. R. I. Alumni Association in St. Louis. It should be in operation by July 1, 1935.

Philadelphia-Camden Chapter

We have been holding meetings regularly, on the first Thursday and third Tuesday of each month. Although it was necessary to vacate our old headquarters at 2744 Frankford Avenue, due to circumstances over which we had no control, our regular meetings are being continued now at 2719 Kensington Avenue.

All of our special equipment has been moved to 2947 Rutledge Street, the home of Secretary Stokes, who has given us the use of a work shop there for laboratory work and meeting headquarters on the Thursday "get-together."

A recent meeting of particular interest was held with Mr. B. L. Elmann, Radio Engineer, formerly with the RCA-Victor Company, as guest speaker. Mr. Elmann gave a very interesting talk on "The Superhetrodyne and Servicing it in the Home."

Philadelphia-Camden is glad to report that our new monthly Local Chapter Bulletin is O.K. and ready to ride. Our first issue will be out shortly. It is edited by Mr. Milton Taggart and will be known as "The Philcam Key."

N. R. I. students or graduates desiring any detailed information regarding the meetings can get in touch with our Secretary, Mr. Clarence Stokes, 2947 Rutledge Street, Philadelphia, or phone Chairman Charles J. Fehn, at Nebraska 3557.

— n r i —

Detroit Local Chapter

Recently, Mr. P. J. Murray, our Executive Secretary, visited Detroit and gave us a fine talk. About forty-five members of the Association were present. Many of them were first nighters at a Detroit meeting, but the Chapter is positive that they will become regular, active members, and thus help the Local to become one of the strongest and largest Chapters of the National Association.

We are going ahead with a very extensive educational program which will include talks by local members on special topics assigned them, which will be of great interest and educational value.

We are also working on a series of talks by engineers and representatives of the many Radio manufacturers and parts companies which will take place soon. Our members have shown a decided preference for practical talks on Radio apparatus illustrated with sketches on the blackboard. They'll get plenty of this.

With the support of the members in the Detroit and suburban area, there is no doubt but the Detroit Local Chapter will do things and go places.

(Page 28, please)

I Built A Radio Business

(Continued from page 25)

bly have to jump all the way over to another part of town to service another set. I sold them on the idea of turning their service work over to me. I promised that the jobs would be serviced within a very short time after the calls were received, consequently the customers would be better satisfied.

In addition, since the sections in which I was going to work were near my shop, my traveling expenses would be less than those of the serviceman from the store and the store could consequently get the work done cheaper by me doing it.

Definite arrangements were made whereby a certain flat price for calls was paid me while the sets were in the original sales guarantee period—in which case the department store had to foot the bill. On the other hand, if the department stores received calls from these customers after the set is out of the guarantee period—a different plan is worked out, whereby I receive a certain percent of the profit on the call—the department store still being responsible for the collection of the account and the payment of my charge.

The whole plan is simple, but it has enabled me to build up a fine big, profitable Radio service business.

— n r i —

Baltimore

Just a word or two to the N.R.I. students and graduates of Baltimore and the surrounding territory. If you missed the talk given by Mr. Jones of the Hygrade-Sylvania Tube Corporation on the subject of Automatic Volume Control—you really missed something. If you didn't hear Mr. Field of RCA on the same subject—that's something else you've missed.

And that's just to mention two of the interesting and instructive lectures brought to its members by the Baltimore Chapter in the past several weeks.

There are plenty more like that to come—if you don't take advantage of them—well, frankly, it's your own hard luck. Believe us when we say that Baltimore is making the sparks fly, and our members are benefitting as a result. Full details regarding meetings can be obtained from P. J. Dunn, Chairman, 713 N. Fulton Avenue, Baltimore, Maryland.

— n r i —

If you want to control others you must learn to control yourself.

Page Twenty-seven



Cleveland

Cleveland Holds Big Meeting

The officers of the Cleveland Chapter of the N. R. I. Alumni Association were particularly pleased with the way N. R. I. students and graduates turned out at a recent meeting of this Chapter. It was probably the largest gathering that Cleveland has had in over a year.

It was a special meeting, called for the purpose of discussing plans for the year 1935 with our Executive Secretary, from Washington, present.

The Cleveland Chairman, Mr. Charles Jesse, addressed the meeting and told of his plans for the year. There were numerous valuable suggestions from the members. It was decided at this meeting that the Chapter should elect new officers, particularly as Secretary Hannum had found it necessary to resign, due to accepting a position which took him out of town.

Chairman Jesse stated that he felt that possibly some of the boys from the East Side of Cleveland wanted a Chairman from their own section of the city, and in order to give them an opportunity to elect such a man to the Chairmanship, Jesse resigned. He was, however, promptly re-nominated, and since no other nominations were forthcoming, he was re-elected unanimously to the chair. Mr. Burton Bailey of Cleveland was elected Secretary, and Mr. James F. Obdrzalek was elected Assistant Secretary.

The members were then given first-hand information, from Washington, by Mr. Murray, on the progress that other Chapters had made during the past year, specifically pointing out that some of the successful plans had originated right in Cleveland.

The officers of the Cleveland Chapter wish to extend to every N. R. I. *student and graduate* in this area, a cordial invitation to attend our meetings. The officers, listed below with their addresses, will be only too glad to give full details regarding the date, place, and program of future meetings. A post card or a phone call will bring you the desired information:

Charles Jesse, Chairman, 3127 West 112th St., Cleveland Ohio.

Burton Bailey, Secretary, 2473 East 89th St., Cleveland, Ohio.

James Obdrzalek, Assistant Secretary, 3454 East 54th St., Cleveland, Ohio.

Page Twenty-six



Chicago Chapter

Chicago held a special meeting, recently, in the Hotel Sherman, for the purpose of hearing an address by our Executive Secretary from Washington, who was visiting the western Chapters.

Our members seemed to like the meeting place in the Hotel Sherman, and negotiations are in progress to keep this as our regular meeting headquarters.

Elaborate plans for the year 1935 were discussed, and it was decided that the Chicago Chapter would follow the plan so successfully worked by some of the eastern Chapters—that of publishing a regular monthly bulletin for the benefit of our members. It will contain news of the Chapter, service notes, and other helpful material, and will be known as "*Chicago Chapter's Chatter*."

Chicago, by reason of its location, good transportation facilities, and the large number of N. R. I. students and graduates in the area, has a wonderful opportunity to build up a fine big organization. We want every N. R. I. student and graduate in this area who is sincerely interested in his Radio career, to get in touch with us and share the benefits of this organization. Full information can be obtained from Mr. Earl Bennett, 931 Wesley Ave., Evanston, Illinois, or Mr. Samuel Juricek, 4223 North Oakley Ave., Chicago, Illinois.

— n r i —

Detroit

** (Continued from page 27)

We receive many letters requesting information on the Local Chapter from N. R. I. students. This is very gratifying and we hope that every student in the Detroit area who reads the NATIONAL RADIO NEWS will request such information. It is our desire to be of help to all students as well as graduates.

Address any request to C. H. Mills, Chairman, 5458 15th Street, Detroit.

— n r i —

Pat—"That was a fine sentiment Casey got off at the banquet last night."

Mike—"What was it?"

Pat—"He said that the sweetest memories in life are the recollections of things forgotten."

Philadelphia-Camden Chapter

We have been holding meetings regularly, on the first Thursday and third Tuesday of each month. Although it was necessary to vacate our old headquarters at 2744 Frankford Avenue, due to circumstances over which we had no control, our regular meetings are being continued now at 2719 Kensington Avenue.

All of our special equipment has been moved to 2947 Rutledge Street, the home of Secretary Stokes, who has given us the use of a work shop there for laboratory work and meeting headquarters on the Thursday "get-together."

A recent meeting of particular interest was held with Mr. B. L. Elmann, Radio Engineer, formerly with the RCA-Victor Company, as guest speaker. Mr. Elmann gave a very interesting talk on "The Superhetrodyne and Servicing it in the Home."

Philadelphia-Camden is glad to report that our new monthly Local Chapter Bulletin is O.K. and ready to ride. Our first issue will be out shortly. It is edited by Mr. Milton Taggart and will be known as "*The Philteam Key*."

N. R. I. students or graduates desiring any detailed information regarding the meetings can get in touch with our Secretary, Mr. Clarence Stokes, 2947 Rutledge Street, Philadelphia, or phone Chairman Charles J. Felm, at Nebraska 3557.

— n r i —

Detroit Local Chapter

Recently, Mr. P. J. Murray, our Executive Secretary, visited Detroit and gave us a fine talk. About forty-five members of the Association were present. Many of them were first nighters at a Detroit meeting, but the Chapter is positive that they will become regular, active members, and thus help the Local to become one of the strongest and largest Chapters of the National Association.

We are going ahead with a very extensive educational program which will include talks by local members on special topics assigned them, which will be of great interest and educational value.

We are also working on a series of talks by engineers and representatives of the many Radio manufacturers and parts companies which will take place soon. Our members have shown a decided preference for practical talks on Radio apparatus illustrated with sketches on the blackboard. They'll get plenty of this.

With the support of the members in the Detroit and suburban area, there is no doubt but the Detroit Local Chapter will do things and go places.

(Page 28, please)

I Built A Radio Business

(Continued from page 25)

bly have to jump all the way over to another part of town to service another set. I sold them on the idea of turning their service work over to me. I promised that the jobs would be serviced within a very short time after the calls were received, consequently the customers would be better satisfied.

In addition, since the sections in which I was going to work were near my shop, my traveling expenses would be less than those of the serviceman from the store and the store could consequently get the work done cheaper by me doing it.

Definite arrangements were made whereby a certain flat price for calls was paid me while the sets were in the original sales guarantee period—in which case the department store had to foot the bill. On the other hand, if the department stores received calls from these customers after the set is out of the guarantee period—a different plan is worked out, whereby I receive a certain percent of the profit on the call—the department store still being responsible for the collection of the account and the payment of my charge.

The whole plan is simple, but it has enabled me to build up a fine big, profitable Radio service business.

— n r i —

Baltimore

Just a word or two to the N.R.I. students and graduates of Baltimore and the surrounding territory. If you missed the talk given by Mr. Jones of the Hygrade-Sylvania Tube Corporation on the subject of Automatic Volume Control—you really missed something. If you didn't hear Mr. Field of RCA on the same subject—that's something else you've missed.

And that's just to mention two of the interesting and instructive lectures brought to its members by the Baltimore Chapter in the past several weeks.

There are plenty more like that to come—if you don't take advantage of them—well, frankly, it's your own hard luck. Believe us when we say that Baltimore is making the sparks fly, and our members are benefitting as a result. Full details regarding meetings can be obtained from P. J. Dunn, Chairman, 713 N. Fulton Avenue, Baltimore, Maryland.

— n r i —

If you want to control others you must learn to control yourself.

Page Twenty-seven

The Service Forum

(Continued from page 11)

RCA MODELS 17M, R17W, & R18W

LOW VOLUME

These models employing an inductor dynamic speaker field using a permanent magnet will lose volume due to loss of magnetism of these fields. The recommended remedy is to replace these speakers with good quality magnetic speakers.

-----n r i-----

RCA VICTOR & G. E. AUTO RADIO

VIBRATOR ADJUSTMENT

Before attempting adjustment of the vibrator of this power supply unit try one or more 6A7 tubes. We have found that a good 90% of the intercarrier noise can be eliminated simply by the selection of the proper 6A7 tube.

-----n r i-----

RCA VICTOR MODEL R-5

INTERMITTENT DISTORTION

Check the voltage between the can of the electrolytic condenser, on top of the chassis, and the chassis before and after the distortion occurs. If the voltage increases with distortion one of the resistors shunting the speaker field is defective. The one connected to the low potential end has a value of 280,000 ohms while the one connected to the grounded end of the field has a value of 50,000 ohms. To be safe replace both. After this let the set play for an hour or so to make sure there is no recurrence of the difficulty. Use of National Union tubes, type 21A, will cause oscillations in most cases due to their higher Gm.

-----n r i-----

RCA VICTOR MODELS 17M, R17W & R27

DEAD OR HUMS

Check the condition of the dry electrolytic condenser in this circuit. It is located on top of the chassis in front of the variable condenser gang. It will probably be found shorted or open and must be replaced in either case.

-----n r i-----

RCA MODEL 80 (EARLY)

IMPROVING

The sensitivity of this set may be increased by removing the shield over the first I.F. transformer and bending the copper shield between the coils a little. This results in a greater energy transfer. The I.F. should then be realigned. If desired, a tone control unit may be purchased together with a second detector plate filter for an RCA Model 82 from your local distributor.

Page Twenty-Eight

Chicago Chapter

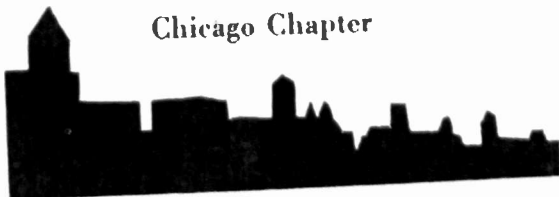

Chicago held a special meeting, recently, in the Hotel Sherman, for the purpose of hearing an address by our Executive Secretary from Washington, who was visiting the western Chapters.

Our members seemed to like the meeting place in the Hotel Sherman, and negotiations are in progress to keep this as our regular meeting headquarters.

Elaborate plans for the year 1935 were discussed, and it was decided that the Chicago Chapter would follow the plan so successfully worked by some of the eastern Chapters—that of publishing a regular monthly bulletin for the benefit of our members. It will contain news of the Chapter, service notes, and other helpful material, and will be known as "*Chicago Chapter's Chatter*."

Chicago, by reason of its location, good transportation facilities, and the large number of N. R. I. students and graduates in the area, has a wonderful opportunity to build up a fine big organization. We want every N. R. I. student and graduate in this area who is sincerely interested in his Radio career, to get in touch with us and share the benefits of this organization. Full information can be obtained from Mr. Earl Bennett, 931 Wesley Ave., Evanston, Illinois, or Mr. Samuel Juricek, 4223 North Oakley Ave., Chicago, Illinois.

-----n r i-----

Detroit

(Continued from page 27)

We receive many letters requesting information on the Local Chapter from N. R. I. students. This is very gratifying and we hope that every student in the Detroit area who reads the NATIONAL RADIO NEWS will request such information. It is our desire to be of help to all students as well as graduates.

Address any request to C. H. Mills, Chairman, 5458 15th Street, Detroit.

-----n r i-----

Pat—"That was a fine sentiment Casey got off at the banquet last night."

Mike—"What was it?"

Pat—"He said that the sweetest memories in life are the recollections of things forgotten."

New York Metropolitan Area

Probably the greatest advance made so far by this Chapter is in the opening of a shop where members can get additional practical experience in various phases of Radio—including Servicing, Custom Contacts, Estimating, Selling a Repair Job, etc.

I have long realized the desire of many of the members of our New York Metropolitan Area Chapter to get additional practical experience. Eventually they came to me and said: "How about using your shop?" Of course I realized that we needed a larger shop to do this thing right, so I proceeded as follows:

I moved my shop to larger quarters; in fact, three times as large, so that I might use the additional space for what we call "N. R. I. Alumni Association Shop Service," and by the way, we have just that name on one of the windows. The next step was to arrive at the cost of operation per man; how much electricity he would use, and the amount that he would have to donate toward the rent.

I offered the members two plans, one where they could donate their physical labor to helping to build the shop, such as painting, plastering, carpenter work, electrical work, etc. The other plan was for the fellow who was unable to offer any such service. In the first case, after the job was done, those who helped build the place were allowed to have their practical experimental periods at a cheaper rate than those who could not help with the construction work. Each member who comes in under this special plan is given three three-hour periods a week.

The hours have been arranged so that a man has a choice, more or less, to suit his convenience.

The next step was the layout, which I made myself. The front part is for counter sales; then a partition which separates the public from our work bench. The part behind the partition is approximately 30 feet long by 15 feet wide. This space is divided into two parts, each approximately 7 feet wide by the above length; one-half of the shop is for my personal service work, where my bench man works, and is screened off from the rest of the shop.

Immediately behind the partition on the side of the remaining half is the delivery rack for sets which are "homeward bound." From this point, and fastened to the wall—is a 24-foot bench, divided into seven sections, so that seven men can work at the same time. There is an individual drop light, and a double power outlet for each space; the outlet is mounted at the front of the bench, while the drop lights are all strung on a trolley wire extending from one end of the bench to the other and directly above. This allows the drop lights to be moved directly across the space allotted to each man.

Each space is a separate bench in itself, with a dividing board at each side and a long board which tops all of these dividing boards running the full length of all the benches. This acts as a shelf and holds the man's testing equipment. The bench is thirty inches high and thirty-two inches deep—just high enough for

(Page 30, please)



New York Chapter's practical training workshop.

a man to use with the ordinary kitchen chair for a seat.

At the rear of the shop there is a space (approximately five feet square) which is to be used for a sound-proof room for making alignments or testing microphones. The bench has already been built, but we are waiting for the shipment of Celotex. I also plan to build a utility bench and a set rack for the fellows to use—my own set racks are inside of my half of the shop.

Each man is required to bring his own equipment, tools, etc., and will be furnished with suitable locker space as soon as the lockers are completed. My shop equipment consists of a Supreme AAA-1 Diagonometer, Supreme 35 and Supreme 85 Tube Checkers, Supreme 400-B Diagonometer, Hickok Resistance Capacity Meters, Hickok Volt-Ohm Milliammeter, Tobe Condenser Checker, Egert All-Wave Oscillator, hand calibrated, two additional oscillators and several A. C. and D. C. voltmeters. A complete set of Rider's Manuals and all of his Handbooks; subscriptions to Service, Radio Retailing, Radio Engineering, and last but not least, a complete file of NATIONAL RADIO NEWS are in the shop Library for the assistance of these men.

In addition to the above equipment, we will shortly have an Oscillograph.

From time to time I take each fellow out with me on service calls so that he may experience how I contact my customers and sell my services. He obtains first hand information on every angle of the Radio service business through personal contact. When he is finished, he will be able to dig in for himself. He has first of all, the best foundation possible—the N. R. I. Training, plus the experience gained here in the shop among his own N. R. I. Alumni Association members who, myself included, are always willing to go out of the way to prove to the public that an N. R. I. trained man is the Radio technician to repair the set.

— n r i —

WILLING TO OBLIGE

An Arkansas clergyman who rides to his church in an automobile, received an anonymous letter calling attention to the fact that the Lord never rode to church in a car. The clergyman read it from the pulpit, and added: "If the writer of this letter will come next Sunday, properly saddled and bridled, I will be glad to follow the Lord's example and come to church as He entered Jerusalem."

National Radio News

"from the Pioneer Radio Home Study School"

Vol. 6
No. 7

Apr.-May
1935

Published every other month in the interest of the students and Alumni Association of the

NATIONAL RADIO INSTITUTE
Washington, D. C.

The Official Organ of the N. R. I. Alumni Association
Editorial and Business Office, 16th & You Sts., N. W.,
Washington, D. C.

P. J. Murray, Managing Editor

Index

Article	Page
The President's Page	2
All-Wave Antenna Systems	3
Easy Measurement Charts	4
Service Forum	5
New Use for Aviation-Radio	6-7
Broadcast from Bobsled	9
Data Sheet Philco Models 45 and 29	13-14
WHICH ROAD?	16-17
Data Sheet Philco Model 118	19-20
WOR's New Station	22
Alumni News	24-25-26-27-28-29-30
Mailbag	31
Calcaterra Service	32



THE MAILBAG

I am very much interested in your article "Easy Measurement Charts" in the December-January NATIONAL RADIO NEWS. They are fine. Wishing you a prosperous New Year.

John J. McNulty.

— n r i —

Another "HAM"

We have an addition to our growing list of N. R. I. Amateur Station operators:

C. C. Johnson, Northfork, W. Va., owns and operates WSMOZ. Hi O. M.

— n r i —

TWO-VOLT TUBES

I'm sure some of our readers have changed over Radios for two-volt tubes and have had the new tubes go dead in two or three months. When the set owner has the battery charged the voltage will be above two-volts, not much over, understand, but sufficient to overload the tube and cause trouble.

To prevent this, install a ballast tube in series with one of the filament leads. This keeps the filament voltage at the two-volt level and prevents overloading.

It is simple to determine the size ballast tube to use. Find the current drain of each tube, that is the filament current, add these together and see that the ballast tube is rated correctly, for the total drain.

S. Hanson, Twin Valley, Minn.

This is a good idea. It is the reason that most modern two-volt sets are equipped with special Amperite ballasts.—Editor.

— n r i —

MORE CANADIAN MATERIAL

Repeatedly, NATIONAL RADIO NEWS has suggested that we send in ideas for the betterment of our magazine. Well, here's mine.

How about we Canadians sending in hints and service notes on Canadian receivers so that they can be published for the benefit of all of us up here.

Let's get together on this and send lots of service notes, diagrams, etc., on Canadian sets to *The Mailbag Editor*.

G. Austin, Dundas, Ont., Canada.

I certainly appreciate your consultation service as far as I have used it. I think it is a very fine thing for a school to give to the students and graduates at no extra charge, after the complete course of training that N. R. I. gives for so nominal a sum.

Wilbur E. Van Horn, Sacramento, Cal.

— n r i —

Here is a tip which might help somebody. Had to service a Fada ten tube set—complaint was set would play for three or four hours and then get very distorted. Set was tested out and found O. K. but after much more testing I found that the field coil of the speaker was covered by some thick fire proof covering. On removal of this covering set operated for hours without distortion. This covering had the effect of causing the field coil and frame work of speaker to heat up gradually until expansion caused voice coil to stick, hence the distortion.

W. H. Gasson, Chapleau, Ont., Canada.

— n r i —

The other day I was working on a General Motors Model 120-A set which would fade then get real loud on all stations. I found the volume control defective.

I also found that the three triple section .1 Mfd. by-pass condensers would open after the set got warm. The condensers are connected as follows: The common terminal connects to cathode, one section going to B plus, the other going to the screen grid element of the No. 24 tubes, and the third section going to chassis and condenser can.

I replaced these with Sprague 3x.1 condensers and connected the can, which is the common terminal, also to chassis and connected one section to cathode, one to screen grid, and the final one to B plus. The set had a bad tunable hum which I found to be due to insufficient capacity across the power choke coil. I shunted this with a .1 Sprague tublar condenser. The result is that the set does not fade nor hum any more.

C. W. Tews, Milwaukee, Wis.

Build Yourself a Valuable Radio Library with these Helpful FREE MANUFACTURERS' BOOKLETS and CATALOGS

A FREE SERVICE DESIGNED TO SAVE YOU TIME AND MONEY

The cooperation of the manufacturers whose catalogs, literature and booklets are listed on this page, and the courtesy of the Calcatera Catalog Service, has made it possible for the N. R. I. Alumni Association to offer to readers of National Radio News a unique and money-saving service in obtaining Radio manufacturers' literature.

All that is necessary for you to obtain the catalogs or other literature listed on this page is to write the

numbers of the items in which you are interested on the coupon, fill in the information asked for and MAIL IT TO THE CALCATERRA CATALOG SERVICE. DO NOT MAIL COUPONS TO THE NATIONAL RADIO INSTITUTE AS THAT WILL DELAY THE FILLING OF YOUR ORDER.

Stocks of the publications listed are kept on hand and they will be sent to you promptly, as long as the supply lasts.

2. HAMMARLUND 1935 PARTS CATALOG. 12 pages. Variable and adjustable condensers, sockets, coils, intermediate frequency transformers, chokes, etc., for broadcast and short wave work.

4. HAMMARLUND 15 TO 200 METER COMET "PRO" SUPERHETERODYNE. Details of a receiver designed especially for laboratory, newspaper, police, airport and steamship use.

5. ELECTRAD 1935 CATALOG. 12 pages. Standard and replacement volume controls, Truvolt adjustable resistors, voltage dividers, vitreous enamelled fixed resistors, public address systems, etc.

6. AMPERITE REAL LINE VOLTAGE CONTROL. Characteristics, uses and chart showing the correct Amperite recommended by set manufacturers for their sets.

25. LYNCH NOISE-REDUCING ANTENNA SYSTEMS. Complete descriptions and instructions issued by Arthur H. Lynch, Inc. for making all kinds of antennas for broadcast and short wave reception. Also a special supplement covering Ham antenna design for transmitting as well as receiving on all the amateur bands including the ultra-high frequencies.

26. LYNCH AUTO RADIO ANTENNAS, FILTERS AND NOISE SUPPRESSORS. Describes a complete line of Lynch antennas, filters and ignition noise suppressors for auto radio installations. The antenna system is of the under-the-car type for easy installation and is specially suited for use with the new "turret-top" cars.

27. THE LYNCH AUTOSTAT CHARGING RATE BOOSTER. This folder describes the new Lynch Autostat designed to automatically increase the charging rate of the automobile car generator by five amperes every time the car radio is turned on so as to eliminate danger of running down the car batteries when the radio is in operation.

28. LYNCH SUPER FILTASTATS FOR AUTO RADIO INSTALLATIONS. Describes and illustrates, with instructions for using, the new Lynch Super Filtastats which do away with the need for suppressors in auto radio installations, giving better performance in operation for both the car and the radio set.

34. ELECTRAD SERVICEMEN'S REPLACEMENT VOLUME CONTROL GUIDE. A 52-page vest-pocket size booklet containing a revised, complete list, in alphabetical order, of over 2,000 different receiver models with the proper type of Electrad Control to use for replacements.

57. RIBBON MICROPHONES AND HOW TO USE THEM. This circular describes the principles and operating characteristics of the Amperite velocity microphones. Also gives a diagram of an excellent humless A. C. and battery operated pre-amplifier.

60. AMERTRAN AUDIO AND POWER TRANSFORMERS AND CHOKE COILS FOR USE IN PUBLIC ADDRESS AMPLIFIERS AND RECEIVERS. A booklet containing very complete information on the characteristics of a wide variety of AmerTran De Luxe and Silcor (popular priced line) audio and power transformers and chokes.

65. NEW SUPREME 1935 LINE OF TESTING INSTRUMENTS. This booklet gives complete information on the new 1935 line of Supreme testing instruments including the new 5" Supreme fan shape meter, the new Model 333 DeLuxe Analyzer, the low-priced Model 333 Standard Analyzer and the Improved Model 85 Tube Tester.

66. A SUPREME A.C.-D.C. TESTER WHICH CAN BE BUILT AT HOME AT LOW COST. This folder gives complete information about the Supreme 5" fan shape meter, rectifier and resistor kit for the home construction of an inexpensive A.C.-D.C. tester.

72. SKYRIDER SHORT WAVE RECEIVERS. Describes the various types of tuned radio frequency and superheterodyne short wave receivers built by Hallicrafters, Inc., featuring ranges of 13 to 200 meters (with broadcast or 10 meter band optional), automatic wave change switch, continuous band spread, built-in monitor, speaker and power supply (or batteries), high fidelity audio and other refinements.

73. HETRO HOME AND AUTO RADIO RECEIVERS AND ACCESSORIES. A folder containing descriptions, list and net prices of the Hetro Electrical Industries line of console, phono-radio and table model home radio receivers, auto radios, phonograph units and other accessories.

74. SPRAGUE ELECTROLYTIC AND PAPER CONDENSER CATALOG. Gives specifications and prices on a complete line of electrolytic and paper condensers made by the Sprague Products Co. for servicemen, experimenters, set builders and engineers.

(Please Use Pencil and Print in Filling in Coupon)
THE CALCATERRA SERVICE NRN-435
Thornwood, N. Y.

Please send me, without charge or obligation, the catalogs, booklets, etc., whose numbers I have filled in below.

Booklet Numbers:

My connection in Radio is checked off below.

() Serviceman operating own business

Serviceman employed by:

() Manufacturer

() Jobber

() Dealer

() Servicing organization

() Dealer

() Jobber

() Radio Engineer

() Experimenter

() Laboratory Technician

() Professional or Amateur Set Builder

() Licensed Amateur

() Station Operator

() Manufacturers' Executive

() Student

() Public Address Work

()

()

I buy approximately \$00 of Radio material a month.

(Please answer above without exaggeration or not at all.)

Name

Address

City State