

NATIONAL RADIO NEWS

April-May, 1934

Volume 6
Number 1



TWENTIETH ANNI-
VERSARY YEAR

OF THE NATIONAL
RADIO INSTITUTE



The President's Page

President
J. E. Smith

IF one-half the *wailing time* used by fellows who think the world is against them were used to good advantage, this world would be a much better place in which to live.

Did you ever notice that the fellow who thinks the *breaks are all against him* gets a certain amount of pleasure from relating his sad plight to others . . . telling them how bad conditions are . . . predicting wholesale starvation . . . revolutions . . . even the nation's downfall?

Not satisfied to be in a serious plight himself, he must, by peddling his silly jabber to others—some of whom are in equally bad circumstances—break down their morale . . . get them too into the habit of *thinking distress* instead of acting.

Now suppose this fellow who is doing the wailing is a laborer. He can't land a job, has a wife and a youngster depending on him for food and shelter—and he's broke. Bad, indeed, we'll admit. But it's an iron-clad cinch that he won't better conditions one bit by bemoaning his fate to others. Wouldn't he be much better off if he pushed door-bells—hour after hour—seeking work—cleaning cellars, raking leaves, shoveling snow? If he pushes enough bells—contacts enough people—**HE'LL MAKE A DOLLAR . . . a dollar he'd never make wailing.**

A gentleman of my acquaintance once made a remark which illustrates the point I am trying to bring you. He said: "You can't break down a concrete barrier by shouting at it—by swearing at it. But beat that barrier with a sledge hammer and even though you may not demolish it, you can at least make a crack large enough to squeeze through."

This example not only applies to the laborer looking for work, it can apply to almost any man who finds himself out of a job. But the real lesson to be learned is that you can do more good by *plugging* than by *wailing*.

NATIONAL RADIO NEWS has, for several years been emphasizing the importance of the Automobile Radio field, and stressing the neglect with which this branch of the Radio industry was being treated, particularly by dealers and independent Radio men.

We have endeavored to make the importance of this field obvious by quoting figures from time to time and we now do so again, at the risk of criticism for repetition.

It is important to know and to remember that in the year 1930 only 34,000 Automobile Radio receivers were installed. In 1931, while a slight amount of pressure was put on the sale, the majority of the 108,000 persons who bought, purchased through their own initiative, without the effort of anyone else to sell them.

By 1932 the automobile owner was beginning to take fair notice of the opportunity to have a Radio in his car and in that year (still with slight sales effort) 143,000 sales were made, a total of more than 1930 and 1931 combined—and this is a very bad depression year.

It remained for 1933 to bring about the first real dealer effort to push the sale of Automobile Radio receivers and consequently about 500,000 were sold, approximately twice the total amount sold in the previous three years.

But while some real effort has been made in the past year to put these sets on the market, the sales figure is still not impressive, because while a comparatively few dealers were plugging the product hard, the great majority of dealers ignored the Auto Radio business. Strange, too, because the automobile-owning public has always been considered a fine market for various specialties.

Just stop to consider; less than one million Radio receiving sets have been sold over a period of four years. And by now, many of these sets are obsolete and ready for replacement. Compare the sales figure to date with the enormous figure representing the total number of pleasure cars and other gasoline operated vehicles which could logically be considered prospects for Automobile Radio receivers. There is but one answer. *The field of Automobile Radio sales is still sadly neglected*—and offers almost unlimited opportunity for dealers and independent Radio men.

Technical Training Essential To A Radio Career

By B. G. ERSKINE, President, Hygrade Sylvania Corp.

INDUSTRIES begin as an experiment or invention or discovery. For a while following the birth of the industry, the developments are due to further experimentation, invention, discovery.

Men come into the industry and grow up with it. They learn as they go. Year after year they accumulate a growing fund of knowledge and experience. Ultimately, the knowledge and experience is properly gathered, analyzed, arranged and reduced to definite rules and formulas. We now have an engineering art for that particular industry.

Henceforth any person entering that industry to engage in its technicalities, should at least start with a background of engineering. Otherwise that person is seriously handicapped; his progress is discouragingly slow; ultimate success is doubtful.

Radio has followed in the footsteps of all great industries. Three decades ago Radio was just an experiment. There were no established rules. Every worker in this field worked out his own engineering principles from day to day, by experimentation, observation and endless tests. Those who knew electrical engineering principles were decidedly at an advantage over the rest. Gradually there accumulated a vast fund of experience, out of which we have our present-day Radio engineering, largely supplemented, of course, by the older mother art, electrical engineering.

The time is past, I believe, when a person can enter the Radio field without some kind of technical training, so far as positions in the engineering, research, production and servicing branches go, unless they choose to do the simplest kind of manual work, or at least routine tasks.

As I write these lines I have before me an interesting batch of data bearing on the very

points just mentioned. This data indicates the varied training of our engineering, research and production personnel.

There are over 160 technical men in our plants at Salem, Mass., Emporium and St. Mary, Pa., and Clifton, N. J. Those men represent almost every outstanding university, college and technical school in this country, and a handful of the universities of England, France and Germany. And let me hasten to point out that not all these technicians are college men. A proportion are men who have gained their technical training through correspondence courses, through attendance at local technical schools, and in large technical organizations.

After all, it is the man's real capability after he has obtained his technical background, which counts. It is the brains in which we are interested, plus the ambition and willingness to work.

Radio is far beyond the tinkering stage. From research worker to design engineer and production, and again out in the field to the service man, a technical background is essential.

The rapid stride of Radio progress cannot wait for the individual to learn as he goes about his actual work in Radio. There must be no delaying of the wheels of progress. Prior knowledge and experience must be mastered before actual work is undertaken, for we cannot afford, at this late date, to have our Radio workers go over the ground already covered by our pioneers.



B. G. Erskine



A Few Words With The N.R.I. Director

E. R. Haas,
Vice-President
and Director

MANUFACTURERS of Radio receivers continue to compete with each other, in placing improvements in their products. In so doing, they increase the complexity of the Radio circuits in the receivers.

This is a blessing in disguise to the properly trained Radio man. To him, once he understands thoroughly the why and wherefore of the underlying principles, any additions—any complicating factors—are merely interesting modifications of the original. It is only necessary for him to analyze the new “gadget” and its hook-up, and to him it is immediately a simple part of the whole apparatus.

Not so, however, the town tinkerer, that neighborhood jack-of-all-trades who, without any special training, claims to fix a leaky roof, repair an automobile, dig a well or cut an order of lamb chops with equal facility.

To this gentleman, the insertion of anything new in the receiver is just another headache. He knows it is in there when the set starts to give trouble. But why it works, or how it works, must long remain a mystery, a source of trouble, an annoyance which slows him down—hurts his income.

A properly trained Radio serviceman can rightfully feel a sense of importance. There never was a service quite so intricate as that being rendered by the Radio-Trician today. Automobile, electrical refrigerator, heating plants and the general run of mechanical servicing are quite simple in comparison. The

Page Four †

average fellow, with little or no special training, can figure out the operation and cause of trouble in something mechanical—something that has moving parts on which there may be wear and tear—but in Radio, where all of the functions are hidden, so to speak, where the man must rely upon knowledge of what is going on unseen, there, is work for a master.

The Radio serviceman should never let his work seem commonplace—to himself, or to anyone else. Radio servicing should not be taken as a “matter of course.” It is not work that can be done by an ordinary mechanic, but is more like the work of a doctor who must diagnose trouble from symptoms rather than from obviously broken parts, knocks, or other signs which indicate trouble in so many mechanical servicing operations.

The Radio serviceman will do much to elevate his position if he will bear in mind the respect in which he is held in the homes he visits. Of course, he must maintain this position by doing good work and respecting the confidence the customer has in his ability.

It is reported by Dun & Bradstreet, Commercial Agency, that the Radio industry started 1934 in the most favorable statistical position since 1930. “Price cutting is declining, inventories have been reduced and Radio is on a more stable basis than at any time in its history,” is their opinion.

In a statement to its stockholders, dated February 24, 1934, the Radio Corporation of America reports a net profit from operations during the last quarter of 1933 of \$1,211,277. This compares with a net loss of \$540,863 for the same quarter of 1932 and a net loss of \$1,793,371 for the first nine months of 1933.

The rapidly rising popularity of Automobile Radio has even invaded the White House. Two new limousines recently acquired for the use of President Roosevelt and his family are equipped with custom-built Automobile Radio receivers.

Intermittent Fading Of Radio Signals

By J. B. STRAUGHN, N. R. I. Radio Servicing Consultant



J. B. Straughn

QUITE frequently a serviceman is called on to repair a receiver because signals fade suddenly from good volume to almost no volume. It is the purpose of this article to discuss the possible cause of this fading, if it is due to some defect in the set and is not the natural fading we get on distant stations.

The symptoms by which this kind of fading can be recognized are: the set will operate normally and then suddenly the volume will die away so that signals are barely audible. Often a faint click is heard at the instant of fading. Jarring the set or turning the switch on and off will sometimes cause the signals to return to normal volume for a few moments and then the trouble occurs again.

The usual cause of this fading is a "thermal contact," which is a broken connection due to heat expansion. A conductor carrying fairly heavy current will often become warm and cause expansion at the joints. Then when the set is turned off the joint has a chance to cool and contract and so make connection again.

The same thing happens in Radio receiving tubes. This is what is known as thermal electrical contact in tubes. When this sort of fading occurs, it is usually wise to check the tubes first. If possible, see if the receiver acts in the same way with a new set of tubes in it. If fading still occurs, we know for a certainty that the trouble is in the wiring of the receiver itself.

Locating a thermal contact in a receiver requires patience. The only thing to do is go over the entire receiver with a stick of insulating material, such as an orange-wood nail stick, and test for weak joints. Press down and pull on all the joints such as the filament returns, power leads, etc., with the stick until you find the bad connection. When the defective joint is pushed the signal will reappear if the contact was open. If closed, the signal will fade. This is often such a tedious

Mr. Straughn will bring you another article on this interesting subject in the next issue of National Radio News. Watch for it. Mr. Straughn is a practical serviceman as well as a capable Instructor.

task, because the least jarring may bring back signals, that some servicemen prefer to resolder the chassis completely to make sure that all joints provide perfect contact. Before resoldering be sure that all parts are tested.

One rather common cause is a defective coupling condenser in the resistance coupled A. F. amplifier or a defective R. F. coupling condenser in capacity and capacity-inductive coupled R. F. transformers. Pay particular attention to the coupling condensers if they are used in the audio amplifier.

A by-pass condenser in the screen or cathode circuits that opens intermittently will also cause fading. These condensers should be checked by shunting a condenser known to be in good condition around the condenser suspected of causing the trouble.

Another possible cause for this fading is leaky filter or by-pass condensers. If any of these condensers are defective, the voltage output from the power pack will be lowered and the sensitivity of the receiver affected or the signal may even disappear entirely. If fading still persists after you have made sure all contacts are perfect, and other parts of the receiver are good, test the filter condensers. They may be disconnected and given individual high voltage tests. Connect a B-battery and voltmeter in series with the condensers. They must be disconnected and if in good condition there will be no steady deflection of the milliammeter needle, unless the condenser is of the electrolytic type, in which case the leakage should not be more than $\frac{1}{4}$ milliampere per microfarad.

A faulty condenser will have low resistance and the meter will show a current flowing. It is wise to replace condensers through which current will flow when 90 volts is applied to them.

If grid leak detection is used, the grid leak may be too high, in which case the signals tend to block. This can easily be determined by trying out leaks of various values.

New Developments In Station Synchronizing

By H. K. BRADFORD, N. R. I. Communications Consultant



TWO sets of synchronizing equipment have been ordered from the Western Electric Company and are ready for shipment to Station WBBM, Chicago, the key station of the Columbia Broadcasting System, and Station KFAB, in Lincoln, Nebraska. The two stations contemplate synchronizing in the latter part of January.

Although we have witnessed station operation in synchronism in many parts of the country, these stations have not been able to take advantage of this new highly precise and highly developed system. The move is regarded as significant as it may create the widespread introduction of synchronization in the commercial broadcasting industry of the country. From the point of view of the listener, we can see that this is a great advantage. The present situation offers no incentive for the owner of a highly sensitive receiver, as he may tune on as many as fifteen or twenty bands and receive the same program from stations on different frequencies. This gives him the selection of only a few programs out of perhaps thirty to fifty stations which his receiver will bring in. If it ever becomes possible to synchronize the carrier frequencies of all stations having a common program, we may be assured that each channel will bear a different program, giving the listener a much wider selection of programs.

The perfection of synchronizing equipment to date now makes such development a practical possibility. The precision of the carrier frequency attained by the equipment to be used by WBBM and KFAB has never before been approached in broadcasting. This development has been done by Bell Telephone Laboratories through years of experimentation, dating as far back as 1927. At this time successful tests with synchronous operation were made.

Previous systems for synchronizing carriers of broadcast stations have involved methods of controlling the oscillator of one transmitter from the oscillator of the other transmitter. This system is entirely new, however, in that both the oscillators of the broadcast station are controlled from a single independent source which may replace the oscillators in each transmitter. The equipment includes an extremely accurate source of carrier frequency, from which a reference frequency is furnished by wire from the Bell Laboratories to the stations whose frequencies are to be controlled. Whenever the local carrier frequency—that is, the crystal oscillator—deviates from the control frequency by even a small fraction of a cycle an automatic mechanism in the synchronizing equipment is set into operation and immediately corrects this minute difference. In this way, the carrier frequencies of the stations included are kept in exact synchronism and in phase at all times.

The system is greatly enhanced due to the fact that no special link between the individual station is required, except as provided by the circuit supplying the reference frequencies to both stations.

At the present time, Stations WBBM and KFAB are sharing time on 770 kilocycles at night time and both operating on this frequency full time in the day. Synchronization will enable these two part-time stations to utilize the air full time. Naturally, the service they render to Radio listeners in their area will be proportionately lengthened.

The Federal Radio Commission gave its sanction several months ago for these two

(Page 9, please)

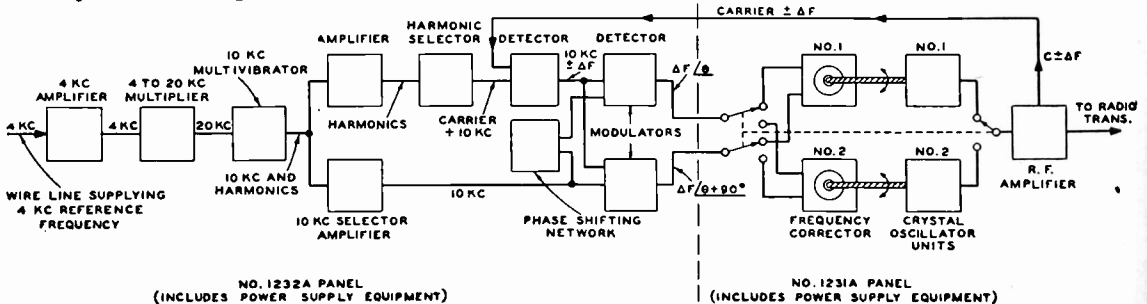

FIGURE 1

RADIO-TRICIAN SERVICE SHEET

REQ. U. S. PAT. OFF.

COMPILED SOLELY FOR STUDENTS & GRADUATES

Philco Model 16

THE PHILCO RADIO MODEL 16 is an eleven-tube superheterodyne broadcast and short-wave receiver, operating upon alternating current and employing the high-efficiency 6.3 volt tubes, automatic interstation noise suppression, and a frequency (wave-band) coverage that permits reception of the short-wave (high-frequency) broadcast programs. The same superheterodyne circuit is used for all reception. The Receiver is equipped with a five-point wave-band switch. The ranges are—

- (1) 520 K. C. to 1500 K. C.
- (2) 1.5 M. C. to 4.0 M. C.
- (3) 3.2 M. C. to 6.0 M. C.
- (4) 5.8 M. C. to 12.0 M. C.
- (5) 11.0 M. C. to 23.0 M. C.

The Receiver employs a Philco Type 77 tube for first detector, a Type 76 for oscillator, a Type 78 for first I. F., a Type 78 for second I. F., and a Type 37 for second detector. The automatic interstation noise suppression circuit uses a Type 78, the first A. F., a Type 77. The driver (second A. F.) is a Type 42; the class "A" amplification is accomplished with two Type 42 tubes as triodes; the rectifier is a Type 5-Z-3. The intermediate frequency is 460 kilocycles. The power consumption of Model 16-122 is 130 watts; of Model 16-121, 120 watts.

Table 1—Tube Socket Data*—A. C. Line Voltage 115 Volts

Circuit	1st Det.	Osc.	1st. I. F.	2nd I. F.	2nd Det.	Inter-Station Noise Suppr. Circuit	1st A. F.	2nd A. F. (Driver)	Output	Rectifier	
Type Tube	77	76	78	78	37	78	77	42	42	42	5-Z-3
Filament Volts—F to F.....	6.3	6.3	6.3	6.3	6.3	6.3	6.3	6.3	6.3	6.3	4.7
Plate Volts—P to K.....	220	53	225	230	0	1.8	130	220	340	340	400
Screen Grid Volts—SG to K....	80	—	80	80	—	1.8	1.8	220	340	340	—
Control Grid Volts—CG to K...	1.6	6.4	0	0	.2	1.6	.4	.6	34	34	—
Cathode Volts—K to F.....	4.2	1.9	2.2	2.5	0	0	0	0	0	0	—

NOTE—These values are for Model 16-122. Model 16-121 uses a Type 80 Rectifier Tube.

* All of the above readings were taken from the underside of the chassis, using test prods and leads, with a suitable A. C. voltmeter for filament voltages, and a high-resistance multi-range D. C. voltmeter for other readings. The Philco Model 048 All Purpose Set Tester is highly recommended for this use. Volume control set at maximum and station selector turned to low frequency end; interstation noise suppression circuit potentiometer turned all the way to the right; and toggle switch (interstation noise suppression circuit) in "ON" ("S") position. Readings taken with a plug-in adapter will NOT be satisfactory.

Table 2—Power Transformer Data

Terminal	A. C. Volts	Circuit	Color
1—2	105—125	Primary	White
3—5	6.3	Filament	Black
6—7	5.0	Filament of 5-Z-3	Blue
8—10	800	Plates of 5-Z-3	Yellow
4	—	Center Tap of 3—5	Black—Yellow Tracer
9	—	Center Tap of 8—10	Yellow—Green Tracer

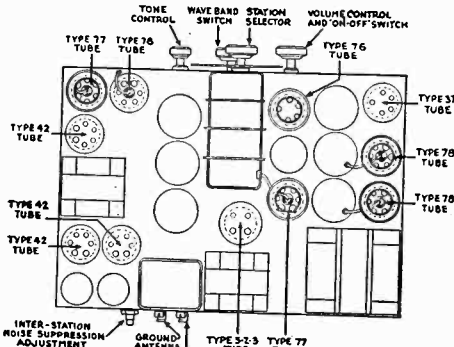
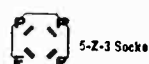
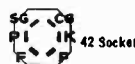
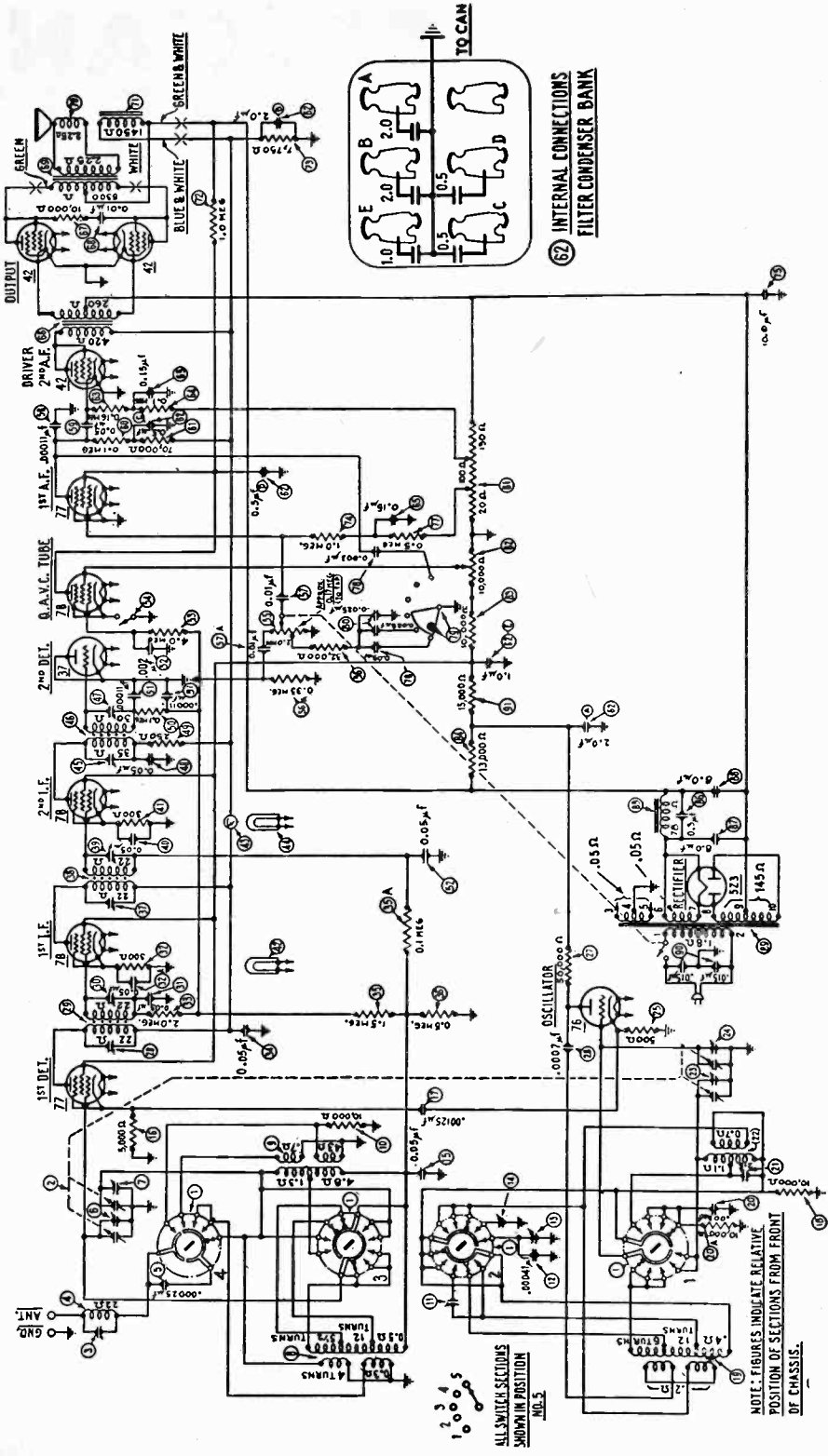

Fig. 1—Top View of Chassis, Showing Tube Locations and Major Parts



Terminal Arrangement of Tube Sockets Viewed from Underside of Chassis

Readers who file Service Data in separate binders remove page carefully; trim on dotted line for same size as Data published heretofore.



6Z INTERNAL CONNECTIONS
FILTER CONDENSER BANK

1 2 3 4
1 0 0 5

ALL SWITCH SECTIONS
SHOWN IN POSITION
FIG. 5

NOTE: FIGURES INDICATE RELATIVE
POSITION OF SECTIONS FROM FRONT
OF CHASSIS.

Synchronizing Developments

(Continued from page 6)

stations to synchronize and considerable importance has been attached to this decision, as it gives evidence to the desire of the Commission to encourage a greater use of synchronization in view of the possibilities it offers for relieving the congested commercial broadcast band and broadening good service.

Referring to the block diagram given in Fig. 1, at the left it will be noted that a four-kilocycle reference frequency is brought into each of the two stations being synchronized. This frequency is amplified and fed into a frequency multiplier, which generates the fifth harmonic of the fundamental frequency, which, of course, in this case is 20 kc. This is used to control a 10 kc. multivibrator. This 10 kc. multivibrator contains the fundamental and all of its harmonics up through the broadcast range. The 10 kc. fundamental is passed through one amplifier and the harmonics are passed through another. The harmonics are amplified and fed into a harmonic selector, which further amplifies that harmonic which is 10 kc. above the assigned carrier. In this case it will be 780 kc. Energy from the crystal oscillator of the transmitter is fed back from the extreme right to a detector, together with the harmonics just mentioned. Let us assume for example that this carrier frequency is greater than or less than 780 kc. by a difference which we will call "D." The carrier frequency, of course, is already 10 kilocycles below the harmonic selected, so that the additional deviation "D" of the carrier will be added to or subtracted from the 10 kilocycle wave, giving a detector output of 10 kilocycles plus or minus "D." This frequency, together with the amplified 10 kc. reference frequency from the multivibrator, constitutes the input to a pair of balanced modulators.

Note by the diagram that before this 10 kilocycle selector amplifier feeds the 10 kc. through the detector, it must go through a phase shifting network. This network shifts the phase of the 10 kc. signal 90 degrees. Thus, in the upper modulator, we have the difference frequency plus 10 kc. at 90-degree phase displacement, and in the lower modulator we have the difference frequency plus 10 kc. at zero phase. The output of each modulator becomes one phase of a two-phase alternating current of the frequency "D." Now if the crystal oscillator in the transmitter increases frequency, this deviation frequency "D" will be in leading phase with respect to the resonant frequency and if the crystal oscillator reduces frequency, the frequency "D" will be lagging phase with respect to the 10 kc. reference frequency. The output of both modulators is fed into the correct unit which consists of a

(Page 22, please)

Student N. G. Hollander Tells the Story of a Service Job

THE tire cover on the rear of my car is painted with a sign, "How's Your Radio—We Repair Any Make or Model."

While stopping at a filling station, a gentleman came up to me and asked if I guaranteed my work. I replied, "Yes, sir, I guarantee every bit of my work on Radios for 90 days—and so will any other responsible Radio man—all he wants is to be assured that no one else will tinker with it during the guarantee period."

To which the gentleman replied, "That's fair enough. Now I have a Radio which went bad. I carried it to Mr. ——— to be repaired and he charged me \$5.50. When I got the set back it worked for a few days and went bad again in the same way. I carried it back—he repaired it again and charged me \$6.00 more. In a few days it went bad again—and this continued until I had spent about \$20 and my set is still of no value."

Consequently this gentleman has been without Radio service for several months. He claims that the serviceman was continually charging him for a condenser, tubes and labor.

Well, I got the job and found that it was a six-tube Zenette "Zenith" and upon looking over the set I found it was in a terrible condition. It had been changed around and jumbled up until no correct checking could be done on it. I decided that the only thing to do was to go over the entire system with a diagram. I found two parts in the Radio which did not belong in it and found that an 8 mfd. electrolytic filter condenser was gone and an 80 tube burned out. Furthermore, a detector plate resistor and a power bias resistor were hurt, due to the mix-up of wiring.

Not only did I want to make this set work, but I wanted to find out what caused the filter condenser to burn out so often. (*Very good point—Editor.*) So I put in a good 80 tube and also a test condenser in place of the bad filter condenser, turned on the set and watched it very closely. It played, but not properly and in a few minutes I noticed the test condenser becoming hot, which, if left, would be ruined in a few days. I found the cause of this. The previous serviceman had placed a plain tin container twin by-pass condenser in the chassis and he used the original color of wire with which the set was wired and by-passed one side of the rectifier 80 tube filament through one of the twin condensers and positive side of the 8 mfd. condenser "filter" through the other. This was the trouble which caused the burn-out of the tube and condenser so many times. I properly replaced the parts needed, took out the unnecessary parts—adjusted the receiver until it worked like new.

(Page 15, please)



Gold in the Backyard

By *H. E. LUBER, N. R. I. Employment Manager

**Mr. Lubber is now managing the N. R. I. Employment Department, replacing Mr. P. J. Murray, who is now Executive Secretary of the N. R. I. Alumni Association.*

SINCE taking over the duties of the National Radio Institute Employment Manager, I have made quite a study of the employment problems of N. R. I. men and will, from time to time, discuss these problems in the columns of National Radio News for the benefit of all our readers.

As a part of this study of employment conditions, I read hundreds of letters from graduates, students and men who are not yet students of the National Radio Institute, and the first question I wish to discuss is one which has been raised by a number of these men. It has to do with WHERE they must go in order to be SUCCESSFUL in Radio.

Many of these men think that because they live in small towns—in rural communities—and are far from the great metropolitan centers, the possibility of their success in Radio is limited.

We know there are opportunities for Trained Radio men in the larger towns. The majority of the broadcasting stations are in the cities, most of the ship operators are hired from the larger seaport towns, and the greatest number of the Radio manufacturing plants are located in these more populous centers. And naturally, due to the large population, there are more sets to be serviced; consequently, more service jobs.

But in the small towns—in farming communities—there are big opportunities for men who want to get started in Radio businesses of their own.

There are fewer Radio men competing for the business and, incidentally, there are fewer GOOD Radio men.

The average small town, as shown by research on the subject, has been neglected by Radio men. These small towns, particularly when they have large surrounding farming districts, are admirably suited to support good Radio sales and service organizations. Farm and rural residents are better off today than they have been in a number of years. Moreover, they are no longer "back numbers"—

but are rapidly modernizing (for which Radio must be given a lot of credit). Radio manufacturers, realizing the value of this big market, have designed Radio sets embracing all of the latest improvements and built for battery operation where no electricity is available. These have been engineered and placed on the market for the purpose of taking advantage of this rural trade.

In addition, the Radio-Trician in the rural community finds that a small battery charging layout, which may be used for charging automobile as well as Radio batteries, is quite a money-maker. There are a number of allied lines which he may handle as an adjunct to his Radio business.

The chief of all reasons why the small towns and rural sections offer such a good market for the services of Radio men is that Radio men have long been considering this question in the wrong light. The minute they feel they are capable Radio men, they head for the big towns, leaving the home-town market sadly neglected.

It's like the man who sold his farm to go away and get in the oil business, to find later that the farm he sold was a very rich oil field.

The little town of Eaton, Colorado, has a population of about 1,500. Just a few hundred miles away is Denver, with well on toward 300,000 population—approximately 200 times the population of Eaton. Yet N. R. I. Graduate Fred Nichols didn't move to the big town to set up his Radio business. No, he built it right in Eaton and has been highly successful.

Harry and Karl Wagner are brothers, both of them N. R. I. graduates, and they operate a Radio service business in the little town of Clinton, N. J. Their reputation as expert Radio men has spread far and wide, and in spite of the fact that Clinton has a population of less than 1,000, their annual business exceeds the ten-thousand-dollar mark.

Let's turn back the pages of history to the middle of the last century. In the year 1848, gold was discovered in California. Many of them left good jobs—to seek the golden wealth in those California hills. True, a number found gold, but many, depressed and beaten, turned their backs on California to return to their homes. And, in so doing, they made their second mistake. For, as it has been proved since, in leaving California, in starting on their second journey, they turned their backs on the best farming land in this country. They failed to see gold beneath their feet—always undertaking to locate it elsewhere.

10,000,000 Radio Prospects

By DON B. LOONEY, Radio Servicing Consultant

TEN million Radio prospects! That sounds big—it IS big—for the wide-awake Radio-Trician who is on the job. According to figures released by the U. S. Department of Commerce, there are approximately this number of homes without electricity, by far the biggest percentage being in the rural sections of the country.

The sale and servicing of Radio receivers in the farming communities has been sadly neglected in the past, and now, with the "New Deal" that the farmers are receiving, it will prove especially profitable to those men that get out and hustle. The fact that the "New Deal" has helped, and is helping, the farmer is borne out by the fact that department store sales in the farm states has increased 12 per cent over the sales in 1932. Also, the Washing Machine Manufacturers Association reports that during the first seven months of 1933 the sale of the gas-engine-driven washing machines increased nearly 100 per cent over the same period in 1932.

Radio receiving sets have not been very popular in homes not equipped with electricity, due to the trouble and inconvenience of having to continually charge the storage battery. The tone and volume of battery sets has also been of poor quality, never equaling the results obtained by electric receivers. For this reason there have been very few Radio sales, and this, of course, results in very little service work in rural localities having no electricity.

However, the development of the two-volt tube, together with the perfection of the Air-cell type battery and the two-volt, long-life storage battery, makes it possible to build receivers which are very economical as far as filament current is concerned. This is, indeed, a boon for persons in rural sections, since the life of these new Aircell batteries, when used with two-volt tubes, is approximately 1,000 hours or, with average use, one year's service. At the end of that time, the battery is discarded and a new battery is obtained at a reasonable cost. The length of service of the new type storage battery is not quite so long, approximately 200 or 300 hours, but it is possible to have the battery recharged several times at any battery service station. However, the unusually long time these batteries will hold a charge, as compared with the old six-volt battery, makes it necessary to charge the battery only three or four times a year.

In addition to the battery type of receivers, several manufacturers are making a 32-volt receiver which will operate directly off of a

Don Looney is a real old-timer with N.R.I. He has been with us about ten years. He knows what the Radio man needs for success, if anyone does — because, in addition to being a very fine Radio Instructor, he is a practical Radio Serviceman as well.



farm lighting system. These receivers obtain all of their current direct from the 32-volt light system and it is not necessary to use batteries of any kind. It is also possible to obtain Radio converters which can be used to convert the 32-volt direct current into 110-volt alternating current, so that an ordinary A. C. receiver can be used and, in fact, any electrical apparatus that is designed for 110-volt A. C. and does not draw too much current.

Radio manufacturers have given much time and thought in designing the new battery and 32-volt type of receivers. The results well justify their efforts, for these new receivers give excellent tone, selectivity and volume, which is equal and often better than many of the popular all-electric receivers. The use of Class B amplification enables a receiver to be built which will give a large amount of undistorted output and at the same time use a very small amount of B battery current. The high degree of development of screen grid tubes, both Radio frequency and power tubes, gives ample selectivity and sensitivity for all ordinary conditions and at the same time keeps the number of tubes at a minimum. This, of course, makes the receiver economical to operate and eliminates to a great extent the big objection to older types of battery receivers, the frequent renewal of A and B batteries.

Quite often a Radio serviceman will think that he would like to build, or assemble from a kit of parts, a receiver for one of his clients. This is not at all advisable, due to the fact that a complete receiver can often be bought, at a wholesale price, cheaper than the parts can be bought separately. It is also practically impossible for the average person to build a set economically and obtain the same

(Page 15, please)

4 Page Eleven

Piezo Crystals in Speakers, Phono pi

THERE have recently been placed on the market loudspeakers, microphones and phonograph pick-ups, whose operation depends upon the piezo-electric properties of Rochelle salt crystals. The development of piezo-activity for acoustic purposes is an interesting one, and it would be well to give a brief historical resume.

Nearly a century ago, it was noticed that certain substances assumed an electric charge when subjected to pressure. Electricity produced by this method was known as piezo-electricity. Becquerel, a French scientist, in 1825, made many experiments and tested a large number of substances with this effect in mind.

In 1880, the Curies, who later worked with radium, carried on experiments with quartz, and determined the amount of electricity generated by unit pressure along various axes of this substance. They discovered the fact that any piezo-electric substance which acts as a generator of electrical energy in response to mechanical motion, will also produce mechanical motion when charged by a varying electrical impulse. They also determined the piezo-electric properties of many crystalline substances, of which, that of Rochelle salt was by far the greatest.

Roentgen, of X-ray fame, is credited with having foreseen, in 1890, the acoustic application of piezo-electric substances.

During the World War, many scientists engaged themselves in the investigation of the application of piezo-electric properties of various substances to the detection and location of submarines by water vibrations beyond the audible range. Langwin, in 1918, combined various piezo-electric devices with vacuum tube amplifiers, for both input and output purposes.

A series of investigations and experiments on the piezo-electric properties of various crystalline substances, including quartz and Rochelle salt, was carried on by the Bell Telephone Laboratories in 1919, but due to the

difficulty in producing clear and homogenous crystals, no commercial value was seen for them at that time.

The Brush Laboratories Company have developed a method of producing Rochelle salt crystals which are clear and homogenous, and have carried their piezo-electric properties into the creation of elements for use in electrical reproducers and microphones.

The principal used in these elements is

The first article by Mr. of Cleveland, cluding install in the June-Anderson wa nected with tories Compan I. Student.

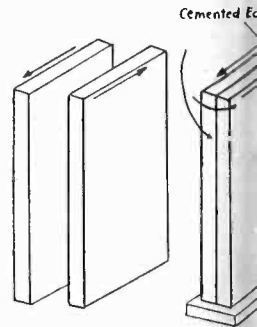
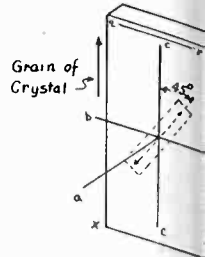
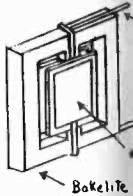
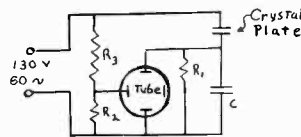
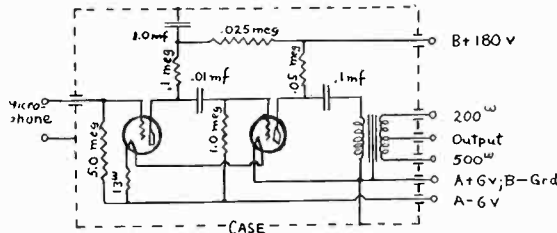
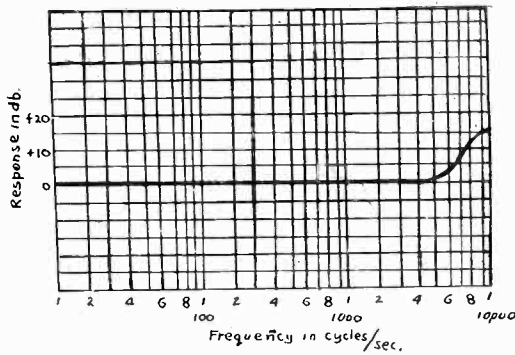

Key to II

Position on Chart	Referred to as
Top-left	Figure 6
Middle-left	Figure 11
Lower-left	Figure 3
Top-center	Figure 5 (A & B)
Center	Figure 1

-ups and Microphones by L. W. Anderson

ment of an
Anderson,
The con-
will appear
issue. Mr.
merly con-
sh Labora-
is an N. R.

similar to that principle made use of in the bimetallic thermostat. In such thermostats, two metals having different linear co-efficients of thermal expansion, are welded together. On temperature change, one of the metals expands more than the other and forces the welded assembly to assume a different curvature. The relative motion of the ends of a strip of such metal is very much greater than the actual difference in expansion

of the two metals. In a similar manner, two sections of Rochelle salt may be cemented together in such a way that, on the application of an electrical field, one of them tends to expand, while the other contracts, resulting in a bending motion of the whole.

Sections of Rochelle salt crystals cemented together in this manner have been successfully used in the development of a variety of crystal units for use in loudspeakers, microphones, phonograph pick-ups, etc.

Before describing the special features of these designs, it would be well to note some of the electrical and mechanical properties of Rochelle salt. In the first place, the properties of this substance vary with reference to the crystalline axes of the salt. For purposes of illustration, it will suffice to restrict consideration to plates cut from the crystal so that their major surfaces are perpendicular to the electric or A-axis. Such plates will then lie in the plane of the B and C axes, with sides parallel to the B or C axis, as shown in Fig. 1.

Referring to Fig. 1, if a plate of Rochelle salt so cut, be coated with tin foil on the surfaces perpendicular to the A-axis, and be electrified with say a 60-cycle alternating potential difference, and at the same time the corners x and y are mechanically prevented from moving, all points in the edge q-r will move back and forth synchronously with the potential difference, and in a straight line parallel with the B-axis. With such a plate, there is a sensitiveness to shear when the plate is so electrified. It has been found that if a bar be cut from the plate at 45 degrees to the B and C axes,

or in other words, at 45 degrees to the grain of the crystal, as indicated by the dotted lines in the Fig. 1, that the shear sensitivness, and also the movement of the crystal, when subjected to the alternating potential difference, will be the greatest. For this reason, it has become the practice to cut sections of Rochelle salt at 45 degrees to the crystalline axis of the

(Page 14, please)

greater than the actual difference in expansion

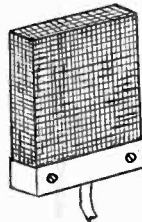
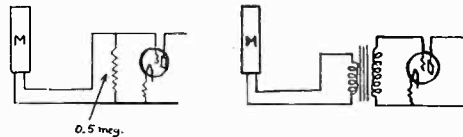
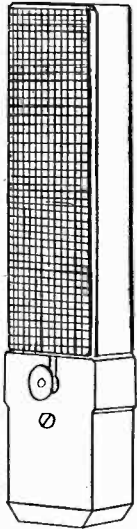
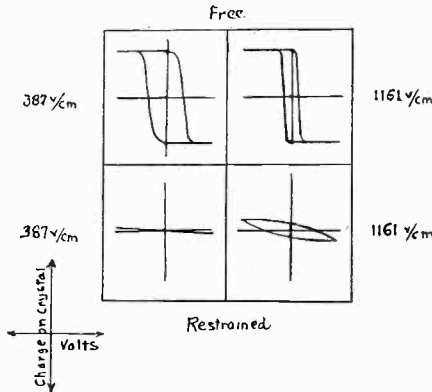
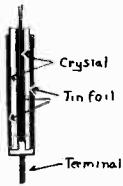

Illustrations

Position on Chart	Referred to as
Lower-center	Figure 4
Right-center (Microphone)	Figure 8
Top-right	Figure 2
Middle-right	Figures 9 and 10
Lower-right	Figure 7

Intermittent Fading

(Continued from page 5)

Another possible cause of this intermittent fading is oscillation. When some sets "spill over" instead of squealing and howling, the signals fade away almost to nothing. If this is the case, the neutralizing condensers must be examined, the plate and grid bias voltages of the R. F. stages checked and if this is not enough to stop oscillation, grid suppressor resistances should be connected in the grid circuits of the R. F. stages.

Sometimes turning an electric light on or off in the vicinity of a receiver will cause it to fade. The same may be true of any household device which draws power from the line. The sudden drain on the line decreases the voltage fed to the receiver. This decrease is followed by a rise in voltage, bringing the line voltage higher than normal. After this surge, the line voltage returns to normal. In one such case the replacing of the rectifier tube with a new tube overcame the trouble. If the surge on the line is large enough, the power transformer might show an increased voltage on the rectifier side and frequently leaks will appear in the filter condensers which might be permanent.

It must not be forgotten that one side of the A. C. power line is grounded. This makes possible a second ground for the Radio receiver. The B— and ground of a Radio receiver trace directly to the secondary connection in the power transformer. This is connected to the primary side of the transformer by capacity and mutual induction. If the receiver ground is a poor one, or it may even be removed, a ground is possible due to this coupling to the power lines. Then when light and power devices are turned on, the ground connection is either improved or made poor, with the result that the signal output may rise or fall in value.

Fading due to light and power devices being turned off or on often appears in receivers which make use of the no-antenna connection. In this case the aerial is replaced by the electric main through a series condenser. When connected properly, one side of the line acts as the aerial and the other side acts as the ground in connection with the regular ground. The line may be a better or worse aerial when lights are turned on and signals may increase or decrease accordingly. The best thing to do in this case is to reverse the terminals of the plug-in and if this does not help, it is advisable to use an antenna with a good regular ground.

(Page 22, please)

Piezo Crystals

(Continued from page 13)

salt. Such sections of Rochelle salt may then be combined as single units with a sound reproducing diaphragm, and so function immediately as the simplest electrical sound reproducing device it is possible to devise.

It is very interesting to consider the current-voltage diagram obtained when such a Rochelle salt plate is connected to an alternating potential difference. In Fig. 2, obtained from a cathode-ray oscillograph, the abscissas are proportional to the voltage, and the ordinates to the charge on the crystal. The traces show both saturation and hysteresis, reminding one of the permeability of iron. As with the permeability of iron, the specific inductive capacity of such Rochelle salt, (with properly adjusted electrodes), is a thousand times greater than that of any other crystalline substance. Thus at 18 degrees Centigrade, the specific inductive capacity is about 18,000 mmf, with 60-cycle alternating current. The type of diagram varies greatly with the temperature.

If all corners of the plate shown in Fig. 1 are mechanically prevented from moving, the traces from the cathode-ray oscillograph change from those shown at the top of Fig. 2, to those shown in the other diagrams, and all evidences of saturation disappear. The same holds true when two such plates are cemented together for greater magnification. Crystal elements may be constructed either to bend or to twist upon the application of an electric field, depending on the arrangement of the plates used in their construction. For example, two Rochelle salt bars cut at 45 degrees to the B and C axes, so that they expand and contract respectively when in the electric field, may be cemented together to form a crystal element, bending as does the bimetallic strip of thermostat metal. Similarly, two plates of Rochelle salt with edges parallel to the B and C axes, as shown in Fig. 4, so that they are responsive to shear sensitivity when in the electric field, may be cemented together to respond by twisting. Either of these elements may act as emitters or receivers of acoustic impulses.

Should a crystal element of lower impedance be desired, it is possible to multiply the number of bars or plates entering into the construction of the element, at the same time reducing their thickness. It is necessary to change the direction of the electric field through each adjacent plate, in a manner similar to that used in the ordinary condenser.

Fig. 3 shows a diagram of the circuit used to obtain oscillograph diagrams. At the left is a resistance which acts as a voltage divider. To the right is the crystal plate under test, connected in series with a condenser whose

(Page 20, please)

QUERIES and ANSWERS



Question: I have a receiver with a burned out power transformer. My customer wants me to rewind it which I will do if I can make a saving—what do you say to this?

Answer: If your time is worth about 25 cents an hour you can save your customer about 50 cents by rewinding that transformer. I wouldn't advise doing this, as you can put the time you would spend to a more profitable use by drumming up some extra trade in your neighborhood.

However, if you decide to try your hand at this be sure to count each turn you remove from each winding so you can wind them up correctly. Also save the insulating paper, so it may be used to separate the new windings and their layers.

You should never try to rewind an audio transformer speaker field unless you have special tools designed for this purpose. Audio transformers sometimes have anywhere from a half to a mile of wire and speaker fields generally more. Obviously such work cannot be done by hand. If, however, the break is at the end, as frequently happens, a few turns may be removed and a new connection made. It is worth while to look for such a break.

(Page 16, please)

10,000,000 Radio Prospects

(Continued from page 11)

excellent results that are obtained with a factory designed and factory built set. Many weeks and often months are spent in the design and perfecting of Radio receivers and it would be impossible for one individual to give the necessary time to this very particular phase of the subject. It will be much better for the person contemplating building receivers to confine his efforts entirely to selling and servicing the receivers. He will soon find that it will be much more profitable in the long run.

The demonstration of a battery-operated receiver has one big advantage over the all-electric receiver—you can have the receiver "set up" in your auto or truck all ready for operation and make your demonstration wherever your prospect is located. If he is out in the barn or working "down in the 40 acres," just drive your auto up, throw out a short antenna and turn the set on. However, a very important thing to remember is to select a time for your demonstration when the farmer is not too busy. A farmer's time is literally his money, especially during his busy seasons and he simply will not be bothered with you or anyone else if he has work to do. Select a

day when the weather does not permit him to work in the fields, or an evening after the chores are done. If it is during a busy season you can possibly arrange for a short, snappy demonstration at the noon hour.

When making a demonstration use a short wire for an antenna. Let your prospect or one of the family take hold of the bare end of the wire. This will cause the signal strength to greatly increase and will immediately create interest in your demonstration. Emphasize to your prospect those points which will appeal to him most. In the case of your farmer friend these will be: first, market and weather reports; second, news items, and third, entertainment features.

Market and weather reports mean dollars and cents to a farmer and for this reason you should stress the value the Radio will be to him in giving him this important information just when he needs it most. By listening to the news bulletins as broadcast over the Radio he will not need to wait twelve to twenty-four hours to know the latest events. As for entertainment value, you yourself know that Radio is unexcelled. It will give him any kind of program, from grand opera to the latest dance hits of Broadway; the friendly talks of our President, educational debates by our statesmen, or the jokes of the world's most popular comedians.

Never be in a hurry in demonstrating your receiver, unless you know your prospect's time is limited. Take plenty of time! Become acquainted with your farmer friend, his family and even his hogs and cows, if necessary. It will pay you! Even though he does not buy a Radio now—he will some day!

Student Hollander

(Continued from page 9)

My charge was \$8.00 for the complete service and parts.

I cannot figure out whether the would-be serviceman wanted to run down that particular brand of set, or whether he merely intended to gyp his customer. But regardless of his idea, he went wrong—and so will every other serviceman who does that kind of work. Jobs like this not only hurt the serviceman, but they give all servicemen a black eye. Believe me, I am doing everything I can to show up men who do this type of work, because Radio men should protect the public—they should protect the manufacturer of the Radio—and they should protect the Radio industry.

The gentleman I just referred to has had his set in use about four months now, and a few days ago he told me that it is still working perfectly and that I will do all of his Radio work from now on. The best way in the world to build up your Radio service business is by making satisfied customers.

THIS and THAT in RADIO

Autocrat Radio

The Autocrat Radio Company, of 3855 North Hamilton Avenue, Chicago, Ill., is offering a complete line of midget Radios for 1934. Their catalog will be supplied upon request and special discounts are offered N. R. I. men. Address them direct, Autocrat Radio Company, 3855 North Hamilton Avenue, Chicago, Ill., for full particulars.

Aviation School Uses Short Wave Radio

The Boeing School of Aeronautics has equipped its training planes with short wave receiving sets and reports that this method is much more satisfactory than the old method of hand signals between pilot and student. It removes the mental hazard associated with the first solo flight, assuring the student pilot that he will not be thrown entirely upon his own resources and that advice will be forthcoming when needed. Less dual instruction is needed before the student can solo safely. The instructor can make criticisms of certain maneuvers immediately, while mistakes are still in mind and without the necessity of landing to discuss such mistakes.

An Interesting Experiment

Student P. J. Oliver, Albany, Wisc., sends this one in. He says, "Just a novel experiment I made on a new S.W. set I built. Coil L is regular grid winding for a plug-in coil. Condensers are both .0001 m.f. max. capacity. Switch S is a single blade, double throw knife type.

"In tuning for stations put switch in contact with C_1 until phone station is heard. Then throw switch to C_2 and tune in other end of conversation. It is then necessary only to throw the switch back and forth as each person speaks. Can only be used when both stations are operating within the same coil and condenser combination. Here's the hookup."

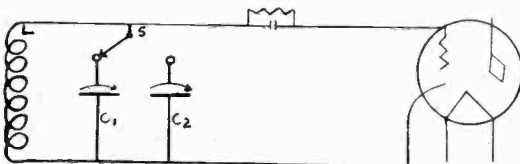

Success Stories

Success Story No. 10

The prize of \$1.00 for Success Story No. 10 is being paid to Graduate M. J. Reef, of Alton, Iowa, for the novel publicity method he has devised.

He publishes a little paper, known as the RADIO BEACON, size 6x9 inches, four page. It contains editorials by Mr. Reef and a particularly popular question and answer section. Between the various articles are little ads—in the form of reading notices—for the various merchants of the city, as well as ads about Mr. Reef's own business, Radio Service. In addition, Mr. Reef obtains additional publicity from his name at the top of the paper, directly under the headline.

The paper is distributed free to residents of the town—and the ads pay for the publication. Therefore, Reef gets himself before the public in a very unobtrusive manner and his only expense is the time necessary to edit the paper. *Good work, Reef—your dollar is in the mails—and we hope some of your fellow graduates profit by this idea.*—EDITOR.

QUERIES and ANSWERS

(Continued from page 15)



Question: What is meant in tube circuits by class C amplification?

Answer: Class C amplification is amplification of high efficiency, which can only be used for Radio frequencies and where wave shape distortion is unimportant.

It is obtained with an exceptionally high bias on the control grid of the tube, so that plate current flows only for a part of the time that the grid is receiving its positive signal impulse. The bias is so great that the grid must be considerably positive to reach plate current cut-off value. If plate current flows only during one-half of the complete positive grid swing, current will flow only during one-fourth of a complete grid cycle, as no current at all will flow during any part of the negative grid swing. As this reduces the time over which plate current flows without changing the output power the efficiency is quite high. The wave form is distorted considerably, but such amplifiers are used where compensations can be made or where compensation is unnecessary.

RADIO-TRICIAN SERVICE SHEET

REQ. U.S. PAT. OFF.

COMPILED SOLELY FOR STUDENTS & GRADUATES

R. C. A. Victor Models 121 and 122 — General Electric K-64

Line-up Capacitor Adjustments

IN order to properly align this receiver it is essential that an oscillator be used. This oscillation should cover the frequencies of 370 K. C. to 15,000 K. C. continuously. In addition to the oscillator, a non-metallic screwdriver and an output meter are required. The output meter should be preferably a thermocouple galvanometer connected across or in place of the cone coil of the loudspeaker.

I. F. Tuning Adjustments—Two transformers, comprising three tuned circuits (the secondary of the second transformer is untuned), are used in the intermediate amplifier. These are tuned to 370 K. C. and the adjustment screws are accessible, as shown in Figure 1. Proceed as follows:

(a) Short circuit the antenna and ground leads and tune the receiver so that no signal is heard. Set the volume control at maximum and connect a ground to the chassis.

(b) Connect the test oscillator output between the first detector control grid and chassis ground. Connect the output meter across the voice coil of the loudspeaker and adjust the oscillator output so that, with the receiver volume control at maximum, a slight deflection is obtained in the output meter.

(c) Adjust the primary of the second, and the secondary and primary of the first I. F. transformers until a maximum deflection is obtained. Keep the oscillator output at a low value, so that only a slight deflection is obtained on the output meter at all times. Go over these adjustments a second time as there is a slight interlocking of adjustments. This completes the I. F. adjustments.

R. F. and Oscillator Adjustments—The R. F. line-up capacitors are located at the bottom of the coil assemblies instead of their usual position on the gang capacitor. They are all accessible from the bottom of the chassis,

except the 600 K. C. series capacitor, which is accessible from the rear of the chassis. Proceed as follows:

(a) Connect the output of the oscillator to the antenna and ground leads of the receiver. Check the position of the indicator pointer when the tuning capacitor plates are fully meshed. It should be coincident with the radical line adjacent to the dial reading of 54. Then set the test oscillator at 1,400 K. C., the dial indicator at 140 and the oscillator output so that a slight deflection will be obtained in the output meter when the volume control is at its maximum position.

(b) With the range switch at the "in" position, adjust the three trimmers under the three R. F. coils, designated as L. W. in Figure D, until a maximum deflection is obtained in the output meter. Then shift the test oscillator frequency to 600 K. C. The trimmer capacitor, accessible from the rear of the chassis, should now be adjusted for maximum output while rocking the main tuning capacitor back and forth through the signal. Then repeat the 1,400 K. C. adjustment.

(c) Now place the range switch at the "out" position, shift the test oscillator to 15,000 K. C. and set the dial at 150. Adjust the three trimmer capacitors designated as SW in Figure 1 for maximum output, beginning with the oscillator trimmer. It will be noted that the trimmer on the oscillator will have two positions at which the signal will give maximum output. The position which uses the minimum trimmer capacity, obtained by turning the screw counter-clockwise, is the proper adjustment. The other point is known as the "image." This completes the line-up adjustment.

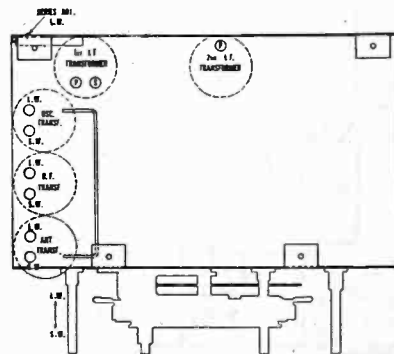
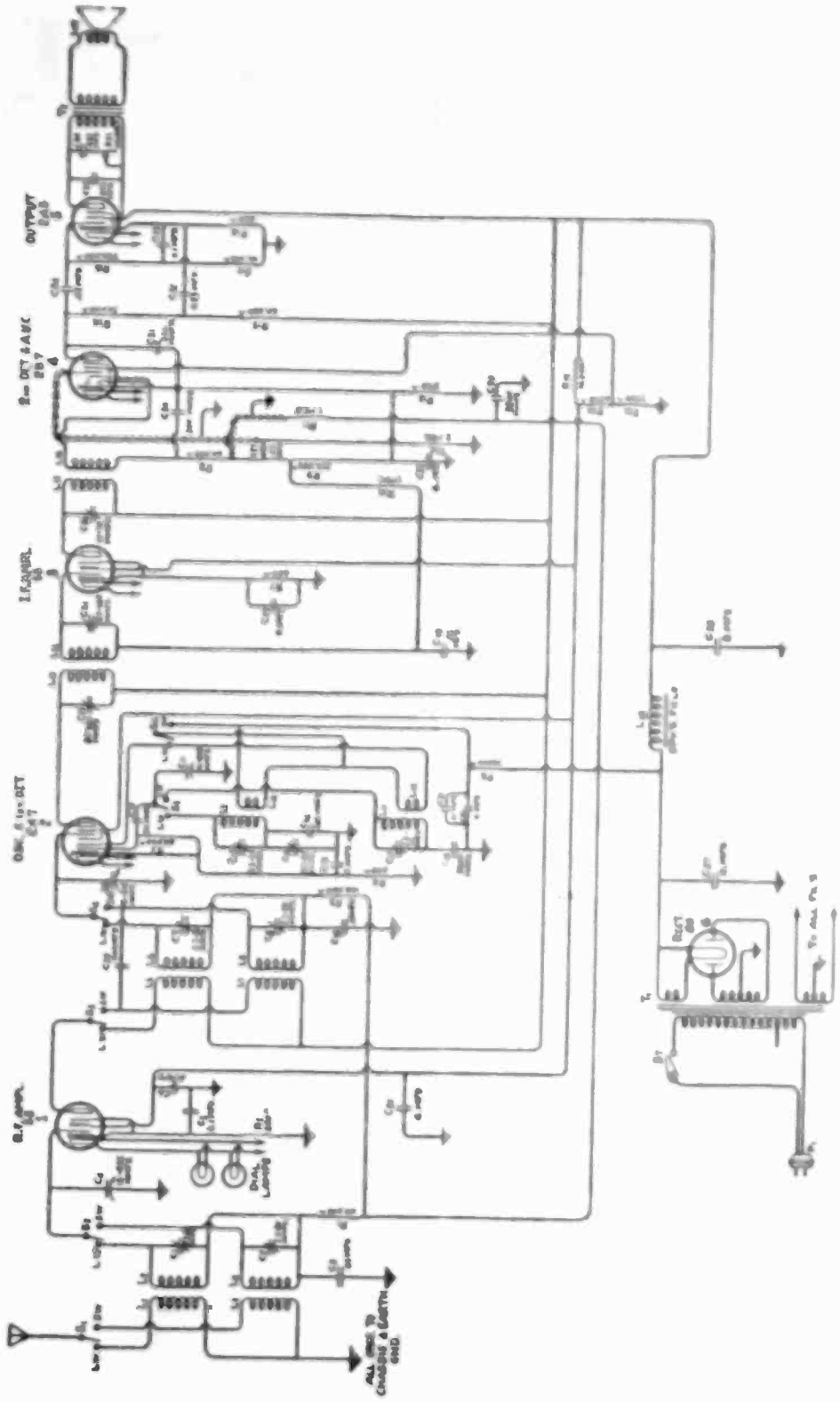
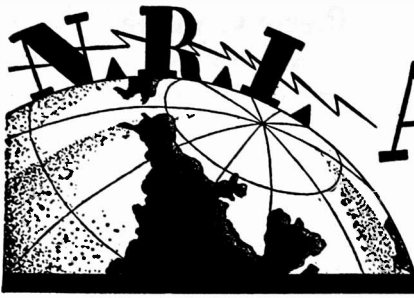

FIGURE 1

Readers who file Service Data in separate binders remove page carefully: trim on dotted line for same size as Data published heretofore.



55 K 64



ALUMNI *News*

Detroit Chapter News

The Detroit Chapter of the N. R. I. Alumni Association has moved into its new home—in Liberty Hall, 2905 Mt. Elliott Ave., Detroit. We are really going places now.

We have had some mighty cold weather—but the loyal Detroit Alumni members are getting to the meetings because they have found them to be interesting and profitable.

Our Secretary, Mr. Hassar, has been in touch with the Sylvania Tube Corporation and is arranging for a talk by one of their representatives on Radio tubes. The Sylvania organization has supplied the men of this Chapter with very helpful booklets on service hints.

Arrangements are being made to place a Public Address System in our meeting hall—and are also working out plans for group purchases of Radio tubes for our members, resulting in larger discounts than could be obtained by individuals.

Plans are underway for a card party and a dance to be held at our new hall—the date of which will be announced later.

At the next meeting of our Chapter, Mr. O'Brien of the Majestic Company of Detroit, will give a talk on Automobile Radios and other speakers are being arranged for future meetings.

New members are coming into our Chapter all the time—we have eight new ones to report now. They are: Stephen S. Grajek, Leslie Anderson, J. E. Rodgers, A. J. Bennett, Frank Haas, Otto Gaebel, G. M. Newman and Percy E. Barlow.

Any N. R. I. graduates who do not belong to the Local Chapter, and who reside in Detroit or the vicinity, should get in touch with us and make arrangements to attend our next meeting. Any man who misses one of these meetings is really missing something worthwhile. If they will get in touch with me at 4833 St. Claire Ave., Detroit, Michigan, or with our Secretary, Mr. George Hassar, 11837 Evanston Ave., Detroit, we will be glad to supply all necessary information.

F. X. SCHACHTNER, Jr., Chairman

Welcome Baltimore Local

At the meeting of N. R. I. Alumni members on February 23, 1934, Baltimore was added to the growing list of Local Chapters of the N. R. I. Alumni Association. Baltimore, we welcome you and wish you every measure of success.

The meeting was held in the showrooms of Southern Wholesalers, Inc., 1511 Guilford Ave., through the courtesy of that organization and cooperation of J. A. McLaurine, N. R. I. graduate who is their service manager. Southern Wholesalers are distributors of R. C. A.-Victor products.

The Charter was issued by Philip J. Murray, Executive Secretary of the N. R. I. Alumni Association who gave a talk on "The Elevation of Radio Servicing Standards." The meeting was also addressed by Mr. W. L. Rothenberger, of R. C. A. Radiotron, Inc., who promised the hearty cooperation of his company to the success of the Chapter.

P. J. Dunn was elected Chairman of the Local and Geo. C. Ruehl, Jr., was elected Secretary.

The following members were signers of the Charter application: Philip Basesi, J. W. Ganz, J. B. Gough, George Oeh, G. C. Ruehl, Jr., B. A. Davidson, W. B. Giese, George A. Hossbach, Chas. Pakalinsky, T. R. Dorsey, S. T. James, Carl Vonderheide, J. Siske, Jr., H. G. Meyers, G. A. Ehrig, E. O. E. Gralley, W. J. Avig, W. T. Spoerer, I. A. Willett, E. R. Traynor, Wm. H. Sauer, W. L. Howard, P. J. Dunn, W. W. Jensen, F. M. Coonan and W. J. Wolosz.

It has just been learned from our Cleveland Chapter, that Charles Jesse, Chairman of that Local, has been ill for sometime, suffering from a nervous disorder. As Charlie is the Associate Editor of National Radio News from that section, we won't have much Cleveland News this time, but hope to make it up in the next issue. Here are our best wishes, friend Jesse, for your speedy recovery and for a continuation of the good work you have been doing in Cleveland.

Pittsburgh Local

This Local has acquired for the use of its members a Double Button Microphone, Input Transformer, cable and disc pickup reproducer. A large 9x14 blackboard (and accessories) has been installed.

We have also added to the Library of our Local "Practical Testing Systems," "Servicing Superheterodynes" and "Servicing Receivers by Means of Resistance Measurements." These books are loaned to members at small fees. In this way they pay for themselves and ultimately provide revenue for our treasury.

At the next meeting group subscriptions to various Radio publications will be discussed. SERVICE Magazine has already favored us with a group subscription plan at quite a saving.

Action is pending on purchase of a complete P. A. System—to be used by members for rental purposes. Net profits from such rentals will go to our treasury.

We have gone on our new schedule of two meetings a month and though our attendance was small we expect members to see the wisdom of this movement and turn out in large numbers. Our associate members, (*N. R. I. students*) are particularly in favor of this new arrangement since they derive a great deal of benefit from the meetings. Actual Radio servicing was discussed and illustrated on sets brought in by students.

One of our members, Mr. Chas. Loche, has been approached by a local musical instrument dealer on a partnership proposition; Mr. Loche to handle the Radio end of the new business.

The following officers have been elected for 1934: T. A. Deschantz, Chairman; T. Edwards, Treasurer; H. Burkhardt, Secretary; Chas. Loche and A. Maas, Financial Committeemen.

T. A. DESCHANTZ,
Chairman, Pittsburgh Local.

Who's Next In Line?

Plans are being considered for the Chartering of two more Local Chapters of the N. R. I. Alumni Association sometime this spring. While nothing has definitely been decided, New York City and Philadelphia have been given a lot of attention due to numerous requests from those points.

National Headquarters would like to hear from Alumni Members in those cities who have ideas on the subject. Address correspondence to P. J. Murray, Executive Secretary, N. R. I. Alumni Association, 1536 You St., Washington, D. C.

Page Twenty ▶

Piezo Crystals

(Continued from page 14)

voltage is proportional to the charge on the crystal.

The various types of Rochelle salt elements are all remarkable for their simplicity. This characteristic is largely due to the lack of necessity for anything in the nature of permanent of electric magnets, or polarizing field. In reality, the Rochelle salt element creates its own electrostatic field.

Present-Day Microphone Requirements

The ordinary type of microphones, such as the condenser or carbon button type, because of its size, has a tendency to fail to give perfect reproduction of sound, due to its own distortion of the sound field in which it is placed. As the frequency at which this distortion occurs, increases as the size of the microphone is reduced, it follows that if the microphone is made small enough, this distortion is negligible for all audible frequencies.

A perfect microphone must be free from mechanical and acoustical resonance. It must also be free from inherent noise often difficult to eliminate when an electro-magnetic or electro-static field must be supplied from some external source.

Crystal Microphones

The Brush Laboratories have developed what is known as a sound cell. The complete sound cell consists of two active Rochelle salt elements, each having an area approximately seven-sixteenths inches square, mounted back to back in a bakelite frame as shown in Fig. 5-A. Each element consists of two surfaces of Rochelle salt cemented together in the principle of opposition. That is, the two cemented surfaces must be of opposite polarity. A layer of tin foil is cemented on each of the two exposed surfaces, and another layer is placed between the two cemented surfaces. Fig. 5-B shows an enlarged cross-section of this element, illustrating its construction and method of terminal connection. It will be seen that the inner layer of tin foil forms one terminal, while the two outside layers form the other terminal. Each element, in spite of its small size, constitutes a complete microphone.

Since the piezo-electric crystal provides its own electro-static field, an additional electro-magnetic or electro-static field is not required. The cell is so small that under normal conditions, there is practically no distortion of the sound field for all frequencies up to 14,000 cycles per second. The sound cell has a flat response curve up to 6,000 cycles, but thereafter gradually rising to 10,000 cycles. This rising response eliminates the necessity for any additional compensation within the ampli-

(Page 21, please)

Chicago Local

Our Chapter is only three months old, but we are coming along nicely. Our membership is growing rapidly and we are hard at work upon plans for an extensive membership drive as we realize the bigger we are the stronger we will be.

Included in this plan is a Bunco and Card party to be given in the near future. H. Horstmann, one of our members is in charge of these arrangements, and he hopes to raise enough money to finance the membership campaign and possibly give a dance for the members as well.

Our systematic reviews of the N. R. I. Course are being received very enthusiastically and the Chapter tenders a vote of thanks to the persons who have acted as demonstrators in this worthwhile procedure.

Heinz Mueller, our Local Secretary, has been ill lately and it is hoped that by the time this appears in print he will be back on the job again.

Now what we want to know is: Who swiped our chalk and eraser from our meeting room? and—what's John Sivovic's new girl-friend's name? (He was late last meeting night.) Brother Marcus, how did you ever grow up without learning to play Bunco? Has the short wave set that appeared at our last meeting been fixed up? Ditto to Sparton 589?

EARL R. BENNETT.

Buffalo

The Buffalo Chapter of the N. R. I. A. A. at a regular meeting has appointed its new membership committee, headed by Frank J. Burns, a hard-working member. They have formulated plans for a concentrated drive, assisted by National Headquarters which is conducting a mail campaign. There are real live wires on this committee and we predict a Local Membership of over seventy-five before this summer.

The new officers of the Buffalo Local are: T. J. Telaak, Chairman; John T. Pollard, Financial Secretary; Norman Smith, Corresponding Secretary; Adam Zalnowski, Finance Committeeman; Lewis Weber, Finance Committeeman.

It has been decided to hold three or four card parties for the benefit of the organization during the spring and early summer. The members have pledged their co-operation and are all pulling for a record crowd.

A nationally known Radio tube engineer will be the guest speaker at the next meeting of the Buffalo Local and we have invited as guests the members of the Institute of Radio Servicemen and members of the Radio Service Engineers of Western New York. We cooperate with both of these organizations to our mutual benefit.

Piezo Crystals

(Continued from page 20)

fier, and gives an actual response at all frequencies. Fig. 6 shows a typical response curve for the crystal sound cell.

The smallest crystal microphone consists of a single sound cell mounted within a monel metal screen as shown in Fig. 7. Due to its small size, this microphone can be easily concealed, as is desirable for sound film recording, etc. It may be used as a "lapel" microphone, for announcing, etc. It has an output of approximately 90 db, and an impedance of about 50,000 ohms, and can be used as far as 15 feet from the pre-amplifier. With so high an impedance, the single sound cell unit may be matched directly to the grid of the first tube of the amplifier. Two such cells in series, would have twice the voltage, but also twice the impedance of a single cell. Since the impedance is greater, the two sound cells must therefore be used closer to the amplifier than in the case of the single cell. Two cells in parallel would produce the same voltage as one cell, but one-half the impedance, and therefore could be used with a lead twice as long as that used with the single cell.

One such unit, which has proved very successful, is illustrated in Fig. 8, and consists of 24 cells, arranged in four bakelite strips, each containing 6 cells connected in parallel. Each pair of strips is connected in parallel, and the two halves thus produced, are connected in series. This results in a voltage output of twice that of a single cell, one-sixth of the impedance, and twelve times the current generated by a single cell unit. It can therefore be used with a long lead from the amplifier. This microphone also has the advantage of being transparent to sound. That is, the strips of sound cells are mounted edgewise to form a grille, so that the sound waves pass directly through the microphone, and parallel to the sound cells. This results in a minimum of distortion of the wave-front, and no reflection or cavity resonance.

This microphone has the additional advantage of being non-directional. It also has a sensitivity somewhat in excess of either the condenser or carbon types of microphones. This particular microphone must be used with a pre-amplifier. It may be connected directly across the grid of the first tube, in parallel with a grid-leak, as shown in Fig. 9, but for maximum level, an output transformer, as shown in Fig. 10, must be used.

Fig. 11 shows the circuit diagram of a pre-amplifier which has been especially designed for use with the crystal microphone. This pre-amplifier has recently been placed in use in connection with crystal microphones in a number of broadcasting stations.

Intermittent Fading

(Continued from page 14)

Oftentimes improving your aerial or ground will help matters. Merely because you have a good, bright contact with the water pipe and have connected it to the set with a short lead, does not mean that the ground is good. There might be high resistance joints in the water pipe or radiator pipe leading directly to the ground of the antenna system. It is best under these conditions to connect the radiator or pipe to other pipe systems wherever they cross in the house.

Synchronizing Developments

(Continued from page 9)

small synchronous two-phase motor mechanically connected to a small variable condenser associated with the crystal oscillator circuit. Since the two-phase current from the modulator stage has a direction of phase rotation or a direction of phase displacement, depending on the carrier deviation, an accurate control may be obtained. For example, if the frequency of the oscillator increases, the phase displacement of the two-phase current will be such that the synchronous motor will rotate in a direction such that it will increase the capacity of the oscillator circuit by a small amount, thus bringing it back to normal frequency. Obviously, when the frequency is identical with the harmonic selector, minus 10 kc., no frequency "D" will be formed and only one-phase output will be obtained from the modulator and the two-phase motor will not rotate.

Any deviation of even a small fraction of a cycle on the carrier will operate the frequency-correcting apparatus. This provides a precision of carrier frequencies never before approached in broadcasting transmitters.

The crystal oscillator unit was especially designed for use in this equipment. The equipment contains a crystal unit and the associated correcting device in duplicate. Should one of the units fail, the other may be placed immediately in service by a simple switching operation. The spare unit, of course, is kept at operating temperature continuously, so that no warming period is required before placing it into service. The quartz crystal control, as well as the oscillator circuit, are housed in a single unit. The crystal, of course, is enclosed in a separate chamber within this unit. The temperature of this chamber is closely regulated by a mercury thermostat which is adjusted and calibrated as a unit at the Bell Telephone Laboratories. This assures high precision and calibration as well as permanency of adjustment. Some advantage is gained through the absence of mechanical relays in the crystal heater circuit in maintaining satisfactory service.

Page Twenty-two ✻

NATIONAL RADIO NEWS

Vol. 6
No. 1

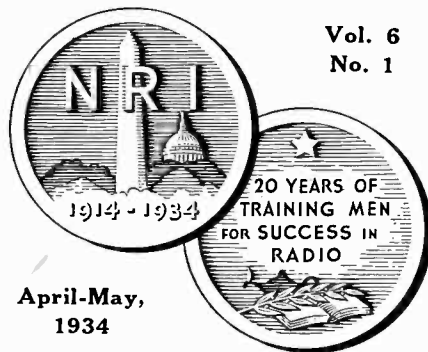

April-May,
1934

Published bi-monthly in the interest of the students
and Alumni Association of the

NATIONAL RADIO INSTITUTE
Washington, D. C.

The Official Organ of the N. R. I. Alumni Association

P. J. Murray, *Managing Editor*

Associate Editors:

T. A. DeSchantz, Pittsburgh T. J. Telaak, Buffalo
Chas. Jesse, Cleveland E. R. Bennett, Chicago
F. X. Schachtner, Detroit P. T. Dunn, Baltimore

Index

Article	Page
The President's Page.....	2
Technical Training Essential.....	3
With the Director.....	4
Intermittent Fading	5
Station Synchronizing	6
Data Sheet Philco 16.....	7-8
The Story of a Service Job.....	9
Gold in the Backyard.....	10
10,000,000 Radio Prospects.....	11
Piezo Crystals (First Installment).....	12-13
Queries and Answers.....	15
This and That.....	16
Success Stories	16
Data Sheet R. C. A.-Victor 121- 122, Gen. Elec. K64.....	17-18
Alumni News	19-20-21
The Mailbag	23
Calcaterra Service	24

THE MAILBAG

Ham Stations

Fred Rogers, Hamilton, Ont., Canada—VE3IQ.

W. Donald Crouse, North Devon, N. B., Canada—VE1FZ.

Chas. E. Lowers, Marietta, Ohio—W8KJG.
Donald Leiphart, Punxsutawney, Pa.—W8JFK.

L. W. Sarkki, Helsinki, Finland—OH2NG.

This is the first time I have written to the Mail Bag Editor and I feel ashamed of myself for not doing so before. The helpful hints published in the Mail Bag, and in National Radio News in general, have been life-savers for me. Not only have they helped my service problems, but whenever I feel blue or discouraged, I pick up a copy of the News and read the success stories of other N. R. I. men.

Those articles by Mr. Smith have a punch and all of the other members of the Institute's staff certainly give a fellow something to think over with their articles in the News.

My Radio work is picking up splendidly and I can handle just about any service job that comes along, with confidence—even though I am still not a graduate. There is plenty of competition in my city, but I get my share of work.

A. GIANDOMENICO, Malden, Mass.

Graduate O. L. Wright reports obtaining a position with Radio Station WNRA at Muscle Shoals, Alabama, through the cooperation of the N. R. I. Employment Department.

Many of the older sets are not equipped with a tone control, but many of them have some provision for local and distance reception. While the local-distance switch may be necessary in some locations, it is seldom needed when broadcasting stations are at a distance of 25 miles or so, as in my case. There are, of course, many ways in which this control is inserted into the circuit, but a study of the wiring diagram of the receiver will help the Radio-Trician convert the local distance switch into an effective one-position tone control.

I have done this on many sets. My latest job was done on a Brandes B-15. The local-distance switch in this case merely opens the

plate circuit of the second R. F. tube. I took the switch leads away from the plate circuit and then made the plate circuit intact. The two switch leads were then connected to the grids of the power tubes in series with a .002 mfd. condenser. I removed a small coupling condenser between the first and third R. F. plates, as it is unnecessary when all the plate circuits are complete. The material used in such a conversion amounts to about ten or fifteen cents, which will allow a reasonable charge and a good profit. I have a pair of adapters which can be inserted under the power tubes to make connection to the grids and in this way can provide a quick demonstration by trying various condenser values until the customer decides which effect is most pleasing.

JOHN ROYAL, Terryville, Conn.

This Month's Cover

On the cover of this issue of National Radio News we bring you a picture of the beautiful Library of Congress, located in Washington, D. C.

The library building is situated about a quarter of a mile east of the United States Capitol building, on ten acres of ground, which the building occupies three and three-quarter acres. It is the largest and most magnificent library in the world. The floor space totals about fourteen acres.

The collection in this library is now the largest in the western hemisphere, comprising about four and a quarter million printed books and pamphlets, almost a quarter of a million maps, charts, etc., over a million pieces of music, and a half million photographs.

Included in the collection are papers of seventeen Presidents of the United States, papers of numerous statesmen, including Morris, Franklin and Hamilton. The library is also the custodian of the originals of the Declaration of Independence and the Constitution of the United States.

While the Library of Congress was established in 1800, it was at that time a part of the Capitol building and was destroyed by fire in 1814. The new building was completed in February, 1897, and cost \$6,347,000 exclusive of the land, which cost \$585,000.

Build Yourself a Valuable Radio Library with these Helpful **FREE MANUFACTURERS' BOOKLETS and CATALOGS**

A FREE SERVICE DESIGNED TO SAVE YOU TIME AND MONEY

The cooperation of the manufacturers whose catalogs, literature and booklets are listed on this page, and the courtesy of the Calcatera Catalog Service, has made it possible for the N. R. I. Alumni Association to offer to readers of National Radio News a unique and money-saving service in obtaining Radio manufacturers' literature.

All that is necessary for you to obtain the catalogs or other literature listed on this page is to

write the numbers of the items in which you are interested on the coupon, fill in the information asked for and MAIL IT TO THE CALCATERRA CATALOG SERVICE. DO NOT MAIL COUPONS TO THE NATIONAL RADIO INSTITUTE, AS THAT WILL DELAY THE FILLING OF YOUR ORDER.

Stocks of the publications listed are kept on hand and they will be sent to you promptly, as long as the supply lasts.

2. HAMMARLUND 1934 PARTS CATALOG. 10 pages. Variable and adjustable condensers, sockets, coils, intermediate frequency transformers, chokes, etc., for broadcast and short wave work.

4. HAMMARLUND-ROBERTS 15 TO 200 METER COMET "PRO" SUPERHETERODYNE. Details of a receiver designed especially for laboratory, newspaper, police, airport and steamship use.

5. ELECTRAD 1934 CATALOG. 16 pages. Standard and replacement volume controls, Truvolt adjustable resistors, voltage dividers, vitreous enamelled fixed resistors, public address systems, etc.

6. AMPERITE REAL LINE VOLTAGE CONTROL. Characteristics, uses and chart showing the correct Amperite recommended by set manufacturers for their sets.

9. INTERNATIONAL 1934 RESISTOR CATALOG. Specifications and prices on International Metallized, Precision wire wound and enamelled wire wound resistors, motor radio noise suppressors and resistor kits.

10. INFORMATION ON THE SUPPRESSION OF MOTOR RADIO NOISES. Circuits and data published by the International Resistance Company on how to overcome troublesome motor noises in auto radio installations.

16. LYNCH RMA STANDARD RESISTOR COLOR CODE CHART. Handy postcard size. Simplifies job of identifying resistance values of coded resistors. Gives a list of most commonly used resistor values and colors.

34. ELECTRAD SERVICEMEN'S REPLACEMENT VOLUME CONTROL GUIDE. A 44-page vest-pocket size booklet containing a revised, complete list, in alphabetical order, of over 2,000 different receiver models with the proper type of Electrad Control to use for replacements.

40. I. R. C. RESISTANCE INDICATOR. This folder contains a complete description of a small, handy instrument designed by the International Resistance Co. to enable servicemen and other Radio men to determine the exact resistance value of a defective resistor without the use of meters, wiring diagrams or specifications of the receiver circuit.

41. HOW TO BUILD THE ECONOMY "EIGHT." A folder prepared by the Wholesale Radio Service Co., which gives complete data on how to build this efficient eight-tube receiver from a kit coating only \$13.75. These receivers can be built and sold in spare time at a profit.

42. HOW TO BUILD USEFUL SERVICING AND TESTING INSTRUMENTS WITH SIMPLE, STANDARD METERS. A folder prepared by the Lynch Mfg. Co. giving circuits and explanations showing how to increase the usefulness of simple meters to measure current, voltage or resistance through any desired range.

52. THE I. R. C. SERVICER. A free monthly house organ published by the International Resistance Co. A sample copy will be sent on request through this service, after which you can subscribe to it, if you like it, by writing direct to the International Resistance Co.

56. SUPREME SERVICING AND TESTING INSTRUMENTS. A catalog containing complete descriptions of a new line of Supreme low-price analyzers, set testers, tube testers, ohmmeters, capacity testers, oscillators and universal meters.

57. HOW TO BUILD A HIGH-QUALITY CONDENSER OR RIBBON MICROPHONE. This circular describes the Superior Microphone Kit and instruction sheets with which it is possible to build, quickly and easily, a high quality condenser or ribbon microphone. The kit is made by the Bruno Division of the Amperite Corporation.

59. THE IRC VOLT-OHMMETER. A folder describing the characteristics and uses of the International Resistance Company Volt-Ohmmeter, a combination voltmeter and ohmmeter specially designed for the point-to-point method of trouble-shooting. The instrument contains the Automatic Vacuum Relay feature which gives positive protection against burn-outs.

60. AMERTRAN AUDIO AND POWER TRANSFORMERS AND CHOKE COILS FOR USE IN PUBLIC ADDRESS AMPLIFIERS AND RECEIVERS. A folder containing very complete information on the characteristics of a wide variety of AmerTran De Luxe and Silcor (popular priced line) audio and power transformers and chokes.

61. WHOLESALE RADIO SERVICE REPLACEMENT PARTS LIST PRICE CATALOG. A handy, pocket-size, 32-page book listing replacement units of all kinds, with list prices, which can be used by servicemen to show to customers in quoting prices for parts.

(Please Use Pencil and Print in Filling in Coupon)
THE CALCATERRA SERVICE NRN-434
Thornwood, N. Y.

Please send me, without charge or obligation, the catalogs, booklets, etc., whose numbers I have filled in below.

Booklet Numbers:

My connection in Radio is checked off below.

- () Serviceman operating own business
- () Serviceman employed by:
 - () Manufacturer
 - () Jobber
 - () Dealer
 - () Servicing organization
- () Dealer
- () Jobber
- () Radio Engineer
- () Experimenter
- () Laboratory Technician
- () Professional or Amateur Set Builder
- () Licensed Amateur
- () Station Operator
- () Manufacturers' Executive
- () Student
- () Public Address Work
- ()
- ()

I buy approximately \$00 of Radio material a month.

(Please answer above without exaggeration or not at all.)

Name.....

Address.....

City.....State.....