

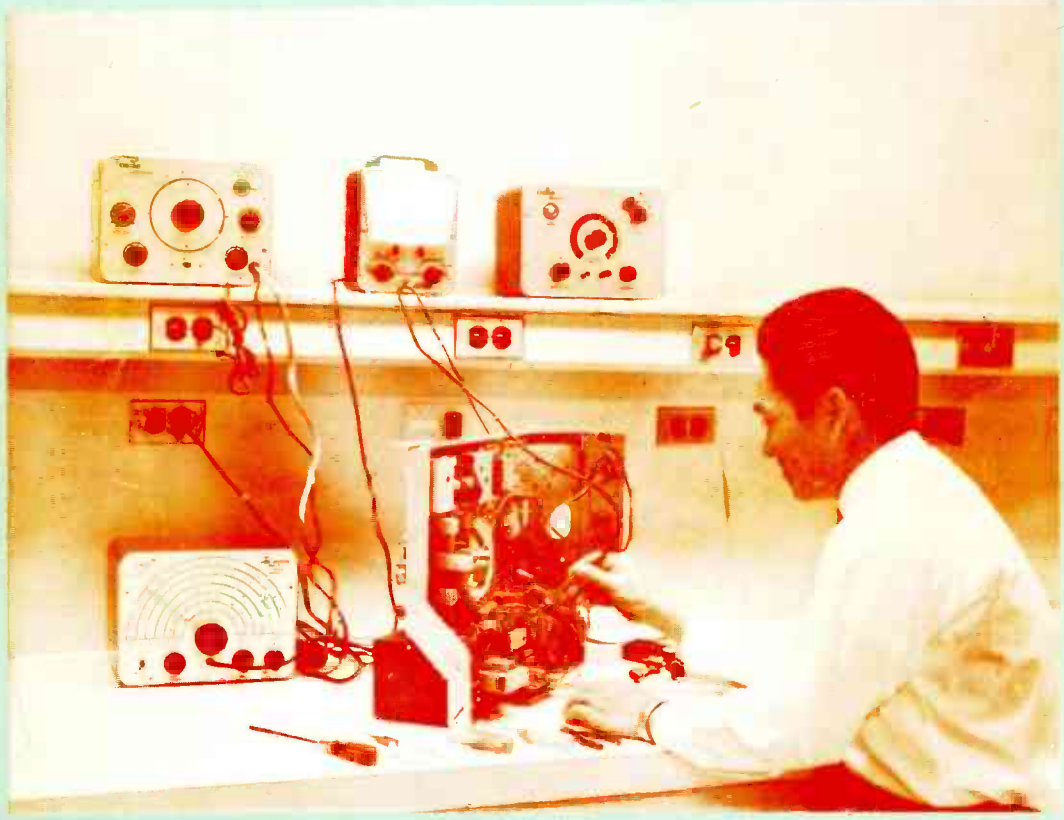

journal

January/February 1968 35 Cents



NRI Consultant Ernie Ruiz Checks Out an Old TV Receiver

IN THIS ISSUE:

J.B. Straughn Talks About CONAR Test Equipment

SPECIAL - BUY ANY 2 TESTERS

Deduct \$5.00

From The Combined Price

**ENCLOSE THIS AD
WITH YOUR ORDER**

OFFER ENDS MARCH 31, 1968



**SAVE
\$ 5⁰⁰**

MODEL 230

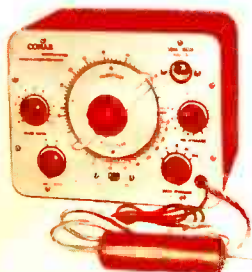

\$5 MONTH

CONAR Tuned Signal Tracer

Only tuned tracer on the market anywhere near the price. Exclusive cathode-follower probe gives outstanding sensitivity. Easily connects to any RF or IF stage with absolute minimum of detuning. Features audio tracing method through built-in 4" PM speaker plus visual indicator using "eye" tube. Quickly locates sources of hum, noise and distortion. Tracks down intermittents, measures gain per stage, accurately aligns radios without signal generator. (Tracer may also be used as sensitive AM radio.) Has two stages of RF amplification. Assembly-operating instructions include more than 12 pages on uses of Model 230. For beginners as well as experienced technicians.

SPECIFICATIONS
FREQUENCY: 170 kc to 1500 kc (2 bands)
TUNING: Planetary Drive, 3:1 ratio
RF TRANSFORMERS: Permeability tuned
ATTENUATORS: Calibrated RF and AF
TUBES: (2) 6GM6, (1) 6AV6, (1) 6AQ5, (1) 6E5, (1) 6X4, (1) 6AB4
CONTROLS: Volume, Band Selector, Main Tuning, Fine Attenuator On-Off, Coarse Attenuator, RF-AF switch
CABINET: Steel, blue finish with satin finish panel, red lettering
DIMENSIONS: 9 7/8" x 7 1/2" x 6 1/2"
POWER SOURCE: 110-120, 60 cycle

KIT-230 UK

\$39.95

ASSEM.-230WT, \$59.95

MODEL 280

CONAR Signal Generator

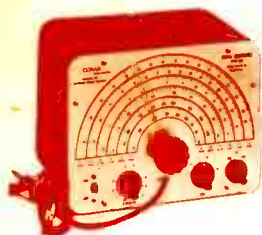

\$5 MONTH

Widely acclaimed as most accurate signal generator near the price. Uses Hartley type oscillator circuit with six separate coils and capacitors to give accuracy within 1% after easy calibration. High output of the Model 280 simplifies signal injection for rapid alignment and troubleshooting of transistor and tube receivers. Covers 170 kc to 60 mc in six ranges with harmonic frequency coverage over 120 mc. Ideally suited as marker generator for TV alignment. Tuning dial features planetary drive with 6:1 ratio for greater accuracy and elimination of backlash. Scale is full 9" wide with transparent hairline pointer. Has single cable for all outputs, no need to change leads when switching from 400 cycle audio to modulated or unmodulated RF.

SPECIFICATIONS
CONTROLS: High-Low Output Selector, Main-Tuning Dial, Band Selector-A thru F, Output Selector-Mod, RF Audio, Attenuator/On-Off switch
TUBES: 6BE6, 12AU7
CIRCUIT: Slug adjusted RF coils with mica trimmers on low bands. Ceramic trimmers on high bands
CABINET: Steel, baked-on blue finish; satin finish panel with red lettering
DIMENSIONS: 9 7/8" x 7 1/2" x 6 1/2"
POWER SUPPLY: solid state 110-120 V, 60 cycle AC

KIT-280UK

\$24.95

ASSEM.-280WT, \$35.95

MODEL 311

CONAR Resistor-Capacitor Tester



\$5 MONTH

The Model 311 gives fast, accurate, reliable test on all resistors and capacitors. Measures capacity of mica, ceramic, paper, oil-filled and electrolytics from 10 mmfd. to 1500 mfd, 0-450 volts. Checks for leakage, measures power factor and useful life. Shows exact value of resistors from 1 ohm to 150 megohms. Clearly indicates opens and shorts. Has "floating chassis" design to greatly reduce shock hazards. The Model 311 will also apply actual DC test voltage to capacitors to reveal break-down under normal circuit conditions, a feature far superior to many R-C testers which give low voltage "continuity" tests. Can be used for in-circuit tests in many applications and circuits.

SPECIFICATIONS
RESISTANCE RANGES: 0-500 ohm, 100-50K, 10K-5M, 1.8 M-150M (extended range)
CAPACITY RANGES: 0.1-50 mfd, .001-5 mfd, .00001-005 mfd, 18-1500 mfd (extended range)
CONTROLS: Range Selector, Leakage Test, Voltage (0-450), Power Factor (0-60%)
TUBES: 6E5 "eye" indicator 5x4
BINDING POSTS: Special 5-way type
CABINET: Steel, smooth blue
DIMENSIONS: 9 7/8" x 7 1/2" x 6 1/2"
POWER SUPPLY: 110-120 V, 60 cycle AC

KIT-311UK

\$21.95

ASSEM.-311WT, \$33.50

 **journal**

January/February 1968

Vol. 25, No. 1

Published every other month by the National Radio Institute, 3939 Wisconsin Avenue, N.W., Washington, D.C. 20016. Subscription \$2.00 a year. Printed in U.S.A. Second class postage paid at Washington, D.C.

Copyright 1968 by National Radio Institute
All rights reserved.

CONTENTS

2. TEST EQUIPMENT YOU NEED

13. ELECTRONIC PUZZLE

14. LITTLE THINGS THAT COUNT

16. HONORS AWARDS

19. COMMUNICATIONS

22. EMPLOYMENT OPPORTUNITIES

25. ALUMNI NEWS

Editor and Publisher W. F. Dunn
Managing Editor A. J. Magann
Associate Editors J. F. Thompson
 H. B. Bennett
Technical Editor J. B. Straughn
Alumni News Editor T. E. Rose
Assistant Editor J.M. Rhodes
Staff Artist Larry Weaver



WORLD'S FINEST
ERSIN
MULTICORE
5-CORE SOLDER

NEW EASY
DISPENSER
PAK

ONLY **69c**

BUY IT AT RADIO-TV PARTS STORES

MULTICORE SALES CORP. WESTBURY, N.Y. 11591

**if you own a
CONAR or NRI
tube tester**

THIS IS FOR YOU

Through special arrangement with Coletronics Service, Inc., owners of the CONAR Models 220, 221 and 223 tube testers or the NRI Model 71 tube tester may subscribe to Coletronics' annual service listing of additional tube supplementary information not on your roll chart. For information write to

COLETRONICS SERVICE, INC.
1744 Rockaway Ave.
Hewlett, Long Island, N.Y. 11557

The Test Equipment You Need

BEST INSTRUMENTS SHOULD COMBINE
ACCURACY, DEPENDABILITY, AND UTILITY
.. AND CONAR PRODUCTS HAVE ALL THREE

By J.B. STRAUCHN

Everyone starting out wonders what he needs in the way of test equipment, the order in which it should be obtained, and what brand is best for him.

The best advice I can give is the result of my own experience as a beginner, and what I have learned since.

My start in electronics was through the back door of phonograph repair. The work at first was strictly mechanical and consisted mainly of replacing springs in spring-wound motors, replacing governor springs, adjusting motor speeds to 78 rpm and polishing cabinets. But soon, the big radio wave of the future came along and washed the mechanical phonograph up on the beach to join the magical lantern, cars with two wheel brakes, and many other odds and ends of junk which today are valuable antiques.

One might say I was literally forced into radio. I learned to put up antennas, install tubes, connect batteries, and many other strange gizmos. I learned just enough to make an awful mess of things and I have often wondered what happened to the storage batteries I filled completely with acid rather than acid and water!

The handwriting on the wall became so painfully clear that without further ado I enrolled for a course in radio repair with NRI. After learning more than a little, I was fired with determination to get some equipment and fix my aunt's new radio whether it needed it or not. The point was: What equipment should I get?

Rather than write to NRI for advice I studied all the test equipment ads in the

magazines and radio supply house catalogs. Finally, I purchased a very moderately priced analyzer which would simultaneously measure the plate voltage, plate current and filament voltage of a stage. I succeeded in checking all stages in my aunt's radio. She always maintained it never worked as good after that, not knowing I had accidentally poked a screwdriver blade through the speaker cone!

Later I discovered there was such a thing as meter sensitivity - ohms per volt - and that my cherished analyzer was practically worthless for servicing. However, it was housed in a nice case, which shortly became a fishing tackle box and served as such for many years.

I never forgot this experience and when in later years part of my job with NRI was the design of test equipment, I always kept the user in mind. From then on, if the proposed equipment was something I would not buy for my own use, I simply did not design it as an NRI or CONAR product.

I am responsible for most CONAR test instruments to date and can testify to their worth.

This brings us up to you, who stand today on the threshold of an electronics career. Like I did, you probably have a desire to put your newly gained knowledge to work and to fortify it with some unsupervised practical experience. If you are like I was, your funds are probably limited and you not only want to get the most for your dollar but want the right kind of equipment.

From many years of experience I know



Fig. 1. The CONAR Model 211 VTVM, built in the second demonstration kit.

you need and can use, in the order given, the following radio service items:

1. A good VTVM.
2. A tuned signal tracer.
3. A signal generator.
4. A resistor-capacitor tester.

THE MODEL 211 VTVM

As part of your course you construct and learn to use the CONAR Model 211 VTVM shown in Fig. 1. I designed this instrument specifically with the serviceman in mind. You can purchase more expensive VTVM's, but you can't get a better one. You have no need as a beginner for an additional VTVM, so there is no problem here!

Most students have received data sheet Y with their VTVM. It contains condensed calibration instructions, information on reading the meter scales and general information on the use of the VTVM. If you did not get a copy or would like another, just write to me at NRI for a copy of data sheet Y and one will be mailed to you.

THE MODEL 230 SIGNAL TRACER

This is a unique instrument and is a training tool as well as the most useful

piece of test equipment a beginning radio serviceman can own.

From your studies you know that signals are passed from stage to stage in a receiver, undergoing frequency transformations at the mixer and at the second detector. If a defect occurs at some point it will be present from that point to the speaker, but ahead of that point the signal will be normal.

In servicing it is necessary to locate the defective stage and the concentrate on it, checking the voltages, circuit resistance and the continuity with your VTVM. Finding the point at which to start checking is nine-tenths of the problem - everything else is fairly routine.

The signal tracer is just what its name suggests. With it you can trace signals through the entire set. You sample the signal at each stage, and by listening to the Signal Tracer speaker can determine where, in the receiver, the signal fails or just where distortion noise or hum has been added. You can also compare the strength of a signal at the input and output of the stage and measure the actual gain of the stage.

The signal tracer is shown in Fig. 2 and its schematic in Fig. 3. All of the amplifying stages, signal selecting stages, measuring circuitry and power supply is contained in the cabinet. The



Fig. 2. Front panel of the CONAR Model Signal Tracer, showing all controls.

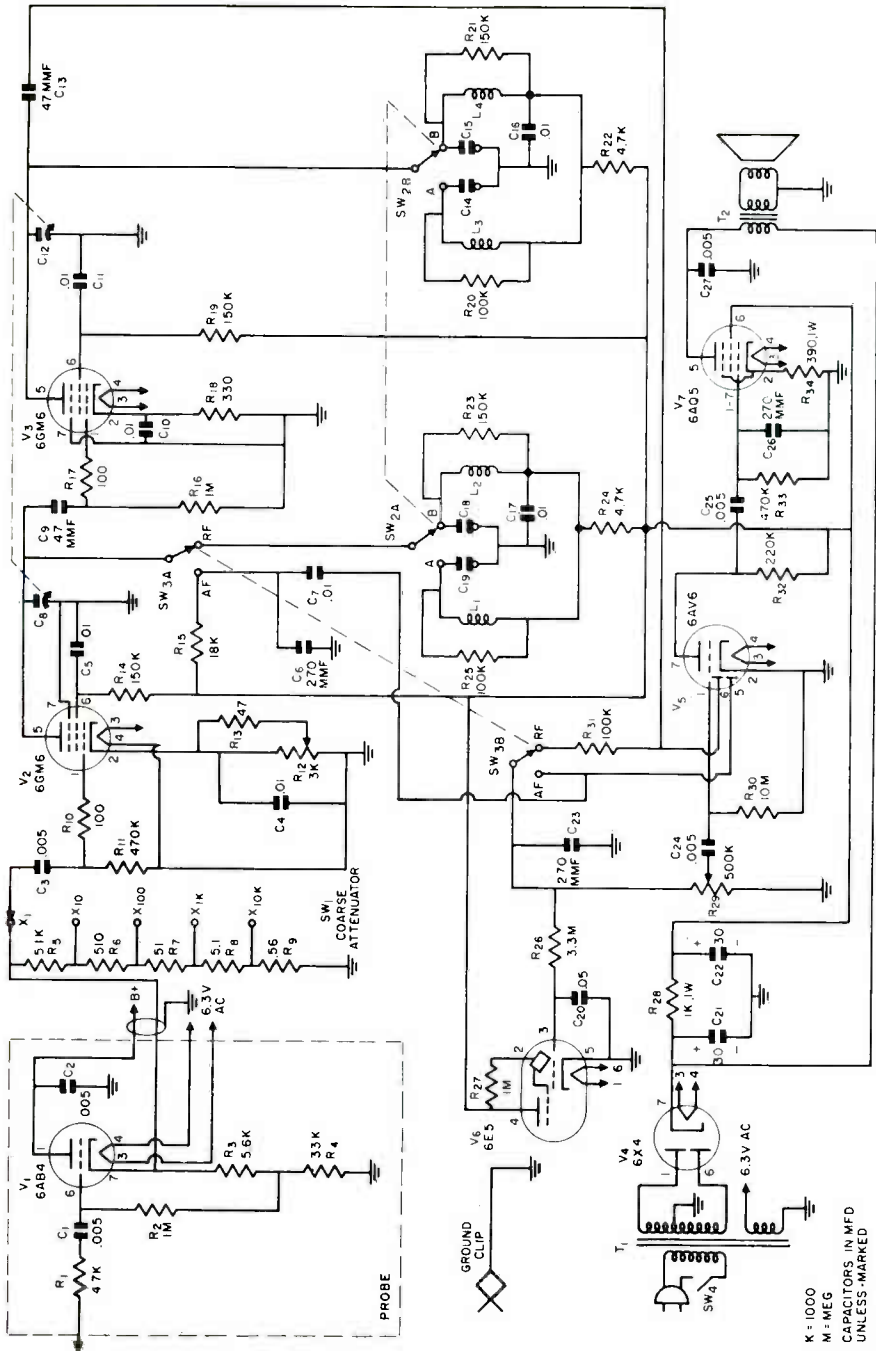

Fig. 3. Schematic of the Model 230 Signal Tracer.

signal pick-off probe at the end of the cable contains a cathode follower tube, which enables you to sample signals from the antenna to the loudspeaker without the slightest danger of damaging the receiver under test or the signal tracer. ITS USE BY THE RANKEST BEGINNER CANNOT RESULT IN DAMAGE; truly a boon to the starting serviceman who wants to experiment on his own without blindly following instructions.

Controls.

The two controls at the right in Fig. 2 are to adjust the sensitivity of the signal tracer and to vary the output of the cathode follower in steps of 10. Note the markings 1, 10, 100, 1000, and 10,000 on the lower control. When set to 1000, the signal delivered to the tracer amplifier from the probe is 1000 times the amount delivered at a setting of 1. The upper right-hand control turns the Tracer on and off and varies the amplifier gain by adjusting the bias of the first stage.

To measure stage gain, the probe is connected to the input of the stage under test. The two right-hand controls are adjusted so the tuning eye just closes. On a scrap of paper you multiply the settings of the two controls. For example, the top control may be at 5 and the bottom control at 10, giving 5×10 or 50.

Then you move the probe to the output of the stage and again adjust the two controls so the eye just closes. Perhaps this time the upper control is at 4 and the lower control is at 100. You multiply 4 by 100 and get 400. The numbers 50 and 400 indicate the relative strength of the two signals and if you divide the output by the input you get the stage gain. In this case, 400 divided by 50 equals 8, so the stage has a gain of 8. This is only done when you wish to measure stage gain precisely. In general you are interested in how the signal sounds so you listen to the speaker rather than watch the tuning eye tube.

The large dial in the middle has two frequency calibrations: A, from 170 to 500 kc, and B, from 500 to 1500 kc.

The band in use is selected by the knob

in the lower left-hand section of the panel, which sets up the circuit for either band A or band B. This is done by switching in a different set of coils. Band A covers all broadcast receiver i-f frequencies while band B covers the broadcast band. The switch in the center of the panel sets the tracer to be ready to pick up signals on bands A or B (rf) or to pick up signals in the receiver audio amplifier (af).

TUNED VS UNTUNED TRACERS

Why do we refer to the Model 230 as a Tuned Signal Tracer when other instruments available on the market and much cheaper in price are just known as Signal Tracers - aren't all Signal Tracers basically the same? This is a good question, but you should know that there is a vast difference in the results between a tuned and untuned Signal Tracer when investigating trouble in the rf/i-f section of a radio receiver. The untuned types can pick up and reproduce the modulation on rf/i-f signals but they cannot measure the relative strength of the rf and i-f carrier - in other words, they cannot measure the rf or i-f stage gain. Also, any modulation present on a carrier will be mixed in the untuned tracer with the desired modulation beyond the possibility of separation. The effect is the same as if a dc voltmeter used to measure the voltage at the input of the power supply filter also responded to and added in the high ripple voltage present at this point. Such a measurement would be worthless for diagnostic purposes.

With a Tuned Signal Tracer you can reject all undesired signals normally present at any point in the receiver and pick up and analyze only the significant signal. For example, in measuring gain in the converter stage you compare the amplitude of the rf signal with that of the i-f signal. The Tracer rejects the oscillator signal, the original rf signal and their sum frequency signal which are also present at the output of the mixer. Without question, a Signal Tracer should be of the tuned type.

The Signal Tracer can be purchased in kit form or as an assembled unit by

CONAR. If you have successfully built your VTVM in your course, construction of the Signal Tracer will be no problem. It comes complete with detailed instructions for use on all kinds of broadcast receivers - home sets - portables - auto sets and either transistorized, hybrid or tube receivers.

While the Signal Tracer can be used for receiver alignment, do not buy it solely for this purpose, as it does not replace a Signal Generator. Its main value in alignment is to make the oscillator and preselector of the receiver track at both ends of the band. This can be done by noting and picking up the i-f produced at the output of the mixer and making certain that this i-f does not change as you tune through stations over the dial.

For regular alignment a Signal Generator is required.

THE MODEL 280 SIGNAL GENERATOR

The handsome CONAR 280 Signal Generator is shown in Fig. 4. It is a fitting companion for the CONAR 230 Signal Tracer, and these instruments can be used separately or to supplement each other.

The Model 280 is available in kit form, or at a slight increase in cost can be obtained built, calibrated, and tested by the

CONAR assembly section. Most servicemen hesitate to purchase a signal generator in kit form because either the signal generator has no means of being aligned for proper calibration or if it does, it does not have the frequency standards required for precision alignment.

Neither of these factors applies to the CONAR 280. The rf coils (except the highest band) have adjustable slugs and each coil is equipped with a trimmer. The coils and trimmers in each kit are adjusted precisely in the CONAR laboratories, using special jigs. Because the leads for all coils and trimmers are short and direct, the distributed capacities do not vary from instrument to instrument, and when assembled the accuracy is excellent, being in the neighborhood of 2%.

This is better than the accuracy of many service type signal generators and is quite satisfactory for all types of service applications. The accuracy can be improved to about 1% by adjusting against known station signals, picked up on a communications receiver or with special standards, as is done in CONAR-assembled instruments. The 280 manual contains full instructions for those who wish to check or recalibrate their Signal Generator. However, the improvement is a minor matter and, because calibration is excellent to start with, does not materially increase the worth of the instrument as a SERVICE tool.

Before going into the uses of the Model 280, let's take a quick look at its operation. A simplified circuit is in Fig. 5. Only a single rf coil is shown and the rf bandswitch has been omitted. This switch changes the connections to the coils and, on the last two bands, switches out variable tuning capacitor C2 and substitutes a smaller variable capacitor.

The Model 280 consists of a variable rf oscillator built around tube V1 and a fixed 400-cycle sine wave oscillator built around the right-hand section of V2 (pins 6, 7, and 8). All output signals are fed to the left-hand section of V2 and are taken from its cathode. The power supply is the conventional half-wave type using a selenium rectifier.

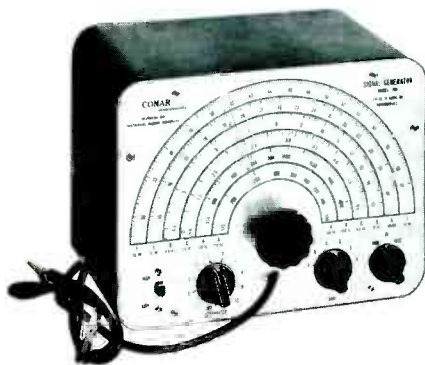

Fig. 4. Front panel of the Model 280.

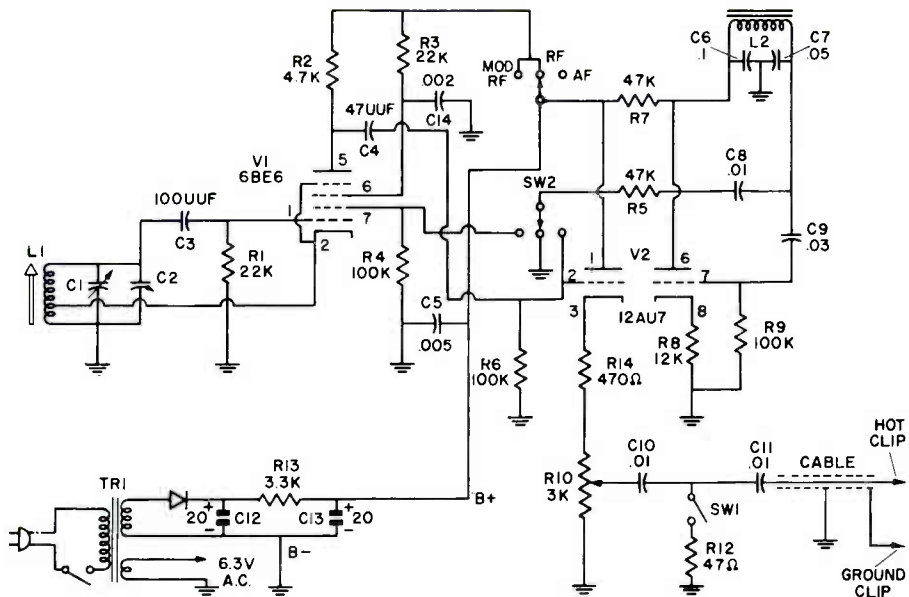

Fig. 5. Simplified schematic of the CONAR Model 280 Signal Generator.

Tube V1 operates as a standard Hartley oscillator. The screen grid (pin 6) acts as the virtual plate and is kept at rf ground potential by capacitor C14. When tube V1 heats up, the cathode current flows from B- through the tap on the tuning coil and, in doing so, shock-excites the resonant circuit consisting of L1, C1 and C2. The resulting signal is applied through C3 to oscillator grid pin 1. A further change in cathode current, at the frequency of the resonant circuit, takes place and oscillation is maintained. Oscillator bias is developed across R1.

The plate current flows through the mixer grid (pin 7), the screen grid, and to the plate. An rf signal is developed across plate load R2 and is fed through C4 to the grid (pin 2) of cathode follower V2.

The rf signal is developed across R10, which serves as the Fine Attenuator Control. By adjusting R10, any amount of the available signal across R10 is fed through C10 and C11 to the output cable and arrives at the hot and ground clips for any use desired. This is a pure unmodulated rf signal.

The 400-cycle signal is produced in the Colpitts oscillator circuit consisting of the right-hand triode of V2, choke L2, capacitors C6, C7, C9, resistors R7, R9, and R8. C8 and R5 are used to couple the audio signal from the oscillator circuit. In the position shown for SW2, R5 is grounded and there is no audio output.

In the af position, the upper section of SW2 removes plate and screen voltage from V1, killing the rf oscillator. The lower section connects R5 to the grid of the cathode follower and the audio signal appears at the output of the cable.

When SW2 is in the MOD RF (modulated) position R5 feeds the 400 cycle signal to pin 7, the mixer grid of V1. The rf and 400 cycle signals are mixed in the tube and the modulated rf signal is fed through C4 to the cathode follower.

This explains everything about the operation of the Model 280 except switch SW1. This is the coarse attenuator switch, and when closed connects a 47-ohm resistor from the junction of C10 and C11 to the chassis. This action causes a great reduction in the signal at the output of the cable. The signal is still controllable

by adjusting R10. Note particularly the presence of C11 in the circuit. This is a high voltage capacitor and makes it possible to even connect the hot probe to the plate of a tube in a receiver without danger of damaging the set or signal generator.

CONTROLS

You are already familiar with the Function Control which enables you to obtain unmodulated rf, modulated rf and af signals, and with the Fine and Coarse attenuator controls which govern the signal level at the output of the cable. The On-Off switch is ganged with the Fine Attenuator Control. The tuning control moves the pointer across the dial and adjusts the frequency of the signal generator over the scale of the band in use.

The bandswitch selects one of six sets of coils and trimmers, thus permitting a wide range of available frequencies. The bands cover the following frequencies:

Band A	170 kc - 550 kc
Band B	550 kc - 1600 kc (1.6 mc)
Band C	1.6 mc - 5 mc
Band D	4.5 mc - 15 mc
Band E	15 mc - 30 mc
Band F	30 mc - 60 mc

USES OF THE 280 GENERATOR

The most important questions to the prospective owner of a Signal Generator are "What do you use it for, and how do you hook it up to the receiver?"

The Signal Generator produces a signal which can be used to align the rf circuits in a receiver to their correct frequency.

The presence of output blocking capacitor C11 in Fig. 5 MEANS THAT EVEN IF YOU MAKE A MISTAKE IN CONNECTING THE SIGNAL GENERATOR YOU WILL HARM NEITHER IT OR THE RECEIVER.

Just how to connect the Signal Generator to a set depends on the injection point you have chosen. The manual for the Model 280 contains detailed instructions for all alignment and test procedures.

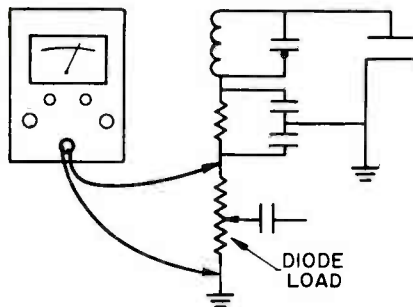

Fig. 6. The dc VTVM connected across the volume control to observe the effect of the rf signal level at the detector output.

When aligning a receiver you need something other than your ears to check changes in output level which, on an am set, should increase as the receiver comes into alignment.

The output indicator may be a VTVM such as the CONAR Model 211. This may be used as a dc voltmeter and connected across the diode load resistor to measure avc voltage (see Fig. 6), or as an ac voltmeter it may be connected from the plate of an output tube to ground or in push-pull transistorized outputs across the primary connections of the output transformer, as shown in Figs. 7 and 8. A less desirable connection, because less signal is available, is across the voice coil of the loudspeaker. When using the ac meter

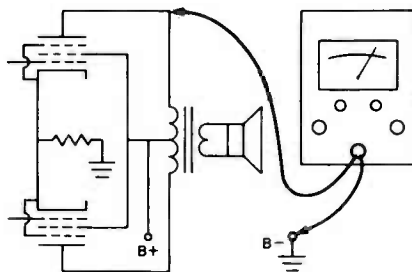

Fig. 7. The VTVM as an ac voltmeter may be connected from either plate to chassis. The sound from the loudspeaker can be kept fairly low with the attenuators.

for output measurements a modulated signal is always required, because you are observing the demodulated signal in the audio section of the receiver.

In addition to aligning broadcast receivers, the signal generator can be used on fm sets for discriminator or ratio-detector alignment and in aligning the video i-f and audio i-f systems of TV receivers.

In addition to alignment you can locate weak and dead stages in a receiver with the signal generator by injecting signals at various points in the set. This is completely covered in the manual. Thus, in a way, it overlaps some of the functions of the Signal Tracer but of course it cannot locate points at which noise, hum or distortion occur in the circuits.

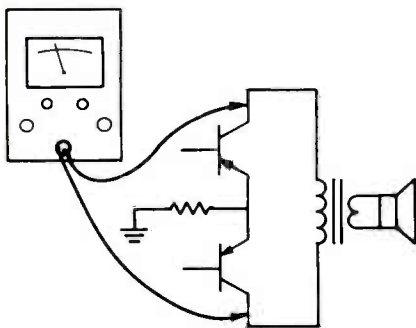

Fig. 8. The VTVM set for ac measurements may be connected to the collector leads of output transistors, or you can get by with a smaller signal from either collector lead to the chassis.

The Signal Generator can also be used in conjunction with the Signal Tracer, feeding the Signal Generator signal into the input of the set and sampling the signals throughout the receiver with the Signal Tracer. The two instruments work together perfectly but you could not replace one with the other.

THE MODEL 311 RC TESTER

As a starter in gathering test equipment the RC Tester is the last instrument to consider. This is true because

you can get along without it in radio service work. There are test methods described in your course that easily enable you to duplicate many of the tests performed with the Model 311, using your VTVM and a few test capacitors of various sizes. Of course, to measure capacity values you need something like the Model 311. However, in radios, as long as the capacitor is not in a frequency determining network (tone control, feedback circuit or resonant circuit) the exact capacity value is not too important. An actual open in a capacitor is easily spotted by shunting the suspect with a test capacitor of about the same size and noting the effect on reception.

It would seem from the above that the RC Tester is not too valuable. Not so - in hi-fi work, in tape recorders, record players and particularly in TV work, the values of capacitors are extremely important and the only check other than an RC Tester would be to install an exact duplicate; obviously impossible where the symptoms might be caused by defects in a number of different capacitors.

Then too, in certain circuits, leakage may develop which could not be spotted with the ohmmeter in the VTVM. The high test voltage produced by the Model 311 will show up such troubles with ease. Also, the ability of the RC Tester to measure very low resistances more accurately than the VTVM ohmmeter

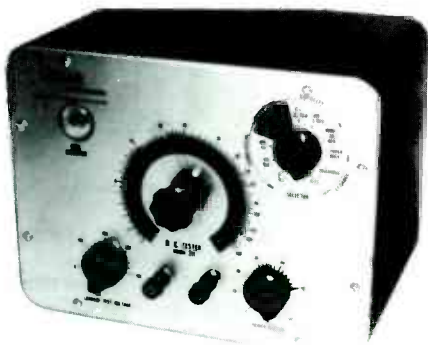

Fig. 9. Front panel of the Model 311.

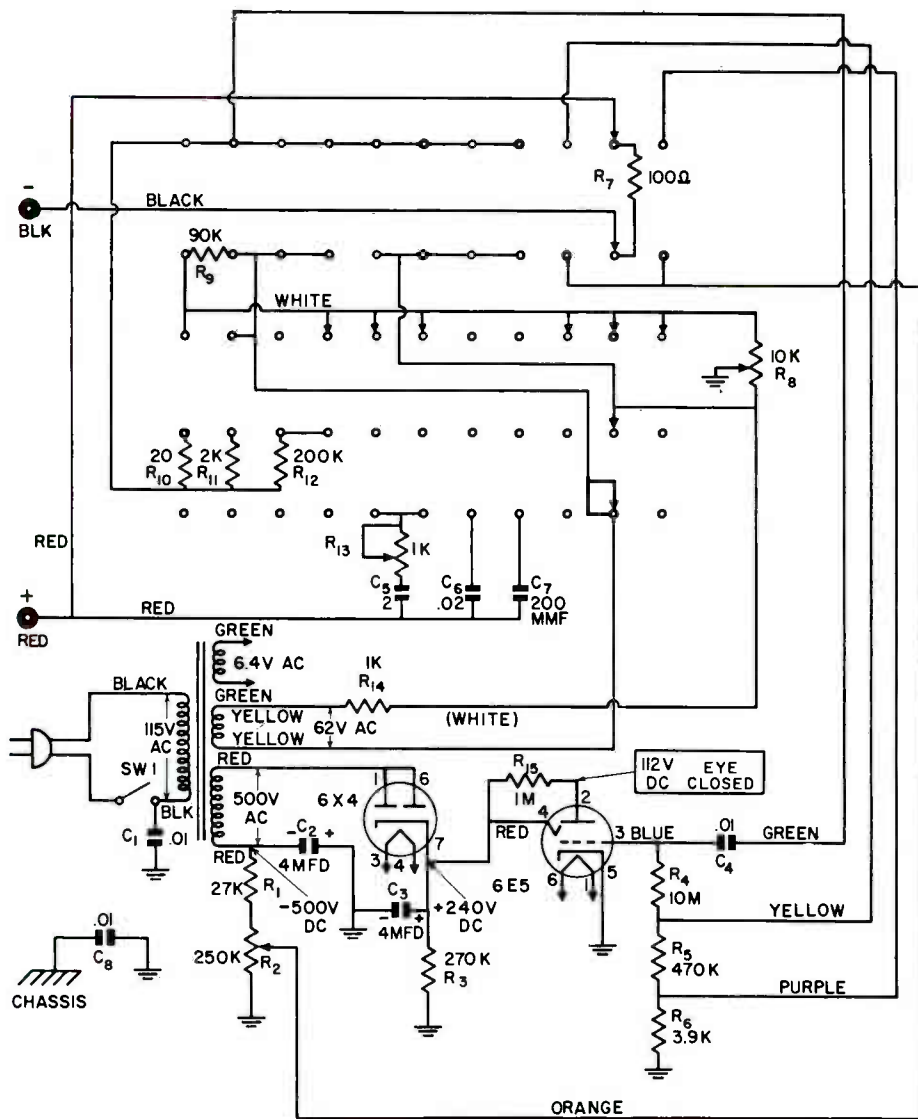

Fig. 10. Complete schematic diagram of the CONAR Model 311 RC Tester.

section is extremely valuable in certain instances.

Just what is an RC Tester? The Model 311 is a bridge type instrument which will measure dc resistance, capacitance, power factor of electrolytics, and capacitor leakage under the rated working volt-

age of the capacitor. It uses a tuning eye tube to indicate when the bridge is balanced by showing maximum opening of the eye.

A picture of the Model 311 front panel is shown in Fig. 9 and its complete schematic in Fig. 10. To show how the instru-

ment is used a summary of the operating instructions follows. The manual accompanying the instrument is of course more detailed.

SUMMARY OF OPERATING INSTRUCTIONS

Measuring Resistance

1. Turn instrument on by turning LEAKAGE TEST VOLTAGE control from "off" position to 0.
2. Set SELECTOR to "discharge" position.
3. Connect resistor across the Model 311 binding posts.
4. Set SELECTOR to appropriate resistance range.
5. Turn MAIN DIAL control until NULL INDICATOR opens.
6. Read value of resistance from MAIN DIAL setting using appropriate multiplying factor. On three lowest ohms ranges, read outside dial scale. On highest ohms range read inside dial, or "extended range". On 1-500 ohms range, multiply reading by 1. On 100-50,000 ohms range, multiply by 100. On 10K to 5M range, multiply by 10,000. On 1.8 to 150M range, multiply all readings by 1,000,000 using extended inner scale.
7. Return SELECTOR to "discharge" position before disconnecting resistor from tester.

Testing Paper, Ceramic, and Mica Capacitors.

1. Turn instrument on and SELECTOR to "discharge" position.
2. Connect capacitor across binding posts - polarity is not important.
3. Set SELECTOR to PAPER-MICA position for most capacitors. (If testing a paper capacitor used for bypass purposes, more leakage can be tolerated, and the ELEC position may be used.) Perform leakage test by turning LEAKAGE TEST VOLTAGE clockwise to dc working voltage of capacitor. NULL INDICATOR shadow should remain open. Part, complete or intermittent closing of NULL

INDICATOR indicates short or leakage.

4. Turn LEAKAGE TEST VOLTAGE control back to 0. Discharge capacitor by setting SELECTOR momentarily on "discharge" position.
5. Set SELECTOR to proper capacity range for capacity measurement. Turn MAIN DIAL until NULL INDICATOR opens.
6. Read value of capacity from MAIN DIAL setting using appropriate multiplying factor. On three lowest capacity ranges, read outside dial scale. On highest capacity range, read inside dial scale or "extended range". On .00001-.005 mfd range, multiply readings by .00001 if reading in microfarads is desired. (Multiply all readings by 10 if you wish to read this range in micromicrofarads.) On .001-.5 mfd range, multiply all readings by .001. On 0.1-50 mfd range, multiply by .1. On the 18-1500 mfd extended range, multiply by 10.
7. Return SELECTOR to "discharge" position before disconnecting capacitor from tester.
8. If you are not able to balance the bridge during the capacity measurements, the capacitor is open.

Testing Electrolytics.

1. Turn instrument on and set SELECTOR in "discharge" position.
2. Connect capacitor across binding posts - OBSERVE POLARITY - red binding post is positive and black post is negative.
3. Turn SELECTOR to ELEC position.
4. Slowly turn LEAKAGE TEST VOLTAGE control clockwise to dc working voltage of capacitor.
5. Observe NULL INDICATOR for signs of leakage. On small capacity electrolytics, the eye should open, although this may occur slowly if the capacitor has been out of use for sometime and needs to be reformed. On large (20-40 mfd and above) electrolytics, the eye will open only about half way. If eye remains closed, ca-

capacitor is leaky or shorted.

6. Turn LEAKAGE TEST VOLTAGE control back to 0.
7. Set SELECTOR to appropriate capacity range.
8. Turn MAIN DIAL control for maximum opening of NULL INDICATOR. Adjust POWER FACTOR control to give further increase in eye opening if possible. (Electrolytic capacitors are usually discarded if power factor is above 15%).
9. Read value of capacity from MAIN DIAL setting, using appropriate multiplying factor. On the "extended range", 18-1500 mfd, read the inside scale and multiply all readings by 10. On the 0.1-50 mfd range, read the outside scale and multiply all readings by .1 (or divide all readings by 10).
10. Return SELECTOR to "discharge" position before disconnecting capacitor from tester.

Of the four instruments we have described, the Model 311 is the easiest to construct and the average technician can built it in one evening. The hardest thing is the assembly of the switch and this is

* * * * *

Difficulties, like work, are blessings in disguise. Life would become monotonous, colorless, deadening without them. Difficulties should act as a tonic, spur us to greater exertion and strengthen our will power.

B. C. Forbes

* * * * *

not nearly as difficult as the two switches you put together in your VTVM.

CONAR ADVANCED EQUIPMENT IS NOW AVAILABLE

There will be other equipment that you will want to get eventually but they are not needed for radio service purposes. When you start working with TV receivers you will definitely want to get a scope and probe set and also a color bar generator. CONAR has two good instruments of this type which I can highly recommend, and you should plan to get them if you are going into TV service work either as a hobby or as a serious business enterprise.

CONAR ANNOUNCES A SALE of Discontinued Test Equipment

Intertech Multimeter, Model 101	→	\$ 3.65
Intertech Multimeter, Model 1330	→	\$ 12.00
Intertech Multimeter, Model 1220	→	\$ 12.00
Anchor Model 475 Picture Tube Tester Rejuvenator	→	\$ 33.10
Vari Volt, Model 810	→	\$ 27.30
B & K Model 850 Color Generator	→	\$122.35
B & K Model 1240 Color Generator	→	\$ 85.45
Midland Model 103 Walkie Talkie	→	\$ 10.40/pr.
Draftette Model 9-B Drafting Machine	→	\$ 10.50
Blonder-Tongue Model 99 UHF Converter	→	\$ 14.50
Hallicrafters Model 11 Walkie Talkie	→	\$ 47.30/pr.
Two-watt Amplifier	→	\$ 6.84
Midland Electronic Guitar Pickup	→	\$ 1.35

••equipment is brand new, in original factory cartons, and is being sold at or below cost to clear before inventory. Many of these items are one or two of a kind, and interested NRI Alumni are advised to write to determine availability before ordering. All sales will be for cash and will be final. Interested Alumni are invited to address inquiries to C.B. Weschke, CONAR Merchandising Manager. Inquiries should be dated as they will be handled on a first-come, first-serve basis.

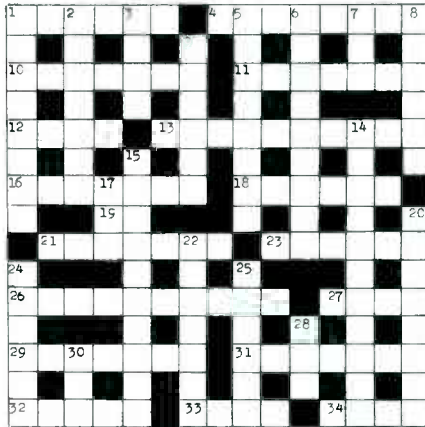

ELECTRONICS CROSSWORD PUZZLE

By Michael Kresila

ACROSS

1. A space from which practically all air or gas has been removed.
4. Coordinate value specifying distance in a horizontal direction from the vertical reference line in a graph.
10. An elephant - ear shaped radiation element on an FM-TV transmitting antenna.
11. The spindle or shaft on a tape recorder which turns the tape reel at a constant speed.
12. Smallest unit of any of the chemical elements.
13. The insulating material between two conductors.
16. To be in action; work.
18. Type of bench.
19. American League (abbr.).
21. A wound-rotor ac motor used for repeating angular motion as to speed and total angle.
23. Cavity formed in the positive carbon electrode of an electric arc.
26. A list of facts, figures or statistics.
27. A device for focusing radio waves.
29. Device used for checking radio or TV programs or audio signals.
31. Television and radar navigation system.
32. Marking code used to specify the electrical value of a part or to identify terminals and leads.

33. A unit of loudness.

34. The cgs unit of physical force.

DOWN

1. Electromagnetic device that converts a dc voltage to pulsating dc or ac.
2. Electron-emitting electrode or semiconductor device.
3. A reference quantity for measuring purposes.
5. Mechanical hysteresis where there is lag between a driving force and the driven object.
6. Radio part of two conducting surfaces separated by an insulating material.
7. Assembled radio equipment.
8. An alloy that holds magnetism, used in loudspeakers, motors and meters.
9. To heat to a great degree.
14. The X-Ray.
15. A machine that computes.
17. Sprinted.
20. Quality of sound reproducing system that creates the illusion of listening to the original.
22. Ground wires or the negative wire in a direct current circuit.
24. A type of weight.
25. To become easily pliable.
28. Altitude (abbr.).
30. Short for nothing.

(Solution on Page 30)

Little Things That Count. . .

Today, manufacturers roll out more than a million IC's every month. By 1970, all the electronic gear you buy will use IC's

Reprinted Courtesy POPULAR SCIENCE Magazine

(c) 1966 POPULAR SCIENCE PUBLISHING CO.

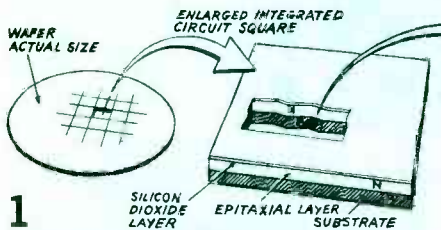

1

Raw material is a disk of P-type silicon a few thousandths of an inch thick. The first step is to grow—in a special furnace—a very thin epitaxial layer of N-type silicon atop the disk. "Epitaxial" means that the N-type layer has actually become part of the crystalline structure of the substrate.

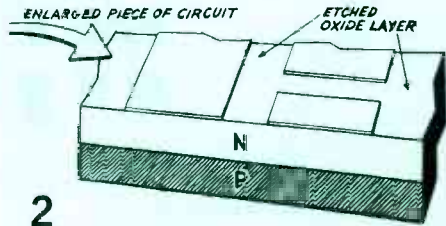

2

Disk's surface is oxidized to form a glasslike silicon dioxide coating. Through ultraprecise photographic and etching techniques, portions of the oxide are then removed to leave protective masks on the silicon surface. For greater clarity, only a small segment of the wafer is shown in the illustration.

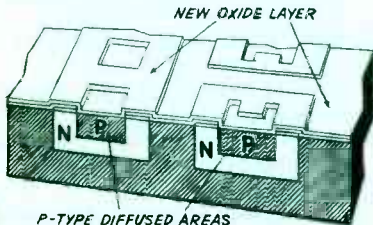

5

P-TYPE DIFFUSED AREAS

Wafer is returned to the diffusion furnace and surrounded with P-type impurities—this time, to form small P-type areas within the N-type islands. These will become transistor bases, diode anodes, and the strips of P-type material used as resistors. Then a third oxide layer is formed on the wafer's surface.

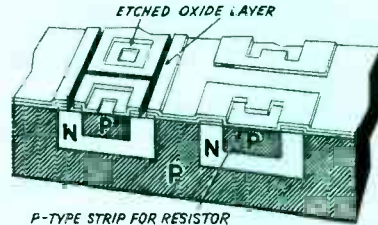

6

P-TYPE STRIP FOR RESISTOR

Windows are etched in the oxide to prepare the wafer for the final diffusion, which will create the N-type transistor emitters and diode cathodes. Diodes and transistors share the same basic structure. To make a diode, the "collector" area is left unused—the "base" and "emitter" form the diode's junction.

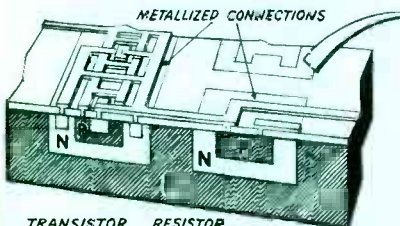

9

TRANSISTOR RESISTOR

Excess metal is etched away to leave a weblike network of interconnecting "wires" deposited across the chip's surface, and a ring of contact pads on the chip's periphery. The various transistors, resistors, and diodes in each chip have now been wired together to form a complete integrated circuit.

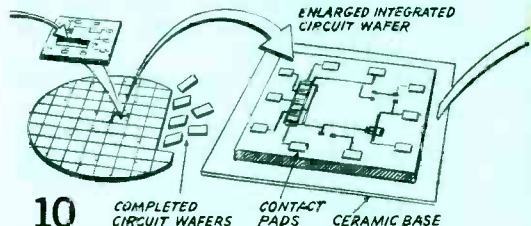

10

COMPLETED CIRCUIT WAFERS CONTACT PADS CERAMIC BASE

The original silicon wafer now contains hundreds of completed IC's and is worth several thousand dollars. It is cut into individual circuit chips with a diamond-tipped scribe, and each chip is bonded to an insulating ceramic wafer. Then each wafer is mounted in a multi-lead gold-plated "header."

Electronically speaking, it is the little things that count. For over a decade, the transistor has been hustling the bulky vacuum tube along the road to obsolescence. Now the transistor seems about to make the same journey—with the integrated circuit (IC) doing the showing.

An IC is a tiny wafer of carefully prepared silicon—an almost invisible chip

that could slip through the eye of a needle with room to spare. A single tiny chip is the electronic equal of a score or more of transistors and a handful of resistors, capacitors, and diodes, all wired into a conventional circuit. What's more, it costs much less than the components it replaces.

Some IC's amplify; some oscillate; some

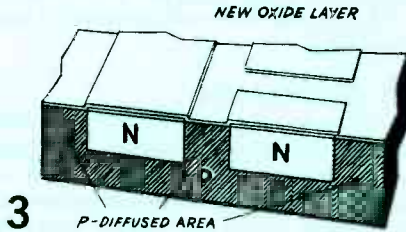

3

Wafer is "cooked" in a high-temperature diffusion furnace, surrounded by an atmosphere rich in P-type impurities. Silicon not covered by an oxide mask is converted into P-type material. The result is the formation of numerous N-type "islands" in a "sea" of P silicon. Next, new oxide layer is formed.

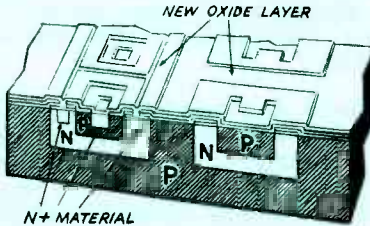

7

The third, and final, diffusion surrounds the heated wafer with an atmosphere rich in N-type impurities. This produces N+ regions (of highly conductive N-type material) in P-type material beneath the etched windows. All of the IC's electronic components have now been formed within the silicon chip.

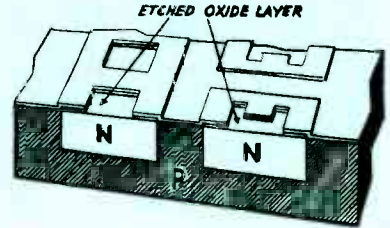

4

Portions of the new oxide layer are removed, through a second sequence of photographic and etching steps, to form windows above the N-type islands. About half the islands (exact number depending on circuit) become collectors for transistors; the rest, foundations for other components.

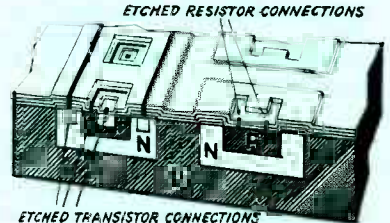

8

Final oxide layer—the fourth—is formed on the wafer's surface, and tiny windows are etched in it to expose the "terminals," or connection points, of transistors, diodes, and resistors. Then the wafer is put in a vacuum, and an ultrathin metal coating (usually aluminum) is deposited across its surface.

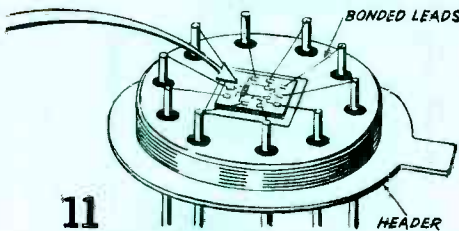

11

Header's terminal leads are connected to the chip's contact pads with ultrafine gold wire (an eight-, 10-, 12-, or 14-lead header may be used, depending on circuit's complexity). Finally, a metal cap is hermetically sealed to the header to protect the chip from air moisture and contaminants.

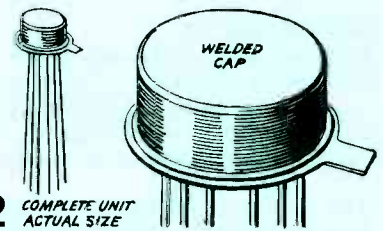

12

Completed package of the TO-5 is rugged and easy to handle. However, it is enormous when compared to the size of the circuit chip inside it: The mass of the can is 1,000 times that of the chip. The alternate flat-pack package (shown in photo) is more efficient: It's only 100 times the mass of a chip.

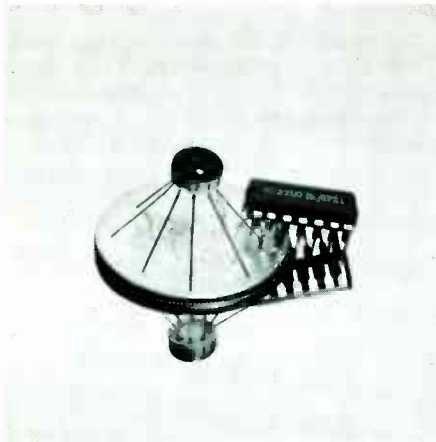

act as a logic circuit in electronic computers. In short, there's an IC for almost every circuit function.

The next TV set you buy may use an IC to amplify the audio i-f signals or to decode received color-picture information. Your next car may have an IC in place of the often unreliable electro-mechanical voltage regulator. And your wife's new washing machine may use an IC instead of a bank of finicky mechanical switches.

CB and ham radio rigs? IC's for these are under development right now. So are IC's for hi-fi, car radios, light dimmers, and power-tool speed controls. Today, IC manufacturers roll out over a million a month--mostly for military and space applications. By 1970, virtually every electronic product you will buy will contain one or more IC's.

INSIDE AN IC.

Different parts of the neat geometric pattern on an IC's surface correspond to resistors, capacitors, diodes, and transistors. But an IC isn't simply a conventional circuit shrunk to pinhead size.

The "components" within are a physical part of the silicon chip, inseparably connected to each other--integrated. They are formed simultaneously on and in the chip. There are no leads you can cut with wire snippers; you can't remove one of

the components without destroying the entire IC.

Because an IC is an indivisible structure, it is inherently far more reliable than any multicomponent circuit. There's an old saw that the reliability of a circuit is inversely proportional to the number of its components. But an IC, no matter how many "components" its circuit contains, acts like a single semiconductor component. Also, there are no interconnections to short-circuit, no solder joints to corrode.

THE TECHNOLOGY.

The IC is an outgrowth of a 10-year-old process developed for making high-frequency transistors. The basic idea is surprisingly simple: Form the electronic components out of alternating layers of N-type and P-type silicon, all within a tiny silicon chip. N- and P-type material have different electrical characteristics, and are made by introducing appropriate chemical impurities to the silicon crystal structure. (The 12 steps detailed here show Motorola's IC process; others are similar.)

Transistors are made from a three-layer sandwich to form the familiar NPN (occasionally, PNP) structure. Junction diodes have a two-layer PN structure. Capacitors are actually diodes in disguise: By cleverly adjusting the voltage applied to a diode it becomes an excellent capacitor. Resistors are isolated strips of N or P material with connections made at both ends--resistance value is a function of the strip's dimensions.



NRI HONORS PROGRAM AWARDS

For outstanding grades throughout their NRI course of study, the following September and October graduates received Certificates of Distinction along with their NRI Electronics Diplomas.

WITH HIGHEST HONORS

Reinaldo Bango, Chicago, Ill.
Dennis Dostie, Marlboro, Mass.
Lewis Duffie, Jr., Amarillo, Texas
Roy A. Franklin, Appomattox, Va.
Franklin Frerking, Marysville, Kans.
Odell Hamilton, Marietta, Ga.
Rolland J. Hastings, Quincy, Ill.
Jim D. Herring, La Luz, N. Mex.
Forttip Hinkle, Hagerstown, Md.
Carl J. Mattson, Appleton, Wis.
Bernard McCafferty, Massapequa Park, N.Y.
Richard Lee McKinney, Keene, Texas
Albert H. Spencer, Minneapolis, Minn.
Robert M. Taylor, ForthMeade, Md.

WITH HIGH HONORS

Hassan Giama Abdulla, Washington, D.C.
George D. Anderson, Burlington, Vt.
Dan D. Archer, Bozeman, Mont.
Herbert M. Bartlett, Erie, Pa.
Victor J. Bellino, Abington, Pa.
William S. Bergeron, New Orleans, La.
John D. Blue, Stone Horse, N.S., Canada
Wayne H. Boston, Castle AFB, Calif.
Joseph R. Bown, Oxon Hill, Md.
Robert E. Brick, Harwick, Pa.
Melvin S. Cafardi, Clinton, Md.
Harry B. Casey, Jr., Covington, Va.
Robert L. Chatfield, Baltimore, Md.
Raymond Christensen, Dell Rapids, S. Dak.
Roger D. Clampitt, Fort Dix, N.J.
James J. Cowan, Otis AFB, Mass.
Ronald L. Cox, Louisville, Ky.
Larry K. Crook, Topeka, Kans.
Ronald A. Curran, FPO San Francisco
William J. Danch, Enon Valley, Pa.
Danny D. Danforth, Lafayette, Ind.
James G. Davidson, Ellington AFB, Texas
Elmo Davis, Blanchard, La.

Vincent DeCristo, Corona, N.Y.
Richard Dimick, Jr., Salt Lake City, Utah
Donald M. Feeney, Detroit, Mich.
Allen J. Fehl, Brookville, Ind.
Jimmie Fields, Newton, Ala.
Robert E. Fiorella, New York, N.Y.
Lawrence F. Fralix, Reevesville, S.C.
W.Y. Garth, Radford, Va.
Louis P. Gillespie, Biloxi, Miss.
Michael L. Gilliland, Kent, Ohio
James C. Gordon, Edwards AFB, Calif.
Louis W. Grass, Littleton, Colo.
Anthony Grasso, Binghamton, N.Y.
Orville C. Hicks, Grandview, Mo.
Albert R. Hilsman, Atlanta, Ga.
William H. Jennings, Crescent Lake, Oreg.
Robert F. Keel, APO New York, N.Y.
John W. Kindley, Fort Stewart, Ga.
Darrel M. Kleeman, Manhattan, Kans.
Milo S. Lauffer, Iowa City, Iowa
John D. Leasia, Royal Oak, Mich.
G.L. Lees, Trenton, Ont., Canada
Art P. Maier, Temple City, Calif.
F.A.J. Martineau, Fairview, Mass.
Elmer J. McKean, Belleville, Ill.
Joseph P. Nagy, Long Island City, N.Y.
Frank Narramore, Yellville, Ark.
John M. Partlow, Jr., Dallas, Texas
Charles P. Pelletier, Methuen, Mass.
Wilbur G. Powell, Franklin, Ohio
Carl B. Rae, Jr., Emporia, Va.
Billy R. Ramsey, Tularosa, N. Mex.
Robert J. Richter, Santa Ana, Calif.
Robert M. Sanders, Speedway, Ind.
Frank G. Schick, Romulus, Mich.
Ronald J. Seifert, Richfield, Minn.
Melvin E. Snyder, Allendale, Mich.
Gary W. Spears, Phoenix, Ariz.
Rodney J. Stage, Jr., Black River Falls, Wis.
Theodore Wayne Thimons, Cheswick, Pa.
O.V. Thomas, Garland, Texas
Tex R. Thompson, Covington, Ga.
Carroll D. Villines, Chicago, Ill.
J.Jay Walton, Broderick, Calif.

Leonard C. Watson, Morehead, Ky.
Everett L. White, Leslie, Mich.
Douglas E. Whitney, Claremont, N.H.
Barry J. Wilson, Greenland, N.H.
Donald R. Winslow, Keene, N.H.
Arlan Yerger, Hamburg, Pa.

WITH HONORS

William F. Adamson, Elgin, Ill.
Harry Armstrong, Jr., Delta Junction, Alaska
Waldon Asher, Asher, Ky.
B. Jay Badgis, Holden, Mass.
Roy D. Baker, Mare Island, Vallejo, Calif.
David L. Blackwell, Patrick AFB, Fla.
Merritt E. Blanchard, Manchester, Conn.
Larry Boyd, Secaucus, N.J.
John D. Boyden, Terre Haute, Ind.
Darrell R. Brady, Decatur, Ill.
Harlis C. Breeding, Lanham, Md.
Fredrick E. Bruneman, Elgin, Ill.
Robert F. Burke, Jr., Ocean City, N.J.
I.W. Cobb, Charlotte, N.C.
Kenneth C. Cox, Wellsburg, W. Va.
Ormand H. Cummings, Sinclair, Wyo.
William K. Curry, Paris, Ky.
Joseph Walter Daigle, Plaquemine, La.
Philip D. Deem, Alexandria, Va.
Ronald H. Doller, Tomah, Wis.
Herman E. Douglas, Murfreesboro, Tenn.
Ivan F. Fender, Rantoul, Ill.
John Edgar Fine, Independence, Va.
John E. Fry, Topeka, Kans.
Joseph V. Gallagher, Clifton, N.J.
Duane M. Garlock, Council Bluffs, Iowa
Richard Louis Genter, Roanoke, Va.
Ray Gerich, Fort Ritchie, Md.
Martin D. Gouveia, Nashua, N.H.
Robert V. Grenman, Columbus, Nebr.
David R. Gundling, West Chester, Pa.
John D. Hamilton, Woodbridge, Va.
Robert A. Heitman, St. Louis, Mo.
Charles O. Hill, Doniphan, Mo.
George A. Holland, Fork, Md.
Allen L. Hyden, Lexington, Ky.
Robert G. Ikenberry, South Boston, Va.
Donald G. Jakusz, APO San Francisco
Jack E. Johnson, Ansted, W. Va.
Marvin G. Kearns, Hereford, Texas
William C. Keesler, Waldon, N.Y.
George M. Kilmer, Sheridan, Wyo.

Lam Van Kinh, Saigon, South Vietnam
George A. Lane, Geneva, Ohio
Bobby Joe Lankford, Baltimore, Md.
John A. Leininger, Cincinnati, Ohio
Jeff Lersch, New Berlin, Wis.
Richard Lieber, Carmel, Ind.
Ronald E. Long, Reistertown, Md.
Gumersindo Lopez, El Paso, Texas
David C. Lowe, Punta Gorda, Fla.
Charles K. Lynk, Marshalltown, Iowa
Hilbert Maddox, Philadelphia, Pa.
Louis Marici, Chicago, Ill.
F. Boyd Martin, Kingston, Ga.
Herbert J. Martinelli, Alamogordo, N. Mex.
Steve G. Maxwell, Crossett, Ark.
James M. McFarland, Jr., Madison, Wis.
Fred J. Nigg, Urbana, Ill.
Willie A. Patterson, Compton, Calif.
Banford Perdue, Lexington, Ky.
Edmund J. Peters, Arlington, Va.
Karol Wayne Rodberg, Lake Worth, Fla.
Joseph L. Rybak, Osakis, Minn.
C.R. Schleining, Portsmouth, R.I.
Thomas W. Schoen, Hoffman Estates, Ill.
Francis E. Schran, New Albany, Pa.
Fred Selensky, New Orleans, La.
Ronald W. Sheeley, Rapids City, Ill.
Oliver E. Short, Chamung, N.Y.
Hunley A. Slaughter, Jr., Memphis, Tenn.
Freeman R. Smith, Jr., Madison, Conn.
Ray O. Smith, Grandville, Mich.
LeRoy W. Snyder, Jr., Hanover, Pa.
Paul W. Stanford, El Paso, Texas
George S. Stevens, Mays Landing, N.J.
Dennis L. Stevenson, Burley, Idaho
Warren Stevenson, Cincinnati, Ohio
R. Suharto, Washington, D.C.
George T. Swan, Sacramento, Calif.
Frederick P. Swanson, Williston, Vt.
Jim Sweeney, Lansing, Mich.
Philip J. Tollefson, Mishicot, Wis.
Robert Upham, Halifax, N.S., Canada
Robert Van Valkenburg, Miami, Fla.
Robert Viotti, Babylon, N.Y.
LeFleur Walker, Spokane, Wash.
Jack A. Ward, Monticello, Ind.
Robert G. Webber, Charleston AFB, S.C.
Edward J. Williams, Peckville, Pa.
Walter N. Williams, Washington, D.C.
Curtis R. Witte, Medina, Ohio
Stephen Wright, Beacon, N.Y.



BY
STEVE
BAILEY

DEAR STEVE,

I am currently studying Lesson 13 on transistors. Could you explain further about how bias stabilization is accomplished?

Fig. 1 shows a common-emitter circuit with R_3 , a bias-stabilizing resistor, in series with the emitter. First, however, consider what would happen without R_3 in the circuit. If the temperature of the transistor should increase, the resistance of the base-collector junction would decrease.

FIG. 1.

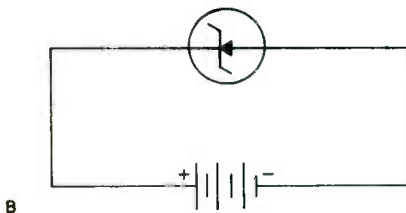
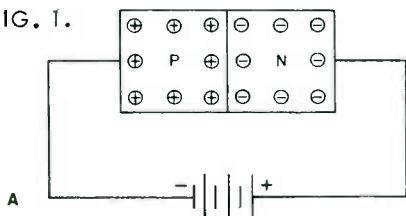

This places the base of a potential near the potential of the collector, which will increase the forward bias still further. A further increase in forward bias results in additional heating of the base-collector junction. This permits more collector current to flow, and the transistor will continue to heat until it is destroyed.

Now, with R_3 in the circuit, an increase in temperature will still result in an increase in forward bias and a greater current flow through the emitter. However, since the collector current also flows through the emitter, this greater current will result in a large voltage drop across R_3 , the bias-stabilizing resistor. The increased voltage drop will subtract from the forward bias so that the effect of the change in temperature on the forward bias is minimized. Thus, the bias-stabilizing resistor helps to keep the forward bias reasonably constant.

DEAR STEVE,

In Lesson 2, I learned that the difference between a primary cell and a secondary cell is that a secondary cell can be recharged, but a primary cell cannot. However, I have seen devices on the market that are supposed to recharge primary cells such as flashlight batteries. Do these devices actually work?

W. R., Colo.

Yes, it is possible to extend the life of a flashlight cell using one of the currently available battery "rechargers". However, these devices could be better described by calling them rejuvenators, rather than rechargers.

A primary cell such as a flashlight battery is able to produce voltage because of a chemical reaction between electrolyte and the zinc in the battery. All the time this chemical action is taking place, the zinc is slowly being eaten away. Also, there are hydrogen bubbles being developed which eventually are attracted to the carbon rod of the battery. After a long period of time, the hydrogen bubbles may collect around the rod, thus building up internal resistance. When this occurs, the battery is so weak as to become useless.

When a weak or "dead" battery is placed in a "recharger", a small current is passed through it in a reverse direction, which removes the hydrogen bubbles from around the carbon rod. Thus, the chemical action is free to take place again and the battery will work. Of course, once the zinc has been eaten away, no amount of "recharging" will make the battery useful again.

Also, even though sales literature generally won't mention it, most rechargers are designed for optimum operation of only specific battery types. In addition, "recharging" a battery too often or before a specific state of weakening is reached may actually shorten the life of a battery rather than prolong it.

DEAR STEVE,

What is a tunnel diode?

W. J., Md.

A tunnel diode is a semiconductor diode consisting basically of a PN junction, but with an extremely thin junction or depletion region. This thin junction allows current carriers to "tunnel" through at a speed approaching the speed

FIG. 2.

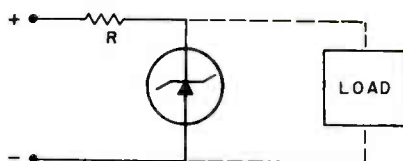

of light. Also, because of this thin junction region, the tunnel diode is characterized by a large current flow when a positive bias is applied. Fig. 2A shows the schematic symbol for this device; Fig. 2B shows its characteristic curve.

Notice in Fig. 2B that the current reaches a peak fairly quickly as the bias is increased. A point will be reached, however, where the conduction conditions will be neutralized by equal energy levels on either side of the junction. The diode current will begin to decrease with increases in bias until a valley point is reached.

This is precisely the opposite of what happens in a regular diode. The name given to this characteristic in this region of the characteristic curve is "negative resistance." Further increases in bias will result in a current increase, and the characteristic curve will resume a more conventional shape. The negative resistance characteristic makes the tunnel diode extremely useful as an amplifier, an oscillator, and in rapid switching applications. In addition, it shows a peculiar resistance to effects of nuclear radiation, which makes it invaluable in nuclear and space applications.

DEAR STEVE,

Please explain what a zener diode is and what it is used for.

R. L., Wis.

As you already know, the primary function of a standard diode is rectification. A zener diode does this, and it also pro-

FIG. 3.

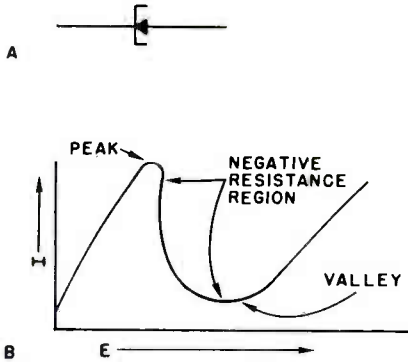

vides voltage regulation. It derives its name from Dr. Carl Zener, who discovered what is now known as zener action or zener effect.

Zener action is what occurs when the voltage applied to the diode reaches a certain level known as the breakdown voltage. Fig. 3A is a simplified illustration of a zener diode. As you can see, it is simply a reverse-biased diode. This is shown schematically in Fig. 3A. With the battery connected to the diode in this manner, only a minute reverse current will flow through it. It is a high resistance circuit for all practical purposes.

Now, if the source voltage is increased, a point will eventually be reached where minority carriers (electrons) in the P-type region will be forced toward the diode junction and across it. These electrons will move the electrons in the N-type region (where electrons are the majority carriers) and a substantial current will flow. The point at which this occurs is the breakdown voltage (or zener voltage) previously mentioned.

Fig. 4 is a typical zener shunt regulator circuit, which illustrates another main characteristic of this device. As the source voltage is increased, there will be an increase in current flowing through the diode and the resistor.

However, there will be an increased volt-

age drop only across the resistor, not across the diode. The resistor will drop all of the applied voltage that is greater than the zener's breakdown voltage. By connecting the load across the diode, we will always have a constant voltage applied to it, regardless of variations in the source voltage.

This characteristic, in addition to the characteristic of a sudden change from low current conduction to high current conduction, makes the zener diode ideal for voltage regulation and switching applications. Zeners are rated according to voltage breakdown and power capabilities and the correct zener must be chosen for the job to be done.

DEAR STEVE,

What is the word "transistor" derived from?

S. B., Va.

In a transistor, the base will act like a variable resistor or varistor. As changes occur in the input signal, the resistance of the base effectively varies, thereby changing the effective resistance between the collector and emitter. Thus, small changes in the input signal current are transferred to larger changes in the output because of the varying resistance of the base.

Since the operation of this device depends on a current "transfer" and the base acts like a "varistor," it is called a "transistor," a combination of the terms that form the base of its operation.

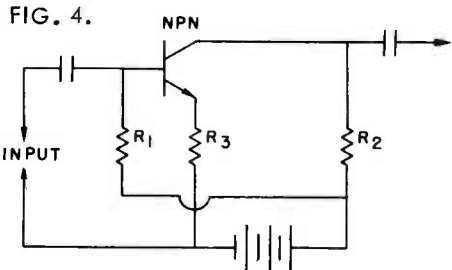

FIG. 4.

--- HELP WANTED ---	--- HELP WANTED ---	--- HELP WANTED ---
<p align="center">Do You Have an FCC License?</p> <p>Immediate openings in TV, Audio, 2-way radio, etc. at Communications Engineering Co., a division of Sylvan Electronics. Located at 306 Kennedy St. N.W., Washington, D.C. Call Mr. Brown, 451-5700.</p>		<p>Looking for a New Job?</p> <p>Polito Communications, Inc. 101 Walnut St., Rochester, New York needs 4 or 5 technicians to service two-way radio equipment. Minimum requirement: Second class radiotelephone license. Call or write Joseph Carl Polito.</p>
<p>Looking for a Chance For Advancement?</p> <p>Weinschel Engineering Company Inc., Gaithersburg, Md. 20760, has immediate openings in Test, Engineering & Repair Departments.</p> <p align="center">PERMANENT POSITIONS EXCELLENT ADVANCEMENT EVENING & WEEKEND INTERVIEWS</p> <p>Contact Mrs. Karen Syence, (301) 948-3434, or write to Weinschel Engineering, Inc.</p>	<p align="center">Electronics Technicians --- Positions Available ---</p> <p>WESTERN UNION Telegraph Co., Write or phone B.L. Krise, Manager of Technical Services, 1405 G Street, N.W. Washington, D.C.</p> <p>sun electric corporation 5708B frederick avenue rockville, maryland</p> <p align="center">openings for electronic technicians</p>	<p>STATION WKRZ, Oil City, Pa. Needs several first-class engineers.</p> <p>STATION WFMD, Frederick, Md. Needs technicians with first-class licenses.</p> <p>Technicians Production Engineers Development Engineers ***SIMPSON ELECTRIC CO. 5200 Kinzie St., Chicago, Ill. 60644</p>
<p>Radio-TV Grads and Advanced Students</p> <p align="center">positions available throughout U.S. good wages above aver. benefits</p>	<p align="center"><u>OPENINGS</u></p> <p>Exchange Office, General Telephone of Indiana, Inc. 501 Tecumseh Street, P.O. Box 1201, Fort Wayne, Ind.</p>	<p align="center">REPAIRMEN NEEDED</p> <p>In Richmond and Roanoke offices of <u>Audio Fidelity Corporation</u>, 6521 West Broad, Richmond, Virginia.</p> <p align="center">RADIO TECHNICIANS</p> <p><u>United Airlines</u>, Washington, D.C., expects a continual need for radio technicians throughout its system in 1967. Graduates are invited to come in for an interview.</p>
<p>CONTACT: Mr. Bob Barkley Regional Training Instructor MONTGOMERY WARD 2600 W. 7th Street Fort Worth, Texas 76101</p>	<p align="center">RCA SERVICE COMPANY, Camden, New Jersey . . .</p> <p>TV SERVICEMEN NEEDED IN MOST RCA FACTORY SERVICE BRANCHES. TECHNICAL SCHOOL TRAINING ESSENTIAL. WE PREFER BLACK/WHITE AND COLOR SERVICE EXPERIENCE. APPLY AT NEAREST RCA BRANCH OR WRITE TO</p> <p align="right">W. R. Speck RCA Service Co. Cherry Hill, New Jersey</p>	

The University of Michigan/Ann Arbor

**NEEDS
QUALIFIED TV STUDIO ENGINEERS**

Ideal applicant should be experienced in installation, operation, and maintenance of educational TV equipment and have his license. Excellent opportunities for advancement with expansion of TV center.

WRITE:

Peter G. Radzivckas, Interviewer
Professional and Managerial Placement
Room 1020, Administration Bldg.
The University of Michigan
Ann Arbor, Michigan 48104

TV SERVICEMEN

NRI Graduate needs TV Servicemen.
Some experience preferred. However,
will train in color television servicing.

**BURTONSVILLE
RADIO AND TV SERVICE**

COLOR TV SPECIALISTS
RCA - ZENITH - PHILCO

15508 OLD COLUMBIA PIKE
FRANK H. LEWIS, PROP. BURTONSVILLE, MD.

**SEARS ROEBUCK HAS OPENINGS
FOR RADIO-TV SERVICEMEN**

Graduates or advanced students
good pay, exceptional benefits,
Washington-Baltimore Area

Contact:

Mr. Frank E. Fisher
Sears Roebuck Service Center
4700 West 41st Street
Baltimore, Maryland 21211
Phone: 301 523-2500 Ext. 401

**Radio Station WETT
Ocean City, Md.**

**For holder of
First-Class License**

Challenging position with growth potential.
Some announcing in addition to maintenance.

Contact:

Mr. or Mrs. Grazier
Station WETT, Box M
Ocean City, Md. 21842

APPLIANCE TECHNICIANS

apply:

Albert's Appliance Repair
113 North Eighth Street
Garland, Texas

**E N G I N E E R S ,
D R A F T S M E N ,
T E C H N I C I A N S ,**

If you are interested in
a job in the N.Y. state
area, Stanley J. Klein
Assn. Inc. will help you
relocate. The assignments
are immediate and chal-
lenging, the fee is paid
and the attention given
to each applicant is per-
sonal and confidential.
For further information
write:

1694 Highland Ave.
Rochester, N. Y. 14618
or phone 716 244-3580

**Where to write
if you want a job as a
Marine Radio Officer**

AMERICAN RADIO ASSN., 270 Madison Ave., New York,
N.Y. 10016

RADIO OFFICERS UNION, 225 W. 34th St., New York,
N.Y. 10018

MILITARY SEA TRANSPORTATION SERVICE, Commandant,
Atlantic Area, 58th St. & 1st Ave., Brooklyn, N.Y. 11220
or Commandant, Pacific Area, Naval Supply Center, Oak-
land, Calif. 94625

HUMBLE OIL & REFINING CO., Marine Dept., Box 1512,
Houston, Texas 77701

TEXACO OIL CO., Marine Dept., Box 1028, Port Arthur,
Texas 77640

LLOYD'S REGISTRY OF SHIPPING, 17 Battery Pl., New
York, N.Y. 10004

RCA COMMUNICATIONS, INC., Radiomarine Dept.,
69 Broad St., New York, N.Y. 10004

ITT WORLD COMMUNICATIONS, Employment Sect.,
67 Broad St., New York, N.Y. 10004

TROPICAL RADIO TELEGRAPH CO., Box 130, Higham,
Mass. 02043 or Box Drawer E, Pearl River, La. 70452

what's

?

new



William J. Hannan of RCA Laboratories has incorporated laser beams into a seeing eye cane. Two invisible beams strike the surface three and six feet in front of the cane. If there are no obstacles, the beams are reflected back to the cane where blunt pins in the handle of the cane vibrate to tell the user that there are no obstacles. If the beams illuminate an obstacle, they are not reflected back and the handle stops vibrating, thus warning the user of a depressed or raised surface in front of him.

COLOR READOUT NEXT TO MONITOR PATIENTS

Meters, numbers and words in patient monitoring are about to be replaced by color readout. The newest concept of patient monitoring at Conductron-Missouri is to show a patient's condition as a display of color. The unit would consist of a screen covering a pattern of lights or an oscilloscope.

One patient's information would be a composite pattern with positioning on the screen corresponding to the body location being monitored and the color indicating the general nature of the abnormality. If a patient needed oxygen it would be shown as a flashing red light on the top of the screen. If he were also experiencing a circulation problem in his left leg, a pulsating blue color would appear on the lower left of the screen. Thus at one glance the physician could give a precise diagnosis. The unit is thought to be two years from actual use.

The Washington Redskins have a computer on their team. Hoping to improve their season, Redskin management commissioned C-E-I-R, Inc., Washington, D. C. to produce weekly reports on forthcoming foes. The reports are based on probability and correlate field situations and show how the opposition handled them.

ELECTRONICS TO VISIT SCENE OF THE CRIME?

A flick of the wrist activates a tiny switch on the band of his hat, a miniature transmitter picks up his "on the scene" reports, and the policeman's words are radioed to the police communications center. A computer analyzes the information, types out orders, and punches a tape directing the rest of the force to predetermined anti-crime positions. True? Not yet, but the International Association of Police Chiefs has decided it needs such an advanced system to combat crime. With more money, the system may become a real one.

RCA DEVELOPS MACHINE TO DUPLICATE CHINESE LETTERS

RCA has performed a task verging on the greatness of the Gutenberg press, or at least for the Chinese. Printing with Chinese letters has remained a laborious hand-labor process because of the thousands of characters involved. Now RCA has developed a typewriter-like machine that breaks down the thousands of characters into a series of 21 "brush strokes". The basis of the machine is a computer memory cell that uses a television tube.



Alumni News

Edited by **TED ROSE**

John Pirrung President
Franklin Lucas Vice-Pres.
James J. Kelley Vice-Pres.
Arthur Howard Vice-Pres.
E. J. Meyer Vice-Pres.
T. E. Rose Exec. Sec.

Pirrung Sweeps '68 Alumni Voting

Heavy voting in Pennsylvania played a major role in John Pirrung's decisive victory in the 1968 NRI Alumni Associations elections. But Peter Salvotti of the San Francisco Chapter, his opponent, did very creditably, too.

We have four brand-new Vice Presidents: Frank Lucas, currently Secretary of the North Jersey Chapter and a former chairman of the New York City Chapter; James J. Kelley, Chairman of the Detroit Chapter for the past eight years; Arthur Howard, Gadsden, Ala., and E. J. Meyer, St. Louis, Mo., who have no local chapter affiliations.

John Arthur Pirrung was born June 15, 1908, in Philadelphia. He became an enthusiastic student early in life. After finishing high school he became interested in electricity, attended Drexel Technical College, Philadelphia, Pa., for two years, majoring in electrical engineering.

Unfortunately, no jobs in this field were available at that time so he went into the printing field. Five years later he took a job in electricity with Publiker Distilleries, a position he still holds after 31 years of service. His job as Chief of Maintenance keeps him and his gang busy in this vast plant.

It wasn't until 1956 that John turned to



Meet John Pirrung, 1968 NRIAA president.

Electronics. He enrolled with NRI in that year and finished the course in less than two years. He built a workshop in his basement, undertook part-time servicing, and still does pretty well at it. He joined the Philadelphia-Camden Chapter in 1958, was elected Chairman in 1959, where he was re-elected every year but one, 1961, when he successfully urged

Herbert Emrich to run as Chairman so he could take a rest.

John has been Chairman more than any other member in the chapter's history and has helped materially in making the

Philadelphia-Camden Chapter the largest and among the most dynamic of all the local chapters.

Our heartiest congratulations to the new President and Vice-Presidents.

ELECTIONS, NEW MEMBERS, COLOR TV TALKS HIGHLIGHT MEETINGS OF ALUMNI CHAPTERS

DETROIT CHAPTER depends largely on its own more experienced and seasoned members for talks and demonstrations at its meetings. One of these is John Nagy. At the last meeting that we have a report on, he brought in a metronome that he constructed himself. He showed the members how to use it in servicing a P. A. system. He uses the metronome's rhythmic sound in preference to a steady tone because the latter gets on a customer's nerves.

Another experienced member that the Chapter depends upon for programs is Chairman Jim Kelley. He brought in and displayed an audio analyzer that he constructed from a kit, showed the members the parts employed and how they were assembled.

Plans have been made to take up a transistor project so the members can learn more about solid-state servicing.

FLINT MEMBERS HAVE GALA EVENING. SEE SHOW

FLINT (SAGINAW VALLEY) CHAPTER members were invited to the fall showing of the Voice of Music's merchandise and new line of products. It was held in the Family Room at Howard Johnson on South Dert Highway.

Taylor Electronics and the Voice of Music Company sponsored the show. Afterward the guests were treated to a steak dinner and an entertaining floor show.

The Chapter has purchased a Color TV Test tube to be used this winter in connection with lectures on Color TV.

LARGE CROWD AT HAGERSTOWN HEARS TOM NOLAN OF NRI

HAGERSTOWN (CUMBERLAND VALLEY) CHAPTER enjoyed such a large attendance when Tom Nolan of the NRI Staff accompanied Ted Rose on his annual visit that the meeting had to be moved to the local high school.

Tom Nolan conducted an excellent, even dramatic, program on the theory and practical servicing of Color TV. He also told the audience all about NRI's new Advanced Color TV Course and how it will prepare the Service Technician for servicing Color TV Receivers.

The Chapter members and the Alumni Association owe George Fulks a vote of thanks for making the arrangements to hold this large meeting.

JACK GREENBERG JOINS LOS ANGELES CHAPTER

LOS ANGELES CHAPTER admitted Jack Greenberg of Los Angeles as its newest member. Our congratulations to you, Jack!

Chairman Gene DeCaussin gave a talk on tuners, the different types that are used and the problems involved in repairing them. In most cases, Gene said, it is better to send the tuner to a shop that

specializes in tuner repair than to try to fix it yourself.

The members discussed color TV kits and training courses at considerable length.

At its next meeting, the Chapter continued the important task of keeping abreast with developments in solid state electronics by having a group study of an article that appeared in a recent issue of PF Reporter. The discussion was led by Chairman DeCaussin and proved to be extremely beneficial to all members.

This was followed by a session in which four televisions with "tough dog" problems were repaired. The sets were brought in by Chapter members and the talents of all the members were utilized in locating the sources of trouble. This will certainly simplify problems should the same tough dog problems be encountered in the future.

IGNACY BARTON NEW MEMBER OF NEW YORK CHAPTER

NEW YORK CITY CHAPTER welcomed Ignacy Barton as a new member.

Chairman Sam Antman discussed the problems of servicing transistor radios, using the Chapter's demonstration board. This created considerable interest and discussion, with all members participating.

Ontie Crowe brought in an RF signal generator and demonstrated alignment techniques, and Al Bimstein talked about troubles in the horizontal output stage, taking up each component in turn and discussing the results of its possible malfunction. In connection with transistor biasing, curves were shown of leakage currents and break-over voltages on the oscilloscope, and the use of a low-voltage transformer as a checker of the diode characteristics of transistors.

CONAR EASY PAYMENT PLAN

IM

Note: Easy payment contracts cannot be accepted from persons under 21 years of age. If you are under 21, have this sheet filled in by a person of legal age and regularly employed.

Enclosed is a down payment of \$_____ on the equipment I have listed on the reverse side. Beginning 30 days from the date of shipment I will pay you \$_____ each month until the total payment price is paid. You will retain title of this equipment until this amount is fully paid. If I do not make the payments as agreed, you may declare the entire unpaid balance immediately due and payable, or at your option, repossess the equipment. Your acceptance of this will be effected by your shipment to me of the equipment I have listed.

Date _____ Your written signature _____

CREDIT APPLICATION

Print Full Name _____ Age _____

Home Address _____

City & State _____ How long at this address? _____

Previous Address _____

City & State _____ How long at this address? _____

Present Employer _____ Position _____ Monthly Income _____

Business Address _____ How Long Employed? _____

If in business for self, what business? _____ How Long? _____

Bank Account with _____ Savings Checking

CREDIT REFERENCE (Give 2 Merchants, Firms or Finance Companies with whom you have or have had accounts.)

Credit Acct. with _____ (Name) _____ (Address) _____ Highest Credit _____

Credit Acct. with _____ (Name) _____ (Address) _____ Highest Credit _____

GEORGE KITCHENS JOINS NORTH JERSEY CHAPTER

NORTH JERSEY CHAPTER was host to two representatives of the Bell Telephone Company who conducted a fine program consisting of a lecture employing slides. Their subject was improvements made in the laser beam.

Members expressed a warm welcome to George Stoll, who has become active again after being on the sick list for several months following a heart attack.

The Chapter held its first meeting with its new transistor board, which was bought with donations from the members. It was assembled by Harry Weitz. Fortunately, Graduate Charles Latyak was present at this meeting as a guest; he stepped right in and took over demonstrating the transistor board with the use of a CONAR Signal Tracer and VTVM. Defects were introduced by one member at a time and were traced with ideas from the groups. A plan was adopted for the

board to be taken home each month by one or more members who volunteered to plan a lecture.

The latest member to join the ranks of the Chapter is George Kitchen. Welcome to you, George!

In Memoriam

Mr. Augustus Matamoros, Bronx, N. Y.

Mr. Paul Ozvath, Santa Monica, Calif.

Mr. Stuart Leavens, Palmetto, Fla.

Mr. M. W. Parker, San Antonio, Tex.

Mr. Anthony J. Seeman, Philadelphia, Pa.

Mr. Herbert M. Gladfelter, Elida, Ohio

Mr. E. J. Petraska, Omaha, Neb.

Mr. Earl C. Smith, Monroeville, Ind.

Mr. Harry C. Stecker, Flushing, Mich.

Mr. Frank L. Tuma, Cwosso, Mich.

CONAR ORDER BLANK

DIVISION OF NATIONAL RADIO INSTITUTE, 3939 WISCONSIN AVE., WASHINGTON 16, D.C.

PLEASE PRINT

NRI STUDENT NUMBER

NAME

CASH

ADDRESS

C.O.D. (20% Deposit required)

CITY

ZONE

STATE

EASY PAYMENT PLAN (10% Deposit)

Quantity	Name of Item	Price Each	Total
If you live in Washington, D.C., add 3% sales tax. All prices are net, F.O.B. Washington, D.C.			TOTAL

ON TIME PAYMENT ORDERS

please be sure to complete the Easy Payment Plan credit information form on the reverse side of this page and include 10% down payment with your order.



Norman Roton, Vice-Chairman of the Philadelphia-Camden Chapter, demonstrated the setup at chapter's first color TV class.

PHILLY-CAMDEN WELCOMES THREE NEW MEMBERS

PHILADELPHIA-CAMDEN CHAPTER has welcomed three new members to its ranks: James W. Booth, Jr., Jessie R. Kirk, and Gerald Pirrung, son of Chairman John Pirrung. We add our own welcome, gentlemen!

The chapter has started with its long-planned color TV class. Vice-President Norman Roton began the class with a Westinghouse Color TV he brought with him. Using a color-bar generator, he went through the whole procedure of setting up the receiver. With a member's assistance, he went into details of how to set up the receiver and how easy it was to do. Norman also gave useful hints on troubleshooting color. He is keeping track of all the hints and after the members have a few pages of them, Secretary Jules Cohen will mimeograph and distribute them to the members.

If this new program works out the way that the Chapter hopes it will, servicing on the service night may be put aside so that the color TV class can be continued. This appears to be likely because of the enthusiastic response of the members to the first color TV class.

The officers to serve for 1968 are: John Pirrung, Chairman; Norman Roton, Vice-Chairman; Joe Burke, Financial Secretary; Jules Cohen, Recording Secretary; W. Wiacek, Librarian; and Herbert Emrich, Sergeant-at-Arms. Our congratulations, gentlemen!

SAN ANTONIO ALAMO CHAPTER members were saddened by the death of one of its most faithful members, Treasurer M. W. Parker. He was succeeded as Treasurer by Sam Dentler.

This entire meeting was devoted to making plans for future meetings and programs.

JOHN PARKER, ANDY ROYAL TEAM UP FOR DEMONSTRATION

SAN FRANCISCO CHAPTER enjoyed a stimulating session in which John Parker and Andy Royal teamed together to demonstrate how an oscilloscope can be used to troubleshoot the vertical circuit of a television receiver. John showed how to obtain waveforms at different points in the vertical circuit, while Andy explained what the waveforms indicate regarding operating conditions.

At the following meeting, John Parker contributed his talents by demonstrating the repair of a small transistor radio. The trouble was found to be due to breaks in the antenna and speaker leads. Following the necessary repairs, the radio operated perfectly.

The Chapter will continue to have the use of test instruments shown by and featuring Harold Jenkins as the speaker at the next meeting. Harold will show how the B and K Television Analyst is used to pinpoint various troubles in a television receiver.

SOUTHEASTERN MASS. LOOKS TO THE FUTURE

SOUTHEASTERN MASSACHUSETTS CHAPTER, like a few other Chapters, used its first meeting of the current



Note the intense interest of Southeastern Mass. Chapter members as J.B. Straughn demonstrates the new CONAR Model 600 Color TV. It's also available in kit form.

season to discuss Electronics and what the future holds for those who are trained in this field. The strongest conclusion that the members came up with was that unless one keeps up with the latest developments by constant study and review -- like any other technical field in the U. S. today -- one could easily "miss the boat" and be left behind.

It is a good idea to stop and take stock like this every now and then. Perhaps some of the other chapters might profit by the Southeastern Massachusetts Chapter's example by spending at least part of a meeting on this subject.

SPRINGFIELD MEMBERS TO ALTERNATE PROGRAMS

SPRINGFIELD (MASS.) CHAPTER used its first meeting of the current season to thoroughly discuss all the potential programs for the new season. Norman Charest came up with an excellent idea which the members voted unanimously to adopt -- that is, have each member write his choice of topic for the next meeting and the topic most desired would then be concentrated on at the following

meeting. The Chapter is now following this plan.

John Parks related two interesting experiences: one a color TV which developed scrambled color whenever a vacuum cleaner was switched off in front of it; the other, that his dog could be used as a substitute Space Command control for changing TV Channels. When John lost the control one day, his son suggested having the dog scratch his collar in front of the TV receiver because he noticed that every time the dog did this the station would change.

John then went on to give a really wonderful talk on the power supply section of transistor equipment. He proved how easy it is to build a power supply to substitute for batteries from parts lying around practically everyone's house. He used a schematic and a pictorial diagram for his demonstration, and answered many questions about it.

The officers of the Chapter for this year are: Br. Bernard Frey, Chairman; Alfred Petersen, Vice-Chairman; Robert Jensen, Secretary; and William Planzo, Treasurer. Our best wishes to the winning candidates!

Solution to Crossword Puzzle

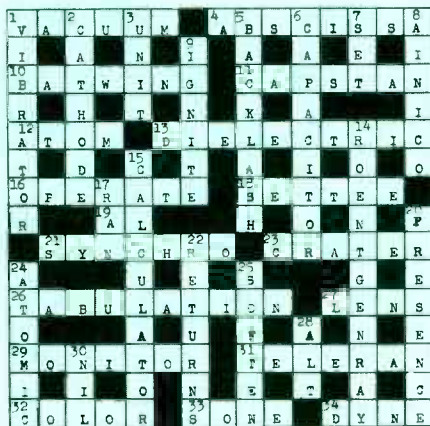

DIRECTORY OF ALUMNI CHAPTERS

DETROIT CHAPTER meets 8:00 P. M., 2nd Friday of each month, St. Andrews Hall, 431 E. Congress St., Detroit. Chairman: James Kelley, 1140 Livernois, Detroit, Mich., VI-14972.

FLINT (SAGINAW VALLEY) CHAPTER meets 8:00 P. M., 2nd Wednesday of each month at Andrew Jobbagy's Shop, G-5507 S. Saginaw Rd., Flint. Chairman: Clyde Morrissett, 514 Gorton Ct., Flint, Mich., 235-3074.

HAGERSTOWN (CUMBERLAND VALLEY) CHAPTER meets 7:30 P. M., 2nd Tuesday of each month at George Fulk's Radio-TV Service Shop, Boonsboro, Md. Chairman: Robert McHenry, RR2, Kearneysville, W. Va. 25430.

LOS ANGELES CHAPTER meets 8:00 P. M., 2nd and last Saturday of each month, at Chairman Eugene DeCaussin's Radio-TV Shop, 4912 Fountain Ave., L. A., Calif., NO 4-3455.

NEW ORLEANS CHAPTER meets 8:00 P. M., 2nd Tuesday of each month at Galjour's TV, 809 N. Broad St., New Orleans, La. Chairman: Herman Blackford, 5301 Tschoupitoulas St., New Orleans, La.

NEW YORK CITY CHAPTER meets 8:30 P. M., 1st and 3rd Thursday of each month, St. Marks Community Center, 12 St. Marks Pl., New York City. Chairman: Samuel Antman, 1669 45th St., Brooklyn, N. Y.

NORTH JERSEY CHAPTER meets 8:00 P. M., last Friday of each month, Players Club, Washington Square (1/2 block west of Washington and Kearney Avenues), Kearney, N. J. Chairman: George Schopmeier, 935-C River Rd., New Milford, N. J.

PHILADELPHIA-CAMDEN CHAPTER meets 8:00 P. M., 2nd and 4th Monday of each month, K of C Hall, Tulip and Tyson Sts., Philadelphia. Chairman: John

Pirrung, 2923 Longshore Ave., Philadelphia, Pa.

PITTSBURGH CHAPTER meets 8:00 P. M., 1st Thursday of each month, 436 Forbes Ave., Pittsburgh. Chairman: Joseph Burnelis, 2268 Whited St., Pittsburgh, Pa.

SAN ANTONIO (ALAMO) CHAPTER meets 7:00 P. M., 4th Friday of each month, Beethoven Home, 422 Pereida, San Antonio. Chairman: Sam Stinebaugh, 318 Early Trail, San Antonio, Texas.

SAN FRANCISCO CHAPTER meets 8:00 P. M., 2nd Wednesday of each month, at the home of J. Arthur Ragsdale, 1526 27th Ave., San Francisco. Chairman: Isalah Randolph, 523 Ivy St., San Francisco, Calif.

SOUTHEASTERN MASSACHUSETTS CHAPTER meets 8:00 P.M., last Wednesday of each month at home of John Alves, 57 Allen Blvd, Swansea, Mass. Chairman: Walter Adamiec, 109 Taunton St., Middleboro, Mass.

SPRINGFIELD (MASS.) CHAPTER meets 7:00 P. M., last Saturday of each month at shop of Norman Charest, 74 Redfern Dr., Springfield, Mass. Chairman: Br. Bernard Frey, 254 Bridge, St., Springfield, Mass.



"I came to install your roof antenna."

STATEMENT OF OWNERSHIP, MANAGEMENT, AND CIRCULATION (ACT OF OCT. 23, 1962; SECTION 4369, TITLE 39, UNITED STATES CODE).

1. Date of Filing: October 1, 1968
2. Title of Publication: NRI Journal
3. Frequency of issue: bimonthly
4. Location of known office of publication: National Radio Institute, 3939 Wisconsin Ave., N. W., Washington, D. C. 20016.
5. Location of the headquarters or general business office of the publication: 3939 Wisconsin Ave., N. W., Washington, D. C. 20016.
6. Editor and Publisher: William F. Dunn, 8802 Fox Hills Trail, Potomac, Md.; Managing Editor: Allene Magann, 2028 N. Vermont, Apt. 202, Arlington, Va. 22207.
7. Owner (if owned by a corporation, its name and address must be stated and also immediately thereunder the names and addresses of stockholders owning or holding 1 percent or more of total amount of stock. If not owned by a corporation, the names and addresses of the individual owners must be given. If owned by a partnership or other unincorporated firm, its name and address, as well as that of each individual must be given).

S. Bartlett, 1 Highland Ave., Dover, Del.
E. Davis, RFD 1, Rochester, N. H.
C. Galbraith, 430 E. Ledbetter Dr., Dallas, Tex.

M. Galbraith, 7 Irving Lane, Orinda, Calif.
G. Peek, 1119 Crest Lane, McLean, Va.
NRI Charitable Trust, c/o J. E. Smith, 1121 Crest Lane, McLean, Va.

J. E. Smith, 1121 Crest Lane, McLean, Va.
C. C. Kendrick-J. M. Smith, Trustees - Will of S. M. Smith, Jesse Bldg., Arlington, Va.
E. Stuart, RFD 9, Webber Hill, Kennebunk, Me.

J. M. Smith, T. M. Smith, 1123 Crest Lane, McLean, Va.

J. M. Smith, Jr., 1537 Cameron Crescent Dr., Reston, Va.

L. M. Smith, 3200 Longview Dr., Bloomington, Ind.

M. Sarich, COMSEC, American Embassy, APO N. Y. 09794.

C. Sarich, 3725 Warren St., N.W., Washington, D. C.

J. Sarich, Pres. Tyler Bldg., 1121 Arl. Blvd., Arl., Va.

D. H. Smith, RFD 1, Box 395, Rochester, N.H.

8. Known bondholders, mortgagees, and other security holders owning or holding 1 percent or more of total amount of bonds, mortgages or other securities (if there are none, so state): none.

9. Paragraphs 7 and 8 include, in cases where the stockholder or security holder appears

upon the books of the company as trustees or in any other fiduciary relation, the name of the person or corporation for whom such person is acting, also the statements in the two paragraphs show the affiant's full knowledge and belief as to the circumstances and conditions under which stockholders and security holders who do not appear upon the books of the company as trustees, hold stock and securities in a capacity other than that of a bona fide owner. Names and addresses of individuals who are stockholders of a corporation which is itself a stockholder or holder of bonds, mortgages or other securities of the publishing corporation have been included in paragraphs 7 and 8 when the interests of such individuals are equivalent to 1 percent or more of the total amount of the stock or securities of the publishing corporation.

10. This item must be completed for all publications except those which do not carry advertising other than the publisher's own and which are named in Sections 132.231, 132.232, and 132.233, postal manual (Sections 435a, 435b, and 4356 of Title 39, United States Code).

A. Total number copies printed (Net Press Run) November/December 1966 through September/October 1967: 259,901; average number copies each issue during preceding 12 months: 43,317; single issue nearest to filing date: 42,665.

B. Paid Circulation.

1. Sales through dealers and carriers, street vendors and counter sales: none.

2. Mail Subscriptions: average number copies each issue during preceding 12 months: 41,04 ; single issue nearest the filing date: 40,059.

C. Total Paid Circulation: Average number copies each issue during preceding 12 months: 41,043; single issue nearest to filing date: 40,059.

D. Free Distribution (including Samples) By Mail, carrier or other means; average number copies each issue during preceding 12 months: 1,040, single issue nearest to filing date 1,033.

E. Total Distribution (Sum of C and D): Average number copies each issue during preceding 12 months: 42,083; single issue nearest to filing date 41,092.

F. Office use, Left-over, unaccounted, spoiled after printing: average number copies each issue during preceding 12 months: 1,234; single issue nearest to filing date: 1,593.

G. Total (sum of E and F--should equal net press run shown in A): 43,317.

I certify that the statements made by me above are correct and complete. Allene Magann.

NEW-2 Superb Test Instruments From PRECISION--Moderately Priced, Too!

MODEL E-410C SWEEP GENERATOR & MARKER ADDER

Stock 41WT
Express Coll.
\$ 169⁹⁵

\$8 Per Month

A wide-range, frequency modulated signal source combined with complete Marker Adder circuitry for the alignment of TV and FM receivers. Furnished with a 4.5 mc crystal and 5 output cables.

SPECIFICATIONS:

- Band A: 3 to 7 mc.
- Band B: 6 to 14 mc.
- Band C: 13 to 33 mc.
- Band D: 35 to 85 mc.
- Band E: 80 to 213 mc.
- Band E_s: 400 to 1080 mc.

Fundamental output to 213 mc: 5" calibrated tuning dial. Continuously variable sweep width: ranging from 0 to 3 mc on band "A" to 0 to 30 mc on band "D." Marker adder: designed to avoid overloading of receiver circuits when inserting markers. Fixed frequency markers: provided by crystal oscillator circuitry with the crystal socket on front panel. External marker input connector; permits use of an external RF generator to provide variable frequency marker "pips" on the scope trace. Continuously variable attenuators control sweep width and vertical scope pattern. Operates on 117 V 50/60 cycles AC. Dimensions: 13" x 8 1/2" x 7".



MODEL B-10 BATTERY ELIMINATOR AND CHARGER

Stock 10WT
Express Coll.

\$ 59⁹⁵

\$5 Per Month

Designed to meet the rigid, low-ripple output requirement of modern transistorized automobile radios and other electronic equipment of 6 and 12 volt ratings. Also functions as an efficient, reliable battery charger with special high-current output at separately labeled terminals.

SPECIFICATIONS:

- Continuously variable output voltage: 0-8 volts, 0-16 volts DC
- Standard output current capacity: 6 volt range, 10 amps DC continuous, 20 amps DC intermittent;
- 12 volt range, 6 amps DC continuous, 12 amps DC intermittent.
- Special (low-ripple) output: 6 volts and 12 volts; 5 amps DC continuous.

Automatic overload protection (thermo-relay assures full instrument safety and protects against external short circuits.) Extractor fuse post is front panel mounted for added protection. Two DC panel meters simultaneously monitor both voltage and current. Operates on: 117 V, 50/60 cycles AC. Dimensions: 11 1/2" x 7" x 5".

USE YOUR CONAR CREDIT-ORDER BLANK ON PAGE 27

6-12 VOLT BATTERY ELIMINATOR



FULLY ASSEMBLED
READY TO USE

Best selling battery eliminator on the market today. Specially designed for operating auto radios—either 6 or 12 volts—transistor or vibrator type.

The ATR Model 610 delivers 6 volts at 10 amps or 12 volts at 6 amps. Has separate meters for volt-amps, eight position voltage control, 6-12 volt switch with safety lock and toggle on-off switch. Full-wave dry disc rectifier gives noiseless, interference free operation.

Housed in steel cabinet, gray hammertone finish. Rubber feet protect bench. Size: 6 1/2" x 9 1/8" x 8 1/2". 110-120 volts, 50-60 cycle AC.

Stock #610WT
Express Collect

\$54⁹⁵

\$5 DOWN
\$5 MONTH

EASY TERMS-- ORDER BLANK ON PAGE 27

NRI JOURNAL
3939 Wisconsin Ave.
Washington D. C. 20016

Mr. Willard F. Yelline
1322 S. 14th
Fargo, N. Dak. 58101

25923-G

Second-class
postage paid
at Washington, D. C.