

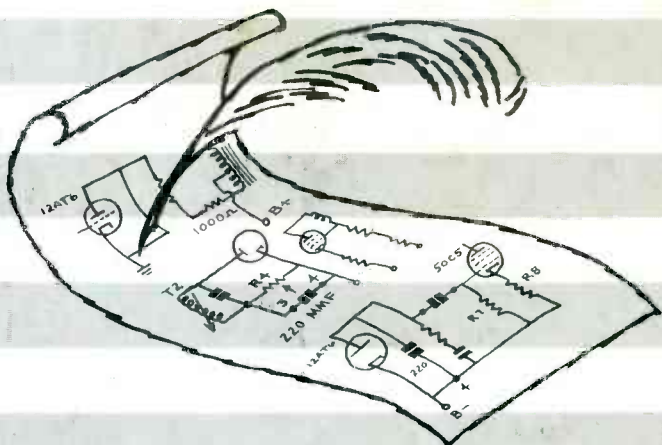

journal

July-August 1966

35 Cents

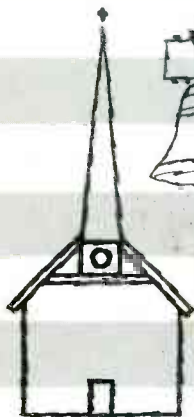

**IN THIS
ISSUE:**

**THE YOUNG AND THE YOUNG AT HEART
IDENTIFYING CAPACITORS
A NEW SLANT ON POWER SUPPLIES
NOMINATIONS OPEN FOR ALUMNI**

From CONAR

AN AMAZING KIT VALUE AT \$209.50!

THE CCTV CAMERA THAT BREAKS THE PRICE BARRIER

MODEL 800



(Stock No. 800UK) (includes vidicon, standard lens, tubes, cabinet, assembly-operating manual — nothing else to buy!) Shipped Express, COD for ship. charges.

- *Lowest priced complete TV camera on the market!*
- *Connects instantly to any standard TV set!*
- *1,001 uses in homes, schools, offices, factories, stores, industry!*
- *On the air in less than 8 hours assembly time!*

YOU CAN OWN IT FOR ONLY \$20.95 DOWN AND \$10 A MONTH

Conar proudly announces the new Model 800 TV Camera Kit — a versatile, low cost, closed circuit camera for use in countless applications. Your own imagination is the only limit to the number of uses for the Model 800 — store minder, baby sitter, swimming pool guard, plant security, production line control, window display, auditoriums, classrooms — to name just a few. Use the Model 800 to attend sick persons or infants. Stage your own TV programs! Use for surveillance anytime, anywhere.

Unlike other closed circuit cameras, the Model 800 does not require expensive monitor sets. It can be connected instantly to the antenna terminals of any standard TV set — or connect up to six standard sets without loss of picture quality. Simply tune your camera to an unused channel in your area (from channel 2 to channel 6), con-

nect camera, switch channel selector and you're in business! Camera will not interfere with normal program reception. The Model 800 can be located as much as 1,000 feet from the TV receiver without noticeable loss of picture quality.

Precision ground 25mm f1.9 lens supplied with kit gives clear, sharp pictures even under shaded conditions. The light from two 100 watt bulbs is entirely adequate for indoor use. The Model 800 even gives a discernible picture in bright moonlight!

Place your order now for one of the most outstanding kit values offered by any manufacturer. You're in for a pleasant surprise when you see this one perform! Conar's usual full year guarantee on all parts of course with exception of vidicon tube which carries 90-day warranty.

SPECIFICATIONS— Size: 5" wide, 7" high, 12 $\frac{1}{4}$ " deep. Weight: 11 lbs. including lens. Power Consumption: 45 watts, 120v, 60 cycle, AC only. Output: Modulated rf, any channel from 2-6. Output Level: Greater than 100,000 mv. Output Impedance: 75 ohms. Sweep Rates: Random interlace, horiz. 15,750 cps; vertical 60 cps line locked. Resolution: 240 lines; 3 mc. Controls: Horiz. Pres., Target, Beam, Focus, On/Off. Adjustments: V. Height, V. Centering, H. Width, H. Linearity, H. Centering, Channel Adjust, High Peaker. Tubes: 5 dual-purpose, 9 semi-conductor diodes give 12 tube performance. Standard Lens: 25mm, f1.9 focusing 2' to infinity. Click stop iris to f22. Standard "C" mount included.

OPTIONAL ACCESSORIES: Wide Angle Lens: 12.5mm, f1.9, focusing 10' to infinity. Click stop to f22. \$36.00 additional. Telephoto Lens: 50mm, f1.9, focusing 2' to infinity. Click stop to f22. \$28.00 additional. Professional type tripod with "C" mount. \$21.00 additional. Complete camera also available factory assembled at \$249.50.

USE THE HANDY ORDER FORM ON PAGE 27

Identifying Capacitors

Knowing the Standard EIA ID System Aids Selection of Right Replacements

By **WILLIAM F. DUNN**

In most applications where a capacitor is used as a coupling capacitor or a bypass capacitor, its value is not particularly critical. A replacement that has a capacity as large or larger than that of the original can usually be used. The replacement must also have a voltage rating as high or higher than the voltage rating of the original capacitor.

However, with the advent of color television, the service technician is likely to run into more critical circuits than ever before. Often in a color TV receiver a capacitor has been selected with special characteristics in order to do the job it is supposed to in the particular circuit in which it is used. In most cases, where capacitors with special characteristics have been selected, the capacitor is used in a frequency-determining circuit which determines the frequency of an oscillator or the bandpass of an amplifier stage.

Often in the service information supplied by the manufacturer, complete characteristics on the original capacitor are missing. The size and voltage rating may be all that are given, but some of the other characteristics of the capacitor may be very important.

Most capacitor manufacturers identify their capacitors by means of the standard EIA (Electronics Industries Association) identification system. Therefore, in order to be able to select suitable replacement capacitors, the technician must be familiar with this identification system.

Three separate systems are used to identify capacitors; one is used for paper capacitors, one for formica capacitors and one for ceramic capacitors. In many respects the identification systems are similar, but there are variations. The purpose of this article is to acquaint the technician with the EIA identification system so he will be able to identify capacitors in a radio or TV receiver and know when it is important that exact duplicate replacement capacitors be used and when a general purpose replacement capacitor can be substituted.

Paper capacitors are the easiest to identify because in most cases the manufacturer simply stamps all the pertinent information on the capacitor. Paper capacitors are made in sizes from about .001 mfd up to 1 mfd. Occasionally you will run into a smaller or a larger capacitor than these values, but they are somewhat rare.

In the class with paper capacitors we can also include the combination paper-mylar capacitors and the dipped type of capacitors which have been dipped in a mylar-type substance to seal the capacitor against moisture.

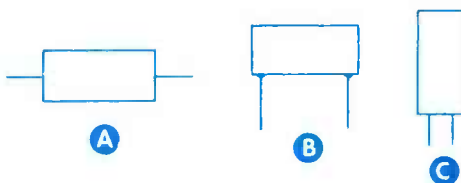

Figure 1

These capacitors are made in three styles with axial leads as shown in Fig. 1A, with radial leads as shown in Fig. 1B and with the two leads coming from one end as shown in Fig. 1C. As far as the electrical characteristics of the capacitor are concerned, the physical shape has no significance whatsoever. If you have to replace a capacitor with radial leads and have an identical capacitor with axial leads, you can bend the leads as shown in Fig. 2A and use the capacitor with axial leads as a substitution. If you need to replace a single ended capacitor and do not have a suitable replacement but have one with axial leads, you can bend the lead from one end as shown in Fig. 2B and usually use an axial-lead type capacitor as a replacement for a single ended capacitor.

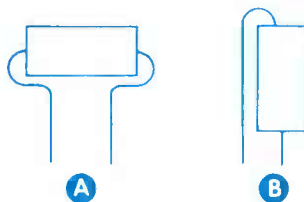

Figure 2

Capacitors of this type are usually identified by the manufacturer by stamping the capacity of the capacitor, the tolerance of the capacitor and the voltage rating on the side of the capacitor. For example, a .033 mfd capacitor might be marked ".033 mfd $\pm 20\%$, 600V". This means that the nominal value of the capacitor is .033 mfd and it is within 20% of this value. 600V means that the capacitor is designed for use in circuits up to 600 volts.

Now, where could this capacitor be used as a replacement? It could be used in a circuit calling for a .033 mfd capacitor with a tolerance of 20% or more. In other words, if you were replacing a .033 mfd capacitor that had a tolerance of $\pm 30\%$, you could use a capacitor with a tolerance of only 20% in its place. The fact is that the 20% capacitor will be closer to the specified capacity than the 30% capacitor and therefore is entirely suitable as a replacement.

You can also use it in place of capacitors having a voltage rating of less than 600 volts. For example, if you had to replace a .033 mfd $\pm 20\%$, 400 volt capacitor you could certainly use a .033 mfd $\pm 20\%$, 600V capacitor. The capacitor that is rated at 600 volts would be overrated insofar as the voltage in the circuit is concerned. The only problem might be that the 600 volt capacitor might be slightly larger than the 400 volt capacitor, but usually there is room for the larger replacement.

You might run into a capacitor where the tolerance is given by a letter rather than by the actual percentage tolerance. The letter K is used to indicate a tolerance of $\pm 10\%$, the letter M a tolerance of $\pm 20\%$ and the letter N a tolerance of $\pm 30\%$. Thus a capacitor marked .033 M is a .033 mfd capacitor with a tolerance of $\pm 20\%$. A capacitor marked .033K is a .033 mfd capacitor with a tolerance of $\pm 10\%$.

The .033 mfd, $\pm 20\%$, 600 volt capacitor might also be marked 6 333M. When a capacitor is marked in this way, the first figure indicates the voltage rating of the capacitor in hundreds of volts. In other words, the 6 means that the voltage rating of the capacitor is 600 volts. The next three figures indicate the capacity of the capacitor in picofarads. The first two digits indicate the first two significant figures. In other words, the first three and the second three indicate that the first two significant figures of the value of the capacitor are 33. The third figure indicates the number of zeros to follow, in this case three zeros. In other words, the capacity is 33000 picofarads. To convert picofarads to microfarads you move the decimal point six places

to the left. Since there are only five figures, you must add a zero and so you get the capacity of .033 microfarads. The final letter, M in this case, indicates the capacity, which as we said before is $\pm 20\%$.

It is seldom that you will find a paper or mylar capacitor marked in this way; usually they are large enough for the manufacturer to actually stamp the capacity, tolerance and voltage rating on the capacitor, and as long as you use one having characteristics that equal or exceed those of the original capacitor you will have no trouble with the replacement.

MICA CAPACITORS

Mica capacitors are not as widely used as paper and ceramic capacitors in radio and TV receivers because they are more expensive. However, in some critical circuits they are used. If you find a mica capacitor in a radio or a TV receiver, the chances are that its value and characteristics are quite critical, otherwise a less expensive capacitor would have been used. Therefore it is important that you correctly identify the capacitor and use a replacement that has a tolerance at least as close as the tolerance of the original.

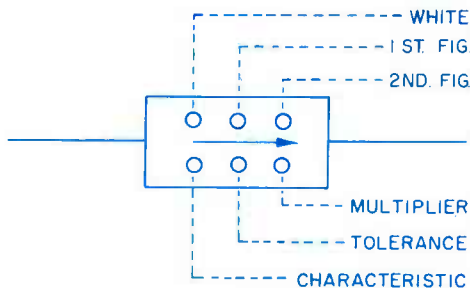

Figure 3

Mica capacitors can be divided into two types, the so-called postage stamp type and the dip type. The postage stamp type looks like the capacitor shown in Fig. 3. Its size, tolerance and temperature characteristics are identified by means of the six dots on the capacitor.

Looking at the capacitor shown in Fig. 3, the dot in the upper left corner will be white if the capacitor follows the standard EIA designation. Line the arrow up as shown and look for the white dot in the upper left corner. If the capacitor is marked in this way, you can be sure that it follows the EIA designation and then you can proceed to completely identify the capacitor.

Color	Characteristic	1st and 2nd Significant Color	Multiplier	Tolerance
Black		0	1	± 20% M
Brown	B	1	10	± 1% F
Red	C	2	100	± 2% G
Orange	D	3	1000	
Yellow	E	4	10000	
Green	F	5		± 5% J
Blue		6		
Purple		7		
Gray		8		
White		9		
Gold				± 1/2% E
Silver				± 10% K

Figure 4

The next two dots on the top give the first and second significant figures. These dots will be colored and they use the same color code as is used to identify resistors. For example, if the first dot is red and the second dot is green, this means that the first significant figure is 2 and the second significant figure is 5. The chart shown in Fig. 4 identifies all the colors used for the first and second significant figures.

The dot in the lower right indicates the multiplier. If the dot is black then the multiplier is 1 and in the case of the capacitor with the first figure 2 and the second 5, the capacity would be 25 picofarads. If the dot is red, then the multiplier is 100, and in this case the capacity would be 2500 picofarads.

The dot in the center bottom indicates the tolerance of the capacitor. Again, this dot will be colored and from the chart in Fig. 4, you can see what the various colors represent insofar as the tolerance is concerned. Ignore the letters at this time - we will see where they are used later.

The final dot on the lower left indicates the temperature characteristic of the capacitor. There is a rather detailed method of figuring out exactly what the temperature coefficient will be but it can be simplified. The brown dot, which represents characteristic B, is not specified. In other words, this means that the capacity of the capacitor may drift somewhat with temperature, but it doesn't matter because the manufacturer has used a capacitor with a wide temperature coefficient. The red dot indicates a C characteristic and this indicates that the maximum capacity drift will be approximately .5%. The orange dot indicates a D characteristic - this is a maximum capacitance drift of approximately .3%. The yellow dot indicates an E characteristic which indicates a maximum capacitance drift of .1%

and the green dot indicates an F characteristic which indicates a maximum temperature drift of approximately .05%.

If you should encounter a capacitor that has a D characteristic with a tolerance of 5% and you have one with an F characteristic with a tolerance of 2%, you could use it as a replacement. The F characteristic indicates that the capacitor drifts less than the original one and the 2% tolerance indicates that it is closer to the indicated value than the original. In both cases the replacement capacitor is better than the original and therefore it can be used as a replacement.

It would be risky to go the other way and use a 5% capacitor as a replacement for a 2% capacitor. The capacitor might upset the performance of a frequency sensitive circuit. It is even more risky to use a capacitor with a wider temperature coefficient. The problem here is that the receiver that you repaired might work satisfactorily for some time until the temperature reached a certain value and by then the capacitor may have drifted enough in capacity to upset the performance of the circuit. When you check the receiver, this might not be evident and you might think that the receiver is working satisfactorily and that the replacement is entirely suitable only to find that you will be called back to fix the set again after it has heated up and the temperature caused the capacitor to reach its maximum capacity drift.

The voltage rating of mica capacitors is often not indicated on the capacitor. Usually it is safe to assume that the capacitor has a working voltage of 500 volts, unless you know for a fact that it has a higher working voltage. As in the case of the paper capacitor, you could replace the mica capacitor with one having a higher working voltage - a replacement capacitor with a higher voltage rating

will usually be somewhat larger than the original, but in most cases there will be room for the larger capacitor.

In addition to the postage stamp type of capacitor, the dipped type mica capacitor will be found in electronic equipment. The dipped capacitor looks like the capacitor shown in Fig. 5. The capacitor is marked as it might be marked by the manufacturer. The first letter, the letter D, indicates the temperature characteristic of the capacitor. The letters mean exactly the same thing as in the case of the postage stamp type. The letter D indicates a maximum capacitance drift of approximately .3%. The next two digits are the first and significant figures of the capacity of the capacitor. In other words, the first two significant figures are 33. The letter 2 indicates that there are two zeros following these two figures; in other words, the capacity of the capacitor is 3300 pf. The letter J indicates the tolerance, and from the chart in Fig. 4 we see that the letter J indicates a tolerance of $\pm 5\%$. Therefore the letter D332J indicates a 3300 picofarad capacitor with a tolerance of $\pm 5\%$ and a maximum capacitance drift of approximately .3%.



Figure 5

Sometimes you will find dipped mica capacitors where the manufacturer has stamped the value and tolerance directly on the capacitor. In other words, the capacitor might be marked $3300 \pm 5\%$. The characteristic might be marked by the letter J above the capacitance of the capacitor or a D preceding the capacitance of the capacitor. If there no letter indicating the characteristic then you can assume that it is not specified. However, whenever you are in doubt, if you can get a F type capacitor, this has the closest temperature coefficient and will work in a circuit regardless of what the temperature coefficient of the original capacitor was.

The voltage rating of the capacitor is determined primarily by the size of the capacitor. As before, most dipped mica capacitors will have a voltage rating of 500 volts or more. However, avoid using a capacitor that is smaller physically than the original; the chances are that its voltage rating will be lower than that of the original.

Perhaps the most difficult type of capacitor to identify fully is the ceramic capacitor. This is due to the fact that there are so many different types of ceramic capacitors with widely different characteristics. However, usually the capacitor manufacturer gives enough information on the capacitor to enable the technician to identify it correctly so he can select a suitable replacement capacitor.

Ceramic capacitors are made in two types, the disc capacitor which is so named because it looks like a disc and the tubular capacitor which looks like a tube with the leads coming out of the ends. Tubular capacitors are more expensive than disc capacitors and as a result are not used nearly as often as disc capacitors. As a matter of fact, in modern radio and TV receivers they have practically disappeared. Disc capacitors can be made in a far wider range of sizes and characteristics than the tubular capacitors and they can be made at a lower cost so we will concentrate on identifying disc capacitors in this article.

Ceramic capacitors can be divided into two types. The first type has a high Q and is used in circuits where stability of capacitance is important. This type of capacitor will either be marked Hi-Q or it will be marked in such a way as to identify its temperature characteristics. It may be marked NPO which means it has a zero temperature coefficient - in other words its capacity does not change with changes in temperature or it may be marked with the letter P followed by a number indicating a positive temperature coefficient or the letter N followed by a number indicating a negative temperature coefficient. There are very few ceramic capacitors with a positive coefficient; most have a negative temperature coefficient.

The temperature coefficient of a capacitor is an indication of how much the capacitance will change as the temperature changes from 25°C . As we mentioned, NPO means that its capacitance will not change with changes in temperature. P-100 indicates that if the temperature increases its capacitance will increase. A P-100 temperature compensating capacitor will increase the capacitance of about 1% as the temperature changes from 25°C to 85°C . Ceramic capacitors with negative coefficients are made with coefficients of N33, N75, N150, N220, N330, N470, N750, N1500 and N2200. These figures indicate how much the capacitance will decrease with changes in temperature. You do not have to

know exactly what the change is, but the larger the number following the letter N the greater the change will be between 25° and 85°. For example, the N-75 type capacitor changes less than 1% as the temperature changes from 25° to 85° C, but on the other hand the N-750 capacitor changes almost 5% with similar temperature change. Since the N indicates negative, the capacity of the capacitor decreases.

In circuits where temperature compensating capacitors are used it is very important that you get a capacitor having the same capacity as the original, the same tolerance as the original and the same temperature coefficient as the original. This capacitor has been selected to compensate for changes in other parts of the circuit with temperature changes. Often these capacitors are used in oscillator circuits where changes in temperature may cause other parts to increase in value. The negative coefficient of an N-type capacitor will cause this capacitor to decrease in value and offset the other changes in the circuit.

Temperature compensating capacitors are marked by the manufacturer by stamping the capacity in picofarads on the capacitor. For example, a 470 picofarad capacitor would be stamped with the number 470. The tolerance of the capacitor will also be stamped on the capacitor. Standard tolerances are $\pm 5\%$, $\pm 10\%$ and $\pm 20\%$. The chances are that one of these values will be stamped on the capacitor to indicate its tolerance. In addition, the temperature coefficient will also be stamped on the capacitor. For example, the 470 pf capacitor we mentioned would be marked 470 and then beneath that $\pm 10\%$ and beneath that the number N-470. This indicates that the capacity of the capacitor is 470 microfarads with a tolerance of $\pm 10\%$ and that the temperature coefficient of the capacitor is N-470.

NPO capacitors are used in some critical oscillator circuits where any change in capacity will affect the oscillator frequency. This type of capacitor is not made in as wide a range of values as the negative temperature coefficient capacitors, but where it is used, it is extremely important that if you must replace it you use a replacement with an NPO temperature characteristic, otherwise it is likely that the oscillator frequency will shift with temperature changes. Also, you should use a replacement having the same tolerance as the original, otherwise some readjustment of the circuit may be necessary.

In temperature compensating capacitors the temperature characteristic is more important than the tolerance. If the tolerance is

somewhat different than the original and this results in a change of capacity that upsets the performance of the circuit, you can usually make some adjustment to compensate for this change. However, if the temperature coefficient is wrong then the circuit may work right at first and then begin to operate incorrectly after the equipment has heated up. Again, this might not occur until the equipment has operated for some time. The serviceman who uses a replacement capacitor with the wrong temperature coefficient might think that he had the equipment repaired and return it to the owner, only to find out later that after the set heated up after several hours of operation it began to act up and this will result in a repeat call.

Capacitors that are not designed for temperature compensating use are identified by means of two letters and a number, which indicates the operating range over which the capacitor can be operated and the maximum capacitance change over the temperature range. If a capacitor is marked Z5, followed by another letter, the capacitor is designed for use between +10° C and 85° C. If the capacitor is marked Y5 it is designed for use between -30° C and 85° C and if a capacitor is marked X5 it is designed for use between -55° C and 85° C. Needless to say the X5 capacitor is the best capacitor; it can be used over the widest temperature range. However, this type of capacitor is seldom found in entertainment type equipment. It is more often used in equipment such as military equipment which may be exposed to wide temperature variations. It is seldom that a radio or TV receiver designed for home use will be exposed to temperature changes greater than +10° C to 85° C and therefore most of the capacitors that you will encounter will be marked Z5 followed by a letter.

The letter following Z5 will indicate the maximum capacitance change that will occur over the temperature range for which the capacitor was designed. The chart in Fig. 6 shows what each of the letters indicate. For example, the letter F indicates a maximum capacitance change of 7.5% over the range for which the capacitor is designed. For example, a Z5F capacitor will not change any more than $\pm 7.5\%$ in capacity as the temperatures vary from +10° C to 85° C. An X5F would not change any more in capacity than $\pm 7.5\%$ as the temperature is changed from -55° C to +85° C.

The capacitance of general purpose ceramic capacitors can be given in either picofarads or microfarads. If the capacity is given in picofarads it will usually be given by three

numbers. For example, 330 would indicate 330 picofarads. On the other hand, if the capacitor had a capacity of 3300 picofarads, the manufacturer would usually mark it .0033 which indicates .0033 mfd. If the capacitor is marked in picofarads then it will be marked 332. The first two threes indicate the first two significant figures, and the 2 indicates the numbers of zeros to follow these figures. Therefore you will find that the third figure is either a 0, missing entirely or a number used to indicate the number of zeros. A capacitor marked 33 would be a 33 picofarad capacitor, one marked 330 would be 330 picofarads, and one marked 332 would be 3300 picofarads.

The tolerance of general purpose capacitors is usually stamped directly on the capacitor. Standard tolerances are $\pm 5\%$; $\pm 10\%$; $\pm 20\%$; $+ 100\% - 0\%$; $+ 80\%$; $- 20\%$ and GMV. The values indicate exactly what they mean. For example $\pm 20\%$ means that the capacity of the capacitor will be within the value stamped on the capacitor $\pm 20\%$. A capacitor that is marked GMV means it has a guaranteed minimum value. For example, a capacitor marked GMV .01 is a capacitor that has a capacity of at least .01 mfd. The manufacturer has guaranteed that the minimum value of the capacitor will be .01 mfd. However, the capacitor may be much larger than this value - on the other hand, it will not be less than .01 mfd.

Often letters are used on disc capacitors to indicate the tolerance instead of stamping the tolerance. The letter J indicates a tolerance of $\pm 5\%$, the letter K a tolerance of $\pm 10\%$, the letter M a tolerance of $\pm 20\%$, the letter P a tolerance of $+100\% - 0$, and the letter Z a tolerance of $+ 80\% - 20\%$. Thus a capacitor marked .005 Z and then beneath it Z5U is a capacitor that has a capacitance of .005 mfd with a tolerance of $+85\% - 20\%$. Z5 indicates that between the operating of $+10^{\circ}\text{C}$ and $+85^{\circ}\text{C}$ it has a temperature coefficient U which means the value will not increase more than 22% nor will it decrease more than 56%.

Ceramic capacitors made by different manufacturers have different voltage ratings. If the voltage rating of a capacitor is not marked, you can assume it has a voltage rating of 500 volts. However, high-voltage ceramic capacitors are widely used in television receivers, but these capacitors usually have their voltage rating marked on them. This should enable you to identify a circuit where a capacitor with a voltage rating higher than 500 volts is required. Ceramic capacitors are also made with low-voltage ratings of 100 volts or less. Capacitors are made with these low-

voltage ratings because they can be made smaller than the standard 500 volt capacitors. Again, these capacitors usually have their voltage ratings marked on them. Of course, you could use a capacitor with a higher voltage rating than a replacement. Similarly, you could use a capacitor with a temperature coefficient less than the temperature coefficient of the original as a replacement.

General purpose ceramic capacitors that are not designed for temperature compensating circuits are generally low-Q capacitors, unless they are marked otherwise. If a capacitor is a high-Q capacitor, it will be marked, and it should not be replaced by a low-Q capacitor. High-Q capacitors are available with the same temperature characteristics, tolerances and voltage ratings as the general purpose ceramic capacitors, and most parts distributors carry both types.

CONCLUSION

One of the best sources of information about capacitors is manufacturers' catalogs. Frequently these catalogs are available at parts wholesalers and it is worthwhile to obtain these catalogs from different wholesalers if you can. They will give you specifications on the capacitors made by the manufacturer. Often the information given in the catalog is useful in identifying capacitors made by the other manufacturers as well as the one who put out the catalog. Also, many wholesalers put out catalogs of their own and these catalogs give some information on capacitors manufactured by different companies as well as general replacement part information. If you can't obtain one of these catalogs from your local wholesaler you can usually obtain one from one of the large mail order firms advertising in the various magazines published for radio and TV technicians.

In selecting a replacement capacitor remember that, in general, in bypass and coupling circuits the value, tolerance and temperature characteristics are not too important. However, in rf circuits, in oscillator circuits, in sweep oscillator and in the color circuits of color TV receivers, often the size, tolerance, and temperature characteristics of the capacitor are important. If the capacitor is a temperature compensating capacitor, you must use a replacement having the same temperature characteristics. If the capacitor is a general purpose capacitor then you should use one having the same capacity as the original, a tolerance equal to or better than the original and a temperature coefficient equal to or better than the original capacitor.



Student's Forum

*Got a brief? A grief? An idea
or a funny story? Share it here.*

. . .

SIGNALS ARE GO FOR NAVY

GERALD J. ANDRES, Signaيمان Second Class on the USS Tallahatchie County, a converted LST now used as an advanced base for aircraft, sent us the following "Commandments" his captain posted on the bulletin board:

Andres has collateral duties with the Navy aboardship in maintenance and operation of the ship's entertainment equipment. Also married and with a child, his home base is in Security Village, Colorado Springs, Colo.

Like his counterpart in the Armed Forces, Robert E. Oliver (see the opposite page), Andres is a student in the NRI Complete Communications Course. His background includes courses in ventriloquism and grapho-analysis! He's a native of Vancouver, Wash.

Ten Electro-Commandments

1. Beware of the lightning that lurketh in an undischarged capacitor lest it cause thee to bounce upon the buttocks in a most unseaman-like manner.
2. Cause thou the switch that applieth large quantities of juice to be opened and thusly tagged that thy days may be long in this earthly vale of tears.
3. Prove to thyself that all circuits that radiateth and upon which thy worketh are grounded and thusly tagged lest they lift thee to RF potentials and causeth thee to make like a radiator.
4. Tarry thou not amongst the fools that engage in intentional shocks, for surely they are non-believers and their days are numbered.
5. Take care that thou useth the proper method when thou taketh the measure of a high voltage circuit, so that thou dost not incinerate both thee and thy test meter, for verily, though thou has no plant account number and can be easily surveyed, the test meter doth not have one and as a consequence bringeth much woe unto the supply officer.
6. Take care thou tampereth not with interlocks and safety devices, for this incurreth the wrath of thy Division Officer and bringeth the fury of the Bureau of Ships about thy head and shoulders.
7. Work thee not on energized equipment, for if thou doest thy shipmates will surely be buying beer for thy widow and consoling her in certain ways not generally acceptable by thee.
8. Verily, verily I say unto thee, never service equipment alone, for electrical cooking is sometimes a slothful process and thou might sizzle in thine own fat upon a hot circuit for hours on end before thy Maker sees fit to end thy misery and drag thee into the fold.
9. Trifle thee not with radioactive tubes and substances lest thou commence to glow in the dark like a lightning bug and cause thy wife to be frustrated nightly and have no further use for thee except for thy wages.
10. Commit thee to memory all the words of the prophets which are written down in the 67th Chapter of the Bible which is BUSHIPS Manual and which giveth out with the straight dope and consoleth thee when thou has suffered a ream job by the Division Officer.

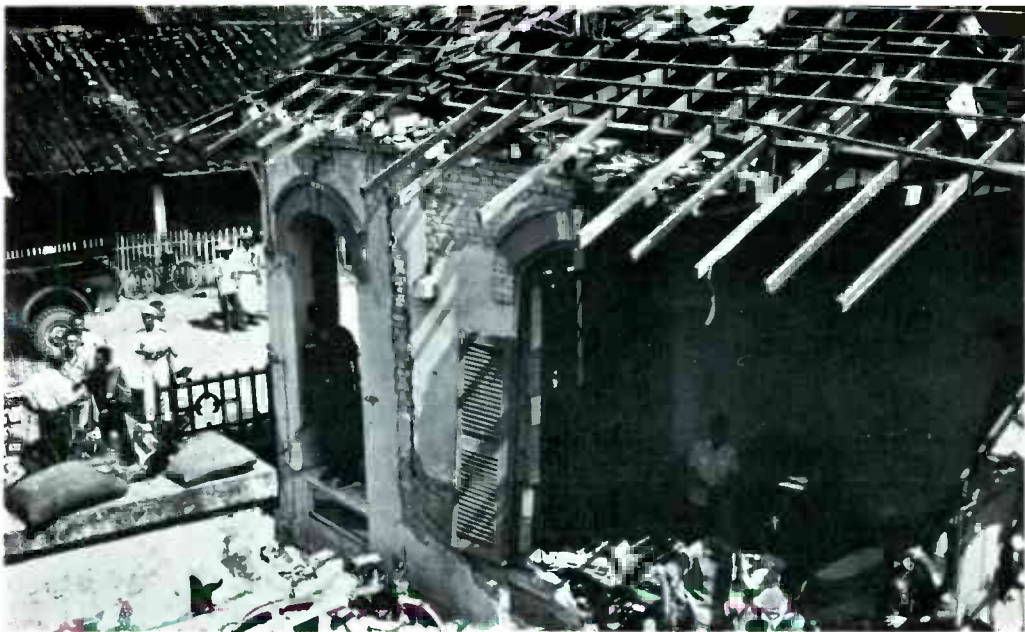

SURVIVAL OF THE FITTEST (KIT)

STUDENT ROBERT E. OLIVER doesn't have too much time these days to study his NRI Communications Course, but he's still a "believer".

Witness a recent letter:

"I claim to have the only NRI kit to survive a terrorist explosion in Viet Nam.

"Recently the 581st Signal Villa was completely destroyed by a terrorist bomb. I was in my bunk about 14 feet from the blast, and was thrown to the floor, but was unhurt.

"When I started to gather my belongings I found my kit was missing. The next day I returned to our bombed-out Villa, and after digging through the rubble found my kit.

"An examination and test proved it good as new.

"I am enclosing a photograph. . ."

The kit in question was the Complete Communications Kit No. 1. Oliver, a native of Parma, Mo., took the NRI FCC course while stationed at Fort Gordon, Ga., and last year added the Communications Course. In the Signal Corps, he serves in Viet Nam as a radio-relay engineer and repairman. His wife and child live in Parma.

"As a certified aircraft mechanic with 18 years' experience, I have seen more and more electronic equipment used in aircraft. Today's aircraft come equipped with electronic equipment that equals 1/3 the selling price of the aircraft. Ten years ago a \$300 radio was all that was needed. Today you need two transmitter-receivers with two omni receivers and indicators, an ADF, a marker beacon receiver, and in the better ships, a transistorized auto pilot with omni coupler ----in other words, about \$7500 worth of radio equipment.

"With the help of NRI, I went along with the changing times. I install radios, antennas, audio systems and mike switching systems with no problem at all.

"The company is now sending me to the Cessna Factory Electronics School to learn about their autopilots. My pay has increased 100% since I started doing radio work along with running the air and engine maintenance shop. I am sure that at least half of these increases in pay were due to my radio servicing."

Harry R. Thompson
West Springfield, Mass.

ELECTRONICS CROSSWORD PUZZLE

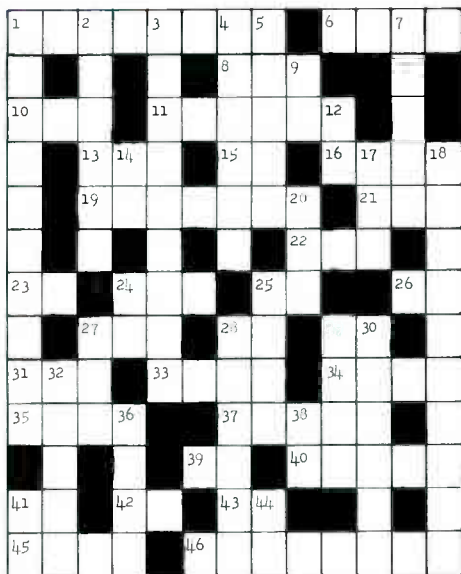

Solution on Page 25.

By James R. Kimsey

ACROSS

1. The coordinate value specifying distance in a horizontal direction from the vertical reference line on a graph.
6. A number of similar pieces of apparatus mounted so they can be simultaneously adjusted by a single control.
8. Large water vessel.
10. A gradation of color.
11. Objects of radar search.
13. Gorilla.
15. Depart.
16. A reflector in the shape of a paraboloid.
19. A trigonometric function.
21. An antique car.
22. Grow old.
23. Common system of radio broadcasting.
24. A pulse or peak on a wave pattern.
25. A switch employed when transmitting and receiving on the same antenna.
26. 3.1416
27. A measured parcel of land.
28. Large Cal. city. (abbr)
29. There are 2.54 of them in one inch.
31. Cooling agent.
33. 12 mos.
34. An alarm for maintaining a continuous watch for distress signals.
35. A number of turns of wire.
37. Damp.

39. A weight measurement.
40. A resistor placed across the terminals of an ammeter.
41. The second tone of the diatonic scale.
42. Most used crystal cut in radio frequency transmitters from 4500 to 10,000 kc.
43. Perform.
45. The cgs unit of physical force.
46. An adder in which the various orders are added simultaneously.

DOWN

1. Color that does not elicit 10 across.
2. The metal wall of a waveguide.
3. Term used to signify strength.
4. Sudden increases of current in a circuit.
5. A gas used in some rectifier tubes.
7. Undesired sound.
9. Compass point.
12. Football score.
14. Amplification system to reach a crowd.
17. Former Engineers organization. (abbr)
18. Pulse that cuts off the electron beam while it is returning to the left side of the screen of a cathode ray tube.
20. Sticky road covering.
24. Power oscillator.
25. A tropical plant.
27. Hawaiian flower wreath.
28. Greek letter to designate wavelength.
29. Best to request when doing service work.
30. A kind of inductance that generates a voltage in one circuit by the varying current on another circuit when inductive coupling exists.
32. Well known island in New York.
36. One of the loops in the radiation pattern of an antenna.
38. Symbol designating internal shield.
41. Genus of swine.
44. A switch that produces an output signal if a signal appears on any of the output lines.

THE ULTIMATE TEACHING MACHINE

An aid to rapid, almost magical learning has made its appearance. Indications are that if it catches on, all the electronic gadgets will be so much junk. It is known as Built-in Orderly Organized Knowledge. The makers generally call it by its initials, BOOK.

© PUNCH, London.

a new *Slant* on power supplies

THE PURPOSE OF THIS article is to give you a new slant on the subject of power supplies. Rectifiers, filters and loads are thoroughly covered in the NRI lesson texts. But a new and different look at the subject will often clarify some point which has been a stumbling block. The explanations which follow are unusual in their approach but will give you much food for thought, and should aid in making the more orthodox explanations easier to understand.

As strange as it may seem, the source of DC voltage in an AC to DC power supply is the filter capacitor! Let's see how this may be.

Suppose you connect two 1.5-volt flashlight cells in series. This will give you a 3-volt battery, as shown in Fig. 1. Now if we touch the leads of a good .25-mfd capacitor to the battery terminals the capacitor will immediately charge up to 3 volts. The capacitor is now disconnected from the battery. It will retain this charge until a conductive path is connected across its terminals.

If the leads of a vtvm are connected to the capacitor terminals it will measure the stored voltage. The voltage will gradually decrease, as shown by the meter reading, as the capaci-

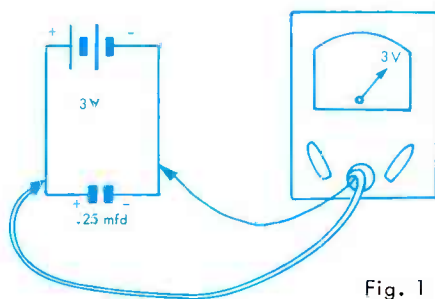

Fig. 1

tor slowly discharges through the internal resistance of the vtvm. If the vtvm is disconnected almost immediately, the voltage remaining in the capacitor will be present weeks later, if not previously discharged. Thus a charged capacitor acts like a battery with a low current capacity.

If a good 20-mfd capacitor is charged by the 3-volt battery, the vtvm reading will remain constant for quite a long time because much

more current can be stored in the larger capacitor and considerably more withdrawn before the capacitor voltage starts to decrease.

If each time the capacitor voltage starts to drop we momentarily connect it to the battery, as shown by the dotted line in Fig. 1, its voltage will remain up as long as we continue to periodically recharge it.

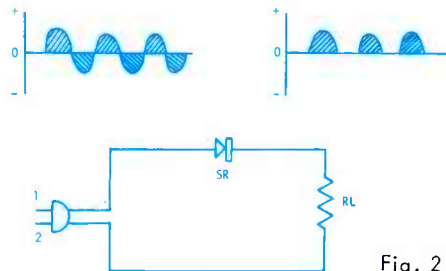

Fig. 2

To start with, we have a source of AC voltage to be used to charge the capacitor; but DC is necessary for this purpose so a rectifier is needed. A simple solid state device such as a selenium or a silicon rectifier may be used, or a tube rectifier may be employed. But does the rectifier furnish pure dc? The output of a rectifier is shown in Fig. 2.

The ac line voltage is a sine wave, three cycles of which are shown ahead of the rectifier (SR). When the side of the power line to which prong 1 of the ac plug connects is positive, prong 2 is negative. The rectifier is thus forward biased and conducts. Electrons flow from the negative side of the line through load resistor RL, through SR to prong 1. Notice the voltage starts at zero, gradually builds up to its maximum positive value and then gradually reduces to zero, at which time the line voltage polarity reverses. When this occurs, the rectifier is back-biased and it acts as an open. Therefore, whenever prong 1 is positive, the rectifier acts like a short, and when prong 1 is negative it acts like an open. Load RL is therefore connected directly across the line on each positive half cycle. This results in pulses of voltage with the correct polarity being applied to RL as shown. The current flow is also shown by these shaded pulses. Thus 60 times each second the current through RL rises from zero to maximum, drops back to zero and repeats when the line

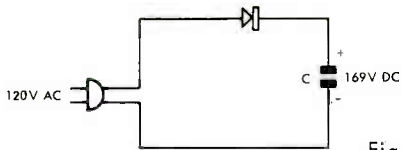

Fig. 3

voltage again reverses in polarity. Such a supply is worthless for operating electronic equipment because, while the voltage always has the proper polarity, it is both intermittent and variable. What we want is steady dc correct polarity.

Since we know that a fully charged capacitor will act like a battery, we can use the rectifier to charge a capacitor as shown in Fig. 3. If a vtvm is connected across C, observing the polarity shown, it will measure just about 169 volts DC. If you connect an ac vtvm across C, no ac will be measured! The 169 volts is the maximum value of the rectified half-wave pulse ($120 \times 1.41 = 169.2$). The capacitor will be fully charged on the first or second rectified pulse. It cannot discharge, so once the capacitor is charged, the rectifier no longer conducts.

This looks like the perfect solution to the problem, but what happens when a load is connected? Look at Fig. 4.

In Fig. 4, SR only conducts when the anode is positive with respect to the cathode. On the first pulse C charges up to the peak of the line voltage. At the same time current flows through RL. When the line voltage drops below the voltage stored in C the rectifier stops conducting and C discharges through RL, furnishing the current required by RL. The voltage across C gradually decreases, as shown by dotted line 1-2. The rectifier is cut off by reversed line voltage polarity. When the line voltage reverses and until its pulse voltage exceeds the voltage remaining in the capacitor the rectifier does not conduct. Conduction occurs at point 2. Then the capacitor recharges to the peak of the pulse and the action

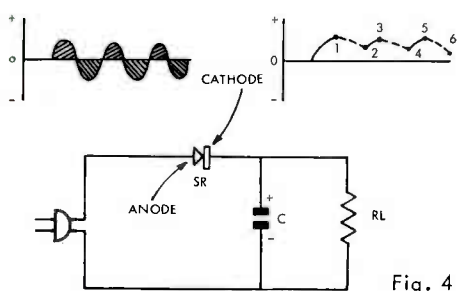

Fig. 4

repeats, as shown. Thus we have a variation in voltage across the capacitor at a frequency of 60 cps, the line frequency. This is not an ac sine wave - its shape is more like a saw-tooth, and this is what you will see displayed on a cathode-ray oscilloscope connected across a heavily loaded input capacitor.

A ripple in the dc supply voltage, as shown in Fig. 4, will result in hum being introduced in the equipment being powered from such a source. The drop, in capacitor voltage, depends on the capacity of C and the amount of current drawn by RL.

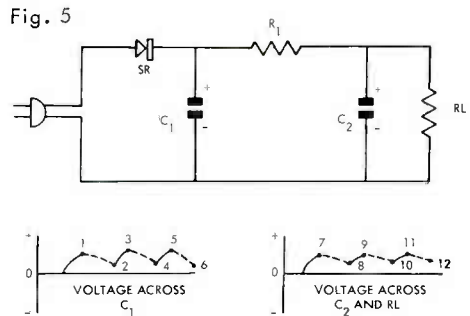

Fig. 5

In special cases where the current requirements of RL are modest, a 500-mfd or a 1000-mfd capacitor may supply a voltage sufficiently ripple-free for normal operation. Usually further steps are required.

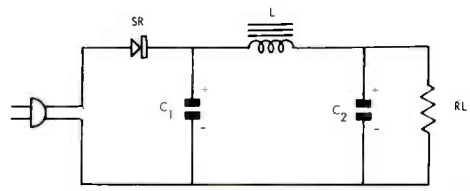

Fig. 6

As you can see from Fig. 4, it is the charging of the capacitor by SR that results in the sudden rise in voltage 60 times each second. If lines 1-2, 3-4, and 5-6 could be made horizontal rather than slanting there would be no ripple in the supply voltage. The supply voltage drops to points 2, 4 and 6 because of the capacitor discharge so they can't be jacked up to the level of points 1, 3 and 5.

Suppose, however, that we dropped points 1, 3 and 5 down near the same level as 2, 4 and 6. This would result in a great reduction in the ripple.

The way to do this is to use another large capacitor and charge it to a somewhat lower

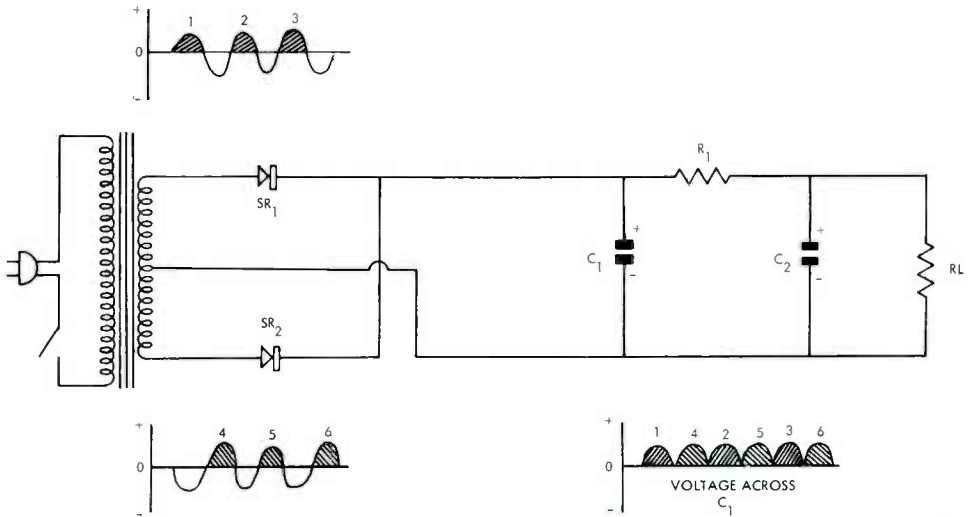

Fig. 7A

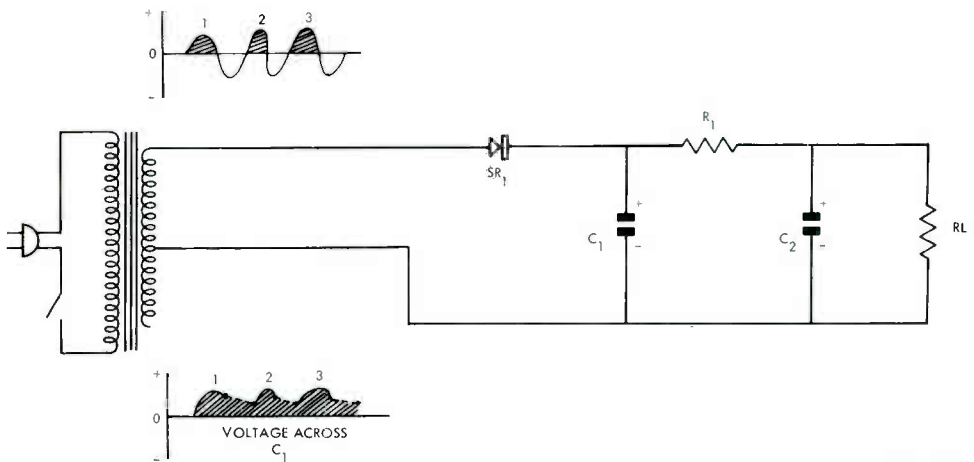

Fig. 7B

voltage through a resistor, so the charging current will be just about the same as the discharge current. Fig. 5 shows the circuit. Notice the usual ripple in the voltage across C_1 . Also note that points 7, 8, 9, 10, 11 and 12 in the C_2 voltage are much nearer the same level. Points 7, 9, and 11 are a little lower than 1, 3, and 5, but points 8, 10, and 12 are a little higher than 2, 4, and 6. Therefore, since C_2 furnishes current to RL by itself for a very limited time, its voltage drops only slightly.

The series limiting resistor R_1 prevents a large surge of current where C_1 furnishes

current to C_2 and the load. For this reason the voltage across C_2 never builds up to the voltage across C_1 and the voltage across C_2 is practically constant (pure DC) at all times.

The difference between the ripple voltage across C_1 and C_2 appears across R_1 . We call R_1 and C_2 a filter because the ripple is reduced across C_2 .

If R_1 is replaced by a choke, the filtering is improved because current is constantly being supplied to C_2 and RL . The nature of a choke is to prevent any change in current through itself. When the voltage across C_1 in Fig. 6

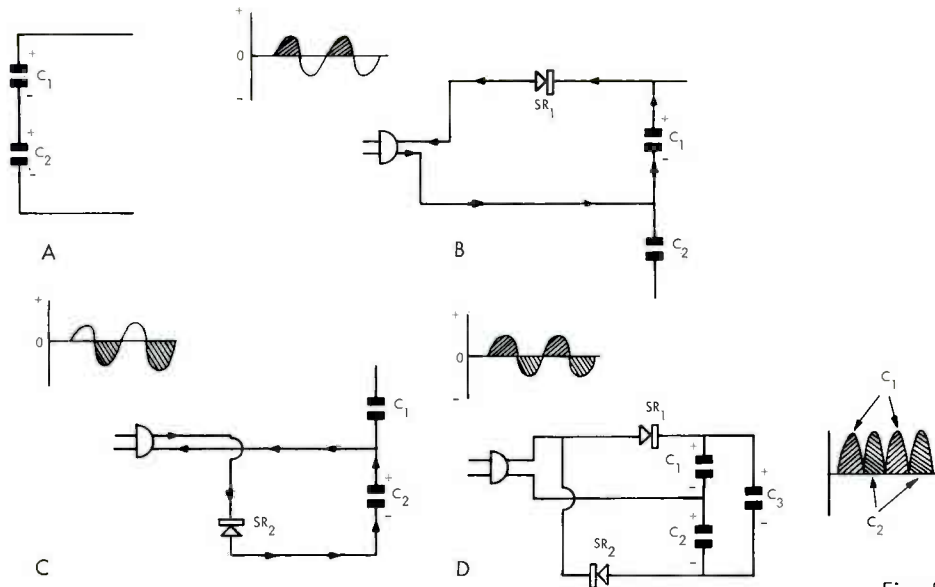

Fig. 8

increases, the current flowing to C_2 and RL would normally increase. The choke prevents this and the excess energy is stored in the magnetic field around choke L.

When the voltage across C_1 drops, C_2 would ordinarily have to take over and furnish all the current required by RL, with a consequent drop in C_2 voltage. However, at this time the magnetic field around L collapses and fur-

nishes most of the extra current required by RL. Thus the voltage across C_2 remains essentially constant.

So far we have considered half-wave rectification only, where a 60-cycle ripple is present across C_1 . Now the rate at which C_1 discharges (its voltage drops) depends, among other things (size of RL, capacity), on the length of time between charging pulses. If

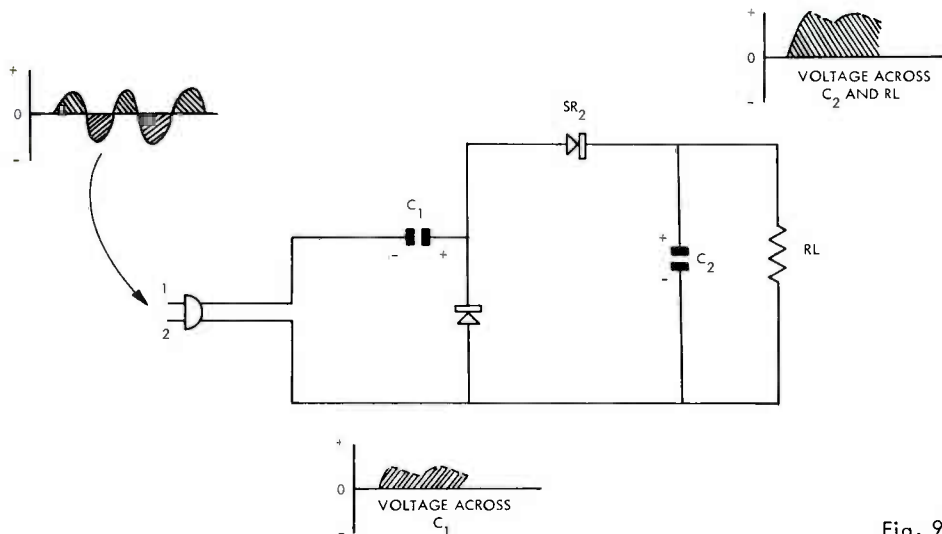
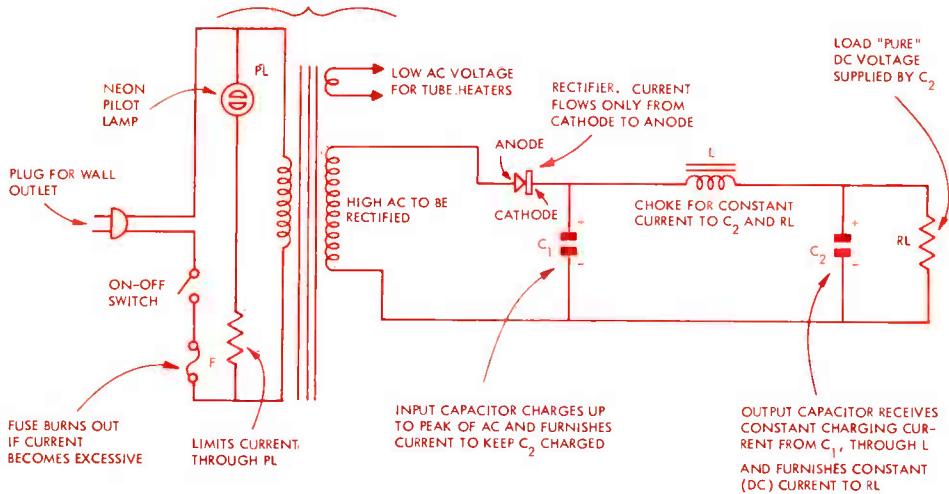

Fig. 9

POWER TRANSFORMER DELIVERS
CORRECT SECONDARY VOLTAGES
AND INSULATES SECONDARIES
FROM POWER LINE EARTH CON-
NECTION

Fig. 12



10. Such resistors, called surge resistors, limit the charging current through the rectifiers and should always be used when a power transformer (whose windings have resistance) is not employed. For simplicity a surge resistor was not shown in previous circuits. The purpose of the resistors is to protect the rectifiers by limiting the charging current into the capacitors. This is necessary with a solid state rectifier as these devices have no protective warm-up time. If you happened to turn on switch SW at the instant maximum forward bias was available to a rectifier, and its capacitor had no charge, the resulting surge of current might ruin the rectifier. The series resistance prevents too high a starting current and several cycles must elapse before the capacitors are fully charged.

So far the only load shown has been a single resistor, RL. The load usually consists, in a radio, of at least four tubes, as shown in Fig. 11. All the points marked + connect to the positive terminal of output filter capacitor C₂, and all the grounded points connect to the negative terminal of C₁.

Each tube draws its own current and is unaffected by the other tubes. Resistor R₁, R₂, R₃, R₄, and R₅ are grid resistors and no dc flows through them from the power supply.

In the case of VT₁, electrons flow from the B-terminal of C₁ to R₁, through the cathode plate

path of the tube, through R₂ to B+.

In tube VT we have electrons flowing up to and away from its cathode---some go to its screen grid (second grid) and to B+. The others pass to the plate, through L₁ to B+. In VT₂ the electrons drawn by this tube flow to its cathode, and some travel to the screen and through R₄ to B+. The remainder of the electrons emitted by this cathode pass to the plate, through R₅ to B+.

VT₃ is a power output tube and acts as a very low resistance load. Electrons flow from B-through R₇ of the cathode; those electrons not captured by the screen and returned directly to B+ reach the plate, pass through the primary of TR and are returned to B+.

Now bear in mind that the only reason the electrons flow is because the individual tubes furnish an electronic path in discharging C₁. No mixup occurs---the current drawn by VT₁ is not going to flow through VT₂ or vice versa. It might seem a bit pointless to even make such a statement, but there are some beginners who have gotten mixed up about this.

One final diagram, for the student who cares, is shown in Fig. 12. Here the purpose of each part is indicated. It will help you to review in your own mind what you have been able to pick up from this article. Let us know if you have any other "stumbling blocks" you'd like clarified, and we'll try it.

what's ?

new ●

Japan is tackling her shortage of nurses in at least one instance, the Juntendo University Hospital in Tokyo, with an electronic device called the "Auto Nurse." The system consists of a thermometer and pulse gauge at each bedside, connected to a central memory and tape read-out. The theory is Pavlovian: When a bell rings, the well-trained patient puts the thermometer under his tongue and sticks his finger in the terminal of the gauge. The gauge, equipped with a miniature bulb, records the quantity of light passing through the finger tip, which varies with the quantity of blood there, which in turn changes with each pulse beat. Accuracy of the temperature sensor is rated at $\pm 0.1C$ ($0.18F$) and the pulse beat ± 3 beats. A thermistor is built into the tip of the instrument, which is 0.2 inches in diameter and 4 inches long. Temperature and pulse readings reach the memory circuit and are taped within two minutes. So far it has been successful, releasing the un-automatic nurses from the routine for more important aspects of the patient's care.

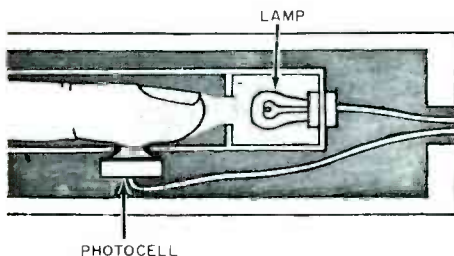

TEXAS HUNT'S ON THE BEAM

Treasure hunters near Salado, Texas, are using a laser beam to drill through limestone. They hope to find coins legend says were buried there by Spaniards centuries ago, but will settle for metal.

The newest idea in fighting traffic congestion in urban areas is proposed in a Cornell study for the Commerce Dept. For city and suburban passenger car travel, it suggests a type of golf cart, a small electrically powered car that would be under automatic control once it moved onto city streets. Careful regulation of spacing would allow 7200 cars an hour. Spacing could be in one of two forms, one in which cars would be coupled into trains, and the other in which each car's spacing was electronically controlled. The latter would require a high degree of electronic sophistication which would probably make its cost prohibitive, and the study concludes, it's not sure that the general public has that much confidence in electronic devices yet. Huh?

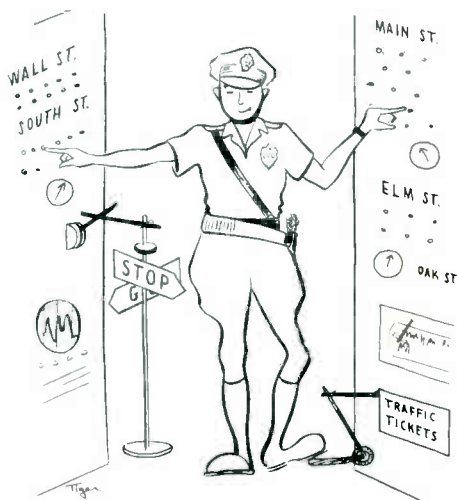

BRITONS GET SOME STATIC, BUT FROM A NEW CHANNEL

A study by the British Post Office Engineering Dept., the equivalent of our FCC, found that of 15,134 complaints of television interference, only 82 were caused by hams, 54 of those on VHF channels. Other causes were traced to radiation from deflection circuits of other TV receivers (343); contact devices such as thermostats and switches (1585); sewing machines (824); portable tools (322); hair-dryers (210); filament type lamps (149); neon signs (366); overhead power lines (1237); and the greatest cause, unsatisfactory conditions at receiver locations (6,160).

NRI STUDENTS: SOME START VERY YOUNG

Recent news item from the SACRAMENTO BEE, Sacramento, Calif.:

"CHICO--Tero J. Walker, 15, of Durham, and Margaret Grahlman, 17, have been named grand winners in the annual California Central Valleys Science Fair here.National Aeronautics and Space Administration Awards were made to Tero J. Walker . . . the Navy Science Cruiser Award was made to Tero J. Walker, the grand winner The grand winners will travel with their exhibits to compete in the 17th International Science Fair in Dallas, Texas, at the Dallas Memorial Auditorium. All expenses of the trip will be paid. . . . Nearly 350 students from elementary and secondary public, private, and parochial schools . . participated in the event. . . ."

(The International Science Fair is an activity of Science Service of Washington, D. C., a non-profit organization devoted to the popularization of science. The Fair was established to inspire greater interest among students in the fields of pure and applied science. In 1950, thirty finalists from thirteen areas of the United States participated; in 1965, four hundred students entered from two hundred twenty one areas, including Canada, El Salvador, Israel, Japan, and Sweden.

(Fifteen thousand regional, state, or nationwide science fairs having a total of nearly one million exhibits lead to the International Science Fair. Payment for entrance fees as well as transportation, meals, and housing for the finalists are assumed by local newspapers or cooperating groups. These local organizations encourage incentive, recognize ability, and honor good sportsmanship and performance.

(Boys and girls eligible for the International Science Fair must be in their last three years of secondary school to qualify. Exhibits must illustrate biological, chemical, physical, or technical principles; laboratory procedures; industrial developments; or collections. The judges are scientists who have been appointed by Science Service -- the awards are based on creative ability, scientific thought, thoroughness, skill, clarity, and dramatic value. Ninety percent of finalists choose science or engineering careers.)

What the story didn't say, quite naturally, is that Tero is an NRI student as well, a recent enrollee in the Electronics Course. He enjoys the course "very much," he wrote NRI president J. M. Smith in a recent letter, although hardest is "finding time for it between school and other activities."

His NASA award entitles Tero to spend a week at a space center; his Navy award included a pair of binoculars and a projected summer cruise for two weeks on a Navy ship. He was also allowed by the International Science Fair's Science Service to make a "wish" for a piece of equipment costing under \$100.

"I wished for a CONAR 5" wide-band oscilloscope (Kit Stock No. 250 UK) and told them if it cost too much I would pay the balance out of my allowance," Tero reported. (It doesn't; list price for the Kit is \$89.50, and students get a sizable discount.)

Winning awards is old stuff to Tero, by the way. For two previous years he was winner of the grand first prize in the junior division of the Science Fair at Chico, and was elated because "this year I was allowed to enter in the senior division."

Tero's project was "Gamma Radiography", which he sums up with considerable erudition. "It shows how gamma rays are absorbed by matter, and can be detected through density changes on photo emulsions. The degree of change is in relation to the density of the matter. The purpose of the project is to observe the inside of the material for defects and flaws."

Tero didn't place in Dallas, but is the high-school sophomore discouraged? Nope. The contest is hardly over, and already he's planning what he will do next year. "Mr. Smith," he wrote, "my next year's project will involve (sic) some electronics. . . I will have progressed in my course to where I can use it. I am in hopes that your staff can advise me on some of the problems as they develop. . ."

Tero, say no more. If you need any help at all, we're here. But what we were wondering was, could you advise us on a few things? . . . ALLENE MAGANN

..... AND SOME ARE VERY YOUNG IN HEART

IT'S NEVER TOO LATE for a new interest. Witness sixty-two year old Myles G. Standish, the eleventh direct descendant of the Captain Miles Standish who together with John Alden established the first colony of pilgrims in Massachusetts.

Because many people ask him to repeat his name, our Mr. Standish has done extensive research into his family background. (Henry Wadsworth Longfellow's poem, "The Courtship of Miles Standish," committed to posterity the lives of Captain Standish, John Alden, and one Priscilla Mullins. When Captain Standish asked John Alden to propose to Priscilla in his behalf, Priscilla told the go-between to speak for himself, and John Alden and Priscilla were married!)

The relationship of the three pilgrims came to the fore again when, in 1940, Mr. Standish worked with a John Alden who was the direct descendant of the suitor who had won Priscilla. During the three years they worked together, business associates would quip, "There goes Myles Standish and John Alden. The only one missing is Priscilla!"

Mr. Standish worked in New York City for a number of years and realized the predominance of electronics plants in that area. Seeking a hobby for his retirement years, he began to consider home-study in the radio-TV-electronics field and enrolled with NRI in November, 1962. Why NRI? "Because, of all the schools I considered," said Mr. Standish, "yours was the one that seemed to give me just what I wanted."

At the time of his enrollment Mr. Standish explained to NRI that he was interested in amateur radio and was a "CB'er -- KBG1273" who wanted a more advanced FCC license so he could leave that already crowded band to work on other bands. As Mr. Standish progressed in his courses, he realized that his intended hobby would provide enjoyment as well as a supplemental income to his Social Security. Later he also took the complete Communications Course.

At the present time, however, Mr. Standish, although a graduate of NRI, is unable to perform full-time radio repair work in his home -- he is quite busy as Eastern Assistant Manager for the Robert W. Hunt Company, a New York engineering firm of more than 400 employees which specializes in consultation, inspection, and testing. How's that for retirement? Mr. Standish maintains that his



NRI courses have helped in his business, "in that we are now able to take on additional assignments having to do with electronic gear and antennas, etc." He also says that he keeps "quite busy, but not busy enough to deprive myself of some pleasures", referring to his interest in ham radio activities.

"Through the knowledge gained through the NRI course," Mr. Standish continues, "I was able to acquire my Radio Amateur License (WB2MAP) and also became active on the MARS net (AL2MAP)." That his NRI courses have proven a successful venture is further evidenced by Mr. Standish's election to the office of secretary-treasurer of K2USA, an amateur radio club at Fort Monmouth, N. J.

His interest in amateur radio brought Mr. Standish into contact with Larry M. McNeese, also a member of the K2USA Amateur Radio Club, which meets at the Fort Monmouth MARS Station. Mr. Standish recommended NRI to Mr. McNeese, who became a student in January, 1966. Mr. McNeese, in turn, has encouraged a number of his friends to enroll. Both men have noted that prospective students are impressed by NRI's use of training kits to facilitate study in the field of radio-TV-electronics.

Mr. Standish has found that his famous name is advantageous in initiating new business contacts. Perhaps it will also prove helpful to his son, Myles K., now a wireman for Electronics Associates, West Long Branch, N. Y.

Students who are discouraged or prospective students who are in doubt will profit by noting Mr. Standish's accomplishments. NRI has given this energetic man a new interest, assistance in his current work, and lasting friendships with associates having a common interest in radio and electronics. And he, in turn, has given NRI more new friends.

... BEVERLY CROUCH



BY STEVE BAILEY



DEAR STEVE:

What is meant by ac resistance and dc resistance and what causes the difference between them?

E. R., N. J.

AC resistance is the non-reactive opposition offered by a conductor to the flow of an alternating current through it. DC resistance is the opposition offered by a conductor to the flow of direct current through it.

At most frequencies, ac and dc resistance are virtually the same. However, at extremely high frequencies, what is known as the "skin effect" takes place. Then most of the current flows on the surface (skin) of the wire. The effect is the same as if a conductor with a smaller diameter (higher resistance) was used. There will then be an increase in power loss ($P = I \times R$) in the conductor. These losses will increase as the frequency is increased. This makes electron flow difficult, so the ac resistance is effectively increased.

DEAR STEVE:

In Lesson 5BB, I am studying the formulas for determining power. I don't quite understand how to use them. Would you give me further information?

M. B., Va.

The formulas for determining power can be used whenever you know two of the three important factors: voltage, current, and resistance. As long as you know two of these factors, you can determine the power dissipation. All you have to do is note what values are given and choose the formula that uses these values

from the three basic power formulas:

$$P = E \times I, P = I^2 \times R, \text{ and } P = E^2/R.$$

To prove this, assume that we know that $E = 100$ volts, $R = 50$ ohms, and $I = 2$ amperes. We can now use all three formulas for power. In each case, the answer should be the same: 200 watts.

$$\begin{aligned} P &= E \times I \\ P &= 100 \times 2 \\ P &= 200 \text{ watts} \end{aligned}$$

$$\begin{aligned} P &= I^2 \times R \\ I^2 &= 2 \times 2 = 4 \\ P &= 4 \times 50 \\ P &= 200 \text{ watts} \end{aligned}$$

$$\begin{aligned} P &= E^2/R \\ P &= 100 \times 100/50 \\ P &= 10,000/50 \\ P &= 200 \text{ watts} \end{aligned}$$

DEAR STEVE:

What is a ground connection and what is its purpose?

L. P., Md.

The word "ground" simply means a point of zero potential. In sets that use a power transformer, ground is normally the chassis. In sets where a power transformer is not used, ground is referred to as "B-". This is a series of common connections that are insulated from the chassis.

A point of zero potential is necessary to establish a reference point so that voltage measurements can be made. For example, the voltage on the plate of the tube is positive with respect to ground. The voltage on the grid may be negative with respect to ground.

Another term you will see is "signal ground." This is a point which is at ground potential only as far as the signal is concerned. Its dc potential is equal to the value of the dc voltage at that point.

The diagram below should illustrate the difference between "ground" and "signal ground" potential. The dc potential at point A is equal to the B+ voltage value minus the voltage drop across resistor R. However, notice capacitor C. This capacitor can be selected so that its reactance at the signal frequency is much lower than the resistance of R. This means that any ac or signal voltage present at point A will take the path of least resistance and flow through the capacitor to ground rather than through the resistor. An ac voltmeter connected from A to ground will measure little or no ac (signal) voltage, but a dc voltmeter will measure a high dc voltage from A to ground. Thus, point A is grounded as far as the signal is concerned, but not as far as dc is concerned.

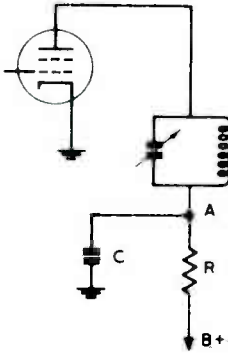

It should be added that ground connections are also used to connect one side of a circuit back to the source so that a complete circuit is formed. By connecting one side of the source to ground and one side of the load to ground, a complete circuit can be formed without the necessity for interconnecting hook-up wire. This greatly simplifies the wiring of a piece of equipment.

DEAR STEVE:

I would like to know more about current relationships in a transformer. I know that voltage will be stepped up in a step-up transformer and stepped-down in a step-down transformer, but what happens to the current?

S. F., Fla.

The easiest way to remember current and voltage relationships in a transformer is to

remember that they are opposite. To find the current ratio, just turn the voltage ratio around.

For example, consider a step-up transformer with a turns-ratio of 1:3 and a secondary load resistance of 300 ohms. The turns-ratio tells us that the secondary voltage will be three times the primary voltage. Thus if the primary voltage is 100 volts, the secondary voltage will be 300 volts.

Now to find the secondary current, we merely use Ohm's Law. In our example the secondary delivers 300 volts and its load resistance is 300 ohms, so

$$I = \frac{E}{R} = \frac{300}{300} = 1 \text{ ampere.}$$

To find the primary current, we turn the voltage turns-ratio around. It is 3:1. From this, we see that the primary current is three times the secondary current. Since $3 \times 1 = 3$ amperes, we have found the primary current.

This can be summed up by saying that the current in a voltage step-up transformer is stepped down and the current in a voltage step-down transformer is stepped-up. Of course, the exact amount of current in either the primary or the secondary depends upon the value of the secondary load resistance and the secondary voltage.

DEAR STEVE:

The formulas I have received in my course really help me in understanding the theory I have studied. My major trouble, however, is in converting known values to units in order to use the formulas. Do you have any suggestions?

D. R., Ala.

The best solution to your problem is for you to keep a conversion chart handy so you can refer to it whenever you work math problems. For your convenience, I have shown just such a chart on the following page.

This chart shows how to convert numbers from small units to whole units or vice-versa. The arrows indicate the direction you are to move the decimal point. For example, to convert milli-units to whole units, move the decimal point three places to the left. To convert from micro-units to whole units, move the decimal point six places to the left. To convert from whole units to either milli-units or micro-units, merely reverse the process.

I suggest you make a copy of this chart and

From	→	To
MEGA	3 places	KILO
KILO	3 places	UNIT
UNIT	3 places	MILLI
MILLI	3 places	MICRO
MICRO	6 places	PICO
To	←	From

Electrical unit conversion table.

keep it handy so you can refer to it easily. After using it a few times, you will find yourself referring to it less and less until you have finally memorized it.

DEAR STEVE:

At this time, I am studying the section in Lesson 9BB on Iron Core Chokes. It states here that if a choke becomes saturated, its inductance will drop. Why is this?

R. J., N. Y.

The inductance of a filter choke is given at a specific DC current. If the specifications of a filter choke are 8 henrys at 250 ma, the choke will have that value of inductance but only when 250 ma flows through it. If a current less than 250 ma flows through the choke its inductance will be greater than 8 henrys. If the current through the choke exceeds 250 ma the inductance will be less than 8 henrys, and the excessive current may damage it.

This change in inductance that occurs when the dc varies is caused by the effects of the iron core used in the choke. The iron core gives a greater inductance than a similar air core coil. In other words, if we compared the inductance of the choke with an iron core to one without an iron core, we would find the inductance to be greater with the iron core. The reason for this is that the iron core has a greater permeability than air. Permeability expresses the ability of a core to conduct magnetic lines of force.

Now we must consider the magnetic field produced by the coil when current flows through it. First we have a choke with an air core. If current flows a magnetic field will be produced. If we use an iron core in the same coil and keep the current the same, the flux lines will be concentrated in the core and the number of flux lines passing through the coil will increase. We can increase the flux density in the core if we increase the current flowing through the coil.

If we continue to increase the current to obtain a greater flux density, we will soon reach a point when there will be no further increase in the number of flux lines passing through the core. This point is called saturation. When it occurs, there is a high current flowing. Saturation causes the permeability of the core to decrease, thus decreasing the inductance of the coil. This effect might even be considered as being the same as removing the iron core when a high current flows.

You may now wonder why the permeability of the core decreases at saturation.

First, remember that as we increase the current through an iron core choke coil, the magnetic field will increase in strength. The iron core becomes increasingly filled with flux lines. Soon the core becomes fully saturated with flux lines and increasing the magnetizing force further will produce no increase in the flux density. As explained before, this is saturation and the permeability of the core decreases, thereby decreasing the inductance of the choke. The permeability is equal to the ratio of the flux density produced to the magnetizing force producing it. The permeability is high as long as a current increase causes a greater magnetic field. As soon as saturation is reached, the flux density no longer increases with an increase in magnetizing force, so the ratio and permeability decreases. The inductance also decreases, since it is directly proportional to permeability.

Most chokes are designed to operate right before saturation occurs. At this point the choke may be partially saturated. So, decreasing the current flowing (the magnetizing force) causes the permeability to increase slightly, thus giving a little more inductance.

DEAR STEVE:

It is my understanding that you can operate a 25-cycle transformer on 60-cycle power, but you will destroy a 60-cycle transformer if you operate it on 25-cycle power. Why is this?

B. R., Calif.

If you remember, one of the characteristics of a coil is inductive reactance. When a transformer is designed, the diameter of the wire and the number of turns used in the primary are selected to handle a certain amount of power. This power will be developed because of the inductive reactance, the current through the primary, and the voltage will be applied to the primary.

METEOROLOGISTS BELIEVE IN GHOSTS, AT LEAST AS AID TO COLLECTING DATA

BOULDER, COLO.---Super-pressure balloons, each with a three-ounce telemetry package and a half-wave dipole antenna, are expected to initiate a new era in meteorological data collection. (Weather data is now available above only about 10 per cent of the earth's surface.)

Data on the position of the balloon is simple to reduce. The operator at the receiver end uses his stopwatch to time the Morse code rate. The balloons, ranging from 5 to 13 feet in diameter, will stay aloft at least 90 days, with expectations that some of the larger ones will stay up about six months.

The project is sponsored by National Center for Atmospheric Research and is called Global Horizontal Sounding Technique (GHOST).

Under the direction of Vincent E. Lally, meteorologist in charge of the program, a second field test was recently conducted in Christchurch, New Zealand, with 100 mylar balloons sent into the troposphere and lower stratosphere of the Southern Hemisphere. Each balloon was calibrated first in a bal-

(Continued from Page 22.)

Also, keep in mind that the inductive reactance is dependent on the frequency of the applied voltage. If the frequency changes, so will the reactance. This relationship is directly proportional, so that an increase in frequency will result in an equivalent increase in reactance. A decrease in frequency means an equivalent decrease in reactance.

When a 25-cycle transformer is operated on 60 cycles, the reactance of the primary will increase, but the operation of the transformer will not be affected. However, when the 60-cycle transformer is operated on 25-cycle power, the reactance decreases to less than half its original value. This value will be so low that it appears to be little more than a direct short across the power line. This means that excessive current will flow and the transformer will be destroyed.

Life is a glass given to us to fill, a busy life is filling it as much as it can hold; a hurried life has had more poured into it than it can contain.

Wm. Adams Brown

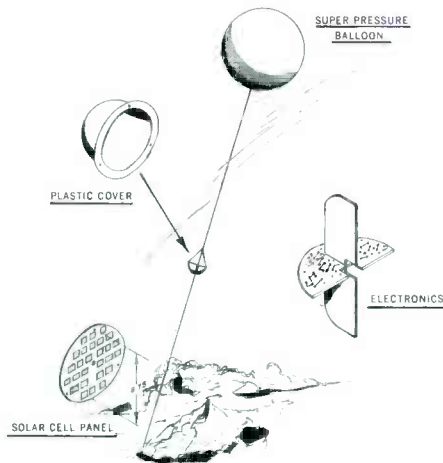

loon calibration chamber built for the occasion.

The 100-gram telemetry package---a repetition of the 1964 successful flight---identified the position of the balloons by simple data transmission. The rate of Morse code transmission was determined by the sun angle on the solar cell panel, with transmitter frequency at 15.025 mc's.

The rate and calculation of the sun's angle tell the meteorologist, to within 60 to 100 miles, the balloon's position, usually from not more than two to three readings.

Ernest Lichfield, developer of the package, also developed a four-channel package to transmit data on the meteorological parameters. The altitude of the balloon, because it flies at a constant air density level, is known from telemetry of the temperature data.

The simpler sun-angle location system will be used on most balloon flights to provide trajectory data and wind information over the Southern Hemisphere. Every fifth flight, according to Mr. Lally, will be equipped with the four-channel telemetry to monitor all elements of balloon performance.

A Ghost network of 10 stations is tracking the balloons' positions, covering nearly the entire Southern Hemisphere. The United Nation's World Meteorological Organization was instrumental in organizing the network.

NOMINATIONS OPEN FOR NATIONAL OFFICES IN NRI ALUMNI ASSOCIATION FOR 1967

One of the fine traditions of the NRI Alumni Association is the opportunity it presents for granting recognition to its outstanding members. It does this through election of these members to National Office. There are five such openings the Presidency and four Vice-Presidencies. We are now ready to undertake the election of these officers for 1967.

We will begin with the nomination of the candidates, two for President and eight for Vice-President. These nominating votes must be mailed to reach NRI by July 25. They will be tallied and the names of the winning nominees will be published in the September-October issue of the NRI Journal.

Of course, only NRI Graduates who have joined the Alumni Association are eligible to vote. Likewise, only members of the Association are eligible for National Office.

There are limitations on re-election to these offices. They are given in Article VI, Section II of our Constitution quoted below:

"The President shall not be eligible for re-election until after expiration of at least eight years following his last term of office and, further, may be a candidate for Vice President only after expiration of at least a year following his term of office as President, Vice-Presidents may not serve more than

two consecutive terms; when re-elected for a second consecutive term they shall not thereafter be candidates for Vice-President until after expiration of at least three years following their second term of office."

These limitations affect the present officers as follows: Howard Tate is ineligible for either the Presidency or a Vice-Presidency; F. Earl Oliver may not run for a Vice-Presidency but is eligible for the Presidency; the remaining officers qualify for nomination either as President or a Vice-President.

There is never a lack of members who deserve the honor of election to one of the National Offices -- there are so many fine men in the Association. Usually, though, there is at least one member -- sometimes two or three or more -- who stands out at the time the election campaign rolls around or to whom the recognition may have been due for sometime. This year it is Eugene DeCaussin. Election to the Presidency has long been due him for the fine work he has done as Chairman of the Los Angeles Chapter for so many years.

Other members you may want to consider nominating, chosen at random by geographical location, are listed under "Nomination Suggestions". Vote as you wish, either from the above list or other preference, and mail your ballot (Page 28) to reach NRI by July 25.

NOMINATION SUGGESTIONS

Clinton J. Kenard, Birmingham, Ala.
Kermit D. Hinkle, Huntsville, Ala.
T. H. Dinwiddie, Tucson, Ariz.
Arthur L. Dillon, Phoenix, Ariz.
Charles N. Bragg, Benton, Ark.
Albert J. Thompson, Little Rock, Ark.
Arnold Hopkins, El Ceritto, Calif.
Harold Jenkins, Oakland, Calif.
Gerry Dougherty, Long Beach, Calif.
Robert Belew, Los Angeles, Calif.
Phil Stearns, San Francisco, Calif.
George Keller, Colorado Springs, Colo.
Edward Gordon, Denver, Colo.
William D. Warner, Stamford, Conn.
Herbert J. Brady, Norwich, Conn.
Lewis B. Best, Wilmington, Del.
Earl F. Clow, Dover, Del.
Walter S. Battle, Washington, D. C.
Charles T. Frye, Washington, D. C.
Carl Fernstrom, Tampa, Fla.
J. Stanley Ross, Miami, Fla.

Jesse C. Smith, Savannah, Ga.
A. H. Moorhead, Sr., Atlanta, Ga.
Joseph H. Bingham, Twin Falls, Idaho
Jack R. Dickerson, Pocatello, Idaho
Paul L. Kline, Carbondale, Ill.
Walter E. White, DeKalb, Ill.
Walter Charkow, Chicago, Ill.
John A. Mitchell, Arlington Heights, Ill.
Howard M. Howell, Indianapolis, Ind.
Donald A. Martin, South Bend, Ind.
P. L. Bishop, Cedar Rapids, Iowa
Normand E. Wood, Sioux City, Iowa
William M. Martin, Kansas City, Kans.
Donald W. Steward, Hutchinson, Kans.
John C. Davis, Louisville, Ky.
William A. Troxell, Lexington, Ky.
Andrew J. Cavin, Baton Rouge, La.
Ernest Carey, Lake Charles, La.
Oral S. Dyer, Freeport, Maine
Ray C. Fogg, Bangor, Maine
George A. Vogel, Baltimore, Md.

Moses Messer, Landover, Md.
 Daniel DeJesus, New Bedford, Mass.
 Edward Bednarz, Fall River, Mass.
 John T. Park, Ware, Mass.
 Frank Plantek, Chicopee Falls, Mass.
 B. W. Hooper, Flint, Mich.
 William C. W. Endahl, Flint, Mich.
 Thomas M. Oliver, Harper Woods, Mich.
 Leo H. Blevins, Detroit, Mich.
 Gene Falkner, Columbus, Miss.
 Jack Haney, Greenville, Miss.
 S. M. Watson, Springfield, Mo.
 Clyde Weston, St. Louis, Mo.
 Harry A. Carroll, Butte, Mont.
 Wayne C. Smith, Missoula, Mont.
 H. R. Ruehl, Lincoln, Nebr.
 Frank J. Zpevak, Omaha, Nebr.
 Lloyd W. LeMay, Reno, Nev.
 Phillip T. Hubel, Henderson, Nev.
 Roland W. DeLisle, Manchester, N. H.
 Norman A. Collishaw, Concord, N. H.
 Alex Bunn, Englewood, N. J.
 George Stoll, Kearny, N. J.
 Ray R. McCarty, Albuquerque, N. Mex.
 Howard Carlton, Carlsbad, N. Mex.
 Samuel Antman, Brooklyn, N. Y.
 Joseph G. Bradley, New York, N. Y.
 James Eaddy, Brooklyn, N. Y.
 Robinson Vargas, New York, N. Y.
 Albert Bimstein, New York, N. Y.
 Henry R. Zeman, Charlotte, N. C.
 James Baskin, Greensboro, N. C.
 Bueford Johnson, Bowman, N. Dak.
 Willard F. Velline, Fargo, N. Dak.
 William E. Cook, Toledo, Ohio
 LeRoy A. Seeger, Columbus, Ohio
 Richard A. Martin, Oklahoma City, Okla.
 William F. Norman, Tulsa, Okla.
 Ernest M. Fix, Portland, Oregon
 Edward J. Rogers, Astoria, Oregon
 Jack Fox, Pittsburgh, Pa.
 James L. Wheeler, Verona, Pa.



Thomas D. Schnader, Irwin, Pa.
 Harvey Morris, Philadelphia, Pa.
 John Pirrung, Philadelphia, Pa.
 Elmer F. Smith, Providence, R. I.
 Harry Desrochers, Woonsocket, R. I.
 H. C. Steele, Columbia, S. C.
 Charles C. Taylor, Charleston, S. C.
 Melvin R. Leeper, Rapid City, S. Dak.
 Arthur Richardson, Beresford, S. Dak.
 Frank J. Hughes, Bristol, Tenn.
 Charles Osborn, Memphis, Tenn.
 Jesse DeLao, San Antonio, Texas
 Robert E. Bonge, San Antonio, Texas
 William B. Hilliard, Bountiful, Utah
 Clifford Taylor, Salt Lake City, Utah
 Edgar P. Howl, Charlottesville, Va.
 Russell N. Pratt, Roanoke, Va.
 Daniel W. Churchill, Springfield, Vt.
 Arthur U. Olson, Bennington, Vt.
 Clarence E. Crane, Vancouver, Wash.
 Johnnie Zimmer, Seattle, Wash.
 Ernest M. Varner, Parkersburg, W. Va.
 A. L. Monroe, Weirton, W. Va.
 Philip R. Frederick, Green Bay, Wis.
 Melvin C. Kuschel, Milwaukee, Wis.
 Harold P. Brown, Laramie, Wyo.
 Garrett Mulhern, Cheyenne, Wyo.
 D. S. Chaney, Honolulu, T. H.
 Clifford B. Berg, Flin Flon, Man., Canada
 R. E. Foster, Victoria, B. C. Canada
 Wilfred F. Arsenault, Dalhousie, N.B., Canada
 Albert A. Porter, St. Johns, Nfld., Canada
 Jack Dodge, Halifax, N. S., Canada
 Karl Leitner, Toronto, Ont., Canada
 Walter G. Dent, Regina, Sask., Canada
 Ben Heller, Montreal, P. Q., Canada



"So you're Bill's boss! My goodness, you don't LOOK like an insufferable fathead!"

EMPLOYMENT OPPORTUNITIES

The following firms have requested that they be listed as continuing prospective employers of NRI graduates in the designated capacities:

RCA SERVICE COMPANY, Camden, N. J.
Needs TV Servicemen at most RCA Service Factory Service Branches. Technical School training essential prefer B/W and Color Service experience. Apply at RCA Branch nearest you, consult Yellow Pages or write to D. A. Giordano, Mgr., Employment, RCA Service Co., Cherry Hill, N. J.

LEONHARDT APPLIANCE INC.
309 Guthrie, Louisville, Ky.
Needs experienced refrigerator man.

RADIATION SERVICE COMPANY
9342 Fraser St., Silver Spring, Md.
Needs Communications Technician with 1st class FCC license to train in Baltimore. No experience necessary. Pays \$80 - \$125 wkly. Car furnished.

GENERAL TELEPHONE OF INDIANA, INC.
501 Tecumseh St., P. O. Box 1201, Fort Wayne, Ind. 46801
Openings in exchange offices in Indiana. No experience needed for: PBX MAN-To install and maintain mobile telephone systems of electronic relay and electro-mechanical types. SWITCHMAN-To install and maintain mobile telephone systems throughout state.

SIMPSON ELECTRIC COMPANY
5200 Kinzie St., Chicago, Ill. 60644
Openings for technicians, design and development engineers, electro-mechanical and production engineers. Write: W. F. Jones.

SYLVAN STEREO AND TV SERVICE CO.
306 Kennedy St., N. W., Washington, D. C.
Opening for radio-TV serviceman. Call Mr. Lee, 726-5800.

COMMUNICATIONS ENGINEERING CO.
(Division of Sylvan Electronics)
6610 Blacklick Rd., Springfield, Va.
Needs technician with FCC license. Call Mr. Brown, 451-5700.

CHESAPEAKE AND OHIO RAILROAD CO.
409 11th St., Huntington, West Virginia
Needs technicians for electronics maintenance on railroad. Must have 2nd class license or better. Openings in Ill., Mich., Ky., and Va.

STATION WFMD, Frederick, Md.
Needs technician with 1st class license.

LEPERT, ELECTRICAL APPLIANCES
623 H St., N. W., Washington, D. C.
836 Leesburg Pike, Falls Church, Va.
Occasional need for appliance servicemen.

AERO TV AND APPLIANCE COMPANY
7314 Little River Turnpike, Annandale, Va.
Needs appliance servicemen. Write: A. Berry.

ALL-TRONICS, INC.
560 Portage St., Kalamazoo, Mich., 49006
Needs electronics technician.

UNITED AIRLINES
Wash. Nat'l. Airport, Washington, D. C.
Openings for radio technician.

AMERICAN TEL. AND TEL.
1130 17th St., N. W., Washington, D. C.
Needs electronics technician.

SACRAMENTO ARMY DEPOT
Sacramento, California
At moment needs 120 radio technicians.

AUDIO FIDELITY CORPORATION
6521 West Broad, Richmond, Virginia
Needs audio-visual repairmen and electronics technician.

INDUSTRIAL AND MERCHANDISING SERVICES, S.A. 4201 Mass. Ave., N.W. Wash. D.C.
This is a large European organization which has just begun to establish appliance service shops throughout the U.S.A. It has openings for appliance servicemen, presently in Baltimore and Washington, later in other cities. Address inquiries to Mr. Carl Schleicher.

DECCA NAVIGATOR SYSTEMS, INC.
1706 L Street, N. W., Washington, D. C.
A London-based world-wide organization needs radio technicians with 1st and 2nd class operator's license for jobs in U. S. A. and overseas. Contact Mr. Lederer at the Washington office of Mr. Riley, Decca Navigator Systems, Inc., 386 Park Avenue, S., New York, N. Y.

WESTERN UNION TELEGRAPH CO.
1405 G. Street, N. W., Washington, D. C.
Needs electronics technicians. Write or telephone Mr. B. L. Krise, Manager, Technical Services.

VANITY FAIR

P. O. Box 111 Monroe Mills
Monroeville, Alabama 36460

Challenging, long-term opportunity in expanding Research and Development Dept. for two or three electronics technicians who can adapt technical training to business-industry needs. Vanity Fair is a nylon lingerie and foundation garment industry with a growth equal to a plant a year for the past 10 years. Seven plants located within 100-mile radius of Monroeville, clean, wide-awake town of 5,000, which is 90 miles north of Pensacola, Fla., and 100 miles southwest of Montgomery. Adhere to policy of promotion from within.

Write George Heard, Director of Industrial Relations.

SUN ELECTRIC CORP., 5708B Frederick Ave., Rockville, Md., is looking for electronics technicians.

NEPTUNE BROADCASTING COMPANY, 300 North 7th St., Steubenville, Ohio, is seeking men with radio training and/or experience for jobs in Ohio, Pennsylvania, and West Virginia.

GENERAL ELECTRIC COMPANY, Appliance Park 6-221, Louisville, Ky. 40225 has openings available throughout U.S.A. with good pay, excellent working conditions, full benefit package. Specialized on-the-job training provided. Consult local telephone directory for factory service operations, or write to above address for location to District Product Service Manager nearest you.

RCA DET Division has openings for electronics technicians. Contact Mr. Townsend, RCA DET Div., Front and Cooper Sts., Camden, N. J.

SINCLAIR PIPELINE COMPANY
Box 521, Tulsa, Okla.

Will have temporary jobs this summer for students attending trade, technical or vocational schools. These jobs will appeal to NRI students in high school or college who are seeking work during summer vacation. The technical aspects of modern pipelining makes training in electronics especially valuable and may enable some temporary employees to qualify for work at higher rates. The starting salary is \$2.67 per hour.

CONAR ORDER BLANK

SO

DIVISION OF NATIONAL RADIO INSTITUTE, 3939 WISCONSIN AVE., WASHINGTON 16, D.C.

PLEASE PRINT

NAME _____

ADDRESS _____

CITY _____ ZONE _____ STATE _____

NRI STUDENT NUMBER

- CASH
- C.O.D. (20% Deposit required)
- EASY PAYMENT PLAN (10% Deposit)

Quantity	Model	Name of Item	Price Each	Total
If you live in Washington, D.C., add 3% sales tax. All prices are net, F.O.B. Washington, D.C.				TOTAL

ON TIME PAYMENT ORDERS

please be sure to complete the Easy Payment Plan credit information form on the reverse side of this page and include 10% down payment with your order.

1967 NOMINATION BALLOT

T. E. ROSE
 Executive Secretary
 NRI Alumni Association,
 3939 Wisconsin Ave.,
 Washington, D. C. 20016

(POLLS CLOSE JULY 25)

I am submitting this Nomination Ballot for my choice of candidates for the coming election. The men below are those whom I would like to see elected officers for the next year.

MY CHOICE FOR PRESIDENT IS

City State

MY CHOICE FOR FOUR VICE-PRESIDENTS IS

1. 3.

City State City State

2. 4.

City State City State

Your Signature

Address

City State

Student Number

CONAR EASY PAYMENT PLAN

\$0

Note: Easy payment contracts cannot be accepted from persons under 21 years of age. If you are under 21, have this sheet filled in by a person of legal age and regularly employed.

Enclosed is a down payment of \$_____ on the equipment I have listed on the reverse side. Beginning 30 days from the date of shipment I will pay you \$_____ each month until the total payment price is paid. You will retain title of this equipment until this amount is fully paid. If I do not make the payments as agreed, you may declare the entire unpaid balance immediately due and payable, or at your option, repossess the equipment. Your acceptance of this will be effected by your shipment to me of the equipment I have listed.

Date _____ Your written signature _____

CREDIT APPLICATION

Print Full Name _____ Age _____

Home Address _____

City & State _____ How long at this address? _____

Previous Address _____

City & State _____ How long at this address? _____

Present Employer _____ Position _____ Monthly Income _____

Business Address _____ How Long Employed? _____

If in business for self, what business? _____ How Long? _____

Bank Account with _____ Savings Checking

CREDIT REFERENCE (Give 2 Merchants, Firms or Finance Companies with whom you have or have had accounts.)

Credit Acct. with _____ (Name) _____ (Address) _____ Highest Credit _____

Credit Acct. with _____ (Name) _____ (Address) _____ Highest Credit _____



Alumni News

Howard Tate	President
Joseph Bradley	Vice President
Edward Bednarz	Vice President
Isaiah Randolph	Vice President
F. Earl Oliver	Vice President
Theodore E. Rose	Executive Sec.

CHAPTERS STUDY NEW TELEVISION PRODUCTION AND SERVICE TECHNIQUES

FLINT (SAGINAW VALLEY) CHAPTER featured an RCA recorded lecture "Successful TV Service and Salesmanship". It dealt with effective advertising and promotion for the TV serviceman: how to make service calls, how to cultivate future customers and keep the old ones, and other techniques which contribute to the serviceman's profit and success. This recorded lecture contained a wealth of ideas and suggestions for the TV serviceman.

Andy Jobbagy gave a short talk on his trip to Tijuana, which the members found amusing and entertaining.

The subject that is under most discussion at the meetings these days is the markings on transistors.

The Chapter has bought a color TV set which it is now using to demonstrate practical color TV servicing techniques. This is a much-needed and important program.

The members were pleased to receive a visit from MRI Graduate Ron Kulpinski.

HAGERSTOWN TROUBLESHOOTERS SEEK CURE FOR RADIO-TV ILLS

HAGERSTOWN (CUMBERLAND VALLEY) CHAPTER has had the building of a solid state audio oscillator under discussion. This is in line with the programs planned for this year: To learn theory and servicing techniques in troubleshooting solid-state home entertainment products.

George Fulks proposed to include in the meetings a study of questions and answers on second-class radiotelephone license examinations. This should be of particular interest to all NRI men in the area. Take advantage of this opportunity to learn all you can on the subject.

George Fulks also worked on an RCA console model TV that had the wrong channels coming in on the right settings of the channel selector. Chairman Bob McHenry said he had this problem on an identical set and it was due to the deterioration of the plastic casting that holds the fine tuning slug in place, thus leaving the fine tuning way off.

HACKENSACK CHAPTER ADOPTS NEW NAME AND MEETING PLACE

HACKENSACK CHAPTER'S George Schopmeier and George Stoll were the victims of a misunderstanding on the part of your Executive Secretary, who stated in the May-June issue that George Schopmeier had to resign as Chairman and that George Stoll was elected to replace him. This is incorrect. Schopmeier definitely has not resigned as Chairman. Because his current duties prevent his regular attendance at the meetings, George Stoll has replaced him as temporary acting Chairman. My apologies to the two Georges.

At one meeting the program for the evening was to troubleshoot any "dog" set that the members brought in. This almost proved to be more than the members bargained for, as it resulted in a very full evening and a variety



Part of the Philadelphia-Camden Chapter group which visited UHF Station WKBS, Philadelphia. Stu Nahan, sportscaster, and Ginny Maurizi, front center, served as guide and narrator.

of troubles. But everyone went home with added knowledge.

All NRI students and graduates in the area, please note: The Chapter has been meeting in Hackensack but due to the efforts of George Stoll, it now has a new and much better meeting place at Washington and Kearny Avenue, Kearney, N. J. The new meeting place is excellent, very attractive and with plenty of room. Because of this change, the Chapter has been re-chartered as the NORTH JERSEY CHAPTER.

LOS ANGELES WELCOMES NEW AND OLD FRIENDS

LOS ANGELES CHAPTER has recently added two new members to its ranks. They are Rudy Olson and Norman Durbin. Welcome to the Chapter, gentlemen!

National Headquarters was delighted to receive a visit from Joe Stocker. He was the organizer of the Los Angeles Chapter in 1957, was its first Chairman, is a former National Vice-President, and has consistently been one of the most active members and leaders of the Los Angeles Chapter. We thoroughly enjoyed his visit here at NRI. Come back again soon, Joe!

'MEN IN SPACE' HIGHLIGHTS NEW YORK CHAPTER MEETING

NEW YORK CITY CHAPTER members saw a film "MEN IN SPACE" presented by Mr. King of the N. Y. Telephone Company, which proved to be both interesting and entertaining. The first section dealt with the various special problems that man faces in space and the

second portion, the Gemini 4 flight with special attention to the walk-in-space and re-entry time. There was also a model satellite that revolved due to energy converted by solar batteries.

Pete Carter brought a Grundig multi-range stereo set, which he had just repaired, to share his experiences with the membership and show that the complexities of this type of set were not so frightful, if one took time to analyze the functions of the various plugs and parts. Joseph Bradley led the group in a thorough review of the RCA slide-lecture on the Transistor Demonstration Board, introducing faults into each stage and showing the effects on current and voltage of that stage, as well as the results in sound-output.

Chairman Schumott gave a preamble to talks planned on Signal Generators for the following month.

PHILADELPHIA-CAMDEN TOURS WKBS AND GENERAL ELECTRIC

PHILADELPHIA-CAMDEN CHAPTER welcomed one of its favorite guest speakers, Bernie Bycer, RCA Design Engineer, for an outstanding talk on horizontal circuits and troubleshooting methods. The members would like to have him as guest speaker at more meetings but he is too busy.

Thirty-five members visited and made a tour of UHF station WKBS, Channel 48. Hostess and host for the station were Miss Ginny Maurizi and Stu Nahan. Miss Maurizi guided the group through the station, Stu Nahan accompanied the group and delivered a running commentary on the many things of interest in the station. After the tour there was a gen-

eral discussion held by the Chief Engineer, who answered all questions. This was a visit worth waiting for; the members were quite impressed.

Less than a month later, the members formed another group to visit the General Electric Company in Philadelphia. George Walker of G. E. did another one of his fine jobs in giving the members first-hand information about the new G. E. Portable Color TV. The members always look forward to these visits to G. E. and appreciate what they learn there.

At another meeting Bernie Bycer attended the Chapter's regular Service Clinic, giving members valuable suggestions on how to set up to service TV's and explained some short cuts in servicing. The members were equally as enthusiastic over a program put on by the Chapter's own Harvey Morris who gave a talk and demonstration on servicing vertical troubles. He also undertook a discussion on some of the various makes of television sets and related his experiences on some of the troubles encountered today. As usual, Harvey packed a lot of valuable knowledge and experience into this program.

In reporting on the Philadelphia-Camden Chapters' activities for this issue of the Journal, we would be remiss if we did not include a news item about the Chapter's outstanding and dynamic secretary, Jules Cohen. A short while ago his daughter presented him with an 8-lb. grandson. It is doubtful if any grandfather in history ever walked around with as much air between his feet and the ground. Congratulations, Jules!

PITTSBURGH CHAPTER LOOKS FOR BIG BOOM IN UHF TV

PITTSBURGH CHAPTER was host to Mr. Tom Dapra, General Sales Manager, Radio Parts Company, Pittsburgh, who showed films and delivered a commentary on Channel Master Antennas in relation to the expected boom in UHF. He also exhibited an interesting film on picture tube rebuilding. The door prize at this meeting, a tube caddy, was won by G. Genelle.

At the next meeting, Mr. J. D. Waters of the X-ray Division of Westinghouse presented an unusual and fascinating program on X-ray tubes and machines and their use. Several tubes and parts and many X-ray films were passed around among the members for examination.

The latest member to join the Chapter is George Turner. Our congratulations to you, George!

DIRECTORY OF ALUMNI CHAPTERS

DETROIT CHAPTER meets 8:00 P. M., 2nd Friday of each month, St. Andrews Hall, 431 E. Congress St., Detroit. Chairman: James Kelley, 1140 Livernois, Detroit, Mich., VI-14972.

FLINT (SAGINAW VALLEY) CHAPTER meets 8:00 P. M., 2nd Wednesday of each month at Andrew Jobbogy's Shop, G-5507 S. Saginaw Rd., Flint. Chairman: Clyde Morrisett, 514 Gorton Ct., Flint, Michigan.; OW. 4-6867.

HAGERSTOWN (CUMBERLAND VALLEY) CHAPTER meets 7:30 P. M., 2nd Thursday of each month at George Fulk's Radio-TV Service Shop, Boonsboro, Md. Chairman: Robert McHenry, RR2, Kearneysville, W. Va. 25430.

LOS ANGELES CHAPTER meets 8:00 P. M., 2nd and last Saturday of each month, 4912 Fountain Ave., L. A. Chairman: Eugene DeCaussin, 4912 Fountain Ave., L. A., NO 4-3455.

MINNEAPOLIS-ST PAUL (TWIN CITIES) CHAPTER meets 8:00 P. M., 2nd Thursday of each month, at the homes of its members. Chairman: Edwin Rolf, Grasston, Minn.

NEW ORLEANS CHAPTER meets 8:00 P.M., 2nd Tuesday of each month at Galjour's TV, 809 N. Broad St., New Orleans, La. Chairman: Herman Blackford, 5301 Tchoupitoulas St., New Orleans, La.

NEW YORK CITY CHAPTER meets 8:30 P. M., 1st and 3rd Thursday of each month, St. Marks Community Center, 12 St. Marks Pl., New York City. Chairman: John Schumott, 1778 Madison Ave., NYC. 722-4748.

NORTH JERSEY CHAPTER meets 8:00 P.M., last Friday of each month, Washington and Kearny Ave., Kearny, N. J. Chairman: George Schopmeier, 935-C River Rd., New Milford, N. J.

PHILADELPHIA-CAMDEN CHAPTER meets 8:00 P. M., 2nd and 4th Monday of each month, K of C Hall, Tulip and Tyson Sts., Philadelphia. Chairman: John Furrung, 2923 Longshore Ave., Philadelphia, Pa.

PITTSBURGH CHAPTER meets 8:00 P. M., 1st Thursday of each month, 436 Forbes Ave., Pittsburgh. Chairman: Joseph Burnelis, 2268 Whited St., Pittsburgh, Pa.

SAN ANTONIO ALAMO CHAPTER meets 7:00 P. M., 4th Friday of each month, Beethoven Home, 422 Pereda, San Antonio. Chairman: Sam Stinebaugh, 318 Early Trail, San Antonio, Texas.

SAN FRANCISCO CHAPTER meets 8:00 P.M., 2nd Wednesday of each month, 1259 Evans Ave., San Francisco. Chairman: Isiah Randolph, 523 Ivy St., San Francisco, Calif.

SOUTHEASTERN MASSACHUSETTS CHAPTER meets 8:00 P. M., last Wednesday of each month at home of John Alves, 57 Allen Blvd, Swansea, Mass. Chairman: Daniel DeJesus, 125 Bluefield St., New Bedford, Mass.

SPRINGFIELD (MASS.) CHAPTER meets 7:00 P. M., last Saturday of each month at shop of Norman Charest, 74 Redfern St., Springfield, Mass. Chairman: Joseph Gaze, 68 Worthen St., W. Springfield, Mass.

In Memoriam

Since the last issue of the Journal we have received word that the following members of the Alumni Association have passed away. We extend the sympathy of the Alumni Association to their families.

Mr. Fred R. Bolognese, New Haven, Conn.
Mr. Thomas B. Gould, North Reading, Mass.
Mr. Alex Pyhtla, Spencer, N. Y.
Mr. Robert G. Kugler, Springfield, Ohio
Mr. George Ditch, Clymer, Pa.
Mr. James M. Hall, Silver Spring, Md.
Mr. Fred Gingher, Philadelphia, Pa.
Mr. Oren D. Shaffer, Manchester, Pa.
Mr. Harry E. Bernhard, Philadelphia, Pa.
Mr. Antonio A. Acosta, New York, N. Y.
Mr. Arthur K. Enders, Globe, Ariz.

35 Years Ago

as recorded in National Radio News

The use of radio in crime prevention had begun. The Michigan State Police installed a transmitter which served as an instantaneous communication medium with thirty-five scout cars and cruisers patrolling the State highways. Eighty receivers were placed in the offices of county sheriffs, municipal authorities, and State Police departments.

Broadcast alarms were repeated three times. In Indiana, an Indianapolis police car picked up two burglars who had held up a filling station thirty seconds before. As the burglars were entering the police car the third broadcast was just beginning. "Boy", said one, "listen to that thing telling on us!"

Engineers estimated that it cost less than one cent an hour to operate an ac Radio receiving set. The electric bill for powering a set having seven or eight tubes and in use for four or five hours a day was less than one dollar per month.

Some radio programs were recorded on a large record resembling a phonograph record; the record was sent to broadcasting stations throughout the country and the quality of the broadcast was nearly as good as that of the original.

Radio talks, or combined sight and sound television programs made their debut in the New York metropolitan area as a means of entertainment. The television facilities of Station W2XCR were combined with the sound broadcasting facilities of Station WGBS. Television studios operated on a regular schedule from 3 to 5 and 6 to 8 p.m.

Radio stations were established at Newark, Camden, Harrisburg, and Pittsburgh to keep pilots in communication with the ground during the Allegheny hop of the transcontinental air mail and passenger route of Transcontinental Air Transport and Western Air Express. All planes were installing two-way radio.



FREE

WITH YOUR ORDER KEY BEAM

A LIFETIME OF LIGHT ON YOUR KEY

- 1st micro-miniature light
- Lifetime Guarantee

\$2.95 value

Use the handy order form on page 27
Offer ends September 1, 1966



MODEL 230



\$4 Down—\$5 Mo.

CONAR Tuned Signal Tracer

Only tuned tracer on the market anywhere near the price. Exclusive cathode-follower probe gives outstanding sensitivity. Easily connects to any RF or IF stage with absolute minimum of detuning. Features audio tracing method through built-in 4" PM speaker plus visual indicator using "eye" tube. Quickly locates sources of hum, noise and distortion. Tracks down intermittents, measures gain per stage, accurately aligns radios without signal generator. (Tracer may also be used as sensitive AM radio.) Has two stages of RF amplification. Assembly-operating instructions include more than 12 pages on uses of Model 230. For beginners as well as experienced technicians.

SPECIFICATIONS

FREQUENCY: 170 kc to 1500 kc (2 bands)
TUNING: Planetary Drive, 3:1 ratio
RF TRANSFORMERS: Permeability tuned
ATTENUATORS: Calibrated RF and AF
TUBES: (2) 6GM6, (1) 6AV6, (1) 6AQ5, (1) 6E5, (1) 6X4, (1) 6AB4
CONTROLS: Volume, Band Selector, Main Tuning, Fine Attenuator On-Off, Coarse Attenuator, RF-AF switch
CABINET: Steel, blue finish with satin finish panel, red lettering
DIMENSIONS: 9 $\frac{7}{8}$ "x7 $\frac{1}{2}$ "x6 $\frac{1}{2}$ "
POWER SOURCE: 110-120, 60 cycle

\$39.95

Kit—230UK Assem.—230WT, \$57.50

MODEL 280



\$2.50 Down—\$5 Mo.

CONAR Signal Generator

Widely acclaimed as most accurate signal generator near the price. Uses Hartley type oscillator circuit with six separate coils and capacitors to give accuracy within 1% after easy calibration. High output of the Model 280 simplifies signal injection for rapid alignment and troubleshooting of transfer and tube receivers. Covers 170 kc to 60 mc in six ranges with harmonic frequency coverage over 120 mc. Ideally suited as marker generator for TV alignment. Tuning dial features planetary drive with 6:1 ratio for greater accuracy and elimination of backlash. Scale is full 9" wide with transparent hairline pointer. Has single cable for all outputs, no need to change leads when switching from 400 cycle audio to modulated or unmodulated RF.

SPECIFICATIONS

CONTROLS: High-Low Output Selector, Main-Tuning Dial, Band Selector—A thru F, Output Selector—Mod, RF, Audio, Attenuator/On-Off switch
TUBES: 6BE6, 12AU7
CIRCUIT: Slug adjusted RF coils with mica trimmers on low bands, Ceramic trimmers on high bands
CABINET: Steel, baked-on blue finish; satin finish panel with red lettering
DIMENSIONS: 9 $\frac{7}{8}$ "x7 $\frac{1}{2}$ "x6 $\frac{1}{2}$ "
POWER SUPPLY: solid state 110-120 V, 60 cycle AC

\$24.95

Kit—280UK Assem.—280WT, \$35.95

MODEL 311



\$2.20 Down—\$5 Mo.

CONAR Resistor-Capacitor Tester

The Model 311 gives fast, accurate, reliable test on all resistors and capacitors. Measures capacity of mica, ceramic, paper, oil-filled and electrolytics from 10 mmfd. to 1500 mfd, 0-450 volts. Checks for leakage, measures power factor and useful life. Shows exact value of resistors from 1 ohm to 150 megohms. Clearly indicates opens and shorts. Has "floating chassis" design to greatly reduce shock hazards. The Model 311 will also apply actual DC test voltage to capacitors to reveal break-down under normal circuit conditions, a feature far superior to many R-C testers which give low voltage "continuity" tests. Can be used for in-circuit tests in many applications and circuits

SPECIFICATIONS

RESISTANCE RANGES: 0-500 ohms, 100-50K, 10K-5M, 1.8M-150M (extended range)
CAPACITY RANGES: 0.1-50 mfd, .001-5 mfd, .00001-0.05 mfd, 18-1500 mfd (extended range)
CONTROLS: Range Selector, Leakage Test Voltage (0-450), Power Factor (0-60%)
TUBES: 6E5 "eye" indicator 6X4
BINDING POSTS: Special 5-way type
CABINET: Steel, smooth blue
DIMENSIONS: 9 $\frac{7}{8}$ "x7 $\frac{1}{2}$ "x6 $\frac{1}{2}$ "
POWER SUPPLY: 110-120 V, 60 cycle AC

\$21.95

Kit—311UK Assem.—311WT, \$31.95

2 CONAR Best Buys!



A \$38.35 VALUE

172 RESISTOR ASSORTMENT

Top-quality, most-needed resistors for hobbyists, technicians, engineers, experimenters. Packed in handy 15-drawer styrene knick-knack cabinet. All are 10%, 1/2 watt rated or better. 30 values from 47 ohm to 10 meg.

\$15⁷⁰ (28 UK)

Shipped Parcel Post



A \$41.15 VALUE

120 CAPACITOR ASSORTMENT

Top-grade, most-needed capacitors—ceramic, disc and paper. All rated 400V or 600V. Shipped in sturdy 15-drawer styrene knick-knack cabinet for your convenience.

\$20⁷⁰ (29 UK)

Shipped Parcel Post

USE THE HANDY ORDER FORM ON PAGE 27

NRJ JOURNAL
3939 Wisconsin Ave.
Washington D. C. 20016

Mr. Willard F. Velline
1322 S. 14th
Fargo, N. Dak. 58101

25923-G

Second-class
postage paid
at Washington, D. C.