

Scanning - Shortwave - Ham Radio - Equipment
Internet Streaming - Computers - Antique Radio



Monitoring Times

A Publication of Grove Enterprises

Volume 28, No. 4
April 2009

U.S. \$5.95
Can. \$5.95
Printed in the
United States

Severe Storm Spotting

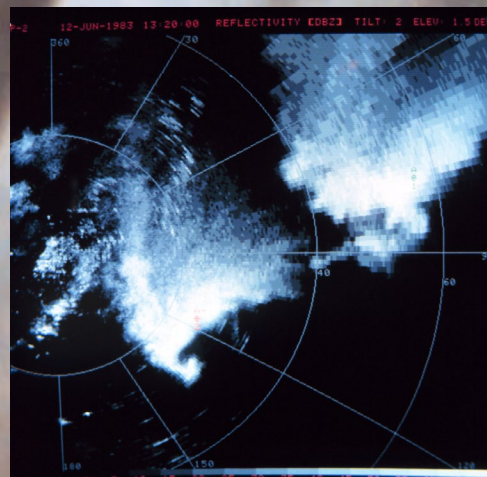

Also in this issue:

- What's the Propagation Forecast for 2009?
- Radio Slovakia International: The Butterfly Effect
- Computer Security using Password Manager

AR5000A+3 Wide Coverage Desktop Communications Receiver

Discover the Choice of Professionals



**Available in a professional and consumer version,
the AR5000A+3 is a proven performer!**

From aircraft and public safety, to broadcast and shortwave, no wonder so many Federal and State law enforcement, military units, surveillance agencies, government users, hospitals, RF labs, news media and monitoring professionals rely on the AR5000A+3 for accuracy, sensitivity and speed!

*The AR5000A+3 advances the frontiers of performance with coverage from 10 KHz to 3 GHz!**

This professional grade receiver with tuning accuracy to 1 Hz delivers automatic electronic front end preselection and precision stability from its built-in TCXO. Other features include:

- All analog mode reception AM, FM, USB, LSB & CW (APCO 25 accessory optional)
- Excellent strong signal handling
- Synchronous AM detector, Automatic Frequency Control & Noise Blanker
- NCO (Numeric Controlled Oscillator) with tuning stops down to 1 Hz
- Multiple I.F. bandwidths 3 KHz, 6 KHz, 15 KHz, 30 KHz, 110 KHz, & 220 KHz
- Rear panel 10.7 MHz IF output
- Auto mode bandplan selection
- Multi-function LCD with 7 character alpha-text comments
- Extensive search & scan facilities
- CyberScan® fast search & scan facilities
- Analog S-meter
- 2,000 memory channels
- 40 search banks with EEPROM storage
- Computer controllable
- Multiple antenna ports
- Auto memory store
- Extensive RS-232C command list
- Sleep timer/alarm
- Fully compatible with AOR SDU5600 Spectrum Display Unit

Add to the capabilities of the AR5000A+3 with options:

- The ARD25 APCO 25 conversion unit
- Collins® Mechanical Filters (500Hz, 2.5 KHz, 4KHz or 6KHz)
- TV5000A NTSC video unit for monitoring TV video
- CT5000 CTCSS decoder module
- DS8000 Analog Voice Descrambler Unit (for Government Use Only.)
- DS3000A external antenna



AOR U.S.A., Inc.
20655 S. Western Ave., Suite 112, Torrance, CA 90501, USA
Tel: 310-787-8615 Fax: 310-787-8619
info@aorusa.com http://www.aorusa.com

The Serious Choice in Advanced Technology Receivers

The AR5000A+3 is another example of why AOR is the Authority On Radio!

Specifications subject to change without notice or obligation.
*Cellular blocked. Unblocked version available for qualified users.
Documentation required.

Extend your receiver's range beyond 8 GHz!

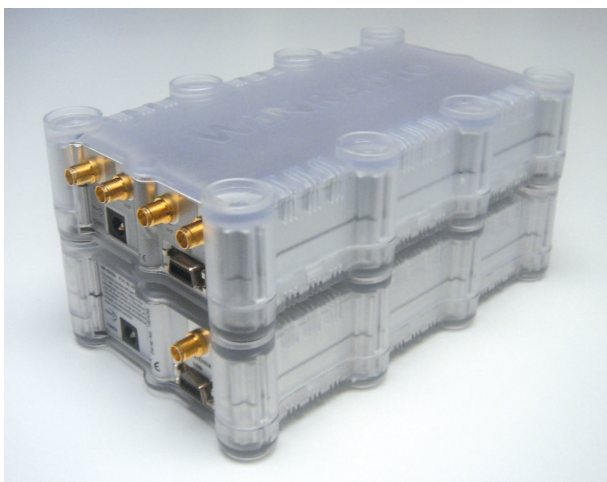

WiNRADiO WR-G315e receiver enhanced with WR-AMFE-3500



The WR-AMFE™ adds additional antenna inputs - and more.

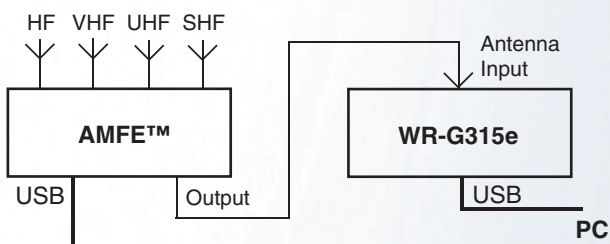

Our latest WiNRADiO accessory redefines the definition of "DC to daylight", yet again. And while it is perfect for the WiNRADiO WR-G315 series of receivers, it can be used to extend the frequency range of almost any VHF/UHF receiver.

The frequency range of the WR-G315 receiver can now be extended up to 8.599 GHz using the "AMFE" option (Antenna Multiplexer and Frequency Extender). This is the first time a receiver of such affordable price range can go that high in frequency.

And you also get an antenna multiplexer thrown in, making it possible to connect four antennas for different frequency bands directly to your receiver: No more hassles with antenna switching!

- Input frequency range up to 8599 MHz
- Output frequency range 96 to 1800 MHz
- High temperature stability
- High input isolation
- High dynamic range
- Low noise figure
- Simple installation
- Integrates with WR-G315e and WR-G315i receivers
- Suitable for any third-party receivers (AMFE-8600 only)
- Low-noise linear power supply included
- Application software included
- Programmers' API included to support third-party development

The AMFE™ unit interfaces neatly with the WiNRADiO WR-G315e or WR-G315i receiver. The receiver's application software is able to recognize the AMFE™ unit and expand the ranges of the frequency input and display automatically. Switching between the antennas and tuning the local oscillator for the downconversion is accomplished automatically and fully transparently to the user. The AMFE™ enclosure is similar to that of the WR-G315e receiver and stacks neatly on top or under it.

Two models are available: WR-AMFE-3500 (DC to 3500 MHz) and WR-AMFE-8600 (DC to 8599 MHz). The AMFE™ units are USB controlled, supplied with application software and a linear AC/DC power adapter. The WR-AMFE-8600 model can be also used with third-party receivers, and can be optionally fitted with an OCXO for enhanced stability of 0.01 ppm, to suit the most demanding monitoring and surveillance applications.

Monitoring Times

Vol. 28 No. 4

April 2009



A Watchful Eye on the Sky

By Loyd Van Horn

If weather conditions have always held a fascination for you, consider combining that interest with your radio hobby by training to be a severe weather spotter. These trained volunteers serve as indispensable “eyes on the ground,” but don’t confuse storm spotters with storm chasers. Storm spotters are trained to observe and report significant weather conditions in their local area. This information is used by the Weather Service to help verify radar data and also helps in post-storm analysis.

Many spotters are hams who stay in contact with each other through a Skywarn or ARES weather net during a severe weather event. Or a spotter may listen to the net via the scanner and report in using a cellular phone. It’s exhilarating, fascinating, and of benefit to your community, so why not give it a try? Turn to page 8 to get started!

All photos, including our cover, courtesy of the National Severe Storms Laboratory.

C O N T E N T S

Propagation Outlook Apr-Sep 12

By Tomas Hood

Last month one *MT* author voiced the common wail: “Will the sunspots ever return?” Propagation columnist Tomas Hood explains what is going on and why there is such disagreement among the experts as to what we can expect from Cycle 24.

While conditions four years out are subject to some guesswork, what we can expect in 2009 can be fairly well predicted. Plus some DX opportunities are seasonal ones that occur every year. Here’s what to look for this spring and summer, from HF through UHF.

Radio Slovakia International 15

By Eric Bryan

Shortwave broadcasting always held high importance in the countries of Eastern Europe, as it does today in the Slovak Republic, part of the former Czechoslovakia. Radio Slovakia International broadcasts via shortwave, satellite, and the internet in a number of languages, including English. Internet streams also give you the chance to listen in on local radio streams

Computer Security 18

By John F. Catalano

Because of the amount of personal or sensitive data which is stored on our computers, within various computer applications, or on websites we routinely access, we attempt to provide some modicum of security with passwords. Keeping track of these passwords can become overwhelming, and we don’t even feel too secure about the security of our passwords ...

Dr. John thinks he has discovered the solution to our problems in an inexpensive program from Large Software called Password Manager. At last, real security by remembering only *one* master password!



Reviews

This month’s *First Look* review is a companion to our *On the Bench* ultrasound project on page 68. Bob Grove assembles and tests the Ultra-RX-1 ultrasound receiver kit from the Xtal Set Society. While the ultrasound receiver is converting pressure waves, not radio waves, into the range of human hearing, we know radio hobbyists love a monitoring challenge. In this case, you’ll be intercepting the secret communications of insects and rodents instead of eavesdropping on human communications. (See page 70.)

Last month the *Computers & Radio* column

tried out the Radio Friendly PC from Hudsonville Computers. This month, Dr. John wraps up that review by putting the RFPC through its paces while controlling a software definable radio as a final test of a “radio-friendly” computer. It passed with flying colors.

On a less encouraging note, Dr. John grouches about the ever-changing Windows environment and learns from experience that all versions are not created equal. It’s one more factor to consider when things go wrong... (See page 72.)



MONITORING TIMES
(ISSN: 0889-5341;
Publishers Mail Agree-
ment #1253492) is
published monthly by
Grove Enterprises, Inc.,
Brasstown, North Caro-
lina, USA.

Copyright © 2009 Grove Enterprises, Inc.
Periodicals postage paid at Brasstown,
NC, and additional mailing offices. Short
excerpts may be reprinted with appropri-
ate credit. Complete articles may not be
reproduced without permission.

Address: 7540 Highway 64 West,
Brasstown, NC 28902-0098
Telephone: (828) 837-9200
Fax: (828) 837-2216 (24 hours)
Internet Address: www.grove-ent.com or
www.monitoringtimes.com
Editorial e-mail: editor@monitoringtimes.com
Subscriptions: order@grove-ent.com

Subscription Rates: \$28.95 in US; \$39.50
Canada; and \$58.50 foreign elsewhere,
US funds. Label indicates number of is-
sues left. Renewal notice is cover sheet 3
months before expiration. See page 76
for subscription information.

Postmaster:
Send address changes to *Monitoring Times*,
7540 Highway 64 West, Brasstown, NC
28902-0098.

Disclaimer:
While *Monitoring Times* makes an effort
to ensure the information it publishes is
accurate, it cannot be held liable for the
contents. The reader assumes any risk for
performing modification or construction
projects published in *Monitoring Times*.
Opinion or conclusions expressed are
not necessarily the view of *Monitoring
Times* or Grove Enterprises. Unsolicited
manuscripts are accepted. SASE if material
is to be returned.

Subscription Questions?
belinda@grove-ent.com

Owners

Bob and Judy Grove
judy@grove-ent.com

Publisher

Bob Grove, W8JHD
bobgrove@monitoringtimes.com

Managing Editor

Rachel Baughn, KE4OPD
editor@monitoringtimes.com

Assistant Editor

Larry Van Horn, N5FPW
larryvanhorn@monitoringtimes.com

Art Director

Bill Grove

Advertising Svcs.

Beth Leinbach
(828) 389-4007
bethleinbach@monitoringtimes.com

TABLE OF CONTENTS

Departments:

Letters 4
Communications 6
Stock Exchange 76
Advertisers Index 76

First Departments

Getting Started
Beginners Corner 22
The Allure of SW Radio
Global Net 24
Storm Season in Tornado Alley

Scanning Report 26
Why are US cellular freqs blocked?
Ask Bob 29

Utility World 30
Canadian Coast Guard Frequencies

Digital Digest 33
Chilean Police and Swiss MFA

Programming Spotlight 34
If it ain't Baroque, don't fix it!

Global Forum 36
Madagascar Uprising Disrupts SW

Broadcast Logs 39
The QSL Report 40
QSL "Bytes"

English Language SW Guide 41

Second Departments

Milcom 54
The US Military on HF

AM Bandscan 56
Money and Radio

BOATS, Planes, Trains 58
Radio on the Waves

Below 500 kHz 60
RDFs Revisited

Outer Limits 61
Pirate-Inspired Station Still Silent

On the Ham Bands 62
Numbers Stations

Technical Departments

Antenna Topics 64
It's a wonder they work at all!

Radio Restorations 66
Globe Scout: It's a Wrap

On the Bench 68
Monitoring Ultrasound

First Look 70
Ultra-Rx1 Ultrasound Receiver Kit

Computers & Radio 72
Unfinished Business

What's New 74

EDITORIAL STAFF Email firstname@monitoringtimes.com

TJ "Skip" Arey On the Ham Bands
Rachel Baughn Letters to the Editor
Kevin Carey Below 500 kHz
John Catalano Computers & Radio
Mike Chace Digital Digest
Marc Ellis Radio Restorations
Bob Grove Ask Bob
Glenn Hauser Global Forum
Chris Parris Fed Files
Ken Reitz Beginners Corner
..... Communications
Iden Rogers Planes
Clem Small Antenna Topics
Doug Smith American Bandscan

Hugh Stegman Utility World
Ernest Robl Trains
Gayle Van Horn Frequency Manager
..... Broadcast Logs
..... QSL Corner
Larry Van Horn Milcom
..... Reviews Editor
..... What's New?
Loyd Van Horn GlobalNet
Dan Veeneman Scanning Report
Ron Walsh Boats
Fred Waterer Programming
..... Spotlight
George Zeller Outer Limits

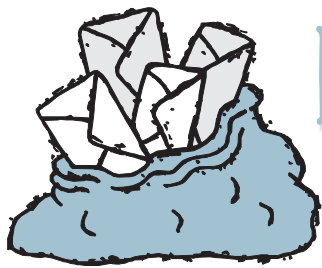

LETTERS TO THE EDITOR

This column is open to your considered comments. Opinions expressed here are not necessarily those of Monitoring Times. Your letters may be edited or shortened for clarity and length. Please mail to Letters to the Editor, 7540 Hwy 64 West, Brasstown, NC 28902 or email editor@monitoringtimes.com
Happy monitoring!
Rachel Baughn, Editor

April Foolishness

It's been a long, hard winter: cabin fever is setting in and we're starting to hear things And when you start to hear things nobody else does, that's a good time to build an ultra-sound receiver. Well, it's as good a reason as any. You could also say you want to hear bat and rodent calls, insect communications, or the sound of rubbing your fingers together -- all equally bizarre. Indulge your curiosity and check out this month's *On the Bench* column and review of a simple kit to build your own receiver.

Antenna Tuner for Long Waves

Bill Bowers allowed us to share a letter he wrote to Harry Weaver, author of January's *On the Bench* article "Antenna Tuner for Long Waves."

"Your article on LW antenna tuners (January 2009) was interesting and your construction beautiful. I could never build things to look as professional as you do.

"Before the days of QRSS transmissions and computer listening, I spent, for 12 years, most of my winter nights trying to pull out the one watt lower signals in Morse code from all the noise in the LW band. I built all types of antennas, including some 1,000 foot long wires. With the long wires I built a dozen different types of tuning and matching circuits.

"The one shown below is *by far* the very best method of matching a long wire to a receiver in the LW band. This high Q resonant type of circuit not only gets rid of a lot of noise, but it

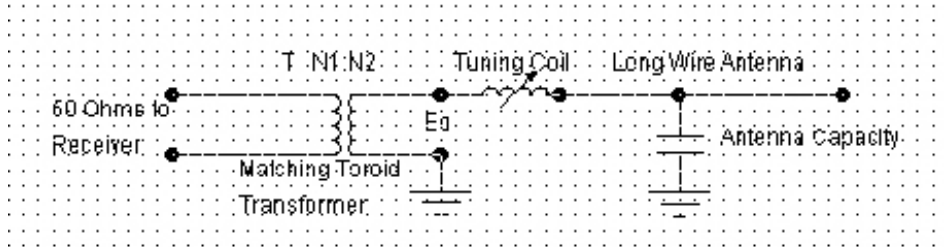

will give you more signal strength than any other type of matching circuit.

"The best solution to matching a long wire antenna is to build a 'universal' coil with a wide range of inductance and the highest possible Q to resonate with the capacity of the antenna at the specified frequency. To get the maximum tuning range, the approach was to put as many turns as possible on the tickler coil and a series of taps on the coil body winding.

"Before the matching transformer is connected, the open circuit voltage, E_o , is measured. Then a variable resistor to ground is connected

to the antenna and the resistance varied until the voltage is $1/2 E_o$. This resistance is the impedance of the tuned antenna circuit. The turns ratio of T is set by winding a matching transformer on a toroid core to give 50 Ohms out to the receiver

"Old age forced me to move from our 80 acre farm in rural Oklahoma to the Houston, TX area. The land behind our townhouse is a power transmission easement. There are five rows of high tension towers with the tallest having 5 foot long insulators that glow in the dark. Needless to say, my LW listening days are over.

"I look forward to your articles in *Monitoring Times*, and it is refreshing to see some hands-on construction and experimenting activity. It was interesting to note that you use a Harris 590 receiver. I have or had top of the line Racal, ICOM, & JRC receivers but in the end, the 590 was clearly the best on LW."

Bill Bowers



Aero Performance of Aviator?

"I was going through my January issue of *Monitoring Times* and read Larry Van Horn's review of the Grundig G6 Aviator radio. He never mentions the Aircraft Band (117 - 137 MHz) operation in the article or lists the band in the specifications. The Grove ad for the Grundig G6 Aviator on the bottom of page 69 does list the Aircraft Band in the specifications.

"Did Larry review the Grundig G5, which doesn't receive the aircraft band...?"

"Thanks for a great magazine."

George Tasson

We apologize for the oversight, which was unintentional. It was the G6 under review, but, not being impressed with the aviation reception on the whip antenna, Larry postponed writing up that aspect and then forgot about it! Bottom line: the radio is acceptable, but not if aviation is the primary reason for the purchase.

US Prices for Bonito Software

MT reviewed Bonito Software's sophisticated RadioCom6 computer control and decoding software in the December 2008 and January

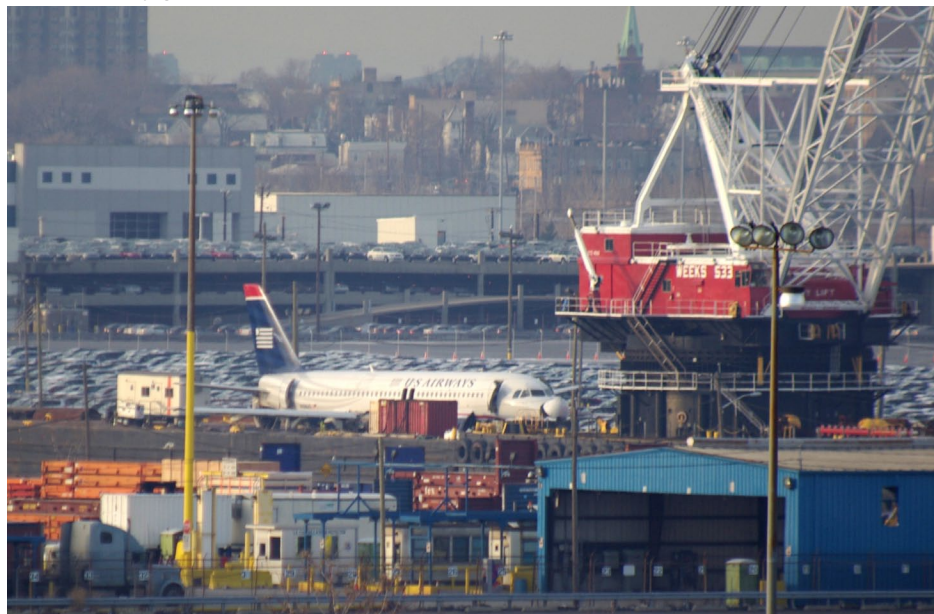

While on a Caribbean cruise (see BOATS page 58), Ron Walsh snapped a picture of the US Airways plane which crashed in the Hudson River in January. It was loaded on a barge in Bayonne, NJ.

2009 *Computers & Radio* columns. Dennis from Bonito has only one update to the article, and that is the price quoted for the software sales to the U.S. Though a look at www.bonito.net suggests prices are fluctuating in the current market, special pricing is made available to non-Euro countries to make it more affordable. Pricing to the US is currently US\$246 according to Dennis. Grove enterprises sells the software at www.grove-ent.com/RC60.html

Radio Telescope Clothesline?

"I agree that it is unlikely that Grote Reber's mother used his radio telescope antenna to dry clothes. (See February *Antenna Topics*.) I had the good fortune to attend a talk by Mr. Reber about his radio astronomy experiments. This was in Washington, DC, in a small auditorium at the Smithsonian Institution, 30 or 40 years ago. I can't prove it, but I had the impression that he was living alone as a bachelor during his experiments. None of his pictures showed laundry on his dish antenna, and he made no mention of such a problem."

Perry Crabill, W3HQX, Washington, DC

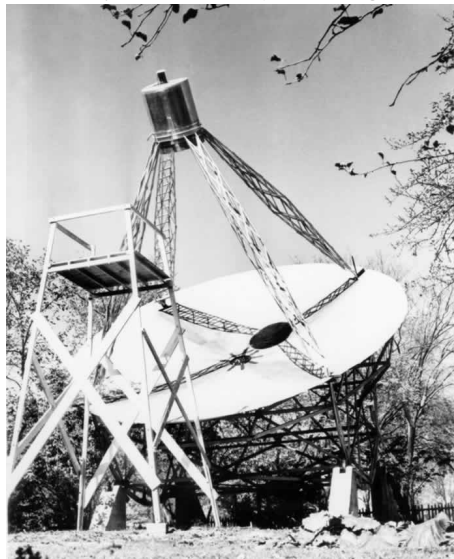

Rebanding?

Jim MacDonald wrote columnist Dan Veeman to ask about tracking rebanded Motorola radio systems such as the Massachusetts State Police and Nashua, NH city P2 digital system. While Dan may answer Jim's other questions in a later *Scanning Report* column, I wanted to call particular attention to this month's *What's New* column on page 74. You'll find information about downloading an update to your Uniden digital scanner's firmware which will enable it to follow the newly rebanded systems.

Unusual Antenna

"I have a question that maybe you could pass on to the right contact. On two recent television programs, one about Air Force 1 and the other about Marine 1, I noticed a fellow in a suit with a standard sized handheld walkie talkie sporting a 2 to 3 foot long helical antenna. It was much longer than the typical low band helical

antenna found on walkie talkie radios. It was also much larger in diameter.

"In both cases the user appeared to be the ground contact for the Marine 1 helicopters. In the AF1 program he was on the ground in Africa. In the Marine 1 program it was New York City. Any idea what frequency or band this radio operates on?"

Pat Griffith

Larry Van Horn and Chris Parris also apparently watched the same shows! Larry wondered the same thing and sent a similar query to Chris, our *Fed Files* columnist. Here's Chris's reply:

"I see we watch the same television shows! I also noted the large antenna on the hand-held radio.

"While I have not confirmed this from any official sources, it appears to me to be a hi-gain UHF air band antenna. I have seen similar antennas on some of the UHF 'rescue radios' that downed flyers are sometimes equipped with. My guess is that they are operating somewhere within the 225-380 MHz military air band. I also wouldn't be surprised if they were using some encryption!

"Although some sources indicate some lo-band FM channels might be used by the HMX-1 squadron, I have not confirmed that they are still in regular use."

Chris

Alternate E-Mail Address

Several subscribers have noted over the past few months that their email has bounced when they have written to the [monitoringtimes.com](http://www.monitoringtimes.com) email addresses. While we don't know the reason for all instances, we do know that our domain is frequently a target for spammers. We apologize for the problem, but there seems to be very little we can do about it in today's internet environment!

If you find you can't get through to your columnist, try this alternative: Send your email to the editor via rachel.baughn@gmail.com for forwarding to the author's personal email address. Or try rachel@grove-ent.com. We'll get it through somehow!

OBITS

Rob Harrington

Wayne Heinen N0POH forwarded the following information from Chris Knight about the passing of radio hobbyist and early *MT* contributor Rob Harrington:

"I received the sad news that Rob Harrington passed away ... Rob had been suffering from a lengthy illness ... Rob founded a SWL/DX club in the early 1970s called Colorado Association of DXers (COADX). He was a member of SPEEDX, NASWA, and other clubs. Although Rob was interested in AM BCB to some degree, his main interests were shortwave listening and computers. He had the SWL call sign WDX0SWL and ham radio callsign N0NNI."

Our sincerest condolences go out to Rob's family and friends.

John Wrisley

by Bob Grove W8JHD

As we prepare this month's edition, we are saddened by the death of John Wrisley, the original engineer at Grove Enterprises, who was responsible for the printed circuit board (PCB) layouts of all the Grove's original products. These included frequency converters, preamplifiers, shortwave preselectors and more.

John's artwork was meticulous, and he would pore over his work repeatedly to insure its perfection. I would hastily sketch the wiring on a piece of paper, making sure I had all the connections right, label the parts, and hand it to him. I know that when I got his work back it would be perfect every time.

Before coming to work for us, John had a colorful career with NASA following his tour of duty with the U.S. Navy. His profession would allow him first-hand participation in the heyday of America's space program, and gave him the perspective we needed to create listening products for our clients.

His irrepressible sense of humor was his trademark, and it was contagious. He was an incurable tinkerer; nothing escaped his attention. One day I looked out the office window during a lunch break and saw him hunched under the open hood of this ancient, blue, Toyota pickup truck. Curious about what he was up to this time, I ventured cautiously toward him and peeked under the hood.

Dangling from the underside of the hood was a canteen of water with a rubber hose leading down to the carburetor; a clothespin controlled the flow, one drop at a time.

"John, I'm not going to ask..."

"Oh, this? I'm trying to wean this engine off gas; I figure a little more water each day, and eventually it'll run completely on water!"

I nodded patronizingly and drifted back inside. Knowing John's ironic sense of humor, I should have known better than to ask.

Then there was his electric-powered soda straw to ease the task of drinking a beverage through an ordinary straw....but that's another story.

We will all miss John, and extend our thoughts to his wife Josephine and their family.



John Wrisley drew the original headers for Monitoring Times' regular departments. Here are two of my favorites.

**SIGNALS
FROM
SPACE**



by Larry Van Horn



COMMUNICATIONS

by Ken Reitz

“Communications” is compiled by Ken Reitz KS4ZR (kenreitz@monitoringtimes.com) from news clippings and links supplied by our readers. Many thanks to this month’s fine reporters: Anonymous, David R. Alpert, Rachel Baughn, Bill Grove, Alokesh Gupta, Doug Smith, Larry Van Horn, and George Zeller.

SHORTWAVE/AMATEUR RADIO

Hams Aid Storm Victims

The need for amateur radio operators for weather emergencies is not just for Tornado Alley or the hurricane season. This past winter saw a devastating ice storm sweep across much of the country from Oklahoma and Arkansas to West Virginia and Pennsylvania, into New England and all points in between. Numerous media reports, both TV and newspaper, extolled the virtues of the abilities of hams to react quickly to the weather events as they unfolded.

Hardest hit Kentucky saw hams utilizing HF and VHF frequencies to coordinate information about available shelters, fuel supplies, the condition of municipal water supplies, as well as assisting public safety officials and the Red Cross in those areas. Millions were without electricity for weeks across several states and more than a thousand National Guard troops were deployed to help with county and state transportation agencies and local power companies.

One result of the bad weather was reported by the *Nashua Telegraph* (NH) with this headline: “Ice Storm Credited with Generating Interest in Ham Radio Course.” The article noted that nearly 20 people showed up shortly after the storm for the two day course in amateur radio fundamentals. Among those signed up: five hospital employees; ten members of the Brookline (NH) emergency response team, and a former police officer who was also a lapsed ham.

FCC Names Hollingsworth Replacement

The FCC announced in January the appointment of Laura L. Smith to replace Riley Hollingsworth K4ZDH as Special Counsel for the Spectrum Enforcement Division of the FCC’s Enforcement Bureau. Hollingsworth, who retired in 2008, had held the post for more than 10 years and was well known in the amateur radio community for his close relationship with hams and his personal appearances at many ham-related activities.

Ms. Smith, a practitioner of the well-known Beltway revolving door, had earlier worked at the FCC in the Mass Media Bureau and Wireless Telecommunications Bureau, as well as the Public Safety and Private Wireless Division. The 1990 graduate of the Pepperdine University School of Law comes to the FCC this time from the lobbying organization Enterprise Wireless Alliance (EWA) which, according to the EWA web site, “represents its membership on all matters pertaining to

national telecommunications policy before the Commission...”

Vatican Radio in Local Health Flap

Radiation from a strictly earth-bound source has caused big headaches for Vatican Radio, according to a report from the *BBC*. After being threatened with having its power cut by Italy’s state-run electric utility, the Vatican reportedly will reduce the power output of its medium wave transmitter on 1530 kHz. According to the report, Italy’s environment minister cited the station for exceeding Italy’s electromagnetic radiation limits. The station’s transmitters are considered to be within the Vatican State, but the emissions were said to have saturated the area by up to three times the amount of acceptable electromagnetic radiation on some transmissions.



ARRL Seeks to Mold Legislation

The American Radio Relay League (ARRL) released a policy statement regarding mobile amateur radio operations during its January executive committee meeting. According to a bulletin from League headquarters, the effort aims to short circuit the growing number of state and local laws regarding the use of wireless devices while operating a motor vehicle. The statement suggests that “licensed amateur radio operation be listed specifically as an exclusion to the proposed regulations.”

Dan Henderson N1ND, ARRL Regulatory Information Manager, said that as of February 1, 2009, there were proposals to limit the use of cell phones by drivers in 11 states including Georgia, Hawaii, Idaho, Illinois, Iowa, Maine, Montana, Texas, Utah, Virginia and Wyoming. Henderson noted that such bills are introduced each year as state legislatures begin their new legislative sessions.

TV/RADIO BROADCASTING

DTV Switch Delayed: It’s On, It’s Off, It’s Both!

The great digital television (DTV) switch, which might otherwise have been a long-running gag on a sitcom -- and that last fall gave us the image of a wrecked FCC sponsored NASCAR race car, flames coming up around its crumpled fenders -- just keeps giving. The coupon program ran out of money with nearly two months left before the switch and had nearly 4 million consumers on a waiting list for the non-existent coupons. The Nielson company, which advises the FCC on the status of households receiving TV off-air, discovered

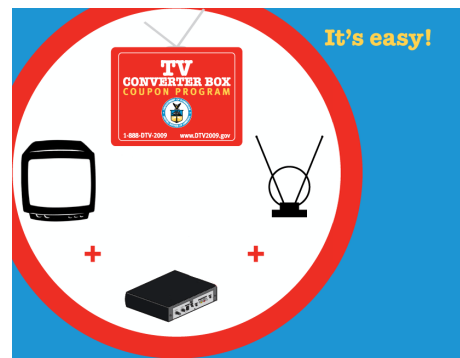

that nearly 7 million households were not ready for the switch despite the ad money poured into the program; consumer groups predicted that, even if coupons were ready on time, retailers would run out of converters in some locations.

After weeks of wrangling in Congress, wailing and gnashing of teeth from the broadcast industry and a sense of despair among consumers slowly sinking in an anemic economy, the official cut-off date was extended to June 12, but with exceptions. TV stations may opt to turn off their analog signals earlier, but they have to have notified the FCC and the public by February 9 of their intention to do so. Even so, the FCC reserves the right to force stations to simulcast their signals if other stations in a given market plan to maintain their analog signals.

If, by the time you read this, you still have a TV set, you’re probably watching movies on Netflix anyway.

PUBLIC SERVICE

‘OpenSky’ Woes in Milwaukee

A television report on *WTMJ*, channel 4 Milwaukee, detailed the problems with the city’s OpenSky radio communications system made by M/A-COM, a subsidiary of Tyco Electronics. In addition to operational issues cited in the report, there have been a series of delays in meeting deadlines stretching back five years.

If the Milwaukee OpenSky problems sound familiar they should: a similar and much larger system for the state of New York was scuttled after similar deficiencies dogged their system.



Glitches Plague Aging Cleveland Radio System

An on-line article in the Cleveland *Plain-Dealer* detailed a third crash of that city's radio system during a six week period. Cleveland citizens can look forward to more problems in the future, because replacing the antiquated system will cost more than \$30 million, according to the article, and require a lengthy bidding period before the tedious job of installing the system can begin. Meanwhile, the article reports that technicians in that city will continue to work on reloading software and patching up the hardware.

SATELLITE

NOAA-19 in Orbit

NASA reports that it successfully launched NOAA-19 on February 9 from Vandenberg Air Force Base. The environmental satellite is the last of five polar-orbiting birds that comprise the Polar-orbiting Operational Environmental Satellites (POES). These satellites are bristling with environmental sensors as well as the Search and Rescue Satellite-Aided Tracking System (SARSAT), which reports say have saved more than 24,500 lives since the program began in 1982.



According to a press release from the National Oceanic and Atmospheric Administration, NOAA-19 will aid in weather analysis, climate research, sea temperature measurement, ocean dynamics research, volcanic eruption monitoring, forest fire detection and global vegetation analysis.

Tales from the Monopoly Zone

Sirius/XM, the satellite radio monopoly, is in a financial bind between the difficulties of the current economic environment and its need to increase revenue. The company is also hamstrung by its agreement with the FCC, which allowed the merger of the two former competitors last year, promising it wouldn't raise prices and that it would make available lower introductory subscriptions.

Word throughout the industry has persisted that by this spring the company would institute a series of fee increases relating to customers having more than one account (up \$2 for additional accounts) and on-line listening (up \$3/month). New and renewing subscribers were said to be urged to shell out up to \$500 for a "lifetime" subscription in order to



avoid future price hikes. This seems a meager way to rescue the business. If only there was some sort of super hero on the horizon....

Wait! Up in the sky! It's a vulture, a very rich vulture! It's...Charlie Ergen owner of the DISH Network money-making machine.

Reports in the *Wall Street Journal* and *Reuters* news agency said Ergen had offered to pump enough money into Mel Karmazin's wobbly satellite enterprise to stave off bankruptcy. Though the offer was initially refused, Ergen is said to be keeping the offer on the table. Stay tuned, radio fans, for the next exciting episode; meanwhile, Mel Karmazin will be drinking directly out of a promotional sized bottle of Bromo-Seltzer.

FCC ENFORCEMENT

Cable Companies Nationwide Fined

An article in the *Washington Post* in late January detailed fines levied by the FCC totaling one-half million dollars on many national cable-TV operators, including Comcast, Time-Warner Cable, Cox Communications, Charter Communications, Cablevision, Midcontinent Communications and Suddenlink Communications. At issue was the practice of transferring analog channels to more expensive digital tiers.

L-P College Station Flunks FCC Exam

It's bad enough to be a high-ticket commercial radio station with deep pockets when the FCC comes around for an inspection, but for Bethune-Cookman College in Daytona Beach, operating WRWS-LP (actual motto: We're Real, We're Serious), flunking the FCC's exam was expensive.

For failing to have a license for the studio-to-transmitter link and failing to have the required Emergency Alert System equipment installed, the Commission slapped the college with a fine for \$18,000. Note to other LP college stations: Don't plead ignorance. While it could work with certain professors, it gets nowhere with the FCC.

Radio Stations Win FCC Fines

Two radio stations rolled the dice with the FCC's rules regarding on-air contests and came up snake-eyes. Both incidences could have been episodes right out of "WKRP in Cincinnati."

In the first, station WDGS (FM) Andover, Kansas, was hit with a \$4,000 fine for confusion over what the correct answer was in the "Guess-how-much-money-is-in-Santa's-sack" contest it ran in December 2005. The apparently winning caller correctly guessed the amount, but according to FCC documents, was told she hadn't, because she hadn't figured in

the value of the \$10 teddy bear that was also in the sack. After complaining to the station, the complainant was given a check for \$1,000 by the station which satisfied the wronged listener but not the FCC. That took a check for \$4,000. Now everybody's happy.

Old-timer KDKA, Pittsburgh, Pennsylvania, ran afoul of the FCC's on-air games rules in November 2007, according to FCC documents, when an on-air personality announced that "he would give away one million dollars to the thirteenth caller, and that he would give away 'a million an hour' thereafter." A listener alleged to the FCC that when he called he was told he was the thirteenth caller and, after spending 43 minutes on hold, the complainant was transferred to the on-air personality. After answering questions, the caller asked about the prize money and the phone line was disconnected.

The persistent listener called the station back and was told there was no million dollar prize. The listener again persisted and sent an e-mail to the on-air personality, who responded that the listener was "the only person in the area who didn't get the joke."

The FCC, not known as a stop on the comedy club circuit, also failed to get the joke and hit the station with a \$4,000 fine.



WWW.SCANCAT.COM

**ORDER TOLL FREE
888-722-6228**

COMBO CD SPECIAL

Reg.
ScanCat-Lite-Plus.....\$29.95
Mr. Scanner FCC Public Safety29.95
Nat-Com's FCC Scancat Files9.95
Bonus Disk Of Frequencies.....15.00
NOW \$49.95 \$84.85

PLUS FREE Scanning Magazine(s)
(With Purchase Of Special. While Supplies Last)

**SUPPORT FOR RADIO SHACK
PRO-160/162/163/164
GRE PSR-100/300/200/400**

ScanCat-Lite-PLUS
Reg. \$39.95 - Limited Time Special \$29.95

**Now It's Easier Than Ever To
Use Your ScanCat Software.**

**FREE walk-you-through set up
video to get you going fast.**

www.scancat.com **You Tube**
Click on learn as you view.

**Scancat-Gold for Windows
Version 8.50 \$99.95**

**Scancat-Gold for Windows-SE -
\$159.95**

Skysweep Decoder Software \$99.95



**COMPUTER AIDED
TECHNOLOGIES**

**ORDERS: (318) 687-4444 FAX: (318) 686-0449
Info/Tech Support: (318) 687-2555
(9 a.m. - 3 p.m. Central M-F)**

WWW.SCANCAT.COM

A Watchful Eye on the Sky

Getting started in severe storm spotting

By Loyd Van Horn, W4LVH

All photos courtesy of the National Severe Storms Laboratory

Have you ever looked up at a darkening afternoon sky and felt that sense of wonder at the beauty and power of nature? Have you ever caught yourself getting irritated when your friends or family keep talking during the local weather reports or a severe weather bulletin? Have you ever driven through an area that was damaged from a storm and thought to yourself “I wish I could have helped?”

There is a good chance that if you are still reading after that first paragraph, you have the foundations of what it takes to be a storm spotter.

Notice I said “storm spotter,” not “storm chaser.” While many people will use the two terms to mean the same thing, storm spotters and storm chasers are two different types of weather enthusiasts. Storm spotters, to begin with, are not always chasers. But a storm chaser is almost always a spotter. Confused?

Storm spotters are people with at least a basic training in severe weather events and reporting procedures, often from training given through their local National Weather Service (NWS) office. They will observe conditions during local severe weather events and report qualifying information to the NWS or other emergency management personnel about severe weather events that are actually happening on the ground.

This information is then used by the NWS, not only to verify radar data and issued warnings and watches, but also to provide another piece of data when analyzing post-storm damage. Usually, though, storm spotters are perfectly content to report what is going on in their backyard.

On the other hand, a storm *chaser* will often drive hundreds of miles to be where conditions are most conducive to produce severe weather, especially tornadoes. Storm chasers will also report severe weather to the local authorities or NWS forecast office in the area in which they are chasing. They, too, will have at least a basic meteorological knowledge of storms and their structure. However, to be a successful storm chaser, a pretty extensive knowledge of forecasting the weather is almost a prerequisite.

Because radio enthusiasts are often amateur radio operators or are at least interested in weather as it applies to radio propagation, you can often find a radio hobbyist or two in most storm spotting circles. It is under that premise

that this information is being presented to you. If you aspire to observe nature at its most severe, this article should provide a basic guide from which to start the journey into the exhilarating and fascinating skill of observing severe thunderstorms.

A CLOSE ENCOUNTER – Lessons Learned

On March 15, 2008, I was helping a friend work an outdoor youth sporting event in Columbia, SC. On the way down Interstate 26 en route to the event, we began talking about the previous night’s storms in Atlanta, GA, including the tornado that ripped through downtown, which had been covered extensively by the national media.

My friend, knowing I am a severe weather enthusiast (in other words, a storm spotter and wanna-be chaser) asked me if I thought we would see anything significant with our weather later that day.

“I sure hope so,” I told him, half joking.

My friend dropped me off at a soccer field in Ballentine, SC, so that he could work another event about 15 minutes across town. All day as the skies darkened, I found myself going back and forth between my duties with the event and my cell phone, where an endless loop of radar images was showing me the progress of the approaching supercells.

By late afternoon, I found myself staring down a classic “mothership” supercell storm. Deep hues of emerald green stretched from the horizon to a deep black gust front. Striations that wrapped themselves around the supercell looked as if someone had carved contours into the icing on a cake. A lowered wall cloud swirled in cyclonic motion, indicating that at any minute, I could be regretting my decision to be standing in a field with no way out.

It wouldn’t take long for that sinking feeling I had in my stomach to come to fruition. One of the event officials asked me what that weird looking cloud that was moving to our right was. The words fell out of my mouth with a mixture of sheer excitement, joy and complete fear.

There, making its way just on the other side of the trees that lined the field, was a tornado – and I had nowhere to go.

I didn’t hear the classic “freight train” sound that everyone else describes. This sounded more like a jet engine in idle on the tarmac before taxiing down the runway. The ground shook, debris flew in the air, and for a brief moment, I was scared.

After the tornado passed, I saw several other areas of circulation passing overhead – potential tornadoes that were trying to get their act together. Thankfully, since they were directly over where I was standing, they hadn’t. Within moments, we were hit by the hail core of the storm.

After the supercell passed and my friend picked me up, I realized what had just happened. I survived a tornadic supercell with nothing more than a pavilion over my head and dumb luck to protect me.

Later, after the NWS office in Columbia had a chance to examine the damage from the storm, it was determined that the tornado I saw was an EF-3 on the enhanced Fujita scale and cut a damage path that was between a quarter to a half-mile wide. This same tornado blew the roof



off of houses and caused damage across a large portion of central South Carolina. I was happy to have had my first personal experience with a tornado, but that was almost too personal.

Even though I had been a storm spotter for several years, my first real severe outbreak was a bust for me as a spotter for several reasons. The first was, I had completely neglected my own safety. I was stuck on the ground with no transportation to evacuate and nothing more than a wooden pavilion over my head as shelter. My cell phone battery was dead and I hadn't brought my 2-meter hand held with me, so I was without a way to communicate to either the NWS for reporting severe weather or to call 911 should I find myself in real trouble. I had no digital camera with me to document any of the storms or resulting debris that I came across when I finally did get transportation out. To say that this event was a learning experience is probably an understatement at best.

The "Ides of March" tornado outbreak was exciting for me as a weather enthusiast, but it was also an experience where I learned a valuable lesson as a storm spotter. So, though you aspiring spotters might not make the same mistakes I made that day, I am going to offer some tips and advice to get the most out of your storm spotting experience, while maintaining your own safety.

Before I get too much further, I want to make a distinction. This article will not delve into the knowledge and tools needed to become a storm chaser. Because of the danger involved in "chasing" storms and the extensive knowledge on storm structure and forecasting that is needed to stay safe, that level of information would be well beyond the scope of this article. There are several good books out there, and I will provide links to a few of them at the end of this article that can help to get you going. This article will focus on how to get started as a storm spotter so that you can determine your own level of involvement from that point.

SPOTTING EDUCATION – Getting smart about storms

Perhaps the first step that I would recommend for any aspiring storm *spotter* would be to sign up for the spotter training courses offered by your local NWS office. Information on the times and locations of these courses can often be found on your local forecast office Web site, and are usually found through the "Skywarn" link (more on Skywarn later in this article). There are two levels of spotter training: basic and advanced.

Depending on your level of interest, the basic training might be just enough to get you started in understanding the things going on in the sky during a severe weather event so that you can accurately report severe events. For those with a bit more thirst for knowledge, the advanced class delves deeper into the science that is happening during storms.

Classes will usually help you define what is reportable as severe weather (in other words, don't call the NWS to tell them it is "raining pretty hard and the wind is blowing"), how to



measure hail sizes and approximate wind speed, basic storm safety, how to differentiate a tornado from other types of commonly misreported cloud formations, and the dynamics of what is happening in and around a thunderstorm.

You will leave the class with a handy guidebook full of weather science and information on how to contact the NWS to report severe weather. Some offices will even mail you a spotter training certificate suitable for framing so that you can show the world you are a "bona fide" spotter.

Training classes are usually taught by meteorologists from the local NWS office and sometimes are even held at their offices. This doubles as an opportunity to tour their offices and get a fascinating glimpse into forecasting operations in your area, as well as get to know some of the forecasters you may be speaking with later while trying to out-run a tornado.

In addition to any storm spotting education you can get from your local NWS office, you might also want to check with your local, county, and state Emergency Management offices to see if they offer any other training courses that could be useful to spotters. These can include everything from coordinating communications with authorities during an emergency or disaster, to basic Cardiopulmonary Resuscitation (CPR). A fundamental knowledge in these areas can make spotters a valuable asset in emergency situations. Amateur radio operators might also want to look into training in emergency response that is offered by their local Amateur Radio Emergency Services (ARES) group or through the American Radio Relay League (ARRL).

Another great source for storm spotting materials and education is Skywarn. Skywarn is the national organization for storm spotters and chasers. On the Skywarn Web site, one can find a wealth of training materials. Mandatory storm spotter resources like the NWS' Basic Spotters' Field Guide, a comprehensive glossary of spotter terms (a fantastic resource to have in hand for any spotter), and a primer on NOAA Weather Radio are found under the Skywarn "Educational Materials" section.

But perhaps for the radio enthusiast, no link provides more tantalizing information than

kBrems Storm Spotting Frequency List. In addition to some general info on 2-meter simplex frequencies, you can also find repeaters used by spotters in every state, local emergency response frequencies, FM stations that broadcast severe weather information, and even some HF frequencies used by spotters.

A LITTLE LIGHT READING – Resources to expand your knowledge further

To take your weather and storm spotting knowledge to the next level, there are a number of excellent books that cover a wide variety of spotter and weather-related topics. These are some that I highly recommend and use myself.

Storm Chasing Handbook by Tim Vasquez

Pretty much the standard reference that every spotter or chaser has in their library. Vasquez has included just about everything a spotter needs, from basic forecasting, spotting and chasing techniques, to the ever present "learn from my mistakes" advice of fellow chasers. This should be required reading once a spotter has completed spotter training.

The Weather Forecasting Handbook by Tim Vasquez

Again, Vasquez has provided a top-notch reference for weather enthusiasts. If you want to learn more about reading models and producing forecasts (which is essential if you want to add storm chasing to your spotting duties), then get this book.

Weather Map Handbook by Tim Vasquez

To add even more value to Vasquez' forecasting handbook, this book will give you in-depth guidance into what all of the symbols and numbers mean when looking at models or even thermodynamic maps to glean information on such crucial severe storm data as CAPE and lifted indicies.

In addition to these, there are hundreds of

other books on forecasting and spotting available. But these should get you started fairly efficiently.

SPOTTING EQUIPMENT – What to have in the field

Storm spotters can often look like they are heading out for a major expedition with the amount of equipment they will take with them into the field. Depending on your level of involvement in storm spotting, the equipment you bring can range from the basic (a cell phone), to the extreme (maps, 2-meter radios, HD camcorders, digital still cameras, mobile Internet radar and more). Most spotters will find they want to bring enough equipment to assist in storm spotting and then have something to show off after the fact, without reducing their mobility. Here are some of the common things storm spotters will bring with them, depending on how serious they are:

Digital still cameras –

Many spotters want to have something to share with fellow spotters or family and friends after their spotting adventures. A camera with a high resolution will help to pull in details from an angry sky. These days, the resolution-to-cost ratio is much different from a few years ago. Today, spotters can get a really nice digital SLR camera with more than 10 mega pixels of resolution for approximately \$500 to \$1000. If that price is too rich for your blood, just about any digital camera with a resolution over 5 mega pixels should suffice.

Cell phone –

This is an essential piece of spotting equipment, especially for spotters who are not amateur radio operators, as this is how they will have to relay information back to the NWS. If you already have a cell phone, most likely it will

be sufficient and you probably already have an idea of what to expect when it comes to signal strength in your area. Just make sure that you have your cell phone charged when the storms roll in and have your local spotter reporting phone number already programmed in your phone. A cell phone with a built-in camera can act as a handy backup in case your camera is beaten apart by hailstones or blown away in a microburst.

Vehicle –

Speaking of hailstones, you will obviously need a reliable vehicle to keep yourself mobile and out of harm's way. Getting caught on the side of the road with a dead vehicle while a severe storm is barreling towards you is not an ideal situation.

If you have the means, it is probably a good idea to take a vehicle into the field that you don't mind getting roughed up a bit. In addition to the aforementioned potentially large hail, storms can throw debris and dirt around, turning a prized sports car into a demolition derby reject. Expect to replace a windshield regularly if you live in a large-hail prone area.

Make sure your vehicle is in top working order. Check the fluids regularly, keep your windshields clean, make sure your tires are properly inflated, and by all means, make sure your gas gauge isn't hovering over 'E.' An emergency kit that includes a spare tire, jack, jumper cables, flares or hazard lights and other provisions is also a really good idea if not a must-have. The phrase "better safe than sorry" was never truer than when going up against mother nature's fiercest storms.

Two-way radio / scanner / weather radio –

For the spotter traveling in a group, or for spotters who are hams, a two-way radio in the vehicle is almost as crucial as a cell phone. When spotting, I actually bring two 2-meter radios with me. One is my ICOM IC-2200H mobile, the

other is my ICOM T-90 2M/440 hand held. By bringing both radios, I not only have a backup should one fail, but I also give myself options in portability, depending on how severe the weather becomes. Should I have to seek shelter, I can still relay reports through my hand held to the NWS on our local repeater.

Many spotter hams will use one of several unofficial spotter simplex frequencies: 146.550, 223.520, 446.100 or 1294.550 MHz. In addition, hams in many areas will organize through Skywarn or ARES on repeaters to report severe weather, sometimes being operated through their local NWS office. Here in Greenville, SC, several of our local hams will take turns operating a WeatherNet during severe storms on one of our local repeaters. Nets are run at the NWS office in Greer and provide not only a service to the NWS during severe weather events to relay storm reports, but help to build a working relationship with the NWS that lasts throughout the year. More information about local spotter use of repeaters for your local area can be found at the kBrews site mentioned above.

Also, I never leave home during storm season without my Uniden BC246 scanner. I have programmed my scanner not only for local emergency frequencies, but also for my local NOAA weather radio to stay informed on warnings and watches issued for my area. I might look funny with a cell phone, ham radio, and scanner clipped to my hip in the field, but communication is the very reason we spotters exist in the first place. It is our duty to relay information on severe weather events happening on the ground back to the NWS. If we don't have the means to do this in the field, we are just wasting our time and possibly putting our lives in danger.

Maps/GPS unit –

A spotter on the road will have to know where they are going and where the "quick exits" are in case things get hairy. A detailed road map or mapping software on a laptop will give a spotter a look at the bigger picture, while a GPS is good for finding specific locations from which to spot from. If a spotter will be doing any amount of extended traveling into unknown areas, a second spotter in the vehicle or a dedicated driver/navigator setup is the best and safest bet.

Video camera –

If you really want to document your spotting adventures, a good high definition digital video camera is the way to go. Like digital cameras, the resolution-to-cost-ratio for HD camcorders has come down dramatically in recent years as technology has improved. For both digital video and digital still cameras, the professional resource that many prefer to use is B&H Photo and Video. Their selection and service is well renowned and they offer a large amount of accessories as well such as tri-pods, lenses, cleaning products and recording media.

Weather instruments –

For the spotter who wants to record exact scientific data, portable weather instruments are a necessity. A spotter in the field can make use of everything from personal lightning detectors,



portable wind meters, thermometers, hygrometers and more. The more scientific data a spotter can give to the NWS about the conditions on the ground, the more useful the data will be in verifying storm information from radar as well in any post-storm damage assessment. Many hand held instruments, some combining features mentioned above, can be found in the Skywarn Store online.

Portable radar imagery –

If a spotter finds themselves on the road with a large super cell looming, an up-to-date radar image can prove helpful. There is a large assortment of mobile radar products available to spotters that want to run mobile broadband connected laptops in their vehicles. For those who are on a budget, a cell phone with Internet access to the NWS' mobile site can also provide a spotter with real-time radar images.

Spare change / cash –

While a debit card will buy almost anything these days, when the power is out, cash is still a perfectly good substitute. Have enough to fill up your gas tank at least once and have quarters for air machines in case of a flat. Even adrenaline-rushed storm spotters have to eat, so some food money is also a good idea, even if it is for a gas station sandwich and a drink.

A spotting partner –

While you can be a solo storm spotter (especially if you have a designated area from which you routinely observe storms), traveling around your area to observe conditions pretty

much requires a spotting partner. If your storm spotting partner is not trained in spotting or knowledgeable in weather, they can drive while you observe conditions in the sky, watch the radar, report conditions to the NWS or find routes on the map.

Storm spotter “swag” –

You will often find storm spotters decked out in their favorite spotter apparel. The Skywarn store has an assortment of hats, shirts, badges, vehicle markers and the like to get you started. If you fall in with a storm spotting group, they will often have apparel you can proudly wear – both on spotting days and when the sky is clear and blue. With the recent surge in the popularity of storm chasing and spotting because of media coverage in movies and on TV, a storm chaser T-shirt is likely to get the wearer a lot of attention!

THE BOTTOM LINE – Have fun, but be safe!

As tempting as it might be to deck ourselves and our vehicles out with enough sensors and antennas to become a portable weather station, don't try to bite off more than you can chew. Don't forget what got you interested in spotting in the first place – the beauty of storms and the call to service. Being a volunteer storm spotter can be a highly rewarding experience, one that can give you a lifetime of stories to tell friends and family. However, being able to observe Mother Nature at its most powerful and destructive can be awe-inspiring, but dangerous.

So keep an eye on the sky and keep yourself prepared for whatever the storm can throw at you.

I hope to see some of you out there learning the science of the storms and contributing valuable information to your local NWS office. Who knows, you may even get that photo or video that lands you an extra 15-seconds of fame!

In addition to the Web sites mentioned in this article, in the table of links below you can also find a few Web sites that offer detailed forecasting information that can be useful during severe weather outbreaks, and other sites that deal with storm spotting and chasing.

STORM SPOTTING LINKS

- National Weather Service – Storm spotting/Skywarn page: www.weather.gov/skywarn/
- Skywarn: <http://skywarn.org/>
- Skywarn Store: www.anythingweatherstore.com/
- NWS Mobile Weather Site: <http://mobile.weather.gov>
- B & H Photo / Video: www.bhphotovideo.com/
- kBrews Storm Spotting Frequency List: www.caps.ou.edu/~kbrews/spotfreq/index.html
- Tornadovideos.net (Reed Timmer of Storm Chasers fame's company Web site): <http://tornadovideos.net/>
- Storm Prediction Center: <http://spc.noaa.gov>
- ARRL/ARES Information: www.arrl.org/FandE/field/pscm/sec1-ch1.html
- Basic Storm Spotters' Guide (in .pdf format): www.nws.noaa.gov/om/brochures/basic-spot.pdf
- Training Materials and Essays on Storm Chasing: www.k5kj.net/training.htm



Alinco DM-330MVT



This handsome, compact, voltage-variable power supply can produce over 30 amps of current—more than 500 watts—to your choice of equipment or accessories! Select 5 to 15 VDC as displayed on the back-lighted meter, and read the current drain as well! Concerned about switching noise? This supply has an adjustment to tune out any of those annoying harmonics!

The programmable pre-set voltage function makes the DM-330MV even easier to use. Just store the most frequently used voltage in the memory, and it is constantly ready to go. A cigar-plug socket (Max 10A), a set of Max current terminals, and 2 sets of snap-in terminals (Max 5A) are conveniently laid-out and offer numerous variations for its operation.

Measuring only 6.9"W x 2.6"H x 6.6"D and operated by 120 VAC, voltage regulation is better than 2% with less than 15 mV ripple.

Order Now!

Order PWR06
Only \$ 189^{95*}

GROVE

800-438-8155

828-837-9200 fax: 828-837-2216

WWW.GROVE-ENT.COM

order@grove-ent.com

7540 Highway 64 West

Brasstown, NC 28902

* plus \$13.95 Priority Mail or UPS Ground shipping in the US

Propagation Outlook for April-September 2009

Summer SW Broadcast Season

By Tomas Hood NW7US

Conversations about the new Solar Cycle 24 continue to focus on what some feel are atypical activity trends.

A lot of scientists who study solar observations use consensus science to postulate what the sun will do each year. Using consensus algorithms rather than pure scientific method has a built-in tolerance for faults and “exceptions” such as we are currently experiencing. Scientists are able to constantly slide the goal posts of solar maximum and how active the cycle will be, rather than proving or disproving or having to make adjustments to each model.

So, once again, models that proved reasonably accurate when tested against past solar cycle data will be tested as we move through this current solar cycle. We can only hope that eventually we’ll better understand the science behind the solar cycles and won’t need to rely on vague guesses based on consensus of many models, but we will finally have a physical model that we can rely on!

Needless to say, there is no current agreement on a prediction of this new solar cycle activity cycle. Will it be a weak, long cycle? Or will it be a strong, short cycle?

The end of Solar Cycle 23 is now positioned statistically on August 2008. Since October 1996 is used as the effective start of cycle 23, cycle 23 lasted eleven years and ten months.

Since August 2008, we’ve seen more cycle 24 spots than cycle 23 spots (figure 1). A spot is considered to belong to cycle 24 if its magnetic structure is oriented in reverse from the orientation of spots observed during the second half of cycle 23. It is typical that some cycle 23 spots will continue to occur during the first 18 months or so of a new cycle. However, new cycle spots are emerging more often than are cycle 23 spots. The eleven-year, ten-month cycle length of cycle 23 is well within the eleven-year solar cycle historical average.

What is causing brisk discussion, though, is not the length of the last cycle, but some of the models used to predict the intensity and length of the new cycle. The panel of scientists that have issued official predictions for both cycle 23 and cycle 24 gave little weight to precursors other than geomagnetic activity and polar field intensities.

Using one geomagnetic activity model, Cycle 24 could peak around 154 (give or take

25 points). Using another, the cycle could peak around 115 (give or take 27 points). The average of these two models (named the “Combined Geomagnetic Precursor”) gives Solar Cycle 24 a peak of roughly 135 (give or take 30 points).

Using polar field strength, the model calls for a cycle peak around 75 (give or take 30 points). This would be significantly less activity than that predicted by the geomagnetic models.

New for this cycle is a model *not* based on geomagnetic activity nor on polar field activity, but on the sun’s internal “dynamo.” This model has accurately predicted the last eight cycles. For each cycle, the previous cycle’s data was fed into the numerical model, resulting in an accurate prediction for the following cycle with error (root-mean-square, or RMS) of less than 10 points. Using this model with Cycle 23 data, Cycle 24 could peak at 165 (give or take only 15 points).

The next few years are critical to the validation of these models and verification of prediction methods. But, what does all of this mean to us radio operators? The consensus gives us a prediction of a large cycle with a peak somewhere near 135 during 2012 and a small cycle peaking around 75 during 2013 (figure 2). Either way, the new cycle will have at least a moderate amount of activity.

The rest of 2009 will see low activity levels, with a steady climb in flux readings (at the time of writing, the 10.7-cm flux has risen slightly above the long run of upper 60s to the low 70s). Additionally, expect a continued low level of geomagnetic activity. Overall, we expect the middle shortwave bands to remain in fair condition, and low frequency conditions to continue much the same as those observed during 2008.

The Spring/Summer Season

It is that season, again, when the Northern Hemisphere transitions from days in which dark hours outnumber sunlit ones, to a season of days with more hours of sunlight than of darkness. The moment (not the day) when the sun is observed to be directly above the equator is known as the Vernal Equinox, which will occur this year on March 20 at 1144 UTC. At

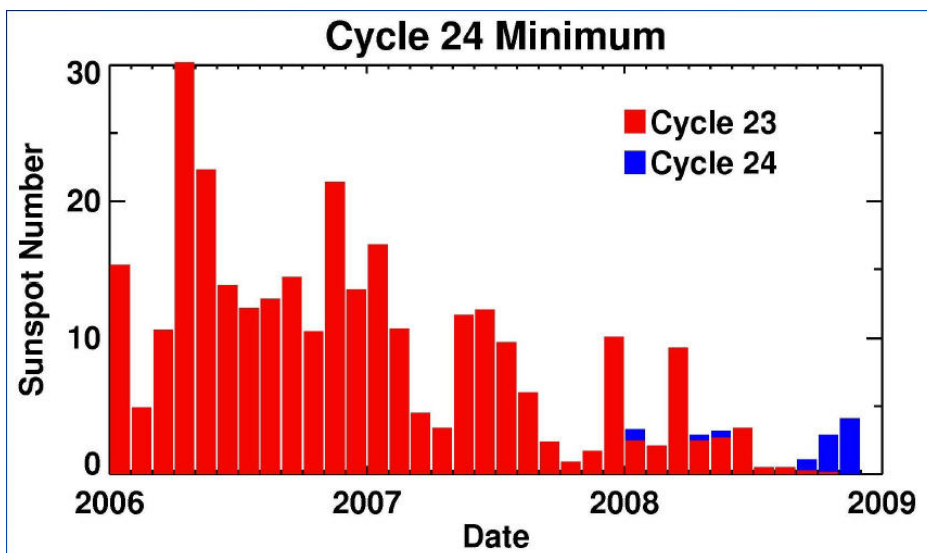

Since August 2008, the number of sunspots belonging to Cycle 24 (blue) is more than the number belonging to Cycle 23 (red). Even though there are occasional Cycle 23 spots occurring after August 2008, it is clear that Cycle 24 has begun. Source: NOAA/SEC

that moment, the center of the Sun will spend a nearly equal amount of time above and below the horizon at every location on Earth, and night and day will be of nearly the same length. These equinoctial transitions occur twice a year, in the autumn and in the spring.

Every minute after the Vernal Equinox until the date when the Sun reaches the highest latitude in the summer season (known as the Summer solstice, June 21 at 0545 UTC), the length of daylight in a 24-hour day grows longer. The ionosphere is affected by the length of exposure to the Sun. The lowest shortwave frequencies and the medium wave frequencies become mostly unusable for most of the day.

Signal absorption in the lowest of the ionospheric layers, the D region, occurs most prominently at these low frequencies. The amount of absorption is directly tied to the amount of sunlight energizing the D region. At night when the D region is in darkness, it quickly loses energy and absorbs very little of the signals that it did during daylight hours (some nighttime absorption still occurs, however).

Since the period of darkness is short in the summer season, the window for hearing a DX medium wave (MW) broadcast station or a tropical shortwave DX station on the lower HF spectrum is very short. At the same time, the radio noise-level caused by weather is higher, masking those weak MF and low HF signals that might still make it through the D region.

The higher shortwave frequencies come alive, though. The more energized the ionosphere, the higher the radio frequencies that it can refract. Even during this period of low sunspot activity, a great amount of radio propagation in the shortwave spectrum is occurring. And the good news is, Solar Cycle 24 is just beginning, meaning that there is a slight increase in solar activity during 2009. This author has seen increased activity on higher shortwave frequencies such as the amateur radio fifteen meter band.

International shortwave broadcasters typically change their transmission schedules and the frequencies they use so they can better reach their audience. This change is made by most broadcasters at the end of March each year, to take advantage of the summer ionospheric conditions. Because they typically use great amounts of power (millions of watts) to overcome the signal loss the radio waves experience between the transmitter and your receiver, many windows of DX opportunity for the shortwave radio listener open up, even during the years of solar cycle minima.

The VHF/UHF hobbyist also benefits from the changes in season. The summer season holds a lot of unique opportunities for exotic radio activity. DXing distant FM radio stations and TV broadcasts via tropospheric ducting becomes an exciting summertime activity. Trans-equatorial propagation between stations on either hemisphere is common during the spring and early summer.

Some hobbyists enjoy catching pings of FM stations off of meteors blazing through the ionosphere that leave behind a thin but dense ion cloud that reflects VHF and sometimes UHF signals. Don't forget the interesting pursuit of exotic VHF propagation via the Aurora, too. The

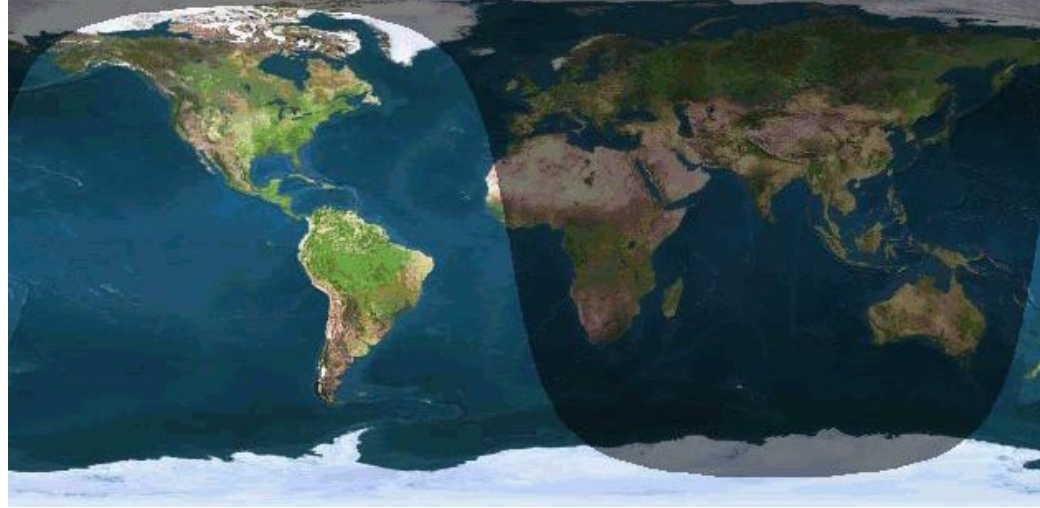

aurora-mode propagation opportunities might increase this year, as Solar Cycle 24 slowly gains intensity.

Summertime Shortwave Propagation

While the lower HF and MF bands become less usable as we move through the spring and into summer in the Northern Hemisphere, the propagation characteristics of the higher HF band change. Paths between many areas of the Earth begin opening up on higher shortwave frequencies. Openings between the northern and southern hemispheres become more reliable. Because the Sun is mostly overhead over the equator during the last part of March and early part of April, we have optimal DX conditions on paths crossing the equator, especially on paths that follow the grey line terminator.

The terminator is the line on the earth between the sunlit side and the side in darkness. This is also known simply as the "grey line." It is also called the "twilight zone." Because of the tilt of the earth as it rotates, in relation to the sun, the location of the terminator line changes dramatically. During the two yearly equinoxes,

the terminator runs straight from pole to pole. This transitional period is significant in terms of radio wave propagation because of how the ionosphere changes during this transitional period. In the most general terms, unique and enhanced modes of HF radio wave propagation exist along this terminator.

As high summer arrives, conditions on shortwave frequencies become quite different from those of winter. Radio paths running east and west are not as strong as the signal paths that run between points north and south. On June 22, 2008 at 0545 UTC, the period of sunlight is the longest of the year in the Northern Hemisphere.

At the end of the summer season, we move again through the equinoctial period, and those east/west paths open back up, and we enter the prime "winter" DX season.

From April to June, fair to good propagation occurs on both daytime and nighttime paths on the middle shortwave bands. The strongest propagation occurs on paths that span areas of both day and night. During April, peaking in May, and still during June, the frequencies between 9 and 16 MHz may offer occasional 24-hour DX to all parts of the world. Thirty-one meters will be the most stable as a nighttime

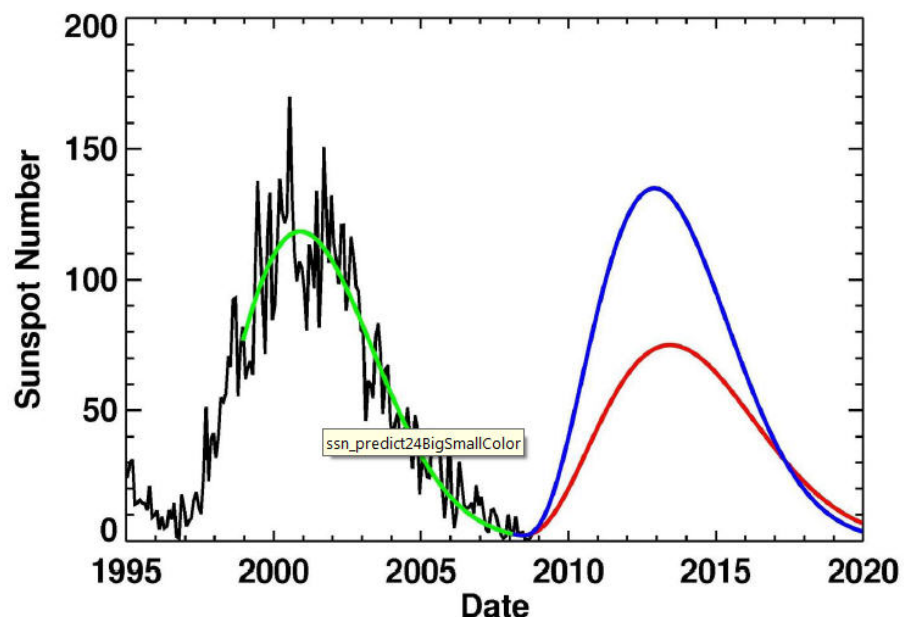

Based on various models (see text), the consensus forecasts two possible cycle peaks. The larger cycle may peak in 2012 with an approximate smoothed sunspot count of 135. The smaller possible cycle peak is around 75 smoothed sunspots sometime during 2013. Source: NASA/SEC



band, with propagation following greyline and nighttime paths.

During the early part of the summer season (April through May) propagation is still hot on lower SW frequencies, like 41 meters, with Europe in the evening, and Asia in the mornings. Occasional DX openings will occur on the tropical bands around sunrise. However, these bands are quickly being degraded by the seasonal increase in noise.

June marks the changeover from equinoctial to summertime propagation conditions on the shortwave bands. Solar absorption is expected to be at seasonally high levels, resulting in generally weaker signals during the hours of daylight when compared to reception during the winter and spring months.

As we move into July, solar absorption is expected to increase. This causes generally weaker signals on the lower to middle shortwave frequencies during the hours of daylight, when compared to reception during the winter and spring months. This higher absorption will continue to play a role in weaker signals on shortwave until the autumn.

The low sunspot activity during 2009 will result in low maximum usable frequencies, consistent with conditions experienced during 2008. During this summer, 19 and 16 meters will be the most reliable daytime DX band, though signals will be weaker and more unstable. Sporadic-E propagation will make reception of signals possible for less distant stations, though.

Twenty-five through 31 meters will be fairly good in the evenings and mornings. At night, those paths that remain open may be marginal. During periods of low geomagnetic activity expected again this year, this band may offer long distance DX all through the night. The most reliable band for both daytime and nighttime should be a toss-up between these two bands.

Forty-one and 49 meters offer domestic propagation during daylight hours and somewhat during the night. The tropical bands (60, 75, 90, and 120 meters) are not noticeably affected by the solar flux, but are degraded during geomagnetic storminess. Through the summer, expect these bands to be more challenging, though less this year than last year, due to the somewhat lower geomagnetic activity levels expected.

Look for Europe and Africa as early as sunset. After midnight, start looking south and west for Pacific, South America, and Asia. Short-skip should be possible out to about 750 miles during the daytime.

Expect some openings on 75 and 90, similar to how 40 meters will be acting. Fairly frequent short-skip openings up to 1000 miles are possible during darkness, but expect very few daytime openings with all the static and absorption. MW and 120 meter propagation is rough in the summer due to the high static and higher overall absorption caused by the short nights and higher D-Layer ionization.

Overall, daytime bands will open just before sunlight and last a few hours after dark. Look higher in frequency during the day, as these frequencies will be less affected by any solar storms occurring, and more broadcasters have transmissions in these upper bands.

VHF

Widespread auroral displays can occur during April, bringing with them unusual ionospheric short-skip openings on the VHF bands. Best times for these to occur are during periods of radio storminess on the SW bands. Look for days with high planetary K (Kp) and A (Ap) figures (typically, the Kp should be over 5).

Will that occur often, this year? Probably not, since we are at the lowest point of the sun's activity. However, because there are recurring coronal holes that spew out massive amounts of solar plasma toward the Earth, we expect occasional periods of moderate geomagnetic storminess. These occasional moments of minor geomagnetic storminess, caused by fast solar winds and the passage of plasma released from the Sun's corona, may trigger aurora, providing possible E region ionospheric propagation (Au).

Expect Sporadic-E (Es) propagation starting in June that may produce some great long-range VHF and even possible UHF DX. During July and August, short-skip propagation over distances as great as 1400 miles should be possible for about ten percent of the time on 6 Meters. Higher VHF (2m) openings may also be possible during periods of intense sporadic-E ionization.

Tropospheric ducting begins to form over

wide areas of North America, and over the Atlantic and Pacific Oceans, during the middle to late summer. Watch for stalled high-pressure weather cells between your location and the distant (DX) station. Stalled high-pressure weather cells, with pressures reaching above 1025 millibars, are known to cause the ducting of VHF radio signals. Ducting allows VHF radio signals to bounce through these natural waveguides far beyond the normal line of sight distances.

Tropospheric ducting forms each year between Hawaii and the U.S. West Coast, and from San Francisco to Los Angeles, Denver to Dallas, Texas to Florida, the Great Lakes to the eastern seaboard, from the Great Lakes to Texas, Nova Scotia to Miami, and from the Midwest to the Southeast.

There are a number of meteor showers during this period between April and September that might provide opportunity for observing VHF/UHF Meteor Scatter propagation DX. Most meteor showers are at their best after midnight. After midnight, you're on the leading edge of the Earth and you're meeting the meteors head-on. Before midnight, you're on the trailing edge of the Earth and the meteors have to catch up to you. As a result, not only are more meteors seen in the pre-dawn hours, but their impact speeds encountering the Earth's atmosphere are much higher and the meteors are generally faster and brighter. This causes greater ionization, which is what you use to refract a radio signal. Look for TV and FM broadcast "pings" (short bursts of reception) during these events. If you are an amateur radio operator, look for six and two meter openings off of the ionized meteor trails.

Lyrids, a major meteor shower, should take place from mid to late April. The unpredictability of the shower in any given year always makes the Lyrids worth watching, since we cannot say when the next unusual return may occur. If this year's event is average or better (30 to 60 good-sized meteors entering the atmosphere every hour), meteor-scatter openings could occur on the VHF bands.

Another major meteor shower, the Eta Aquarids, will occur in May. This shower has a peak rate of up to 20 to 50 per hour.

Minor showers include the Alpha Aurigids (continuing from August), the Beta Cassiopeids (peaking September), the Epsilon Perseids (peaking September), the Delta Aurigids (peaking September) and the Piscids.

WRITE ME

I hope to hear from you regarding your observations and with any questions you may have about space weather, the solar cycle, and radio propagation. Please explore the online resources at <http://propagation.hfradio.org> and at <http://hfradio.org/forums>. If you have a cell phone or other handheld device capable of reading WML, I have a WAP version of this resource center at <http://wap.hfradio.org>

I wish you a happy radio-monitoring season!

73 de NW7US, Tomas Hood
nw7us@arrl.net
(P.O. Box 9, Stevensville, Montana 59870)



Radio Slovakia International and The Butterfly Effect

The fall of the Berlin Wall and the subsequent collapse of the Soviet Union have been watershed events for shortwave listeners: The downfall of the communist governments in Eastern Europe created fertile ground in which new shortwave stations sprouted up, and allowed those formerly under Soviet control (such as Radio Vilnius) to gain an independent voice. With the disintegrating countries and moving borders and breakaway republics, Eastern Europe has been a jumping hotbed of shortwave activity for the last 15-20 years.

These new and newly-free broadcasters used and turned to shortwave for one of its traditional, classic uses: a medium to tell others around the globe about themselves --their respective countries, peoples, cultures, independence, what it was like living under police-state regimes -- and for getting their points of view, and sometimes propaganda, across.

One of those newly-independent countries was the Slovak Republic, or Slovakia. When Slovakia gained its freedom, it didn't waste any time in establishing an international presence on shortwave with the founding of Radio Slovakia International. And now in the face of numerous threats of cuts and closure, as reported in Glenn Hauser's *Global Forum* and *DX Listener's Digest*, Radio Slovakia International is still braving the shortwave waters and continues faithfully with its daily English broadcasts to the Americas.

Geo-History

In the 10th century, Slovakia was part of The Kingdom of Hungary. After World War I, it joined the Czech territories of Moravia, Bohemia, and Silesia to create Czechoslovakia. Slovakia had a period of independence from 1939 to 1945, when it was again absorbed as part of Czechoslovakia. A communist government in the Soviet mold reigned from 1948 to 1989. When Czechoslovakia fragmented in 1993, Slovakia gained its independence and Radio Slovakia International was formed.

Modern, independent Slovakia has an area of almost 19,000 square miles and is landlocked in the center of Europe. It's bordered by Hungary in the south, Austria to the southwest, the Czech Republic to the northwest, Poland to the north, and Ukraine to the east.

One of Slovakia's famous attractions is its

almost 4000 caves, though only 14 are open to the general public. The country is also noted for its 300 or so wooden churches, 23 thermal spas (and about 1300 mineral springs), nine national parks and 14 protected reserves (36% of Slovakia is forested), and its 180 castles and châteaux (the latter being castles whose defenses have been dismantled).

Blood Bath at Čachtice Castle?

One of the most famous of Slovakia's castles, Čachtice Castle, in the Little Carpathians in western Slovakia, might be familiar to readers of vampire lore. This was the residence, and later the prison, of Countess Alžbeta Báthory -- anglicized, that's Elizabeth Bathory, the blood-bathing countess.

Born in 1560 of royal Hungarian stock, Bathory was raised on her family's estates in the foothills of the Carpathian Mountains, of which Slovakia's Tatras range is the highest part. The region is rich in the folklore of the vampire

and werewolf, and the Countess may have had had a Satanist uncle or servant who trained her in sorcery and witchcraft. Her family ruled Transylvania, at the time part of the Kingdom of Hungary.

Bathory reputedly tortured and killed up to 650 young women from 1585 to 1610. Apparently one of her methods of termination was to stab or impale the girls in an iron maiden. This device was suspended over a bath which collected the victims' blood. Bathory supposedly bathed in the blood, particularly in that of virgins, in the belief that it would keep her skin smooth and supple.

But this wasn't all a means to an end: Bathory was reportedly a sadist who also tortured the girls with needles, burning candles, and hot iron, sometimes letting the sufferers go afterwards. Reputedly, one of Bathory's victims escaped in 1600 and told what the Countess was doing to young women at the castle. But the Bathory family was so well connected that nothing happened -- the prime minister and local governor were both her cousins.





The story goes on that in 1610, Bathory's henchmen kidnapped a girl from a local village, and the parish priest there raised such an outcry about it that he got King Matthias II's attention. Count Gyorgy Thurzo, another cousin of the Countess, was sent to arrest her. He caught her in the very act of torture. She was detained in her castle during the trial in 1611.

Instead of being beheaded or burned at the stake as her accomplices were, Bathory was walled up in a room, perhaps her own chamber, in Čachtice Castle. Slits were left in the wall for oxygen and the conveyance of food and water. After three years of this existence, one morning the Countess' dead body was found lying on the floor of her room.

Some scholars aver that the Countess was a victim of a political conspiracy, and that the witness' testimony at the trial was itself elicited by torture. Various sources say her late husband, the Count, had loaned the government a large sum, which motivated them to find the Countess guilty and wall her up in order to release them from the debt they owed to her estate.

Reported actions showing other sides to Bathory's character include her providing medical aid to the Slovak and Hungarian peasants, interceding on behalf of poor women, reading and writing in three or four languages, and having interests in astronomy and science.

Most seem to agree, however, that the Countess Bathory was, to some extent and in some form, a sadist and killer. But they disagree on the number of Bathory's victims. Some say the 650 figure is grossly exaggerated, and put the number at 50 or less. Others assert the number is closer to 100 or 200. Many believe the blood-bathing accusations were extracted under torture and are only legend.

Considering her Hungarian roots, Slovakian history considers her a scourge on the Slovak people. But the village of Čachtice and environs seem to have made the Countess their own, as her story and legend attract interest and tourism from around the world.

A Sample Program

I've been hearing RSI semi-regularly on 7230 kHz at 0100 UTC here in the Northwest. I tuned in and sampled a broadcast on a local Sunday. Rather than starting with a traditional news bulletin, the transmission began with *Sunday Newsreel*, a recap of the week's news. This included mention of the Visegrád Four (V4 – Slovakia, Czech Republic, Hungary, and Poland) and Baltic States meeting in Gdańsk, Poland, which focused on the global financial crisis, energy, and climate. Also covered were stories on Slovakia's healthcare system, budget, and economic growth; and the European Parliament's prognosis on the European economy.

The rest of the broadcast was filled with a magazine program, *Listener's Tribune*, which started with reviews of topics and headlines covered over the past week. These included a story on Slovak motorcyclist Jaroslav Katrinak, who completed the 2007 Dakar Rally, an almost 8000 km ordeal that ran from Lisbon, Portugal, through Spain, Morocco, Mauritania, Mali, and finished up in Dakar, Senegal. There were categories for motorcycle, car, and truck. Katrinak came in 9th in the motorcycle category, with a time of 55:17:03 over a 16 day span.

The week's review also covered the European Parliament's plan to cut greenhouse gases; the 60th anniversary of the Universal Human Rights Declaration, with concern for the Roma and Hungarian populations in Slovakia; and how distant adoption programs can decrease child labor.

Next there was a long, melodic, Slovakian pop song. This led into a listeners' letters section of the broadcast, with letters from Bangladesh, Nova Scotia, Peru, Mexico, Pakistan, England, and Tunisia. There was reference to the traditional Slovak folk instrument the *fujara*, a shepherd's pipe which is a sort of large, upright, bass flute; and a brief talk about the strong economy of Slovakia's capital, Bratislava, which is luring workers away from other Slovak cities.

The broadcast, amounting to about 27 minutes, ended with email and postal address contact information, which are:
Radio Slovakia International
Mýtna 1, P.O. Box 55
817 55 Bratislava 15
Slovakia
valocka@rozhlas.sk

RSI Online

Radio Slovakia International supports its shortwave broadcasts with a clear, easy to use, multilingual (Slovak, English, German, French, Russian, and Spanish) website. For the homepage in English, go to www.rozhlas.sk/inetportal/rsi/core.php?lang=2 The striking thing about this webpage is its completeness despite its relatively spare simplicity – most everything is accessible on this single page. The main body of the page is made up of news stories, each with links in order to read in more detail; a box of miscellaneous headlines, each linking to an article; and an article archive with links going back to October 2005.



To the upper left of the page is a menu of links which lead to news and information on various topics such as history, culture, and "kitchen," the latter including recipes for traditional Slovak dishes.

Also here are links to contact information and the shortwave broadcast schedule. The winter 2008/2009 English schedule for North America is listed for 0100-0130 UTC daily, on 7230 kHz at a 305° azimuth; and to South and Central America at the same time on 9440 kHz at a 245° azimuth.

Just below is a link which carousels through images of RSI's QSL cards. The link leads to the QSL page, with images of current and archived QSL cards. You can click on each image for a closer view. There are some beautiful photos here evoking the Slovakian countryside and villages.

RSI On-Demand

The lower bulk of the RSI homepage is occupied by on-demand links going back 10 days of RSI's English shortwave broadcasts. There are two links for each transmission: You can choose "stream" or "download." Depending on how you have your system configured, clicking "stream" can bring up the Windows Media Player to the left of your screen, allowing you to listen to the stream while you browse the website. You can also undock the Media Player and move it where you want around the page.

Clicking "download" calls up the Quick Time Player, amounting to a blank white page



with a virtual console in the middle. As far as the audio goes, either option works well.

Another aspect of the site's online streaming allows you to get even more specific: If you explore the news and information menu, you'll find the stories linked to it not only have the handy printable format link icon, but some also have a stream or download link attached to them. Clicking these lets you hear that particular story as broadcast on RSI.

More Online Radio

For more Slovak radio streams, at the top of the news and information menu, click slovakradio.sk You'll land on a page mostly in Slovak. Here you'll see seven other radio links in addition to RSI: Slovensko, Regina, Devín, FM, and Patria. Near the top of the page, click Livestream, and a page of streaming links will appear, or go directly here:

www.rozhlas.sk/inetportal/2007/index.php?lang=1&stationID=0&page=livestream



For streaming, I found the "MP3 - 64 kbps" links to have by far the best sound (despite the MP3 tag, this is a streaming link). Here's a sampling of what I heard on each stream, focusing on music, as none of the talk seems to be in English:

- Slovensko: Slovak pop, jazz, and world music.
- Regina: Slovak pop and folk music, and world music (sometimes a simulcast with Slovensko). Regina Bratislava, Regina Banská Bystrica, Regina Košice.
- Devín: Classical, orchestral and choral.
- _FM: "Alternative" stream with bizarre rap and pop in English ("MP3 - 128 kbps" sounded clearest here).
- Patria: From the listings on the site, Patria appears to carry cultural and historical programs, plus pop music.

Radio Archives

To explore further, on the same streaming links page, go to the upper right and click Program. This takes you to a page where you can see daily and monthly schedules for each stream

www.rozhlas.sk/inetportal/2007/index.php?lang=1&stationID=0&page=program&act=showProgram&stationID=0). You can choose which stream you want to search via the menu near the top center of the page. Click a stream and you'll be given that day's schedule down the main body of the page. You can then click on the programs in the daily schedule which have links, and hear that particular program on-demand via the Media Player, etc.

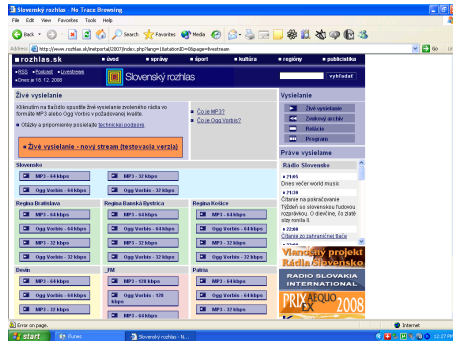

To enter the schedules and programs archive, go to the calendar near the top and choose a month and day, and that day's schedule with some on-demand links will appear down the page. As an example, on the Slovensko stream I sampled the program "Nočná pyramída" (just because I liked the sound of the words, which translate as "night pyramid") for 16.12.2008 (Dec. 16th). Though there was no talk in English, they played several songs, some sung in English, and the ones apparently sung in Slovak were melodic and very listenable (as a Slovak proverb says, where there is a Slovak, there is a song). There was a pretty song by Chris Rea ("Fool [If You Think It's Over]"), called "Driving Home For Christmas," on this particular archived program. You never know what gems are tucked away in seemingly unlikely places. And an Enya song (also in English) made an appearance on this program.

And More Music

For more music and some English, return to the slovakradio.sk page at www.rozhlas.sk/inetportal/2007/ Go to the menu of links on your left and click New Talent. This takes you to the page for The International Forum of Young Performers (IFYP, now called simply New Talent), an annual European contest for young musicians coordinated by the European Broadcasting Union.

If you go to the menu on your left and click Sample Player, a small player window will appear where you can hear samples from the contestants, who are noted by country and instrument. Two Canadians were listed, so the competition apparently isn't restricted to Europeans.

Little Big Country

On their website, RSI describes their daily programs as half-hour "magazines" which "contain news from Slovakia, features on Slovak economy, sciences, culture, geography, environment, sports, examples of verbal and musical arts and portraits of important personalities." They note that they broadcast "worldwide on SW,



satellites and Internet."

These are big ambitions for a small country, but they reflect Slovakia's new motto, "Little Big Country", and its new symbol, the butterfly, both chosen by the Slovak Tourism Board and Economy Ministry to raise the country's international profile.

As in chaos theory, where the flapping of a butterfly's wings has far-reaching influence, Slovakia's new symbol is meant to show that when the Little Big Country flaps its wings, the action can have political, economic, and diplomatic sway around the world. And a vital part of making Slovakia's butterfly effect felt is through RSI's broadcasts on shortwave, satellite, and Internet.

MT



The **Microtelecom Perseus** is a cutting-edge, multimode, software defined receiver covering 10 kHz to 30 MHz. Enjoy world class performance: 3rd order IP: +31 dBm, Sensitivity: -131 dBm, Dynamic Range: 104 dB (BW 500 Hz CW). An impressive full span lab-grade spectrum display function is featured. An almost magical spectrum record feature allows you to record up to an 800 kHz portion of radio spectrum for later tuning and decoding. The audio source is via your PC soundcard. The Perseus operates from 5 VDC and comes with an international AC power supply, AC plug converter, SO239 to BNC RF adapter, USB cable and CD with software and detailed manual. Made in Italy. Visit www.universal-radio.com for details!

Universal Radio
 6830 Americana Pkwy.
 Reynoldsburg, OH 43068
 ♦ Orders: 800 431-3939
 ♦ Info: 614 866-4267
www.universal-radio.com

Computer Security

Making Your Passwords Easier but Stronger

By Dr. John F. Catalano

How do we *adequately* secure personal data in our computers? With our social, business and financial lives now centered on the PC, we should be asking ourselves this important question. Clearly this is more of a problem to those of us who rely on laptops. But anyone who has a network and/or Internet connection should be just as concerned.

In the February *Computers & Radio* column we explored biometric computer security in the form of Microsoft's fingerprint reader. It was interesting, but not exactly the Hollywood stereotypical "total security." Take it from me, as a former CEO of a fingerprint biometrics company: total biometric fingerprint security is more perceived than real. For "total" security without a high incidence of false positives (giving the wrong people access) or false negatives (not giving the right people access), careful fingertip preparation and a very powerful and expensive computing system are necessities. These are government and military standard systems – not consumer.

The kicker in the Microsoft product is that it *still* relies on password(s) stored in the PC for access! This reminds me of the old definition of a consultant: A consultant is someone you pay to tell you the time, but to do so, they borrow your watch...and then keep it. (*Apologies to all those excellent consultants out there, including me...*)

Using a biometric fingerprint reader, a number of problems can occur. Dirt or other contamination of the fingertip, even humidity, can alter the image that the sensor sees. If not running on a powerful processor, the software may only look at a very limited number of fingerprint features. This increases the speed of operation while decreasing the required computing power. Or, as usually is the case with consumer biometric fingerprint products, both types of problems combine to degrade its performance significantly.

The disclaimer from DigitalPersona, a major player in the biometrics fingerprint market says it all: "The biometric (fingerprint reader) feature in this device is not a security feature and is intended to be used for convenience only...."

So what is the answer to our initial question? How do we obtain an adequate level of security for the personal information in our laptops and PCs? Will a well-designed password

manager do the job? Perhaps, but first we should ask the question, how many applications exist in our PC which are capable of being secured by passwords?

Passwords are Everywhere!

Passwords abound in our PCs, starting with the very first software routine our PC accesses when we turn it on. This first small, but critically important piece of code – called BIOS (basic input output system) – is the first routine every PC runs. Simply put, BIOS tells the operating system where the hardware such as disk drives and keyboards are located. All BIOS have a password that can be set to challenge the user for a correct response upon turn-on.

By pressing the F2 or F10 key during the boot-up or POST sequence, you can access BIOS and set your password. (A word to the wise: BIOS settings are *very* critical to the correct operation of your PC. BE VERY CAREFUL WHEN MAKING CHANGES TO BIOS. You have been warned!) If you do set a BIOS password, make sure you write it down and store it in a safe place. Lose this password and you may not ever be able to use your PC without a major technical effort. So, even before we get

to Windows, we have our first encounter with a password.

After successfully giving the BIOS password, it's on to the operating system. XP and Vista versions of Windows have the capability of requiring that the user enter a password. In Vista you can add or change the Windows' sign-on password by giving your PC the "3-fingered salute" (Alt-Ctrl-Del). Then, on the menu that appears, choose the "Change Pass Word" selection and follow the directions. In XP the password feature can be accessed from the Control Panel.

Here, once again be very careful. If you forget your Windows password, you may be in for a pile of ...work. If you are signed in as an Administrator and have previously created a Password Reset Disk, you can rest easy. Just use the disk. If not, it may mean completely re-installing Windows...UGH!

Once you set a Window User's password, it can also be used to lock out unauthorized people after the screen saver is activated. Go to "Display" in Control Panel then Screen Saver. Check the "secure with password" box. Now, when the screen saver is activated, your PC will demand your password before it lets anyone get back into Windows.



Document Secure

Did you know you can “protect” any MS Word document? To require that a password be entered to open a document, do the following. Load or type a document. Then go to the “File” menu and click “Save As.” Look for the “Tools” menu on this screen and click “General Options.” Enter the desired password in the box at the lower left, “Password to open:” and also in the “Reenter password to open” box. Click “OK” and “Save.” Now, to open this document or a copy of it on any computer, the password must be entered.

Following the same procedure, a document can be made secure from being changed except by those with the password. To do this, follow the above procedure, but enter the password in “Password to modify:” box.

The excellent free program *Open Office*, which offers the functionalities of MS Office, has the password capabilities accessed in a very similar manner. Password protection methods for Microsoft Excel sheets and other Microsoft products are also available. Searching various applications’ Help files (usually F1) for “password” should display capabilities and instructions.

The Outside Password World

Our most acute need for security comes from dealing with the outside world via a network or the Internet. After all, when we connect to the Web, we are opening our digital doors to the world. In a perfect world, people would respect each other’s privacy. But as a civilization (and I use the term loosely) we have not yet evolved to that level. Therefore, privacy, security, and protection take on whole new meanings and immediacy once we sign on to the Web.

The need for security in accessing your bank, credit card, email and other such personal websites is obvious. But for most people it is currently relegated to a collection of haphazardly created passwords, at best.

The two major web browsers, Internet Explorer (IE) and FireFox, both have website password management capabilities. These password managers can be set up to automatically fill in the password and user ID for each website that requires them. In addition, they have a feature that automatically completes the appropriate fields on Web forms such as name, address and more...sometimes too much more! There are times when we don’t want to divulge certain private information. But if you are running on auto-pilot-form-fill-out you could inadvertently give out this info. Not good. Worst yet, if someone other than yourself is using your PC, they have access to all your websites.

To help prevent this situation, both Firefox 3 and IE 7 have Master password features. This feature forces the user to enter a master password every time the browser is about to retrieve a specific website User ID and/or Password.

Password Explosion

Did I hear someone say, “The solution is simple: Just make all the passwords the same?”

That is a disastrous idea, almost like having no security at all. If someone discovers/cracks/finds that one password, your whole life is up for grabs. I don’t know about you, but the possible/probable consequences of that solution are just too scary for me consider.

So what’s the answer?

Capo de Capo

Password Manager from Large Software may be one answer. Large Software was the company that brought us the very useful *PC Tune-Up* program that was reviewed in *Computers & Radios* a few months ago. The first claim of this password program is “Password Manager remembers usernames and passwords for ANY web page or application.”

But both IE and Firefox will do the “for any web site” function. But hold on. Did they say *any application*? That would be a major help for our overworked puny human brains. No more trying to remember passwords for all applications.

Password Manager claims the following features:

Works with All Applications and Internet Browsers
The uses of multiple encryption algorithms (AES, Frog, Sapphire) to store the passwords for higher levels of security, multiple passwords for each site/application.

Portability – can be loaded onto a memory stick, leaving nothing behind on your host computer.

These are impressive claims from this \$30 program. Let’s see if Large Software’s program can really perform as billed.

Installation and Use

The program was installed on the Radio Friendly PC (RFPC) from Hudsonville Computers, <http://hcss.webs.com/>. The RFPC has an Atom 230 1.60 GHz processor running Windows XP Home Edition SP3, with a bus speed of 533 MHz, 160G SATA hard drive, 2 Gig DDR2 RAM, DVD/CD writable drive, Realtek ALC662 audio sound ports and a video port using the Intel Graphics Media Accelerator 950.

As a consequence of a number of “interest-

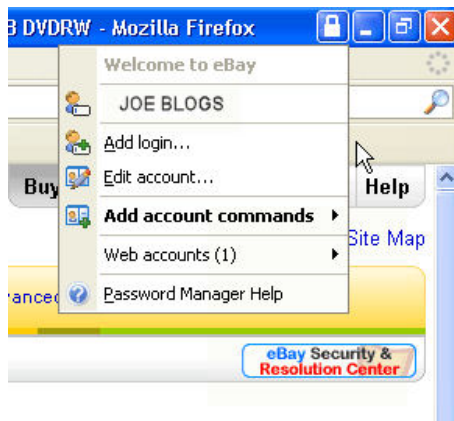

Figure 1 – Large Software’s Password Manager running in Firefox. Notice the “Lock” menu at the top right.

ing” starts that I encountered, I strongly recommend that the program’s installation directions be *strictly* followed. That means all, and I do mean ALL, programs and applications are closed before installing Program Manager. After these instructions were heeded, the program installed easily and was ready to go in under a minute.

Enter a choice for a master password by selecting one of the eight-encryption algorithms. Agree to the default selections on other functions and we are ready to use the program. An icon will appear at the lower right in the program tray to indicate Password Manager is now in residence. Let’s start slowly and see how it works with the Firefox 3.0.5 browser.

Adding Site Info

When Firefox is started, Program Manager puts itself into the browser as an add-on. A small “lock” icon now appears on the top right of the Firefox screen. Assume the user, Joe Blogs, has already saved the IDs and passwords of websites using the Firefox’s manager. For example, let’s go to the eBay website. Left click the top right “lock” icon. The menu in Figure 1 will be displayed. Select “Add Account” and Program Manager pops up a screen on the lower right, see Figure 2. Notice the ID and password have been automatically entered. Click “Add.” The website data is now being managed by Password Manager in an encrypted form. Now, whenever Joe Blogs visits the eBay site, his ID and password will be automatically entered and he will find himself logged into eBay.



Figure 2 – Pop up account window for Joe Blog’s eBay sign-in.

To enter the info for a new website, follow the same procedure and simply enter your new ID and password into the box in Figure 2 when you are challenged for sign-in information.

Wholesale Security

Password Manager gives the user the opportunity to convert all previously stored passwords for various applications to Password Manager with one click. For example, all Firefox and Yahoo passwords can be converted. If you use this feature, there is no need to add each website password and ID separately.

Quite frankly, I was too scared to try this feature. In the event I wanted to uninstall Password Manager I was concerned that it might take all my passwords with it into oblivion. I’m sure that Large Software has made provisions for reconstituting and reloading unencrypted passwords back to their original application upon uninstallation. Although this could be considered

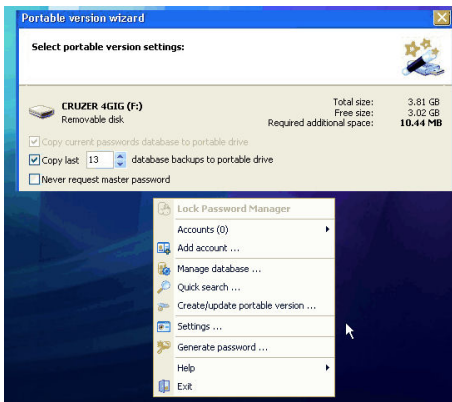

Figure 3 - Lower right functions menu where among other commands the portable version is created as seen above it.

a security risk, I really hope they have included this feature. But again, I didn't try it.

The password managers found in IE and Firefox work quite well, but only with the one browser that they are resident in. Large Software's Password Manager is very different and works with both browsers, simultaneously and seamlessly. If you open Internet Explorer in another window, you'll see the same lock icons and they will operate in the same way. Program Manager gets high marks on its catholic operation.

We could not find a single Internet application that did not work with Password Manager. All the Instant Message services, search engines and website sign-ins worked perfectly. Also Windows User Passwords worked easily with the program.

However, the "any" application claim is a bit exaggerated. Since no programs are active when BIOS runs, this program cannot be used for managing the BIOS password. That's understandable. But remember our discussion on document passwords? Unfortunately, they, too, are out of the realm of Password Manager's control.

Gone - Without a Trace

Password Manger can be totally contained on a USB memory stick. In this configuration, when the stick is unplugged, no trace of the program or its passwords remain on the PC. This is a great feature if you do a lot of traveling and log-on from cyber cafes, hotels, or other public PCs. The program can be made resident on the USB stick via the menu in the lower section of Figure 3. This appears with a right click of the icon on the program tray at the lower right of the screen. Click "Create Update portable version," then follow the simple instructions. The top section of Figure 3 shows Password Manager being loaded onto a USB memory stick.

Once transferred to the USB memory stick,



Figure 4 - The innocuous, but attention getting "stopped working" screen on the Vista PC turn on screen.

you can delete it from your PC. The portable version can then be started from the stick drive's menu. Alternatively, you can create a shortcut to it that will appear on the Desktop. When the USB stick is connected, you will have automatic access to all of your User IDs and passwords – that is, AFTER you enter your master password. Removing the USB memory removes all traces and access to your IDs and passwords. Remember to exit the Password Manager via the program's tray menu before you remove the USB memory.

This complete portability adds another level of security. The passwords are encrypted and protected by a master password. But instead of being stored on the computer, they are only resident on a tiny portable USB "key" device. We now have multiple levels of security. In order to access application and websites, the user must have the master password AND in be in physical control of the USB key. This is a real, not just perceived, high level of security.

Oh Yes, Vista

Our discussions so far have centered around the use of Password Manager on the Radio Friendly PC, which has an XP Home operating system. For perspective, and because I'm a masochist, I loaded the program on a Windows Vista Home basic PC. Both PCs had the most recent Windows updates installed. However, the Password Manager on the Vista PC caused an annoying, but easy-to-overcome hiccup.

When the Vista PC was turned on after a cold boot (that is, shut down totally and then started), an alarming message appeared as seen in Figure 4. The message warns that "Large Software's Password Manager Has Stopped Working." My first reaction was one of panic, thinking I had just lost my all of my passwords.

But this was not the case at all. In fact, after closing the warning box, Password Manager seemed to function perfectly. I'm not quite sure what's going on here. My constant worry is that problems I encounter may be unique to my PC's configuration and start-up programs. I do have anti-virus, spyware and firewall programs always activated. Perhaps these are causing the problem. On one occasion I had problems shutting down the Vista PC. In any case, this "situation" may need to be considered by Vista users and investigated by Large Software.

Interestingly, once the Vista PC was converted to the Portable Password Manager, the "stopped working" startup problem went away. Just remember to Lock the program before you exit. If you don't, a message will appear that the USB memory cannot be "safely" removed from your PC. Once "locked," the USB memory removal went perfectly.

Just in Case

A question that's always in the back of my mind when I try new software is how easy will it be to uninstall and will I lose any data or functions I previously had? I found no problems when I uninstalled Password Manager, carefully following its directions. It cleaned itself out of the PC without a trace and left all my previously stored IE and FireFox passwords ready for use.

However, after the removal process, the user must go back into the browser's "Options" and/

or Security menus and enable the "remember passwords for sites."

Anatomy of a Password

Not all passwords are created equal. Passwords are rated in strengths. The more random the characters, the stronger the password. The greater the number of characters, the stronger it is. The greater the number of character types (for example alpha and numeric), the stronger the password.

For more information on the subject of creating strong passwords check out www.microsoft.com/protect/yourself/password/create.msp and our discussion in the February *Computers & Radio* column. Password Manager has an interesting feature that will generate a "strong" password instead of you trying to create them.

Summary

Password Manager is very simple and easy to install and use. With the exception of the start-up message glitch on Vista, it performed nicely. The caveat that it does not handle document or file passwords makes it less than a total password manager. Its portability and broad use gives it definite major advantages in convenience and security over Windows, Firefox or IE password managers. Large Software's Password Manager costs \$29.95 and is available for downloading at <http://largesoftware.com/html/passwordmanager.html>.

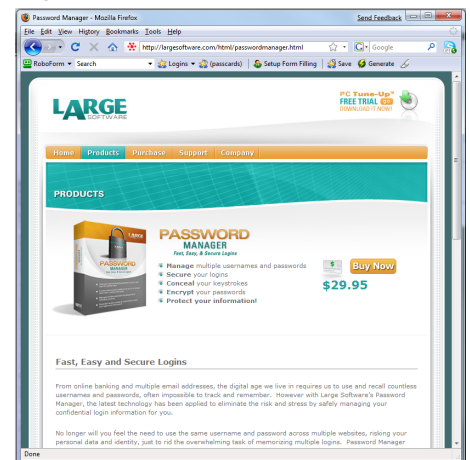

The use of well-chosen and varied passwords may still be the best method of security for our personal data on PCs. However, when passwords are "layered" with other security methods, their effectiveness increases exponentially. Password Manager enables this layering by utilizing a master password, various encryption methods, AND physically remotes all encrypted passwords, and itself, to a USB "key." This gives us the best of both worlds – convenience and moderately high levels of security. To obtain this security only one master password need be remembered.

Of course, you'd better not lose your USB key or you'll be doing lots of head scratching, guessing, typing, emailing and begging for your passwords. However, if you do lose the key, at least you still can be "secure" in knowing that no one else can read your key's encrypted data ... except perhaps the government.

Big Savings on Radio Scanners

Uniden® SCANNERS



Bearcat® 796DGV Trunk Tracker IV with free scanner headset

Manufacturers suggested list price \$799.95
CEI Special Price \$519.95

1,000 Channels • 10 banks • CTCSS/DCS • S Meter
Size: 6 1/16" Wide x 6 9/16" Deep x 2 3/8" High

Frequency Coverage: 25,000-512,000 MHz., 806,000-956,000 MHz. (excluding the cellular & UHF TV band), 1,240,000-1,300,000 MHz.

When you buy your Bearcat 796DGV TrunkTracker package deal from Communications Electronics, you get more. The GV means "Great Value." With your BC796DGV scanner purchase, you also get a **free deluxe scanner headphone** designed for home or race track use. Headset features independent volume controls and 3.5 mm gold right angle plug. The 1,000 channel Bearcat 796DGV is packed with features to track Motorola Type I/II/III Hybrid, EDACS, LTR Analog Trunk Systems and Motorola APCO 25 Phase I digital scanner including 9,600 Baud C4FM and CQPSK. Also features control channel only mode to allow you to automatically trunk many systems by simply programming the control channel, S.A.M.E. weather alert, full-frequency display and backlit controls, built-in CTCSS/DCS to assign analog and digital subaudible tone codes to a specific frequency in memory, PC Control and programming with RS232C 9 pin port (cable not supplied), Beep Alert, Record function, VFO control, menu-driven design, total channel control and much more. Our CEI package deal includes telescopic antenna, AC adapter, cigarette lighter cord, DC cord, mobile mounting bracket with screws, owner's manual, trunking frequency guide and one-year limited Uniden factory warranty. For maximum scanning enjoyment, order magnetic mount antenna part number ANTMMBNC for \$29.95. For complete details, download the owners manual from the www.usascan.com web site. For fastest delivery, order on-line at www.usascan.com.

Bearcat® BCT8 Trunk Tracker III

Manufacturer suggested list price \$299.95
CEI Special Price \$169.95

250 Channels • 5 banks • PC Programmable
Size: 7.06" Wide x 6.10" Deep x 2.44" High

Frequency Coverage: 25,000-54,000 MHz., 108,000-174,000 MHz., 400,000-512,000 MHz., 806,000-823,987.5 MHz., 849,012.5-868,995.0 MHz., 894,012.5-956,000 MHz.

The Bearcat BCT8 scanner, licensed by NASCAR, is a superb preprogrammed 800 MHz trunked highway patrol system scanner. Featuring TrunkTracker III, PC Programming, 250 Channels with unique BearTracker warning system to alert you to activity on highway patrol link frequencies. Preprogrammed service searches makes finding interesting active frequencies even easier and include preprogrammed police, fire and emergency medical, news agency, weather, CB band, air band, railroad, marine band and department of transportation service searches. The BCT8 also has preprogrammed highway patrol alert frequencies by state to help you quickly find frequencies likely to be active when you are driving. The BCT8 includes AC adapter, DC power cable, cigarette lighter adapter plug, telescopic antenna, window mount antenna, owner's manual, one year limited Uniden warranty, frequency guide and free mobile mounting bracket. For maximum scanning enjoyment, also order the following optional accessories: External speaker ESP20 with mounting bracket & 10 feet of cable with plug attached \$19.95. Magnetic Mount mobile antenna ANTMMBNC for \$29.95.



Bearcat® BCD396T Trunk Tracker IV

Suggested list price \$799.95/CEI price \$519.95

APCO 25 9,600 baud compact digital ready handheld TrunkTracker IV scanner featuring Fire Tone Out Paging, Close Call and Dynamically Allocated Channel Memory (up to 6,000 channels), SAME Weather Alert, CTCSS/DCS, Alpha Tagging. Size: 2.40" Wide x 1.22" Deep x 5.35" High

Frequency Coverage:

25,000-512,000 MHz., 764,000-775,987.5 MHz., 794,000-823,987.5 MHz., 849,012.5-868,876.5 MHz., 894,012.5-956,000 MHz., 1,240,000 MHz.-1,300,000 MHz.

The handheld BCD396T scanner was designed for National Security/Emergency Preparedness (NS/EP) and homeland security use with new features such as **Fire Tone Out Decoder**. This feature lets you set the BCD396T to alert if your selected two-tone sequential paging tones are received. Ideal for on-call firefighters, emergency response staff and for activating individual scanners used for incident management and population attack warning.



Close Call Radio Frequency Capture - Bearcat exclusive technology locks onto nearby radio transmissions, even if you haven't programmed anything into your scanner. Useful for intelligence agencies for use at events where you don't have advance notice or knowledge of the radio communications systems and assets you need to intercept. The BCD396T scanner is designed to track Motorola Type I, Type II, Hybrid, SMARTNET, PRIVACY PLUS, LTR and EDACS® analog trunking systems on any band. Now, follow UHF High Band, UHF 800/900 MHz trunked public safety and public service systems just as if conventional two-way communications were used. **Dynamically Allocated Channel**

Memory - The BCD396T scanner's memory is organized so that it more closely matches how radio systems actually work. Organize channels any way you want, using Uniden's exclusive dynamic memory management system. 3,000 channels are typical but **over 6,000 channels are possible** depending on the scanner features used. You can also easily determine how much memory you have used and how much memory you have left. **Preprogrammed Systems** - The BCD396T is preprogrammed with over 400 channels covering police, fire and ambulance operations in the 25 most populated counties in the United States, plus the most popular digital systems. **3 AA NiMH or Alkaline battery operation and Charger** - 3 AA battery operation - The BCD396T includes 3 premium 2,300 mAh Nickel Metal Hydride AA batteries to give you the most economical power option available. You may also operate the BCD396T using 3 AA alkaline batteries. **Unique Data Skip** - Allows your scanner to skip unwanted data transmissions and reduces unwanted birdies. **Memory Backup** - If the battery completely discharges or if power is disconnected, the frequencies programmed in the BCD396T scanner are retained in memory. **Manual Channel Access** - Go directly to any channel. **LCD Back Light** - A blue LCD light remains on when the back light key is pressed. **Autolight** - Automatically turns the blue LCD backlight on when your scanner stops on a transmission. **Battery Save** - In manual mode, the BCD396T automatically reduces its power requirements to extend the battery's charge. **Attenuator** - Reduces the signal strength to help prevent signal overload. The BCD396T also works as a conventional scanner to continuously monitor many radio conversations even though the message is switching frequencies. The BCD396T comes with AC adapter, 3 AA nickel metal hydride batteries, belt clip, flexible rubber antenna, wrist strap, SMA/BNC adapter, RS232C cable, Trunk Tracker frequency guide, owner's manual and one year limited Uniden warranty. Not compatible with AGEIS, ASTRO or ESAS systems. Order on-line at www.usascan.com or call 1-800-USA-SCAN.

More Radio Products

Save even more on radio scanners when purchased directly from CEI. Price includes delivery in the continental USA excluding Alaska.

Bearcat 898T 500 channel TrunkTracker III base/mobile.....	\$209.95
Bearcat 796DGV 1,000 channel TrunkTracker III base/mobile.....	\$519.95
Bearcat BCD396T APCO 25 Digital scanner with Fire Tone Out.....	\$519.95
Bearcat 246T up to 2,500 ch. TrunkTracker III handheld scanner.....	\$214.95
Bearcat Sportcat 230 alpha display handheld sports scanner.....	\$184.95
Bearcat 278CLT 100 channel AM/FM/SAME WX alert scanner.....	\$129.95
Bearcat 248CLT 50 channel base AM/FM/weather alert scanner.....	\$104.95
Bearcat 92XLT 200 channel handheld scanner.....	\$109.95
Bearcat 72XLT 100 channel handheld scanner.....	\$99.95
Bearcat BR330T up to 2,500 ch. TrunkTracker III with Tone out.....	\$274.95
Bearcat BCT8 250 channel information mobile scanner.....	\$169.95
Bearcat 350C 50 channel desktop/mobile scanner.....	\$104.95
AOR AR16BQ Wide Band scanner with quick charger.....	\$199.95
AOR AR3000AB Wide Band base/mobile receiver.....	\$1,079.95
AOR AR5000A+3B Wide Band 10 KHz to 3 GHz receiver.....	\$2,599.95
AOR AR8200 Mark IIIIB Wide Band handheld scanner.....	\$594.95
AOR AR8600 Mark III Wide Band receiver.....	\$899.95
AOR AR-ONE Government/Export sales only 10 KHz-3 GHz.....	\$4,489.95
Scantcat Gold For Windows Software.....	\$99.95
Scantcat Gold For Windows Surveillance Edition.....	\$159.95

Bearcat® BC246T Trunk Tracker III

Suggested list price \$399.95/CEI price \$214.95
Compact professional handheld TrunkTracker III scanner featuring Close Call and Dynamically Allocated Channel Memory (up to 2,500 channels), SAME Weather Alert, CTCSS/DCS, Alpha Tagging. Size: 2.72" Wide x 1.26" Deep x 4.6" High

Frequency Coverage:

25,000-54,000 MHz., 108,000-174,000 MHz., 216,000-224,980 MHz., 400,000-512,000 MHz., 806,000-823,987.5 MHz., 849,012.5-868,987.5 MHz., 894,012.5-956,000 MHz., 1,240,000 MHz.-1,300,000 MHz.

The handheld BC246T TrunkTracker scanner has so many features, we recommend you visit our web site at www.usascan.com and download the free owner's manual. Popular features include **Close Call Radio Frequency Capture** - Bearcat exclusive technology locks onto nearby radio transmissions, even if you haven't programmed anything into your scanner. **Dynamically Allocated Channel Memory** - Organize channels any way you want, using Uniden's exclusive dynamic memory management system. 1,600 channels are typical but **over 2,500 channels are possible** depending on the scanner features used. You can also easily determine how much memory is used. **Preprogrammed Service Search (10)** - Makes it easy to find interesting frequencies used by public safety, news media TV broadcast audio, Amateur (ham) radio, CB radio, Family Radio Service, special low power, railroad, aircraft, marine, racing and weather frequencies. **Quick Keys** - allow you to select systems and groups by pressing a single key. **Text Tagging** - Name each system, group, channel, talk group



ID, custom search range, and S.A.M.E. group using 16 characters per name. **Memory Backup** - When power is lost or disconnected, your BC246T retains the frequencies that were programmed in memory. **Unique Data Skip** - Allows the BC246T to skip over unwanted data transmissions and birdies. **Attenuator** - You can set the BC246T attenuator to reduce the input strength of strong signals by about 18 dB. **Duplicate Frequency Alert** - Alerts you if you try to enter a duplicate name or frequency already stored in the scanner. **22 Bands** - with aircraft and 800 MHz. The BC246T comes with AC adapter, 2 AA 1,800 mAh nickel metal hydride batteries, belt clip, flexible rubber antenna, wrist strap, RS232C cable, Trunk Tracker frequency guide, owner's manual and one year limited Uniden warranty. For more fun, order our optional deluxe racing headset part #HF24RS for \$29.95. Order now at www.usascan.com or call 1-800-USA-SCAN.

Buy with Confidence

Order on-line and get big savings

For over 36 years, millions of communications specialists and enthusiasts worldwide have trusted Communications Electronics for their mission critical communications needs. It's easy to order. For fastest delivery, order on-line at www.usascan.com. Mail orders to: Communications Electronics Inc., P.O. Box 1045, Ann Arbor, Michigan 48106 USA. Price includes \$30.00 UPS Ground shipping/handling/insurance per scanner to a street address in the continental USA excluding Alaska. Add \$20.00 shipping for all accessories. For shipments to Canada, Puerto Rico, Hawaii, Alaska, Guam, P.O. Box, APO/FPO, USPS Priority Mail or UPS 2 business day delivery, add \$30.00. Michigan residents add sales tax. No COD's. For Bearcat scanners your satisfaction is guaranteed or return item in unused condition in original packaging within 61 days for refund, less shipping charges. 10% surcharge for net 10 billing to qualified accounts. All sales are subject to availability, acceptance and verification. Prices, terms and specifications are subject to change without notice. We welcome your Discover, Visa, American Express, MasterCard, IMPAC or Eurocard. Order toll free, call 1-800-USA-SCAN or 1-734-996-8888 if outside Canada or the USA. FAX anytime, dial 1-734-663-8888. Dealer and international inquiries invited. Order your radio scanners from Communications Electronics today.

For credit card orders call
1-800-USA-SCAN

e-mail: cei@usascan.com

www.usascan.com

PO Box 1045, Ann Arbor, Michigan 48106-1045 USA
For information call 734-996-8888 or FAX 734-663-8888

COMMUNICATIONS ELECTRONICS INC.
Emergency Operations Center

Visit WWW.USASCAN.COM • 1-800-USA-SCAN

The Never-Ending Allure of Shortwave Radio

If you listen to pessimists, there are plenty of reasons not to be a shortwave listener today: The better radios are too expensive; many neighborhoods won't allow you to put up an outdoor antenna; we're at the bottom of an apparently bottomless sunspot cycle; everything's going to be digital soon...

I've heard these same arguments applied to every other mode of monitoring I've ever been involved with and they've mostly proved false. So, I'd like to try to change your mind, or at least get you to thinking about shortwave listening.

❖ The Golden Age is Past

Some believe that the best days of shortwave radio are behind us, that shortwave radio's "golden age" is past. But, there are many golden ages. On the shortwave bands in the 1960s there were dozens of great shortwave stations, international press feeds, AFRTS, and legendary broadcasters like Willis Conover and his "Voice of America Jazz Hour." There were hilarious propaganda screeds from Radio Moscow touting the great advances of the latest five year plan. There were spooky spy stations and nearly all the hams ran tube-fired AM gear. It's true that some of those old services are gone, but there is still a lot to be thankful for: There is more variety of listening opportunities than ever, and better equipment on which to listen.



While we may be at the dawn of the digital era for shortwave broadcasters, there are many analog broadcasters still on the bands and there will be for many years to come. That's because shortwave broadcasting is still the single best way to reach great portions of the world that are under-served or totally unserved by the Internet. And, with private companies such as WorldSpace satellite radio going bankrupt, those areas are not likely to be served by anything more expensive than a shortwave radio, especially in today's economic climate.

Part of what I see as our current golden age comes from the availability of very inexpensive, feature packed, portable shortwave radios that would run laps around anything

made in the 1960s. I had to labor hard and long to save up enough money to buy a Knight-Kit Star Roamer shortwave radio in 1965, and then had the job of putting it together. As much as I enjoyed that radio, there are dozens of portables today that would put it to shame. If you can afford them, there are desk-top and computer-based shortwave radios available that are phenomenal performers. It truly is a golden age of shortwave radio design.

There can be no doubt that eventually Digital Radio Mondiale (DRM), the HF version of HD-Radio, will dominate the shortwave bands and eventually there will be affordable, portable receivers available and a new golden age of shortwave broadcasting will commence. But, for now, we have a very active analog-based HF spectrum and very capable radios with which to enjoy it.



My message to scanner listeners new to HF is: Take advantage of the superior design of today's portable shortwave radios and broaden your listening horizons. You can start with the Kaito 1103 (see my review in the April 2007 issue of MT) which will give you the best introduction to shortwave for the money (\$89.95 from Grove Enterprises). It's



The Kaito 1103 is the best portable shortwave radio under \$90 that's available. It's a great way to get started in shortwave listening and it's available from Grove Enterprises. (Courtesy: Kaito U.S.A.)

portable, versatile, loaded with features and it can take a good outdoor antenna without overloading.

Once you start tuning in, you can explore other modes available at virtually no cost. With just the addition of a simple mini-plug patch cord and free downloadable software, you can tune in to the many digital modes, including Slow Scan TV, used by hams from around the world. Most hams welcome reception reports from SWLers and will send QSL cards with an SASE.

❖ A World of Interest for Your Ears

For me, part of the charm of shortwave listening is the programming. To my ear and for my interests, shortwave radio still entertains. As I've done for the last 40 years, I listen to the shortwave bands for content. I like to tune in to WBCQ, a throw-back to the heyday of international shortwave broadcasting with its mixture of Jesus, economic doomsters, old time radio, and replays of the late and incomparable Jean Sheppard.

I listen to the flashbacks of the old Soviet Bloc era from Radio Havana with its series of broadcasts "Voces de la Revolución" that features actual speeches from Fidel Castro. Some, made at the dawn of the Cuban revolution, can be heard complete with echoes of his voice bouncing back into the microphone from around the stadium where tens of thousands listened for hours in adoring silence.

I like listening to the Voice of America. Their signal to Africa is usually very strong in my location, and their news from Africa





adds to that which I get from the BBC and directly from African national broadcasters. Their "African Beat" program, featuring music from across the continent, is outstanding.

Sometimes I listen to the haunting music from the many stations from the Mideast with their unique rhythmic structure and impenetrable language. Even more, I enjoy listening to the hypnotic beat of the stations from Latin America combining salsa and hip-hop for a unique Spanish flavored sound.

And, oddly but thankfully, there are still the cryptic numbers stations, now digitized but none the less fascinating, with their tireless messages hinting of coup and counter-coup that keep numbers enthusiasts dreaming.

I enjoy shortwave listening so much that I put one in my car. It took over a year of trying everything from outboard converters to mounting a ham transceiver in the car. Finally, a few years ago I found a real in-dash AM/FM/SW radio made by Sony (see my review in the June 2006 issue of *MT*) and installed it. It has made for interesting listening every time I get in and turn the ignition key.

Even under the dismal sunspot count of the last few years I've enjoyed listening on the road to everything from Radio Austria, BBC, Radio Exterior de España, Radio Nacional de Venezuela, Japan Radio, China Radio International, and too many others to mention. I've even heard die-hard AM ham operators on 40 meters and the never-ending spy numbers stations. There's just nothing like cruising along the Interstate and listening to shortwave radio.

❖ New Mobile SWL from Sony

There were a couple of drawbacks to Sony's earlier model: it was intended for African and European listeners, and so the AM band tuning was not suitable to U.S. AM station spacing, and it had a cassette deck. For those of us looking for shortwave reception on the road, these weren't significant drawbacks.

But now a new Sony model (CDX-GT470U) is available and it's totally up to date. It's iPod-ready; has a front mounted USB port; a front mounted auxiliary input for MP3 players or any other similar audio device; and it has a built-in CD player. All functions can be accessed through a credit-card sized remote control.

The tuner part of this radio tunes the AM band from 531-1602 or 530-1710 as the user selects; the FM band tunes from 87.5-107.9 or 87.5-108 as the user chooses; and it tunes shortwave in two bands: 2940 kHz to 7735 kHz and 9500 kHz to 18135 kHz (except 10140 kHz to 11575 kHz). There is no provision for single side-band reception.

This radio also features a menu driven equalizer and bass/treble controls, a detachable front panel and dimmer control on a 13 segment LCD display. The radio can power four speakers with a 52 watt amplifier and has a pre-amplifier output for your subwoofer should you already have one. While I have not actually used this radio, I'm confident that it will perform at least as well as the older Sony model I've used for years.

While it's possible to do the installation yourself, my own experience leads me to recommend taking it to a professional car stereo installer. Given the difficulty of getting to the components of modern radios inside modern auto dashboards, you may find that it's worth paying someone who knows what they're doing to do the installation.

I'm shocked that this radio is not available through any dealers in the U.S. If more people knew of the availability of these radios, I believe more would be sold and more people would be tuning into shortwave radio on the road. Luckily, this model is available from Durham Radio, also known as "The Shortwave Store" in Ottawa, Canada for \$299.95 (U.S.) plus shipping at 888-426-9617 or www.shortwavestore.com. Durham Radio takes care of the customs forms. I spoke with the manager of Durham Radio and he assured me that he keeps the product in stock.

These Sony in-dash AM/FM/SW radios are very well designed and built. Very little ignition noise is heard, the audio is excellent and reception, even on my car's built-in AM/FM antenna is surprisingly good. But, reception in your car will not equal what you're used to hearing at home. It takes a significant signal to be heard on an in-dash shortwave radio. You're pretty much going to be limited to listening to the big international broadcasters. Still, it always surprises me what the radio finds when I hit the "seek" button.

One of the few shortcomings of this radio is that there are only six presets for each band (12 total for the two shortwave bands and 18 total for FM1, FM2, and FM3). And, with the seasonal changes of frequencies, presets you



Sony is still making shortwave-capable car radios for the rest of the world. The CDX-GT470U offers AM/FM/SW reception plus a built-in CD player and front-mounted USB and MP3 ports for all your latest electronic needs. Luckily, it's available in the U.S. at the Shortwave Store.com. (Courtesy: The Shortwave Store.com)

set in the summer will not be functional during the winter months. There is no provision for direct frequency entry; you can only use the seek function. But, you don't need to be fumbling with entering shortwave frequencies when you're driving, anyway.

The digitization of the shortwave bands is lagging many years behind that of the TV and FM bands, but it's undeniably coming, as I find out every time the tuner zips across a DRM frequency. Meanwhile, we can look forward to years of analog shortwave broadcasts and years of rising sunspots that should support many years worth of commuting trips to and from work for those of us who are tired of local radio and concerned about the shaky future for satellite radio.

Let's face it, work gets in the way of our hobbies. Many of us, forced to work jobs that require us to commute, find less time for our shortwave listening hobby than we'd like. But, I say take your hobby to work. Switch out your current car stereo for a Sony in-dash shortwave radio and start reclaiming your hobby.

And, one last thing: One of the best things about *MT* is found in the center of the magazine: the "Shortwave Guide." I rely on it almost daily in tracking down stations I want to hear. Gayle Van Horn, along with the many contributions from avid listeners, maintains one of the most useful shortwave listening resources available. It's concise, accurate, easy to carry around and user-friendly. Kudos to all who contribute to this effort.

NASB

National Association of Shortwave Broadcasters

Representing the privately-owned shortwave stations in the USA

- Find links to all of our members at www.shortwave.org
- Subscribe to our free Newsletter: nasbmem@rocketmail.com
- Listen to "The Voice of the NASB" on the third Saturday of each month on HCJB's DX Party Line: 12 midnight Eastern Time on 9955 kHz
- Come to our next annual meeting May 7-8, 2009 in Nashville, TN.
- More info at www.shortwave.org/meeting.htm

NASB is a member of the HFCC (High Frequency Coordination Conference) and the DRM (Digital Radio Mondiale) Consortium

Storm Season in Tornado Alley

Each spring when warm, moist air from the Gulf of Mexico clashes with cold air coming down from the Rockies, the skies over the heartland of the United States are filled with a performance by Mother Nature that makes any Hollywood special effects pale in comparison.

It's storm season in tornado alley and you can have a front row seat, right in your own home.

From the casual observer to the fullblown, ravenous, "weather geek," online streaming can give Web storm chasers all the information and footage they need to fill their appetite for storm season in "the Alley" -- without all of the driving and bad gas station food.

For more information on getting started as a storm spotter, see my companion feature story in this issue of *MT*.

❖ "Have you seen the sky today?"

Although chasing storms that are hundreds or thousands of miles away from a computer in your home might lack the sheer thrill of "being there," one can gain valuable knowledge about storms while still getting to see and hear amazing accounts of storm reports and tales of survival on the front lines.

Any online storm chase must first start with browsing the forecasts of the cities you are tar-

geting for the day. The strength of probability for severe storms will determine where you should point your Web browser. So, how can you figure out who is in for a bumpy ride on a given day?

The National Weather Service's Storm Prediction Center, based in Norman, Oklahoma, offers a snapshot portrayal of the risk of severe weather outbreaks in the United States and gives detailed forecasting discussions and scientific data for areas where severe weather is possible. For the knowledgeable weather enthusiast, the mesoanalysis page even offers detailed scientific forecasting maps, which provide more in-depth information on the potentially severe events.

There are also a large number of other forecasting sites that provide additional information on various forecasting models and thermodynamic data to assist in the forecasting of areas of potential severe weather. Many, though definitely not all of these, are located in research departments at various universities in tornado alley. Some of the ones that I use on a regular basis when looking for areas of interest can be found in the table at the conclusion of this article.

❖ "We're going green."

Once severe weather breaks, you can be on top of the action, thanks to streaming radio broadcasts live from tornado alley. While the

following list will by no means be complete, it will give you a place to start when the sky turns angry in the heartland of the United States.

There are several tornado-prone states which will not be included in this list, due primarily to space constraints. For the sake of this article, I will be focusing on the major hot spot states of tornado alley: Texas, Oklahoma, Kansas, Nebraska, South and North Dakota. Several bordering states also deserve close attention during severe weather outbreaks and do see quite a bit of storm activity during storm season. These areas include Indiana, Missouri, Illinois, Iowa, Arkansas and parts of Ohio, Wyoming, Colorado, Minnesota, Kentucky, Louisiana and Tennessee.

Obviously, there are many stations that provide excellent coverage during severe weather outbreaks, but which do not have a Web stream. For the purposes of this column, I have focused only on those stations that are streaming their broadcasts.

Texas

Perhaps no state in tornado alley endures more twisters than Texas. Fortunately, much of the area that is routinely hit by tornadoes is sparsely populated (which won't offer many streaming options for this area of tornado alley). But to give you a start, here are some stations to listen for when the tornado warnings start popping up in the Lone Star state.

- 🔊 www.kgncfm.com/
KGNC - 97.9 FM - Amarillo, TX
- 🔊 www.krld.com/
KRLD - 1080 AM - Dallas, TX
- 🔊 www.kntu.com/
KNTU - 88.1 FM - Denton, TX
- 🔊 www.klll.com/
KLLL - 96.3 FM - Lubbock, TX

Oklahoma

Of all of the states in tornado alley, probably no state is more "twister crazed" than Oklahoma. A wide network of trained spotters, research scientists, amateur meteorologists and weekend forecasters on the ground are primed each storm season to relay reports of severe events to the NWS and to nearly any broadcaster that will break-in for live coverage.

In addition to the various 2-meter amateur radio frequencies in use by spotters and local emergency response frequencies, many streaming broadcasters will provide the Web storm chaser with up-to-the-minute detailed information on what is happening on the ground. Some key stations to keep handy during storm season in Oklahoma include:



- 📻 www.k101online.com/home/
KWOX – 101.1 FM – Woodward, OK
- 📻 www.1210kgyn.com
KGYN – 1210 AM – Guymon, OK
- 📻 www.kwhw.com/joomla/
KWHW – 1450 AM – Altus, OK (During severe weather, will go live from the Altus EOC).
- 📻 www.kyis.com/
KYIS – 98.9 FM – Oklahoma City, OK
- 📻 http://krmg.com/
KRMG – 740 AM – Tulsa, OK
- 📻 www.kvoo.com/
KVOO – 98.5 FM / 1170 AM – Tulsa, OK
- 📻 www.kisr.net/
KISR – 93.7 FM – Ft. Smith, AR/OK

Kansas

Another severe weather hotbed is Kansas. Just about any station streaming on the Internet from Kansas will provide severe weather coverage, especially when storms are heading for their city of license. However, the following stations should provide a good start for the aspiring Web storm chaser.

- 📻 www.gardencity.net/kbuf/
KBUF – 1030 AM – Garden City, KS
- 📻 www.955klos.com/
KOLS – 95.5 FM – Dodge City, KS
- 📻 www.klwn.com/
KLWN – 1320 AM – Lawrence, KS
- 📻 www.y937.com/
KYEZ – 93.7 FM – Salina, KS
- 📻 www.sunny1025.com/
KBLS – 102.5 FM – Manhattan, KS
- 📻 www.kfdi.com/
KFDI – 101.3 FM – Wichita, KS
- 📻 www.knssradio.com/
KNSS – 1240 AM – Wichita, KS

Nebraska

As the season progresses and the conditions that are favorable for severe storm development move further to the north, Nebraska becomes an area that is ripe for supercells. There is even a station in Omaha that uses the name “Twister 93.3.” How’s that for people with a “tornado-minded” approach to doing things?

- 📻 www.krvn.com/
KRVN – 880 AM – Lexington, NE
- 📻 www.kbbn.com/
KBBN – 93.5 FM – Broken Bow, NE
- 📻 www.kcni1280.com/
KCNI – 1280 AM – Broken Bow, NE
- 📻 www.twister933.com/main.html
KHUS – 93.3 FM – Omaha, NE:

South Dakota

Still further to the north, the wide open ranges of South Dakota provide chasers willing to drive the long distances with storms of a massive scale. If an excursion to the home of the Badlands is a bit too far for you, you can always listen in to reports from the front lines online.

- 📻 www.mix97-3.com/
KMXC – 97.3 FM – Sioux Falls, SD
- 📻 www.kwsn.com/index.php
KWSN – 1230 AM – Sioux Falls, SD
- 📻 www.kotaradio.com
KOTA – 1380 AM – Rapid City, SD
- 📻 www.bobfm953.com/
KLXS – 95.3 FM – Pierre, SD

North Dakota

Without making your way into Canada (and there is good storm chasing to be had in Manitoba, chasers say), North Dakota often is the Northern end of the line for chasers. Like South Dakota, North Dakota gives chasers a lot of wide-open space in which to chase storms. For the Web chaser, though, there are few online resources for listening in to severe weather coverage.

- 📻 <http://truecountryfm106.homestead.com>
KQLX – 106.1 FM / 890 AM – Lisbon/Fargo, ND
- 📻 http://froggyweb.com/
WWFG – 99.9 FM – Fargo, ND:

❖ “You know what? I think we’ve seen enough.”

In addition to listening to broadcasters with storm spotter reports, many of the major cities in tornado alley have extensive coverage of severe storms on their television broadcasts, but many of these televisions do not stream their coverage online. However, they can be good sources of radar imagery during storms and video after the storms have passed.

Overall, a chaser stuck with clear skies in his hometown can be right in the middle of the action with a good Internet connection and a little persistence. In addition to these broadcast stations, some of the online scanner Web sites I discussed in a previous edition of GlobalNet might turn up some of the on the ground spotter communications in tornado alley. And finally, try finding streams of NOAA Weather Radio broadcasts originating from the forecast office for the target area you are Web chasing.

As I also mentioned in my feature article on storm spotting in this issue of *MT*, there is a Web site for the radio enthusiast storm chaser that is invaluable. Kbrews’ Storm Spotting Frequency Guide is a one-stop resource for all things storm spotting over radio waves. A link to the site can be found in the table below.

Until next month.

GLOBALNET LINKS

Storm Prediction Center – www.spc.noaa.gov/
A lot of forecasting information and a great way to see where severe weather is likely to break out.

TwisterData – www.twisterdata.com/

The forecasting component to famous storm chaser Reed Timmer’s TornadoVideos.net.

Weather Underground – <http://wunderground.com>

Some of the best free radar imagery on the Web. Can provide detailed cell information including storm tracks, indicators for mesos and tornado cyclone signatures and more.

kBrews Storm Spotting Frequency List – www.caps.ou.edu/~kbrews/spottfreq/index.html

A state by state breakdown of simplex and repeater frequencies used by storm spotters, frequencies for local emergency management and response agencies and NOAA weather radio frequencies.

Sangean WiFi Radios

Now you can enjoy the excitement of accessing over 16000 Internet Radio Stations almost anywhere when you own a new Sangean WFR-1 Internet Radio and in addition enjoy any of your local standard FM broadcasts using the built in FM tuner with RDS or upload your favorite or any internet station to your Sangean WFR-1’s “My Station” allowing quick and easy future access. You no longer need to be glued to your computer to access your favorite Internet station nor do you even have to have your computer on. All you need is a broadband internet connection and a wired or wireless router. Add to your listening pleasure by creating your own Digital Music Library. The Sangean WFR-1 offers the ultimate in Internet Radio listening.

GROVE

Order RCV56
\$349^{95*}

* plus \$13.95 UPS Ground shipping in the U.S.



800-438-8155
828-837-9200 fax: 828-837-2216

www.grove-ent.com



CCRadio-SWP

Pocket Shortwave Radio

- Exceptional AM, FM, SW Reception and Audio for its 5" x3" Size
- 200 Memories with Memory Scan
- Direct Key Entry
- Covers 70~108.8 MHz FM for World Use
- Runs 70 hrs. on 2 'AA' Batteries (not incl.) or Optional AC Adapter
- Incl. Carry Pouch, Earbuds, Lanyard

\$49⁹⁵

C. CRANE

Free Catalog

800-522-8863 • ccrane.com

Why are U.S. cellular frequencies blocked?

For scanner users who weren't around fifteen years ago, it may seem odd that all of the scanners on the U.S. market today have such stark and repetitive warnings about not listening to cellular telephone calls. With most cell traffic these days carried via complex digital services, it seems a rather silly and pointless prohibition.

Dan,

In your February column you say "According to FCC regulations, the use of encryption with secret keys puts such transmissions off-limits to scanner users. ... So despite the ability to handle ESK, monitoring [the FSLERS] is still not technically possible [due to...] and might possibly not be fully legal due to the use of actual encryption on voice channels."

I knew there was an FCC rule prohibiting receivers with the capacity to receive the frequencies of the US 800 MHz cellphone segment. (Wasn't this due to Newt Gingrich or some other politician being embarrassed once back in the 1980s and subsequently having a civil law contrary to the laws of physics passed?) And I knew there was a long-standing principal – or rule – that prohibited the divulging of received transmissions. But I had never heard of a "transmissions off-limits" rule.

Encryption – strong encryption – itself effectively puts the information content of the transmission "off-limits" to the scanner user in the first place, doesn't it? Understanding and "breaking" the control channel and addressing might allow the scanner user to follow a particular user. Then, if the user were not encrypted his information could be monitored. And if the user were encrypted, no information

would be available to the monitor.

I'm not trying to trip you up on this, but can you give me the reference to the FCC rule? Or explain to me what I'm not understanding?

73, Skip in Massachusetts

During the heyday of analog cell phones two decades ago, it was easy enough for almost anyone to listen in. Scanners capable of monitoring the 800 MHz band were available at local stores and via mail order and could be used to eavesdrop on calls in the local area with little effort.

After a series of well-publicized eavesdropping incidents, the cellular telephone industry came under fire for a lack of privacy afforded by their products. Unfortunately, their response was an all-too-common process that demonstrated the adage that "the United States has the best Congress money can buy." Rather than encrypt cell phone transmissions and actually protect call content from over-the-air eavesdropping, the industry chose instead to have their lobbyists write a Federal law to prohibit the reception of cellular transmissions.

The 1986 Electronic Communications Privacy Act (ECPA) was a milestone. For the first time since the original Communications Act of 1934, the mere listening to certain radio frequencies was against the law. However, enforcement of this ban was a practical impossibility and cell phone calls remained as unprotected as ever. So the cell phone lobby got back to work and had their friends in Congress pass a bill that included a requirement for the Federal Communications Commission (FCC) to deny authorization to any scanner that could monitor cellular telephone frequencies.

As a result, since 1994 the FCC has

required that scanners imported or sold in the United States be crippled in their receiving ability – they must not be able to tune to the frequencies assigned to analog cellular telephone companies. These frequencies are between 824 and 849 MHz, where mobiles transmit to a base station, and also between 869 and 894, where base stations transmit to mobiles.

The FCC rules prohibiting monitoring the cellular bands are written up in the Code of Federal Regulations (CFR) Title 47, Section 15.121. Note that the section is specific to "scanning receivers and frequency converters," where the term "scanning receiver" is defined in Title 47, Section 15.3(v). There is also a general prohibition against intercepting "private conversations" in Section 15.9.

Despite the sunset of analog service in the U.S. and the transition of most cell phone service to digital operation in the 1.9 GHz band, the historic monitoring prohibition continues in force and U.S. citizens are still legally prevented from purchasing fully functional scanners.

It is also interesting to note that cell phone voice traffic is still not generally encrypted. Even in many of the cases where encryption is in use, the actual encryption key in use is the default provided by the equipment manufacturer and is not changed. Cellular operators rely on the unavailability of GSM and CDMA monitoring equipment to the general public to protect their customer's privacy.

Cell Phone Interception

The cell phone interception you mention was the recording of a December 1996 conference call between House Republicans regarding an Ethics Committee investigation of Speaker of the House Newt Gingrich. Representative John Boehner was on vacation in Florida at the time and his cell phone connection was intercepted and recorded.

That interception was a violation of U.S. Code Title 18, Section 2511, which is not part of the FCC's purview but rather falls under U.S. criminal law. That particular section prohibits interception and disclosure of, among other things, electronic communication. The section has a number of exceptions, including communications which are "readily accessible to the general public" and specifically "public safety communications system."

Section 2510 provides definitions for terms used in 2511, including "readily accessible to the general public." Paragraph (16)

RadioShack® CAT. NO. 20-522 **B**
PRO-92 SCANNING RECEIVER
POWER: DC9V ("AA" BATTERY X 6) OR ADAPTER: 9VDC 200mA
FREQ. RANGE: 29-54, 108-136.9875, 137-174, 380-512,
806-823.9875, 849-868.9875, 894-960 MHz
WARNING: MODIFICATION OF THIS DEVICE TO RECEIVE CELLULAR
RADIOTELEPHONE SERVICE SIGNALS IS PROHIBITED UNDER FCC
RULES AND FEDERAL LAW.
FCC ID: AAO2000522 S/NO. **C006027**
CUSTOM MANUFACTURED IN CHINA FOR RADIOSHACK
A DIVISION OF TANDY CORPORATION, FORT WORTH, TX 76102

Cellular Frequencies

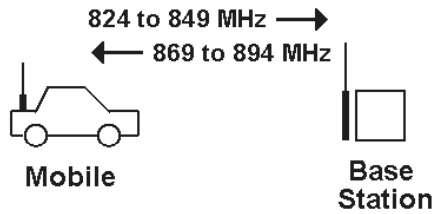

defines this term and specifically excludes scrambling and encryption. So, a reading of U.S. law shows that scrambled or encrypted electronic communication is off-limits for scanner listeners.

Although I am not a lawyer and none of this is intended to constitute legal advice, I would make the following arguments regarding the EDACS System Key (ESK) feature used on control channels:

Despite the name, ESK is not encrypted in the sense that you need a decryption key to understand it.

Scrambling is not defined in the chapter, but I would argue ESK is not technically scrambling either, since all of information necessary to understand it is publicly available. Nothing about the technical details of ESK has been hidden or withheld from the public.

One could also make another argument, namely that control channel traffic is not "content" or "communication" under the law, but is simply information that describes the operation of the system, and is therefore not protected.

Fairfax County, Virginia

Hello,

I work for the Fairfax County Fire and Rescue Department. I was wondering if you could tell me the frequency for only the dispatch. Thanks.

Via the Internet

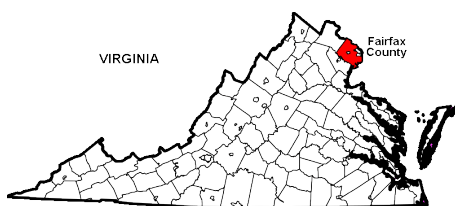

Fairfax County is located in Northern Virginia, just west of Washington, D.C., and is the most heavily populated county in the Washington Metropolitan Area with just over one million residents. It is home to seven Fortune 500 companies and numerous government agencies and offices.

Last October the Fairfax County Fire Department made their last transmission on the old conventional dispatch channel of 460.575 MHz. This marked the end of the previous fire radio system after many years of service. The Department transitioned to a trunked radio network several years ago, but had continued simulcasting dispatch activity on 460.575 MHz. Fire dispatch is now heard only on talkgroup 17616 in digital form.

The current Fairfax County trunked radio

system is a Motorola Type II that carries voice traffic in both analog and APCO Project 25 digital formats. Because the dispatch talkgroup and most other activity on the system is now digital, you will need a digital trunk-tracking scanner to hear Fairfax County dispatches. Any scanner with APCO Project 25 capability will be able to track and monitor county activity.

Frequencies in use are:

852.9625, 853.1875, 853.3375, 853.4625, 853.4875, 853.6375, 853.7875, 853.9125, 853.9625, 854.1375, 854.2625, 854.2875, 854.4625, 855.9625, 855.9875, 856.2625, 857.2625, 858.2625, 859.2625, 860.2625 MHz

Decimal Hex Description

16016	3E9	County Police Dispatch Headquarters (Channel 1)
16032	3EA	County Police Motorcycle Operations 1
16048	3EB	County Police Headquarters Operations 1
16064	3EC	County Police Motorcycle Operations 2
16080	3ED	County Police Headquarters Operations 2
16112	3EF	County Police Operations Support Bureau (OSB)
16128	3F0	County Police Narcotics/Vice
16144	3F1	County Police OSB Operations 1
16176	3F3	County Police OSB Operations 2
16192	3F4	Police Mutual Aid Radio System (P-MARS) Simulcast
16224	3F6	Police (Encrypted)
16848	41D	County Police Mount Vernon Dispatch (Channel 2)
16880	41F	County Police Mount Vernon Operations 1
16912	421	County Police Mount Vernon Operations 2
16944	423	County Police Franconia Dispatch (Channel 6)
16976	425	County Police Franconia Operations 1
17008	427	County Police Franconia Operations 2
17040	429	County Police West Springfield Dispatch (Channel 7)
17072	42B	County Police West Springfield Operations 1
17104	42D	County Police West Springfield Operations 2
17136	42F	County Police Mason Dispatch (Channel 4)
17168	431	County Police Mason Operations 1
17200	433	County Police Mason Operations 2
17232	435	County Police McLean Dispatch (Channel 3)
17264	437	County Police McLean Operations 1
17296	439	County Police McLean Operations 2
17328	43B	County Police Reston Dispatch (Channel 5)
17360	43D	County Police Reston Operations 1
17392	43F	County Police Reston Operations 2
17424	441	County Police Fair Oaks Dispatch (Channel 8)
17456	443	County Police Fair Oaks Operations 1
17488	445	County Police Fair Oaks Operations 2
17520	447	County Police Sully Dispatch (Channel 9)



17552	449	County Police Sully Operations 1
17584	44B	County Police Sully Operations 2
17616	44D	County Fire Dispatch
17648	44F	County Fire Response
17680	451	County Fire Incident 1
17712	453	County Fire Incident 2
17744	455	County Fire Incident 3
17776	457	County Fire Incident 4
17808	459	County Fire Incident 5
17840	45B	County Fire Incident 6

UNIDEN BCD396T

State-of-the-art scanner radio with TrunkTracker IV and automatic scanning capabilities. You can use the scanner's scroll control to quickly select channels and frequencies, and you can automatically program channels in a system using the Auto-Store feature.

Monitor:

- Analog and digital trunked public safety systems*
- Includes 380-399.9 and 700 MHz band
- Police and fire departments (including rescue and paramedics)
- NOAA weather transmissions
- Business/Industrial radio
- Utilities
- Marine and amateur (ham radio) bands
- Aero Bands: Civilian and Military
- Railroad

Order SCN47

\$ 499^{95*}

* plus \$17.95 UPS Ground shipping in the U.S.



GROVE

800-438-8155
828-837-9200 fax: 828-837-2216
order@grove-ent.com
7540 Highway 64 West
Brasstown, NC 28902

www.grove-ent.com

17872	45D	County Fire Incident 7 (Interstate Highways)
17904	45F	County Fire Incident 8
17936	461	County Fire Incident 9
17968	463	County Fire Incident 10
18000	465	Fairfax Hospital
18032	467	County Fire Special Events
18064	469	County Fire Operations
18096	46B	Aircare Communications
18128	46D	County Fire Major Incident Command
18160	46F	County Fire Major Incident Suppression
18192	471	County Fire Major Incident EMS
18224	473	County Fire Major Incident Staging
18256	475	County Fire Major Incident Sector 1
18288	477	County Fire Major Incident Sector 2
18320	479	County Fire Major Incident Sector 3
18352	47B	County Fire Major Incident Sector 4
18384	47D	County Fire Major Incident Sector 5
18416	47F	County Fire Major Incident Sector 6
18448	481	County Fire Major Incident Rehabilitation
18480	483	County Fire Major Incident Announcement
18512	485	County Fire Systems Headquarters
18544	487	County Fire Systems Tactical 1
18576	489	County Fire Systems Tactical 2
18608	48B	County Fire Systems Tactical 3
18640	48D	County Fire Systems Tactical 4
18672	48F	County Fire Systems Tactical 5
18704	491	County Fire Systems Tactical 6
18736	493	County Fire Systems Tactical 7
18768	495	County Fire Systems Tactical 8
18800	497	County Fire Systems Tactical 9
18832	499	County Fire Systems Tactical 10
18864	49B	County Fire Systems Tactical 11
18896	49D	County Fire Major Incident Hazardous Materials
18928	49F	County Fire System Announcements
18960	4A1	Fire Inspectors
19024	4A5	Fire Investigators
20432	4FD	County Animal Control
20464	4FF	County Animal Control (Tactical)
20560	505	Fairfax City Fire Administration
20592	507	Fairfax City Fire Prevention 1
20608	508	Fairfax City Fire Prevention 2
20656	50B	Fairfax City Police Tactical 2
20688	50D	Fairfax City Police and Fire Event Coordination
20704	50E	Fairfax City Police and Fire Training
20720	50F	Fairfax City Police Dispatch
20752	511	Fairfax City Police Tactical 1
20784	513	Fairfax City Police Tactical 2
20816	515	Fairfax City Police Tactical 3
20848	517	Fairfax City Police Tactical 4
20880	519	Vienna Police Dispatch
20912	51B	Vienna Police Tactical 1
20944	51D	Vienna Police Tactical 2
20976	51F	Herndon Police Dispatch
21008	521	Herndon Police Tactical 1
21040	523	Herndon Police Tactical 2
21072	525	Herndon Police Tactical 3
21104	527	Herndon Police Tactical 4
21808	553	Falls Church Police

You may also want to monitor the following conventional (non-trunked) analog channels:

Frequency Description

154.28000	Fairfax County Fire Mutual Aid Radio System (F-MARS)
866.86250	Fairfax County Fire/EMS Talkaround 1
867.76250	Fairfax County Fire/EMS Talkaround 2

Fairfax County Police Districts

The Fairfax County Police Department headquarters is located in the courthouse complex in Fairfax City. Eight district police stations, located in Fair Oaks, Franconia, Mason, McLean, Mount Vernon, Reston, Sully and West Springfield, serve the county. The corresponding district dispatch channels are typically combined into the following four patches:

Headquarters (1), Fair Oaks (8) and Sully (9) Mount Vernon (2) and Franconia (6) McLean (3) and Reston (5) Mason (4) and West Springfield (7)

Delaware

In February the State of Delaware selected Tyco Electronics Wireless Systems to build a statewide Project 25-compatible radio network.

Delaware currently operates a Motorola Type II trunked radio network in the 800 MHz band that carries analog and Project 25 digital voice traffic. The system has three zones that correspond to the State's three counties, with 14 radio channels in New Castle County and 10 radio channels in both Kent and Sussex Counties. The existing system serves more than 13,000 users from 32 sites across the state and handles an average of more than 115,000 calls per day.



State officials were looking for additional capacity to allow more local first responders and state agencies, such as Delaware Department of Transportation (DelDOT), to communicate with each other during emergencies. Unfortunately, the existing system is often busy and there are no new 800 MHz frequencies available.

The new Tyco system will operate in the 700 MHz band and serve as an overlay to the existing system. It is expected to use existing repeater sites and equipment, which will allow the state to stay within the \$7.3 million Federal Public Safety Interoperable Communications grant the state received. Ten transmitters, each with four radio channels, will be installed at repeater sites across the state. The grant money will also cover 1,300 mobile radios.

The new system will use a Tyco product called VIDA (Voice, Interoperability, Data, Access) that uses Internet Protocol data delivery over radio. VIDA supports Project 25 digital radio standards and will interconnect with the 800 MHz system at key points.

The new system is expected to be opera-

tional by the end of September 2010, so readers local to the Delaware area should be thinking about getting a scanner with 700 MHz capability. The following is a chart listing models that would be compatible with a trunked system in the 700 MHz band:

Scanner Model	Type	Comments
GRE PSR-500	Handheld	
GRE PSR-600	Base/Mobile	
Radio Shack PRO-106	Handheld	Similar to GRE PSR-500
Radio Shack PRO-197	Base/Mobile	Similar to GRE PSR-600
Uniden BCD396XT	Handheld	Available first quarter 2009
Uniden BCD396T	Handheld	
Uniden BCD996T	Base/Mobile	

700 MHz

The 700 MHz band runs from 698 MHz up to 806 MHz and is the former home of UHF television channels 52 to 69. Broadcasters are supposed to be vacating these channels as they transition to digital television, leaving them open for commercial and public safety users.

The 700 MHz Public Safety Band has three parts: Broadband, Narrowband, and Guard Band. They are assigned as follows:

Part	Base/Mobile Transmit	Mobile Transmit
Broadband	763 to 768 MHz	793 to 798 MHz
Guard Band	768 to 769 MHz	798 to 799 MHz
Narrowband	769 to 775 MHz	799 to 805 MHz

The Broadband part is designed to foster a public/private partnership to develop a shared nationwide network for public safety agencies and commercial users. During emergencies, public safety agencies would have priority on the network, while commercial users could make use of the spectrum at other times. The hope is that new technologies, such as streaming live video and high-speed data links, will make use of the 10 MHz of bandwidth and become available to first responders at the scene of incidents and emergencies.

To help avoid issues with interference, 1 MHz of Guard Band was allocated as a buffer between Broadband and Narrowband activity.

Each Narrowband segment is divided into 960 channels, each 6.25 kHz wide. These channels are half the bandwidth of the current 12.5 kHz-wide voice channels commonly in use today. New, more spectrally efficient radios are needed for these narrow bandwidth channels, which will help drive agencies to replace their existing radios and repeater equipment.

In addition to licensing Narrowband channels on a repeater site basis, the FCC has set aside 192 channels for availability under a "State License." States and Territories can apply and receive a license to use these channels on a geographic service area basis, giving them greater flexibility in operating and expanding radio networks within their borders.

That's all for this month. Check my web site at www.signalharbor.com for more scanner details and comparison charts, and as always I welcome your questions, comments and frequency listings at danveeneman@monitoringtimes.com. Until next month, get outside and enjoy the springtime!

HAZARDS OF THE ALL AMERICAN FIVE

In our February column, Dan Marshall addressed the issue of attaching an antenna to the vintage Hallicrafters S38E. Walter Shepherd, K2ZPA, wrote with a reminder of the danger built into the old "All American Five" radios. These were receivers that simply connected all five tube filaments in series across the power line and one side was connected to the chassis ground.

In these old radios before the days of polarized plugs (one blade wider than the other), it was easy to insert the plug in the wall socket so that metal parts on the chassis were "hot," posing a dangerous shock hazard for the unsuspecting user standing on a wet floor or near other earth-grounded objects.

When working with old AC-powered radios that don't have power transformers, it's a good idea to have a voltmeter handy to measure any AC presence between the exposed metal parts of the radio and the AC neutral or ground wire. If there is, reverse the plug in the wall and check again.

If a dangerous AC level is still present, you might need to acquire an isolation transformer (120VAC input: 120VAC output) to reduce the shock hazard.

Q. *I purchased an Alpha RF power meter to measure the signal strength from a local TV transmitter. It measured 4 microwatts/cm squared at .4 miles distance. I submitted the results to the FCC, and they responded, asking me what type of meter I was using and how much I paid for it.*

When I told him he replied, "The types of meters we use for measuring RF power cost over \$5000. You cannot get an accurate reading of power with the meter you have." Is this true? (Bob Kane, email)

A. Although the FCC response appears off-handed and arrogant, there is a valid reason behind their response. The Alpha meter is an excellent unit for a wide variety of applications, but it is broadband, so it responds to all arriving energy within a wide spectrum. Thus, the reading you had was a pool of RF energy (or could have been) from multiple sources. An example would be attempting to monitor the

signal strength of an 800 MHz trunking system while you are near a cell tower – what you get is a glut of everything!

The more accurate way to measure the radiation from a specific emitter is to use a frequency-selectable spectrum analyzer attached to a cut-to-frequency dipole antenna, and get as close to the transmitting antenna as practical. Then you can submit more reliable measurements (and in the proper units) of the target transmitter on its unique frequency.

Q. *Car makers often shield their radios from ignition noise by using resistor spark plugs and resistor ignition wires, even bonding the hood to the frame with a metal braid. Why is this necessary when the spark occurs within the metal engine block? Doesn't this make a Faraday shield? (Mark Burns, Terre Haute, IN)*

A. While it's true that the spark occurs within a Faraday shield, the cable to the spark is the actual antenna. Whatever energy is passed by the spark goes through the wire as well, resulting in a radiating field. That's why another ignition noise suppression technique is to use shielded cable for the ignition leads.

Q. *The term five by five always meant loud and clear to me. Is this an accurate description? (Ed Leese, email)*

A. "Five by five" is the military equivalent of the amateur "599." In the first case, for voice operators, signal strength and clarity are rated one to five. In the second, readability, signal strength and tone quality (RST) of a Morse signal are rated one to five and one to nine as indicated above. Thus, five by five and five, nine, nine both mean "loud and clear," sometimes said phonetically as "LC" or "Lima Charlie."

Q. *After a few hours of fishing, my buddy and I went to his garage to filet the catch with an electric carving knife; his hands were wet, and he got a shock from the two-wire outlet. Would a ground-fault circuit interrupter (GFCI) type of outlet have helped*

in this situation? (Mark Burns, Terre Haute, IN)

A. Absolutely. While a two-wire AC circuit does have one wire grounded, it isn't always at the same zero-voltage potential as the earth you're standing on. A GFCI contains a sensitive circuit which detects any unexpected current flow that isn't confined to the two wires, but is flowing instead through an external path like your friend, and instantly activates a circuit breaker to disconnect the voltage from the outlet.

GFCI should always be installed where there is a potential shock hazard, such as a basement floor, or near water like the bathroom and kitchen.

Q. *The memory battery has gone bad in my receiver, but I don't know what its number is. Can I replace the old button cell with an AAA battery holder and batteries to make changing it easier in the future? Will there be any problem with stray signal coupling from the new battery leads? (George Bailey, North Little Rock, AR)*

A. Yes, it's safe to replace that battery with one or two of equal (or very close) voltage rating (A 1.5 VDC cell can replace a 1.3 VDC button cell). The advantage of a button cell is its shelf life; it doesn't have to produce much current.

You could use another button cell of its size, or even non-rechargeable lithium cells for longevity. The physical size of the battery doesn't matter in this application, just so long as you have the room. Just be sure the voltage is close so you don't damage the microprocessor that it powers.

If you want to retain what's in memory (assuming it's still being held), you can bridge another voltage source like an equivalent battery or a variable-voltage power supply across the circuit terminals before you remove and replace the old cell just to provide a holding voltage.

The lead length shouldn't be a problem; the circuit is well-filtered and bypassed for any stray voltages that might be impressed upon it.

Questions or tips sent to Ask Bob, c/o MT are printed in this column as space permits. Mail your questions along with a self-addressed stamped envelope in care of MT, or e-mail to bobgrove@monitoringtimes.com. (Please include your name and address.)

Canadian Coast Guard Frequencies

Spring begins the busy season for the Canadian Coast Guard. Their enormous area of responsibility includes parts of two oceans, a good chunk of the Arctic, much of the Great Lakes, and the St. Lawrence River.

April also brings the peak iceberg season. The CCG, International Ice Patrol, and other agencies make a tremendous effort to warn shipping.

All these far-flung assets require a large and frequently confusing array of stations and frequencies. Let's try to sort some of this out.

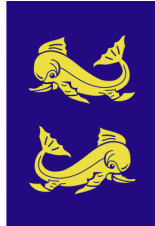

been established for other languages, including French in the case of Canada.

NAVTEX broadcasts repeat on a 4-hour cycle. Unique single-letter station identifiers appear in the message headers. On 490 kHz, these are:

- D Rivière-au-Renard
- J Sydney
- S Iqaluit
- V St. John (Fundy Radio).

And on 518:

- C Rivière-au-Renard
- D Prince Rupert
- H Tofino
- O St. John's
- P Thunder Bay
- Q Sydney
- T Iqaluit
- U St. John (Fundy Radio)
- X Goose Bay.

RAMN Publications

Fortunately for us, Canada publishes two extremely comprehensive radio guides in April of every year. These are the Radio Aids to Marine Navigation (RAMN). One is for the Pacific Coast and Western Arctic. The other is for the Atlantic Coast, St. Lawrence, Great Lakes, Lake Winnipeg, and the Eastern Arctic. Vessels operating in these areas are required to carry copies of the publications.

These can be downloaded, in free PDF files, at the Marine Communications and Traffic Services (MCTS) web site. The link is: www.ccg-gcc.gc.ca/eng/CCG/MCTS_Radio_Aids. At press time, the 2008 version was online. Updates are made available over the course of the year in Notices to Mariners (NTMs).

The four major MCTS comm centers are in Montreal, Quebec City, Les Escoumins and Rivière au Renard. They control remote transmitters and radar transponders in many locations. Detailed maps of the Quebec region are at www.marinfo.gc.ca/en/general/accueil.asp



Other Frequencies

All frequencies are kilohertz (kHz). The mode is Upper Sideband (USB) voice unless specified. NBDP is Narrow Band Direct Printing, usually in SITOR mode A. DSC is Digital Selective Calling, which sounds like SITOR-B but decodes differently. NOTSHIPs are Notices to Shipping, and SAR stands for Search and Rescue.

FAX is radiofacsimile, using the standard parameters of 120 lines per minute and 576 Index of Cooperation. Most radios show a frequency 1.9 kHz lower than the listed one when tuned in USB.

Note that additional wide-coverage FAX broadcasts are made from Halifax, NS by the Canadian Forces Meteorological and Oceanographic Centre (METOC). These are on 122.5, 4271.0, 6496.4, 10536.0, and 13510.0 kHz. Charts start on the hour, and Baudot radioteletype (RTTY) is broadcast afterward.

The areas used in Canadian Coast Guard listings are as follows:

- Pac Pacific and Western Arctic
- 1 Newfoundland and Labrador
- 2 Atlantic Coast, Gulf and St. Lawrence River up to and including Montreal
- 3 Great Lakes (including St. Lawrence above Montreal)
- 4 Eastern Arctic

CANADIAN COAST GUARD FREQUENCIES			
Shore	Ship	Area	Use
490.0		All	NAVTEX in French (Sitor-B)
518.0		All	NAVTEX in English (Sitor-B)
	2003.0	2	Intership (Lower St. Lawrence to Anticosti Island)
	2040.0	Pac	Intership (vessels other than fishing and towing)
2054.0	2054.0	Pac	Public correspondence
2514.0	2118.0	1, 2, 4	Public correspondence
	2134.0	1, 2	Inter-ship (fishing vessels only)
2550.0	2158.0	All	Public correspondence (U.S. vessels only)
2182.0	2182.0	All but 3	International distress and calling.
2187.5	2187.5	All	Distress, safety & calling (DSC)
	2237.0	1, 2	Inter-ship (other than fishing vessels)
	2318.0v	Pac	Intership (fishing vessels).
	2366.0	Pac	Intership (other than fishing vessels).
2458.0	2340.0	Pac	Public correspondence
2582.0	2206.0	1, 2, 4	Public correspondence
2598.0		1, 2	Weather and NOTSHIP broadcasts
	2638.0	Pac, 1, 2	Intership (shared with U.S. vessels)
	2738.0	Pac, 1, 2	Intership (shared with U.S. vessels)
2749.0		2	Weather and NOTSHIP broadcasts
2530.0	2815.0	2	Public correspondence
3023.0	3023.0	All	International SAR On-Scene (Aircraft/Vessels)
3253.0		4	Iqaluit FAX
4125.0	4125.0	All	Distress and Safety, includes SAR aircraft/vessels
4177.5	4177.5	Pac, 4	Narrow Band Direct Printing (NBDP)
4213.5	4175.5	2	Narrow Band Direct Printing (NBDP)
4207.5	4207.5	All	Distress, safety & calling (DSC)
4363.0	4071.0	Pac, 4	Public correspondence Channel 403
4375.0	4083.0	1, 2, 4	Public correspondence Channel 407
4378.0	4086.0	1, 2	Public correspondence Channel 408
4393.0	4101.0	1, 2	Public correspondence Channel 413
4408.0	4116.0	1, 2	Public correspondence Channel 418
4416.0		2	Sydney FAX
5680.0	5680.0	All	International SAR On-Scene (Aircraft/Vessels)
5803.0	5803.0		Distress & calling (Athabasca & Mackenzie waterways)
6215.0	6215.0	Pac, 4	International distress and calling
6268.0	6268.0	Pac, 4	Simplex Narrow Band Direct Printing (NBDP)
6312.0	6312.0	Pac, 4	Alerting frequency (DSC)
6317.5	6266.0	All	Radioteletype
6318.5	6267.0	All	Radioteletype
6507.0	6206.0	1, 2, 4	Public correspondence Channel 603
6513.0	6212.0	1, 2, 4	Public correspondence Channel 605
6915.1		2	Sydney FAX
7710.0		4	Iqaluit FAX
8291.0	8291.0	Pac, 4	International distress and calling
8376.5	8376.5	Pac, 4	Narrow Band Direct Printing (NBDP)
8414.5	8414.5	Pac, 4	Alerting frequency (DSC)
8419.5	8379.5	Pac, 1, 2	Radioteletype
8457.8			Inuvit FAX
8716.5	8355.5	Pac, 2	Radioteletype
8752.0	8228.0	1, 2, 4	Public correspondence Channel 812
8785.0	8261.0	1, 2	Public correspondence Channel 823
8791.0	8267.0	1, 2, 4	Public correspondence Channel 825
12290.0	12290.0	Pac, 4	International distress and calling
12520.0	12520.0	Pac, 4	Narrow Band Direct Printing (NBDP)
12577.0	12577.0	Pac, 4	Alerting frequency (DSC)
12598.5	12496.0	2	Radioteletype
13077.0	12230.0	1, 2, 4	Public correspondence 1201
13113.0	12266.0	1, 2	Public correspondence 1213
16420.0	16420	Pac, 4	International distress and calling
16695.0	16695.0	Pac, 4	Narrow Band Direct Printing (NBDP)
16804.5	16804.5	Pac, 4	Alerting frequency (DSC)
16821.5	16698.5	2	Radioteletype
17251.0	16369.0	1, 2	Public correspondence Channel 1604
17335.0	16453.0	1, 2	Public correspondence Channel 1632
22405.0	22313.0	2	Radioteletype
22732.0	22036.0	2	Public correspondence Channel 2213

ABBREVIATIONS USED IN THIS COLUMN

AFB.....	Air Force Base
ALE.....	Automatic Link Establishment
AM.....	Amplitude Modulation
ARQ.....	Automatic Repeat reQuest
AWACS.....	Airborne Warning And Control System
CAMSLANT.....	Communications Area Master Station, Atlantic
CAMSPAC.....	Communications Area Master Station, Pacific
COTHEN.....	Customs Over-The-Horizon Enforcement Network
CW.....	On-off keyed "Continuous Wave" Morse telegraphy
DEA.....	US Drug Enforcement Administration
DSC.....	Digital Selective Calling
E10.....	Israeli female phonetic letter voice callup/message
EOC.....	Emergency Operations Center
FAX.....	Radiofacsimile
FEMA.....	US Federal Emergency Management Agency
FSK.....	Frequency-Shift Keying
HFDL.....	High-Frequency Data Link
HF-GCS.....	High-Frequency Global Communication System
JSTARS.....	Joint Surveillance Target Attack Radar System
LSB.....	Lower Sideband
M08a.....	Cuban 3-msg Morse, ANDUWRIGMT = 1-0
MARS.....	Military Affiliate Radio System
Meteo.....	Meteorological (weather office)
MFA.....	Ministry of Foreign Affairs
MSK.....	Minimum-Shift Keying
NAVTEX.....	Navigational Telex, in SITOR-B
NDB.....	Non-Directional Beacon
PSK.....	Phase Shift Keying
RTTY.....	Radio Teletype
SITOR-A.....	Simplex Telex Over Radio, mode A
SITOR-B.....	Simplex Telex Over Radio, mode B
Stanag.....	Standardization Agreement
Stanag 4285.....	Military single-tone 8-PSK data mode
UK.....	United Kingdom
Unid.....	Unidentified
US.....	United States
USAF.....	US Air Force
USCG.....	US Coast Guard
V02a.....	Cuban Spanish female voice, 3 messages
VOLMET.....	Formatted aviation weather broadcasts

All transmissions are USB (upper sideband) unless otherwise indicated. All frequencies are in kHz (kilohertz) and all times are UTC (Coordinated Universal Time). "Numbers" stations have their ENIGMA (European Numbers Information Gathering and Monitoring Association) designators in ().

310.5	"500"-Differential Global Positioning Service beacon, Norway, 100-baud MSK corrections at 0241. (Michel Lacroix-France)
332.0	LL-NDB, Lille, France, CW at 1133. (Ary Boender-Netherlands)
343.0	HBC-NDB, Maersk Oil Halfdan B platform, North Sea, CW at 0302. (Boender-Netherlands)
402.0	KB-NDB, Gaz de France, Placid K12-B platform, Netherlands, CW at 0645. (Boender-Netherlands)
410.0	2BKQ8-NDB, Stena Drilling Ltd. operations vessel <i>Stena Carron</i> , CW at 0115. (DL8AAM-Germany)
490.0	"L"-Hamburg NAVTEX, Germany, at 0550. "M"-Cabo de la Nao, Spain, NAVTEX at 1550. (Boender-Netherlands)
518.0	"B"-Algiers Radio, Algeria, NAVTEX at 0410. "F"-Arkhangelsk Radio, Russia, NAVTEX at 0050 and 2050. "I"-Izmir Turk Radio, Turkey, NAVTEX at 0500. (Boender-Netherlands)
1888.0	IPD-Civitavecchia Radio, Italy, voice synthesized weather in Italian, at 1950. (PPA-Netherlands)
1890.0	PBK-Dutch Coast Guard, Den Helder, voice weather observations at 2144. (Lacroix-France)
2187.5	255982000-Cargo ship <i>Braga</i> , DSC distress relay from 576623000, drilling service vessel <i>Monarch</i> , at 0744 (PPA-Netherlands)
2350.5	ICA-Italian Navy, Ancona, coordinating Stanag 4285 in voice with Delta Lima, at 1951. (PPA-Netherlands)
2456.0	ART-Israeli intelligence (E10), phonetic identifier and 5-letter group message in reduced-carrier USB, at 2005. (PPA-Netherlands)
2598.0	VCP-Canadian Coast Guard, Placentia, weather at 0737. (PPA-

2608.4	Netherlands) FUO2-French Navy, Toulon, Stanag 4285 "voyez le brick" marker at 2042. (Boender-Netherlands)
2643.0	A9M-Manama Radio, Bahrain, Morse identifier in SITOR-A marker, at 2005. (MPJ-UK)
2680.0	IDC-Cagliari Radio, Italy, coastal warnings in English and Italian, at 2011. (MPJ-UK)
2749.0	VCO-Canadian Coast Guard, Sydney, weather in French at 0757. (PPA-Netherlands)
2804.2	IGJ41-Italian Navy, Stanag 4285 channel bulletin marker at 1608. (Boender-Netherlands)
3050.0	India Foxtrot-US Navy tracking link coordination net, with Echo, Hotel, Bravo, and Magic (an E-3 AWACS), at 0027. (Mark Cleary-SC)
3152.0	India Whiskey-US Navy air defense net with Bravo, at 0304. (Cleary-SC)
3278.5	"G-5-N"-Italian North Atlantic Treaty Organization player, asked by German unit "K-1-F" to test "ABC," followed by brief data transmission, at 2028. (MPJ-UK)
3308.0	AFA5ML-USAF MARS Region 5 net with AFA5RK, at 1216. (Cleary-SC)
3455.0	New York Radio-Oceanic air traffic control, NY, position check with Air Canada 975, at 2356. (Allan Stern-FL)
3850.0	LEZSEE-German Sea Police, calling BP25 in ALE, at 1725. (Lacroix-France)
4012.0	AGAT-144-Ukrainian military, encrypted RTTY messages in "Kriptograma" format, at 2039. (ALF-Germany)
4026.9	AAM4TKY-Control station in US Army MARS Region 4 net, at 1224. (Cleary-SC)
4032.9	AAA3VA-US Army MARS Region 3 net, with AAT3OL, AAM3RE, and NNN0AUH, in LSB at 1237. (Cleary-SC)
4045.0	<i>Sea Dancer</i> -Vessel working net control <i>Bel Ami</i> , in Caribbean weather net at 1155. (Cleary-SC)
4067.1	Tashkent Meteo, Russia, noisy FAX weather chart at 1843. (PPA-Netherlands)
4149.0	Tug <i>Monitor</i> -Crowley Maritime, working "WPE Jacksonville," at 1425. (Cleary-SC) UKG-Kerch Radio, Ukraine, voice synthesized navigation warnings at 1838. (PPA-Netherlands)
4152.5	DRAN-German Navy Frigate <i>Augsburg</i> , voice and Stanag 4285, at 1235. (Lacroix-France)
4207.5	003669991-USCG, Boston, MA, calling self in DSC test, at 0818. (PPA-Netherlands)
4295.0	FUE-French Navy Brest, Stanag 4285 test loop, also 6348, at 1555. (Boender-Netherlands)
4446.6	MBY-Unknown US government or military "three-letter net," calling IZA, also using 4934.1, 5690.0, 7325.0, 8045.6, and 9019.0; ALE at 1518. (Jack Metcalfe-KY)
4457.0	RHP-Saudi Arabian military, calling AAP in ALE, at 1940. (Lacroix-France)
4469.0	Florida CAP 90-US Civil Air Patrol net with Florida CAP 852, Hill CAP 536, Georgia CAP 44, Iowa CAP 101, and Southeast CAP 43; at 1234. (Cleary-SC)
4500.0	AFF4FL-USAF MARS net with AFA4FQ and AFA4BT, at 1326. (Cleary-SC)
4542.0	Unid-Russian Air Defense plotting station, highly formatted CW datagrams at 1954. (MPJ-UK)
4560.0	YHF2-Israeli intelligence (E10), identifier only at 1704. (Lacroix-France)
4712.0	Ufa Radio-Russian female, radio checks with Perm, Samara, Ural, Orenburg, and Volgograd; at 0325. (ALF-Germany)
4745.0	ADWSPR-USAF Secret Internet Protocol Router node, Andrews AFB, MD, also on 5702, ALE sound at 1239. (MDMonitor-MD)
4819.0	LTJQ-Probable Russian military, working LENJ in RTTY, at 0520. (ALF-Germany)
4840.0	IET32-Italian Carabinieri, Ancona, calling many IET5xx stations in Italian, LSB at 0630. (ALF-Germany)
4850.0	RBI-Russian point-to-point net, short RTTY messages for RI12, RJW2, and RRH9, at 0525. (ALF-Germany)
4970.0	RFT6-Russian point-to-point net, FSK Morse with RND79, at 0520. (ALF-Germany)
5000.0	4XZ-Israeli Navy, Tel Aviv, CW markers at 0257 and 0531. (DL8AAM-Germany)
5018.0	RJE65-Russian Navy, working REL5, CW at 0535. (ALF-Germany)
5094.0	RMGB-Russian Navy vessel, working RCV, CW at 1850. (ALF-Germany)
5195.0	DRA5-Amateur CW propagation beacon, Kiel, Germany, ionosphere data at 2247. (MPJ-UK)

- 5196.0 USDPRAYF-Unknown Russian airport, RTTY messages to USDS, Tarko-Sale Airport, also using 5430, at 0600. (ALF-Germany)
- 5225.0 RVR39-Russian point-to-point net, FSK Morse with RTW54, at 0545. (ALF-Germany)
- 5325.0 RND79-Russian point-to-point net, FSK Morse with RBW, at 0635. (ALF-Germany)
- 5400.0 Bravo 3-Libyan oil net, working Bravo 11 at 0610. (ALF-Germany)
- 5402.0 FC6-FEMA Region 6, TX, ALE sounding, also on 7348, 9462, 11108 and 12216, at 0800. (MDMonitor-MD)
- 5547.0 San Francisco Radio-Oceanic air traffic control, CA, working USAF Air Mobility Command transport Reach 6158, at 1145. (Stern-FL)
- 5550.0 New York, passing a turbulence warning to Jet Blue 786, at 2316. (Stern-FL)
- 5574.0 San Francisco, position from United 48, at 1205. (Stern-FL)
- 5598.0 Santa Maria-Oceanic air traffic control, Azores, clearing USAF Reach 676 to flight level 370, at 1014. (Stern-FL)
- 5696.0 CAMSLANT Chesapeake-USCG, VA, working Coast Guard 2003, an HC-130J, for ops-normal and position, at 2203. (Stern-FL)
- 5732.0 LNT-USCG CAMSLANT, calling helicopter J19, ALE at 0900. (MDMonitor-MD)
- 5792.0 2401-Morocco Civil Police, calling 2001 ALE at 2221. (Lacroix-France)
- 5883.0 Cuban AM "numbers," (V02a), Spanish callup 11681 67871 71241, at 0700. (PPA-Netherlands)
- 5898.0 V02a, 5-figure message in progress at 0807 (PPA-Netherlands)
- 6326.0 70-Singapore Navy Frigate *Steadfast*, working CN3 (Changi Naval Base), ALE at 1554. (ALF-Germany)
- 6428.0 ABC-Israeli intelligence (E10), possible test identifier, at 2120. (Mike L-West Sussex, UK)
- 6470.0 UWS3-Kiev Radio, Ukraine, fast CW navigation messages at 0835. (PPA-Netherlands)
- 6586.0 Starway 037-XL Airways, France, working New York Radio, at 2339. (Stern-FL)
- 6676.0 Sydney Volmet, Australia, aviation weather at 0802. HSD-Bangkok Volmet, weather at 1713. (Lacroix-France)
- 6679.0 ZKAK-Auckland Volmet, New Zealand, weather at 0853. (PPA-Netherlands)
- 6730.0 Herakles-Austrian Air Force, working C-130K JGP11 in German, gave secondary frequency 5720, at 1035. (ALF-Germany)
- 6809.0 FC4FEM-FEMA Region 4, GA, ALE sounding, also on 9264, 10194, 10588, and 11108.0, at 0317. FC8FEM-FEMA Region 8, CO, ALE sounding, also on 8050, 10588, 12216, 13446, and 14776, at 0948. (MDMonitor-MD)
- 6911.5 DKB-US Army, Savannah, GA, ALE sounding at 2243. (MDMonitor-MD)
- 6998.0 SH7-CW "Italian Crazy Pirate," religious rant in Italian at 1352. (DL8AAM-Germany)
- 7090.0 Unid-Russian non-amateur FAX weather chart, parallel on 5103, at 1400. (DL8AAM-Germany)
- 7348.0 IN5FEM-Indiana State EOC, calling FC8FEM, FEMA Region 8, ALE at 1420. (MDMonitor-MD)
- 7361.5 INDOPS-Indiana National Guard, ALE sounding at 1637. (MDMonitor-MD)
- 7450.0 REBOM1-Petroleos Mexicanos (PEMEX) Rebombeo Platform 1, ALE sounding at 0600. (MDMonitor-MD)
- 7527.0 PAC-USCG CAMSPAC Pt. Reyes, CA, calling J38 (helo Juliet 38), at 1333. OPB-DEA Operations, Bahamas and Tortugas (OPBAT), Nassau, calling J19 (USCG helo Juliet 19), in ALE at 1347. (MDMonitor-MD)
- 7633.5 AFA5RS-USAF MARS, IN, patch for USAF Reach 5142, came from 13927, at 1945. (Stern-FL)
- 7770.0 L2AC-Argentine Coast Guard vessel *Thompson*, working unknown station in Spanish, at 2240. (ALF-Germany)
- 8149.2 IGJ44-Italian Navy, Stanag 4285 channel bulletin marker at 1551. (Boender-Netherlands)
- 8156.0 C6DR-Partial call of unknown Bahamas vessel, radio check with Coral Harbour Base, at 1318. (Cleary-SC)
- 8190.0 CINUS-Italian Coast Guard Patrol Boat *Cinus*, working MESSINA (Financial Police, Messina), ALE at 2009. (MPJ-UK)
- 8291.1 AKALN2-PEMEX Akal-N2 Platform, also on 9265, ALE sounding at 2300. (MDMonitor-MD)
- 8337.6 Shark 01-USCG Cutter *Farallon*, working Dolphin 27 (USCG HH-65C helo), at 1527. (Cleary-SC)
- 8414.5 9VYJ-Singapore registry Ro-Ro *Aegean Breeze*, DSC with Lyngby Radio, Denmark, at 1225. (Lacroix-France)
- 8435.0 XSQ-Guangzhou Radio, China, SITOR-A traffic for unknown vessel, at 0905. (Lacroix-France)
- 8453.0 FUG8-French Navy, La Regine. Stanag 4285 test loop at 1442. (Boender-Netherlands)
- 8467.5 JJC-Tokyo Radio, Kyodo News FAX in Japanese, at 1514. (Lacroix-France)
- 8864.0 Gander Radio-Oceanic air traffic control, NFD, selcal check and position check with Continental 17, at 1118. (Stern-FL)
- 8912.0 LNT-USCG CAMSLANT, calling 720 (Coast Guard 1720, an HC-130H), ALE at 1444. WST-COTHEN Western Regional Node, calling T74 (US Customs Beech A200), ALE at 1536. (MDMonitor-MD)
- 8971.0 Fiddle-US Navy, Jacksonville, FL, working 71C, a P-3C, at 0007. (Stern-FL)
- 8983.0 CAMSLANT-USCG, VA, working Coast Guard 2003, an HC-130J, at 2205. (Stern-FL)
- 8992.0 PELICAN 711-US Navy P-3C, patch via Andrews HF-GCS, at 1712. (Cleary-SC)
- 9025.0 200180-USAF C-17A #00-0180, ALE-initiated patch to Offutt AFB, NE, identified as Reach 698 in voice, at 1538. DKB-US Army, GA, ALE sounding at 2041. (MDMonitor-MD)
- 9106.0 OARNNN-US Navy/Marine Corps MARS NNNNOAR, ALE sounding at 1440. (MDMonitor-MD)
- 10172.2 UOKA-Control of unknown net, working URJ3 and URJ7 in SITOR-B, at 2030. (Mike Chace-Ortiz-ME)
- 10194.0 FC6FEM-FEMA Region 6, TX, calling OH5FM, Ohio State EOC, ALE at 1421. (MDMonitor-MD)
- 10202.0 SA3-Unknown US government, calling CRB (US Customs Caribbean Regional Node), also on 11485, ALE at 1645. (Metcalf-KY)
- 10242.0 LNT-USCG CAMSLANT, calling J14 (USCG helo Juliet 14), ALE at 1818. (MDMonitor-MD)
- 10509.6 1TLFUO-French Navy/ Thales, Toulon, calling 1TFDR, ALE at 1509. (MPJ-UK)
- 10538.6 Coast Guard 1707-USCG HC-130, position for Sector Key West, FL, at 1617. (Cleary-SC)
- 11175.0 Reach 530T-USAF, getting Guantanamo arrival weather at 1621. (Cleary-SC) Lajes-USAF HF-GCS, Lajes Field, Azores, patch for Condor 3981 at 1638. (PPA-Netherlands) Puerto Rico-USAF HF-GCS, Salinas, PR, patch for US Navy P-3C Lima Lima 62, at 2138. (Stern-FL)
- 11232.0 Trenton Military-Canadian Forces, ONT, working Canforce 3223, at 1711. (Cleary-SC) Trenton, patching Peach 32 (E-8C JSTARS) to Peachtree Ops (Robins AFB, GA), at 1755. (Stern-FL)
- 11300.0 Speedbird 65-British Airways flight, working Tripoli at 1433. (Lacroix-France)
- 11348.0 HS-TNB-Thai International flight THA971 (an A340), HFDL position for Las Palmas, at 1253. (MPJ-UK)
- 11548.0 RLA88-Russian Navy vessel calling RMP, CW at 1446. (ALF-Germany)
- 12577.0 SWZJ-Greek registry tanker *Aegean Freedom*, DSC with Lyngby, at 1334. (Lacroix-France)
- 12599.5 UAT-Moscow Radio, Russia, SITOR-A marker at 0816. (Lacroix-France)
- 12903.0 VTH7-Indian Navy Mumbai, RTTY test loop at 1125. (PPA-Netherlands)
- 13215.0 PLA-USAF, Lajes, Azores, ALE message, "I NEED A COOKIE!" at 1308. (MPJ-UK)
- 13446.0 FC6FEM-FEMA Region 6, TX, calling KS7FEM, Kansas State EOC, at 1421. (MDMonitor-MD)
- 13510.0 CFH-Canadian Forces, Halifax, NS, FAX surface analysis at 1530. (PPA-Netherlands)
- 13533.5 Unid-North Korean MFA, Pyongyang, encrypted ARQ text at 0940. (Eddy Waters-Australia)
- 13927.0 AFA5RS-USAF MARS, patch for Teal 85, USAF Reserve 53rd Weather Recon, at 1941. (Stern-FL)
- 14401.5 OEY51-Austrian Army, Vienna, working OEY71, Austrian UN contingent in Golan Heights, Syria, ALE at 1248; ALEARQARQ on 14438.5 at 1257. (MPJ-UK)
- 14412.7 Unid-Unknown military station, idling in Stanag 4285, at 0955. (Waters-Australia)
- 15867.0 D45-US Customs P-3, calling CRB (COTHEN Caribbean Regional Node), ALE at 2004. (MDMonitor-MD)
- 16026.7 Unid-Egyptian MFA, Cairo, Arabic SITOR-A text for an unknown embassy, at 0948. (Waters-Australia)
- 17468.0 RIW-Russian Navy, Moscow, working RGR77 and RJQ84, CW at 1237. (MPJ-UK)
- 17967.0 VP-BRZ-Aeroflot flight SU0282 (an A320) working Muharrag in HFDL, at 1242. (MPJ-UK)
- 18034.7 Unid-Egyptian MFA, calling Spain embassy in Arabic SITOR-A, at 0935. (Waters-Australia)
- 18072.0 Unknown-Russian Vocoder transmission having 12 channels and a 3300 Hz pilot tone, at 1020. (Waters-Australia)
- 18528.0 Algerian MFA, Rabat, working Kuwait embassy with 5-figure groups in Coquelet-13 (an old French teleprinting scheme), at 0948. (Waters-Australia)

Chilean Police and Swiss MFA

This month we present a mixed bag, with a look at the Chilean Police HF ALE network and a long-overdue update on the Swiss Diplomatic Service.

Back in December, a few interesting ALE identifiers turned up on 7527 kHz. As is often the case when new ALE networks appear, it wasn't more than a few weeks before a couple more frequencies came to light.

The Chilean Carabineros, the country's uniformed national police, is some 30,000 officers strong, and has primary responsibility for public order, border control, anti-drug operations and counter-terrorism. They are organized in three main areas – North, Central and South – which are further divided into 16 zones, including the capital Santiago, which makes up the Metropolitan Zone.

Each of the zones is subdivided into various prefectures, sub-prefectures, commissariats, lieutenantcies, reserves and outposts. You can hear most of this organization through the ALE identifiers. At the time of writing, the stations heard are as follows:

BASEBAVE	Comisaria Bave, Prefectura Nuble
BASECHACABUCO	Comisaria Quillota, Prefectura Vina del Mar, Zona V
BASEHUSARES	3rd Mounted Regiment, Angol, Zona IX
BASELOSANGELES	Comisaria Los Angeles, Prefectura Bio-Bio, Zona VII
BASEVICTORIA	Comisaria Victoria, Prefectura Malleco, Zona IX
BASEYUNGAY	Comisaria Yungay, Prefectura Nuble, Zona VIII
BASEJEFCOM	HQ, Santiago
BASETALCA	Comisaria Talca, Prefectura Talca, Zona VII
BASEMATURANA	2nd Artillery Regiment, La Union
BASERANCEROS	Unidentified
BASEAYSEN	Comisaria, Puerto Aysen, Zona XI
BASEESCINF	Possibly Escuela Infanteria
BASEROSELA	Unidentified
BASECOQUIMBO	2nd Comisaria, Coquimbo, Zona IV
BASEMEMBRILLAR	Comisaria Membrillar, Prefectura Valparaiso, Zona V

The ALE can frequently be heard triggering USB voice on the channels. However, old habits die hard and the longtime standby of a few loud whistles into the microphone is often used to rouse the other end from whatever they were doing and come to the radio. No data modem traffic has been heard on any channel.

Frequencies that have come to light so far are as follows: 8125, 7527 and 6920 kHz. Doubtless more will be heard soon.

❖ Swiss Diplomatic Service HF Operations

Until about 2002, the MFA Berne ran a very extensive and active diplomatic network using standard SITOR-A. It wasn't uncommon to hear two or three channels working at the same time, sending mailbox traffic to embassies around the world from the callsign HBD20.

There appeared to be a gap of a couple of years before the network reemerged, this time based on the typical pairing of MIL-188-110A serial tone high-speed modem and MIL-188-141A ALE for calling and link control. The contract for this system was awarded to Harris Corporation.

Unlike many other networks, the Swiss use link protection for their ALE signals, which renders the identifiers useless unless you know the key. There are many cases of monitors happening upon a Swiss channel and posting a selection of juicy new identifiers, only to learn that they are garbles produced when a normal decoder attempts to scrambled interpret the signal.

The MIL-188-110A high-speed modems which carry the diplomatic X.400-based network traffic can be read by selecting synchronous 8 bit decoder setting. Without hearing the initial exchanges between MFA and outstation, the Swiss traffic appears encrypted, which indeed most of it is. However, the first few frames of the message usually reveal the sender and recipient, usually by virtue of their email address, as the following sample from the embassy in Madrid to the MFA in Berne shows:

```
mail@bfmadf1.mad.rep.admin.ch
mail@bfspaf1.bf.ugfu.admin.ch
```

```
Email ID=x400!CH!ADMIN!VBSMXS1-
081222101435Z-1594
EncryptionMode= CFB64
IDEAKeyld= 20000222
InitialVector= 0058094921EA0022
```

There is also a great deal of file transfer activity, which is most often done by virtue of the venerable UNIX "uuencoded" format. Uuencode was a simple way of coding binary data so that it could travel over ASCII-only data channels. This format is also easy to recognize with the "M" that starts each line.

```
mail@bfapsf1.bf.ugfu.admin.ch
mail@bfpotff1.otf.rep.admin.ch
```

```
begin 666 /tmp/
CFB64005610495A15B41C21927D P689.
dat
```

```
MMHUWGX:K$F">O]?PUI]K]_(?G;;RY.
HYL<(SWEF*_ =X8
M@RU=!4Q@
I<QR[W]*#03.@4Y1"G81QC_?W*]IJ9\FNJ;
M_[$@LQ_D:EACK.>/0"HW_
L2WWY_H*% ^DZYF3[/2=»
```

With a strong, error-free signal, it is quite possible to capture the files and uudecode them revealing the encrypted file. Not that it does a lot of good!

The Swiss still operate an extensive HF network, though much of it is confined to the lower reaches of the shortwave spectrum. Given the currently dismal propagation conditions, it is quite difficult to catch from the US. Here is a list of channels and embassies; these were heard at Digital Towers, reported via the WUN/UDXF mailing list, or posted by Munich-based monitor Leif Dehio.

That's it for this month. Enjoy your digital DX.

SWISS DIPLOMATIC SERVICE INTERCEPTS

4545	Berlin, London, Paris, Prague, Rome, Sofia, Vienna
5090	Paris, Rome, Stockholm
5768	Brussels
5777	London, Madrid, Rome, Stockholm
7673	Brussels
7683	Brussels, Kiev
7720	Belgrade, Berlin, Paris, Rome, Vienna
7725	Belgrade, London, Moscow
9166	Algiers, Ankara, Kiev
9177	Algiers, Brussels
9185	Madrid, Moscow, Sofia
9308	Berlin, Moscow, Stockholm, Vienna
10190	London, Madrid, Sofia
10238	Helsinki, Rome, Stockholm, Tel Aviv, Nicosia
10347	Islamabad, New Delhi
10952	Algiers, Ankara, Kiev
10967	Algiers, Ankara
13452	Moscow, Sofia, Stockholm, Tel Aviv
13457	Berlin, Budapest, Cairo, Sofia
13951	Algiers, Ankara
13955	Ankara, Brussels, Kiev
13967	Washington
13968	Tehran
13976	Tehran
13990	Washington, Ottawa
16094	Amman, Ankara, Kiev
16124	London, Moscow, Rome, Tel Aviv
16130	Ottawa
16224	Tehran
16234	Tokyo, Djakarta
16424	Beijing, Tokyo
18231	Moscow
18281	Cairo
19190	Vienna
20613	Cairo
20625	Moscow

PROGRAMMING SPOTLIGHT

WHAT'S ON WHEN AND WHERE?

Fred Waterer

fredwaterer@monitoringtimes.com

www.doghouscharlie.com/radio

If It Ain't Baroque, Don't Fix It

I know, some of you may yawn at just the mention of classical music. I certainly used to when I was younger. But, I was fortunate to grow up in a musical family. My father was a country music fan and musician, appearing on local radio programs in Saskatchewan and later in Ontario. My mother was a fan of jazz and musicals. And my Aunt Edith planted the seeds of appreciation for classical music. And of course I grew up in the rock and roll era. I was exposed to all of these types of music and learned to appreciate each of them.

This month we shine the *Programming Spotlight* on classical music programs via short-wave, domestic radio and the internet.

What IS "classical music"? It evolved over the past millennium from monophonic chant of a religious nature to compositions involving multiple voices and increasingly complex combinations of musical instruments, as these became more and more sophisticated. With the invention of standardized musical notation, magnificent compositions ensued.

The music eventually passed from the preserve of the Church and the ruling classes to a more popular form of entertainment. In many cases, the works of great composers endure to this day and inspire modern day musicians to continue to create beautiful music. A recent example was the Obama Inauguration. www.youtube.com/watch?v=zmJAZ9h7Lf0

Australia -

Radio Australia and Radio National are home to *The Music Show*. "The Music Show is a mix of music, interviews and information about the latest developments in music, hosted by composer Andrew Ford. It aims to entertain and inform a wide audience about music, providing two hours of essential listening every week. The Music Show began in 1991 and it has a strong following due to its broad definition of 'good music' and a willingness to break down traditional categorizations of music. All music styles are heard and talked about in the program, from medieval chant to Webern string quartets and Elvis Costello singing Burt Bacharach." The Radio Australia website suggests the program is on UTC Sundays at 0905 UTC.

Austria -

In past centuries, Vienna was the political

and cultural capital of an extensive, multicultural empire, home to symphonies, grand opera and all the various facets of European culture. Ö1 listeners who can speak German (and even those who can't) can hear *Die Ö1 Klassiknacht* daily from 0008-0600 Austrian time (UTC + 1 hr). One can listen online via the Ö1 website at

☞ <http://oe1.orf.at/service/schema> Just click Webradio at the top of the page.

Knowledge of German would certainly be helpful in following some of the discussions of the music and musicians. But not absolutely essential to enjoy the music!

Canada -

Sound Advice - For many years, Rick Phillips hosted *Sound Advice* on CBC Radio One and Two (and on the CBC Northern Quebec Short-wave Service). The program was "the weekly guide to classical music and recordings on CBC Radio One and Radio Two. *Sound Advice* had a weekly national audience of 400,000 ranging from newcomers to classical music, to seasoned veterans to classical record collectors, young and



old. Prior to *Sound Advice*, Rick was a Producer and Exec. Producer of CBC Radio programs like *RSVP*, *Stereo Morning*, *Arts National* and *A Little Night Music*, in Montreal, Edmonton, Calgary and Toronto."

In the past year or so, CBC Radio changed their schedule quite a bit, and while most of the changes are good, in the process they eliminated two of my favorite programs, much to my consternation.

The first to go was *Northern Lights* with Andrea Ratuski (and predecessor *That Time of the Night*) - featuring soft classical music in the early morning on Radio Two; it also aired late evenings on Radio One. I found this a very relaxing program at the end of the day.

Secondly, they cut *Sound Advice*. I learned more from that weekly program about classical music, than from just about all others combined. Rick is very good at explaining aspects of music, without talking down to the listener and without

"dumbing down" the material. Although the CBC Radio program is gone, Rick continues to present the program via his website

☞ <http://rickphillips.ca/>

Here you can listen to his reviews of new releases, and his recommendations for building a classical music collection "Your First 25 CDs." All programs in the web cast version are archived and available to stream or download. I hope the program finds its way back to the CBC Schedule some day, but if not, it's great that Rick is continuing to educate via the internet.

In September 2008, CBC Radio 2 revamped its programming schedule. While at one time classical music could be heard 12 hours per day, it was cut back to 5 hours in the new scheme. From 10-3pm weekdays one can hear "*Tempo* - Classical music to keep you company at work or in your home, hosted by Julie Nesrallah."

On weekends one can still hear *Saturday Afternoon at the Opera*, live from the Met in New York, at 1pm Eastern time.

☞ www.cbc.ca/radio2/thenew2/

Germany -

Concert Hour: "Concert Hour features live recordings of the world's music stars performing in Germany's palaces, churches and concert halls, bringing a sense of the immediacy and festivity of these renowned musical events."

"If you can't fly to Germany for the music festival season, we'll bring the concerts and performances to you! *Concert Hour* features live recordings of the world's music stars performing in Germany's palaces, churches and concert halls, bringing a sense of the immediacy and festivity of these renowned musical events. The one-hour program is broadcast every Sunday, or listen to the audio stream here on the Internet.

"Hosted and produced by Rick Fulker, *Concert Hour* explores the diversity of the events and locations of Germany's renowned festivals."

Rick is Deutsche Welle's "Music Man," hosting or producing DW music programs *Concert Hour*, *A World of Music* and *Hits in Germany*.

Concert Hour can be heard via FM radio, assuming you are in Albania or Kosovo! Otherwise, listen to this fine program via the internet at the DW On Demand page at: www.dw-world.de/dw/0,,4703,00.html

New Zealand -

Radio New Zealand Concert is the classical music network of Radio New Zealand. It is similar to BBC Radio 3 (see below) and to what CBC Radio 2 once was. RNZ Concert

airs many hours of classical music, as well as forays into jazz, world music and other eclectic genres. One can hear opera from New York (on a delayed basis), concerts and recordings and lots of background information. Listen at

🔊 www.radionz.co.nz/concert/home

Radio New Zealand International's schedule includes *Saturday Night with Peter Fry*. While not a classical music program in itself, classical music does feature in the selections offered. It airs UTC Saturdays at 0808. Try 9765 kHz.

Russia –

The Voice of Russia offers its listeners many hours of cultural and musical programs. Russians are extremely proud of their culture, for very good reasons. Moscow was founded by an empire, which fancied itself the next Rome. Art, literature and music were all created on a grand scale. Russian composers, and musicians are known the world over, such luminaries as Tchaikovsky, Mussorgsky and Shostakovich are held in the same esteem as great writers like Tolstoy and Pushkin. So it's no surprise to find a number of programs dedicated to classical music.

"*Musical Tales* is a series of weekly programs for classical music lovers who want to know more about world musical culture and history. A wealth of eye-opening information – unknown facts and new versions, forgotten names, unexpected revelations and surprise comparisons, a veritable constellation of celebrities – these and other topics will be featured in the *Musical Tales* series contributed by Olga Fyodorova.

"Tune in to *Musical Tales* on Monday at 09.30, Wednesday 03.30, 08.30, 18.30 and 21.30, Friday at 20.30 and Saturday 03.30 UTC."

🔊 www.ruvr.ru/main.php?lng=eng&rt=109&p=

1000 Years of Music – this musical multi-sequel leads you, year-by-year and century-by-century, through the history of Russian music. UTC Fridays at 0430, alternating with "Guest Speaker"

Music Calendar is a monthly program about musicians and musical events that have



Olga Fyodorova

stood the test of time – the strictest and most objective judge ever. In each broadcast we'll be remembering the high points of the incoming month. UTC Tuesdays at 0530 alternating with "Music Around Us"

Music and Musicians presents "stories about contests, festivals, and close acquaintance with the country's outstanding composers and performers await classical music lovers in our 47-minute program." UTC Thursdays at 0500, UTC Sundays at 0400.

🔊 www.ruvr.ru/main.php?lng=eng&rt=135&p=

While we are in Russia, I have to mention one of my favorite websites, Radio 101 in Moscow. I stumbled onto this one in 2001. At the time it had 2 or 3 really unreliable web streams (or maybe it was me, I was still on dial-up then). Fast forward to 2009 and they have literally dozens of music streams, featuring every genre one can think of. Included in this plethora of offerings are three classical music channels. The Opera channel features music from Russia and the world.



The Pop Classical channel features familiar, shorter classical pieces, by performers from around the world, such as *Ave Maria* (Sara Brightman) and excerpts from the *Barber of Seville* among others.

Spivakov Classic features longer pieces.

You don't have to speak any Russian to enjoy this website. A smattering of Russian will help. You can access these (and many more) at

🔊 www.101.ru/?an=index_eng

United Kingdom –

BBC Radio 3 is your home for live music and the arts at the BBC. Radio 3 alone broadcasts seventeen different programs featuring classical music. Highlights include:

Composers of the Year: "Four great composers celebrate anniversaries in 2009 - Purcell, Haydn, Handel and Mendelssohn. Radio 3 and BBC Two mark the anniversaries with special programmes throughout the year."

Baroque 09: "Baroque 09 links cultural organisations in a year-long celebration inspired by the Purcell and Handel anniversaries."

Perhaps the best program on Radio 3 (in my opinion) is *Composer of the Week*. "Composer of the Week is one of Radio 3's longest running programmes, now presented by Donald Macleod." As the name suggests, each week Macleod takes an in-depth look at the life of a composer, in a series of five one-hour programs. In many ways, regular tuning to this program is like a university level course in music. Macleod dissects the lives of his subjects, professionally and personally. Highly recommended!



Donald Macleod

Check out what's on offer on Radio 3 for yourself, at

🔊 www.bbc.co.uk/radio3/ As always, all

BBC programs are archived for 7 days. Many programs also offer podcasts; however, some podcasts are not available outside the United Kingdom.

BBC Radio 7 - *All Classical Music Explained*: This program has run on BBC 7 a few times over the past several years. Not only is it educational, but it's also hilarious. Rainer Hersch presents a discussion of Classical music like you've never heard before. In six episodes he reveals "how 'Cosi Fan Tutte' is actually about TV chefs, assembles the largest collection of stylophones in one building, investigates the Master of the Baroque and his Big Boomy Special Effects, brings you Bruch's Violin Concerto (frequently), and explains the cost of concerts – and how to fall asleep subtly."

🔊 www.bbc.co.uk/programmes/b00f3n6t/episodes/2009 If you aren't subscribed to the BBC 7 newsletter, check the Radio 7 website frequently for future airings of this very good series.

There are many programs spread across all the BBC radio networks. Consult the Classical listings here:

🔊 www.bbc.co.uk/radio/programmes/genres/music/classical/player

United States –

National Public Radio offers a great page for classical music fans, which can be accessed at:

www.npr.org/templates/story/story.php?storyId=10003

Many local NPR stations offer classical music programs, or indeed classical music channels, such as my own local WNED-FM 94.5 in Buffalo, NY.

Classical music is everywhere. It's in your movie soundtracks. It's in rock and pop music. Elvis Presley's *It's Now or Never* is based on *O Solo Mio*. *Lover's Concerto* by the Toys is based on *Bach's Minuet in G*. And you've got to love ELO's version of *Roll Over Beethoven*, which incorporates actual Beethoven elements, and Procol Harum's *Conquistador*, which was recorded with the Edmonton Symphony Orches-

Madagascar Uprising Disrupts Shortwave Broadcasting

The rebellion against Pres. Marc Ravalomanana in late January centered on the government radio and TV station in the capital, which was burned and put off the air temporarily. The rioting spread to other areas. Several other stations were destroyed. The main SW frequency, however, 5009.94v, probably from another site, was soon back on the air, but mostly with music, per numerous monitoring reports around the world, including Scott Barbour, NH; Anker Petersen, Denmark; Terry Krueger, FL; Ron Howard, CA; Jim Evans, TN; Giovanni Serra, Italy; Carlos Gonçalves, Portugal; Jerry Lenamon, TX; Paul Brouillette, IL; Chuck Bolland, FL. Usual reception time in North America is 0200-0415, but Ron Howard in California also heard it via long-path at 1516-1545.

Wolfgang Büschel points out that the 5009.94 transmitter is probably the same one previously used by Südwestrundfunk in Germany on 7265v, sold to Madagascar as foreign aid. Kai Ludwig adds that before that it was used on 6190 by Radio Bremen. In Madagascar it had been using USB only, but lately it was modulating both sidebands, says Steven J. Price, PA, in NASWA who had also been trying to QSL that outlet without success, sending 40 to 50 reports during 2008!

Operators at Radio Netherlands' relay station at Talata must have been somewhat distracted, for on January 28 between 1429 and 1557, instead of the usual RNW English broadcast to South Asia on 15595, we heard a relay of Vatican Radio in European languages. The wrong satellite downlink was put on the air and no one noticed. Apparently there was no down time, as in previous emergencies, when diesel fuel supply was cut off.

The RNW site also transmits a program for the Lutheran Church on the island, R. Feon'ny Filazantsana at 1630 on 3215. Jari Savolainen, Finland, confirmed this was still appearing normally.

Also threatened by the uprising was World Christian Broadcasting, building a new SW station on the northwest coast of Madagascar, due to fire up later this year, as a complement to their first station, KNLS in Alaska. WCBC had proudly claimed that Ravalomanana, a Presbyterian, was their patron in allowing the project. The WCBC newsletter for December said he had waived tariffs on materials for the station, worth \$2 million. So if he were to lose power, the project might be sunk. As of mid-February, World Christian Broadcasting had not posted any updates on its website about the situation (gh)

AFGHANISTAN [and non] Radio Solh vanished without notice, as of January 28, no longer heard via Rampisham, UK, before 1500 on 13830, where it had been daily since the B-08 season began at the end of October. We could only wonder if this PsyOp were a casualty of the new administration in Washington, although it seemed unlikely that would be much of an Obama priority; but saving our taxpayer money is called for: this was the most redundant service on earth, playing exactly the same content day after day – it might cost less to give every Afghan a CD of it. Then we read that VTC had deleted all Solh transmissions as of Jan 27 with no replacements! (gh) According to IBB Monitoring audio files, R. Solh's existence ended at 1800 UT Jan 23 (Dragan Lekic, Serbia, **DX LISTENING DIGEST**)

Radio Solh closes on Friday 23 January. And the next working day (in the US), Monday 26 January, VOA expands its overnight service to Afghanistan and Pakistan [but not on SW]. There may not be an exact correlation in terms of costs, but perhaps the idea of ending one project and shifting the funds to another one might have appealed to a tidy bureaucratic mind (Chris Greenway, UK, DXLD)

I had not heard the other R. Solh inside Afghanistan on 6700 for some days, but perhaps there is still some infrastructure left in Kandahar to be seen (Al Muick, Kabul, *ibid.*) Solh transmitters on 6700 in Afghanistan have not been audible at my QTH since (at least) beginning of 2009 (Jari Savolainen, Finland, *ibid.*)

Although they had the same name, I have never been convinced that the 6700 Radio Solh from inside Afghanistan was directly connected with the R. Solh via UK and UAE, the latter using overt transmission means just like any other major broadcaster, and certainly not airborne PsyOp like 6700 was originally, but ground-based for a long time since that became feasible (gh)

ALBANIA R. Tirana tentative A-09 English, effective March 30, Mon-Sat/UT Tue-Sun, all 100 kW, 300 or 310 degrees for NAm and/or Eu (gh):

1430-1500	13625
1845-1900	13640 7435
2000-2030	13640 7465
0030-0045	9345
0145-0200	7425
0230-0300	7425
0330-0400	7425

AUSTRALIA HCJB's Kununurra site, which has been on air for five years, has room for only two transmitters and three antennas. Now HCJB is relocating to adjacent property where there is room for expansion, and it is further from the local airport, allowing masts to be higher, reach more target areas and operate more efficiently. The new site should be on the air by third quarter 2009. One new antenna being moved in is the "eggbeater" from Ecuador (HCJB News)

AUSTRIA Tentative A-09 for OE1 to the Americas on three different beams at 0000-

0130, perhaps still including brief English and French news segments around the middle of each semi-hour weekdays as in the B-08 season: 9820 (gh)

BRAZIL Rádio Nacional da Amazônia, 6185 and 11780, planned to buy two new 250 kW SW transmitters in February, and could be on the air a few months later (Lucio Haeser, Brasília, *radioescutas* yg)

Maybe that will get rid of 25 mb spurs. Most winter nights around 0630, not much on 25m besides RNA, Brasília on 11780, but for weeks and weeks marred by split-second audio dropouts every few seconds, unlistenable; identical on // 6185, so a modulation input problem. No one paying attention in the control room?

In mid-Feb on 0633, 11780 again put extremely distorted spurs plus and minus 50 kHz, causing severe interference to RFI in Portuguese via South Africa on 11830, and on 11730 ratcheting the top side of RNZI 11725, requiring one to side-tune lower. But no audio drop-outs this time.

11765 reactivated, heard around 0900, with impressive canned IDs as Súper Rádio Deus é Amor. I never heard any Rádio Tupi IDs but suppose station is still Rádio Tupi (Christer Brunström, Sweden, **WORLD OF RADIO**) Also 0615-0705 on // 9564.94 and 6060 (Brian Alexander, PA, DXLD) I.e. preacher David Miranda speaking a bastardized mixture of Spanish and Portuguese. Collided with BBC via South Africa at 0620; roughly equal strength to BBC with 25 times the power, and fast SAH of maybe 15 Hz, // Curitiba on 9565 in the clear. (Where's Cuban jamming on 9565 we need them?) gh

11815, R. Brasil Central, Goiânia, music // 4985 at 0630. 11815 only fair, much weaker than 11765 and 11925 Brazilians.

11925, R. Bandeirantes, São Paulo, such a treat to hear real Brazilian programming rather than gospel hucksters; Feb 5 at 0631 talking about Carnaval do Salvador; 0632 "*Bandeirantes, a caminho do sol*", meaning on the way to sunrise, timecheck for 4:30 am – but that's DST, it was really only 3:30 am; news headlines. Good booming signal (gh, OK)

COSTA RICA The silent TIRWR SW facility in Cahuita is still in limbo. All the transmitting tubes need to be replaced, which would cost around \$80,000, plus other repairs to get it operational, and there is no sign that Pastor Melissa Scott is prepared to spend what it takes to bring it back on the air. Just in case, 7375 and 9725 are still registered (gh)

[non] Radio for Peace International was a progressive radio station, unique on SW, which was forced off the air in 2003. Since then it continued as a webcaster via www.rfpi.org but in November 2008 we noticed that the stream no longer worked and the schedule had not been updated (gh)

In September, James Latham told me that Joe Bernard, Jean Parker, and he – the three who had kept the RFPI audio up and running online – had all agreed that it was time to move on to other things in their lives, which had evolved. James now coordinates volunteers working with inner city youth in Saint Thomas, Virgin Islands. Jean, who used to host Disability Radio Worldwide, is a stringer for NPR and other broadcasters, working out of Pune,

*All times UTC; All frequencies kHz; * before hr = sign on, * after hr = sign off; // = parallel programming; + = continuing but not monitored; 2 x freq = 2nd harmonic; sesqui = one and a half; A-09=spring/summer season; [non] = Broadcast to or for the listed country, but not necessarily originating there; u.o.s. = unless otherwise stated*

India. Joe was in computer recycling in Oregon (Franklin Seiberling, IA, DXLD)

"That's about it. Online activity never brought listenership up to the level of what it had been on shortwave. That says a lot about SW broadcasting. It became less and less viable. It was sad to stop, but hard to justify so much time placed into it with so few listeners. We do plan on keeping the memory of RFPI alive. I started writing a book about the station that will tell some stories that never had been told before to the public. I have been sorting through the station's files, photos and 15 years of newsletters. I had tried to write the book before but the sadness of what happened was too difficult to deal with. The website should stay there with updates." (James Latham, VI, via Seiberling, ibid.)

CUBA I am deeply offended by RHC's constant references to the US trade embargo as the "genocidal blockade," (in Spanish as "el genocida bloqueo"). Americans have differing opinions about the blockade, but it is not "genocidal", i.e. designed to kill great masses of people! Nor has it. Lots of money, food and other aid still get into Cuba from the USA, including wheat from Oklahoma, and what they cannot get from us they get from elsewhere. Additional US aid is offered and usually rejected, after emergencies such as hurricanes. In this and so many other ways, RHC is totally lacking in credibility (gh)

EGYPT R. Cairo, English, tentative A-09 from March 29 (gh):

1215-1330	17870 As
1530-1600	15255 Eu [new transmission, unconfirmed]
1600-1800	12170 Eaf
1900-2030	11510 Waf
2115-2245	6255 Eu
2300-2430	11590 ENAm
0200-0330	7540 NAm

ERITREA [non] Eritrean opposition website Asena announced: "Voice of ASENA will start broadcasting to Eritrea beginning Monday 16th of February 2009, with a frequency 9610 kHz. The trial radio program, which will have the Eritrean people and army as its target audience, runs Mondays, Wednesdays and Fridays from 8:30 to 9:00 PM Eritrean time [1730-1800 UT]." This broadcast is brokered by TDP, so presumably via same 250 kW transmitter in Samara (Russia) as for other Eritrean and Ethiopian opposition broadcasts on that frequency (Dave Kernick, UK, Media Network blog)

ETHIOPIA [non] Radio Bilal, mentioned last month, Sundays 1700-1800 on 9610; although there is an FM station by same name in Uganda, that was a red herring (gh) R. Bilal started January 18. There is no link with Kampala. The station is based in Washington and broadcasts to Ethiopia in Amharic (Ludo Maes, TDP, DXLD) Hansjörg Biener says the station name, unless it's an acronym, clearly indicates an Islamic background. Ask a search engine about Bilal ibn Riba / Bilal al Habaschi (Kai Ludwig, Germany, ibid.) Heard January 18 at *1700-1733, ID seven times, followed by chant "Allahu akbar" and schedule. From 1710, reports mentioning Washington, Canada, democracy; postal address in Washington, DC (Patrick Robic, Austria, DSWCI DX Window)

15195, Addis Dimts Radio, via Samara, Russia, 1618-1700*, on Sunday, spirited talks in Amharic including interviews with several people via telephone, 1659 Id. Fair. They verified an electronic report in just 13 minutes from v/s Abebe, Host and Producer who responded via his iPhone. E-mail address is: abelewd@yahoo.com (Richard D'Angelo, PA, DSWCI DX Window)

FRANCE Radio France Internationale's website and broadcasts were disrupted Jan 29 due to staff participation in a general strike called by trade unions.

RFI suddenly adopted a new French program schedule in mid-January, now showing little difference between programming for Africa and the rest of the world. I have no idea why such an abrupt programming revamp, unless related to planned staff cutbacks. There is no mention of shortwave on any of the pages. I can't find a single shortwave frequency anywhere on RFI's Web site.

RFI's bottom-of-the-hour newscasts have been cut from ten minutes in length to three minutes, so feature programs can now run longer, starting at :33 instead of :40 after the hour. As much as I like RFI's newscasts – they are freshly written, well-delivered and really include last-minute info – I'm glad to see a step taken away from so much news every hour (Mike Cooper, GA, DXLD)

But RFI English confirmed still on SW, 15605, for the 1600 broadcast; Saturday at 1631, Network Europe, which saves RFI from having to produce a full hour of programming itself; sufficient reception though aimed 170 degrees from Issoudun across Africa, about as close as we get to a North American service from RFI, which is not close at all, but enough of that 500 kW can wander over here on a good day.

RFI English, tentative A-09, daily, entire season u.o.s., all via Issoudun site to Africa; earlier morning shows may be M-F only (gh):

04-05	11995 9805
05-06	15160 13680 11995
06-07	17800 15160
	11610 until 6 Sept
	9765 from 6 Sept
07-08	3675
12-13	21620 until 3 May, from 6 Sept
	17800 from 3 May until 6 Sept
16-17	17605 15605

HUNGARY Magyar Rádió's only remaining broadcast to NAm in A-09 is at 0100-0200 on 6150, 250 kW, 306 degrees; also try 1600-1700 on 15160, 250 kW, 187 degrees to Africa; all in Hungarian (gh)

INDIA AIR transmitter on 7410 [Delhi (Khampur)] at 1745-2230 is again putting spurs plus and minus 359 kHz away on 7051 and 7769 in mid-January, like it was in Dec 2007 (Uli Bihlmayer, Germany, DARC/IARU Bandwatch via BC-DX, also complaint to AIR about intruding in the 40m hamband)

More AIR spurs monitored inside India: Chennai using both 7160 and 7270 around 1030 UT put intermodulation with both audios on 7050. Mumbai on 4840 and 7195 around 0230 puts spur on 7065, which is 3 x 7195 minus 3 x 4840. Also monitored at Lucknow the 15th harmonic of Tiruchirappalli 936 kHz on 14040, the fixed frequency for all "Islands on the Air - IOTA" expeditions.

There was a serious case of AIR Thiruvananthapuram, emitting five frequencies in the 40m amateur band whenever they started their morning domestic service on 7290, from 0230 UT. Worst was 7050, where emergency communications for Tsunami etc., were carried out by hams from India and Sri Lanka, but after complaints the latter subsided.

AIR Najibabad Domestic service on 954 kHz was regularly heard on 10th harmonic 9540, with heterodyne; many SWLs enjoyed listening to the spur (B. L. Manohar "Arasu" VU2UR, Bangalore, to AIR HQ New Delhi, via DARC)

AIR stations between 7105 and 7195 are shifted to frequencies on the higher side of the 41 meter band (above 7200 kHz) from the A-2009 broadcasting period (Jose Jacob, dx_india yg)

Some of the tentative new frequencies: 7250 Goa; 7315 Shillong; 7325 Jaipur; 7335 Imphal; 7340 Mumbai; 7360 Delhi; 7370 Delhi; 7380 Chennai; 7390 Port Blair; 7420 Guwahati, Hyderabad; 7430 Bhopal; 7440 Lucknow; 9950 Aligarh (Wolfgang Büschel, DXLD) Generally for daytime use only, some opening around sunrise.

Most of the 7100-7200 stations worldwide have been cleared out of HFCC registrations, to make that segment exclusively ham; the few exceptions all being in Asia, and many of them inactive (gh)

INDONESIA RRI also shifted five regional transmitters in the 7100-7200 range exactly 100 kHz higher – except they were all inactive, anyway (gh)

IRAN VIRI tentative A-09 English (gh):

1030-1130	15600 17660
1530-1630	7305 9600 9635
1930-2030	6205 7205 9800 9925 [plus a Lithuanian relay TBA]
0130-0230	7235 9495

KOREA NORTH [non] JSR, Shiokaze/Sea Breeze via Yamata, Japan at 1400-1430, used 5985 for a few weeks in January but collided with Myanmar and also became jammed, so I sent an audio file to Mr. Sadaki Manabe at COMJAN; he agreed they should move and two days later on Feb 6, went back to previous frequency, 5910. That week, English was not only on Friday but also on Wednesday with a completely different format, detailed info about abductees, rather than North Korean issues as on Friday (Ron Howard, CA, DXLD)

Another program for abductees in North Korea, is Furusato no Kaze, 9880 via Darwin, Australia at 1430-1500 in Japanese. Replied to my e-mail report in English in 12 days from hai@rachi.go.jp with no verie details but said: "This program is sent for Japanese people being abducted and still captive in North Korea." See www.rachi.go.jp/en/index.html

And watch the documentary "MEGUMI" in English, animation on abduction of Japanese girl by North Korea.

☞ <http://www.rachi.go.jp/en/shisei/keihatsu/anime.html> (Al Muick, Afghanistan, DXLD)

A press release in Spanish from Transworld Radio via noticiacristiana.com brags that TWR smuggled 3400 radios into North Korea last year, to counter permitted radios which can only tune official broadcasts (via José Miguel Romero, Spain, DXLD)

The only known Korean-language broadcast by TWR is at 1400-1515 on 11570 via Guam, and continues in A-09, extended Saturdays to 1545. So are these 3400 radios fix-tuned to that frequency, in order to lock out everyone else who may broadcast on SW in Korean, including competing evangelists, numerous secular clandestines, VOA and RFA? (gh)

KURDISTAN [non] 11530, Denge Mezopotamya, heard at 0525 on 1 Jan playing The Internationale! Full marching-band style. Local level signals. I am quite surprised to hear this on a station supposedly looking for a "free" Iraq. I will have to check their political statement (Al Muick, Afghanistan, DXLD) Never heard that, but enjoy their mix of traditional and modern music, best heard after WYFR closed, 1345-1500* on 11530 via Ukraine. Also sometimes audible on next frequency, 7540 from *1500 (gh) 7540 carrier on as early as 1435 (Anker Petersen, Denmark, playdx) In A-09 plans to collide with WYFR only at 0400-0900, and prolong 11530 until 2000 (gh)

MALAYSIA 6049.60, Suara Islam/Voice of Islam via RTM at 1530-1540 in vernacular has 10 minutes of a regularly scheduled Monday segment about higher education in Malaysia; talking about several colleges, especially "Universiti Pertahanan Nasional Malaysia, UPNM" (which is Malaysia's first college focusing on developing modern armed forces); included nice singing jingle with many verses of "Kuala Lumpur, Kuala Lumpur"; program started and ended with the singing "Malaysia" jingle; ID "Suara Islam, Kuala Lumpur"; fair. The next day, Suara Islam was off the air during post-1500 checks, and also missing the next day. But heard the program again three weeks later (Ron Howard, CA, DXLD)

I never heard more than a het from this beating against something closer to 6050.0, but on Feb 10 at 1400, finally timesignal and ID as R. Suara Islam – then no program heard after that (gh, OK) Until 1400 this frequency carries Asyik FM, heard the same day, 1400 changing to Suara Islam, but off at 1401 (Ron Howard, CA, DXLD)

MICRONESIA Pohnpei, The Cross Radio: still planning to return to SW 4755.

Per e-mail from Melinda R. Espinosa in Guam, they are still waiting for a technician (John Durham, Jan NZ DX Times)

MONGOLIA A new alternative frequency for VOM, including English at 1030-1100 and 1530-1600, is 9665, besides usual 12085. Look out for Korea North on 9666v (gh) Voice of Mongolia renewed website, English:

📻 www.vom.mn/en/ (Li Wang, China, via Takahito Akabayashi, Japan, DXLD)

MYANMAR 5985.0 at 1529-1545, signature indigenous instrumental music, "Good evening. This is Myanma Radio. We are calling with our second English transmission located on 5985 kHz. Now you can hear the news," activities of various government military leaders (e.g., Minister for Rail Transportation Major General Aung Min); weather; pep talk about national policy and development, always sounds like it's given over a loudspeaker (reverberation); played pop songs in English; would have been good reception except for splatter / QRM from adjacent station (Ron Howard, CA, DXLD)

NEPAL Following up last month's report about R. Nepal possibly reactivating on 5005: dead carrier several mornings between 2350 and 0140, similar signal to AIR stations. Ram Karki is the Technical Director for Radio Nepal; he and I worked together for the UN in Sudan. E-mail from him said they were broadcasting on FM, MW and 5005. But "it is very old Harris SW 100 transmitter and running on very low power. Perhaps you remember I asked your help to find the some manufacturer for about 50 kW Short wave transmitter." And later, "Regarding SW transmitter, I need to find the donors. Government is not funding us this time. We are not in priorities. So it may take long time." It seems that DXers will still have to wait a while more before a new shortwave transmitter is brought online in Nepal (Al Muick, Afghanistan, DXLD)

NIGERIA The Voice of Nigeria transmitting station in Abuja will be completed by the first quarter of 2009, according to Alhaji Abubakar Jijiwa, Director-General. Cost of the project, located in Lugbe on the airport road Abuja, has been put at 4.8 giganaira. The D-G said that on completion, it would produce the first radio station with capability to broadcast in digital and analog, within the SW bands. The new transmitters would expand international coverage, with capability of a rotating antenna that can target any country in the world when desired (VON via Scott Walker, Thorsten Hallmann, also via *Daily Triumph* via Mike Terry) Presumably the digital system is DRM, although VON is not presently listed as a DRM Consortium member at any level (Kim Andrew Elliott, kimandrewelliott.com)

PALESTINE [non?] Following the relays of Al Aqsa TV soundtrack on 5815 and 5835 kHz reported last month, a similar relay on 6220 from an unidentified source appeared January 31 around 1900 UT, first reported by (S. Hasegawa, Japan, NDXC, DXLD) It closed just before 1958 UT, leaving Europirate Mystery Radio in the clear; numerous references to Israel (Bryan Clark, New Zealand, *ibid.*) Then I heard it around 1910, mentioned viewers, so another TV audio track. Mauno Ritola from Finland sent me an audio file and I heard the ID, news from AlQuds network. AlQuds in Arabic means Jerusalem; that station transmits on the Atlantic Bird satellite, also on Badr sat (ex Arab sat). See

📻 www.qudstv.com/ based in Lebanon for a live stream and compare to the audio on 6220. The day after that, heard 6220 at 1610 with Al Quds TV news in the clear, probably starting at 1600. All of them gone by mid-Feb (Tarek Zeidan, Egypt, *WORLD OF RADIO*)

PAPUA NEW GUINEA The NBC website www.nbc.com.pg/tunein.htm and consequently WRTH 2009 exchanged two stations by mistake. 3905 is still R. New Ireland, Kavieng, and 3235 is R. West New Britain, Kimbe. Thanks to Thomas Nilsson of SWB, Sweden, spotting this. I heard 3905 same as a year before, New Ireland signing on at 1930 with a German folksong (Christoph Ratzler, Austria, DXLD) From 1885 until Aussies took over in WWI, New Ireland was in a German colony (gh)

POLAND [non] PRES, tentative A-09 English, 100 kW analog, u.o.s.: 1200-1300 7330 via Nauen, 5 degrees, 9525 via Wertachtal, 300 degrees 1700-1800 7265 via Wertachtal, DRM 40 kW, 300 degrees; 9555 via Issoudun, 25 degrees.

9555 might have a chance of making it to NAM, while 9525 may collide with Indonesia unless it has moved by then (gh)

ROMANIA RRI tentative A-09 English, 300 kW, many to NAM or to Eu at same azimuths:

0530-0600	7305 9655 15435 17770
1100-1200	11775 15210 15430 17730
1700-1800	9535 11735 [collides with ZANZIBAR]
2030-2100	9765 11810 11940 15465
2200-2300	7440 9675 9790 11940
0000-0100	9580 11790
0300-0400	6150 9645 9735 11895

North Americans expecting a breakfast broadcast at 1200 UT as last summer will have to get up an hour earlier, and hope for propagation (gh)

RUSSIA [non] VOR tentative A-09 relays via GUIANA FRENCH (gh): 2300-2400 11605, 250 kW, 180 degrees to SAm [Portuguese] 0000-0200 9810, 250 kW, 195 degrees to SAm [Spanish] 0100-0500 9735, 250 kW, 320 degrees to NAM [Russian, English]

SA'UDI ARABIA BSKSA, 15435, again in mid-Feb was having big buzz problems on the 15-18 UT transmission in Arabic; sounds like something frying, but so far the transmitter had not burned up. Schedule remains in A-09 (gh)

SERBIA International Radio Serbia enhanced its audio webstreaming. Instead of mono 64 kbps, mp3 steam is now stereo, 112 kbps:

📻 <http://74.53.35.106:12000/listen.pls> Capacity of 10,000 listeners! Or download mp3 at 128 kbps, 44 kHz stereo, updated once or twice a day, entire English show, 27.5 MB: [www.glassrbije.org/emisije/en-](http://www.glassrbije.org/emisije/en-gleska.mp3)

[gleska.mp3](http://www.gleska.mp3) (Dragan Lekic, Serbia, DXLD)

SPAIN Re COLOMBIA last month on 5555: Anker Petersen in Denmark was hearing something here from *2300 to 0157*, tentatively R. Juventud, but the frequency was precise, and an automatic time signal ran on the hour and half-hour. This made us suspect it was really a mixing product from Spain (gh) Identified! It is a spurious signal caused by two transmitters of R. Exterior de España in Noblejas, in Spanish at these hours to South America: 11680 - 6125 = 5555 kHz! (Anker Petersen, Denmark, DXLD)

SUDAN [non] Afia Darfur, the SW program financed by the U.S. State Department, uses standard Arabic, rather than the local dialect; not only is it not understood by the uneducated audience, but it offends them since that is used by their oppressors (gist of "Critics Say U.S. Radio Program For Darfur Goes Soft On Sudan" by Sheri Fink, ProPublica, www.propublica.org/article/critics-say-u.s.-radio-program-for-darfur-goes-soft-on-sudan-090202 via Paco Alameda, *WORLD OF RADIO*) Another legacy of the Bush regime, and bumbling efforts in USG external broadcast, failure to grasp the first thing about the target audience (gh)

SYRIA In early February, R. Damascus reactivated 12085, sporadically using it instead of or in addition to 9330 between 1600 and 2300; reports wanted (Kris Janssen, DXLD)

R. Damascus English announces in its mailbox program (heard online) that 12085 is targeting Europe and N. America while 9330 is for Australia, New Zealand and Japan (Sergei S., Moscow, *ibid.*)

12085 at 1822 in German, very good signal. I stopped listening because of the very low modulation; the talk was unreadable (Dragan Lekic, Serbia, *ibid.*) Same day, 12085 at 1855 German until French at 1900 with talk and Mid-east music. Abrupt sign off 1935*. Strong carrier level but slightly low modulation, loud hum and slight distortion (Brian Alexander, PA, *ibid.*)

THAILAND Since the flood on November 13, 2008, 6105 at 1100-1130, BBCWS in Burmese to Myanmar, has been via Udornthani, the IBB site instead of BBC site. Is the 49 mb antenna still kaput in Nakhon Sawan? Or a matter of propagation? Udorn Thani is 400 km further away from Myanmar (Wolfgang Büschel, BC-DX) Udorn may be at a more favorable skip distance, so why not? (gh)

R. Thailand, HSK9, tentative A-09 English (gh):

0000-0030	Saf 9640
0030-0100	ENAm 12120
0200-0230	ENAm 15275
0530-0600	Eu 17655
1230-1300	Au 9890
1400-1430	Au 9455
1900-2000	Eu 7570
2030-2045	Eu 9680

TURKEY VOT tentative A-09 English:

1230	15450, 15520
1830	9785
2030	7205
2200	9830
0300	5975, 6155, 7325-Canada

15520, 9830 and 6155 are notably new compared to A-08. 9830, 5975 and 7325 are for NAm, but 15450, 9785 for Eu also aimed USward (gh)

UAE Ran across English preaching on 12045 at 1422 from FEBA, Mondays only at 1400-1430 to S Asia; in A-09 on 12025 instead. I'd think the UA Emir would be in trouble with his Islamic brethren for broadcasting all this Infidel stuff... (gh)

UK BBC has been announcing the wrong frequencies for its 1330-1500 Bengali broadcasts since October, also wrong on their website. Repeated attempts to contact them and get this corrected were fruitless as of February; BBC bungling Bangla, shaking my faith in professional broadcasters (Dr Supratik Sanatani, West Bengal, DXLD)

USA After decades on the air and the expense of half a gigadollar, it remains unclear whether any Cubans listen to or watch U.S.-funded radio and television broadcasts to the island, according to a new congressional report on Radio and TV Martí.

Last year, fewer than 1 percent of people surveyed said they had listened to Radio Martí in the past week, said the study by the Government Accountability Office, the investigating arm of Congress. But the same report said nearly half of new Cuban arrivals to the United States said they had listened to the broadcasts in the past six months.

Pedro Roig, director of the Office of Cuba Broadcasting, questioned the listener surveys because even the pollsters acknowledged that Cubans who responded to survey calls believed the surveyor was a member of the Cuban government – and Radio Martí is illegal in Cuba (Denver *Post* via Zacharias Liangas, Greece, DXLD)

Reports from Congressional investigators state that gauging the audience for TV and Radio Martí is not an exact science, but their best guess is that less than 2% of Cubans have heard or seen the broadcasts in the past two years. This is, undoubtedly, in part due to Cuba's efforts to jam the signals, an operation the investigation finds the US has few details on (Miami *New Times* via Liangas, *ibid.*)

Cuban-Americans in Congress hope to preserve R. Martí at the expense of definitely closing TV Martí by May 20 (*Cubaperiodistas*, Cuba, via José Miguel Romero, Spain, DXLD) See also SUDAN [non]

Until the Next, Best of DX and 73 de Glenn!

BROADCAST LOGS

NOTEWORTHY LOGS FROM OUR READERS

Gayle Van Horn, W4GVH

gaylevanhorn@monitoringtimes.com

http://mt-shortwave.blogspot.com

0006 UTC on 4780

DJIBOUTI: RTV Djibouti. Arabic service running late or coming on early. Qu'ran recitations to '70s funk and African hi-life music. No ID observed during booming signal (Scott Barbour, Intervale, NH). 0410, Regional to pop music amid Arabic service. Poor signal on subsequent recheck 0439-0445 (Joe Wood Greenback, TN; Jim Evans, Germantown, TN). 4780, 2050-2102.* Arabic service to ID and national anthem to sign-off (Brian Alexander, Mechanicsburg, PA).

🔊 On demand audio www.rtd.dj

0300 UTC on 6160

CANADA: CKZU/CBC Radio One via Vancouver/Richmond. Local news and weather to "CBC Radio One on 88.1 FM and 690 AM." As it Happens program featuring topics on The Hague and on-going trial for Congolese militia leader (Ron Asilomar Beach, CA). CKZU 0702-0710 (Jim Evans, Germantown, TN). CFRX 6070, 2140. Skyway Traffic (Bob Fraser, Belfast, ME). NHK/Radio Japan via Sackville, Canada 6145, 0005 (Stewart Mackenzie, Huntington Beach, CA).

0302 UTC on 4930

BOTSWANA: Voice of America relay. Newscast with focus on Africa. Good signal despite CODAR interference. SINPO 33333; 4930, 0425-0435. VOA relays: São Tomé 4960, 0303-0310; 4960, 0435-0440; Thailand 7460, 2350-0000 (Evans). Radio Liberty via Thailand 7270. *1500 (John Wilkins, Wheat Ridge, CO). VOA Botswana 9600, 0505-0530* (Wood). VOA Philippines relay 15205, 2335 Indonesian (Mackenzie).

🔊 Streaming, on-demand audio www.voa.gov

0405 UTC on 11690

SOUTH AFRICA: Radio Okapi. Station ID as "Radio Oak-ka-pea." French mentions of Democratic Republic Congolese to Afro pops and possible jingle ID to rap music. Good signal despite interference observed under Okapi (Wood).

🔊 Streaming, on-demand audio www.radiookapi.net

0408 UTC on 4976

UGANDA: UBC. African news mix to native music bits at 0413. Signal poor against 3975 heterodyne from Peru (Barbour). 4975.9, 0412-0419. News and "Radio Uganda" ID. Poor signal barely above noise level (Evans).

0429 UTC on 4799.9

GUATEMALA: Radio Buenas Nuevas. Spanish talk segment to ID, frequency and closing announcements to 0432.* Good signal despite CODAR interference. SINPO 33333 (Evans). 4800, 0955 (Tancoo).

0434 UTC on 4905

BRAZIL: Rádio Anhanguera (Anhanguera). Portuguese news and ID. Braz pops faint but very clear signal (Wood). Rádio Nacional da Amazonia 11780, 1038 (Tancoo). Super Rádio Deus e Amour 9564.94, 0615-0705 // 0700-0702 on 11765, 6060 (Alexander).

0443 UTC on 5910

COLOMBIA: Radio Marfil Estereo. Latin pops and ballads to Spanish station ID at 0446, 0545 and 0500. Fair signal for this rare reception in my area (Wood). 5910, 0511-0535 (Evans). 5910, 0930 (Bruce Barker, Broomall, PA). LV de tu Conciencia 6009.95, 0515-0525 (Howard). 6010, 0534-0601 (Wood). 6010, 0942-1035 religious format to easy-listening music. Fair signal for references as "Conciencia." (Barbour). LV de Guaviare 6035, 1150-1250 (Dave Valko, PA/Cumbre DX).

0450 UTC on 4790

PERU: Radio Vision. Usual Spanish echo-effect religious programming to announcer's text. Moderate signal despite CODAR interference. SINPO 32232

🔊 Streaming audio www.visionradioperu.com Additional Peruvians in Spanish: Radio Tarma 4775, 2306-2321; La Voz de la Selva 4824, 2332-2337; Radio Huanta 2000, 4746.9, 2335-2345; Radio La Hora 4857.4, 2338-2345; Radio Cultural Amauta 4955, 2344-2350.

🔊 Streaming audio www.rca.es.vg (Evans). Radio Unión (presumed) 6114.97, 1038-1050

🔊 Streaming audio www.unionlaradio.com; Radio Huanta Dos Mil 4746.88, 1045-1055; Radio Tarma 4774.91, 1052-1100; Radio Cusco 6195.82, 1057-1105; Radio Sicuani (presumed) 4826.48, 1100-1105; Radio Maranon 4835.46, 1104 (Chuck Bolland, Clewiston, FL). Radio San Antonio 4939.96, 1104-1115 (Valko). Radio Vision 4790, 0040 (Robin Tancoo, Fyzabad, Trinidad & Tobago).

0550 UTC on 7335

RUSSIA: Voice of Russia. Presumed via Chita. Jazz music program to ID, frequency schedules and interval signal at 0558 (Wood). Tchiakovsky Musical Competition 6055, 1815 (Fraser). VOR 6240, 0215; 7120, 0146; 7330, 0045 (Tancoo). VOR 6115, 1046-1100 (Bolland).

0736 UTC on 5995

MALI: RTV Du Mali. Lengthy French text to announcements accompanied by string instruments at 0758. Flute interval signal at 0800, noting signal weak but readable (Barbour). Sign-on routine to ID and French segments to 0830 (Barker). 5995, 0745-0759.* French. 9635, *0800-0828. French/vernaculars (Alexander, Barker).

0730 UTC on 9575

MOROCCO: Radio Medi. French "canned" station promos to Arabic comments from announcer duo. Frequency steady against Aussie past 0830 (Barker).

🔊 Streaming, on-demand audio www.medi1.com RTV Marocaine 15345, 1640-1653 (Arabic) (Evans).

0740 UTC on 9541.54

SOLOMON ISLANDS: SIBC. Local morning programming to ads. "You are listening to SIBC." SINPO 33333 (Arnaldo Slaen, Buenos Aires, Argentina). Weak carrier only on 9541.43 observed in Denmark (Anker Petersen, Denmark). Website: www.sibconline.sb/. Mp3 attachment to sibcnews@solomin.com.sb (Joachim Thiel, A-DX/BC-DX). 9541.53, 0750-0855 (Alexander).

0850 UTC on 3339.98

HONDURAS: HRMI-Radio Misiones Internacionales. Spanish ID to religious program format. Radio Luz y Vida 3250.04, 0350-0400* Spanish (Alexander; Tancoo).

0930 UTC on 9690

NIGERIA: Voice of Nigeria. Listed as Hausa service. Items covering Nigeria to 1000. Station identification as "Voice of Nigeria-Lagos" into newscast. VON, Ikorodu 9690, 0804 (Hausa) (Barker). VON 7255, 2146-2201 (Barbour).

🔊 Streaming, on-demand audio www.voiceofnigeria.org Radio Nigeria, Kaduna 4770, 0603-0611 (Evans).

1005 UTC on 6134.80

BOLIVIA: Radio Santa Cruz. Observed music at tune-in to local time check and ID. Signal good until fading by 1046. Additional Bolivians in Spanish: Radio Mosoj Chaski 3310, 0944 (Tancoo) 3310, 1016-1035; Radio San Miguel 4699.4, 1031-1045; Radio Yura 4716.71, 1038-1055; Radio Fides 6155.24, 1042-1100 (Bolland).

🔊 Streaming audio www.radiofides.com; Radio Santa Cruz 6134.8, 2347-0000 (Evans).

1416 UTC on 6130

LAOS: Lao National Radio. English/Laotian language lesson program, New Dynamic English from Kathy and Max. Laotian programming at 1431 including Southeast Asian music. Signal fair with interference from PBS Xizang (Howard).

1759 UTC on 15344.50v

ARGENTINA: RAE. Tune-in to interval signal and time pips. "RAE" identifications to French programming. Signal fair and best in LSB to avoid heterodyne (Howard). 11710, 0102 (Tancoo).

🔊 Streaming audio www.radionacional.gov.ar

1823 UTC on 15190

PHILIPPINES: Radio Pilipinas. Tagalog/English program mix to 1830 identification. Signal poor with interference from weak Radio Africa (Howard). VOA, Tinang, Philippines relay 11610, 2240-2250, // 7250 weaker SINPO 33333. FEBC, Bocaue, Philippines relay (presumed) 9730, 2305-2315 (Evans).

1940 UTC on 6050

TURKEY: Voice of Turkey. Our Culture feature on the Turkish language. SIO 554 (Fraser). 6165, 0115-045; 7240 // 7325, 0430-0445 (T.J. Banks, Dallas, TX).

🔊 On-demand audio and video www.trt.net.tr/

2340 UTC on 6015

ROMANIA: Radio Romania International. Letterbox program. SIO 554 (Fraser). World of Culture 9610, 2208 (Tancoo).

🔊 On-demand audio www.rrri.ro

Additional loggings excluded for space constraints are posted as Blog Logs on the Shortwave Central Blog at the above web address.

Thanks to our contributors – Have you sent in YOUR logs?
Send to Gayle Van Horn, c/o Monitoring Times
English broadcast unless otherwise noted.

THE QSL REPORT

VERIFICATIONS RECEIVED BY OUR READERS

Gayle Van Horn, W4GVH

gaylevanhorn@monitoringtimes.com

QSL "Bytes"

Call it what you will...bites or "bytes" ... but it's become a phenomenon. In October, in addition to my daily shortwave postings at the *Shortwave Central* blog at <http://mt-shortwave.blogspot.com>, I began posting brief bites of short-wave news, updates, and QSL tips entitled *Shortwave Blog "Bytes."* Response has been phenomenal, and the obvious next step is to introduce *QSL "Bytes"* to our *MT* readers.

In addition to the usual QSL tips, I'll be including brief "bytes" covering QSL info, postal or email address updates, QSL policies, veri-signers, and general QSL news from amateur radio, clandestine, medium wave, pirate, utility and shortwave broadcast stations. Suggestions, comments and questions are always welcome to the Brasstown postal or my email address.

Now on to this month's "Bytes."

Addis Dimts Radio, clandestine relaying from Samara, Russia verified an electronic report in 13 minutes. The veri-signer, Abehe-Host and Producer, responded via his iPhone for program details to abelewd@yahoo.com (Rich D'Angelo/DSWCI-DX Window 369)

Bolivia's Radio Causachun Coca, E-QSL from Manuel Andrée radiokawsachuncoca@gmail.com Blog spot <http://radiokawsachuncoca.blogspot.com/> (DSWCI-DX Window 369)

Correspondence for testing from Amhara Regional State Radio (6090, 7264, 9740; 0300-0600, 0900-1100, 1400-1700 UTC) are announced as ammawebmaster@yahoo.com (DSWCI-DX News)

Democratic Voice of Burma relay from Wertachtal, Germany 9490 kHz. Media Broadcast scenery E-QSL card in two months for report to Michael Puetz, Frequency Manager michael.puetz@media-broadcast.com (T.J. Banks, Dallas, TX)

Europirate, Free Radio Service Holland, 6220 kHz. Full data E-QSL in two days from Peter V. frs.holland@hccnet.nl (playdx2003)

Electronic reports to Uganda's Dunamis Broadcasting via High Adventure Gospel Communications Ministries, may be sent to dunamis@4.750@hotmail.com

Radio Dabanga, part of the Radio Darfur Network (7315, 13800 kHz) via Wertachtal, Germany contact person is Leon Willems-Network Manager, Radio Darfur Network, Press Now. willems@pressnow.nl. Postal address: Press Now, Witte Kruslaan 55, 1217 AM Hilversum, The Netherlands. The station is a project of the Radio Darfur Network, a coalition of Sudanese journalists and international development organizations. (Rich D'Angelo/DSWCI-DX Mirror)

Radio Taiwan International is offering a set of 12 different QSL cards featuring orchids in color. Post program details at: <http://english.rti.org.tw/customerservice/ReceptionForm.aspx> or postal P.O. Box 123-199, Taipei 11 199 Taiwan, Republic of China. (DSWCI-DX News).

Reception reports for broadcast from HCJB Australia: The Voice of the Great South Land, GPO 691, Melbourne, Australia 3001. Email english@hcjb.org.au

Solomon Island's SIBC in Honiara, verified via E-QSL for 9542.54 kHz (see April Broadcast Logs). The mp-3 file attachment to: sibcnews@solomon.com.sb, replied by Nilortavo [Nilortavo@yahoo.com.au](mailto:nilortavo@yahoo.com.au) (Joachim Thiel, Germany/A-DX, BC-DX)

Suriname's Radio Apintie E-QSL in two days for reception report to apintie@sr.sr

Streaming audio www.apintie.sr (Rod Pearson, St Augustine, FL). Reception reports to China's Voice of the Strait, should be sent to Box 187, Voice of Strait, Fuzhou, Fujian, 350012 People's Republic of China, or posted at www.vos.com.cn/ (Ron Howard, Asilomar Beach, CA)

Transmitter Documentation Project (TDP) www.tdp.info has added another station to their expanding list of stations operating as a brokered broadcaster. Radio Bilal in Amharic on 9610, 1700-1800 UTC. Electronic reporting may be sent to info@transmitter.org or Transmitter Documentation Project (TDP), Attention: Ludo Maesus-Managing Director, P.O. Box 1, B-2310 Rijkvorsel, Belgium. (DX Mix News).

CHILE

CVC La Voz 17680 kHz. Full data antenna/console card unsigned. Received in 42 days for CD report and \$1.00. Station address: Casilla 395, Talagante, Santiago, Chile. (Harold Woering, Easthampton, MA) Email ondacorta@cvclavoz.cl

Streaming audio www.cvclavoz.cl



for Jülich, Germany complex via Michael Puetz. Received in four months. (See above Media Broadcast email address) (Frank Hillton, SC).

LIBYA

Voice of Africa. 17725, 21695 kHz. Partial data card in Arabic featuring *Sebratah Theater*. Received in 184 days for program details on station's report form. QSL address: P.O. Box 4677, Soug al Jama, Tripoli, Libya (Joe Wood, Greenback, TN). No data card, *Welcome to Libya...Land of Hospitality*. Reception report form enclosed, will use it in hopes of a full data card (Woering).

MEDIUM WAVE

KCKK, 1510 AM kHz. Littleton, CO. *Mile High Sports*. Nice packet of goodies from radio DXer Patrick Griffith-Broadcast Engineer, including full data QSL card, verification letterhead, Denver postcard and *Mile High Sports* magazine. QSL address: NRC Broadcasting, 1201 18th Street, Suite 200, Denver CO 80202 USA (Patrick Martin, Seaside, OR).

MOLDOVA

Deutsche Welle via Grigoriopol relay 9380 kHz. Full data *100 Jahre Nauen* card. Received in 18 days for report to Customer Service, D-53110 Bonn, Germany (Wendel Craighead, Prairie Village, KS).

UTILITY

LowFER Beacon XR, 184.322 operating in

QRSS-60 CW.

Station log reported to www.lwca.org/mb/index.html.

Screen capture of beacon traffic via Argo software

sent to beacon operator "Andy." Received full data "XR" card in eight days (Jim Mc Calanahan WA4JBM, Bowdon Junction, GA).

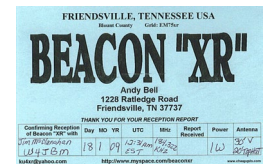

USA

WHRA Greenbush, ME 17690. Full data *20 Years of Shortwave Ministry* card signed by "LWV.". Received in seven months for program *Ragseedsleewa*. Although this presumed Arabic service program may be a democracy-type broadcast, it could also be a religious program. Address announced as; P.O. Box 6007, Milton, TN 37118 USA. QSL address: World Harvest Radio, P.O. 12, South Bend, IN 46624. (Craighead) (or) LeSEA Broadcasting, 61300 Ironwood Road, South Bend, IN 46614 USA

Streaming audio www.vhr.org
WRNO 7505 kHz. Full data station scenery card, unsigned. Received in 11 days for an English report and \$1.00. QSL address: P.O. Box 895, Ft. Worth, TX 76101 USA (Bill Wilkins, Springfield, MO).

Additional QSL contributions excluded for space constraints are posted at the *Shortwave Central* blog at <http://mt-shortwave.blogspot.com>



HOW TO USE THE SHORTWAVE GUIDE

0000-0100 twhfa USA, Voice of America 5995am 6130ca 7405am 9455af
 ① ② ⑤ ③ ④ ⑥ ⑦

Convert your time to UTC.

Broadcast time on ① and time off ② are expressed in Coordinated Universal Time (UTC) – the time at the 0 meridian near Greenwich, England. To translate your local time into UTC, first convert your local time to 24-hour format, then add (during Daylight Time) 4, 5, 6 or 7 hours for Eastern, Central, Mountain or Pacific Times, respectively. Eastern, Central, and Pacific Times are already converted to UTC for you at the top of each hour.

Note that all dates, as well as times, are in UTC; for example, a show which might air at 0030 UTC Sunday will be heard on Saturday evening in America (in other words, 8:30 pm Eastern, 7:30 pm Central, etc.).

Find the station you want to hear.

Look at the page which corresponds to the time you will be listening. English broadcasts are listed by UTC time on ①, then alphabetically by country ③, followed by the station name ④. (If the station name is the same as the country, we don't repeat it, e.g., "Vanuatu, Radio" [Vanuatu].)

If a broadcast is not daily, the days of broadcast ⑤ will appear in the column following the time of broadcast, using the following codes:

Codes	
s/Sun	Sunday
m/Mon	Monday
t	Tuesday
w	Wednesday
h	Thursday
f	Friday
a/Sat	Saturday
occ:	occasional
DRM:	Digital Radio Mondiale
irreg	Irregular broadcasts
vl	Various languages
USB:	Upper Sideband

Choose the most promising frequencies for the time, location and conditions.

The frequencies ⑥ follow to the right of the station listing; all frequencies are listed in kilohertz (kHz). Not all listed stations will be heard from your location and virtually none of them will be heard all the time on all frequencies.

Shortwave broadcast stations change some of their frequencies at least twice a year, in April and October, to adapt to seasonal conditions. But they can also change in response to short-term conditions, interference, equipment problems, etc. Our frequency manager coordinates published station schedules with confirmations and reports from her monitoring team and MT readers to make the Shortwave Guide up-to-date as of one week before

print deadline.

To help you find the most promising signal for your location, immediately following each frequency we've included information on the target area ⑦ of the broadcast. Signals beamed toward your area will generally be easier to hear than those beamed elsewhere, even though the latter will often still be audible.

Target Areas

- af: Africa
- al: alternate frequency (occasional use only)
- am: The Americas
- as: Asia
- ca: Central America
- do: domestic broadcast
- eu: Europe
- me: Middle East
- na: North America
- pa: Pacific
- sa: South America
- va: various

Mode used by all stations in this guide is AM unless otherwise indicated.

MT MONITORING TEAM

Gayle Van Horn
 Frequency Manager

gaylevanhorn@monitoringtimes.com

Larry Van Horn, MT Asst. Editor

larryvanhorn@monitoringtimes.com

Thank You ...

Additional Contributors to This Month's Shortwave Guide:

Rich D' Angelo/NASWA Flash Sheet, NASWA Journal; Arnie Coro/R Havana; Alokesh Gupta, New Delhi, India; Ivo Ivanov; Bulgaria; Frank Hillton, Charleston, SC; Jose Jacob, India; Dave Kenny, UK; Daniel Sampson, Ernest Riley/PTSW; Harold Sellers, Canada/ODXA, DX Listening-In; Tom Taylor, UK; Sam Wright, Biloxi, MS; Wolfgang Büeschel, Germany/WWDXC BC DX, Top News; AOKI; Ardic DX Club; Cumbre DX; DX Asia; British DX Club; EIBI; HFCC; Hard-Core DX; DX Mix News; World DX Club/Contact.

Shortwave Broadcast Bands

kHz	Meters
2300-2495	120 meters (Note 1)
3200-3400	90 meters (Note 1)
3900-3950	75 meters (Regional band, used for broadcasting in Asia only)
3950-4000	75 meters (Regional band, used for broadcasting in Asia and Europe)
4750-4995	60 meters (Note 1)
5005-5060	60 meters (Note 1)
5730-5900	49 meter NIB (Note 2)
5900-5950	49 meter WARC-92 band (Note 3)
5950-6200	49 meters
6200-6295	49 meter NIB (Note 2)
6890-6990	41 meter NIB (Note 2)
7100-7300	41 meters (Regional band, not allocated for broadcasting in the western hemisphere) (Note 4)
7300-7350	41 meter WARC-92 band (Note 3)
7350-7600	41 meter NIB (Note 2)
9250-9400	31 meter NIB (Note 2)
9400-9500	31 meter WARC-92 band (Note 3)
9500-9900	31 meters
11500-11600	25 meter NIB (Note 2)
11600-11650	25 meter WARC-92 band (Note 3)
11650-12050	25 meters
12050-12100	25 meter WARC-92 band (Note 3)
12100-12600	25 meter NIB (Note 2)
13570-13600	22 meter WARC-92 band (Note 3)
13600-13800	22 meters
13800-13870	22 meter WARC-92 band (Note 3)
15030-15100	19 meter NIB (Note 2)
15100-15600	19 meters
15600-15800	19 meter WARC-92 band (Note 3)
17480-17550	17 meter WARC-92 band (Note 3)
17550-17900	17 meters
18900-19020	15 meter WARC-92 band (Note 3)
21450-21850	13 meters
25670-26100	11 meters

Notes

- Note 1 Tropical bands, 120/90/60 meters are for broadcast use only in designated tropical areas of the world.
- Note 2 Broadcasters can use this frequency range on a (NIB) non-interference basis only.
- Note 3 WARC-92 bands are allocated officially for use by HF broadcasting stations in 2007
- Note 4 WRC-03 update. After March 29, 2009, the spectrum from 7100-7200 kHz will no longer be available for broadcast purposes and will be turned over to amateur radio operations worldwide

**GLENN HAUSER'S
 WORLD OF RADIO**
<http://www.worldofradio.com>

For the latest DX and programming news, amateur nets, DX program schedules, audio archives and much more!

0000 UTC - 8PM EDT / 7PM CDT / 5PM PDT

0000	0000	UK, BBC World Service	5970as	6195as	
		7105as	9410as	9740as	15335as
		15360as	17615as		
0000	0004	Canada, R Canada International		9755na	
0000	0020	Japan, NHK World Radio Japan		6110na	
		6120na	6145na	11705na	13650as
		17810as			
0000	0020	DRM Japan, NHK World Radio Japan		5920eu	
0000	0030	Australia, HCJB Global	15410as	15525as	
0000	0030	Egypt, Radio Cairo	6850na		
0000	0030	Thailand, Radio Thailand World Svc		9680na	
		12095na			
0000	0030	USA, Voice of America	7405as		
0000	0045	India, All India Radio	9705as	9950as	
		11620as	11645as	13605as	
0000	0045	USA, WYFR/Family Radio Worldwide		6085na	
0000	0057	Canada, R Canada International		9800as	
0000	0057	China, China Radio International		6020na	
		6075as	6180as	7130eu	7350eu
		9425as	9570as	11650as	11790as
		11885as			
0000	0057	Germany, Deutsche Welle	7265as		
0000	0058	Germany, Deutsche Welle	9785as		
0000	0100	Anguilla, Worldwide Univ Network		6090am	
0000	0100	Australia, ABC NT Alice Springs		2310do	
		4835do			
0000	0100	Australia, ABC NT Katherine	5025do		
0000	0100	Australia, ABC NT Tennant Creek		4910do	
0000	0100	Australia, Radio Australia	9660as	12080as	
		13690as	15240pa	17715as	17750va
		17775va	17795va		
0000	0100	Bulgaria, Radio Bulgaria	5900na	7400na	
0000	0100	Canada, CFRX Toronto ON	6070na		
0000	0100	Canada, CFVP Calgary AB	6030na		
0000	0100	Canada, CKZN St John's NF	6160na		
0000	0100	Canada, CKZU Vancouver BC	6160na		
0000	0100	Costa Rica, Worldwide Univ Network		7325va	
		9725va			
0000	0100	Germany, Deutsche Welle	15595as		
0000	0100	Guyana, Voice of Guyana	3291do		
0000	0100	Malaysia, RTM/Traxx FM	7295as		
0000	0100	DRM New Zealand, Radio NZ International		17675pa	
0000	0100	New Zealand, Radio NZ International		15720pa	
0000	0100	vi Papua New Guinea, Wantok R. Light		7325va	
0000	0100	Spain, Radio Exterior Espana	6055na		
0000	0100	USA, American Forces Network		4319usb	
		5446usb	5765usb	6350usb	7811usb
		10320usb	12132usb	13362usb	
0000	0100	USA, WBCQ Monticello ME	5110am		
0000	0100	mffas USA, WBCQ Monticello ME	7415am		
0000	0100	USA, WBOH Newport NC	5920am		
0000	0100	USA, WEWN Vandiver AL	11520af		
0000	0100	USA, WHRA Greenbush ME	5850eu		
0000	0100	USA, WHRI Cypress Creek SC	5875na	7315sa	
		7385na			
0000	0100	USA, WINB Red Lion PA	9265am		
0000	0100	USA, WRMI Miami FL	9955am		
0000	0100	USA, WTJC Newport NC	9370na		
0000	0100	USA, WWCR Nashville TN	5070na	7465na	
		9980na			
0000	0100	USA, WWRB Manchester TN	3185va	5050na	
		5745va	6890va		
0000	0100	USA, WYFR/Family Radio Worldwide		5950na	
		9505na	11720sa	15440am	
0000	0100	Zambia CVC/ The Voice Africa	4965af		
0005	0100	Canada, R Canada International		9755na	
0005	0100	Mon Greece, Voice of Greece	7475eu	9420eu	
0030	0045	Sun Germany, Pan American BC	9640as		
0030	0100	Australia, Radio Australia	15415as		
0030	0100	China, China Radio International		11730as	
0030	0100	fas UK, Bible Voice BC	6030as		
0030	0100	USA, Voice of America	7405va	9325va	
		9620va	9715va	11695va	12005va
		15185va	15205va	15290va	
0030	0100	Uzbekistan, CVC International	7395as		

0100 UTC - 9PM EDT / 8PM CDT / 6PM PDT

0100	0104	Canada, R Canada International		9755na	
0100	0125	Vietnam, Voice of Vietnam	6175na		
0100	0127	China, China Radio International		11730as	
0100	0127	Czech Rep, Radio Prague	6200na	7345na	
0100	0127	Slovakia, R Slovakia International		7230na	
		9440sa			
0100	0128	mtwhfa Serbia, Intl Radio Serbia	6185na	6190al	

0100	0130	Australia, Radio Australia	9660as	12080as	
		13690as	15240pa	17715as	17750va
		17775va	17795va		
0100	0155	Turkey, Voice of Turkey	6165am		
0100	0156	Romania, R Romania International		6145na	
		9515na			
0100	0157	DRM China, China Radio International		6080na	
0100	0157	China, China Radio International		6005na	
		6020na	6075as	7180as	7350 ey
		9410na	9570na	9580as	11650as
		11885as			
0100	0158	DRM New Zealand, Radio NZ International		17675pa	
0100	0159	Canada, R Canada International		5840va	
		6165as	7255as		
0100	0200	Anguilla, Worldwide Univ Network		6090am	
0100	0200	Australia, ABC NT Katherine	5025do		
0100	0200	Australia, ABC NT Tennant Creek		4910do	
0100	0200	Australia, HCJB Global	15410as		
0100	0200	Canada, CFRX Toronto ON	6070na		
0100	0200	Canada, CFVP Calgary AB	6030na		
0100	0200	Canada, CKZN St John's NF	6160na		
0100	0200	Canada, CKZU Vancouver BC	6160na		
0100	0200	Costa Rica, Worldwide Univ Network		7325va	
		9725va			
0100	0200	Cuba, Radio Havana Cuba	6000na	6060na	
		6140na			
0100	0200	Guyana, Voice of Guyana	3291do		
0100	0200	Malaysia, RTM/Traxx FM	7295as		
0100	0200	New Zealand, Radio NZ International		15720pa	
0100	0200	North Korea, Voice of Korea	7140as	9345as	
		9730as	11735am	13760am	15180am
0100	0200	Palau, T8WH/World Harvest	15680as		
0100	0200	vi Papua New Guinea, Wantok R. Light		7325va	
0100	0200	Sri Lanka, SLBC	6005as	9770as	15745as
0100	0200	Taiwan, R Taiwan International	11875as		
0100	0200	UK, BBC World Service	5940va	5970as	
		9410as	7105as	7410me	11750as
		11955as	15310as	15335as	15360as
		17615as			
0100	0200	Ukraine, R Ukraine International		7440na	
0100	0200	USA, American Forces Network		4319usb	
		5446usb	5765usb	6350usb	7811usb
		10320usb	12133usb	13362usb	
0100	0200	USA, Voice of America	7325va	9435va	
		11705va			
0100	0200	USA, WBCQ Monticello ME	5110am		
0100	0200	USA, WBCQ Monticello ME	7415am		
0100	0200	USA, WBOH Newport NC	5920am		
0100	0200	USA, WEWN Vandiver AL	11520af		
0100	0200	USA, WHRA Greenbush ME	5850eu		
0100	0200	USA, WHRI Cypress Creek SC	5875na	7315sa	
		7385na			
0100	0200	USA, WINB Red Lion PA	9265am		
0100	0200	USA, WRMI Miami FL	9955am		
0100	0200	USA, WTJC Newport NC	9370na		
0100	0200	USA, WWCR Nashville TN	5070na	7465na	
		9980na			
0100	0200	USA, WWRB Manchester TN	3185va	5050na	
		5745va	6890va		
0100	0200	USA, WYFR/Family Radio Worldwide		5950na	
		7455na	9505na	15195as	15440am
0100	0200	Uzbekistan, CVC International	7395as		
0100	0200	Zambia CVC/ The Voice Africa	4965af		
0105	0200	twhfa Canada, R Canada International		9755na	
0130	0145	twhfas Albania, Radio Tirana	7425na		
0130	0200	Australia, Radio Australia	9660as	12080as	
		13690as	15240pa	15415as	17715as
		17750va	17795va		
0130	0200	Iran, VOIRI/IRIB	6120na	7160na	
0130	0200	twhfa USA, Voice of America	5960va	7405va	
0145	0200	Mon/Sat United Arab Emirates, FEBA	6140af		

0200 UTC - 10PM EDT / 9PM CDT / 7PM PDT

0200	0204	twhfa Canada, R Canada International		9755na	
0200	0227	Czech Rep, Radio Prague	6200na	7345na	
0200	0227	Iran, VOIRI/IRIB	6120na	7160na	
0200	0228	Serbia, Intl Radio Serbia	6185na	6190al	
0200	0230	Uzbekistan, CVC International	7395as		
0200	0257	China, China Radio International		11770as	
		13640as			
0200	0258	Sun Lithuania, Mighty KBC Radio	6110na		
0200	0300	Anguilla, Worldwide Univ Network		6090am	
0200	0300	mtwhf Argentina, RAE	11710va		
0200	0300	Australia, ABC NT Alice Springs		2310do	
		4835do			
0200	0300	Australia, ABC NT Katherine	5025do		
0200	0300	Australia, ABC NT Tennant Creek		4910do	

0200	0300	Australia, HCJB Global	15410as	
0200	0300	Australia, Radio Australia	9660as 12080as	
		13690as 15240pa 15415as 15515as		
		17750va 21725va		
0200	0300	Canada, CFRX Toronto ON	6070na	
0200	0300	Canada, CFVP Calgary AB	6030na	
0200	0300	Canada, CKZN St John's NF	6160na	
0200	0300	Canada, CKZU Vancouver BC	6160na	
0200	0300	Costa Rica, Worldwide Univ Network	7325va	
		9725va		
0200	0300	Cuba, Radio Havana Cuba	6000na 6060na	
		6140na		
0200	0300	Egypt, Radio Cairo	7535na	
0200	0300	Guyana, Voice of Guyana	3291do	
0200	0300	Indonesia, Voice of Indonesia	9526va 11784al	
0200	0300	Malaysia, RTM/Traxx FM	7295as	
0200	0300	DRM New Zealand, Radio NZ International	17675pa	
0200	0300	New Zealand, Radio NZ International	15720pa	
0200	0300	North Korea, Voice of Korea	13650as 15100as	
0200	0300	Palau, T8WH/World Harvest	15680as	
0200	0300	vi Papua New Guinea, Wantok R. Light	7325va	
0200	0300	Philippines, Radyo Pilipinas	11880va 15285va	
		17710va		
0200	0300	Russia, Voice of Russia	6100na 6240na	
		7250na 12040na 13735na		
0200	0300	South Korea, KBS World Radio	9580sa	
0200	0300	Sri Lanka, SLBC	6005as 9770as 15745as	
0200	0300	Taiwan, R Taiwan International	5950na	
0200	0300	Thailand, Radio Thailand World Svc	15275na	
0200	0300	UK, BBC World Service	6005af 6195me	
		15310as		
0200	0300	USA, American Forces Network	4319usb	
		5446usb 5765usb 6350usb 7811usb		
		10320usb 12133usb 13362usb		
0200	0300	USA, KJES Vado NM	7555na	
0200	0300	USA, KJES Vado NM	7555na	
0200	0300	smt USA, WBCQ Monticello ME	7415am	
0200	0300	m USA, WBCQ Monticello ME	5110am	
0200	0300	USA, WBOH Newport NC	5920am	
0200	0300	USA, WEWN Vandiver AL	11520af	
0200	0300	USA, WHRA Greenbush ME	5850eu	
0200	0300	USA, WHRI Cypress Creek SC	5875na 7315sa	
		7490na		
0200	0300	USA, WINB Red Lion PA	9265am	
0200	0300	USA, WRMI Miami FL	9955am	
0200	0300	USA, WTJC Newport NC	9370na	
0200	0300	USA, WWCR Nashville TN	3215na 5070na	
		5890na		
0200	0300	USA, WWRB Manchester TN	3185va 5050na	
		5745va 6890va		
0200	0300	USA, WYFR/Family Radio Worldwide	5985sa	
		7455na 9505na 9525am 11855sa		
0215	0230	Nepal, Radio Nepal	5005as	
0230	0255	Vietnam, Voice of Vietnam	6175ca	
0230	0257	China, China Radio International	15435me	
0230	0300	Malaysia, RTM/Voice of Malaysia	15295pa	
0230	0300	Netherlands, R Netherlands Worldwide	11550as	
0230	0300	South Korea, KBS World Radio	9560na	
0230	0300	Sweden, Radio Sweden	6010na 11550va	
0230	0300	Uzbekistan, CVC International	11650as	
0245	0300	Albania, Radio Tirana	7390na	
0245	0300	Myanmar, Myanma Radio	9731do	
0250	0300	Vatican City, Vatican Radio	6040am 7305na	
0255	0300	vi Rwanda, Radio Rwanda	6055do	

0300 UTC - 11PM EDT / 10PM CDT / 8PM PDT

0300	0320	Vatican City, Vatican Radio	6040am 7305na	
0300	0330	Egypt, Radio Cairo	7535na	
0300	0330	Myanmar, Myanma Radio	9731do	
0300	0330	Philippines, Radyo Pilipinas	11880va 15285va	
		17710va		
0300	0330	Sri Lanka, SLBC	6005as 9770as 15745as	
0300	0330	USA, KJES Vado NM	7555na	
0300	0330	Vatican City, Vatican Radio	7360af 9660af	
0300	0357	China, China Radio International	6190na	
		9460as 9690na 11770as 13620as		
		15110as 15120as		
0300	0358	Germany, Deutsche Welle	9800as	
0300	0359	Germany, Deutsche Welle	13810as	
0300	0400	Anguilla, Worldwide Univ Network	6090am	
0300	0400	Australia, ABC NT Alice Springs	2310do	
		4835do		
0300	0400	Australia, ABC NT Katherine	5025do	
0300	0400	Australia, ABC NT Tennant Creek	4910do	
0300	0400	Australia, Radio Australia	9660as 12080as	
		13690as 15240pa 15415as 15515as		
		17750va 21725va		

0300	0400	Bulgaria, Radio Bulgaria	5900na 7400na	
0300	0400	Canada, CBC NQ SW Service	9625na	
0300	0400	Canada, CFRX Toronto ON	6070na	
0300	0400	Canada, CFVP Calgary AB	6030na	
0300	0400	Canada, CKZN St John's NF	6160na	
0300	0400	Canada, CKZU Vancouver BC	6160na	
0300	0400	Costa Rica, Worldwide Univ Network	7325va	
		9725va		
0300	0400	Cuba, Radio Havana Cuba	6000na 6060na	
		6140na		
0300	0400	Guyana, Voice of Guyana	3291do	
0300	0400	Malaysia, RTM/Traxx FM	7295as	
0300	0400	Malaysia, RTM/Voice of Malaysia	6175as	
		9750as 15295as		
0300	0400	New Zealand, Radio NZ International	15720pa	
0300	0400	DRM New Zealand, Radio NZ International	17675pa	
0300	0400	North Korea, Voice of Korea	7140as 9345as	
		9730as		
0300	0400	Oman, Radio Oman	15355as	
0300	0400	Palau, T8WH/World Harvest	15680as	
0300	0400	vi Papua New Guinea, Wantok R. Light	7325va	
0300	0400	Russia, Voice of Russia	6100na 6155na	
		6240na 7340na 7350na 12040na		
		13735na		
0300	0400	vi Rwanda, Radio Rwanda	6055do	
0300	0400	South Africa, Channel Africa	3345af 7390af	
0300	0400	Taiwan, R Taiwan International	5950na 15215sa	
		15320as		
0300	0400	UK, BBC World Service	3255af 6005af	
		6145af 6190af 6195me 6245af		
		7255af 7375af 9410me 9750af		
		11760va 15310as 17790as		
0300	0400	USA, American Forces Network	4319usb	
		5446usb 5765usb 6350usb 7811usb		
		10320usb 12133usb 13362usb		
0300	0400	USA, Voice of America	4930af 6080af	
		9885af 15580af		
0300	0400	USA, WBCQ Monticello ME	7415am	
0300	0400	m USA, WBCQ Monticello ME	5110am	
0300	0400	USA, WBCQ Monticello ME	9330am	
0300	0400	USA, WBOH Newport NC	5920am	
0300	0400	USA, WEWN Vandiver AL	9455af	
0300	0400	USA, WHRA Greenbush ME	5850eu	
0300	0400	USA, WHRI Cypress Creek SC	5875na 7315sa	
		7385va		
0300	0400	USA, WRMI Miami FL	9955am	
0300	0400	USA, WTJC Newport NC	9370na	
0300	0400	USA, WWCR Nashville TN	3215na 5070na	
		5890na		
0300	0400	USA, WWRB Manchester TN	3185va 5050na	
		5745va 6890va		
0300	0400	USA, WYFR/Family Radio Worldwide	7455na	
		9505na 9985sa 13615sa		
0300	0400	Uzbekistan, CVC International	11650as	
0300	0400	Zambia CVC/ The Voice Africa	4965af	
0330	0355	Vietnam, Voice of Vietnam	6175na	
0330	0400	Albania, Radio Tirana	6110na	
0330	0400	Sweden, Radio Sweden	6010na	
0330	0400	UK, BBC World Service	11945af	

0400 UTC - 12AM EDT / 11PM CDT / 9PM PDT

0400	0427	Czech Rep, Radio Prague	6080na 6200na	
		7345na		
0400	0430	Australia, Radio Australia	9660as 12080as	
		13690as 15240pa 15515as 17750va		
		21725va		
0400	0430	mtwhf France, Radio France International	7315af	
		9805af		
0400	0430	Netherlands, R Netherlands Worldwide	9575af	
0400	0430	Uzbekistan, CVC International	11650as	
0400	0445	USA, WYFR/Family Radio Worldwide	7455na	
		9505na		
0400	0455	Turkey, Voice of Turkey	6020am 7240va	
		7325na		
0400	0456	Romania, R Romania International	6115na	
		9515na 9690as 11895as		
0400	0457	China, China Radio International	6190na	
		9590as 13650as 15120as 17725as		
0400	0457	Germany, Deutsche Welle	5945af	
0400	0458	Germany, Deutsche Welle	15600af	
0400	0458	DRM New Zealand, Radio NZ International	15720pa	
0400	0459	New Zealand, Radio NZ International	17675pa	
0400	0459	Germany, Deutsche Welle	5905af	
0400	0500	Anguilla, Worldwide Univ Network	6090am	
0400	0500	Australia, ABC NT Alice Springs	2310do	
		4835do		
0400	0500	Australia, ABC NT Katherine	5025do	

0400	0500		Australia, ABC NT Tennant Creek	4910do
0400	0500	twhf	Canada, CBC NQ SW Service	9625na
0400	0500		Canada, CFRX Toronto ON	6070na
0400	0500		Canada, CKZN St John's NF	6160na
0400	0500		Canada, CKZU Vancouver BC	6160na
0400	0500		Costa Rica, Worldwide Univ Network	7325va
			9725va	
0400	0500		Cuba, Radio Havana Cuba	6000na
			6140na	6060na
0400	0500		Germany, Deutsche Welle	6180af
0400	0500		Guyana, Voice of Guyana	3291do
0400	0500		Malaysia, RTM/Traxx FM	7295as
0400	0500		Malaysia, RTM/Voice of Malaysia	6175as
			9750as	15295as
0400	0500		Netherlands, R Netherlands Worldwide	12080af
0400	0500		Palau, T8WH/World Harvest	15680as
0400	0500	vl	Papua New Guinea, Wantok R. Light	7325va
0400	0500		Russia, Voice of Russia	6135na
			6240na	7335na
			9855na	12030na
			7250na	9840na
0400	0500	DRM	Russia, Voice of Russia	15735as
0400	0500	vl	Rwanda, Radio Rwanda	6055do
0400	0500		South Africa, Channel Africa	7230af
0400	0500	vl	Uganda, UBC Radio	4976do
0400	0500		UK, BBC World Service	3255af
			6005af	6190af
			9650af	11945af
			15360me	17790as
			7255af	9410me
			12035af	15310as
0400	0500		Ukraine, R Ukraine International	7440eu
0400	0500		USA, American Forces Network	4319usb
			5446usb	5765usb
			10320usb	12133usb
0400	0500		USA, Voice of America	4930af
			6080af	9885af
				15580af
0400	0500	stwhfa	USA, WBCQ Monticello ME	7415am
0400	0500		USA, WBCQ Monticello ME	9330am
0400	0500		USA, WBOH Newport NC	5920am
0400	0500		USA, WEWN Vandiver AL	9455af
0400	0500		USA, WHRA Greenbush ME	5850eu
0400	0500		USA, WHRI Cypress Creek SC	5875na
			7385va	7315sa
0400	0500		USA, WRMI Miami FL	9955am
0400	0500		USA, WTJC Newport NC	9370na
0400	0500		USA, WWCR Nashville TN	3215na
			5890na	5070na
0400	0500		USA, WWRB Manchester TN	3185va
			5745va	6890va
0400	0500		USA, WYFR/Family Radio Worldwide	5950am
			6915na	9680na
0400	0500		Zambia CVC/ The Voice Africa	4965af
0430	0457		Czech Rep, Radio Prague	9855af
0430	0500	twhf	Albania, Radio Tirana	6100na
0430	0500		Australia, Radio Australia	9660as
			13690as	15240pa
			17750va	21725va
0430	0500		Nigeria, Radio Nigeria/Kaduna	6090do
0430	0500	mtwhf	Swaziland, TWR	3200af
0430	0500		Uzbekistan, CVC International	155610as
0459	0500		New Zealand, Radio NZ International	11725pa
0459	0500	DRM	New Zealand, Radio NZ International	11675pa

0500 UTC - 1AM EDT / 12AM CDT / 10PM PDT

0500	0507	twhf	Canada, CBC NQ SW Service	9625na
0500	0530		Australia, Radio Australia	9660as
			13690as	15160as
			17750va	15240pa
0500	0530	mtwhf	France, Radio France International	9805af
			11995af	
0500	0530		Germany, Deutsche Welle	6180af
			9755af	12045af
			15600af	7285af
0500	0530		Japan, NHK World Radio Japan	5975eu
			6110na	9770af
				9875as
				15325as
0500	0530	twhfa	USA, WBCQ Monticello ME	7415am
0500	0530		Vatican City, Vatican Radio	7360af
			11625af	9660af
0500	0557		China, China Radio International	5960na
			6190na	7220na
			15465va	17505as
			17855as	17540as
				17725as
0500	0600		Anguilla, Worldwide Univ Network	6090am
0500	0600		Australia, ABC NT Alice Springs	2310do
			4835do	
0500	0600		Australia, ABC NT Katherine	5025do
0500	0600		Australia, ABC NT Tennant Creek	4910do
0500	0600		Bhutan, Bhutan Broadcasting Svc	6035as
0500	0600		Canada, CFRX Toronto ON	6070na
0500	0600		Canada, CKZN St John's NF	6160na

0500	0600		Canada, CKZU Vancouver BC	6160na
0500	0600		Costa Rica, Worldwide Univ Network	7325va
			9725va	
0500	0600		Cuba, Radio Havana Cuba	6000na
			6140na	6060na
0500	0600		Guyana, Voice of Guyana	3291do
0500	0600		Iran, VOIRI/IRIB	6120na
0500	0600		Kuwait, Radio Kuwait	15110va
0500	0600		Malaysia, RTM/Traxx FM	7295as
0500	0600		Malaysia, RTM/Voice of Malaysia	6175as
			9750as	15295as
0500	0600		New Zealand, Radio NZ International	11725pa
0500	0600	DRM	New Zealand, Radio NZ International	11675pa
0500	0600		Nigeria, Radio Nigeria/Kaduna	4770do
0500	0600		Palau, T8WH/World Harvest	15680as
0500	0600	vl	Papua New Guinea, Wantok R. Light	7325va
0500	0600		Russia, Voice of Russia	6135na
			7350na	9840na
				9855na
				12030na
0500	0600	DRM	Russia, Voice of Russia	15735as
0500	0600		South Africa, Channel Africa	7230af
0500	0600		Swaziland, TWR	3200af
0500	0600		Swaziland, TWR	3200af
0500	0600	vl	Uganda, UBC Radio	4976do
0500	0600		UK, BBC World Service	3255af
			6190af	7255af
			11945af	12095eu
			15420af	17640af
				9410me
				15310as
				15360me
0500	0600	DRM	UK, BBC World Service	3995af
0500	0600		USA, American Forces Network	4319usb
			5446usb	5765usb
			10320usb	12133usb
				13362usb
0500	0600		USA, Voice of America	4930af
			9885af	15580af
0500	0600		USA, WBOH Newport NC	5920am
0500	0600		USA, WEWN Vandiver AL	9455af
0500	0600		USA, WHRA Greenbush ME	7465va
0500	0600	mtwhf	USA, WHRI Cypress Creek SC	7315sa
0500	0600	Sat/Sun	USA, WHRI Cypress Creek SC	11565pa
0500	0600		USA, WHRI Cypress Creek SC	5875na
0500	0600		USA, WRMI Miami FL	9955am
0500	0600		USA, WTJC Newport NC	9370na
0500	0600		USA, WWCR Nashville TN	3215na
			5890na	5070na
0500	0600		USA, WWRB Manchester TN	3185va
0500	0600		USA, WYFR/Family Radio Worldwide	5950na
			6915na	9680na
0500	0600		Uzbekistan, CVC International	15610as
0500	0600		Zambia CVC/ The Voice Africa	4965af
0515	0530	vl	Rwanda, Radio Rwanda	6055do
0530	0600		Australia, Radio Australia	9660as
			13690as	15160as
			15515as	17750va
				15240pa
				15415as
0530	0600	vl	Rwanda, Radio Rwanda	6055do
0530	0600		Thailand, Radio Thailand World Svc	11730va

0600 UTC - 2AM EDT / 1AM CDT / 11PM PDT

0600	0615	Sat/Sun	South Africa, Trans World Radio	11640af
0600	0629		Germany, Deutsche Welle	5945af
0600	0630	Sat/Sun	Australia, Radio Australia	15180as
0600	0630		Australia, Radio Australia	9660as
			12080as	13690as
			15515as	17750va
				15160as
				15240pa
0600	0630	mtwhf	France, Radio France International	7315af
			11995af	13680af
				15160af
0600	0630		Germany, Deutsche Welle	12045af
0600	0630		Nigeria, Radio, National Svc/Abuja	7275do
0600	0630		Vatican City, Vatican Radio	4005eu
			7250eu	5965eu
0600	0645	mtwhf	South Africa, Trans World Radio	11640af
0600	0657		China, China Radio International	16115na
			11750af	11880as
			15350as	15465as
			17710as	17505va
				17770me
0600	0658		New Zealand, Radio NZ International	11725pa
0600	0658	DRM	New Zealand, Radio NZ International	11675pa
0600	0700		Anguilla, Worldwide Univ Network	6090am
0600	0700		Australia, ABC NT Alice Springs	2310do
			4835do	
0600	0700		Australia, ABC NT Katherine	5025do
0600	0700		Australia, ABC NT Tennant Creek	4910do
0600	0700		Canada, CFRX Toronto ON	6070na
0600	0700		Canada, CFVP Calgary AB	6030na
0600	0700		Canada, CKZN St John's NF	6160na
0600	0700		Canada, CKZU Vancouver BC	6160na
0600	0700		Costa Rica, Worldwide Univ Network	7325va
			9725va	
0600	0700		Cuba, Radio Havana Cuba	6000na
				6060na

0600	0700	DRM/ vl	6140na		
0600	0700		Germany, Deutsche Welle	3995eu	
0600	0700		Guyana, Voice of Guyana	3291do	
0600	0700		Kuwait, Radio Kuwait	15110va	
0600	0700		Malaysia, RTM/Traxx FM	7295as	
0600	0700		Malaysia, RTM/Voice of Malaysia		6175as
			9750as	15295as	
0600	0700		Nigeria, Radio Nigeria/Kaduna	4770do	
0600	0700	vl	Papua New Guinea, Wantok R. Light		7325va
0600	0700		Russia, Voice of Russia	17665pa	17805pa
0600	0700		South Africa, Channel Africa	7230af	15255af
0600	0700		UK, BBC World Service	6005af	6190af
			7255af	9410af	9860af
			11765af	15310as	15420af
			17790as		17640af
0600	0700	DRM/ vl	UK, BBC World Service	3995af	
0600	0700		Ukraine, R Ukraine International		7440eu
0600	0700		USA, American Forces Network		4319usb
			5446usb	5765usb	6350usb
			10320usb	12133usb	13362usb
0600	0700		USA, Voice of America	6080af	9885af
			15580af		
0600	0700		USA, WBOH Newport NC	5920am	
0600	0700		USA, WEWN Vandiver AL	9455af	
0600	0700		USA, WHRA Greenbush ME	7465va	
0600	0700	mtwhf	USA, WHRI Cypress Creek SC	7315sa	
0600	0700	Sat/Sun	USA, WHRI Cypress Creek SC	11565pa	
0600	0700		USA, WHRI Cypress Creek SC	7385va	
0600	0700		USA, WRMI Miami FL	9955am	
0600	0700		USA, WTJC Newport NC	9370na	
0600	0700		USA, WWCR Nashville TN	3215na	5070na
			5890na		
0600	0700		USA, WWRB Manchester TN	3185va	
0600	0700		USA, WYFR/Family Radio Worldwide		5745eu
			6000sa	9680na	11530eu
					11580af
0600	0700		Uzbekistan, CVC International	15610as	
0600	0700	vl	Vanuatu, Radio Vanatu	7260do	
0600	0700		Zambia CVC/ The Voice Africa	6065af	13590af
0630	0656		Romania, R Romania International		7180eu
			9690eu	15560pa	17780pa
0630	0700		Australia, Radio Australia	9660as	11650as
			12080as	13690as	15160as
			15415as	15515as	17750va
0630	0700		Vatican City, Vatican Radio	7360af	9660af
			11625af		
0659	0700		New Zealand, Radio NZ International		9765pa
0659	0700	DRM	New Zealand, Radio NZ International		9870pa

0700 UTC - 3AM EDT / 2AM CDT / 12AM PDT

0700	0703		Croatia, Voice of Croatia	15360eu	17655eu
0700	0703	vl	Croatia, Voice of Croatia	6165eu	9470pa
			11690pa		
0700	0706		UK, BBC World Service	6005af	
0700	0727		Slovakia, R Slovakia International		13715va
			15460va		
0700	0730		France, Radio France International		11725af
			15605af		
0700	0730		Liberia, Star Radio	11875af	
0700	0730	mtwhf	UK, BBC World Service	15575as	
0700	0745		USA, WYFR/Family Radio Worldwide		5745eu
0700	0757		China, China Radio International	11785eu	
			11880as	15125as	15350as
			17540as		17490eu
0700	0800		Anguilla, Worldwide Univ Network		6090am
0700	0800		Australia, ABC NT Alice Springs		2310do
			4835do		
0700	0800		Australia, ABC NT Katherine	5025do	
0700	0800		Australia, ABC NT Tennant Creek		4910do
0700	0800		Australia, Radio Australia	9475as	9660as
			9710as	11650as	11945as
			13630pa	15160va	15240pa
0700	0800		Bhutan, Bhutan Broadcasting Svc		6035as
0700	0800		Canada, CFRX Toronto ON	6070na	
0700	0800		Canada, CFVP Calgary AB	6030na	
0700	0800		Canada, CKZN St John's NF	6160na	
0700	0800		Canada, CKZU Vancouver BC	6160na	
0700	0800		Costa Rica, Worldwide Univ Network		7325va
			9725va		
0700	0800	DRM/vl	Germany, Deutsche Welle	3995eu	
0700	0800		Guyana, Voice of Guyana	3291do	
0700	0800		Kuwait, Radio Kuwait	15110va	
0700	0800	Sat	Latvia, Radio SWH	9290eu	
0700	0800		Malaysia, RTM/Traxx FM	7295as	
0700	0800		Malaysia, RTM/Voice of Malaysia		6175as
			9750as	15295as	
0700	0800		Myanmar, Myanma Radio	9731do	
0700	0800		New Zealand, Radio NZ International		9765pa

0700	0800	DRM	New Zealand, Radio NZ International		9870pa
0700	0800		Nigeria, Radio Nigeria/Kaduna	4770do	
0700	0800		Palau, T8WH/World Harvest	9930as	15680as
0700	0800	vl	Papua New Guinea, R East New Britain		3385do
0700	0800	vl	Papua New Guinea, Wantok R. Light		7325va
0700	0800	DRM	Russia, Voice of Russia		11635eu
0700	0800		Russia, Voice of Russia	17665pa	17805pa
0700	0800	vl	Solomon Islands, SIBC	5020do	
0700	0800	vl	South Africa, Channel Africa	9625af	
0700	0800		UK, BBC World Service	6190af	9860af
			11760me	11765af	15310as
			15420af	17790as	15400af
0700	0800	DRM/ vl	UK, BBC World Service		3995eu
0700	0800	Sat	UK, Bible Voice BC 5945eu		
0700	0800		USA, American Forces Network		4319usb
			5446usb	5765usb	6350usb
			10320usb	12133usb	13362usb
0700	0800		USA, WBOH Newport NC	5920am	
0700	0800		USA, WEWN Vandiver AL	9455af	
0700	0800	mtwhf	USA, WHRI Cypress Creek SC	7315sa	11565va
0700	0800	Sat/Sun	USA, WHRI Cypress Creek SC	5875va	11565va
0700	0800		USA, WHRI Cypress Creek SC	7385na	
0700	0800		USA, WRMI Miami FL	9955am	
0700	0800		USA, WTJC Newport NC	9370na	
0700	0800		USA, WWCR Nashville TN	3215na	5070na
			5890na		
0700	0800		USA, WWRB Manchester TN	3185va	
0700	0800		USA, WYFR/Family Radio Worldwide		6915na
			7455na	9495sa	9715am
					9985af
0700	0800		Uzbekistan, CVC International	15610as	
0700	0800	vl	Vanuatu, Radio Vanatu	7260do	
0700	0800		Zambia CVC/ The Voice Africa	6065af	13590af
0730	0745		Vatican City, Vatican Radio	4005eu	5965eu
			7250eu	9645eu	11740eu
					15595eu
0730	0800		Australia, HCBJ Global		11750pa
0730	0800		Bulgaria, Radio Bulgaria	5900eu	7400eu
0730	0800	Sat/Sun	UK, BBC World Service		15575as
0745	0800	Sun	Germany, TWR-Europe		6105eu
0745	0800	Sun	Monaco, TWR-Europe		9800eu
0750	0800		Saudi Arabia, BSKSA		17785as

0800 UTC - 4AM EDT / 3AM CDT / 1AM PDT

0800	0815	Sat	Guam, KTWR/TWR		11840pa
0800	0815	Sat	UK, Bible Voice BC 5945eu		
0800	0825		Malaysia, RTM/Voice of Malaysia		6175as
			9750as	15295as	
0800	0827		Czech Rep, Radio Prague	7345eu	9860eu
0800	0830		Australia, ABC NT Katherine	5025do	
0800	0830		Australia, ABC NT Tennant Creek		4910do
0800	0830		Myanmar, Myanma Radio	9731do	
0800	0835	mtwhf	Guam, KTWR/TWR		11840pa
0800	0845		USA, WYFR/Family Radio Worldwide		9985af
0800	0850	mtwhf	Germany, TWR-Europe	6105eu	
0800	0850	mtwhf	Monaco, TWR-Europe	9800eu	
0800	0857		China, China Radio International		9415as
			11785eu	11880as	15350as
			15625va	17490eu	17540as
0800	0900		Anguilla, Worldwide Univ Network		6090am
0800	0900		Australia, ABC NT Alice Springs		2310do
			4835do		
0800	0900		Australia, HCBJ Global	11750pa	
0800	0900		Australia, Radio Australia	5995as	9475as
			9580va	9590as	9710as
			12080as	13630pa	11945pa
0800	0900		Bhutan, Bhutan Broadcasting Svc		6035as
0800	0900		Canada, CFRX Toronto ON	6070na	
0800	0900		Canada, CFVP Calgary AB	6030na	
0800	0900		Canada, CKZN St John's NF	6160na	
0800	0900		Canada, CKZU Vancouver BC	6160na	
0800	0900		Costa Rica, Worldwide Univ Network		7325va
			9725va		
0800	0900	DRM	Germany, Deutsche Welle	9610eu	
0800	0900	Sun	Germany, TWR-Europe	6105eu	
0800	0900		Guyana, Voice of Guyana	3291do	
0800	0900		Malaysia, RTM/Traxx FM	7295as	
0800	0900	Sun	Monaco, TWR-Europe	9800eu	
0800	0900		New Zealand, Radio NZ International		9765pa
0800	0900	DRM	New Zealand, Radio NZ International		9870pa
0800	0900		Nigeria, Radio Nigeria/Kaduna	4770do	
0800	0900		Nigeria, Voice of Nigeria/Lagos		9690af
0800	0900		Palau, T8WH/World Harvest	9930as	15680as
0800	0900	vl	Papua New Guinea, R East New Britain		3385do
0800	0900	vl	Papua New Guinea, Wantok R. Light		7325va
0800	0900		Russia, Voice of Russia	15195as	17665pa
			17805pa		
0800	0900	vl	Solomon Islands, SIBC	5020do	
0800	0900	vl	South Africa, Channel Africa	9625af	

0800	0900	Sun	South Africa, SA Radio League	7205af	17860af	
0800	0900		South Korea, KBS World Radio		9570as	
0800	0900		UK, BBC World Service	6190af	9860af	
			11760me	15310as	15400af	17640as
			17790af	17830af	21470af	
0800	0900	Sat/Sun	UK, BBC World Service		15575me	
0800	0900	Sun	UK, Bible Voice BC 5945eu			
0800	0900		USA, American Forces Network		4319usb	
			5446usb	5765usb	6350usb	7811usb
			10320usb	12133usb	13362usb	
0800	0900		USA, KNLS Anchor Point AK	9615as		
0800	0900		USA, WBOH Newport NC	5920am		
0800	0900		USA, WEWN Vandiver AL	9455af		
0800	0900	mtwhf	USA, WHRI Cypress Creek SC	7315sa	11565va	
0800	0900	Sat/Sun	USA, WHRI Cypress Creek SC	5875va	11565pa	
0800	0900		USA, WHRI Cypress Creek SC	7385na		
0800	0900		USA, WRMI Miami FL	9955am		
0800	0900		USA, WTJC Newport NC	9370na		
0800	0900		USA, WWCR Nashville TN	3215na	5070na	
			5890na			
0800	0900		USA, WWRB Manchester TN	3185va		
0800	0900		USA, WYFR/Family Radio Worldwide		5950am	
			6915na	7455na		
0800	0900		Uzbekistan, CVC International	15610as		
0800	0900	vl	Vanuatu, Radio Vanatu	7260do		
0800	0900		Zambia CVC/ The Voice Africa	6065af	13590af	
0805	0900	thf	Guam, KTWR/TWR	15170as		
0815	0850	Sat	Germany, TWR-Europe	6105eu		
0815	0850	Sat	Monaco, TWR-Europe	9800eu		
0815	0900	f	UK, Bible Voice BC 5945eu			
0820	0900	w	Guam, KTWR/TWR	15170as		
0830	0900		Australia, ABC NT Katherine	2485do		
0830	0900		Australia, ABC NT Tennant Creek		2325do	
0835	0900	m	Guam, KTWR/TWR	15170as		

0900 UTC - 5AM EDT / 4AM CDT / 2AM PDT

0900	0915	Sun	UK, Bible Voice BC 5945eu			
0900	0920	Sun	Germany, TWR-Europe	6105eu		
0900	0920	Sun	Monaco, TWR-Europe	9800eu		
0900	0930		Australia, HCJB Global	11750pa		
0900	0930		Japan, NHK World Radio Japan		9625va	
			9825pa	11815as	15590as	17810as
0900	0930		Uzbekistan, CVC International	15610as		
0900	0957		China, China Radio International		9415as	
			15210pa	15270eu	15350as	17490eu
			17570eu	17690pa	17750as	
0900	1000		Anguilla, Worldwide Univ Network		6090am	
0900	1000		Australia, ABC NT Alice Springs		2310do	
			4835do			
0900	1000		Australia, ABC NT Katherine	2485do		
0900	1000		Australia, ABC NT Tennant Creek		2325do	
0900	1000		Australia, Radio Australia	9475va	9580va	
			9590va	11945as	12080as	
0900	1000		Bhutan, Bhutan Broadcasting Svc		6035as	
0900	1000		Canada, CFRX Toronto ON	6070na		
0900	1000		Canada, CFVP Calgary AB	6030na		
0900	1000		Canada, CKZN St John's NF	6160na		
0900	1000		Canada, CKZU Vancouver BC	6160na		
0900	1000		Costa Rica, Worldwide Univ Network		7325va	
			9725va			
0900	1000		Germany, Deutsche Welle	17710as	21840as	
0900	1000	DRM	Germany, Deutsche Welle	9610eu		
0900	1000		Guyana, Voice of Guyana	3291do		
0900	1000		Malaysia, RTM/Traxx FM	7295as		
0900	1000		Netherlands, R Netherlands Worldwide		9795as	
0900	1000		New Zealand, Radio NZ International		9765pa	
0900	1000	DRM	New Zealand, Radio NZ International		9870pa	
0900	1000		Nigeria, Radio Nigeria/Kaduna	4770do		
0900	1000		Nigeria, Voice of Nigeria/Lagos		9690af	
0900	1000		Palau, T8WH/World Harvest	9930as	15680as	
0900	1000	vl	Papua New Guinea, R East New Britain		3385do	
0900	1000	vl	Papua New Guinea, Wantok R. Light		7325va	
0900	1000		Russia, Voice of Russia	15195as	17665pa	
0900	1000	DRM	Russia, Voice of Russia	13670eu		
0900	1000		Saudi Arabia, BSKSA	15250af		
0900	1000	vl	Solomon Islands, SIBC	5020do		
0900	1000	vl	South Africa, Channel Africa	9625af		
0900	1000		UK, BBC World Service	6190af	6195as	
			9740as	9860af	11760me	15310as
			15400af	15575me	17640af	17760as
			17790as	17830af	21470af	
0900	1000		USA, American Forces Network		4319usb	
			5446usb	5765usb	6350usb	7811usb
			10320usb	12133usb	13362usb	
0900	1000		USA, WBOH Newport NC	5920am		
0900	1000		USA, WEWN Vandiver AL	9390as		
0900	1000	mtwhfa	USA, WHRI Cypress Creek SC	7315sa		

0900	1000	Sun	USA, WHRI Cypress Creek SC	11565pa		
0900	1000		USA, WHRI Cypress Creek SC	5875na	7385na	
0900	1000		USA, WRMI Miami FL	9955am		
0900	1000		USA, WTJC Newport NC	9370na		
0900	1000		USA, WWCR Nashville TN	5070na	5890na	
			9985na			
0900	1000		USA, WWRB Manchester TN	3185va		
0900	1000		USA, WYFR/Family Radio Worldwide		5950am	
			6915na	7455na	9450as	9465as
0900	1000	vl	Vanuatu, Radio Vanatu	7260do		
0900	1000		Zambia CVC/ The Voice Africa	6065af	13590af	
0930	1000		Australia, CVC International	15555as		

1000 UTC - 6AM EDT / 5AM CDT / 3AM PDT

1000	1027		Czech Rep, Radio Prague	9955am	15710af	
			21745af			
1000	1030		Vietnam, Voice of Vietnam	9840as	12020as	
1000	1057		China, China Radio International		5995as	
			7135as	7215as	9415as	13590as
			13720as	15190as	15210pa	15270eu
			15350as	17490eu	17570eu	17690pa
			17750as			
1000	1058		New Zealand, Radio NZ International		9765pa	
1000	1058	DRM	New Zealand, Radio NZ International		9870pa	
1000	1100		Anguilla, Worldwide Univ Network		11775am	
1000	1100		Australia, ABC NT Alice Springs		2310do	
			4835do			
1000	1100		Australia, ABC NT Katherine	2485do		
1000	1100		Australia, ABC NT Tennant Creek		2325do	
1000	1100		Australia, CVC International	15555as		
1000	1100		Australia, Radio Australia	9475va	9580va	
			9590va	11945as	12080as	
1000	1100		Canada, CFRX Toronto ON	6070na		
1000	1100		Canada, CFVP Calgary AB	6030na		
1000	1100		Canada, CKZN St John's NF	6160na		
1000	1100		Canada, CKZU Vancouver BC	6160na		
1000	1100		Costa Rica, Worldwide Univ Network		7325va	
			9725va			
1000	1100		Guyana, Voice of Guyana	3291do		
1000	1100		India, All India Radio	7270as	13710pa	
			15235as	15260as	17510as	17800as
			17895pa			
1000	1100		Indonesia, Voice of Indonesia	9526va	11784al	
1000	1100		Malaysia, RTM/Traxx FM	7295as		
1000	1100		Netherlands, R Netherlands Worldwide		6040as	
			9720as	12065as		
1000	1100		Nigeria, Radio Nigeria/Kaduna	4770do		
1000	1100		Nigeria, Voice of Nigeria/Lagos		9690af	
1000	1100		North Korea, Voice of Korea	6185as	6285am	
			9335am	9850as		
1000	1100		Palau, T8WH/World Harvest	9930as	12130as	
1000	1100	vl	Papua New Guinea, R East New Britain		3385do	
1000	1100	vl	Papua New Guinea, Wantok R. Light		7325va	
1000	1100		Saudi Arabia, BSKSA	15250af		
1000	1100	vl	Solomon Islands, SIBC	5020do		
1000	1100	vl	South Africa, Channel Africa	9625af		
1000	1100	Sat/Sun	UK, BBC World Service	15400af	17830af	
1000	1100		UK, BBC World Service	6190af	6195as	
			9605as	9740as	9860af	11760me
			15310af	15575as	17640af	17790as
			21470af			
1000	1100		Ukraine, R Ukraine International		9950eu	
1000	1100		USA, American Forces Network		4319usb	
			5446usb	5765usb	6350usb	7811usb
			10320usb	12133usb	13362usb	
1000	1100		USA, KNLS Anchor Point AK	6150as		
1000	1100		USA, WBOH Newport NC	5920am		
1000	1100		USA, WEWN Vandiver AL	9390as		
1000	1100	Sun	USA, WHRI Cypress Creek SC	11565pa		
1000	1100	mtwhfa	USA, WHRI Cypress Creek SC	7315sa		
1000	1100		USA, WHRI Cypress Creek SC	7385na	9865sa	
1000	1100		USA, WINB Red Lion PA	9265am		
1000	1100		USA, WRMI Miami FL	9955am		
1000	1100		USA, WTJC Newport NC	9370na		
1000	1100		USA, WWCR Nashville TN	5070na	5890na	
			15825na			
1000	1100		USA, WWRB Manchester TN	3185va		
1000	1100		USA, WYFR/Family Radio Worldwide		5950am	
			6890na	6915na	7455na	9450as
			9465as	9900	skd0109	
1000	1100		Zambia CVC/ The Voice Africa	6065af	13590af	
1015	1045	Sun	UK, Bible Voice BC 5945eu			
1030	1100		Australia, HCJB Global		15400as	
1030	1100		Iran, VOIR/IRIB	15460as	17660as	
1030	1100	Sun	Italy, NEXUS/IRRS	9510va		
1030	1100		Mongolia, Voice of Mongolia	12085as		
1059	1100		New Zealand, Radio NZ International		13660pa	

1100 UTC - 7AM EDT / 6AM CDT / 4AM PDT

1100	1103	mtwhf	Croatia, Voice of Croatia	9830eu	
1100	1127		Iran, VOIRI/IRIB	15460as	17660as
1100	1130		Australia, CVC International	15555as	
1100	1130	f/ DRM	Japan, NHK World Radio Japan		9750eu
1100	1130		UK, BBC World Service	15400af	
1100	1130		Vietnam, Voice of Vietnam	7285as	
1100	1145		USA, WYFR/Family Radio Worldwide		5950am
			6000sa		
1100	1157		China, China Radio International	5960na	
			5995as	6060as	9570as
			11795as	13645as	13665eu
1100	1158	DRM	New Zealand, Radio NZ International	9870pa	
1100	1200		Anguilla, Worldwide Univ Network	11775am	
1100	1200		Australia, ABC NT Alice Springs	2310do	
			4835do		
1100	1200		Australia, ABC NT Katherine	2485do	
1100	1200		Australia, ABC NT Tennant Creek		2325do
1100	1200		Australia, HCJB Global	15400as	
1100	1200	DRM	Australia, Radio Australia	5995pa	
1100	1200		Australia, Radio Australia	6020va	9475as
			9560as	9580va	9590va
					11945as
1100	1200	Sat/Sun	Canada, CBC NQ SW Service	9625na	
1100	1200		Canada, CFRX Toronto ON	6070na	
1100	1200		Canada, CFVP Calgary AB	6030na	
1100	1200		Canada, CKZN St John's NF	6160na	
1100	1200		Canada, CKZU Vancouver BC	6160na	
1100	1200		Costa Rica, Worldwide Univ Network		7325va
			9725va		
1100	1200	Sun	Italy, NEXUS/IRRS	9510va	
1100	1200		Malaysia, RTM/Traxx FM	7295as	
1100	1200		New Zealand, Radio NZ International		13660pa
1100	1200		Nigeria, Radio Nigeria/Kaduna	4770do	
1100	1200		Nigeria, Voice of Nigeria/Lagos		9690af
1100	1200		Palau, T8WH/World Harvest	9930as	12130as
1100	1200	vl	Papua New Guinea, R East New Britain		3385do
1100	1200	vl	Papua New Guinea, Wantok R. Light		7325va
1100	1200		Saudi Arabia, BSKSA	15250af	
1100	1200	vl	Solomon Islands, SIBC	5020do	9545al
1100	1200	vl	South Africa, Channel Africa	9625af	
1100	1200		Taiwan, R Taiwan International	7445as	11715as
1100	1200		UK, BBC World Service	6190af	6195as
			9605as	9740as	9860af
			15310as	15575me	17640af
			17830af	21470af	17790as
1100	1200		USA, American Forces Network		4319usb
			5446usb	5765usb	6350usb
			10320usb	12133usb	13362usb
1100	1200		USA, WBOH Newport NC	5920am	
1100	1200		USA, WEWN Vandiver AL	9390as	
1100	1200	mtwhfa	USA, WHRI Cypress Creek SC	7315sa	
1100	1200		USA, WHRI Cypress Creek SC	5875na	7385na
1100	1200		USA, WINB Red Lion PA	9265am	
1100	1200		USA, WRMI Miami FL	9955am	
1100	1200		USA, WTJC Newport NC	9370na	
1100	1200		USA, WWCR Nashville TN	7490na	9980na
			15825na		
1100	1200		USA, WWRB Manchester TN	3185va	
1100	1200		USA, WYFR/Family Radio Worldwide		6890na
			7455na	11725sa	11830sa
1100	1200		Zambia CVC/ The Voice Africa	6065af	13590af
1105	1200	Sun	Greece, Voice of Greece	9420eu	15605eu
1115	1130	mwf	UK, Bible Voice BC 5950as		
1115	1145	st	UK, Bible Voice BC 5950as		
1115	1200	Sat	UK, Bible Voice BC 5950as		
1130	1157		Czech Rep, Radio Prague	11640eu	17545af
1130	1200		Australia, CVC International	13635as	
1130	1200		Guam, KSDA/AWR 15260as		
1130	1200		Vietnam, Voice of Vietnam	9840as	12020as
1145	1200		UK, Bible Voice BC 5950as		

1200 UTC - 8AM EDT / 7AM CDT / 5AM PDT

1200	1230		France, Radio France International	21620af	
1200	1230		Japan, NHK World Radio Japan	6120na	
			9625va	9695as	17585eu
1200	1230		Saudi Arabia, BSKSA	15250af	
1200	1245		USA, WYFR/Family Radio Worldwide		6890na
1200	1257		China, China Radio International	5955as	
			7250as	9460as	9600as
			9730as	9760pa	11650as
			11760pa	11980as	12080as
			13790eu	17490eu	13665eu
1200	1258		New Zealand, Radio NZ International		13660pa
1200	1300		Anguilla, Worldwide Univ Network		11775am
1200	1300		Australia, ABC NT Alice Springs		2310do

1200	1300		4835do		
1200	1300		Australia, ABC NT Katherine	2485do	
1200	1300		Australia, ABC NT Tennant Creek		2325do
1200	1300		Australia, CVC International	13635as	
1200	1300		Australia, HCJB Global	15400as	15540as
1200	1300		Australia, Radio Australia	6020va	9475as
			9560pa	9580va	9590va
					11945as
1200	1300	DRM	Australia, Radio Australia	5995va	12080pa
1200	1300	Sat/Sun	Canada, CBC NQ SW Service	9625na	
1200	1300		Canada, CFRX Toronto ON	6070na	
1200	1300		Canada, CFVP Calgary AB	6030na	
1200	1300		Canada, CKZN St John's NF	6160na	
1200	1300		Canada, CKZU Vancouver BC	6160na	
1200	1300		Costa Rica, Worldwide Univ Network		7325va
			9725va		
1200	1300	Sun	Italy, NEXUS/IRRS	9510va	
1200	1300	Sun	Latvia, Radio SWH	9290eu	
1200	1300		Malaysia, RTM/Traxx FM	7295as	
1200	1300		Nigeria, Radio Nigeria/Kaduna	4770do	
1200	1300		Nigeria, Voice of Nigeria/Lagos		9690af
1200	1300		Palau, T8WH/World Harvest	9930as	12130as
1200	1300	vl	Papua New Guinea, Wantok R. Light		7325va
1200	1300	vl	Solomon Islands, SIBC	5020do	9545al
1200	1300		South Korea, KBS World Radio		9650na
1200	1300	f/ DRM	Taiwan, R Taiwan International	9850eu	
1200	1300		UK, BBC World Service	5975as	6190af
			9605as	9740as	9860af
			15310as	15575me	17640af
			21470af		17790as
1200	1300		Ukraine, R Ukraine International		9950eu
1200	1300		USA, American Forces Network		4319usb
			5446usb	5765usb	6350usb
			10320usb	12133usb	13362usb
1200	1300		USA, KNLS Anchor Point AK	6150as	6915as
1200	1300		USA, Voice of America	7575va	9320va
			9345va	9640va	11705va
			15190va		11730va
1200	1300		USA, WBOH Newport NC	5920am	
1200	1300		USA, WEWN Vandiver AL	5755va	
1200	1300		USA, WHRA Greenbush ME	15665af	
1200	1300	Sat	USA, WHRI Cypress Creek SC	7315sa	9410sa
1200	1300	mtwhf	USA, WHRI Cypress Creek SC	7335sa	
1200	1300	Sun	USA, WHRI Cypress Creek SC	9410sa	
1200	1300		USA, WHRI Cypress Creek SC	7385na	
1200	1300		USA, WINB Red Lion PA	9265am	
1200	1300		USA, WRMI Miami FL	9955am	
1200	1300		USA, WTJC Newport NC	9370na	
1200	1300		USA, WWCR Nashville TN	7490na	9980na
			15825na		
1200	1300		USA, WWRB Manchester TN	3185va	
1200	1300		USA, WYFR/Family Radio Worldwide		7455na
			11530sa	11970am	
1200	1300		Zambia CVC/ The Voice Africa	6065af	13590af
1215	1300		Egypt, Radio Cairo	17835as	
1230	1257		China, China Radio International		11780as
1230	1300		Bangladesh, Bangla Betar	7250as	
1230	1300		Bulgaria, Radio Bulgaria	11700eu	15700eu
1230	1300		Germany, AWR-Europe	15495as	
1230	1300		Thailand, Radio Thailand World Svc		9810va
1230	1300		Vietnam, Voice of Vietnam	9840as	12020as

1300 UTC - 9AM EDT / 8AM CDT / 6AM PDT

1300	1330		Australia, HCJB Global	15540as	
1300	1330		Egypt, Radio Cairo	17835af	
1300	1330		Poland, Polish Radio	7325eu	9450eu
1300	1345		USA, WYFR/Family Radio Worldwide		7455na
			11970am		
1300	1356		Romania, R Romania International		11970eu
			15105eu		
1300	1357		China, China Radio International		5955as
			7300as	9590na	9655as
			9765as	9870as	11760pa
			11900pa	11980as	13610eu
			15230na		13790eu
1300	1400		Anguilla, Worldwide Univ Network		11775am
1300	1400		Australia, CVC International	13635as	
1300	1400		Australia, Radio Australia	6020va	9560as
			9580va	9590va	
1300	1400	DRM	Australia, Radio Australia	5995va	12080pa
1300	1400	Sat/Sun	Canada, CBC NQ SW Service	9625na	
1300	1400		Canada, CFRX Toronto ON	6070na	
1300	1400		Canada, CFVP Calgary AB	6030na	
1300	1400		Canada, CKZN St John's NF	6160na	
1300	1400		Canada, CKZU Vancouver BC	6160na	
1300	1400		Costa Rica, Worldwide Univ Network		7325va
			9725va		
1300	1400		Indonesia, Voice of Indonesia	9526va	11784al

1300	1400	Malaysia, RTM/Traxx FM	7295as	
1300	1400	New Zealand, Radio NZ International		6170pa
1300	1400	Nigeria, Radio Nigeria/Kaduna	4770do	
1300	1400	Nigeria, Voice of Nigeria/Lagos		9690af
1300	1400	North Korea, Voice of Korea	7570eu	9335na
		11710na	12015eu	
1300	1400	Palau, T8WH/World Harvest	9930as	
1300	1400	Papua New Guinea, Wantok R. Light		7325va
1300	1400	Solomon Islands, SIBC	5020do	9545al
1300	1400	South Korea, KBS World Radio		9570na
		9770as		
1300	1400	UK, BBC World Service	5975as	6190af
		6195as	9410as	9740as
		11760me	15310as	15420af
		17640af	21470af	15575me
1300	1400	USA, American Forces Network		4319usb
		5446usb	5765usb	6350usb
		10320usb	12133usb	13362usb
1300	1400	USA, Voice of America	7575va	9640va
		11705va		
1300	1400	USA, WBOH Newport NC	5920am	
1300	1400	USA, WEWN Vandiver AL	5755va	
1300	1400	USA, WHRA Greenbush ME	15665af	
1300	1400	USA, WHRI Cypress Creek SC	9495sa	9840na
1300	1400	USA, WHRI Cypress Creek SC	11785na	
1300	1400	USA, WINB Red Lion PA	9265am	
1300	1400	USA, WRMI Miami FL	9955am	
1300	1400	USA, WTJC Newport NC	9370na	
1300	1400	USA, WWCR Nashville TN	7490na	9980na
		15825na		
1300	1400	USA, WWRB Manchester TN	9385va	
1300	1400	USA, WYFR/Family Radio Worldwide		11830na
		11520as	11560as	11855na
		15670as		13810as
1300	1400	Zambia CVC/ The Voice Africa	6065af	13590af
1310	1340	Japan, NHK World Radio Japan		9875as
1330	1357	Czech Rep, Radio Prague	9850eu	
1330	1400	Australia, HCJB Global	15435as	
1330	1400	Guam, KSDA/ AWR	11935as	15660as
1330	1400	India, All India Radio	9690as	11620as
		13710as		
1330	1400	Laos, National Radio	7145as	
1330	1400	Sweden, Radio Sweden	7465va	
1330	1400	Turkey, Voice of Turkey	11735pa	12035eu
1330	1400	Vietnam, Voice of Vietnam	9840as	12020as
1355	1400	Guam, KTWR/TWR	9975as	

1400 UTC - 10AM EDT / 9AM CDT / 7AM PDT

1400	1425	Turkey, Voice of Turkey	11735pa	12035eu
1400	1427	Czech Rep, Radio Prague	11600as	13580na
1400	1428	Serbia, Intl Radio Serbia	7200eu	
1400	1430	Australia, HCJB Global	15400as	15425as
1400	1430	Australia, Radio Australia	5995va	6080va
		7240va	9590va	
1400	1430	Germany, Pan American BC	15205as	
1400	1430	Guam, KTWR/TWR	9975as	
1400	1430	Japan, NHK World Radio Japan		9875as
		11705va	11780eu	21560eu
1400	1430	New Zealand, Radio NZ International		9750pa
1400	1430	Thailand, Radio Thailand World Svc		9725va
1400	1430	United Arab Emirates, FEBA	12045as	
1400	1457	China, China Radio International		5995as
		7300as	9460as	9700eu
		9795as	11665as	11675na
		13740na	15230na	17630af
1400	1500	Anguilla, Worldwide Univ Network		11775am
1400	1500	Australia, CVC International	13635as	
1400	1500	Bhutan, Bhutan Broadcasting Svc		6035as
1400	1500	Canada, CBC NQ SW Service	9625na	
1400	1500	Canada, CFRX Toronto ON	6070na	
1400	1500	Canada, CFVP Calgary AB	6030na	
1400	1500	Canada, CKZN St John's NF	6160na	
1400	1500	Canada, CKZU Vancouver BC	6160na	
1400	1500	Costa Rica, Worldwide Univ Network		7325va
		9725va		
1400	1500	Germany, CVC Intl/Voice Africa		15745af
1400	1500	Germany, Overcomer Ministries		6110eu
		13810eu		
1400	1500	Guam, KTWR/TWR	9975as	
1400	1500	India, All India Radio	9690as	11620as
		13710as		
1400	1500	Iran, VOIR/IRIB	15460as	17660as
1400	1500	Jordan, Radio Jordan	11690na	
1400	1500	Libya, Voice of Africa	17725af	21695af
1400	1500	Malaysia, RTM/Traxx FM	7295as	
1400	1500	Netherlands, R Netherlands Worldwide		5825as
		9345as	11520as	12080as
				15595as

1400	1500	New Zealand, Radio NZ International		6170pa
1400	1500	Nigeria, Radio Nigeria/Kaduna	4770do	
1400	1500	Nigeria, Voice of Nigeria/Lagos		9690af
1400	1500	Oman, Radio Oman	15140as	
1400	1500	Palau, T8WH/World Harvest	9930as	9955as
1400	1500	Papua New Guinea, Wantok R. Light		7325va
1400	1500	Solomon Islands, SIBC	5020do	9545al
1400	1500	UK, BBC World Service	5960as	5975as
		6190af	6195as	9410as
		9860af	11760me	11915as
		21470af		15420af
1400	1500	Sat/Sun	UK, Bible Voice BC	11695as
1400	1500	USA, American Forces Network		4319usb
		5446usb	5765usb	6350usb
		10320usb	12133usb	13362usb
1400	1500	USA, KJES Vado NM		11715na
1400	1500	USA, KNLS Anchor Point AK	6150as	
1400	1500	USA, Voice of America	4930af	6080af
		7575va	9480va	9760va
		12150va	15205va	15580af
		17750af		17715af
1400	1500	USA, WBOH Newport NC	5920am	
1400	1500	USA, WEWN Vandiver AL	5755va	
1400	1500	USA, WHRA Greenbush ME	15665af	
1400	1500	USA, WHRI Cypress Creek SC	9495sa	9840na
1400	1500	USA, WHRI Cypress Creek SC	11785na	
1400	1500	USA, WINB Red Lion PA	13570am	
1400	1500	USA, WRMI Miami FL	9955na	
1400	1500	USA, WTJC Newport NC	9370na	
1400	1500	USA, WWCR Nashville TN	7490na	9980na
		15825na		
1400	1500	USA, WWRB Manchester TN	9385va	
1400	1500	USA, WYFR/Family Radio Worldwide		6135as
		7320as	9365as	9615as
		11560as	11565na	11725as
		na	11860as	13695na
				13810as
1400	1500	Zambia CVC/ The Voice Africa	6065af	13650af
1415	1430	Germany, Pan American BC	15205as	
1415	1430	Nepal, Radio Nepal	5005as	
1415	1430	United Arab Emirates, FEBA	12045as	
1430	1445	Germany, Pan American BC	15205as	
1430	1445	Moldova, Radio PMR/Pridnestrovie		7370eu
1430	1500	Australia, Radio Australia	5995va	6080va
		7240va	9475as	9590va
				11660pa
1430	1500	Ethiopia, Radio Ethiopia	5990af	7110af
		9704af		
1430	1500	f/ DRM	South Korea, KBS World Radio	9750eu
1430	1500		Sweden, Radio Sweden	9400va

1500 UTC - 11AM EDT / 10AM CDT / 8AM PDT

1500	1510	mtwhfa	Turkmenistan, Turkmen Radio	5015eu
1500	1527		Czech Rep, Radio Prague	9955na
1500	1528		Vietnam, Voice of Vietnam	7285va
			12020va	9840va
1500	1530		Australia, HCJB Global	15425as
1500	1530		Guam, KSDA/ AWR	12105as
1500	1530		Nigeria, Radio, National Svc/Abuja	7275do
1500	1530		UK, BBC World Service	9410af
			15105af	11860af
1500	1530	Sat	UK, Bible Voice BC	11895as
1500	1530		UK, Sudan Radio Service	17745af
1500	1545		USA, WYFR/Family Radio Worldwide	15210sa
1500	1550		New Zealand, Radio NZ International	6170pa
1500	1557		Canada, R Canada International	9635as
			11975as	
1500	1557		China, China Radio International	5955as
			6095va	7160as
			9525eu	9720va
			13685af	13740na
				17630af
1500	1557		Libya, Voice of Africa	17725af
1500	1600		Anguilla, Worldwide Univ Network	11775am
1500	1600		Australia, CVC International	13635as
1500	1600		Australia, Radio Australia	5995va
1500	1600		7240va	9475as
1500	1600	Sat/Sun	Canada, CBC NQ SW Service	9625na
1500	1600		Canada, CFRX Toronto ON	6070na
1500	1600		Canada, CFVP Calgary AB	6030na
1500	1600		Canada, CKZN St John's NF	6160na
1500	1600		Canada, CKZU Vancouver BC	6160na
1500	1600		Costa Rica, Worldwide Univ Network	7325va
			9725va	
1500	1600		Germany, CVC Intl/Voice Africa	15745af
1500	1600		Germany, Overcomer Ministries	6110eu
			13810me	17485af
1500	1600	vl	Italy, NEXUS/IRRS	15650af
1500	1600		Jordan, Radio Jordan	11690na
1500	1600		Malaysia, RTM/Traxx FM	7295as

1500	1600		Myanmar, Myanma Radio	5985as		
1500	1600		Netherlands, R Netherlands Worldwide	5825as	5825as	15595as
			9345as	11520as	12080as	
1500	1600		Nigeria, Radio Nigeria/Kaduna	4770do		
1500	1600		Nigeria, Voice of Nigeria/Lagos		9690af	
1500	1600		North Korea, Voice of Korea	7570eu	9335na	
			11710na	12015eu		
1500	1600		Palau, T8WH/World Harvest	9930as		
1500	1600	vl	Papua New Guinea, Wantok R. Light		7325va	
1500	1600		Russia, Voice of Russia	7350as	7260as	
			9660as			
1500	1600	DRM	Russia, Voice of Russia	5905eu	9675eu	
1500	1600	vl	Solomon Islands, SIBC	5020do	9545al	
1500	1600	vl	South Africa, Channel Africa	9625af		
1500	1600		Uganda, Dunamis Shortwave	4750af		
1500	1600	DRM	UK, BBC World Service	5970eu		
1500	1600		UK, BBC World Service	5975as	6040as	
			6190af	6195as	9410as	9740as
			9855va	9860af	11915me	12095af
			15400af	21470af		
1500	1600		USA, American Forces Network		4319usb	
			5446usb	5765usb	6350usb	7811usb
			10320usb	12133usb	13362usb	
1500	1600		USA, KJES Vado NM	11715na		
1500	1600		USA, Voice of America	4930af	6080af	
			6140af	7520va	7575va	9590va
			9685va	9760va	11525va	11765va
			12150va	13735va	15460va	15580af
			17715af	17895af		
1500	1600		USA, WBCQ Monticello ME	9330am		
1500	1600		USA, WBOH Newport NC	5920am		
1500	1600		USA, WEWN Vandiver AL	5755va		
1500	1600	mtwhfa	USA, WHRA Greenbush ME	15665af		
1500	1600	Sun	USA, WHRA Greenbush ME	13650af		
1500	1600	Sat/Sun	USA, WHRI Cypress Creek SC	9495sa	9840na	
1500	1600		USA, WHRI Cypress Creek SC	11785na		
1500	1600		USA, WINB Red Lion PA	13570am		
1500	1600		USA, WRMI Miami FL	9955na		
1500	1600		USA, WTJC Newport NC	9370na		
1500	1600		USA, WWCR Nashville TN	7490na	9980na	
			15825na			
1500	1600		USA, WWRB Manchester TN	9385va		
1500	1600		USA, WYFR/Family Radio Worldwide		6180as	
			7320as	11565na	11855na	11860as
			12015as	15520as	15750af	17760am
1500	1600		Zambia CVC/ The Voice Africa	6065af	13650af	
1507	1600		Canada, R Canada International		9610as	
1507	1600	DRM	Canada, R Canada International		9800na	
1515	1530	vl/ mtwhf	Moldova, Radio PMR/Pridnestrovie		7370eu	
1530	1557		China, China Radio International		9600me	
1530	1600	mtwhfa	Albania, Radio Tirana	13720na		
1530	1600		Germany, AWR-Europe	11675as		
1530	1600		Iran, VOIR/IRIB	6160as	7330as	
1530	1600		Mongolia, Voice of Mongolia	12085as		
1530	1600		Sweden, Radio Sweden	9360va		
1530	1600	Sat	UK, BBC World Service	9410af	11860af	
			15105af			
1530	1600		UK, Bible Voice BC 12035as			
1551	1600	DRM	New Zealand, Radio NZ International		6170pa	
1551	1600		New Zealand, Radio NZ International		7145pa	

1600 UTC - 12PM EDT / 11AM CDT / 9AM PDT

1600	1615	vl/ mtwhf	Moldova, Radio PMR/Pridnestrovie		7370eu	
1600	1615		Pakistan, Radio Pakistan	9385va	11565va	
			15100af			
1600	1615	Sat	UK, BBC World Service	9410af	11860af	
			15105af			
1600	1627		Iran, VOIR/IRIB	6160as	7330as	
1600	1628		Vietnam, Voice of Vietnam	7220va	7280va	
			9550va	9730va		
1600	1630	Sun	Germany, Pan American BC	13830me		
1600	1630		Guam, KSDA/ AWR	9585as	11690as	
1600	1630		Myanmar, Myanma Radio	9730do		
1600	1630		Nigeria, Voice of Nigeria/Lagos		9690af	
1600	1630		Yemen, Rep of Yemen Radio	9780me		
1600	1645		USA, WYFR/Family Radio Worldwide		11565na	
			11830na	17760am		
1600	1650	DRM	New Zealand, Radio NZ International		6170pa	
1600	1650		New Zealand, Radio NZ International		7145pa	
1600	1657		China, China Radio International		6060as	
			7110af	7235as	7255eu	9435eu
			9525eu	9600af	11650eu	
1600	1658		Germany, Deutsche Welle	5965as	9560as	
1600	1700		Anguilla, Worldwide Univ Network		11775am	
1600	1700		Australia, CVC International		13635as	
1600	1700		Australia, Radio Australia	5995va	6080va	
			7240as	9475va	9580va	9710as

						11660pa
1600	1700	Sat	Canada, CBC NQ SW Service		9625na	
1600	1700		Canada, CFRX Toronto ON		6070na	
1600	1700		Canada, CFVP Calgary AB		6030na	
1600	1700		Canada, CKZN St John's NF		6160na	
1600	1700		Canada, CKZU Vancouver BC		6160na	
1600	1700		Canada, R Canada International		9610as	
1600	1700	DRM	Canada, R Canada International		9800na	
1600	1700		Costa Rica, Worldwide Univ Network		7325va	
			9725va			
1600	1700		Egypt, Radio Cairo	12170af		
1600	1700		Ethiopia, Radio Ethiopia	7165af	9560af	
1600	1700		France, Radio France International		11615af	
			15605af			
1600	1700		Germany, CVC Intl/Voice Africa		15745af	
1600	1700	DRM/ vl	Germany, Deutsche Welle		3995eu	
1600	1700	vl	Italy, NEXUS/IRRS	15650af		
1600	1700		Malaysia, RTM/Traxx FM		7295as	
1600	1700		Nigeria, Radio Nigeria/Kaduna	4770do		
1600	1700		North Korea, Voice of Korea	9990va	11545va	
1600	1700		Palau, T8WH/World Harvest	9930as		
1600	1700	vl	Papua New Guinea, Wantok R. Light		7325va	
1600	1700		Russia, Voice of Russia	4965va	4975va	
			6130eu	7260as	7305as	7320as
			9470va			
1600	1700	vl	Rwanda, Radio Rwanda		6055do	
1600	1700	vl	Solomon Islands, SIBC		5020do	9545al
1600	1700		South Korea, KBS World Radio		9515eu	
1600	1700		Taiwan, R Taiwan International		9785as	11550as
1600	1700		Uganda, Dunamis Shortwave		4750af	
1600	1700	DRM/ vl	UK, BBC World Service		3995eu	
1600	1700		UK, BBC World Service		3255af	5975as
			6190af	7355as	9740as	12095me
			15400af	15420af	21470af	
1600	1700		USA, American Forces Network		4319usb	
			5446usb	5765usb	6350usb	7811usb
			10320usb	12133usb	13362usb	
1600	1700		USA, Voice of America		4930af	6080af
			9345va	13600va	15445va	15580af
			17715af	17895af		
1600	1700		USA, WBCQ Monticello ME		9330am	
1600	1700		USA, WBOH Newport NC		5920am	
1600	1700		USA, WEWN Vandiver AL		5755va	
1600	1700		USA, WHRA Greenbush ME		17650af	
1600	1700		USA, WHRI Cypress Creek SC		9495sa	9840va
			11785na			
1600	1700		USA, WINB Red Lion PA		13570am	
1600	1700		USA, WRMI Miami FL		9955na	
1600	1700		USA, WTJC Newport NC		9370na	
1600	1700		USA, WWCR Nashville TN		9980na	12160na
			15825na			
1600	1700		USA, WWRB Manchester TN		9385va	
1600	1700		USA, WYFR/Family Radio Worldwide		6085as	
			11740as	11760af	11850af	13630af
			13695na	15705af	17690af	18980eu
			21455eu			
1600	1700		Zambia CVC/ The Voice Africa	6065af	13650af	
1605	1700		Canada, R Canada International		9610as	
1605	1700	DRM	Canada, R Canada International		9800na	
1615	1700	Sat/Sun	UK, BBC World Service	9410af	11860af	
			15105af			
1630	1700		Guam, KSDA/ AWR		11980as	
1630	1700		Nigeria, Voice of Nigeria/Lagos		15120af	
1630	1700	Sun	UK, Bible Voice BC 9460me			
1640	1650	mtwhfa	Turkmenistan, Turkmen Radio		4930eu	
1645	1700	vl/ mtwhf	Moldova, Radio PMR/Pridnestrovie		7370eu	
1645	1700		Tajikistan, Tajik Radio		7245as	
1645	1700	mwhfa	UK, Bible Voice BC 9460me			
1651	1700	DRM	New Zealand, Radio NZ International		9890pa	
1651	1700		New Zealand, Radio NZ International		9765pa	

1700 UTC - 1PM EDT / 12PM CDT / 10AM PDT

1700	1704		Canada, R Canada International		9610as	
1700	1704	DRM	Canada, R Canada International		9800na	
1700	1705	Sun	Croatia, Voice of Croatia		6165eu	
1700	1715	mtwhfa	Croatia, Voice of Croatia		6165eu	
1700	1715	whfa	UK, Bible Voice BC 9460me			
1700	1720	t	UK, Bible Voice BC 9460me			
1700	1727		Czech Rep, Radio Prague		5930eu	15710af
1700	1730		Jordan, Radio Jordan		11690na	
1700	1730	Sat	USA, WRMI Miami FL		9955am	
1700	1745		UK, BBC World Service		9410af	11860af
1700	1750	DRM	New Zealand, Radio NZ International		9890pa	
1700	1750		New Zealand, Radio NZ International		9765pa	
1700	1757		China, China Radio International		6090as	
			6100va	6140as	7100me	7120as
			7130as	7180as	7205eu	7255eu

1700	1800		7335eu	9600me		
1700	1800		Anguilla, Worldwide Univ Network		11775am	
1700	1800		Australia, CVC International	13635as		
1700	1800		Australia, Radio Australia	5995va	6080va	
			9475as	9580va	9710as	11880as
1700	1800	Sat	Canada, CBC NQ SW Service	9625na		
1700	1800		Canada, CFRX Toronto ON	6070na		
1700	1800		Canada, CFVP Calgary AB	6030na		
1700	1800		Canada, CKZN St John's NF	6160na		
1700	1800		Canada, CKZU Vancouver BC	6160na		
1700	1800		Canada, R Canada International		9610as	
1700	1800		Costa Rica, Worldwide Univ Network		7325va	
			9725va			
1700	1800		Egypt, Radio Cairo	12170af		
1700	1800		Equatorial Guinea, Radio Africa		15190af	
1700	1800		Germany, CVC Intl/Voice Africa		15745af	
1700	1800	vl	Italy, NEXUS/IRRS	15650af		
1700	1800		Malaysia, RTM/Traxx FM		7295as	
1700	1800		Nigeria, Radio Nigeria/Kaduna	4770do		
1700	1800		Nigeria, Voice of Nigeria/Lagos		15120af	
1700	1800		Palau, T8WH/World Harvest		9930as	
1700	1800	vl	Papua New Guinea, Wantok R. Light		7325va	
1700	1800		Russia, Voice of Russia		4975me	6175as
			7125as	7320eu	9470va	
1700	1800	vl	Rwanda, Radio Rwanda		6055do	
1700	1800	vl	Solomon Islands, SIBC		5020eu	9545al
1700	1800	vl	South Africa, Channel Africa		15235af	
1700	1800		Taiwan, R Taiwan International		11850eu	
1700	1800		Uganda, Dunamis Shortwave		4750af	
1700	1800		UK, BBC World Service		3255af	5975as
			6190af	7355as	9740as	11665af
			12095af	15400af	15420af	
1700	1800	DRM/ vl	UK, BBC World Service		3995eu	
1700	1800	Sun	UK, Bible Voice BC	9460me		
1700	1800		USA, American Forces Network		4319usb	
			5446usb	5765usb	6350usb	7811usb
			10320usb	12133usb	13362usb	
1700	1800		USA, Voice of America		6080af	13710af
			15580af	17895af		
1700	1800		USA, WBOH Newport NC		5920am	
1700	1800		USA, WEWN Vandiver AL		15610eu	
1700	1800		USA, WHRA Greenbush ME		17650af	
1700	1800		USA, WHRI Cypress Creek SC		9495sa	9840va
			11785na			
1700	1800		USA, WINB Red Lion PA		13570am	
1700	1800		USA, WRMI Miami FL		9955am	
1700	1800		USA, WTJC Newport NC		9370na	
1700	1800		USA, WWCR Nashville TN		9980na	12160na
			15825na			
1700	1800		USA, WWRB Manchester TN		9385va	
1700	1800		USA, WYFR/Family Radio Worldwide		9790af	
			13630af	13695na	17545af	17555am
			18980eu	21455eu	21680af	
1700	1800		Zambia CVC/ The Voice Africa		4965af	9420af
1715	1730		Vatican City, Vatican Radio		4005eu	5885eu
			7250eu	7290eu	9645eu	
1715	1800		UK, Bible Voice BC	9460me		
1730	1745		UK, Bible Voice BC	9460me		
1730	1800		Slovakia, R Slovakia International		5915eu	
			6055eu			
1730	1800	mtwhf	UK, Sudan Radio Service		9840af	
1730	1800		Vatican City, Vatican Radio		9755af	11625af
			13765af			
1745	1800		Bangladesh, Bangla Betar		7250as	
1745	1800		India, All India Radio		7410eu	9445af
			9950eu	11620eu	11935af	15075af
			15155af	17670af		
1751	1800	DRM	New Zealand, Radio NZ International		9890pa	
1751	1800		New Zealand, Radio NZ International		9765pa	

1800 UTC - 2PM EDT / 1PM CDT / 11AM PDT

1800	1804		Canada, R Canada International		9610as	
1800	1815	vl	UK, Bible Voice BC	9460me		
1800	1825		Vietnam, Voice of Vietnam		5955eu	
1800	1827		Czech Rep, Radio Prague		5930eu	9400va
1800	1830		Australia, CVC International		13635as	
1800	1830		Nigeria, Radio, National Svc/Abuja		7275do	
1800	1830	DRM	Romania, R Romania International		5895eu	
1800	1830		South Africa, AWR Africa		3215af	3345af
			11830af			
1800	1830		UK, BBC World Service		7260as	9740as
1800	1830	mtwhf	USA, Voice of America		4930af	12080af
			15775af			
1800	1850		New Zealand, Radio NZ International		9765pa	
1800	1850	DRM	New Zealand, Radio NZ International		9890pa	
1800	1856		Romania, R Romania International		7215eu	
			9640eu			

1800	1857		China, China Radio International		6020eu	
			6100eu	6165me	7100eu	7265eu
1800	1859		Canada, R Canada International		7185af	
			11875af	13650af	15365af	17790af
1800	1900		Anguilla, Worldwide Univ Network		11775am	
1800	1900	mtwhf	Argentina, RAE		9690va	15345eu
1800	1900		Australia, Radio Australia		6080va	7240as
			9475va	9580as	9710as	11880as
1800	1900		Bangladesh, Bangla Betar		7250eu	
1800	1900		Canada, CFRX Toronto ON		6070na	
1800	1900		Canada, CFVP Calgary AB		6030na	
1800	1900		Canada, CKZN St John's NF		6160na	
1800	1900		Canada, CKZU Vancouver BC		6160na	
1800	1900		Costa Rica, Worldwide Univ Network		7325va	
			9725va			
1800	1900		Equatorial Guinea, Radio Africa		15190af	
1800	1900		Germany, CVC Intl/Voice Africa		11775af	
1800	1900	DRM/vl	Germany, Deutsche Welle		3995eu	
1800	1900		India, All India Radio		7410eu	9445af
			9950eu	11620eu	11935af	15075af
			15155af	17670af		
1800	1900		Kuwait, Radio Kuwait		11990va	
1800	1900		Malaysia, RTM/Traxx FM		7295as	
1800	1900		Netherlands, R Netherlands Worldwide		6020af	
			11655af	12045af		
1800	1900		Nigeria, Radio Nigeria/Kaduna		4770do	
1800	1900		Nigeria, Voice of Nigeria/Lagos		15120af	
1800	1900		North Korea, Voice of Korea		7570eu	12015eu
1800	1900		Palau, T8WH/World Harvest		9930as	9955as
1800	1900	vl	Papua New Guinea, Wantok R. Light		7325va	
1800	1900		Poland, Polish Radio		7345eu	
1800	1900	DRM	Poland, Polish Radio		6015eu	
1800	1900		Russia, Voice of Russia		4975me	6125as
			7230af	7240eu	7320eu	7335va
			11510af			
1800	1900	Sat/Sun	Russia, Voice of Russia		6055eu	6175eu
			6245eu			
1800	1900	vl	Rwanda, Radio Rwanda		6055do	
1800	1900	vl	Solomon Islands, SIBC		5020do	9545al
1800	1900		South Korea, KBS World Radio		7275eu	
1800	1900		Swaziland, TWR		3200af	
1800	1900		Taiwan, R Taiwan International		3965eu	
1800	1900		Uganda, Dunamis Shortwave		4750af	
1800	1900	DRM/ vl	UK, BBC World Service		3995eu	
1800	1900		UK, BBC World Service		3255af	5875eu
			5945me	5955va	6190af	7390eu
			9630af	12095af	15400af	15420af
1800	1900	Sat/Sun	UK, Bible Voice BC	6110me	9460va	
1800	1900		USA, American Forces Network		4319usb	
			5446usb	5765usb	6350usb	7811usb
			10320usb	12133usb	13362usb	
1800	1900		USA, Voice of America		6080af	
			11975af	13710af	15580af	17895af
1800	1900		USA, WBCQ Monticello ME		15420am	
1800	1900		USA, WBOH Newport NC		5920am	
1800	1900		USA, WEWN Vandiver AL		15610eu	
1800	1900	mtwhf	USA, WHRA Greenbush ME		15665af	
1800	1900	Sat	USA, WHRA Greenbush ME		13730af	
1800	1900	Sun	USA, WHRA Greenbush ME		17650af	
1800	1900	mtwhf	USA, WHRI Cypress Creek SC		17650va	
1800	1900	Sat/Sun	USA, WHRI Cypress Creek SC		9495va	
1800	1900		USA, WHRI Cypress Creek SC		9840va	11785na
1800	1900		USA, WINB Red Lion PA		13570am	
1800	1900		USA, WRMI Miami FL		9955am	
1800	1900		USA, WTJC Newport NC		9370na	
1800	1900		USA, WWCR Nashville TN		9980na	12160na
			15825na			
1800	1900		USA, WWRB Manchester TN		9385va	
1800	1900		USA, WYFR/Family Radio Worldwide		6045af	
			7395af	9895af	13630af	13695af
			13730na	13780me	15115af	17535am
			17555am	18980eu		
1800	1900		Yemen, Rep of Yemen Radio		9780me	
1800	1900		Zambia CVC/ The Voice Africa		4965af	9420af
1830	1900		Bulgaria, Radio Bulgaria		6200eu	7400eu
1830	1900		UK, BBC World Service		6005af	9410af
1830	1900		UK, Bible Voice BC	9460me		
1845	1900	Sun	UK, Bible Voice BC	7260af		
1851	1900	DRM	New Zealand, Radio NZ International		9890pa	
1851	1900		New Zealand, Radio NZ International		11725pa	

1900 UTC - 3PM EDT / 2PM CDT / 12PM PDT

1900	1928		Vietnam, Voice of Vietnam		7280va	9730va
1900	1929		Germany, Deutsche Welle		11690af	
1900	1930		Germany, Deutsche Welle		9735af	13780af
			15275af			
1900	1935		New Zealand, Radio NZ International		11725pa	

1900	1935	DRM	New Zealand, Radio NZ International	9890pa
1900	1945		India, All India Radio 7410eu 9950eu 11620eu 11935af 15075af	9445af
1900	1945	Sat	UK, Bible Voice BC 6015eu 9460me	7245af
1900	1945		USA, WYFR/Family Radio Worldwide 15565eu 18980eu	6085sa
1900	1957		China, China Radio International 7295va 9440va	7285eu
1900	1957		USA, WYFR/Family Radio Worldwide	7395af
1900	2000		Anguilla, Worldwide Univ Network	11775am
1900	2000		Australia, Radio Australia 6080va 9500va 9580va 9710as 11880as	7240as
1900	2000		Canada, CFRX Toronto ON 6070na	
1900	2000		Canada, CFVP Calgary AB 6030na	
1900	2000		Canada, CKZN St John's NF 6160na	
1900	2000		Canada, CKZU Vancouver BC 6160na	
1900	2000		Egypt, Radio Cairo 9310af	
1900	2000		Equatorial Guinea, Radio Africa	15190af
1900	2000		Germany, CVC Intl/Voice Africa	11775af
1900	2000	DRM/ vl	Germany, Deutsche Welle 3995eu	
1900	2000		Germany, Overcomer Ministries	3975eu
1900	2000		Iran, VOIRI/IRIB 6160as 7330as	
1900	2000	fas	Italy, NEXUS/IRRS 7290va	
1900	2000		Kuwait, Radio Kuwait 11990va	
1900	2000		Malaysia, RTM/Traxx FM 7295as	
1900	2000		Netherlands, R Netherlands Worldwide 11655af 11805af 12045af	7120af
1900	2000		Nigeria, Radio Nigeria/Kaduna 4770do	
1900	2000		Nigeria, Voice of Nigeria/Lagos	15120af
1900	2000		North Korea, Voice of Korea 7100af 11535va 11910af	9975va
1900	2000		Palau, T8WH/World Harvest 9930as	
1900	2000	vl	Papua New Guinea, Wantok R. Light	7325va
1900	2000		Russia, Voice of Russia 6175eu 7290eu 7335af 11510af	7240eu
1900	2000	vl	Rwanda, Radio Rwanda 6055do	
1900	2000	vl	Solomon Islands, SIBC 5020do	
1900	2000	vl	South Africa, Channel Africa 3345af	
1900	2000	mtwhf	Spain, Radio Exterior Espana 9605af	9690eu
1900	2000		Swaziland, TWR 3200af	
1900	2000		Thailand, Radio Thailand World Svc	9805eu
1900	2000	vl	Uganda, UBC Radio 4976do	5026do
1900	2000	DRM/ vl	UK, BBC World Service 3995eu	
1900	2000		UK, BBC World Service 3255af 5945me 5955va 6190af 7390eu 9630af 12095af 15400af	5875eu
1900	2000	Sun	UK, Bible Voice BC 7260af 9470me	
1900	2000		USA, American Forces Network 5446usb 5765usb 6350usb 7811usb 10320usb 12133usb 13362usb	4319usb
1900	2000		USA, KJES Vado NM 15385na	
1900	2000		USA, Voice of America 4930af 4940af 6080af 9785va 11975af 12020va 13710af 15580af 17895af	
1900	2000	mtwhf	USA, WBCQ Monticello ME 7415am	9330am
1900	2000		USA, WBCQ Monticello ME 15420am	
1900	2000		USA, WBOH Newport NC 5920am	
1900	2000		USA, WEWN Vandiver AL 15610eu	
1900	2000	mtwhf	USA, WHRA Greenbush ME 13730af	
1900	2000		USA, WHRI Cypress Creek SC 9495sa 11785na	9840va
1900	2000		USA, WINB Red Lion PA 13570am	
1900	2000		USA, WRMI Miami FL 9955am	
1900	2000		USA, WTJC Newport NC 9370na	
1900	2000		USA, WWCR Nashville TN 9980na 15825na	12160na
1900	2000		USA, WWRB Manchester TN 9385va	
1900	2000		USA, WYFR/Family Radio Worldwide 6020af 7240eu 7345me 7395af 9480af 9520eu 9610af 9885af 13695na 15115af 17535na 17555am	3230af
1900	2000		Zambia CVC/ The Voice Africa 4965af	9420af
1905	1910	Sat	Croatia, Voice of Croatia 6165eu	
1905	1915	mtwhf	Croatia, Voice of Croatia 6165eu	
1905	2000	Mon	South Africa, SA Radio League 3215af	
1930	1958		Serbia, Intl Radio Serbia 6100eu	7200eu
1930	2000	fas	Germany, Pan American BC 9515af	
1930	2000		Iran, VOIRI/IRIB 6010eu 7320eu 11695af	9855af
1930	2000		Slovakia, R Slovakia International 7345eu	5915eu
1930	2000		Turkey, Voice of Turkey 6050eu	
1930	2000		UK, Bible Voice BC 9470me	
1936	1950		New Zealand, Radio NZ International	11725pa
1945	2000	mtwhfa	Albania, Radio Tirana 7465eu	11645na
1951	2000	DRM	New Zealand, Radio NZ International	9890pa
1951	2000		New Zealand, Radio NZ International	11725pa

2000 UTC - 4PM EDT / 3PM CDT / 1PM PDT

2000	2005	Mon	South Africa, SA Radio League 3215af	
2000	2015	Sun	Germany, Pan American BC 9515af	
2000	2025		Turkey, Voice of Turkey 6050eu	
2000	2027		China, China Radio International	7160eu
2000	2028		Iran, VOIRI/IRIB 6010eu 7320eu 11695af	9855af
2000	2030		Egypt, Radio Cairo 9310af	
2000	2030	fa	Germany, Pan American BC 9515af	
2000	2030		Swaziland, TWR 3200af	
2000	2030		USA, Voice of America 4930af 4940af 6080af 11975af 13710af	
2000	2030		Vatican City, Vatican Radio 7365af 9755af 11625af	
2000	2045		USA, WYFR/Family Radio Worldwide 5745eu 9480af 9610af 9635af 11970eu 15115af 15195af 17535na 17575sa	
2000	2050		New Zealand, Radio NZ International	11725pa
2000	2050	DRM	New Zealand, Radio NZ International	9890pa
2000	2057		China, China Radio International 5960eu 5985va 7190eu 7285eu 7295va 9440va 9660eu 11640va 13630va	
2000	2057		Germany, Deutsche Welle 9735af	
2000	2058		Germany, Deutsche Welle 13780af	
2000	2059		Germany, Deutsche Welle 9690af	15275af
2000	2100		Anguilla, Worldwide Univ Network	11775am
2000	2100		Australia, ABC NT Alice Springs 4835do	2310do
2000	2100		Australia, ABC NT Katherine 2485do	
2000	2100		Australia, ABC NT Tennant Creek	2325do
2000	2100	Sat/Sun	Australia, Radio Australia 6080va 12080as	7240va
2000	2100		Australia, Radio Australia 9500va 11650as 11660pa 11880as	
2000	2100		Canada, CFRX Toronto ON 6070na	
2000	2100		Canada, CFVP Calgary AB 6030na	
2000	2100		Canada, CKZN St John's NF 6160na	
2000	2100		Canada, CKZU Vancouver BC 6160na	
2000	2100		Equatorial Guinea, Radio Africa	15190af
2000	2100		Germany, CVC Intl/Voice Africa	11775af
2000	2100	DRM/ vl	Germany, Deutsche Welle 3995eu	
2000	2100	fas	Italy, NEXUS/IRRS 7290va	
2000	2100		Kuwait, Radio Kuwait 11990va	
2000	2100	vl	Liberia, ELWA 4760do	
2000	2100		Malaysia, RTM/Traxx FM 7295as	
2000	2100		Netherlands, R Netherlands Worldwide 11655af 17810af	7120af
2000	2100		Nigeria, Radio Nigeria/Kaduna 4770do	
2000	2100		Nigeria, Voice of Nigeria/Lagos	15120af
2000	2100		Palau, T8WH/World Harvest 9930as	
2000	2100	vl	Papua New Guinea, R East New Britain	3385do
2000	2100	vl	Papua New Guinea, Wantok R. Light	7325va
2000	2100		Russia, Voice of Russia 6145eu 7240eu 7330eu	
2000	2100	vl	Rwanda, Radio Rwanda 6055do	
2000	2100	vl	South Africa, Channel Africa 3345af	
2000	2100	vl	Uganda, UBC Radio 4976do	5026do
2000	2100		UK, BBC World Service 3255af 6190af 9630af 12095af 15400af	6190af
2000	2100	DRM/ vl	UK, BBC World Service 3995eu	
2000	2100		Ukraine, R Ukraine International	5840eu
2000	2100		USA, American Forces Network 5446usb 5765usb 6350usb 7811usb 10320usb 12133usb 13362usb	4319usb
2000	2100		USA, WBCQ Monticello ME 15420am	
2000	2100	smtwhf	USA, WBCQ Monticello ME 7415am	
2000	2100		USA, WBOH Newport NC 5920am	
2000	2100		USA, WEWN Vandiver AL 11520me	
2000	2100	Sat/Sun	USA, WHRA Greenbush ME 11740af	
2000	2100	mtwhf	USA, WHRA Greenbush ME 7520va	
2000	2100	asmtwhf	USA, WHRI Cypress Creek SC 9495va	
2000	2100	f	USA, WHRI Cypress Creek SC 15665va	
2000	2100		USA, WHRI Cypress Creek SC 9515va 11785na	
2000	2100		USA, WINB Red Lion PA 13570am	
2000	2100		USA, WRMI Miami FL 9955am	
2000	2100		USA, WTJC Newport NC 9370na	
2000	2100		USA, WWCR Nashville TN 9980na 15825na	12160na
2000	2100		USA, WWRB Manchester TN 9385va	
2000	2100		USA, WYFR/Family Radio Worldwide 7430eu 9480af 9610af 9635af 11970eu 15115af 15195af 17535na 17575sa	6020af
2000	2100		Zambia CVC/ The Voice Africa 4965af	9420af
2000	2100		Thailand, Radio Thailand World Svc	9535eu
2030	2045		Vietnam, Voice of Vietnam 7220va	7280va
2030	2058		Vietnam, Voice of Vietnam 9550va 9730va	

2030	2100		Cuba, Radio Havana Cuba	11760va	
2030	2100		Sweden, Radio Sweden	9895va	
2030	2100		USA, Voice of America	4930af	4940af
			6080af	7595as	11975af 13710af
2045	2100		India, All India Radio	7410eu	9445eu
			9910pa	9950eu	11620eu 11715pa
2045	2100	DRM	Vatican City, Vatican Radio	9800am	
2050	2100		Vatican City, Vatican Radio	4005eu	5885eu
			7250eu		
2051	2100		New Zealand, Radio NZ International		17675pa
2051	2200	DRM	New Zealand, Radio NZ International		15720pa
2051	2200	DRM	New Zealand, Radio NZ International		15720pa

2100 UTC - 5PM EDT / 4PM CDT / 2PM PDT

2100	2120		Vatican City, Vatican Radio	4005eu	5885eu
			7250eu		
2100	2127		Czech Rep, Radio Prague	5930eu	9430va
2100	2130	mtwhfa	Albania, Radio Tirana	7510eu	9345na
2100	2130		Australia, ABC NT Katherine	2485do	
2100	2130		Australia, ABC NT Tennant Creek		2325do
2100	2130		Austria, AWR-Europe	9830af	
2100	2130	Sat	Canada, CBC NQ SW Service	9625na	
2100	2130		Cuba, Radio Havana Cuba	11760va	
2100	2130		Nigeria, Radio, National Svc/Abuja		7275do
2100	2130		USA, Voice of America	7595as	
2100	2130	DRM	Vatican City, Vatican Radio	9800ca	
2100	2145		USA, WYFR/Family Radio Worldwide		6915eu
			17535na	17555am	
2100	2157		China, China Radio International		5960eu
			6135eu	7120eu	7190eu
			7225eu	7285eu	7325af
			11640af	13630af	9600eu
2100	2157		Germany, Deutsche Welle	13780af	
2100	2159		Germany, Deutsche Welle	7280af	
2100	2200		Angola, Radio Nacional de Angola		7217do
2100	2200		Anguilla, Worldwide Univ Network		11775am
2100	2200		Australia, ABC NT Alice Springs		2310do
			4835do		
2100	2200		Australia, Radio Australia	9500as	9660as
			11650pa	11660pa	11695as
			13630as	15515as	12080as
2100	2200		Belarus, Radio Belarus Minsk	7135eu	7360eu
			7390eu		
2100	2200		Canada, CFRX Toronto ON	6070na	
2100	2200		Canada, CFVP Calgary AB	6030na	
2100	2200		Canada, CKZN St John's NF	6160na	
2100	2200		Canada, CKZU Vancouver BC	6160na	
2100	2200		Equatorial Guinea, Radio Africa		15190af
2100	2200		Germany, Deutsche Welle	9545af	11690af
2100	2200	DRM/ vl	Germany, Deutsche Welle	3995eu	
2100	2200		Germany, Overcomer Ministries		6175eu
2100	2200		Guyana, Voice of Guyana	3291do	
2100	2200		India, All India Radio	7410eu	9445eu
2100	2200		9910pa	9950eu	11620eu
			11715pa		
2100	2200	vl	Liberia, ELWA	4760do	
2100	2200		Malaysia, RTM/Traxx FM	7295as	
2100	2200		New Zealand, Radio NZ International		17675pa
2100	2200		Nigeria, Radio Nigeria/Kaduna	4770do	
2100	2200		Nigeria, Voice of Nigeria/Lagos		7255af
2100	2200		North Korea, Voice of Korea	7570eu	12015eu
2100	2200		Palau, T8WH/World Harvest	9930as	
2100	2200	vl	Papua New Guinea, Wantok R. Light		7325va
2100	2200		Russia, Voice of Russia	6145eu	7330eu
2100	2200	vl	South Africa, Channel Africa	3345af	
2100	2200		Syria, Radio Damascus	9330eu	
2100	2200		UK, BBC World Service	3255af	3915as
			5965as	5975as	6005af
			6190af	6195as	7445af
					15400af
2100	2200	DRM/ vl	UK, BBC World Service	3995eu	
2100	2200		USA, American Forces Network		4319usb
			5446usb	5765usb	6350usb
			10320usb	12133usb	13362usb
2100	2200		USA, Voice of America	6080af	15580af
2100	2200		USA, WBCQ Monticello ME	15420am	
2100	2200	smtwhf	USA, WBCQ Monticello ME	7415am	
2100	2200		USA, WBOH Newport NC	5920am	
2100	2200		USA, WEWN Vandiver AL	11520me	
2100	2200		USA, WHRA Greenbush ME	7520af	
2100	2200		USA, WHRI Cypress Creek SC	7315sa	9525va
			11785na		
2100	2200		USA, WINB Red Lion PA	9265am	
2100	2200		USA, WRMI Miami FL	9955am	
2100	2200		USA, WTJC Newport NC	9370na	
2100	2200		USA, WWCR Nashville TN	7465na	9980na
			12160na		
2100	2200		USA, WWRB Manchester TN	9385va	

2100	2200		USA, WYFR/Family Radio Worldwide		5950na
			7430eu	9480af	9610af
			15115af	15195af	12055af
2100	2200		Zambia CVC/ The Voice Africa	4965af	9420af
2115	2200		Egypt, Radio Cairo	6255eu	
2130	2156		Romania, R Romania International		6030eu
			6115na	7145na	9755na
2130	2157		China, China Radio International		7160eu
			7325eu		
2130	2200		Australia, ABC NT Katherine	5025do	
2130	2200		Australia, ABC NT Tennant Creek		4910do
2130	2200	mtwhfa	Canada, CBC NQ SW Service	9625na	
2130	2200		Guam, KSDA/ AWR	9625as	
2130	2200		Lithuania, Mighty KBC Radio	6055eu	
2130	2200		Sweden, Radio Sweden	7390va	
2130	2200		Turkey, Voice of Turkey	7180va	
2130	2200		USA, Voice of America	7405as	

2200 UTC - 6PM EDT / 5PM CDT / 3PM PDT

2200	2100	Sat/Sun	Spain, Radio Exterior Espana	6125eu	
2200	2225		Turkey, Voice of Turkey	7180va	
2200	2228		Lithuania, Mighty KBC Radio	6055eu	
2200	2228		Serbia, Intl Radio Serbia	6100eu	7200eu
2200	2230		India, All India Radio	7410eu	9445eu
			9910pa	9950eu	11620eu
2200	2230		Japan, NHK World Radio Japan		13640va
2200	2230		South Korea, KBS World Radio		3955eu
2200	2230	w	USA, WBCQ Monticello ME	15420am	
2200	2235		New Zealand, Radio NZ International		17675pa
2200	2235	DRM	New Zealand, Radio NZ International		15720pa
2200	2245		Egypt, Radio Cairo	6255eu	
2200	2245		USA, WYFR/Family Radio Worldwide		17690af
2200	2257		China, China Radio International		5915as
			7170eu		
2200	2259	DRM	Canada, R Canada International		9800na
2200	2300		Anguilla, Worldwide Univ Network		6090am
2200	2300		Australia, ABC NT Alice Springs		2310do
			4835do		
2200	2300		Australia, ABC NT Katherine	5025do	
2200	2300		Australia, ABC NT Tennant Creek		4910do
2200	2300		Australia, HCJB Global	15525as	
2200	2300		Australia, Radio Australia	12010va	13630pa
			15230va	15240pa	15515as
			17795va		17785pa
2200	2300		Belarus, Radio Belarus Minsk	7135eu	7360eu
			7390eu		
2200	2300		Bulgaria, Radio Bulgaria	6200eu	7400eu
2200	2300	smtwhf	Canada, CBC NQ SW Service	9625na	
2200	2300		Canada, CFRX Toronto ON	6070na	
2200	2300		Canada, CFVP Calgary AB	6030na	
2200	2300		Canada, CKZN St John's NF	6160na	
2200	2300		Canada, CKZU Vancouver BC	6160na	
2200	2300		Equatorial Guinea, Radio Africa		15190af
2200	2300		Guyana, Voice of Guyana	3291do	
2200	2300	vl	Liberia, ELWA	4760do	
2200	2300		Malaysia, RTM/Traxx FM	7295as	
2200	2300		Nigeria, Radio Nigeria/Kaduna	4770do	
2200	2300		Nigeria, Voice of Nigeria/Lagos		7255af
2200	2300	vl	Papua New Guinea, Wantok R. Light		7325va
2200	2300		UK, BBC World Service	5955as	5965as
			6110af	6135as	6155af
			9740as	15400af	6195as
2200	2300		Ukraine, R Ukraine International		5830eu
2200	2300		USA, American Forces Network		4319usb
			5446usb	5765usb	6350usb
			10320usb	12133usb	13362usb
2200	2300		USA, Voice of America	5910va	6105va
			7220va	7405as	7425va
			9490va	11610va	7480va
2200	2300	fs	USA, WBCQ Monticello ME	7415am	
2200	2300		USA, WBOH Newport NC	5920am	
2200	2300		USA, WEWN Vandiver AL	11520me	
2200	2300		USA, WHRA Greenbush ME	7520af	
2200	2300		USA, WHRI Cypress Creek SC	9615na	11785na
2200	2300		USA, WINB Red Lion PA	9265am	
2200	2300		USA, WRMI Miami FL	9955am	
2200	2300		USA, WTJC Newport NC	9370na	
2200	2300		USA, WWCR Nashville TN	5070na	7465na
			9980na		
2200	2300		USA, WWRB Manchester TN	9385na	
2200	2300		USA, WYFR/Family Radio Worldwide		5950na
			7285af	9620eu	11740na
			17690af		15440am
2200	2300		Zambia CVC/ The Voice Africa	4965af	
2230	2245	vl/ mtwhf	Moldova, Radio PMR/Pridnestrovie		6240na
2230	2257		Czech Rep, Radio Prague	5930na	9435af

2230	2300	Guam, KSDA/ AWR	15320as	
2230	2300	Sweden, Radio Sweden	5850va	
2230	2300	USA, Voice of America	7230va	9780va
		15445va		
2236	2300	New Zealand, Radio NZ International	15720pa	
2236	2300	DRM New Zealand, Radio NZ International	17675pa	
2245	2300	India, All India Radio	9705eu	9950as
		11620as	11645as	13605as

2300 UTC - 7PM EDT / 6PM CDT / 4PM PDT

2300	0000	Anguilla, Worldwide Univ Network	6090am	
2300	0000	Australia, ABC NT Alice Springs	2310do	
		4835do		
2300	0000	Australia, ABC NT Katherine	5025do	
2300	0000	Australia, ABC NT Tennant Creek	4910do	
2300	0000	Australia, HCJB Global	15525as	
2300	0000	smtwhf Canada, CBC NQ SW Service	9625na	
2300	0000	Canada, CFRX Toronto ON	6070na	
2300	0000	Canada, CFVP Calgary AB	6030na	
2300	0000	Canada, CKZN St John's NF	6160na	
2300	0000	Canada, CKZU Vancouver BC	6160na	
2300	0000	DRM China, China Radio International	9800ca	
2300	0000	China, China Radio International	5990sa	
		6020na	6040na	9570na
2300	0000	Cuba, Radio Havana Cuba	9550sa	
2300	0000	Egypt, Radio Cairo	6850na	
2300	0000	Guyana, Voice of Guyana	3291do	
2300	0000	India, All India Radio	9705eu	9950as
		11620as	11645as	13605as
2300	0000	Iran, VOIR/IRIB	6010eu	7260eu
		9855af	11695af	
2300	0000	Malaysia, RTM/Traxx FM	7295as	
2300	0000	New Zealand, Radio NZ International	15720pa	
2300	0000	DRM New Zealand, Radio NZ International	17675pa	
2300	0000	vi Papua New Guinea, Wantok R. Light	7325va	
2300	0000	UK, BBC World Service	3915as	5955as
		5965as	6000as	6135as
		9570as	9740as	11955as
2300	0000	USA, American Forces Network	4319usb	
		5446usb	5765usb	6350usb
		10320usb	12133usb	13362usb
2300	0000	USA, Voice of America	6105va	7220va
		7265va	7405va	7480va
		11610va		9490va
2300	0000	fas USA, WBCQ Monticello ME	7415am	
2300	0000	USA, WBOH Newport NC	5920am	
2300	0000	USA, WEWN Vandiver AL	11520me	
2300	0000	USA, WHRA Greenbush ME	5850eu	
2300	0000	USA, WHRI Cypress Creek SC	7315sa	5875na
		7335na	9615na	
2300	0000	USA, WRMI Miami FL	9955am	
2300	0000	USA, WTJC Newport NC	9370na	
2300	0000	USA, WWCR Nashville TN	5070na	7465na
		9980na		
2300	0000	USA, WWRB Manchester TN	5050na	5745va
		6890va	9385va	
2300	0000	USA, WYFR/Family Radio Worldwide	5950na	
		9430sa	15400sa	15440am
2300	0000	Zambia CVC/ The Voice Africa	4965af	
2300	2305	vi Liberia, ELWA	4760do	
2300	2315	Nigeria, Radio Nigeria/Kaduna	4770do	
2300	2330	Australia, Radio Australia	9660as	12010pa
		12080pa	13690pa	15230va
		17785va	17795va	
2300	2330	USA, Voice of America	6180va	7460va
		11840va		
2300	2345	DRM USA, WYFR/Family Radio Worldwide	11740na	
2300	2345	Vatican City, Vatican Radio	7370am	
2300	2355	Turkey, Voice of Turkey	5960va	
2300	2356	Romania, R Romania International	6015eu	
		6115eu	7105eu	9610na
2300	2357	China, China Radio International	5915as	
		6145as	7180as	7350eu
		11790as		9610as
2305	0000	Canada, R Canada International	9755na	
2315	2330	Croatia, Voice of Croatia	3985eu	7375sa
2315	2330	mtwhf Moldova, Radio PMR/Pridnestrovie	6240na	
2330	0000	Australia, Radio Australia	9660as	12010as
		12080as	13690as	15230va
		17750va	17795va	
2330	0000	UK, BBC World Service	6170as	
2330	0000	USA, Voice of America	6180va	7460va
		11655va	11840va	13640va
2330	0000	m USA, WBCQ Monticello ME	7415am	
2330	2357	Czech Rep, Radio Prague	5930na	7345na
2330	2358	Vietnam, Voice of Vietnam	9840as	12020as

MT ENGLISH LANGUAGE SHORTWAVE STATION RESOURCE GUIDE

Albania, Radio Tirana	http://rtsh.sil.at/
Angola, Radio Nacional de Angola	www.rna.ao/
Anguilla, Worldwide Univ Network	www.worldwideuniversitynetwork.com/
Argentina, RAE	www.radiocanal.gov.ar/rae/rae.asp
Australia, ABC NT Alice Springs	www.abc.net.au/radio/
Australia, ABC NT Katherine	www.abc.net.au/radio/
Australia, ABC NT Tennant Creek	www.abc.net.au/radio/
Australia, CVC International	www.christianvision.com/
Australia, HCJB Global	www.hcjb.org/
Australia, Radio Australia	www.abc.net.au/ra/
Austria, AWR Europe	www.awr2.org/
Austria, Radio Austria Intl	http://oe1.orf.at/service/international
Bahrain, Radio Bahrain	www.radiobahrain.net/
Bangladesh, Bangla Betar	www.betar.org.bd/
Belarus, Radio	www.radiobelarus.tv.by/eng/
Bhutan, BBS	www.bbs.com.bt/
Bulgaria, Radio	www.bnr.bg/
Canada, CBC NQ SW Service	www.cbc.ca/north/
Canada, Radio Canada Intl	www.rcinet.ca/
China, China Radio Intl	www.cri.cn/
Costa Rica, Worldwide Univ Network	www.worldwideuniversitynetwork.com/
Croatia, Croatian Radio	www.hrt.hr/
Cuba, Radio Havana	www.radiohc.cu/
Czech Rep, Radio Prague	www.radio.cz/en/
Finland, Overcomer Ministries	www.overcomerministries.org
France, Radio France Intl	http://rfienglish.com
Germany, AWR Europe	www.awr2.org/
Germany, CVC Intl/Voice Africa	www.christianvision.com/
Germany, Deutsche Welle	www.dw-world.de/
Germany, Overcomer Ministries	www.overcomerministry.org/
Germany, Pan American BC	www.radiopanam.com/
Germany, The Overcomer Ministries	www.overcomerministry.org/
Germany, TWR Europe	www.twr.org/
Greece, Voice of Greece	www.voiceofgreece.gr/
Guam, AWR/KSDA	www.awr2.org/
Guam, TWR/KTWR	www.twr.org/
Guyana, Voice of	http://voiceofguyana.com/
India, All India Radio	www.allindiaradio.org/
Indonesia, Voice of Indonesia	www.vi-online.com/
Iran, Voice of the Islamic Rep of Iran	www.2.irib.ir/worldservice/
Italy, IRRS	www.nexus.org
Japan, NHK World/Radio Japan	www.nhk.or.jp/english/
Jordan, Radio	www.rtvjo/ri/index.php
Latvia, Radio SWH	www.radioswh.lv/index.php
Liberia, ELWA	www.elwaministries.org/
Liberia, Star Radio	www.radioswh.lv/index.php
Libya, Voice of Africa	www.libc.net/home.php
Lithuania, Radio Vilnius	www.lt.lt/
Malaysia, RTM/Traxx FM	www.traxxfm.net/index.php
Malaysia, RTM/Voice of Malaysia	http://202.190.233.9/vom/utama.htm
Monaco, TWR Europe	www.twr.org/
Nepal, Radio Nepal	www.radionepal.org/
Netherlands, Radio Netherlands	www.radioneetherlands.nl/
New Zealand, Radio NZ Intl	www.rnz.com
Nigeria, Radio, Natl Svc/Abuja	http://radionigeriaonline.com
Nigeria, Radio/Kaduna	http://radionigeriaonline.com
Nigeria, Voice of/ Ext. Svc Lagos	www.voiceofnigeria.org
Oman, Radio Oman	www.oman-tv.gov.om
Pakistan, Radio	www.radio.gov.pk
Papua New Guinea, NBC	www.nbc.com.pg/
Papua New Guinea, Wantok R. Light	http://wantokradio.net/
Philippines, Radio Pilipinas	www.radiopilipinas.com/
Poland, Polish Radio	www.polskieradio.pl/zagranica/gb/
Romania, Radio Romania Intl	www.rri.ro/
Russia, Voice of Russia	www.vor.ru/world.html
Saudi Arabia, BSKSA	www.saudiradio.net/
Slovakia, Radio Slovakia Intl	www.rsi.sk
Solomon Islands, SIBC	www.sibconline.com.sb/
South Africa, AWR Africa	www.awr2.org/
South Africa, Channel Africa	www.channelafrica.org
South Africa, Trans World Radio	www.twr.org/
South Korea, KBS World Radio	http://rki.kbs.co.kr/english/
Spain, Radio Exterior Espana	www.ree.rne.es/
Sri Lanka, SLBC	www.slbc.lk
Swaziland, Trans World Radio	www.twr.org/
Sweden, Radio	www.sr.se/rs/english/
Syria, Radio Damascus	www.rtv.gov.sy/
Taiwan, Radio Taiwan Intl	http://english.rti.org.tw/
Thailand, Radio	www.hsk9.com/
Turkey, Voice of	www.trt.net.tr
UK, BBC World Service	www.bbc.co.uk/worldservice/
UK, Bible Voice BC	www.biblevoice.org/
UK, FEBA	www.feba.org.uk
UK, Sudan Radio Service	www.sudanradio.org/
Ukraine, Radio Ukraine Intl	www.nrcu.gov.ua/
USA, American Forces Radio	http://myafn.dodmedia.osd.mil/
USA, KNLS Anchor Point AK	www.knls.org/
USA, KTBN Salt Lake City UT	www.tbn.org/
USA, KWHR Naalehu HI	www.whr.org/
USA, Voice of America	www.voanews.com/
USA, WBCQ Monticello ME	www.wbcq.com/
USA, WBOH Newport NC	www.fbndradio.com/
USA, WEWN Vandiver AL	www.ewtn.com
USA, WHRA Greenbush ME	www.whr.org/
USA, WHRI Cypress Creek SC	www.whr.org/
USA, WINB Red Lion PA	www.winb.com/
USA, WRMI Miami FL	www.wrmi.net/
USA, WTJC Newport NC	www.fbndradio.com/
USA, WWCR Nashville TN	www.wvcr.com
USA, WWRB Manchester TN	www.wvrb.org/
USA, WYFR/Family Radio Worldwide	www.worldwide.familyradio.org
Uzbekistan, CVC International	www.christianvision.com/
Vatican City, Vatican Radio	www.vaticanradio.org
Vietnam, Voice of Vietnam	www.vov.org.vn
Yemen, Rep of Yemen Radio	www.yemenradio.net
Zambia, CVC Intl/Christian Voice	www.christianvision.com/

Monitoring the US Military on HF

I have had several questions from readers recently asking if the U.S. military still uses HF or where have all the military HF communications gone off to? Most people will be surprised to know that the U.S. military is still one of the larger users of the HF radio spectrum, but things have changed quite a bit in the last 10 years.

Some of the apparent lack of activity I can attribute to the solar cycle minimum we are currently experiencing. The lack of sunspots limits the use of higher frequencies and also reduces the amount of worldwide communications we can actually hear from our shack. But also, newer technologies are coming into play that allow for more digital and less analog voice communications than we experienced just a few short years ago.

This month, I will start our look at HF DoD comms with the largest and most visible of the Department of Defense (DoD) HF systems – the HFGCS network.

❖ USAF High Frequency Global Communications System (HFGCS)

The HFGCS System is a worldwide network of 13 high-power HF stations providing air/ground HF command and control radio communications between ground agencies and U.S. military aircraft and ships. Allied military and other aircraft are also provided support as appropriate. The HFGCS is not dedicated to any service or command, but supports all DoD authorized users on a traffic precedence/priority basis.

This over-the-horizon, long haul communication system provides automated and operator assisted voice services, data transmission and an HF e-mail capability that has an interface to both the classified and unclassified DoD email networks. General services provided by the HFGCS to its users include:

- General Phone Patch and Message Relay Services
- Automatic Link Establishment (ALE)
- HF Data Support
- Command and Control Mission Following
- Emergency Assistance
- Broadcasts
- HF Direction Finding Assistance
- Air Traffic Control(ATC) Support
- E-Mail connectivity to NIPRNeT and SIPRNeT

Mark Grant, the program manager of the HFGCS, wrote in a recent published article:

“The attacks of 9/11, and subsequently the global War on Terror, caused extensive use of the HFGCS system by many units to complete their military missions. Immediately after the 9/11 attacks, satellites were saturated with users, causing many of them to shut down. This crippled the ability of many military units and Government officials to coordinate a response to the event.”

Grant stated that, “Air Force One was no exception; air-to-ground telephone communications were severely degraded. This is where HFGCS stepped in. The HFGCS operators at Andrews AFB were able to connect Air Force One, enabling air-to-ground phone calls over HF.”

“The E-3 Airborne Warning and Control System aircraft used the HF e-mail capability during Operation Iraqi Freedom. In a point-to-point configuration, the system was used to send mission data to and from this vital C2 platform,” Grant said.

Today, AWACS uses the system to send classified messages over the air. These messages can be vital when an air tasking order change is required. HFGCS was the key enabler to passing this data from the ground to airborne mission crew personnel.

❖ Modernizing the HFGCS

This network has undergone extensive modernization over the last decade. SCOPE Command replaced the older high power Global HF equipment. SCOPE Command incorporates and embraces Automatic Link Establishment (ALE) technology to automate communications. All HFGCS transmit and receive equipment is remotely controlled from the Centralized Network Control Station (CNCS) at Andrews Air Force Base (AFB), Maryland, just outside of Washington, D.C.

An HFGCS station consists of three sites: transmitter, receiver, and control, including station infrastructure of antennas and feedlines, and inter-site communications, plus other support systems. Also considered to be part of the system are the operators and maintainers, logistics support, and the training system.

The SCOPE Command HF radio system functions as totally integrated HF radio equipment. The ground stations allow remote or local operators to select operating frequencies, sideband selection, transmitter power, antenna

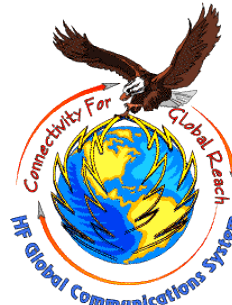

selection, and azimuth selection for directional antennas, half or full duplex operation, and initiation of an Automatic Link Establishment (ALE) sequence.

Late last year, another significant change was announced by the U.S. Air Force in conjunction with this network. The 130-person 319th Communications Squadron at Grand Forks AFB, North Dakota, is busy preparing the base for a new critical project for the entire Air Force. As mentioned previously, HFGCS is operated by communications technicians at Andrews Last year, Air Mobility Command officials selected Grand Forks AFB to take on responsibilities as the system’s alternate control station.

The “new mission will task us with the responsibility of supporting the airborne communications system used by the White House, the Joint Chiefs of Staff and other major commands around the globe,” said Lt. Col. Sam Bass, the 319th Communication Squadron commander.

To prepare for this mission, base officials started a sizable facility renovation project to house the sophisticated support computers and will soon have dozens of high-speed communications circuits installed.

“The new circuits will ensure reliable connectivity to antenna locations around the world to provide secure data and voice connections to command and control aircraft,” said Staff Sgt. Russell Mullens of the 319th CS Plans and Resources Flight.

When the alternate control station becomes operational in 2009, Grand Forks AFB communicators will ensure that national leadership flying around the world will be able to communicate securely.

Another item we have uncovered is a possible new station to upgrade Central Command (CENTCOMs) capability in the Middle East. The new station is supposed to be located at the Al Udeid Air Base in Qatar. As of this writing, we have still not seen any evidence that this new HFGCS station has come online.

❖ Published Frequency Listings

HFGCS stations operate on “core” frequencies to provide increased “Global” coverage. The published frequency listing does not reflect complete system frequency authorizations. These published frequencies will be used for initial contact, EAM broadcasts, and short-term C2 phone patch and message delivery. Other extended or special services will be moved to each station’s available “discrete” frequencies.

QUICK GUIDE TO HFGCS FREQUENCIES

Note: All frequencies are in kiloHertz (kHz) unless otherwise noted.
 Collective call sign: MAINSAIL
 Station Call sign: [Station name] GLOBAL
 Primary HFGCS Frequencies - 24 Hours: 8992.0 and 11175.0 kHz
 Back up HFGCS Frequencies - Day: 13200.0 and 15016.0 kHz
 Back up HFGCS Frequencies - Night: 4724.0 and 6739.0 kHz

STATION FREQUENCY GUIDE

Summer Schedule (April-September)

Andrews AFB, MD
 4721.0 0500-1330Z; 6739.0 0300-1600Z; 8992.0 24 hours; 11175.0 24 hours;
 13200.0 1330-0500Z; 15016.0 1600-0300Z

Ascension Island
 4721.0 2300-0700Z; 6739.0 2200-0900Z; 8992.0 24 hours; 11175.0 24 hours;
 13200.0 0700-2300Z; 15016.0 0900-2200Z

Croughton AB, UK
 4721.0 2300-0600Z; 6712.0 2100-0800Z; 8992.0 24 hours; 11175.0 24 hours;
 13200.0 0600-2300Z; 15016.0 0800-2100Z

Diego Garcia
 4721.0 1400-0100Z; 6739.0 1200-0200Z; 8992.0 24 hours; 11175.0 24 hours;
 13200.0 0100-1400Z; 15016.0 0200-1200Z

Elmendorf AFB, AK
 4721.0 0600-1500Z; 6739.0 0400-1700Z; 8992.0 24 hours; 11175.0 24 hours;
 13200.0 1500-0600Z; 15016.0 1700-0400Z

Andersen AFB, GU
 4721.0 1300-2200Z; 6739.0 1100-2400Z; 8992.0 24 hours; 11175.0 24 hours;
 13200.0 2200-1300Z; 15016.0 2400-1100Z

Hickam AFB, HI
 4721.0 0800-1700Z; 6739.0 0700-1800Z; 8992.0 24 hours; 11175.0 24 hours;
 13200.0 1700-0800Z; 15016.0 1800-0700Z

Lajes AB, Azores
 4721.0 2200-0800Z; 6739.0 2000-1200Z; 8992.0 24 hours; 11175.0 24 hours;
 13200.0 0800-2200Z; 15016.0 1200-2000Z

Offutt AFB, NE
 4721.0 0400-1330Z; 6730.0 0200-1700Z; 8992.0 24 hours; 11175.0 24 hours;
 13200.0 1330-0400Z; 15016.0 1700-0200Z

Salinas, Puerto Rico
 4721.0 0400-1200Z; 6730.0 0100-1400Z; 8992.0 24 hours; 11175.0 24 hours;
 13200.0 1200-0400Z; 15016.0 1400-0100Z

Sigonella, Sicily, Italy
 4721.0 2200-0530Z; 6739.0 1900-0900Z; 8992.0 24 hours; 11175.0 24 hours;
 13200.0 0530-2200Z; 15016.0 0900-1900Z

West Coast, CA
 4721.0 0600-1400Z; 6739.0 0300-1800Z; 8992.0 24 hours; 11175.0 24 hours;
 13200.0 1400-0600Z; 15016.0 1800-0300Z (see note)

Yokota AB, Japan
 4721.0 1300-2200Z; 6739.0 1100-2200Z; 8992.0 24 hours; 11175.0 24 hours;
 13200.0 2200-1300Z; 15016.0 2200-1100Z

Winter Schedule (October-March)

Andrews AFB, MD
 4721.0 2400-1200Z; 6739.0 2200-1400Z; 8992.0 24 hours; 11175.0 24 hours;
 13200.0 1200-2400Z; 15016.0 1400-2200Z

Ascension Island
 4721.0 2200-0800Z; 6739.0 2100-1000Z; 8992.0 24 hours; 11175.0 24 hours;
 13200.0 0800-2200Z; 15016.0 1000-2100Z

Croughton AB, UK
 4721.0 1800-0600Z; 6712.0 1700-0900Z; 8992.0 24 hours; 11175.0 24 hours;
 13200.0 0600-1800Z; 15016.0 0900-1700Z

Diego Garcia
 4721.0 1600-2300Z; 6739.0 1400-0200Z; 8992.0 24 hours; 11175.0 24 hours;
 13200.0 2300Z-1600Z; 15016.0 0200-1400Z

Elmendorf AFB, AK
 4721.0 0330-1630Z; 6739.0 0200-1800Z; 8992.0 24 hours; 11175.0 24 hours;
 13200.0 1630-0330Z; 15016.0 1800-0200Z

Andersen AFB, GU
 4721.0 1300-2030Z; 6739.0 0800-2200Z; 8992.0 24 hours; 11175.0 24 hours;
 13200.0 2030-1300Z; 15016.0 2200-0800Z

Hickam AFB, HI
 4721.0 0700-1600Z; 6739.0 0400-1800Z; 8992.0 24 hours; 11175.0 24 hours;
 13200.0 1600-0700Z; 15016.0 1800-0400Z

Lajes AB, Azores
 4721.0 1800-0730Z; 6739.0 1700-0900Z; 8992.0 24 hours; 11175.0 24 hours;
 13200.0 0730-1800Z; 15016.0 0900-1700Z

Offutt AFB, NE
 4721.0 0030-1330Z; 6739.0 2300-1400Z; 8992.0 24 hours; 11175.0 24 hours;
 13200.0 1330-0030Z; 15016.0 1400-2300Z

Salinas, Puerto Rico
 4721.0 0100-1100Z; 6739.0 2300-1200Z; 8992.0 24 hours; 11175.0 24 hours;
 13200.0 1100-0100Z; 15016.0 1200-2300Z

Sigonella, Sicily, Italy
 4721.0 1700-0500Z; 6739.0 1600-0800Z; 8992.0 24 hours; 11175.0 24 hours;
 13200.0 0500-1700Z; 15016.0 0800-1600Z

West Coast, CA
 4721.0 0130-1400Z; 6739.0 0030-1500Z; 8992.0 24 hours; 11175.0 24 hours;
 13200.0 1400-0130Z; 15016.0 1500-0030Z (see note)

Yokota AB, Japan
 4721.0 0900-2100Z; 6739.0 0800-2200Z; 8992.0 24 hours; 11175.0 24 hours;
 13200.0 2100-0900Z; 15016.0 2200-0800Z

Note: Station McClellan renamed West Coast.

❖ Missions Performed by the HFGCS

As already mentioned, SCOPE Command is an upgrade and modernization program that is upgrading the high frequency (HF) ground stations worldwide to support four unique missions:

United States Air Force (USAF) Global

This mission supports a wide range of users by providing air-ground-air, ship-to-shore, broadcast, and Automatic Link Establishment (ALE) capability to various DoD customers.

HFGCS ALE CHANNEL CHART

Station	Address	Frequencies
Andrews	ADW	3137.0 4721.0 5708.0 6721.0 9025.0 11226.0 13215.0 15043.0 18003.0 23337.0
Ascension	HAW	3137.0 4721.0 6721.0 9025.0 11226.0 13215.0 15043.0 18003.0 23337.0
Croughton	CRO	3137.0 4721.0 5708.0 6721.0 9025.0 11226.0 13215.0 15043.0 18003.0 23337.0
Diego Garcia	JDG	3137.0 4721.0 5708.0 6721.0 9025.0 11226.0 13215.0 15043.0 18003.0 23337.0
Elmendorf	AED	3137.0 4721.0 5708.0 6721.0 9025.0 11226.0 13215.0 15043.0 18003.0 23337.0
Andersen	GUA	3137.0 4721.0 5708.0 6721.0 9025.0 11226.0 13215.0 15043.0 18003.0 23337.0
Hickam	HIK	3137.0 4721.0 6721.0 9025.0 11226.0 13215.0 15043.0 18003.0 23337.0
Lajes	PLA	3137.0 4721.0 5708.0 6721.0 9025.0 11226.0 13215.0 15043.0 18003.0 23337.0
West Coast	MCC	3137.0 4721.0 5708.0 6721.0 9025.0 11226.0 13215.0 15043.0 18003.0 23337.0
Offutt	OFF	3137.0 4721.0 5708.0 6721.0 9025.0 11226.0 13215.0 15043.0 18003.0 23337.0
Salinas	JNR	3137.0 4721.0 5708.0 6721.0 9025.0 11226.0 13215.0 15043.0 18003.0 23337.0
Sigonella	ICZ	3137.0 4721.0 5708.0 6721.0 9025.0 11226.0 13215.0 15043.0 18003.0
S. Atlantic	MPA	3137.0 4721.0 5708.0 6721.0 9025.0 11226.0 13215.0 15043.0 18003.0 23337.0
Yokota	JTY	3137.0 4721.0 5708.0 6721.0 9025.0 11226.0 13215.0 15043.0 18003.0

Mystic Star

This mission provides HF communications for the President, Vice-President, cabinet members, and other senior government and military officials while aboard Special Air Mission aircraft. A wide variety of HF frequencies and encrypted communications are used for this mission.

SITFAA

This is a Spanish/English/Portuguese language network (Information and Telecommunications System of the American Air Forces) supporting North, Central, and South American Air Force users in 18 countries. Provides voice and data HF links. Frequencies reported as part of this mission include:

4503.5 4764.0 5743.5 7317.0 7320.0 7929.0 7932.0 7935.0 8059.0 8061.0
 8064.0 8067.0 9043.5 11547.0 13217.0 13897.0 13918.0 13921.0 14640.0
 14643.0 14646.0 14649.0 15675.0 18367.5 18370.5 18373.5 18376.5 19497.0
 19500.0 20597.0 20600.0 20860.0 23066.5 24860.0

DCS HF Entry

This mission provides HF communications services for tactical units in areas of the world where Defense Communications System connectivity is unavailable or insufficient. Frequencies that have been reported as part of this mission include:

2001.0 2582.0 2618.0 2664.0 2797.0 3373.0 4445.0 4505.0 4528.0 4562.5
 4595.0 4985.0 5370.0 5400.0 5434.0 5817.5 5820.0 5835.0 6830.0 6897.5
 6905.0 6912.5 6989.0 7362.5 7469.0 7690.0 7935.0 8000.0 8041.0 8060.0
 8064.0 8162.0 8170.0 9145.0 9190.0 9259.0 9320.0 9417.5 9958.0 9970.0
 10586.0 10690.0 10720.0 10730.0 11410.0 11422.5 11482.5 11513.5 11535.0
 11995.0 12045.0 12060.0 12090.0 12105.0 12240.0 12255.0 12324.0 13545.0
 13610.0 13680.0 14375.0 14385.0 14646.0 14667.0 14867.5 15595.0 15895.0
 16090.0 16100.0 16170.0 16225.0 16340.0 16422.5 17410.0 17460.0 17480.0
 17500.0 17519.0 18036.0 18060.0 18162.5 19005.0 19047.0 19160.0 19510.0
 20035.0 20050.0 20075.0 20124.0 20151.0 20350.0 20400.0 20425.0 20438.0
 20550.0 20763.0 20950.0 21856.0 21886.0 21918.0 23180.0 23500.0 23600.0
 23690.0 23700.0 24120.0 24510.0 25360.0 25425.0 25516.0 26575.0 26650.0
 26750.0 26850.0

In future Milcom columns we will continue to explore other HF radio nets used by the U.S. military to communicate with their forces worldwide.

Money and Radio Times are Tough Everywhere

These days, the economy is on everybody's mind. On my way down to Huntsville this weekend, a pair of announcers on WPLN-1430 were discussing what to call the current mess – A crisis? An emergency? A downturn? Whatever it is, it started affecting the financial industry and has grown to affect just about every other area of business. What does it mean for radio?

Strangely enough (or maybe not), the Great Depression of the 1930s was the golden age of radio. Everybody listened – every business that was still in business advertised. Then again, in the 1930s radio didn't have much competition. If you couldn't afford to go out to the movies/concert hall, radio was really your only alternative for a night's entertainment. Today, obviously there are more choices. Television, the Internet – none of it existed in the 1930s.

The automotive segment is one of the most important groups of advertisers. With many would-be buyers out of work, those with jobs too worried about keeping them to be making large purchases, and financing difficult to find, this segment of advertising has largely dried up. Home improvement doesn't do well either when people are having trouble simply paying their mortgages.

Things are tough everywhere, and radio is no exception.

Clear Channel made headlines (at least in the industry press) on Inauguration Day when they laid off some 1,500 employees. Because of the sheer size of Clear Channel, this figure sounds large – but it isn't out of proportion to layoffs in other radio groups. Many of the layoffs were in the stations' sales departments; DXers probably won't much notice.

What DXers might notice is a promised move towards "national programming." Exactly what this means hasn't been explained. A most likely explanation is "voice tracking," where programming is automated with a centralized announcer pre-recording the "bits" between songs.

What about engineering? We may never hear officially. Most likely, unnecessary technical upgrades will be postponed. One might expect deployment of IBOC to be stalled. (We won't, however, see it removed at stations where it's already been installed. There is little or no ongoing expense for operating IBOC on AM stations once it's been installed, and the ongoing expense for FM-IBOC is fairly small. That said, we may see stations not bothering to repair IBOC equipment if it fails.)

Will we see stations go away altogether? Maine Public Broadcasting had planned to shut down three transmitters along the eastern edge of the state. The TV transmitter in Calais and FM



WMCA-570's transmitter building in New Jersey.

transmitters in Calais and Fort Kent would have been silenced for six months. This plan is on hold at deadline, with serious opposition in the state's legislature. MPBN's stations statewide will also be going off the air for five hours every night.

I know of a small number – fewer than five – small AM stations that have suspended operations for financial reasons. It is fairly common for such suspensions to become permanent. But if, by this time next year, it looks like things are turning around, I think the vast majority of broadcasters will stick it out.

❖ Analog TV: maybe not dead yet?

Last time, I wrote a few words on this topic, concerning the so-called "Short-term Analog Flash and Emergency Readiness Act" which would allow analog TV transmitters to remain on the air until sometime in March, but only to broadcast emergency and digital transition information. That bill has since passed and been signed into law, under the much more manageable name the "Analog Nightlight Act." Not that there would be much point to reporting in the April issue of *Monitoring Times* about a law whose effect would end in March.

But it's quite likely that, as you read this in early April, many analog TV transmitters are indeed still on the air. Further legislation was introduced in late January which would completely delay the digital TV changeover into mid-June.

The "DTV Delay Act" passed the Senate on January 26th. It would rescind Congress' action in requiring the FCC to cancel analog TV licenses on February 17th, and would require the Commission to extend those licenses until June 12th.

This Act seems to be an answer to concerns that the public is not ready for the end of analog over-the-air television. The converter box coupon program ran out of money in late 2008. And the Wilmington, North Carolina early shutdown test showed many viewers are unable to receive a digital signal from stations they're used to watching

in analog.

The Delay Act was expected to find easy sailing through the House. So everyone (including myself) was surprised when, a few days after passing the Senate, it failed in the House. Actually, it didn't exactly fail – more House members voted for it than against it. But it failed (by two votes) to get a 2/3 majority. Apparently the greater majority was necessary in order to bypass the normal committee procedure, due to the urgent nature of this legislation.

As I write this, the bill has been re-introduced in both the House and Senate. From what I'm hearing, they're going to try again, but this time going through the normal committee procedure. Only a simple majority is necessary this way. Since the bill has already come within two votes of getting a 2/3 majority, it seems almost certain to get a simple majority. President Obama is outspoken in favor of this bill; you can assume he will sign it into law. Unfortunately it is not likely to see final action until after my deadline.

So chances are, analog TV will still be legal as you read this, for another six weeks or so.

Even though they're still legal, that doesn't necessarily mean they're on the air. The Act explicitly ensures stations may continue to sign off their analog signals on February 17th, as originally planned, as long as they comply with existing FCC regulations requiring that the Commission, and viewers, be notified. Several hundred stations had already made such notifications as of the end of January. These stations include most of the major network-affiliated stations in Nashville, New Orleans, and Wichita, among many other stations.

And then, there are those stations that silenced their analog signals well before February 17th. PBS stations in North Dakota, Nebraska, and Maine all shut down their analogs early. So did the NBC station in Hastings, Nebraska.

In mid-January, all the analog stations in Hawaii signed off. (The stations on Maui have lost their lease on their analog transmitter site. They had to dismantle the analog site in January and February, as tower work at that site later in the year would disturb an endangered species. Their digital transmitters are elsewhere. The shutdown on Maui seemed, apparently, to be a good excuse to also close the analog transmitters on Oahu and the Big Island of Hawaii.) It should be noted there have been no mobs of pitchfork-wielding TV protestors in the 50th State...

TV stations have not budgeted for continued operation of their old analog transmitters after February 17th. The electrical power to operate a TV transmitter is not cheap! I've seen figures of as much as \$20,000/month quoted for high-powered

UHF stations. If times were good, I could see stations finding some extra money in their budgets to fund another four months of analog operation. Of course, times aren't good, and nobody has any extra money in their budget. Some stations have indicated the cost of leaving their analog transmitters on until June would force layoffs.

Bottom line, do not be surprised if most of your local analog TV stations are gone by the time you read this, even though it may have been legal for them to remain on the air.

❖ FCC notes

You'll note in the sidebar that WRGC Sylva, North Carolina has been granted permission to move from 680 kHz to 540. What the sidebar doesn't show is that WRGC will also move their towers – to two different sites. One site will be used for daytime operation; a different site roughly two miles away will be used at night. Ironically, neither site is the one they're using right now.

These two-site operations are rare but not unheard-of. A good example is WMIX-940 Mount Vernon, Illinois. To avoid interfering with other stations, WMIX is required to operate with directional antennas day and night. Their daytime pattern must protect stations to the east and west of Mount Vernon – it beams most of their power north and south. From a transmitter site north of the city, this pattern provides a strong signal to the community.

At night, they must protect stations to the north and south of Mount Vernon – the station must beam its power to the east and west. If this pattern were used from their daytime site north of the city, the signal in town would be too weak to provide good service. (and too weak to comply with FCC regulations...) So a second site, west of the city, is used for nighttime operation.

You will also note in the sidebar an application for a new station in Santee, California, a San Diego suburb. This station also proposes two-site operation, with the two sites about four miles apart. Directional patterns can't explain this one, as the proposed station is non-directional both day and night. If granted it would also be the only Class C ("graveyard") station using two different sites.

❖ Canadian notes

Last time I reported on the CBC's request to move CBE-1550 Windsor to FM 97.5. That application was denied, but the AM station has by no means seen a reprieve. Two FM transmitters would have been necessary to replicate AM-1550's coverage: the 97.5 transmitter in Windsor and another in Leamington. Use of 91.5 for the proposed transmitter in Leamington was found unacceptable, resulting in the denial of the entire application. The application has since been refiled, specifying 91.9 FM in Leamington with a somewhat higher antenna. Presuming it's approved this time, AM 1550's days are numbered.

I also reported on applications filed for two new AM stations in the Greater Toronto Area. There's now a third application on file: United Christian Broadcasters have filed for 1480. As you might guess, this would be a religious station. The frequency was previously used north of Toronto in Newmarket, by station CKDX. CKDX moved to 88.5 FM years ago.

❖ 'Til next month

Have you logged any unexpected last-minute analog TV DX? Write me at 7540 Highway 64 West, Brasstown NC 28902-0098, or by email to dougsmith@monitoringtimes.com. Good DX!

URLS IN THIS MONTH'S COLUMN:

<http://americanbandscan.blogspot.com>

My AM DX blog.

www.chron.com/disp/story.mpl/headline/biz/6221249.html

Houston Chronicle on Clear Channel budget cuts & layoffs.

www.cbc.ca/windsor/

CBC Radio 1/Windsor, on 1550 for now but not for long...

www.mpbnet.com/News/MaineNews/tabid/181/cid/ViewItem/mid/1858/ItemId/8635/Default.aspx

Maine Public Broadcasting plans to close three transmitters.

www.hawaiigoesdigital.com/

Hawaiian TV stations switch to digital early.

[http://thomas.loc.gov/cgi-bin/query/z?c111:S.352:](http://thomas.loc.gov/cgi-bin/query/z?c111:S.352)

The "DTV Delay Act" which would allow analog TV to continue until June.

AMERICAN BANDSCAN STATION REPORT

NEW

New stations on the air:

Wasilla, Alaska	1430	KMBQ	1,000/1,000 ND
(relaying KMBQ-FM 99.7 with light music)			
Mississauga, Ontario	1630	CINA	1,000/680 ND
(South Asian music, announcers in English)			

New station permits granted

Chugiak, Alaska	1160	9,800/410 ND
Stanfield, Arizona	1460	2,000/2,000 DA-2
Brooklet, Georgia	1450	1,000/1,000 ND

New station applications denied/dismissed

Juneau, Alaska	1190	
Santa Maria, California	1320	

Applications for new stations

Santee, California	1400	500/500 ND
Toronto, Ontario	1480	1,000/500

CHANGES

Stations requesting moves to new frequencies

Windsor, Ontario	97.5	CBE	from 1550 AM
			(refiled, to specify different frequency for Leamington FM relayer)
Goodlettsville, Tennessee	830	WQZQ	from 1550
			(also to move city from Clarksville; 2,000 watts daytime only)

Stations granted moves to new frequencies

Daphne, Alabama	540	WASG	from 550
			(also to move city from Atmore; 2,500/19 ND)
Athabasca, Alberta	94.1	CKBA	from 850 AM
Sylva, North Carolina	540	WRGC	from 680
			(5,000/210 DA-N)

Callsign changes

Bakersfield, California	1410	KERI	from KERN
Lompoc, California	1410	KSMA	from KUHL
San Diego, California	1240	KNSN	from KSON
San Francisco, California	1550	KFRC	from KYCY
Santa Maria, California	1440	KUHL	from KINF
Wasco, California	1180	KERN	from KERI
Keystone, Colorado	1320	KWLW	(new station)
Fort Walton Beach, Fla.	1400	WZFN	from WTKE
Rossville, Georgia	980	WUWQ	from WUUS, but promptly changed back
Jeffersonville, Indiana	1450	WQKC	from WAVG
Greenville, Michigan	1380	WGLM	from WSCG
Sauk Rapids, Minnesota	540	WPPI	from WMIN
Sauk Rapids, Minnesota	1010	WMIN	from WPPI
Bellevue, Nebraska	1180	KOIL	from KYDZ
Plattsmouth, Nebraska	1020	KMMQ	from KOIL
Middletown, New York	1400	WYNY	from WMJQ
Ontario, New York	1330	WMJQ	from WYNY
Fair Bluff, N. Carolina	1480	WWKO	from WSRC
Jacksonville, N. Carolina	1400	WSTK	from WJQQ
Salem, Oregon	1390	KVXX	from KKSJ
Powell, Tennessee	1040	WTKI	from WQBB
New Boston, Texas	1530	KLBW	from KNBO
Madison, Wisconsin	1550	WHIT	from WTUX

ND: non-directional

DA-N: directional at night only

DA-D: directional during daytime only

DA-2: directional all hours, two different patterns

DA-3: directional day, night and critical hours, three different patterns

Radio on the Waves

Last winter my wife and I went cruising – and returned to bitterly cold weather and snow. Even so, the cruise remains a pleasant memory while we wait for spring to arrive.

Our group went by bus to New York City and then boarded the *Explorer of the Seas* for a trip to the Caribbean. We visited San Juan, Puerto Rico, St. Thomas, USVI and Samana, Dominican Republic. Like all good radio enthusiasts, I had to take some gear along. My Sangean ATS 505, short wave portable, Icom T90A, and small marine VHF handheld found their way into the luggage, along with my camera.

Although I did not have much leisure time for listening, it is surprising what you can pick up on HF using a whip antenna when you are 12 decks above the ocean. Here are some examples of what I heard:

- 2182 Canadian Coast Guard radio stations
- 2582 ZBR Bermuda Radio, weather broadcast
- 2598 Canadian Coast Guard weather broadcasts
- 2670 US Coast Guard weather
- 2749 Canadian Coast Guard weather
- 4125 Mainly Spanish traffic
- 6501 NMN Chesapeake, US Coast Guard "Iron Mike" weather
- 8420 WLO, Mobile, Alabama
- 8424 SVO, Athens, Greece
- 8502 NMG New Orleans, US Coast Guard "Iron Mike" weather
- 8983 CAMSLANT Chesapeake calling CG 2120

I had several crew and passengers ask me about the short wave radio and also listen to some of the traffic. Gander Radio's weather on 3485, and New York air weather on 6605 kHz especially held their interest. I also got some air traffic on 8847 kHz involving Reach 1020 and a back up frequency of 13306 kHz. The most interesting air traffic was Honolulu Radio



San Juan Pilot Boat

mentioning Fairbanks Alaska weather at 0259Z!

I also monitored some international short-wave broadcasters on various frequencies. Radio Canada International came in well on 9775 kHz and kept me aware of news at home. However, I was pleased to hear the shortwave service of CFRB, Toronto, on 6070 kHz, along the East Coast. The signal was strong in the mornings and I got some weather data that gave me an idea of what to expect on our trip home to Kingston from New York.

I was most interested in the new frequency for CHU, the Dominion Observatory time signal from Ottawa. They recently moved from 7335 kHz to 7850 kHz. Signals in the 7 MHz segment of the spectrum are being shifted to eventually allow 7.0 to 7.2 MHz to be exclusively for amateur radio use. The 7850 signal was heard every evening during the trip. I also heard 3330 at night and did record their 14,670 kHz signal during the daytime. I have sent a report to CHU to verify the reception and also to verify their 7335 kHz signal which went off the air at 0000, January 1, 2009.

❖ VHF/UHF En Route

On the VHF marine band, I monitored some useful traffic. Channels 11 and 14 were heard in the New York Harbor area. While at St. Thomas, channel 12 was used for traffic and channel 14 was the local pilot. One of the other cruise ships had to leave two people behind as they were late returning to the ship, and this was reported to the authorities. I sure hope it was not their last port of call before returning to New York!

The traffic in Samana was on channel 9. It consisted mainly of the local tenders talking in Spanish. They are the small boats which take the passengers ashore when the ship anchors instead of securing to a pier. I do not speak Spanish, but you could tell when something was going on.

The NOAA weather frequencies were very useful as we did encounter some force 8 and even force 9 winds on the trip. The ship was large, 1021 feet long and had stabilizers, so it remained quite steady. Near New York I monitored 162.55 and 162.475 MHz with marine and land forecasts. In San Juan, I heard 162.4, 162.45 and 162.55 MHz with weather given in English and Spanish. St. Thomas also had weather radio on 162.45 and 162.5 MHz.

Like most of the cruise ships, UHF frequencies were used to coordinate activities. The bridge here used 457.525 MHz. I was able to hear the tie up routines, when the ship was cleared by the port authorities, etc.

The most interesting traffic occurred when we were an hour out of Samana. We somehow had damaged a propeller while in the channel. The next morning, we stopped inside the Turks and Caicos Islands. The ship was allowed to drift while they sent divers down to examine the cause of the vibration from the starboard propeller. They also launched two fast rescue zodiacs to recover the divers as the ship was setting at 1.5 to 2 knots, in the wind.

The UHF frequencies for various lines are listed on several web sites. A Google search will turn up the line or vessel you are interested in.



Explorer of the Seas in St. Thomas



Rescue zodiacs from the Explorer of the Seas assisting the divers examining the damaged propeller.

❖ Local Marine Radio Check

Back home in the radio shack, I got an interesting phone call. Wade, on the yacht *Joanna*, is planning a cross Atlantic journey next year. The yacht is being readied over the winter here in Kingston Harbour. He called to ask me how he should ground his radio. I put him in touch with Les, VE3KFS, who has done this on his own boats. Wade also wanted a signal check on his radio. He made a call on 8125 kHz and I monitored the signal. I returned his call and gave him a good report on signal strength and audio.

I was reminded how important marine HF radio still is when I monitored the USCG and the disabled fishing vessel *Green Acre* on 2182. The 125 ton vessel was in need of a tow to port as the engines could not be restarted. Communications were not solid for a while, so I monitored until the communications improved.

The local VHF radio was very active this December. As the Seaway began to close for the winter our weather turned worse. The temperature dropped and the snow became heavy. The wind rose significantly. We had several gale warnings and two storm warnings. Many vessels sought shelter due to weather, both in our area and all over the Great Lakes. The *Canadian Navigator* reported winds of over 50 knots and seas of 25 feet plus on Lake Ontario.

One vessel had to stop at the Iroquois lock. She had accumulated so much ice on her superstructure that the weight caused the vessel to be over the allowed draft for transiting the seaway. The ice had to be removed to allow the vessel to rise in the water.

We also have a local project going on here. The 86 huge windmills are still being built on Wolfe Island. Transportation of windmill parts stopped for the winter, but the tugs *Lac Manitoba* and *Vigilant 1* are still ferrying supplies back and forth from the island. Several marine channels are used in this project and they have had quite a time battling ice and wind this winter.

It is always a good idea to scan the entire marine VHF band occasionally. You will come across users you were not aware of. For example, I heard the USCG ask a station to answer primary: when I scanned the bands I found this was channel 21A.

I also experienced a unique inversion here this fall. For about 6 hours, I could hear Seaway Long Point on Lake Erie using channel 11. This is far beyond the usual range here. This does happen during certain weather conditions, but usually those conditions are during the hot summer weather.

❖ Amateur Radio

If you want to hear amateur marine mobile stations, the best place is still the Maritime Mobile Service Net on 14,300 USB. You can also enjoy some Great Lakes information if you tune to the Transprovincial Net on 7055 kHz LSB at 1600 Eastern Time. Dave VA3SWO is an ex-Great Lakes sailor and loves to chat about the ships. You may even hear VE3GO there, as I frequently enjoy having a chat with my friend.



St. Thomas harbor and cruise ships from Paradise Point

❖ Low Frequency DX

In previous columns I have mentioned copying Navtex Bulletins on 518 kHz using Multipsk to decode the signals. I can finally report reception of the transmission from Bermuda (B) on 518 kHz. They have resumed their transmissions using new equipment, but the signal is usually blocked out here by other stations. However, in between these stations I saw the text warning to stay clear of Bermuda Radio, broadcast by ZBR.

I also wandered down onto the LF bands this December. Although these beacons are not all marine beacons, it was great listening and the CW identifiers made it easy to know what station I was listening to. Over two nights I heard 42 different beacons between 216 and 416 kHz. My best catch was beacon CLB from Wilmington/Carolina Beach. It was weak but identifiable. Equipment used was my sloper antenna and the Kenwood TS-570.

I also heard WE2XGR/6 on 507 kHz. This station is part of the lowfer (low frequency experimental radio) test of the 500 kHz region, with the intent to get this designated as an historic frequency range and to allow amateur use of the frequency. I heard them between 2252 and 2305Z. Reports are requested from listeners. The ID is by CW, but is slow and gives a person good Morse code practice.

According to Richard Dillman W6AWO at the historic marine station KSM, a new coast station has been granted a license. Steve Russell of Stoneham, MD, was granted the call WNE for his station. WNE will use 500 watts on 500 and 472 kHz in the name of the New England Historical Radio Society. This station joins recently licensed KDR, Bellevue, WA (500 and 482 kHz) and WFT, Palmetto,

FL (500 and 486 kHz). They are my next low frequency targets. I have heard KSM on the HF but I want to get them on 500 kHz.

❖ VE3GO

By the time this is printed, my wife and I will have enjoyed the month of March in Myrtle Beach, SC. I plan to take my 2 meter rig and a new Grundig Satellite radio with me so I can do some DX from the sunny south. Plans for the shack here include ground mounting my R-8 in the spring, as it takes too much punishment from the wind and ice on the tower, and adding a long wire for my S-38.

So what have you been hearing on the marine bands lately? Drop us a note at the email above or in care of the Brasstown office and let us know your listening preferences or what you'd like to learn more about when it comes to monitoring radio on the waves.

CHANNEL LIST

9	156.450
11	156.550
12	156.600
14	156.700



Container vessel entering New York Harbor

RDFs Revisited

Only a few times, during my 17+ years with *MT*, have I been surprised by the reader response to something mentioned in one of my columns. The first time was when I lashed together a simple tabletop loop out of some junk box parts and described its construction here (*September 1992*), as well as the follow-on pre-amplifier (*November 1993*). Those columns turned out to be very popular, and reprint requests are still received today.

Last September was another such column. Almost on a lark, I ran a brief piece on marine Radio Direction Finders (RDFs) and their potential use in longwave DXing. With the development of GPS, RDFs have become a rarity on pleasure craft, and many RDF units are now showing up at swap meets. The timing to write about them was apparently right.

Several readers responded with pictures of their own RDF units or had questions about their operation. We were even able to assist one reader with a power cord for his otherwise ready-to-go unit. It turns out that RDFs are wildly popular – more so than I realized. Of course, they have practical advantages because of their directive antennas, but also, many are just fun to look at. As we mentioned, there’s an entire website devoted to RDF images at: www.angelfire.com/space/proto57/rdf.html. (Check out the unit made by Sperry to see one of my favorites – it looks like something out of a Jetson’s episode!)

This month we present one more reader’s RDF treasure – an RCA AR8712 (see photo). This unit is owned by Bob Lewis of Bethany Beach, DE. Bob picked it up at the Kutztown, Pennsylvania, hamfest last year for just \$40. It works well, but he would very much like to find a schematic and operating manual for it.



Doing an online search, I was able to find one picture of an AR8712 (not as nice as Bob’s unit), but unfortunately no leads on user documentation. Is there anyone out there who might

be able to help? Drop me a line at the magazine, and I’ll pass the information on to Bob. About the only thing I could learn about this unit is that the 1.5-volt battery it uses is only needed for the BFO circuit. The unit will operate in regular AM mode without the battery.

❖ Rochester Hamfest – May 30th

One of my favorite radio meets in the Northeastern U.S. has always been the Rochester (NY) Hamfest. The event has consistently been a great place to find vintage radios and parts, including longwave receivers and related accessories. I’ve written before about how I found a nearly perfect National RBL-5 there for \$40 a few years ago.

Now celebrating its 75th year, the Hamfest has some exciting changes in store for attendees this year, starting with an all-new location. This expanded venue, located just outside the city, features nearly unlimited flea market space. There will be clubs, dealers, and traditional “tailgaters” at this meet. The event will be held on Saturday, May 30th. Full information is available online at www.rochesterham.org.

I am working as a volunteer on the hamfest this year, so I would be glad to answer any questions you may have, or at least put you in touch with someone who can. I hope to see you there!

❖ Loggings

Ron Bailey, AA4S, (NC) sent a list of non-USA beacon loggings made with his Drake R8A receiver and seven 560-foot long terminated Beverage antennas. He also uses an MFJ-784B tunable DSP filter with this setup. You may recognize Ron’s name from his recent articles on mediumwave DXing here in *MT*, but he is also a longwave fan, and shares some of his best catches in Table 1. Ron also has a list of his best daytime catches, which I plan to include next month.

For a complete list of ITU codes, see www.wordiq.com/definition/ITU_letter_codes
See you next month!

Table 1. Non-USA Loggings Heard in NC

FREQ	ID	PR/ITU	CITY
206	QI	NS	Yarmouth
212	TS	ON	Timmins
212	SJ	NB	Saint John
218	YUY	QC	Rouyn-Noranda
218	RL	ON	Red Lake
219	YMG	ON	Manitouwadge
220	BX	QC	Lourdes-de-Blanc
221	HM	ON	Hamilton
223	YYW	ON	Armstrong

230	QB	QC	Quebec
232	GP	QC	Gaspe
235	CN	ON	Cochrane
236	OW	ON	Ottawa
239	VO	QC	Val-D’or
243	YVB	QC	Bonaventure
244	DG	QC	Chute-des Passes
245	YZE	ON	Gore Bay
248	UL	QC	Montreal
250	UAC	QC	Poste Montagnais
253	YTF	QC	Alma
256	UNV	CUB	Nuevitas
263	QY	NS	Sydney
266	ZHM	ON	Hamilton
268	UBY	CUB	Bayamo
272	YQA	ON	Muskoka
276	YEL	ON	Elliot Lake
278	UBA	CUB	Baracoa
280	QX	NF	Gander
283	PT	ON	Pelee Island
317	ZZR	ON	Trenton
323	UWP	NL	Argentia
326	FC	NB	Fredericton
332	YFM	QC	LaGrande
335	ZKF	ON	Kitchener
340	YY	QC	Mont-Joli
341	YU	ON	Kapuskasing
343	ZBM	QC	Bromont
344	ZOW	ON	Ottawa
344	ZIY	CYM	Georgetown
344	ZSB	ON	Sudbury
346	YXL	ON	Sioux Lookout
360	UCV	CUB	Ciego de Avila
370	GR	QC	Magdalen Islands
371	GW	QC	Kuujuarapik
373	2Q	QC	Mont-Laurier
376	ZIN	BAH	Great Inagua
377	YRR	ON	Ottawa
378	RJ	QC	Roberval
379	YPQ	ON	Peterborough
380	UCY	CUB	Cayojoabo
386	D8	QC	Dolbeau
387	6E	NB	Grand Manan
387	SPP	SAP	San Andres Island
402	C	CUB	Camaguey
404	ZYB	ON	North Bay
414	3U	QC	Ottawa
421	V	CUB	Varadero
516	YWA	ON	Petawawa
520	F9	NB	Miramichi
526	ZLS	BAH	Stella Maris

Longwave Resources

✓ **Sounds of Longwave** CD or Audio Cassette (please specify) featuring WWVB, Omega, Whistlers, Beacons, European Broadcasters, and more!
\$13.95 postpaid

✓ **The BeaconFinder** A 65-page guide listing Frequency, ID and Location for hundreds of LF beacons and utility stations. Covers 0-530 kHz.
\$13.95 postpaid

Kevin Carey
P.O. Box 56, W. Bloomfield, NY 14585

Norwegian Pirate-Inspired Station Still Silent

Since 2001, **Northern Star International Broadcasters AS** in Norway has been attempting to broadcast a pirate-inspired radio format on either longwave or medium wave from Norway. The firm has explored a variety of transmitter sites, including old abandoned transmitter sites in Norway and offshore platforms used by oil production firms. Several of these transmitter site alternatives did not materialize for a variety of reasons. But, Sven Martinsen of NSIB reports that the firm's board continues to seriously explore new options for starting a broadcasting service from Norway.

Martinsen points out that NISB currently holds a provisional license from the Norway Mass Media Authority. That license authorizes operation on 216 kHz longwave with a power of 1.2 million watts. But, NISB reports that despite interest from investors in multiple countries, the firm has not yet raised sufficient capital to construct and operate this quasi-pirate radio station in Norway.

The firm cites various stations as its inspiration, including old Mexican "border radio" stations such as **XERF**, and also several pirate radio stations that have operated in the past from international waters adjacent to Europe. NISB indicates that they are also exploring the possibility of shortwave broadcasts.

Since the station does not actually broadcast, it has reminded some observers of other stations such as **NDXE** that provided extensive publicity about allegedly forthcoming broadcasts that never actually materialized. If you would like to follow any future developments at this proposed quasi-pirate, their web site at www.northernstar.no/ is updated from time to time.

❖ **Cochiguaz Anniversary**

Radio Cochiguaz, the most prominent pirate that operates from South America, notes that they are celebrating their 12th anniversary on the air. They report that technical issues curtailed broadcasts during late 2008, but that they have future plans for 2009. The station still uses *Casilla de Correo 159, Santiago 14, Chile* for postal mail correspondence. They refer listeners to www.geocities.com/rcochiguaz/ for updates on any forthcoming 2009 transmissions.

They also remind us that in 1998 they finished first in the pirate popularity poll conducted by SRS-News in Sweden. When active in the past, this one has used variable frequencies around 6925 kHz and 11430 kHz. They point out that they sometimes relay other pirates, both from Chile and from other countries.

❖ **Gospel for Antarctica**

As we see here this month, Gene Patterson got an excellent QSL for a relay of the new pirate *Gospel for Antarctica*. Despite the name, they have little to do with religion or the Polar Regions.

GOSPEL FOR
ANTARTICA
Tacky? Yeah...but its still a QSL!



Transmitter Site: Werchatal

DATE: 11/31/08 TIME: 1833 - 1900 FREQ: 6.925
#4

HEARD BY: Gene Patterson

❖ **Nexus Radio**

It's too late to hear them now, but DXers in the Philadelphia, Pennsylvania, area heard an unusual broadcast in early February from a station calling itself *Nexus Radio*. It operated on 1650 kHz during an arts fair in Philadelphia. Programming included various arts features including experimental music allegedly produced in Germany and Austria and sent to Philly via the internet. We thank Wil Lindsay and Bill Finn from Philly for this unusual logging. Bill is also one of the volunteer editors at *Free Radio Weekly*.

❖ **What We Are Hearing**

Monitoring Times readers heard more than thirty different pirate radio stations this month. You can hear them, too, if you use some simple techniques. Pirate radio stations never use regularly announced schedules, but shortwave pirate broadcasting increases noticeably on weekends and major holidays. You sometimes have to tune your dial up and down through typically used pirate radio frequencies to find the stations, but more than 95% of all North American shortwave pirate broadcasts are heard on 6925 kHz, plus or minus 30 or 40 kHz.

Ann Hoffer Radio- This station is dominated by Ann Hoffer singing cover versions of songs composed by artists other than herself. (None known)

Area 51- This show is commonly heard via WBCQ relay, but it also sometimes gets relays as a shortwave pirate. (Belfast)

Balls to the Wall Radio- We still know little about this new one, which has largely transmitted tests instead of broadcast programming. (ballstothewall@gmail.com)

Captain Morgan- Their standard format is rock music mixed with TV audio bridges from the old *Twilight Zone* TV show. (None, says to send loggings to the Free Radio Network web site)

Fellatio Radio- This is not a typo. The programming covers the subject matter implied in the station name. Obviously licensed stations don't cover this sort of activity. (None known)

Liquid Radio- Their recent format has been electronic music with techno dance music. (wwrbfm@gmail.com)

MAC Shortwave- Sometimes Paul Star recruits a young boy as a supplemental announcer on his top 40 rock oldies productions. They apologize for a 2 year QSL delay, and they hope to do better this year. (macshortwave@yahoo.com)

Moonshine Radio- Despite their name, early shows from this one have been rock music productions. (None known)

Mystery Radio- This one remains the best heard European pirate in North America, with the best reception on weekends around local sunset near the east coast on 6220 kHz. (radio6220@hotmail.com)

Mystery Science Radio- They mix science fiction and diverse rock music into their broadcasts. (None known)

Outhouse Radio- Country music dominates their programming. (None known)

Radio Azteca- Bram Stoker remains the most prominent comedy and parody show produced about shortwave radio and DXing today. (Belfast)

Radio First Termer- From time to time this Dave Rabbit documentary about military broadcasting during the Viet Nam war gets another relay on the pirate bands. (None announced)

Radio Free Euphoria- Captain Ganja hosts this rock music, comedy, and drug advocacy operation. (Belfast)

Radio Gong- Several new pirates are well described in the station name. This one programs Gongs. (None announced)

Radio Pigmeat International- Rock music dominates their broadcasts. (pigmeat_voab@yahoo.com)

Random Radio- Robert Random features different musical genres from show to show, in congruence with the station name. (None, asks for reports to the Free Radio Network web site)

Sycko Radio- As with many pirates, Sycko features rock music and comedy productions. (syckoradio@yahoo.com)

Truck Driving Man- This new one discusses CB radios used by truckers. (None announced)

Undercover Radio- Dr. Benway remains active on the pirate bands "from the middle of no-

Continued on page 63

Numbers Stations

No this is NOT an April Fool's column. (I am fully capable of being foolish just about any time of the year, but that is beside the point.) Nor will it be a study of those mysterious and clandestine number groups heard across the HF spectrum. You will find that sort of number station amply provided for in other places within the pages of *MT*.

That said, numbers abound in ham radio, especially on the CW portions of the spectrum. Hams of all stripes give each other signal reports. CW folks always share their RST for Readability, Signal Strength and Tone, with a full scale reading being 599. Numbers are an essential part of even the briefest QSO. In a common rag chewing session, hams exchange their local weather temperature, their age, how many years they have been a ham. Lots of numbers there so far, but there are lots more, I can assure you.

If you are not a regular on the CW bands, you may be surprised the first time you hear an exchange similar to the following:

FB OM FISTS NR 6214 CC NR 2052 ARCI NR 8634 BK

"Okay," I hear you say, "What the heck are those code freaks putting down?!"

CW Ops see themselves as a breed apart, keepers of a classic mode of communication in the face of a changing world. I should know: I am one of them! CW folks tend to band together in clubs and organizations, some devoted to CW practice and some devoted to operating styles that are best supported by CW, such as QRP (low power operation). Most of these groups offer membership numbers. These numbers can be exchanged over the air. Often, awards can be achieved for working a certain number of folks in a given club or organization.

To further complicate matters, the various groups are full of entangling alliances. As you will see later in this column, it is possible to be affiliated with a CW group, and a QRP group, with a devotion to operating with a manual key or semi-automatic bug, and even professing loyalty to one specific collectable key.

The string you see above is something that you might actually hear Old Uncle Skip send if you come down to the bottom end of 40 meters (or 80 after sunset...pray for sunspots!). Allow me to do a bit of translation. Not only will things start to make sense, you may just discover you want to get in on all the fun.

❖ FISTS

The first thing you see after my "Fine Business Old Man" is FISTS NR 6214. By sending this out over the airwaves, I am letting the station on the other end of the QSO know that I am a proud and practicing member of *The International Morse Preservation Society*, more commonly known as the FISTS CW Club. FISTS folks commonly exchange their personal number on the air and also share it on their QSL cards.

The club offers a number of fun awards centered around working other members of the organization. One of the more common of these awards is the Century Award Certificate. You receive points for various types of QSOs. One point for domestic contacts, 2 points for DX, 5 points for FIST Club stations. When you can total up 100 points, you can apply for the "CC", and then you can add the CC number to your signal string. In my case this is CC NR 2052. There are higher levels to this award system for working more stations up to 1000 points. There are also endorsing awards. For example, since I worked all my CC contacts as a QRP Op, I also have the 1xQRP number 116.

Okay, you are probably wondering why I would bother sending out my CC number. To address the opportunity for another award, of course. If I total up 100 points worth of fellow CC number holders, I can earn the Platinum award.

If you are not a big wall paper collector, this may all seem like an exercise in futility. But there is a method to this particular madness. It is all about encouraging folks to communicate using CW. If you start operating CW, you will probably find yourself joining FISTS or quickly wish you did. Find out more by visiting the club Web site at: www.fists.org/

Okay, so that takes care of the first two numbers, but what is that other number in the string?

❖ QRPARCI

ARCI NR 8634 indicates that I am also a member of the *QRP Amateur Radio Club International*. As I mentioned earlier, the interests of the CW community and the QRP community overlap by quite a bit. This is because CW is such an efficient mode of low power communication. The QRPARCI is one of the larger QRP clubs, with many on air operating activities and events. During these activities, it is common to share your ARCI number. During club contests, it is necessary for point credit. The number can also be exchanged to achieve the "Worked All ARCI" award. If you enjoy the challenge of trying to play radio with 5 watts or less, you will find many kin-

dred spirits in the QRPARCI. Check out their Web site at: www.qrparci.org for more information.

❖ SKCC NR Anyone?

You might also hear someone sending an SKCC number with a very distinctive fist. That is because this number identifies a member of the *Straight Key Century Club*. These folks not only like CW, they like it Old School, preferring to operate using a Hand Key, Bug, or Side Swiper. The group has only been on the bands since 2006 and they have grown rapidly with more than five thousand members at this time. They offer a series of awards, some with similar rules to the FISTS organization, but many are unique awards. They also support a series of regular contests and sprints along with an "Elmer" program to help folks build their CW skills.

As I write this, the SKCC Group has just completed their Third Year Anniversary, commemorated, in part, by having their members operate using the callsign K3Y from the various call regions.

After working a few of these folks, I couldn't help but dust off my J-38 and my Vibroplex Champion and join in the fun. If you hear N2EI using a hand key, Old Uncle Skip will more than likely be sending out his SKCC number 5246 as well.

You can learn much more about this club and its activities at their Web Site: www.skccgroup.com/

❖ Yet Another QRP Number

A great group that combines the joys of CW and QRP is *The North American QRP CW Club* (NAQCC). Their name tells the whole tale. In addition to swapping member numbers over the air, this club offers monthly on-air challenges that are entertaining and fun. For example, one month the challenge might be to work folks using less than 1 watt. (Not as hard as it sounds, even during current solar conditions.) Another recent event was the "Rag Chew Challenge." Here you had to log as many 20 minute or longer QSOs as you could. CW rag chewing? My kind of contest!

With over 3000 members (that's a lot of numbers; I am number 3317, by the way), you may



I wonder what Old Samuel F.B. Morse would have to say about all these number being passed back and forth?

want to join in the fun at: www.usatek.net/~yoel/index.html

❖ My Favorite Number

You read the mention of my Vibroplex Champion semi-automatic keyer (bug) above. This bug was given to me by Wilbert "Bubbe" Jobs WA2YOB shortly before he went "Silent Key." He was a great friend and I like to honor his memory by putting The Champion on the air from time to time. Made in 1948 when Vibroplex was still in New York City, it is a bit worn around the edges, but still sends great code.

If I hear another bug on the air (easy to pick out amongst the perfectly shaped signals of electronic keyers of today), I will plug my bug in and have a nice rag chew with a fellow traveler in the world of classic key systems. During that exchange, I will proudly send "NY 159633" letting the Op on the other end know he or she is hearing real New York steel from (as Obi Wan Kenobi said) "a more civilized age."

❖ 73 Minus 1

When working the CW bands (or even the Phone Bands during QRP contests) you may think you are hearing an error in sending when an OM or YL closes out their contact by sending 72 instead of the hams' traditional farewell of 73. You would be wrong in your assumption. QRP folks send 72 to each other as a way of saying "We manage to get along with a little less." It's a mutual acknowledgment of skill common in a QRP to QRP contact.

❖ Uncle Skip's Book of the Month

The ARRL Handbook for Radio Communications
2009 - 86th Edition (Book and CD)
ISBN# 978-0-87259-139-4
ARRL Order # 0261
\$44.95
The American Radio Relay League
225 Main Street, Newington, CT 06111-1494
www.arrl.org/shop; 1-888-277-5289

Some of you are probably asking why I push a review on *The Handbook* every year. The answer is simple. *The Handbook* is THAT GOOD! It is the one essential text for amateur radio operators of any skill level. If you are new to the hobby, you will learn things that will grow your abilities. If you are an Old Timer, you will learn about new technologies that didn't even exist when you entered the hobby.

This latest edition of *The Handbook* does not disappoint. As always, it contains the basic principals of electronics and the fundamentals of radio communication and design. But in addition to the excellent theory, *The Handbook* places its best emphasis on using radio in real world settings.

When I get my new edition each year, the first thing I do is dig in to find any new projects worth building. In addition to many favorite designs, this year's edition adds coverage of Dave Benson K1SWL's "RockMite" QRP CW Transceiver. You have heard me mention this design in previous columns about kit building. I am very happy to see Dave's diminutive rig elevated to status as a project in *The Handbook*.

Other exciting new projects this year include an Audio Interface for contesting that allows two operators to share one radio, a Remote Power Controller that allows you to switch high current devices from a safe distance, and an Audible Antenna Bridge, great for tuning for the lowest SWR by ear.

Another important subject expanded in this edition is that of The Web, Wi-Fi, Wireless and PC Technology. Like it or not, the lines between radio communication and Internet communication are becoming blurred. You can use *The Handbook* to get up to speed on the latest thinking in this area.

And, as in recent years, this edition of *The Handbook* includes the complete handbook and additional supportive files on a handy CD ROM.

I have always learned enough new information to justify the cover price.

So, no April Foolin' around here. Some numbers stuff, a bunch of great clubs, and the greatest book in the ham radio world. How can you go wrong? So dust off that old straight key you have up on the shelf, come on down to the bottom end of 40 meters and swap a few numbers with me. Having fun...That's Number One!

Outer Limits continued from page 59

where" with rock music and travel tales. (Merlin and uses undercoverradio@gmail.com)
Voice of Hell- They are largely a parody of WYFR. (None; apparently there is no mail in Hell)
Voice of Prozac- Advocacy of drug use and calm behavior is their major theme. (thevoiceofprozac@yahoo.com)

WBNY- Elaborate recent productions from Commander Bunny of the Rodent Revolution make fun of "monkey" DXers with cameo appearances by many other pirate operators. (Belfast and rodentrevolutionhq@yahoo.com)

WDDR- With their drug advocacy music this one appears to be a different operation from the old WDDR. (None announced)

WEAK- Leonard Longwire's veteran rock music pirate has returned after a dormant period. (weak_chicago@yahoo.com)

WMR- This offshoot of WBNY with a "We Monkeys Radio" slogan has been widely heard. (None announced)

WMLK- This overtly racist station appeared on Martin Luther King Day with pejorative racial remarks spliced into a Martin Luther King speech. The new pirate has nothing to do with licensed WMLK in PA. (None announced)

Wolverine Radio- Rock music is this station's nearly exclusive focus. (None announced)

WMPR- Techno dance music dominates the broadcasts of Micropower Radio. (Known to QSL occasionally and mysteriously only at the Kulpville Winter SWL Fest)

WRPR- With a format of rock music, the station uses a slogan of "Real Pirate Radio." (None known)

WTCR- Their slogan of "20th Century Radio" accurately describes their music from various decades between 1900 and 1999. (Belfast)

WTPR- The consistent message of "Tire Pressure Radio" is that DXers should turn the show off, lest they lose all of the air pressure in their tires. (None)

❖ QSLing Pirates

Reception reports to pirate stations require three first class stamps for USA maildrops or \$2 US to foreign locations. The cash defrays postage for mail forwarding and a souvenir QSL to your mailbox. Letters go to these addresses, identified above in parentheses:

PO Box 1, Belfast, NY 14711

UNCLE SKIP'S CONTEST CALENDAR

QCWA Spring QSO Party
1800 UTC Apr 4 - 1800 UTC Apr 5

Missouri QSO Party
1800 UTC Apr 4 - 2400 UTC Apr 5

ARS Spartan Sprint
0100 UTC - 0300 UTC Apr 6

Georgia QSO Party
1800 UTC Apr 11 - 2359 UTC Apr 12

Michigan QSO Party
1600 UTC Apr 18 - 0400 UTC Apr 19

Ontario QSO Party
1800 UTC Apr 18 - 0500 UTC Apr 19
1200 UTC - 1800 UTC Apr 19

QRP - the Field
1500 UTC Apr 25 - 0300 UTC Apr 26

Florida QSO Party
1600 UTC Apr 25 - 2159 UTC Apr 26

Nebraska QSO Party
1700 UTC Apr 25 - 1700 UTC Apr 26

PO Box 109, Blue Ridge Summit, PA 17214
PO Box 146, Stoneham, MA 02180
PO Box 293, Merlin, Ontario N0P 1W0.

PO Box 69, Elkhorn, NE 68022 is no longer a valid address.

Some pirates prefer e-mail, bulletin logs or internet web site reports instead of snail mail correspondence. The best bulletin for submitting pirate loggings is the e-mailed *Free Radio Weekly* newsletter, free to contributors via freeradioweekly@gmail.com. A few pirates will sometimes QSL reports left on the outstanding Free Radio Network web site, at www.frn.net. *The ACE*, a formerly widely read print bulletin, now has a good loggings section and a valuable archive of *Free Radio Weekly* issues at www.theaceonline.com/

❖ Thanks

Your loggings and news about unlicensed broadcasting stations are always welcome via 7540 Highway 64 W, Brasstown, NC 28902, or via the e-mail address atop the column. We thank this month's valuable contributors: Brian Alexander, Mechanicsburg, PA; Skip Arey, Beverly, NJ; Artie Bigley, Columbus, OH; Ross Comeau, Andover, MA; Wendel Craighead, Prairie View, KS; Richard Cuff, Allentown, PA; Rich D'Angelo, Wyomissing, PA; Bill Finn, Philadelphia, PA; John Figliozzi, Albany, NY; Harold Frodge, Midland, MI; William T. Hassig, Mt. Prospect, IL; Harry Helms, Corpus Christi, TX; Ed Insinger, Summit, NJ; Kracker, Belfast, NY; Ed Kusalik, Camrose, Alberta; Wil Lindsey, Philadelphia, PA; Chris Lobdell, Tewksbury, MA; Greg Majewski, Oakdale, CT; Senn Martinsen, Rong, Norway; A. J. Michaels, Belfast, NY; Cachito Mamani, Santiago, Chile; Gene Patterson, Gibsonia, PA; Mike Rhode, Columbus, OH; Chuck Rippel, Chesapeake, VA; Greg Smith, No QTH; Lee Silvi, Mentor, OH; and Andy Walker, UK.

Sometimes It's a Wonder They Work at All!

While reading this month's column, as always, it's good to keep antenna reciprocity in mind. Antenna reciprocity means that things like an antenna's feed point impedance and radiation pattern remain the same whether the antenna is transmitting or receiving. In fact, an antenna's radiation pattern could reasonably be called the antenna's "radiation and reception" pattern.

❖ Funny Feed Points

I remember my confusion one time when I made an antenna-impedance meter. I connected it to my half-wavelength dipole to measure its feed-point impedance and got nowhere near the nominal 72 ohms I thought it was supposed to have. It took a while before I learned that an antenna's environment can affect the antenna's electrical characteristics dramatically. My antenna was about 12 ft above the earth under the eaves of my house.

After some reading, I realized that the antennas that my antenna books were reporting to have 72-ohm feed point impedance were assumed to be in outer space! So, I learned that just because we cut our antennas to the length our antenna texts say is correct, it doesn't mean that they will have the same characteristics as the text-book antennas in outer space.

Later, I was making another dipole antenna out in the clear, away from buildings, gutters, and other things that I thought might affect it. Surprise! To my consternation I found that as I raised or lowered the antenna, the feed-point impedance varied wildly! It could

be around 72 ohms at some heights, but very different at other heights.

Then, in my antenna books, I learned that antenna impedance can vary from almost zero ohms to around one hundred ohms as its height above ground is changed. The earth is a conductor, and when the antenna is relatively close to the earth, there is an interaction between the electromagnetic waves with which the antenna deals and the earth. Different heights lead to different results. If I wanted a 72-ohm feed point, I had to use a height that gave 72 ohms.

❖ DX or Close In?

And, I would notice that sometime DX was not at all plentiful with some antennas, but on other antennas DX would often be easy to work. Why didn't some antennas give me that skip on the ionosphere that I read was supposed to happen on short wave bands? Then I came across a military radio operator's manual which talked about a propagation mode called "near-vertical incidence skywave" (NVIS).

It said that if my horizontal HF antenna was near the earth (say, about a tenth to a quarter wavelength), then my radiation pattern would be almost straight up (fig. 1). The radiation then returns to earth out to a few hundred miles all around my location. This is not DX! But, on the other hand, if the antenna were up around a half wavelength above earth, the earth's effect on the radiation pattern changed, and low-angle vertical radiation became plentiful (fig. 1). And low-angle radiation is what leads to DX.

So now I could decide if I'd rather have an NVIS or DX antenna. But, consider that on 4 MHz a half wavelength in air is 123 ft (37.5m). Even as high as 15 MHz, a half wavelength in air is still 32.8 ft (10m)! Getting a horizontal HF antenna up a half wavelength in the air for that DX, especially on the lower end of the HF band, is difficult to impossible for many of us.

❖ Verticals to the Rescue

Once I made a cubical quad beam. The beam was sitting on the lawn prior to putting it up on the roof, and I thought, why not give it a try right on the ground there? I was living in California, and I easily worked Guam with the antenna right on the ground! I had read that antennas on the ground worked very poorly, and yet this one was doing great.

There are antennas that are supposed to work DX when they are close to the earth. Vertical antennas are almost legendary for furnishing that low, vertical-angle radiation that leads to DX contacts.

What does that have to do with my quad? Well, the way my quad was sitting, it was fed at the middle of one side of the driven element's loop. That meant its polarization was vertical, and so I had a vertical antenna sitting on my lawn. Vertically-polarized antennas, even at ground level, tend to give good low-angle radiation. My quad was doing what a vertical antenna should!

So now we have a solution for us poor souls who want to work DX, but can't get their horizontal antennas up high enough to favor that kind of propagation. Vertical antennas such as the grounded quarterwave (the Marconi), and the various ground-plane antenna designs are often chosen for just this reason. Also the commercial, multi-band verticals so popular these days are basically vertical dipoles.

Actually, an NVIS antenna can work some DX, and a DX antenna will work some nearby stations. But the NVIS antenna is best for close in, and a DX antenna best for the long haul.

❖ Can't Get My SWR Down to 1:1!

I had also read that the ideal standing-wave ratio (SWR) between transmitter and

Fig. 1. RADIATION PATTERN OF A HORIZONTAL, HALF-WAVELENGTH DIPOLE A QUARTER WAVELENGTH ABOVE GROUND (SOLID LINE), AND THE SAME ANTENNA A HALF-WAVELENGTH ABOVE EARTH (DASHED LINE). ANTENNA IS VIEWED FROM ONE END.

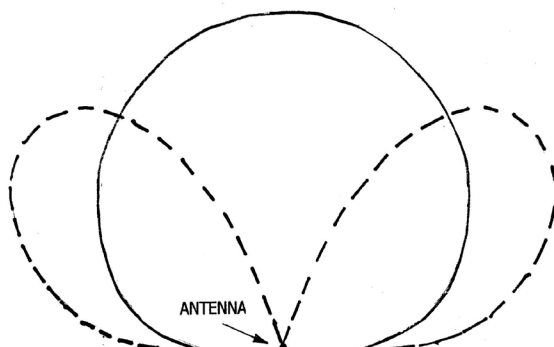

This Month's Interesting Antenna-Related Web site:

A site devoted to antenna problems:
www.k0bg.com/problems.html

Info on the growing field of fractal antennas:
http://en.wikipedia.org/wiki/Fractal_antenna

A listing of 85 kinds of antennas with links to their descriptions:
http://en.wikipedia.org/wiki/Category:Radio_frequency_antenna_types

feed line, or between feed line and antenna, is 1:1. That 1:1 SWR seemed something to strive for if I was ever going to have a decent transmitting antenna.

Impedance values for commonly-available coaxial cable are 50 ohms and 72 ohms. But the heights at which I erected my horizontal antennas rarely yielded even close to a 72-ohm, or 50-ohm feed-point impedance for the antenna. And this meant my SWR wouldn't be very close to a 1:1 value.

More reading in the antenna books led me to understand that, if I used an antenna tuner between my transmitter and feed line, the antenna system could be impedance matched to the transmitter by the antenna tuner. This was good news, but then I learned that the mismatch between the feed line and antenna feed point wasn't really converted to a match by the antenna tuner.

So, should I worry? Not if my feed line

RADIO RIDDLES

Last month:

I asked, "All the dipoles discussed this month are 'center fed.' This means that they have their feed lines connected at the antenna's center. Can a dipole be fed at other places than its center?"

Yes; for example, the Zepp antenna is fed at one end and the Windom is fed at a point between the center and the end. The farther the feed point is away from the center toward an

end of the dipole, the higher is the feed-point impedance.

This Month:

As explained above, an antenna's height above ground is important to its functioning. But some ground is more damp, or more rocky, etc. than other ground. Does this make a difference in the antenna's functioning?

You'll find an answer to this month's riddle, another riddle, another antenna-related web site or so, and much more, in next month's issue of Monitoring Times. 'Til then Peace, DX, and 73.

was relatively low-loss line, because the RF energy reflected back down the feed line by the antenna-feed point mismatch is re-directed back up the line to the antenna again by the tuner, and most is eventually radiated. And, if the line is low-loss, the extra trips up and down the line don't waste much energy – the system is still reasonably efficient.

❖ **The Good News**

It is interesting that, regardless of the kinds of problems mentioned above, most of the antennas we make give us a lot of good service and pleasure. Although the problems mentioned are real problems, they don't completely prevent our antennas from work-

ing. On the other hand, it seems likely that an understanding of the ideas discussed above can help us select and site our antennas for maximum performance.

Antenna Designer

New Version 2.1 for Microsoft Windows 95 and 98

Computer program helps you design and build 17 different antennas from common materials. Based on Antenna Handbook by W. Clem Small.

Only \$39.95

\$5 S/H on all orders
CA residents add 8.5%
Shipped on CD ROM

Send check or money order to:

Small Planet Systems
623 Mangels Avenue
San Francisco, CA 94127

www.smallplanetsystems.com 415-337-9394



Listening is only half the fun... POPULAR COMMUNICATIONS is the other half!

If you enjoy radio communications in all its variety, you'll love **POPULAR COMMUNICATIONS**

Since 1982 Pop'Comm has delivered thousands of pages of great reading for both the radio enthusiast and the professional communicator.

Every month Pop'Comm is crammed with scanner frequencies, shortwave listings, broadcast and utility loggings, radio nostalgia, and technical information. Plus you'll find great features on amateur radio, public service communications, DXing, pirates, clandestines, and much, much more.

YES! Enter my subscription to Popular Communications today!

Name _____
Address _____
City _____ State _____ Zip _____
 Check MasterCard VISA AMEX Discover
Card No. _____ Expires _____
Signature _____

	USA	Canada/Mexico	Foreign
1 Year	<input type="checkbox"/> 32.95	<input type="checkbox"/> 42.95	<input type="checkbox"/> 52.95
2 Years	<input type="checkbox"/> 58.95	<input type="checkbox"/> 78.95	<input type="checkbox"/> 98.95
3 Years	<input type="checkbox"/> 85.95	<input type="checkbox"/> 115.95	<input type="checkbox"/> 145.95

Popular Communications, 25 Newbridge Road, Hicksville, NY11801 • Phone: 516-681-2922 • Fax 516-681-2926
Visit our web site: www.popular-communications.com

The Globe Scout: It's a Wrap

❖ The Reversed Switch Mystery

At the end of last month's work session, we had finally found an explanation for the rig's bizarre behavior during tune-up – resolving a major difficulty in getting the Globe Scout 680 back into action. The answer emerged when, in a last-ditch effort, the wiring to the meter switch was checked. Unbelievably, it turned out that the meter was reading grid current at the final when the switch was in the plate current position and vice versa.

"What's so unbelievable about that?" you ask. "It was probably a wiring error – or maybe the toggle switch was installed upside-down." But neither was the case! As it happens, though the 680 was also sold as a kit, this is a factory-wired version. I had, however, downloaded the complete kit construction manual from the internet, so I had both pictorial and schematic diagrams of the wiring.

The switch was definitely not installed upside down; its locating notch was pointed in the right direction. And even if it had been upside down, there would have been no problem as long as the wiring was correct. The operation of a s.p.d.t. switch of this type is symmetrical around the center terminals, where the meter is connected.

As long as the wires from the various points were connected to the upper and lower switch terminals in the physical positions shown on the pictorial diagram, the switch functions should still have matched the panel labels. And they were! Furthermore, there was absolutely no sign of post-manufacture tampering of any kind.

The only conclusion I can come to is that not only is the wiring orientation shown on the pictorial diagram wrong, but the wiring was factory-installed in accordance with that wrong specification. How could such an error have escaped final testing at the factory? If any reader has insights, I'd like to hear from him or her!

❖ Correcting the Problem

This problem is not so easy to correct in an assembled set. The most obvious – turning the switch upside-down leaving the wiring as is – has to be ruled out. The switch is held by one

of those decorative "ring nuts" at the front panel and there is no clearance to get a wrench on the conventional nut backing it up behind the panel.

My careful effort to loosen the front nut with a pair of pliers had only the expected effect of causing a couple of scratches. I have heard that there was once a special "wrench" available for loosening those. Does any reader know of a tool or technique that works?

Another obvious fix -- changing the wiring at the back of the switch -- would be possible only if the switch could be dismounted. Otherwise, there wouldn't be enough clearance. Changing the wiring at the other end of the circuitry, where it connects to the current-sensing resistors, is also a discouraging prospect. As mentioned in earlier articles, the wiring is very dense and tight, and most of it is cabled.

Still, this was something that needed to be fixed, not only for my benefit but, more importantly, to keep possible future owners from falling into the same trap that had baffled me for so long. The only road open to me seemed to be to re-label the front panel. I don't have much talent for cosmetic fixes, but I do have a little lettering device that prints very neatly on strips of self-stick tape.

It had a type style comparable to the original lettering, and I made up "F. GRID" AND "F. PLATE" labels to paste over the originals. These

much for that!

Come to think of it, perhaps the factory had detected the switch mixup only after several sets had been manufactured, then reached the same conclusions I did about the difficulty of making a real fix. Perhaps they also applied a paste-over label and perhaps, over the years, it dried up and fell off.

❖ Final Fixes

At the close of last month's work session, with the meter switch mystery solved, I was able to tune up the Globe Scout properly. And it responded by pumping its rated 50 watts of r.f. into my dummy load. This was a great moment, but I still wasn't done. Because, listening to the signal on a nearby receiver, I could hear no modulation with the transmitter switched to a.m. mode.

The microphone I was using was a vintage Astatic D-104. That particular mic, being a crystal type, is susceptible to performance degradation caused by moisture absorbed over time. I hadn't used the unit in quite awhile, though I had been careful to store it in a dry location. As it happens, I had another D-104, also carefully stored, and tried that one. Results were a little better. But the sound was hardly robust!

I finally hit paydirt when I remembered that I had a Shure high-impedance dynamic mic that had once been used with a Heathkit transmitter. This was also a vintage unit, though a couple of decades younger than the D-104s. But dynamic mics don't degrade in storage the way crystal mics can. Connecting it up in place of the D-104, I was pleased to hear good audio on the transmitted signal at last.

But the Globe Scout managed to throw one final curve before giving in to my ministrations. During the final rounds of testing for modulation, the rig suddenly began coming up in transmit mode with the "transmit/standby" switch still in the "standby" position. That switch activates the transmit function by grounding a bus that includes the cathodes of the oscillator and power amplifier tubes. So I had to look along the bus for a ground that shouldn't be there.

My chief suspect was the eyelet rivet that secured one of the lugs on a terminal strip. The eyelet had a lead soldered to it because there had been no more room left on the lug. There was almost no clearance between the eyelet and the

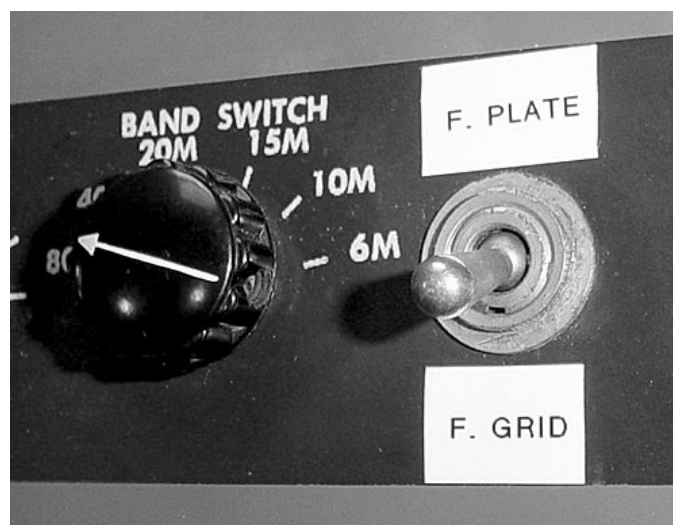

My practical, if inelegant, solution for the "upside down" meter switch.

black-on-white strip labels make no pretense at looking like the original white lettering silk-screened onto the charcoal panel. However, they do the job and can easily be removed by someone who might have a more elegant fix in mind. So

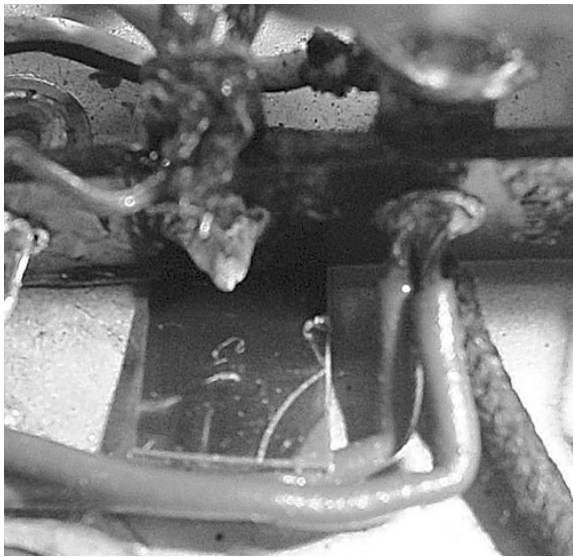

Rectangle cut from credit card being shoved under terminal strip eyelet (see text).

chassis, and I figured that a wisp of wire or a tiny drop of solder might be bridging the tiny gap and causing the ground.

Using miniature screwdrivers and a knife blade, I attempted – several times – to clean out under the eyelet, and thought I had done quite a thorough job – but the problem persisted. Time after time, I watched the plate current meter slowly begin to rise after power was turned on, but with the rig in “standby” position. Time after time, I checked all along that cathode bus to see if I could find any other suspicious points.

There were no other such points, so once again I was reduced to last ditch measures as in the case of the meter switch mixup. I cut a small strip of plastic out of an expired credit card and forced it under the terminal strip at the location of the eyelet. Presto – no more short to ground and the plate current meter rested obediently on its left-hand pin as long as the function switch remained in the “standby” position.

❖ Reader Comments

I recently received the following e-mailed comments from Derick Ovenall, who has made other interesting contributions to the column in the past.

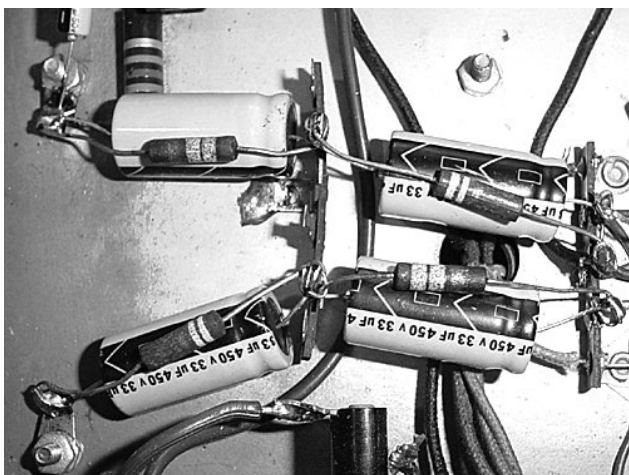

The Globe Scout's filter electrolytics are now protected with equalizing resistors.

Equalizing Resistors

First of all, remember the two high-voltage filter electrolytics that I replaced in the Globe scout near the beginning of the restoration? Specs for those units were 12uF @ 700v.

Electrolytics of such high voltage are not readily obtainable, so the manufacturer made each one up by series-connecting two 20uF @450v units. Connected this way, each pair of combined capacitors should present a capacity of 10uF @ 900v. I used 30uF @450v units in making my replacements, which therefore had a value of 15uF 900v each.

Derick reminded me that the nominal capacity ratings of capacitors are far from accurate and that unequal capacities in a series pair will result in unequal voltage distribution. If the difference becomes too great, the voltage across one of the caps could become great enough to exceed its voltage rating. The result could be explosive!

The remedy is to connect equalizing resistors (both of the same value) across each individual capacitor in the pair – thus “forcing” the voltage across the pair to distribute evenly between the two caps. While aware of this issue, I had ignored it – following the practice of the Globe Scout's designers, who had not installed the equalizing resistors.

However, Derick's note convinced me. After doing some research, it appeared that 270k ohm resistors would be about right for this purpose. I happened to have four 240k units and installed those.

Insensitive SW-54s

Noting that I had used a little National SW-54 SWL receiver in testing the Globe Scout, Derick passed along some information about an SW-54 that he is working on. Finding that it didn't seem to be as sensitive as the approximately equivalent Hallicrafters S-38C he had previously restored, he did some reading and came across an article describing an SW-54 in which the manufacturer had omitted some components.

A couple of resistors and capacitors were missing from inside the second i.f. transformer. Restoring these resulted in much improved performance. Derick hasn't opened his own transformer yet, but continuity tests do suggest a similar problem. My own SW-54 is just used to make occasional bench tests, so I won't be going into it again. However, readers who are seriously using one of these cute little Nationals might be advised to take a peek.

Another Ghirardi Book

In my overview of the invaluable radio repair and theory books published by Alfred Ghirardi (February '09 issue), I happened to leave one out that Derick has found invaluable. I do have a copy in my own library but didn't think of it because it was published so much later than the other books and Ghirardi was not the sole author. But I agree that it is an invaluable book and well worth mentioning. It's *Radio and Television Receiver Troubleshooting and Repair* by Alfred A. Ghirardi and J. Richard Johnson, Rinehart Books, 1952, 822 pages.

Browsing through this book, I'm very glad that Derick brought it to our attention. In the preface, the authors state that their emphasis will be on the practical, and that they will assume that the reader is already grounded in basic electronic theory and receiver circuitry. For those who are not, they recommend a companion volume, *Radio and Television Receiver Circuitry and Operation*. That's one I've never seen; I'll have to keep my eye out for it!

The opening chapter of this volume deals with individual receiver components and their typical troubles. Following are 19 chapters divided, roughly, into three major categories: troubleshooting; realignment; and repair and replacement of individual components. Within each category, individual chapters, or sections of chapters, deal with the problems of various types of radio and television receivers. Record players and home recorders are dealt with separately in the last two chapters of the book.

All of this very practical material will be of high value to the radio repairer and restorer, but with certain types of components becoming harder and harder to find, the sections on individual component repair will be of special interest.

Next time you attend a radio meet, keep your eyes peeled for this book. It will be well worth it!

MT READERS ONLY

To access the restricted website for the month of April, go to www.monitoringtimes.com, click on the key, and when prompted, enter “mtrader” under the user name. Your password for April is “skywarn” – Check in each month for new material!



JOIN THE AWA

Antique Wireless Association

The original and largest historical radio-collector group

• Publishes *The AWA Journal*, Marc Ellis, Editor, with:

- Battery and AC receiver restoration
- Vacuum-tube history and collecting
- Old-time amateur-radio contests
- Communications receivers
- Free want-sell-swap ads
- Early television
- Horn loudspeakers
- News of U.S. and foreign clubs



• Produces the famous annual Rochester meet

• Maintains unique radio-TV museum

Membership is only \$20 per year in U.S.; \$25.00 elsewhere.

Mail check to:

AWA Membership - P.O. Box 421, Dept. 2 Bloomfield, NY 14469-0421

<http://www.antiquewireless.org>

awamembership@rochester.rr.com (585) 392-3088

Monitoring Ultrasound

By Phil Anderson, WØXI

Each time I see a rendering of Leonardo da Vinci's Vitruvian Man, exploring the relationship between man and nature, I'm reminded of thoughts I had while taking a course in electro-magnetism many years back: Wouldn't it be neat if we had glasses that allowed us to "see" magnetic fields, and if there's a shadow behind a pole due to sunlight, wouldn't there also be an electro-magnetic shadow due to incoming radio waves?

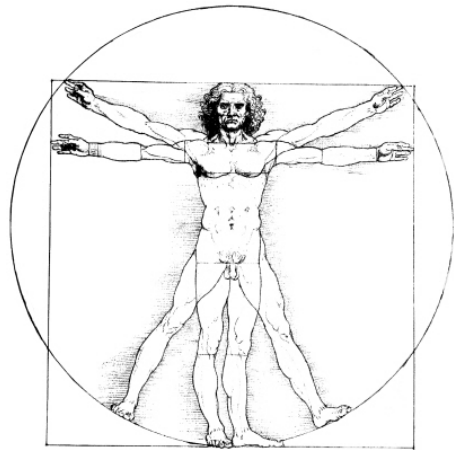

You might counter that we do see radiation already; we see sunlight with the naked eye. As humans, we see the visible, hear and produce audio, feel and give off heat, perceive smells by excitation of our olfactory nerves, and we can produce and sense pressure as well.

With technical assistance, we can see *infrared* using night vision goggles, hear detected radio signals, watch reconstituted images on TV, see inside the body, and view distant galaxies.

So wouldn't it be neat to hear ultrasound – those frequencies high above the limits of human hearing? We could hear what dogs can hear, listen in on bat conversations, or even monitor multi-mile conversations by elephants using infrasound below human hearing range.

We can, and a small handful of folks already do!

❖ An Ultrasound Receiver

I ran across an article some months back about a bat detector a fellow hobbyist in the UK had built. (I guess they like bats in their belfries there.) I got fired up and decided to investigate, design, and build my own units to listen to and transmit ultrasound and infrasound. I've finished my first 40 kHz ultrasound receiver, described here briefly, and have a transmitter working on the bench.

As you'll see, the architecture of the receiver is direct conversion, which should be familiar to radio amateurs. The front end could easily be converted to listen to radio signals in the ELF (3-30Hz), VLF (3-30kHz), and Low-FER (under 500 kHz) bands as well.

Before describing the receiver, a short introduction/refresher about sound is in order. Humans hear from about 20 Hz to 20,000 Hz. The useful range for pressure waves (which is what sound waves are) actually extends far above that, all the way up to roughly 10 MHz! Medical applications, such as imaging sonograms, are probably the most familiar use.

Many insects, rodents, bats, and fish utilize portions of the ultrasound spectrum for feeding, communication, and navigation. Some use human-range audio, too, of course. Except for structural and medical testing, the use of ultrasound above about 160 kHz by living organisms is virtually non-existent, since air is so absorptive to these pressure waves.

Elephants and whales use infrasound – signals below 20 Hz. It's been documented that elephants can communicate over tens of miles at these low frequencies.

Arguably, some humans use infrasound, too: teenagers with their car stereos thumping at low frequencies as they drive by, mesmerized by the pounding sound. This habit will, no doubt, become a new source of patients for audiologists, if not already! More elegantly, concert-goers feel the deep pulse of a base drum, evoking a primordial response in the psyche of the listener.

Table 1 summarizes the frequency ranges and their inhabitants. Note the overlap between the high end of the pressure waves and our AM broadcast band. The difference is, of course, that the pressure waves are an upper extension of acoustical sound – vibration of air molecules – while radio signals are electromagnetic.

TABLE 1

Band	Frequency Range	Users
infrasound	0-20 Hz	Elephants, whales
audio	20 Hz-20 kHz	Humans, insects, animals, fish, sonar
ultrasound	10-30 kHz	Rodents
ultrasound	20-75 kHz	Insects
ultrasound	20-160 kHz	Bats, dolphins
ultrasound	100-2000 kHz	Structures testing
ultrasound	1-10 MHz	Medical applications
mediumwave	0.5-1.6 MHz	AM radio

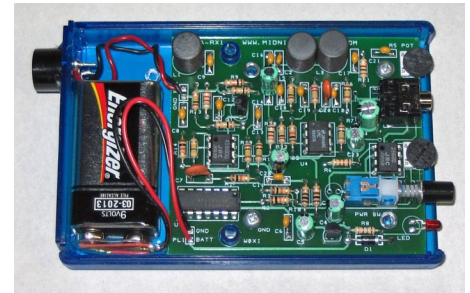

Figure 1: The Direct-Conversion Ultrasound Receiver, RX1

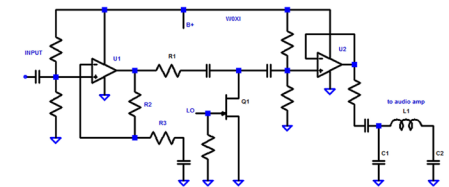

Figure 1-A: Simplified Schematic

❖ The Receiver

A block diagram for the Ultra-RX1 receiver is displayed in Figure 1. A simplified schematic of the pre-amp, mixer, and low-pass filter is shown in Figure 1-A. Power supply and audio components are not shown. R2 and R3 set the gain of U1; the +5 volt TTL signal of the LO turns on and off Q1, the N-channel FET; and the U2 buffer sets the drive impedance for the first section of the low-pass filter.

A Kobitone 400SR16 piezoelectric transducer (PZT) – essentially a high frequency microphone – takes the place of the usual RF antenna. Pressure variations arriving at the PZT generate a low voltage signal, which is then amplified by a 34-dB operational amplifier.

The amplified signal is mixed with a frequency-adjustable local oscillator (LO) using a conventional N-channel field effect transistor (FET) as a "chopper" mixer. The mixer output is a collection of signals: the PZT output, the LO, harmonics of each, and products of the two (sums and differences – "beat" frequencies).

Without filtering, the final detected signal could sound more like the simultaneous audition of 20 American Idol contestants – and amplified at that! For this reason, a two-stage, passive, low-pass filter was added, removing all but the desirable product.

The final step, an audio amplifier, consists of two stages, a 27 dB op-amp with filter feedback, and a common, 8-pin, DIP audio



Figure 3: Two Ultra-RX1 Kits, assembled and in the case

IC. For listening, I use a set of 24-ohm iPod headphones, but an 8-ohm ear bud or even high impedance phones will work, too. Basically, if it's an earphone or a headset, plug it in!

❖ A little theory

So, what's the frequency range of the receiver? What pressure and voltage levels are involved? What can one hear on a calm sunny day in the spring? (Winter is a dead-zone for bio-ultrasound listening.)

PZTs are inherently narrow-banded with a typical 3-dB bandwidth of about one kHz. While their circuit model resembles that of an RF quartz crystal (see Figure 2), the Q is much lower. By adding an inductance in parallel as noted in figure 2, the response bandwidth can be expanded to over 10 kHz. Since many bats and insects chat at or about 40 kHz, I chose a PZT with a series resonant frequency of just that.

The receiver is made to listen from at least 35 to 45 kHz; by tuning the LO through this range, the human-range audio can hear the entire

band of ultrasonic signals. In a way, the RX1 is actually a mini-ultrasonic spectrum analyzer!

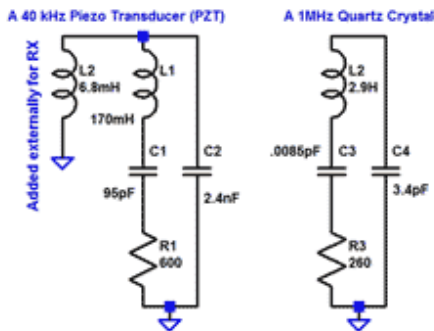

Figure 2: Typical Electrical Models of a Piezo Transducer and a Quartz Crystal

Many insects, bats, and some mammals produce sound pressure levels (SPL) of 70 to 110 dB as measured at one foot distance. SPL is defined as 20 times the logarithm of the signal pressure divided by the pressure for the threshold of human hearing, about 20 micro-pascals (20 uPa).

Since sound pressure dissipates at a rate inverse to the distance, the signal pressure at 50 feet will be dissipated to 1/50th that at 1 foot in front the emitter. Thus, the pressure heard at 50 feet would be reduced 34 dB. A strong signal of 110 dB would thus be less than 70 dB at the receiver. The corresponding pressure would be 0.06 uPa. That is a strong signal for our receiver!

❖ Applications

To first check out the unit, turn it on with the volume control set low (this receiver has tremendous gain!) and tune the oscillator adjustment while jingling keys nearby. You should hear the ultrasonic overtones converted to audio. Now listen to your fingers and hands rubbing each other, a comb through your hair, water dripping, cellophane crumpling – you'll think of other sources as well! But let's get practical.

While bats hibernate during the winter months, expect them to start coming out in the early spring. Listen for them during feeding time – early and mid-evening. Expect to hear their "clicking" song as they come up to you – unexpectedly, checking you out!

As soon as the ground is warmer, expect to hear many types of bugs chatting endlessly – "eek, eek, eek," in the trees and in your lawn. And don't forget to check out the brush piles and ground holes for rodent communication between mom and the kids!

Credits

Thanks go to Philip Tate (UK), M1GWZ, Joe Eisenberg, NØNEB, and Bob Grove, W8JHD, for beta testing the Ultra-RX1. The receiver is available in kit form from the Xtal Set Society, www.midnightscience.com/ultra-sonics.html (or call 1-405-517-7347, or write The Xtal Set Society, PO Box 3636, Lawrence, KS 66046): \$69.96 for the full kit, or \$24.95 for the PCB and instructions only.

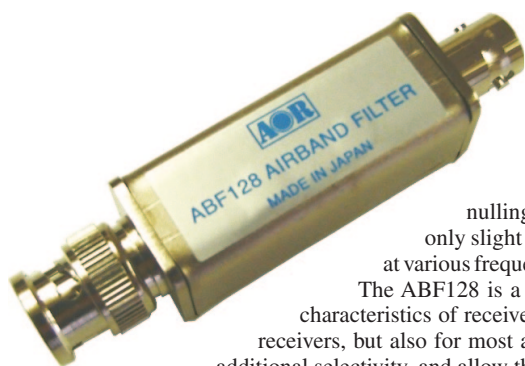

AOR ABF128 VHF Air Band Filter

This new band-reject filter from AOR will eliminate the problem! With very deep nulling of the aircraft band, the filter allows normal reception of non-aircraft frequencies with only slight signal reduction near the aircraft band. The accompanying graph shows the attenuation at various frequencies. BNC coupling for most common antenna connections.

The ABF128 is a receive (only) bandpass filter especially designed to improve strong signal handling characteristics of receivers for VHF commercial Airband listening. The AFB128 is suitable not only for AOR receivers, but also for most airband and wideband receivers on the market. The addition of ABF128 will provide additional selectivity, and allow the receiver's circuitry to cope much more easily with strong interfering signals such as Band-2 Stereo or Shortwave broadcast transmissions, which can be manifest in many ways such as "hissing", multi-signal hash and desensitization of the receiver.

The ABF128 will provide additional selectivity (in many situations) to any receiver's "front end" by reducing the multitude of unwanted strong signals from reaching and saturating the receiver's first mixer stage. This results in less interference and improved reception.

This makes the ABF128 suitable for connection to both external antennas and right under the whip antenna of a handheld receiver.

The ABF128 is not an amplifier and will not "boost" signals, however the additional selectivity offered can significantly improve reception in many situations by removing unwanted strong signals which may overload the receiver and reduce its effectiveness. Band attenuation is very small, due to the excellent in band V.S.W.R. of 2:1 resulting in a loss of only about 4dB.



800-438-8155

828-837-9200 fax: 828-837-2216

WWW.GROVE-ENT.COM

order@grove-ent.com

7540 Highway 64 West
Brasstown, NC 28902

* plus \$9.95 Priority Mail or UPS Ground shipping in the US



Order FTR07
Only
\$52^{95*}

Ultra-Rx1 Ultrasonic Receiver Kit

Review by Bob Grove

The website at www.midnightscience.com/ultra-kits.html says, "You can DX the alien nations – insects, rodents, bats, and more – in the 35 to 45 kHz ultrasound band, listening to their feeding, communication, and navigational signals." Since anything out of the ordinary has always been a fascination of mine, I decided to order the Ultra-RX1 kit from the Xtal Set Society.

❖ Let's assemble the kit

The parts are separated in groups which match the steps in the accompanying manual, and all are adequately marked for recognition. You should plan on several hours for the complete assembly and testing, including drilling and filing holes for the controls in the panel. An accurate drilling template is provided.

The manual is an informational, step-by-step set of instructions with excellent background information, technical details, and appropriate assembly order. The parts are of good quality, as is the professional layout and etching of the circuit board, which is well marked with parts placement legends.

There are three successive points in the assembly where you can verify operation up to that point, reassuring the kit builder that if the final instrument doesn't work right, it probably wasn't one of those steps!

For the tests, you will need at least a VOM (volt-Ohm-milliammeter) or DVM (digital voltmeter), and it wouldn't hurt to have an audio signal generator as well. An oscilloscope would disclose the injection oscillator operation and waveform, and you will need earphones or a speaker, too.

Upon completion, you will be eager to turn the Ultra-RX1 on to find out what you can hear. Don't switch it on with the earphones on or in your ears, however! The audio output is extremely high, and you will want to first adjust it while away from your ears for safe comfort.

❖ Switching it on

After completing the assembly, I carefully inspected all my solder joints under a magnifying glass, snipping suspiciously long leads and looking for solder shorts on the circuit traces. All was well. I switched the instrument on, and lo! I beheld sounds

coming out of the earphones!

Turning the gain down comfortably and putting the earphones in place, I began tuning the frequency control through its near-40 kHz range. I had been told that jingling keys had extremely high overtones, so out of my pocket they came.

As I gently allowed them to collide in front of the ultrasonic transducer (that's techie talk for high frequency microphone!), the unmistakable clatter of church bells assailed my ears. Next I rubbed my fingers together in front of the mike and, to my amazement, the high frequency components of skin rubbing sounds like grating sandpaper! Rubbing my fingers through my hair disclosed the rough sound as well.

❖ Wide and varied uses

Ultrasonic detectors have vital application potential in biology, commerce, and industry. Biologists monitor the ultrasonic emissions of a variety of insects to relate the sounds with mating, eating and communications. The ability to directionally locate specific destructive insects can provide clues to the propagation of invasive colonies that threaten crops, ornamental plants, trees, and animals as well. The distinctive sounds from each species permit identification of those intruders.

Perhaps the most widely publicized uses for wildlife monitoring using ultrasound is the tracking of bats. Since they are only active at night, visual studies are nearly impossible. Infrared provides some good imaging, but their ultrasonic communications, used for echolocation, is a distinct advantage in chronicling the activities of these fascinating creatures.

Commercial industrial applications include the detection of pressure leaks from gas and

steam lines, providing an immediate alert to the possibility of a pending explosion. The high pressure release passing over the edge of the break produces a loud sound above the range of human hearing that only the ultrasonic detector can hear to activate an alarm.

Intrusion alarms abound with a variety of technologies including radio, infrared, visible light, and sound. One of these techniques employs bathing a protected area with an ultrasound, setting the detector to monitor the stable level. Anyone entering the area offsets the level by reflecting or absorbing the ultrasonic waves, thus alerting the detector to the presence of an intruder.

❖ ...and other titillating experiments

Decades ago, a Sarasota, FL scientist performed a variety of studies employing a sonic detector with a simple dipole antenna which he immersed in rivers, lakes and ocean waters. He repeatedly detected sonic emissions over a wide band of frequencies from fish, enabling their identification from the analysis of the sounds as well as their direction from the position of the antenna.

Sadly, the scientist died before his data could be shared widely, but it is rumored that the U.S. Navy took note of his work and continued the project separately, under the cloak of secrecy, for tactical applications. His files still remain undisturbed in a relative's home.

And how about the sounds from our own earth? Seismic geologists have been monitoring earthquake sounds and their precursors for decades. Are they missing something? The vast majority of studies are done at

sub-sonic frequencies – typically 1 Hz and below. Yet we know that the Piezo effect, so widely studied for frequency stabilizing oscillators and filters, is also present when pressures are imposed on rocks, especially quartz-bearing varieties. Could it be that the secret for earthquake prediction actually lies in the ultrasonic spectrum?

If you're tired of shortwave static and pager tones, give ultrasound a try! See the accompanying article by Phil Anderson on page 68 for contact and ordering information.

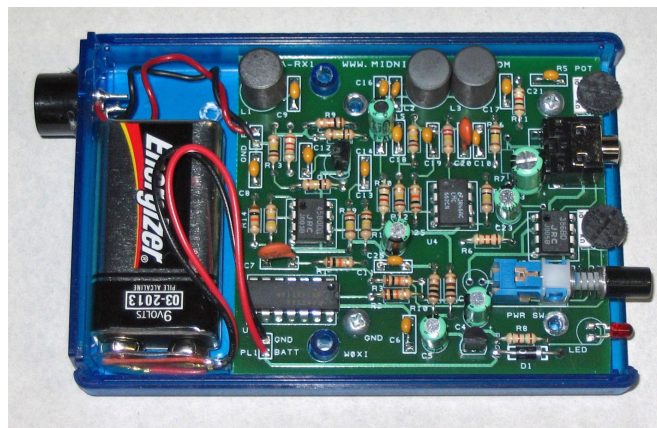

Want to SEE who is watching you?

The **AR-STV** handheld receiver captures hidden video signals!

Now, with the AR-STV handheld wireless camera receiver from AOR, you can see who is watching you on wireless video surveillance cameras. It's a valuable addition to any security operation. This easy to operate receiver features a large 2.5 inch color LCD display, still picture recorder and sensor that captures video signals in real-time. The USB connector makes it easy to download stored images into a computer. And the AR-STV comes complete with an internal clock that allows captured images to be time-stamped. With an optional 4 GB SD memory card, the AR-STV can be used to store up to nearly 2000 images.

Add to the power of your security force with this pocket-sized video receiver from AOR!

- Receives and displays analog video signals on L-band (1.2 GHz) or S-band (2.4 GHz)
- 2.5 inch color LCD display
- Still picture recorder
- Can be set for continuous search between 900 ~ 2800 MHz
- Detects NTSC or PAL analog video signals in real-time
- Built-in clock allows captured images to be time-stamped
- USB connector makes it easy to download stored images into a computer
- Easy to operate
- Powered by four AA size batteries or external DC power
- NiMH batteries, belt clip and battery charger included
- Rubber duck antenna with SMA connector
- Optional 4 GB SD memory card can store nearly 2000 images

Available from your favorite AOR dealer!



Authority on Radio
Communications

AOR U.S.A., Inc.
20655 S. Western Ave., Suite 112, Torrance, CA 90501, USA
Tel: 310-787-8615 Fax: 310-787-8619
info@aorusa.com • www.aorusa.com

Specifications are subject to change
without notice or obligation.

Unfinished Business

❖ The RFPC

Last month we were introduced to the Radio Friendly PC (RFPC), see Figure 1, from Hudsonville Computers at <http://hcss.webs.com/>. Using the new Intel Atom processor, we saw how this desktop, with a diminutive size 8.7”(w) x 5.1”(h) x 13”(d) and price at around \$400, did a great job running Ham Radio Deluxe and Radio Com 6.

However, in the 21st century, in order for a computer to be called “Radio Friendly” it must also be capable of running a real SDR, Software Definable Radio. So this month we’ll put the RFPC to the test with RF Space’s SDR-14 (www.rfspace.com/SDR-14.html) running the latest version of SpectraVue software 2.3.

To summarize, the RFPC has an Atom 230 single core, 1.60 GHz processor, running Windows XP Home Edition SP3, with a bus speed of 533 MHz, 160G SATA hard drive, 2 Gig DDR2 RAM, DVD/CD writable drive, Realtek ALC662 audio sound ports, and a video port using the Intel Graphics Media Accelerator 950. See last month’s column for more details.



Figure 1 – The Radio Friendly PC (RFPC) from Hudsonville Computers and The Atom – “Intel’s smallest chip. Built with the world’s smallest transistors”

The SDR

RF Space’s SDR-14 has been one of my favorite radios since its introduction a few years ago. See Figure 2. This compact little box does triple duty as a receiver, spectrum analyzer, and panoramic adapter and does it all very well. I’ll let its website www.rfspace.com/SDR-14.html speak for itself.

“The SDR-14™ is a 14-bit software defined radio receiver. It offers a broad range of spectrum analyzer and demodulation capabilities. The hardware samples the whole 0.05-30 MHz band using a high performance analog to

digital converter (ADC) running at 66.6 MHz. The digital data from the ADC is processed into I and Q format using a direct digital converter (DDC). The I and Q data is then sent to the PC for processing using a USB 2.0 interface. All of the demodulation and spectral functions are done on the PC side. The SDR-14™ comes with a High Frequency (HF) amplified front-end with switched attenuators and 1Hz tuning. A direct input port to the ADC is also included. This port can be used to sample signals directly up to 230 MHz+. This port can also be used to connect downconverters and spectrum analyzer front-ends.”



Figure 2 – RF Space’s very capable SDR-14 Software Definable Radio. Power in a small package.

SpectraVue, www.moetronix.com/spectravue.htm a freely distributed program, is used to control all facets of the SDR-14’s operation. It runs in both Windows XP and Vista.

One excellent and useful capability of the SDR-14 is not mentioned above. This is the SDR-14’s ability to receive and store, in digital form, any 200 kHz wide segment of the radio spectrum from 0.05 to 30 MHz. Once stored, the file can be “tuned,” as if listening in real time. All signals captured in the file of the frequency segment can be tuned to and demodulated in various modes.

The Challenge

Is the Radio Friendly PC, using “Intel’s smallest chip, and built with the world’s smallest transistors,” up to handling the demands of SpectraVue and the SDR-14? Let’s see.

The installation of SpectraVue and the USB driver for the SDR-14 were fast. The receiver was up and running within a minute. The RFPC was showing the no-signal 2D signal display without a hint of hesitation. These days, finding a decent signal on the shortwave band

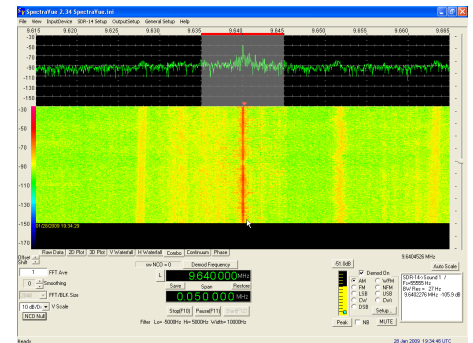

Figure 3 – No sweat! The SDR-14 and the RFPC working well together demodulating and displaying (combo mode) a signal at 9.640 MHz.

takes far longer. After a few minutes of tuning, an AM broadcast station was found at 9.640 MHz. The simple 2D display ran smoothly on the RFPC. So we pushed the RFPC by going into the Combo Mode, displaying both the simple 2D and the more complex Waterfall display. As we can see in Figure 3, the RFPC still didn’t break a sweat! Finally, we tried the last display mode, SpectraVue’s 3D display, Figure 4. The RFPC’s display was smooth showing no delay. In all the tests, the signal demodulation was clear and constant.

In my last attempt to push the RFPC over the edge while in the receiver mode, the SDR-14 was rapidly tuned over a wide range, at a 27 Hz bandwidth resolution and in the 3D display mode. A bit (less than 1 sec) of 3D display delay was noted when the tuning rate was whirling at its maximum rate. However, the delay did not impede operation. This was the only evidence of slowdown we observed during tuning and monitoring operations.

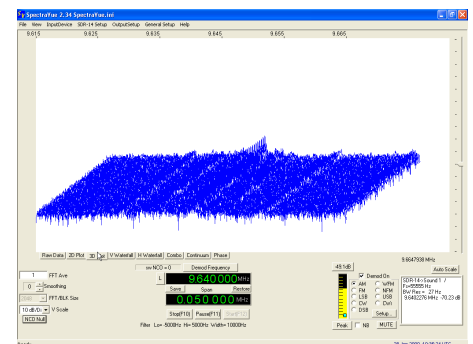

Figure 4 – The Dynamic Duo (SDR-14 & RFPC) displaying the station at 9.640 in the 3D Display Mode.

A Non-Radio Operation

As we said earlier, saving 200 kHz of spectrum to a file for later “tuning” is a very useful feature of the SDR-14 and SpectraVue. The RFPC performed this task without a problem. However, the saving operation seemed to take a lot longer on the RFPD than I remembered when using a Duo Core Pentium. Disclaimer: I don’t have hard timing numbers on his operation for the Pentium. The saving operation’s effect on the display was obvious. It jittered and stopped for brief periods. However, once the file saving was completed, the display returned back to normal operation.

Final Tally

The Radio Friendly PC proved it could easily handle the control, demodulation, and display operations required by RFSpace’s SDR-14 running under Spectravue 2.3. However, the user should expect some delay when performing a large file saving operation, in parallel with normal receiver operation and displays. As for the RFPC performance during the spectrum save operation, I give it a B to B-: acceptable, but noticeably near/at its performance limits. For all other operations I give the RFPC performance with the SDR-14, and the other radio applications we ran, a solid “A”.

You can check out the Radio Friendly PC at <http://hcss.webs.com/>. Tell them you saw it in *MT's Computers & Radios*.

❖ Windows: Walking on Broken Glass

Regular readers of this column know my opinion of Microsoft’s business methods for their operating systems. Years after product release, with their customer’s help, sweat and money, MS operating systems evolve into solid products. Right about that time Microsoft charges us for a new OS and the process starts all over again.



Soon, with Windows 7 coming down the pike, there will be three different Windows operating systems. But that’s not really the whole story: I believe today there are *thousands* of different operating systems on our PCs.

Have I gone crazy? (Years too late to ask that question.) So what am I talking about?

Recently I downloaded the latest version of a very popular application on my radio-software-testing Windows XP PC. The application, non-radio related, will remain nameless to protect the innocent. Of the many (to my wife’s chagrin) computers that I own, two are dedicated to radio-software-testing. One is running Vista Home and the other XP Home. They both show lots of wear and were cobbled together from junk box (literally junkyard) and new components. But trying to keep all my PCs’ operating systems up to date is becoming a full time job, and almost impossible.

When I allowed automatic updates on my Vista PCs, they seem to be needed on the average of every other day. This varied from week to week. It got so overwhelming and time consuming that I had to disable the automatic

update feature. I still perform manual updates about three times a month on the Vista PCs.

But Windows XP is a “stable” older operating system, nearing the end of its life. Therefore, I assumed any updates since my Service Pack 2 (SP2) installation would primarily be for its Windows Media Player, Internet Explorer and such. No changes that would affect the operating system. That assumption proved wrong.

Men Plan and Wives...Laugh

The application downloaded fine, and even installed without a problem. When I restarted my Windows XP PC, things went really bad. The PC would POST through BIOS fine. It would even get to the first Windows screen. But then the display flashed and a black system error message occupied the screen. Finally, the PC turned itself off with a sickening loud *SNAP*. It refused to turn on when the “on” button was pushed. The PC would only restart after it was unplugged from the AC mains. But then it behaved in the exact same manner. I could not even get it to operate in “safe mode.” It had all the symptoms of a bad processor or bad RAM.

As you can imagine, the unplanned time troubleshooting the problem was not a big hit with my wife who was waiting for me to go shopping. But I was consumed with the dilemma. Was the problem software or hardware? After telling her I needed about thirty minutes to discover the source of this problem, I dug in.

After hours of PC component testing, replacing and the laborious task of re-installing Windows I was no closer to an answer. However, divorce was almost a certainty. Out of pity she told me to keep working on the problem and cancelled our shopping trip.

What Did I Miss?!

I had read and re-read the application’s system minimum requirement over the past hours. My PC matched or exceeded them. Processor needed: check. RAM amount: check. Display requirements: check. Windows XP latest version: check.

As I read the requirement one more time, I became uncomfortable. Could my Windows XP version be the problem?! I distinctly remember shelling out \$89.99 for this boxed version of XP about a year ago. A sticker on the box proudly announced that latest SP2 update was included. On further reflection of the multitude of events in my life since that purchased, I came to the conclusion it was closer to two years ago.

A check of the cheery (grit teeth) Microsoft website showed that there had been another service pack issued for Windows XP in May of 2008. Wasn’t that around the time Microsoft warned customers that XP would soon be taken off the market? I know for sure that finding an XP PC at a retail store was a rarity by May 2008. Yet this mature operating system required yet another “update”?

Reading further on the MS site, “Windows XP SP3 includes all previously released updates for the operating system, in addition to a small number of new updates. Windows XP SP3 will not significantly change the Windows XP experience.” “All previously released updates...?” Does that mean that since SP2 there have been

that many major updates? “SP3 will not significantly change the Windows XP experience?” Does that mean that since MS had our money we were still stuck with an obsolete operating system that they were about to discontinue? I was not in a happy place. For completeness, and to satisfy my scientifically trained mind, I downloaded and installed SP3.

A Lesson Learned

The XP PC ran without a problem, and so did the newly downloaded application. I guess that the application must have called a routine in the XP operating system that had been changed in one of the “previously released updates” since SP2’s release. The result was that this call stopped the SP2 operating system dead. The surprising thing is that a safe mode boot still encountered problems. It almost seems as if it had something to do with the BIOS as well. “Oh what a tangled web we weave ...” Perhaps this should be the motto of Microsoft’s Windows’ developers.

OK. So how many versions of Windows are in service? Thousands. Maybe millions. Why? Every PC that does not have **ALL** of the up-to-minute Microsoft released updates is running some unique version of Windows. What their particular version looks like is dependent on their updating habits of how often and how complete. Can you imagine the number of system variations that exist with the almost daily Vista updates?

In order to accurately describe what version of Windows we are running, three parameters are needed:

- The Operating System Family – Windows Vista Home Basic
- The Latest Installed Service Pack – SP1
- The date and time of the last *total & complete* update – Jan 30, 2009 @ 0800 hours UTC

Only by defining all of these can be sure that we are comparing equal Windows versions.

Lucky 7 or More of the Same?

Thank you again, Microsoft, for a wonderful Saturday. I’m really looking to the release of Windows 7. Maybe Microsoft will even top themselves and require hourly updates with 7.

Hey, MS people and management, how about having some pride and putting an operating system on the market that is a real finished product? Or, how about we, your customers (remember us?), start charging *you* for our time in constantly “updating” (i.e., fixing) your product’s shortcomings? If we did, I bet Microsoft’s product release criteria would see a MAJOR change.

Excuse me. I guess I must need a complete weekend off. Till next time. Remember to “update” your car the next time it doesn’t start.

Books by Ernest H. Robl:

THE BASIC RAILFAN BOOK

UNDERSTANDING INTERMODAL

THE POWDER RIVER BASIN

Detailed descriptions at

<http://www.robl.w1.com>

What's NEW

Tell them you saw it in Monitoring Times

Uniden News

According to Uniden officials, the electronic updates to facilitate reception of those 800 MHz trunk radio systems which are being rebanded are now available on the internet for nine of their scanner models. Once these updates are loaded into the appropriate scanner, the user will have no problems once a public safety trunk system is rebanded and the new frequencies are entered into the scanner.

The Uniden scanners that can have their firmware updated for 800 MHz rebanding includes: BC246T, BCT15, BCD396T, BCD996T, BCT8, BC898T, BC296D, BC796D, and BR330T scanners.

For more information on these updates go to <http://info.uniden.com/twiki/bin/view/UnidenMan4/ScannerManuals>

In an related story, sometime this summer after the DTV conversion, the FCC plans to open up the 700 MHz Block D spectrum (758-763 MHz) for public safety auction. We have been told by two different sources that current scanners should be able to receive those frequencies after test units have been recertified by the FCC for the new frequencies. Our sources indicate that this will be done as a firmware update sometime in the future.

New Icom Transceiver Announced

Icom has announced a new transceiver that will replace their popular 756 series radios – the Icom IC-7600.

This transceiver covers the 160 to 6 meter amateur bands. It utilizes Icom's proven IF-DSP technology and features selectable roofing filters at 3kHz, 6kHz and 15kHz.

Like the IC-7700 and IC-7800, the IC-7600 uses dual 32-bit floating-point Texas Instruments DSP chips -- one for the radio and the other for the spectrum scope.

The radio has a 104dB dynamic range, and +30dbm 3rd order intercept point is achieved on the HF bands. It uses a double superheterodyne receiver with an image-rejecting 2nd mixer circuit for improved handling of in-band intermodulation distortion.

The 5.8 inch (diagonal) color WQVGA display has a quick-start LED backlight and views well from any angle and you can even program your startup screen. Dual frequency watch is available with same band operation. There is a built-in RTTY and PSK31 encoder/decoder.

All the creature comforts that hams have come to expect from Icom are included – Band-pass tuning, receiver and transmitter incremental tuning, keypad, 24 hour clock-timer, 101 memories and multiple scan modes. There is also a built-in voice recorder and voice synthesizer (English/Japanese selectable) and it even has two USB ports. The front panel USB port is for keyboard or memory drive (not supplied), and one on the rear panel for PC control and audio.

This radio has six transmit meter functions and three meter display modes, plus a meter output jack on the rear panel.

There is both a mechanical relay (16V/0.5A) and FET relay (250V/200mA) for keying an external amplifier. Separate RX-OUT and RX-IN antenna ports are provided, allowing connection of external preselectors, multicouplers etc. There is even a transverter port for adding other VHF/UHF band capability. The radio requires 13.8 VDC at 23 amps.

At presstime we do not have any information on availability or pricing information. Most Icom amateur radio dealers have indicated that they will carry this radio.

Published specifications from Icom for the IC-7600:

General

- Frequency coverage:
 - Receive – 0.030–60.000 MHz (Depending on version)
 - Transmit – 1.800–1.999, 3.500–3.999, 5.33050, 5.34650, 5.36650, 5.37150, 5.40350, 7.000–7.300, 10.100–10.150, 14.000–14.350, 18.068–18.168, 21.000–21.450, 24.890–24.990, 28.000–29.700, 50.000–54.000 MHz (Some frequency bands are not guaranteed and coverage depends on version.)
- Mode: USB, LSB, CW, RTTY, PSK, AM, FM
- Number of memory channels: 101 (99 regular, 2 scan edges)
- Antenna connector type: SO-239 ' 2 and phono jack (RCA; 50 ohm impedance)
- Temperature range: 0_C to +50_C (+32_F to +122_F)
- Frequency stability: Less than ±0.5 ppm 5 min. af-

- ter power ON. (0_C to +50_C; +32_F to +122_F)
- Frequency resolution: 1 Hz
- Power supply: 13.8 VDC ±15% (negative ground)
- Power consumption: Transmit – Max. power 23 A; Receive – Standby 3.0 A; Max. audio – 3.5 A
- Dimensions: 340 (W) x 116 (H) x 279.3 (D) mm (projections not included) 13 3/8 (W) x 4 9/16 (H) x 11 (D) inches
- Weight (approx.): 10.0 kg; 22 lbs.
- ACC 1 connector: 8-pin DIN connector
- ACC 2 connector: 7-pin DIN connector
- CI-V connector: 2-conductor 3.5 (d) mm (1€8")
- Display: 5.8-inch (diagonal) TFT color LCD

Transmitter

- Output power: (continuously adjustable) SSB/CW/RTTY/FM – Less than 2 to 100 W; AM – Less than 1 to 30 W
- Modulation system: SSB – Digital PSN modulation; AM – Digital Low power modulation; FM – Digital Phase modulation
- Spurious emission: HF bands – Less than –50 dB; 50 MHz band – Less than –63 dB
- Carrier suppression: More than 40 dB
- Unwanted sideband: More than 55 dB suppression
- Microphone connector: 8-pin connector (600 ohm)
- ELEC-KEY connector: 3-conductor 6.35 (d) mm (1/4")
- KEY connector: 3-conductor 6.35 (d) mm (1/4")
- SEND connector: Phono jack (RCA)
- ALC connector: Phono jack (RCA)

Receiver

- Receive system: Double superheterodyne system
- Intermediate frequencies: 1st – 64.455 MHz; 2nd – 36 kHz
- Sensitivity (typical):
 - SSB, CW, RTTY – 0.15 µV (1.80–29.99 MHz) (10 dB S/N) BW=2.4 kHz/0.12 µV (50.0–54.0 MHz)
 - AM (10 dB S/N) – 6.3 µV (0.1–1.799 MHz) BW=6 kHz 2 µV (1.80–29.99 MHz)/1.6 µV (50.0–54.0 MHz)
 - FM (12 dB SINAD) – 0.5 µV (28.0–29.99 MHz) BW=15 kHz/0.3 µV (50.0–54.0 MHz)
- Squelch sensitivity (Pre-amp: ON): SSB – Less than 3.2 µV; FM – Less than 0.3 µV
- Selectivity (IF filter shape is set to SHARP):
 - SSB (BW: 2.4 kHz) – More than 2.4 kHz/–6 dB, Less than 3.8 kHz/–60 dB
 - CW (BW: 500 Hz) – More than 500 Hz/–6 dB, Less than 900 Hz/–60 dB
 - RTTY (BW: 350 Hz) – More than 350 Hz/–6 dB, Less than 650 Hz/–60 dB
 - AM (BW: 6 kHz) – More than 6.0 kHz/–6 dB, Less than 15.0 kHz/–60 dB
 - FM (BW: 15 kHz) – More than 12.0 kHz/–6 dB, Less than 20.0 kHz/–60 dB
- Spurious and image: More than 70 dB, rejection ratio (except IF through on 50 MHz band)
- AF output power : More than 2.0 W at 10% (at 13.8 V DC) distortion with an 8 ohm load
- RIT variable range : ±9.999 kHz
- PHONES connector : 3-conductor 6.35 (d) mm (1/4")
- External SP connector : 2-conductor 3.5 (d) mm (1/8")/8 ohm
- DSP ANF attenuation : More than 30 dB (with 1 kHz single tone)
- DSP NR attenuation : More than 6 dB (noise rejection in SSB)

Antenna Tuner

- Matching impedance range:
 - HF bands – 16.7 to 150 ohm unbalanced (Less



What's NEW

Tell them you saw it in *Monitoring Times*

than VSWR 3:1)

50 MHz band – 20 to 125 ohm unbalanced
(Less than VSWR 2.5:1)

- Minimum operating input power – 8 W (HF bands)/15 W (50MHz band)
- Tuning accuracy – VSWR 1.5:1 or less
- Insertion loss – Less than 1.0 dB (after tuning at RF power 100W)

There are several ways to view an English pdf of the operating manual. Going to www.icom.co.jp/world/index.html and using the search function for IC-7600 will give you the option to download the manual when you click on the user's agreement.

FLEX-3000 SDR Now Available

The FLEX-3000 from FlexRadio Systems is a scaled-down software-defined radio from the makers of the FLEX-5000. Designed for portable and fixed operations, the FLEX-3000 fits in a laptop-computer case. It measures 12.25 x 12.25 x 1.75 inches and weighs in at 7 pounds.



The FLEX-3000 is a 100 watt, 160-6 meter all mode transceiver that connects to your computer via a FireWire connection. A built-in automatic antenna is included at no additional cost. Retail price is \$1599.00. For more information visit www.flex-radio.com.

Grundig Releases a Passive Antenna

For AM broadcast band (540-1700 kHz) portables, nothing peeps up a portable's reception like an external loop antenna. And now Grundig has introduced a new antenna for AM broadcast band enthusiasts. The Grundig AN200 is a passive, fully adjustable indoor antenna for the AM broadcast band. It is a low cost, nine inch diameter, tunable ferrite loop antenna.

Inductive coupling makes it easy to use with most portables that have an AM Ferrite bar antenna. Simply placing this antenna near the radio will improve reception. You just adjust the AN200 tuning knob for maximum gain. There is



also an output jack for a "wired" connection to radios with AM antenna terminals. The supplied cable has a 3 conductor 3.5mm plug at one end, and bare wires at the other end.

The AN200 (ANT59) is available from Grove Enterprises for \$29.95 plus shipping and handling.

Monitoring Times Back Issues in Sets

Grove Enterprises has put together a lightly-used archive of *Monitoring Times* magazines to be sold by year (volume) only, at \$19.95 plus \$5 shipping USPS per set. To order, email order@grove-ent.com or call 1-800-438-8155 and specify which year(s) you wish to purchase.

To see what topics were covered, click on www.grove-ent.com/mtbackissues.html to view the yearly index. These sets will not be broken. If you wish to purchase individual back issues to complete your own sets, call 1-800-438-8155 to see if those issues are available from our limited archives.

MT Anthology DVD

Another way to get back past issues of *Monitoring Times* is now electronically on DVD. Grove Enterprises has released the ultimate radio reference: the past 10 years of *Monitoring Times* magazine all on one DVD! This remarkable tool has the full information contained from every issue of since January 1999.

All of the articles are fully indexed and searchable. Frequencies and text can be copied and pasted into any compatible program. All the pages are in high resolution and full color! And all of this material is available for only \$79.95 plus shipping and handling (order SFT27-DVD). You can order online at www.grove-ent.com or call 1-800-438-8155.

Perseus Databases

If you are looking for some databases to use with your Perseus SDR receiver, you might want to check out this URL on the Free File Sharing website: www.4shared.com/dir/5567845/166a39bd/sharing.html

There are two versions of the database and both are compressed using the .rar file protocol/ You will also find an interesting pdf file, Perseus Third Party Software Guide v11, available for download on the same webpage.

Best of all, it is all available for "free."

UCS Releases New Satellite Database

A new version of the Union of Concerned Scientists Satellite Database, which includes launches through January 1, 2009, has been posted at http://ucsusa.org/satellite_data-

base. There are currently 905 active satellites in the database.

The new Excel format file is called "UCS_Satellite_Database_1_21-09.xls" and the tab-delimited text version is called "UCS_Satellite_Database_1-21-09.txt".

The versions in which the "Name" column contains only the official name of the satellite (in the case of government and military satellites) and the most commonly used name (in the case of commercial and civil satellites) are called "UCS_Satellite_Database_officialname_1-21-09.xls" and "UCS_Satellite_Database_officialname_1-21-09.txt".

The Database page has been newly organized for easier navigation, and it has several new features, including some analysis:

- "Satellite Quick Facts" box, giving current satellite counts, updated quarterly, and
- "Quick Facts & Analysis" page, explaining the derivation of the Satellite Quick Facts and answering some more in-depth questions, updated occasionally.

- Also new to the Database page are:
 - "Quick Guide to Using the Database," a how-to for several basic database tasks
 - "Featured Satellite," detailing one of the interesting active satellites in the database, updated quarterly.
 - Link to the new "Space Age Trivia" page, highlighting interesting facts about space, past and present, updated quarterly.

The other changes to this version of the database include:

- Reorganization of the orbital information into columns with "Class of Orbit," e.g., LEO, and "Type of Orbit," e.g., Sun-Synchronous. All GEO longitude information has been moved to the column "Longitude of GEO"
- The addition of 20 satellites
- The deletion of 14 inactive satellites
- The addition of and corrections to some satellite data
- The updating of the orbital information for the GEO satellites

And I forgot to mention the cost – Yes, again, absolutely free.

Another HF Receiver Company Gone

It would appear that JRC has completely withdrawn from the HF receiver marketplace. According to company sources, their NRD-630 receiver is no longer being sold, leaving them with no HF tabletop radio in the marketplace. So it would appear that JRC has followed in the footsteps of Drake and will no longer make any HF radios for the radio hobby.

Books and equipment for announcement or review should be sent to What's New, c/o Monitoring Times, 7540 Highway 64 West, Brasstown, NC 28902. Press releases may be faxed to 828-837-2216 or emailed to Larry Van Horn, larryvanhorn@monitoringtimes.com

INDEX OF ADVERTISERS

Antique Wireless.....	67
AOR.....	Cover 2, 71
C Crane.....	25
Carey, Kevin.....	60
CIDX.....	76
Communications Electronics.....	21
Computer Aided Technology.....	7
Cumbre DX.....	76
Grove Enterprises.....	11,25,27, 69, CVR3
Hauser, Glenn.....	41
ICOM.....	Cover 4
NASB.....	23
ODXA.....	76
Popular Communications.....	65
Robl, Ernest.....	73
Small Planet Systems.....	65
Universal Radio.....	17, 76
WiNRADiO.....	1

Stock Exchange

LINE ADS

NON-COMMERCIAL SUBSCRIBER RATES: \$.25 per word. All merchandise must be personal and radio-related.
COMMERCIAL, NON-SUBSCRIBER, AND MULTIPLE SALES RATES: \$1.00 per word. Commercial line ads printed in bold type.

Ads for Stock Exchange must be received 45 days prior to publication date. All ads must be paid in advance to Monitoring Times. Ad copy must be typed for legibility.

1-3/4" SQUARE DISPLAY AD:

\$50 per issue if camera-ready copy or, \$85 if copy to be typeset. Photo-reduction \$5 additional charge. For more information on commercial ads, contact Beth Leinbach, 828-389-4007.

Subscribe to MT for as little as \$15.50 (U.S. Second Class Mail)

7540 Hwy. 64 W.; Brasstown, NC 28902
1-800-438-8155 US and Can.; 828-837-9200; Fax 828- 837-2216
e-mail order@grove-ent.com

	6 months	One Year	Two Years	Three Years
US Rates	<input type="checkbox"/> \$15.50	<input type="checkbox"/> \$28.95	<input type="checkbox"/> \$51.95	<input type="checkbox"/> \$76.95
US 1st Class	<input type="checkbox"/> \$30.00	<input type="checkbox"/> \$57.95	<input type="checkbox"/> \$112.00	<input type="checkbox"/> \$168.00
Canada Surface*	<input type="checkbox"/> \$20.50*	<input type="checkbox"/> \$39.50*	<input type="checkbox"/> \$75.95*	<input type="checkbox"/> \$112.95*
Foreign International*	<input type="checkbox"/> \$30.75*	<input type="checkbox"/> \$58.50*	<input type="checkbox"/> \$114.95*	<input type="checkbox"/> \$171.50*
Electronic Subscription		<input type="checkbox"/> \$19.95	<input type="checkbox"/> \$38.90	<input type="checkbox"/> \$57.85

*All payments must be in U.S. Funds drawn on a U.S. Bank!

www.SecondHandRadio.com **FREE** classified advertising with photos for used radios & electronics.

Log stations, manage QSLs with Reception Log: **www.dxtreme.com**

Got something you'd like to sell? Can't find something you've been searching for? **MT** is THE way to buy or sell all of your radio equipment! It's inexpensive and is seen by tens of thousands of fellow hobbyists! Call today to get your listing in the next issue!

MT BLOGS

Blogs offer an opportunity for columnists to share information that does not make their columns. The news might be too timely for deadline, too short, confined to a small geographical area, too far away to be heard in North America, or even off the columnist's regular "beat." Bookmark these blogs for frequent visits!

MT: AMERICAN BANDSCAN

<http://americanbandscan.blogspot.com/> - by Doug Smith

MT: FED FILES

<http://mt-fedfiles.blogspot.com/> - by Chris Parris

MT: MILCOM

<http://mt-milcom.blogspot.com/> - by Larry Van Horn

Larry's Monitoring Post

<http://monitor-post.blogspot.com/> - by Larry Van Horn

MT: SHORTWAVE

<http://mt-shortwave.blogspot.com/> - by Gayle Van Horn

MT: UTILITY WORLD

<http://mt-utility.blogspot.com/> - by Hugh Stegman

Listening In

That's what we do and who we are!
Since 1974

Acclaimed worldwide as one of the top publications for radio listeners. Get a free sample of our electronic monthly magazine and see for yourself.

E-mail us and mention this ad

Ontario DX Association

155 Main St.N., Apt. 313
Newmarket, Ontario L3Y 8C2 Canada
E-mail: listeningin@rogers.com

www.odxa.on.ca

Cumbre DX is the world's best shortwave DX publication. We feature news and loggings that you just won't find elsewhere. But the best part about Cumbre DX is that it is absolutely

FREE!

Send and email to
cumbredx@yahoo.com
or visit our
website at www.cumbredx.org
to subscribe.

Join the Club!

Open to hobbyists worldwide, the **CANADIAN INTERNATIONAL DX CLUB** is Canada's national, general coverage radio club serving members since 1962.

For a free sample of our monthly electronic newsletter, **Messenger**, please e-mail CIDX at:

cidxclub@yahoo.com

Web: www.cidx.ca

HUGE 100 PAGE CATALOG

- ▶ Shortwave & Ham Gear
- ▶ Scanners & RTTY/FAX
- ▶ Antennas & Accessories
- ▶ Radio Books & CDs.

Send \$1 to
Universal Radio
6830 Americana Pkwy.
Reynoldsburg, OH 43068
Tel. 800 431-3939
www.universal-radio.com

GROVE

Your Source for
Radio Scanners,
Receivers, Accessories,
and Publications

AOR

AR-5000A Plus 3	RCV44P	\$2569.95
AR-8600II	RCV11	\$899.95
AOR SR2000A (B)	RCV36	\$2899.95

KAITO	KA1103	RCV55	\$89.95
	KA1121	RCV37	\$149.95

SANGEAN

ATS-505P	RCV7	\$109.95
ATS-909	RCV8	\$239.95
WFR-20	RCV40	\$299.95
WFR-1	RCV56	\$349.95

GRUNDIG	S350 DELUXE	RCV4	\$99.95
	G5	RCV10	\$149.95
	G6	RCV59	\$99.95
	Satellit 750	RCV58	\$299.95

ICOM

R75	RCV32	\$619.95
PCR1500	RCV15	\$499.95
R1500	RCV25	\$599.95
PCR2500	RCV35	\$729.95
R2500	RCV52	\$899.95

PERSEUS	RCV57	\$1299.00
----------------	-------	-----------

WINRADIO

WR-G33EM	RCV16	\$849.95
WR-G33EM/GPS	RCV16/GPS	\$999.95
WR-G33WSM	RCV28	\$999.95
WR-3500 (External)	RCV49-E	\$1995.95
WR-3500 (Internal)	RCV49-I	\$2195.95
WR-3700 (External)	RCV50-E	\$2895.95
WR-G303e	RCV46E	\$549.95
WR-G303e w/pro demodulator	RCV46EP	\$699.95
WR-G303i	RCV46	\$449.95
WR-G303i w/ pro demodulator	RCV46-P	\$549.95
WR-G313 (Internal)	RCV31	\$949.95
WR-G313 (External)	RCV31-E	\$1149.95
WR-G305i	RCV53	\$519.95
WR-G305i w/pro demodulator	RCV53P	\$619.95
WR-G305e	RCV63	\$619.95
WR-G305e w/pro demodulator	RCV63P	\$719.95
WR-G315 (Internal)	RCV54	\$CALL
WR-G315 (External)	RCV64	\$CALL

Grove means service. You won't find better customer service anywhere. **BUY TODAY!**

Established in 1979 by well-known communications expert Bob Grove, Grove Enterprises has become a world leader in radio monitoring equipment, accessories, and publications.

If you decide you don't like a product, Grove Enterprises doesn't penalize you for it. There is NO restocking fee so long as you call our toll free number for a return authorization within fifteen days of shipment and the item is returned in new condition. Once the item is received we will give you credit toward another item or issue a full refund (less shipping charges). Software cannot be returned if opened.

That's it! No hassle! No negotiations! Just call 1-800-438-8155 and our friendly staff will assist you with a return authorization number.

WINRADIO Accessories

WR-DNC-3500 Frequency downconverter	CVR02	\$189.95
APCO P25 Decoder, G305 Series	SFT42	\$89.95
AX-07B flexible VHF/UHF antenna	ANT47	\$24.95
AX-37A wide-band log-periodic antenna	ANT28	\$389.95
AX-71C discone antenna	ANT01	\$89.95
AX-815 active HF antenna	ANT51	\$189.95
AX31-B Antenna	ANT 4	\$99.95
WR-AX-31C	ANT58	\$139.95
AX-91M magnetic antenna base	ANT48	\$24.95
WR-LNA-3500 LOW NOISE AMPLIFIER	PRE03	\$199.95
Mounting Clamps for AX-71C	ACC71	\$14.95
USB Adaptor	ACC 2	\$49.95
Client Server Option-1000/1500 Series	ACC 14C	\$99.00
Client Server Option-3000 Series	ACC14B	\$399.00
Client Server Option-G313 Series	ACC14D	\$149.95
G303 Professional Demodulator	SFT20	\$179.95
G305 Professional Demodulator	SFT40	\$199.95
PCMCIA PC Card	ACC 28	\$89.95
FSK Decoder	DEC 1	\$349.95
WR-PPS portable power supply for external 1000/1500/3000 series receivers	PWR 5	\$189.95
Digital Suite	SFT 15	\$85.00
Advanced Digital Suite Upgrade	SFT 15U	\$85.00
Advanced Digital Suite	SFT 15A	\$179.95
World Radio Database Manager	SFT 16	\$85.00
Trunking Software	SFT 23	\$89.95
AX-37AM wide-band log-periodic antenna	ANT29	\$499.95
WR-G3E-WMB Wall-mount Bracket for G3	BRK02	\$19.95
WR-PPS-G3 portable power supply for G3	PWR09	\$189.95

Shipping/ Handling Charges

Total Order	Shipping Charges
\$1-\$29.99	\$3.00
\$30-\$49.99	\$6.95
\$50-\$99.99	\$9.95
\$100-\$399.99	\$13.95
\$400-\$899.99	\$17.95
\$900-\$1499.99	\$20.95
\$1500-\$1999.99	\$24.95
\$2000-\$2499.99	\$28.95
\$2500+	\$32.95

Make sure to
visit us on the
web to get
the latest and
greatest deals!

GROVE

(800) 438-8155

Grove Enterprises, Inc. - www.grove-ent.com
(800) 438-8155; (828) 837-9200; fax: (828) 837-2216
7540 Hwy 64 W; Brasstown, NC 28902 - email: order@grove-ent.com

**Icom has the radio
for the experts...**



IC-R9500 ICOM'S ULTIMATE WIDE BAND RECEIVER

- 0.005 - 3335.000MHz*
- USB, LSB, CW, FSK, FM, WFM, AM
- 1020 Alphanumeric Memory Channels
- P25 (Option UT-122)
- Five Roofing Filters and so much more!

**...or for those just
getting started.**



IC-R75 WIDE BAND RECEIVER

- 0.03 - 60.0 MHz*
- Triple Conversion
- Twin Passband Tuning
- Digital Signal Processing (DSP)

Now bundled with RadioCom 4.5

Icom's black box radios now come bundled with Bonito's RadioCom 4.5 software.

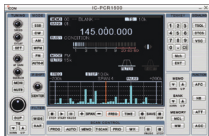

PCR1500

THE "BLACK BOX"

- 0.01 ~ 3299.99 MHz*
- AM, FM, WFM, CW, SSB
- Record and Save Audio as .WAV File
- USB Cable Connection
- Optional DSP



IC-R1500

MOBILE OR PC CONTROL

- 0.01 - 3299.99 MHz*
- AM, FM, WFM, USB, LSB, CW
- 1000 Memory Channels
- Fast Scan
- Optional DSP (UT-106)
- PCR Software Included
- Very Compact Design



PCR2500

DUAL BAND "BLACK BOX"

- 0.01 ~ 3299.99 MHz* (Main)
- 50 to 1300 MHz* (Sub)
- AM, FM, WFM, CW, SSB
- Opt. APCO 25 and D-STAR
- Dual Wideband Receivers
- Dual Watch PC Window
- Optional DSP



IC-R2500

2 WIDE BAND RX IN 1

- 0.01 - 3299.99 MHz*
- AM, FM, WFM, SSB, CW (Main)
- AM, FM and WFM (Sub)
- 1000 Memory Channels
- Optional D-STAR (UT-118)
- Optional P25 (UT-122)
- Optional DSP

NEW IC-RX7

STYLISH SCANNER WITH SMART INTERFACE

- 0.150 - 1300.000MHz*
- AM, FM, WFM
- 1650 Alphanumeric Memory Channels
- Digital Signal Processing (DSP)
- IPX4 Water Resistant Rating



IC-R5 SPORT

COMPACT WIDE BAND

- 0.5 - 1300.0 MHz*
- AM, FM, WFM
- 1250 Memory Channels
- CTCSS/DTCS Decode
- Weather Alert



IC-R20

ADVANCED WIDE BAND

- 0.150 - 3304.0 MHz*
- AM, FM, WFM, SSB, CW
- 1000 Memory Channels
- Dual Watch Receiver
- 4 Hour Digital Recorder



Contact your favorite Authorized Icom Dealer today!



*Frequency coverage may vary. Refer to owner's manual for exact frequency specs.
©2009 Icom America Inc. The Icom logo is a registered trademark of Icom Inc. All specifications are subject to change without notice or obligation. 30161