

Scanning - Shortwave - Ham Radio
Equipment - Computers - Antique Radio

Volume 25, No. 12
December 2006

U.S. \$5.95
Can. \$8.95
Printed in the
United States



Monitoring Times

A Publication of Grove Enterprises



In this issue:

Interview with Bob Grove
Zenith Radio Transforms the Arctic
Special Holiday Programming

MT Reviews:

WiNRADiO G305i Wideband Receiver
MT's Digital TV Buying Guide



AOR SDU5600 Spectrum Display Unit

Spectrum Display Just Got More Interesting!



*With sampling at up to six times per second,
you're quickly aware of new active frequencies.*

*The "waterfall display" function is a new
convenience, along with a host of menu
driven selections and features.*

The AOR SDU5600 is the "next generation" in spectrum display units. Using a five-inch TFT color display, DSP and FFT (Fast Fourier Transform), faster sampling rates and color imaging, the SDU5600 opens the door to new possibilities and applications.

Enjoy full control of compatible AOR receivers. The 10.7 MHz input may be compatible with receivers from other manufacturers as well. PC control is also present, as is highly accurate frequency management.

AOR SDU5600

- High resolution 5 inch color TFT display
- Built-in "waterfall" display function
- Now features FFT signal analysis
- DSP
- Uses 10.7 MHz IF input frequency
- Wide input level range: 0 ~ -90 dBm
- High dynamic range, 60 dB
- Fully interactive with AOR AR5000 models, AR8600, AR-ONE
- 10 MHz bandwidth (± 5 MHz from center frequency)
- Samples up to 6x per second
- Four frequency resolutions: 4, 32, 64, 128 KHz
- Image output to your PC
- Bus signal can be saved to memory
- Graphic display and statistical (text) data
- Menu driven operation
- Two RS-232C ports for receiver and computer control
- Easy to operate



AOR U.S.A., Inc.
20655 S. Western Ave., Suite 112, Torrance, CA 90501, USA
Tel: 310-787-8615 Fax: 310-787-8619
info@aorusa.com http://www.aorusa.com

Specifications subject to change without notice or obligation.

**The Serious Choice in
Advanced Technology
Receivers™**

WINRADIO G305 VHF/UHF receivers.

Low cost, with loads of bells and whistles.

The latest WR-G305 software-defined VHF/UHF receivers are in town. With numerous functions and facilities not normally available on any conventional receiver, and all at a great price, these receivers are sure to impress. They come in two versions: Internal PCI card and external USB box.

Hide a PCI-based monitoring receiver inside your desktop PC, doing away with all the cables and clutter on your desk; or go portable, with the USB-based receiver, a great companion device for your laptop or notebook while travelling.

Their excellent hardware parameters and extensive software support define a new standard for communications intercept and monitoring tools.



WR-G305i receiver: No clutter on your desk

WR-G305e receiver: Portable and powerful

The WR-G305e (USB) and WR-G305i (PCI) are the first commercially available VHF/UHF software-defined scanning receivers. Their all-mode digital demodulator works entirely in software, with easy upgradability and high performance level typical of receivers costing many times more.

These receivers are designed for demanding applications where the ability to locate even the weakest signals in background noise and extract the cleanest possible audio is important.



- 9 kHz-1800 MHz frequency range (except cellular bands where required by law)
- Optional 3500 MHz downconverter
- Tracking front-end filters
- Dual-loop AGC and AFC
- Software-defined demodulation
- Excellent sensitivity
- Fast scanning speed
- Multiple squelch modes
- Real-time spectrum analyzer
- Sweeping spectrum analyzer
- Hit counter
- Accurate S-meter
- Adjustable IF bandwidth
- Adjustable digital audio filter
- Digital communications ready
- Digital Bridge™ compatible
- Standard PCI card or USB box
- Easy "Plug and Play" installation

To all our customers and dealers
Merry Christmas and Happy New Year!

www.winradio.com
...the future of radio.™

E1XM

World's First and Only



Etón E1XM AM/FM/Shortwave/XM Satellite Ready Radio | \$500*

- Reception Modes: AM, FM-stereo, Single Sideband (selectable USB/LSB) and CW
- Programmable Memories: 500 user programmable with alpha labeling plus 1200 user definable country memories, for a total of 1700
- Superior Audio Quality via a bridged type audio amplifier, providing high output power with battery operation
- Direct Shortwave Band Entry, allows instant access to the shortwave band of choice

G5

Designed Without Compromise



GRUNDIG G5 AM/FM/Shortwave Radio | \$150*

- FM-stereo, AM and Full-Shortwave coverage (1711-29999 KHz)
- 700 programmable memory presets with memory scan and auto tuning storage
- Clock, sleep timer and alarm functions with world zone settings
- Tunes via auto-scan, manual-scan, direct key-in entry and tuning knob
- Internally recharges Ni-MH batteries
- Station name input

AOR, the Authority on Radio Makes MORE Than Great Radios!

Discover these Accessories & Add to your Capabilities.



DA3000

Antennas for the Great Outdoors

DA3000: a 16 element receive wideband discone antenna with useable frequency coverage from 25MHz to 2GHz. Using different length elements to ensure true wideband characteristics, the DA3000 also includes one 'loaded' element to enhance low frequency performance. Engineered and manufactured to AOR's exacting standards, the DA3000 comes with 50 feet of quality RG58/U coaxial cable terminated in a BNC plug for the radio connection and a low-loss TNC plug in the antenna base. Pole clamps are also standard.



SA7000

Designed for areas where space is a problem or when an "unobtrusive" installation is essential, **SA7000** is a super wideband coverage receive antenna with useable frequency coverage of 30 KHz to 2 GHz. The SA7000 is a passive arrangement with two whip elements: a long element for short wave up to 30 MHz and a second shorter loaded whip antenna for frequencies up to 2 GHz. The loading coils are tuned around 150 & 800 MHz to enhance VHF & UHF performance.

Antennas for Indoor Enjoyment

AOR has made performance even better with the new **LA380** indoor antenna as successor to the popular LA350. The LA380 features full frequency coverage (40KHz - 500MHz) using a single receiving element. Designed to provide reception when away from the main monitoring location or when large external antennas are not practical, the LA380 is a compact active (1 foot diameter) loop antenna which features an

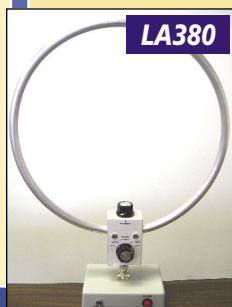

LA380

internal high-gain amplifier (20dB for 40KHz-250MHz) and excellent overall strong signal handling (high IP3 +10dBm). The loop design allows directional control and nulling noise or interference. Perfect for listening in remote locations or in antenna-restricted areas.

Accessories for Added Monitoring Capability

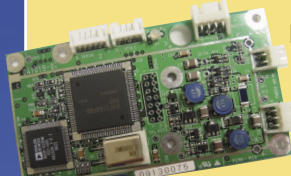

P25-8600
APCO25 Decoder

Now you can monitor APCO 25 signals using an AR8600MKII. The **P25-8600 APCO25 Decoder** can be installed in the AR8600MKII receiver to automatically decode the APCO25 signal. The decoded audio is then output from the receiver's speaker. *(Installation is required.)*

The **TV5000A NTSC TV Internal Converter** adds the ability to receive broadcast television signals (NTSC) and allow monitoring video feeds from a variety of sources including broadcast TV channels, public safety agencies, aircraft, Amateur Radio FSTV, news media video and more when used with AOR AR5000A series of communications receivers.



TV5000A NTSC
TV Internal
Converter



TVA-1 External
NTSC TV Converter

The **TVA-1 External NTSC TV Converter** is compact, lightweight and easy to install. Designed to be used with the AOR AR5000A series of communications receivers, its simple operation uses the 10.7 MHz IF input from your receiver. Audio and video outputs allow monitoring a variety of sources such as broadcast TV, public safety agencies, aircraft, Amateur Radio FSTV, news media video and more.

The **TV2000 External NTSC Video Decoder** is designed to be used with the AOR SR2000. Compact and lightweight, no external power supply is required (power is supplied from the SR2000). The video output is available from the rear panel of the TV2000 and audio is provided from the SR2000 through the external speaker jack.



TV2000 External
NTSC Video Decoder



Authority on Radio
Communications

AOR U.S.A., Inc.
20655 S. Western Ave., Suite 112, Torrance, CA 90501, USA
Tel: 310-787-8615 Fax: 310-787-8619
info@aorusa.com http://www.aorusa.com

Specifications are subject to change without notice or obligation

For more great accessories, visit the website at www.aorusa.com.

WORLD RADIO TV HANDBOOK

WRTH 2007

After the success of our 60th anniversary edition we are now proud to announce the 2007 edition of the bestselling directory of global broadcasting on LW, MW, SW & FM

The Features section includes a further series of interviews with leading industry figures on *The Future of Radio* and a history of *Broadcasting in the Pacific*

The remaining pages are, as usual, full of information on:

- National and International broadcasts and broadcasters by country with frequencies, powers, languages, station addresses, email, web, phone and fax, leading personnel, QSL policy, and more
- Clandestine and other target broadcasters
- MW frequency listings by region
- International and domestic SW frequency listings
- International SW broadcasts in English, French, German, Portuguese & Spanish, listed by UTC
- Equipment reviews, *Digital Update* and more
- A new look at TV by country
- Reference section with Transmitter Site Location Table, Standard Time & Frequency Transmissions, DX clubs, Internet Resources, and much more

Available December 2006

SOME COMMENTS ON WRTH 2006

The most respected reference book in the radio hobby . . . *World Radio TV Handbook 2006* remains the authoritative source for every serious listener – *Gayle Van Horn, Monitoring Times, USA*

2006 *WRTH* is fully packed with information – *Wolfgang Bueschel, Germany*

WRTH 2006 is a worthy sequel in a tradition of high quality handbooks – *Michael Schaay, The Netherlands*

The 2006 edition is definitely the best and most comprehensive ever – *Richard Dixon, Radio Nederland*

This 2006 edition really has outdone all previous ones. I do not know how a serious radio listener could be without the yearly *WRTH* and its online supplements, and I cannot imagine any radio professional doing without it – *Joe Analssandrini, Italy*

WRTH 2006 is very comprehensive, up-to-date and accurate and absolutely worth purchasing – *Anker Petersen, DSWCI*

The most accurate and complete edition of the *WRTH* I've ever seen – *Michael Schmitz, ADDX*

Congratulations upon the release of *WRTH 2006* – the quality is superlative! – *Adán Mur, Paraguay*

How can you improve a masterpiece? 2006 *WRTH* is magnificent! – *Howard Ragan, USA*

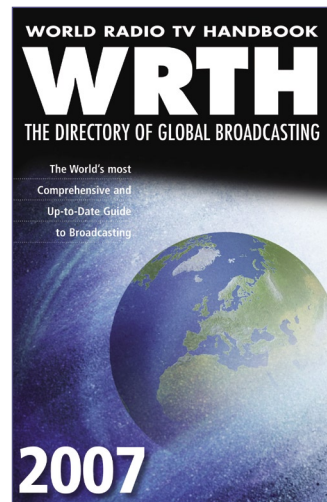



Cover Story

Happy Birthday Monitoring Times!

MT will have completed 25 years of publication at the end of this month. We start our celebration this month with an interview with founder Bob Grove on page 10. Bob also shares his experience of Growing Up with Radio (page 11). You may not find it shocking, but he certainly did!

You're invited to join in the celebration, too, by entering our 25th anniversary contest and drawing. We have more surprises in store for you on the website and coming up in future issues. Thanks for making it all possible!

C O N T E N T S

How Zenith Transformed the Arctic and Amateur Radio 13 By Harold Cones and John Bryant

In the dynamic years of the early 20th Century, an historic convergence between an explorer, an industrial and merchandising visionary, and the fledgling American Radio Relay League not only forever changed the experience of Arctic explorers, but also reshaped the evolution of amateur radio.

Radio transformed the Arctic experience for the 1923 Expedition. But when Zenith wanted to use short waves during the 1925 Expedition to achieve more reliable communications, they realized no one would hear them. Amateur radio operated almost exclusively on medium wave at the time. So Zenith embarked on an ambitious campaign to encourage amateurs to build shortwave sets. Included in this article are Zenith's original plans if you want to build one yourself!

After the Expedition demonstrated the viability of shortwave radio, the Arctic never again returned to its nearly complete isolation, and long distant wireless communications was no longer a subject of speculation.

Reviews

MT takes a **First Look** at WIN-RADiO's new wide coverage software defined receiver, the G305i/e, designed to replace the now-venerable WR1550e. Our reviewer finds that, as a wideband communications receiver, it gives good performance overall, though purchase of the optional Professional Demodulator is recommended to get full benefits. See page 70 for the full review.

Most of us know that to be truly prepared for power outages, it's necessary to have at least one old-fashioned land-line phone with a real cord between the hand set and the telephone base! But why not have a little fun with this necessity by making yours a collectible antique? Yes, many of the old

phones still work or can still be repaired, if your yard sale find isn't functional. See **On the Bench** page 66.

Turning from nostalgia to modern technology, Ken Reitz sets out to clear up some of the confusion of buying a high definition television or big screen. Both are likely to be popular purchases at the holiday season, but available information isn't necessarily consumer-friendly. Here are some tips on how and where to get your questions answered. (Page 68.)

Computers and Radio turns 15, "StumblesUpon" a new search engine, and discovers the Ultimate Shack Assistant (page 72).



MONITORING TIMES
 (ISSN: 0889-5341;
 Publishers Mail Agree-
 ment #1253492) is
 published monthly
 by Grove Enterprises,
 Inc., Brasstown, North
 Carolina, USA.

Copyright © 2006 Grove Enterprises, Inc.
 Periodicals postage paid at Brasstown,
 NC, and additional mailing offices. Short
 excerpts may be reprinted with appropri-
 ate credit. Complete articles may not be
 reproduced without permission.

Address: 7540 Highway 64 West,
 Brasstown, NC 28902-0098
 Telephone: (828) 837-9200
 Fax: (828) 837-2216 (24 hours)
 Internet Address: www.grove-ent.com or
www.monitoringtimes.com
 Editorial e-mail: editor@monitoringtimes.com
 Subscriptions: order@grove-ent.com

Subscription Rates: \$28.95 in US; \$39.50
 Canada; and \$58.50 foreign elsewhere,
 US funds. Label indicates number of is-
 sues left. Renewal notice is cover sheet 3
 months before expiration. **See page 76**
for subscription information.

Postmaster:
 Send address changes to *Monitoring Times*,
 7540 Highway 64 West, Brasstown, NC
 28902-0098.

Disclaimer:
 While *Monitoring Times* makes an effort
 to ensure the information it publishes is
 accurate, it cannot be held liable for the
 contents. The reader assumes any risk for
 performing modification or construction
 projects published in *Monitoring Times*.
 Opinion or conclusions expressed are
 not necessarily the view of *Monitoring*
Times or Grove Enterprises. Unsolicited
 manuscripts are accepted. SASE if material
 is to be returned.

Owners

Bob and Judy Grove
judy@grove-ent.com

Publisher

Bob Grove, W8JHD
bobgrove@monitoringtimes.com

Managing Editor

Rachel Baughn, KE4OPD
editor@monitoringtimes.com

Assistant Editor

Larry Van Horn, N5FPW

Art Director

Bill Grove

Advertising Svcs.

Beth Leinbach
 (828) 389-4007
bethleinbach@monitoringtimes.com

TABLE OF CONTENTS

Departments:

Communications 8
 Stock Exchange..... 75
 Advertisers Index..... 75

First Departments

Getting Started
 Beginners Corner..... 20
The Readers Write
 Ask Bob..... 22
 The MT Help Desk 23
 Scanning Report 24
Mixed Bag from Readers
 Utility World..... 28
Updated Cuban Numbers Schedule
 Digital Digest..... 31
Current Traffic
 Global Forum..... 32
Daylight Savings Time Expands
 Broadcast Logs 35
 Programming Spotlight 36
Special Holiday Programming
 The QSL Report 38
MT's QSL Holiday Special
 English Language SW Guide 39

Second Departments

Milcom..... 52
The Navy MARISAT System
 AM Bandscan 54
Digital Debacle?
 Boats, Planes, TRAINS 56
Railroads and Geography
 Below 500 kHz 58
Miscou 2006 DXpedition
 Outer Limits..... 59
Global Crisis Watch
 On the Ham Bands 60
I've Been a VERY Good Boy!

Technical Departments

Antenna Topics 62
Useful Antennas for Your Handheld
 Radio Restorations 64
Those Monumental Rider's Manuals
 On the Bench 66
Antique Telephones: Still Useful
 MT Review 68
MT's Digital TV Buying Guide
 First Look..... 70
WiNRADiO G305i Wideband Receiver
 Computers & Radio..... 72
Goodbye Win 98 - Hello XP
 What's New..... 74

EDITORIAL STAFF Email firstname@monitoringtimes.com

TJ "Skip" Arey.....	On the Ham Bands	Clem Small	Antenna Topics
Rachel Baughn	Communications	Doug Smith.....	American Bandscan
.....	Letters to the Editor	Hugh Stegman	Utility World
.....	What's New?	Ernest Robl.....	Trains
Kevin Carey	Below 500 kHz	Gayle Van Horn	Frequency Manager
John Catalano	Computers & Radio	Broadcast Logs
Mike Chace.....	Digital Digest	QSL Corner
Jim Clarke	First Look	Larry Van Horn.....	Milcom
Marc Ellis	Radio Restorations	First Look
Bob Grove	Ask Bob	MT Help Desk
Glenn Hauser	Global Forum	Dan Veeneman	Scanning Report
Chris Parris	Fed Files	Ron Walsh.....	Boats
Ken Reitz.....	Beginners Corner	Fred Waterer	Programming
Lee Reynolds	First Look	Spotlight
Iden Rogers.....	Planes	George Zeller.....	Outer Limits



COMMUNICATIONS

“Communications” is compiled by Editor Rachel Baughn KE4OPD from newsclippings from these fine contributors: Anonymous, Joe Craig, Norman Hill, Tomas Hood, John Figliozzi, HL4, Bart Lee, John Mayson, Ken Reitz, Doug Robertson, Larry Van Horn.

Duplicating Marconi

In the December 2001 issue, *Monitoring Times* ran an article by Bart Lee KV6LEE which ventured an explanation for how, 100 years earlier, Marconi was able to send a mediumwave signal from Poldhu, Cornwall, UK, to Newfoundland at the bottom of the sunspot cycle. Realizing that December 2006 should show similar conditions, it was thought to try to replicate Marconi's feat.

The best estimate of the frequency used by Marconi in 1901 is somewhere between 800 and 900 kHz. Today, this frequency is so crowded with transmitters, a clear channel would be impossible to find. Therefore, a temporary license has been acquired to operate a beacon (GB3SSS) on the amateur frequency of 1960 kHz during November - February 2007.



The Marconi Museum at Poldhu

The transmitting sequence will be the same as that used by UK 5 MHz beacons: a two minute sequence on the hour, consisting of CW identification followed by a series of bursts of carrier each reducing in power by 6dB. There is then an identification in PSK31. This is repeated at 15minute intervals.

Joe Craig, VO1NA, in St. John's, Newfoundland, will be monitoring for the signal, using a Beverage antenna. The Antique Wireless Association in New York will also be monitoring from W2AN. Software is available to monitor the transmissions and can easily be found by searching for '5MHz beacon' in a search engine, or going to: www.rsgbspectrumforum/5mhz%20beacon%20monitoring.htm. Reports may be sent to: gb3sss@yahoo.co.uk.

For more background information, also check out www.californiahistoricalradio.com/photos53.html and [Photos64.html](http://photos64.html)

FCC passes Omnibus ruling

It's been a long time coming. In WT Docket 04-140 released October 10, the FCC adopted nearly all of the changes it had put forth in its 2004 *Notice of Proposed Rulemaking*. The *R&O* does **not** include action on the Commission's proposal to eliminate the Morse code requirement for all license classes. *A Report and Order* in that proceeding, WT Docket 05-235, is still pending.

The ARRL summarized the actions included in the *Report and Order* on its website. Among other actions, the FCC:

- * expanded the phone subbands in the 75 and 40 meter bands;
- * agreed to allow Novice and Tech Plus (Technician with Element 1 credit) licensees to operate in the General class CW subbands on 80, 40, 15 and 10 meters;
- * implemented rules to discourage multiple vanity call sign filings;
- * permitted auxiliary stations to transmit on portions of the 2 meter band;
- * permitted the use of spread spectrum on 222-225 MHz;
- * permitted amateurs to retransmit communications from the International Space Station;
- * permitted hams to designate a specific club to receive their call sign *in memoriam*;
- * eliminated certain restrictions governing external RF power amplifiers intended for Amateur Radio use;
- * clarified that "amateur stations may, at all times and on all frequencies authorized to the control operator, make transmissions necessary to meet essential communication needs and to facilitate relief actions";
- * deleted the frequency bands and segments specified for Radio Amateur Civil Emergency Service (RACES) stations;
- * deleted the requirement to publicly announce Amateur Radio examination locations and times, and
- * permitted ham stations in Alaska and surrounding waters more flexibility in providing emergency communications.

The FCC also agreed to "refarm" the HF segments currently authorized to Novice and Technician Plus licensees. The reallocation will expand the phone subbands for General, Advanced and Amateur Extra licensees. Changes in spectrum can be seen in a downloadable chart at www.arrl.org/announce/regulatory/wt04-140/Hambands3_color.pdf

Planespotters and SBS-1

Next time you're in the bookstore looking for the latest copy of *MT*, you might want to check out an unusual book entitled *Torture Taxi: On the Trail of the CIA's Rendition Flights* by Trevor Paglen and A.C. Thompson. These two investigative journalists had a major break in their line of enquiry when they discovered the hobby of planespotting.

The Village Voice reprinted a whole section of the book pertaining to the plane spotters. (See <http://villagevoice.com/news/0642,torturetaxi,74732,2.htm>)

"Ray" is a planespotter - a person obsessed with almost everything having to do with aviation. As a hobby, Ray tracks airplanes, logs their serial numbers and movements, analyzes their radio systems, and keeps detailed records of the frequencies and designs that their systems use. He tries to understand how aviation systems work, how planes communicate with the ground controllers and with each other, and how the

military and the Federal Aviation Administration manage various kinds of airspace. On this mild spring day, Ray's testing a new piece of gear: a Kinetic Avionics SBS-1, a 'virtual radar' system. Attached to his laptop with a USB cable, the system allows him to watch air traffic within a forty- or fifty-mile radius and to log call signs and basic information about the planes."



In an interview with Amy Goodman of "Democracy Now!" Thompson elaborated on how "Ray's" techniques helped them:

A.C. THOMPSON: "...what we did is sort of adopted their techniques. 'Ok, so you know how to track planes. You know where they go. You know that even a CIA plane has to file a flight plan with the FAA. Let's use that information and figure out where these suspicious planes that we've linked to the CIA are going.'"

Sound intriguing to you? ENIcomm has donated another SBS-1 Virtual Radar to *MT* as our grand prize drawing. Enter the contest, and who knows where it might lead?

800 MHz Rebanding Freeze?

To no one's surprise, the 800 MHz rebanding effort is seriously behind schedule. Sprint Nextel apparently suggested freezing the 800 MHz rebanding timetable two years to allow public safety agencies to complete the planning process for the rebanding. The Association of Public-Safety Communications Officials (APCO) International responded by saying it found no rationale as to how a freeze would enhance the process.

"However, APCO International recognizes that the rebanding process has not proceeded as expected and would consider minor adjustments if absolutely necessary to ensure safe and effective rebanding. Until rebanding is complete, first responders and the public they serve are at risk due to the continued potential for interference."

APCO International attributes the delays, in part, to the difficulty experienced by several agencies going through negotiations and seeking reimbursements for planning funding. "If public safety has not proceeded with planning," continued the release, "it is often because agreements could not be reached with Sprint Nextel regarding the cost of such planning."

Worldwide SWL Contest

As in years past, French SWLer Frank Parisot is hosting an SWL contest to coincide with the ARRL 10-meter (28 MHz) contest December 9 and 10. For rules and more information, visit <http://monsie.orange.fr/28mhzswlcontest/index.jhtml>

Monitoring Times Celebrates 25 Years

1/1982 - 12/2006



Bob, Judy and your devoted Art Director, Bill Grove at an early hamfest. Bringing a bit of country to the 'fest! I was selling Apple Cider out of the barrel next to me in the photo! The "shack" behind us was a collapsible display that we could assemble easily from convention to convention, made from real wood planks! -Bill

dressing. Our intent is to populate the website with useful resources that stay valid over time, as we don't have the staff to manage daily updates.

On the other hand, we don't want to build up the website at the expense of the magazine that it supports. Therefore, there will be a password which will change monthly in order to access the bonus section of the website. The password will be printed somewhere within in EACH issue of *Monitoring Times*. Hopefully this will help ensure the restricted pages benefit those who actually buy the magazine, without penalizing those readers who buy their issues from the newsstand.

We look forward to continuing to grow and change with the times, in the traditional spirit of the radio hobby. Our feature article on Zenith radio is an eye-opener regarding the importance of amateur radio operators in the evolution of radio technology. Radio – wireless – is on the growing edge of technology just as much today as it was when the Zenith Transoceanic made its first experimental trip to the Arctic! Maybe more so, as technology finds more and more uses for electromagnetic waves from dc to daylight!

Longwave Resources

✓ **Sounds of Longwave** CD or Audio Cassette (please specify) featuring WWVB, Omega, Whistlers, Beacons, European Broadcasters, and more!
\$13.95 postpaid

✓ **The BeaconFinder** A 65-page guide listing Frequency, ID and Location for hundreds of LF beacons and utility stations. Covers 0-530 kHz.
\$13.95 postpaid

Kevin Carey
P.O. Box 56, W. Bloomfield, NY 14585



NAME THE COVER STORY CONTEST!

What was the cover story for Volume 1 Issue 1 of *Monitoring Times*?

The Grand prize of a *LIFETIME* subscription to *Monitoring Times* will be awarded to one person whose name is drawn from those with the correct answer. All entries, whether correct or not, will be entered for the First* and Second Prize drawings. Contest deadline: January 15, 2007

Grand Prize: Lifetime subscription to MT

First Prize: Kinetic Avionics SBS-1 Virtual Radar

Second Prize: MT Anthology on CD 1999-2005

Sorry: no email entries will be accepted. If you don't know the answer to the question, you can enter anyway. Send your entry in a letter or on a postcard, including your NAME, MAILING ADDRESS, and your EMAIL or PHONE number, to:

MT 25th Anniversary Contest
7540 Hwy 64 West
Brasstown, NC 28902

* *Monitoring Times* is very grateful to ENIcomm for its generous gift. Please visit their site at www.ENIcommunications.com

At the end of December, *Monitoring Times* will have completed its 25th year of publication. In January 2007 we'll move into Volume 26. That's a mere infant compared to magazines like the venerable *National Geographic*, but it's not a bad accomplishment in the short life expectancy of hobby magazines. So we plan to celebrate!

In addition to our usual forward-looking articles, we plan to do some looking back during the coming year – interviewing long-time writers, reprinting significant stories from past editions, noting milestones, and running contests for loyal readers. We start out with an interview with our founder and publisher Bob Grove, together with a very revealing article about his early experiments with electricity! (He's also fascinated by fire ...)

You are also invited to enter our first contest as outlined in the sidebar. We are very grateful to Mark Phillips of ENIcommunications Corporation for donating the First Prize for this contest (a value of \$800). The company is currently the new US distributor for Kinetic Avionics products and for Jingtong amateur radio equipment, along with their other wide-ranging talents in telephonics, broadcast technology, and radio program production in their digital studio. Check out ENIcomm's website at www.kineticavionics.us or visit them at 70 Brookside Road, Randolph, NJ 07869, or call (866) 500 SBS-1.

Bonus Pages for MT Readers

As we look back, we are also looking forward. In 2007 we plan to inaugurate a special section of the *Monitoring Times* website just for our regular readers. We'd like to say "Thank you" to those of you who continue buying the magazine – whether as a subscriber or at the newsstand. We wouldn't be here without you, and we're always looking for ways to make our website a more helpful resource to you in your radio listening.

In the Bonus section we will be posting such items as an expanded glossary of radio terms and acronyms used in *MT*, additional audio file samples to download so you can identify digital modes from all those weird noises you hear on HF, Bob Grove's antenna book, additional articles from past *MTs*, and so forth. As time and talent allow, we hope to add podcasts of interviews with some of our writers and experiment with other creative uses of the internet combined with radio. Your suggestions are welcome, especially if you see a need no one else is adequately ad-



A Visit with Bob Grove WJ8HD

Publisher, Monitoring Times; Owner, Grove Enterprises

In this issue of MT you have recounted some of your childhood electrical experiments and how you got your start in ham radio. Could you elaborate on your background in radio and journalism prior to creating Monitoring Times?

Standing in front of a group of people and expounding on something began with a speech class in high school, where I first discovered I had a flair for writing. During college, I was Music Director and Quiz Host of our college radio station; I also earned a little money as an announcer/engineer for a commercial radio station. After I graduated, I became Public Affairs Director and an interviewer for an ABC TV/FM/AM affiliate broadcaster. Most of my writing has been allied with electronic topics, appearing in *Radio-Electronics*, *Envirosouth*, *CQ* and, of course, the *RCMA Journal*.

You seem to have acquired a particular expertise in antennas – how did that come about?

Ever since discovering at age 10 that a long string of wire attached to a crystal set could bring voices and music to a pair of earphones, antennas have fascinated me. When I finally got my ham radio license at 13 and couldn't afford to buy an antenna, that's when the experimenting really began. I've been doing it ever since.

What was it that inspired you to publish the first issue of Monitoring Times 25 years ago?

MT evolved from a regular supplement included with the early Grove Enterprises catalogs; our readers pled for more information, so we finally published the first issue of the only magazine that was exclusively designed for the monitoring hobby.

What was the primary focus of the original publication? Has that focus changed over the years?

Wide-spectrum reception of signals, from under the sea to land to space. If it emitted a signal, we covered it. We still do. While other magazines have copied our lead, we are still recognized as the leading authority on radio reception.

We've had a few changes in emphasis – For example, we greatly increased coverage of shortwave broadcasting when we incorporated Larry Miller's shortwave broadcast publication, *INTERNATIONAL RADIO* in June of 1986. The shortwave guide grid is a legacy from that publication and is still a major element in the magazine. On the other hand, we dabbled with publishing TVRO and weather satellite information, consumer electronics, and PCS, but those all went by the wayside. We may mention topics like those

occasionally, but they are not our mainstay.

Do you think Monitoring Times fulfilled your hopes for it, and do you think it has a role to play in the years to come?

Absolutely. We have watched our competitors come and go (and we even had to put one of our own publications – *Satellite Times* – to rest). *MT* has surpassed my hopes in some ways: we always had good writers, but I don't know if I ever envisioned keeping such a competent core of writing staff for this many years. *MT* owes its longevity to their high standards. We are also one of the few remaining outlets for free-lance authors wanting to write about shortwave radio and scanning.

With the advent of the Internet, similar information to that contained in *MT* became available at the tap of a key, but much of it was plagiarized from *MT*, or bogus, or outdated. On the other hand, we decided to use the internet to our advantage by creating our electronic publication, *MT Express*, which is quite successful and growing in popularity. As you'll be seeing, we plan to continue to use the Internet to make interviews, articles, and other resources available to our readers.

Are there some high points in MT's history of which you are particularly proud?

Definitely. We became the focus, along with Grove Enterprises as a dealer, of radio privacy issues during the cellular scanning issue a decade ago. *MT* and Grove were interviewed and quoted regularly on TV networks, radio broadcasts and newspaper issues.

When we published the *Federal Frequency Directory*, we learned that many of our nation's undercover agents were using it as a signals surveillance tool.

We were the first to expose the sources and locations of the mysterious spy numbers transmissions.

MT is considered a "must read" by federal intelligence agencies.

We were the first publication to publish confirmation of the *Stealth* aircraft as our adept listeners reported transmissions from their test flights.

We were the first radio print magazine to establish an on-line subscription, *MT Express*.

For seven years straight, *MT* and Grove Enterprises sponsored internationally-attended radio expositions in Knoxville and Atlanta, bringing in experts worldwide.

Our coverage of super-secret Area 51 communications was quite popular, and still inspires inquiries from radio listeners and the press.

Our authority and leading-edge reporting resulted in my being called to Washington to testify before Congress on cellular security issues, and my being confirmed as a court-approved expert on radio communications.

What have you personally enjoyed the most about publishing MT?

I've enjoyed the respect that *MT* has earned as the top publication in its field. If it's printed in *MT*, it has validity, and in those rare cases where we make a mistake, it's always corrected in the next available issue. Our leadership position has given me a personal opportunity to speak to many organizations and meet outstanding individuals in their fields. It has also given me a personal opportunity to meet hundred of our readers over the years.

I recall one recent incident in which I had attended a symphony orchestra performance. During the intermission, I moved to the stage to congratulate some of the musicians, when two violinists came over and asked, "Aren't you Bob Grove?" I was flattered, of course, but proud that our magazine has such diverse outreach, and that Grove Enterprises is so well known.

What new technologies excite you and how do you see them being incorporated into radio and MT in the future?

Digital communications has greatly expanded radio's capabilities. While it looked for a while that this new technology might doom scanner monitoring, the recent adoption of publicly-available P-25 digitization as a national standard has guaranteed its future.

Trunking systems make radio traffic handling more efficient, and is now built into most scanners.

Component miniaturization allows superior performance and multiple functions in compact receivers.

DRM promises to improve shortwave reception.

Satellites beam down more and more communications and programming.

As these technologies enjoy growing implementation, and others are born, *MT* will be there. With a lively dialogue between writers and contributors, *MT* will continue to inform the public – and the profession – of equipment, techniques, frequencies and schedules.

But *MT* doesn't operate in a vacuum. As your radio world changes, let us know what answers you need. Let us know what answers you've found. It's been a great partnership for 25 years!

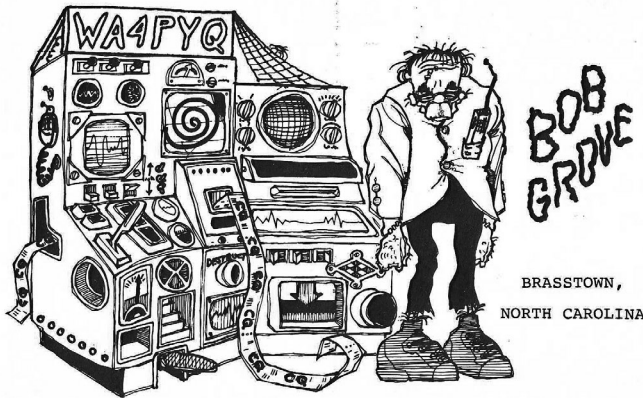

Growing Up With Radio

by Bob Grove W8JHD

An inquisitive youth

Some of us discover radio late in life, but radio, in one form or another, has been part of my life since my earliest childhood recollections.

As a very small child growing up in Cleveland, Ohio, I would reach up and press the buttons that energized the motor-driven dial of my grandparents' console, hypnotized by the moving needle and the humming motor as it searched for stations. English language shortwave programs were more common then, so the chance of hitting an active frequency that I could understand was pretty good.

My grandparents' house was an old Victorian style, and its many floors held a trove of treasures to be explored, with the dusty attic particularly appealing.

The temptation to dig through drawers and boxes became a childhood obsession; every week I could expand my exploratory horizons by venturing down the street, digging through the neighbors' trash cans before the rubbish collectors arrived.

Obsessed with the concept of treasures awaiting my discovery in trash cans, I would go rubbish picking (now known more euphemistically as "dumpster diving") on my way to school. Fearing that someone else might find my trove, I would hide the day's take beneath an old tree in a nearby woods, then anxiously await the dismissal bell to race back and recover my plunder.

One of those salvage missions took me behind an automotive shop where, among greasy, discarded bearings and dripping oil containers, I found a discarded Tungar bulb from an old battery charger. I immediately recognized it – it looked just like the powerful tube inside the robot's chest in one of the 25-cent, science-fiction, cliff-hanger serials that I used to attend every Saturday at the Homestead Theater! I was hooked.

That old tube was the premier exhibit in my dresser-drawer collection of jetsam and flotsam rescued from untold trashcans. I would take it to bed with me, sit and admire it, and jealously protect it. Then, one day, as Mom was trying to hurry me for school, the inevitable happened. I tossed my cap pistol into the drawer.... "POP!" I knew what had happened, but I agonizingly dragged myself to the drawer and looked in.

There – in the front of my drawer – was a pile of shiny, metal-coated, glass fragments – the disarrayed remains of my prized Tungar bulb! I was inconsolable, and a replacement for that tube was not to be found for several decades (and that one is still on display in my office!)

The movies

I was a very impressionable youngster and

never lacked entertainment. My mother was a movie addict (and, at a spry 94 years of age, still is!), so there was hardly a Hollywood release that I didn't see. I recall one particular dance routine of Fred Astaire as he pirouetted about, alternatively thrusting his hands toward the stage, each time eliciting a flash of fire! Wow, could I do that? At the impressionable age of eight, I was sure I could.

Let's see... what could make those sparks? Of course – *spark plugs!* I could hardly contain myself with my self-congratulations for this sheer genius. I awoke often during that night, eager to race back to that automotive repair shop. Arriving there early the next morning, digging through the grease and grime, I emerged triumphant with a discarded plug! I can still see the looks on the faces of those crusty mechanics watching me as I whirled about, threw the spark plug to the ground with great anticipation, then staring in dismay when all it did was go "Thud!"

My laboratory

When I was nine years old, we moved to a big, old farmhouse in suburban Rocky River; original, carbon-filament light bulbs were still in their sockets, and the dingy basement would become my laboratory.

My first Christmas there was highlighted by a Chem-Craft chemistry set. As I pored through the pages of the little experiment handbook, my eyes froze immediately on one entitled, "*A Safe Explosive.*" OK, that's a really good start, I thought.

This one involved saturating iodine crystals with ammonia. When this stuff dries out, even a speck of dust sets it off with a very loud bang. With great expectation, I put a soggy pile of the concoction on the basement floor to dry, not even thinking about where I'd put it – right in the pathway of where my mother would be carrying a load of clothes to the washing machine.

As I sat upstairs watching Super Circus on our new Dumont TV, mom was dutifully carrying that huge basket of clothes down the basement stairs, her mind a thousand miles away in thought. At the bottom of the stairs, she turned and took a step toward the washing machine. "*BLAM!*"

Words can't begin to describe the next few minutes as I tried to explain my innocence while helping my mother pick up clothes from all over the basement. I was strongly encouraged not to try that experiment again.

Apparently other mothers had similar experiences with their young scientists – future reprints of that little manual had a blank page where there used to be instructions for "*A Safe Explosive.*"

Next: electricity!

It was only natural that my curiosity should evolve through the mysteries of electricity, and while my electrical experiments were not hazardous to other people, they were to me. AC/DC tube radios, with their "hot chassis" always gave me a buzz when I touched them as I stood on the damp basement floor.

Dr. Frankenstein was my mentor. His famous laboratory with lightning flashing from every direction was awe inspiring. I had to have this.

I acquired an old, Model T ignition coil and soldered a pair of stiff, parallel wires to the contacts. I actually made a Jacob's ladder. The sparks were small as they slowly ascended, but they were sparks! Further experimentation with this fiendish device left a macabre pile of electrocuted weeds and bugs, and usually left me with a share of painful electric shocks as well.

Did you know that you can cook a hot dog in a moving vehicle? All you need is a DC/AC power inverter, a plug, some wire and, of course, the wiener. I tried this on a trip to Florida during a school break with my Cousin Steve.

I stuck the wires in opposite ends of the wiener, turned on the inverter and, in a matter of seconds, the 120 volts split the steaming wiener. But when I attempted to retrieve the weenie while the inverter was still on, it darned near cooked me as well! It would be several years before I heard the admonition from experienced hams to keep one hand in my pocket while poking inside high-voltage equipment.

And finally: Radio!

Since I was something of a geek, I often went to the library after school. There I discovered some ancient books about radio. I pored over these old, tattered documents and their photos, firmly convinced that the modern approach to radio communications was to mount the sockets for bulbous vacuum tubes on a breadboard, and wind coils out of copper tubing. Even better, these relics resembled the contraptions I'd seen used by my long-time movie hero, Dr. Frankenstein!

Fortunately, I was rescued from this misconception by an elderly gentleman who, it turned out, had been watching me cruising by the radio book shelf. He cautioned me that radio had progressed further than that, and he lived nearby if I'd like to see *real* radio communications equipment. Thus began an enduring friendship with my new mentor, Dave Crossley, W8BCO.

Dave had built most of his own gear, and admittedly, some of it was on breadboards. But he taught me about radios, electronic theory, and how

WN8JHD

21605 CENTER RIDGE RD.
ROCKY RIVER, OHIO

Radio _____ Confirming Qso of _____
at _____ EST _____ Mc. Ur Sigs Rst _____
TRANS. _____ Rcvr. _____
73's, Bob Grove

to learn the Morse code. Yes, I was ham-radio bound at 13 years of age.

After memorizing the code, I went to the Cleveland Public Library where the FCC tests were then administered. It was 1951 and the newly-approved Novice Class license was available to encourage entry-level amateurs. The code test, supposed to be an easy 5 words per minute, must have been at least 150! The dots and dashes echoed through the room as I desperately tried to remember what they meant. I flunked; and a few weeks later, I flunked again. But three was a charm, and I finally earned my Novice call, WN8JHD.

Dave loaned me his crystal-controlled, bread-board transmitter with its plug-in coils, and an old National FB-7 receiver; I put up a random-wire antenna.

Nature's pyrotechnics

I remember waking up early one stormy morning to the sound of a loud "crack" every time the lightning discharged outside my window. Giving it little thought, I went over to the window and sat down on the carpeted floor to watch the fireworks.

Still, there was that persistent, loud "crack," synchronized with each lightning flash, and it seemed louder now. My eyes traced the antenna and ground leads from the window, down the sill, and under the carpet to the rig. I had unraveled the mystery: the lightning was jumping from the antenna lead to the ground wire, right where I was sitting, between my left and right buttocks!

On the air

It may seem incredible that I had survived my childhood so far, but I was actually ready to go on the air! Needless to say, Dave was my first contact. The world was literally at my fingertips as I tapped out the rhythmic Morse on the airwaves, communicating with other hams around the world; Germany, Italy, Russia, Japan – it was a magical time. One might assume that I had finally graduated from a fumbling youngster to an adept ham. But you'd be wrong.

In my manic state of overconfidence, I decided it was time to build my own transmitter. I had saved my allowance money and had purchased a chassis, front panel, and components for a 6AG7-6L6 rig. Surplus and salvage companies overflowed with World War II electronics. Components – and even some equipment – were available for 25 cents a pound. I made the tube-socket holes with my shiny Greenlee punches, and put my soldering iron on the stove to heat it up. Yes, sir, I was in business now.

As the soldering iron started heating up in the gas-stove flame, I began the long process of meticulously attaching the wires, capacitors, resistors and coils. Then the final touch: Melt the solder to secure the connections. It was then that I learned a very important lesson: Always use rosin-core solder

for electronic work; the acid-core solder now in my hand should be reserved for repairing cracks in automobile radiators.

The smelly, caustic, smoky, acid-core solder was doing its thing – sticking the parts together, but corroding the whole works at the same time! In what seemed like mere minutes after completing the assembly, I could see rust beginning to form everywhere.

It was a long drive to Dave's house, but I, with tears in my eyes, presented the clump of rust to him. Dave shook his head, but offered some encouragement: He actually thought it could be salvaged! As a matter of fact, within a couple of hours, he had it on the air! I was not only appreciative, I was astounded.

Another, more painful lesson

Dave worked for National Carbon Company, so getting batteries was no big deal. I needed about 90 volts to power up an old radio that I had found somewhere, and Dave came through. I was sure it was a good battery, but I wanted to check it anyhow.

I didn't have a voltmeter, but I had been shown by another ham how to check a flashlight battery by putting my tongue on the positive terminal and touching the base with my finger to complete the circuit. Sure, this was how I could check the 90-volt battery.

YEOW! A brilliant flash illuminated my eyeballs as my tongue retreated, attempting to curl up in the back of my throat like a window shade!

As I peeled myself off the wall on the other side of the room, still dazed by that white flash, I realized that there's a big difference between 1-1/2 and 90 volts! Another lesson learned. Clearly, it was time to invest in a test meter while I was still alive, and my tongue could still help me place the order!

My first multimeter

A birthday trip to an electronics store was rewarded with a multimeter. It was an expensive trip for me, liquidating my entire \$14.95 allowance savings, but now I could measure voltage, current and resistance all with one instrument! Fantastic! I brought the little meter home, went into my radio room, and expectantly began testing everything I could poke the prods into. I quickly learned another painful lesson: There are *lots* of milliamps in a wall socket!

The loud "bang" was accompanied by little bits of resistors showering out of the case, accompanied by sparks and a puff of smoke. It was quite a display, but there was no question about it – I had *really* gone and done it now!

Trying to return the meter to the store by telling the salesman that it seemed to be defective proved to be predictably futile; I think the salesman noticed some residual smoke wafting from the meter case, and probably heard the rattling noise inside and saw the curled shape of the needle on the meter as well. Dejected, I returned home with my bag-full of destruction.

But Dave – bless his heart – came to the rescue again: He showed me how to build a volt-ohm-milliammeter (VOM) myself. This time I used a wood-burning tool as a temperature-controlled soldering iron, and I even had enough sense to use rosin-core solder. Yes, the meter worked; and no, I didn't try to

see how many milliamps were in that wall socket!

Going mobile

By the time I was in my mid-teens, I had my own car ... it was *mobile* time! During those days, only hams and police cars had long whip antennas. I recall pulling up to a traffic light and seeing another ham alongside; we spent some considerable time with a car-horn QSO before the light changed, much to the obvious annoyance of other motorists who were clearly not hams.

With my ELMAC AF54 transmitter, Gonset Tri-Band converter and Master all-band antenna, I communicated with everyone I heard – worldwide!

During one local, 10-meter QSO, my contact, who was also a mobile station on the other side of town, reported: "Hey, there's another mobile and he's got his call on the door." He pulled up closer – "It's P-O-1-I-C-E!"

I spent a good deal of time cruising the electronics shops; I even found a place that would give me the innards from old juke boxes. And there was a shoe store that let me take the high-voltage transformer out of an old shoe-fitting fluoroscope – the kind you could look into and see the bones in your feet when you tried on a new pair of shoes.

I was in ham heaven. I brought the husky transformer home, with visions of a climbing-spark Jacob's ladder dancing in my head.

Hooking the husky, high-voltage wires to a vertical pair of coat-hanger wires, and separating them by about four inches at the bottom and flaring them out to about one foot at the top, I was ready.

Holding my breath expectantly, I plugged the transformer into the wall. The house lights dimmed as an arc of fire started at the bottom, emitting an audible "ZZZZHHHHHH" as it slowly danced upward between the electrodes, expanding to an enormous foot across at the top before it finally extinguished. My jaw dropped; I was jubilant. I had created my own Frankenstein's laboratory! I was also out one monstrous transformer which I could smell cooking before me.

An appreciative look back

My senses were overwhelmed by our enticing hobby back then. I can still see the warm glow of vacuum-tube filaments in a night-filled room, and the pulsating, blue radiance from mercury-vapor rectifiers. I can smell the waxy, dusty aroma from resistors and capacitors in a hot chassis, and the poignant, metallic smell from a broken vacuum tube. But I'd rather forget the rank odor released from the spongy inside of a Mallory power-supply vibrator, and the acrid nasal assault from a blown selenium rectifier (Whew! What did I step in?).

But most of all, I shall never forget the patient kindness of ham radio's "Elmers" like Dave Crossley, W8BCO, whose key is now silent, and the meticulous, on-air practices taught to me by Tom Tabler, W8WZH ("When you announce your call, you say 'This is, not here is...'").

Those smells, sights, sounds, tastes, friendships and lessons will never be forgotten. They are part of my being. They paved the way for a series of careers that have included teaching, technology and journalism, all inspired by those early, unforgettable life experiences.



How Zenith and SW Transformed the Arctic and Amateur Radio!

By Harold Cones and John Bryant

Test pilot Green and radio designer/engineer Karl Hassell proudly display the Zenith aircraft transceiver designed for the 1925 polar expedition.

Introduction

From The Commander's Files ...

As authors Harold Cones and John Bryant completed a book on a Zenith Radio Corporation product in 1992/1993, they became further interested in the early years of the corporation. They were amazed at the general lack of information available. The Zenith "archives," like those of many near-century old companies, were pitifully incomplete, most of the corporate history having been lost or discarded over the years.

In August 1993, however, the authors stumbled into a time capsule of immense value: In an old soon to be closed television assembly plant, up under the rafters, covered with pigeon droppings, were the personal files of Zenith's Founder, Commander Eugene F. McDonald, Jr., wax-sealed immediately after his death in 1958.

The 138 file drawers not only revealed a great deal of information about Zenith Radio Corporation and McDonald's adventures, inventions, and relationships with historical figures, but also provided an intimate view of American society and culture between 1922 and 1958. The files were transferred to 238 archival storage boxes, stored in a climate controlled area and are currently being prepared by the authors for eventual donation to a scholarly institution so that they will be available for all researchers.

Among the files were two full file drawers of material – hundreds of pages of memos and directives – that covered the dealings of the Navy, McDonald, and Zenith in Donald B. MacMillan's 1923 and 1925 Arctic expeditions. It is from the original letters and memos in these file drawers, except where noted, that the following factual information was taken. Archives of the MacMillan Library, Bowdoin, Maine, the Byrd Archives at Ohio State University, and the personal logs of three participants in the 1925 MacMillan Arctic Expedition were also utilized.

Radio technology, properties of propagation, and radio merchandising were new and often not well understood in the early 1920s. Because of its newness, the potential of radio in Arctic research was far from the thoughts of veteran Arctic explorers, even though some had spent years marooned on the ice. The earliest use of both medium wave and shortwave radio in the Arctic was the result of a chance meeting between Arctic explorer Donald B. MacMillan and emerging industrial and merchandising giant Eugene F. McDonald, Jr.

Commander Eugene F. McDonald, Jr., was the Founder and President of Zenith Radio Corporation.¹ When McDonald and MacMillan first met in 1922, McDonald had just started shaping Zenith, moving it away from the production of amateur products toward the burgeoning consumer radio market. Having a personal interest in exploring, McDonald not only realized the ultimate potential of the new technology, but also saw the MacMillan Expedition as an excellent merchandising opportunity.

Fascinated with the dynamics of marketing radio to the public, McDonald was also very interested in challenging the technical boundaries of the medium. His love of adventure, coupled with his leadership in the radio industry and the

knowledge that radio had not been successfully used in the Arctic, led to his involvement in MacMillan's 1923-24 and 1925 Arctic Expeditions. This style of forward thinking resulted in rapid growth for the small company and by the mid-1930s, Commander McDonald had made Zenith a giant of the new radio industry and was one of America's wealthiest and best known men.

Arctic explorer Donald B. MacMillan was a member of Peary's successful expedition to the North Pole in 1909 and returned to the North again on a 1913 expedition that left him stranded for four years in the Arctic. By the 1920s, MacMillan was America's most famous Arctic explorer. Just prior to his 1923-24 expedition, he had met Zenith founder Eugene F. McDonald, Jr. through a mutual friend, U.G. "Sport" Herrmann, and McDonald not only convinced MacMillan that he should take radio on the Expedition, but that it should be Zenith radio.

❖ 1923-24 EXPEDITION

As with MacMillan's 1921 Expedition, the Department of Terrestrial Magnetism and Atmospheric Electricity of the Carnegie Institution sponsored the 1923-24 Expedition for the



collection of magnetic data in the Arctic. The National Geographic Society was an additional sponsor. Unlike the 1921 Expedition, however, which attempted using longwave radio in the Arctic with no success, the 1923-24 Expedition utilized medium wave radio in the Arctic for the first time, thus becoming the first Polar expedition to shed the rock cairn as the primary method of communication.

Since a government network did not exist to monitor the expedition, cooperation of the American Radio Relay League (ARRL), the organization of radio amateurs, was enlisted, a natural association for McDonald and Zenith. The connection between Zenith and the radio amateur community was crucial to the very founding and success of Zenith.

The precursor company, Chicago Radio Laboratory, had been founded in 1918 as a manufacturing and sales organization to the amateur community by two well known amateurs, Ralph H. G. Mathews, 9ZN² and Karl Hassel. In the instance of ARRL involvement, it was probably R. H. G. Mathews, in his capacity as Vice President of the ARRL, who suggested utilizing the large and enthusiastic amateur community to monitor communications from the 1923 Expedition. It was McDonald, however, who worked personally with ARRL President Hiram Percy Maxim, *QST* (the ARRL journal) Editor K. B. Warner, and ARRL Traffic Manager Fred Schnell in planning that support. From a list of volunteers Donald H. Mix, 1TS, was chosen as radio operator for the expedition, and MacMillan was awarded a special station license, WNP (Wireless North Pole) by the U.S. Government.

The radio activity during the expedition was closely monitored by the ARRL and the radio amateur community. The July 1923 *QST* explained the critical role that radio amateurs would play in the success of the expedition:

“Our job is going to be work Mix and get the story from him, and deliver it to the nearest newspaper ... It’s going to be a tough proposition when the weather is bad, and no man knows what success we will have when WNP is in daylight for five months nor when she is on ‘the other side of the Aurora,’ because no man has ever tried

those things before ... and if anybody can copy WNP we know it will be done by us amateurs of the ARRL.”

The propagation of radio waves over long distances was little understood in 1923. The equipment of the 1923 Expedition operated at 180 meters, in what is now considered medium wave (300-3000 kHz) and proved to be of limited use except during the long Arctic night.

McDonald accompanied the expedition as far as Labrador, and then returned home to begin broadcasting news to the expedition over WJAZ, Zenith’s commercial station built in Chicago specifically for the expedition. The propagation to the Arctic of WJAZ’s signals on 448 meters formed a second aspect to the understanding of signal propagation in polar regions.

On the trip North, Don Mix was able to communicate with a number of amateurs as well as monitor broadcast stations for crew entertainment. As they proceeded north up the Greenland coast, stations from New England faded out and both amateur and broadcast stations from the Mid-West were heard. As they passed under the auroral belt, all communication was lost. The expedition reached the north coast of Greenland in August as planned and selected Refuge Harbor as their wintering-in anchorage. It was not until the lengthening nights of late September that WAP’s signal was finally heard by a young radio amateur, Jack Barnsley, 9BP, in Prince Rupert, British Columbia.

Although Mix eventually worked several hundred amateurs briefly during the next 12 months, the only reliable communications link was between 9BP and WAP, most likely, according to memos in the McDonald files, due to the configuration of the high cliffs around Refuge Harbor and the fact that Prince Rupert is almost 1000 miles closer by the Great Circle to Refuge Harbor than is Washington, DC. The story of Jack Barnsley’s copying of tens of thousands of words of press releases from MacMillan, as well as the hundreds of personal messages to and from the small, isolated, frozen-in party is one of the least known heroic tales of the early days of amateur radio.

The success of the new technology had

great impact on the 1923 MacMillan Expedition and set the stage for further radio use in expeditioning. On November 1923, MacMillan sent the following Radiogram to McDonald: “Am very thankful that Arctic Exploring Ship Bowdoin is equipped with complete Zenith radio apparatus. You at home cannot fully appreciate what such an addition to my equipment means to me and my crew. Here at the top of world in darkness of Great Arctic night isolated as we are from even outposts of civilization radio has conquered solitude banished anxiety over welfare of friends relatives at home. And has removed monotony during necessarily inactive periods. We have already listened to stations practically all over United States from Europe and even from far away Honolulu music, vocal, and instrumental, speeches, prayers, sermons are penetrating Auroral belt and reaching little Bowdoin fast frozen in ice eleven degrees and half from North Pole. We are almost as incredulous as Eskimos that this can be so. But here we are and nightly it comes to bind us intimately with great busy world to South of us. Zenith has united the ends of the Earth.”³

After each Arctic trip, MacMillan, as all explorers of the day, raised money for his next trip by making paid speeches about his adventures. In the months following the expedition, he spoke from a script titled, “What We Northern Men Owe Zenith.” The importance of radio and the excitement of MacMillan are evident in the last two paragraphs of this speech:

But how different with us, the first Arctic expedition to be equipped with radio! And how different from my fifth expedition, when we were cut off from the world for four years. And can you imagine our feelings upon arrival at this very place six years later we hear the buzz—W.N.P.—W.N.P.—our call—Wireless North Pole—Wireless North Pole. A small boy sending message with his home made set from more than 2,000 miles away—from home—he tells us that President Harding is dead. Slowly with bowed heads we stand on the deck of the Bowdoin and raise the flag to half-mast—the most northern American flag in the world so raised in observance of the death of a president.

And there under the snow, with only masts and rigging showing, the depth of an Arctic night, with the wind howling, and shrieking over the ice, and up the valleys, and over the mountains, we sat in our electrically lighted warm cabins and heard the music of the operas, of Prima Donnas, the leading ladies, who sang for Zenith by request, for us spending a winter in the Far North. We heard the hearty laugh of Commander McDonald who read us letters from home, and who gave us all the important news of the day. There was no time for monotony, for a feeling of loneliness. There was no lack of topic for conversation. We were happy and friendly and companionable. We could talk with the great busy world to the south. We could talk with far off Honolulu, with ships in the Pacific. We were a part of the world. We were not forgotten. Every Arctic man is

The Bowdoin, MacMillan’s Arctic schooner and the expedition’s QSL card.



deeply in debt to Radio and I personally to the Zenith Radio Corporation, a pioneer in one of the miracles of the century.

Radio was utilized next in the Arctic in 1924 when the Canadian ship C.G.S. *Arctic* used radio at a higher frequency, 120 meters, a frequency still within the medium wave band and with medium wave propagation characteristics. Modeled after the MacMillan Expedition, the *Arctic* depended on amateur radio contacts and a commercial radio station, Westinghouse station KDKA in Pittsburgh.

❖ 1925 EXPEDITION:

Zenith, motivated by McDonald's enthusiasm, developed true *shortwave* equipment for the 1925 MacMillan-National Geographic Expedition. In an effort to better understand propagation of the new shortwave technology, Zenith conducted a solar eclipse transmission test in Escanaba, Michigan, in January 1925, to determine if sunlight effected radio signals. The experiments, which asked listeners to note transmission differences as the eclipse swept over Escanaba, were performed on 40 and 80 meters, as well as the medium wave band. Zenith's pioneer mobile broadcasting station, WJAZ, served as the base for the experiment.

The 1925 MacMillan expedition was not only the first expedition to use shortwave in the Arctic but was also the first geographic expedition to use airplanes (commandeered by the Navy, through McDonald's request for presidential intervention, from the Army, and equipped with Zenith shortwave radio) in the Arctic. The near prototype Navy Loening amphibians, commanded by Lt. Cmdr. Richard E. Byrd (Byrd's *first* exposure to the Arctic ⁴), performed important aerial surveying during the expedition's stay in Greenland and is believed to mark the first time shortwave radio was used "in mission" by military airplanes.

Prior to the 1925 Expedition, Zenith undertook an intensive research and development effort to perfect both shortwave receivers and transmitters for the expedition. Zenith's Karl Hassel led the design team, with well known radio amateur John Reinartz also making significant contributions. The shortwave transmitters were 250 watt and 2 kilowatt units (aboard MacMillan's *Bowdoin* and McDonald's *Peary* respectively; McDonald was Second in Command of the expedition) and were capable of transmitting on 20, 40, 80 and 275 meters. The Navy, unsure of the viability of shortwave, insisted that a large and very heavy traditional longwave transmitter be included in the expedition's radio compliment; it was never used.

While the expedition was anchored at its summer base at Etah on the northwest tip of Greenland, McDonald was in almost daily contact with base stations in the United States, (including Zenith Radio Corporation) and also organized and hosted at least three entertainment broadcasts via shortwave, fulfilling his promise to broadcast the "song of the Eskimo" to an American audience. Two of the three broadcasts were received well enough by base stations in Chicago to be rebroadcast to a large audience over medium wave frequencies.

The most important experiments, however, involved communication with the U.S. Pacific Fleet, then on a summer cruise in Australian and New Zealand waters. It was these latter experiments that led directly to the U.S. Navy, and eventually the world, abandoning long wave communications and adopting shortwave for all communications over planetary distances.

During the intense research and development phase in the spring of 1925, McDonald was made aware of the fact that most amateurs were

still operating on medium wave frequencies, meaning that only a small number of American radio amateurs (estimated at 20) would be able to monitor or communicate with the expedition on the proposed operating frequency of 20 meters.

In order to increase the number of possible radio contacts during the expedition, Zenith embarked on a major campaign to interest amateur radio operators in shortwave.⁵ In April 1925, a mass mailing containing schematics and parts

THE PRE-EXPEDITION MAILING

E. F. McDONALD, JR., PRES. & TREAS.
T. M. FLETCHER, VICE-PRES.

ADDRESS ALL COMMUNICATIONS TO THE COMPANY

N. A. FEGEN, SECV.
S. I. MARKS, ASST. TREAS.

ZENITH RADIO CORPORATION



"LONG DISTANCE" RADIO APPARATUS

EXECUTIVE OFFICES
332 S. MICHIGAN AVENUE
WABASH 2165
CHICAGO, ILL.

**The Radio Editor,
For immediate release.**

We are enclosing herewith, as we promised, the wiring diagram and description of the Reinartz-Zenith Short Wave Receiver and a front elevation of the same, as well as the wiring diagram and description of the Reinartz-Zenith Short Wave Transmitter, and a front elevation of same.

We desire to impress upon the radio editors of the United States that these short wave receivers and transmitters are not a commercial project. We intend building none of them for sale. We will only build these for our own use both on the MacMillan Arctic Expedition Ship and in our transmitting stations here in Chicago, and we are presenting one to the United States Navy.

We desire to have the amateurs of the United States supplied with the information so that they themselves may construct their own transmitters and receivers, and to that end we will supply gratis to any amateur writing us any additional information he may desire. We have employed John L. Reinartz the short wave wizard as the radio operator to go with the MacMillan Expedition ⁶ at the highest salary ever paid any radio operator, namely \$1,000.00 a month. We did this as we believe Reinartz has done the most constructive work in short waves of any amateur in the United States, and we wanted to insure the messages getting back from that twenty four hour daylight district in the Arctic.

Lieutenant Reinartz permanently enters the employ of the Zenith Radio Corporation, and his duty in our laboratory will be through correspondence to instruct the amateurs of the United States in short wave transmission and reception, and this gratis. We desire to keep the American amateur in the lead that he has always enjoyed in the past, yet the startling fact is that although there were 17,000 American amateurs who could receive and transmit on 180 meters during the last MacMillan Arctic Expedition, there are less than 20 American amateurs who are now equipped with short wave transmitters.

It is hoped with the cooperation of the newspapers throughout the United States that we will have 1,000 amateurs equipped with short wave transmitters before the MacMillan Expedition sails in June.

In spite of the fact there were 17,000 amateurs equipped to receive and transmit with the MacMillan Expedition the last time it was in the Arctic, only approximately 15 carried on consistent communication with the Expedition.

If you as the editor, desire additional information, do not hesitate to write Lieutenant J. L. Reinartz, in care of this organization. He is at your service.

While 20 meters has made wonderful strides in the past six months, it is by no means to be believed that this is the minimum that will be reached. Lieutenant Reinartz has done much constructive work in wave lengths below 1 meter, in frequencies so high that they were not possible of measurement with the present day instruments. Lieutenant Reinartz believes that he will eventually be able to reach the natural period of certain metals.

I will have more to say on this subject later.

E. F. McDonald, Jr.

lists for the new equipment was sent gratis to major newspapers and radio magazines. After the Expedition returned in November 1925, another gratis mailing was sent with updated materials. The following are the pre-expedition and post-expedition mailing materials as they were found in the McDonald files. The value of these mailings to researchers lies in not only understanding a then state of the art radio apparatus, but in understanding the 1925 attempts and methods of introduction of a new technology as well.

❖ The Reinartz-Zenith Short Wave Receiver

[from the pre-expedition mailing]

A receiving set which will cover any range desired on the short wave band is illustrated in Figures 1 and 2. Figure 1 shows the wiring diagram, in conventional form. Figure 2 is a suggested panel layout, although the circuit is extremely flexible and may be mounted in almost any way the individual desires. It is necessary, however, to keep very short leads in the grid and plate circuits, in order to reach as low a wavelength as possible.

The tuning inductances, designated by the coil ABC and coil D in Figure 1, may be wound on a form about 3-1/2" in diameter in either the Lorenz fashion, or as a single layer winding on a cardboard tube. Coil D is the antenna coupling coil and should consist of five turns of about number 16 D.C.C. wire for the 20 and 40 meter bands, and ten turns for the 80 meter band. Coil ABC is really a single coil tapped in two places, as shown on the diagram. Each part, A, B and C, have three turns each for the 20 meter band, six turns each for the 40 meter band, and 12 turns each for the 80 meter band. Three coils are required to cover the entire range from below 20 meters to over 80 meters.

Coil G is a radio frequency choke coil which may consist of a form one inch in diameter and three inches long wound full of any wire in the neighborhood of number 30 D.C.C.

Condensers E and F should have about five plates each, and may, if desired, be cut down to five plates from a LARGER condenser.

Either a dry cell or storage battery tube may be employed with 45 volts on the plate.

The antenna may be the usual receiving antenna, or a single vertical wire about thirty-five feet high.

Stock List FOR SHORT WAVE RECEIVER

- 2 - 250 m. m. f. Variable condensers.
- 2 - sockets.
- 1 - 20 ohm rheostat.
- 1 - Single circuit phone jack.
- 1 - 3 1/2 to 1 Audio transformer.
- 1 - 1 1/2 megohm grid leak.
- 1 - grid leak clip.
- 1 - .00025 grid condenser.
- 2 - 4" dials
- 1 - base 16x7x5/8"
- 1 - bakelite panel 16x7x1/4"
- 1 - 3" x 1-3/4 Bakelite tube
- 1 - 3x3/3 bakelite tube
- 1 - 1-3/8 x 2" long cardboard tube
- Appr. 15 ft - #18 D.C.C. Copper wire
- Appr. 25 ft - #28 D.C.C. Copper wire

- 6 - binding posts
- 2 - Bakelite strips for mounting posts
- As req - #16 Bare copper, for wiring
- Choke coil - 60 turns of #28 D.C.C. on 1-3/8 cardboard tube
- Antenna coil consists of 3 turns of #18 D.C.C.
- Secondary coil consists of 8 turns of #18 D.C.C. tap taken at 3rd turn as shown.

Last three turns of opposite end tapped, flexible connection shown. Also have end of inductance connected to grid leak as shown, in order to start out the turns to reach the lowest wave length.

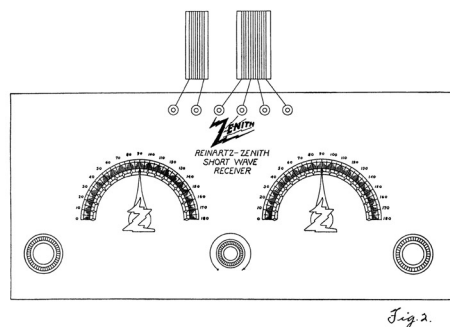
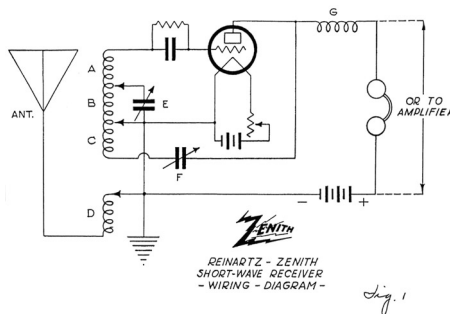

❖ Reinartz-Zenith Short Wave Transmitter

A short wave transmitter may be constructed from standard parts, and a suggested arrangement is shown in Figure 3. The framework should be made of any hard wood which has been boiled in paraffin to drive out all moisture. Bakelite or rubber should not be used. The wiring diagram is shown in Figure 4. Plate and filament voltages suitable for the particular type of power tube used, should be supplied.

Condensers A, C, D and E, are transmitting variable condensers capable of withstanding the plate voltage, and are of about 250 M.M.F. capacity. B is a fixed condenser of 1000 M.M.F., suitable for the plate voltage used.

Coils G and H are edgewise wound helices about six inches in diameter, supported on three glass rods as shown in the illustration. Twelve turns on each coil should be used for 40 meters and five turns on each for 20 meters,

F is a single layer choke coil one inch in diameter and four inches long, wound full of #24 D.C.C. wire. The grid leak, L, may be about 10,000 ohms.

In operation, condensers A and D are set alike and at a low value of capacity. Condenser E is then varied until maximum antenna current

is obtained. Condenser C is used to adjust the plate input, and to secure stable operation. Coils G and H are usually placed about twelve inches apart. The key is placed in the circuit as shown at K in the diagram.

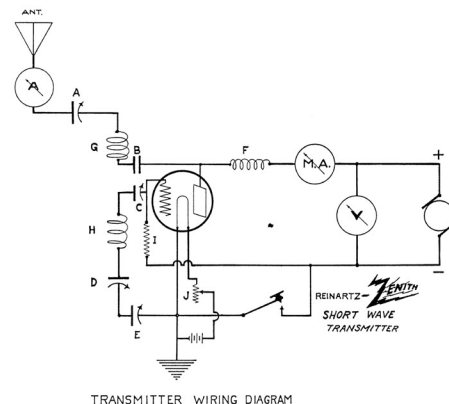
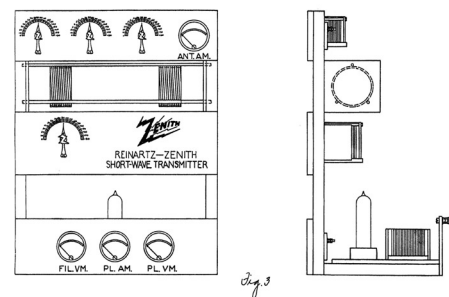

The antenna should be a vertical wire about 35 feet high, and should be well insulated.

❖ The Post-Expedition Mailing

Reinartz made changes in the expedition radios up until their final use. After the expedition, it was obvious that shortwave was viable and valuable for long distance communications and Zenith again provided the leading radio magazines and clubs, as well as amateurs requesting information, with updated material. This mailing, along with the very public success of shortwave radio during the 1925 Expedition, stimulated the permanent migration of radio amateurs from medium wave to shortwave

Enclosed herewith are two wiring diagrams, one of the Zenith Short Wave Receiver, and the other the Zenith Short Wave Transmitter. A description of each is also enclosed.

We are forwarding these to you not with the thought that we are offering them for sale, as at the present time we are not equipped to manufacture either the parts nor the sets. We have built these sets solely for the MacMillan Arctic Expedition which recently returned to the United States, also for our own transmitting station in Chicago. One of these sets has also been presented to the United States Navy.

Our thought in forwarding these diagrams is to aid you in constructing your own receiver and transmitter, and trust to learn of your subsequent success in their operation. We hope to hear of the thousands of amateurs equipped with short wave

apparatus. At the present time, only a very small number of American amateurs are thus equipped.

The success attained by the Mac-Millan Expedition during the period from June to October, 1925, operating with Zenith transmitters and receivers, leads us to believe that the time is not far distant when both code transmission and voice broadcast will be generally operating on short waves. The experience of the MacMillan Expedition was such that both voice and code were heard more than one-half way around the globe. It was common to be in constant communication between the MacMillan anchorage within twelve degrees of the North Pole and points in the South of Australia and New Zealand. Messages were picked up and transmitted at high noon from ranges heretofore unheard of on the higher waves.

We will be very glad to have you write us for any further information needed in the construction of this apparatus.

Cordially,
Zenith Radio Corporation
K. E. Hassel

❖ **SHORT WAVE RECEIVER**
[from the post-expedition mailing]

Fig. 1 shows the wiring diagram for a short wave receiver which will cover wavelengths from 18 to 100 meters.

Three sets of coils will be required and they should be made easily interchangeable. Coils AB is one winding with a tap brought out at the proper point. Coil C should be movable with input to coil AB so as to adjust the coupling to the antenna.

The proper number of turns for the different wavelengths is given below:

20 meter	40 meter	80 meter
A = 5	A = 10	A = 22
B = 3	B = 6	B = 10
C = 3	C = 5	C = 12

The coils should be wound with about No. 16 double cotton covered wire spaced its own diameter on a cardboard tube about 3 1/2 inches in diameter.

The two variable condensers should have a maximum capacity of not over 250 m.m.f. and the plates should be cut away at the low end so as to give easier tuning. The condensers need not be of the straight line frequency type necessarily but should resemble such. It is desired to use larger condensers, the capacity may be lowered by cutting off several of the plates. The coil marked RFC is a radio frequency choke coil and may be wound on a form about one inch in diameter and three inches long wound with 100 turns of wire in the neighborhood of No. 30 D. C. C.

Either dry cell or storage battery tubes may be used. For 20 meters and lower it is advisable to use the dry cell tubes. If dry cell tubes are used it is advisable to incorporate a filament voltmeter to prevent excessive filament voltage being used on these tubes as they are very easily

damaged.

The audio transfer can be any good make of fairly low ratio to prevent distortion. It if is desired to use a loud speaker it may be necessary to use two stages of audio amplification.

The exact arrangement of the apparatus is quite flexible but several precautions are necessary. Keep the coils at least 4 inches from any metal parts such as condensers. Keep the grid and plate leads as short as possible. The builder can suit himself about a front panel and cabinet.

The antenna should be a single wire 30 feet to 100 feet long, well insulated.

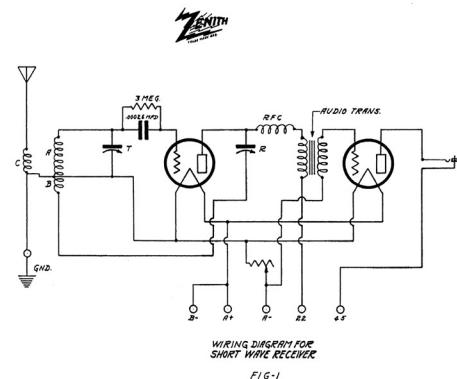

❖ **Operation**

With all connections made the receiver is tuned in the following manner:

Starting with condenser T at O advance condenser R to a point where a muffled click is heard. This indicates the detector tube is oscil-

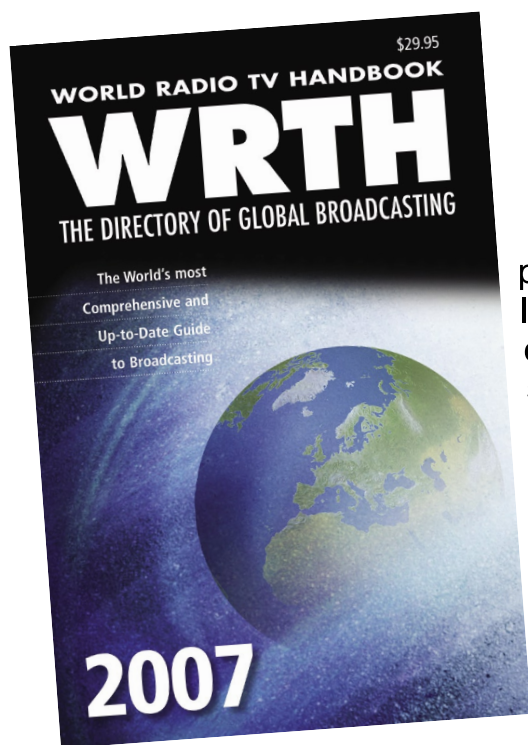

2007 EDITION WORLD RADIO TV HANDBOOK

This information-packed reference for professional monitoring stations and serious shortwave listeners bulges with station information, staff listings, contact information, worldwide mediumwave and shortwave frequencies, and schedules for programs in all languages.

A special English language program section makes station selection a breeze. Includes non-U.S. TV and FM broadcasters as well!

Available January 2007.

Order BOK03-07

\$26⁹⁵

Shipping to Canada & Mexico, \$8/book by Global Priority Mail. Other Countries are \$14/book Air Mail.

plus \$3 First Class Mail

www.grove-ent.com

GROVE

800-438-8155

828-837-9200; FAX 828-837-2216 7540 Highway 64 West, Brasstown, NC 28902 email: order@grove-ent.com

lating. Now advance T very slowly keeping R advanced sufficiently to maintain oscillation and when a whistle is heard (assuming this is a broadcasting and not a code station) then lower condenser R slowly keeping T adjusted so as to hear the whistle. When the whistle stops a very slight adjustment of T should bring in the broadcasting station. It should be remembered that many amateur code stations are working on the low wave-lengths and no phone reception will be obtained from them.

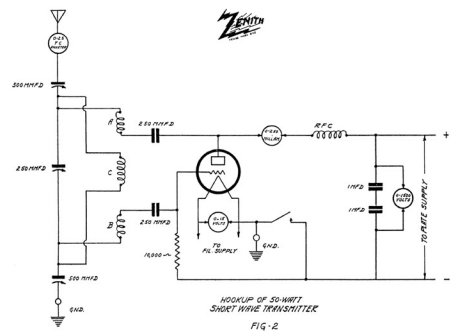

❖ Short Wave Transmitter

Fig. 2 shows the circuit diagram for a short wave transmitter which will operate on either the 20 or 40 meter bands by the use of interchangeable coils.

Coils A and B should be six turns about 6 inches in diameter for the 20 meter band and 12 turns for the 40 meter band. Coil C should be five or six turns. These coils should be made

from edgewise wound copper strip if possible, otherwise heavy copper strip or wire. The coils should be as near self supporting as possible as insulating materials used for supports will cause losses and reduce the efficiency. The coils should be mounted on glass rods.

The variable condensers should all be of the transmitting type. The fixed condensers should be capable of withstanding plate voltage. The grid leak should be of a value to suit the tube being used. About 10,000 ohms is an average value and is a standard product.

A filament voltmeter should be used and this will have to be suitable for the kind of current used. A. C. is usually employed to light the filaments and a 0-15 volt A. C. voltmeter is recommended. The plate millimeter should be of a range suitable for the tube being used.

The use of a plate voltmeter is optional. The radiation meter should be of the thermo-couple type and the range suitable for the tube. If a 5 watt transmitting tube is used then a 0-1 ammeter will suffice. For a 50 watt tube a 0-2.5 ammeter is recommended.

The radio frequency choke should consist of a tube 1 inch in diameter and 4 inches long wound full of No. 24 D. C. C. wire spaced its own diameter. About 60 turns is required. This is usually done by winding two wires together at the same time and then removing one.

The antenna should consist of a single wire 30-50 feet long. The best length will have to be determined by experiment.

1. The Commander was a larger than life figure in the history of radio. His contribution to "radionics," his term for radio electronics, are numerous and documented. His achievements were acknowledged posthumously by his peers on April 4, 1967, when his name was entered in the Broadcast Pioneer's Hall of Fame. Among the accomplishments listed in the citation were his role as Founder, President and the first Board Chairman of Zenith Radio Corporation, his dynamic merchandising strategies (he "invented" time payments for automobiles and radio receivers, as well as many innovative marketing methods still in use today), his inventions and innovations (leading to, among other things, the first all-band shortwave portable and the baby monitor, inspired by the Lindbergh kidnapping), his role as explorer (including second-in-command on the 1925 MacMillan Arctic Expedition) and his role as the first President (and Founder) of the National Association of Broadcasters. He was also cited for having established one of the nations earliest radio stations, WJAZ, built to provide news to the 1923 Arctic Expedition of his lifelong friend, Donald B. MacMillan, and for pioneering the development of shortwave radio (nearly a dozen patents), international communication, ship-to-shore, FM, VHF and UHF television, radar and subscription television.

2. The 1919 radio products of Matthews and Hassel were advertised first as 9ZN, then 9Z-Nith, then Z-Nith, and after McDonald joined the company, Zenith. The Patent application for the famous Zenith lightning bolt logo was initiated in April 1922.



3. A copy of this radiogram was frozen in a large block of ice and stood as the center-piece of the Zenith booth at the First Radio World's fair held in Madison Square Gardens, September 22-28, 1924. Zenith tied the Arctic Expedition to much of its advertising for many years and MacMillan was a spokesperson for Zenith well into the 1950s.

4. Many popular press articles dealing with Byrd's role in polar exploration credit the 1926 flight over the Arctic as Byrd's first exposure to the Arctic. Part of this untruth may be due to the suppression of information about the 1925 Expedition because of the Billie Mitchell Court Marshal trial, which involved the use of the Loening aircraft used in the expedition; little, therefore, has been available to scholars. The author's 2000 book, "Dangerous Crossings, the First Modern Expedition, 1925," for the first time presents the details of the expedition, Byrd's involvement, and his attempts to claim it as his own. Popular history (*National Geographic*, etc.) usually credits Byrd with leading the expedition. In reality, having three Navy Commanders involved in a leadership role in the high Arctic created problems for all three; however, there is no doubt that MacMillan was in charge.

5. It is interesting to note that radio amateur Arthur Collins, then a precocious high school student, eventual founder of Collins Radio Corporation, served as an important American base station throughout the expedition.

6. Series of letters in the McDonald Files to Captain Ridley Mclean during March and April 1925 chronicle the work of McDonald in obtaining a commission in the Navy reserve for Reinartz before the expedition left. Reinartz received the

commission and was referred to as "Lieutenant Reinartz" in expedition press releases. Reinartz was removed from position as first radio operator during the expedition and demoted to third radio operator for a variety of indiscretions. Among them was his working of radio amateurs at the expense of official radio contacts and ignoring calls from the *Bowdoin* while she was battling a severe three day storm in open water. He was replaced by Paul Magee before the end of the expedition. Reinartz published very little in radio journals after the expedition.

❖ Authors' Notes

Cones and Bryant are best known for their Zenith Radio Corporation history series: *Zenith Radio, The Early Years, 1919-1935; Zenith Radio, The Glory Years, 1936-1945, Vol. 1: History and Products; Zenith Radio, The Glory Years, 1935-1945, Vol. 2: Illustrated Catalog and Database; and The Zenith Transoceanic, The Royalty of Radio*; all by Schiffer Publishing, Ltd. Less known is their research work in Arctic exploration, part of which is presented in *Dangerous Crossings, The First Modern Polar Expedition, 1925*, published by The Naval Institute Press (2000).

The historical circuits contained in this article have not been constructed and tested by the authors. As with all construction projects, hazards exist and construction of the apparatus presented here is undertaken at the builder's risk. If an experimenter desires to build any of these projects of the 1925 Arctic Expedition, the authors feel the post expedition transmitter and receiver would be most rewarding.

Race Scanning

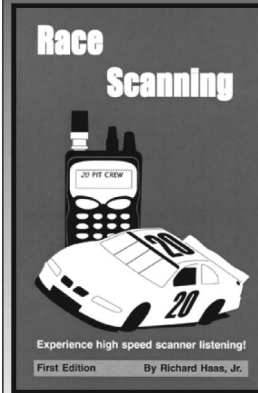

Chapters:

- History of race comms.
- What you can hear
- Racing terms
- Racing flags
- Choosing a scanner
- Tips and tricks
- Racing frequencies

By Richard Haas, Jr. Listening to a scanner radio at the track adds a dramatic new element to the race fan's experience. This book will help you be properly equipped and informed to enjoy the race from a new perspective. Listen to, and understand exciting real-time transmissions from the driver's seat and support communications from behind the scene. Printed September 2003 with up-to-date frequencies. #0031 **Only \$4.95** (+\$2.00 ship)



Universal Radio
6830 Americana Pkwy.
Reynoldsburg, OH 43068
♦ Orders: 800 431-3939
♦ Info: 614 866-4267
www.universal-radio.com

HEAR BOTH SIDES OF WORLD EVENTS

RX-340

USED BY GOVERNMENTS WORLDWIDE!

HF SWL receiver, 5 kHz – 30 MHz. IF stage DSP. Sync AM/selectable sideband, SAM, AM, SSB, ISB, CW, FM. Over 90 bandwidth filters, programmable AGC, built-in high stability TCVCXO. Completely remote controllable via RS-232 interface. DRM ready, no modification needed (user supplies decoding software). 90-264 VAC operation. **\$4,250**

RX-320D

LISTEN TO THE WORLD ON YOUR PC!

General coverage from 100 kHz – 30 MHz. "Black box" receiver connects to your PC via one serial port. Your PC provides the operation horsepower. A 12 kHz I-F output is included for decoding DRM transmissions with your PC sound card (user supplies decoding software). Download the actual operating software from our website for a pre-purchase test drive. **\$349**

1254

KIT BUILDING IS A WORLD OF FUN!

Build your own HF SWL receiver with our model 1254 shortwave receiver kit. 500 kHz – 30 MHz coverage in 2.5 kHz steps with clarifier control allowing tuning of all frequencies. LED digital readout. AM, SSB, CW capable. Complete step-by-step instructions and all components included. See our website for information on other available kits! **\$195**



RX-340



RX-320D



1254



1185 Dolly Parton Pkwy., Sevierville, TN 37862 **800-833-7373** www.tentec.com
Mon-Fri 8:00-5:30 EST We accept Visa, MC, American Express, and Discover Office: (865) 453-7172 Service: (865) 428-0364

The Readers Write: 10 Meter Challenge - FTA - FM Translators

French *MT* reader Frank, F-14368, wants to remind readers of a 10 meter SWL DX contest this month from December 9 at 0000 Z to December 10 2400 Z. The contest coincides with the ARRL's 10 meter contest. Rules for the 10 meter SWL contest can be found at www.mdxc.org/swl/28_mhz_con.htm. SWL logs are to be sent by January 31, 2007, to Ruud Ivens, NL290 Hittekamp 29, 3956 RE Leersum, The Netherlands or via e-mail at NL290@amsat.org.



The Mediterraneo DX Club has a number of HF contests on their web site which are open to SWLers. You can check them out here: www.mdxc.org/swl/contest.htm. The contests are not just about SSB, either. You can try your skills at CW and RTTY throughout the year.

As a ham I've noticed that SWLers are much more active on the amateur HF bands in Europe than in the U.S. Every batch of QSLs I receive via the bureau contains several from SWLers across the Continent. I asked Frank about this and here's his reply:

"...Yes, many SWLers are active in Europe because the ham licenses to go on HF are hard to get. Many prefer to stay as SWLers or operate on 27 MHz." Frank adds that DXing via CB radio is still very popular in Europe because of lax regulatory enforcement. He also points out that by registering as an SWLer via the REF (French version of ARRL), SWLers have QSL bureau privileges which allows him to send thousands of QSLs if he wishes via the bureau for the annual membership fee.

He says, "...You can also receive QSLs even if you are not a member. But you need to know the manager of your department to send the SASE (in France we have 99 departments like 50 states in the U.S.). I have sent many QSLs to the U.S.A. via the bureau, but only a few have been received." Frank has a novice call F0DUW but is confined to VHF activities on 2 meters. To have HF privileges he must upgrade to an F4 call.

Many U.S. hams ignore SWL reports, whether from abroad or stateside. This is a deplorable practice and is not the ham spirit. If American hams want to be seen as global leaders in amateur radio, that leadership shouldn't be confined to honchoing DXpeditions and building fancy radio shacks to wow the less financially endowed. Do the polite thing and confirm SWL reports!

❖ MPEGII FTA Beginner

MT reader George has a question about getting started in Free-To-Air (FTA) MPEGII satellite TV reception: "...I have salvaged an unused DirecWay dish from work, and plan on purchasing an MPEGII receiver. My question is, what do I need to do to the DirecWay dish/feedhorn for FTA reception? Can I use it as-is or do I need to replace the LNB? And, with everything going digital, if I set up an FTA system now will it be obsolete soon? On another note, I just found an old Paracclipse 10ft dish for sale, which I purchased. I am looking forward to getting my 'feet wet' with home satellite reception. I have a lot of catching up to do..."



DirecWay dish is a Ku-band dish with LNB intended for satellite Internet. With a new universal LNBF to replace the original LNB and an MPEGII FTA receiver such as the Fortec Star Mercury II, it could be a good MPEGII FTA system. (Courtesy: Elite Satellite and Sadoun Satellite Sales)

First, an update on the subject for the rest of the beginners. MPEGII FTA satellite reception refers to the reception of C and Ku-band satellite signals sent in the Digital Video Broadcast (DVB) standard. This is the international digital standard first used in Europe and, in the last 10 years, widely adopted here in the U.S. The FTA part is Free-To-Air, meaning that the signals are not encrypted and anyone with an MPEGII FTA receiver may tune in. These receivers are widely available and very cheap (full information on

MPEGII reception may be found in the August 2006 issue of *MT*, pages 16-18).

The good news is that you should be set to go. The DirecWay satellite Internet service uses HughesNet transponders which are all on normal broadcast Ku-band satellites. All you need is the FTA receiver hooked up to the DirecWay dish with a run of RG/6 coax cable from the receiver in the house to the dish. Simply line the dish up on whatever satellite you're interested in and configure the reception parameters on the receiver following the instructions in your receiver's manual.

Here's a tip: pointing a non-steerable dish can be a real nightmare. To find out where to point the dish, use this handy web site: www.spacecom.com/customer_tools/html/body_colors_unknown.htm

DISH Network and DirecTV dishes won't work as MPEGII FTA dishes, because the LNBs are not the right band or polarity. The dishes are also too small for broadcast Ku-band signals which have far less power output than the DBS services.

❖ Translators and Boosters

MT regular Judy May asks, "...I have heard the term 'FM translator' on occasion, but I have never had a clear understanding of its definition. My best guess is that it is a lower power transmitter site that broadcasts simultaneously the content from an FM radio station some distance away. The intent would be to increase the reception area further than the main station could reach on its own. Am I close to being correct? Would the translator always be on a different frequency?"

This is what an FM translator operation looks like. The complete package from Nicom includes a dedicated FM receiver which feeds a dedicated 30 watt FM transmitter into a special FM antenna. At only \$3,000, it's easy to see how a station gets deep penetration into a weak signal area on the cheap. (Courtesy: Nicom)



How would the translator ID itself at the top of the hour – just the main radio station's call sign?"

Judy, you are exactly correct about the translators and here's a little more. There are actually two different types of re-broadcast stations allowed: "Translators" and "boosters." The intention of the FCC was to make it possible for listeners in any given station's reception territory to get clear reception if they happen to live in a hollow or behind a mountain. (FM's line-of-sight nature often prohibits good reception under such geographic conditions.) Translators and boosters were to fill that role. Translators operate on different frequencies from the main station (but must be within 92 MHz and 108 MHz) and are limited to 250 watts PEP. Boosters operate on the same frequency as the main transmitter and are limited to 20% of the main station's power (but they must stay within the protected contours of the main station).

Translators ID with the traditional W (East of the Mississippi) and K (West of the Mississippi), followed by the channel number they are licensed to occupy (remember that the FCC sees the FM band as divided into channels and not frequencies), and finally a 2 letter suffix, giving the calls an almost amateur appearance: W250XD, for example. Meanwhile, booster call signs use the parent station's call with the suffix -FM, followed by the booster number. For example, if WTJU had a booster, it would ID as "WTJU-FM1."

Normally, since translators and boosters are really just repeaters retransmitting the programming (they're not allowed to originate programming), the call signs are usually given



Sangean's ATS-505P: It's a radio, a receiver and a communications receiver! Call it what you like, but it tunes 150 kHz to 30 MHz (SSB and CW!) and the FM band at a very low price. (Courtesy: Grove Enterprises)

all at once. For some stations this makes for a long and tedious broadcast of station call sign and IDs.

However, there is a separate reality. Most big commercial stations ignored the use of such devices because they had whopping signals from massive transmitters and enormous towers. But, down in the public broadcasting portion of the FM band (88 to 91.9 MHz), where budgets are always tight, antennas minimal, transmitters small, and income dribbles in from listeners, translators and boosters were seen as a way to try to expand the listenership and, hopefully, donations.

From the 1990s until recently, there has

been a land rush at the FCC to grab up all the translator frequencies available. But, when the public stations sought to sign up, they discovered that many of the available translator frequencies had already been claimed by a very aggressive consortium of nationwide religious broadcasters who also realized the gold mine potential of setting up similar milking operations for their own purposes.

Now, large broadcast corporations, which are allowed to own nearly all stations in any given market, have joined the fray. When they bring their huge bank accounts to the table anything can happen. And, finally, the FCC is to decide whether or not to allow commercial AM stations to operate FM translators to broadcast their programming on the FM band. So long, community radio!

❖ A Radio By Any Other Name

Valerie Gautreaux notes that she's seen the Sangean ATSS05P listed as a "shortwave receiver" and the Sangean ATS-606AP listed as a "radio," and she asks, "...What is the difference between a radio and a receiver?"

The 505 and the 606 are both shortwave radios, but to make them seem more sophisticated than just the usual portable they are sometimes called "receivers" or even more sophisticated "communications receivers." But, they're all just radios. Incidentally, I like the 505 better, because it has SSB/CW tuning capability to let you listen to hams and other digital modes. There are some other subtle differences, but the side band capability makes this my choice.

Ready to upgrade your radio?

Your favorite communications company doesn't just **SELL** radios, we **BUY** them as well!

Grove trade-ins are a **win-win program!** You receive an excellent allowance for your used receiver or scanner, and when you buy a trade-in from Grove, you're assured of a **fully-tested and guaranteed** radio at a **bargain-basement price!**

Why go through the hassle and delay of trying to sell your radio and buy another all on your own when you can depend on Grove's **legendary customer service?** We've bought and sold thousands of radios, making us the country's **number one choice for trade-ins!** With such activity, our inventory changes daily, so stop by our web site right now at **www.grove-ent.com/hmpgbbb.html**, and visit us often!

www.grove-ent.com/hmpgbbb.html

All of our previously-owned equipment is tested and guaranteed against defects for 90 days. This list is updated frequently, visit often to catch outstanding bargains!

GROVE

7540 Highway 64 West
Brasstown, N.C. 28902
800-438-8155 US & Can.
828-837-9200
Fax 828-837-2216
e-mail: order@grove-ent.com
web: www.grove-ent.com

Visit our
website
TODAY!



Grove is
Always
your **Best Value.**

Q. *I would like to sell my AOR AR3000A scanner, but it has full cellular coverage because it was made before the ban on cellular-capable scanners. Does that mean I can't sell it? (Mike F., email)*

A. Any product originally certified by the FCC can continue to be owned and resold; advertise and sell it with a clear conscience.

Q. *I have a 30-year-old Sony weather radio and I'd like to get an AC power supply for it, but I find no markings as to voltage or polarity. What should I get? (Steve Bove, email)*

A. By far, the easiest answer is to get a universal "wall wart" with switchable voltages and polarities. The operating voltage will be 1.5 times the number of cells the radio uses. Start with a voltage setting below that of the total battery voltage, either polarity. Continue this routine upward in voltage, alternating polarities, until the radio becomes operational.

Q. *In your August column you addressed the illegality of owning a descrambler. I recently purchased an analog speech-inversion descrambler manufactured by a U.S. company; I was told that only digital transmissions are illegal to monitor – analog are not. (Name withheld)*

A. Unfortunately, that's totally untrue. Any type of descrambler – analog (like your speech inversion decoder) or digital – has been illegal to own, use, possess, advertise, sell or import for the last 20 years (ever since passage of the 1986 Electronic Communications Privacy Act). That doesn't mean that some people don't have them, or that they aren't being illicitly manufactured, only that they are illegal and actionable by law. We used to manufacture and sell speech inversion descramblers until they were banned. I'm sure your ill-informed source meant well, but his enterprise is in violation of federal law.

Q. *Is it possible and legal to use a broad-spectrum jammer to defeat a hidden radio-frequency microphone (bug)? (C.B., Baltimore, MD)*

A. While a jamming device to disable surreptitious radio-frequency listening devices is a surveillance countermeasures device, not a surveillance device, it wouldn't violate federal law prohibiting eavesdropping, but it would violate FCC Rules and Regulations, because its wide-spectrum jamming would intentionally disrupt legally-licensed services within its frequency range.

A sweep generator with high output connected to an antenna system might qualify, but you wouldn't know if you were hitting the appropriate frequency or not, nor whether your level was strong enough to dominate the offending device at the perpetrator's listening position.

If your concern is to compromise an illicit RF listening device, you'd do better with a spectrum analyzer, since it shows all frequency activity within a very wide range and allows you to home in on the device; when found, you can disable it or deliver false information to it.

The best solution for holding a private conversation is away from the office or home, and in a noisy crowd.

Q. *I notice that CB is virtually dead, when years ago it used to be packed with stations. Where have all the hunters gone that used to communicate on CB? (Name withheld, Fayetteville, NC)*

A. Many of these former users of the CB frequencies, especially the hunters, are taking advantage of the low-cost, VHF marine transceivers now readily available on the market. It's illegal, of course, but they are short range and would generally interfere only with other illegal users. So far as the migration of communicators away from CB, we are at the low end of the 11-year sunspot cycle, and the appearance of abandonment may be largely due to the absence of distant skip signals.

Q. *My new shortwave receiver works very well, but the sensitivity is not as good on the AM broadcast band (below 1.8 MHz); why is that? (Tony, email)*

A. As the shortwave and ham radio hobby grew, a common complaint was interference from local AM broadcasters on shortwave reception; it produced desensitization, intermodulation and image responses. Because of those undesirably-strong broadcast signal levels, most manufacturers now routinely design some attenuation below 1800 kHz in their communications receivers. The attenuation can be defeated by stalwart AM-band DXers, but they void the receivers' warranties.

Q. *How do the newer wide-frequency-coverage scanners compare with their more expensive communications receiver counterparts? (Greg Marles, email)*

A. Since virtually all modern receivers have good sensitivity and stability, the two most common complaints are selectivity (sharp rejection of adjacent-channel interference) and dynamic range (the ability to handle strong signals without overloading the receiver and producing phantom signals). Scanner overload from using efficient outdoor antennas is a good example. High performance means high cost, and the consumer electronics market is very price conscious.

Most vulnerable are the wide-frequency-coverage receivers. It's relatively simple to design narrow-bandwidth equipment like a shortwave-only receiver or VHF/UHF-only scanner, but when you mix high-sensitivity design for small VHF/UHF antennas with shortwave applications using large antennas, that's where the trouble begins.

Competitively priced, wide-frequency-coverage scanning receivers are simply not on par with more expensive, professional communications receivers; \$500 for a combination 100 kHz-1000+ MHz scanner does not buy the single-signal reception capability built into a \$2000+ communications receiver.

Q. *I'm trying to decide between the active or the passive Stridsberg 4-port multicoupler for my four scanners. Have you a recommendation? (Jim Miossi, email)*

A. An active multicoupler has no loss in signal strength because it amplifies the signal before it divides it out. But an active multicoupler also has a smaller dynamic range which presents a greater likelihood of intermodulation (phantom signals).

A passive multicoupler divides the signal voltage lower and lower with each branch; a four-port splitter loses at least 6 dB in strength for the coupled receivers, but has no overload problems, doesn't require power and has no critical components to burn out (unless you're hit by lightning, then you've got other problems!).

Therefore, if the signals you want to hear are generally strong, go with the passive multicoupler; if they are usually very weak, go with the active multicoupler. If you have intermod or desense problems from a local transmitter, you can put a PAR notch filter in the antenna line.

Questions or tips sent to Ask Bob, c/o MT are printed in this column as space permits. Mail your questions along with a self-addressed stamped envelope in care of MT, or e-mail to bobgrove@monitoringtimes.com. (Please include your name and address.)

Q. I heard a Spanish conversation between two people on 263.825 MHz NFM. This was from my location in northeast Ohio. I believe this is a military SATCOM frequency. Any ideas what this was? I was listening on my PRO-43 with just a 220 MHz Ham Band rubber duck antenna indoors with NO pre-amp. (Frank J. Bals via the Milcom newsgroup)

A. This is a pretty common occurrence on some of the downlink frequencies in the satellite subband of the UHF military aeronautical band (225-400 MHz). These transmissions usually occur due to one of two conditions.

The most common occurrence is that the 292.850-317.350 MHz portion of this spectrum, where the uplink frequencies are located, is not used in other countries for military aero communications. In some other countries it is used for terrestrial communications such as point-to-point, broadcasting links, and even some land mobile communications. These transmissions are picked up by the uplink receiver onboard the satellite and are automatically relayed back down to earth on the downlink for that particular uplink frequency.

The second occurrence is along the same line. Intruders know the uplinks and downlink frequencies for these transponders and are using them intentionally for communications. These uplink/downlink frequencies are available online from official Department of Defense documents that are in the public domain, so they are easy to locate. I am sure the temptation is huge for these pirates to use these geostationary repeaters at 36,000 km above the equator for their personal and private channels. In the case cited above, 263.825 has been used by two DoD bandplans – Leasat Whiskey (no longer operational) and the newer UFO Quebec bandplan (Quebec channel 17). The uplink for that channel is 297.425 MHz.

Q. I read a chart on this website, www.wpscanner.com/reband/reband.htm about the scanners that will be affected by rebanding and what will happen to them. The chart shown for the RS Pro-97 says it can be reprogrammed for the Motorola analog trunked system; a great thing I must say! But it also says the Pro-2055 will need to be replaced and cannot be reprogrammed for Motorola analog systems. Hopefully this is a misprint. I thought these radios were practically identical. Please enlighten me. (Rick Copeland via email)

A. First, let's explain what rebanding is. In order to clean up the mess in the 800 MHz public safety portion of the band, caused by allowing Nextel and other SMR carriers to share the 854-861 MHz spectrum with public safety, the FCC released a public order that rearranges the entire spectrum and separates the SMR frequencies from those used by public safety agencies. This is called rebanding.

All the public safety systems will be relocated to the bottom end of the band away from the SMR frequencies and the SMR users will be placed in the top portion of the band. This will affect most of the older trunk scanners being used to follow Motorola analog-only trunk systems. It will have no effect on following an EDACS or LTR trunk system.

But, if you are using a scanner to trunk one of these Motorola analog trunk systems and the firmware that the scanner uses to follow that system cannot be reflashed (a download of updated firmware from the manufacturer that is uploaded to your radio via the computer), then you will have to replace the scanner if you want to continue to track your Motorola analog trunk system after rebanding has taken place in your area.

Here is the rebanding status of the Radio Shack scanners based on all the information we have in hand at presstime. Reportedly, the only safe Radio Shack scanners are the Pro-2096 and Pro-96 (reflashed) and Pro-97/92 (reprogrammed). Any other Radio Shack trunk tracker will have to be replaced if you want to monitor a Motorola analog system after rebanding is implemented in your area. I strongly suggest that those interested check out the internet address mentioned by Rick for additional information on 800 MHz rebanding.

Q. I just heard a USB station at approximately 10.050 MHz or higher. It was off the upper end of the scale on my Drake R-4B receiver. Sounded like air traffic in New York and really good copy in Oklahoma. Was it military or commercial? (Rob Mills via email)

A. Rob, you have monitored a transmission from the New York VOLMET station at Islip, New York. The actual frequency is 10.051 MHz or 10051 kHz using upper sideband (USB).

From Wikipedia, the free encyclopedia listing:

“VOLMET, or meteorological information for aircraft in flight, is the term applied to a worldwide network of radio stations that broadcast TAF, SIGMET and METAR reports on shortwave frequencies. Reports are sent using automated voice transmissions, in the upper sideband or J3E mode. As the name suggests, pilots on international air routes use these transmissions to determine what procedures to use for descent, approach, and landing, such as a visual approach or an instrument approach and the correct approach heading.

“The VOLMET network divides the world into specific regions, and individual VOLMET stations in each region broadcast weather reports for specific groups of air terminals in their region at specific times, coordinating their transmission schedules so as not to interfere with one another. Schedules are determined in intervals of five minutes, with one VOLMET station in each region broadcasting reports for a fixed list of cities in each interval. These schedules repeat every hour.”

What you heard on 10051 kHz is part of the North American family of VOLMET frequencies. The other frequencies in this network are 3485, 6604 and 13270 kHz. There are two stations that transmit weather info in this network: New York and Gander, Newfoundland, in Canada.

As I wrap up the column for this month, this marks the one year anniversary since we began the *MT Help Desk* column. So it is time I remind our readers: if you have a frequency or specific radio equipment question you would like answered, send them to our email address, larryvanhorn@monitoringtimes.com, or you can snail mail it to *MT Help Desk*, P.O. Box 78, Brasstown, NC 28902. We use questions in this column in the order we receive them, so please be patient. To all our *MT* readers, I want to wish you and your family a happy holiday season, and we will see you again in 2007.

Handheld “HF” Antenna

Fantastic Multiband Reception!*

- Experience great fun with handheld HF!
- Extremely high gain antenna over VHF/UHF HT antennas*
- I mean high gain – no kidding*!
- Super long 33” whip for added performance
- 5 primary bands are in 80m–10m ham or 41m–13m shortwave in 2 versions and a multitude of other non-primary bands
- No fidgeting push button operation
- Sleek design w/black housing
- Lightweight construction



Antenna Shown (Collapsed) w/Kenwood TH-F6A

\$99.95
+ \$7.00 S&H
to Lower 48 States

Package includes tuned antenna system, PL-259 and BNC adapters, pocket reference card



Performance HF, Inc.
11925 Meriden Lane
San Diego, CA 92128
Patent Pending

*See www.PerformanceHF.com for additional information

To order call (858) 487-8050 or go to www.PerformanceHF.com

Mixed Bag from Readers

One of the most enjoyable parts of writing for *Monitoring Times* is hearing from readers. In this column, for the magazine's 25th anniversary issue, we cover multiple simulcast systems, firmware upgrades, an unusual radio technology and studio broadcast links. In short, a variety of issues that represent a cross section of the varied interests of our readers.

Lebanon County, Pennsylvania

Dan,

How can I listen to local activity on my Radio Shack scanner, a model PRO-96? I live in Lebanon County, Pennsylvania, and the whole county has switched to EDACS with digital ProVoice. I programmed the scanner like the book said, but all I hear is a series of beeps. How can I correct this? Thanks for any help.

Tracy in Pennsylvania

Lebanon County is located in the southeast part of Pennsylvania, near the state capitol of Harrisburg, and is home to about 120,000 residents.

The county operates an Enhanced Digital Access Communication System (EDACS) that uses both analog and digital formats on the voice channels. Unfortunately, the digital voice traffic is a proprietary format called ProVoice. No scanner available to consumers is currently able to correctly process ProVoice, including the PRO-96. What this means is that the talkgroups using ProVoice will not be heard on your scanner. Instead, you'll hear buzzing or other noise, but no clear voices.

However, the system also carries analog talkgroups, which you should be able to hear just fine.

A complicating factor in Lebanon County is the fact that there are seven different sites, each transmitting on one of three sets of frequencies. Each of these sets is *simulcast* (simultaneous broadcast) from each repeater site, so you should hear the same traffic regardless of which site is actually closest to you.

The sites at Lebanon City, Mount Wilson, Myerstown and Palmyra use the following frequen-



Lebanon County, Pennsylvania

cies (listed in Logical Channel Number order):

LCN	Frequency
01	453.0250
02	453.1875
03	453.5125
04	453.6375
05	460.1500
06	460.3125
07	460.5000

The sites at Grantville and Jonestown transmit on the following frequencies:

LCN	Frequency
01	453.3125
02	453.7125
03	460.1375
04	460.2625
05	460.4625

Finally, the site identified as "North Simulcast," also located in Jonestown, uses the same frequencies as the previous two sites with the addition of 453.0750 MHz in LCN 1 and 453.5625 MHz in LCN 3.

LCN	Frequency
01	453.0750
02	453.3125
03	453.5625
04	453.7125
05	460.1375
06	460.2625
07	460.4625

Because this is EDACS, it is important that these frequencies be entered in Logical Channel Number (LCN) order. The procedure for doing this on PRO-96 is described starting on Page 34 of your manual, under the title "Programming EDACS Trunking Systems." I would suggest entering these three frequency sets as three different systems in your scanner and check to see if you can hear any of these analog talkgroups:

Decimal	AFS	Description
528	04-020	Lebanon County Fire (All Call)
529	04-021	Lebanon County Fire 1
530	04-022	Lebanon County Fire 2
531	04-023	Lebanon County Fire 3 (Fireground)
532	04-024	Lebanon County Fire 4 (Fireground)
533	04-025	Lebanon County Fire 5 (Fireground)
534	04-026	Lebanon County Fire 6 (Fireground)
535	04-027	Lebanon County Fire 7 (Fireground)
536	04-030	Lebanon County Fire 8 (Fireground)
537	04-031	Lebanon County Fire 9 (Fireground)
538	04-032	Lebanon County Fire 10 (Fireground)
539	04-033	Lebanon County Fire 11 (Fireground)
540	04-034	Lebanon County Fire 12 (Fireground)

Please let us know how things work out.

Dearborn Heights, Michigan

Hi Dan,

I took my Uniden Bearcat scanner down to Dearborn Heights, Michigan, to my buddy's house who is on the force and for some reason I don't receive the system. My radio is set to scan the right frequencies and does stop on them but the voices are not coming through, almost like they are scrambled and we would really like to know how to make it work. I would love to find someone who is knowledgeable about my Bearcat 796D scanner and why I am having problems with Dearborn Heights.

I am receiving all other APCO 25 digital jurisdictions but not the Heights. When my radio is in scan mode and it senses a digital signal it stops to monitor and says APCO 25 under the name of the city. When it stops at the Heights it doesn't say digital and I am so confused because they have the APCO25 digital system. Please help or maybe you can put me in touch with someone who can.

Jeff in Michigan

Dearborn Heights is a suburb of Detroit located in southeast Michigan. It is part of the western Wayne County 800 MHz trunked radio system, along with the municipalities of Garden City, Inkster, Wayne and Westland. This is a mixed analog and digital system that uses APCO Project 25 standards when delivering voice information in digital format. Scanners from Radio Shack and Uniden are capable of processing transmissions from this system, including the Uniden Bearcat BC796D.

The western Wayne County uses the following frequencies: 866.5500, 866.6125, 866.7500, 867.2500, 867.5500, 867.7000, 867.7500, 868.0500, 868.1375, 868.1875, 868.5625, 868.7750 and 868.8000 MHz.

Here are some common talkgroups for Dearborn Heights:

Decimal	Hex	Description
4176	105	Dearborn Heights Police Operations
4716	126	Dearborn Heights Police Operations
4800	12C	Dearborn Heights Police Command
4816	12D	Dearborn Heights Police Dispatch
4832	12E	Dearborn Heights Police (Car-to-Car)
4848	12F	Dearborn Heights Police Administration
4912	133	Dearborn Heights Police Detectives
5936	173	Dearborn Heights Police Tactical
6416	191	Dearborn Heights Fire Dispatch
6448	193	Dearborn Heights Fireground
6480	195	Dearborn Heights Emergency Management
6608	19D	Dearborn Heights Fire Tactical
6928	1B1	Dearborn Heights Fire Tactical
14992	3A9	Dearborn Heights Police
26208	666	Dearborn Heights Public Works
29392	72D	Dearborn Heights Police Detectives

35216	899	Dearborn Heights Police Detectives
37584	92D	Dearborn Heights Police (Alternate Dispatch)
53968	D2D	Dearborn Heights Police Detectives

Regarding Jeff's problem: my first thought is to check and see if the firmware in the BC796D scanner is up to date. Most modern scanners use microprocessors to perform scanning and audio processing duties. These microprocessors follow instructions carried in *firmware*. This firmware can be updated using a personal computer and a data cable. By downloading a program from Uniden's Internet web site, you can load the latest firmware into your 796D.

When the scanner was first introduced in 2003 there were some initial problems with talkgroups numbered above 40,000. As you saw in the talkgroups listed above, some Dearborn Heights talkgroups are above this number. If your scanner is using an early version of firmware you may have trouble related to this issue. Uniden corrected this problem in a later release of firmware and have continued to make improvements since then.

Go to Uniden's support download page at <http://uniden.com/index/downloads.cfm?product=BC796D> and look for the entry described as "BC796D UPDATE PROGRAM." As I write this, the file is named BCD796Dv3.29.zip and carries a release date of February 17, 2006. By downloading this program onto your Windows-based personal computer and following the directions, you can quickly bring your scanner up to version 3.29.

In order to see which version of firmware is loaded in your scanner, perform the following steps (which also work on other Uniden models):

1. Turn off the scanner.
2. Hold down the [2], [4] and [9] keys simultaneously.
3. While holding down those three keys, turn the scanner on.

The display will show the version and a *checksum* of the loaded firmware. The checksum is just a way of double-checking that the firmware is stored correctly. If the reported version on your scanner is less than 3.29, I would suggest upgrading and see if that fixes the problem.

McMinnville, Oregon

Dan,

I am writing to ask you about the trunked radio system in McMinnville, Oregon. McMinnville City police have been trying for about a year to get it up and going and I still have little problems monitoring their system.

Bruce in Oregon

McMinnville is a town of about 30,000 people in Yamhill County, in northwest Oregon. The town is famous (or infamous) for several aviation-related historical artifacts, including serving as home to the *Spruce Goose*, the enormous wooden plane built and flown by Howard Hughes. It is also the town whose local paper in 1950 ran photographs purporting to show a flying saucer.

These days the Yamhill Communications Agency (YCA), the main Public Safety Answering Point (PSAP) for the county, operates an unusual trunked radio system. Although one of the initial goals of the system was to provide interoperability with state and federal agencies, including the Oregon State Police and the U.S. Forest Service, the equipment chosen happens to be incompatible with pretty much everyone else in Oregon. The YCA radio system uses a technology called *MPT-1327*, most commonly used in Europe and Australia for business



Yamhill County, Oregon

and industrial applications. In other parts of the world it is also used for public safety applications, but is rarely seen in the United States.

MPT-1327

Like APCO Project 25, MPT-1327 is a

standard for trunked radio systems. It originated in Great Britain in the late 1980s and was later standardized for use in Europe.

MPT-1327 systems have two kinds of channels: at least one control channel (CC) and one or more traffic channels (TC). The control channel carries digital command and status information at 1200 bits per second (bps). Traffic channels are trunked, meaning they are shared among all subscribers and are assigned to a talkgroup only for the duration of the call.

Each radio in an MPT-1327 system has a unique identifier, referred to as a *call number*. This 20-bit identifier consists of a 3-digit prefix, a 4-digit fleet number and a subscriber number (2 or 3 digits). Each MPT-1327 can theoretically handle more than one million addresses.

Radios communicate through base stations to a Trunking System Controller (TSC). The TSC provides oversight and controls channel assign-

Welcome to the Micro Standard!

Once again, Alinco engineers have redefined miniature electronics technology. With its leading edge "credit card" size radios, Alinco proves performance and quality can be found in micro-size receivers. Now, you can put all the action on fire, public safety, aircraft, weather, Amateur Radio and many other exciting frequencies right into your pocket with this trio of high performance wide band receivers.

DJ-X7T Wide Range Pocket Size Communications Receiver

100KHz to 1.3GHz* Triple conversion AM/NFM; double conversion WFM, plus FM, SW, and TV

Super small "credit card" size delivers AMAZING audio quality in a size and weight (as thin as 14.5 mm, as light as 103g) that you can take almost anywhere. Easy to read illuminated LCD, 1,000 memory channels, five operating modes, three different antenna modes, easy to program with free downloadable software (optional cable required), cable-clone, and a long-lasting Lithium ion battery! Standard adapter charges the Li-Ion battery AND operates with AC power, even at the same time, so you can listen while charging.

DJ-X2000T Multimode Wide Range "Intelligent Receiver"

100KHz to 2.15GHz*

Experience monitoring on a whole new level with the DJ-X2000T "Intelligent Receiver". This triple conversion handheld receiver offers many unique features such as Flash Tune™ which locks onto nearby signals, Transweeper™ "bug" detector, and Channel Scope™ spectrum display. It also has 2000 memory channels, alphanumeric labeling, RF frequency counter, digital sound recorder, and receives AM, WFM, NFM, LSB, USB, CW and FM stereo.** Super extras include an on-line "help" feature, 20 scan programs, computer programmable capabilities (download free software from Alinco website), CTCSS decode, two level attenuator, field strength meter, and more!

DJ-X3TD Multimode Wide Range Communications Receiver

100KHz to 1.3GHz* WFM mono and stereo, NFM, AM**

Small but powerful triple conversion receiver with excellent audio, SMA flex and internal ferrite bar antennas, large easy-to-read display, 700 memories, NiMH battery, four scan modes, and dry cell battery pack. Computer programmable with free control software from www.alinco.com

WWW.ALINGO.com

Distributed in North America by Ham Distribution, Inc., 15 South Trade Center Pkwy, #B5, Conroe, Texas, 77385.
Phone: 936-271-3366. Fax: 936-271-3398. email: Alinco@consolidated.net
Specifications subject to change without notice or obligation. *Cellular blocked in USA. Unlocked versions available to qualified users, documentation required. **Optional stereo headphones required.

December 2006

MONITORING TIMES

25

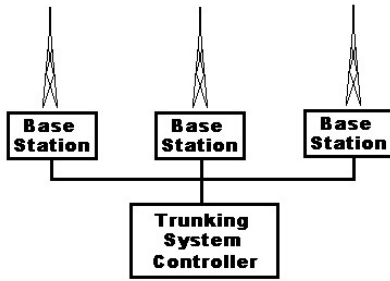

Generic MPT 1327 System

ments for the radios.

The MPT-1327 standards are publicly available, making it possible to create a computer program to track and monitor these systems. However, the consumer scanners sold in the United States do not have the ability to follow MPT-1327 transmissions. This leaves you with a handful of options, all of which require a personal computer.

The WiNRADiO Trunking Option includes the ability to monitor MPT-1327 systems using their radio products. An internal WiNRADiO receiver or an external receiver with "data output" capability, along with a Windows software program and a soundcard, will allow you to follow the YCA system.

Other commercial MPT-1327 monitoring decoders and programs are available for sale from several locations on the Internet. Two such products are described at www.tbsa.com.au/trunk.html and www.trunksniffer.com.

TrunkView is an MPT-1327 decoder that uses a soundcard under the Windows operating system to monitor control channel activity. You can read more about it and download the latest version at www.linato.net/trunkview

If you would like to experiment with some actual computer program source code, you can check out *TrunkSnort*, a Windows program based on an earlier open source UNIX program called *Tronkito*. You can find TrunkSnort at hometown.aol.de/trunksniffer/index_2.htm

More information about MPT-1327 is available on my web site at www.signalharbor.com.

McMinnville and Yamhill County

The McMinnville site uses the following four frequencies: 460.0375, 460.2625, 460.3375 and 460.63750 MHz. However, without an MPT-1327 decoder you probably won't hear much.

So, until you have an MPT-1327 decoder running, you can listen to county operations on the following frequencies:

Freq	Description
45.32	Yamhill County Sheriff Dispatch
45.46	Yamhill County Sheriff
45.64	Yamhill County Sheriff Car-to-Car
46.10	Yamhill County Fire Primary
46.22	Yamhill County Fire Tactical
46.26	Yamhill County Fire West Tactical
46.28	Yamhill County Fire East Tactical
46.32	Yamhill County Fire Central Tactical
46.42	Yamhill County Fire Dispatch
163.250	Yamhill County Fire Paging

Studio Transmitter Links

Hello Dan,

I have a VR-5000 that I bought about 2 years ago at the Dayton Hamvention. As a radio technician for the Ohio Turnpike I travel the area from Toledo to the Indiana line every day. I have just this past week found something called an STL Studio-Transmitter Link. The ones I have found are all wide FM and carry the audio from the studio to the transmitter site. What follows is a list of what I have found.

945.0 MHz	96.1	WMTR
945.5 MHz	107.3	WJUC
946.0 MHz	1470	WLQR
946.5 MHz	97.3	WJZE
947.5 MHz	1370	WSPD
948.5 MHz	92.5	WVKS

All of them are located in the 945 to 950 MHz area. They are very directional from studio to transmitter. I have never found any mention of STL's in *Monitoring Times* that I recall.

Are there other frequencies used for this such as microwave and what about digital? There are several stations in the area that use some sort of STL but I have not found them. One is 93.5 WRQN, which has a link from Toledo to the Haskins / Lucky area but I can not find their STL. TV stations must use some sort of STL as well. Do you know where they would operate?

Thanks, Wayne in Ohio

Many television and radio stations use Studio-Transmitter Links (STL) to carry their video and audio signals from the studio to the transmitter. Often a broadcast station will have a transmitter site that is located some distance from the studio where programming originates. STLs may also connect other facilities, such as a main studio with an auxiliary studio. Many stations started out linking their studio to their transmitter via leased telephone lines and are now switching over to wireless connections, making STL activity more common.

STL is part of what the Federal Communications Commission (FCC) calls Broadcast Auxiliary Microwave Service (BAS). These services operate in the 944 MHz to 952 MHz band, as Wayne has discovered. License terms may also allow the station to lease their bandwidth for other uses, so the assigned frequency may not always carry broadcast programming.

There are thirteen possible 500 MHz-wide channels in this band: 944.5, 945.0, 945.5, 946.0, 946.5, 947.0, 947.5, 948.0, 948.5, 949.0, 949.5, 950.0, 950.5, 951.0 and 951.5 MHz. Because there are so few channels, the FCC allows the use of unused UHF television frequencies when no regular STL channels are available.

While searching for activity, keep in mind that the links are usually point-to-point and very directional. You will need to be somewhere between the studio and the transmitter site in order to receive these links effectively. Also, as technology improves, transmissions may go from analog to digital, making them impossible to hear on your scanner.

The FCC has also allocated BAS a block of frequencies between 1990 MHz and 2110 MHz and another block between 2450 MHz and 2500 MHz for television stations, intended for use by on-scene electronic news gathering (ENG) crews. Signals from ENG equipment, whether on the ground or from aircraft, are received by remote sites and relayed back to the studio for editing and broadcast.

The FCC does provide a lookup service to find information about broadcast stations, which can help locate the geographic location of station facilities:

Station Link

- Television www.fcc.gov/fcc-bin/audio/tvq.html
- FM radio www.fcc.gov/mb/audio/fmq.html
- AM radio www.fcc.gov/mb/audio/amq.html

Using license holder ownership information, you can match up frequency records found through the FCC's Universal Licensing System (ULS) search tool, located on the web at wireless2.fcc.gov/UlsApp/UlsSearch/searchAdvanced.jsp

Entering the STL frequency and your state into the form will bring up the current license holder for that frequency.

Somerset County, Maryland

Our county, Somerset County, Maryland, recently installed a four-frequency M/A-COM system. Do you have a handheld recommendation for tracking it? The manufacturer said in a meeting that it couldn't be tracked.

Robert in Maryland

The Somerset County system is indeed manufactured by M/A-COM and is an older EDACS network rather than the newer OpenSky technology being installed in other states including Michigan, New York, and Pennsylvania. The voice traffic is a mix of analog (which many scanners can monitor) and a M/A-COM proprietary digital format called ProVoice (which no consumer scanner is able monitor). Perhaps the representative at the meeting was referring to the ProVoice digital not being trackable.

The FCC license database reports five frequencies licensed to Somerset County that are worth checking: 854.9625, 855.4875, 857.2125, 859.9625 and 860.9625 MHz. These are all transmitted from two tower locations, one on Route 1 in Princess Anne and the other in Marion. I don't know how much of the system traffic is analog versus digital, but it would be interesting to find out!

I have a list of scanners on my website at www.signalharbor.com/trunking.html which might work for you in Somerset County. Look for a scanner with "Yes" in the "EDACS" column to find a handheld that might fit your needs. If you travel to the Baltimore or Washington D.C. areas you may wish to consider a handheld that is also capable of monitoring APCO Project 25 systems.

That's all for this month. Have a peaceful holiday season and a Happy New Year!

Big Savings on Radio Scanners

Uniden® SCANNERS



Bearcat® 796DGV Trunk Tracker IV with free scanner headset

Manufacturers suggested list price \$799.95
CEI Special Price \$519.95

1,000 Channels • 10 banks • CTCSS/DCS • S Meter
Size: 6 15/16" Wide x 6 9/16" Deep x 2 3/8" High

Frequency Coverage: 25,000-512,000 MHz., 806,000-956,000 MHz. (excluding the cellular & UHF TV band), 1,240,000-1,300,000 MHz.

When you buy your Bearcat 796DGV TrunkTracker package deal from Communications Electronics, you get more. The GV means "Great Value." With your BC796DGV scanner purchase, you also get a **free deluxe scanner headphone** designed for home or race track use. Headset features independent volume controls and 3.5 mm gold right angle plug. The 1,000 channel Bearcat 796DGV is packed with features to track Motorola Type I/II/III Hybrid, EDACS, LTR Analog Trunk Systems and Motorola APCO 25 Phase I digital scanner including 9,600 Baud C4FM and CQPSK. Also features control channel only mode to allow you to automatically trunk many systems by simply programming the control channel, S.A.M.E. weather alert, full-frequency display and backlit controls, built-in CTCSS/DCS to assign analog and digital subaudible tone codes to a specific frequency in memory, PC Control and programming with RS232C 9 pin port (cable not supplied), Beep Alert, Record function, VFO control, menu-driven design, total channel control and much more. Our CEI package deal includes telescopic antenna, AC adapter, cigarette lighter cord, DC cord, mobile mounting bracket with screws, owner's manual, trunking frequency guide and one-year limited Uniden factory warranty. For maximum scanning enjoyment, order magnetic mount antenna part number ANTMMBNC for \$29.95. For complete details, download the owners manual from the www.usascan.com web site. For fastest delivery, order on-line at www.usascan.com.

Bearcat® BCT8 Trunk Tracker III

Manufacturer suggested list price \$299.95
CEI Special Price \$169.95

250 Channels • 5 banks • PC Programmable
Size: 7.06" Wide x 6.10" Deep x 2.44" High

Frequency Coverage: 25,000-54,000 MHz., 108,000-174,000 MHz., 400,000-512,000 MHz., 806,000-823,987.5 MHz., 849,012.5-868,995.0 MHz., 894,012.5-956,000 MHz.

The Bearcat BCT8 scanner, licensed by NASCAR, is a superb preprogrammed 800 MHz trunked highway patrol system scanner. Featuring TrunkTracker III, PC Programming, 250 Channels with unique BearTracker warning system to alert you to activity on highway patrol link frequencies. Preprogrammed service searches makes finding interesting active frequencies even easier and include preprogrammed police, fire and emergency medical, news agency, weather, CB band, air band, railroad, marine band and department of transportation service searches. The BCT8 also has preprogrammed highway patrol alert frequencies by state to help you quickly find frequencies likely to be active when you are driving. The BCT8 includes AC adapter, DC power cable, cigarette lighter adapter plug, telescopic antenna, window mount antenna, owner's manual, one year limited Uniden warranty, frequency guide and free mobile mounting bracket. For maximum scanning enjoyment, also order the following optional accessories: External speaker ESP20 with mounting bracket & 10 feet of cable with plug attached \$19.95. Magnetic Mount mobile antenna ANTMMBNC for \$29.95.



Bearcat® BCD396T Trunk Tracker IV

Suggested list price \$799.95/CEI price \$519.95

APCO 25 9,600 baud compact digital ready handheld TrunkTracker IV scanner featuring Fire Tone Out Paging, Close Call and Dynamically Allocated Channel Memory (up to 6,000 channels), SAME Weather Alert, CTCSS/DCS, Alpha Tagging. **Size: 2.40" Wide x 1.22" Deep x 5.35" High**

Frequency Coverage:

25,000-512,000 MHz., 764,000-775,987.5 MHz., 794,000-823,987.5 MHz., 849,012.5-868,976.5 MHz., 894,012.5-956,000 MHz., 1,240,000 MHz.-1,300,000 MHz.

The handheld BCD396T scanner was designed for National Security/Emergency Preparedness (NS/EP) and homeland security use with new features such as **Fire Tone Out Decoder**. This feature lets you set the BCD396T to alert if your selected two-tone sequential paging tones are received. Ideal for on-call firefighters, emergency response staff and for activating individual scanners used for incident management and population attack warning.

Close Call Radio Frequency Capture - Bearcat exclusive technology locks onto nearby radio transmissions, even if you haven't programmed anything into your scanner. Useful for intelligence agencies for use at events where you don't have advance notice or knowledge of the radio communications systems and assets you need to intercept. The BCD396T scanner is designed to track Motorola Type I, Type II, Hybrid, SMARTNET, PRIVACY PLUS, LTR and EDACS® analog trunking systems on any band. Now, follow UHF High Band, UHF 800/900 MHz trunked public safety and public service systems just as if conventional two-way communications were used. **Dynamically Allocated Channel**

Memory - The BCD396T scanner's memory is organized so that it more closely matches how radio systems actually work. Organize channels any way you want, using Uniden's exclusive dynamic memory management system. 3,000 channels are typical but **over 6,000 channels are possible** depending on the scanner features used. You can also easily determine how much memory you have used and how much memory you have left. **Preprogrammed Systems**

- The BCD396T is preprogrammed with over 400 channels covering police, fire and ambulance operations in the 25 most populated counties in the United States, plus the most popular digital systems. **3 AA NiMH or Alkaline battery operation and Charger** - 3 AA battery operation - The BCD396T includes 3 premium 2,300 mAh Nickel Metal Hydride AA batteries to give you the most economical power option available. You may also operate the BCD396D using 3 AA alkaline batteries. **Unique Data Skip** - Allows your scanner to skip unwanted data transmissions and reduces unwanted birdies. **Memory Backup** - If the battery completely discharges or if power is disconnected, the frequencies programmed in the BCD396T scanner are retained in memory. **Manual Channel Access** - Go directly to any channel. **LCD Back Light** - A blue LCD light remains on when the back light key is pressed. **Autolight** - Automatically turns the blue LCD backlight on when your scanner stops on a transmission. **Battery Save** - In manual mode, the BCD396T automatically reduces its power requirements to extend the battery's charge. **Attenuator** - Reduces the signal strength to help prevent signal overload. The BCD396T also works as a conventional scanner to continuously monitor many radio conversations even though the message is switching frequencies. The BCD396T comes with AC adapter, 3 AA nickel metal hydride batteries, belt clip, flexible rubber antenna, wrist strap, SMA/BNC adapter, RS232C cable, Trunk Tracker frequency guide, owner's manual and one year limited Uniden warranty. Not compatible with AGEIS, ASTRO or ESAS systems. Order on-line at www.usascan.com or call 1-800-USA-SCAN.

More Radio Products

Save even more on radio scanners when purchased directly from CEI. Price includes delivery in the continental USA excluding Alaska.

Bearcat 8987 500 channel TrunkTracker III base/mobile.....	\$209.95
Bearcat 796DGV 1,000 channel TrunkTracker III base/mobile.....	\$519.95
Bearcat BCD396T APCO 25 Digital scanner with Fire Tone Out.....	\$519.95
Bearcat 246T up to 2,500 ch. TrunkTracker III handheld scanner.....	\$214.95
Bearcat Sportcat 230 alpha display handheld sports scanner.....	\$184.95
Bearcat 278CLT 100 channel AM/FM/SAME WX alert scanner.....	\$129.95
Bearcat 248CLT 50 channel base/AM/FM/weather alert scanner.....	\$104.95
Bearcat 92XLT 200 channel handheld scanner.....	\$109.95
Bearcat 72XLT 100 channel handheld scanner.....	\$99.95
Bearcat BR330T up to 2,500 ch. TrunkTracker III with Tone out \$274.95	
Bearcat BCT8 250 channel information mobile scanner.....	\$169.95
Bearcat 350C 50 channel desktop/mobile scanner.....	\$104.95
AOR AR16BQ Wide Band scanner with quick charger.....	\$199.95
AOR AR3000AB Wide Band base/mobile receiver.....	\$1,079.95
AOR AR5000A+3B Wide Band 10 KHz to 3 GHz receiver.....	\$2,599.95
AOR AR8200 Mark III Wide Band handheld scanner.....	\$594.95
AOR AR8600 Mark III Wide Band receiver.....	\$899.95
AOR AR-ONE Government/Export sales only 10 KHz-3 GHz.....	\$4,489.95
Scancat Gold For Windows Software.....	\$99.95
Scancat Gold For Windows Surveillance Edition.....	\$159.95

Bearcat® BC246T Trunk Tracker III

Suggested list price \$399.95/CEI price \$214.95
Compact professional handheld TrunkTracker III scanner featuring Close Call and Dynamically Allocated Channel Memory (up to 2,500 channels), SAME Weather Alert, CTCSS/DCS, Alpha Tagging. Size: 2.72" Wide x 1.26" Deep x 4.6" High

Frequency Coverage:

25,000-54,000 MHz., 108,000-174,000 MHz., 216,000-224,980 MHz., 400,000-512,000 MHz., 806,000-823,987.5 MHz., 849,012.5-868,987.5 MHz., 894,012.5-956,000 MHz., 1,240,000 MHz.-1,300,000 MHz.

The handheld BC246T TrunkTracker scanner has so many features, we recommend you visit our web site at www.usascan.com and download the free owner's manual. Popular features include **Close Call Radio Frequency Capture** - Bearcat exclusive technology locks onto nearby radio transmissions, even if you haven't programmed anything into your scanner. **Dynamically Allocated Channel Memory** - Organize channels any way you want, using Uniden's exclusive dynamic memory management system. 1,600 channels are typical but **over 2,500 channels are possible** depending on the scanner features used. You can also easily determine how much memory is used. **Preprogrammed Service Search (10)** - Makes it easy to find interesting frequencies used by public safety, news media TV broadcast audio, Amateur (ham) radio, CB radio, Family Radio Service, special low power, railroad, aircraft, marine, racing and weather frequencies. **Quick Keys** - allow you to select systems and groups by pressing a single key. **Text Tagging** - Name each system, group, channel, talk group

ID, custom search range, and S.A.M.E. group using 16 characters per name. **Memory Backup** - When power is lost or disconnected, your BC246T retains the frequencies that were programmed in memory. **Unique Data Skip** - Allows the BC246T to skip over unwanted data transmissions and birdies. **Attenuator** - You can set the BC246T attenuator to reduce the input strength of strong signals by about 18 dB. **Duplicate Frequency Alert** - Alerts you if you try to enter a duplicate name or frequency already stored in the scanner. **22 Bands** - with aircraft and 800 MHz. The BC246T comes with AC adapter, 2 AA 1,800 mAh nickel metal hydride batteries, belt clip, flexible rubber antenna, wrist strap, RS232C cable, Trunk Tracker frequency guide, owner's manual and one year limited Uniden warranty. For more fun, order our optional deluxe racing headset part #HF24RS for \$29.95. Order now at www.usascan.com or call 1-800-USA-SCAN.

Buy with Confidence

Order on-line and get big savings

For over 36 years, millions of communications specialists and enthusiasts worldwide have trusted Communications Electronics for their mission critical communications needs. It's easy to order. For fastest delivery, order on-line at www.usascan.com. Mail orders to: Communications Electronics Inc., P.O. Box 1045, Ann Arbor, Michigan 48106 USA. Price includes \$30.00 UPS Ground shipping/handling/insurance per scanner to a street address in the continental USA excluding Alaska. Add \$20.00 shipping for all accessories. For shipments to Canada, Puerto Rico, Hawaii, Alaska, Guam, P.O. Box, APO/FPO, USPS Priority Mail or UPS 2 business day delivery, add \$30.00. Michigan residents add sales tax. No COD's. For Bearcat scanners your satisfaction is guaranteed or return item in unused condition in original packaging within 61 days for refund, less shipping charges. 10% surcharge for net 10 billing to qualified accounts. All sales are subject to availability, acceptance and verification. Prices, terms and specifications are subject to change without notice. We welcome your Discover, Visa, American Express, MasterCard, IMPAC or Eurocard. Order toll free, call 1-800-USA-SCAN or 1-734-996-8888 if outside Canada or the USA. FAX anytime, dial 1-734-663-8888. Dealer and international inquiries invited. Order your radio scanners from Communications Electronics today.

For credit card orders call
1-800-USA-SCAN

e-mail: cei@usascan.com
www.usascan.com
 PO Box 1045, Ann Arbor, Michigan 48106-1045 USA
 For information call 734-996-8888 or FAX 734-663-8888



Visit WWW.USASCAN.COM • 1-800-USA-SCAN

Updated Cuban Numbers Schedule

The designator assigned by ENIGMA (European Numbers Intelligence Gathering and Monitoring Association) to the current version of the Cuban female voice that gives 5-figure groups of numbers in Spanish is "V2a." This "A" variant contains three equal messages, which are preceded by a callup of "Atencion!" (Attention!), plus three message identifier groups. The V2a format is the only one in use right now. There have recently been a few weird call-ups using the "old" voice and other strange deviations, but these seem more likely to be software or operator errors. Unless something goes wrong, which it often does, the whole transmission is about 45 minutes long.

The grid printed here in Table 1 is the result of considerable editorial effort spent assembling and collating thousands of logs made available to the hobby by several dedicated listeners in the June through October 2006 time period. We

thank them for their efforts. They have made it possible to find several weekly patterns in V2a frequency use that brings at least partial order to the relative chaos that is Cuban numbers broadcasting.

Frequencies always end on the even kilohertz (kHz), though some drift is possible. However, all frequencies are plus or minus 1-2 kHz, for reasons known only in Havana.

Slots usually have activity, but not always, except in the daily cycles from 1700 to 2245 Coordinated Universal Time (UTC). These are as reliable as anything ever gets with this organization.

Odd mistakes and malfunctions are common in all slots. Some of the equipment is old, or just not very good. Station operators often run the Morse code (M8a) format by mistake, or let both go at once, producing a total mess. There are also some interesting audio mixes, including

weak M8a from schedules on other frequencies. On rare occasion, there has even been brief audio from La Voz de Venezuela (The Voice of Venezuela). Recent world events seem to suggest a political significance here, though it's hard to tell what this might be.

The hours 2200-0100 have not been reported as active during this period, and so they are omitted. Also notice how the spies, presumably most of whom are working in the Western Hemisphere, get Saturday nights off.

Note the weird, 10,126-kilohertz slot on Fridays at 1400. This is in the 30-meter amateur band. Even if the station is legal there by band sharing agreements, the guaranteed extra attention from amateur intruder watch groups makes it a rather bad choice of frequency.

It is not known if a differential transmitter is used for the V2a 10126 kHz transmission, as it apparently is for the M8a when it comes up in this band. The 30-meter M8a transmission has attracted a

large amount of attention lately, as it has been repeatedly and reliably triangulated by different groups of amateurs (see cover story Oct. *MT*), and every time it has been shown to be coming from the northeastern United States. Your editor tends to concur, because wintertime propagation does not support a Cuban origin, and the Cuban embassy in Canada has been ruled out. Just when one thinks this hobby can't get any stranger, it does just that!

Getting back to Cuba, there are other frequencies, which repeat on a monthly basis, or with even longer cycles. Also, they often transmit on the wrong frequency. Finally, the seasonal propagation shift will probably have changed some frequencies during the lead time before this grid is widely published. Tuning around for open carriers just before the hour can often prove rewarding when dealing with Cuban numbers.

❖ More on Differential GPS

September's Differential Global Positioning System (DGPS) frequency list created quite a bit of interest. Some listeners have had a ball logging these, while others are simply wondering what the mode is all about.

The most frequently asked question regards what software is necessary to decode DGPS on a standard computer. Well, it's a bit limited. Unfortunately, I can't find any free programs, nor can I find anything at all for the Mac.

For the PC, there is one very old program, Radioraft, which comes from the MS-DOS era, and one new very new one (SkySweeper), which uses Windows and the sound card. Of course, there are also the big high-end packages by Wavecom and HOKA, which most certainly do DGPS. Both of these high-end packages are professional-grade products that you can spend years growing into, though at their awesome prices they're hardly the kind of things one would buy for just a DGPS mode. (Not to mention they're not really legal for U.S. consumers to use, because they include a few modes which are not open to the public.)

Radioraft is still available, at a garage-sale price, though it requires real DOS (Disk Oper-

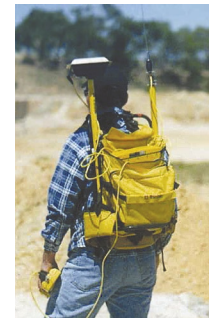

Table 1: Cuban Spanish "Atencion" AM Numbers Broadcasts (V2a)

UTC	Mon	Tue	Wed	Thu	Fri	Sat	Sun
0100		3389			4028	6768	
0200	12165	3292 12215	12180		5417 12215	5762	
0300	5800 6855 10446	4017	4479 10446		11566	4028	
0400	5117	3292 3926	4329	9323	4479	3292 5762	
0500	3245 9331 10446	3389	3360	3297 8097	3389 4028 4479	5883	
0600	3360 9331	4028	4035	4028 8097	4028 8010	8097	
0700	3360 9238	5930 7692 9112	9063	7862 9112 9153	9063 9238	9112 9153	8097 9063
0800	8010	7862	8010	7862	8010	7862	7681 7975
0900	7527 9040	7520 9040	7842 9040	7527 9040	7520 9040	7887 9040	8136 9040
1000	7681 9240	7887 9240	7861 9240	7681 9240	7887 9240	7975 9240	7975 9240
1100			3360		3245	4507	
1200	4035 10446 10566	10566	4035 6855 11566	10566	4035 10566	10715	11566
1300	11566	10715	5417 10446	10566 10715	9153 11566 10126	10566	10566
1400			5762		5771	5771	5771
1500	5771		5762		5771	5771	5771
1600	6867 7975	6867 7975	6855 7975	7975	7975	6867 7975	6867 7975
1700	8010	8010	8010	8010	8010	8010	8010
1800	8097	8097	8097	8097	8097	8097	8097
1900	8097	8097	8097	8097	8097	8097	8097
2000	7887	7887	7887	7887	7887	7887	7887
2100	6855	6855	6855	6855	6855	6855	6855

ating System), version 6.2 or newer. It won't work in the pseudo-DOS that newer versions of Windows use for command line windows. It also requires a hardware "Hamcomm" interface, but this, too, is dirt cheap.

In other words, Radioraft is one excuse to revive that old DOS computer you could never bear to give away. Users of anything after Windows 98 will have the rather unusual experience of finding out that their computer is too new. They'll have to boot plain old DOS from a disk, if they even have a floppy drive, or use the launcher available on the web site.

Radioraft's official download site is **perso.orange.fr/radioraft/**, owned by a French amateur with the callsign of F6FLT. It's a typical demo package, which you unlock by paying for a keycode. Being DOS software, its download time is measured in seconds rather than minutes. It is also sold, with interface, by Pervisell in the UK, **www.pervisell.co.uk/ham/raft_en.htm**.

SkySweeper is a much newer product from a Finnish company, SkySweep Technologies, at **www.skysweep.com**. It has three versions, from basic (and inexpensive) to professional (and amazingly comprehensive, at a price that is still a good deal). DGPS is in all three of them. All three have the same underlying modular setup. As you go up in price, all that happens is that you get more modules. You can run these from their stock configs or patch up your own experimental setups as your tech savvy and computer power permit. It all gets a bit esoteric, and sometimes the documentation is pretty minimal, but fortunately the tech support (via a Yahoo! group) is personal and topnotch. It's by and for radio enthusiasts.

SkySweeper is another downloaded demo, where you activate all the good stuff by ponying up the money and getting a keycode. No hardware interface is needed for receiving; though, of course, it is needed for transmitting. On the hardware scale, it's about as far from Radioraft as you can get. Its minimum recommended sys-

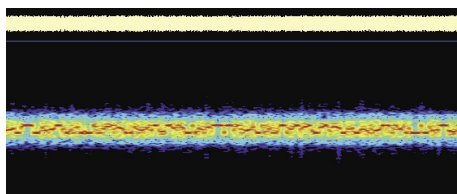

tem is not too heavy duty by current standards, but it'll still take all the power and speed you can give it.

Pervisell has SkySweeper, too, though at press time they didn't have the latest (x.10-2) version. I assume this won't be the case when the column runs. I would definitely get whatever is the very latest version of SkySweeper, because it is currently being improved on a weekly basis. Version x.10-2 came out literally yesterday. It improved the clock calibration routine, and dramatically improved the amateur packet radio decoder.

❖ Receiving DGPS

As we noted in September, DGPS sounds on the speaker like a cross between radio teletype (RTTY) and narrowband phase-shift keying. What you're hearing is pretty much what you're

getting. The mode is Minimum Shift Keying (MSK or G1D emission), which combines both techniques to achieve a narrow bandwidth approaching the theoretical ideal. The 1-kilohertz channel spacing is a huge overdesign, even at 200 baud.

The typical spectrogram display will show DGPS on-frequency, looking like a fuzzy line. Due to the laws that govern these things, 200 baud is wider, and so it's a bigger line. This is one way to determine the baud rate. Things get a little more interesting when using the "eye" display on an analyzer, which gives a distinctive loopy pattern resembling two sine waves out of phase. As the signal gets noisier or more out of tune, the "eye" closes.

What I did for receiving was to change the SkySweeper offset to the same as my receiver's RTTY mode. Since G1D emission centers on the assigned carrier frequency, the radio then reads the frequency shown on the lists. After this, it's a simple matter to set a 1-kHz scan and manually jump through the band. I stored the dead frequencies, and came back to them later, eventually getting identifiable signals (if only seconds long) from nearly every frequency.

Most SkySweeper decoders just love to scroll reams of information down the screen. This is great for professional signal analysis. The DXer, however, does not need to know what it all means. However for curiosity's sake, it's

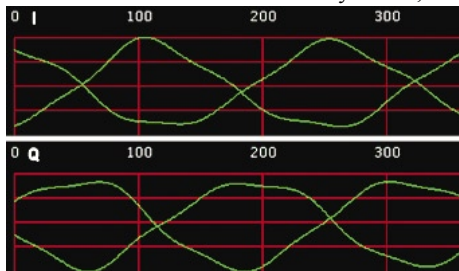

good to know what's filling up your text buffer at such an alarming rate. Mostly, you're seeing corrections for satellite navigation (type 9 messages). In a type 9 message, the "station number" is the important data for a positive station identification. The messages are broadcast in a continuous stream. A really good DGPS decoder will produce one of these every few seconds, scrolling its constituent data packets quickly down the screen.

There are a few other message types, mostly regarding stations, satellites, and their locations or "health." Health is a set of technical tolerances, which is constantly checked to maintain quality control sufficient for safe use at sea. This helps determine the "UDRE Scale Factor," which is a means of correcting the corrections. 1.0 is perfect. UDRE stands for "User Differential Range Error."

The "Sequency Count" is a packet number, and should increment by 1 until the next message. Finally, the "Z-count" is the GPS version of a time stamp. For the geeks out there, it's a 29-bit binary number (expressed in decimal for obvious reasons), which combines the GPS week number and number of 1.5-second periods into that week. These are all in GPS time, which is not equal to UTC for a variety of extremely technical reasons. (You really wanted to know

all this, right?)

A real good introduction to the fine points of DGPS DXing is at **www.beaconworld.org.uk/files/dgpsguide.pdf**.

Well, that ends another year. Have a great holiday, get that shiny new box from Santa, and have fun with this stuff in 2007.

ABBREVIATIONS USED IN THIS COLUMN

AFB.....	Air Force Base
ALE.....	Automatic Link Establishment
AM.....	Amplitude Modulation
AMC.....	Air Mobility Command
ARQ.....	Automatic Repeat Request
CAMSLANT.....	Communication Area Master Station, Atlantic
CAMPAC.....	Communication Area Master Station, Pacific
CW.....	"Continuous Wave" Morse telegraphy
DGPS.....	Differential Global Positioning System
E3.....	Lincolnshire Poacher, Cyprus, with musical tune
E10.....	Israeli phonetic station (xxx2=null message)
FAX.....	Radiofacsimile
FEC.....	Forward Error Correction
HFDL.....	High-Frequency Data Link
HF-GCS.....	High-Frequency Global Communication System
M8a.....	Cuban 3-msg CW/MCW, ANDUW-RIGMT = 1-0
MARS.....	Military Affiliate Radio System
MCW.....	Modulated CW or AM tone Morse
MFSK.....	Multiple-Frequency-Shift Keying
Navtex.....	Navigational Telex
NPHRN.....	US National Public Health Radio Network
RSA.....	Republic of South Africa
RTTY.....	Radio Teletype
SITOR-B.....	Simplex Telex Over Radio, FEC mode
Unid.....	Unidentified
US.....	United States
USCG.....	United States Coast Guard
UK.....	United Kingdom
V2a.....	"Atencion" Spanish numbers 3-msg format
V21.....	Weird Cuban semi-coherent male numbers voice
Volmet.....	From French, loosely "Flying Weather"

All transmissions are USB (upper sideband) unless otherwise indicated. All frequencies are in kHz (kilohertz) and all times are UTC (Coordinated Universal Time). "Numbers" stations have their ENIGMA (European Numbers Information Gathering and Monitoring Association) designators in ().

302.0	Miraflores Panama Canal DGPS, 200-baud corrections at 1824. (Cam Castillo-Panama)
326.0	AT-Nondirectional aero beacon at Tocumen Airport, Panama City, MCW at 1822. (Castillo-Panama)
350.0	DAV-Nondirectional aero beacon at David, Panama, MCW at 0235. (Castillo-Panama)
518.0	ZSC-Cape Town Radio, RSA, SITOR-B Navtex at 1225. (Bob Hall-RSA)
4028.0	Cuban AM Spanish (V2a), callup 33783 99893 48744, at 0100. (Tom Severt-KS)

- 4295.0 FUE-French Navy, RTTY test loop at 0335. (Sevart-KS)
 4317.0 NMG-USCG, New Orleans, LA, FAX weather chart at 0118. (Sevart-KS)
 4757.0 KEY798-Unknown NHPRN station, ALE sound at 1507. (Jack Metcalfe-KY)
 4991.0 NK1-US Federal Bureau of Investigation, Newark, NJ, calling QT1, Quantico, VA, ALE at 0302. (Mark Cleary-SC)
 4995.0 Unid-Two fishing trawler captains discussing Atlantic fishing, references to the Hague Line and the "triangle," plus the usual "salty" language, at 1412. (Dean Burgess-MA)
 5320.0 Sector St. Petersburg-USCG, radio check with District 7 at 1314. (Cleary-SC)
 5417.0 Cuban AM Spanish (V2a), 5-figure groups at 0200. (Sevart-KS)
 5616.0 Reach 246-US Air Force AMC transport, working Gander air control, at 0156. (Allan Stern-FL)
 5649.0 Gander-North Atlantic oceanic air route control, working Delta 51, Speedbird 2192, Lufthansa 439, Shamrock 132, and Virgin 46, sent some to 4675, starting at 0130. (Robert Wukich-USA)
 5680.0 Rescue 122-UK Coast Guard on a search and rescue, working Kinloss Rescue Centre at 1935. (Patrice Privat-France)
 5696.0 CAMSLANT-US Coast Guard, VA, working "Romeo-1-Kilo," went to 8983, at 0053. (Sevart-KS)
 5732.0 Coast Guard 1716-USCG HC-130, setting guard with CAMSPAC at 0227. (Cleary-SC)
 5787.5 RUH958-US Army helicopter, calling WAROPS (1-228 Aviation, Soto Cano Air Base, Honduras), ALE at 0138. (Cleary-SC)
 6519.0 WLO-Shipcom/Mobile Radio, AL, hurricane warning, weather, and traffic list at 1800. (Cyclops-TX)
 6529.0 The Babblers (V21), Cuban sing-songy numbers in Spanish, weak and rough copy as always, at 1301. (Chris Smolinski-MD)
 6640.0 New York-Long Distance Operational Control, patch to Medlink from Air France 632, regarding an in-flight medical emergency, at 0414. (Sevart-KS)
 6721.0 450034-US Air Force tanker, calling ADW, Andrews HF-GCS, ALE at 0700. (Cleary-SC)
 6761.0 RUH958-US Army helicopter, calling SKYWAT (Army Flight Following, Soto Cano), ALE at 0134. (Cleary-SC)
 6855.0 Cuban MCW cut number station (M8a), 5-letter groups in progress with a bad hum, at 2120. Cuban AM V2a in progress, 5-figure groups until 2142. (Cyclops-TX)
 6867.0 Cuban AM Spanish numbers (V2a), but with a different voice, and word "grupo" (group) replacing 3's and 9's, parallel on 7975, stopped and restarted at 1615. (Smolinski-MD) [Oops! Several others logged similar weirdness at different times. -Hugh]
 6932.0 Cuban CW cut number station (M8a), 5-letter groups in progress with a good clean signal [For a change! -Hugh], at 2115, and signed at 2136. (Cyclops-TX)
 7313.6 AFA2CV-US Air Force MARS, working AFA2AJ at 1348. (Metcalfe-KY)
 7527.0 Juliet 09-USCG helicopter on Hampton Roads patrol, setting guard with CAMSLANT at 1253. (Cleary-SC)
 7535.0 Norfolk SESEF-US Navy Ship Electronic Systems Evaluation Facility, VA, testing voice and digital modes with Bronze Warrior, at 1325. (Metcalfe-KY)
 7831.0 AFA1DA-US Air Force MARS, MFSK exercise messages at 1414. (Metcalfe-KY)
 7887.0 Cuban AM Spanish (V2a), callup 90253 31853 67003, at 2003. (Sevart-KS)
 7975.0 Cuban AM Spanish (V2a), callup 54921 09251 48181, at 1602. (Castillo-Panama)
 7975.4 Cuban CW cut number station (M8a), callup and 5-letter groups, at 2100. (Cyclops-TX)
 8009.0 Cuban CW cut number station (M8a), 5-letter groups in progress, parallel on 6854 (distorted), at 2010. (Cyclops-TX)
 8010.0 Cuban AM Spanish (V2a), callup 54921 09251 48181 at 1701. V2a, AM callup 54922 09252 48182, also 1701. (Castillo-Panama)
 8096.0 Cuban MCW cut number station (M8a), callup NRAIA UUWWA MURNA (26171 44551 94621), at 1901. (Castillo-Panama)
 8097.0 Cuban CW (M8a), carrier up at 1745, callup at 1800, ended 1836. (Cyclops-TX)
 8098.1 Cuban CW (M8a), 5-letter groups in progress, but should have been the 8097 voice (V2a) daily schedule, at 1820. (Cyclops-TX)
 8301.6 Sector San Juan-USCG, calling helicopter Stingray 02, at 2032. (Cleary-SC)
 8764.0 NMN-USCG CAMSLANT, VA, high seas weather in "Perfect Paul" voice, parallel on 8502 and 13089 (better), at 1545. (Cyclops-TX)
 8788.0 WLO-Shipcom/ Mobile Radio, AL, working M/V Atlas Tide at 1402. (Cyclops-TX)
 8971.0 Pelican 71B-US Navy P-3C, working Fiddle (USN, Jacksonville, FL), at 2353. (Cleary-SC)
 8983.0 Sector Upper Mississippi-USCG, radio check with CAMSLANT at 1457. (Cleary-SC) Coast Guard 1503-USCG C-130, position for CAMSLANT Chesapeake, VA, at 1700. (Stern-FL)
 8992.0 Pelican 71D-US Navy P-3C, patch via Puerto Rico HF-GCS to Fiddle, Jacksonville, FL, at 0700. (Stern-FL)
 9007.0 Canforce 3736-Canadian Forces, patch via Trenton Military to Wing Ops, at 2111. (Cleary-SC)
 9022.0 Nightstar-US Air Force E-8C, clear and secure radio checks with E-8C Stargate, at 1333. (Metcalfe-KY)
 10051.0 Gander-Gander Volmet (VFG), Canada, aviation weather for Canadian airports at 1622. New York-New York Volmet (WSY 70), North Atlantic aviation weather at 2148. (Cyclops-TX)
 11175.0 King 22-US Air National Guard 106th Rescue, patch via Offutt to Angel Ops, at 0155. (Cleary-SC)
 11494.0 53A-US Drug Enforcement Administration helicopter, setting guard with Panther, Bahamas, at 2148. (Cleary-SC)
 11566.0 Cuban V2a, 5-figure groups at 0306. (Sevart-KS)
 12136.7 RFFTJD-French Air Force, ARQ idler at 1925. (Hall-RSA)
 12164.0 141CDCS48-US Centers for Disease Control, sounding on NPHRN net at 1737. (Metcalfe-KY)
 12603.5 SVO-Olympia Radio, Greece, SITOR-B news in Greek at 0600. (Privat-France)
 12695.5 UWS-Kiev Radio, Ukraine, CW traffic for unknown vessel at 1200. (Privat-France)
 12750.0 NMF-USCG, Boston, MA, FAX wind/wave chart with hurricane Ernesto location, at 2002. NMF, FAX satellite image with hurricane Florence, at 2152. (Sevart-KS)
 13110.0 WLO-Shipcom/ Mobile Radio, AL, hurricane Helene warning and traffic list at 1501. (Cyclops-TX)
 13321.0 LH8296-Lufthansa, registration D-ALCR, HFDL position for Johannesburg at 1356. (Hall-RSA)
 13927.1 AFA4DD-US Air Force MARS, patch for AMC transport Reach 215, at 1545. (Stern-FL)
 15043.0 Condor 01-US Air Force E-3, ALE-initiated voice call to Raymond 24, Tinker AFB, at 1843. (Cleary-SC)
 15682.0 Lincolnshire Poacher-UK M16/SIS (E3), music and "01015," at 1400. (Cyclops-TX)
 16606.0 Unid-UK military, Cyprus, encrypted MFSK message at 1240. (Hall-RSA)
 17147.0 CBV-Playa Ancha Radio, Chile, FAX surface chart at 1120. (Hall-RSA)
 17310.8 KLB-Seattle Radio, WA, voice weather and traffic list at 1500. (Cyclops-TX)
 18238.0 ZSJ-South African Navy, FAX surface chart, parallel 7508, at 1110. (Hall-RSA)

Current Traffic

This month we take a look at a few recently heard networks and modes.

❖ Indian Diplomatic Service

With some careful listening, the Ministry of External Affairs (MEA) New Delhi can be heard daily using standard 50bd/170Hz shift Baudot RTTY.



As we've mentioned before in this column, the network is unusual in that it uses callsigns that denote the link in use – so signals may emanate from the same station but use a different callsign according to the destination. Callsigns starting with the 8WD+1 or 2 digits prefix are the MEA, while replies from embassies use 8WA, 8WB+1 or 2 digits.

Here are the frequencies on which the Indians have been heard in the past:

9358	10475	10477	10723	11147	11155
12104	12112	12160	12163	15755	15916
15919	15917	15919	15920	16203	
16375	16378	16379	16412	16414	
17535	17540	17541	18277	18285	
18325	18407	18459	18470	18463	
18465	18466	18469	18725	19003	
19021	19022	19035	19052	19055	
19057	19440	19440	20375	20610	
20614	20841	20882	20885	20887	
20892	kHz				

Note that these represent nominal frequencies around which the MEA and embassies will congregate.

There is some characteristic behavior on the Indian network to be aware of, too: "rrrrrrrrrrrrrr" indicates the message was received OK; "ovovovovovovov" indicates that the sender should go ahead with message; "ofofofofofof" terminates the conversation.

❖ Mode of the Month: STANAG 4285

Following the trend on the excellent Utility DX Forum mailing list, *Digital Digest* emails have also recently centered around questions regarding the STANAG 4285 mode.

Along with the MIL-188-110A and B standards, STANAG 4285 is probably the most commonly heard of the NATO 2400bd high-speed modem signals. It's now quite difficult to tune over any 1 MHz piece of HF spectrum

without hearing one or more of these modems. The sound of the signal is quite characteristic: an approximately 3 kHz wide "lump" of constant chugging white noise. See the Resources section for audio clips of the signal.

The Hoka and Wavecom decoders have supported this mode for some time, but the emergence of the much lower-priced software from SkySweeper (see Resources) has brought STANAG 4285 into the homes of more monitors than ever before.

The signal is quite tricky to tune, as a few hundred Hertz of error will prevent the decoder from achieving a satisfactory lock. Signals need to be quite strong and reasonably free from multi-path distortion and rapid fading if a good decode is to be had, too. The fact that the signal is a big lump of "white noise" makes it even harder to find the required center: 3 to 400Hz either side of it sound exactly the same to the ear!

Fortunately, the vast majority of these signals sit on a 0.2 kHz offset when tuning using a 2.4 kHz or 3 kHz USB filter. Some other '4285s may use a 0.7 kHz offset, and fewer still use the kilohertz point. Some really odd ones use a 0.6 kHz offset.

STANAG 4285 has taken the place of many on-air 75bd/850Hz KG84 encrypted RTTY NATO signals – particularly from naval locations – the old signal sources are simply plugged into the new modem. And herein lies the rub for most listeners wishing to try out this new signal: even when you have it tuned in on the decoder, all you see is garbage, because the underlying signal is encrypted!

There are further complications, too. The underlying data being sent on one 2400bd 4285 signal uses different speed and interleaver settings depending on the settings at the transmitter. You have no way of knowing what it may be when you tune in: try any combination of 75, 150, 300, 600, 1200 and 2400bps speed with short or long interleaver! Oh, and if that wasn't enough to contend with, is it 7 or 8 bit ASCII or 5 bit Baudot coded?

Just as in the case of the "where do I tune?" question, we are fortunate that the majority use the same settings. Most 4285s send data using 600bd or 300bd and long interleaving with relatively few using anything else – 1200bd and long being probably the next most common (but very small portion) of all 4285 signals.

The 4285 module in the Hoka decoder features a bit error rate counter that is most

instructive in figuring these settings out. Once the correct one is selected, most signals sync in and settle quickly to zero errors.

As for coding, most are unfortunately encrypted, but the few that aren't are using 5N1 (5 bit, normal polarity, 1 stop bit) Baudot (ITA2) coding. We provided details of these unencrypted naval stations in the October 2005 *DD*.

Here are some recently active frequencies on which to try out your new STANAG4285 decoder:

Freq kHz User, Traffic

9235.00	Unidentified user, 300bd/L crypto tfc
10751.60	Unidentified user, Unidentified speed/interleave
10264.10	Unidentified user, 600bd/L crypto tfc
10274.30	Unidentified user, 600bd/L crypto tfc
10559.20	Unidentified user, 600bd/L crypto tfc
10568.20	Unidentified user, 600bd/L crypto tfc
10264.10	Unidentified user, 1200bd/L crypto tfc
10963.20	Unidentified user, 600bd/L crypto tfc
11020.00	Unidentified user, 600bd/L crypto tfc
11042.60	Unidentified user, 600bd/L crypto tfc
12666.60	RFFME, French Navy, La Regine, 300bd/L ITA2
12456.00	Unidentified user, 600bd/L crypto tfc
13410.00	Unidentified user, Mauritania, 600bd/L
13442.00	Unidentified user, Sierra Leone, 600bd/L crypto tfc
13411.60	Unidentified user, 1200bd/L crypto tfc
14749.20	DHJ59, German Navy, Wilhelmshaven, 600bd/L crypto tfc

It's worth noting that an idle STANAG 4285 does have a more distinctive sound than one sending traffic, and many military outfits send short data messages using the modem – most notably German Navy, and Canadian Army and Army Reserves. If you hear one on idle, make sure you stick with it in case of any traffic.

That's it for this week. Please keep the email and letters coming.

RESOURCES

SkySweep Technologies
www.skysweep.com
STANAG 4285 clip
www.signals.taunus.de/WAV/STAN-AG4285_BRASS-idle_tfc.WAV
and www.monitoringtimes.com/html/STANAG4285.wav
Utility DX Forum - www.udxf.nl
Utility Monitoring Central
www.chace-ortiz.org/umc/

Daylight Savings Time Expands in 2007

In a misguided effort to "save" more daylight, the USA will start observing DST earlier next year, moving to the second Sunday in March instead of the first Sunday in April. Do those who make such decisions even consider the impact on coordinating scheduling of international SW broadcasting?

For many years there has been a Week of Confusion from the last Sunday in March when most of Europe goes on DST. Now there will be a Fortnight of Confusion in the other direction, as the US (and Canada, too), are on DST two weeks ahead of the rest of the world.

Almost all private US SW stations insist on operating on local time rather than UT, which means their schedules have to shift one hour of real time as DST comes and goes. This can lead to frequency collisions if a one-hour buffer or frequency changes are not planned in advance. Until now, wholesale seasonal frequency changes have also been carried out as much as possible at the end of March or start of April.

But now North American stations have to finish the B-06 season with a shifted fortnight, or should they start the A-07 season two weeks

early with not only new times but new frequencies? It appears that last August's HFCC meeting did not take this problem into account, so a lot of shifting and shuffling is likely come March 11.

WYFR does not shift time, anyway. Jeff White of WRMI and NASB says: it looks like it's going to be every station for itself. If WENW is going to stay on the same UT until A07 starts, which is what I understood Stanley Leinwoll to say, we will be forced to do so as well, at least in terms of our 1400-1600 on 7385 becoming 1300-1600 UT. So there may be some strange programming things going on during that "limbo time."

That's not all. Next fall, DST in the USA is to last one week longer until the first Sunday in November, producing a new Week of Confusion, if Europe keeps ending DST on the traditional last Sunday in October.

But that's still not all: Every few years, March will have five Sundays, such as in 2008. That means there will be Three Weeks of Confusion from the second Sunday to the last (and fifth) Sunday – all assuming the present A/B seasonal change dates stick, and the DST dates remain as newly defined.

What a mess! How about just abolishing DST for starters?

AFGHANISTAN As of mid-October, still no sign of the new 100 kW SW transmitter (gh) 9345 at 0300-1400, continuous songs without announcements heard before 0630 news (Jose Jacob, Mussoorie DXpedition, North India, dx_india) R. Solh, 9345, marginal signal, no S-meter indication at 1305 (Zacharias Liangas, Greece, DX Listening Digest)

R. Peace, 9345 is rather regular here in Finland, say after 1200 UT when the channel is clear. Has long periods of non-stop Afghan music. At times, news at bottom of hour (Jari Savolainen, ibid.)

[non] Always when I have tuned in to R. Solh, 17700 via UK, they have played the very same lovely song in Dari with an Afghan traditional big orchestra accompaniment at 1302-1307. I am getting the impression that they are playing the very same musical selections throughout, from day to day, and have been doing so for months (Olle Alm, Sweden, ibid.)

ALBANIA R. Tirana B-06 in English, daily exc. Sun/UT Mon: Eu 1945-2000 6130 7465, 2100-2130 7530; NAm 0245-0300 & 0330-0400 6115, 7465 (gh)

ARGENTINA unID Spanish on 13363.4 USB at 2300, romantic ballads with acoustic guitar, low-key announcer (J. D. Stephens, AL, HCDX) An Argentine LTA feeder? I found a log of R. Rivadavia on 13363.5 LSB at 0100, by one Vambo in Colorado, wunclub via UDXF. Altho this was LSB, these feeders to Antarctica could be USB and/or LSB and also relay other stations, such as R. Diez (gh) Also heard this Spanish in NZ, but at 0300 in English, definite AFN ID; Guam as listed on 13362-USB (Adrian Verry, HCDX) AFN has been doing some strange things lately on SW with music instead of talk, but no Spanish on their schedule. Quite a coincidence with two military program USB feeds from two different countries on same frequency! (gh) Argentine feeders are mainly for fútbol, especially Sunday afternoons; R. Rivadavia also heard here at 0200-0500+ on 13363.5 (Raúl Saavedra, Costa Rica, DXLD)

ARMENIA V. of Armenia / Public Radio of Armenia has new website <http://int.armradio.am/> (J M Aubier, France, DXLD) Only news on demand, not the rest of program, or a live feed (Erik Køie, Denmark, ibid.) 7-minute news audio for last three days. At least we still have that because: (gh)

PRA pulled the plug on SW, no longer heard in German from October 1. A letter said it would be "made available via Internet only; nothing but your response can change this" (Paul Gager, Kai Ludwig, WORLD OF RADIO) English was at 1910-1930 on 9960 (gh) Silent after 1830; however, 4810 was still on with Arabic until 1829 (J M Aubier, France, ibid.) SW relays of foreign stations also continued, e.g. V. of Russia in English at 17-19 on 11510 via Gavar (Wolfgang Büschel, Germany, ibid.) A great shame; Armenia was an interesting country to learn about, and now it's lost its voice (Christopher Lewis, Oct 7, ibid.)

AZERBAIJAN Radio Dada Gorgud lives! – I was briefly in Baku in early September and can report that Radio Dada Gorgud is still on the air – just. I heard it at various times, including the sole daily English transmission

at 1700 on both 1296 and 6111 (approx). Strength on 6111 was poor, maybe because I was in the skip zone. The ID is still being used, "Radio Dada Gorgud, the Voice of Azerbaijan." Poor signals and audio quality meant that station was not properly monitorable in its own capital city (Chris Greenway, DXLD)

BANGLADESH Bangladesh Betar, [nom. 4750] varying to 4753 at 1345-1601* with English news at 1530-1600 (NDXC-HQ, S. Hasegawa, Japan, BCDX)

BELARUS Radiostantsiya Belarus expanded German Sept 1 to daily 1800-1900 and English 1900-2100 on 1170, 7105, 7390 and 7440 and via <http://www.tvr.by> English was previously 2 hours 30 minutes a week (via Dr. Hansjoerg Biener via Kai Ludwig, DXLD) So Europe now gets a daily 2-hour block in English on SW – but what about NAm, which had been getting non-daily half-hours at different times in the 0200-0400 period? Finding anything about SW on their website is a problem (gh) Frequency info appears to be accurate and complete: <http://www.radiobelarus.tvr.by/eng/station.asp> So no transmissions after 2400 anymore (Kai Ludwig, Germany, ibid.)

Tentative B-06, Radio Belarus, in English: 2000-2200 daily from Minsk site: 7360 075 kW / 270 deg, 7390 150 kW / 260 deg, 7420 250 kW / 255 deg (DX Mix News, Bulgaria)

Still heard until 0700 on 11930, A-06 HFCC registered as 0400-0700 from Minsk, 100 kW, 75 degrees, and I think in Russian (Noel R. Green, NW England, DXLD) The language of Belaruskaje Radyjo programs is actually a mix of Belarussian and Russian. Typically announcers use Belarussian, and interviewed persons, etc. speak Russian (Sergey Nikishin, Moscow, ibid.) 18240, BR1, Minsk (3 x 6080) heard at 1350 (Tim Bucknall, N/W England, harmonics yg)

BOLIVIA Violent clashes between unionized and salaried miners led to R. Nacional Huanuni being bombed off the air October 5, per reports at <http://www.abi.bo> but government promised to bring it back (gh) It was heard again, one week later, on 5968.58v at 1020-1035, local and national news, good signal (Arnaldo Slaen, Argentina, DXLD)

BRAZIL More on R. Marumby, reported last month: it was running only 500 watts, half its rated power, says Isaac Rosa in Ceará when I heard it at 2108 on 11749.8 (Carlos Gonçalves, Portugal, DXLD) This and its 9665 frequency were sold to the Gideons evangelical church by Matéus Yansen, who will retain the Curitiba 6080, 9515 and 11725 Rádio Novas de Paz stations. The Marumby stations moved to Camboriú SC (Isaac Rosa, radioescutas) The HQ of Gideões Missionários da Última Hora, <http://www.gmuh.com.br/radio/radio.htm> (Carlos Netto, via Célio Romais, Panorama, @tividade DX)

Rádio Gazeta, São Paulo, dispensed with its professional DJs and resumed news produced by students at the Fundação Cásper Libero, heard on 5955, 9685 and 15325, the only active Brazilian on 19m. Previously heard at 1925 with sertaneja music (Célio Romais, ibid.)

CANADA RCI cancelled most of its feature programming at the end of September. During the

All times UTC; All frequencies kHz; * before hr = sign on, * after hr = sign off; // = parallel programming; + = continuing but not monitored; 2 x freq = 2nd harmonic; B-06=winter season; [non] = Broadcast to or for the listed country, but not necessarily originating there; u.o.s. = unless otherwise stated

"transitional" month of October, weekdays contained a one-hour *Canada Today* magazine of music and news; weekends, an extended *Maple Leaf Mailbag* (Rich Cuff, *swprograms*) RCI also got the green light to produce programs/websites for ethnic minorities in Canada, following the lines of Radio Sweden (Jonathan Marks, *Media Network* blog)

Maple Leaf Mailbag explained that from end of October a new two-hour weekday show would be called *The Link*, hosted by Marc Montgomery; the first hour for domestic consumption online, the second hour on SW for abroad.

My opinion: to have RCI spend its money on domestic broadcasting is a monumental waste. We have the rest of the CBC and its multimillion-dollar budget to produce domestic broadcasting. Surely CBC can come up with a few bucks to pay for a program directed at new Canadians, so RCI can apply all its resources to make great programs for its world audiences (Ricky Leong, AB, *swprograms*) Could be RCI was faced with: do this, or else your external service is toast (gh) There were reports about these plans already in mid-August in the French language press, ignored by the English (Dan Say, BC, *swprograms*) Let's see what the RCI Action Committee says about this: <http://www.geocities.com/rciaction/> (gh)

Several times in October, Sackville appeared on the wrong frequencies: RCI/CBC on 9490 instead of 9515 in the mornings; RN relay on 17760 instead of 17660 on a Saturday afternoon; China relay on 6175 instead of 6190 at 0530 (gh)

CFRX, 6070, Toronto, normally S9+ here all day, is missing (Steve Lare, MI, *DXLD*) Off the air Sept 20; engineer had not found problem, says Steve Canney. BTW, new QSL card has been printed and is now in use for CFRX and CFRB (Harold Sellers, Ont., *ODXA*) CFRX was still off as of October 18 (gh)

CHU, 14670, 7335 and 3330, from mid October added this announcement during the first half of odd-numbered minutes: "From April 1, 2007, CHU needs to stop operating, change frequency, or re-licence. Contact radio.chu@nrc.gc.ca or mail CHU Canada, K1A 0R6." And the equivalent in French alternate minutes. Nothing was found about the potential demise of CHU on its website, not even under the Important Notices link via http://inms-iennm.nrc-cnrc.gc.ca/time_services/shortwave_broadcasts_e.html Many listeners in eastern NAM and even in Texas told us they receive CHU better, more reliably than WWV (gh)

CHILE The CRI relay in English via CVC for B-06 is scheduled on 15540 instead of 17625 at 1300-1400 (via Andreas Volk, *ADDX*, *BCDX*)

CHINA [and non] In late Sept, Sound of Hope seemed to have settled on 10400, 13970, 14600 and 17330, using all four frequencies at the same time, some of them audible during jamming breaks at top of hours. SOH is rather strong on 14600 and 10400 and has the same program with synchronous audio on these two frequencies, so the beams seem to be directed at Central China, possibly in Shanghai dialect. 17330 is rather poor and 13970 very poor at my location. The programs on the latter two frequencies have been different from each other and from the service on the other two frequencies when I have been able to pick up SOH audio on all four channels. Jammers on 14600 and 17330 are synchronous, while the other two have different delays. Firedrake audio is a network "program" from several jamming sites and is used by all jammers when CNR-1 is off the air. Sound of Hope revised frequencies on Oct 10: 10450, 13970, 14700, 17310, some of them assumed only due to presence of jamming (Olle Alm, Sweden, *DXLD*)

COLOMBIA R. Lider, Santa Fe de Bogotá, reactivated Sept. 22, on 6139.79 at 0145-0205+ with romantic Spanish ballads, frequent IDs. Strong, best in ECSS-LSB due to Cuba on 6140 (Brian Alexander, PA, *DXLD*) Cuba on until 0500, then WHRI a problem on 6145 at 0500-0600, but R. Lider widely reported especially later at night, in the clear. It had last been heard for a few nights around Mother's Day in May. Previous active spurts lasted only a week or so, followed by months of silence. Would the same thing happen this time? Yes! It was gone again after Sept 30. Maybe back for Xmas? (gh)

CONGO DR Re R. Kahuzi, 6210, schedule last month: The Monday and Friday only note was for the 1600-1700 period only. I believe they are operating daily the other times. And the time segments I posted may refer to programs produced locally; other times may have pre-recorded programs produced by other organizations. On Mondays and Fridays they seem to be on at least until 1700, sometimes as late as 1725 (Jari Savolainen, Finland, *DXLD*) Unlikely in NAM. Beware of ERA5, Avlis, Greece on 6210 at 1600-2000, a mixing product, 15630 minus 9420 (gh)

CZECH REPUBLIC [non] Found R. Prague with new unscheduled English broadcast at 1400-1430 on 15350, relay? Yes, subsequently heard RCI Montreal harmonica music fill. And these shows were running one day later than direct RP transmissions; very good reception here, so if this keeps up, we have this alternative to the direct B-06 broadcast to ENAM at 1400 on 21745. But 15350 won't work in B-06, colliding with Turkey; clear if shifted to 1500. RP at same time 1400 via WRMI 7385 was not a day late, using WRN feed (gh, OK) 15350 was 285 degrees (*DX Mix News*, Bulgaria) Experimental for WNAM, difficult to reach otherwise (Oldrich Cip, R. Prague)

ECUADOR R. Quito, La Voz de la Capital, 4919.0, reactivated October 7 after long absence, heard from 0425 to 0708, nice program of Latin American songs, news on the hour, frequent IDs as 4920 kHz (Manuel Méndez, Spain, *DXLD*)

EQUATORIAL GUINEA Religious broadcaster Radio Africa has a new website at <http://www.radioafricanetwork.com> - quite slick, but rather low on content. "Under construction" are three audio streams, to supplement (or replace?)

SW 15190 (Dave Kernick, *DXLD*) Based in Silicon Valley.

FRANCE [non] RFI's English broadcast at 1400 was supposed to be on 21620 from France in spring and fall, but no trace of it; in summer it was on 7220 via Chita, Russia, unheard in Sept-Oct. Quite by chance I found it October 10, on 6120 - that is on the RFI schedules as Vietnamese via Japan. But English continued during the following week, poor here, but should be good further west if it keeps up (gh, OK)

The 1200-1230 English to Africa for B-06 is on 15275 via Ascension (VT via Andreas Volk, *ADDX*, *BCDX*)

Libya via TDF noted at 1350 on 17630, 17640 and 17645, totally wiping out BBC on 17640. They have no shame at all (Olle Alm, Sweden, *DXLD*) I.e. in jamming Libyan opposition Sawt al-Amal (gh)

GABON It pays to patrol the mostly empty 19-21 MHz range; almost every day in early-mid October I was hearing Africa Number One on 19160, the second harmonic of 9580, from as early as 1334 past 2100, peaking 15 over S9 at the rather late hour of 2000. This is nominally 500 kW on fundamental, so considerable power could be radiated on the harmonic. Yet, of all the stronger signals here on 31m, only this one comes through on a harmonic. Easily identified by // 9580 toward the end, 17630 or 15475 earlier. This had been reported several times from Europe, but not from North America (gh, OK)

GERMANY DW B-06 English, never to NAM, but these are our best-bet picks for reception here:

0400-0447 Waf 7225-Portugal
0400-0500 Waf 5905 & 9565-Germany, 6180-Rwanda
0500-0530 Af 6180 & 9755 & 12045-Rwanda, 7285-Germany
0600-0630 Waf 7240-Portugal, 7285 & 9565-Germany, 12045-Rwanda
1600-1700 SAs 11695-Germany
1900-1930 Eaf 9735-Germany, 11690 & 15275-Portugal
2000-2057 Af 9830-Rwanda
2000-2100 C&Saf 9735 & 12025-Germany
2100-2200 Waf 7280-Germany, 11690-Rwanda

However, there will be changes from January 1, notably moving the Wertachtal, Germany, site to UK (gh, info from DW via Joe Hanlon, Alan Roe, *WDXC*)

GREENLAND On 3815-USB, from fade-in 2050 to 2110* in mid-Sept, Kalaalit Nunaata R, via Tasiilaq, Greenlandic announcement, local songs, 2100 KNR interval signal and news in Danish, utility QRM (Anker Petersen, Denmark, *playdx* yg) December should be our best month for this in the rest of NAM, when on winter time it runs an hour later (gh)

HUNGARY Radio Budapest B-06 English: Eu, 1600-1628 Sun 6025 9565; rest daily: 2000-2028 3975 6025, 2200-2228 6025; Saf, 2200-2228 9535; NAM, 0200-0228 6110; 0330-0358 6035 (via Andreas Volk, *ADDX*, *BCDX*)

INDIA From an expedition in northern India: the strongest local station was AIR Shimla on 3223 and 6020, with several strong spurious signals also on 3161, 3190, 3255, and 5986, 6052, 6080, etc. Lucknow 4880 and Ranchi 4960 both sign on at 0025 (Jose Jacob, Mussoorie, *dx_india*) see also KASHMIR

INDONESIA Another abrupt and protracted absence of Suara Indonesia started September 14, missing from 9525 during daily checks in the 1300 hour (gh) Also missing, 15150 for Spanish at 1700 (Raúl Saavedra, Costa Rica, *DXLD*) Also RRI Jakarta 9680, but it was finally back on October 17 (Ron Howard, CA, *DXLD*) And 9525 on October 18, but gone again on the 19th (gh) Announced website remained unreachable, <http://www.rri-online.com> (José Miguel Romero, Spain, *ibid.* and gh)

IRAN [non] Radio Zameh, new surrogate service based in Holland reported last month, 1700-2100 on 6245, is via a 300 kW transmitter in Simferopol, Ukraine, at 134 degrees. From mid-October was adding another broadcast from same at 0200-0400 on 7590 (*DX-Mix News*, Bulgaria) Though both may have changed for B-06

ISRAEL Israel Radio tentative B-06 English: 0430-0445 6280, 11605, 17600; 1030-1045 13630; 1830-1845 6985[?]; 2000-2030 6280, 6985, 9435, 11605, 15640 (via Wolfgang Büschel, *DXLD*)

ITALY Rai B-06 English: 0055-0115 NAM 11800; 0445-0500 Naf 5965 6120 7170; 1935-1955 Eu 6035 9760; 2025-2045 Eaf/ME 6010; 2205-2230 FE/Au 6090 (via Andrea Borgnino, *bclnews.it*)

JORDAN On Sunday October 1, R. Jordan was found by Joe Hanlon, NJ, on clear 11960 instead of 11690 during its English news at 1605, presumably an error. Numerous checks the following few days found it back on 11690, colliding with HCJB, RTTY, and then CRI in French also moved onto 11690. The following Sunday, Noel Green, UK, found it missing from 11690 again, but not confirmed on 11960. Worth checking in case it happens again (gh)

KASHMIR From the Indian side: Radio Kashmir, Jammu was noted back on SW 4830, 5965 on 29 Sept after being off air for some time. Radio Sadayee Kashmir from Delhi was heard well on 6100 at 0230-0330 & 1430-1530 and on 9890 at 0730-0830.

From the Pakistani side: Azad Kashmir Radio on 4790 at 0045, 1815; 7265 at 0900-1215. Voice of Jammu & Kashmir Freedom on 5990.5 at 0245-0415, 15 minutes later than before. Also on 7230 at 0745-0848 and 5102.23, 5101.94 etc. at 1300-1430 with very rough audio (Jose Jacob, Mussoorie *DX-pedition*, North India, *dx_india*)

KURDISTAN On new 4890 at *0230-0240, Clandestine, Voice of Iranian Kurdistan, via Al-Sulaymaniyah, Iraq, Kurdish ID: "Aira dangi Kurdistani Irana," Kurdish songs. Iranian jammers were active on 4860/4870 (in vain) and // 3970

(Anker Petersen, Denmark, *playdx yg*)

MICRONESIA Pray for Pastor Norbert & Silvia Kalau, in Pohnpei, as they work out final details to install a SW radio station (*Galcom Prayer Bulletin*) Norbert Kalau also runs Pacific Missionary Aviation. Galcom is that purveyor of fixed-tuned radios allowing recipients to hear only approved missionary broadcasts (gh) Nob Kalau of PMA in Pohnpei told me the SW will be 500 Watts "tropical wave." In early Oct, they were pouring the foundation for the tower and the foundations that the 40' container radio building will sit on (Jari Savolainen, Finland, *DXLD*)

NETHERLANDS ANTILLES [and non] All DRM transmissions from Bonaire were cancelled in late Sept, for installation of new antenna switches (Andy Sennitt, RN, *DXLD*) Replaced by RN in Dutch via French Guiana at 1600-1730 on 17810 DRM (Jacques Gruson, TDF via George Poppin, *DXLD*) Weekdays only, 150 kW beamed to USA for rest of A-06 at least (Andy Sennitt, *Media Network*) Right after Brother Stair relay (gh)

NEW ZEALAND [and non] In mid-Oct, Brother Stair began testing via France at 20-21 on 13730, colliding with RNZI. However, RNZI analog transmissions became irregular, missing unpredictably from this frequency or from 7145 at 1300, while the DRM on 15720 and 6095 kept running. The "On the Air" box at <http://www.rnzi.com> does not tell you when frequencies are really down (gh)

PAKISTAN Home Service SW schedules were irregular with normally very rough audio, hum etc. Quetta 5025 was drifting on 5034 at *0045 and till around 1805. Islamabad irregularly on 5080 drifting with very rough audio at 0200, 1300, etc., sometimes only open carrier.

Islamabad very strong on 6065 at 0430-0515 & 0530-0615 but audio and carrier very rough. Quetta on 7150.3 from 0600 instead of listed 7155, occupied by a strong Chinese. These listed SW HS channels were not heard, viz. 5055, 5860, 5925, 7220. At 1615 they announced 6140 which was also not heard.

External service was on 7495 at 0045-0200 & 0215-0300 in Assamese/English/Bengali/Hindi rather than listed 7445 (Jose Jacob, Mussoorie, North India, *dx_india*)

PERÚ New station heard in late Sept on 5602.6. R. La Voz de los Andes, from el Centro poblado El Higuero, Distrito de San Miguel de El Faique, Huancabamba, Piura, with music from 2220 to 0103*. At close-down gave SW schedule as 2200-0100, owner-manager as Sr. Alberto Toco Santos (Rafael Rodriguez R., Colombia, *condig list*) I think that station name is already taken (gh) Or is it 2300-0200? Good reception here (César Rojas Gordillo, Chimbote, Perú, *ibid.*) A station in the same location on 5602.7 with the same owner was active in 1998, according to Henrik Klemetz' *Dateline Bogotá*, then called R. La Voz del Campesino, originally on 4004.9 discovered in 1997 by Pedro F. Arrunátegui (Rodríguez, *ibid.*)

On 4965.83, R. Santa Mónica but several IDs now heard instead between 1004 and 1037 as R. Santa Ana (Dave Valko, PA, *HCDX*)

PHILIPPINES 6169.8 kHz, Radio ng Bayan at 0939-1000 in Tagalog, 0946 ID also mentioning Philippine Broadcasting Service (Iwao Nagatani, *Japan Premium*) Probably 250 watts, ex-9580v (gh)

POLAND [non] R. Polonia announced it would start relays via Germany Oct. 29 including English: 1300-1400 on 5975 and 9525, 1800-1900 on 6015 and 7130 (Erik Kåie, Denmark, *DXLD*) Nauen 5975, Wertachtal 9525, 6015, but 7130 is really Issoudun, France (Wolfgang Büschel, *ibid.*) Full schedule shows some broadcasts via Jülich, Monte Carlo; and even French Guiana, but those are aimed back toward Europe: 2030-2100 German 9640, 11940; 2200-2300 Polish 9660 (via Andreas Volk, *ADDX*, Büschel) So they could resume a real North American service now by putting Polish and English on French Guiana in our morning or evening. Why not? Could just be repeats of earlier broadcasts to Europe. The 1300 on 9525 at 300 degrees could make it on poorly to NAM, better than direct from Poland managed, but collide with Indonesia, when active (gh)

SLOVAKIA RSI announced Oct 15 that it would resume SW from Oct 29 (Alan Roe, UK, *DXLD*) Tentative English: 0700-0730 Au 13715, 15460; 1730-1800 Eu 5915 6055; 1930-2000 Eu 5915, 7345; 0100-0130 NAm 7230, SAm 9440 (Wolfgang Büschel, *ibid.*)

SUDAN [non] Southern Sudan Interactive R. Instruction via UAE, 15205, heard at *0630-0659* in English with chorus, quiz, reopening at *0700 (Kouji Hashimoto, *Japan Premium*)

SWEDEN R. Sweden B-06 English: 1330 15240 direct to NAm, 11550, 7420-Madagascar; 1430 15240-Sackville to NAm, 11550; 1830 6065; 2030 6065, 7420-Madagascar; 2230 6065; 2300 9800-Sackville DRM to NAm; 0130 11550-Madagascar; 0230 & 0330 6010-Sackville to NAm (via Andreas Volk, *ADDX*, Wolfgang Büschel, *BCDX*)

THAILAND The coup in mid-September was not mentioned on the R. Thailand broadcasts immediately following, which must have been recorded earlier. The NAm relays via Greenville & Delano 5890 at 0030 and 0200 were filled with noise or music, but the next day it was back to business as usual (gh)

Nobody calling Thailand: CNN, BBC, CNBC, and Bloomberg were all blocked on Thai cable television systems, CNN reported. The BBC Thai Service was taken off the air early in 2006, and was not restored despite pleas from Thailand's National Union of Journalists. VOA Thai was slated to be

discontinued in October; has not been on SW but FM affiliates in Thailand (*kimandrewelliott.com*) VOA promptly resumed SW in Thai at 2300-2400 on 7215, 9685, but will it last? As far as we could tell, the SW relay stations of BBC and VOA in Thailand were not disrupted (gh)

TURKEY VOT's Turkish broadcasts, including great music, change schedule Jan 1: 0200-0355 7180, 0800-0955 11925, 0800-1355 15350, 11955; 1000-1355 17650; 1400-2155 5980; 1630-1955 9560; 1630-2155 6080 7250 (via *DX Mix News*, Bulgaria)

UGANDA R. Uganda, UBC, 4975.97, was on all night in Sept-Oct, heard 2314-0247 with hi-life music, English (Dave Valko, PA, *HCDX*) Possibly for Ramadan, though Uganda is only 16 percent Muslim. Normally closes at 2100 (gh)

UKRAINE RUI B-06 English: 2200 Eu 5840; 0100 & 0400 NAm 5820; 1200 Eu 9925 (RUI via Swapan Chakroborty, *DXLD*) Contrary to last month, will not be adding more languages (Dietmar Birkhahn, A-DX, via Kai Ludwig, *DXLD*)

U K [non] BBCWS B-06 to Caribbean via Guiana French, 295 degrees: 11-12 6130, 12-13 9750, 22-23 5975 (VT via Andreas Volk, *ADDX*, *BCDX*) via WHRI: see last month

VT has a 20 megapound, 5-year contract commencing in January to relay Deutsche Welle on SW, analog and DRM (*Manufacturing News* via Mike Terry, *DXLD*)

UNITED NATIONS [non] UN Radio B-06 English to Africa via Merlin-VT: M-F 1730-1745 7170 South Africa, 9565 Rampisham UK, 17810 Ascension (via Andreas Volk, *ADDX*, *BCDX*)

USA [see last month] Kenneth Tomlinson survived as BBG Chairman; the board split 3-3 along party lines on a proposal to strip him of his post (*NY Times* via David Cole, OK)

In late Sept, the US started yet another distinct service, Radio Deewa, in Pashto for Pakistan's border region with Afghanistan, mainly on FM but also one hour on SW, 1300-1400 via Morocco 15645, Sri Lanka 11510, audible in NAM, first reported by Wolfgang Büschel (gh) Details at <http://www.voadeewaradio.com> and <http://www.voanews.com/deewa/schedule.cfm> (Kim Andrew Elliott, VOA, *DXLD*) Deewa means light (*DX-Mix News*, Bulgaria) With the IBB's separate Azadi Radio, Radio Ashna, Deewa Radio and Radio Aap ki Dunya all now broadcasting to Afghanistan and Pakistan I kinda wonder if the good folk of those countries will have the time to listen to all these stations (Chris Greenway, UK, *DXLD*)

In mid-Oct, R. Marti appeared on new 9515 after 2200, not a spur and heavily jammed already. That makes four frequencies at once again, instead of three, // 6030, 11930, 13820. On another occasion at 1454, 11930 put out dirty distorted spurs around 12115, 11745, 11550; also weak but unjammed mixing products on 11965, 12015, 12140 (gh)

What's going on with AFN? SSB SW frequencies are supposed to carry talk stream, but on various occasions heard with music instead, such as Oldies Radio at 0536 on 7811; 1312 on 12133.5. It's always fun to have music on SSB challenging one's fine-tuning skills (gh) 5765 Guam had *American Country Countdown* at 1317 (Ron Howard, CA, *DXLD*)

WRMI added another Cuban exile show in Oct, *Radio Nueva Nación*, Sat 1230-1300 on 9955 (gh) WRMI B-06 schedule on 7385 to NAM, mostly in English: daily 13-16, 22-23, M-F 23-24, Tue-Sat 00-05. At all other times on 9955 to Carib/LAM, mostly in Spanish (via Jeff White) and mostly jammed

WRNO-Worldwide as of Oct 10: still needed some cooling work, antenna feedline to be repaired, antenna to be lowered, inspected and repaired; balun to be mounted, site to be fenced. Then reps from Elcor would commission the transmitter and do a proof. FCC gave them an extension; airdate still unknown (Aaron Zawitzky, *DXLD*)

In mid-Oct, KAJI Dallas showed up on new frequencies, partly with Dr. Gene Scott (DGS): 9895 going from DGS to Genesis network at 2200 (gh) Colliding with RN from Flevo in Spanish after 2300 (Raúl Saavedra, Costa Rica, *DXLD*) Also on 9975 at least from 14 to 17, including DGS after 1500. DGS also with a weak signal at 1423 and 2148, on 10475, a spur, but from which outlet? (gh)

VENEZUELA [non] Since accurate up-to-date schedules are not published, the only way to find R. Nacional de Venezuela relays via Cuba is by random monitoring; there could be more as yet unfound besides these: 1000 6180, 1100 6060, 1200 11705, 2000 17705, 2200 11670, 2300 15250, 13680. In the B-season the collision with China via Canada on the last one should be gone again. These broadcasts are nothing but Chávez propaganda. You'd think that in a diverse nation of 25 megapeople, something important might be going on that did not involve its egomaniacal leader (gh)

WESTERN SAHARA [non] Radio Nacional de la RASD, the Polisario clandestine, unexpectedly switched from 7460 to 7425 in mid-September, mornings and evenings (Noel Green, England and Anker Petersen, Denmark, *DSWC DX Window*) In Arabic except the Spanish hour some days at 1700 (Raúl Saavedra, Costa Rica, *DXLD*) Or 2300-2400, very nice reception (Alex Vranes, Jr., WV, *ibid.*)

ZIMBABWE [and non] A Zimbabwean judge Sept. 25 threw out a case against 10 staffers of an independent radio station, Voice of the People, charged with breaking tough audiovisual laws, after branding the dragging trial a "circus." (Sapa-AFP via *Independent Online*, RSA, via Mike Cooper, *DXLD*) However, VOP equipment remained confiscated, so apparently unable to resume program production (CPJ, gh)

Until the Next, Best of DX and 73 de Glenn!

BROADCAST LOGS

NOTEWORTHY LOGS FROM OUR READERS

Gayle Van Horn, W4GVH

gaylevanhorn@monitoringtimes.com

http://mt-shortwave.blogspot.com

0040 UTC on 6950 USB

PIRATES: Northwoods Radio. Great show with lots of good music. Show was in a broadcast band station format. Several mentions of Motor City and Wayne County. Several IDs amid parodies to 1960's music tunes. Address as northwoodsradio@yahoo.com. The Call of the Loon signal to time pips and sign-off. **KIPM** 6950 USB, 2347-0017+. (Joe Wood, Greenback, TN).

0130 UTC on 9610

VATICAN STATE: Vatican Radio. Spanish. News and current affairs program. Interviews on political conflicts in the Middle East, followed by update on Israeli conflicts. (M. Branco, Islip, NY) 13765, 1958-2003. Interval signal, station identification to news about Pope Benedict and discussion on the book of Acts. Good signal // 9755 poor. (Wood, TN)

0210 UTC on 7235

IRAN: VOIRI. News and commentary in English regarding resistance to U.S. and U.K. in Iraq. Good signal with SINPO 34333, //9495 noted with fading and atmospheric noise. SINPO34222. (Jim Evans, Germantown, TN) 7540 via Sitkunai 2033 IN Spanish. (Arnaldo Slaen, Buenos Aires, Argentina).

0229 UTC on 12025

UK: RTA Algerienne relay. First log of this station. Male's Arabic text covering news and presumed Qu'ran recitation followed by pop music. Very good signal. (Wood, TN) 9765, 2020+ Arabic // 12125 SINPO 34433. (Slaen, ARG)

0310 UTC on 4780

DJIBOUTI: RTV Djibouti (tentative). Qu'ran recitations followed by male's Arabic (or related vernacular). Horn of Africa style music to lady's talk. Poor signal, deteriorating to noise level at 0340 tune-out. SINPO 24222 at best. No identification, but little doubt this was Djibouti. (Evans, TN; Slaen, ARG)

0420 UTC on 3320

SOUTH AFRICA: Radio Sondergrense. Ballad pop music from the '60s. Good signal for text in Afrikaans. (Evans, TN) **BBC World Service** relay 7120, 0454 English news on Monrovia and Nigeria. (Stewart MacKenzie, Huntington Beach, CA)

0926 UTC on 4909.21

ECUADOR: Radio Chaskis. Spanish. Long live concert of contemporary Christian music. Time check at 0932 including shortwave freq and "Otavalo, Amazonas, Ecuador." Brief music and canned announcement to additional mentions of Ecuador. More live religious music, fading and no ID noted. Decent strength but modulation a bit low. (Dave Valko, PA/Cumbre DX)

1023 UTC on 3325

INDONESIA: RRI-Palangkaraya. Indonesian. Nice "island" ballads to announcer's canned message. Fair/poor fade out by 1050 recheck, plus bits of audio from **RRI-Pontianak** during this time. Indo's monitored: **RRI-Merauke** (tentative) 3905, 1040-1050+. (Scott Barbour, Intervale, NH) **RRI-Manokwari** 3987.5, 1258-1357*; **RRI-Makassar** 4749.95; **RRI-Fak Fak** 4789.97, 1315-1400*; **RRI-Serui** 4604.95, 1402. (John Wilkins, Wheat Ridge, CO)

1250 UTC on 3905

PAPUA NEW GUINEA (New Ireland) Radio New Ireland. English pop songs to lady announcer's Pidgin text. Station ID to anthem at 1257, followed by apparent news at 1300, but very undermodulated. Left the air around 1315 per spot checks. **Radio Bougainville** (tentative) 3325, 1213-1223. (Wilkins, CO) **Radio Central** 3290, 1100-1140. (Valko, PA)

1254 UTC on 7270

MALAYSIA (SARAWAK): Wai FM. Usual recitation program to clear "Wai FM" jingle. Lady announcer's brief comments and two time pips at 1300. "Berita nasional RTM" (news) and into music at 1310; 5964.9 likely // during news but not certain. No heterodyne noted from 7270.15, but co-channel interference right on 7270.5964.9 **Nasional FM** via RTM 1257-1325. (Wilkins, CO) 7295, 1048-1100. (Barbour, NH)

1254 UTC on 4739.75

VIET NAM: Son La BC Station (tentative). Vocal and flute music to

1300, followed by talk and male/female's possible newscast to 1313. Rest of broadcast consisted mostly of music from male announcer. Fair strength at best with signal peak around 1315. Weak carrier by 1400, but did note signal dropping then per schedule. Considerably weaker the next day. **Voice of Vietnam** 7220, 1320-1327* //9550. (Wilkins, CO)

1330 UTC on 15450

TURKEY: Voice of. Station identification into news of fair signal quality. (Bob Fraser, Belfast, ME) 9860, 2242-2247*. ID, freqs and English schedule. Closing, "You've been listening to the Voice of Turkey," followed by interval signal. Fair signal quality. (Wood, TN)

1750 UTC on 15120

NIGERIA: Voice of. News and current affairs program covering military conflicts, economic index report and family budgeting. Continued topics on regional affairs and Indonesian earthquake. Signal poor. (Branco, NY) 1910+ (Slaen, ARG)

1930 UTC on 13780

GERMANY: Deutsche Welle. English service with German folk music. Lots of songs about hiking and fresh air. (Wood, TN) 9720, 2245 with Mailbag show; 15705, 1653; 6170, 1601 (Gerald Brookman, Kenai, AK)

2003 UTC on 11785

NORTHERN MARIANAS: Radio Free Asia. First log covering oriental music with a strong percussion line and wind instruments. Mostly instrumentals to the 2100 vernacular statement and back ground music. (Wood, TN)

2025 UTC on 6055

RWANDA: Radio Rwanda. French. Announcer's continuous talk, joined by another at 2050. Wiped out by Radio Japan via U.K. at 2100. Poor/noisy conditions. (Barbour, NH) **Deutsche Welle** Rwanda relay 9630, 0420. (MacKenzie, CA)

2053 UTC on 11980

RUSSIA: Voice of. Jazz music program featuring guitars. Call for letters and mentions of jazz festival in St. Petersburg //9890. (Wood, TN) Voice of 15595, 0338 // 15555, 9665. (MacKenzie, CA)

2220 UTC on 9705

NIGER: La Voix du Sahel. French. Station audible during enhanced conditions to Africa. Variety music program of traditional dance to modern techno rap tunes. Several clear station IDs at 2229 and 2250 including announcer's evening program preview. Qu'ran recitations at 2252 to early sign-off at 2257 minus and national anthem. Initial fair signal copy to very solid copy. (Ed Kusalik, Alberta, Canada)

2245 UTC on 9420

CROATIA: Voice of. Intro for afternoon music program of jazz, funk and pop tunes. (Branco, NY) 6165, 2209-2300*. Oldies music program for the 1950s, '60s and '70s. (Barbour, NH) 9925, 0205 News and music. (Brookman, AK)

2310 UTC on 15290

PHILIPPINES: VOA relay. *World News Now* segment to VOA identification and *American Profile* program // 15185 (SIO 333). Subsequent logging 2343-0000* including ID and Yankee Doodle melody. (MacKenzie, CA).

2320 UTC on 9700

BULGARIA: Radio Bulgaria. Talk from announcer on internet fraud, followed by general news on the Balkan region. (Wood, TN; MacKenzie, CA)

2327 TC on 9625

CANADA: CBC Northern Service. Classical music with SIO 344. **CBC Vancouver** 6160, 15565 with news program. SIO 333; 6160, 0130 **Radio Canada Int'l** 15235, 2055, SIO 333; 9755, 0040; 15360, 1552. (Brookman, AK)

Thanks to our contributors – Have you sent in YOUR logs?
Send to Gayle Van Horn, c/o Monitoring Times
English broadcast unless otherwise noted.

Special Holiday Programming

December is a time of endings and new beginnings, as one year morphs into another. We look back on the year past, and look forward to the promise of a new year to come. December brings Christmas and all the festivities associated with it.

December also means many special radio programs. This month we'll take a look at some annual seasonal favorites. While this will certainly not be a comprehensive list, I hope you will find some programming of interest.

❖ Lead-up to Christmas...

EBU Day of Music

Each year, the European Broadcasting Union presents a day of Christmas music, spanning some 12 hours. It usually falls on the Sunday before Christmas. Heavy on classical and choral music, the program is in fact 12-one hour broadcasts from individual EBU members. You can hear music in the Russian Christmas choral tradition, a philharmonic orchestra from Slovenia, Christmas Jazz from Iceland and folk tunes from Denmark and England. This program will be broadcast on many stations worldwide, including CBC Radio 2 in Canada, beginning at 6 a.m. local. You can hear it via the internet by going to www.cbc.ca/local, pick a city and click on that city's Radio 2 stream.

Most radio stations in North America will air seasonal music, and some will even broadcast radio programs from days gone by. It's an opportunity to hear music only heard at this time of the year. Of course, some people wish they didn't have to hear it at all. I am not one of those, but I digress.

If you are lucky enough to be in range of a nostalgia station, you may hear the Christmas adventures of old friends like Jack Benny, George Burns and The Bickersons. Or, you may hear the delightful Dickens story of the reformation of that old miser, Ebenezer Scrooge, portrayed by the legendary John Barrymore.

I am very fortunate to be within range of two such radio stations. CHWO AM 740 in Toronto has a killer signal heard far and wide in Eastern North America. They even had a reception report from Belgium recently. On the Monday before Christmas, Brian Peroff's *Flashback* program will feature three Jack Benny Christmas episodes and

lots of Christmas music.

The other station near me is CHML 900 in Hamilton, Ontario. While it is not a powerful broadcaster, it does stream on the net. And virtually every night around 10 pm you can hear a few hours of "Those Old Radio Shows" (occasionally pre-empted for a baseball or hockey game). Each night one can hear delightful radio shows from comedy to drama and suspense, everything from *The Life of Riley* to *The Shadow*. Several hours of these shows are aired on Christmas Eve. Of course they are Christmas oriented episodes. Listen over the air or via www.900chml.com/.

"I remember as a kid hearing a radio production of *A Christmas Carol* and being intrigued by the similarities and differences between the radio version and the classic black and white movie version starring Alistair Sim. The radio version was intriguing in its own way, because you were able to use your imagination and visualize in the mind's eye what was going on in the scene. Every year I scan the AM radio dial late at night on Christmas eve, looking for that radio play, and every once in a while, I will find it playing on some obscure station that fades in and out, making the production even more interesting and spell binding." (Tim Sykes)

If you know other of other broadcasters carrying these very popular old radio programs, please let me know via my e-mail address at the top of this column.

❖ Christmas Eve

A BBC World Service tradition...

1502-1630 UTC

Live from the Chapel of King's College, Cambridge.

"It's 75 years since the first Carol Service was broadcast from the magnificent fan-vaulted Chapel of King's College, Cambridge – a service

which for many people all over the world marks the beginning of Christmas.

"As the sun sets over Cambridge, the nine lessons, read mainly by members of the College, from a Chorister to the Provost, tell the story of the loving purposes of God as revealed in the Bible. The Choir sings carols old and new and leads the congregation in traditional Christmas hymns." (BBC Religion programmes web page)

"First held on Christmas Eve in 1918, the Festival of Nine Lessons and Carols comes from the beautiful chapel of King's College, Cambridge.

"A traditional celebration of the birth of Christ in readings from the Bible and choral music, the service has always begun with the hymn *Once in Royal David's City*.

"The service was first broadcast in 1928 and, with the exception of 1930, has been broadcast annually, even during the Second World War, when the ancient glass had been removed from the Chapel and the name of Kings could not be broadcast for security reasons." www.bbc.co.uk/worldservice/programmes/carols_from_kings.shtml

As well as airing on the World Service it should be repeated on BBC Radio 3 and be available on demand at the BBC website.

A Canadian tradition...

Live from Toronto and points worldwide: *As It Happens Christmas Eve*. (As Christmas Eve is on a Sunday this year, it should be heard on Friday evening, Dec 22. It can be heard via CBC Radio, Radio Canada International, CBC Northern Quebec Shortwave Service, NPR in the US, Internet Audio)

Each year, *As It Happens* contacts units of the Canadian Armed Forces serving with the UN, NATO, and NORAD. Each unit has a few representatives speak for those serving with the unit. They send Christmas greetings to loved ones at home and describe how they are celebrating Christmas where they are serving.

At the conclusion of the greetings, the units are each invited to sing a verse of a Christmas carol. In past years, the units have served in such diverse locations as Canadian Forces Base Alert (Arctic), Colorado Springs (NORAD), Germany, Cyprus, Golan Heights, Bermuda, the Persian Gulf, Somalia, Bosnia, Croatia, Kosovo and Afghanistan. It is a really nice program with moments of humor and moments of poignancy as soldiers send greetings home.

A reading of "The Shepherd" by the late Alan "Fireside Al" Maitland usually follows – a very

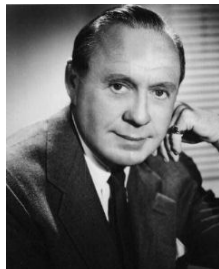

nostalgia station, you may hear the Christmas adventures of old friends like Jack Benny, George Burns and The Bickersons. Or, you may hear the delightful Dickens story of the reformation of that old miser, Ebenezer Scrooge, portrayed by



WHRI's first broadcast was December 25, 1985.

unusual Christmas story about a lost RAF pilot that is not to be missed.

As it Happens can be heard at 6:30 p.m., local time across Canada.

Israel

I'm not sure how cutbacks to the Israel Broadcasting Authority and the continuing conflict in the West Bank have affected this, but in the past, Israel Radio has been known to broadcast from Bethlehem on Christmas Eve. To be honest, I have not heard it in a long time. Perhaps it's something to look for.

❖ Christmas Day

RCI

Listen on Christmas Day for special programs in English and French consisting of greetings (many tearful) between Canadian Forces personnel serving abroad and their families.

BBC World Service –

The Queen's Christmas Message

“The Christmas Broadcast dates back to 1932, when King George V spoke on the ‘wireless’ to the Empire from a small office at Sandringham. The time chosen was 3 p.m. – the best time for reaching most of the countries in the Empire by short waves from the transmitters in Britain. The first Broadcast lasted two and a half minutes, and included the King's reflections on the closer relationships made possible by such wondrous technology.

“To men and women so cut off by the snows, the desert, or the sea, that only voices out of the air can reach them: to those cut off from fuller life by blindness, sickness, or infirmity; and to those who are celebrating this day with their children and grand-children. To all – to each – I wish a Happy Christmas. God Bless You!”

www.royal.gov.uk/output/page385.asp

King George VI continued the broadcast through the dark days of World War II, making it both a morale booster and a voice of hope. The King continued the tradition through to the end of the war and into the post-war era until his death in 1952.

His daughter Queen Elizabeth II followed suit and has made a broadcast in every year of her reign. The message moved to TV in 1957 and was live until 1960 when the policy was to record it in advance so it could be shown in many countries at an appropriate time. It then moved to the internet in 1999 as well. To this day it remains the one time of the year that the Queen speaks to all the people of the British Commonwealth. Its one of the longer lived broadcasts on the BBC World Service.



Other nations

Deutsche Welle's German Service has traditionally suspended regular programming on Christmas Eve and Christmas Day to devote that time to holiday oriented programming.

The United States has been largely left out of this survey. Most private shortwave stations in the United States, although nominally Christian, either ignore the event completely, or, as in the case of the late Dr Gene Scott, Pastor Jacob Meyer of WMLK, or the Christian Identity “preachers,” actually rant against the celebration of Christmas.

Mother Angelica's WEWN, in Birmingham, Alabama, usually carries the Pope's Christmas Eve Mass on the 24th around 2300, then a Mass from the Basilica in Washington, DC, at 0300. Christmas Day Mass from Washington and the Vatican as well as the Pope's Christmas Message can be heard on the 25th. In past years, WEWN has aired a 3-hour performance of “The Messiah.”

You can count on Vatican Radio to bring you



A winter scene from Radio Norway

news of the Christmas events in Vatican City, and the activities of Pope Benedict.

December 25 is the birthday of HCJB, having been founded by Clarence Jones in Ecuador in 1931. This year would mark the 75th anniversary of that event, but the English Service from Quito, Ecuador, did not quite make it to 2006. The anniversary used to be marked by a special program on the history of HCJB. Perhaps HCJB – Australia or online – will continue this tradition.

Secular radio stations, especially in countries with a Christian tradition, are also bound to have a variety of interesting programs, highlighting the celebration of Christmas in their particular country. You might hear a Maori choir sing *Silent Night* via Radio New Zealand International, or a description of a traditional Christmas meal of Carp via Radio Prague.

Even countries that aren't Christian will probably make note of the holiday.

❖ Hanukkah

All Israeli stations have different programs for Jewish holidays. The more religious stations will offer programming dealing with the religious parts of the holiday. The non-religious stations just change their schedules and air special programs (not necessarily always related to that specific holiday) (Elad Benari)

Hanukkah is on Dec 16 this year.

❖ Orthodox Christmas and New Year

Since the collapse of the Former Soviet

Union, you are more likely to hear a church service, an address by the Metropolitan of the Russian Orthodox Church, or some kind of religious programming at this time of year from Moscow, Kiev, or Sofia. Also remember that Orthodox Christmas is January 6. Try Bulgaria and Kiev in particular for stunningly beautiful church music.

The week between Christmas and New Years Day is usually filled with retrospective programs, all recorded before the holidays. The year in review, the year in sports, the year in politics, and so on. Many of these can be quite entertaining as we look back at the year that is ending.

As the year finally comes to a close, one can embark on an annual trip around the world as the New Year is rung in around the planet. Meet the New Year in New Zealand at 1100, Australia at 1300, Japan at 1500, most of Europe at 2300 and of course, you can hear the peals of Big Ben as it strikes midnight via the BBC.

Another New Year tradition originates in Vienna on New Year's Day itself. The annual Vienna Philharmonic New Year concert is seen or heard by an audience estimated at 1 billion persons. With audience participation reminiscent of the BBC Proms, the lively Strauss music is an annual treat. It can be heard via shortwave on ORF and can usually be seen on television in North America. Check out the Vienna Philharmonic website closer to the time.

So, there you have a quick survey of some of the things you might hear around Christmastime. If you happen to hear something interesting this year, by all means let me know! Have a happy holiday season and I'll see you back here next year!

C. CRANE

Wi-Fi Radio

4,000 Radio Stations
Local & Worldwide



Works Independent of Your Computer on Your Existing Broadband

- No Subscription Fee
- Crystal Clear Audio
- Use Alone or With Headphones or Amplified Speakers

\$299⁹⁵ – Incl. FREE U.S. Shipping

FREE C. CRANE COMP. CATALOG **!**

800-522-8863 • ccrane.com

THE QSL REPORT

VERIFICATIONS RECEIVED BY OUR READERS

Gayle Van Horn, W4GVH

gaylevanhorn@monitoringtimes.com

MT's QSL Holiday Special

It is December and your QSL columnist is cleaning out her inbox of MT readers' card and letter verifications before the end of the year arrives. So we will dispense with the normal QSL tip and proceed to some goodies received recently by this month's contributors.

Your QSL conquests are always welcome and may be sent to me via email or regular mail. Contributions for the MT Shortwave Central Blog (<http://mt-shortwave.blogspot.com/>) may also be submitted using either method above. Due to space constraints,

additional QSLs (and additional loggings) may be viewed at the blog.

Don't forget to fire up your receiver for all the special holiday programming and the annual trek around the globe on New Years Eve via shortwave radio. Also remember that this is also a good time to hear U.S. and European pirate stations with their unique holiday shows.

Here's hoping your QSLing quest in the coming year will be the best ever!

ALBANIA

Radio Tirana International 6115 kHz. Full data *Traditional Peasant Woman in Dress* card unsigned, plus station decal. Received in 39 days for an English report. Station address: External Service, Rruga Ismail Qemali Nr. 11, Tirana, Albania (T.J. Taylor, Ontario, Canada.) Reports may also be sent to: dcico@icc.al.eu. org Web: www.rtsh.com.al

AMATEUR RADIO

Croatia, 9A150NT 20 meter CW. Full data card. Received in 15 days for one US dollar. Verification via 9A6AA, E. Mahnmutovic, Slovenska 15 HR 10000 Zagreb, Croatia. (Greg Harris, WDX9KHY, Forest Park, IL)

Italy, IO1SKE, 20 meters CW. 2006 *Winter Olympic Special Event* card. Received in seven months, 17 days for one US dollar and SWL card. Verification via 1IJQJ, Mauro Prelliasco, Corso Agnelli 34 10137 Torino-TO Italy. (Harris, IL)



Turks & Caicos, VP5/W9RN, 40 meters SSB. Full data color photo card. Received in 36 days via ARRL bureau. (Van Horn, NC)

AUSTRALIA

ABC Darwin Local Radio, 6080 kHz (presumably via Shepparton). Partial data verification letter from Kathryn Ainsworth, Administration Officer for temporary Darwin service. Received in 14 days for an English report. Station address: GPO Box 9994, Darwin NT 0801, Australia. (Wendel Craighead, Prairie Village, KS)

CHINA

Voice of the Strait, Fuzhou 4940 kHz. Full data *Golden Monkey* card from endangered animals series, with illegible signature. Received in 62 days via China Radio International. Initial report to VO Strait unanswered. QSL address: 16A Shijingshan Street, Beijing 100040 People's Republic of China (or) P.O. Box 4216 CRI-2 Beijing 100040 People's Republic of China. (Tom Banks, Dallas, TX) Web: www.chinabroadcast.cn/

CZECH REPUBLIC

Radio Prague, 21475 via Litomysl. Full data *Czech scenery* card unsigned with site noted, plus schedule and station souvenirs. Received in four weeks for an English report posted at: www.radio.cz/en/report Station address: Vinohradská 12, 12099 Prague 2, Czech Republic. Web: www.radio.cz/en/ (Brian Bagwell, St. Louis, MO)

QSL



GERMANY

Radio Africa via Jülich, 15650 kHz. Partial data letter via T-Systems, signed by Sabine Gawol-Back Office SW Sales. Received in 37 months for report sent to: Pan American Broadcasting, 2021 The Alameda, Suite 240, San Jose, CA 95126-1145 USA. Station is a religious broadcaster sometimes listed as Voice of Africa. No response from Pan American or Radio Africa. QSL address: T-Systems International, Rundfunksendestelle Jülich, Merscher Höhe D-52428 Jülich, Germany. (Craighead, KS)

GUATEMALA

Radio Verdad 4052 kHz. Full data QSL card and letter signed by Dr. Edgar A. Madrid, plus pennant and souvenirs. Received in 68 days for a Spanish report, two mint stamps and an SAE. Station address: Apartado Postal 5 Chiquimula, Guatemala. (Frank Hillton, Charleston, SC)

KAZAKHSTAN

WYFR/Family Radio via Alma Ata, 12150 kHz. Full data (w/site) *Three Decades of Faithful Service*, plus religious materials. Received in 38 days for an English report. QSL address: Family Stations, Inc. 290 Hegenberger Road, Oakland, CA 94621-1436 USA. (Ed Kusalik, Alberta, Canada)

LATVIA

KWRN Nordland Radio (former Ulbroka, Latvia relay) 9290 kHz. Full data card signed by Felix Stein-DJ & Operator, plus calendar. Received in one month for an email report to: kwrn@freenet.de. **Radio Waves International** (former Ulbroka, Latvia relay) 9290

kHz. Full data QSL folder card signed by Peter Hill-DJ, plus folk music CD. QSL address: Boite Postal 130, 91504 Rueil Cedex, France. (Arnado Slaen, Buenos Aires, Argentina) **Radio Joystick** (former Ulbroka, Latvia relay) 9290 kHz. Full data QSL card signed by Charlie Prince, plus letter. Received for a CD report and one IRC. QSL address: P.O. Box 100812, D-45408, Muelheim/Ruhr, Germany. (Craig Edwards, NT Australia)

MEDIUM WAVE

CFGO, 1200 AM kHz. Friendly verification letter signed by Harrie Jones-Chief Engineer. Received in 17 days after follow up (193 days total). Station address: 87 George Street, Ottawa, Ontario, Canada K1N 9H7. QSL # 30 from Ontario, # 282 Canada, AM QSL 2,933. (Patrick Martin, Seaside, OR)

Philippines-DYIN Kalibo 1107 AM kHz. Partial data verification from "Mar." Received via email for an AM report to: newscenter@bombaradyo.com (Edwards, AUS)

PIRATE

Northwoods Radio 6925 USB kHz. Full data *Playing in the Traffic* QSL sheet signed by The Jackpine, plus info sheet and membership card for the Traffic Cone Preservation Society. Received in 35 days for a report posted at: northwoodsradio@yahoo.com (anonymous, PA)

UNITED STATES

Truth for the World via WHRI, 9840 kHz. Friendly full data verification letter with transmitter notation, signed by Don Blackwell-Director of Broadcasting, plus an information booklet. Received in ten months and seven days. QSL address: Truth for the Word, P.O. Box 5048, Duluth, GA 30096-0065 USA. (Kusalik, CAN)

WHRI, 9840 kHz. Full data map card signed by L.W. Vehorn-WHRI Engineering. Notation of Special Relay of WWL Katrina Emergency, plus station decal. Received in 320 days for an English report, one US dollar and an address label (not used). Station address: World Harvest Radio, 61300 Ironwood Road, South Bend, IN 46614. (Bill Wilkins, Springfield, MO)

UTILITY

Puerto Rico-American Forces Radio/AFRTS, 6458.6 kHz. Full data AFR card signed by Robert Winkler. Received in 56 days for an email report to: qsl@dodmedia.osd.mil. Mailing address: American Forces Network, Department of Defense, NMC Det AFRTS-DMC, 13755 Z Street, Bldg. 2730, Riverside, CA 92518-2017 USA. (Duane Hadley, Bristol, TN) Web: www.afrts.osd.mil/



HOW TO USE THE SHORTWAVE GUIDE



0000-0100 twhfa USA, Voice of America 5995am 6130ca 7405am 9455af
 ① ② ⑤ ③ ④ ⑥ ⑦

Convert your time to UTC.

Broadcast time on ① and time off ② are expressed in Coordinated Universal Time (UTC) – the time at the 0 meridian near Greenwich, England. To translate your local time into UTC, first convert your local time to 24-hour format, then add (during Standard Time) 5, 6, 7 or 8 hours for Eastern, Central, Mountain or Pacific Times, respectively. Eastern, Central, and Pacific Times are already converted to UTC for you at the top of each hour.

Note that all *dates*, as well as *times*, are in UTC; for example, a show which might air at 0030 UTC *Sunday* will be heard on *Saturday* evening in America (in other words, 7:30 pm Eastern, 6:30 pm Central, etc.).

Find the station you want to hear.

Look at the page which corresponds to the time you will be listening. On the top half of the page English broadcasts are listed by UTC time on ①, then alphabetically by country ③, followed by the station name ④. (If the station name is the same as the country, we don't repeat it, e.g., "Vanuatu, Radio" [Vanuatu].)

If a broadcast is not *daily*, the days of broadcast ⑤ will appear in the column following the time of broadcast, using the following codes:

Day Codes	
s/S	Sunday
m/M	Monday
t/T	Tuesday
w/W	Wednesday
h/H	Thursday
f/F	Friday
a/A	Saturday
D	Daily
mon/MON	monthly
occ:	occasional
DRM:	Digital Radio Mondiale

In the same column ⑤, irregular broadcasts are indicated "tent" and programming which includes languages besides English are coded "vl" (various languages).

Choose the most promising frequencies for the time, location and conditions.

The frequencies ⑥ follow to the right of the station listing; all frequencies are listed in kilohertz (kHz). Not all listed stations will be heard from your location and virtually none of them will be heard all the time on all frequencies.

Shortwave broadcast stations change some of their frequencies at least twice a year, in April and October, to adapt to seasonal conditions.

But they can also change in response to short-term conditions, interference, equipment problems, etc. Our frequency manager coordinates published station schedules with confirmations and reports from her monitoring team and MT readers to make the Shortwave Guide up-to-date as of one week before print deadline.

To help you find the most promising signal for your location, immediately following each frequency we've included information on the target area ⑦ of the broadcast. Signals beamed toward your area will generally be easier to hear than those beamed elsewhere, even though the latter will often still be audible.

Target Areas

- af: Africa
- al: alternate frequency (occasional use only)
- am: The Americas
- as: Asia
- ca: Central America
- do: domestic broadcast
- eu: Europe
- irr: irregular (Costa Rica RFP)
- me: Middle East
- na: North America
- oc: Oceania
- pa: Pacific
- sa: South America
- va: various

Shortwave Broadcast Bands

kHz	Meters
2300-2495	120 meters (Note 1)
3200-3400	90 meters (Note 1)
3900-3950	75 meters (Regional band, used for broadcasting in Asia only)
3950-4000	75 meters (Regional band, used for broadcasting in Asia and Europe)
4750-4995	60 meters (Note 1)
5005-5060	60 meters (Note 1)
5730-5900	49 meter NIB (Note 2)
5900-5950	49 meter WARC-92 band (Note 3)
5950-6200	49 meters
6200-6295	49 meter NIB (Note 2)
6890-6990	41 meter NIB (Note 2)
7100-7300	41 meters (Regional band, not allocated for broadcasting in the western hemisphere) (Note 4)
7300-7350	41 meter WARC-92 band (Note 3)
7350-7600	41 meter NIB (Note 2)
9250-9400	31 meter NIB (Note 2)
9400-9500	31 meter WARC-92 band (Note 3)
9500-9900	31 meters
11500-11600	25 meter NIB (Note 2)
11600-11650	25 meter WARC-92 band (Note 3)
11650-12050	25 meters
12050-12100	25 meter WARC-92 band (Note 3)
12100-12600	25 meter NIB (Note 2)
13570-13600	22 meter WARC-92 band (Note 3)
13600-13800	22 meters
13800-13870	22 meter WARC-92 band (Note 3)
15030-15100	19 meter NIB (Note 2)
15100-15600	19 meters
15600-15800	19 meter WARC-92 band (Note 3)
17480-17550	17 meter WARC-92 band (Note 3)
17550-17900	17 meters
18900-19020	15 meter WARC-92 band (Note 3)
21450-21850	13 meters
25670-26100	11 meters

Notes

- Note 1 Tropical bands, 120/90/60 meters are for broadcast use only in designated tropical areas of the world.
- Note 2 Broadcasters can use this frequency range on a (NIB) non-interference basis only.
- Note 3 WARC-92 bands are allocated officially for use by HF broadcasting stations in 2007. They are only authorized on a non-interference basis until that date.
- Note 4 WRC-03 update. After March 29, 2009, the spectrum from 7100-7200 kHz will no longer be available for broadcast purposes and will be turned over to amateur radio operations worldwide

MT MONITORING TEAM

Gayle Van Horn

Frequency Manager

gaylevanhorn@monitoringtimes.com

Daniel Sampson

danielsampson@monitoringtimes.com

Larry Van Horn, MT Asst. Editor

larryvanhorn@monitoringtimes.com

Thank You ...

Additional Contributors to This Month's Shortwave Guide:

Rich D'Angelo/*NASWA Flash Sheet*; Anker Petersen/*DX Window*; Adrian Sainsbury/R.NZ Intl; Harold Sellers/*ODXA/DX Ontario*; Larry Van Horn N5FPW, MT Asst. Editor; *BCL News*; *Cumbre DX*; *Hard Core DX*; *NASWA Journal*; WWDXC-Top News.

**GLENN HAUSER'S
WORLD OF RADIO**
<http://www.worldofradio.com>

For the latest DX and programming news, amateur nets, DX program schedules, audio archives and much more!

0000 UTC - 7PM EST / 6PM CST / 4PM PST

0000	0015	Japan, Radio Japan/NHK World 17810as	13650as	
0000	0027	Czech Rep, Radio Prague	7345na	9440na
0000	0030	Australia, HCJB	15405as	15525as
0000	0030	Australia, Radio	15405as	15525as
0000	0030	Burma, Dem Voice of Burma		5955eu
0000	0030	Egypt, Radio Cairo	11885na	
0000	0030	Thailand, Radio	9570va	
0000	0030	UK, BBC World Service	3915as	11945as
		17615as		
0000	0030	USA, Voice of America	7555as	
0000	0040	Lithuania, Radio Vilnius	9875na	
0000	0045	India, All India Radio	9705as	9950as
		11620as	11645as	13605as
0000	0045	USA, WYFR/Family R Okeechobee FL		17805am
0000	0057	Canada, Radio Canada Intl	11700as	
0000	0057	Netherlands, Radio	6165na	
0000	0059	Canada, Radio Canada Intl	9755am	
0000	0059	Spain, Radio Exterior Espana	15385am	
0000	0100	Anguilla, University Network	6090am	
0000	0100	Australia, ABC NT Alice Springs		2310do
		4835do		
0000	0100	Australia, ABC NT Katherine	5025do	
0000	0100	Australia, ABC NT Tennant Creek		4910do
0000	0100	Australia, Radio	9660pa	12080pa
		15240va	17715pa	17750as
		17795va		17775va
0000	0100	Bulgaria, Radio	7400na	9700na
0000	0100	Canada, CFRX Toronto ON	6070na	
0000	0100	Canada, CFVP Calgary AB	6030na	
0000	0100	Canada, CKZN St John's NF	6160na	
0000	0100	Canada, CKZU Vancouver BC	6160na	
0000	0100	China, China Radio Intl	6020na	7180as
		9515as	9570na	13600eu
0000	0100	Costa Rica, University Network	5030va	6150va
		7375va	9725va	
0000	0100	Cuba, Radio Havana	9550na	
0000	0100	f Germany, Bible Voice BC Network	6140me	
0000	0100	Germany, Deutsche Welle	7265as	9900as
		15320as		
0000	0100	m Greece, Voice of	7475va	9420va
0000	0100	Guyana, Voice of	3291do	15650va
0000	0100	Japan, Radio Japan/NHK World		6145na
0000	0100	Malaysia, RTM/Trax FM	7295as	
0000	0100	vi Namibia, Namibian BC Corp	3270do	3290do
		6060do	6175do	
0000	0100	New Zealand, Radio NZ Intl	15720pa	
0000	0100	DRM New Zealand, Radio NZ Intl	17675pa	
0000	0100	vi Papua New Guinea, Wantok R. Light	7120va	
0000	0100	Singapore, MediaCorp Radio	6150do	
0000	0100	UK, BBC World Service	5970as	6195as
		9605as	9740as	11955as
		15360as		15285as
0000	0100	DRM UK, BBC World Service	6010na	
0000	0100	f UK, Bible Voice	6140me	
0000	0100	f UK, Bible Voice	6140me	
0000	0100	USA, American Forces Radio	4319usb	5446usb
		5765usb	6350usb	7812usb
		12133usb	12759usb	10320usb
0000	0100	USA, KAIJ Dallas TX	5755na	
0000	0100	USA, KTBN Salt Lake City UT	7505na	
0000	0100	USA, WBCQ Kennebunk ME	5110na	7415na
		9330na		
0000	0100	USA, WBOH Newport NC	5920am	
0000	0100	USA, WEWN Birmingham AL	5810va	5835va
0000	0100	USA, WHRA Greenbush ME	7520na	
0000	0100	USA, WHRI Cypress Creek SC	7490am	7555am
0000	0100	USA, WHRI Cypress Creek SC	9820am	13760am
		twhfa		
0000	0100	USA, WINB Red Lion PA	9265am	
0000	0100	twhfa USA, WRMI Miami FL	7385na	
0000	0100	sm USA, WRMI Miami FL	9955am	
0000	0100	USA, WTJC Newport NC	9370na	
0000	0100	USA, WWCR Nashville TN	3215na	5070na
		7465na	13845na	
0000	0100	USA, WWRB Manchester TN	3185na	5050na
		5745na	6890na	
0000	0100	USA, WYFR/Family R Okeechobee FL	6065am	
		9505am	11835am	
0000	0100	Zambia, Christian Voice	4965af	
0030	0100	Thailand, Radio	5890na	
0030	0100	USA, Voice of America	9715va	9780va
		15185va	15205va	15290va
		17740va	17820va	15560va
0035	0100	sm Austria, Radio Austria Intl	9870am	
0043	0058	twhfa Austria, Radio Austria Intl	9870am	
0055	0100	Italy, RAI Intl	11800na	

0100	0115	Italy, RAI Intl	11800na	
0100	0127	Czech Rep, Radio Prague	6200na	7345na
0100	0128	Vietnam, Voice of	6175na	
0100	0129	s Germany, Universal Life	9480as	
0100	0130	Slovakia, Radio Slovakia Int	7230na	9440sa
0100	0145	w Australia, Radio	15405as	
0100	0156	Romania, Radio Romania Intl	6150na	9515na
0100	0157	Netherlands, Radio	6165na	
0100	0159	Canada, Radio Canada Intl	9755am	13710am
0100	0200	Anguilla, University Network	6090am	
0100	0200	Australia, ABC NT Katherine	5025do	
0100	0200	Australia, ABC NT Tennant Creek		4910do
0100	0200	Australia, CVC International	7355as	
0100	0200	Australia, Radio	9660pa	12080pa
		15240va	15415va	17715pa
		17775va	17795va	17750as
0100	0200	Canada, CFRX Toronto ON	6070na	
0100	0200	Canada, CFVP Calgary AB	6030na	
0100	0200	Canada, CKZN St John's NF	6160na	
0100	0200	Canada, CKZU Vancouver BC	6160na	
0100	0200	DRM China, China Radio Intl	6140na	
0100	0200	China, China Radio Intl	6020na	6080na
		9570na	9580na	9790na
		13600eu	13640as	11870as
0100	0200	Costa Rica, University Network	5030va	6150va
		7375va	9725va	
0100	0200	f Germany, Bible Voice BC Network	6140me	
0100	0200	Guyana, Voice of	3291do	
0100	0200	Indonesia, Voice of	9525as	11785pa
		15150al		
0100	0200	Japan, Radio Japan/NHK World		6030va
		11860as	11935sa	15325as
		17810as	17825ca	17845as
0100	0200	Malaysia, RTM/Trax FM	7295as	
0100	0200	vi Namibia, Namibian BC Corp	3270do	3290do
		6060do	6175do	
0100	0200	New Zealand, Radio NZ Intl	15720pa	
0100	0200	DRM New Zealand, Radio NZ Intl	17675pa	
0100	0200	North Korea, Voice of Korea	7140as	9345as
		9730am	11735ca	13760ca
0100	0200	vi Papua New Guinea, Wantok R. Light	7120va	
0100	0200	Russia, Voice of	7250na	9665na
		15595na		15555na
0100	0200	Singapore, MediaCorp Radio	6150do	
0100	0200	Sri Lanka, SLBC	6005eu	9770eu
0100	0200	Taiwan, Radio Taiwan Intl	11875as	15465as
0100	0200	UK, BBC World Service	7320as	9605as
		11955as	15285as	15310as
0100	0200	f UK, Bible Voice	6140me	15360as
0100	0200	Ukraine, Radio Ukraine Intl	5820na	
0100	0200	USA, American Forces Radio	4319usb	5446usb
		5765usb	6350usb	7812usb
		12133usb	12759usb	10320usb
0100	0200	USA, KAIJ Dallas TX	5755na	
0100	0200	USA, KTBN Salt Lake City UT	7505na	
0100	0200	USA, KWHR Naalehu HI	17655as	
0100	0200	USA, Voice of America	7430va	11705va
		11725va		
0100	0200	USA, WBCQ Kennebunk ME	5110na	7415na
		9330na		
0100	0200	USA, WBOH Newport NC	5920am	
0100	0200	USA, WEWN Birmingham AL	5810va	5835va
0100	0200	USA, WHRA Greenbush ME	7520na	
0100	0200	USA, WHRI Cypress Creek SC	7490am	7555am
0100	0200	USA, WHRI Cypress Creek SC	9820am	13760am
		sm		
0100	0200	USA, WHRI Cypress Creek SC	7315am	
0100	0200	USA, WINB Red Lion PA	9265am	
0100	0200	twhfa USA, WRMI Miami FL	7385na	
0100	0200	sm USA, WRMI Miami FL	9955am	
0100	0200	USA, WTJC Newport NC	9370na	
0100	0200	USA, WWCR Nashville TN	3215na	5070na
		5745na	6890na	
0100	0200	USA, WYFR/Family R Okeechobee FL	6065va	
		9505va	15195va	
0100	0200	Uzbekistan, Christian Vision	7355as	
0100	0200	Zambia, Christian Voice	4965af	
0103	0200	Iran, Voice of the Islamic Rep	7235am	9495am
0105	0110	Pakistan, Radio	7445eu	9340eu
0105	0130	sm Austria, Radio Austria Intl	9870am	
0113	0130	twhfa Austria, Radio Austria Intl	9870am	
0115	0130	a Austria, Radio Austria Intl	9870na	
0115	0130	twhfa Seychelles, FEBA	5885as	
0130	0200	Sweden, Radio	11550va	
0130	0200	twhfa USA, Voice of America	7405am	13740am
0133	0200	sm Austria, Radio Austria Intl	9870na	
0140	0200	Vatican City, Vatican Radio	7335as	9650as
0143	0158	twhfa Austria, Radio Austria Intl	9870na	
0145	0200	w Australia, HCJB	15405as	

0100 UTC - 8PM EST / 7PM CST / 5PM PST

0100	0100	Cuba, Radio Havana	6000na	6060na
		9820na		

0200 UTC - 9PM EST / 8PM CST / 6PM PST

0200	0215	Croatia, Croatian Radio	9925na	
0200	0227	Iran, Voice of the Islamic Rep	7235am	9495am

0200	0228	Hungary, Radio Budapest	6110na	
0200	0230	Thailand, Radio	5890na	
0200	0245	USA, WYFR/Family R Okeechobee FL	11835va	
0200	0300	Anguilla, University Network	6090am	
0200	0300	Argentina, RAE	11710am	
0200	0300	Australia, ABC NT Alice Springs	2310do	
		4835do		
0200	0300	Australia, ABC NT Katherine	5025do	
0200	0300	Australia, ABC NT Tennant Creek	4910do	
0200	0300	Australia, CVC International	7355as	
0200	0300	Australia, Radio	9660pa	13630pa
		13670pa	15240va	15415va
		17750as	21725va	15515va
0200	0300	Canada, CFRX Toronto ON	6070na	
0200	0300	Canada, CFVP Calgary AB	6030na	
0200	0300	Canada, CKZN St John's NF	6160na	
0200	0300	Canada, CKZU Vancouver BC	6160na	
0200	0300	China, China Radio Intl	11870as	13640as
0200	0300	Costa Rica, University Network	5030va	6150va
		7375va	9725va	
0200	0300	Cuba, Radio Havana	6000na	6060na
		9820na		
0200	0300	Egypt, Radio Cairo	7270na	
0200	0300	Greece, Voice of	7475va	17520va
0200	0300	Guyana, Voice of	3291do	
0200	0300	Malaysia, RTM/Trax FM	7295as	
0200	0300	Namibia, Namibian BC Corp	3270do	3290do
		6060do	6175do	
0200	0300	New Zealand, Radio NZ Intl	15720pa	
0200	0300	New Zealand, Radio NZ Intl	17675pa	
0200	0300	North Korea, Voice of Korea	13650as	15100as
0200	0300	Papua New Guinea, Wantok R. Light	7120va	
0200	0300	Philippines, Radio Pilipinas	11885va	15270va
		17665va		
0200	0300	Russia, Voice of	9665na	9860na
		15595na		15555na
0200	0300	Singapore, MediaCorp Radio	6150do	
0200	0300	South Korea, KBS World Radio	11810sa	9560na
		15575na		
0200	0300	UK, BBC World Service	6035af	6195as
		7320as	11750as	11955as
		15310as	15360as	17760as
0200	0300	USA, American Forces Radio	4319usb	5446usb
		5765usb	6350usb	7812usb
		12133usb	12759usb	10320usb
0200	0300	USA, KAIJ Dallas TX	5755na	
0200	0300	USA, KJES Vado NM	7555na	
0200	0300	USA, KTBN Salt Lake City UT	7505na	
0200	0300	USA, KWHR Naalehu HI	17655as	
0200	0300	USA, WBCQ Kennebunk ME	5110na	7415na
		9330na		
0200	0300	USA, WBOH Newport NC	5920am	
0200	0300	USA, WEWN Birmingham AL	5810va	5835va
0200	0300	USA, WHRA Greenbush ME	5850na	
0200	0300	USA, WHRI Cypress Creek SC	7315am	
0200	0300	USA, WHRI Cypress Creek SC	5875am	7490am
		9515am		
0200	0300	USA, WINB Red Lion PA	9265am	
0200	0300	USA, WRMI Miami FL	7385na	
0200	0300	USA, WRMI Miami FL	9955am	
0200	0300	USA, WTJC Newport NC	9370na	
0200	0300	USA, WWCR Nashville TN	3215na	5070na
		5935na	7465na	
0200	0300	USA, WWRB Manchester TN	3185na	5050na
		5745na	6890na	
0200	0300	USA, WYFR/Family R Okeechobee FL	5985va	
		6065va	9505va	11855va
0200	0300	Uzbekistan, Christian Vision	7355as	
0200	0300	Zambia, Christian Voice	4965af	
0200	3000	Taiwan, Radio Taiwan Intl	5950na	9680na
0215	0220	Vatican City, Vatican Radio	15560oc	
0215	0230	Nepal, Radio	3230as	5005as
		7165as		6100as
0230	0258	Vietnam, Voice of	6175na	
0230	0300	Sweden, Radio	6010na	
0245	0300	Albania, Radio Tirana	6115eu	7465eu
0245	0300	Myanmar, Radio	9730do	
0250	0300	Vatican City, Vatican Radio	7305am	9610am

0300 UTC - 10PM EST / 9PM CST / 7PM PST

0300	0320	Vatican City, Vatican Radio	7305am	9610am
0300	0327	Czech Rep, Radio Prague	7345na	9870na
0300	0330	Egypt, Radio Cairo	7270na	
0300	0330	Myanmar, Radio	9730do	
0300	0330	Philippines, Radio Pilipinas	11885va	15270va
		17665va		
0300	0330	Swaziland, TWR	3200af	
0300	0330	USA, KJES Vado NM	7555na	
0300	0330	USA, Voice of America	4930af	6080af
		7340af	9885af	12080af
0300	0330	USA, WBCQ Kennebunk ME	5110na	7415na
		9330na		

0300	0330	Vatican City, Vatican Radio	9660af	
0300	0358	Germany, Deutsche Welle	7330as	9480as
		9785as		
0300	0359	New Zealand, Radio NZ Intl	15720pa	
0300	0359	New Zealand, Radio NZ Intl	17675pa	
0300	0400	Anguilla, University Network	6090am	
0300	0400	Australia, ABC NT Alice Springs	2310do	
		4835do		
0300	0400	Australia, ABC NT Katherine	5025do	
0300	0400	Australia, ABC NT Tennant Creek	4910do	
0300	0400	Australia, CVC International	13685as	
0300	0400	Australia, Radio	9660pa	13630pa
		13670va	15240va	15415va
		17750as	21725va	15515va
0300	0400	Bulgaria, Radio	7400na	9700na
0300	0400	Canada, CBC NQ SW Service	9625na	
0300	0400	Canada, CFRX Toronto ON	6070na	
0300	0400	Canada, CFVP Calgary AB	6030na	
0300	0400	Canada, CKZN St John's NF	6160na	
0300	0400	Canada, CKZU Vancouver BC	6160na	
0300	0400	China, China Radio Intl	9690na	9790na
		11870as	15110as	
0300	0400	Costa Rica, University Network	5030va	6150va
		7375va	9725va	
0300	0400	Cuba, Radio Havana	6000na	6060na
		9820na		
0300	0400	Guyana, Voice of	3291do	
0300	0400	Japan, Radio Japan/NHK World	21610pa	
0300	0400	Malaysia, RTM/Trax FM	7295as	
0300	0400	Malaysia, RTM/Voice of Malaysia	9750as	6175as
		15295as		
0300	0400	Namibia, Namibian BC Corp	3270do	3290do
		6060do	6175do	
0300	0400	North Korea, Voice of Korea	7140as	9345as
		9730as		
0300	0400	Oman, Radio Oman	15355as	
0300	0400	Papua New Guinea, Wantok R. Light	7120va	
0300	0400	Russia, Voice of	5900na	9665na
		9890na	15425na	15455na
		15595na		
0300	0400	Rwanda, Radio	6055do	
0300	0400	Singapore, MediaCorp Radio	6150do	
0300	0400	South Africa, Channel Africa	3345af	7390af
0300	0400	Taiwan, Radio Taiwan Intl	5950va	15215va
		15320va		
0300	0400	UK, BBC World Service	6195as	
0300	0400	UK, BBC World Service	3255af	6005me
		6145af	6190af	7130af
		9410as	9750af	11760as
		15360as	17760as	17790as
0300	0400	USA, American Forces Radio	4319usb	5446usb
		5765usb	6350usb	7812usb
		12133usb	12759usb	10320usb
0300	0400	USA, KAIJ Dallas TX	5755na	
0300	0400	USA, KTBN Salt Lake City UT	7505na	
0300	0400	USA, WBCQ Kennebunk ME	5110na	7415na
0300	0400	USA, WBOH Newport NC	5920am	
0300	0400	USA, WEWN Birmingham AL	5810va	5835va
0300	0400	USA, WHRA Greenbush ME	5850na	
0300	0400	USA, WHRI Cypress Creek SC	5860am	
0300	0400	USA, WHRI Cypress Creek SC	7520am	
0300	0400	USA, WHRI Cypress Creek SC	5875am	7315am
0300	0400	USA, WINB Red Lion PA	9265am	
0300	0400	USA, WRMI Miami FL	7385na	
0300	0400	USA, WRMI Miami FL	9955am	
0300	0400	USA, WTJC Newport NC	9370na	
0300	0400	USA, WWCR Nashville TN	3215na	5070na
		5765na	5935na	
0300	0400	USA, WWRB Manchester TN	3185na	5050na
		5745na	6890na	
0300	0400	USA, WYFR/Family R Okeechobee FL	6065va	6065am
		9505am	11740am	15255am
0300	0400	Uzbekistan, Christian Vision	13685as	
0300	0400	Zambia, Christian Voice	4965af	
0300	0400	Zimbabwe, ZBC Corp	5975do	
0300	0500	UK, Sudan Radio Service	7120af	
0330	0357	Czech Rep, Radio Prague	5990am	9455va
		11600va		
0330	0358	Hungary, Radio Budapest	6035na	
0330	0358	Vietnam, Voice of	6175am	
0330	0400	Albania, Radio Tirana	6115eu	7465eu
0330	0400	Sweden, Radio	6010na	
0330	0400	UK, BBC World Service	11665af	
0330	0400	USA, Voice of America	4930af	6080af
		9885af	12080af	15580af
0330	0400	USA, WBCQ Kennebunk ME	9330na	

0400 UTC - 11PM EST / 10PM CST / 8PM PST

0400	0427	Czech Rep, Radio Prague	6100na	
0400	0430	France, Radio France Intl	9805af	11700af
0400	0430	USA, Voice of America	4930af	4960af
		6080af	9575af	9885af
		11835af		

0400	0445		12080af USA, WYFR/Family R Okeechobee FL 6855va	15580af 9505va	6065va	
0400	0447		Germany, Deutsche Welle	7225af		
0400	0456		Romania, Radio Romania Intl 9690va	6115va 11895va	9515na	
0400	0500		Anguilla, University Network	6090am		
0400	0500		Australia, ABC NT Alice Springs 4835do		2310do	
0400	0500		Australia, ABC NT Katherine	5025do		
0400	0500		Australia, ABC NT Tennant Creek		4910do	
0400	0500		Australia, CVC International	13685as		
0400	0500		Australia, Radio	9660pa 12080pa 15240pa	13670va 21725va	
0400	0500	twhf	Canada, CBC NQ SW Service	9625na		
0400	0500		Canada, CFRX Toronto ON	6070na		
0400	0500		Canada, CKZN St John's NF	6160na		
0400	0500		Canada, CKZU Vancouver BC	6160na		
0400	0500		China, China Radio Intl	6020na 9560na	6080na	
0400	0500		Costa Rica, University Network	5030va 7375va	6150va	
0400	0500		Cuba, Radio Havana	6000na 9820na	6060na	
0400	0500		Germany, Deutsche Welle	5905af 9565af	6180af	
0400	0500		Guyana, Voice of	3291do		
0400	0500		Malaysia, RTM/Trax FM	7295as		
0400	0500		Malaysia, RTM/Voice of Malaysia	9750as 15295as	6175as	
0400	0500	vl	Namibia, Namibian BC Corp	3270do 6060do	3290do	
0400	0500		New Zealand, Radio NZ Intl	17675pa		
0400	0500	DRM	New Zealand, Radio NZ Intl	15720pa		
0400	0500		Nigeria, Radio/Kaduna	6090do		
0400	0500	vl	Papua New Guinea, Wantok R. Light	7120va		
0400	0500		Russia, Voice of	5900na 15555na	9860na	
0400	0500	vl	Rwanda, Radio	6055do		
0400	0500		Singapore, MediaCorp Radio	6150do		
0400	0500		South Africa, Channel Africa	3345af		
0400	0500		Turkey, Voice of	6020na 7240as		
0400	0500	vl	Uganda, Radio	4976do		
0400	0500		UK, BBC World Service	3255af 6190af 11665af 15360as 21660as	6005af 7160af 15310as 17790as	
0400	0500	DRM	UK, BBC World Service	6010na		
0400	0500		Ukraine, Radio Ukraine Intl	5820na		
0400	0500		USA, American Forces Radio	4319usb 5765usb 12133usb	5446usb 10320usb	
0400	0500		USA, KAIJ Dallas TX	5755na		
0400	0500		USA, KTBN Salt Lake City UT	7505na		
0400	0500		USA, KWHR Naalehu HI	17655as		
0400	0500		USA, WBCQ Kennebunk ME	5110na	7415na	
0400	0500		USA, WBOH Newport NC	5920am		
0400	0500		USA, WEWN Birmingham AL	5810va	5835va	
0400	0500		USA, WHRA Greenbush ME	5850na		
0400	0500	twhfa	USA, WHRI Cypress Creek SC	5860am		
0400	0500	sm	USA, WHRI Cypress Creek SC	5752am		
0400	0500		USA, WHRI Cypress Creek SC	5875am	7315am	
0400	0500	mtwhfa	USA, WMLK Bethel PA	9265eu		
0400	0500	thwhfa	USA, WRMI Miami FL	7385na		
0400	0500	sm	USA, WRMI Miami FL	9955am		
0400	0500		USA, WTJC Newport NC	9370na		
0400	0500		USA, WWCR Nashville TN	3215na 5765na	5070na	
0400	0500		USA, WWRB Manchester TN	3185na 5745na	5050na	
0400	0500		USA, WYFR/Family R Okeechobee FL	7780va 9715va		
0400	0500		Uzbekistan, Christian Vision	13685as		
0400	0500		Zambia, Christian Voice	4965af	6065af	
0400	0500	vl	Zimbabwe, ZBC Corp	5975do		
0430	0445		Israel, Kol Israel	6280va 17600va	9345va	
0430	0500		Nigeria, Radio/Ibadan	6050do		
0430	0500		Nigeria, Radio/Kaduna	4770do		
0430	0500		Nigeria, Radio/Lagos	3326do	4990do	
0430	0500	mtwhf	Swaziland, TWR	3200af		
0430	0500		USA, Voice of America	4930af 6080af	4960af 12080af	
0445	0500		Italy, RAI Intl	5965af	6120af	7170af

0500 UTC - 12AM EST / 11PM CST / 9PM PST

0500	0507	twhf	Canada, CBC NQ SW Service	9625na		
0500	0520		Vatican City, Vatican Radio	5885eu	7250eu	
0500	0530	mtwhf	France, Radio France Intl	13680af	15160af	
0500	0530		Germany, Deutsche Welle	6180af	7285af	

0500	0530	vl	Rwanda, Radio	6055do		
0500	0530		Vatican City, Vatican Radio	9660af 13765af	11625af	
0500	0557		Netherlands, Radio	6165na		
0500	0600		Anguilla, University Network	6090am		
0500	0600		Australia, ABC NT Alice Springs	4835do	2310do	
0500	0600		Australia, ABC NT Katherine	5025do		
0500	0600		Australia, ABC NT Tennant Creek		4910do	
0500	0600		Australia, CVC International	13685as		
0500	0600		Australia, Radio	9660pa 15160va 17750as	12080pa 15415va	13670va 15515va
0500	0600		Bhutan, BBS	6035as		
0500	0600		Canada, CFRX Toronto ON	6070na		
0500	0600		Canada, CKZN St John's NF	6160na		
0500	0600		Canada, CKZU Vancouver BC	6160na		
0500	0600		China, China Radio Intl	6020na 9560na	6190na	
0500	0600		Costa Rica, University Network	5030va 7375va	6150va	
0500	0600		Cuba, Radio Havana	6000va 9550va	6060va	
0500	0600		Guyana, Voice of	3291do		
0500	0600		Japan, Radio Japan/NHK World	6110na 21755pa	5975eu	17810as
0500	0600		Malaysia, RTM/Trax FM	7295as		
0500	0600		Malaysia, RTM/Voice of Malaysia	9750as 15295as	6175as	
0500	0600	vl	Namibia, Namibian BC Corp	3270do 6060do	3290do	
0500	0600		New Zealand, Radio NZ Intl	17675pa		
0500	0600	DRM	New Zealand, Radio NZ Intl	15720pa		
0500	0600		Nigeria, Radio/Ibadan	6050do		
0500	0600		Nigeria, Radio/Kaduna	4770do	6090do	
0500	0600		Nigeria, Radio/Lagos	3326do	4990do	
0500	0600		Nigeria, Voice of	15120af		
0500	0600	vl	Papua New Guinea, Wantok R. Light	7120va		
0500	0600		Russia, Voice of	17635oc	21790oc	
0500	0600		Singapore, MediaCorp Radio	6150do		
0500	0600		South Africa, Channel Africa	7240af	9685af	
0500	0600	as	Swaziland, TWR	4775af		
0500	0600		Swaziland, TWR	6120af	9500af	
0500	0600	vl	Uganda, Radio	4976do	5026do	
0500	0600		UK, BBC World Service	3255af 6190af	6005as 9410eu	
0500	0600		UK, Sudan Radio Service	6195af 11665af	7160af 11760as	11765af
0500	0600	mtwhf	UK, BBC World Service	11955as 17640af	12095eu 17790as	15575as 21660as
0500	0600	vl/mtwhf	USA, American Forces Radio	4319usb 5765usb 12133usb	5446usb 10320usb	
0500	0600		USA, KAIJ Dallas TX	5755na		
0500	0600		USA, KTBN Salt Lake City UT	7505na		
0500	0600		USA, KWHR Naalehu HI	11565as	13650as	
0500	0600		USA, Voice of America	4930af 6180af	6080af	
0500	0600		USA, WBCQ Kennebunk ME	5110na	7415na	
0500	0600		USA, WBOH Newport NC	5920am		
0500	0600		USA, WEWN Birmingham AL	5850va		
0500	0600		USA, WHRA Greenbush ME	6145na		
0500	0600	twhfa	USA, WHRI Cypress Creek SC	5860am	7465am	
0500	0600	sm	USA, WHRI Cypress Creek SC	7315am		
0500	0600	mtwhfa	USA, WMLK Bethel PA	9265eu		
0500	0600		USA, WRMI Miami FL	9955am		
0500	0600		USA, WTJC Newport NC	9370na		
0500	0600		USA, WWCR Nashville TN	3215na 5765na	5070na	
0500	0600		USA, WWRB Manchester TN	3185na 5935na		
0500	0600		USA, WYFR/Family R Okeechobee FL	9355va	6855va	
0500	0600		Uzbekistan, Christian Vision	13685as		
0500	0600		Zambia, Christian Voice	4965af	6065af	
0500	0600	vl	Zimbabwe, ZBC Corp	5975do		
0505	0520	m	Austria, Radio Austria Intl	17870me		
0505	0530	as	Austria, Radio Austria Intl	17870me		
0515	0600		Germany, CVC The Voice Africa	9555af		
0525	0600	vl	Ghana, Ghana BC Corp	3366do	4915do	
0530	0600		Thailand, Radio	17655eu		
0530	0600	vl/mtwhf	Vatican City, Vatican Radio	6185va		
0535	0600	as	Austria, Radio Austria Intl	17870me		
0545	0600	twhf	Austria, Radio Austria Intl	17870me		
0545	0600	vl	Rwanda, Radio	6055do		

0600 UTC - 1AM EST / 12AM CST / 10PM PST

0600	0615	as	South Africa, TWR	11640af		
0600	0630	mtwhf	France, Radio France Intl	9865af	15160af	
				17800af		

0600	0630		Germany, Deutsche Welle	7240af	7285af
			9565af	12045af	
0600	0645	mtwhf	South Africa, TWR	11640af	
0600	0645	vl/ mtwhf	Vatican City, Vatican Radio	6185va	
0600	0659		New Zealand, Radio NZ Intl	17675pa	
0600	0659	DRM	New Zealand, Radio NZ Intl	15720pa	
0600	0700		Anguilla, University Network	6090am	
0600	0700		Australia, ABC NT Alice Springs	4835do	2310do
			Australia, ABC NT Katherine	5025do	
0600	0700		Australia, ABC NT Tennant Creek		4910do
0600	0700		Australia, CVC International	15335as	
0600	0700		Australia, Radio	9660pa	13670va
			15160va	15240va	15515va
			17750as		
0600	0700		Canada, CFRX Toronto ON	6070na	
0600	0700		Canada, CFVP Calgary AB	6030na	
0600	0700		Canada, CKZN St John's NF	6160na	
0600	0700		Canada, CKZU Vancouver BC	6160na	
0600	0700		China, China Radio Intl	11870as	11880as
			13620as	15350as	15465as
			17505as	17540as	17490eu
0600	0700		Costa Rica, University Network	5030va	6150va
			7375va	9725va	11870va
0600	0700		Cuba, Radio Havana	6000va	6060va
			9550va	9820va	11760va
0600	0700		Germany, CVC The Voice Africa		9555af
0600	0700		Germany, Deutsche Welle	6140eu	
0600	0700	vl	Ghana, Ghana BC Corp	3366do	4915do
0600	0700		Guyana, Voice of	3291do	
0600	0700		Japan, Radio Japan/NHK World		7230eu
			11690va	11715eu	11740as
0600	0700		Liberia, ELWA	4760do	
0600	0700		Malaysia, RTM/Trax FM	7295as	
0600	0700		Malaysia, RTM/Voice of Malaysia		6175as
			9750as	15295as	
0600	0700	vl	Namibia, Namibian BC Corp	3270do	3290do
			6060do	6175do	
0600	0700		Nigeria, Radio/Ibadan	6050do	
0600	0700		Nigeria, Radio/Kaduna	4770do	6090do
0600	0700		Nigeria, Radio/Lagos	3326do	4990do
0600	0700		Nigeria, Voice of	15120af	
0600	0700	vl	Papua New Guinea, Wantok R. Light		7120va
0600	0700	irreg/ vl	Russia, Voice of	17635oc	21790oc
0600	0700		Sierra Leone, SLBS 3316do		
0600	0700		Singapore, MediaCorp Radio	6150do	
0600	0700	vl	Solomon Islands, SIBC	5020do	9545do
0600	0700		South Africa, Channel Africa	7240af	15255af
0600	0700	as	Swaziland, TWR	4775af	
0600	0700		Swaziland, TWR	6120af	9500af
0600	0700		UK, BBC World Service	6005af	6190af
			6195eu	7160eu	9410eu
			11940af	12095eu	11765af
			15360as	15420af	15575as
			17760as	17790as	21660as
0600	0700		USA, American Forces Radio	4319usb	5446usb
			5765usb	6350usb	7812usb
			12133usb	12759usb	10320usb
0600	0700		USA, KAIJ Dallas TX	5755na	
0600	0700		USA, KTBN Salt Lake City UT	7505na	
0600	0700		USA, KWHR Naalehu HI	11565as	13650as
0600	0700		USA, Voice of America	6080af	6180af
			12080af	15580af	
0600	0700		USA, WBCQ Kennebunk ME	5110na	7415na
0600	0700		USA, WBOH Newport NC	5920am	
0600	0700		USA, WEWN Birmingham AL	5850va	7570va
0600	0700		USA, WHRA Greenbush ME	5860na	
0600	0700		USA, WHRI Cypress Creek SC	7315am	7465am
0600	0700	mtwhfa	USA, WMLK Bethel PA	9265eu	
0600	0700		USA, WRMI Miami FL	9955am	
0600	0700		USA, WTJC Newport NC	9370na	
0600	0700		USA, WWCR Nashville TN	3215na	5070na
			5765na	5935na	
0600	0700		USA, WWRB Manchester TN	3185na	
0600	0700		USA, WYFR/Family R Okeechobee FL		6000va
			7780va	9680va	11530va
					11580va
0600	0700		Uzbekistan, Christian Vision	13685as	
0600	0700	vl	Vanuatu, Radio	4960do	
0600	0700		Yemen, Rep of Yemen Radio	9780me	
0600	0700		Zambia, Christian Voice	6065af	
0600	0700	vl	Zimbabwe, ZBC Corp	5975do	
0630	0645		Vatican City, Vatican Radio	4005eu	5885eu
			6185eu	7250eu	9645eu
			15595va		11740eu
0630	0645		Vatican City, Vatican Radio	15595va	
0630	0656		Romania, Radio Romania Intl	7180va	9690va
			15135va	17780va	
0630	0700		UK, BBC World Service	11795af	
0630	0700		Vatican City, Vatican Radio	11625af	13765af
			15570af	15595af	
0659	0700		New Zealand, Radio NZ Intl	9890pa	
0659	0700	DRM	New Zealand, Radio NZ Intl	9870pa	

0700 UTC - 2AM EST / 1AM CST / 11PM PST

0700	0706		UK, BBC World Service	6005af	
0700	0727		Czech Rep, Radio Prague	9880eu	11600eu
0700	0730		Slovakia, Radio Slovakia Int	13715oc	
0700	0745		USA, WYFR/Family R Okeechobee FL		7780va
0700	0757	DRM	Netherlands, Radio	7300eu	
0700	0800		Anguilla, University Network	6090am	
0700	0800		Australia, ABC NT Alice Springs	4835do	2310do
			Australia, ABC NT Katherine	5025do	
0700	0800		Australia, ABC NT Tennant Creek		4910do
0700	0800		Australia, CVC International	15335as	
0700	0800		Australia, HCJB	11750pa	
0700	0800		Australia, Radio	9660pa	9710pa
			12080pa	13650pa	15160va
			15415va	17750as	15240va
0700	0800		Canada, CFRX Toronto ON	6070na	
0700	0800		Canada, CFVP Calgary AB	6030na	
0700	0800		Canada, CKZN St John's NF	6160na	
0700	0800		Canada, CKZU Vancouver BC	6160na	
0700	0800		China, China Radio Intl	11880as	13710eu
			15350as	15465as	17490eu
0700	0800		Costa Rica, University Network	5030va	6150va
			7375va	9725va	11870va
0700	0800		France, Radio France Intl	17800af	
0700	0800	f	Germany, Bible Voice BC Network		5945me
0700	0800	s	Germany, Bible Voice BC Network		5945eu
0700	0800		Germany, CVC The Voice Africa		9555af
0700	0800		Germany, CVC The Voice Africa		9555af
0700	0800		Germany, Deutsche Welle	6140eu	
0700	0800	vl	Ghana, Ghana BC Corp	3366do	4915do
0700	0800		Guyana, Voice of	3291do	5950do
0700	0800	as	Italy, IRRS	9310eu	
0700	0800		Liberia, ELWA	4760do	
0700	0800		Liberia, Star Radio	9525af	
0700	0800		Malaysia, RTM/Trax FM	7295as	
0700	0800		Malaysia, RTM/Voice of Malaysia		6175as
			9750as	15295as	
0700	0800		Myanmar, Radio	9730do	
0700	0800	vl	Namibia, Namibian BC Corp	3270do	3290do
			6060do	6175do	
0700	0800		New Zealand, Radio NZ Intl	9890pa	
0700	0800	DRM	New Zealand, Radio NZ Intl	9870pa	
0700	0800		Nigeria, Radio/Ibadan	6050do	
0700	0800		Nigeria, Radio/Kaduna	4770do	6090do
0700	0800		Nigeria, Radio/Lagos	3326do	4990do
0700	0800	vl	Papua New Guinea, Wantok R. Light		7120va
0700	0800		Russia, Voice of	17495oc	17635oc
0700	0800	irreg/ vl	Sierra Leone, SLBS 3316do		
0700	0800		Singapore, MediaCorp Radio	6150do	
0700	0800	vl	Solomon Islands, SIBC	5020do	9545do
0700	0800	vl	South Africa, Channel Africa	9620af	
0700	0800	as	Swaziland, TWR	4775af	
0700	0800		Swaziland, TWR	6120af	9500af
0700	0800		Taiwan, Radio Taiwan Intl	5950na	
0700	0800	mtwhf	UK, BBC World Service	15400af	
0700	0800		UK, BBC World Service	5875eu	6190af
			6195eu	7320eu	9410eu
			11760me	11765af	11795eu
			11955as	12095eu	15360as
			15575as	17790as	15420af
0700	0800	as	UK, Bible Voice	5945eu	
0700	0800		USA, American Forces Radio	4319usb	5446usb
			5765usb	6350usb	7812usb
			12133usb	12759usb	10320usb
0700	0800		USA, KAIJ Dallas TX	5755na	
0700	0800		USA, KTBN Salt Lake City UT	7505na	
0700	0800		USA, KWHR Naalehu HI	11565as	13650as
0700	0800		USA, WBCQ Kennebunk ME	5110na	7415na
0700	0800		USA, WBOH Newport NC	5920am	
0700	0800		USA, WEWN Birmingham AL	5850va	7570va
0700	0800		USA, WHRA Greenbush ME	5860na	
0700	0800		USA, WHRI Cypress Creek SC	7315am	7495am
0700	0800	mtwhfa	USA, WMLK Bethel PA	9265eu	
0700	0800		USA, WRMI Miami FL	9955am	
0700	0800		USA, WTJC Newport NC	9370na	
0700	0800		USA, WWCR Nashville TN	3215na	5070na
			5765na	5935na	
0700	0800		USA, WWRB Manchester TN	3185na	
0700	0800		USA, WYFR/Family R Okeechobee FL		5985va
			6855va	9505va	9715va
					9930va
0700	0800	vl	Vanuatu, Radio	4960do	
0700	0800		Zambia, Christian Voice	6065af	
0715	0800	f	UK, Bible Voice	5945eu	
0730	0800		Bulgaria, Radio	9500eu	11500eu
0730	0800		Pakistan, Radio	15100eu	17835eu
0745	0800	s	Albania, TWR Europe		11865eu
0745	0800	s	Monaco, TWR Europe		9800eu

0800 UTC - 3AM EST / 2AM CST / 12AM PST

0800	0815	f	Germany, Bible Voice BC Network	6140me
------	------	---	---------------------------------	--------

0800	0825	Malaysia, RTM/Voice of Malaysia	6175as
		9750as 15295as	
0800	0830	Australia, ABC NT Katherine	5025do
0800	0830	Australia, ABC NT Tennant Creek	4910do
0800	0830	Liberia, ELWA	4760do
0800	0830	Myanmar, Radio	9730do
0800	0830	Pakistan, Radio	15100eu 17835eu
0800	0830	f UK, Bible Voice	5945eu
0800	0830	Vatican City, Vatican Radio	9625na
0800	0845	s Germany, Bible Voice BC Network	5945eu
0800	0845	a Guam, TWR/KTWR	11840pa
0800	0845	as UK, Bible Voice	5945eu
0800	0845	USA, WYFR/Family R Okeechobee FL	5950va
		9930va	
0800	0900	s Albania, TWR Europe	11865eu
0800	0900	mtwhf Albania, TWR Europe	11865eu
0800	0900	Anguilla, University Network	6090am
0800	0900	Australia, ABC NT Alice Springs	2310do
		4835do	
0800	0900	Australia, CVC International	15335as
0800	0900	Australia, HCJB	11750pa
0800	0900	Australia, Radio	5995pa 9580pa 9590pa
		9710pa 11750pa 12080pa 13630pa	
		15240va 15415va 17750as	
0800	0900	Canada, CFRX Toronto ON	6070na
0800	0900	Canada, CFVP Calgary AB	6030na
0800	0900	Canada, CKZN St John's NF	6160na
0800	0900	Canada, CKZU Vancouver BC	6160na
0800	0900	China, China Radio Intl	11880as 13710eu
		15350as 15465as 17490eu 17540as	
0800	0900	Costa Rica, University Network	5030va 6150va
		7375va 9725va 11870va	
0800	0900	Germany, CVC The Voice Africa	9555af
0800	0900	Germany, Deutsche Welle	6140eu
0800	0900	vi Ghana, Ghana BC Corp	3366do 4915do
0800	0900	mtwhf Guam, TWR/KTWR	11840pa
0800	0900	Guyana, Voice of	3291do 5950do
0800	0900	Indonesia, Voice of	9525as 11785pa
		15150al	
0800	0900	as Italy, IRRS	9310eu
0800	0900	Liberia, Star Radio	9525af
0800	0900	Malaysia, RTM/Trax FM	7295as
0800	0900	s Monaco, TWR Europe	9800eu
0800	0900	mtwhf Monaco, TWR Europe	9800eu
0800	0900	DRM New Zealand, Radio NZ Intl	9890pa
0800	0900	DRM New Zealand, Radio NZ Intl	9870pa
0800	0900	Nigeria, Radio/Ibadan	6050do
0800	0900	Nigeria, Radio/Kaduna	4770do 6090do
0800	0900	Nigeria, Radio/Lagos	4990do
0800	0900	Papua New Guinea, Catholic Radio	4960do
0800	0900	Papua New Guinea, NBC	4890do
0800	0900	vi Papua New Guinea, Wantok R. Light	7120va
0800	0900	DRM Russia, Voice of	17495oc 17635oc 21790oc
0800	0900	irreg/ vi Russia, Voice of	15780eu
0800	0900	Sierra Leone, SLBS 3316do	
0800	0900	Singapore, MediaCorp Radio	6150do
0800	0900	vi Solomon Islands, SIBC	5020do 9545do
0800	0900	vi South Africa, Channel Africa	9620af
0800	0900	South Korea, KBS World Radio	9570as
		9640eu	
0800	0900	Swaziland, TWR	6120af 9500af
0800	0900	Taiwan, Radio Taiwan Intl	9610as
0800	0900	UK, BBC World Service	5875eu 6190af
		6195eu 7320eu 9740as 11760va	
		11940af 12095eu 15285as 17790as	
		17885af 21470af 21660as	
0800	0900	mtwhf UK, BBC World Service	15400af 17830af
0800	0900	as UK, BBC World Service	15575as 17830af
0800	0900	USA, American Forces Radio	4319usb 5446usb
		5765usb 6350usb 7812usb 10320usb	
		12133usb 12759usb 12579usb	
0800	0900	USA, KAIJ Dallas TX	5755na
0800	0900	USA, KNLS Anchor Point AK	6150as
0800	0900	USA, KTBN Salt Lake City UT	7505na
0800	0900	USA, KWHR Naalehu HI	9930as 11565as
0800	0900	USA, WBOH Newport NC	5920am
0800	0900	USA, WEWN Birmingham AL	5850va 7570va
0800	0900	USA, WHRA Greenbush ME	5860na
0800	0900	USA, WHRI Cypress Creek SC	7315am 7495am
0800	0900	USA, WRMI Miami FL	9955am
0800	0900	USA, WTJC Newport NC	9370na
0800	0900	USA, WWCR Nashville TN	3215na 5070na
		5765na 5935na	
0800	0900	USA, WWRB Manchester TN	3185na
0800	0900	USA, WYFR/Family R Okeechobee FL	5985va
		6855va	
0800	0900	vi Vanuatu, Radio	4960do
0800	0900	Zambia, Christian Voice	6065af
0805	0900	mtwhf Guam, TWR/KTWR	15170as
0815	0850	a Albania, TWR Europe	11865 ey
0815	0850	a Monaco, TWR Europe	9800eu
0830	0900	Australia, ABC NT Katherine	2485do
0830	0900	Australia, ABC NT Tennant Creek	2325do
0845	0900	f UK, Bible Voice	17595va

0900 UTC - 4AM EST / 3AM CST / 1AM PST

0900	0900	USA, WBCQ Kennebunk ME	5110na 7415na
0900	0915	vi Ghana, Ghana BC Corp	3366do 4915do
0900	0920	s Albania, TWR Europe	11865eu
0900	0920	mtwhf Albania, TWR Europe	11865eu
0900	0920	s Monaco, TWR Europe	9800eu
0900	0920	mtwhf Monaco, TWR Europe	9800eu
0900	0927	Czech Rep, Radio Prague	9955am 9880eu
		21745va	
0900	0930	Mongolia, Voice of	12085as
0900	1000	Anguilla, University Network	6090am
0900	1000	Australia, ABC NT Alice Springs	2310do
		4835do	
0900	1000	Australia, ABC NT Katherine	2485do
0900	1000	Australia, ABC NT Tennant Creek	2325do
0900	1000	Australia, CVC International	11955as
0900	1000	Australia, Radio	9580pa 9590pa 11750pa
		11880as 15240as 15415va	
0900	1000	Bhutan, BBS	6035as
0900	1000	Canada, CFRX Toronto ON	6070na
0900	1000	Canada, CFVP Calgary AB	6030na
0900	1000	Canada, CKZN St John's NF	6160na
0900	1000	Canada, CKZU Vancouver BC	6160na
0900	1000	China, China Radio Intl	15210oc 17490eu
		17690oc	
0900	1000	Costa Rica, University Network	5030va 6150va
		7375va 9725va 11870va	
0900	1000	Germany, CVC The Voice Africa	9555af
0900	1000	Germany, Deutsche Welle	6140eu
0900	1000	as Italy, IRRS	9310eu
0900	1000	Malaysia, RTM/Trax FM	7295as
0900	1000	vi Namibia, Namibian BC Corp	3270do 3290do
		6060do 6175do	
0900	1000	DRM New Zealand, Radio NZ Intl	9890pa
0900	1000	DRM New Zealand, Radio NZ Intl	9870pa
0900	1000	Nigeria, Radio/Ibadan	6050do
0900	1000	Nigeria, Radio/Kaduna	4770do 6090do
0900	1000	Nigeria, Radio/Lagos	4990do
0900	1000	Papua New Guinea, Catholic Radio	4960do
0900	1000	Papua New Guinea, NBC	4890do
0900	1000	vi Papua New Guinea, Wantok R. Light	7120va
0900	1000	vi Rwanda, Radio	6055do
0900	1000	irreg/ vi Sierra Leone, SLBS 3316do	
0900	1000	Singapore, MediaCorp Radio	6150do
0900	1000	vi Solomon Islands, SIBC	5020do 9545do
0900	1000	vi South Africa, Channel Africa	9620af
0900	1000	mtwhf UK, BBC World Service	15400af 15575as
		17830af	
0900	1000	UK, BBC World Service	5975as 6190af
		6195as 7320eu 9470eu 9740as	
		11760me 11940af 12095eu 15285as	
		15485eu 17760as 17790as 17885af	
		21470af 21660as	
0900	1000	as UK, BBC World Service	15575as 17830af
0900	1000	mtwhf UK, BBC World Service	15400af 15575as
		17830af	
0900	1000	f UK, Bible Voice	17595va
0900	1000	USA, American Forces Radio	4319usb 5446usb
		5765usb 6350usb 7812usb 10320usb	
		12133usb 12759usb 12579usb	
0900	1000	USA, KAIJ Dallas TX	5755na
0900	1000	USA, KTBN Salt Lake City UT	7505na
0900	1000	USA, KWHR Naalehu HI	9930as 11565as
0900	1000	USA, WBCQ Kennebunk ME	5110na 7415na
0900	1000	USA, WBOH Newport NC	5920am
0900	1000	USA, WEWN Birmingham AL	5850na
0900	1000	USA, WHRI Cypress Creek SC	7315am 7520am
0900	1000	USA, WRMI Miami FL	9955am
0900	1000	USA, WTJC Newport NC	9370na
0900	1000	USA, WWCR Nashville TN	3215na 5070na
		5765na 5935na	
0900	1000	USA, WWRB Manchester TN	3185na
0900	1000	USA, WYFR/Family R Okeechobee FL	5985va
		6885va 9755va	
0900	1000	vi Vanuatu, Radio	4960do
0900	1000	Zambia, Christian Voice	6065af
0905	1000	s Greece, Voice of	9420eu 12120eu 15630eu

1000 UTC - 5AM EST / 4AM CST / 2AM PST

1000	1015	f UK, Bible Voice	17595va
1000	1030	UK, BBC World Service	5975as 15285as
		21660as	
1000	1057	Netherlands, Radio	6040as 9795as
		12065as	
1000	1059	New Zealand, Radio NZ Intl	9890pa
1000	1100	Anguilla, University Network	11775am
1000	1100	Australia, ABC NT Alice Springs	2310do
		4835do	
1000	1100	Australia, ABC NT Katherine	2485do

1000	1100	Australia, ABC NT Tennant Creek	2325do	
1000	1100	Australia, CVC International	11955as	
1000	1100	Australia, HCJB	15400as 15540as	
1000	1100	Australia, Radio	9580pa 9590pa	11880as
			15240as 15400as	15415va
1000	1100	Canada, CFRX Toronto ON	6070na	
1000	1100	Canada, CFVP Calgary AB	6030na	
1000	1100	Canada, CKZN St John's NF	6160na	
1000	1100	Canada, CKZU Vancouver BC	6160na	
1000	1100	China, China Radio Intl	6040na	17490eu
1000	1100	Costa Rica, University Network	5030va	6150va
			7375va 9725va	11870va 13750va
1000	1100	Germany, CVC The Voice Africa		9555af
1000	1100	Guyana, Voice of	3291do	5950do
1000	1100	India, All India Radio	13695oc	15020as
			15410as	17510as 17800as
1000	1100	Italy, IRRS	9310eu	
1000	1100	Japan, Radio Japan/NHK World		6120na
			9695as	11730as 17585va
			21755oc	17720me
1000	1100	Malaysia, RTM/Trax FM	7295as	
1000	1100	New Zealand, Radio NZ Intl	9870pa	
1000	1100	Nigeria, Voice of	15120af	
1000	1100	North Korea, Voice of Korea	6185as	6285am
			9335ca	9850as
1000	1100	Papua New Guinea, Catholic Radio		4960do
1000	1100	Papua New Guinea, NBC		4890do
1000	1100	Papua New Guinea, Wantok R. Light		7120va
1000	1100	Singapore, MediaCorp Radio	6150do	
1000	1100	Solomon Islands, SIBC	5020do	9545do
1000	1100	South Africa, Channel Africa	9620af	
1000	1100	UK, BBC World Service	6190af	6195as
			7320eu	9470eu 9740as 11760me
			11940af	11945as 15485eu 15575as
			17640eu	17790as 17885af 21470af
1000	1100	UK, BBC World Service	17830af	
1000	1100	USA, American Forces Radio	4319usb	5446usb
			5765usb	6350usb 7812usb 10320usb
			12133usb	12759usb
1000	1100	USA, KAIJ Dallas TX	5755na	
1000	1100	USA, KNLS Anchor Point AK	6150as	
1000	1100	USA, KTNB Salt Lake City UT	7505na	
1000	1100	USA, KWHR Naalehu HI	9930as	11565as
1000	1100	USA, WBCQ Kennebunk ME	5110na	7415na
1000	1100	USA, WBOH Newport NC	5920am	
1000	1100	USA, WEWN Birmingham AL	5850na	
1000	1100	USA, WHRI Cypress Creek SC	7520am	7555am
1000	1100	USA, WINB Red Lion PA	9265am	
1000	1100	USA, WRMI Miami FL	9955am	
1000	1100	USA, WTJC Newport NC	9370na	
1000	1100	USA, WWCR Nashville TN	5070na	5765na
			5935na	15825na
1000	1100	USA, WWRB Manchester TN	3185na	
1000	1100	USA, WYFR/Family R Okeechobee FL		5950va
			5985va	6855va 9755va
1000	1100	Zambia, Christian Voice	6065af	
1030	1045	Ethiopia, Radio	5990af	9704af
1030	1045	Israel, Kol Israel	15760va	17535va
1030	1057	Czech Rep, Radio Prague	9880eu	11665va
1030	1058	Vietnam, Voice of	7285as	
1030	1100	Iran, Voice of the Islamic Rep	15600as	17660as
1030	1100	UK, BBC World Service	9605as	11750as
			15285as	15545as

1100 UTC - 6AM EST / 5AM CST / 3AM PST

1100	1127	Iran, Voice of the Islamic Rep	15600as	17600as
1100	1128	Vietnam, Voice of	9840as	7220as 7285as
1100	1130	Australia, HCJB	15540as	
1100	1130	Australia, Radio	5995pa	9475va 9590va
			9580pa	9590pa 11880va 15240va
			15540as	
1100	1130	UK, BBC World Service	6130am	
1100	1145	USA, WYFR/Family R Okeechobee FL		9550va
			9755va	
1100	1159	Germany, Universal Life	6055me	
1100	1200	Anguilla, University Network	11775am	
1100	1200	Australia, ABC NT Alice Springs		2310do
			4835do	
1100	1200	Australia, ABC NT Katherine	2485do	
1100	1200	Australia, ABC NT Tennant Creek		2325do
1100	1200	Australia, CVC International	13635as	
1100	1200	Canada, CBC NQ SW Service	9625na	
1100	1200	Canada, CFRX Toronto ON	6070na	
1100	1200	Canada, CFVP Calgary AB	6030na	
1100	1200	Canada, CKZN St John's NF	6160na	
1100	1200	Canada, CKZU Vancouver BC	6160na	
1100	1200	China, China Radio Intl	6040na	11750na
			13650eu	17490eu
1100	1200	Costa Rica, University Network	5030va	6150va
			7375va	9725va 11870va 13750va
1100	1200	Germany, CVC The Voice Africa		9555af
1100	1200	Germany, Overcomer Ministries		6110eu
1100	1200	Italy, IRRS	9310eu	

1100	1200	Japan, Radio Japan/NHK World		6120na
			9695as	11730as
1100	1200	Libya, Voice of Africa	17725af	21695af
1100	1200	Malaysia, RTM/Trax FM	7295as	
1100	1200	New Zealand, Radio NZ Intl		13840pa
1100	1200	New Zealand, Radio NZ Intl	9870pa	
1100	1200	Nigeria, Voice of	15120af	
1100	1200	Papua New Guinea, Catholic Radio		4960do
1100	1200	Papua New Guinea, NBC		4890do
1100	1200	Papua New Guinea, Wantok R. Light		7120va
1100	1200	Singapore, Radio Singapore Intl		6080as
			6150as	
1100	1200	South Africa, Channel Africa	9620af	
1100	1200	Taiwan, Radio Taiwan Intl	7445as	
1100	1200	UK, BBC World Service	5875am	6130am
1100	1200	UK, BBC World Service	6190af	6195as
			7320eu	9470eu 9740as 11760me
			11940af	11945as 15485eu 15575as
			17640eu	17790as 17830af 17885af
			21470af	
1100	1200	USA, American Forces Radio	4319usb	5446usb
			5765usb	6350usb 7812usb 10320usb
			12133usb	12759usb
1100	1200	USA, KAIJ Dallas TX	5755na	
1100	1200	USA, KTNB Salt Lake City UT	7505na	
1100	1200	USA, KWHR Naalehu HI	9930as	11565as
1100	1200	USA, WBOH Newport NC	5920am	
1100	1200	USA, WEWN Birmingham AL	5850na	
1100	1200	USA, WHRI Cypress Creek SC	7520am	7555am
1100	1200	USA, WINB Red Lion PA	9265am	
1100	1200	USA, WRMI Miami FL	9955am	
1100	1200	USA, WTJC Newport NC	9370na	
1100	1200	USA, WWCR Nashville TN	5070na	5935na
			15825na	
1100	1200	USA, WWRB Manchester TN	3185na	
1100	1200	USA, WWRB Manchester TN	3185na	
1100	1200	USA, WYFR/Family R Okeechobee FL		5950va
			5985va	7780va 9625va
1100	1200	Zambia, Christian Voice	6065af	
1130	1145	UK, BBC World Service	7135as	11920as
1130	1159	Germany, Universal Life	6055me	
1130	1200	Australia, HCJB	15425as	
1130	1200	Australia, Radio	5995pa	9475va 9590va
			9580pa	9590pa 11880va 15425as
1130	1200	Guam, AWR/KSDA	15435as	
1130	1200	UK, BBC World Service	5875am	6130am
1130	1200	Vatican City, Vatican Radio	15595va	17515va
1157	1200	Greece, Macedonias Radio	9935eu	

1200 UTC - 7AM EST / 6AM CST / 4AM PST

1200	1230	France, Radio France Intl	15275af	17815af
			21620af	
1200	1230	USA, AWR Africa	15140as	15365as
1200	1245	USA, WYFR/Family R Okeechobee FL		5950am
			5985am	
1200	1257	Netherlands, Radio	11675na	
1200	1259	Canada, Radio Canada Intl	9660as	15170as
1200	1259	New Zealand, Radio NZ Intl	13840pa	
1200	1259	New Zealand, Radio NZ Intl	9870pa	
1200	1300	Anguilla, University Network	11775am	
1200	1300	Australia, ABC NT Alice Springs		2310do
			4835do	
1200	1300	Australia, ABC NT Katherine	2485do	
1200	1300	Australia, ABC NT Tennant Creek		2325do
1200	1300	Australia, CVC International	17860me	
1200	1300	Australia, Radio	5995pa	9475va 9590va
			9580pa	9590pa 11880va
1200	1300	Canada, CBC NQ SW Service	9625na	
1200	1300	Canada, CFRX Toronto ON	6070na	
1200	1300	Canada, CFVP Calgary AB	6030na	
1200	1300	Canada, CKZN St John's NF	6160na	
1200	1300	Canada, CKZU Vancouver BC	6160na	
1200	1300	China, China Radio Intl	9730as	9760oc
			11760oc	11980as 13650eu 13790eu
			17490eu	17625af
1200	1300	Costa Rica, University Network	9725va	11870va
			13750va	
1200	1300	Germany, CVC International	13860eu	17830as
1200	1300	Germany, CVC The Voice Africa		9555af
1200	1300	Germany, Overcomer Ministries		13810eu
1200	1300	Italy, IRRS	15750af	
1200	1300	Libya, Voice of Africa	17670af	17675af
			17680af	21695af
1200	1300	Malaysia, RTM/Trax FM	7295as	
1200	1300	Nigeria, Voice of	15120af	
1200	1300	Papua New Guinea, Catholic Radio		4960do
1200	1300	Papua New Guinea, NBC		4890do
1200	1300	Papua New Guinea, Wantok R. Light		7120va
1200	1300	Singapore, Radio Singapore Intl		6080as
			6150as	
1200	1300	South Africa, Channel Africa	9620af	
1200	1300	South Korea, KBS World Radio		9650na
1200	1300	Taiwan, Radio Taiwan Intl	7130na	

1200	1300		UK, BBC World Service	5975as	6190af	
			6195as	7320eu	9470eu	9660am
			9740as	9750am	11760me	11895as
			11940as	15310as	15485eu	15575as
			17640eu	17790as	17830af	17885af
			21470af			
1200	1300		Ukraine, Radio Ukraine Intl	9925eu		
1200	1300		USA, American Forces Radio	4319usb	5446usb	
			5765usb	6350usb	7812usb	10320usb
			12133usb	12759usb		
1200	1300		USA, KAIJ Dallas TX	5755na		
1200	1300		USA, KNLS Anchor Point AK	6915as		
1200	1300		USA, KTVN Salt Lake City UT	7505na		
1200	1300		USA, KWHR Naalehu HI	11565as	12130as	
1200	1300		USA, Voice of America	6160va	9645va	
			9760va	11750va		
1200	1300		USA, WBOH Newport NC	5920am		
1200	1300		USA, WEWN Birmingham AL	5850na		
1200	1300		USA, WHRA Greenbush ME	15665na		
1200	1300		USA, WHRI Cypress Creek SC	9495am	9840am	
			12050am			
1200	1300		USA, WINB Red Lion PA	13570am		
1200	1300		USA, WRMI Miami FL	9955am		
1200	1300		USA, WTJC Newport NC	9370na		
1200	1300		USA, WWCR Nashville TN	7465na	9985na	
			13845na	15825na		
1200	1300		USA, WWRB Manchester TN	3185na		
1200	1300		USA, WYFR/Family R Okeechobee FL	17555am		
			17750am			
1200	1300		Zambia, Christian Voice	6065af		
1205	1220	m	Austria, Radio Austria Intl	6155eu	13730eu	
			17715as			
1205	1230	as	Austria, Radio Austria Intl	6155eu	13730eu	
			17715va			
1215	1230	twhf	Austria, Radio Austria Intl	17715va		
1215	1300		Egypt, Radio Cairo	17835as		
1230	1258		Vietnam, Voice of	9840as		
1230	1300		Bangladesh, Bangla Betar	7185as		
1230	1300		Bulgaria, Radio	11700eu	15700eu	
1230	1300		Thailand, Radio	9835va		
1235	1300	as	Austria, Radio Austria Intl	6155eu	13730eu	
			17715va			
1245	1300	twh	Austria, Radio Austria Intl	6155eu	13730eu	
			17715va			
1255	1258		Finland, YLE/Radio Finland	13715do	15400do	
1259	1300		New Zealand, Radio NZ Intl	5950pa		
1259	1300	DRM	New Zealand, Radio NZ Intl	7145pa		

1300 UTC - 8AM EST / 7AM CST / 5AM PST

1300	1315	w	Australia, HCJB	15435as		
1300	1315	w	Australia, Radio	15435as		
1300	1327		Czech Rep, Radio Prague	13580as	17540na	
1300	1330		Australia, HCJB	15400as		
1300	1330		Australia, Radio	15400as		
1300	1330		Egypt, Radio Cairo	17835as		
1300	1350	s	Italy, IRRS	15750as		
1300	1356		Romania, Radio Romania Intl	15105eu	17745eu	
1300	1359		Poland, Radio Polonia	5975eu	9525eu	
1300	1400		Anguilla, University Network	11775am		
1300	1400		Australia, CVC International	17860me		
1300	1400		Australia, Radio	5995pa	6020pa	9560pa
			9580pa	9590pa		
1300	1400	as	Canada, CBC NQ SW Service	9625na		
1300	1400		Canada, CFRX Toronto ON	6070na		
1300	1400		Canada, CFVP Calgary AB	6030na		
1300	1400		Canada, CKZN St John's NF	6160na		
1300	1400		Canada, CKZU Vancouver BC	6160na		
1300	1400		Canada, Radio Canada Intl	9515am	13655am	
			17800am			
1300	1400		China, China Radio Intl	9570na	9650pa	
			11760oc	11900oc	11980as	13790eu
			15260na	15595eu	17490eu	
1300	1400		Costa Rica, University Network	9725va	11870va	
			13750va			
1300	1400		Germany, CVC International	13860eu	17830as	
1300	1400		Germany, CVC The Voice Africa	6140eu	9555af	
1300	1400		Germany, Deutsche Welle	6140eu		
1300	1400		Germany, Overcomer Ministries		13810eu	
1300	1400		Jordan, Radio	11690na		
1300	1400	vl	Libya, Voice of Africa	17690af	17675af	
			17680af	21695af		
1300	1400		Malaysia, RTM/Trax FM	7295as		
1300	1400		New Zealand, Radio NZ Intl	5950pa		
1300	1400	DRM	New Zealand, Radio NZ Intl	7145pa		
1300	1400		Nigeria, Voice of	15120af		
1300	1400		North Korea, Voice of Korea	7570eu	9335na	
			11710na	12015eu	13760eu	15245eu
1300	1400		Papua New Guinea, Catholic Radio		4960do	
1300	1400		Papua New Guinea, NBC	4890do		
1300	1400	vl	Papua New Guinea, Wantok R. Light		7120va	
1300	1400		Singapore, Radio Singapore Intl	6150as	6080as	
1300	1400	vl	South Africa, Channel Africa	9620af		

1300	1400		South Korea, KBS World Radio	9570na		
			9770na			
1300	1400		UK, BBC World Service	5975as	6190af	
			6195as	7320eu	9470eu	9740as
			11760me	11895as	11940af	15310as
			15420af	15485as	15575as	17640eu
			17790af	17830af	17885af	21470af
1300	1400		USA, American Forces Radio	4319usb	5446usb	
			5765usb	6350usb	7812usb	10320usb
			12133usb	12759usb		
1300	1400		USA, KAIJ Dallas TX	5755na		
1300	1400		USA, KTVN Salt Lake City UT	7505na		
1300	1400		USA, KWHR Naalehu HI	12130as		
1300	1400		USA, Voice of America	9645va	9760va	
1300	1400	w f	USA, WBCQ Kennebunk ME	9330na		
1300	1400		USA, WBOH Newport NC	5920am		
1300	1400		USA, WEWN Birmingham AL	5850na		
1300	1400		USA, WHRA Greenbush ME	15665na		
1300	1400		USA, WHRI Cypress Creek SC	9840am	11785am	
			12050am			
1300	1400		USA, WINB Red Lion PA	13570am		
1300	1400		USA, WRMI Miami FL	7385na		
1300	1400		USA, WTJC Newport NC	9370na		
1300	1400		USA, WWCR Nashville TN	7465na	9985na	
			13845na	15825na		
1300	1400		USA, WWRB Manchester TN	9385na		
1300	1400		USA, WYFR/Family R Okeechobee FL	11830va	11865va	
			11520va	11560va		
			11910va	17750va		
1300	1400		Zambia, Christian Voice	6065af		
1330	1400	s	Australia, HCJB	15435as		
1330	1400	s	Australia, Radio	15435as		
1330	1400	DRM/ a	Czech Rep, Radio Prague	9595eu		
1330	1400	twhfa	Guam, AWR/KSDA	15275as		
1330	1400		India, All India Radio	9690as	11620as	
			13710as			
1330	1400		Laos, National Radio	7145as		
1330	1400		Sweden, Radio	7420va	11550va	15240va
1330	1400	DRM	Sweden, Radio	7275eu		
1330	1400		Turkey, Voice of	11735as	12035eu	

1400 UTC - 9AM EST / 8AM CST / 6AM PST

1400	1415		Russia, FEBA	9500as		
1400	1415		Seychelles, FEBA	7190as		
1400	1427		Czech Rep, Radio Prague	7385na	15350na	
1400	1430		Australia, Radio	5995pa	6080pa	7420va
			9590pa	11750as		
1400	1430	DRM	Canada, Radio Canada Intl	9815eu		
1400	1430	DRM/ f	Czech Rep, Radio Prague	9595eu		
1400	1430		Guam, TWR/KTWR	9975as		
1400	1430		Thailand, Radio	9830va		
1400	1430		Turkey, Voice of	11735as	12035eu	
1400	1430		UK, BBC World Service	9470eu		
1400	1500		Anguilla, University Network	11775am		
1400	1500		Australia, CVC International	15795as		
1400	1500		Bhutan, BBS	6035as		
1400	1500	as	Canada, CBC NQ SW Service	9625na		
1400	1500		Canada, CFRX Toronto ON	6070na		
1400	1500		Canada, CFVP Calgary AB	6030na		
1400	1500		Canada, CKZN St John's NF	6160na		
1400	1500		Canada, CKZU Vancouver BC	6160na		
1400	1500		Canada, Radio Canada Intl	9515am	13655am	
			17800am			
1400	1500		China, China Radio Intl	6100af	9560as	
			11675as	11765as	11775as	13685af
			13710na	13740na	13790na	17490eu
			17650eu			
1400	1500		Costa Rica, University Network	9725va	11870va	
			13750va			
1400	1500		France, Radio France Intl	6120as		
1400	1500	as	Germany, Bible Voice BC Network	15690as		
1400	1500		Germany, CVC International	13860eu	15795as	
1400	1500		Germany, CVC The Voice Africa	6140eu	9555af	
1400	1500		Germany, Deutsche Welle	6140eu		
1400	1500		Germany, Overcomer Ministries		17810me	
1400	1500	a	Greece, Voice of	9420eu	15630eu	
1400	1500	mtwh	Guam, TWR/KTWR	9975as		
1400	1500		India, All India Radio	9690as	11620as	
			13710as			
1400	1500	s	Italy, IRRS	9310eu		
1400	1500		Japan, Radio Japan/NHK World	9875as	11840oc	7200as
			11690na			
1400	1500		Jordan, Radio	11690na		
1400	1500		Libya, Voice of Africa	17725af	17850af	
1400	1500		Malaysia, RTM/Trax FM	7295as		
1400	1500		Netherlands, Radio	9345as	12080as	
			15595			
1400	1500		New Zealand, Radio NZ Intl	5950pa		
1400	1500	DRM	New Zealand, Radio NZ Intl	7145pa		
1400	1500		Nigeria, Voice of	15120af		
1400	1500		Oman, Radio Oman	15140as		

1400	1500	vi	Papua New Guinea, Wantok R. Light	7120va	
1400	1500		Russia, Voice of 6205as	7165as	7370as
			9745as	11755as	12055as
			17645as		15605as
1400	1500		Singapore, MediaCorp Radio	6150do	
1400	1500	vi	South Africa, Channel Africa	9620af	
1400	1500		Taiwan, Radio Taiwan Intl	15265as	
1400	1500		UK, BBC World Service	5975as	6190af
			6195as	7320eu	9410eu
			11760as	11895as	11920as
			12095eu	15485eu	17830af
			21470af		17885af
1400	1500	as	UK, Bible Voice	15690as	
1400	1500		USA, American Forces Radio	4319usb	5446usb
			5765usb	6350usb	7812usb
			12133usb	12759usb	10320usb
1400	1500		USA, KAIJ Dallas TX	13815na	
1400	1500		USA, KJES Vado NM	11715na	
1400	1500		USA, KNLS Anchor Point AK	6150as	
1400	1500		USA, KTBN Salt Lake City UT	7505na	
1400	1500		USA, KWHR Naalehu HI	9930as	
1400	1500		USA, Voice of America	15490va	17730va
1400	1500		USA, WBCQ Kennebunk ME	9330na	
1400	1500		USA, WBOH Newport NC	5920am	
1400	1500		USA, WEWN Birmingham AL	9955na	
1400	1500		USA, WHRA Greenbush ME	17650na	
1400	1500		USA, WHRI Cypress Creek SC	9840am	11785am
			12050am		
1400	1500		USA, WINB Red Lion PA	13570am	
1400	1500		USA, WRMI Miami FL	7385na	
1400	1500		USA, WTJC Newport NC	9370na	
1400	1500		USA, WWCR Nashville TN	9985na	12160na
			13845na	15825na	
1400	1500		USA, WWRB Manchester TN	9385na	
1400	1500		USA, WYFR/Family R Okeechobee FL	9415eu	
			11520va	11560va	11830va
			13695va	17750va	11910va
1400	1500		Zambia, Christian Voice	6065af	
1415	1430		Nepal, Radio	3230as	5005as
			7165as		6100as
1430	1459	s	UK, Bible Voice	12005as	
1430	1500		Australia, Radio	5995pa	6080pa
			9475pa	9590pa	11660pa
					11750pa
1430	1500	DRM	South Korea, KBS World Radio		9770eu
1430	1500		Sweden, Radio	11550va	15240va
1430	1500		UK, BBC World Service	7465eu	

1500 UTC - 10AM EST / 9AM CST / 7AM PST

1500	1510	mtwhfa	Turkmenistan, Turkmen Radio	5015eu	
1500	1528		Vietnam, Voice of 9550va	9840va	12020va
			13860va		
1500	1530		Mongolia, Voice of 12015eu		
1500	1530		UK, BBC World Service	11860af	15420af
			17885af		
1500	1530	fs	UK, Bible Voice	13840as	
1500	1545		Germany, CVC The Voice Africa		9555af
1500	1545		Russia, FEBA	7320as	
1500	1545		Seychelles, FEBA	7340as	
1500	1545	a	UK, Bible Voice	15690as	
1500	1545		USA, WYFR/Family R Okeechobee FL	15770va	
1500	1557		Canada, Radio Canada Intl	11675as	15360as
			17720as		
1500	1557		China, China Radio Intl	6100af	7160as
			9800as	11965eu	13640eu
			13740na	17490eu	13685af
1500	1557		Netherlands, Radio	9345as	12080as
			15595as		
1500	1559		Canada, Radio Canada Intl	9515as	13655as
			17800as		
1500	1559		Germany, Deutsche Welle	6140eu	
1500	1559	w	UK, Bible Voice	15680as	
1500	1600		Anguilla, University Network	11775am	
1500	1600		Australia, CVC International	15795as	
1500	1600		Australia, Radio	5995pa	6080pa
			9475pa	9590pa	11660pa
					11750pa
1500	1600	as	Canada, CBC NQ SW Service	9625na	
1500	1600		Canada, CFRX Toronto ON	6070na	
1500	1600		Canada, CFVP Calgary AB	6030na	
1500	1600		Canada, CKZN St John's NF	6160na	
1500	1600		Canada, CKZU Vancouver BC	6160na	
1500	1600		Costa Rica, University Network	9725va	11870va
			13750va		
1500	1600		France, Radio France Intl	17850af	
1500	1600	a	Germany, Bible Voice BC Network		15680as
1500	1600		Germany, CVC International	15795as	
1500	1600		Germany, Overcomer Ministries		17810me
1500	1600		Japan, Radio Japan/NHK World		6190as
			7200as	9505va	9875as
1500	1600		Jordan, Radio	11690na	
1500	1600		Libya, Voice of Africa	17725af	17850af

1500	1600		21695af		
1500	1600		Malaysia, RTM/Trax FM	7295as	
1500	1600		New Zealand, Radio NZ Intl	5950pa	
1500	1600	DRM	New Zealand, Radio NZ Intl	7145pa	
1500	1600		North Korea, Voice of Korea	7570eu	9335na
			11710na	12015eu	13760eu
					15245eu
1500	1600	vi	Papua New Guinea, Wantok R. Light		7120va
1500	1600		Russia, Voice of 4965me	4975me	7370eu
			9660as	7300eu	9810eu
1500	1600		Singapore, MediaCorp Radio	6150do	
1500	1600	vi	South Africa, Channel Africa	9620af	
1500	1600		South Africa, Channel Africa	17770af	
1500	1600		UK, BBC World Service	5875eu	5965as
			5975as	6190af	6195as
			9410eu	9740as	9810as
			11920as	11940af	12095eu
			15400af	17830af	21470af
1500	1600	vi/mtwhf	UK, Sudan Radio Service	15575af	
1500	1600		USA, American Forces Radio	4319usb	5446usb
			5765usb	6350usb	7812usb
			12133usb	12759usb	10320usb
					12579usb
1500	1600		USA, KAIJ Dallas TX	13815na	
1500	1600		USA, KJES Vado NM	11715na	
1500	1600		USA, KTBN Salt Lake City UT	7505na	
1500	1600		USA, KWHR Naalehu HI	9930as	
1500	1600		USA, Voice of America	6080af	7125va
			9590va	9760va	12040va
			13735va	13795va	15105va
			15580af	17895af	15550va
1500	1600		USA, WBCQ Kennebunk ME	9330na	
1500	1600		USA, WBOH Newport NC	5920am	
1500	1600		USA, WEWN Birmingham AL	9955na	
1500	1600		USA, WHRA Greenbush ME	17650na	
1500	1600		USA, WHRI Cypress Creek SC	9840am	11785am
			13760am		
1500	1600		USA, WINB Red Lion PA	13570am	
1500	1600	smtwhf	USA, WMLK Bethel PA	9265eu	
1500	1600		USA, WRMI Miami FL	9955na	
1500	1600		USA, WTJC Newport NC	9370na	
1500	1600		USA, WWCR Nashville TN	9985na	12160na
			13845na	15825na	
1500	1600		USA, WWRB Manchester TN	9385na	11915na
1500	1600		USA, WYFR/Family R Okeechobee FL	6280va	11915na
			11830va	11910va	15750af
					17750va
1500	1600		Zambia, Christian Voice	4965af	
1500	1600	f DRM	Taiwan, Radio Taiwan Intl	9770eu	
1505	1520	m	Austria, Radio Austria Intl	13775am	
1505	1530	as	Austria, Radio Austria Intl	13775am	
1515	1530	twfh	Austria, Radio Austria Intl	13775am	
1530	1559	smhf	UK, Bible Voice	15680as	13840al
1530	1600		Bangladesh, Bangla Betar	4750as	
1530	1600	mh	Germany, Bible Voice BC Network		15680as
1530	1600	s	Germany, Bible Voice BC Network		13590me
1530	1600		Iran, Voice of the Islamic Rep	7370as	9635as
1530	1600		Pakistan, Radio	4790va	5080va
1530	1600		UAE, AWR Africa	15225as	
1530	1600		Vatican City, Vatican Radio	12065va	13765va
			15235va		
1535	1600	as	Austria, Radio Austria Intl	13755am	
1540	1600	mtwhf	Germany, Bible Voice BC Network		13590me
1540	1600	t	UK, Bible Voice	13590me	
1545	1600	mtwhf	Austria, Radio Austria Intl	13755am	
1545	1600	a	UK, Bible Voice	13590me	

1600 UTC - 11AM EST / 10AM CST / 8AM PST

1600	1615	mtwhf	Germany, Bible Voice BC Network		13590me
1600	1615		Pakistan, Radio	4790va	5022va
			11570va	12105va	15725va
1600	1615	mwf	UK, Bible Voice	13590me	
1600	1620	mtwh	Moldova, Radio DMR Pridnestrovye		5965eu
1600	1627		Czech Rep, Radio Prague	5930eu	17485af
1600	1627		Iran, Voice of the Islamic Rep	7370as	9635as
1600	1628	s	Hungary, Radio Budapest	6025eu	9565eu
1600	1628		Vietnam, Voice of 7280va	9550va	9730va
			11630va	13860va	
1600	1630		Guam, AWR/KSDA 11640as	11680as	
1600	1630		Jordan, Radio	11690na	
1600	1630		Myanmar, Radio	9730do	
1600	1630	as	Swaziland, TWR	6070af	
1600	1640	f	Moldova, Radio DMR Pridnestrovye		5965eu
1600	1645	h	UK, Bible Voice	13590me	
1600	1645		USA, WYFR/Family R Okeechobee FL	11830va	
			11865va	17750va	
1600	1650		New Zealand, Radio NZ Intl	5950pa	
1600	1650	DRM	New Zealand, Radio NZ Intl	7145pa	
1600	1658		Germany, Deutsche Welle	6170as	9795as
			11695as		
1600	1700		Anguilla, University Network	11775am	
1600	1700		Australia, CVC International	15795as	
1600	1700		Australia, Radio	5995pa	6080pa
			9475pa	9710pa	11660as

1600	1700	a	Canada, CBC NQ SW Service	9625na	
1600	1700		Canada, CFRX Toronto ON	6070na	
1600	1700		Canada, CFVP Calgary AB	6030na	
1600	1700		Canada, CKZN St John's NF	6160na	
1600	1700		Canada, CKZU Vancouver BC	6160na	
1600	1700		China, China Radio Intl	6100af	9570af
			11900af	11940eu	11865eu
			17490eu		13760eu
1600	1700		Costa Rica, University Network	11870va	13750va
1600	1700		Egypt, Radio Cairo	11740af	
1600	1700		Ethiopia, Radio	5990af	7110af
			9560af	9704af	7165af
1600	1700		France, Radio France Intl	7170af	11615af
			15160af	15605af	17605af
1600	1700		Germany, CVC International	15795as	
1600	1700	f	Italy, IRRS	9310va	
1600	1700	s	Italy, IRRS	9310eu	
1600	1700		Malaysia, RTM/Trax FM	7295as	
1600	1700		North Korea, Voice of Korea	9990va	11545va
1600	1700	vi	Papua New Guinea, Wantok R. Light	7120va	
1600	1700		Russia, Voice of	6070as	9405as
			11755as	11985af	12055va
			15540me		12115as
1600	1700		South Korea, KBS World Radio	5975va	
1600	1700		Taiwan, Radio Taiwan Intl	11550as	
1600	1700		UK, BBC World Service	3255af	3915af
			5875eu	5975as	6190af
			7465eu	9410eu	9740as
			11820eu	11920as	12095eu
			15400af	21470af	15105af
1600	1700	ta	UK, Bible Voice	13590me	
1600	1700	vi/ mtwhf	UK, Sudan Radio Service	15575af	
1600	1700		USA, American Forces Radio	4319usb	5446usb
			5765usb	6350usb	7812usb
			12133usb	12759usb	10320usb
1600	1700		USA, KAIJ Dallas TX	13815na	
1600	1700		USA, KJES Vado NM	11715na	
1600	1700		USA, KTBN Salt Lake City UT	15590na	
1600	1700		USA, KWHR Naalehu HI	9930as	
1600	1700		USA, Voice of America	4930af	6080af
			12080af	13600af	15580af
					17895af
1600	1700		USA, WBCQ Kennebunk ME	9330na	
1600	1700		USA, WBOH Newport NC	5920am	
1600	1700		USA, WEWN Birmingham AL	6890na	
1600	1700		USA, WHRA Greenbush ME	17640na	
1600	1700		USA, WHRI Cypress Creek SC	9840am	13760am
			15285am		
1600	1700		USA, WINB Red Lion PA	13570am	
1600	1700	smtwhf	USA, WMLK Bethel PA	9265eu	
1600	1700		USA, WRMI Miami FL	9955am	
1600	1700		USA, WTJC Newport NC	9370na	
1600	1700		USA, WWCR Nashville TN	9985na	12160na
			13845na	15825na	
1600	1700		USA, WWRB Manchester TN	9385na	11915na
1600	1700		USA, WYFR/Family R Okeechobee FL	6085va	
			13695va	18980va	21455va
1600	1700		Zambia, Christian Voice	4965af	
1615	1630		Vatican City, Vatican Radio	4005eu	5885eu
			7250eu	9645eu	15595va
1615	1700	as	UK, BBC World Service	11860af	15420af
			17885af		
1615	1700	mwf	UK, Bible Voice	9430me	
1630	1659		Swaziland, TWR	6070af	
1630	1700	as	Germany, Bible Voice BC Network		9430me
1630	1700		Guam, AWR/KSDA	11975as	
1630	1700	as	Swaziland, TWR	6130af	
1630	1700	mtwhf	UK, BBC World Service		15420af
1630	1700	mtwf	UK, Bible Voice	13580me	
1630	1700	as	UK, Bible Voice	9430me	
1640	1650	mtwhfa	Turkmenistan, Turkmen Radio	4930eu	
1645	1700	mtwhf	Swaziland, TWR	6130af	
1645	1700		Tajikistan, Tajik Radio	7245as	
1651	1700		New Zealand, Radio NZ Intl	9870pa	
1651	1700	DRM	New Zealand, Radio NZ Intl	9440pa	

1700 UTC - 12PM EST / 11AM CST / 9AM PST

1700	1715	mtwhf	Swaziland, TWR	6130af	
1700	1715	t	UK, Bible Voice	13580me	
1700	1727		Czech Rep, Radio Prague	5930va	17485va
1700	1730		France, Radio France Intl	15605af	17605af
1700	1735	mwf	UK, Bible Voice	9430me	13580al
1700	1740		Moldova, Radio DMR Pridnestrovye		6205eu
1700	1745		UK, BBC World Service	6005af	9630af
1700	1750		New Zealand, Radio NZ Intl	9870pa	
1700	1750	DRM	New Zealand, Radio NZ Intl	9440pa	
1700	1759	as	UK, Bible Voice	9430me	
1700	1800		Anguilla, University Network	11775am	
1700	1800		Australia, CVC International	13635as	
1700	1800		Australia, Radio	5995pa	6080pa
			9580pa	9710pa	11880pa
1700	1800	a	Canada, CBC NQ SW Service	9625na	
1700	1800		Canada, CFRX Toronto ON	6070na	

1700	1800		Canada, CFVP Calgary AB	6030na	
1700	1800		Canada, CKZN St John's NF	6160na	
1700	1800		Canada, CKZU Vancouver BC	6160na	
1700	1800		China, China Radio Intl	9570af	9600eu
			11900af	11940eu	13760eu
1700	1800		Costa Rica, University Network	11870va	13750va
1700	1800		Egypt, Radio Cairo	11740af	
1700	1800	as	Germany, Bible Voice BC Network		13590me
1700	1800	f	Italy, IRRS	9310va	
1700	1800	s	Italy, IRRS	9310va	
1700	1800		Japan, Radio Japan/NHK World		9535va
			11970eu	15355af	
1700	1800	DRM	Japan, Radio Japan/NHK World		9770eu
1700	1800		Malaysia, RTM/Trax FM	7295as	
1700	1800		Nigeria, Voice of	15120af	
1700	1800	vi	Papua New Guinea, Wantok R. Light		7120va
1700	1800		Russia, Voice of	7370eu	9405as
			11510af	11985af	
1700	1800	as	Russia, Voice of	7390eu	11675eu
1700	1800		South Africa, Channel Africa		15235af
1700	1800		Swaziland, TWR	3200af	
1700	1800		Taiwan, Radio Taiwan Intl		15690va
1700	1800		UK, BBC World Service		3255af
			5875eu	5975as	6190af
			7465eu	9410eu	9740as
			11955as	12095af	15400af
1700	1800	vi/ mtwhf	UK, Sudan Radio Service		11705af
1700	1800		USA, American Forces Radio	4319usb	5446usb
			5765usb	6350usb	7812usb
			12133usb	12759usb	10320usb
1700	1800		USA, KAIJ Dallas TX		13815na
1700	1800		USA, KTBN Salt Lake City UT		15590na
1700	1800	as	USA, KWHR Naalehu HI		9930as
1700	1800		USA, Voice of America		4930af
1700	1800		USA, Voice of America		6080af
			15580af		15410af
1700	1800		USA, WBCQ Kennebunk ME	9330na	18910na
1700	1800		USA, WBOH Newport NC	5920am	
1700	1800		USA, WEWN Birmingham AL	6890va	15220va
1700	1800		USA, WHRA Greenbush ME	17640na	
1700	1800		USA, WHRI Cypress Creek SC	13760am	15285am
			15665am	15785am	
1700	1800		USA, WINB Red Lion PA	13570am	
1700	1800	smtwhf	USA, WMLK Bethel PA	9265eu	
1700	1800		USA, WRMI Miami FL	9955am	
1700	1800		USA, WTJC Newport NC	9370na	
1700	1800		USA, WWCR Nashville TN	12160na	13845na
			15825na		
1700	1800		USA, WWRB Manchester TN	9385na	11915na
			15250na		
1700	1800		USA, WYFR/Family R Okeechobee FL		13690va
			17795va	18980va	21455va
1700	1800		Zambia, Christian Voice	4965af	
1730	1745	mtwhf	UK, United Nations Radio	7170af	9565me
			17810af		
1730	1800		Guam, AWR/KSDA	9385as	
1730	1800		Liberia, ELWA	4760do	
1730	1800		Philippines, Radio Pilipinas		11720va
			17720va		15190va
1730	1800		Slovakia, Radio Slovakia Int	5915eu	6055eu
1730	1800		Swaziland, TWR	9500af	
1730	1800		Vatican City, Vatican Radio		11625af
			15570af		13765af
1745	1800		Bangladesh, Bangla Betar	7185eu	
1745	1800		India, All India Radio	7410eu	9445af
			9950eu	11620eu	11935af
			15075af	15155af	17670af
1751	1800		New Zealand, Radio NZ Intl		11675pa
1751	1800	DRM	New Zealand, Radio NZ Intl		13840pa

1800 UTC - 1PM EST / 12PM CST / 10AM PST

1800	1815	t	UK, Bible Voice	13590me	
1800	1828		Vietnam, Voice of	5955eu	7280va
1800	1830		Austria, AWR Europe		15315af
1800	1830		South Africa, AWR Africa		3215af
			11830af		3345af
1800	1830		UK, BBC World Service	9740as	
1800	1830	as	UK, Bible Voice	13590me	13810al
1800	1830	whf	UK, Bible Voice	11710me	
1800	1830		USA, Voice of America	6080af	15410af
			15580af	17895af	
1800	1830	as	USA, Voice of America	4930af	
1800	1845		USA, WYFR/Family R Okeechobee FL		17535va
1800	1856		Romania, Radio Romania Intl	7120eu	9640eu
1800	1857		Netherlands, Radio	6020af	7395af
			9895af	11655af	
1800	1859		Canada, Radio Canada Intl	9530af	11765af
			13730af	15255af	
1800	1859		Poland, Radio Polonia	6015eu	7130eu
1800	1900		Anguilla, University Network	11775am	

1800	1900	mtwhf	Argentina, RAE	9690eu	15345eu		
1800	1900		Australia, Radio	6080pa	7240pa	9475va	
			9580pa	9710pa	11880pa		
1800	1900		Bangladesh, Bangla Betar	7185eu	6070na		
1800	1900		Canada, CFRX Toronto ON	6070na			
1800	1900		Canada, CFVP Calgary AB	6030na			
1800	1900		Canada, CKZN St John's NF	6160na			
1800	1900		Canada, CKZU Vancouver BC	6160na			
1800	1900		China, China Radio Intl	9600eu	11940eu		
			13760eu				
1800	1900		Costa Rica, University Network	11870va	13750va		
1800	1900	fas	Germany, Bible Voice BC Network	9430me			
1800	1900		Germany, Overcomer Ministries	13855af			
1800	1900		India, All India Radio	7410eu	9445af		
			9950eu	11620eu	11935af	13605af	
			15075af	15155af	17670af		
1800	1900		Italy, IRRS	9310va			
1800	1900		Liberia, ELWA	4760do			
1800	1900		Malaysia, RTM/Trax FM	7295as			
1800	1900	DRM	New Zealand, Radio NZ Intl	13840pa			
1800	1900		New Zealand, Radio NZ Intl	11675pa			
1800	1900		North Korea, Voice of Korea	7570eu	12015eu		
			13760eu	15245eu			
1800	1900	vi	Papua New Guinea, Wantok R. Light	7120va			
1800	1900		Philippines, Radio Pilipinas	11720va	15190va		
			17720va				
1800	1900		Russia, Voice of	7300eu	9430af	9745af	
			9820eu	9890eu	11510af		
1800	1900		Swaziland, TWR	3200af	9500af		
1800	1900		Taiwan, Radio Taiwan Intl	3965eu			
1800	1900		UK, BBC World Service	3255af	5875eu		
			5955as	5970eu	6190af	6195eu	
			7465eu	9410eu	11955as	12095af	
			15400af	17830af	21470af		
1800	1900	as	UK, Bible Voice	6015eu	11710al		
1800	1900		USA, American Forces Radio	4319usb	5446usb		
			5765usb	6350usb	7812usb	10320usb	
			12133usb	12759usb	12579usb		
1800	1900		USA, KAIJ Dallas TX	13815na			
1800	1900		USA, KTBN Salt Lake City UT	15590na			
1800	1900	smtwhf	USA, WBCQ Kennebunk ME	7415na			
1800	1900		USA, WBCQ Kennebunk ME	9330na	18910na		
1800	1900		USA, WBOH Newport NC	5920am			
1800	1900		USA, WEWN Birmingham AL	6890va	15220va		
1800	1900		USA, WHRA Greenbush ME	17640na			
1800	1900		USA, WHRI Cypress Creek SC	13760am	15285am		
			15665am	15785am			
1800	1900		USA, WINB Red Lion PA	13570am			
1800	1900	smtwhf	USA, WMLK Bethel PA	9265eu			
1800	1900		USA, WRMI Miami FL	9955am			
1800	1900		USA, WTJC Newport NC	9370na			
1800	1900		USA, WWCR Nashville TN	9975na	12160na		
			13845na	15825na			
1800	1900		USA, WWRB Manchester TN	9385na	11915na		
			15250na				
1800	1900		USA, WYFR/Family R Okeechobee FL	7240va			
			13690va	13800af	15750va	17795va	
			18980va				
1800	1900		Yemen, Rep of Yemen Radio	9780me			
1800	1900		Zambia, Christian Voice	4965af			
1830	1845		Israel, Kol Israel	6985va	7545va	9345va	
			17535va				
1830	1900		Bulgaria, Radio	5800eu	7500eu		
1830	1900		Sweden, Radio	6065eu			
1830	1900		UK, BBC World Service	6005af	9630af		
1830	1900		USA, Voice of America	4930af	6080af		
			15410af	15580af	17895af		
1845	1900		Congo, RTV Congolaise	4765af	5985af		

1900 UTC - 2PM EST / 1PM CST / 11AM PST

1900	1915		Congo, RTV Congolaise	4765af	5985af		
1900	1928		Vietnam, Voice of	7280va	9730va		
1900	1929	s	Germany, Universal Life	11880me			
1900	1930		Germany, Deutsche Welle	7245af	9735af		
			11690af	12025af	15275af		
1900	1930		Lithuania, Radio Vilnius	9710eu			
1900	1930		Philippines, Radio Pilipinas	11720va	15190va		
			17720va				
1900	1930	as	UK, Bible Voice	6015eu	9775al		
1900	1945		India, All India Radio	7410eu	9445af		
			9950eu	11620eu	11935af	13605af	
			15075af	15155af	17670af		
1900	1945		USA, WYFR/Family R Okeechobee FL	6085va			
1900	1950	DRM	New Zealand, Radio NZ Intl	13840pa			
1900	1950		New Zealand, Radio NZ Intl	11675pa			
1900	1957		Netherlands, Radio	7120af	7395af		
			9895af	11655af	17725na	17820af	
1900	1957	as	Netherlands, Radio	15315na	15525na		
1900	2000		Anguilla, University Network	11775am			
1900	2000		Australia, Radio	6080pa	7240pa	9500as	

1900	2000		Canada, CFRX Toronto ON	9580pa	9710pa	11880pa	
1900	2000		Canada, CFVP Calgary AB	6030na			
1900	2000		Canada, CKZN St John's NF	6160na			
1900	2000		Canada, CKZU Vancouver BC	6160na			
1900	2000		China, China Radio Intl	7295af	9440va		
			11940eu				
1900	2000		Costa Rica, University Network	11870va	13750va		
1900	2000		Egypt, Radio Cairo	15375af			
1900	2000		Eqt Guinea, Radio Africa	15190af			
1900	2000		Germany, Overcomer Ministries	13855af			
1900	2000	vi	Ghana, Ghana BC Corp	3366do	4915do		
1900	2000		Italy, IRRS	5775eu			
1900	2000		Liberia, ELWA	4760do			
1900	2000		Malaysia, RTM/Trax FM	7295as			
1900	2000	vi	Namibia, Namibian BC Corp	3270do	3290do		
			6060do	6175do			
1900	2000		Nigeria, Radio/Ibadan	6050do			
1900	2000		Nigeria, Radio/Kaduna	4770do	6090do		
1900	2000		Nigeria, Radio/Lagos	3326do	4990do		
1900	2000		Nigeria, Voice of	15120af			
1900	2000		North Korea, Voice of Korea	3560va	7100af		
			11535 9975	11535va	11910af		
1900	2000		Papua New Guinea, Catholic Radio	4960do			
1900	2000		Papua New Guinea, NBC	4890do			
1900	2000	vi	Papua New Guinea, Wantok R. Light	7120va			
1900	2000		Russia, Voice of	7195eu	9890eu	12070eu	
1900	2000	irreg/vi	Sierra Leone, SLBS 3316do				
1900	2000	vi	Solomon Islands, SIBC	5020do	9545do		
1900	2000	vi	South Africa, Channel Africa	3345af			
1900	2000		South Korea, KBS World Radio	7275eu	5975va		
1900	2000	a	Sri Lanka, SLBC	6010eu			
1900	2000		Swaziland, TWR	3200af			
1900	2000		Thailand, Radio	7155eu			
1900	2000	vi	Uganda, Radio	4976do	5026do		
1900	2000		UK, BBC World Service	3255af	5875eu		
			5955as	6005af	6190af	6195eu	
			9410eu	9630af	11955as	12095af	
			15400af	17830af			
1900	2000		UK, Bible Voice	9405af			
1900	2000		USA, American Forces Radio	4319usb	5446usb		
1900	2000		5765usb	6350usb	7812usb	10320usb	
			12133usb	12759usb	12579usb		
1900	2000		USA, KAIJ Dallas TX	13815na			
1900	2000		USA, KJES Vado NM	15385na			
1900	2000		USA, KTBN Salt Lake City UT	15590na			
1900	2000		USA, Voice of America	4930af	4940af		
			6040me	6080af	9670me	15410af	
			15445af	15580af	17895af		
1900	2000		USA, WBCQ Kennebunk ME	7415na	9330na		
			18910na				
1900	2000		USA, WBOH Newport NC	5920am			
1900	2000		USA, WEWN Birmingham AL	6890va	15220va		
1900	2000		USA, WHRA Greenbush ME	13710na			
1900	2000		USA, WHRI Cypress Creek SC	13760am	15285am		
			15665am	15785am			
1900	2000		USA, WINB Red Lion PA	13570am			
1900	2000		USA, WRMI Miami FL	9955am			
1900	2000		USA, WTJC Newport NC	9370na			
1900	2000		USA, WWCR Nashville TN	9975na	12160na		
			13845na	15825na			
1900	2000		USA, WWRB Manchester TN	9385na	11915na		
			15250na				
1900	2000		USA, WYFR/Family R Okeechobee FL	3230va			
			7370va	13800va	17795va	17845va	
			18930va	18980va			
1900	2000		Zambia, Christian Voice	4965af			
1900	2000	vi	Zimbabwe, ZBC Corp	5975do			
1930	2000	as	Germany, Bible Voice BC Network	9775af			
1930	2000		Iran, Voice of the Islamic Rep	6205eu	7205eu		
			7540af	9800af	9925af		
1930	2000		Slovakia, Radio Slovakia Int	5915eu	7345eu		
1930	2000		Turkey, Voice of	6055eu			
1930	2000	s	UK, Bible Voice	9775af			
1935	1955		Italy, RAI Intl	6035eu	9760eu		
1945	2000	mtwhf	Albania, Radio Tirana	6130eu	7465eu		
1945	2000	vi	Rwanda, Radio	6055do			
1950	2000		New Zealand, Radio NZ Intl	17675pa			
1950	2000	DRM	New Zealand, Radio NZ Intl	15720pa			
1950	2000		Vatican City, Vatican Radio	4005eu	5885eu		
			7250eu	9645eu			

2000 UTC - 3PM EST / 2PM CST / 12PM PST

2000	2020		Turkey, Voice of	6055eu			
2000	2020		Vatican City, Vatican Radio	4005eu	5885eu		
			7250eu	9645eu			
2000	2025		Israel, Kol Israel	6280va	7545va	9345va	
			15640va				
2000	2027		Czech Rep, Radio Prague	5930va	11600va		

2000	2027	Iran, Voice of the Islamic Rep	6205eu	7205eu
		7540af 9800af	9925af	
2000	2028	Hungary, Radio Budapest	3975eu	6025eu
2000	2030	Egypt, Radio Cairo	15375af	
2000	2030	Italy, IRRS	5775eu	
2000	2030	Mongolia, Voice of	12015eu	
2000	2030	South Africa, AWR Africa	9655af	
2000	2030	Swaziland, TWR	3200af	
2000	2030	UK, Bible Voice	9605va	
2000	2030	USA, Voice of America	4930af	4940af
		6080af 15410af	15445af	15580af
2000	2030	Vatican City, Vatican Radio	9755af	11625af
		13765af		
2000	2045	USA, WYFR/Family R Okeechobee FL	13690va	
		17750va		
2000	2057	Germany, Deutsche Welle	6145af	9735af
		9830af 12025af	15275af	
2000	2057	Netherlands, Radio	7120af	11655af
		15525na 17725na	17810af	
2000	2057	Netherlands, Radio	15315na	15525na
		17725na		
2000	2059	Canada, Radio Canada Intl	5850eu	7235eu
		11765eu		
2000	2059	Spain, Radio Exterior Espana	9595af	15290eu
2000	2100	Anguilla, University Network	11775am	
2000	2100	Australia, ABC NT Alice Springs	4835do	2310do
2000	2100	Australia, ABC NT Katherine	2485do	
2000	2100	Australia, ABC NT Tennant Creek	9500as	2325do
2000	2100	Australia, Radio	11880pa 12080pa	11660pa
2000	2100	Belarus, Radio	7360eu	7420eu
2000	2100	Canada, CFRX Toronto ON	6070na	
2000	2100	Canada, CFVP Calgary AB	6030na	
2000	2100	Canada, CKZN St John's NF	6160na	
2000	2100	Canada, CKZU Vancouver BC	6160na	
2000	2100	Canada, Radio Canada Intl	15325am	17765am
2000	2100	China, China Radio Intl	7295as 9440va	
		9800eu 11640af	11790eu	13630af
2000	2100	Costa Rica, University Network	13750va	
2000	2100	Eqt Guinea, Radio Africa	15190af	
2000	2100	Ghana, Ghana BC Corp	3366do	4915do
2000	2100	Indonesia, Voice of	9525as	11785pa
		15150al		
2000	2100	Italy, IRRS	5775eu	
2000	2100	Liberia, ELWA	4760do	
2000	2100	Malaysia, RTM/Trax FM	7295as	
2000	2100	Namibia, Namibian BC Corp	6060do 6175do	3290do
2000	2100	New Zealand, Radio NZ Intl	17675pa	
2000	2100	New Zealand, Radio NZ Intl	15720pa	
2000	2100	Nigeria, Radio/Ibadan	6050do	
2000	2100	Nigeria, Radio/Kaduna	4770do	6090do
2000	2100	Nigeria, Radio/Lagos	3326do	4990do
2000	2100	Nigeria, Voice of	15120af	
2000	2100	Papua New Guinea, Catholic Radio	4960do	
2000	2100	Papua New Guinea, NBC	4890do	
2000	2100	Papua New Guinea, Wantok R. Light	7120va	
2000	2100	Russia, Voice of	7195eu 9890eu	15735sa
2000	2100	Solomon Islands, SIBC	5020do	9545do
2000	2100	South Africa, Channel Africa	3345af	
2000	2100	Uganda, Radio	4976do	5026do
2000	2100	UK, BBC World Service	3255af	5875eu
		6005af 6190af	6195eu	9630af
		12095af 15400af	17830af	
2000	2100	UK, Bible Voice	9405af	
2000	2100	USA, American Forces Radio	4319usb	5446usb
		5765usb 6350usb	7812usb	10320usb
		12133usb 12759usb	12579usb	
2000	2100	USA, KAIJ Dallas TX	13815na	
2000	2100	USA, KJES Vado NM	15385na	
2000	2100	USA, KTBN Salt Lake City UT	15590na	
2000	2100	USA, WBCQ Kennebunk ME	7415na	9330na
		18910na		
2000	2100	USA, WBOH Newport NC	5920am	
2000	2100	USA, WEWN Birmingham AL	6890va	15220va
2000	2100	USA, WHRA Greenbush ME	13710na	
2000	2100	USA, WHRI Cypress Creek SC	9840am	13760am
		15285am		
2000	2100	USA, WINB Red Lion PA	13570am	
2000	2100	USA, WRMI Miami FL	9955am	
2000	2100	USA, WTJC Newport NC	9370na	
2000	2100	USA, WWCN Nashville TN	9975na	12160na
		13845na 15825na		
2000	2100	USA, WWRB Manchester TN	9385na	11915na
		15250na		
2000	2100	USA, WYFR/Family R Okeechobee FL	3230va	
		13800va 17725va 17795va	17845va	
		18980va		
2000	2100	Zambia, Christian Voice	4965af	
2000	2100	Zimbabwe, ZBC Corp	5975do	
2005	2100	Syria, Radio Damascus	9330eu	12085eu
		13610al		
2025	2045	Italy, RAI Intl	6010va	
2030	2045	Thailand, Radio	9680eu	

2030	2058	Vietnam, Voice of	7280va	9550va	9730va
		13860va			
2030	2100	Cuba, Radio Havana	9505va	11760va	
2030	2100	Sweden, Radio	6065va	7420va	
2030	2100	USA, Voice of America	4930af	6080af	
		7555af 15410af	15445af	15580af	
2030	2100	USA, Voice of America	4940af		
2045	2100	India, All India Radio	7410eu	9445eu	
		9910oc 9950eu	11620va	11715oc	
2055	2100	DRM	Vatican City, Vatican Radio	9800na	

2100 UTC - 4PM EST / 3PM CST / 1PM PST

2100	2123	Serbia, International Radio Serbia	6185eu	
2100	2130	Albania, Radio Tirana	7530eu	
2100	2130	Australia, ABC NT Katherine	2485do	
2100	2130	Australia, ABC NT Tennant Creek		2325do
2100	2130	Austria, AWR Europe	11955af	
2100	2130	Canada, CBC NQ SW Service	9625na	
2100	2130	China, China Radio Intl	11640af	13630af
2100	2130	Cuba, Radio Havana	9505va	11760va
2100	2130	South Korea, KBS World Radio		3955eu
2100	2130	Vatican City, Vatican Radio	9800na	
2100	2145	Nigeria, Radio/Ibadan	6050do	
2100	2145	USA, WYFR/Family R Okeechobee FL	4835do	13690va
		13800va 17795va	18980va	
2100	2150	New Zealand, Radio NZ Intl	17675pa	
2100	2150	New Zealand, Radio NZ Intl	15720pa	
2100	2159	Canada, Radio Canada Intl	9800na	17765na
2100	2159	Spain, Radio Exterior Espana	9595af	9840eu
2100	2200	Anguilla, University Network	11775am	
2100	2200	Australia, ABC NT Alice Springs	4835do	2310do
2100	2200	Australia, Radio	7240pa 9660pa	11650pa
		11660pa 11695pa	12080pa	13630pa
2100	2200	Belarus, Radio	7360eu	7420eu
2100	2200	Canada, CFRX Toronto ON	6070na	
2100	2200	Canada, CFVP Calgary AB	6030na	
2100	2200	Canada, CKZN St John's NF	6160na	
2100	2200	Canada, CKZU Vancouver BC	6160na	
2100	2200	China, China Radio Intl	9600eu	9800eu
		11790eu		
2100	2200	Costa Rica, University Network	13750va	
2100	2200	Eqt Guinea, Radio Africa	15190af	
2100	2200	Germany, Deutsche Welle	7280af	9615af
		11690af		
2100	2200	Ghana, Ghana BC Corp	3366do	4915do
2100	2200	Guyana, Voice of	3291do	5950do
2100	2200	India, All India Radio	9910oc	11620oc
		11715oc		
2100	2200	Italy, IRRS	5775eu	
2100	2200	Japan, Radio Japan/NHK World	6090eu 6180eu	11855ca
		21670pa		
2100	2200	Liberia, ELWA	4760do	
2100	2200	Malaysia, RTM/Trax FM	7295as	
2100	2200	Namibia, Namibian BC Corp	6060do 6175do	3290do
2100	2200	Nigeria, Radio/Kaduna	4770do	6090do
2100	2200	Nigeria, Radio/Lagos	3326do	4990do
2100	2200	North Korea, Voice of Korea	7570eu	12015eu
		13760eu 15245eu		
2100	2200	Papua New Guinea, Catholic Radio	4960do	
2100	2200	Papua New Guinea, NBC	4890do	
2100	2200	Papua New Guinea, Wantok R. Light	7120va	
2100	2200	Russia, Voice of	15735sa	
2100	2200	Rwanda, Radio	6055do	
2100	2200	Sierra Leone, SLBS	3316do	
2100	2200	South Africa, Channel Africa	3345af	
2100	2200	Syria, Radio Damascus	9330eu	12085eu
		13610al		
2100	2200	UK, BBC World Service	3255af	3915as
		5875eu 5965as	6005af	6125as
		6190af 6195va	9650eu	9660am
		11675am 15400af		
2100	2200	USA, American Forces Radio	4319usb	5446usb
		5765usb 6350usb	7812usb	10320usb
		12133usb 12759usb	12579usb	
2100	2200	USA, KAIJ Dallas TX	13815na	
2100	2200	USA, KTBN Salt Lake City UT	15590na	
2100	2200	USA, Voice of America	6080as	15580af
2100	2200	USA, WBCQ Kennebunk ME	7415na	9330na
		18910na		
2100	2200	USA, WBOH Newport NC	5920am	
2100	2200	USA, WEWN Birmingham AL	6890va	15220va
2100	2200	USA, WHRA Greenbush ME	11610na	11765na
2100	2200	USA, WHRI Cypress Creek SC	9840am	13760am
		15285am		
2100	2200	USA, WINB Red Lion PA	13570am	
2100	2200	USA, WRMI Miami FL	9955am	
2100	2200	USA, WTJC Newport NC	9370na	
2100	2200	USA, WWCN Nashville TN	9975na	12160na
		13845na 15825na		

2100	2200	USA, WWRB Manchester TN	9385na	11915na
		15250na		
2100	2200	USA, WYFR/Family R Okeechobee FL	6045va	
		11565va 17725va 17845va		
2100	2200	Zambia, Christian Voice	4965af	
2100	2200	vi Zimbabwe, ZBC Corp	5975do	
2115	2200	Egypt, Radio Cairo	15375af	
2130	2156	Romania, Radio Romania Intl	6055va	6115va
		7145va 9755va		
2130	2157	Czech Rep, Radio Prague	9410na	11600af
2130	2200	Australia, ABC NT Katherine	5025do	
2130	2200	Australia, ABC NT Tennant Creek	4910do	
2130	2200	Canada, CBC NQ SW Service	9625na	
2130	2200	DRM Netherlands, Radio	9800na	
2130	2200	Turkey, Voice of	9525as	
2150	2200	New Zealand, Radio NZ Intl	15720pa	
2151	2200	DRM New Zealand, Radio NZ Intl	17675pa	

2200 UTC - 5PM EST / 4PM CST / 2PM PST

2200	2210	Syria, Radio Damascus	9330eu	12085eu
2200	2220	Turkey, Voice of	9525as	
2200	2228	Hungary, Radio Budapest	6025eu	9535af
2200	2230	Cuba, Radio Havana	9505va	11760va
2200	2230	India, All India Radio	9910oc	11620oc
		11715oc 9950eu 11620va 11715oc		
2200	2230	Papua New Guinea, NBC	4890do	
2200	2245	Egypt, Radio Cairo	9990eu	
2200	2245	DRM USA, WYFR/Family R Okeechobee FL	15770va	
2200	2257	Netherlands, Radio	15425na	
2200	2259	Canada, Radio Canada Intl	6100na	
2200	2300	Anguilla, University Network	6090am	
2200	2300	Australia, ABC NT Alice Springs	4835do	2310do
2200	2300	Australia, ABC NT Katherine	5025do	
2200	2300	Australia, ABC NT Tennant Creek	4910do	
2200	2300	Australia, Radio	12010va 13620as 13630pa 15515pa 15230as 15240pa 17785pa	
2200	2300	Belarus, Radio	7360eu	7390eu 7420eu
2200	2300	Bulgaria, Radio	5800eu	7500eu
2200	2300	smtwhf Canada, CBC NQ SW Service	9625na	
2200	2300	Canada, CFRX Toronto ON	6070na	
2200	2300	Canada, CFVP Calgary AB	6030na	
2200	2300	Canada, CKZN St John's NF	6160na	
2200	2300	Canada, CKZU Vancouver BC	6160na	
2200	2300	DRM Canada, Radio Canada Intl	9800na	
2200	2300	China, China Radio Intl	7170eu	
2200	2300	Costa Rica, University Network	13750va	
2200	2300	Eq Guinea, Radio Africa	15190af	
2200	2300	vi Ghana, Ghana BC Corp	3366do	4915do
2200	2300	Guyana, Voice of	3291do	
2200	2300	Italy, IRRS	5785va	
2200	2300	f Italy, IRRS	5775va	
2200	2300	Malaysia, RTM/Trax FM	7295as	
2200	2300	vi Namibia, Namibian BC Corp	3270do	3290do
		6060do 6175do		
2200	2300	DRM New Zealand, Radio NZ Intl	15720pa	
2200	2300	New Zealand, Radio NZ Intl	17675pa	
2200	2300	Nigeria, Radio/Kaduna	4770do	6090do
2200	2300	Nigeria, Radio/Lagos	3326do	4990do
2200	2300	Papua New Guinea, Catholic Radio	4960do	
2200	2300	vi Papua New Guinea, Wantok R. Light	7120va	
2200	2300	irreg/ vi Sierra Leone, SLBS 3316do		
2200	2300	vi Solomon Islands, SIBC	5020do	9545do
2200	2300	Sweden, Radio	6065eu	
2200	2300	Taiwan, Radio Taiwan Intl	15600eu	
2200	2300	UK, BBC World Service	5955as 5965as	
		5975am 6195as 9740eu 15400af		
2200	2300	Ukraine, Radio Ukraine Intl	9925eu	
2200	2300	USA, American Forces Radio	4319usb 5446usb	
		5765usb 6350usb 7812usb 10320usb		
		12133usb 12759usb		
2200	2300	USA, KAIJ Dallas TX	13815na	
2200	2300	USA, KTBN Salt Lake City UT	15590na	
2200	2300	USA, Voice of America	7215va 7555as	
		11725va 15185va 15290va		
2200	2300	mtwhf USA, WBCQ Kennebunk ME	5110na 18910na	
2200	2300	USA, WBCQ Kennebunk ME	7415na 9330na	
2200	2300	USA, WBOH Newport NC	5920am	
2200	2300	USA, WEWN Birmingham AL	9975va 15745va	
2200	2300	USA, WHRA Greenbush ME	11610na 11765na	
2200	2300	USA, WHRI Cypress Creek SC	7490am 9840am	
		13760am 15285am		
2200	2300	USA, WINB Red Lion PA	13570am	
2200	2300	USA, WRMI Miami FL	7385na	
2200	2300	USA, WTJC Newport NC	9370na	
2200	2300	USA, WWCR Nashville TN	7465na 9985na	
		12160na 13845na		
2200	2300	USA, WWRB Manchester TN	9385na	11915na

2200	2300	USA, WYFR/Family R Okeechobee FL	11740va	
		15195va		
2200	2300	Zambia, Christian Voice	4965af	
2205	2230	Italy, RAI Intl	6090va	
2215	2230	Croatia, Croatian Radio	9925sa	
2230	2257	Czech Rep, Radio Prague	7345na	9415af
2230	2300	Papua New Guinea, NBC	9675do	
2230	2300	USA, Voice of America	9570va	13755va
		15145va		
2245	2300	India, All India Radio	9705as 9950as	
		11620as 11645as 13605as		

2300 UTC - 6PM EST / 5PM CST / 3PM PST

2300	0000	Anguilla, University Network	6090am	
2300	0000	Australia, ABC NT Alice Springs	4835do	2310do
2300	0000	Australia, ABC NT Katherine	5025do	
2300	0000	Australia, ABC NT Tennant Creek	4910do	
2300	0000	Belarus, Radio	7360eu	7390eu 7420eu
2300	0000	smtwhf Canada, CBC NQ SW Service	9625na	
2300	0000	Canada, CFRX Toronto ON	6070na	
2300	0000	Canada, CFVP Calgary AB	6030na	
2300	0000	Canada, CKZN St John's NF	6160na	
2300	0000	Canada, CKZU Vancouver BC	6160na	
2300	0000	China, China Radio Intl	5990am	6145na
		13680na		
2300	0000	Costa Rica, University Network	13750va	
2300	0000	Egypt, Radio Cairo	9990eu	
2300	0000	Guyana, Voice of	3291do	
2300	0000	India, All India Radio	9705as 9950as	
		11620as 11645as 13605as		
2300	0000	Malaysia, RTM/Trax FM	7295as	
2300	0000	vi Namibia, Namibian BC Corp	3270do	3290do
		6060do 6175do		
2300	0000	New Zealand, Radio NZ Intl	15720pa	
2300	0000	Papua New Guinea, Catholic Radio	4960do	
2300	0000	Papua New Guinea, NBC	9675do	
2300	0000	vi Papua New Guinea, Wantok R. Light	7120va	
2300	0000	irreg/ vi Sierra Leone, SLBS 3316do		
2300	0000	Singapore, MediaCorp Radio	6150do	
2300	0000	vi Solomon Islands, SIBC	5020do	9545do
2300	0000	UK, BBC World Service	3915as 5965as	
		5985as 6170as 11945as 11955as		
2300	0000	USA, American Forces Radio	4319usb 5446usb	
		5765usb 6350usb 7812usb 10320usb		
		12133usb 12759usb		
2300	0000	USA, KAIJ Dallas TX	13815na	
2300	0000	USA, KTBN Salt Lake City UT	15590na	
2300	0000	USA, Voice of America	7215va 7555as	
		11725va 15185va 15290va		
2300	0000	USA, WBCQ Kennebunk ME	5110na 7415na	
		9330na 18910na		
2300	0000	USA, WBOH Newport NC	5920am	
2300	0000	USA, WEWN Birmingham AL	9975va 15745va	
2300	0000	USA, WHRA Greenbush ME	11610na 11765na	
2300	0000	USA, WHRI Cypress Creek SC	7490am 9840am	
		13760am 15285am		
2300	0000	USA, WINB Red Lion PA	13570am	
2300	0000	USA, WRMI Miami FL	7385na	
2300	0000	USA, WTJC Newport NC	9370na	
2300	0000	USA, WWCR Nashville TN	7465na 9985na	
		12160na 13845na		
2300	0000	USA, WWRB Manchester TN	9385na	11915na
2300	0000	USA, WYFR/Family R Okeechobee FL	15255am	
		17750am		
2300	0000	Zambia, Christian Voice	4965af	
2300	2315	Nigeria, Radio/Kaduna	4770do	6090do
2300	2315	Nigeria, Radio/Lagos	3326do	
2300	2330	Australia, Radio	9660pa 12010pa 12080pa	
		13670va 15230va 15240va 17785va		
		17795va		
2300	2330	USA, Voice of America	9570va	13755va
		15145va		
2300	2345	USA, WYFR/Family R Okeechobee FL	11740va	
2300	2350	Turkey, Voice of	5960na	
2300	2356	Romania, Radio Romania Intl	6055va	6155va
		7105va 9610va		
2330	0000	Australia, HCJB	15390as	
2330	0000	Australia, Radio	9660pa 12010pa 12080pa	
		13670va 15230va 15390as 15415va		
		17750as 17785pa 17795va		
2330	0000	Burma, Dem Voice of Burma	5955eu	
2330	0000	Lithuania, Radio Vilnius	9875na	
2330	0000	DRM Sweden, Radio	9800na	
2330	0000	USA, Voice of America	7260va 9570va	
		13725va 13755va 15145va		
2330	2358	Vietnam, Voice of	9840as	12020as

The Navy MARISAT Satellite System

In April 1976, the U.S. Secretary of the Navy William Middendorf II, sent a very special message to the fleet:

"The transmission of this message marks the achievement of a major milestone as we move toward the realization of a real-time worldwide command and control system. Operations on the Atlantic Gapfiller represent the first major step toward improved links between our fleets and shore commands."

This was the first message sent from a shore station to a military satellite which retransmitted the message to the ships at sea. The satellite was MARISAT 101. Thus, the age of military satellite

MARISAT OVERVIEW

Commercial Services Communications Packages

1537-1541 MHz	L-band Downlink
4195-4199 MHz	C-band Downlink
3945.5/3954.5 MHz	Tracking, Telemetry and Control (TT&C)

UHF Gapfiller Characteristics

EIRP Wideband Channel	28 dBW
EIRP Narrowband Channels	23 dBW (each)
Receive G/T	-18 dB/K
UHF Antenna Coverage	19 degrees earth coverage

25-kHz Narrowband Channels

Ch	Downlink (MHz)	Uplink (MHz)
A	254.150	307.750
B	257.550	311.150

Gapfiller 500-kHz Wideband Channels

Ch	Downlink (MHz)	Uplink (MHz)
1	248.850	302.450
2	248.875	302.475
3	248.900	302.500
4	248.925	302.525
5	248.950	302.550
6	248.975	302.575
7	249.000	302.600
8	249.025	302.625
9	249.050	302.650
10	249.075	302.675
11	249.100	302.700
12	249.125	302.725
13	249.150	302.750
14	249.175	302.775
15	249.200	302.800
16	249.225	302.825
17	249.250	302.850
18	249.275	302.875
19	249.300	302.900
20	249.325	302.925

MARISAT Constellation

Satellite	Location (drift)*	Intl Desig	SSC No	Launch Date	Status
MARISAT 101	88 deg W (+3.849 W)	1976-017A	08697	2/19/1976	Retired
MARISAT 103	154 deg W (+15.746 W)	1976-053A	08882	6/9/1976	Retired
MARISAT 102	34 deg W (+0.001 E)	1976-101A	09478	10/14/1976	Backup

communications was ushered in full time to the U.S. Navy.

Three MARISAT satellites were launched into geostationary orbit from Cape Canaveral between February and October 1976, using Delta 2914 rockets manufactured by McDonnell Douglas. The satellites had a diameter of 85 inches, an overall height of 150 inches, and an in-orbit weight of 727 pounds. Hughes Aircraft, under contract to COMSAT® General, built the three multi-band communication satellites, which formed the world's first space-based maritime communications system, also known as Gapfiller. Each satellite provided communications coverage over the three major ocean areas – the Atlantic, Pacific, and Indian Oceans.

Each satellite was equipped with three transponders. The L-band transponder (1.5/1.6 GHz) was used for commercial ship-to-shore communications, while the C-band (4/6 GHz) transponder was used for commercial coast-to-coast communications links in the United States. Each satellite used C-band frequencies for satellite tracking, telemetry and command functions.

As of this writing we do not know the status of operational transponders on MARISAT 102, which is parked at 34 degrees west. Based on orbital elements and drift rates, MARISAT 101 and 103 appear to be retired from service. Only MARISAT 102 appears to be in a stabilized location in the geostationary Clarke Belt.

❖ Air Force Satellite Communications System (AFSATCOM)

AFSATCOM provides secure, reliable and survivable two-way global communications between the National Command Authority (NCA) and the national strategic nuclear forces. The AFSATCOM system is used for Emergency Action Message (EAM) dissemination, Joint Chiefs of Staff (JCS)/Commander-in-Chief (CINC) Internetting, CINC force direction message dissemination, force report back, and other high-priority user traffic dissemination.

Strategic nuclear forces include ICBM launch and control centers, B-52, B-1B and B-2 bombers, and nuclear capable submarines (SSBNs).

AFSATCOM transponders are hosted as "passengers" on other satellite systems, including the AFSATs, the Leased Satellites (LEASAT), the

Gapfiller satellites, the Satellite Data System (SDS), DSCS, the Lincoln Experimental Satellites (LES), the Package D payloads, and the Milstar satellites. The payload uses the Ultra High Frequency (UHF) portion of the frequency spectrum to provide two-way data transfer between a family of airborne and ground terminals.

The basic communications package consists of 12 AFSATCOM 5-kHz channels which are independent of other communications on their host satellites. Additionally, on the CONUS, Atlantic and Pacific AFSATs, and the CONUS (Continental US) LEASAT (Leased Satellite), there is a 500-kHz wideband channel. The AFSATCOM 5-kHz channels 11-17 are regenerative, which means that the uplink RF signal at 317-MHz containing 75 bps messages, is converted to baseband; the message bits are amplified, reshaped, and remodulated, and transmitted on the downlink at 243 MHz. Processing limits the signal to 75 bps and requires a special radio. AFSATCOM 5-kHz channels 18-22 are non-regenerative as there is no processing done other than the conversion.

On the FLTSATCOM satellites, all twelve 5-kHz narrow-band channels and the one 500-kHz wide-band channel have been dedicated to the AFSATCOM mission. Seven of the twelve 5-kHz narrow-band channels are regenerative and can only be used for 75 bps digital communications (not voice).

In addition to FLTSATCOM satellites, as mentioned above, AFSATCOM also has transponders on board other host satellites to provide coverage over the North Pole. There are two systems in use for polar coverage – the Satellite Data System (SDS) and Package D, a piggy-back payload on classified host vehicles. SDS satellites include a payload similar to the twelve-channel 5-kHz system on-board the FLTSATCOMs. However, unlike the FLTSATCOM packages, all twelve are regenerative and can only be used for 75 bps data. The Package D satellites provide a UHF package similar to the SDS satellites. Ground control of the AFSATCOM packages on these high flying orbital satellites is accomplished by the host satellite network.

A secondary communications sub-system on the DSCS III satellites consists of an AFSATCOM single channel transponder (SCT). The SCT has its own UHF transmitting and receiving antennas that can be connected to the X-band Earth coverage or MBA receiving antennas. The SCT demodulates the received uplink and then remodulates it for transmission and can also store messages for repeated transmission. The X-band uplink for this package has anti-jamming protection.

The new UHF Follow On (UFO) satellite constellation does not replace the regenerative, frequency-hopped 5-kHz channels serving the

EAM dissemination and nuclear reporting mission of AFSATCOM. The Milstar system and the EHF transponders on UFO satellites fulfill these latter requirements.

The new Milstar satellites carry four UHF AFSATCOM IIR channels and one UHF fleet broadcast channel on each satellite package. These IIR channels operate at 75 bps with the KTBCST operating at 1.2 kbps.

We will discuss some of these other military satellite platforms in future *Milcom* columns.

❖ Army Aviation Comms

Are you interested in listening to US Army aviation comms? Do you live near an Army airfield? Here is a list of Army airfields and their communications frequencies compiled from the latest Department of Defense IFR Supplement.

MT Milcom Army Air Field Frequency List All frequencies are in MHz.

Alan C. Perkinson Blackstone AAF (FT Pickett), Virginia
38.300 122.950 126.200 241.000
A.P. Hill AAF (Ft A.P. Hill), Virginia
38.500 126.200 241.000
Biggs AAF (Ft Bliss), Texas
122.700 127.900 342.250
Campbell AAF (Ft Campbell), Kentucky
65.200 120.900 128.750 278.800 285.625
Condron AAF (White Sands), New Mexico
41.500 126.950 294.600 295.200 397.700
Davison AAF (Ft Belvoir), Virginia
126.300 229.400 241.000
Dawson AAF (Camp Dawson), West Virginia
122.900
Decker AAF (Wendover), Utah
122.800
Felker AAF (Ft Eustis), Virginia
126.300 269.250
Fort Harrison AAF (Ft William Harrison), Montana
40.650 126.200
Godman AAF, Kentucky
126.800 233.700
Gray AAF (Ft Lewis), Washington
32.300 119.325 256.800
Grayling AAF, Michigan
36.500 122.800 126.200 241.000
Hagler AAF (Camp Shelby - Hattiesburg), Mississippi
126.200 241.000
Henry Post AAF (Ft Sill), Oklahoma
124.950 229.400
Hood AAF (Ft Hood), Texas
119.650 143.100 269.450 357.900
Hunter AAF, Georgia
133.550 279.575
Lawson AAF (Ft Benning), Georgia
119.050 269.525 288.275
Long Horn Auxiliary Landing Strip (Ft Hood), Texas
143.350 237.400
Mackall AAF, North Carolina
46.750 121.000 139.350 254.400 249.900
Marshall AAF (Ft Riley), Kansas
40.550 126.200 248.650
McCoy AAF (Ft McCoy), Wisconsin
38.500 41.900 46.800 124.600 241.000 247.400 363.000
Michael AAF (Dugway Proving Grounds), Utah
36.100 126.200 270.300
Muir AAF (Ft Indiantown Gap), Pennsylvania
40.900 126.200 241.000
Phillips AAF (Aberdeen Proving Grounds), Maryland
126.150 229.600 241.000
Polk AAF (Ft Polk), Louisiana
40.950 41.500 119.000 123.700 143.200 248.200 261.300 373.300
Ray S. Miller AAF (Camp Ripley), Minnesota
36.100 49.200 49.650 126.200 241.000 304.300
Robert Gray AAF (Ft Hood), Texas
30.450 38.300 38.750 120.750 143.100 241.000 285.500 357.900
Sherman AAF (Ft Leavenworth), Kansas
126.200 139.350 322.900
Short Horn Auxiliary Landing Strip (Ft Hood), Texas
143.350 237.400
Simmons AAF (Ft Bragg), North Carolina
46.750 121.000 125.900 240.625 254.400
Stallion AAF (Socorro), New Mexico
129.950 294.600 295.200

Vagabond AAF (Yakima), Washington
41.500 126.200 256.800
Wheeler Sack AAF (Ft Drum), New York
118.750 120.800 141.025 280.800 290.250 397.750
Wright AAF, Georgia
38.700 41.300 123.850 127.350 269.275 279.625

❖ Tri Service MARS HF ALE Net

I have been monitoring ALE (Automatic Link Establishment) communications on the new Tri Service MARS HF ALE network. The net appears to be picking up the level of activity almost daily and could be an interesting set of frequencies on which to monitor future MARS operations. Here are the latest frequencies I have found to be part of this net (ALE/USB): 4765.0 9303.5 11098.5 14512.5 kHz.

The following stations have been seen sounding on this network:

AFA1CC MA	
AFA1LZ NY	
NNOKBN	SC
NNOKBPIN	
NNOAR	IL
NNOTJC AZ	
NNOWKC	IL

❖ DoD FLIP Foreign Enroute/ Planning Pubs Removed

As previously reported in this column, some of the DoD FLIP enroute and planning publications have been removed from the public NGA website on October 1, 2006. The first pubs to be removed from the public website were the foreign enroute and AP sups. Here is what is missing as of press-time: AP-2/2A and AP-4/4A, Africa, ENAME, EEA, PAA

The following publications remain on the public website as of this writing:

Planning Document

AP1 North and South America, AP1A, AP1B, AP3 Pacific-Australasia-Antarctica, AP3A, General Planning (GP), and the Flight Information Handbook (FIH).

Enroute Supplements

Caribbean/South America Supplement, U.S. IFR Supplement, and the U.S. VFR Supplement.

As I have written before in this column, these DoD pubs, while they do have some old info, are much more accurate than the online FAA ATA-100 database that DoD sources told me the public could use instead. My source in DoD made a big point of saying during our phone conversation that we would still have access to military aero info via this ATA-100 database. But the facts are very clear that the FAA ATA-100 is nowhere near as comprehensive nor accurate as the DoD pubs, and, of course, they do not include any of the foreign info or planning pubs we just lost on October 1, 2006.

So, we in the milair community have suffered a major loss. To my friends across the pond in Europe, I know this has a big impact on you, especially with all the recent changes in the NATO bandplan and the 8.33 kHz spacing changes. It will also be a major impact down the road for milair monitors in the United States, since the UHF milair band (225-400 MHz) is now in a state of flux with aero service frequencies being moved around to fit what appears to be some sort of new bandplan in this frequency range.

And that does it for this month. Until next time, 73 and good hunting.

INFORMATION & ORDERING WWW.SCANCAT.COM

INTERNET DOWNLOADS AVAILABLE
ORDER TOLL FREE
888-722-6228

NEW! All-In-One COMBO CD

Reg.
ScanCat-Lite-Plus.....\$29.95
Mr. Scanner FCC Public Safety29.95
Nat-Com's FCC Scancat Files9.95
Bonus List Of Frequencies15.00
\$84.85

SPECIAL \$49.95

SCANCAT®

Since 1989, The Recognized
Leader in Computer Control

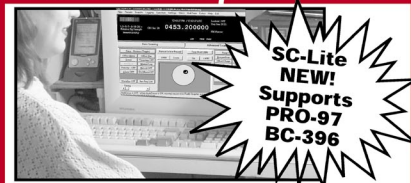

Once you use SCANCAT with YOUR radio, you'll NEVER use your radio again WITHOUT SCANCAT!

ScanCat-Lite-PLUS

Limited Time \$29.95 Intro Special

Program Your Scanner

As Easy As 1-2-3-CLICK!

SC-Lite Supports PRO-83, PRO-95, PRO-96, BC246 & over 15 more Trunking Scanners

ScanCat-Gold for Windows

Version 8.50 \$99.95

Supports all radios in ONE program - share files with all radios.

Two Scanning modules:

A Simple Basic Module - for beginners
Plus—An Advanced Scanning System for the "experts".

ScanCat-Gold for Windows-SE -

\$159.95

All the features of our "Standard Scancat" plus additional functions.

- Long term logging of frequencies to hard drive.
- Record Audio to hard drive using sound card.
- Improved spectrum analysis with several great graphical analysis screens.

Skysweep Decoder Software

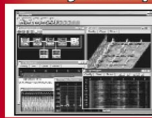

Order On Line \$99.95

Advanced Digital Signal Processing Software For HF/VHF Applications

All you need is any Windows® soundcard demo on our website



COMPUTER AIDED TECHNOLOGIES

P.O. Box 18285 Shreveport, LA 71138

ORDERS: (318) 687-4444 FAX: (318) 686-0449

Info/Tech Support: (318) 687-2555

(9 a.m. - 3 p.m. Central M-F)

INTERNET DOWNLOADS AVAILABLE
INFORMATION & ORDERING
WWW.SCANCAT.COM

Digital Debacle?

Reader Jeff Hawk asks a question that's succinct and to the point: "What is IBOC and why should I, a MW DXer, be worried about it?" I keep mentioning the mode, but as Jeff's question suggests, I've been somewhat remiss about explaining exactly why DXers find it such an important subject.

IBOC stands for "In Band On Channel." It's also known as "HD Radio." IBOC is a technology that allows regular AM/FM radio stations to transmit a digital signal at the same time as their existing analog signal, and "on the same frequency." (More on this later.)

IBOC offers several advantages to the station and its listeners. Digital transmission improves audio quality; hiss, noise, and multipath distortion are not heard on a digital broadcast. On FM stations, as many as three programs can be broadcast simultaneously on the same station. Potentially, music or talk formats not economical to broadcast on an existing station could be carried on a "HD2" or "HD3" subchannel. "Program Associated Data" is also available – the HD Radio station can broadcast text (or other) data related to the program currently on the air.

These are three good reasons why IBOC radio is a good thing. What makes it a bad thing? *Interference.*

A quick technical explanation is in order. We say that a radio station broadcasts on a specific frequency, but in fact it uses a band of frequencies. We say that WABC broadcasts on 770 kHz; in fact, it occupies a range of frequencies between 760 and 780 kHz. We say that WFMT-FM broadcasts on 98.7 MHz, but in fact it occupies a range between 98.6 and 98.8 MHz.

Moreover, some amount of "spill" outside these ranges is an inevitable result of the transmission of program material. FCC regulations allow an AM station to radiate a signal only 25dB below the "carrier" as far as 20 kHz from their center frequency – for WABC, between 750 and 790 kHz. For FM stations, this material may spread out as far as 240 kHz – for WFMT, between 98.46 and 98.94 MHz.

In the second paragraph above, I wrote that the digital signal is transmitted "on the same frequency" as the analog. That's not strictly true. If the digital signal was transmitted on the same frequency as the analog, it would interfere with the analog; you'd hear buzz, hiss, and/or other noises when trying to listen to the station on an existing analog receiver. In fact, the digital signal is transmitted in these "spill" areas. For an AM station, the digital extends between 4.9 and 14.7 kHz from the center frequency. (For WABC, between 755.3 and 765.1 kHz, and on the top side between 774.9 and 784.7 kHz) For an FM station, it extends between 129.4 and

198.4 kHz from center. (For WFMT, between 98.5 and 98.57, and on the top side between 98.83 and 98.9 MHz) In both cases, the digital signal is restricted in power to comply with this 25dB attenuation requirement.

It still looks like this shouldn't cause any problems. WABC can already radiate a signal as little as 25dB below carrier between 750 and 790 kHz; adding an IBOC signal within this range shouldn't cause any interference that isn't already happening, should it?

Well, the thing is, the FCC regulations anticipated the "spill" would be the result of the broadcast of high-pitched audio content – cymbal crashes, tenors hitting high notes, applause after a home run. This kind of material is rare and intermittent. WABC's analog "spill" may have already interfered with WJR-760, but only for a few seconds once or twice a day. Chances are most WJR listeners never even heard the interference.

The IBOC digital signal, and any interference it may cause, is continuous. It's there 100% of the time. It's as if WABC adopted an "all cymbals, all the time" format.

So, that's the problem. Even on the best receiver, IBOC-AM results in severe interference to the first adjacent channel on either side, because the digital signal is actually broadcast *in* the first adjacent channel on either side. On most receivers, interference is also present on the *second* adjacent channel on either side – in



One of the towers of WADO-1280, New York.

FCC ACTIONS

New AM station permits granted:

Albert Lea, Minn.	1100	850/230 DA-2
Huntley, Mont.	1340	250/250 ND
Kearsarge, Penna.	1590	500/900 DA-2
Essex Junction, Vt.	670	50,000/300 DA-2
Jackson, Wyo.	1450	1,000/1,000 ND

Applications for new AM stations:

Steamboat Springs, Colo.	1340	1,000/1,000 ND
Battle Mountain, Nev.	1450	250/250 ND
Tonopah, Nev.	1400	1,000/1,000 ND
Langtry, Tex.	1400	1,000/1,000 ND

Frequency changes:

CKDO-1580	Oshawa, Ont.	Moved from 1350
WFYL-1180	King of Prussia, Penna.	Moved from 1530 at McConnellsburg
WISS-1100	Berlin, Wis.	Moved from 1090
KMER-940	Kemmerer, Wyo.	Moved from 950

Canadian stations requesting moves to FM:

CFWB-1490	Campbell River, B.C.
CHQB-1280	Powell River, B.C.
CBA-1070	Moncton, N.B.
CHVO-560	Carbonear, N.L.
CJNB-1050	North Battleford, Sask.

WABC's case, on WSB-750 and a number of stations on 790 kHz. WABC is essentially operating 250-watt transmitters on 760 and 780. There are no stations authorized to operate at night on 760 or 780 in the Northeast; even at 250 watts, such stations would cause interference to WJR-760 and WBBM-780.

To the point: the problem for the AM DXer is that the AM-IBOC station not only blocks DX on its own frequency, but on two more frequencies on either side. Instead of a 50,000-watt station preventing DX on one frequency, it prevents it on five frequencies.

As of deadline for this column, the FCC prohibits nighttime IBOC operation, so the problem is nowhere near as severe as it could be. To a large degree, by the time it's dark enough at night for an IBOC station to cause much interference to DX, the FCC has required the station to shut down its digital signal. IBOC does, however, make sunrise/sunset DX more difficult – it could be daytime where the interfering station is, but dark over most of the path to your DX location, allowing the interfering digital signal to blast in. Also, some interpretations of the FCC regulations suggest AM stations may leave the IBOC on until 6pm local time, even if sunset is much earlier.

❖ More on IBOC

Back when AM stereo first came out, there were five competing technical standards. The system proposed by Leonard Kahn was the simplest of the bunch; many engineers also believed it was the best of the proposed systems. However, Motorola's system had the support of chip- and equipment-makers, and it ended up winning in the marketplace.

Kahn is now back with a system called "CAM-D." This stands for "Compatible AM – Digital." It promises to allow digital AM broadcasts *without* spilling over into adjacent frequencies. How this is accomplished is a good question, as no technical details have been released... According to the Wikipedia online dictionary, three stations are using CAM-D: KDYL-1060 Salt Lake City, and KRCM-1380 and KOLE-1340 in the Beaumont, Texas, area.

(As Bryan, W8LN writes, many engineers also believe Kahn's legal challenges to the Motorola AM stereo decision are what stunted the growth of AM stereo and resulted in its eventual demise in the marketplace. Bryan suggests "With any luck, he'll work his magic again and start a legal mess that will cause the FCC to give up on digital...")

Also on the IBOC front: Sangean is introducing two new IBOC radios. The HDR-1 is a tabletop clock radio, while the HDT-1 is a tuner designed for use with a stereo amplifier. The HDT-1 also supports Radio Data System (RDS) on analog FM stations; this technology provides the same text data system provided by "PAD" on IBOC digital stations.

According to an article in *Radio Magazine*, suggested list price for the HDT-1 is \$299. No price is given for the HDR-1 but I would expect it to be similar. Universal Radio has pages up for both sets (see the URLs below), but cannot offer either for sale until FCC approval is obtained. The *Radio Magazine* article indicates the HDT-

1 and two other IBOC sets are being offered to radio stations at special promotional prices of as little as \$99. (There's still a *long* way to go to match the price of an analog radio!)

The FCC held another open meeting in late September. IBOC was never on the agenda – there's been no further word on any plans to consider nighttime IBOC operation.

In a rather unscientific survey... checking the ads in the October 1st Nashville *Tennessean*, I find H.H. Gregg offering three analog car stereos and two Sirius sets. Best Buy is selling four analog radios (one "Satellite-Ready") and an XM receiver. Neither store is advertising HD receivers.

❖ New stations – and stations going away

It's been a busy summer on both sides of the border. The FCC has granted permits for five new AM stations; four more applications have been accepted for filing; three stations in the U.S. and one in Canada have changed frequencies; and five more Canadian stations have filed to leave the AM band altogether.

Some references may show a WLIQ-1530 in Quincy, Illinois, a frequency which has not been previously used in Quincy. However, WLIQ is *not* a new station. It moved across the Mississippi from Bowling Green, Missouri, where it was KPCR. This station is reportedly simulcasting KHMO-1070, Hannibal.

The potential move of CBA-1070 to FM is really messing with tradition (<grin>). This station went on the air in 1939 from Sackville, site of Radio Canada International. It's also your best bet for logging the Maritimes – at least it will be until it goes off the air!

❖ 750 kilowatts?

Bryan W8LN also had a question. He found a Grand Ol' Opry souvenir program from 1969 at an antique store. This flyer stated that WSM-650 had applied to increase power to 750 kilowatts. Bryan was of the impression WLW-700 was the only station to ever apply for more than 50,000 watts of power.

No, actually WLW was the only station (in the U.S.) to ever be *granted* permission to use more than 50,000 watts. From 1933 through 1939, WLW held an experimental permit to operate at 500,000 watts. The high power operation was under Special Temporary Authority; finally, in 1939, the FCC refused to renew the high power permit. Rumor has it permission was renewed occasionally for specific broadcasts during WWII. The 500 kilowatt transmitter still existed well into the 1990s, before it was finally dismantled.

According to Jeff Miller's history site, by 1938 fifteen other stations also applied for powers beyond 50 kW. You'll probably recognize almost all of them: KDKA, KFI, KNX, KSL, WBZ, WGN, WGY, WHAS, WHO, WJR, WJZ, WOAI, WOR, WSB, and WSM. (WJZ is now WABC) None of them were granted. In the 1960s, a handful of stations tried again, this time going for 750 kW instead of 500. The FCC still wasn't interested.

❖ DX!

Chris Friesen in southern Manitoba is a shortwave listener who decided to try for some of the stations listed in the August *American Bandscan* column. He succeeded with WTAM-1100, Cleveland. Using a Grundig G4000A and a 4500 kHz TTFD antenna at six feet, WTAM put in an entertainment-quality signal. Chris heard the end of the Cleveland-Seattle baseball game (Cleveland lost...) and the post-game show.

About three weeks later, Chris received a verification letter from WTAM's Regional Programming Coordinator, Cheryl Z. The letter notes WTAM is heard in "...38 states and half of Canada." (I don't think Manitoba is normally included in that half!) and that the station has been known by several other call signs over the years, including WKYC, KYW, and WWWE. (Yes, KYW was once in Cleveland. It was also once in Chicago. There's not enough room to go into that this month!)

If you receive WTAM, you can send your report to Clear Channel Radio, 6200 Oak Tree Blvd., 4th Floor, Cleveland OH 44131-2510.

❖ Till next month

IBOC hasn't caused much grief for my DXing yet – how about you? Write me at 7540 Highway 64 West, Brasstown NC 28902-0098, or by email to dougsmith@monitoringtimes.com. Good DX!

Links for this month's column:

<http://americanbandscan.blogspot.com>

My new blog
www.dxtests.info

Brandon Jordan's site covering AM DX test broadcasts

<http://members.aol.com/jeff560/jeff.html>

Jeff Miller's broadcast history site

www.ibility.com

Ibiquity, the company responsible for the HD Radio standard

www.wrathofkahn.org

Leonard Kahn's site on AM broadcasting standards

www.wikipedia.org

Wikipedia online encyclopedia

www.universal-radio.com/CATALOG/specialty/0111.html

Universal Radio's pages on Sangean's new HD/IBOC radios

www.universal-radio.com/CATALOG/specialty/0149.html

<http://beradio.com>

Radio Magazine

**DIGITAL ACCURACY
FOR VINTAGE RECEIVERS
DD-103 Universal Digital Dial**



DD-103 Universal Digital Dial Electronic Specialty Products LLC

Stop guessing what frequency you're on. Pre-programmed for many vintage receivers. Connects to the receiver VFO. Uses a TCXO for 10HZ accuracy. Selectable 10Hz or 100Hz resolution.

\$125.00 Assembled \$100.00 Kit \$10.00 S&H

ELECTRONIC SPECIALTY PRODUCTS
3054 MOORE DR., OVIEDO, FL 32765
407-366-4859, espelectronics.com

Railroads and Geography

Railroads are all about geography – where the lines run, where the trains are, and where they are going. Therefore, much of the radio traffic on railroad frequencies relates to locations.

Railroads use two main means of stating locations: Named locations and mileposts. Names are given to both stations and control points. Stations do not necessarily have to have a structure at them. Most members of the public equate a railroad station with a building. But to railroaders, that would be a station *building*. A station is simply a named location, such as a siding, a switching yard, or the end of a line. Of course, stations can also have buildings, particularly when a line has passenger traffic.

❖ Stations

In some cases, station names coincide with the names of towns. In other cases, they are unique to the railroad. For example, within the town of Glasgow, Va., on a CSX main line, you will find a station called Balcony Falls. There is no town of Balcony Falls.

While it may be obvious that a railroad may have a number of named locations within a large metropolitan area, why have a station within a small town that is different from the town's name? Because, in the case of Glasgow, Norfolk Southern (and before that, predecessor Norfolk & Western), which also runs through the town, already had a location called Glasgow.

There has long been a connecting track between the two railroads in Glasgow. So it only makes sense that the two locations have different names so that it's possible to describe a train as moving between Balcony Falls and Glasgow, rather than Glasgow on the CSX and Glasgow on the NS, which could lead to confusion.

❖ Control points

While stations can designate a passing siding, defining the distance between one main line switch and another at the opposite end, this designation works best in unswitched territory. Trains are told to proceed to the siding at Smallville and either told to hold the main line or to enter the siding. Railroad rules prescribe that, unless instructed otherwise, trains told to enter a siding always enter at the first switch encountered in their normal direction of movement.

In signaled territory, where each end of a siding now has three signals – one facing the siding, which permits trains to either proceed on the main line or to enter the siding, and one each for both the siding and main line, govern-

ing movement in the opposite direction, things get more complicated. In this case, typically, rather than the siding having a name, each end of the siding has a name. That makes it easier for everyone from signal and track maintainers to train crews to uniquely identify the location.

In other cases, control points – any location where trains may change tracks or routes, such as a junction – may simply have a numeric designation, such as the “milepost 14.7 crossovers.” (Crossovers are sets of switches in multiple track territory that allow a train to move from one main track to another main track.)

❖ Mileposts

Mileposts would appear simple, but they are not. The basic idea is to simply indicate one-mile intervals along a route, from one end to the other. But, where to begin?

Some railroads, as a matter of principle, numbered all mileposts away from their headquarters city. Others numbered east to west, or north to south, depending on the primary direction of their main route.

Obviously, if you have multiple routes, each of which has mileposts with the same numbers, you now need to differentiate between them. Most railroads not only name the divisions or subdivisions within their systems but also provide a one or two-letter designation in front of the milepost number for easy reference. The Norfolk Southern (NS) line that runs through my hometown in North Carolina is the system's H line. So, a location within this city would be milepost H-52.

Large systems inherited milepost numbers from predecessor lines and usually keep those. However, in a few cases, it was extremely confusing when two somewhat parallel lines, originating with different railroads, were numbered in opposite directions, so the railroad finally renumbered one of these lines.

There is no guarantee that railroad mileposts are exactly a mile apart, or that mileposts are necessarily consecutive. How would that happen?

When lines were first built, the goal was often to get them built as quickly and as cheaply as possible. So, the line would go around a mountain rather than tunneling through it. Later, as operating efficiencies and speed of operation became more important, alignment of lines was often changed.

So for example, a three-mile

detour around a mountain may be replaced with a one-mile segment that tunnels through the mountain. Where you initially had milepost M-233 on one side of the mountain and milepost M-236 on the other, it may be simpler to leave those designations in place and simply issue instructions that the distance between M-233 and M-236 is 1.1 miles.

Keep in mind that railroads also designate some structures such as bridges and tunnels by milepost numbers, so if mileposts were changed, all documentation affecting these structures would have to be changed.

Because of these possible discrepancies, railroads have specially designated “measured mile” segments, where the mileposts are exactly one mile apart and can be used to check locomotive speedometers and odometers.

❖ Employee and railfan timetables

How do railroad employees (and you) find out about all these things – named stations, control points, milepost numbering, and – most important to you – the radio frequencies used on a particular segment?

All of this information is contained in the employee timetable (ETT) issued by the railroad.

Yes, long ago, these timetables did contain the scheduled operating times of trains, as, under the old train-order timetable operations, scheduled trains normally had priority over unscheduled trains, and this also affected other areas of operations.

Today, however, most employee timetables do not contain any train schedules (with the possible exception of Amtrak trains). Rather, they contain much of the minutia that railroads need to operate their trains: Named locations, the length and car capacity of sidings, special instructions governing operations at particular locations, special hazards, and so on.



New employee timetables, usually covering an entire railroad division, are issued as needed, often timed to coincide with the changes between standard and daylight savings time – a throwback to when times of passenger trains were a major factor in a railroad’s operations and when passenger train schedules often changed between the winter and summer seasons.

Though employee timetables are highly prized by railfans, because they give so much insight into operations, older editions, which can often be found at railroad shows, frequently work just as well. Many of the details that change from edition to edition are of little interest to fans and others who monitor railroad operations.

Because of this, some publishers have produced “Railfan timetables” specifically for fans. These include the basic line data, such as named locations and their mileposts, locations of major tunnels and bridges, and radio frequencies. But they leave out other operational details of little interest to fans. These railfan timetables also often included maps to help orient fans. A major advantage of such timetables is that they compile route listings for several railroads in a region into a single timetable.

By far the best known publisher of such timetables, covering much of the western and central U.S., was Rob Carlson, who operated Altamont Press. Sadly, Rob, also a talented graphic artist and mapmaker, died unexpectedly earlier this year.

As Altamont Press was primarily a one-person operation, though Carlson drew on contributions from part-time workers and volunteers, the future of the company is still unclear as this is being written. Members of Carlson’s family are reportedly negotiating with interested parties for the sale of the company and future production of railfan timetables. The Altamont Press Web site (www.altamontpress.com) was still up, several months after Carlson’s death.

So, if a store near you still has Altamont Press timetables for an area where you live or where you intend to travel in stock, by all means grab them. Or, if you see used Altamont Press timetables at a railroad show, get them, too.

❖ Directions

As early operating rules distinguished between eastbound and westbound trains, or between northbound trains and southbound trains, a railroad would designate all its lines north-south or east-west. That worked fine as long as the railroad’s main line was primarily north-south or east-west, even if the line sometimes physically ran northeast or southwest.

When branches or new lines were added, their direction was assigned based on the primary directions that traffic flowed onto them or out of them at the point that they joined the existing main line. So, on a railroad where all routes were designated as east-west, a branch running north from an existing line, but whose traffic flowed mostly toward the west would have its northernmost point designated as the east end of the line.

In other words, a train originating on the west end of the main line but turning north at the junction to the branch would continue to be considered going eastbound.

Therefore, railroads distinguish between “timetable direction” and actual directions. You need to understand what directions are assigned to a line to understand which physical direction a train is going.

For example, the busiest railroad freight line in North America, BNSF’s Orin line in the Powder River Basin of Wyoming, runs essentially north-south. However, as BNSF and predecessor Burlington Northern designated lines east-west, Bridger Junction at the south end is considered the east end and Donkey Creek Junction at the north end is considered the west end.

And, to make matters worse, as the railroad’s practice is to list routes east to west, the line is listed in timetables going from south to north – the opposite direction of what you would see on a map. (Railfan timetables can list the line in the opposite direction, making it easier to pair named points with a map.)

❖ Radio History

America’s largest railroads are each licensed to operate on a dozen or more radio frequencies. Often, having a list of all frequencies available to a particular railroad may not be particularly helpful. In a large metropolitan area that is a hub for the railroad, many of these frequencies may be in use. But, you may be interested in monitoring only radio traffic for one particular line, and scanning all of these channels would end up with your scanner pausing on conversations relating to other lines. So, you miss the radio traffic related to the line of primary interest.

Here’s where some understanding of history helps. In most cases, when railroads merged, the new larger railroad simply kept the existing frequencies of the predecessor railroads. That was simpler than changing out all remote base stations or overloading any one frequency.

So, for instance, if you know that a particular Norfolk Southern line is an ex-Southern Railway line, it’s the ex-Southern frequencies you will likely find in use on that line. Similarly, if you know that the CSX line through central Virginia was once the main line of the Richmond, Fredericksburg and Potomac (RF&P), you’ll know that you will most likely find the CSX frequencies that are ex-RF&P in use there. (See the sidebar with some of the frequencies I monitor between my home in North Carolina and Washington, D.C.)

Yes, in a few cases, railroads have re-assigned frequencies as lines were consolidated, but if you know the previous operator of a line and what frequencies it used, that’s a good place to start.

❖ Narrowbanding

With increased railroad traffic, many urban centers are finding increased congestion on existing railroad frequencies, just as railroads are looking at new ways to communicate data and operational control messages. With other non-railroad frequencies also becoming more congested, gaining additional spectrum was not an option.

The Federal Communications Commission (FCC), in coordination with

the Association of American Railroads (AAR, the trade group that handles assignment of the railroad frequencies), has instead decided to add more channels within the existing railroad band. The new frequencies will be exactly halfway between the existing frequencies, which should not be a problem, with newer equipment being able to discriminate better between adjacent frequencies.

This change will not have an immediate effect, as it will take time to phase out older radio equipment. We’ll look at this further in a future column.

NC - DC SCANNER SETUP

01	Washington Terminal	160.29
02	CSX (ex-Chessie)	160.23
03	CSX (ex-Chessie)	160.32
04	CSX (ex-SCL)	160.59
05	CSX (ex-SCL)	161.10
06	CSX (ex-L&N)	161.37
07	CSX (ex-L&N/RF&P)	161.52
08	CSX (ex-RF&P)	161.55
09	CSX (ex-RF&P)	161.49
10	NS (ex-Southern)	161.92
11	NS (ex-Southern)	160.95
12	NS (ex-Southern)	160.245
13	NS (ex-NW)	161.25
14	NS (ex-NW)/Wash.Term.	160.44
15	NS	161.19
16	Amtrak (Northeast Corr.)	160.92
17	Conrail	160.80
18	Conrail	161.07
19	WEA1 Weather	162.55
20	WEA2 Weather	162.40

Notes:

Why only 20 frequencies? I originally came up with this list for an older scanner that did not have the weather frequencies pre-programmed and 20 channels filled up two banks that could be turned on and off when I was in another region. Now I use slots 19 and 20 for the frequencies of various shortlines or regional railroads.

I used these frequencies for travel between my home in North Carolina and Washington, D.C., either by car or train. Most are also in use to the south and west on CSX and Norfolk Southern lines, including, for example, South Carolina and Tennessee. This list is not all-inclusive: additional frequencies may be used in yards, shops, or by maintenance crews.

Washington Terminal (Washington, D.C.) is an Amtrak subsidiary that operates the trackage at and around Washington Union Station, including nearby yards. Prior to the formation of Amtrak, Washington Terminal was jointly owned by railroads that operated passenger trains into Washington Union Station.

Abbreviations: Chessie=Chessie System (Baltimore & Ohio and Chesapeake and Ohio); L&N=Louisville & Nashville; NS=Norfolk Southern; NW=Norfolk & Western; SCL=Seaboard Coast Line.



Successful Miscou 2006 DXpedition

From September 15th to 22nd I attended a DXpedition to Miscou Island, New Brunswick. The other participants included Jacques d'Avignon (ON), Ken Alexander (ON), and Niel Wolfish (ON). Miscou is a remote area off the northeast coast of NB. We chose this site for its remarkably quiet radio conditions and clear water path to much of Europe and Africa.

We managed to log 23 countries/ITU entities on longwave, which was a new record for us. Where else in the radio spectrum can you do that in the space of just 500 kHz, and do it during a sunspot minimum? Once again, the magic of longwave comes shining through.

Our equipment consisted of three AOR 7030+ receivers and one Drake R8, with the following antennas available via 4-way amplified splitters: a Wellbrook amplified loop, LF Engineering active antenna, and two EWE antennas oriented to favor Europe. The EWEs proved to be excellent performers, even though they were optimized for use on mediumwave. A longwave-optimized EWE is already in the works for next year. To read more about these interesting antennas, enter "EWE Antenna" in your favorite web search engine.

Table 1 shows selected longwave loggings by Jacques d'Avignon and me. We were the main longwave DXers, with Ken and Niel focusing on mediumwave broadcast stations. To see the entire logs of the DXpedition, plus more information about our trip, check out: www.dxing.info/dxpeditions/miscou2006.dx.

Table 1. Miscou, NB, Loggings

FREQ	ID	ST/PR/ITU	LOCATION
60	MSF	G	England (Time Stn.)
75	HBG	SUI	Nyon, Switzerland (Time Stn.)
77.5	DCF77	D	Mainflingen, Germany (Time Stn.)
100	LORAN		Various Loc.
122.5	CFH	NS	Halifax (Fax & Rtty)
129			Unid Carrier
145			Unid Data Bursts
153	Bdcst		Germany
153	Bdcst		Algeria
162	Bdcst		France
171	Bdcst		Morocco
177	Bdcst		Germany
183	Bdcst		Germany
189	Bdcst		Iceland
198	Bdcst		England
198	DIW	NC	Dixon
207	BDCST		Morocco
208	YSK	NU	Belcher Islands
219	ZQY	NS	Bras D'or
220	BX	QC	Blanc Sablon
221	RQM	ME	Rangeley
225	Bdcst		Poland
234	BDCST		Luxembourg

252	BDCST		Algeria
252	BDCST		Ireland
257	YR	NL	Goose Bay
257	YXR	ON	Earlton
265	JH	GRL	Qaqortoq
270	FLO	AZR	Flores
272	OLD	ME	Old Town
274	SAL	CPV	Sal
279	BDCST		Belaruskaye
298	KU	GRL	Kook Islands
305	YQ	MB	Churchill
323	SMA	AZR	Santa Maria
331	FH	GRL	Frederikshab
332	FAR	POR	Faro
332	PH	MI	Port Huron
335	YUT	NU	Repulse Bay
338	DE	MI	Detroit
338	PST	MDR	Porto Santo
344	ZIY	CYM	Georgetown
359	NA	GRL	Narsarsuaq
360	ASN	ASN	Ascension Island
369	ZDX	ATG	St Johns
371	MGL	AZR	Sao Miguel
372	OZN	GRL	Prins Christian Sound
380	FIL	AZR	Horta
382	LAR	POR	Arruda
386	CP	GRL	Constable Pt.
386	SP	SPM	St Pierre
402	MQ	SPM	Miquelon
410	LF8A		Unid-Poss. Oil Rig, North Sea
417.2	EAIETU		Unknown (Neg. Keying)
450	PPA	DOM	Puerta Plata
454			Unid Strong Signal
492	E8	NL	Natuashish

❖ What the Others are Saying

Vol. 25, No. 37 of the *ARRL Letter* reported the following longwave news: The project manager for the ARRL 500-kHz experiment, Fritz Raab, W1FR, says the 500 KC Experimental Group for Amateur Radio is still in the organizational stages but has already recorded its first two-way contact. The FCC's Office of Engineering and Technology on September 13 granted Part 5 experimental license WD2XSH to the ARRL on behalf of a group of radio amateurs interested in investigating the LF spectrum. The two-year authorization permits experimentation and research between 505 and 510 kHz (600 meters) using narrowband modes at power levels of up to 20 W effective radiated power (ERP).

"It will probably be a free for all through October as guys get their stations on the air," Raab told ARRL Headquarters. The Midwest stations will be limited to 505 to 508 kHz for the time being, and the rest can use 505 to 510 kHz. He said a couple of the WD2XSH participants got on the air the day after the license was issued, and several others activated the first week, generating a number of reception reports.

"Many are for distances of about 300 miles, of course, but some are much longer," Raab told ARRL Headquarters. He reports that W0RPK in Iowa copied the WD2XSH/20 station in Oregon



From left to right: Kevin Carey, Niel Wolfish, Ken Alexander, Jacques d'Avignon. (Photo by Ken Alexander)

early on September 26 – a distance of 1500 miles. The first QSO took place September 21 between the stations in Tennessee and North Carolina – a distance of some 300 miles.

Raab eventually would like to see at least a secondary 600-meter Amateur Radio allocation from 495 to 510 kHz. He envisions eventual use of the spectrum to provide Amateur Radio emergency communication via groundwave.

Announcement of the license grant earlier this month brought a few requests from radio amateurs interested in joining the experimental group. Raab says there are no plans to expand the group's membership, however. He does invite reception reports of transmissions made by group members at the website <http://w5jgv.com/500kcreportform.htm>.

For the time being, the WD2XSH group is only using CW. The ARRL Part 5 application had requested permission to use both CW and PSK31, but the license grant omitted the latter mode. Raab says he's working to secure permission to add PSK31 to the grant.

During October, the 21-station experimental group will develop a band plan that assigns frequencies for QRSS – very slow speed CW – as well as for CW beacons and for two-way communication, Raab said. WD2XSH participant Conrad Murray, WS4S (WD2XSH/11) reports he's transmitting a QRSS beacon on an irregular basis on 505.505 kHz from his Tennessee location.

More information is on the 500 kc Experimental Group for Amateur Radio Web site at www.500kc.com/.

❖ Up the Dial...

Want to try for beacons a little higher in the radio spectrum? Try the 10 Meter amateur beacons (28.115-28.200 MHz). You will find an extensive list of these stations on the 10-10 International website at www.ten-ten.org/. Many of these run quite low power, so they are an interesting challenge for beacon hunters.

That's it for December. I wish all readers a Merry Christmas, and joyous holiday season. I hope that you'll be able to log some special times with friends and family. See you next month!

Global Crisis Watch

Martin Schoech, European managing editor of Clandestine Radio Watch (www.Clandestineradio.com), reminds us of the "Global Crisis Watch" podcasts which were launched by CRW in May 2005. The podcasts and other video and audio clips are available at www.GlobalCrisisWatch.com.

These weekly podcasts, hosted by Richard Lafayette and Nick Grace, include news and interviews related to international conflicts and pro-democracy efforts. If you follow clandestine radio to hear another side of the news, don't overlook this site. The Global Crisis Watch website also includes audio and video from a variety of worldwide sources.

As always, Clandestine Radio Watch is the internet place to go for schedule listings, news, loggings, links, and information on how to listen to clandestine radio.

❖ Old Pirate QSLs

Once again this month we have reports of old pirate QSLs in the collection of *MT* readers. It is amazing to see the history of pirate radio emerging from these remarkable antique QSLs. Some of the better ones arrived from Bob Combs. He has a very old one from Radio Caroline. In addition, he sent in the nice card from **Radio Veronica**, which was using 8 kW from the ship antenna that we see here. NASWA Executive Director Rich D'Angelo reports that his oldest pirate verie is from **Radio Dublin**, circa 1981.

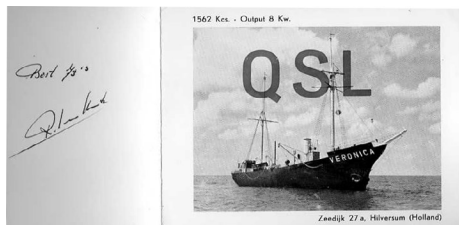

❖ Radio Cuba Libre Returns

Veteran DXers will remember the old anti-Castro clandestine with an ID of **Radio Cuba Libre**. This operation has returned to the air via a relay over WRMI. You can hear them on 9955 kHz for two hours at 0700 UTC, even though that hour is the middle of the night in Cuba.

❖ Non Clandestine

According to the Associated Press, Islamic militants closed down licensed Somalia's **Radio Jowhar** in mid-September because it was play-

ing "love songs." Thus, for the time being, in areas toward the south of Mogadishu, listeners who want to hear love songs will have to tune to pirates, clandestines, or other DX.

❖ Joe Walsh a Ham

Via *DXplorer*, veteran DXer Terry Kreuger forwards information that well known rock musician Joe Walsh of the Eagles is licensed ham, WB6ACU. According to *Rolling Stone* magazine, Walsh's current shack consists of a Collins KW-1 transmitter; a Hallicrafters model HT-32; a Multi-Elmac AF-67 exciter; a copy of *Basic Electronics Theory With Projects and Experiments*, fourth ed.; an old Racal RA6790/GM; an old National high-frequency receiver; and an old coil set, "type C."

Of course, Walsh has some connection to pirate radio, since the very active North American pirate **Take it Easy Radio** uses music by the Eagles as their theme song.

❖ What We Are Hearing

Monitoring Times readers heard sixteen different North American pirates again this month. You can hear them, too, if you use some simple techniques. Pirate radio stations never use regularly announced schedules, but short-wave pirate broadcasting increases noticeably on weekends and major holidays. In the United States, Christmas will be the next upcoming major holiday under this definition. You sometimes have to tune your dial up and down through the pirate radio band to find the stations, but more than 95% of all North American shortwave pirate broadcasts are heard on 6925 kHz, plus or minus 30 or 40 kHz.

Ann Hoffer Radio- This one features Ann herself singing with her guitar. (None known)

Altered States Radio- Recent programming from this one has combined both rock and reggae music, with audio from the old Outer Limits TV show. (Merlin)

CKLW- The pirate version of this old pioneering Windsor, Ontario rocker has returned to the air. It is a good commemorative replica of the now departed medium wave station. (None)

Dr. Who- This one is back, but recent shows have had little programming beyond IDs. (Uses drwho@yahoo.com e-mail)

KIPM- Alan Maxwell's existential drama programming remains on the air. Few other pirates devote so much effort to program production. (None; formerly used Elkhorn)

MAC Shortwave- The pirate produces a good replica of old top 40 rock formats from commercial radio. At times the "shortwave"

portion of the ID is missing. Commonly used frequencies are 6925 and 6851 kHz. (Uses macshortwave@yahoo.com e-mail)

North Woods Radio- Broadcasting "from the Great Lakes," their loon bird call noise leads into rock music and humor. They have been QSLing. (Uses northwoodsradio@yahoo.com e-mail)

Radio First Termer- This one is an entertaining commemorative program about rock music broadcast to USA troops during the Vietnam war. (None)

Robot Radio- The big hit tune on this one is a computerized robot singing Daisy, Daisy, on a bicycle built for two. This one does not replicate the September 19th "Talk Like a Pirate Day." (None known)

Take It Easy Radio- They combine various rock music (including Joe Walsh Eagles tunes and other artists) with announcements in support of American military forces. (Merlin)

The Crystal Ship- The "Voice of the Blue States Republic," a longtime veteran pirate with their announcer "The Poet," still programs classic rock and leftist political commentary on highly variable frequencies such as 6875, 1710, 3320, 6854, 6925, and 9057 kHz. (Belfast and uses tcshortwave@yahoo.com e-mail)

Touch Tone Radio- This new one gives its ID's sprinkled with tones from a telephone dialer, but its format is generally new age music. (None)

Voice of Bozo- This one mixes rock music with a discussion of attendees at the Winter SWL Festival in Kulpsville, PA. (None known)

WAIR- The call letters stand for All Indie Radio, and they claim that they QSL via carrier pigeon, a dubious method. (Good Luck with the pigeon)

WMFQ- The signature feature of this veteran pirate is its slogan, where the announcer asks where my QSL is. (Announces Providence, which is no longer valid)

WMPR- This "dance party" techno rock pirate remains mysterious, but it has been widely heard. (None; has QSLed only at the Winter SWL Festival)

❖ QSLing Pirates

Reception reports to pirate stations require three first class stamps for USA maildrops or \$2 US to foreign locations, especially in Europe where the value of the US dollar has plunged considerably. The cash defrays postage for mail forwarding and a souvenir QSL to your mailbox. Letters go to these addresses, identified above in parentheses: PO Box 1, Belfast, NY 14895; PO Box 109, Blue Ridge Summit, PA 17214; PO Box 69, Elkhorn, NE 68022; PO Box 146, Stoneham, MA 02180; 383 Kingston Avenue, Suite 94, Brooklyn NY 11213; and PO Box 293, Merlin, Ontario N0P 1W0. Unfortunately,

Continued on page 61

I've Been a VERY Good Boy!

During many of the past holiday seasons, I have posted some ideas for gift giving for hams. The kind of thing you may want to find wrapped in nice paper with a ribbon on it one winter morning. This year I have decided to kick things up a few decibels. If I was making up my list to the Big Pixie at the North Pole, what would I ask for? No...even better... what would I ask for if I had been really really *really* good this past year? What would I ask for if everyone you gave me a gift this holiday season had all won their various State Lotteries and were feeling very generous?

This holiday season, I want to give you all something to dream about. If you really could send a list and get what you wanted, what would it be? Your ideas about this may vary, but for me, the following list would be just about the best HF station I could ever hope to find under my tree.

TEN TEC ORION II TRANSCEIVER
\$3995.99
1185 Dolly Parton Parkway
Sevierville, TN 37862
Phone: (865) 453-7172
<http://radio.tentec.com>



If I can't build it myself, I would prefer a radio made by the engineers at Ten Tec. Over the years I have had the privilege to own or operate many fine Ten Tec rigs. For me, in place of sugar plums dancing in my head on a December evening, I envision the TFT color display of Ten Tec's top of the line transceiver. Ten Tec combines their years of building uncompromising HF equipment with the latest science in both audio and RF digital signal processing to produce my idea of a DX Dream Machine. The list of features would well exceed the scope of this column. But let me point out a few that really stand out for me.

A good place to start would be Ten Tec's superb transmit audio. The SSB "voice" can be fully equalized and there are 18 selectable transmit bandwidths. You can dial in your audio for tough contest conditions or easy arm chair rag chewing.

Many modern high performance transceivers now come with dual receivers instead of just dual VFOs. Ten Tec goes many of its competitors one better with fully integrated diversity reception. In addition to using dual receive for spotting and

contest activity, you can use the diversity reception feature to really reel in a weak signal, especially in these propagationally challenged times at the bottom of the solar cycle. This feature also blends quite nicely with Ten Tec's panoramic stereo receive functions. This function allows for true binaural reception.

Add a few of their roofing filters (You can bet I'll want the 250 Hz filter installed for playing CW) and you can hear everything there is to hear. And once you can hear 'em, the rest of the toys on my list will make sure you can work 'em!

ALPHA 9500 LINEAR AMPLIFIER
\$8950
Alpha Radio Products, LLC
6185 Arapahoe Rd.
Boulder, Colorado 80303
Phone (303)473-9232
www.alpharadioproducts.com



Okay, this item on my wish list is guaranteed to get me thrown out of the QRP Amateur Radio Club. But since this is a dream station, why whistle when you can rock and roll! Ask most hams with serious DX or contesting experience what they think the best linear amp ever made was, and most, if not all, are likely to say the Alpha 87A. Using two Eimac 3CX800A7 triodes in grounded-grid configuration, the 87A ruled the airwaves.

Recently, Alpha announced that it was sending this well regarded workhorse out to pasture. Its replacement, the Alpha 9500, is destined to build the same reputation for uncompromising RF power as the good old 87A. You have to love the basic specifications as they are stated in the brochure. "Power Output - 1500 Watts Minimum." MINIMUM! Talk about a pileup buster. You will be able to key your mic and calmly send out your callsign, knowing full well that the station on the other end will need to turn their gain control down. You will be on a first name basis with every major contester on the planet. You'll never have to worry about holding a frequency in a contest again.

The Alpha 9500 uses the trustworthy and oh so sturdy Eimac 8877 triode. This tube has remained in continuous production for over 35 years. Quite a testimony to its popularity as well as its durability in a world that has moved to solid

state final set ups.

Controlled by no less than five separate microprocessors, the 9500 has fully automatic tuning and reliable protection circuits to keep your 8877 in peak condition. And, of course, for CW folks like me, vacuum relays providing full QSK.

GM-4 MICROPHONE
\$145
Heil Sound Ltd.
5800 North Illinois Fairview Heights, IL 62208
Phone: (618)257-3000
www.heilsound.com



Bob Heil K9EID is one of my biggest radio heroes. Essentially a self taught radio and electronics genius, he has provided the sound systems for some of the greatest bands in the world, including The Grateful Dead, The Who and The Eagles. His expertise with exceptional audio has been shared with the amateur radio community through his microphones and headsets. My dream station wouldn't be complete without one of his wonderful GM-4 mics fitted with his HC-4 "DX Dream Machine" element.

The GM-4 is optimized for SSB frequency response. I suppose I should point out here that, while the first two items on my list might well require a second mortgage or the indentured servitude of your first born, the GM-4 is not an unreasonably priced holiday gift. You could even add the SM-1 Spider Shock Mount for just \$50 more. You might want to drop a hint or two to your significant other.

Any ham station would benefit from top of the line Bob Heil sound. And every time you key the mic, you can even imagine that you're standing up there on stage next to Jerry Garcia, Joe Walsh, or Roger Daltrey, shouting down to Bob asking for "more monitor!"

VIBROPLEX BLUE RACER
\$119.95
Vibroplex
11 Midtown Park East
Mobile, AL 36606 - 4141
(800) 840.8873

Okay, so what kind of guy spends nearly as

much on a key as he does on a microphone? Well, I do! I am one of those "Old School" types who likes his ham radio nice and basic. That means CW more often than not. And if you are going to want to put out that classic CW sound, there is nothing quite like a well handled semi-automatic "bug." And there is no bug quite like the legendary Blue Racer.

Patented in 1914, but out of production since the '60s, the Blue Racer was recently restored to the Vibroplex product line at the request of folks just like me. Designed for high speed operation well into the 50 WPM range, the Blue Racer is the CW op's dream tool. Just the thing for my dream HF station.

You can spend a few dollars more and get the "deluxe" model Blue Race with a chromed base. But to a classic CW op that would be sacrilege. The Blue Racer's base should be... well... Blue!

Obviously, you can spend a lot more on a CW key if you've a mind to. (I still dream of getting Stan W9WBL to come out of retirement and build me one of his custom keys.) But nothing provides the sense of ham radio history like working the world with a Blue Racer.

Okay, now let's get this signal out into the ether. Since I sold my QRP soul when I started talking about linear amplifiers, I may as well also abandon my life long love of simple wire antennas. Remember, I have been a very very *very* good boy.

STEPPIR MONSTER IR 4 ELEMENT BEAM

\$4395
 Steppir Antennas Inc.
 23831 SE Tiger Mt Road
 Issaquah, WA 98027
 (425) 391-1999
 www.steppir.com/

You can forget about your Super Thunderbirds and your X7s. Beam antenna design took a giant leap forward when Steppir entered the market. The standard Steppir stick is an internally tunable, motor driven element structure. Essentially, the antenna changes its overall length to the specific frequency you are operating on. Apply this to beam antenna construction and you get an antenna that will always throw the maximum RF allowable by the basic laws of physics.

The Monster is the 4 element version of this innovative antenna design. Continuously tunable from 40 meters through 6 meters, this design provides maximum gain and front to back ratio. It has a 34 foot boom length and its longest element is 70 feet. It also has a 100 MPH wind rating.

Fair warning: unless your neighbors are all jealous hams, be prepared to have your lawyer argue the application of PRB-1 to your town council.



Still, it will be worth the effort. The Monster is most assuredly the Dream Beam.

Every good beam needs a tower and rotor. Let's see what we can scare up to complete this dream HF station.

HDX-572MDPL 72-ft CRANK UP TOWER
 \$10,719
 US Towers
 1099 West Ropes Ave.
 Woodlake, CA 93286
 Phone: (559) 564-6000
 www.ustower.com/

The U.S. Towers HDX series crank-up units are strong and built to last. They can handle serious weight and wind load. Just what the doctor ordered for my Steppir beam.

I chose to go with their 72' model that cranks down to just under 23' for easy servicing of both beam and rotor. This model comes with motor drive and a hinged base to further facilitate its usefulness. I am not afraid to climb a tower. I just don't enjoy the prospect during an ice storm. The U.S. Towers system is great for all around use and a super addition to my dream HF station.

M2 ORION 2800 ROTOR
 \$1598
 M2 Antenna Systems
 4403 N. Selland
 Fresno, CA 93722
 (559) 432-8873
 www.m2inc.com/



A "no compromise" antenna system needs a rotor that can stand up to the job. Designed by hams for hams, the Orion exceeds the need. With a starting torque of 3500 inch pounds and regular rotating torque of 2800 inch pounds, I wouldn't want to meet it in a dark alley late at night. It also has a 2000 pound thrust bearing and precision worm drive, eliminating the need for an antenna brake. The accompanying RC2800 control unit includes an RS-232 port for easy interfacing with computer logging systems that support rotor control.

I didn't set out to look at the world this way, but it appears that my dream station is made up essentially of U. S. made products. I would have to admit that such a result would probably not be possible if I were looking into a dream VHF/UHF station. Much of the great gear there comes from Asia. Still, it's nice to know that the U.S. is still the best when it comes to HF equipment, at least in this

author's humble opinion. So, a no compromise HF station will cost a few dollars short of \$30,000.

Santa, please remember, I have been a very very very, exceptionally, amazingly good boy this year!

N2EI, his XYL KA2BAM, his harmonics, and pets, all wish you a joyous and peaceful holiday season. I'll see you on the bottom end of 40 meters, with a much more modest station than I am dreaming of.

UNCLE SKIP'S CONTEST CALENDAR	
ARRL 160-Meter Contest	Dec 1 2200 UTC - Dec 3 1600 UTC
ARS Spartan Sprint	Dec 5 0200 UTC - 0400 UTC
ARRL 10-Meter Contest	Dec 9 0000 UTC - Dec 10 2400 UTC
NA Meteor Scatter Winter Rally	Dec 10 0000 UTC - Dec 18 0700 UTC
Russian 160 Meter Contest	Dec 15 2100 UTC - 2300 UTC
QRP ARCI Holiday Homebrew Sprint	Dec 17 2000 UTC - 2400 UTC
Stew Perry Topband Challenge (160 Meters)	Dec 30 1500 UTC - Dec 31 1500 UTC

Outer Limits continued from Page 59

PO Box 69, Elkhorn, NE 68022 is no longer a valid address.

Some pirates prefer e-mail, bulletin logs or internet web site reports instead of snail mail correspondence. The best bulletin for submitting pirate loggings with a hope that pirates might QSL is now the e-mailed *Free Radio Weekly* newsletter, still free to contributors via yukon@tm.net. A few pirates will sometimes QSL reports left on the Free Radio Network web site, at <http://www.frn.net> on the internet.

❖ Thanks

Your loggings and news about unlicensed broadcasting stations are always welcome via 7540 Highway 64 W, Brasstown, NC 28902, or via the e-mail address atop the column. We thank this month's valuable contributors: Skip Arey, Beverly, NJ; Kirk Baxter, North Canton, OH; Jerry Berg, Lexington, MA; Artie Bigley, Columbus, OH; Dean Burgess, Manchester, MA; Ross Comeau, Andover, MI; Richard Cuff, Allentown, PA; Bob Combs, NM; Gerry Dexter, Lake Geneva, WI; Rich D'Angelo, Wyomissing, PA; Bill Finn, Philadelphia, PA; Harold Frodge, Midland, MI; Nick Grace, Washington, DC; William T. Hassig, Mt. Prospect, IL; Harry Helms, Smithville, TX; Terry L. Krueger, Clearwater, FL; Ed Kusalik, Coaldale, Alberta; Chris Lobdell, Stoneham, MA; Larry Magne, Penn's Park, PA; Greg Majewski, Oakdale, CT; Will Martin, St. Louis, MO; A. J. Michaels, Blue Ridge Summit, PA; Joe Miller, Troy, MI; Mark Morgan, Cincinnati, OH; John Poet, Belfast, NY; Martin Schoech, Eisenach, Germany; John Sedlacek, Omaha, NE; Bryan Wade, Elizabethtown, KY; and Joe Wood, Greenback, TN.

Some Useful Antennas for Your Handheld

When signals are moderately strong, a random length of wire of a few inches in length plugged into our handheld scanner (HH) or handheld transceiver (HT) will often suffice for decent VHF-UHF reception and/or transmission. But sometimes it's good or even necessary to have an antenna that is somewhere close to resonant (i.e., tuned to frequency) for the band that we are using. This will usually give better performance compared to a rubber duck or random-length piece of wire.

I recently bought a used, two-band (2-meter, 440 MHz) HT. At first I didn't realize that the rubber-duck antenna that came with the HT was a one-band (2-meter) antenna rather than a dual-band antenna as the HT needed. Before I discovered that fact, the 440 MHz section of the HT seemed almost "dead." But when I made a 440 antenna for the HT, it came to life on that band. I didn't want to have to switch antennas each time I changed bands, so, as described below, I made some dual-band antennas (DBAs) for my HT. But, if you prefer, the directions given also work for making one-band antennas that will outperform a rubber duck.

❖ One Approach

One way to make a dual band antenna is to attach an element for a second band to an existing rubber duck antenna (fig. 1A). Make the new element (using bare wire or a small-diameter, bare rod) a quarter-wavelength long at

the center of the band on which you will use it. The formula for the new element's length is: L (in) = $2808/\text{freq}$ (MHz), or, in cm, $L = 7132/\text{freq}$ (MHz).

For example, the total length of the new element for 446 MHz would be $2808/446 =$ or 6.3 inches. However, remember to add enough extra length to this wire to allow you to wind it once around the old antenna where you will solder it in place. The remaining length that will then extend out from the duck should be that given by the formula above.

Adding the second element degrades the performance of the original antenna somewhat, and so spacing the second element away from the original element is essential to reduce this loss (fig. 1A). Space the antenna away from the duck as shown by the amount given by the following formulas: In inches, $S = 550/\text{freq}$ (MHz), and in cm, $S = 1397/\text{freq}$ (MHz). For 446 MHz the spacing would be: $550/446 = 1.25$ in.

The new element is attached to the duck's element near the antenna's coax connector (fig. 1A). To do this you must expose a little of the bottom of the duck's antenna element. This is done by removing a bit of the insulating cover on the duck antenna near the connector. Wrap and solder the end of the new element around the old antenna element as close to the connector as practical without touching the connector's metal shell. Be sure you solder the new element to the actual antenna element, and not to the shell of the connector.

❖ A Second Approach

A second way to make a DBA is to make both of the antenna's elements from wire "home brew" style: no rubber duck needed (Fig. 1B). Use the same formula as above for the lengths of the two elements.

Solder one end of the longer element into the recess in the back of the center pin of a purchased antenna connector. Then slide a short piece of insulating tubing over the element as shown (Fig. 1C). Install it in the connector and fill the remaining space in the connector shell around the element with non-conductive epoxy, hot glue, or other non-conductive filler to help hold the antenna upright.

The shorter of the two elements is then soldered to the longer element just above the top of the antenna connector's shell (fig. 1B). The element must not touch the connector's shell.

I made this antenna from No. 12 bare copper wire. Using soft copper wire allows bending the antenna for storage if needed.

If you use a wire whose diameter is too large to slide into the recess on the antenna connector's center pin for soldering, you can file it down a bit to fit. I also filed the top ends of my wire antennas to take off sharp edges, and then soldered a small blob of solder there to reduce the possibility of sticking myself with them.

❖ Yet Another Approach

Various manufacturers offer telescoping antennas for connectors. A telescoping antenna can be used as a multi-band antenna without any cutting, soldering, or other violence such as is needed for the first two methods above. You simply tune the antenna to the desired band by adjusting the antenna's length to a quarter wavelength for the band you want to use. Use the formula given above to determine that length.

❖ One Band Antennas that Beat a Rubber Duck

You can use the above directions to make a one-band antenna that will give improved performance over an ordinary, rubber duck antenna. Just make

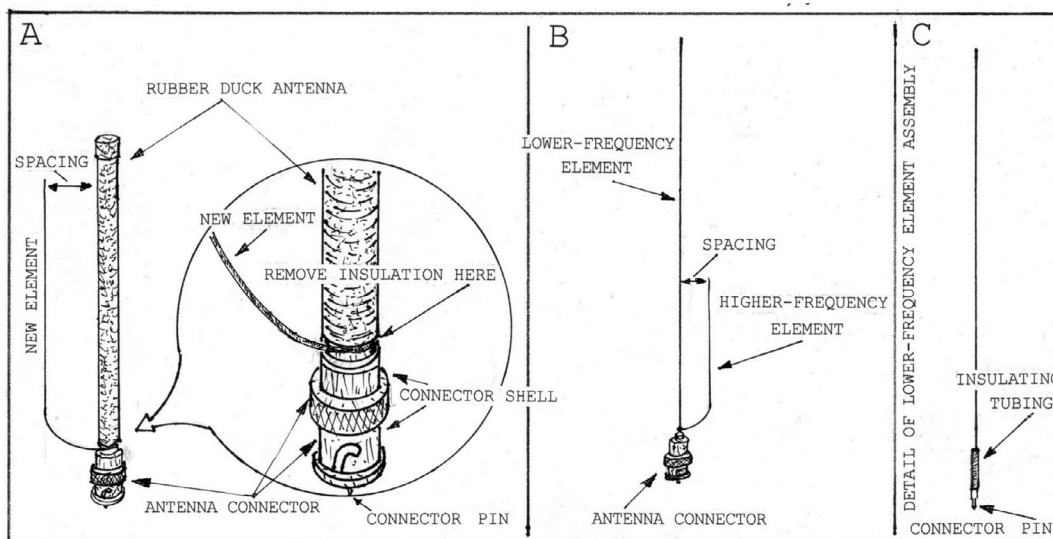

Fig. 1. A rubber duck antenna with an element added for a second band (A), a "Home-brew" two-band handheld radio antenna (B), and construction detail for the longer element of the home-brew antenna (C).

This Month's Interesting Antenna-Related Web site:

Check this one out for sure – it's a good discussion of the use of various antennas for hand-held rigs:

www.scc-ares-races.org/emergency_operations_and_ht.htm

This next site has a calculator that computes the line of sight distance for different antenna heights:

www.qsl.net/kd4sai/distance.html

The next site is a listing of the frequency limits of various short wave bands:

www.qsl.net/kd4sai/range.html

the antenna for the one band you want, and forget about adding a second band.

❖ Some General Comments

By adding a second element for a second band to a single-element antenna, you improve your ability to communicate on the second element's band. You also reduce the original antenna's first-band performance somewhat. On the other hand, the quarter wavelength elements used give better performance than does a rubber duck.

Just as for any antenna, the antennas of handheld devices are affected by their environment. So, when the antenna of a handheld device is held close to your body, it performs less well than if it's held out away from your body. For example, you may have noticed that weak signals are sometimes received better when the handheld is held away from your

body than when held close. This effect is not so noticeable with longer elements, such as the 2-meter quarter-wavelength element.

Using the quarter-wavelength formula given above will get you close to a resonant length for your antennas. That should improve performance over random wire lengths and rubber duck antennas. If you have an SWR analyzer, or if you are a ham radio operator and have an SWR meter, you can adjust your antenna lengths more precisely to resonance. Usually, however, antennas cut to the formula length are satisfactory without this adjustment.

❖ Further Possibilities

Multi-band antennas sometimes have more than two elements to permit them to cover more than two bands. I haven't tried that with hand-held antennas yet, but it should work.

RADIO RIDDLES

Last Month:

I asked: "What in the world is 'sky billiards'?" Hint: No, it's not playing pool while riding in a jet liner."

Well, we know that for long-distance skip communications, the shortwave radio signals involved propagate by "bouncing" between the earth and the ionosphere – hopefully to

reach some receiving antenna. When this kind of signal propagation was first discovered, it reminded radio operators of how billiard balls bounce between the rails of a billiard table – hopefully to reach one of the table's pockets. Thus shortwave skip propagation was sometimes called "sky billiards."

This Month:

Of what use is the line-of-sight calculator mentioned in the sidebar on interesting web sites? It is often said that communications on VHF, UHF and microwave are limited to line-of-sight distances. But is the distance that we can cover on these bands actually limited to the line-of-sight distance that you could visually see from the antenna to the distant horizon?

You'll find an answer to this month's riddle, another riddle, another antenna-related web site or so, and much more, in next month's issue of *Monitoring Times*. 'Til then Peace, DX, and 73.

Antenna Designer

New Version 2.1 for Microsoft Windows 95 and 98

Computer program helps you design and build 17 different antennas from common materials. Based on Antenna Handbook by W. Clem Small.

Only \$39.95 Send check or money order to:
 \$5 S/H on all orders Small Planet Systems
 CA residents add 8.5% 623 Mangels Avenue
 Shipped on CD ROM San Francisco, CA 94127

www.smallplanet-systems.com 415-337-9394

Listening is only half the fun...
POPULAR COMMUNICATIONS is the other half.

If you enjoy radio communications in all its variety, you'll love *Popular Communications*

Since 1982 *Pop'Comm* has delivered thousands of pages of great reading for both the radio enthusiast and the professional communicator.

Name your favorite interest... *Popular Communications* is there for you. Whether you're into Short-wave Listening, Scanner Monitoring, searching out Pirate Radio broadcasters, CB Radio, Satellite Broadcasting, ACARS, or Ham Radio; you name it, we cover it, every month.

Popular Communications
 Subscribe today and save up to 58% off the newsstand price. Save even more with two or three year subs!

YES! Enter my Subscription to Popular Communications today!

Name _____
 Address _____
 City _____ State _____ Zip _____
 () Check () MasterCard () VISA () AMEX () Discover
 Card No. _____ Expires _____
 Signature _____

	USA	Canada/Mexico	Foreign Air Post
1 Year	<input type="checkbox"/> 28.95	<input type="checkbox"/> 38.95	<input type="checkbox"/> 48.95
2 Years	<input type="checkbox"/> 51.95	<input type="checkbox"/> 71.95	<input type="checkbox"/> 91.95
3 Years	<input type="checkbox"/> 74.95	<input type="checkbox"/> 104.95	<input type="checkbox"/> 134.95

Allow 6 to 8 weeks for delivery

FOR FASTER SERVICE FAX 1-516-681-2926 MT 01

Popular Communications 25 Newbridge Road, Hicksville, NY 11801 Telephone (516) 681-2922



Those Monumental Rider's Manuals

I hate to start a column with an apology, but I do have to apologize for not being able to move along our Trans-Oceanic project this month. An orthopedic problem has been slowly creeping up on me for the past year – and has finally reached the point where it is interfering with my workbench activities. That will be resolved next week, when I enter the hospital for hip surgery. I'm assured that I'll be good as new after that, though it will take a few weeks of rehab time to fully recover. And so, for this month (and probably next) I'm having to fall back on topics that depend more on research than physical activity.

❖ **The Perpetual Troubleshooter's Manual**

Most people entering the antique radio hobby soon become preoccupied with radio schematics and servicing literature. And it takes only a visit or two to an antique radio meet to become aware of *The Perpetual Troubleshooter's Manual* – a hefty series of binders produced by John F. Rider. Those ponderous dark blue volumes with their quaint cover illustrations of an antenna strung between two towers still turn up quite frequently.

The term “perpetual” in the title comes from the fact that this was a subscription series, with new volumes released at regular intervals over the years as new radios were released by the manufacturers. The volumes vary widely in page count, ranging from a few inches in thickness to five or six, depending on how many new sets were released during the time period.

The information included on a particular ra-

dio depends on what the manufacturer decided to supply the publisher. Almost all entries include at least a schematic, parts list, and basic alignment instructions, but it is not unusual to find several pages of additional information – particularly in the case of communications receivers and other complicated sets.

The complete set contains 23 tomes covering virtually every radio manufactured from the dawn of broadcasting in the 1920s to the early 1950s, when publication ceased. The 23 volumes require maybe eight feet of shelf space – but don't hold me to this guess. I've never had the room to line up my volumes all in one place!

Here I should mention that the complete Rider's set has been offered on CD by various vendors. Obviously this could be a space-saving boon. But a word to the wise: be sure you are satisfied with the quality of the scanning before investing in a CD set. The Rider's pages contain a lot of very fine type that really requires high resolution for decent legibility. To scan the thousands of pages in a complete Rider's set takes time – a lot of time. Some producers may be tempted to cut corners here – and even eliminate entries for less common radios.

❖ **Useful Rider's Lore**

If purchasing individual books, probably volumes one through thirteen should be highest on your want list. These cover radios manufactured through about 1942, and thus include all of the “golden age” prewar sets. The earliest volumes (one through four or so) and latest ones (after about volume 16 and particularly volumes 20-23) tend to be somewhat rare and expensive.

Prices have come down a bit with the availability of the CD sets. Asking prices for the more common books in the middle of the set may range from five to ten dollars, depending on condition and the mood of the owner. As for the rest, it's whatever the traffic will bear. I had to pay 40 bucks (this was before the CD era) for the last volume (21) needed to complete my set.

Keep your eyes open for alternate versions of the early books. I was fortunate enough to be able to start my Rider's collection with the combined (and unabridged) compilation of volumes one through three that had been offered as a promotion by RCA. Known as the *RCA Redbook*, it's similar in size and design to the normal Rider books, except for its red cover and the substitution of an RCA vacuum tube for the usual antenna-and-towers logo. There's

also a one-volume abridgement of volumes one through five, with the standard Rider cover, that is cheaper and easier to find than the individual volumes.

Here's some very interesting, not commonly known Rider's information I received some years ago from A.G. Tannenbaum, the well-known source of radio schematics and data sheets. It seems that the original Rider's Manual was sold as the 1931 *Troubleshooter's Manual*. The word “Perpetual” was added to the title a little later that same year. Updates to the “Perpetual” manual were sent out to monthly subscribers. To quote John Rider directly from his September 1931 *Service Digest*, “There shall be no announcements of yearly editions of *The Perpetual Troubleshooter's Manual* by John F. Rider. The manual shall be the basic book for YEARS to come and will be kept up to date by the *Monthly Supplementary Service*.” Apparently this policy lasted only two years. In 1933, the material was reorganized for publication via periodically released volumes.

The pages in the 1931 edition were numbered consecutively from 1 to 804. The first supplement of about 50 pages was included with the manual. These pages had to be numbered 2-A, 24-A, etc for insertion into their appropriate locations in the book. Some time later, Rider abandoned this clumsy, consecutive numbering scheme. Instead, service data was grouped by manufacturer and assigned a composite number consisting of a volume number and a sequential document number. This method was used right up to the end of the service.

Additions to the 1931 manual continued monthly for at least a year. Ultimately, more than 700 pages were added. Since it was up to the user to insert the new pages and space in the binder was limited, these manuals are usually found to be incomplete.

During 1933, Rider went back and reorganized the original “Perpetual” manual for periodic release in volumes. Some of the data from that manual was put into Volume I and some into Volume II along with newly-released material. According to information published in Volume V, a complete volume I should have at least a thousand pages. Volume II should have 800 pages and Volume III should have 1185. A complete 1931 *Perpetual Troubleshooter's Manual* with all updates will have approximately 1600 pages.

The 1931 perpetual, without updates, contains only 80% of the material in Rider's I. If all updates are included, the book will contain all of the Volume I material and 70% of that in Volume

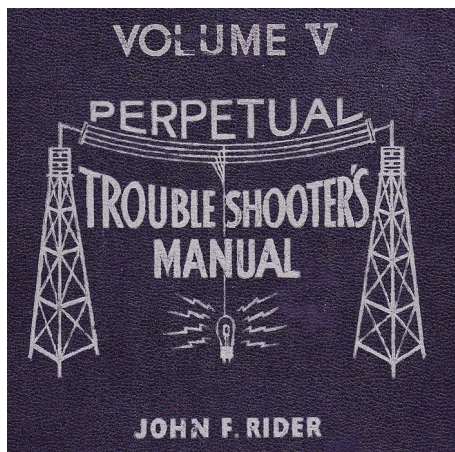

Most Rider's volumes carried this quaint antenna-and-towers logo.

II. Remember that the page numbers cannot be used as a guide for assessing the completeness of a 1931 Perpetual because the update pages referenced the original page numbers.

❖ Roadmaps to Rider's

Over the years, Rider published indexes to various individual volumes and groups of volumes in the *Perpetual Troubleshooters* series. But these don't seem to turn up as often as the books themselves. Without an index, you are reduced to a trial-and-error search for your radio of interest.

The sets are alphabetized by manufacturer in each book and, by guessing the year of manufacture of your set, you can estimate the correct volume by its copyright date. However, this is a ponderous and not always successful procedure. And you probably won't find production changes that may have been published in later years.

Reproduction Rider's indexes are available, one source being Antique Electronic Supply., www.tubesandmore.com, 6221 S. Maple Ave., Tempe, AZ 85283. At this writing, their on-line catalogue shows a Volume 1-15 index at \$21.95 and a 16-22 index at \$8.95. Though not listed in the catalogue, some years ago AES was able to supply me with a Volume 23 index for a few dollars.

If you can get your hands on a copy of *The P.R. Mallory Radio Service Encyclopedia*, Sixth Edition (1948), you'll have a very useful substitute for the official Rider indexes. This publication provides a very complete alphabetical listing of the radio receivers produced up to its release date. A recommendation is provided for the correct replacement Mallory controls, capacitors and/or vibrator to be used with each



My flea-market Mallory controls assortment came with a slot that just fit the Radio Service Encyclopedia, 6th Edition.

one.

The proper Rider's reference is shown for each set, as are two other very useful pieces of information: the i.f. peak, if the radio is a superheterodyne, and the tube complement. The latter is very useful in tracking down receivers with missing model number identification. I suspect that the Rider's references are from the Rider's index to Volume 1-15, which appeared in 1947.

Some time after purchasing the Mallory

book, I acquired a serviceman's assortment of Mallory controls housed in a special metal storage cabinet. The cabinet has a rear compartment just the right size to accept the Sixth Edition, which must have been included with the control deal. By the way, the *Rider's Manual* references may not be included in all versions of the *Encyclopedia*. A 1937 edition in my possession does not have them.

❖ Other Sources of Manufacturer's Data

You might also like to keep your eye out for a series of manuals (about seven) published by Gernsback that parallel the Rider's material, but sometimes contain additional information. Yet another series out there to be discovered is the "Most Often Needed" collection marketed by Supreme Publications.

Supreme, like Rider, published a new book each year. But the Supreme books don't provide the exhaustive coverage offered by the Rider volumes. The relatively slim, soft-cover Supreme books included only those sets considered by the editors to turn up most frequently on the radio serviceman's workbench.

The first volume, *Most-Often-Needed 1926-1938 Radio Diagrams and Servicing Information*, bears a 1941 copyright date. After that, a new manual was published every year, at least until the late 1960s, with a gap during World War II. Volume 1 was reprinted several times

Supreme's 1926-1938 volume was reprinted many times and is commonly available.

over the years and is not hard to find at antique radio meets. It's certainly a good starter book for the newcomer, but will soon be found wanting once its purchaser becomes a serious collector. To visualize how much Volume 1 *doesn't* contain, keep in mind that this half-inch-thick book covers a time span represented by perhaps three feet of Rider volumes.

Another well-known source of at least occasional interest to the antique radio collector is the *Sams Photofact* folder collection, a service that went into operation in 1946. Originally, each Sams folder contained the information for a small group of unrelated radios or TVs. To



Detail from the front cover of a Photofacts data set.

identify the proper folder, one needed a copy of the annual index. Collecting all of these folders would require an immense amount of filing cabinet space and, in any case, the service does not reach back to the years of greatest interest to the antique radio buff.

Sams is still supplying schematics and service data, and one can purchase hard copies or electronic downloads of individual schematic sets via their web site at www.samswebsite.com. I spent some time at this site trying to figure out how the Sams service worked, and I found it very confusing. However, I did learn that one can download – or use on line via a search function – a complete index of Sams service publications. I looked up the Zenith Trans-Oceanic that is our current restoration project and found that I could purchase a hard copy of the service data for \$31.25 (including shipping and handling of almost ten dollars). Pretty steep!

See you next month, probably with another "research oriented" column. The Trans-Oceanic project will resume in the February column.

Daniel Sampson's PRIME TIME SHORTWAVE

<http://www.primetimeshortwave.com>

Your guide for up-to-date English shortwave schedules sorted by time, country and frequency plus a DX media program guide and newsletter

JOIN THE AWA

Antique Wireless Association

The original and largest historical radio-collector group

- Publishes *The AWA Journal*, Marc Ellis, Editor, with:
 - Battery and AC receiver restoration
 - Vacuum-tube history and collecting
 - Old-time amateur-radio contests
 - Communications receivers
 - Free want-sell-swap ads
 - Early television
 - Horn loudspeakers
 - News of U.S. and foreign clubs



- Produces the famous annual Rochester meet
 - Maintains unique radio-TV museum
- Membership is only \$20 per year in U.S.; \$25.00 elsewhere.

Mail check to:

AWA Membership - P.O. Box 421, Dept. 2 Bloomfield, NY 14469-0421
<http://www.antiquewireless.org>
awamembership@rochester.rr.com (585) 392-3088

FREE SAMPLE COPY!

ANTIQUE RADIO CLASSIFIED

Antique Radio's Largest-Circulation Monthly Magazine

Articles - Classifieds - Ads for Parts & Services
 Also: Early TV, Ham Equip., Books, Telegraph, 40's & 50's Radios & more...

Free 20-word ad each month. Don't miss out!

1-Year: \$39.49 (\$57.95 by 1st Class)
 6-Month Trial - \$19.95. Foreign - Write.

A.R.C., P.O. Box 802-P14, Carlisle, MA 01741

Phone: (978) 371-0512; Fax: (978) 371-7129

Web: www.antiqueradio.com

Ed Note: Since we're into nostalgia, here's something a little different for this month's On the Bench – a little history, collecting, and tinkering combined!

Antique Telephones: Durable, Cheap & Still Useful!

By Ken Reitz KS4ZR

The history of communications is a road down which the further you travel the faster you move! It was the spring of 1876 and 21 years before Marconi's wireless feat when young Alexander Bell used his new invention to call to his assistant in the next room. Fast forward one hundred and thirty years: tiny, wireless cell phones with color video displays and text messaging instantly connect people worldwide.

❖ The Old Reliable Land Line

Despite electronic advances, the vast wireless cellular phone systems, or even the shaky but still functioning Iridium satellite constellation, there is still a need for the incredibly complex tangle of copper wire which is our land line telephone system. Since that first call, wire in thick cables has been strung across the continents and under the oceans. The wire itself has been upgraded through the decades and much of the cable in urban areas has been replaced with fiber optic cable capable of transmitting huge amounts of bandwidth and bringing high definition cable TV and Internet services along with traditional phone calls.



This Bakelite phone from North Electric (not to be confused with Northern Electric) circa 1936 embellished the lines of Henry Dreyfuss' Bell Telephone Labs phone and created their own classic which typically sells for \$100-250. (Courtesy: Phoneco, Inc.)

Each local telephone exchange "floats" on the power of a large number of lead acid batteries, enough to keep the exchange running during brief power outages and making it the last service to go when a weather-related catastrophe hits. When cell phone towers are toppled, lose power, or simply get overloaded with people trying to use their cell phones, the land line with its enormous capacity stays up the longest.

❖ Telco Compatibility

Because early phones didn't have dials, customers placed calls directly with the local exchange operator by lifting the "receiver" off the hook and cranking a small magneto on the side of the phone. This signaled the operator that the customer wanted to make a call. By the 1920s most phones had dials, and throughout the next 100 years operators would be gradually phased out. The phone company was one of the first to press for the introduction of automation. Today, few customers actually encounter a real operator and when you do you'll see the extraordinary charge on your bill.

The next big advancement came in 1963 with the introduction of TouchTone dialing into general service. This revolutionary concept actually uses a combination of two tones for each of the 12 buttons on the dial pad, thus the term *dual-tone multi-frequency* (DTMF) dialing. This kind of electronic keying made all sorts of calls possible, culminating in today's common "voice jail" where callers are forced to navigate a maze of options which sometimes result in having to make the call again.

One of the most interesting things about the progress of the telephone has been its "backward compatibility." Since all new phone innovations such as TouchTone dialing earned the customer additional charges on their bill, many opted to keep what they had for as long as they could. This meant that the design of the entire system had to accommodate the previous technology. That's still the way it is today: a telephone built in the 1920s, as long as it has a dial and has been outfitted with a modular plug, can still be used to make calls anywhere in the world.

❖ The Art of Phone Design

Early telephone history depicts a market free-for-all with dozens of independent companies nationwide making telephones and parts, while other companies set up local telephone exchanges to make it all work (virtually predicting the computer/Internet market development of the 1990s). Since the phones were leased, the customer had no say in what was installed; however, the engineers at Bell Telephone Laboratories (BTL) were keen to constantly improve their design. The actual design of the phones followed what we've come to know as "ergonomics," designing for comfort and use. All manner of materials were used: wood, Bakelite, steel, brass, and even cast aluminum as early as 1930.

Every facet of the telephone was examined.

Extensive tests proved, for instance, that putting the numbers on the outside of the dial made dialing a phone number faster*; the tones emitted from the two bells in the ringer were tinkered with; the curve of the handset was flattened to allow shoulder cradling; a hand hold was created to allow moving the phone while talking without risking a disconnect.

Competition among the independent manufacturers was fierce, and noted industrial designers were brought in to make art of these modern tools. Henry Dreyfuss Associates, premier industrial designers since 1929 (and still around today www.hda.net) had a hand in many designs. By 1937, Dreyfuss himself was working with BTL engineers in the design for the award winning 302 style telephone (see photo). That style remained virtually unchanged until after the end of World War II when the model 500 was introduced. But, Dreyfuss didn't have a monopoly on design and many other smaller companies produced classics of their own.

Many telephone companies started out in the early days of the industry, but most were either absorbed by other manufacturers or went out of business. Throughout the decades American Telephone & Telegraph (AT&T) emerged as the dominant player in the industry until the legality of its monopoly was successfully challenged. At the start of 1984 a Federal court had ordered the divestiture



Western Electric 202 said to be a Dreyfuss design before he went to Bell Labs. Typically sells for around \$300. (Courtesy: Phoneco, Inc.)



Once thought to be the look of the telephone of the future, this Ericofone from 1955 is of Swedish design, has a dial in the bottom and comes in assorted colors. For \$50 more you can have a TouchTone pad installed. (Courtesy: Phoneco, Inc.)

of AT&T (known more or less affectionately as Ma Bell) into seven regional companies (known more or less pejoratively as "baby bells"). One year later AT&T began production of residential telephones in Hong Kong. That signaled the end of American telephone production.



How to tell an obsession: Just like radio collectors the Old Phoneman's basement is full. (Courtesy: oldphoneman.com)

❖ Starting Your Own Collection

Today, most people use cordless phones which "talk" to a base unit (which is plugged into the land line system), via an RF link in the MHz or GHz range. They're inexpensive, small, and versatile. They come packed with features Bell wouldn't have dreamed of: a built-in answering machine, speaker phone, caller ID, call waiting ID, speed dialing, and more. But they also have a big problem: When the power goes out, they don't work.

So, before you lay out another dime for a cheap plug-in phone to use when the power goes out, why not go for something a little more exotic? Look in second hand shops, junk shops, antique stores, yard sales, and flea markets. You'll be amazed at what you can find. Years ago I paid \$10 for a 1942 Western Electric phone with steel base and Bakelite handset now selling in the catalogs for \$200. Just last year my wife picked up two desk phones, one from the 1970s and the other a beautiful 1936 North Electric solid Bakelite phone in perfect condition. Her price? \$45 for both. The North Electric phone alone is now selling for \$250 in the catalogs in similar condition.

You have to pay attention, because there are a number of recently made phones imported from China which are made to look like real retro phones but aren't. Vintage retro phones have rotary dials, not push buttons, arranged around a circle where the dial would be. Except for European-built phones, all real retro phones have identifying marks on the bottom, usually etched in the steel plate where the make and model number is easily read; they also typically say "made in U.S.A." Even so, real phones may not be totally original. You may find that the stiff wire handset cord has been replaced with a modern coiled cord. A handset may not be original to the base. Some phones may have been painted. Expect to pay between \$5 and \$50 for a working retro phone in good condition.

You may have to convert your phone to a modular plug, but all the parts are still found at

Radio Shack. If the diagram for conversion isn't on the package, check out the vintage article from *Mother Earth News* from March 1984 listed below in the "resources." It also gives you a flavor for the disaffection many Americans had for AT&T at the time.

For more esoteric parts, such as replacements for old handset receivers and transmitters, there is one great source: Phoneco, Inc. (www.phonecoinc.com) For decades this company has been buying up dumpster loads of used phones, refurbishing the best and deconstructing the rest to make a huge inventory of parts. Their catalog of old phones is second to none. You'll find everything from genuine 1920's candlestick phones to the futuristic 1950's Ericofone. They have literally tons of "as is" phones at much lower prices and a parade of miscellaneous phone related gear and ephemera such as posters and charts. They also have an impressive list of phone related books including Ralph Meyer's *Old-Time Telephones: technology, restoration & repair*. It's the phone fanatic's bible, with an amazingly detailed history of the telephone, an in-depth explanation of phone circuits and tips on restoring phones of all ages.

Several other sources are available for vintage telephones (see resources below). While not as extensive an inventory as Phoneco, Inc., you can look to them for second or third opinions on old phone prices.

Retro-look phones are big sellers in many trendy stores and catalogs at premium prices. But, the real thing – actual antique phones – can be found for a fraction of the price and are not only useful but provide a great decorating touch and a fun conversation piece. Vintage radio collectors should look for period phones to match their radios.

** Later tests showed that, with the numbers removed, a black dial spinning against a black background also slowed down dialing because the user couldn't easily tell when the dial stopped moving. To solve that problem, a white dot was put in the center of each dial hole.*

RESOURCES

Phoneco, Inc. www.phonecoinc.com
19831 East Mill Road P.O. Box 70 Galesville, WI 54630
608-582-4124

Phone Vault www.phonevault.com
P.O. Box 770 Ocean Park, WA 98640 360-783-2057

Old Phones.com www.oldphones.com
5541 Beverly Place Pittsburgh, PA 15206 412-361-3330

Antique Telephone Repair: Steve Hilsz www.navysalvage.com/
VTS Industrial Co. 66776 E. Highway 60 (UPS) or
P.O. Box 429 (mail) Salome, AZ 85348 928-859-3595

Another collector:
The Old Phoneman www.oldphoneman.com
20425 W. 103 Terrace Olathe, KS 66061 913-782-0607

Old-Time Telephones:
Technology, Restoration, & Repair by Ralph Meyer published by McGraw-Hill and widely available.

If you get the phone bug:
Telephone Collectors International www.telephonecollectors.org publishes monthly newsletter "Singing Wires" for collectors. Lists regional collector events on web site.

Converting old style phones to modular:
www.motherearthnews.com/library/1984_March_April/Install_Your_Own_Telephone.

FREE SPEECH RADIO WBCQ Shortwave

7.415 - 9.330 - 5.110 - 18.910

wbcq.com

spacetransmissions.com



*We are the only free speech
shortwave station on the planet*



MT



REVIEW

MT's Digital TV/Big Screen Buying Guide

By Ken Reitz KS4ZR

This holiday season will see an unprecedented push for consumers to hop on the digital HDTV bandwagon. You'll see prices slashed on all sizes of HDTV sets and surround sound audio systems. Here's what to look for, what to avoid, and where to go for the information you need.

❖ HDTV Basics

There's basically no choice anymore in TV sets. The Congressional/FCC mandate for all TV stations to convert their analog transmissions to digital signals within the decade makes the old analog TV tuners obsolete. For that matter, the old cathode ray picture tube is also gone. It's been replaced by a number of flat screen displays ranging in size from 10" to 55".

However, if you purchased an analog set within the last few years and don't want to trash it in its prime, you can adapt it to receive digital TV signals by adding a digital off-air tuner. The wide-screen 16:9 aspect ratio image being transmitted can be adjusted via the tuner's menu to conform to your 4:5 analog set. In addition, you can record digital TV programs on an old fashioned VCR. Of course, the picture won't be HD, but it'll look better than the analog signal you're used to.

Prices on out-board digital tuners have dropped dramatically in the last three years. Top quality out-board set top boxes such as ProBand International's Digital Stream HD 3150+ have seen big price reductions. I found this model at Circuit City for \$230. Three years ago its less talented predecessor sold for \$350.

You've no doubt noticed that prices on small (10" to 30") flat screen TVs have also plummeted, but one reason for the low price is that many of the small units have only NTSC standard definition receivers built-in. You'll still need to get an out-board tuner to watch off-air HDTV in the ATSC (Advanced Television Stan-

dards Committee) standard.

Prices on the best big screen TVs (32" and up) have dropped by 50% over the last three years as well. Most big screen HDTV sets now have built-in digital as well as analog off-air tuners. But, not all tuners have the same capabilities. For example, some have much more useful software allowing better on-screen guides. The data transmitted from the digital off-air channel include the guide information, but not all receivers display all the data. This is just one of the things you'll need to check out in the showroom before you buy.

❖ Information Please!

One thing which has improved your chances of getting the kind of digital TV you're looking for is the widespread availability of good information. Here are just a few places to look.

Consumer Reports magazine has published details of HDTV sets including rear-projection, front-projection, LCD, and plasma sets which are available to subscribers on-line (www.consumerreports.org). You can get a lot of the details by buying the annual *Consumer Reports Buying Guide* which is published each year in December. Your local library will have back issues of the magazine and it may be worth a trip to check out the September 2006 issue, which covers the recommendations of their experts concerning plasma and LCD TVs, particularly Panasonic, Sony and Hitachi models. However, CR's model number information is often out of date. Try to determine which new models replace the ones listed.

Most web sites selling HD tuners and TV sets are short on information you really need to make an informed purchase. There is one excellent exception: Crutchfield, the national consumer electronics catalog store, has a well written tutorial on everything you need to know to get started. To access the information go here: www.crutchfieldadvisor.com/SJMOUL4BKQOS/learningcenter/home/tv.html

The Crutchfield Learning Center includes a must-read glossary of terms: How to tell an LCD from an LCoS, know the difference between 1080i and 1080p, and what in the world is "wobulation?" Now, of course, they're in the business to sell the merchandise and they don't discount the narrow range of brands they sell (mostly high-end products you're not likely



The DISH Network ViP211 delivers the most HDTV channels of either satellite TV service and most digital cable TV services. It also delivers Dolby 5.1 Surround Sound and has a built-in off-air HDTV tuner. (Courtesy: DISH Network)

to find in the discount stores), but it's a good place to get information and compare prices on similarly advertised products.

One of the best things about the Crutchfield site is the "Scratch & Dent Store." Here, catalog returns are repackaged and sold at deep discounts. I got a terrific deal years ago on a Kenwood receiver with Dolby Surround which has worked flawlessly under 24/7 operation for the last seven years. You can get to the Scratch & Dent Store via the Crutchfield site map.

To compare prices on HDTV tuners and TV sets, check out these two web sites: www.nextag.com and www.bizrate.com. Here you can compare prices on the same products available at several different retailers. Other places to look for real world information are on-line forums populated by hobbyists and enthusiasts eager to share their actual experiences. The AV Science Forum has four related forums: Local HDTV Info & Reception; HDTV Reception Hardware; HDTV Programming and HDTV Recorders. You can access all four here: www.avforum.com/avs-vb/forumdisplay.php?forumid=6. Be prepared to spend hours combing through the AVSF, as there are hundreds of thousands of posts!

High Def Forum.com (www.hidefforum.com) has an interesting on-going thread called "High Definition News & Informative Articles." Here are posted dozens of the latest articles on the subject of HDTV from all over the print world. HiDef Forum is the place you'll also see many postings from DirecTV and DISH Network subscribers who detail reception of those HD services on a huge variety of HDTV sets.



ProBand International's Digital Stream HD3150+ can turn your new analog TV into a digital set. It features Dolby 5.1 Surround Sound, lets you watch multicast programming and record to VCR or DVD. (Courtesy: Circuit City)



Even Walmart is on the HDTV bandwagon. This Pioneer stereo features 700 watts of Dolby 7.1 Surround Sound with three analog audio inputs, two digital coax audio inputs and one fiber optic input. All this for way less than \$200. (Courtesy: Walmart)

There are far too many forums to list here.

Yet another forum is the HDTV Voice (www.hdtvvoice.com). Though not as massive as the other two, I found a lot of good advice here and certainly worth the look. As with the others, you'll find topics such as what antennas work best, what to do about "plasma burn-in," what type of wide-screen set to buy, getting the most out of your audio outputs, and much more.

❖ It Doesn't Look Like HD!

Just because a TV signal is being transmitted digitally doesn't mean it's a High Definition signal. Many off-air channels are opting to transmit two, three, or even four separate channels, known as *multicasting*, on their assigned frequency. That takes away from the amount of space needed to transmit a real HD signal, so the data streams are squeezed in order to get one semi-HD channel and one or two auxiliary channels into the space available. The result is a picture resolution which more closely resembles pictures found on the highly compressed small dish or cable TV. And, depending on the set on which you're viewing, they could look even worse!

With digital cable and satellite TV you get what you pay for. In order to watch real HDTV

programming on DirecTV, DISH Network or digital cable, you'll have to have a special HDTV satellite receiver or set-top box which tunes the specially transmitted HDTV signals. Even then, only a handful of HDTV channels are actually available. Right now, DISH Network leads the pack, thanks to picking up the remains of this country's only all-HDTV satellite service (Voom) which went bankrupt over a year and a half ago. Check the channel count, extra programming fees (yes, you'll pay extra for a special

HD programming package) and extra equipment prices (you'll need a dish with an extra LNB to access the HDTV satellite) before taking the plunge. Check to see that your DVD player can output to your new screen standards. Check that your stereo can take the fiber optic inputs used for Dolby Surround Sound and that you have the right speakers to deliver the audio.

❖ Test Driving the Gear

When you go to the HDTV showroom, it's like gambling in Vegas. The odds are with the house. The sets are cranked to their limits. They're usually showing a recent movie on a high-end DVD player; screens are displayed in the "vivid" mode for enhanced contrast and sharpness; audio is passed through high-end stereos and speakers designed to rattle the walls. The salesmen and women, like the dealers in Vegas, are not your friends.

Try to look at competing sets side-by-side using the same video source; ask to see the same sets connected to an off-air antenna; watch an HD live-action sports show. This is often where the digital processing in many sets breaks down. Look for extra video inputs. Many sets now have HDMI inputs to view images directly from digital

still or video cameras. They can take signal inputs from a wide array of sources, including the Internet. Look for easy access to those inputs. Some inputs are nearly impossible to reach if you wall mount the unit. Remember that wall mounts are extra (add another \$50-100). Fiber optic cables are extra, as are "component video cables."

When buying a stereo amp here's what to look for: at least 5.1 Dolby Surround Sound (that's a left and right speaker, center speaker, left and right rear ambient sound speakers and subwoofer). A minimum of three fiber optic inputs (one each for your DVD player's audio, satellite or cable HD audio and your off-air HDTV tuner). Make sure there are additional audio inputs for other analog services such as satellite radio, MPEGII FTA radio, old-fashioned VCR or analog C-band satellite audio. Don't worry about buying matched speakers for the Surround Sound audio. I pieced my audio system together with various speakers purchased on sale at different places, and I can assure you that if I need to rattle the walls at our house I can!

❖ Final Considerations

Household penetration of HDTV is expected to hit the 50% mark at the end of this year. That's brought a number of manufacturers (mostly from China) with products that aren't quite ready for prime time. For instance, I tested a 36" HDTV set carrying the Westinghouse brand which was plagued by glitches. The price was right but the set was wrong. Similar products abound. Make sure you can return the product for a full refund, exchange, or up-grade to a different product wherever you make your purchase.

Here are a few other things you should consider: The bigger the screen, the further away you'll need to sit for comfortable viewing. Your TV viewing room may be too small for the really big screens.

Look for extra screen capabilities. Picture-in-picture is nice, but side-by-side picture-in-picture is even better: the 42" screen on the Sony Wega gives you the option of two 20" screens from two different sources (a must for sports fans!).

Digital TV reception requires more signal than analog. If you're in an urban or suburban location, you'll probably do fine with only rabbit ears. The further away you get, the harder it will be to get solid reception. Remember that with digital TV you've either got a great picture or no picture.



Top of the line HDTV sets such as this 42" rear projection LCD Sony Wega model features numerous video inputs, side-by-side picture input display, has built-in off-air HDTV tuner, and memory stick reader for just under \$1,400. (Courtesy: Sony)



Back side of the Sony Wega HDTV set shows 6 audio/video and two RF inputs. (Courtesy: Crutchfield)

WiNRADiO's G305i Wide Coverage Radio

By Lee Reynolds KD1SQ

Australia's WiNRADiO Communications continues to work on expanding, updating and improving their product line. So far they've done a stellar job of producing reasonably priced PC-oriented software-defined shortwave receivers with great performance for the consumer and commercial markets. The G303i/e and G313i/e series have all been reviewed in earlier *MT* editions. Not resting on their laurels, the guys at the research labs have come up with an interesting new addition to their DC-to-Daylight product line (the WR series). With a few consumer level exceptions, these products have been aimed largely at the professional market.

This new receiver is aimed directly at the consumer market and is intended to replace the now venerable WR-1550e. WiNRADiO's new G305 series comes in both internal and external versions. We tested the G305i, the PC PCI slot card version. In both physical appearance and pricing terms it bears a resemblance to the G303i LF/MF/HF receiver, but don't let that mislead you – this device has a different ancestry to the '303 line and is stated by the manufacturer to primarily be a VHF/UHF receiver with improved LF/MF/HF receiving abilities added on.

First thoughts:

This was something I found intriguing. DC to Daylight receivers are reasonably common, but hobbyist experience says that in this price range they're usually much better scanners than they are HF receivers, often suffering from susceptibility to overload, limited reception modes, poor stability and worse selectivity. The wideband receivers that can do a good job are usually far more expensive devices at three or four times the cost – the ICOM IC-R9000 and IC-R8500 and some AOR models come to mind as two examples of good wideband receivers.

I own an R8500. It's a beautifully built and thought out receiver with excellent performance in general and outstanding sensitivity on VHF/UHF. There's one thing that it is not, however, and that is a good scanner. It's a communications receiver, not a scanner. You use things like communications receivers to ferret out the weak, elusive signals. You use them for casual monitoring of a few channels, because their scanning speed is so slow or because the relay switched front ends will drive you mad with their clicking. You use them to find the good stuff that you then use lesser devices – scanners – to monitor full time.

Scanners, on the other hand, are often designed in such a way that manual tuning across frequencies is less than easy or intuitive; they

support a limited number of reception modes and are really built to be able to store and scan large numbers of frequencies automatically.

Communications receivers and scanners are complimentary to each other in the shack, but are really two different things; making a single radio to do both things well is hard. It'll be interesting to see if the G305i falls into the communications receiver or scanner camp – or sits somewhere between.

For comparison and testing purposes I had available an ICOM IC-R8500, ICOM IC-R75, ICOM IC-PCR1500, WiNRADiO G303i, Bearcat BC796D and Radio Shack PRO-2006. Antennas used were an Alpha-Delta DX-Ultra and a TRAM discone, both feeding into 8-port Stridsberg multi-couplers so all receivers and scanners saw exactly the same signal.

Specs:

The specifications of this radio don't look too bad at all, given its intended audience and purpose. If I lived in the New Jersey Meadowlands where ambient RF levels are extremely high, I might expect problems with desense or crossmod. (Then, again, almost *any* radio would have problems in that kind of RF environment.) Claimed sensitivity, dynamic range and stability all look to be adequate for the job for which the receiver is intended.

Block Diagram/What's Inside:

Looks like a nice straightforward design; roughly analogous to the G303i/G313i line.

Being built on the same common mother card design, the G303i and the G305i initially look almost identical, but internally, the G305i is very different from the G303i. The component count is higher, the front end board is twice the size of the G303's and the optional Wide FM module (if included) is entirely new. (Again, let me emphasize, this is not a G303 with VHF/UHF capability; this is a VHF/UHF receiver with LF/MF/HF abilities added in. I use the G303i for comparison purposes solely because it's still the closest relative.)

Installation:

Installation was straightforward, just like adding any plug and play device to a PC. No unforeseen problems were encountered. As with other WiNRADiO models and installers, I'd strongly suggest letting the installer put the software into the default location on the hard drive – some of the WiNRADiO plug-ins for the

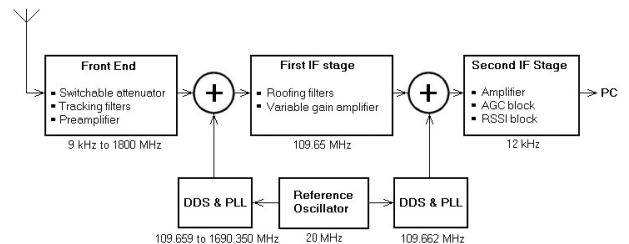

software don't like being installed to other than the C: drive.

The installer looks and works exactly like the G303/313 installers do. Connect the IF (12 kHz audio) output to your PC's sound card line input, the antenna to the SMA antenna connector, and you're ready to go.

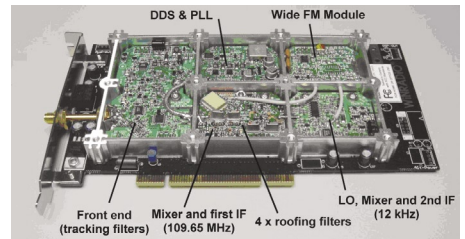

Interface:

The graphical user interface (GUI) closely follows the layout found in the G303/313 line with an easily read frequency display, large S-meter, tuning knob and a real time spectrum display that occupies approximately 20% of the virtual front panel. (This screenshot is from the receiver running the Professional Demodulator option.)

On the far right of the GUI center panel, are the squelch controls – five different types: Level, Noise, Voice, CTCSS and DCS. There's also a switchable preamp, audio filter and AGC control. These are the G305i-specific differences most immediately noticeable. Passband tuning or other draggable operations using the realtime spectrum display are not implemented in the G305i.

How well does it play?

So, it installs easily, has a user interface that is easy to figure out and can be seen to be functionally slanted towards the VHF/UHF side of the spectrum. Is it competent to do what the manufacturer claims it can do?

My testing methods are simple and biased towards the user who wants straightforward feedback: feed a group of receivers the same signal in realtime, wander all over the bands, find interesting things to listen to, see what does a good job



of picking out a given signal and which, if any, fail to perform a given task.

First, I wanted to play with the radio on LF/MF/HF – I remembered reading comments regarding the older WR line, in which users felt that coverage below VHF seemed like an afterthought. I wanted to see if WinRADIO had addressed those concerns.

I ran the radio from 23 kHz up to 30 MHz looking at low frequency beacons, NAVTEX transmissions, AM stations (both weak and extremely strong), amateur transmissions, pirate transmissions, SW broadcast stations, numbers stations and utility stations.

Frequency stability and selectivity were good; the variable selectivity provided by the Professional Demodulator software was very useful

TABLE 1: SPECIFICATIONS

Receiver type: DDS-based dual-conversion superheterodyne with software-defined last IF stage and demodulator

Frequency range: 9 kHz - 1800 MHz (3500 MHz with optional downconverter; except cellular frequencies where required by law)

Tuning resolution: 1 Hz

Mode: AM, AMN, AMS, LSB, USB, CW, FMN Optional: ISB, DSB, FMW

Image/Spurious Rejection: 60 dB

IP3: 0 dBm @ 20kHz

MDS: -135 dBm

Spurious-free Dynamic Range: 90 dB

Phase noise: -148 dBc/Hz @ 100 kHz

RSSI accuracy: 5 dB

RSSI sensitivity: 1 μV

Selectivity (-6dB)

AM	6 kHz
AMN	4 kHz
AMS	4 kHz
LSB, USB	2.5 kHz
CW	500 Hz
FM3	3 kHz
FM6	6 kHz
FMN	12 kHz
FMW (optional)	230 kHz

Scanning speed: 60 channels/s max

Sensitivity (AM/SSB/CW 10dB S/N) (FM 12dB SINAD)

Mode	0.15-500 MHz	500-1800 MHz
AM, AMS	1.7μV	1.85μV
LSB, USB	0.35μV	0.37μV
CW	0.2μV	0.25μV
FM3, FM6, FMN	0.7μV	0.8μV
FMW (optional)	2.0μV	2.0μV

Intermediate frequencies: IF1: 109.65 MHz IF2: 12 kHz

Roofing filter: 2 x 4-pole 20 kHz BW crystal filter

Frequency stability: 10 ppm (0 to 60° C)

Antenna input: 50 ohm (SMA connector)

Output: 12 kHz IF2 output (sound card Line Input compatible)

Form factor: 2/3 length PCI card

Interface: PCI 2.2 compliant

Dimensions

Length: 195 mm (7.68") (excluding mounting bracket)

Height: 99 mm (3.90") (excluding edge connector)

Thickness: 19 mm (0.75") (incl. components on either side)

Weight: 310 g (10.9 oz)

in picking out stations crowded closely together. Strong signal handling was a little better than that of the ICOM IC-PCR1500 once the DSP filters were adjusted for maximum filter lengths.

Some DRM testing was in order as well. (I use my G303i with WinRADIO's DRM plug-in and the plug-in works just as happily with the G305i.) Performance was more than acceptable, the main limitation being that of the digital transmission mode itself. DRM always demands a pretty high signal to noise ratio for continuously decoded audio.

Overall, the G305i acquitted itself quite well on HF. Almost as good as the R-75 in a number of cases, the R-75 being a bit better on the weaker stuff. Not bad for a receiver that's designed and intended mainly for VHF/UHF use.

VHF/UHF was the next thing to consider. The first thing looked at was handling of strong signals: with any wideband device there's always a possibility for problems. I ran comparisons of the G305i, R8500 and PCR1500 using extremely strong pager signals as the test input. I use one particular frequency – a transmitter that's within a mile of me – for receiver front end testing. At a separation of 20 kHz from the paging transmitter frequency, the R8500 did best, the PCR1500 was unable to keep signal breakthrough from occurring, and the G305i was about 80% successful at handling such a large signal.

Signal sensitivity was next up for testing, and here I found some deviation from what I expected, given the specs. One standard test I use for VHF reception ability is the standard seven-channel bouquet of NOAA weather transmitters from 162.400 through 162.550 MHz at 25 kHz intervals. At my location, using the R8500, I can receive a signal on all seven frequencies that range from very strong down to "something barely audible in the noise." The G305e only produced signals or signal indications on five of those seven channels. Comparing it to the other radios in the shack, the sensitivity of the G305i seemed to be roughly equal to that of the BC796D. A second G305 series receiver was tested in the same way, in case the first one was an atypically poor performer. Same result. It was time to ask questions – I contacted WinRADIO and Grove Enterprises and queried the results I was getting.

WinRADIO issued this statement as to the matter of slightly decreased sensitivity:

The typical sensitivity of the WR-G305 is within specifications of most high-grade VHF/UHF receivers, i.e. around -113 dBm (0.5μV), typical of other highly acclaimed scanning receivers.

While some of the comparable scanners (including our own earlier model WR-1550e) offer somewhat higher sensitivity, this is usually at the expense of strong signal handling. In this respect the WR-G305e is superior to many general-coverage scanners, offering strong signal performance not typical for this class of products. As a result, it is able to provide optimum performance across the entire HF/VHF/UHF range.

The most frequent criticism of our earlier WR-1550e has been in fact excessive sensitivity

and insufficient strong signal handling, which we have now addressed in the WR-G305e. We believe that the balance is just right in the WR-G305e and customer feedback appears to confirm this.

We do realize that there will be some customers operating outside typical RF-dense urban environments who may require higher sensitivity. For these users we are offering a matching low-noise preamplifier (see <http://www.winradio.com/home/lna-3500.htm>), which, when used in conjunction with the WR-G305, makes it possible to achieve quite extraordinary MDS levels of approx. -140 dBm, certainly more than satisfactory for extraction of the weakest signals from noise.

So, it was a deliberate design choice made when evaluating the tradeoff between high sensitivity and resistance to front end overload. WinRADIO chose improved overload resistance in exchange for slightly reduced sensitivity.

Back to testing – I ran the receiver through its paces: it did well as a VHF/UHF receiver overall. Sensitivity, although lower than some receivers, was in line with many present day scanners; strong signal handling was better than that displayed by many other scanners and receivers, and the AM aero band reception was particularly good. Scanning speed was adequate – much faster than the R8500, for example, although not quite up to the 60 cps claimed (This may be due to the nature of the various squelch types available – some just demand a longer sampling time than regular level-only squelch methods.) The various squelch methods worked as they ought to. Although capable of receiving up to 1800 MHz, there just isn't much up there in my neck of the woods to receive. I did test up to the 1 GHz range, though, finding performance to be good overall.

Pros:

- I particularly like the various squelch types, especially the DSP-based ones that offer the only realistic hope of a reliable HF channel squelch for the hobbyist.
- Deliberately lowered sensitivity – although I am an advocate of the more, the better, it's quite possible that cranking the G305's sensitivity up higher could have resulted in a receiver that could suffer badly from overload and mixing problems.
- Good strong signal handling ability.
- The HF reception is nice; it works well and the receiver has no obvious problems doing its job there.
- The G305e does nicely on DRM – there are still so very few real DRM receivers around that it's good to see another well-executed one come into existence.
- With the addition of the Advanced Digital Suite software (an optional extra), the G305e can gain a number of very nice abilities and tools, such as NAVTEX decoding, ACARS decoding, CTCSS/DTMF search and decoding, Packet Radio reception, FAX reception, and some nice audio adjustment tools. It's nice to have an all-in-one ACARS receiver, for example. The ADS with its mix of VHF and HF tools makes a lot more sense as a purchase now that it has a new wideband receiver with which to take advantage of all of them.

Cons:

- No out of the box ability to listen to broadcast FM (hard to do with presently available DSP

continued on page 73

Goodbye Win 98 - Hello XP

If you have read this column over the past fifteen years you'll realize two things. The first is that I enjoy, in fact get great pleasure from, running radio application programs on the most inexpensive computer systems possible. And the second is that much has changed, technically and in the world, since I created and began writing this column 15 years ago

The first fact is what is foremost in my mind as I sit to write this month. Microsoft announced that, as of Oct 2006, they would no longer support upgrades, modifications and fixes for Windows 98. No bug fixes, no security hole filing, no new tools, nothing. Oh, boy.

Over the years I have proudly resisted the move to newer Windows operating system as I watch the "situations" develop with each new Microsoft product such as Windows ME and Windows 2000. Although I have two PCs running XP since 2002, I have always attempted to run the new monitoring software reviewed in this column on the simplest system. This adheres to my technical minimalist approach. Windows 95 was used until 2000 and Windows 98 (and second edition SE) since. Over the past few years, XP was used for programs that would not run under the older Windows. But Windows 98 was the mainstay. However, starting this month all that has changed!

Now, Windows XP, with the SP2 update, will be the default operating system used for programs that we run in this column. According to Microsoft, the recommended hardware for running Windows XP is a PC with 300 MHz processor, 128 MB of RAM, 1.5GB of available hard drive space and Super VGA (800X600). In today's world, these are very modest PC requirements, though the RAM is a bit above the very basic 64 MB for some older laptops.

With the new Microsoft Vista operating in beta testing and many more programs requiring XP, it was the right time to change. So here we go.

❖ StumbleUpon

Did you ever wonder why searching the internet for a topic, such as "radio software," using different search engines usually brings back the same results? Internet search engines are one of my sources for programs for this column, so I have observed this fact first-hand while spending several hours each week in searching.

I recently tried a new search engine, StumbleUpon, that has brought back some interesting results. Many of the websites it found are not easily found using the traditional

search engines. As the StumbleUpon website explains "...StumbleUpon uses ratings to form collaborative opinions on website quality. When you stumble, you will only see pages which friends and like-minded stumblers have recommended."

In its first hour of use it brought up a few new sites with useful radio application programs that I had not previously discovered using the other browsers. One of these sites, PTB Software, will be covered below.

StumbleUpon can be downloaded at www.stumbleupon.com. You must choose the correct version based on which browser and operating system you are using. Once downloaded and installed it will appear as a new bar on your browser.

A few hundred pre-loaded search categories are available on the StumbleUpon website. Although yielding copious results, I found these categories to be too generic to be of real use.

Or you can enter your own search phrase in the box on the StumbleUpon line. Pressing the Enter key moves the search phrase to the right of the StumbleUpon logo. A website, the result of your search, will appear in your browser window. Don't be surprised if the site is not even close to what you expected. Instead, keep clicking on the StumbleUpon logo until an appropriate website is displayed.

StumbleUpon will definitely NOT replace Google, which I have used for over five years as my main search engine. However, I have found websites using StumbleUpon that I have yet to find in general searches using big name search engines. Give it a try and let me know what you think.

❖ Stop - Read - Follow!

Although I don't often explicitly say it, it is strongly suggested that all readers, *before* they download any software, *carefully* read and understand *all* instructions concerning the hardware requirements, file choices, downloading and program use. These can usually be found on the program's website. Then follow the webpage's instructions exactly and explicitly. I encourage you to do this to minimize grief, PC crashes, swear word usage and marital unrest.

❖ PTB Software

One of the websites that I "stumbled upon" was the PTB Software site at <http://hamshack.w4kgu.net/news.php>

This site has some interesting ham news

and is the home of a useful piece of monitoring software named *USA, Ultimate Shack Assistant* version 1.10. Although aimed at hams, it can also be of use to radio listeners. It was designed for simplicity. USA is actually twenty-one operating aids and charts brought together in one program. Figure 1 shows the "tabbed" format of USA. Each of its features is accessed via the tabs at the top of the screen.

Our ham readers will recognize that a few of the tabs are devoted to keeping track of ham radio goals such as WAS (worked all states) and DXCC (worked 100 countries). Each time a new state or country is worked (or heard), the user can "x" it and store it in these tabs. The DXCC tab also keeps track of how close you are to "worked all continents" (WAC) certificate.

Card File for Everyone

USA's method of storing contacts or stations monitored is via a card file system under the "Contacts" tab. Figure 1 shows one of the filled-in "cards" for a fictitious BBC intercept. When the "New" button is clicked, the date and time are added to a blank card. Then a Call Sign box appears. Entering a ham call automatically causes USA to check sites on the Internet for data on the call. If found, this data, such as physical location, can be copied into the Location field of the card.

All other fields are entered manually. The program assists with pop-up menus for signal strengths (Sent/Rcvd). The Log and QSL fields are text boxes that can be used for anything, such as detailed program content for shortwave listeners (SWLers).

This "card" system works well for both hams and SWLers. However, the program de-

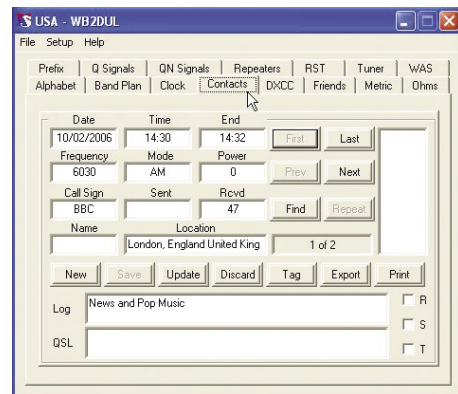

Figure 1- Tabs at the top of the USA screen select the method of keeping track of stations - the contacts "card file."

mands that entries be made in both the Mode and (transmitter) Power boxes before it will save the card entry. As you can see from Figure 1 it was happy with a 0 in the Power box.

Using the "Find" button, the card file can be searched via the call sign for any previous loggings. A New card can then be generated or the original card Updated using the buttons of the same names.

Finally, the Log Capture utility allows you to "... enter additional data into the USA contacts log either by importing ADIF files from other software or entering the contacts manually from old printed logs."

More Than a Clock

The "Clock" tab, shown in Figure 2, displays a six-digit clock of either local or GMT time. It also has a timer feature, which reminds the operator to identify their station every ten minutes. This is via a voice message at the one-minute marks and once again if the ten minutes lapses without an ID.

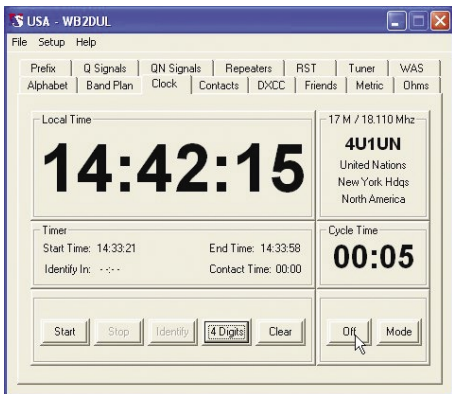

Figure 2- Clock, stopwatch and beacon station identifier/propagation guide

At the right of the clock screen is a simple but useful propagation tool. The user chooses a ham band, for example, 14 MHz. Then the display shows the frequency and location of beacon stations transmitting in that band in real-time. That is, as they transmit in a staggered sequence, the active station's frequency and location is displayed. Beacon station information is available for 14, 18, 21, 24 and 28 MHz ham bands.

Using this method, the user can tell which frequencies are currently open to which areas of the world from their location – all in less than five minutes.

The Repeater feature is formatted to store VHF/UHF ham repeater loggings such as offset between input and output frequency and access tone frequency. However, it could be used as a very basic scanner log. The other tabs in USA are charts and formulae mostly useful to hams.

PTB's USA is useful and very simple to use. There it squarely hits its mark. A rig control feature and auto rig frequency and mode transfer into the card file would be a very useful added feature. Since many of the features run in the free demo version you should give USA version 1.10 a try. But, for the princely sum of \$20 for the full registered version, USA is good value for money.

Scanner & Shortwave

If you don't need all the features of USA, some of the individual operating modules are available as separate downloads. Also on the PTB website you'll find two other programs – SWL Assistant and Scanner Freak. These programs, seen in Figures 3 & 4 respectively, are easy to use logging programs customized for their radio application.

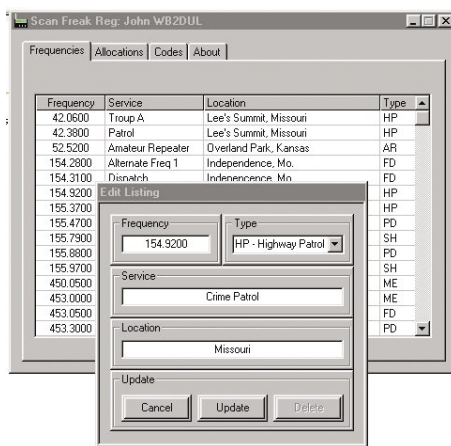
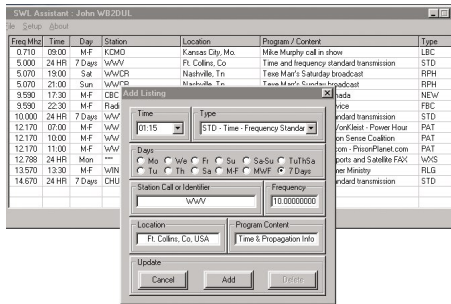

For example, in SWL Assistant, double clicking on a line in the main window brings up the entry box. This is the smaller box in Figure 3. Clicking on the "Type" box opens a drop-down menu with thirty-four station-types from "ALC - Airline Corporate Comm" to "WXS - Weather Satellite." The list covers just about all the types of stations found on shortwave. Scanner Freak has fifty types of stations found in the VHF/UHF spectrum.

These logs can be sorted by simply clicking on a column. Download the demo versions for free or pay \$2 each to have fully registered versions. A data link to receivers, at least for the SWL Assistant, would be a great addition. That's my two dollars, I mean two cents worth. Oh, and by the way, they will work in Windows 98SE as well as XP. (I just had to throw that in.)

15 Years - In a Blink !

So much has changed in technology and the world since I was given the privilege of starting a column on the strange subject of computers and radios. Having worked in microelectronics and military communications, I had been living with the marriage of the two since 1980.

But, even 11 years later in 1991, when I started the Computers & Radio column, commercially available radio programs were few and far between. There may have been about nine of them available, and some were pretty rough. In

the early years I did more beta testing and bug chasing for these new radio software companies than writing... all gratis. I wanted to help and encourage the new industry mature. And so it did, maybe peaking about 1998.

Today, my search for new, different and useful radio programs has become almost as hard as when I started. The difference now is that it's hard to find a unique program among all the thousands of software applications that exist.

My entire career as technologist and business executive was in the insanity and pressure of the high tech world, with 18 hour days. My dream was to someday retire and spend my last days looking out my window at the beauty of the surrounding forest – all while decoding shortwave utility stations from around the world, many of which I had visited in my career.

But as the ancient Greeks said, "Men plan and gods laugh." The world has changed in ways we could not imagine fifteen years ago. The power and the universality of the PC. Instant worldwide communication and news. The rise of the Internet and the fall of shortwave and, with it, the extinction of unencrypted utility stations. The end of the cold war and the spread of worldwide terrorism. Losing freedoms in the name of freedom. I don't understand it anymore, or perhaps I never did.

But one thing is still good: I enjoy hearing from readers. And when they tell me that they enjoy the column and my efforts, life is good. So till next time, thank you readers and MT for fifteen years.

First Look continued from page 71

- horsepower/soundcard abilities, so it's done instead as a standalone internal FM tuner which is an optional extra.)
- No CTCSS/DCS search – this is likely to be added in future software releases.
- No ability to follow trunk systems or decode P25 digital signals (WR says this is in the works).
- An antenna duplexer is needed if you want to use both a good VHF/UHF antenna and a good LF/MF/HF antenna without having to manually switch them.
- Deliberately lowered sensitivity – this is a two-edged blade which appears as both a Pro and a Con. Slightly lowered sensitivity means that you will miss the very weakest signals. On the other hand, you're much less likely to find your local 50 kW AM station mixing in with the signals on 3.5 MHz.

Summary:

In my opinion, the G305i receiver is a very usable wideband communications receiver that incorporates a greater number of scanner-like abilities than has been the norm up until now. As with the G303 series, I would say that the Professional Demodulator option is mandatory; you give up too many useful abilities if you don't have it. If you want a flexible, all-in-one solution to your desire for both scanning and LF/MF/HF reception, you could do far worse than to acquire one of these devices, especially for the price.

The G305e (\$619.95) and G305i (\$519.95) WinRADiO receivers are available from Grove Enterprises. Call 800-438-8155 or email order@grove-ent.com for more information.

What's NEW

Tell them you saw it in *Monitoring Times*

The Pocket Idiot's Guide to Satellite Radio

You don't have to be an idiot to be confused by the options available for listening to satellite radio. And every choice comes with a pretty hefty price-tag, so it makes sense to do some research first. This slim 4-1/4x7-1/2 inch book will list the major strengths and weaknesses of the primary two providers, XM and Sirius, and how to subscribe. It gives advice on choosing a receiver and accessories (including handheld personal players), and general installation instructions for use in the home or in a vehicle. It lists the programming and pricing current at the time the book was written, with details on other services such as music downloads, and weather and traffic reports.

Before spending the big bucks, spend \$9.95 for *The Pocket Idiot's Guide to Satellite Radio* by Damon Brown, published by Alpha Books; you can find it at www.idiotsguides.com or look for it at your favorite bookstore.

Getting Started with Ham Radio

This American Radio Relay League "Guide to your First Amateur Radio Station," by veteran author Steve Ford WB8IMY, is a much-needed addition to the new ham's library. As every newbie knows, there's a huge gap between

being issued your first license and actually putting what you've learned into practice.

The first challenge is simply to obtain equipment on which to operate – What radio? What transmission line? What antenna? What accessories?

Once you've decided on equipment for HF or FM, what is proper operating technique for your chosen mode of operation? What about digital modes? Contesting?

Getting Started with Ham Radio contains everything you need to get on the air with confidence. It is well-illustrated and written in such direct, easy-to-understand language, it does the job in only 9 chapters and fewer than 150 pages, including room for notes, comprehensive glossary, and advertising by equipment dealers.

Getting Started with Ham Radio is \$19.95 from the ARRL (225 Main Street, Newington, NC 06111-1494; www.arrl.org; or call 1-888-277-5289).

Crystal Clear

Crystal Clear: The Struggle for Reliable Communications Technology in World War II by Richard J. Thompson, Jr. is a fascinating account of a nearly-forgotten technology leap that impacted the course of the war. Whenever he was asked how his small recon unit survived, Private First Class Irwin Gottlieb of the First Reconnaissance Cavalry Troop of the first Infantry Division would reply, "we were heavily armed, and we had crystals."

Quartz crystals were so important to reliable communications on the front lines, that an all-out effort was made to perfect the mass production of manufactured quartz oscillators. In a major engineering feat, the industry moved from 100,000 units per year producing crystals for amateur radio enthusiasts, to producing millions of units per month for the US Armed Forces by the end of 1943.

Investing so heavily in the new crystal oscillators was a gamble, but it paid off, and, of course, formed the cornerstone for much of the technology that shaped our modern era, including watches, clocks, color televisions, cellular phones and computers.

This 230-page hard-bound

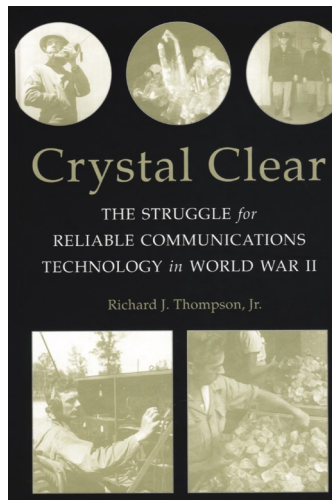

book is published by Wiley-IEEE Press. It's somewhat pricey at \$54.95, but the largely untold story involved much original research and contains some unique archival photos. A soft-cover version should soon be available. You can order directly from the publisher at www.wiley.com or check for it at your favorite bookstore.

Wrist Crystal Set Kit

Construct your own crystal radio! The Xtal Set Society announces their latest crystal radio kit, the XS-W. The set is assembled on a 1.5 by 2.0-inch printed circuit board, small enough to wear on your wrist. An end-fed antenna and high-impedance ear piece attach to the pcb via 3.5mm mono plugs to pcb-mounted jacks. A manual is provided, and solder assembly is required. For most hobbyists, kit assembly is less than one hour. Solder, tools, and antenna wire are not included. A completed assembly is shown in the picture.

The set tunes the AM broadcast band (550-1650 kHz) via an array of capacitors jumper-selected on the pcb. These jumpers may be changed for tuning after

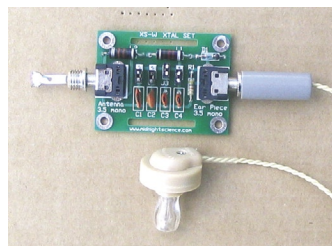

assembly. Small size is achieved by using molded inductors for the main LC circuit and for antenna coupling. As with all crystal sets, operation is maximized when the set is grounded and attached to a sufficient antenna.

XS-W "Wrist Crystal Set Kit," is \$16.95 plus \$4.95 shipping/handling. Orders may be placed via their website catalog at www.midnightscience.com or to The Xtal Set Society, P.O. Box 3636, Lawrence, KS 66046, 405-517-7347. For additional information, visit the site or email xtalset@sunflower.com.

MFJ Solar-Powered Atomic Clock

MFJ has all kinds of gadgets to make radio hobbyists happy at Christmas. For example, the solar-powered 24/12 hour atomic clock never needs batteries, has a large LCD display (time digits are 2-1/4 inches tall) and gives precision accurate time from WWVB. The clock is housed in a gray/silver plastic cabinet (3"Wx4-1/4"Hx1-1/2"D") to make a handsome desktop addition. It also includes an alarm function and a green backlight. To order, ask for the MFJ-136RC, \$29.95



Wireless Weather Station

You might also want to check out the Compact Atomic Wireless Weather Station for only \$59.95! For these and other great gift ideas, call and ask for MFJ's catalog at 1-800-647-1800, or write to: MFJ, 300 Industrial Park Road, Starkville, MS 39759; or go online: www.mfjenterprises.com

Books and Equipment for announcement or review should be sent to What's New, c/o Monitoring Times, 7540 Highway 64 West, Brasstown, NC, 28902. Press releases may be faxed to 828-837-2216 or emailed to Rachel.Baughn,editor@monitoringtimes.com.

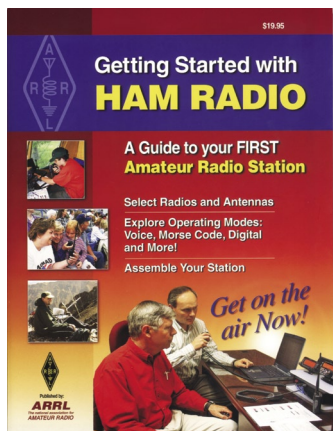

World's #1 Selling Shortwave Guide!

PASSPORT to World Band Radio

Edition 2007



If you need it, PASSPORT TO WORLD BAND RADIO has it within 20 helpful chapters in almost 600 pages.

PASSPORT'S frequency-by-frequency Blue Pages section is almost a book by itself. This quick-access schedule guide offers details for each of the world's stations — frequencies, times, days, locations and powers. Also, target zones, network affiliations, languages and even if there's jamming.

**TRUSTED BY OVER A MILLION READERS
SINCE 1984.
WWW.PASSBAND.COM**

PASSPORT'S program guide, "What's On Tonight," builds on this with hour-by-hour descriptions of news, music and entertainment shows in English. Station contacts and web simulcasts?

PASSPORT'S "Addresses PLUS" chapter is the industry bible, crammed with juicy tips. Other chapters include on-the-spot reports from the armed facedown zones of Korea and Taiwan.

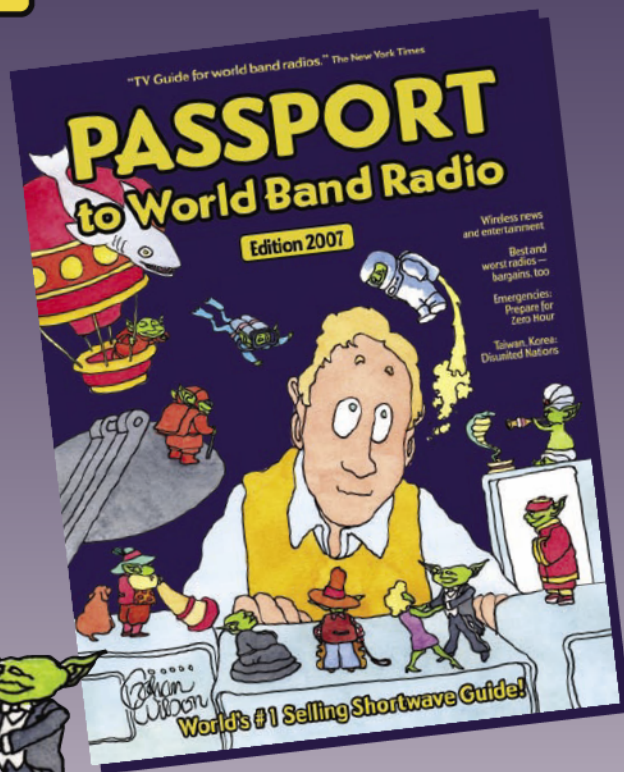

PASSPORT REPORTS tests, evaluates and rates dozens of the latest portable, PC controlled, professional and tabletop receivers—outdoor and indoor antennas, too. Outside magazine minces no words, "The best. They tell you what's good about the good, bad about the bad, and advertisers be damned."

**PASSPORT TO WORLD BAND RADIO is the world's #1 selling guide to shortwave listening.
Available from major dealers and bookstores, or by fast, free Priority Mail direct from the publisher:**

PASSPORT to World Band Radio Edition 2007

Box 300
Penn's Park, PA 18943

\$22.95, ISBN 978-0-914941-63-7 (0-914941-63-1)
24/7 automatic ordering (215) 598-9018
Fax (215) 598 3794

mktg@passband.com
www.passband.com

Stock Exchange

LINE ADS

NON-COMMERCIAL SUBSCRIBER RATES: \$.25 per word. All merchandise must be personal and radio-related.
 COMMERCIAL, NON-SUBSCRIBER, AND MULTIPLE SALES RATES: \$1.00 per word. Commercial line ads printed in bold type.

Ads for Stock Exchange must be received 45 days prior to publication date. All ads must be paid in advance to Monitoring Times.
 Ad copy must be typed for legibility.

1-3/4" SQUARE DISPLAY AD:

\$50 per issue if camera-ready copy or, \$85 if copy to be typeset. Photo-reduction \$5 additional charge. For more information on commercial ads, contact Beth Leinbach, 828-389-4007.

Subscribe to MT for as little as \$15.50 (U.S. Second Class Mail)

7540 Hwy. 64 W.; Brasstown, NC 28902
 1-800-438-8155 US and Can.; 828-837-9200; Fax 828- 837-2216
 e-mail order@grove-ent.com

	6 months	One Year	Two Years	Three Years
US Rates	<input type="checkbox"/> \$15.50	<input type="checkbox"/> \$28.95	<input type="checkbox"/> \$51.95	<input type="checkbox"/> \$76.95
US 1st Class	<input type="checkbox"/> \$30.00	<input type="checkbox"/> \$57.95	<input type="checkbox"/> \$112.00	<input type="checkbox"/> \$168.00
Canada Surface*	<input type="checkbox"/> \$20.50*	<input type="checkbox"/> \$39.50*	<input type="checkbox"/> \$75.95*	<input type="checkbox"/> \$112.95*
Foreign International*	<input type="checkbox"/> \$30.75*	<input type="checkbox"/> \$58.50*	<input type="checkbox"/> \$114.95*	<input type="checkbox"/> \$171.50*
Electronic Subscription		<input type="checkbox"/> \$19.95	<input type="checkbox"/> \$38.90	<input type="checkbox"/> \$57.85

*All payments must be in U.S. Funds drawn on a U.S. Bank!

Time to Renew? Your label will tell you how many issues remain in your subscription. When it's time to renew, your MT will arrive with a bright yellow cover sheet with the renewal form. Renew by the second notice to avoid missing an issue!

Attention all those wanting to know what's going on with ham radio in the New Orleans area, check out: <http://groups.yahoo.com/group/GNOAmateurRadio/>

Drake R8B SW Communications Receiver (Drake no longer makes. This was their best radio) Like NEW condition \$995 / ICOM R-100 Communications Receiver Very Good Condition \$400 / ICOM SP-20 Selectable Communications Speaker Like NEW condition \$100 / SAN-GEAN ATS-909 Very Good Condition \$150 / Details and MORE stuff at:www.stuffishere.mysite.com or e-mail me: stuffishere@juno.com

Alinco 25
 Antique Radio..... 65
 Antique Wireless..... 65
 AOR..... Cover 2, 4
 C Crane..... 37
 Carey, Kevin..... 9
 CIDX..... 76
 Communications Electronics..... 27
 Computer Aided Technology 53
 Cumbre DX..... 76
 Dave's Hobby Shop..... 76
 Electronic Specialty Products..... 55
 Eton 2 & 3
 Grove Enterprises 17, 21, Cover 3
 Hauser, Glenn 39
 ICOM Cover 4
 ODXA..... 76
 Passport 75
 Performance HF, Inc..... 23
 Popular Communications 63
 Prime Time Shortwave 65
 Skyvision 76
 Small Planet Systems 63
 Ten-Tec 19
 Universal Radio 19, 76
 WBCQ 67
 WiNRADiO..... 1
 WRTH 5

**Want more?
 Check out the
 Monitoring Times Website at
www.monitoringtimes.com**

C Ku Satellite Equipment
 Big Dish • FTA Dish • Parts
 LNBs • Switches • Feeds
 Shortwave • Ham Gear
 CB Radios • Scanners
 Antennas • Cables • Accessories
 Books • Electronic Parts
Dave's Hobby Shop
 600 Main • Van Buren, AR
 479-471-0751
www.daveswebshop.com

Listening In
 That's what we do and who we are!
Since 1974

Acclaimed worldwide as one of the top publications for radio listeners. Get a free sample of our electronic monthly magazine and see for yourself.
E-mail us and mention this ad

Ontario DX Association
 155 Main St.N., Apt. 313
 Newmarket, Ontario L3Y 8C2 Canada
 E-mail: listeningin@rogers.com
www.odxa.on.ca

Join the Club!

Open to hobbyists worldwide, the **CANADIAN INTERNATIONAL DX CLUB** is Canada's national, general coverage radio club serving members since 1962.

For a free sample of our monthly electronic newsletter, **Messenger**, please e-mail CIDX at:
cidxclub@yahoo.com
 Web: www.anarc.org/cidx/

HUGE 100 PAGE CATALOG

- ▶ Shortwave & Ham Gear
- ▶ Scanners & RTTY/FAX
- ▶ Antennas & Accessories
- ▶ Radio Books & CDs.

Send \$1 to **Universal Radio**
 6830 Americana Pkwy.
 Reynoldsburg, OH 43068
 Tel. 800 431-3939
www.universal-radio.com

Satellite Dish Parts
 Residential and Commercial
 Get it all with just one call!

Ice Zapper™
 Melts snow and ice!
 Simply attach to your existing dish—works on metal dishes up to 1.2m!

www.icezapper.com
www.skyvision.com
800-500-9275

Cumbre DX is the world's best shortwave DX publication. We feature news and loggings that you just won't find elsewhere. But the best part about Cumbre DX is that it is absolutely

FREE!

Send and email to
cumbredx@yahoo.com
 or visit our
 website at www.cumbredx.org
 to subscribe.

Stocking Stuffers for the Radio Enthusiast



Max Systems
Only \$29.95



1 year MT
Only \$28.95!



ETON S350DL Deluxe
Only \$99.95



GE Superadio III
Only \$54.95



MFJ 1020C
Only \$84.95!

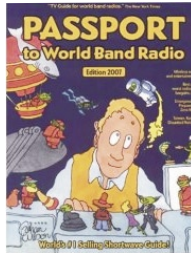

2007 Passport
Only \$22.95



KAITO KA-1102
Only \$79.95

Complete 6 year set of Monitoring Times Anthology CDs. **\$69⁹⁵!**

FREE Priority Mail shipping in the U.S.

for subscribers to MT
\$89.95 for non-subscribers

Grove Flex-Tenna VU - Only \$9⁹⁵

Lightning Protector with F connector - Only \$19⁹⁵

Speco DMS-3P Extension Speaker - Only \$49⁹⁵

Not sure what to get?
How about a Grove
Gift Certificate?
Available in \$25, \$50
& \$100 denominations!

GROVE

800-438-8155
828-837-9200 fax: 828-837-2216
WWW.GROVE-ENT.COM
7540 Highway 64 West
Brasstown, NC 28902

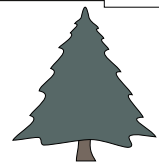
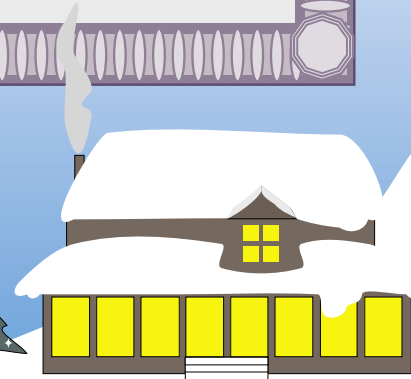



*For this holiday season...
there's nothing sweeter!*

IC-PCR1500

- 0.01 ~ 3299.99 MHz**
- AM, FM, WFM, CW, SSB
- Record and Save Audio as .WAV File
- USB Cable Connection
- Optional DSP

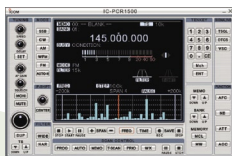

IC-R1500



- 0.01 ~ 3299.99 MHz**
- AM, FM, WFM, CW, SSB
- Single Receiver
- Mobile or PC Controlled

Podcasting, anyone?

Icom's new black box receivers have wide spectrum coverage, USB connectivity, and .wav file recordability. Save your favorite radio programs for personal Podcasts!



IC-PCR2500

Free UT-122 P25 Module with Purchase!*

- 0.01 ~ 3299.99 MHz** (Main)
50 to 1300 MHz* (Sub)
- AM, FM, WFM, CW, SSB
- Optional APCO 25 and D-STAR
- Dual Wideband Receivers
- Dual Watch PC Window



IC-R2500

Free UT-122 P25 Module with Purchase!*



- 0.01 ~ 3299.99 MHz** (Main)
50 to 1300 MHz* (Sub)
- AM, FM, WFM, CW, SSB
- Dual Wideband Receiver
- Mobile or PC Controlled
- Optional APCO 25 and D-STAR
- Dual Receiver Diversity

For the love of DC to Daylight.