

Scanning - Shortwave - Ham Radio  
Equipment - Computers - Antique Radio



# Monitoring Times

A Publication of Grove Enterprises

Volume 25, No. 9  
September 2006

**U.S. \$5.95**

**Can. \$8.95**

Printed in the  
United States

## MT SERIES LAUNCH: MONITORING MILITARY SATELLITES

**Propagation, Space Weather, and You  
Listening to Lithuania  
MT Reviews the Uniden BCT15**



AOR, the Authority on Radio Makes MORE Than Great Radios!

# Discover these Accessories & Add to your Capabilities.



DA3000

## Antennas for the Great Outdoors

**DA3000:** a 16 element receive wideband discone antenna with useable frequency coverage from 25MHz to 2GHz. Using different length elements to ensure true wideband characteristics, the DA3000 also includes one 'loaded' element to enhance low frequency performance. Engineered and manufactured to AOR's exacting standards, the DA3000 comes with 50 feet of quality RG58/U coaxial cable terminated in a BNC plug for the radio connection and a low-loss TNC plug in the antenna base. Pole clamps are also standard.

Designed for areas where space is a problem or when an "unobtrusive" installation is essential, **SA7000** is a super wideband coverage receive antenna with useable frequency coverage of 30 KHz to 2 GHz. The SA7000 is a passive arrangement with two whip elements: a long element for short wave up to 30 MHz and a second shorter loaded whip antenna for frequencies up to 2 GHz. The loading coils are tuned around 150 & 800 MHz to enhance VHF & UHF performance.



SA7000

## Antennas for Indoor Enjoyment

AOR has made performance even better with the new **LA380** indoor antenna as successor to the popular LA350. The LA380 features full frequency coverage (40KHz - 500MHz) using a single receiving element. Designed to provide reception when away from the main monitoring location or when large external antennas are not practical, the LA380 is a compact active (1 foot diameter) loop antenna which features an

internal high-gain amplifier (20dB for 40KHz-250MHz) and excellent overall strong signal handling (high IP3 +10dBm). The loop design allows directional control and nulling noise or interference. Perfect for listening in remote locations or in antenna-restricted areas.



LA380

## Accessories for Added Monitoring Capability

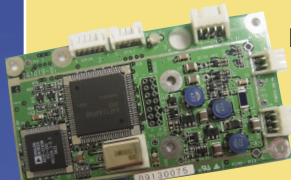

P25-8600  
APCO25 Decoder

Now you can monitor APCO 25 signals using an AR8600MKII. The **P25-8600 APCO25 Decoder** can be installed in the AR8600MKII receiver to automatically decode the APCO25 signal. The decoded audio is then output from the receiver's speaker. (Installation is required.)

The **TV5000A NTSC TV Internal Converter** adds the ability to receive broadcast television signals (NTSC) and allow monitoring video feeds from a variety of sources including broadcast TV channels, public safety agencies, aircraft, Amateur Radio FSTV, news media video and more when used with AOR AR5000A series of communications receivers.



TV5000A NTSC  
TV Internal  
Converter



TVA-1 External  
NTSC TV Converter

The **TVA-1 External NTSC TV Converter** is compact, lightweight and easy to install. Designed to be used with the AOR AR5000A series of communications receivers, its simple operation uses the 10.7 MHz IF input from your receiver. Audio and video outputs allow monitoring a variety of sources such as broadcast TV, public safety agencies, aircraft, Amateur Radio FSTV, news media video and more.

The **TV2000 External NTSC Video Decoder** is designed to be used with the AOR SR2000. Compact and lightweight, no external power supply is required (power is supplied from the SR2000). The video output is available from the rear panel of the TV2000 and audio is provided from the SR2000 through the external speaker jack.

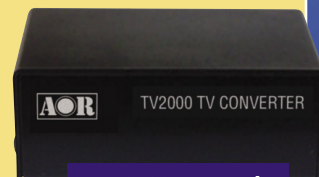

TV2000 External  
NTSC Video Decoder



Authority on Radio  
Communications

® AOR U.S.A., Inc.  
20655 S. Western Ave., Suite 112, Torrance, CA 90501, USA  
Tel: 310-787-8615 Fax: 310-787-8619  
info@aorusa.com http://www.aorusa.com

Specifications are subject to change without notice or obligation

For more great  
accessories, visit  
the website at  
[www.aorusa.com](http://www.aorusa.com).

# Looking for USB-based VHF/UHF receivers? Your search is over.

## At WiNRADiO, the innovation never stops:

This month we are pleased to introduce our WiNRADiO WR-G305e radio receiver, the first software-defined VHF/UHF scanning receiver with a USB interface.

- 9 kHz-1800 MHz frequency range  
(except cellular bands where required by law)
- Optional 3500 MHz downconverter
- Tracking front-end filters
- Dual-loop AGC and AFC
- Software-defined demodulation
- Excellent sensitivity
- Fast scanning speed
- Multiple squelch modes
- Real-time spectrum analyzer
- Powerful user interface
- USB interface (serial optional)
- Plug and Play installation



The WiNRADiO WR-G305e receiver is designed for demanding applications where the ability to locate even the weakest signals in background noise and extract the cleanest possible audio is important.

The receiver construction is ground breaking and innovative. The remarkably compact, well shielded receiver connects to the computer using a universal connector which contains USB, serial and IF outputs.

In a software-defined receiver, the entire last intermediate frequency stage and an all-mode demodulator are implemented entirely in signal-processing software running on a personal computer. This brings about significant advantages: flexibility, performance, configurability, reliability and convenience. New demodulators for new types of digital modulations can be added by simply upgrading the software.

The numerous types of squelch, scanning modes and high scanning speed make this receiver a highly flexible and versatile scanner, eminently suitable for demanding VHF/UHF monitoring tasks.

Its excellent hardware parameters and extensive software support provide the G305e receiver's user with an excellent communications intercept and experimentation tool, ready for exploring classical modulation modes as well modern digital modulations.

The G305e has also a number of hardware and software options to suit many applications. Check out [www.winradio.com](http://www.winradio.com) for all the latest options available, and more detailed information about this remarkable receiver.



For more information about WinRADiO USB-based radio receivers, visit:

[www.winradio.com](http://www.winradio.com)

...the future of radio.™



## Cover Story

On our cover, the final Titan IV B-26 rocket booster launches a military payload into orbit from Vandenberg Air Force Base, California. The October 19, 2005 launch was the last of the Titans.

It's been a long time since *Monitoring Times* has covered the world of milsats, while they have become ever more critical to communications and military operations. This month, the Milcom column begins a series of articles, beginning with an overview of all the primary military satellite constellations.

Cover photo by Pat Corkery, courtesy Lockheed Martin.

## Recapture the Magic

Enthusiasts generally greet the beginning of a new SW/MW DX season with a mixture of emotions. Many are hoping to recapture a certain thrill of monitoring that they have experienced in the past. In *A Shortwave Century Weekend* and *A trip to the Balkans* the authors are looking for programming that brings other cultures closer. *Propagation Weather* talks of the thrill of the hunt and becoming skilled in one's approach to radio listening. In *The Magic of Radio* Jim Clarke is trying to find a radio which will help him re-experience the thrill of just tuning around. What is it you are looking for? Will you find it this season? We'll help you look!

## C O N T E N T S

### A Shortwave Century Weekend ..... 8

By Joe Cuhaj

With an eye to recapturing the thrill of past radio adventures after a long time away from shortwave monitoring, our author sets out to see if he can nab 100 English broadcast stations in a weekend. Does he succeed? Well, you'll have to read the story starting on page 8.

### Propagation, Space Weather, and You ..... 11

By Tomas Hood, NW7US

For folks who find their primary pleasure in the thrill of the hunt, understanding radio propagation is not an option. It's a necessary skill in their quiver if they want to achieve their goal – or even understand why they didn't. Understanding propagation is also useful to maximize your limited radio time – which applies to us all.

After spending some time on theory, Tomas introduces us to a computer tool that will take a lot of the guesswork and the computations out of a scientific approach to DXing.

### Lithuania Radio ..... 16

By James Hydzik

Lithuania celebrated its 80th anniversary of broadcasting this past June. Though broadcasting is only one element in a full range of media used by Lithuania Radio and Television (LRT), its importance – past and present – should not be underestimated. A tour of Radio Vilnius, as the broadcaster is generally known, is an education into Eastern Europe's history.

### Buffalo Scanning ..... 18

By John Mayson

This month we explore the western New York city of Buffalo and Niagara County, sharing a border and the famous Niagara Falls with Canada. Visit now while the leaves and the thermometer both show some red!

## Reviews

Top on our list of reviews this month is the **Uniden BCT15 Bear Tracker** scanner. Based on the same software and hardware model as the Uniden BCD996T (reviewed in July), this mobile/base scanner sports a lot of the same features. Its primary difference is that it follows analog trunking but not digital – which leads to the most agreeable difference in specifications – its price (page 70).

The never-ending search for decent indoor HF reception is hard enough, but hams confined to indoor operation have an even more difficult time finding an antenna which

will perform without causing dangerous RF exposure. Ken Reitz does some experimenting with the small transmitting loop, **MFJ-932 Mini Loop Antenna Tuner**. He runs some comparisons and addresses MFJ's on line loop tuner tutorial (page 68).

From the prolific brain of Charles Brain comes a software program **PC-HFDL** that will decode both shortwave and VHF ACARS signals – the digital transmissions that provide position and flight information. It's the author's first foray into monitoring HF ACARS (p.72).



**MONITORING TIMES**  
 (ISSN: 0889-5341;  
 Publishers Mail Agree-  
 ment #1253492) is  
 published monthly  
 by Grove Enterprises,  
 Inc., Brasstown, North  
 Carolina, USA.

Copyright © 2006 Grove Enterprises, Inc.  
 Periodicals postage paid at Brasstown,  
 NC, and additional mailing offices. Short  
 excerpts may be reprinted with appropri-  
 ate credit. Complete articles may not be  
 reproduced without permission.

Address: 7540 Highway 64 West,  
 Brasstown, NC 28902-0098  
 Telephone: (828) 837-9200  
 Fax: (828) 837-2216 (24 hours)  
 Internet Address: [www.grove-ent.com](http://www.grove-ent.com) or  
[www.monitoringtimes.com](http://www.monitoringtimes.com)  
 Editorial e-mail: [editor@monitoringtimes.com](mailto:editor@monitoringtimes.com)  
 Subscriptions: [order@grove-ent.com](mailto:order@grove-ent.com)

Subscription Rates: \$28.95 in US; \$39.50  
 Canada; and \$58.50 foreign elsewhere,  
 US funds. Label indicates number of is-  
 sues left. Renewal notice is cover sheet 3  
 months before expiration. **See page 76**  
**for subscription information.**

Postmaster:  
 Send address changes to *Monitoring Times*,  
 7540 Highway 64 West, Brasstown, NC  
 28902-0098.

*Disclai*  
 While *Monitoring Times* makes an effort  
 to ensure the information it publishes is  
 accurate, it cannot be held liable for the  
 contents. The reader assumes any risk for  
 performing modification or construction  
 projects published in *Monitoring Times*.  
 Opinion or conclusions expressed are  
 not necessarily the view of *Monitoring*  
*Times* or Grove Enterprises. Unsolicited  
 manuscripts are accepted. SASE if material  
 is to be returned.

**Owners**

Bob and Judy Grove  
[judy@grove-ent.com](mailto:judy@grove-ent.com)

**Publisher**

Bob Grove, W8JHD  
[bobgrove@monitoringtimes.com](mailto:bobgrove@monitoringtimes.com)

**Managing Editor**

Rachel Baughn, KE4OPD  
[editor@monitoringtimes.com](mailto:editor@monitoringtimes.com)

**Assistant Editor**

Larry Van Horn, N5FPW

**Art Director**

Bill Grove

**Advertising Svcs.**

Beth Leinbach  
 (828) 389-4007  
[bethleinbach@monitoringtimes.com](mailto:bethleinbach@monitoringtimes.com)

**TABLE OF CONTENTS**

**Departments:**

Letters ..... 6  
 Communications ..... 8  
 Stock Exchange..... 75  
 Advertisers Index..... 75

**First Departments**

**Getting Started**  
 Beginners Corner..... 20  
*Readers' Choice*  
 Ask Bob..... 22  
 The MT Help Desk ..... 23

Scanning Report ..... 24  
*Scanning as a Group Effort*  
 Utility World..... 28  
*DXing Differential GPS Beacons*  
 Digital Digest..... 31  
*Brazilian Digital HF Users*

Global Forum..... 32  
*Chinese Invade 20 Meters*  
 Broadcast Logs ..... 35  
 Programming Spotlight ..... 36  
*A Trip to the Balkans*  
 The QSL Report ..... 38  
*Better DX Conditions*

English Language SW Guide ..... 39

**Second Departments**

Milcom..... 52  
*US Military Satellite Overview*  
 The Fed Files ..... 54  
*Shining Light on the Dept of Energy*  
 Boats, Planes, TRAINS ..... 56  
*Understanding RR Radio Transmissions*  
 Below 500 kHz ..... 58  
*DXing on the High Seas*  
 Outer Limits..... 59  
*Elkhorn Maildrop Closes*  
 On the Ham Bands..... 60  
*The New Tech Test and Linux*

**Technical Departments**

Antenna Topics ..... 62  
*Catching That Elusive Signal*  
 Radio Restorations ..... 64  
*Concluding the "Little Fellow"*  
 On the Bench ..... 66  
*The Magic of Radio*  
 MT Review ..... 68  
*MFJ 932 Mini Loop Tuner*  
 First Look..... 70  
*Uniden's BCT15 Bear Tracker*  
 Computers & Radio..... 72  
*HF ACARS with PC-HFDL*  
 What's New..... 74

**EDITORIAL STAFF** Email [firstlast@monitoringtimes.com](mailto:firstlast@monitoringtimes.com)

TJ "Skip" Arey.....	On the Ham Bands	Lee Reynolds.....	First Look
Rachel Baughn.....	Communications	Ilden Rogers.....	Planes
.....	Letters to the Editor	Clem Small.....	Antenna Topics
.....	What's New?	Doug Smith.....	American Bandscan
Kevin Carey.....	Below 500 kHz	Hugh Stegman.....	Utility World
John Catalano.....	Computers & Radio	Ernest Robl.....	Trains
Mike Chace.....	Digital Digest	Gayle Van Horn.....	Frequency Manager
Jim Clarke.....	First Look	.....	Broadcast Logs
Marc Ellis.....	Radio Restorations	.....	QSL Corner
John Figliozzi.....	Programming Spot- light	Larry Van Horn.....	Milcom
Bob Grove.....	Ask Bob	.....	First Look
Glenn Hauser.....	Global Forum	.....	MT Help Desk
Chris Parris.....	Fed Files	Dan Veeneman.....	Scanning Report
Ken Reitz.....	Beginners Corner	Ron Walsh.....	Boats
		George Zeller.....	Outer Limits

# E1XM

World's First and Only



## Etón E1XM AM/FM/Shortwave/XM Satellite Ready Radio | \$500\*

- Reception Modes: AM, FM-stereo, Single Sideband (selectable USB/LSB) and CW
- Programmable Memories: 500 user programmable with alpha labeling plus 1200 user definable country memories, for a total of 1700
- Superior Audio Quality via a bridged type audio amplifier, providing high output power with battery operation
- Direct Shortwave Band Entry, allows instant access to the shortwave band of choice

# G5

## Designed Without Compromise



### **GRUNDIG G5** AM/FM/Shortwave Radio | \$150\*

- FM-stereo, AM and Full-Shortwave coverage (1711-29999 KHz)
- 700 programmable memory presets with memory scan and auto tuning storage
- Clock, sleep timer and alarm functions with world zone settings
- Tunes via auto-scan, manual-scan, direct key-in entry and tuning knob
- Internally recharges Ni-MH batteries
- Station name input

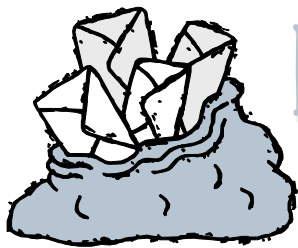

# LETTERS TO THE EDITOR

## Utility World Blog

We're proud to announce that another *Monitoring Times* columnist has started a blog in which late-breaking or additional information which doesn't make the monthly column can be made available. Hugh Stegman has inaugurated the Utility World blog with a large list of useful links: Check it out at <http://mt-utility.blogspot.com/>

As soon as activity heated up in the Middle East, our utility, military, and shortwave broadcast blogs were posting the information needed to follow radio activity from the region. Did you miss it? No matter – all blogs are archived; it's not too late.

You are invited to share responses and input to all columns and blogs (whether they are online or not), but please do so privately via email. If you don't know the email address, any columnist may be contacted using [firstname.lastname@monitoringtimes.com](mailto:firstname.lastname@monitoringtimes.com)

For weekly samples of what is being heard on shortwave, I highly recommend former *MT* frequency monitor Dan Roberts' half-hour "Shortwave Report," available at [www.outfarpress.com/outfarpress/shortwave.shtml](http://www.outfarpress.com/outfarpress/shortwave.shtml) for download or even rebroadcast.

## Call RadioLabs for SUPER-909

Some readers, following up on Ken Reitz's mention in the July *Getting Started* column of a modified Sangean ATS909, have been calling Sangean headquarters to ask about this model. Please don't; it is not available from Sangean! You must contact RadioLabs at [www.radiolabs.com](http://www.radiolabs.com) or call 1-877-575-3700. We apologize for not listing the RadioLabs' phone number in the original article.

To see Jim Clarke's review of the modified Sangean "Super-909," check out his review in the April 2005 *First Look* column, or on line at [www.monitoringtimes.com](http://www.monitoringtimes.com)

## 996 Review Missing Text

In Larry Van Horn's review of the new Uniden BCD996T base/mobile scanner in the July *Monitoring Times*, a mistake was made in continuing from page 71 to page 73. Table 1 was repeated, and the final paragraph of text was omitted. Here are the final two paragraphs, including the missing text. Our apologies for the error!

"Finally, while the GPS capability is a neat feature, it is very labor and research intensive to get it up and operating. I am sure that with time, like other aspects of the scanner hobby, information will be shared through the internet to aid hobbyists in programming location information

for a variety of radio systems nationwide. But that will be at some point down the road and probably only a few will fully utilize the GPS features in this scanner in the near term.

"Bottom line, this is one heck of a scanner. This unit is the most advanced and feature rich radio scanner ever released by any radio company. No scanner in the marketplace even gets close to the BCD996T in features, listening capability, and overall performance, especially in its price range. There is a lot of scanning capability loaded into this small package. So if you are looking for one unit that does a lot, with the features you could only dream about three years ago, this is it – the first, truly high tech base/mobile scanner of the 21st century."

*The Uniden BCD996T (SCN 49) is available from Grove Enterprises (1-800-438-8155 or [www.grove-enterprises.com](http://www.grove-enterprises.com)) For \$539.95 plus shipping.*

## The Digital Effect

Ken Reitz received the following email in response to his April 2006 *Monitoring Times* article on digital radio.

"Regarding IBOC on the regular broadcast band, for the analog reception of most AM stations also sending the digital signal, the station sounds the same. One would not know the station was also broadcasting digitally.

"But there is a significant exception in which use of a digital signal meant a significant decrease in analog signal quality. The World's Highest Fidelity Radio Station (by its own definition) is no more. Of course I mean the 'gold standard' of broadcasting, WLW, Cincinnati.

"From 1959 until it started digital transmissions, WLW broadcast a high fidelity signal of considerable band width. Check the article on page 100 in September 1959 *Broadcasting*: R. J. Rockwell was cited as saying that the signal stays within plus or minus 1 decibel between 17 Hertz and 21.500 kilohertz, over 10 full octaves, with a distortion of 0.3%. In other words, WLW sounded better than a lot of FM transmissions.

"... I first became aware of WLW when I started college in September 1960 at Wittenberg in Springfield, Ohio. It was not long until I found WLW. At first, I thought the WLW promos of its signal was just so much bluster. But, the WLW signal was much better than the local stations.

"I had read in one of Doug Smith's WLW links that the high quality signal ended. Then I heard the music in one of Gary Burbank's skits on WLW. The music was distorted; before, the music would not have been."

– Timothy Kuryla, Lexington, Kentucky

## Go to the Source

"In the July edition of *Monitoring Times*,

on page 7, under the article entitled, "Senate and House Look at Telecommunications Laws," there is a statement that caught my eye. In the fourth paragraph, about five lines down, it says, "...The COPE Act BPL amendment adds a section (under Title V) to the proposed legislation that would require the FCC to study and report on the interference potential of BPL systems within 90 days of the bill's enactment."

"Quite by accident, while looking for something else, I came across a site page that includes a study of the effects of BPL that was conducted in 2003 by the National Telecommunications and Information Administration (NTIA).

"Based on the recent clamor about the BPL prototyping that is going in Prince William County (mostly in Manassas, near Washington, DC), I thought you might be interested in reading the full report."

[www.ntia.doc.gov/ntiahome/fccfilings/2004/bpl/FinalReportWord/Volumel/EXECSUMMARY.DOC](http://www.ntia.doc.gov/ntiahome/fccfilings/2004/bpl/FinalReportWord/Volumel/EXECSUMMARY.DOC)

– Melvin D. Calvert, Oak Ridge, TN

## QSL Expert

Gayle Van Horn sent a picture from one of her frequent contributors. "Edward Kusalik lives in Coaldale, Alberta, Canada. He's an active member of ODXA and contributes quite a bit to *MT's QSL Report* plus NASWA and Cumbre DX (and I think Glenn's DXLD). Ed comes up with some amazing QSLs. From the look of his NASWA awards on the wall, it looks like he definitely is an expert in QSLing!"



*This page is open to your considered comments. Opinions expressed here are not necessarily those of Monitoring Times. Your letters may be rephrased or shortened for length and clarity. Please mail to Letters to the Editor, 7540 Hwy 64 West, Brasstown, NC 28902, or email [editor@monitoringtimes.com](mailto:editor@monitoringtimes.com)*

*Happy monitoring!  
– Rachel Baughn, KE4OPD, Editor*





# COMMUNICATIONS

## Predicting Space Weather

After a lengthy period with few solar storms, early July saw an M-class solar flare and a large coronal ejection. A coronal mass ejection (CME) creates clouds of energized particles which may reach the Earth in two to three days. Their interaction with Earth's magnetic field not only creates auroral displays, but they can play havoc with satellites, communication links and power grids, and can endanger astronauts.

Although the particles are often deflected, sparing Earth from the most damaging effects of a CME, there is an urgent need for earlier assessment and warning, as modern life becomes increasingly dependent upon satellites and the power grid. To improve these predictions, scientists need to analyze the magnetic field that permeates the particles when they are further away than current instruments allow.

As it turns out, a novel antenna being erected in the Australian outback to study the origins of the universe could provide such early warnings. The Mileura Widefield Array - Low Frequency Demonstrator will consist of 500 "tiles" - each of which contains 16 simple dipole antennas. The telescope will operate in the spectrum used by FM radio and television, requiring an area of radio silence.

As explained in an article from [www.universetoday.com](http://www.universetoday.com) "...as we look at greater distances, we also look back in time ... It turns out that hydrogen, which made up most of the ordinary matter in the early universe, efficiently emits and absorbs radio waves. It is these radio waves, stretched by the expansion of the universe, which can be detected, measured and analyzed by the new telescope."

"The telescope will see thousands of bright radio sources. The plasma ejected from the sun changes those sources' radio waves as they pass through, but in a way that depends on the magnetic field strength and direction. By analyzing those changes, scientists will at last be able to deduce the all-important magnetic field properties of coronal mass ejections."

Australia is also hoping Mileura will be the site of the \$2billion Square Kilometer Array proposal. The SKA project involves 17 countries building the world's biggest radio telescope and WA is one of four sites in the world vying to host the project.

## Navigating Galileo

"Imagine someone builds a lighthouse, and I've gone by and see how often the light flashes and measured where the coordinates are. Can the owner charge me a licensing fee for looking at the light? ... No."

Sound familiar? Remind you of radio hobbyists who were trying to make sense of new modes and new signals being broadcast into their radios, like trunking and cellular signals? Here, however, the lighthouse represents the navigational signals

being broadcast by a satellite, and the remark was made by Mark Psiaki, co-leader of Cornell University's GPS Laboratory. GIOVE-A (Galileo In-Orbit Validation Element-A) is a prototype for 30 satellites that by 2010 will compose Galileo, Europe's global navigation satellite system. The GPS Lab deciphered Galileo's pseudo random number (PRN) codes from off-air signals when those codes were not made public.

Following a published statement by Galileo that it considered the open source codes to be intellectual property, however, Psiaki's group sought legal help. "We were told that cracking the encryption of creative content, like music or a movie, is illegal, but the encryption used by a navigation signal is fair game," said Psiaki.

Unlike the United States' GPS system, which is funded by taxpayers, Galileo is partially funded by investors who expect a return on their money, presumably by charging a fee for PRN codes. Galileo has so far made light of the Cornell achievement, saying a portion of Galileo's codes will be "open source," per an agreement between Europe and the US, but that what Cornell cracked was for this first experimental satellite and not the final codes.

## GPS Scramble

The Indian Space Research Organisation (ISRO) announced that it will be establishing a satellite navigation system on the lines of the US Global Positioning System (GPS). The proposed Indian Regional Navigation Satellite System (IRNSS), which will consist of a constellation of eight satellites, is likely to be operational in six years time.

Japan has proposed three satellites for its area of the world. The US GPS system contains 29 satellites, with about a dozen replacement satellites under contract. Galileo is planning for 30. Russia's GLONASS system has eight satellites.

## Who's Who in Space

Currently, over 800 satellites are in orbit, owned or operated by 41 different countries. Most nations are only concerned with communications in space. A growing use of space is surveillance (mostly photo sats). About a third of the satellites are military, or dual military/civilian use, most operated by the United States.

Only about a dozen countries can launch satellites. Russia, China and the United States are the major powers when it comes to putting stuff in orbit. New technologies, like more available rockets, and smaller "micro-satellites" mean more countries are going to be putting satellites up. In the next decade, many countries will have dozens of satellites, mostly micro-sats, in orbit. America will continue to have the edge in satellite capability (the best resolution, and abilities to detect many more things), but they are already a minority in terms of all the satellites up there.

*(Excerpted from a May 3, 2006, report from an unknown source.)*

## Ultimate DX

On March 31, 2006, a joint AMSAT team from the UK and Germany successfully received a signal from the most distant object ever built by mankind, the American space probe *Voyager 1*. *Voyager 1* was launched September 5, 1977, and is now about 14.7 billion km away from Earth! The received signal was clearly identified through means of Doppler shift and position in the sky.

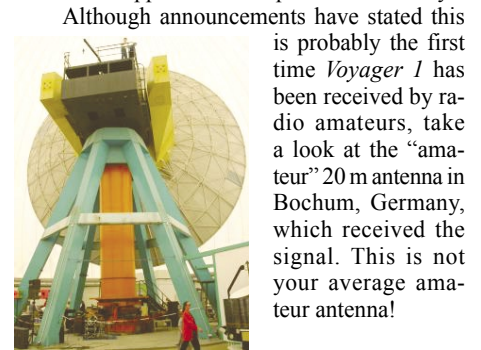

Although announcements have stated this is probably the first time *Voyager 1* has been received by radio amateurs, take a look at the "amateur" 20 m antenna in Bochum, Germany, which received the signal. This is not your average amateur antenna!

BULLETIN BOARD

**Sept 2-3: Shelby, NC**  
50th Annual Shelby Hamfest at Cleveland County Fairgrounds (3-1/2 mi east on US74 Business), talk-in 146.28/88 or visit [www.shelbyhamfest.org](http://www.shelbyhamfest.org). Adm \$6. Volunteer exams Sat and Sun 2pm (at Cleveland County Office Building)

**Sept 9: Lowell, MI**  
GRAHamfest 2006 (Grand Rapids Area Hamfest) at the Kent County Fairgrounds (Hwy I-96 exit #52, north 4 miles to fairgrounds), Talk-in 147.26+ (94.8 Hz) and 146.52 simplex. Inside and outside sales, exams (10AM). Contact Jack Amelar NY8D [grahamfest06@w8dc.org](mailto:grahamfest06@w8dc.org) evenings (616)897-6885 [www.grahamfest.org](http://www.grahamfest.org)

**Sept 16: Special Event Station**  
K5R, New Orleans, LA, commemorating the first anniversaries of Hurricanes Katrina and Rita. 1400Z-200Z on Sept. 16, 2006.14.250 and 7.250 +/- QRM. S.A.S.E. for certificate: Southeast Amateur Radio Club (SELARC), K5R, P.O. Box 1324 Hammond, LA 70404. <http://groups.yahoo.com/group/K5R>

**Sept 17: Newtown, CT**  
Western CT Hamfest. Contact Joe de Groot AB1DO (30 Sunnysvale Drive, Redding CT 06896; 203/938-4880) Talk-in 147.300 PL 100. Adm \$5.

*Communications is compiled by editor Rachel Baughn KE4OPD from newsclippings submitted by our readers. Thanks to this month's fine reporters: Anonymous NY, John Figliozzi, Bob Grove, Norman Hill, John Mayson, Ken Reitz, Doug Robertson, Greg Smith, Larry Van Horn, David Zantow.*



# Around the World in 48 Hours: A Shortwave Century Weekend

By Joe Cuhaj

**L**ike many people, I am a frustrated traveler. Just look at my passport – empty. Not a stamp; not a smudge; not even an Italian Nutella Fondue stain. Nothing. There’s never enough time, never enough money. Heck, *The Amazing Race* hasn’t even answered my application. The closest I ever got to traveling the world was when I was a DXer in the ‘70s and ‘80s.

But recently the bug bit me again. I decided to dust off that old Radio Shack DX-392 (aka Sangean ATS-818CS) receiver to see if the magic was still there. I would embark on a trip around the world; a trip that would take me from my home to the far reaches of the globe and back again within 48 hours. I was about to embark on a Shortwave Century Weekend.

The premise is simple enough: log 100 stations within the allotted time frame, in my case, 48-hours. I’ve read where it had been done before, but that was back in “the day” – or back in the 1970s anyway – when shortwave was still the primary form of electronic media for small, developing countries. The excitement of picking up the right skip and hearing a faint signal from Papua, New Guinea, was exhilarating. The programming took you directly to the land and culture.

That was then; this is now. As I said, I had been in and out of DXing the last 30 years (mostly out), when I decided to give it another go, but there were questions: Would it be the same today in this world of incredible technology such as the Internet, digital satellite receivers, and cell phones? Would the excitement be there? Were there still challenging catches to be logged?

## Ready, Set ...

So that was my quest. The first step was to make sure I had the proper equipment and, more importantly, make sure it still worked after all these years. I pulled the DX-392 out of the closet, plugged in the four “D” and three “AA” batteries, and cranked it up. I immediately headed to the 19 meter band and WWV. It worked like a champ.

Next was the antenna. I wanted to have the

best chance of reaching my goal. I’ve always liked long wire antennas, but that was a problem, since my property is located smack dab in the middle of a cotton field with no trees whatsoever.

I looked online and broke out my old American Radio Relay League (ARRL) books for a quick throw together home-brew antenna, but in the end decided not to take the chance. With my luck, it would short out the whip antenna and I’d sit here all weekend catching nothing and thinking it was caused by “bad conditions.”

I headed for Radio Shack and there the manager directed me to a wall where I found a neat little contraption – the Portable SW Antenna (catalog # 278-1374). At \$9, this little gem was perfect. It is a 27-foot long wire antenna that rolls up into a case that resembles a chalk line container. The loose end has a clip on it that snaps onto the receiver’s whip antenna. Cool.

Next, I had to scope out the best possible weekend to pull this off and, as any serious DXer will tell you, a set of propagation charts was in order. I downloaded two nice charts – one from [hfradio.org](http://hfradio.org) (Tomas Hood’s site) and the other from the ARRL.

The information from [hfradio.org](http://hfradio.org) is a little more difficult to use since it’s a Gantt chart (uses rows and columns) to maneuver you through

time, regions, and frequencies. The ARRL chart was a bit easier to use. It uses nice tri-colored bell curves to show MUF, LUF, and a mid-range for all regions making the information “pop” off the page.

While I could have gone about this haphazardly and just started scanning up and down the dial blindly, I decided I needed to take a methodical approach using an up-to-date broadcast schedule. In addition to *Monitoring Times’* English language shortwave schedules, I found [primetimeshortwave.com](http://primetimeshortwave.com), the website of Daniel Sampson, who is also a frequency monitor for *MT*. Updated frequently, the list gives a thorough rundown of English language broadcasts in frequency, time, station, or country order. In addition, it identifies any special days of the week for broadcasts, target areas, and if the programming is sent via a relay station.

By using this list, I identified 111 different stations I could conceivably log and decided that the English broadcasts were the only way to go. Trying to identify a foreign language station could take up precious time.

Having everything I needed, I combined the propagation charts and schedules and didn’t like what I saw. We were already on the downside of the solar cycle, and the charts I had acquired were painting a bleak picture for a successful

TRANSMITIENDO GRATAS NUEVAS ALEGRES  
Telling the Good News Abroad

From  
GUATEMALA  
"Beautiful land  
of the Quetzal"

Frequencies:

- 730 khz
- 3,300 khz
- 5,955 khz
- 100.7 mhz FM



Facts:

The Quetzal is the national emblem of Guatemala. This bird seldom survives in captivity, hence, symbol of liberty.

"If the Son (Christ) therefore shall make you free, ye shall be free indeed".

John 8:36

weekend. The local weatherman said a cold front was coming through the following weekend. I hoped that this would boost reception even if only a little. I marked the weekend in red on the calendar and was ready to begin.

After a slight delay (I had to wash the dog, wash the car, mow the lawn – you know, typical things to delay a good DXing session), I was ready to start for real. The door gets locked, the radio turns on, and off we go.

## Go!

Turning on the radio, I quickly realized that this wasn't going to be easy. My goal wasn't to receive a QSL for the loggings. But I did need to hear an ID or anything to verify the station. I began at 1700 UTC and faced a possible 19 stations on 55 different frequencies. I could have done a scan of the bands, but the dial would stop on everything, again wasting time.

The DX-392 has 18 shortwave memory settings, so I put them to use. Whenever I had a few minutes before the next window of opportunity, I would program in 18 frequencies. This made it easy to push a button, listen a bit, push the next button, listen, and so on, until one of them came through with a verified logging.

After my first logging at 1705 UTC (Voice of Nigeria), I was feeling pretty good about my chances – an African station at this time of day used to be a rare occurrence with my meager equipment. But as the weekend bore on and the rain poured down outside, patterns began appearing: 31 meters was weak and 25 was virtually shut down, but 41 and above was humming

along quite nicely.

UTC	kHz	Log
1705	15120	Voice of Nigeria – Weak but it looks like we're off to a good start. I've always had trouble logging this one.
1735	17810	UN Radio – A surprise for me. I used to miss this one when I was more into the hobby, so catching it now made me feel like it was going to be a good weekend.
1740	9985	WWCR – Interesting discussion of someone hacking into their computers and the Dick Cheney hunting accident.
1745	21470	BBC – Get the easy ones out of the way, I always say.
2101	15180	Radio Canada
0003	13650	Radio Japan – A horrible signal. Wonder why stations can't synchronize their IDs with the fading so that it fades in when they're identifying themselves. (I'm getting giddy already.)
0010	11650	China Radio International – Fairly good signal.
0015	7325	ORF – Great signal. Things are looking up.
0033	5890	Radio Thailand – This is a Greenville relay? Terrible signal. Things aren't as good as I thought.
0038	7335	Vatican Radio – Caught their interval signal but there's heavy interference from CHU blaring over the top of it. They are strong enough to make them both out. At least the Vatican was right on time getting on the air.
0055	11800	RAI – Very weak, barely audible but enough.
0058	7345	Radio Prague – My people! I

0105 6175  
0105 7145

0110 7230

0115 5880  
0116 9820

0121 5850  
0145 15000

0145 5000  
0150 7335  
0155 7250  
0200 7270  
0205 5950

0210 9515  
0215 9560  
0229 6010  
0245 6115  
0259 7400

0300 7390

knew they wouldn't let me down. Caught their complete frequency list and I mean COMPLETE. It seemed to go on forever.

Voice of Vietnam  
Universal Life – I think I'm going to get a good dose of religion before this is over.

Radio Slovakia – Ugh. They beat the U.S. in Olympic hockey today. Very interesting discussion of the Slovak language – old people dying, young people leaving the country, local dialects are disappearing.

Radio Ukraine  
Radio Havana Cuba – Picked it up on 9.820. Also on 6.000 but it was really weak.

WHRA  
WWVH – Could hear the female voice identifying the Hawaiian time station under WWV. Hey, why not? I make an executive decision – time stations count. So...

WWV  
CHU  
Voice of Russia  
Radio Cairo  
Taiwan Radio International – I remember the days when Taiwan was a real gem of a catch. It was easy tonight with the relay.

Radio Budapest  
KBS World Radio  
Radio Sweden  
Radio Tirana  
Radio Bulgaria – Good signal on 7.400 and also on 9.700.

Channel Africa – Ah, the days of Radio RSA come flooding

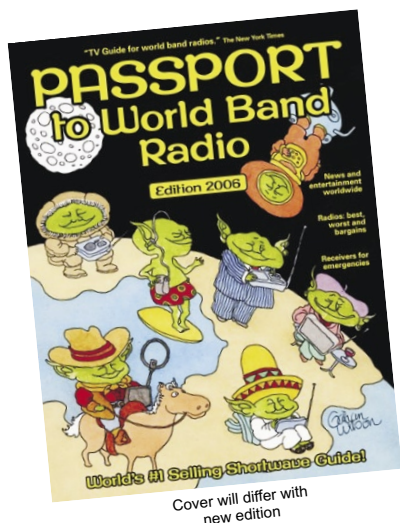

# 2007 EDITION

## PASSPORT TO WORLD BAND RADIO

The world's best selling shortwave guide is now bigger and better! Edited by Lawrence Magne, Passport is the ultimate shortwave hobbyist's listening reference. At a glance, Passport's exhaustive chart shows world broadcasters by frequency and time, indicating station power and language as well.

Passport includes extensive chapters on program profiles, English language listening, catching clandestine and pirate broadcasters, receiver reviews and ratings, planning your listening post, and Internet Web radio. A powerful listening tool at a low, low price!

**Order NOW to be one of the FIRST to get this year's edition!** (Expected Delivery, October, 2006)

Order BOK18-07  
\$22<sup>95</sup>  
plus \$3  
First Class Mail

www.grove-ent.com

**GROVE**

800-438-8155

828-837-9200; FAX 828-837-2216 7540 Highway 64 West, Brasstown, NC 28902 email: order@grove-ent.com

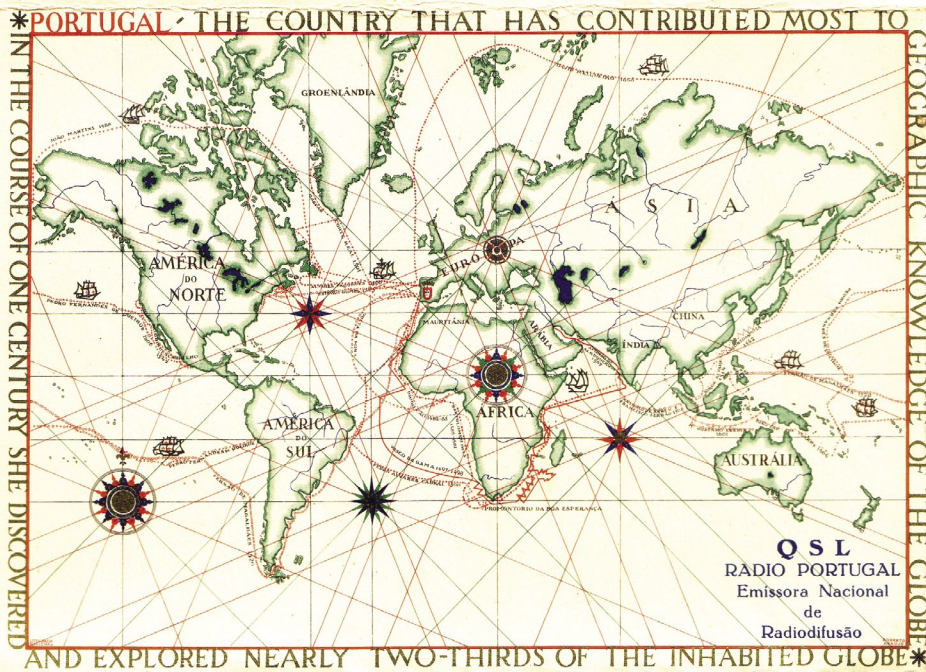

ant surprise, VERY weak, but made out an ID.

1410 11715 KJES  
1500 13810 Overcomer Ministry  
1605 15590 KTBN - Thank goodness for American radio.

By 1630 UTC, almost 24 hours since I began the quest, I had 65 stations logged, 58 of those were positive IDs with the remaining being debatable. I continued for the next 24-hours, but the conditions were horrendous as the front pushed through and the bands were going silent and my weekend had come to an end.

### The "New World" of Shortwave

It was obvious that in this day, even as broadcasters disappear from the airwaves daily and head to the Internet and satellites, successful century weekends are still possible. There were a few restrictions that put a crimp in my actually hitting 100 loggings. The propagation for the weekend was not on my side. The number of possible catches was reduced by my using only English language broadcasts. And there were the schedules themselves, with a number of stations broadcasting only on weekdays.

The main thing I walked away with was a feeling of sadness. While the experiment was great fun and challenging, the lure, excitement, and adventure of a DXpedition such as this wasn't there for me. It was a pleasure to hear a couple of stations that I had not heard before and a couple of old friends, but much of the programming sounded more westernized than it used to. The feel for cultures half a world away was missing.

On one broadcast, Radio Slovakia had a story about their older citizens dying and the younger ones leaving the country for better jobs at an alarming rate. As a consequence, rare dialects and cultures from different regions were vanishing. I had the feeling I was witnessing the same on the shortwave bands.

back with their bokmakene bird interval signal.

- 0303 7285 Croatian Radio - Interesting news headlines. Each item is accentuated with a dramatic music burst - da-da-daaa!
- 0310 9750 Radio Malaysia - Heavy QRM from all sides.
- 0327 7210 Radio Belarus - Interference is pretty heavy.
- 0359 9555 Radio France International - The schedules I have said it was supposed to be in English. There was an English ID then into French.
- 0402 6020 Voice of Turkey - Picked it up on 6.020 and also on 7.240 but it was weak.
- 0427 6050 Radio Nigeria - Heavy QRM from nearby Spanish station
- 0435 6280 Israel Broadcasting Authority - Weak, weak, weak. But it looks like 25 meters is opening up.
- 0455 9775 Voice of America - I remember when I first started and picked VOA up for the first time as a kid. I really thought I had something.
- 0500 6165 Radio Netherlands
- 0505 9565 Deutsche Welle
- 0510 3185 WWRB
- 0515 5850 WEWN
- 0520 7415 WBCQ - The odd one of the session. They played a phone call from "Roving Radio Dude Dwayne" in Orlando. He talked about his reports on WBCQ. The word "sucks" used 3 times...wait, 6...wait 9...wait, the same 5 minute phone call is being re-broadcast, at least 3 times in 15 minutes. THAT sucks.
- 0600 6150 Universal Network
- 0605 11640 Trans World Radio

The eyes have it - or have had it. It's time to turn in and get the ringing out of the ears. Next thing I know it's 1000. Ugh, only wanted to sleep an hour or so. Oh well, back at it.

- 1014 11775 World Universal Radio
- 1106 9475 Radio Australia
- 1110 5950 WYFR
- 1115 13840 Radio New Zealand Interna-

tional - Another one that used to be an elusive catch and poof! Here it is.

- 1120 12005 HCJB - Where have I been? HCJB used to be all over the bands at all hours of the day from Ecuador. This isn't Kansas anymore.

Then, nothing. Everything is dying off. Hopefully some of the North American stations will come through for me.

- 1255 7520 WHRI
- 1300 11850 Radio Polonia - VERY weak, almost inaudible but caught an ID.
- 1305 15105 Radio Romania - My ears will be ringing after this one. Horrible interference.
- 1310 13570 WINB
- 1330 9690 All India Radio - A pleas-

club ondes courtes de

# Radio-Canada

shortwave club

#### Certificate of membership

We have ascertained that all membership requirements have been fulfilled, and we hereby certify that

J O E C U H A J  
is a member of the  
Radio-Canada Shortwave Club

#### Certificat de qualification

Nous reconnaissons que toutes les exigences de l'adhésion ont été satisfaites, et nous certifions par les présentes que

est membre du  
Club ondes courtes de Radio-Canada

This/ce 23rd day/jour of/de AUGUST 19 73

No. 14208



# Propagation, Space Weather, and You

By Tomas Hood, NW7US

For many of us radio hobbyists, the sheer thrill of the hunt keeps us coming back into our radio shack to tirelessly tune the radio spectrum for interesting signals. Whether the hunting ground is the shortwave segment from 300 kilohertz to 30 megahertz, or perhaps the public service or military allocations on the VHF and UHF spectrum, I've been known to happily pass hours and days with pen and paper in hand recording anything I can hear. Much to the grief of friends and family, such unplanned expeditions through the electromagnetic radio signal landscape can result in too much time spent on the hunt.

Experienced VHF and UHF scanning enthusiasts can attest to the wisdom of limiting the spread of frequencies that should be scanned for new signals. Too wide a spread and the odds of actually catching a real transmission become unrealistic. Hunting on shortwave can be even more daunting, as you search for that needle in a haystack.

Even so, I've heard amateur radio operators chatting on late-night "round table" frequencies expressing such sentiments as, "I don't really need to know what the Sun is doing, I just get on the air and try my luck at catching some DX," or, "I like the thrill of the hunt; get on the radio, tune around, and just see what I can catch," or other such comments that convey the idea that exploring the science of propagation is a waste of time. A great many folks just throw up their hands at the idea of figuring out the mystery of space weather and how to predict when and where to operate on the high frequencies. Some operators have gone so far as to tell me that trying to forecast propagation conditions and plan their operation accordingly seems unsportsmanlike!

Sure – I, too, have fully enjoyed the sheer joy of randomly picking a range of frequencies and patiently tuning around to find new and exotic signals. What a pleasure to discover a radio broadcast from South Africa or the Near East. When such finds are an unplanned surprise, the warm feeling is almost like meeting a new friend. And, I did not need to know any propagation science to have a most exciting radio experience.

I've done the same thing on a lazy summer day: I grab some fishing bait, my fishing pole, some snacks, and head up a hiking path to a favorite fishing hole. I sit on the banks of the water, casting a line out randomly, while drinking in the sounds and sights of nature while hoping for a bite. It has been fun "trying my luck," fishing with no plan and no real skill. It is more than fishing: It is simply enjoying the

out-of-doors.

However, there are those times when I'm out camping, and I'm hungry for a real tasty trout dinner. With a limited budget of time and bait, I want to maximize my fishing endeavor. Under these constraints, I might want to know when and where to fish.

It is considered good sportsmanship to acquire the type of equipment that helps the fisherman, or the hunter, to find and secure the hunted. A lot of money is spent for sonar, bait, scents, or anything that might give an edge to the hunt. Sports enthusiasts want to maximize their investment in time, energy, and expense.

Wouldn't it then make sense that the radio hobbyist might want to build better antennas, study space weather, apply the tools of propagation forecasting, and hone operating skills? Of course!

The logical question that arises when planning a hunting expedition on HF radio (whether a real DXpedition, or simply an afternoon or evening listening session) is, "What frequencies are most likely to be active during my operating time?" Or, "When should I turn on my radio so I can hear a particular area of the world?" Or simply, "When will good propagation occur?"

Answering these questions with some accuracy helps you plan when to set aside some time in a busy family schedule for "hunting." If you were to know that conditions are likely to be lousy this weekend but great next weekend, then you might want to plan your lawn mowing for this weekend and have the next weekend for a mini DXpedition from your favorite campground, where you could put out a Beverage antenna and catch some nice foreign signals.

## Some Basics

Before an answer can be found as to when propagation will be "good," some basic concepts need to be understood about how shortwave radio signals propagate and what factors contribute to that propagation.

When talking about radio signal propagation on shortwave (the high frequency spectrum), we're most interested in receiving signals that originate from stations far away, beyond line of sight. After we move far enough away from a transmitting station and are no longer in a direct line-of-sight view, there are generally two paths that a radio signal travels (or, propagates). One path is along the ground, and propagation along this path is known as *groundwave propagation*. The other is known as *skywave propagation*.

Groundwave propagation describes how a radio wave travels away from the transmitting source, out along the surface of the Earth. In a sense, the radio signal hugs the surface for great distances as it moves out away from the generating source, bending with the curve of the Earth, until the energy of the radio wave is absorbed. Groundwave propagation is most efficient at lower frequencies where absorption is low. Groundwave is especially efficient in the low frequency (LF or longwave, 30-300 kHz) bands and below, and somewhat useful in the medium frequency bands (MF or MW, 300 kHz-3 MHz), home of domestic AM broadcast stations.

Skywave propagation describes how a radio signal that radiates up and away from an antenna is reflected or refracted by the ionosphere back toward the Earth at the opposite angle from its source, causing the radio wave to reach very distant areas. A simple way to visualize this ionospheric "bounce" is to think of the reflection of a beam of light from a flashlight. When you stand off to the side of a mirror and shine the flashlight at an angle toward the mirror, the beam will be reflected at the same, but opposite angle, toward a distant spot.

When shortwave radio signals spread out away from their source and reach the ionosphere, they may be reflected back toward the Earth. They might make such "hops" more than once, bounced back toward the ionosphere by the Earth, repeating this skip several times or more. In this way, skywave propagation allows a signal to reach around the world.

Groundwave tends to lose its energy through the loss it experiences traveling along

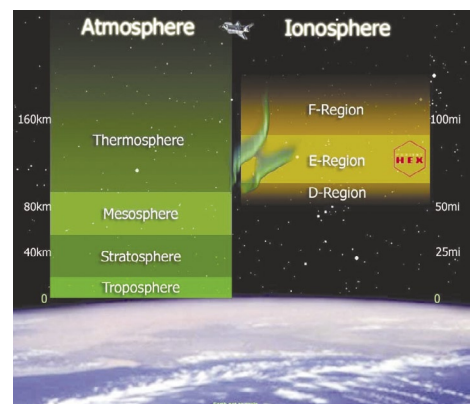
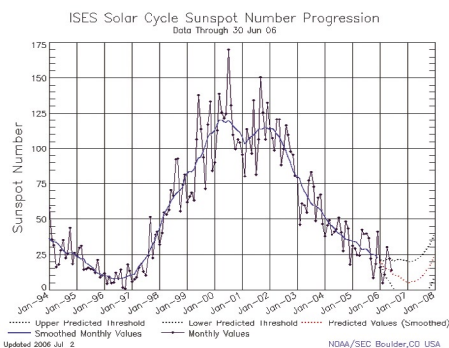

Figure 1: The ionospheric regions in relation to Earth's atmosphere. The ionosphere is composed of three main parts: the D, E, and F regions. Credit: HEX (Horizontal E-Region Experiment)



**Figure 2: Sunspot Cycle 23.** Source: NOAA/SEC Boulder, CO

the surface of the Earth. While skywave can be absorbed at certain frequencies in the lower regions of the ionosphere, skywave experiences much less attenuation because the majority of its journey is through the atmosphere.

At night, mediumwave signals and the lower shortwave frequency signals travel better by skywave. During the day, mediumwave signals tend to be absorbed by the lowest regions of the ionosphere, so tend to only be received by groundwave propagation. Higher shortwave frequencies may be propagated during the day by skywave, depending on the condition of the ionosphere.

Competing with these signals arriving by way of the ionosphere and earth-sky-earth bounces is interference from noise or other transmissions. In the case of noise, it could be that the noise you are hearing has been propagated from very distant sources. In addition to man-made noise, atmospheric noise from lightning and static electricity reduce the effectiveness of the signal you are hunting.

Since skywave depends completely on the condition of the ionosphere, let's take a quick look at this region of our atmosphere.

## What is the Ionosphere?

Earth's atmosphere is a mixture of gases held to the surface of the Earth by gravity. These gases vary in density and composition as the altitude increases above the surface. As the atmosphere extends outward from Earth, it becomes thinner and blends with particles of interplanetary space (see figure 1).

The first sixty miles of Earth's atmosphere consist of a homogeneous mixture of various gases. This region is called the homosphere. Above the homosphere lies the heterosphere, where the gases are no longer uniformly mixed. Relatively more of the heavier gas molecules are found near the bottom of this region, and relatively more of the lighter gases are found near the top.

The atmosphere is also divided into four regions according to temperature trends: the troposphere, the stratosphere, the mesosphere, and the thermosphere. The lowest region is the troposphere, which extends from the Earth's surface up to about six miles. The gases in this region are heavier than those in higher altitudes. The atmosphere above the troposphere is called the stratosphere, starting at about six miles out. Gas composition changes slightly as the altitude increases and the air thins. Incoming solar ra-

diation at wavelengths below 240 nanometers is able to create ozone, a molecule of Oxygen consisting of three Oxygen atoms ( $O_3$ ), in this layer. This gas reaches a peak density of a few parts per million at an altitude of about 16 miles.

At altitudes above fifty miles, the gas is so thin that free electrons can exist for short periods of time before they are captured by a nearby positive ion. The existence of charged particles at this altitude and above marks the beginning of the ionosphere, a region having the properties of a gas and of plasma.

Above the ionosphere, a vast region of charged particles known as the magnetosphere is formed by the interaction between the solar wind and the Earth's magnetic field. The magnetosphere begins at about 600 miles above the Earth's surface. It extends to a distance of about 40,000 miles on the side facing the sun, and to even greater distances on the side of the Earth that is turned away from the sun.

## How is the Ionosphere Formed?

Much of the energy from the sun that reaches our atmosphere is absorbed. All of the hazardous ionizing radiation, gamma rays and x-rays are blocked before they reach the surface. Much of the ultraviolet radiation from the sun is also absorbed. The deepest-penetrating of these waves is in the ultraviolet range. The atmospheric ozone layer is the greatest absorber of ultraviolet radiation.

Atoms in the ionosphere absorb the incoming solar radiation, causing them to become highly excited. When an atom becomes energized, an electron may break away from its orbit. This produces free electrons and positively charged ions. Since the photons of energy at these ultraviolet and shorter frequencies are capable of dislodging an electron from a neutral gas atom or molecule during a collision, solar radiation at ultraviolet and shorter wavelengths is considered to be "ionizing."

At the highest levels of the Earth's outer atmosphere, solar radiation is very strong, but there are few atoms to interact with, so ionization is small. As the altitude decreases, more gas atoms are present, so the ionization process increases. At the same time, however, an opposing process called *recombination* begins to take place in which a free electron is "captured" by a positive ion if it moves close enough to it. As the gas density increases at lower altitudes, the recombination process accelerates, since the gas molecules and ions are closer together.

Because the composition of the atmosphere changes with height, the ion production rate also changes, and this leads to the formation of several distinct ionization regions, known as the D, E, and F layers (the F layer splits apart into three layers, F1, F2, and F3). The boundary between layers is based on what wavelength of solar radiation is absorbed in that region most frequently.

The D region is the lowest in altitude, though it absorbs the most energetic radiation, known as hard x-rays. The D region doesn't have a definite starting and stopping point, but

includes the ionization that occurs below about 56 miles. This region absorbs high frequency (HF) waves between 3 and 30 megahertz or wavelengths between 100 meters and 10 meters. It refracts frequencies in the range of 3 to 30 kilohertz (very low frequencies, or VLF).

The D region is a daytime layer, due to the density of the gases. Absorption of ultraviolet and visible light radiation creates more negative ions than electrons during the day. At night these ions quickly recombine with other ionic particles, and the layer all but disappears. (Without going into great detail, the D region doesn't really disappear at night. VLF communication circuits depend on the D region ionosphere in both day and night.)

The E region of the ionosphere extends from about 56 miles to about 65 miles, where the air is considerably thinner than the layers below it. As a result of this thin air, there are fewer collisions of ions and electrons, resulting in a population of molecular ions. The E region absorbs soft x-rays. This layer is highly variable from day to night.

The F region is the largest part of the ionosphere, as well as the highest. It extends from about 65 miles up through the end of our atmosphere. Since particle densities decrease as you travel away from Earth, it is difficult to say exactly where our atmosphere ends. Since it is such a large region, the F layer is primarily divided into two sections, the daytime layer, F1, and the denser F2 region which exists during both day and night.

In the upper reaches of the ionosphere, gravity has a lessening effect on particles. As a result, particles create different layers depending on their mass. The heavier particles sink to the bottom of the F region and the lighter ones rise to the top. This explains why electron density increases with altitude.

Along the day / night meridian, electron numbers rise and fall. At sunset, electron numbers decrease, due to the recombination of these particles with ions in the F1 layer during the night. On the sunrise meridian, electron numbers increase as neutral molecules and atoms absorb solar radiation, mostly ultra-violet.

The F3 region has been discovered recently, and has only been observed as mostly existing during the high-noon hours over the low equatorial latitudes. The lowest of the F regions is the F1 region, and the highest is the F3 region.

## Radio Waves in the Ionosphere

As an electromagnetic wave enters the ionosphere at the D layer, the energy sets electrons in motion. Because this layer is so dense, there is a high probability that the energy will be absorbed in a collision with nearby molecules. The electromagnetic energy is turned into kinetic energy (heat) and, as far as radio propagation is concerned, is lost. The higher the frequency and the shorter the wavelength, the higher the energy, but also the fewer collisions between free electrons and gas molecules than at lower frequencies. As a result, lower frequency signals are attenuated far more than

those at higher frequencies. It is possible that the lowest frequencies are completely absorbed, while higher frequencies will make it through to the E layer.

Since the E layer is less dense than the D layer, electrons are not so quickly recombined with neighboring atoms, so losses are lower. Because these electrons are not as quickly bound with other atoms, losing energy, the electromagnetic wave is re-radiated. Because the signal is traveling in an area where electron density is increasing, the farther it will go. At the same time, the wave is bent away from the denser, and higher, area of electrons. The amount of bending, or refraction, is dependent on the frequency of the wave. The higher the frequency, the more energy that wave has, and the more likely it is to pass through the layer to reach the next higher region.

When an electromagnetic wave enters the F layer, the same science takes place. The radio signal rides the free electrons of this layer, and if the frequency of the signal is high enough, it will pass through the layer, out into space. Otherwise, it will gradually bend back away from the higher and denser layers of electrons to be sent back toward Earth.

Those frequencies that are refracted back to Earth have to pass through the lower ionospheric layers, again. D layer absorption will attenuate the signal some more. If there is enough energy in the signal, the wave may bounce between the Ionosphere and Earth multiple times, greatly extending the distance it can travel. Other times, it might be so absorbed that no communications are possible. Yet at other times, a radio wave will enter the Ionosphere, bounce off of the F layer, but then refract back up away from the E layer, doing these multiple hops until it can punch back through the E layer and back to Earth.

All of this depends on how ionized the gases become in these various layers and how dense each layer is, as well as the strength, angle of incidence, and frequency of the radio signal. Ionization depends on the direct energy from solar radiation. Would all of the layers of the Ionosphere perform identically if they each received the same amount of solar energy? No; because of the different gases found in each layer and the density of those layers, each layer has unique characteristics.

## Sunspots and the Ionosphere

As you might have guessed, since the ionosphere depends on solar radiation for its existence, and since radio waves are refracted by a strongly energized ionosphere, the level of activity on the Sun is tied to radio signal propagation.

The Chinese and many other early civilizations were the first to discover sunspots. Since the time of Galileo Galilei, who made the first European observations of sunspots in 1610, observers and scientists have discovered a great deal about the Sun and its influence on the Earth and our atmosphere. Daily sunspot observations were started at the Zurich Observatory in 1749. By 1849, continuous sunspot observations were being recorded.

Over time, cycles in solar activity were

revealed. The Sun's sunspot activity has a cycle that lasts for an approximate eleven year period (see figure 2 for the current cycle, Cycle 23). The cycle starts quietly with very few sunspots, peaking about three to five years later with a very high number of daily sunspots, and then decreasing in sunspot activity until the end of the solar cycle.

The sunspot number is calculated by first counting the number of sunspot groups and then the number of individual sunspots. The "sunspot number" is then given by the sum of the number of individual sunspots and ten times the number of groups. Since most sunspot groups have, on average, about ten spots, this formula for counting sunspots gives reliable numbers even when the observing conditions are less than ideal and small spots are hard to see. It is these monthly averages of the sunspot numbers that show us the eleven year cycle in the number of sunspots visible on the Sun.

Sunspots are regions on the Sun with magnetic field strengths thousands of times stronger than the Earth's magnetic field. Plasma flows in these magnetic field lines.

Visually, sunspots appear as dark spots on the surface of the Sun. Temperatures in the dark sunspot centers (the "umbra") drop to about 3700 K, compared to 5700 K for the surrounding photosphere. This difference in temperatures makes the spots appear darker than elsewhere. Sunspots typically last for several days, although very large ones may live for several weeks. They are seen to rotate around the sun, since they are on the surface, and the sun rotates fully every 27.5 days.

Sunspots usually form in groups containing two sets of spots. One set will have a positive or north magnetic field while the other set will have a negative or south magnetic field. The magnetic field is strongest in the darker parts of the sunspot. The field is weaker and more horizontal in the lighter part (the "penumbra").

Sunspot numbers give us a way to measure the sun's overall activity. The more active the Sun, the higher the sunspot count. Scientists have discovered a direct correlation between the Sun's sunspot activity and our ionospheric activity. The more sunspots observed, the greater the ultraviolet energy bombarding the Earth. Since the ionosphere is formed by the ultraviolet energy from the Sun, the more sunspots on the Sun, the more energized the ionosphere becomes.

By keeping close record of the sunspot number and the overall propagation conditions, scientists have developed models that help us forecast HF communication openings on any given path. Of course, there are some other space weather events that also influence the condition of the ionosphere and the Earth's geomagnetic field. But, in basic terms, the Sun's sunspot cycle directly relates to shortwave radio signal propagation.

Related to sunspot counts is the 10.7-cm flux measurement. This is a measurement of the strength of the 10.7-cm radio signal arriving from the Sun. This frequency is most closely associated with the ultraviolet energy level of the Sun, so it gives us a highly accurate gauge

of how much energy is entering the ionosphere. When we look at the daily measurements of the 10.7-cm solar flux, we find that the higher this reading, the more ionized these various layers become, making it possible for higher shortwave frequencies to propagate by refraction over great distances. When the flux readings are low, the ionosphere is weaker, and only the lower shortwave frequencies will be propagated. Of course, there are many variations during the day, between regions in daylight and darkness, and from season to season.

The method used to chart the monthly solar activity is known as the Smoothed Sunspot Number, or SSN. It is important to understand that when you see the acronym SSN, it does not mean Sun Spot Number. It means Smoothed Sunspot Number, and is an average of 13 monthly RI numbers, centered on the month of interest. The RI number refers to the daily index of sunspot activity (R), defined as  $R = k(10g + s)$  where S = number of individual spots, g = number of sunspot groups, and k is an observatory factor.

## The Current Solar Cycle 23

The current sunspot cycle, number 23, started in 1996. Two activity peaks were observed: The monthly smoothed sunspot number first peaked at 120.8 during April 2000, with a second but lower peak at 115.6 for November 2001. Since these two peaks, we have seen a steady decline in the cycle's activity. Many experts feel that this cycle will end during the beginning of 2007, and the next sunspot cycle will begin.

Taking this into consideration, is there much hope for hearing rare or weak shortwave stations when the ionosphere is at its least energetic state in the current sunspot cycle? The short answer is, yes, but only on the lower frequencies of the shortwave spectrum, and only during certain times of the day and year.

Knowing the best times to catch a station can make your DX chasing more successful. You need to know when propagation will be best, as well as when a station is transmitting. Using the listings included in this magazine, as well as other resources such as various lists on the Internet (for instance, my listings at <http://swl.hfradio.org/>), you can determine the windows of time in which you might hunt for a station.

Armed with the times and frequencies, the next step is to do some propagation forecasting. The idea is to look for times when propagation is predicted to be good enough for a station's signal to propagate between its transmitter and your listening location.

## Coming Full Circle

Back to the question at hand: When will good propagation occur?

When the question is asked, "When will good propagation occur?" the reader should look at more factors than just concentrating on the space-weather environment. The other factors that affect propagation are radio circuit path length and orientation, frequency, diurnal effects, as well as the transmitter power and

antenna gain, and the parameters of the receiving station. Space weather and geophysical (weather, geomagnetic field, location) factors are not changeable by the average radio hobbyist. The rest of these factors are those you can control.

Whether you are an amateur radio operator or a shortwave listener, noise is always a factor limiting what you can hear. But noise is only one aspect of HF reception. The varying ionosphere makes even powerful broadcast signals come and go, and it's hard to know what to expect when you settle down for an evening of shortwave listening. Of course, you can always tune to the frequency where you last heard a favorite station, but if there is noise yet no radio signal, what then? It's frustrating to just *listen in the blind*.

Trying to figure out this complex relationship between the sunspot activity, the ionospheric conditions, signal path losses, and antenna patterns is nearly impossible if you depend on mental calculations or a notepad and pencil to work out the formulas and graphs. But fortunately, software tools have been created to assist you in planning your communications over radio signal paths between point A and point B. In addition to doing all the computations for you, the most accurate of these software tools use HF propagation models developed over a very long period of observation and validation.

## HF Propagation Models: A Brief History

HF propagation models have a long history of development, going back to the U.S. Army's *Ionospheric Radio Propagation Technical Report #9*, published by the National Bureau of Standards in 1948. The Institute for Telecommunication Sciences and Aeronomy released the first computer prediction program called ITSA-1 in 1966.

Then a second generation of ionospheric prediction programs, ITS-78, sometimes called HFMUFES-4, was developed in 1969. This led to continued work by the National Telecommunications and Information Administration's *Institute for Telecommunication Sciences (ITS)*, and the well-known IONCAP model – the third generation of HF predictions programs – was eventually released to the public.

In 1985, the Voice of America selected IONCAP for their modernization program and launched a model improvement project with development by the Naval Research Laboratory, ITS, and the VOA staff led by Mr. George Lane. The NRL effort found many coding errors in IONCAP and together with ITS, added new capabilities such as area coverage predictions. The result was named VOACAP (Voice of America Coverage Analysis Program) and was released to the public in 1993. Since that time, VOACAP has been maintained by ITS in Boulder, Colorado.

Because of its decades of historical development and the many years of validation through VOA listener reports, VOACAP has emerged as the *gold standard* of HF propagation models. It is used throughout the world by gov-

ernment and amateur radio operators, as well as by international broadcasters. VOACAP was calibrated through measurements made during a wide range of environmental conditions, so that the resulting Signal-to-Noise Ratio (SNR) distributions implicitly include the effects of a range of disturbed conditions. The range of environmental effects is built into the model, and shows up in the statistical factors. From a radio hobbyist standpoint, it's a relief to know that even with these credentials, VOACAP is still easier to use than other models where such factors must be laboriously worked out and inputted.

## ACE-HF PRO, version 2.05

One powerful and popular software package used by shortwave radio listeners and amateur radio operators alike is ACE-HF, which selected VOACAP for its computational model. The programmers of ACE-HF work directly with ITS personnel to develop new capabilities. ACE-HF funded ITS to implement the new reception area coverage predictions, which are so important to SWL enthusiasts.

Other ham radio programs utilize VOACAP, as well. However, for the purpose of illustrating concepts in this article, I have chosen to use ACE-HF because of its close tie with current VOACAP development.

If you are an amateur radio operator, you have probably heard of the *ACE-HF System Simulation and Visualization Software* that was first released several years ago. This year, a much more powerful version 2.05 has been released which is specifically designed for shortwave listeners as well as hams.

ACE-HF is derived from the professional ACE-HF Network software for government and commercial HF network operators. "ACE" stands for *Animated Communications Effectiveness*, the copyrighted technique for displaying both transmission and reception coverage on maps of the world. This key feature yields great insight into the coverage achieved by any HF station, but is especially helpful to see whether a particular broadcaster covers your listening post. You can also simulate a point-to-point circuit from any world location to your station and show the predictions graphically. All ACE-HF charts may be animated – one of the hottest features of the program.

New in this year's version are many features that will benefit both hams and SWLs. You can easily switch the software from Ham Radio mode to SWL mode. In the SWL mode, the transmitter can be set to any location, and you can pick from a database of at least 642 International Broadcast transmit locations. You can now select from thirteen service types, including many digital modes. Simulations of both ALE and conventional HF operation can now be made – features of interest to hams experimenting with Automatic Link Establishment operation as well as to utility listeners.

## Antenna Tricks

Perhaps the most interesting new capability is enhanced antenna analysis. In addition to the built-in HFANTENNA program (with which you can analyze and view antenna pat-

terns for the many supplied antenna models or for models that you create), there is a new animated chart for comparing antenna patterns with predicted elevation angles.

One of the most vexing problems in choosing antennas for your station is to figure out the best vertical radiation pattern for a given circuit. This problem is particularly troublesome when short circuits that rely on NVIS (Near Vertical Incidence Skywave) propagation must be accommodated. For NVIS, a simple vertical monopole simply won't do. But at what distance will each circuit work well with your favorite antenna?

The new ACE-HF Antenna Analysis Chart automatically graphs the antenna's vertical acceptance (take-off) pattern, along with elevation angles of the arriving propagation modes. The chart may be animated through the user's selected frequencies, and directivity gain is given for each. You can select different antennas without leaving the chart, so comparisons can easily be made. This chart is great fun to play with, and will quickly become a favored tool in your radio operation toolbox.

## Putting ACE-HF to Work

If you look at the two Area Coverage Maps I created using ACE-HF PRO's animated coverage feature, you can see how the sunspot activity level affects the propagation of a 14 MHz radio signal from my location. I created one coverage map (figure 3) for the peak of the solar cycle, and the other for this year (figure 4). Each is run for the same month of the year (September), using the same antennas, power level, and so on. The only change between the two maps is the year in the current solar cycle. As you can see, during the peak of the solar cycle, a 14 MHz signal propagates over greater areas than during the minimum period of solar cycle activity.

The next two maps (figures 5 and 6) show the same comparison, but with a different antenna. Notice how drastically different the results are with this other antenna (a Yagi, instead of an isotropic antenna). This illustrates that good propagation depends on more than just space weather, but also on your equipment!

The next comparison I made using ACE-HF is for the circuit between my location in Washington State and a station in Sierra Leone (9L prefix). This time, I chose January as the month, and again chose for the first chart a smoothed sunspot count typical of the solar cycle maximum, and for the second chart, the sunspot count for this year in January. As you can see (in figure 7), during the peak of the cycle, at 1900 UTC, 10 meters is hot! But, this year, the best bands, using the same time, antenna type and power level, are 17 meters and 15 meters (figure 8). Ten meters is dead.

## Listening from Riyadh

To investigate the world of international broadcasting on shortwave, I used ACE-HF PRO to simulate a shortwave circuit from the well-known WWCN (Worldwide Christian Radio) station in Nashville, Tennessee, to my pretended location in Riyadh, Saudi Arabia. There is an HFCC (High Frequency Co-or-



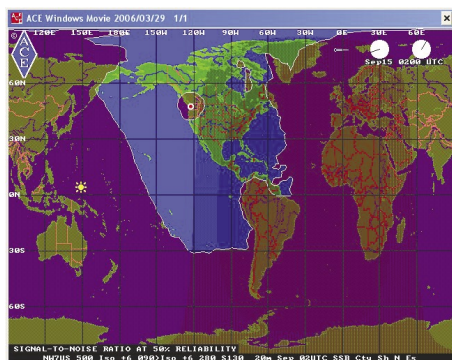

Figure 3: One slide from the ACE-HF PRO v2.05 Animated Coverage Area based on the solar cycle maximum, from NW7US in Washington State at 0200 UTC in September.

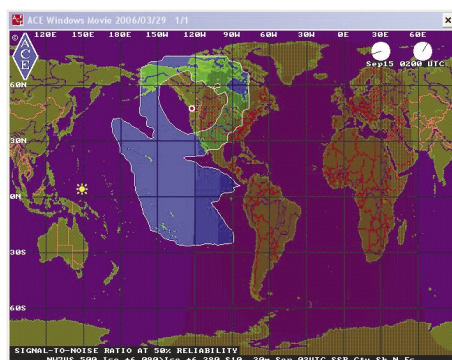

Figure 4: One slide from the ACE-HF PRO v2.05 Animated Coverage Area based on the solar cycle minimum, from NW7US in Washington State at 0200 UTC in September.

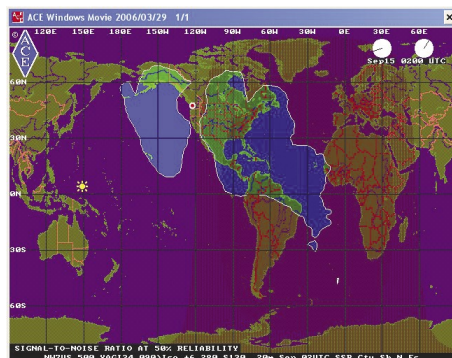

Figure 5: One slide from the ACE-HF PRO v2.05 Animated Coverage Area based on the solar cycle maximum, from NW7US in Washington State at 0200 UTC in September.

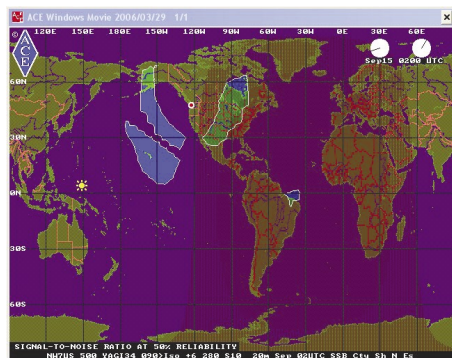

Figure 6: Same as Figure 5, but with a different antenna.

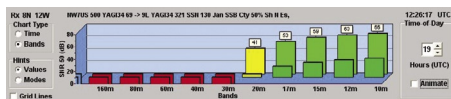

Figure 7: Band opening chart created by ACE-HF PRO v2.05 for the circuit between Washington state and 9L, Sierra Leone, Africa, in January during the solar sunspot cycle maximum.

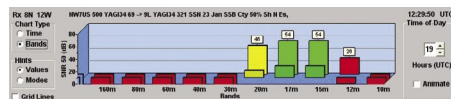

Figure 8: Band opening chart created by ACE-HF PRO v2.05 for the circuit between Washington state and 9L, Sierra Leone, Africa, in January during the solar sunspot cycle minimum.

dination Conference) database of over 640 International Broadcast transmit sites that has a new sorting feature, so I was able to quickly select the WWCR station.

I set WWCR's transmit power at 100,000 watts and selected the CONST17.VOA antenna from the more than 660 HFCC antenna models now included in ACE-HF. This general purpose

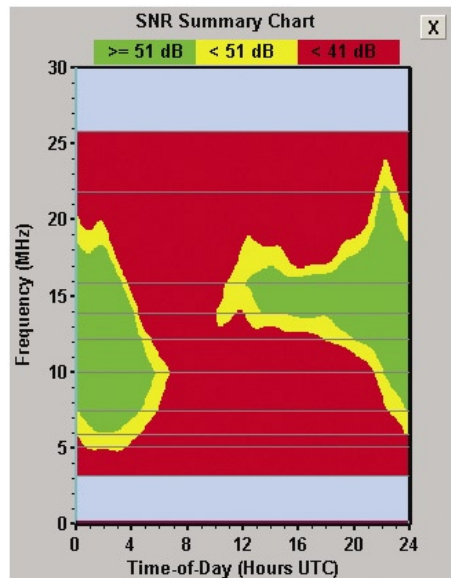

Figure 9: Summary Chart by ACE-HF PRO showing the signal-to-noise ratio between WCR and Riyadh, Saudi Arabia.

17-dBi, omni-directional antenna is recommended by the Voice of America, but I could have selected another one of the HFCC models that include curtain arrays with up to 30-dBi gain. I assumed the SWWHIP.VOA antenna for my receiver. And I selected the AM service type, although I could have chosen the new IB service type for commercial quality HF reception.

The ACE-HF design assumes that the user employs International Broadcasting schedules as posted on the Internet, where details such as transmit power, azimuth (main beam) angles, frequencies and time schedules are readily available. Two good sources for this rapidly changing data are [www.hfcc.org](http://www.hfcc.org), and [www.ilgradio.com/ilgradio.htm](http://www.ilgradio.com/ilgradio.htm). (Don't forget that I also have shortwave broadcast search tools at

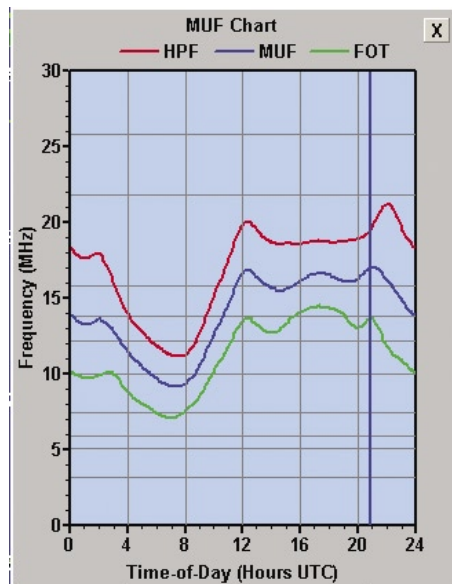

Figure 10: Maximum Usable Frequency graph by ACE-HF PRO showing the MUF during one full 24 hour period, between WCR and Riyadh, Saudi Arabia.

<http://hfradio.org/swbc/>).

All these adjustments take more time to read about than to set up, so I just clicked on Run Circuit Predictions to see the prediction charts for my circuit. I always look first at the Signal to Noise Ratio (SNR) Summary Chart,

continued on page 69

### SMOOTHED SUNSPOT NUMBERS FOR CYCLE 23

	Jan	Feb	Mar	Apr	May	Jun	Jul	Aug	Sep	Oct	Nov	Dec
1996	10	10	10	9	8*	9	8	8	8	9**	10	10
1997	11	11	14	17	18	20	23	25	29	32	35	39
1998	44	49	53	57	59	62	65	68	70	71	73	78
1999	83	85	84	86	91	93	94	98	102	108	111	111
2000	113	117	120	121	119	119	120	119	116	114	113	112
2001	109	104	105	108	109	110	112	114	114	114	116	115
2002	114	115	113	111	109	106	103	99	95	91	85	82
2003	81	79	74	70	68	65	62	60	60	58	57	55
2004	52	49	47	46	44	42	40	39	38	36	35	35
2005	35	34	34	32	29	29	29	28	26	26	25	23
2006	21	18	16	15	15	13	11	11	10	9	8	7
2007	5	6	6	6	7	8	10	11	13	16	18	21

\* May 1996 marks Cycle 23's mathematical beginning.

\*\* October 1996 marks the beginning of Cycle 23 according to a consensus of scientists, which NGDC is now using.

Notes: Predicted values start in January 2006.

End of Cycle 23 will be sometime between December 2006 and February 2007.



# Lithuania Radio

By James Hydzik

**L**ithuania celebrated its 80th anniversary of broadcasting this past June. Though AM broadcasting on shortwave (SW) and mediumwave (MW) is only one element in a full range of media used by Lithuania Radio and Television (LRT) to carry Lithuanian news and culture, its importance – past and present – should not be underestimated. A tour of Radio Vilnius, as the broadcaster is generally known, is an education into Eastern Europe’s history.

“Radio Vilnius doesn’t exist in the proper sense,” LRT Radio News Director Audrius Braukyla points out. “For several reasons, during the Soviet occupation of Lithuania they found it useful to call our station Radio Vilnius instead of Radio Moscow. And the name stuck.” However, the decision to create Radio Vilnius in the first place was to have ramifications that played a role in the unraveling of the Soviet Union itself.

Mr. Braukyla, who manages the English Service, says that the first broadcast came from near the capital of the inter-war Lithuanian Republic, Kaunas. “The first words spoken were, ‘Hello, hello. This is Kaunas speaking.’”



*This Continental transmitter from Texas sits ‘round the corner from its predecessor from the Leningrad Comintern factory*

## The Sitkunai Transmitters

The current SW and MW transmitter site near Kaunas, adjacent to the village of Sitkunai, was put into service in the early 1950s, though construction of the facility had been largely completed before the Soviet occupation of 1939. The first transmitter installed was part of the Soviet war reparations material, a 1938 Telefunken Olympia 50kw MW transmitter hauled in from Eastern Germany. It was refurbished after the war and put into service. It is still in use today, primarily as a back up transmitter for LRT’s 666 kHz broadcasts, and is kept warmed-up for that purpose.

“Other transmitters were put into the building over the Soviet era,” says Rimantus Pleykis, Director of Radio Baltic Waves, which also uses the facilities at Sitkunai. “Transmitters from the Comintern factory in Leningrad were brought in the 1970s to service both 666 and 1386 kHz, and the power distribution block was tailor-made by the shipyard in Sevastopol.” Shortwave transmitters to relay Radio Moscow on shortwave were also brought in.

“In the 1950s and 1960s about 50 people worked here,” Mr. Pleykis explains. “In the early 1970s, a decision was made by the government to install a studio so that if the station’s feed from Moscow was broken, someone could read copy until order was restored.” Changes in technology meant lower staff levels over time, and much was automated. However, the ‘70s-era studio was kept.

The site’s studio is currently maintained in its 1990s configuration, with a reel-to-reel tape deck and Hungarian-made sound board.

“This setup became important in 1991 when the Red Army was sent in to squelch Lithuania’s opposition. Radio Moscow feeds were relayed via Vilnius at that time, and there was a short local news program that was created in Vilnius as well. When the revolution came, the radio and television building in Vilnius was placed under siege by the Red Army then occupied, and eventually the link was cut.



*Stretching out to the western portion of the antenna farm, these transmission lines handle both MW and SW chores.*

“The station was largely empty, and an engineer taped a message to the world to prepare for the inevitable arrival of the Soviets. When they arrived, the engineer barricaded himself in the studio and played this tape several times.”

The recording, in Lithuanian, English, German, Polish and Russian, let the people of the world know that Lithuania had not given up its fight despite the fact that its broadcasting voice was being silenced. “After the army cut the power, the engineer gave himself up. There were some tense consultations afterwards, but nobody was hurt.”

## Open Secrets

Though the engineer in Sitkunai escaped the wrath of the Soviets, not everyone in Lithuania was so fortunate. The Vilnius radio and television tower was the site of a massacre by Soviet troops on January 12, 1991. The current headquarters of Lithuanian Radio and Television was also the location of an extended confrontation between soldiers and station



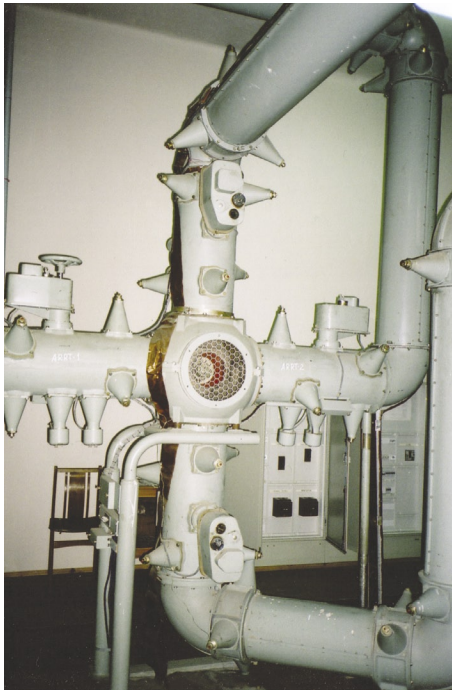

*This monstrous switch is rated at over 500KW on MW. For scale, there is a folding chair in the background.*

personnel, among others. One person died in the siege of the building.

"We were evicted from the building on January 13, 1991, and set up in what was supposed to be a clandestine studio in the Institute for the Blind not far down the road from our normal offices," Vladas Dobilas remembers. "It had to be the biggest open secret in Vilnius at the time, but we did get away with it for 6 months."

Another ingenious coup used the Soviet radio network against itself. "When the crack-down began, we sent our transmission through to other transmitters in the system, and the site in Khabarovsk in the Siberian Far East ended up broadcasting our message for us."

Despite what he calls "the excitement of the times," Mr. Dobilas says that the period was one filled primarily with being busy. "When we were in our 'secret location' we had only one room for everything, so it was usually very noisy, except when we would record. Then everybody had to stop what they were doing and wait."

## Saved by Prestige

Though the political strife turned in favor of the Lithuanians, changes in technology and culture have yielded mixed results. "We used to have writers creating shows exclusively for us; now we translate news and some cultural programs from other parts of LTR," laments Violeta Karpaviciene. "Instead of the specialists and reporters of the past, we're now jacks-of-all-trades." During the economic crisis of 1998, there was talk of shutting down the station completely. Then-president Adamkus and some parliamentarians stepped up and talked about the international image and prestige involved, and the rumors died.

"Luckily, we still have a devoted listener

base, both here and in North America. We still get cassettes along with handwritten verification reports. Electronic versions, with e-mails and .wav files make up about half of our correspondence these days," Mr. Braukyla notes.

## Radio Baltic Waves

Some needed upgrades to the elderly equipment came with the turn of the century, and the Vilnius studio went digital in 2002. Satellite and high-speed land-line links connect Vilnius with Siauliai, and a Continental transmitter covering 5.9-12.1 MHz was installed in 1999.

These changes, along with the curtailed schedule, have enabled Radio Baltic Waves, a private company, to come in and make use of the facilities. Created primarily to broadcast western-based information into Belarus on MW, its scope broadened to include relaying Voice of Russia and others beaming towards other parts of Europe. "We use satellite feeds, so the content can come from anywhere. And when someone asks why we would transmit such different viewpoints, I refer him to Charter 19 of the Declaration of Human Rights," Mr. Pleykis insists.

He says that further transmissions aimed at Belarus may be in the offing, as different tactics on reaching people in the country are considered. "Radio makes sense in this case, as internet penetration is very low in the country. However, practically everyone has an AM radio, and even the oldest car has one in it." Whether transmissions will be aimed at Belarus or western Europe will greatly determine the upgrades. "One potential customer looking to cover the area west of here is considering a 1MW transmitter for 666 or 1386 kHz, and it will require a significant upgrade to our incoming power transmission cables, as well as removing some unused towers that could distort the pattern."

Whatever the outcome, Lithuania Television and Radio seems set on continuing its external service on shortwave as well as MW coverage for the time being. And with warnings of a new Cold War ahead, radio could again play a part in the history of the region.

## Lithuanian Radio English Program

At presstime we had received no reply to our query about changes to the schedule for Fall 2006. Following is the information as posted on LTR's website at [www.ltr.lt](http://www.ltr.lt)

"The programme offers listeners impartial information, opinions of politicians, people in culture and common citizens, and also plays Lithuanian music. The translators and presenters are Vladas Dobilas, Violeta Karpaviciene, Diana Kukainyte and Valdemaras Sadauskas."

9710 kHz to Europe, 08.00 – 09.00 GMT  
 9875 kHz to North America, 23.00 – 24.00 GMT  
 11690 kHz to North America, 00.00 – 01.00 GMT

## INFORMATION & ORDERING WWW.SCANCAT.COM

INTERNET DOWNLOADS AVAILABLE  
**ORDER TOLL FREE**  
**888-722-6228**

**NEW! All-In-One COMBO CD**

Reg.  
 ScanCat-Lite-Plus.....\$29.95  
 Mr. Scanner FCC Public Safety .....29.95  
 Nat-Com's FCC Scancat Files .....9.95  
 Bonus List Of Frequencies .....15.00  
 \$84.85

**SPECIAL \$49.95**

## SCANCAT®

Since 1989, The Recognized  
 Leader in Computer Control

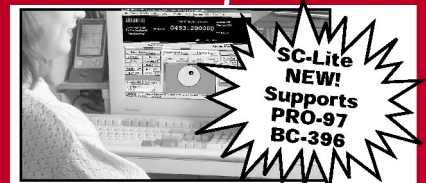

**SC-Lite  
 NEW!  
 Supports  
 PRO-97  
 BC-396**

**Once you use SCANCAT with YOUR  
 radio, you'll NEVER use your radio  
 again WITHOUT SCANCAT!**

### ScanCat-Lite-PLUS

Limited Time \$29.95 Intro Special

Program Your Scanner

As Easy As 1-2-3-CLICK!

SC-Lite Supports PRO-83, PRO-95, PRO-96, BC246  
 & over 15 more Trunking Scanners

### ScanCat-Gold for Windows

Version 8.50 \$99.95

Supports all radios in ONE program -  
 share files with all radios.

Two Scanning modules:

A Simple Basic Module - for beginners  
**Plus**—An Advanced Scanning System  
 for the "experts".

### ScanCat-Gold for Windows-SE -

\$159.95

All the features of our "Standard  
 Scancat" plus additional functions.

- Long term logging of frequencies to hard drive.
- Record Audio to hard drive using sound card.
- Improved spectrum analysis with several great graphical analysis screens.

### Skysweep Decoder Software



Order On Line \$99.95

**Advanced Digital Signal  
 Processing Software For  
 HF/VHF Applications**

All you need is any  
 Windows® soundcard  
 demo on our website



### COMPUTER AIDED TECHNOLOGIES

P.O. Box 18285 Shreveport, LA 71138

ORDERS: (318) 687-4444 FAX: (318) 686-0449

Info/Tech Support: (318) 687-2555

(9 a.m. - 3 p.m. Central M-F)

## INTERNET DOWNLOADS AVAILABLE INFORMATION & ORDERING WWW.SCANCAT.COM

# Buffalo Scanning

By John Mayson

**Q**uick! What's the smallest U.S. city with a subway? If you said "Buffalo, New York" you'd be correct. This month we're going to explore this western New York city along with neighboring Niagara Falls.

During the mid-18th century, the French built settlements along the mouth of Buffalo Creek, but following the French and Indian War the region was taken over by the British. By the early 19th century, the city's population had exploded to 500 people. It continued to grow until December 30, 1813, when British troops, invading what was now American territory, burned the city to the ground during the War of 1812.

Residents rebuilt the city and in 1825 it became the western terminus of the Erie Canal connecting Buffalo to New York City. By the middle of the 19th century, the city boasted a population of 10,000 people and was noted as the starting point for western adventure for people taking the canal from the east.

The city played an important role in 19th century American history. It was the northernmost terminus for the Underground Railroad, an informal network of safe houses for runaway slaves from the southern United States. The slaves then took the ferry from Boston to Fort Erie, Ontario, Canada, and freedom.

In 1901 Theodore Roosevelt was sworn in as president in Buffalo following the assassination of his predecessor, William McKinley, making him one of the few presidents to be sworn in outside of Washington, DC. It was about the time the city earned the nickname "The City of Lights," being the first large North American city to have widespread electric lighting due to the nearby power generators at Niagara Falls.

The Peace Bridge which connects Buffalo to Fort Erie, Ontario, was opened on August 7, 1927. This boosted traffic and commerce between the two cities. At the time it was the only vehicular bridge on the Great Lakes east of Minnesota and today it remains a critical link between the two nations.

Today, Buffalo has a reputation as a blue-collar, rust-belt city with lots of snow. But, as with most stereotypes, the facts don't support this. The area's 1.1 million people enjoy a wide variety of arts, museums, culture, and nightlife. It's home to a number of universities and a diverse population. The city has moved away from steel and cars and is leading the way in the areas of bioinformatics, human genome research, and cancer research.

No one would confuse Buffalo's weather with the weather found in say, San Diego, but it's not the snowiest, wettest, nor even coldest city in the region. Buffalo enjoys long, moderate summer days.

We opened this article with a bit of trivia, so we'll add some more: Buffalo is one of three major cities in the United States that has never recorded a temperature over 100°F. The other two, oddly enough, are Honolulu and Miami.

## Scanning the City of Lights

If you ever have the opportunity to visit Buffalo, be sure to pack your scanner. If you only own a conventional, non-trunking scanner, bring it along anyway. While some trunking is used in the region, it's still primarily analog conventional in these parts. Let's talk about what you can expect to hear.

Buffalo is the principal city in the region and the county seat for Erie County. Buffalo uses conventional UHF frequencies, while the county has a Motorola digital trunked radio system (TRS) planned.

Some readers might be surprised to see frequencies between 420 and 430 MHz listed. Isn't that part of the 70-cm amateur radio band? Yes it is. But not in Buffalo! Canada uses that range of frequencies for land-mobile operations and it is not available to hams in Canada. Per international



Border Plaque - (John Mayson)

agreement, US hams are not allowed to use these frequencies in the border areas. However, the FCC does license these frequencies to land-mobile operators, similar to Canada. It's quite common to find police, fire, EMS, and businesses operating on these frequencies in and around Buffalo, Cleveland, and Detroit.

## Buffalo Police Department

BPD was founded in 1871 with a force of 204. The department was originally dispatched using a Morse telegraph system and officers responded in horse-drawn carriages. Today BPD boasts 1,300 members and uses a modern UHF radio system. And yes, they have motorized vehicles now, too.

Output	CTCSS	Chan	Description
460.325	151.4 Hz	1	Tactical / Housing Authority
460.350	97.4 Hz	2	South Districts
460.425	114.8 Hz	3	North Districts
460.475		4	Car-to-Car
460.025		5	Information and Warrant Checks
460.275	151.4 Hz	6	
423.875			Detectives
423.925			Special
424.875			
425.375			

## Buffalo Fire Department

BFD protects and serves Buffalo's nearly 300,000 residents.

Output	DPL	Chan	Description
424.225	D-565	1	Dispatch
424.350	D-251	2	Fireground
423.900	D-114	3	
153.830			Hazmat Service
423.825			
425.250			

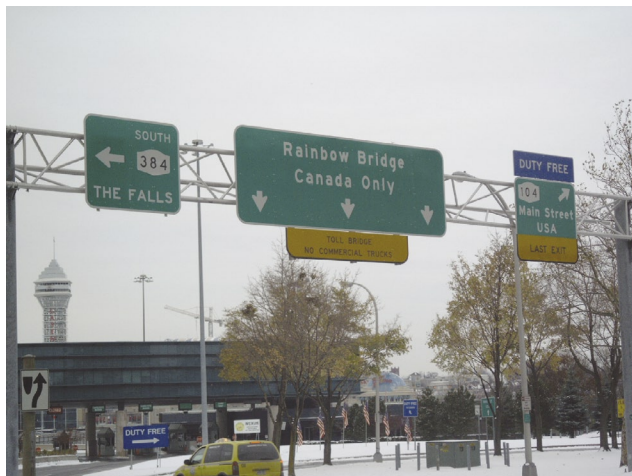

Niagara Falls, NY, near border (John Mayson)

## Buffalo EMS

Buffalo Emergency Medical Service can be found on two frequencies: 424.375 and 155.760 MHz.

## Erie County

Erie County has plans to switch over to a Motorola APCO-25 trunked radio system (TRS). As of November 2005, this system is not operational and the county continues to use its conventional frequencies. Following are the frequencies for this system:

### Erie County TRS

Site 1:  
868.1500, 868.3125, 868.3750, 868.6500, 868.7500

Site 2:  
868.2500, 868.4125, 868.6000, 868.7250, 868.8000

Site 3:  
868.3500, 868.5750, 868.7000, 868.8125, 868.8250

Site 4:  
868.1750, 868.2875, 868.4375, 868.4750, 868.6250

## Erie County Sheriff's Office

The ECSO provides law enforcement for unincorporated parts of Erie County along with providing court security and operating the jail.

Output	CTCSS	Chan	Description
460.450	151.4 Hz	1	Dispatch
460.200	151.4 Hz	2	ECSO
460.400	151.4 Hz	3	ECSO

## Erie County Fire Control

The county and many towns in the county share a VHF low-band network. DXers will want to note these frequencies as they can skip hundreds, if not thousands, of miles when conditions are right.

Freq	Description
46.20	County
46.22	Mutual Aid
46.24	East Aurora and West Seneca
46.26	Amherst



It was COLD!! (John Mayson)

46.28 Cheektowaga  
46.32 Springville  
46.38 Mutual Aid

We'll now move north to Niagara County, which is home to the city of Niagara Falls, New York. Niagara Falls is the county seat of Niagara County. The city boomed in the 19th century, thanks to the enormous power generation potential of the adjacent waterfalls. Factories sprung up on both sides of the border.

In more recent times, Niagara Falls, Ontario, opened a number of casinos and hotels, becoming the "Las Vegas of Canada," while the New York side did not. Most of the tourism has move to the Canadian side of the border. The Seneca Nation has since opened a casino in the heart of Niagara Falls, New York, in hopes of capitalizing on the tourism trade and putting the New York side back on the map.

## Niagara Falls Police Department

The city of Niagara Falls is not only proud of their fine law enforcement officers, but they can also brag the NFPD placed first in Law and Order 2002



best designed police cars. And if fine looking patrol cars weren't enough, the previous year they won honorable mention for being the best dressed police department. Superintendent John Chella commands this team of police officers in spiffy clothes and attractive cruisers.

The department uses two UHF frequencies: 460.125, 460.375.

## Niagara Falls Fire Department

The NFFD responds to more than 4,000 calls per year. The rivers that feed the Falls

give the department lots of opportunities to perform swift water rescues. The department also responds to auto accidents, fires, and HAZMAT incidents. Like the NFPD, they use a two channel UHF system: 460.525, and 460.575 MHz with a CTCSS tone of 151.4 Hz.

## Federal

With Buffalo being not only a major city, but on the border with Canada, there is a lot of federal law enforcement activity taking place. Unfortunately, in our security conscious world, virtually all of it is unmonitorable.

The fire department of the Niagara Falls Joint Air Reserve Station has been reported on 173.5875 MHz.

## Canada

In our June 2003 issue, John Corby told us about the Canadian side of the Falls. While my American pride wants to tell him the American side has more attraction, I will concede that the view is better from Canada. But it's only because the Falls lie mainly on the American side and to best view them, you need to be standing in Canada.

John provided many useful frequencies for the Canadian side and I dutifully programmed them into my Uniden BC296 digital scanner. I regret to report that all of the public safety communications I intercepted from Canada were encrypted.

If you're lucky enough to visit during the summer (I was there in November with 25°F/-4°C weather), you should be able to monitor the many attractions – and don't forget about all the activity on the maritime VHF band!



## Readers' Choice

This month it's the readers' turn as I field questions from the far-flung reaches of the *Beginner's Corner*. First a little advice about:

### ❖ Buying a Short Wave Radio

Mark Lovmo writes: "...I just bought a junky little Bell & Howell 9 band receiver (made in China). I remember having a nice little Grundig about 13 years ago and, at that time, I was able to listen to 'numbers stations.' Now that I have a radio again, those stations are gone. What happened to them? Also, what \$200-300 receiver would you buy?"

You might think that with the end of the "cold war" would come an end to the relic of spy numbers stations. But, there are still some around. You just have to know where and when to look. Here's one place to get started: [www.spynumbers.com](http://www.spynumbers.com). Also watch the *Ute World* logging pages in this magazine and you'll see some active ones listed nearly every month.

As to what receiver I would buy in the \$200-300 range: There are a number of choices for excellent receivers in that price range. But, first consider shopping for something used. While used Kenwood, Icom and Yaesu high-end HF receivers are still considerably over that mark, you can find 10 year old Kenwood, Icom and Yaesu transceivers near that price range. These venerable rigs have great reputations among hams as reliable performers and many thousands are found on the shelves of many ham shacks as back up rigs.



Consider a well cared for, older, all-band HF transceiver as your next short wave radio such as this old Kenwood TS-140s. You'll get excellent performance on the SW bands and when you get your General Class ticket you're all set to hit the airwaves! (Courtesy: Rigpix.com SM00FV)

These transceivers include all-mode, full coverage tuning typically from 50 kHz to 30 MHz. Drawbacks to buying a used transceiver (aside from the fact that it's used) are that they

lack direct frequency tuning, generally have poorer audio quality, they're not portable and may require you to buy an outboard power supply.

The big advantage (aside from the fact that it's much cheaper than a new all band, all mode HF receiver) is that when you finally get your ham ticket you'll be all set to get on the air. Even if you have to go \$50 over budget it could be well worth the investment. Here are some places to look for used HF rigs: [www.eham.net/classifieds/results/39](http://www.eham.net/classifieds/results/39), [www.burghardt-amateur.com/Burghardt/HTML/main\\_frame.html](http://www.burghardt-amateur.com/Burghardt/HTML/main_frame.html) (click on "used product search"), [www.aesham.com](http://www.aesham.com) (click on "menu" then on "used and demo list").

There were, at my last visit to eBay, three Kenwood TS-140s transceivers with full 50 kHz to 30 MHz general coverage shortwave reception in that price range. Of course, the advantage to buying from a reputable retail dealer is that they'll have some sort of warranty or equitable refund policy. That alone could be worth the extra price tag.

But, if it's a new portable HF receiver you're looking for, I like the Sangean ATS-909 which is right in the middle of your price range. I found it at several locations from \$240 ([www.grove-enterprises.com](http://www.grove-enterprises.com), 800-438-8155) to \$260 ([www.ccrane.com](http://www.ccrane.com), 800-438-8155). Modified versions of this radio are available from both C. Crane and Radio Labs ([www.radiolabs.com](http://www.radiolabs.com), 877-575-3700) which purport to improve reception, audio quality and give you a sexy blue LCD display panel. The straight package has been out for over a decade with little negative comment, and Jim Clarke checked out the "Super-909"



Sangean's ATS-909 is a serious portable short wave radio in the \$250 price range. (Courtesy: Grove Enterprises)

in the *First Look* column in April 2005 ([www.monitoringtimes.com/html/mtsuper909.pdf](http://www.monitoringtimes.com/html/mtsuper909.pdf)).

What I like about the ATS-909 is that it's a serious portable shortwave radio which features keypad frequency entry, SSB/CW reception, covers 150 kHz to 30 MHz in five tuning methods, supports RDS transmissions, has sleep and awake timers, accessories include AC adaptor and portable "reel" antenna. The ATS909 covers the FM broadcast band as well.

### ❖ Terk's AM Advantage

Richard Schultz writes: "...follow-up to your *Getting Started* article, Feb. 2006: I found a Terk AM Advantage loop antenna at [www.bhphoto.com](http://www.bhphoto.com) for \$28." Richard also wanted to know a good web site for IDing AM radio stations.



Terk's AM Advantage, a great little AM loop antenna, just got cheaper at BHPHOTOVIDEO.COM: \$27.95 (plus shipping) and just in time for the AM DX season! (Courtesy: BHPHOTOVIDEO.COM, 800-606-6969, B&H, 420 9th Avenue, NY, NY 10001)

Thanks for the tip on the Terk AM Advantage. I checked it out and found that with shipping the price is typically under \$35. I really like the AM loop antennas for close quarter AM DXing where space is at a premium. They work particularly well with portable or small table radios. I also like that they can be rotated to null out strong signals on or near the target frequency.

There are two great sites for IDing AM stations. The site I use most often is the FCC's

AM Query page (<http://www.fcc.gov/mb/audio/amq.html>). If you hear a call sign, you can find out exactly where the station is located, its power output and antenna array. If you are trying to ID a station on a particular frequency, simply call up that frequency and look at the list. It's usually easy to narrow it down to one or two possibilities by eliminating daytime only operators, low power operators, or opposite coast operators.

The other site is Radio Locator.com ([www.radio-locator.com](http://www.radio-locator.com)). Here you may find the station by call sign, if you know it, or by location (city and state) if you know it. New to this site is a locator for "vacant" FM frequencies in your location. If you have a micro power FM transmitter such as the one from C.Crane, you can tune the transmitter for the least amount of interference.

### ❖ Repairing Broken Antennas

Alvin Dattner asks: "...Do you know of a source to replace the forward element on my FM Yagi? They got broken moving...I listen to a station in Tucson 100 miles away and I wonder if replacing the broken director will improve the quality of signal. I now have a 6 element Yagi and am considering a 10 element Yagi."

Sure, you can replace any broken antenna elements with a similarly sized piece of aluminum (solid or tube). I had to do just that on a large UHF-TV antenna which lost some reflector elements when I was moving it. The replacement cost of that antenna would have been \$50 or more. I found similar sized solid aluminum rods at a nearby hardware store and for a couple

of bucks I was able to restore the old antenna.

I cut the aluminum stock to the exact size of the broken element. Since it was a reflector element, it was easy to size. If it's an element in a Yagi antenna where each element is a slightly different size, you can derive the dimension of the missing element by splitting the difference between the element in front and the element behind the missing one. Simply drill a small hole through the element and through the boom. Using an appropriately sized machine bolt, slip the bolt through the holes, thread a lock washer and nut onto the bolt, and tighten.

Even though you can repair your antenna, you might consider upgrading to a better antenna such as the Winegard HD0605P 10 element Yagi FM antenna (MT April, '06). At about \$60 it is the best FM antenna for the least amount of money. Here's a good place to buy it: [www.starkelectronics.com/wca6065.htm](http://www.starkelectronics.com/wca6065.htm) (Stark



*The APS-13 FM Yagi antenna may be the only hope of hearing HD FM stations from 100 miles out. Don't forget to add a good antenna pre-amp! (Courtesy: Stark Electronics)*

Electronics, 888-372-361, 401 Royalston Ave N, Minneapolis, MN 55405).

That said, however, if you've got the bucks you might consider the ultimate FM DX antenna: the APS-13 sporting 13 elements and a \$200 price tag:

[www.starkelectronic.com/aps13.htm](http://www.starkelectronic.com/aps13.htm)

It's difficult to say how much better the 13 element Yagi performs over the one with 10 elements. The specs on each claim nearly identical performance, but spec sheets can be misleading. Only a side by side comparison will truly tell.

There will come a time when analog FM signals will be gone and if you're trying to listen to your favorite station from 100 miles away, the APS-13 might be the only antenna which will give you any hope of doing so. I can pretty much guarantee that the 6 element FM Yagi will not be up to the task of bringing in HD Radio signals from that distance.

The other thing to know is that FM and TV (UHF or VHF) reception can be dramatically improved by adding a good quality, mast-mounted, antenna amplifier to your antenna. Stations unheard before will come in quite strong. Don't forget to use RG/6 low-loss coax cable from the antenna to your receiver. These last two items may be found at most Radio Shack stores.



*Mast-mounted antenna pre-amp makes all the difference in bringing in the signals on the FM and TV bands. Don't forget to use low loss RG/6 coax! (Courtesy: Radio Shack)*

# HORIZON EXPANDERS

LISTEN TO THE WORLD WITH A TEN-TEC SHORTWAVE RECEIVER



**RX-340 "The Ultimate"**

The Ultimate HF SWL receiver. 50 kHz–30 MHz. IF stage DSP. Sync AM/selectable sideband, SAM, AM, SSB, ISB, CW, FM. 57 bandwidth filters, programmable AGC, built-in high stability TCVCXO. Completely remote controllable via RS-232 interface. DRM reception capable with no modification needed. 115/230 VAC operation.

**\$4,250**



**RX-320 PC Radio**

New model RX-320D adds a 12 kHz I-F output for decoding DRM transmissions to the world famous RX-320 PC Radio. General coverage HF from 100 kHz–30 MHz. "Black box" receiver connects to your PC via one serial port. Your PC provides the operation horsepower. Download the actual operating software from our web site for a pre-purchase test drive.

**\$349**



**RX-350D**

RX-350D is a full-featured HF DSP receiver for today's demanding shortwave listener. 100 kHz–30 MHz. Modern IF-DSP architecture accommodates 34 built-in bandwidth filters, DSP automatic notch, and DSP noise reduction. Flash ROM updateable via Internet file downloads. Large LCD graphics panel for display of all receiver functions. Selectable sideband/Sync AM, SAM, AM, FM, CW, and SSB modes. Momentary SWEEP function shows band activity on LCD screen. 1024 memories. Timer and squelch activation circuitry. 12/24-hour clock. Hi Z and Lo Z antenna inputs. 115/230 VAC or 13.8 VDC operation.

**\$1,199**

**Call Toll-Free (800) 833-7373**

We also have receiver kits you can build! Visit our website!



**TEN-TEC**

1185 Dolly Parton Parkway  
Sevierville, TN 37862  
Sales Dept: 800-833-7373  
Monday - Friday 8:00 - 5:30 EST  
We accept VISA, Mastercard,  
American Express, and Discover

Office: (865) 453-7172 • FAX: (865) 428-4483  
Repair Dept.: (865) 428-0364 (8 - 5 EST)

[www.tentec.com](http://www.tentec.com)



**302R REMOTE/ENCODER KEYPAD**

Allows armchair tuning of the RX-350D. Function buttons allow operation of various receiver controls. Direct frequency entry via keypad.

**\$139**

**Q.** *Just how much signal is lost by feeding two scanners from one antenna through a splitter? (James Ashe, Clearwater, FL)*

**A.** Since you are dividing the power in half, this is a 3 dB loss for each line. If you are familiar with signal-strength meters (S-meters) on shortwave receivers and transceivers, this is half an S unit. Such a minor loss of signal would be noted as an increase in background noise (hiss) on only the weakest signals, already on the brink.

**Q.** *One of my backyard antennas is a Grove Skywire ANT-2. As presently configured, the shorter of the two elements comes into contact with a tree branch on its way to the fence where it is anchored. Should I use a stand-off insulator to keep it from touching the branch, or is it ok as-is? (Matt Stanley)*

**A.** At higher frequencies, the antenna will exhibit high impedance as you get farther from the center; if the wet tree branches or leaves touch the wire at these points, the resistive path to ground could cause erratic signal fluctuation or static. It would be better to keep the bare wire from the wet limbs, especially if you notice this effect; if you don't, you probably don't need to do anything!

**Q.** *How far do signals go on the various frequency ranges? (Neil Draeger, La Farge, WI)*

**A.** Wow, that's an entire course in radio propagation – but let's look at the basics.

Generally speaking, the lower the frequency, the farther the signal can go at any given power level. But signals propagate (travel) by different methods. For example, at the lowest frequencies (ULF, LF) they may follow the surface of the earth, or even go through the earth. But the higher in frequency you go, the more a radio signal behaves like a beam of light. Instead of following the curve of the earth, they begin straightening out.

At higher frequencies they are also more easily absorbed by moisture in the air, clouds, trees and leaves, dust and smog particles, and any other obstacles in their path, shortening their expected distance.

The sun also has quite an influence on radio waves. During daylight and summer, the sun electrifies the upper atmosphere (ionosphere),

causing it to absorb and reflect different frequencies of radio waves which also have electrical properties. Summer and tropical lightning storms also cause barriers to reception with their composite noise. (See the feature article in this issue - ed.)

The result, then, is that at night during winter, frequencies below about 10 or 15 MHz can be heard around the globe at power levels of only a few to a few hundred watts, while during the day, or during the summer, worldwide coverage is heard from signals in the 10-50 MHz range, but only for a few hundred miles below 10 MHz.

For VHF and UHF, it's rare for signals to travel more than 100 miles or so except when the electrified ionosphere acts like a giant reflector, allowing signals to "skip" (bounce back to the earth) over hundreds, and occasionally thousands, of miles.

At UHF such extended range becomes less likely, and line-of-sight dependability – a few tens of miles – is more often the case.

**Q.** *One of the keys on my Realistic PRO 2006 scanner has lost its response when I press it. I have tried squirting a contact cleaner/solvent on the edge of the button, but that does nothing. Is there a better solution? (Peter Bach, email)*

**A.** Rubberized keys do lose their contact surface over time as the conductive carbon deposit gradually wears away. However, there's a simple solution.

Carefully disassemble the rubber keypad, and glue a small piece of aluminum foil inside the button that's giving you the problem. That will restore its conductivity indefinitely.

**Q.** *I'm thinking of getting the computer-hosted WiNRADiO G303e for my first shortwave receiver; what do you think of that choice? (email)*

**A.** For a shortwave newcomer, you might first try a stand-alone receiver, since you have no experience judging whether or not what you are hearing is what you should be hearing. You could start with an inexpensive portable (typically \$100-\$150 range), or even borrow a receiver or buy a trade-in radio for a short time. This would allow you to get your feet wet – so to speak – and let you better judge what is normal reception.

That said, the WiNRADiO G303e (or upscale G313e) would be an excellent choice for a computer-hosted receiver (and infinitely better

than the portables!).

Next to the receiver, the antenna is the most important consideration. For shortwave listening, you will want an outdoor antenna such as a suspended wire or even an active antenna (preamplified short whip). Power line and electrical appliance interference can be brutal at the shortwave frequencies, so outside, away from the dwelling, distant from power lines, and fed by coaxial cable are the main rules for antenna location.

**Q.** *Could you please show an example of what USB and LSB actually are in terms of frequency spacing? (Larry Marsee, email)*

**A.** When a conventional AM signal has modulation (voice, music, data, etc.) on it, it occupies a portion of the spectrum defined by the highest modulation frequency. The bandwidth is symmetrical, so that if there is, say, a 2000 Hz tone, then there will be approximately 2 kHz deviation above and below the center carrier, making a 4 kHz total bandwidth.

But, having the same information on both sidebands is a waste of spectrum space, so upper sideband (USB) transmissions remove the center carrier and the lower sideband, and vice versa for lower sideband transmissions. Therefore, a common USB or LSB signal has a typical 2-3 kHz bandwidth.

When a sideband signal is detected by a receiver, the missing carrier frequency is reinserted by the amount of sideband offset, typically 1.5 kHz above or below the suppressed carrier (center) frequency. Many older communications receivers like the ICOM R70 displayed those offsets rather than showing the center frequency.

**Q.** *What frequency range is used by the Sirius and XM radio satellites? (Piran Mohazzabi, AB8HU)*

**A.** Both use S-band allocations in the 2332.5-2345.0 MHz range. Sirius, owned by American Mobile Satellite Corporation, is provided by SES Sirius, a major Swedish satellite broadcaster, owning their own fleet of three radio, TV and communications satellites. XM Satellite Radio of Washington, DC, is hosted by two satellites owned by Hughes' (Boeing) Satellite Development Center.

Questions or tips sent to Ask Bob, c/o MT are printed in this column as space permits. Mail your questions along with a self-addressed stamped envelope in care of MT, or e-mail to [bobgrove@monitoringtimes.com](mailto:bobgrove@monitoringtimes.com). (Please include your name and address.)



**Q.** I want to upgrade my scanners with a new Uniden BC-396. With your expertise in such matters, can you advise me if this scanner works well with the State of Delaware's Public Safety System (Digital)? (David W. Bender-Wilmington, Delaware.)

**A.** The big change in the Delaware Statewide Public Safety system is that they are working on being compliant with rebanding after 18 months from license issuance. They will be keeping their Motorola Mixed Mode (3600 baud) trunk system as they make this changeover. Based on everything we know at this point, the BCD396T should handle both the analog/digital trunking duties for this system, as well as the rebanding of frequencies when it occurs in the near future.

**Q.** I can't seem to actually get an answer to this question, so I thought I would see what you think. Will the Uniden BCD996T work on the new Virginia STARS trunk radio system? (Ben Sager via email)

**A.** Based on everything I see on this system, the BCD996T should handle this system no problem. Same with the 396. The 996 is an extremely capable scanner and should work well with its multi-site capability on statewide systems.

**Q.** I recently purchased a Grundig 1000, a world band receiver, to try to get into shortwave listening. Last night I was listening at 2032 UTC on frequency 11975 kHz, and heard an interesting broadcast. I could not make out what the language was. But they mentioned Finland a lot in the broadcast. I looked in the Passport to World Band Radio, and could not come up with a listing that had Finnish, Danish, or Norwegian origin. My question is, since I am fairly new to this, how can I decipher what location the broadcast is coming from? I might have two or more locations listed for that frequency.

So how can I distinguish what I am listening to? (Bruce Sellers - Middletown, IN)

**A.** From our resident shortwave broadcast expert, Gayle Van Horn:

"Bruce, I am not sure what station you were listening to on 11975 kHz. I see no listing that fits the program profile you provided for that time and frequency. The dominant station I hear on the east coast during that time frame (2000-2100 UTC) is the Voice of America in English transmitting from Sao Tome.

"The best thing you can do while monitoring a station is to listen long enough for a positive identification. Most shortwave stations identify on the hour and half hour. When you have positively identified the broadcaster, then you can look them up in our *MT Shortwave Center Section* listings (if they are broadcasting in English), or *Passport to World Band Radio* or the *World Radio Television Handbook* for other languages. Once you have narrowed down the station to that frequency, any of the guides mentioned above will give you the exact location of the transmitter being used by that broadcaster for that transmission."

**Q.** I heard a U.S. military callsign FASTBALL or FAST BALL. Who uses this? I can't seem to find it on any internet callsign lists. I'm new to military HF listening. (Jay Dehm via email)

**A.** It is one of the daily changing tactical callsigns used by Command and Control assets of our US military. By their nature, these calls mask the true identity of the asset using them. In other words, it is classified, and by design, you and I will never know for sure what unit we are listening to. This is just one call word of thousands in a classified document that these units draw on randomly.

**Q.** Awhile back I heard a message from SKYKING on 11175 kHz. What exactly is this callsign? (Anonymous via email)

**A.** This is a collective call sign used by the Department of Defense for all Single Integrated Operational Plan (SIOP) committed aircraft and missile crews. Its meaning is "all SIOP committed aircraft and missile crews copy the following message." Other callsigns you may hear on a regular basis on the HF Global network include:

Brickwall - Osan Air Mobility Control Center (AMCC)

Denali - Elmendorf Air Mobility Control Center (AMCC)

Hilda Global - Tanker Airlift Control Center Scott AFB

Mainsail - Authorized users may contact and request service from Global HF System stations by using the general net air-ground call sign "MAINSAIL." Any Global station hearing the call "MAINSAIL" will respond and provide the requested service.

S4JG - A universal Navy call sign assigned to Patrol Squadrons (VP) for use in radio checks. Instead of using the briefed, tactical call sign, the Navigation/Communications operator on the P-3C Orion aircraft would use S4JG on voice and also teletype to get a communications check with a Tactical Support Center (TSC), HF-GCS station or Anti-Submarine Warfare (ASW) Operations Center (ASWOC). In theory, by using S4JG, the tactical call sign is less likely to be compromised.

Skybird - The collective call sign for all U.S. Strategic Command (USSTRATCOM) command posts, launch control centers, Global HF stations, Air Traffic Control (ATC) towers on Air Combat Command (ACC)/Air Mobility Command (AMC) host tenant bases, Single Sideband (SSB) HF radio stations, and air defense sites in Canada.

Skymaster - The collective callsign to all USSTRATCOM airborne command posts.

Tracker - US Air Force Europe Tanker Recce Airlift Control Center (UTRACC)

**Q.** I am new at this type of monitoring (commercial aeronautical). And I saw this on an internet link: "Aeronautical SSB frequencies aircraft crossing the Atlantic still use SSB to communicate with the National Air Traffic Service (NATS) in Shannon, Ireland and..." I thought that all commercial aero stuff was always just plain AM. Can you please explain when (and if) SSB is used rather than plain AM for commercial air communications for air to ground, and vice versa? (Mr. B via email)

**A.** The Single Sideband mode (SSB), normally Upper Sideband, is used for aero communications in the HF range of 1.6 to 30 MHz. The AM mode is used in the VHF civilian aeronautical band (118-137 MHz) and in a majority of the UHF mil aero band (225-400 MHz). There are still aeronautical assignments that use the AM mode in the new 380-400 MHz DoD land mobile subband, but the majority of the communications in this band use narrowband FM (P25 digital).

## Scanning as a Group Effort

**W**ith so many new radio systems coming on-line, it's often difficult to get reliable information about frequencies, talkgroups, and activity. One source of current, up-to-the-minute listener reports can be found in Internet discussion groups. This month we'll take a look at how such groups can help educate users and make scanning more enjoyable.

Hello Dan,

I have a police scanner from about 10 years ago that I have been using. It is a Pro-64 from Radio Shack. It doesn't get some of the 800 frequencies or some 900 MHz. Nine counties around me have changed to the "Southeast Texas Area Radio Network" (STARNET). I do not understand what I need to do to get the frequencies now. Do I need a new digital police scanner or am I supposed to "program" codes (and what does THAT mean) into this scanner. I just don't understand this STARNET system and am trying to get help from anyone who can explain it to me. Is it simply 800 frequencies or what? Can you help?

Ben in Texas

The Radio Shack PRO-64 is a handheld 400-channel scanner introduced nearly 10 years ago. It sold for about \$300 and was a trendsetter by being the first Radio Shack scanner to have a computer interface for downloading channel frequencies. The frequency coverage for the PRO-64 is 29 to 54 MHz, 108 to 174 MHz, 380 to 512 MHz and three segments in the 800 MHz band: 806-824, 849-869, and 894-960 MHz. The "gaps" in 800 MHz coverage are to try and prevent users from overhearing cellular telephone conversations, which is a crime under the Electronic Communications Privacy Act (ECPA).

Although the PRO-64 was a very capable scanner when introduced, it has two basic shortcomings when trying to monitor the Southeast Texas Area Radio Network (STARNET).

The first shortcoming is that the scanner is not able to follow conversations in a trunked radio system. STARNET, like nearly all of the large public safety systems, uses their assigned frequencies in *trunked* rather than *conventional* mode. Trunked systems maintain a "pool" of available radio frequencies from which they draw when a voice channel is needed. When a police officer or other user wants to talk on a trunked system, pressing the push-to-talk button sends a channel request to the system

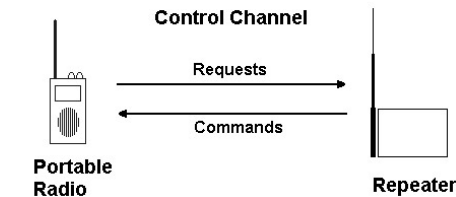

controller. The controller immediately checks the pool for a radio frequency that is not in use at that moment and temporarily assigns it to the user. It quickly sends a response back to the user's radio instructing it to tune to the frequency it just assigned. When the user is done talking and releases the push-to-talk button, the controller removes the temporary assignment and returns the frequency back to the pool, where it becomes available for the next request.

So, depending upon how busy the system is, a complete conversation consisting of many transmissions may take place on more than one radio frequency. If you have a conventional scanner like the PRO-64, it will be a hit-or-miss effort to catch each transmission. If it's the middle of the night and not much is going on, you may be able to follow a conversation if each voice frequency is programmed into the scanner. However, if there is more than one conversation occurring on the system, the conventional scanner will stop on the first transmission it finds, whether it is part of the conversation you're interested in or not.

Scanners that follow trunked conversations do so by listening to the control messages sent out from the system controller to the two-way radios. This allows the scanner to tune to the proper frequency at the proper time to hear each transmission of a particular conversation. Unfortunately for Ben, the PRO-64 is not able to monitor these control messages and as a result it does not know which frequencies are assigned to the conversation as it progresses.

The second shortcoming is that the PRO-64 is unable to monitor digital voice transmissions. The PRO-64 is not alone in this regard, since the first consumer scanners capable of monitoring a digital voice transmission (the

Uniden Bearcat BC250D and BC785D) were introduced in 2002, long after the PRO-64 had been discontinued.

Older public safety systems typically transmit voice in *analog* format, which all consumer scanners are able to monitor. Newer public safety systems often make use of *digital* voice transmissions.



An increasingly popular digital voice format is described in a set of standards called Project 25 (P25), developed by the Association of Public-Safety Communications Officials International, Inc. (APCO). At present there are eight consumer scanners able to monitor digital transmissions. Listed from newest to oldest, they are:

Scanner	Manufacturer	Type
BCD996T	Uniden	Base/Mobile
BCD396T	Uniden	Handheld
PRO-2096	Radio Shack (GRE)	Base/Mobile
PRO-96	Radio Shack (GRE)	Handheld
BC-296D	Uniden	Handheld
BC-796D	Uniden	Base/Mobile
BC-250D	Uniden	Handheld
BC-785D	Uniden	Base/Mobile

Each of these scanners is also capable of tracking trunked radio transmissions, although the last two on the list are not able to follow conversations on "pure" P25 systems.

So Ben, the bottom line is that you're going to need one of the newer digital scanners in order to hear everything on the STARNET system.

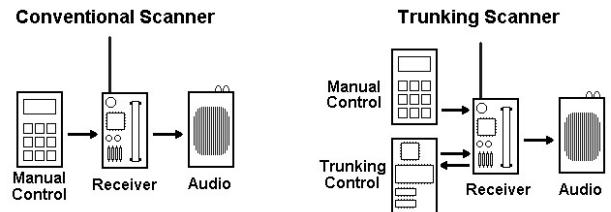

APCO-25 Digital Trunking Scanner

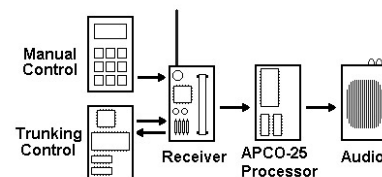

## ❖ Southeast Texas

STARNET covers nine counties around the Houston metropolitan area in southeastern Texas and serves more than 100 state and local agencies as well being the primary radio network for county agencies in Brazoria, Chambers, Fort Bend and Harris Counties. It carries both analog and APCO P25 voice traffic on a Motorola Type II trunked system.

With such a large system in a heavily populated area, you shouldn't be surprised to learn that there are a lot of frequencies in use. STARNET has two dozen repeater sites, each using anywhere from five to as many as 27 frequencies. For example, the repeater site in downtown Houston is licensed for the following frequencies:

856.7125, 857.2375, 857.4875, 857.7125, 858.2375, 858.7125, 859.2125, 859.2375, 859.4875, 860.2125, 860.2375, 860.4875, 866.0750, 866.4250, 866.4625, 867.0625, 867.5375, 867.6375, 867.8875, 867.9125, 867.9375, 868.1375, 868.2375, 868.3875, 868.4875, 868.6375, 868.8875 MHz.

You can see that it would take a lot of keypad presses to get all of the frequencies for all of the repeater sites into the scanner!

In addition to frequencies, trunked radio systems have identifiers that are known as *talkgroups*. These may be the "codes" Ben mentions in his letter. Simply put, talkgroups are a way of identifying separate conversations in a system. Talkgroup identifiers are numbers and are usually represented in either decimal (base 10) or hexadecimal (base 16) format. Depending on the scanner, the identifier may appear on the display as a decimal number, a hexadecimal ("hex") number, or a short alphanumeric description.

For the STARNET system, here are some common talkgroups and their associated identifiers:

Dec	Hex	Description
1648	67	Harris County Sheriff (All Call)
5520	159	Harris Sheriff District 1 (Dispatch)
5808	16B	Harris Sheriff Organized Crime 7
6192	183	Harris County Flood Control
6224	185	Harris County Flood Control
6256	187	Harris County Flood Control
6384	18F	Harris Sheriff Major Violators 1
6512	197	Harris County Fire Marshal
8336	209	Harris County Emergency Management
8496	213	Harris Sheriff District 2 (Dispatch)
8560	217	Mutual Aid 1
8592	219	Mutual Aid 2
8656	21D	Harris County Sheriff Motorist Assistance Patrol (MAP)
8976	231	District 3 (Dispatch)
9008	233	District 4 (Dispatch)
9104	239	Harris County Detectives
9392	24B	Emergency Response Teams (Command)
9424	24D	Emergency Response Teams
9712	25F	Automobile Theft
10096	277	Harris County Detectives
10256	281	Harris County Vice/Narcotics 8
10896	2A9	Harris County Emergency Dispatch Center
10960	2AD	Harris Countywide EMS
10992	2AF	Harris Countywide Fire
11728	2DD	Harris County Traffic

13008	32D	Harris Sheriff Internal Affairs
13168	337	High Intensity Drug Trafficking Areas (HIDTA)
14224	379	Mutual Aid 3
14768	39B	Harris Sheriff Tactical (North)
14800	39D	Harris Sheriff Tactical (East)
14832	39F	Harris Sheriff Tactical (South)
14864	3A1	Harris Sheriff Tactical (West)
14896	3A3	Harris Sheriff Tactical (Central)
16656	411	Harris County Fire Marshal
18384	47D	Harris Sheriff Pursuit 1
18416	47F	Harris Sheriff Pursuit 2
18480	483	Harris Sheriff District 5 (Dispatch)
18544	487	Mutual Aid 4
18576	489	Mutual Aid 5
18608	48B	Mutual Aid 6
18736	493	Harris County Emergency Management
18832	499	Harris County Fire Marshal
23600	5C3	Walker County Sheriff
23952	5D9	Brazoria County Sheriff (Dispatch)
23984	5DB	Brazoria County Sheriff
24016	5DD	Brazoria County Sheriff (Patrol)
24048	5DF	Brazoria County Sheriff (Patrol)
24144	5E5	Brazoria County Detectives
24176	5E7	Brazoria County Detectives
50032	C37	Galveston County Sheriff (North)
50064	C39	Galveston County Sheriff (South)
50096	C3B	Galveston County Sheriff (Car-to-Car)
50128	C3D	Galveston County Sheriff
50160	C3F	Galveston County Sheriff (Patrol)
54384	D47	Galveston County Emergency Medical Services

## ❖ Programming Scanners

Before scanners had computer interface ports, they had to be programmed by hand. (Very early scanners required the purchase and installation of crystals, but we're not going back *that far*.) In most cases "programming" meant entering radio frequencies into scanner memory locations through a front-panel keypad.

Once the computer interface became available, it was possible to create and modify lists of frequencies on a personal computer, then connect a cable and *download* the list into the scanner. Clearly this saved a lot of button pressing on the scanner.

Two recent advances have made this data entry process even easier. One is that some scanners come pre-loaded with frequencies. The Radio Shack PRO-96, for example, has a feature called "V-Scanner" (*virtual scanner*) that allows the user to select a set of frequencies originally programmed at the factory. This also saves a lot of button pushing and allows the scanner to be immediately useful right out of the box, although over time the pre-loaded frequencies will grow old and become out of date.

The second development is the use of the Internet to share frequency lists. Web sites started out just displaying lists of frequencies and talkgroups, intending for readers to copy down and manually enter the information. These web sites were "generic" in the sense that the simply lists did not take into consideration the type of scanner a reader might use.

## ❖ Birds of a Feather

At the same time, owners of particular scanner models began to use the Internet to share tips and tricks with other owners. Gradually this casual sharing grew into groups of users dedicated to a specific scanner. Because computer interfaces make it easy to transfer frequency and talkgroup lists between a scanner and a personal computer, members of these groups began to share lists for different geographic areas. For example, both the PRO-96 and the BCD396T have dedicated communities of users who compile and share frequency lists that can be found on the Internet and immediately downloaded into the scanner.

Yahoo! Groups is a popular web site for a number of scanner-related interest groups. At the main page, <http://groups.yahoo.com>, you will find a search box that will help you locate existing groups. The "BCD396T" group, for instance, has nearly 4,000 members and numerous frequency lists in the File area. Likewise, the "PRO-96" group has more than 2,200 members and a significant number of frequency lists.

Besides groups for particular scanners, there are also groups for particular geographic areas. Ben might be interested in the Yahoo! Group called "HoustonScan," a group specifically set up for radio scanner enthusiasts in and around the Houston, Texas, area. It currently has more than 700 members and should be full of useful information.

**PAR ELECTRONICS → EF-SWL**

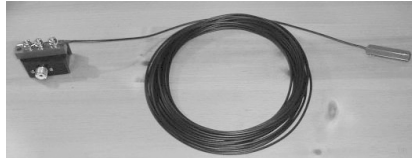

The **Par EF-SWL** is an end-fed short wave antenna optimally designed for 1-30 MHz reception. The radiator is 45 feet of gauge #14 gauge black polyethylene coated Flex-Weave wire (168 strands of #36 gauge woven copper). This material is very strong yet can easily be coiled like a rope for portable work. The UV resistant matchbox houses a wideband 9:1 transformer wound on a binocular core. Unlike other transformers, external stainless studs on the matchbox allow the user to configure the primary and secondary grounds for best noise reduction at their particular location. Output is via a silver/teflon SO239 connector.

**Par EF-SWL** Order #2205 \$57.95

Universal also carries the **Par MON3** omni VHF-UHF base antenna and **Par RF filters**.

Note: Orders under \$100 ship UPS for only \$6.95.

**Universal Radio**  
 6830 Americana Pkwy.  
 Reynoldsburg, OH 43068  
 ♦ Orders: 800 431-3939  
 ♦ Info: 614 866-4267  
 ♦ Fax: 614 866-2339

**www.universal-radio.com**

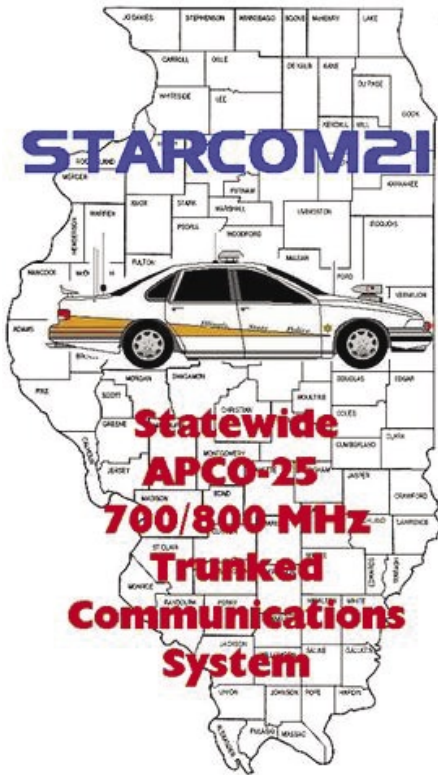

❖ **Coordinated Discovery**

Another interesting use of these kinds of Internet groups is to work out the details of a particular radio system. For example, more than 300 people are subscribed to a group called "STARCOM21" devoted to the new Illinois statewide APCO Project 25 network. Since the network is still under construction, there is a lot of testing and tuning going on. Residents living in areas where testing is underway are exploring the system and posting their findings to the group. These reports help everyone to develop a better understanding of the network and answer many questions about system details.

Sometimes the reports are brief, like these three:

- I was informed today ISP District 17-LaSalle is beginning testing of the Starcom 21 System. I will be monitoring the system and post updates as they become available.

- Another new one today. Site ID 338 on Control Frequency of 866.9625. I would guess that this is the Nebo site in Calhoun County."

- Also got a new one yesterday. Site ID 356 on Control Channel Frequency of 866.8500. This I would guess is the Kritesville site in Calhoun.

Some reports are longer, like this one (edited slightly for clarity):

I have a few updates on the Area-3 towers of Starcom 21. I took a little drive this morning. St. Louis down Illinois Route 3 to Route 149, then East to I-57. Then South to Route 3. Then back north to St. Louis. I took my PRO-96, and put in all of Area-3's tower's frequencies in radio as 'MOT-TRunk'

programmed. But, I put the PRO-96 into Non-Trunk Mode so it would stop on any hits as I traveled around.

I used my PRO-96 inside car with stock antenna (all inside vehicle). This way I could use attenuator to assist in figuring out those sites with 'DIRECTIONAL' antennas.

It seems that 700 MHz sites are mostly confined to the Saint Louis area (as far as towers in the Starcom 21's Area-3). I made frequent scans of the 772 - 777 MHz range in several key locations: Sparta-Evansville; Chester; Gorham; Murphysboro-Carbondale; I-57 & I-24 interchange. No 700 MHz.

First, here are the Site Identifiers I got that have not been previously known:

Gorham, IL (Jackson County) is on-air today on: 867.3125; PRO-96 reports: HEX ID: T0320 (or T332 decimal). I heard voice comms coming from Gorham. Though I did not put radio into 'TRUNK' mode to get the talkgroups. Also, this site has a very directional pattern. On IL Route 3, the site is hard to hear south of the 'FOUNTAIN BLUFF', 'GAS PIPE-LINE BRIDGE' & 'Tower Rock'. Or even along-side 'FOUNTAIN BLUFF'. But signal is great to the NW & N of FOUNTAIN BLUFF. Signal to Chester; Signal from Gorham is great.

Makanda, IL (Randolph County) is on-air today on 866.8625; PRO-96 reports: HEX ID: T031D (or T329 decimal).

Cora, IL (Randolph County) was on-air. But was in 'TEST' mode only.

DuQuoin, IL is on-air. And seems to be spitting out 9600-trunk. But the PRO-96 does not decode it.

- Chester is NOT on-air. No signals.
- McClure is NOT on-air. No signals.
- Cobden is NOT on-air. No signals.
- Nothing detected from Thompsonville.
- Nothing detected from Alto Pass.
- Nothing detected from Elco.

Cypress is NOT on-air, although while I was at the I-57/I-24 exchange I heard an unexpected 9600-baud data channel. It's on 867.4875 and sounded like 9600-baud. But PRO-96 would not display anything.

I think it's encouraging to see how the Internet can help scanner listeners improve their enjoyment of the hobby by enabling the quick and easy sharing of information.

❖ **Washington County, Maryland**

Washington County in northwest Maryland awarded a \$19.3 million contract to Motorola for a new public safety radio system. The county has a population of about 132,000 and a land area of about 450 square miles.

As with most of these kinds of announcements, the county officials expect the new radio system to provide better interoperability between police, fire and emergency medical personnel. The new digital system will replace a 30-year-old analog system and will require the construction of three repeater sites.

Until the new system becomes opera-

tional, you can monitor county activity on the following frequencies:

Frequency	Description
33.08	Civil Defense
33.16	Fire Police
33.80	County Fire (Fireground 1)
33.82	County Fire (Fireground 3)
33.84	County Fire (Fireground 2)
33.86	County Fire (Dispatch)
39.18	Sheriff (Dispatch)
39.60	Sheriff
154.280	County Fire (Mutual Aid)
155.085	County Detention Center
155.160	Board of Education
155.280	Health Department
155.745	Hagerstown Fire
155.790	Hagerstown Fire
453.650	Public Buses
462.975	County EMS (Dispatch)
856.7125	Hagerstown Police
857.7125	Hagerstown Police
858.7125	Hagerstown Police

Most County Sheriff activity takes place on 39.18 MHz, including information checks during traffic stops. The Maryland State Police also have this frequency in their cruisers for Mutual Aid support. The secondary Sheriff channel is also shared with the Detention Center.



The National Park Service operates Antietam National Battlefield in Washington County. The Battle of Antietam (Battle of Sharpsburg, if you're from the South) took place on September 17, 1862, and resulted in casualties of more than 23,000, making it the bloodiest one-day conflict in American history. I have three frequencies listed for the Battlefield: 166.350, 166.950 and 170.050 MHz.

That's all for this month. You can get more frequencies and radio-related information on my website at [www.signalharbor.com](http://www.signalharbor.com) and I welcome your electronic mail to [danveeneman@monitoringtimes.com](mailto:danveeneman@monitoringtimes.com). Until next time, happy scanning!

# Big Savings on Radio Scanners

## Uniden® SCANNERS



### Bearcat® 796DGV Trunk Tracker IV with free scanner headset

Manufacturers suggested list price \$799.95  
**CEI Special Price \$519.95**

1,000 Channels • 10 banks • CTCSS/DCS • S Meter  
**Size: 6 15/16" Wide x 6 9/16" Deep x 2 3/8" High**

**Frequency Coverage:** 25,000-512,000 MHz., 806,000-956,000 MHz. (excluding the cellular & UHF TV band), 1,240,000-1,300,000 MHz.

When you buy your Bearcat 796DGV TrunkTracker package deal from Communications Electronics, you get more. The GV means "Great Value." With your BC796DGV scanner purchase, you also get a **free deluxe scanner headphone** designed for home or race track use. Headset features independent volume controls and 3.5 mm gold right angle plug. The 1,000 channel Bearcat 796DGV is packed with features to track Motorola Type I/II/III Hybrid, EDACS, LTR Analog Trunk Systems and Motorola APCO 25 Phase I digital scanner including 9,600 Baud C4FM and CQPSK. Also features control channel only mode to allow you to automatically trunk many systems by simply programming the control channel, S.A.M.E. weather alert, full-frequency display and backlit controls, built-in CTCSS/DCS to assign analog and digital subaudible tone codes to a specific frequency in memory, PC Control and programming with RS232C 9 pin port (cable not supplied), Beep Alert, Record function, VFO control, menu-driven design, total channel control and much more. Our CEI package deal includes telescopic antenna, AC adapter, cigarette lighter cord, DC cord, mobile mounting bracket with screws, owner's manual, trunking frequency guide and one-year limited Uniden factory warranty. For maximum scanning enjoyment, order magnetic mount antenna part number ANTMMBNC for \$29.95. For complete details, download the owners manual from the [www.usascan.com](http://www.usascan.com) web site. For fastest delivery, order on-line at [www.usascan.com](http://www.usascan.com).

### Bearcat® BCT8 Trunk Tracker III

Manufacturer suggested list price \$299.95  
**CEI Special Price \$169.95**

250 Channels • 5 banks • PC Programmable  
**Size: 7.06" Wide x 6.10" Deep x 2.44" High**

**Frequency Coverage:** 25,000-54,000 MHz., 108,000-174,000 MHz., 400,000-512,000 MHz., 806,000-823,987.5 MHz., 849,012.5-868,995.0 MHz., 894,012.5-956,000 MHz.

The Bearcat BCT8 scanner, licensed by NASCAR, is a superb preprogrammed 800 MHz trunked highway patrol system scanner. Featuring TrunkTracker III, PC Programming, 250 Channels with unique BearTracker warning system to alert you to activity on highway patrol link frequencies. Preprogrammed service searches makes finding interesting active frequencies even easier and include preprogrammed police, fire and emergency medical, news agency, weather, CB band, air band, railroad, marine band and department of transportation service searches. The BCT8 also has preprogrammed highway patrol alert frequencies by state to help you quickly find frequencies likely to be active when you are driving. The BCT8 includes AC adapter, DC power cable, cigarette lighter adapter plug, telescopic antenna, window mount antenna, owner's manual, one year limited Uniden warranty, frequency guide and free mobile mounting bracket. For maximum scanning enjoyment, also order the following optional accessories: External speaker ESP20 with mounting bracket & 10 feet of cable with plug attached \$19.95. Magnetic Mount mobile antenna ANTMMBNC for \$29.95.



### Bearcat® BCD396T Trunk Tracker IV

Suggested list price \$799.95/CEI price \$519.95

APCO 25 9,600 baud compact digital ready handheld TrunkTracker IV scanner featuring Fire Tone Out Paging, Close Call and Dynamically Allocated Channel Memory (up to 6,000 channels), SAME Weather Alert, CTCSS/DCS, Alpha Tagging.  
**Size: 2.40" Wide x 1.22" Deep x 5.35" High**

#### Frequency Coverage:

25,000-512,000 MHz., 764,000-775,987.5 MHz., 794,000-823,987.5 MHz., 849,012.5-868,976.5 MHz., 894,012.5-956,000 MHz., 1,240,000 MHz.-1,300,000 MHz.

The handheld BCD396T scanner was designed for National Security/Emergency Preparedness (NS/EP) and homeland security use with new features such as **Fire Tone Out Decoder**. This feature lets you set the BCD396T to alert if your selected two-tone sequential paging tones are received. Ideal for on-call firefighters, emergency response staff and for activating individual scanners used for incident management and population attack warning. **Close Call Radio Frequency Capture** - Bearcat exclusive technology locks onto nearby radio transmissions, even if you haven't programmed anything into your scanner. Useful for intelligence agencies for use at events where you don't have advance notice or knowledge of the radio communications systems and assets you need to intercept. The BCD396T scanner is designed to track Motorola Type I, Type II, Hybrid, SMARTNET, PRIVACY PLUS, LTR and EDACS® analog trunking systems on any band. Now, follow UHF High Band, UHF 800/900 MHz trunked public safety and public service systems just as if conventional two-way communications were used. **Dynamically Allocated Channel Memory** - The BCD396T scanner's memory is organized so that it more closely matches how radio systems actually work. Organize channels any way you want, using Uniden's exclusive dynamic memory management system. 3,000 channels are typical but **over 6,000 channels are possible** depending on the scanner features used. You can also easily determine how much memory you have used and how much memory you have left. **Preprogrammed Systems** - The BCD396T is preprogrammed with over 400 channels covering police, fire and ambulance operations in the 25 most populated counties in the United States, plus the most popular digital systems. **3 AA NiMH or Alkaline battery operation and Charger** - 3 AA battery operation - The BCD396T includes 3 premium 2,300 mAh Nickel Metal Hydride AA batteries to give you the most economical power option available. You may also operate the BCD396D using 3 AA alkaline batteries. **Unique Data Skip** - Allows your scanner to skip unwanted data transmissions and reduces unwanted birdies. **Memory Backup** - If the battery completely discharges or if power is disconnected, the frequencies programmed in the BCD396T scanner are retained in memory. **Manual Channel Access** - Go directly to any channel. **LCD Back Light** - A blue LCD light remains on when the back light key is pressed. **Autolight** - Automatically turns the blue LCD backlight on when your scanner stops on a transmission. **Battery Save** - In manual mode, the BCD396T automatically reduces its power requirements to extend the battery's charge. **Attenuator** - Reduces the signal strength to help prevent signal overload. The BCD396T also works as a conventional scanner to continuously monitor many radio conversations even though the message is switching frequencies. The BCD396T comes with AC adapter, 3 AA nickel metal hydride batteries, belt clip, flexible rubber antenna, wrist strap, SMA/BNC adapter, RS232C cable, Trunk Tracker frequency guide, owner's manual and one year limited Uniden warranty. Not compatible with AGEIS, ASTRO or ESAS systems. Order on-line at [www.usascan.com](http://www.usascan.com) or call 1-800-USA-SCAN.



### Bearcat® BC246T Trunk Tracker III

Suggested list price \$399.95/CEI price \$214.95

Compact professional handheld TrunkTracker III scanner featuring Close Call and Dynamically Allocated Channel Memory (up to 2,500 channels), SAME Weather Alert, CTCSS/DCS, Alpha Tagging.  
**Size: 2.72" Wide x 1.26" Deep x 4.6" High**

#### Frequency Coverage:

25,000-54,000 MHz., 108,000-174,000 MHz., 216,000-224,980 MHz., 400,000-512,000 MHz., 806,000-823,987.5 MHz., 849,012.5-868,987.5 MHz., 894,012.5-956,000 MHz., 1,240,000 MHz.-1,300,000 MHz.

The handheld BC246T TrunkTracker scanner has so many features, we recommend you visit our web site at [www.usascan.com](http://www.usascan.com) and download the free owner's manual. Popular features include **Close Call Radio Frequency Capture** - Bearcat exclusive technology locks onto nearby radio transmissions, even if you haven't programmed anything into your scanner. **Dynamically Allocated Channel Memory** - Organize channels any way you want, using Uniden's exclusive dynamic memory management system. 1,600 channels are typical but **over 2,500 channels are possible** depending on the scanner features used. You can also easily determine how much memory is used. **Preprogrammed Service Search (10)** - Makes it easy to find interesting frequencies used by public safety, news media TV broadcast audio, Amateur (ham) radio, CB radio, Family Radio Service, special low power, railroad, aircraft, marine, racing and weather frequencies. **Quick Keys** - allow you to select systems and groups by pressing a single key. **Text Tagging** - Name each system, group, channel, talk group



ID, custom search range, and S.A.M.E. group using 16 characters per name. **Memory Backup** - When power is lost or disconnected, your BC246T retains the frequencies that were programmed in memory. **Unique Data Skip** - Allows the BC246T to skip over unwanted data transmissions and birdies. **Attenuator** - You can set the BC246T attenuator to reduce the input strength of strong signals by about 18 dB. **Duplicate Frequency Alert** - Alerts you if you try to enter a duplicate name or frequency already stored in the scanner. **22 Bands** - with aircraft and 800 MHz. The BC246T comes with AC adapter, 2 AA 1,800 mAh nickel metal hydride batteries, belt clip, flexible rubber antenna, wrist strap, RS232C cable, Trunk Tracker frequency guide, owner's manual and one year limited Uniden warranty. For more fun, order our optional deluxe racing headset part #HF24RS for \$29.95. Order now at [www.usascan.com](http://www.usascan.com) or call 1-800-USA-SCAN.

## Buy with Confidence

### Order on-line and get big savings

For over 36 years, millions of communications specialists and enthusiasts worldwide have trusted Communications Electronics for their mission critical communications needs. It's easy to order. For fastest delivery, order on-line at [www.usascan.com](http://www.usascan.com). Mail orders to: Communications Electronics Inc., P.O. Box 1045, Ann Arbor, Michigan 48106 USA. Price includes \$30.00 UPS Ground shipping/handling/insurance per scanner to a street address in the continental USA excluding Alaska. Add \$20.00 shipping for all accessories. For shipments to Canada, Puerto Rico, Hawaii, Alaska, Guam, P.O. Box, APO/FPO, USPS Priority Mail or UPS 2 business day delivery, add \$30.00. Michigan residents add sales tax. No COD's. For Bearcat scanners your satisfaction is guaranteed or return item in unused condition in original packaging within 61 days for refund, less shipping charges. 10% surcharge for net 10 billing to qualified accounts. All sales are subject to availability, acceptance and verification. Prices, terms and specifications are subject to change without notice. We welcome your Discover, Visa, American Express, MasterCard, IMPAC or Eurocard. Order toll free, call 1-800-USA-SCAN or 1-734-996-8888 if outside Canada or the USA. FAX anytime, dial 1-734-663-8888. Dealer and international inquiries invited. Order your radio scanners from Communications Electronics today.

For credit card orders call  
**1-800-USA-SCAN**

e-mail: [cei@usascan.com](mailto:cei@usascan.com)

[www.usascan.com](http://www.usascan.com)

PO Box 1045, Ann Arbor, Michigan 48106-1045 USA  
 For information call 734-996-8888 or FAX 734-663-8888

**COMMUNICATIONS ELECTRONICS INC.**  
 Emergency Operations Center

## More Radio Products

Save even more on radio scanners when purchased directly from CEI. Price includes delivery in the continental USA excluding Alaska.

Bearcat 8987 500 channel TrunkTracker III base/mobile.....	\$209.95
Bearcat 796DGV 1,000 channel TrunkTracker III base/mobile.....	\$519.95
Bearcat BCD396T APCO 25 Digital scanner with Fire Tone Out.....	\$519.95
Bearcat 246T up to 2,500 ch. TrunkTracker III handheld scanner.....	\$214.95
Bearcat Sportcat 230 alpha display handheld sports scanner.....	\$184.95
Bearcat 278CLT 100 channel AM/FM/SAME WX alert scanner.....	\$129.95
Bearcat 248CLT 50 channel base/AM/FM/weather alert scanner.....	\$104.95
Bearcat 92XLT 200 channel handheld scanner.....	\$109.95
Bearcat 72XLT 100 channel handheld scanner.....	\$99.95
Bearcat BR330T up to 2,500 ch. TrunkTracker III with Tone out \$274.95	
Bearcat BCT8 250 channel information mobile scanner.....	\$169.95
Bearcat 350C 50 channel desktop/mobile scanner.....	\$104.95
AOR AR16BQ Wide Band scanner with quick charger.....	\$199.95
AOR AR3000AB Wide Band base/mobile receiver.....	\$1,079.95
AOR AR5000A+3B Wide Band 10 KHz to 3 GHz receiver.....	\$2,599.95
AOR AR8200 Mark III Wide Band handheld scanner.....	\$594.95
AOR AR8600 Mark III Wide Band receiver.....	\$899.95
AOR AR-ONE Government/Export sales only 10 KHz-3 GHz.....	\$4,489.95
Scancat Gold For Windows Software.....	\$99.95
Scancat Gold For Windows Surveillance Edition.....	\$159.95

Visit [WWW.USASCAN.COM](http://WWW.USASCAN.COM) • 1-800-USA-SCAN

## DXing Differential GPS Beacons

As September comes and nights grow longer, we start to see dramatic improvement at the low end of the commonly used radio spectrum. Late at night, frequencies between 200 and 520 kilohertz (kHz) can offer distances rivaling high-frequency (HF) short-wave, and often with much steadier signals.

Those who haven't listened between 286 and 325 kilohertz (kHz) in a couple of years are in for a major surprise, provided they live in North America, Europe, Australia, or parts of the Middle East. Differential Global Positioning System (DGPS) has taken over. Many older radio beacon stations, and even the defunct, non-navigational, Ground Wave Emergency Network (GWEN) sites are rapidly being converted to this newer service, which greatly improves the accuracy of DGPS-capable GPS navigation receivers in range of a good signal.

As the nationwide US system nears completion, a good night may provide audible signals to some locations on just about every frequency, and most of these should decode. Emission is minimum-shift keying (MSK), a very narrow digital mode. Most stations are 100 bits per second, and the few using 200 bps look wider on the spectrogram.



A Leica DGPS base receiver

Just tune a strong station on an exact kHz, and set the software for a good decode. It's then easy to step through the band in 1-kHz increments, scooping up identifiers. Most of the time, you'll copy the number of the "A" reference receiving station, a source of the GPS correc-

tions on the beacon you hear. This number should appear somewhere in every decoded correction set, though exactly where varies between computer programs. Less frequent message types contain the "B" reference, and/or the international number of the actual transmitter being heard, and so we've listed these, too.

That's really all there is to it. Good hunting!



Handheld DGPS receiver.

### North American DGPS Stations

kHz	Location	TX #	Ref. A	Ref. B	bps
286.0	Sandy Hook, NJ	804	8	9	200
286.0	Key West, FL	811	22	23	100
286.0	Upolu Point, HI	879	258	259	100
286.0	Wiaraton, ON	918	310	311	200
287.0	Polson, MT	849	60	61	100
287.0	Pigeon Point, CA	883	266	267	100
287.0	Fort Stevens, OR	886	272	273	100
288.0	Gustavus, AK	892	284	285	100
289.0	Topeka, KS	765	202	203	200
289.0	Driver, VA	806	12	13	100
289.0	Cape Canaveral, FL	809	18	19	100
289.0	Cold Bay, AK	898	296	297	100
290.0	Penobscot, ME	799	44	45	200
290.0	Pahoa, HI	877	254	255	100
290.0	Cape Ray NF	942	340	341	200
291.0	Hawk Run, PA	788	184	185	100
291.0	Albuquerque, NM	845	54	55	100
292.0	Kensington, SC	778	192	193	100
292.0	Cheboygan, MI	836	112	113	200
292.0	Pine River, MN	841	96	97	100
292.0	Cape Mendocino, CA	885	270	271	100
292.0	Cape Hinchinbrook, AK	894	288	289	100
293.0	Moriches, NY	803	6	7	100
293.0	English Turn, LA	814	28	29	200
294.0	New Bern, NC	771	196	197	100
295.0	Isabela, PR	817	34	35	100
295.0	Level Island, AK	891	282	283	100
295.0	Partridge Island NB	939	326	327	200
296.0	Wisconsin Point, WI	830	100	101	100
296.0	St. Jean Richelieu PQ	929	312	313	200
297.0	Bobo, MS	792	136	137	200
297.0	Milwaukee, WI	833	106	107	100
298.0	Upper Keweenaw, MI	831	102	103	100
298.0	Omaha, NE	868	166	167	200
298.0	Potato Point, AK	895	290	291	100
298.0	Hartlen Point, NS	937	330	331	200
299.0	Sallisaw, OK	866	162	163	200
299.0	Rigolet, NF	946	344	345	200
300.0	Mobile Point, AL	813	26	27	100
300.0	Louisville, KY	869	168	169	200
300.0	Appleton, WA	871	172	173	100
300.0	Kokole Point, HI	880	260	261	200
300.0	Sandspit, BC	906	306	307	200
300.0	Rivière du Loup, PQ	926	318	319	200

301.0	Macon, GA	822	48	49	200
301.0	Angleton, TX	828	246	247	100
301.0	Saginaw Bay, MI	837	114	115	100
301.0	Annapolis, MD	847	58	59	200
302.0	Point Loma, CA	881	262	263	100
302.0	Whidbey Island, WA	888	276	277	100
303.0	Greensboro, NC	824	46	47	100
303.0	Myton, UT	873	174	175	100
304.0	Aransas Pass, TX	816	32	33	100
305.0	Bakersfield, CA	795	84	85	100
305.0	Alexandria, VA	820	40	41	100
305.0	Kansas City, MO	867	164	165	200
305.0	Biorka Island, AK	890	280	281	100
306.0	Acushnet, MA	772	198	199	200
306.0	Cardinal ON	919	308	309	200
307.0	Hackleburg, AL	825	50	51	100
307.0	Hagerstown, MD	834	130	131	100
307.0	Pueblo, CO	872	200	201	100
307.0	Fox Island NS	934	336	337	200
309.0	Pickford, MI	835	110	111	200
309.0	Clark, SD	850	146	147	100
309.0	Reedy Point, DE	870	170	171	200
309.0	Alert Bay, BC	909	300	301	200
309.0	Lauzon PQ	927	316	317	200
310.0	Seneca, OR	773	214	215	100
310.0	Whitney, NE	859	148	149	100
310.0	Memphis, TN	861	152	153	200
310.0	Kenai, AK	896	292	293	100
310.0	Cape Norman, NF	944	342	343	200
311.0	Rock Island, IL	863	156	157	200
312.0	Austin, NV	798	74	75	100
312.0	Tampa, FL	827	244	245	200
312.0	Western Head, NS	935	334	335	200
313.0	C2CEN*, Portsmouth, VA	821	1008	1009	200
313.0	Vicksburg, MS	860	150	151	200
313.0	Billings, MT	874	62	63	100
313.0	Kodiak, AK	897	294	295	100
313.0	Moisie, PQ	925	320	321	200
314.0	Lincoln, CA	764	210	211	200
314.0	Sturgeon Bay, WI	832	104	105	100
315.0	Amphitrite Point, BC	908	302	303	200
315.0	Cape Race NF	940	338	339	200
316.0	Brunswick, ME	800	42	43	100
316.0	Spokane, WA	848	68	69	100
317.0	Hartsville, TN	858	144	145	100
317.0	St. Paul, MN	864	158	159	200
318.0	Summerfield, TX	823	52	53	100
318.0	Chico, CA	878	256	257	100
319.0	Savannah, GA	818	36	37	100
319.0	Detroit, MI	838	116	117	200
319.0	Flagstaff, AZ	876	64	65	100
319.0	Pt. Escuminac NB	936	332	333	200
320.0	Millers Ferry, AL	865	160	161	200
320.0	Richmond, BC	907	304	305	200
321.0	Lompoc, CA	882	264	265	100
322.0	Miami, FL	810	20	21	100
322.0	Youngstown, NY	839	118	119	100
322.0	St. Louis, MO	862	154	155	200
323.0	Robinson Point, WA	887	274	275	200
323.0	Annette Island, AK	889	278	279	100
324.0	Hudson Falls, NY	844	94	95	200
325.0	Medora, ND	851	176	177	100

\*C2CEN = US Coast Guard Command and Control Engineering

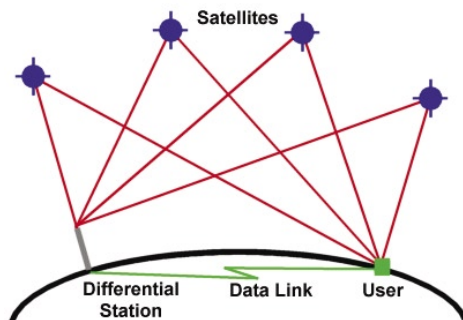

How DGPS works

### ABBREVIATIONS USED IN THIS COLUMN

AFB.....	Air Force Base
ALE.....	Automatic Link Establishment
AM.....	Amplitude Modulation
ARINC.....	Aeronautical Radio, Inc.
ARQ.....	Automatic Repeat Request
AWACS.....	Airborne Warning and Control System
CAMSLANT.....	Communication Area Master Station, Atlantic
CAMSPAC.....	Communication Area Master Station, Pacific
CW.....	"Continuous Wave" Morse telegraphy
DGPS.....	Differential Global Positioning System
DSC.....	Digital Selective Calling
E3.....	UK Intelligence, female English voice, Cyprus
E6.....	Russian Intelligence "English Man," synthesized voice
E7.....	"English Man," null-message format
E10.....	Israeli Intelligence, English phonetic station
E10a.....	Null-message format, postpends "2" to callup
EAM.....	Emergency Action Message
FAX.....	Radiofacsimile
FEC.....	Forward Error Correction
FEMA.....	US Federal Emergency Management Agency
JSTARS.....	Joint Surveillance Target Attack Radar System
HF DL.....	High-Frequency Data Link
HF-GCS.....	High-Frequency Global Communication System
LSB.....	Lower Sideband
M8a.....	Cuban 3-message CW, ANDUWRIGMT = 1-0
MARS.....	Military Affiliate Radio System
Meteo.....	Meteorological
NDB.....	Non-Directional Beacon
RSA.....	Republic of South Africa
RTTY.....	Radio Teletype
S10d.....	"Czech Woman," "Pozor nn nn Konec" variant
Selcal.....	Selective Calling
SITOR-A.....	Simplex Telex Over Radio, ARQ mode
SITOR-B.....	Simplex Telex Over Radio, FEC mode
Unid.....	Unidentified
US.....	United States
USCG.....	United States Coast Guard
UK.....	United Kingdom
V2.....	Generic "Atencion" Spanish numbers
Volmet.....	From French, loosely "Flying Weather"

All transmissions are USB (upper sideband) unless otherwise indicated. All frequencies are in kHz (kilohertz) and all times are UTC (Coordinated Universal Time). "Numbers" stations have their ENIGMA (European Numbers Information Gathering and Monitoring Association) designators in ().

- |       |   |        |   |
|-------|---|--------|---|
| 227.0 | SJY-NDB, San Jacinto, CA, AM Morse identifier at 2134. (Hugh Stegman-CA)                          | 378.0  | CPM-NDB, Compton Airport, CA, AM Morse at 0546. (Stegman-CA)  |
| 233.0 | LG-Long Beach Airport outer marker, CA, AM Morse identifier at 2226. (Stegman-CA)                 | 397.0  | SB-San Bernardino Airport middle marker, CA, AM Morse at 2239. (Stegman-CA)   |
| 253.0 | UR-Bob Hope Airport middle marker, Burbank, CA, AM Morse identifier at 3246. (Stegman-CA)         | 400.0  | ENS-NDB, Ensenada, Mexico, AM Morse at 2215. (Stegman-CA)   |
| 291.0 | 54-DGPS beacon, Albuquerque, NM, 100-baud satellite corrections at 0522. (Stegman-CA)             | 2182.0 | Coast Guard sector Mobile-USCG, Mobile, AL, calling unknown distressed vessel with no joy, at 0055. (Tom Sevart-KS)   |
| 302.0 | 262-DGPS beacon, Point Loma, CA, 100-baud satellite corrections at 0501. (Stegman-CA)             | 3161.0 | XJV-Unknown "XSS Net," calling XSS in ALE, at 0053 and 1955. (Patrice Privat-France)  |
| 305.0 | 84-DGPS beacon, Bakersfield, CA, at 0457. (Stegman-CA)  | 3227.4 | XSS-Unknown "XSS Net," ALE sounding at 0441. (Privat-France)  |
| 312.0 | 74-DGPS beacon, Austin, NV, at 0504. (Stegman-CA)   | 3413.0 | Shannon Volmet-International aviation weather broadcast, observations for European airports at 0210. ("Cyclops"-TX)   |
| 314.0 | 210-DGPS beacon, Lincoln, CA, 200 baud, at 0506. (Stegman-CA)                                     | 4021.5 | B1Z171-US Army 1-171st Aviation, calling helicopter R26327, ALE at 0108. (Mark Cleary-SC)   |
| 316.0 | 68-DGPS beacon, Spokane, WA, at 0507. (Stegman-CA)  | 4028.0 | Cuban AM Spanish female "numbers" voice (V2), 5-figure groups in progress, bad carrier which sounded better in sideband mode, at 0100. (Sevart-KS)  |
| 318.0 | 256-DGPS beacon, Chico, CA, at 0531. (Stegman-CA)   | 4156.5 | ZSC-Globe Wireless network, Cape Town, RSA, Globedata marker, also on 4274, at 1614. (Bob Hall-RSA)   |
| 319.0 | 64-DGPS beacon, Flagstaff, AZ, at 0513. (Stegman-CA)  | 4214.0 | XSV-Tianjin Radio, China, CW identifier in SITOR-A phasing bursts, at 1553. (Hall-RSA)  |
| 321.0 | 264-DGPS beacon, Lompoc, CA, at 0517. (Stegman-CA)  | 4270.0 | PCD-Israeli Intelligence, phonetic callup and message in 5-letter groups, at 1930. (Mike L-West Sussex, UK)   |
| 337.0 | NA-John Wayne Airport middle marker, Santa Ana, CA, AM Morse at 2230. (Stegman-CA)                | 4369.0 | WLO-Mobile Radio, AL, weather and traffic list at 1400. (Cyclops-TX)  |
| 344.0 | FCH-NDB, Chandler Airport, Fresno, CA, AM Morse at 2159. (Stegman-CA)                             | 4469.0 | Southeast CAP 43-US Civil Air Patrol, opening net with Florida Cap 90, Southeast CAP 49, many others, at 0002. (Cleary-SC)  |
| 350.0 | NUC-NDB, US Navy Auxiliary Landing Field, San Clemente Island, CA, AM Morse at 2330. (Stegman-CA) | 4500.1 | AFA2VT-US Air Force MARS, in a net at 0052. (Sevart-KS)   |
| 359.0 | EMT-NDB, El Monte, CA, AM Morse at 2332. (Stegman-CA)   | 4585.0 | Sand Lapper 4-SC Civil Air Patrol net, with Sand Lapper 431, Sand Lapper 552, and Middle East 34, at 0002. (Cleary-SC)  |
| 370.0 | PAI-NDB, Whiteman Air Park, Pacoima, CA, AM Morse at 0544. (Stegman-CA)                           | 4739.0 | Falcon 1-Unknown unit, possible UK accent, working Fiddle (USN, Jacksonville, FL), at 0021. (Cleary-SC)   |
|       |   | 4790.0 | R26327-US Army helicopter, calling B1Z171, 1-171st Aviation, ALE at 0046. (Cleary-SC)   |
|       |   | 5135.0 | SEMOHQ-FEMA state net, MO, ALE sounding at 0333. CL1AR-New Hampshire emergency net, Clarendon, ALE sounding at 0431. (Privat-France)  |
|       |   | 5202.0 | AAR7FN-US Army MARS, in a net at 0107. (Sevart-KS)  |
|       |   | 5302.5 | R23558-US Army helicopter, calling 147, possible 147th Aviation of the WI National Guard, at 0205. (Cleary-SC)  |
|       |   | 5450.0 | Royal Air Force Volmet, London, UK, aviation weather for various African airports at 0215. (Cyclops-TX)   |
|       |   | 5696.0 | Coast Guard 1705-USCG HC-130, Elizabeth City, radio check with CAMSLANT at 2321. (Cleary-SC)  |
|       |   | 5711.0 | Cape Radio-US Air Force, Cape Canaveral, FL, space shuttle launch support with Booster Recovery Vessels <i>Liberty Star</i> and <i>Freedom Star</i> , tried unsuccessfully to move them to 9132, at 1409. (Allan Stern-FL)  |
|       |   | 5732.0 | CAMSLANT-USCG, Norfolk, VA, taking position and ops-normal from aircraft Juliet 32, at 0036 and 0053. (Sevart-KS) J36-USCG, calling LNT in ALE, then voice position report as Juliet 36 for CAMSLANT, at 0142. (Cleary-SC) 716-USCG, ALE to PAC, then voice as Coast Guard 1716, securing radio guard with CAMSPAC Point Reyes, CA, at 2019. (Stegman-CA) |
|       |   | 5778.5 | R26602-US Army helicopter, calling B1Z171, 1-171st Aviation, ALE at 0244. (Cleary-SC)   |
|       |   | 5833.5 | G24525-US Army helicopter, calling STPOPS (Army Aviation Support Facility, St. Paul Airport, MN), ALE at 0156. (Cleary-SC)  |
|       |   | 6314.0 | NMF-USCG, Boston, MA, with SITOR-B weather and Navarea IV maritime safety information, simulkeying on 8416.5 and 12579, strong on all frequencies at 0140. (Eric Christensen-NC)  |
|       |   | 6529.0 | A7-AFP - Qatar Airlines flight 550, an A330, HF DL message for station 17, Telde, Grand Canary Island, at 0613. VS0022-Virgin Airlines flight 22, position for 17 at 0618. (Patrice Privat-France)  |

- 6761.0 Archibald-US military, probable "Nightwatch" net, antenna testing in voice and data modes with Andrews and "Andrews One," at 0255. (Jeff Haverlah-TX)
- 6801.5 BR01-Unknown station working CL31, ALE at 0236. (Jack Metcalfe-KY)
- 6911.5 R26329-US Army helicopter, calling B1Z171, ALE at 0203. (Cleary-SC)
- 6923.0 Unid-Pirate "numbers" parody station, male voice in LSB reading numbers in WBNY/"Rodent Revolution" format, at 2252. (Chris Smolinski-MD)
- 6959.0 The Lincolnshire Poacher-UK Intelligence "numbers" (E3), Poacher tune and message "31337," parallel 9251 and 11545, Tuesday at 1901. (Mike L-UK)
- 6985.0 R26154-US Army helicopter, calling T12 (12th Aviation, VA), ALE at 0051. (Cleary-SC)
- 7527.0 Panther-US Drug Enforcement Administration, Bahamas, calling 39C, at 0002. (Cleary-SC)
- 7650.0 R26135-US Army National Guard helicopter, calling T2Z135 (2-135th Aviation), ALE at 0402. (Cleary-SC)
- 7718.5 G24525-US Army helicopter, calling STPOPS (St. Paul, MN) ALE at 0241. (Cleary-SC)
- 7805.0 LA1NC-NH emergency net, Lancaster, ALE sounding at 0008. (Privat-France)
- 7905.0 G58-Unknown, calling MR8 in ALE, at 1958. (Privat-France)
- 8003.0 R24485-US Army helicopter, working T3Z238, ALE at 2008. (Privat-France)
- 8020.0 2528-Unknown, calling 2527 in ALE, at 1954. (Privat-France)
- 8050.0 FC8FEM-FEMA Region 8, ALE sounding at 1949. (Stegman-CA)
- 8097.0 Cuban AM Spanish female (V2), 5-figure groups in progress at 1838. (Sevart-KS)
- 8125.0 Unid-Russian Intelligence "numbers" (E6), callup 690 852/113, then message in 5-number groups, Sunday at 1930. (Mike L-UK)
- 8130.0 Unid-Russian "numbers" (E6), callup "690 384/197" and message, Sunday at 1930. (Mike L-UK)
- 8192.0 9MR-Malaysian Navy, coded RTTY message in 5-letter groups at 1620. (Hall-RSA)
- 8435.0 XSQ-Guangzhou Radio, China, CW in SITOR-A marker, at 1607. (Hall-RSA)
- 8462.0 9MR-Malaysian Navy, RTTY 5-letter groups at 1549. (Hall-RSA)
- 8788.0 WLO-Mobile Radio, AL, tropical weather report and traffic list at 1300. (Cyclops-TX)
- 8776.0 Outplay-US military, probably "Nightwatch" net, radio check with unid station at 2355. (Cleary-SC)
- 8834.0 ZS-SJN - South African Airways flight 182, a Boeing 737, HFDL position for ARINC ground station 08, Johannesburg, RSA, at 1117. ZS-SFJ, SA flight 81, an A319, HFDL position at 1130. ZS-SFI, flight 617, an A319, with HFDL messages at 1214. ZS-SFL, flight 471, an A319, HFDL position at 1220. (Hall-RSA)
- 8933.0 New York-ARINC Long Distance Operational Control, working a US Air flight diverting to Barcelona with low fuel, also Selcal check BG-AP, at 0242. (Stern-FL)
- 8971.0 Goldenhawk-US Navy, Brunswick, ME, clear and secure with P-3Cs Wafer 21 and Wafer 33, at 0713. (Stern-FL) Tiger 21-US Navy P-3C, requesting instructions from Goldenhawk regarding return to base with a live missile, at 2246. (Cleary-SC)
- 8983.0 "U-7-O"-USCG, position for CAMSLANT at 1236. (Cleary-SC)
- 9025.0 Ruby 37-US Air Force tanker, patch via Puerto Rico at 0058. (Cleary-SC) Sentry 51-US Air Force AWACS, autopatch to Raymond 24 (Tinker AFB, OK) and "351," at 2129. (Sevart-KS)
- 9132.0 King 2-US Air Force rescue C-130, doing range safety on the Atlantic Test Range in support of the shuttle launch, working Cape Radio, FL, at 1658. (Stern-FL)
- 9152.8 Cuban AM Spanish female (V2), 5-figure groups in progress, parallel on 11566, at 1312. (Cyclops-TX)
- 9190.0 PR1-Venezuelan Navy Radio Station 1, calling DHN in ALE, at 0144. (Privat-France) [DHN is probably the national hydrographic office (Dirección de Hidrografía y Navegación). -Hugh]
- 9985.0 Unid-Czech "numbers" (S10d), identifier "555 721," then 5-number groups, signed "Pozor 46 38 Konec," Wednesday at 0820. (Mike L-UK)
- 10270.0 Unid-Russian "numbers" (E6), same traffic as on 8125, Sunday at 1830. (Mike L-UK)
- 10780.0 Cape Radio-US Air Force, Cape Canaveral, FL, working Air Transport 530 at 0427. King 3-US Air Force rescue C-130 doing range safety on shuttle launch, asking King 1 for the working frequency, given 9132 and gone, at 1658. (Stern-FL) Cape Radio, Eastern Test Range space shuttle launch support with Ascension Radio, at 1259. (Larry Van Horn-NC)
- 11175.0 Handball-US military, 28-character EAM at 0000. No Trump-Same US military unit prior to zero-Zulu name change, same EAM, simulcast on HF-GCS 4724, 8992, and 15016, at 2320. (Haverlah-TX) Reach 1024-US Air Force C-130 enroute to LGSA, Souda Bay Airport, Greece, with several HF-GCS patches to Moody AFB, GA, at 0407. (Stern-FL) Headline-US military, probable "Nightwatch" net, patch via Andrews HF-GCS to Offutt AFB, NE, at 1248. Soda 51-Tennessee Air National Guard tanker, patch to Soda Control at 1343. (Cleary-SC)
- 11220.0 Archibald-US military, probable Nightwatch net, working Andrews, went to 9027 but bad interference there, then tried 6761 [Usually the air-air frequency. -Hugh], all starting at 0235. (Haverlah-TX)
- 11232.0 Peach 31-US Air Force E-8C JSTARS, patches via Trenton Military to Peachtree Ops (Robins AFB, GA), at 1557 and 1645. (Stern-FL) Strikestar-US Air Force E-8 JSTARS, also identifying as Peach 62, patch via Trenton to Peachtree, Robins AFB, GA, for weather at 1920. (Cleary-SC)
- 11485.0 043CDCS42-Probable US Center for Disease Control, sounding in LSB ALE at 1705, then on 12164 in LSB ALE at 1709. (Metcalfe-KY)
- 12115.0 Unid-Russian Intelligence "male" "numbers" voice, callup "113/000" only (E7), at 2030. (Mike L-UK)
- 12575.7 VRVL2-Hong Kong container ship OOCL Singapore, calling Lyngby Radio, Denmark, in DSC at 0626. (Privat-France)
- 12594.5 A9M-Hamala Radio, Bahrain, CW in SITOR-A marker, at 1555. (Hall-RSA)
- 12935.0 HLG-Seoul Radio, Korea, CW calling marker at 1855. (Sevart-KS)
- 13110.0 WLO-Mobile Radio, AL, schedule and traffic list at 1900. (Sevart-KS)
- 13152.0 WLO-Mobile Radio, AL, tropical weather report and traffic list at 0204. (Cyclops-TX)
- 13215.0 NATO 02-North Atlantic Treaty Organization aircraft, patch to Washington Ops regarding electronic problems at 2148. (Sevart-KS)
- 13321.0 ZS-SFH-South African flight 173 (A-319), HFDL position for Johannesburg at 1233. (Hall-RSA)
- 13405.0 Unid-Czech identifier "555 674" (S10d), parallel on 14445, signed "Pozor 52 27 Konec," Wednesday at 1856. (Mike L-UK)
- 13419.0 Cuban CW cut-number station (M8a), callup "58943 13033 06643," at 1802. (Cam Castillo-Panama)
- 13510.0 CFH-Canadian Forces, Halifax, NS, FAX weather chart at 1912. (Sevart-KS)
- 13511.0 Unid-Russian Intelligence, English callup "113/000" only (E7), at 2010. (Mike L-UK)
- 13927.1 SPAR 01-US Air Force Distinguished Visitor flight with a general aboard, MARS patch to Little Rock Command Post, at 1415. Shark 80-US Air Force C-130, MARS patch to Soto Cano Air Base, Honduras, then US Southern Command meteo, at 1425. (Stern-FL) Reach 6018-US Air Force Air Mobility Command transport, morale patch via Air Force MARS at 2018. (Cleary-SC)
- 14000.0 VLB2-Israeli Intelligence, English phonetic callup only (E10), at 1848. (Mike L-UK)
- 14453.5 950DVA-US Department of Veterans Affairs, WV, ALE sounding at 0132. (Metcalfe-KY)
- 14487.0 The Lincolnshire Poacher (E3), 5-letter groups in progress at 1545. (Hall-RSA)
- 15016.0 Puerto Rico-US Air Force HF-GCS, Salinas, Puerto Rico, working C-40A US Navy AX 860, Fleet Logistics Support Squadron 59 (VR-59), went to 8992, at 0017. (Cleary-SC)
- 16812.7 A9M-Hamala Radio, Bahrain, CW in SITOR-A marker, at 1605. (Hall-RSA)
- 16830.5 SVO-Olympia Radio, Greece, CW marker at 1603. (Hall-RSA)





## Chinese Invade 20 Meters; Jamming is Paramount

From mid-June, China National Radio program I was heard on various frequencies inside the 20-meter ham band, changing from day to day and skipping some days: 14180, 14260, 14310 were monitored here around 1300, and were easily identified since they were parallel to CNR-1 jammers on 15265 against Taiwan and on 15285 against BBC Mandarin.

But why? The same tactic has been used on the 17 and 18 MHz bands, as jammers against the clandestine Sound of Hope. The Chinese Communist jamming is so effective that SOH is hardly ever audible underneath. Wolfgang Büschel reported to *HCDX* that SOH is transmitted from CBS, Tanshui, Taiwan.

The first report of 14180 at 1424 UT June 22 came from Wade Smith in New Brunswick, as CNR appeared to be broadcasting the Ghana-USA World Cup match; but later it was back to regular programming which now sounds very "commercial." Subsequent monitoring found these transmissions at many times of day audible in Europe as well. José Miguel Romero in Spain reported 44444 reception at 1330. Jari Savolainen in Finland made more parallels on 9605, 11710, 11765 and 15495. Walt Salmaniw in BC heard 14180 at 0621.

In *DSWCI DX Window*, the 14180 jamming site was reported as Guangxi; how do they know? But that frequency was active for only two days. Anker Petersen, Denmark, said the SOH broadcasts and hence the jamming were scheduled 2205-1800, except for "jam checks" for five minutes at the top of each hour. That is, the jammers go off during the news so monitors can check whether their target is still on frequency. We could not hear SOH then, either, so perhaps they were playing the same game.

Almost a week later, we found the next frequency, 14260 around 1330. This was also reported by Uli Bihlmayer, DJ9KR, of the German

Amateur Radio Club intruder watch, who also monitored it other days on 14180, 14230, 14310 and 14350. We were listening to it on 14310 as the MARCO medical net at 1400 was trying to function on 14309.

The Chinese intruders on the 20m ham band were also reported by the Wireless Institute of Australia, who assumed the CNR had decided to "establish" itself as a broadcaster on the ham bands.

In fact, it is the fault of Sound of Hope for choosing to operate on such frequencies. In Communist China, jamming is of the highest priority, so wherever clandestine and any other uncontrolled external broadcasts go, the jammers will follow, even into the ham bands. SOH was probably well aware this would bring down condemnation upon China.

DJ9KR complained to the Chinese ambassador in Germany, and was assured China would look into the problem; and a few days later it seemed to have been resolved.

But this was all dependent on the frequency usage of Sound of Hope. On some days we heard the jamming on a previously used channel, 17350, which is neither a ham nor a broadcast band. Complaints from maritime utility users might then be expected. Wade Smith also heard 14310 and 18160 (also in a ham band) in use simultaneously. Damage to the ham bands, and to any listeners or stations outside China, is purely a by-product of this situation. Of course the Chinese authorities allow this: they are doing it.

Meanwhile, ham intruder watch groups in the UK and USA also kept monitoring this situation; reports continued to come in from Asia and other parts of the world. It is somewhat ironic that only when such jamming invades the ham bands does anyone seem to care. The bane of jamming is just as disruptive and contrary to freedom of expression when it is within the shortwave broadcasting bands.

**ALBANIA** Drita Cico, head of SWBC and technical director of R. Tirana (on 6115 and 7445) bemoans the lack of reception reports, only a handful over the years from NAm. Give it a go and send her a report, to dcico@abcom-al.com The broadcasts aren't long but they can be interesting and play some good Albanian music (Sue Hickey, NF, *CIDX Forum*)

Programs include: *Albania in a Week, Cultural Activities, UT Tue; Mail-Box, UT Wed; Albanian Economy, Focus on Albania, UT Fri; Mosaic of the Week, Folk Music, UT Sun* (Richard G. Read, *World DX Club Contact*) How would all the same programs fit into the quarter-hour broadcasts? Each one cut in half? Tue-Sun 0145-0200 & 0230-0300. Started A-06 season on 7455, apparently shifted on 7445 due to RTTY (gh)

**ALGERIA** [non] In early June, VT Merlin tests were heard on 9710 until 2300 (Ed Insinger, NJ, *DX Listening Digest*) Turned out to be new relays of TDA, via UK sites:

0400-0600 7260 9540  
1900-2000 9765 11810  
2000-2100 9765 12025  
2100-2300 7150 9710

It's the ENRS Kor'an programme, *Entreprise Nationale de Radiodiffusion Sonore* (Radio Algerienne) (Wolfgang Büschel, Germany, *ibid.*)

Heard signing-on 11810, 9765 at 1900 with national anthem, "Huna El Djazair" and then "Idha'atu Qur'an al-Kareem" [Holy Kor'an Radio]. (Dave Kernick, UK, *HCDX*) Previously tested via France in mid-January, Merlin early February, France again mid-February, now UK again in June (Wolfgang Büschel, *ibid.*) There were planned schedules for each which never materialized; now is this here to stay? (gh)

TDA means *Télédiffusion d'Algérie* (Andy Sennitt, Netherlands, *ibid.*) In each case the lower frequency is from Rampisham with 500 kW at 190 degrees, the higher from Woofferton with 300 kW at 160 degrees (*DX Mix News*, Bulgaria) Aimed back toward Algeria, NAF (gh)

Algeria's own SW closed down in summer 2003 after having been highly unreliable for a couple of years (Kai Ludwig,

Germany, *DXLD*) Is this now solely the Kor'an program, and why? (gh)  
**ANTARCTICA** R. Nacional Arcángel San Gabriel, 15476, very strong for 15 minutes at 1910 June 23 (Maurits Van Driessche, Belgium, *DXLD*) Continues to elude NAm DX listeners; must keep trying M-F 19-21. LRA36 is essential for HAC "heard all continents." (gh)

**AZERBAIJAN** 6110.84, R. Dada Gorgud, IS and English from 1700 (Kouji Hashimoto, *Japan Premium*) Are they really still using that ID rather than V. of Azerbaijan? (gh) Also heard on 2<sup>nd</sup> and 3<sup>rd</sup> harmonics 12222v and 18333v as long as 24 years ago (Harald Suess, Austria, *BC-DX*) Which at that hour would have a better chance of making it to NAm

**BOLIVIA** 4450, R. Estación Frontera, Cobjia, in Spanish and Indian dialect, music, 1010 surprise ID, fades. A great and surprising find (Johno Wright, *Cataract DXpedition, NSW*) Had been inactive for years; *WRTH 2006* shows 250 watts (gh) Tentatively, varying to 4449.90, at 0955-1020. Other Bolivians surveyed include: strong signals every day at 1000-1030 from R. Yura, 4716.70v; R. Mallku, 4796.42v; and R. San Miguel, 4901.927. Measured on 4545.39v, R. Virgen de Remedios, under CODAR (radar) interference at 0000-0130 (Bob Wilkner, FL, *SW Bulletin*)

R. Virgen de Remedios, Tupiza, 4545, heard announcing their power as 500 watts when reading reception reports at 0030 on a UT Mon (Horacio A. Nigro, Uruguay, *DXLD*)

**BRAZIL** Following the DRM tests in Brasilia on 25885, it was suggested by the University's Humberto Abdala that each city and region could have an additional 20 local radio channels by using DRM on 11 meters (Célio Romais, *Panorama, @tividad DX*)

R. Rural de Petrolina, PE, reactivated 4945 June 23 after tube problems for several months, but to save power is on reduced schedule 08-11 and 19-22 (Isaac Rosa, CE, *radioescutas yg*)

R. Inconfidência, Belo Horizonte MG, transmitter operator told me that after replacing tubes, they would reactivate 6010 with 25 kW, and also on 19m (Jaime Soares, *radioescutas yg*) No sign of 15190, off the air for many years (gh) Heard again on 6010 at 1810 (Paulo Cabral, ES, *radioescutas*) Also at 1030 with very good audio quality (Luiz Chaine Neto, SP, *ibid.*) And at 2330 with ad for fibre

All times UTC; All frequencies kHz; \* before hr = sign on, \* after hr = sign off; // = parallel programming;  
+ = continuing but not monitored; 2 x freq = 2nd harmonic; B-06=winter season; [non] = Broadcast to or for the listed country, but not necessarily originating there; u.o.s. = unless otherwise stated

optics (Reinaldo Gomes, PN, *ibid.*) Bad news for Colombia and Mexico already colliding on 6010 (gh)

Rádio Clube de Marília is heard again on 3235 at 0450; after a long time relaying R. Guarujá Paulista instead (Renato Uliana, SP, @*atividade DX*) Also at 2345 with *Show da Noite* (Reinaldo Gomes, PR, *ibid.*)

Rádio Guarujá Paulista, heard at 2013 on 3385 relaying Rádio Gaúcha with World Cup. 3385 will be its new permanent frequency; also plans to use 9715. R. Globo, Rio de Janeiro, reactivated 11805 but was quite irregular, even during the World Cup (Célio Romais, *Panorama*, @*atividade DX*)

**BULGARIA** Third harmonic of 9400 from R. Bulgaria put an S7 signal on 28200 at 1400 (Uli Bihlmayer, Germany, DJ9KR, DARC Monitoring System Intruder Watch)

**CUBA** [and non] Adil Mina, a VP at Continental Electronics said that in the last four to five years, over 90% of new SW transmitting equipment has been purchased by the Chinese; and that China will be installing seven 500 kW transmitters in Cuba this year (Rich D'Angelo, report on the May NASB meeting, *NASWA Journal*)

We have been testing from mid-June a new curtain antenna for 6-12 MHz, 19.5 dB gain, aimed 160 degrees, 11-15 on 11805, 00-05 on 9600; instead of an old rhombic at 130 degrees dating back to the beginning of RHC in 1961 (Arnie Coro, via Nicolás Eramo, *condig list*)

RHC's new transmitters and/or antennas are certainly beeping up their already strong signals from only 2 megameters away, but there is no improvement in the spurious output. At 1330 I heard RHC IS on 11715, which is 11805 leapfrogging 11760, pretty weak, but still overriding KJES which had not built up to full strength (gh, OK)

Google Earth coordinates: RHC Bauta site – I see some masts 3.66 kilometers south of Bauta. Exact location is Latitude: 22N57 00, Longitude: 82W32 45. Quivicán is another, new, 250 kW RHC site south of Habana. Exact location is 22N49 33, 82W17 33. I guess Quivicán is the main site of RHC; I see 21 tall SW masts (Wolfgang Büschel, *BC-DX*)

WRMI added another exile broadcaster, MRR (*Movimiento de Recuperación Revolucionaria*) UT Tue-Sat 0400-0430 on 9955. As of mid-July R. República hours on 9955 had reduced to M-F 1100-1300, UT Sun & Mon 0200-0400 (Jeff White, WRMI) See also USA

**ETHIOPIA** [non] From June 17, V. of Oromia Independence is beaming a weekly program to Ethiopia, Sat 1500-1530 on 15650 via Germany; says it is not affiliated with existing Ethiopian/Oromo program (Andy Sennitt, *Media Network*) Opens with Radio Miami International ID in English (José Miguel Romero, Spain, *DXLD* who put the entire broadcast on his website <http://valenciadx.multiply.com/>)

Webpage is <http://www.avofio.com> and e-mail for reception reports and comments is [ganamo@hotmail.com](mailto:ganamo@hotmail.com) (Jeff White, *DXLD*) Brief reply received: "yes it very accurate... thank you jama!" On July 8, first half of the broadcast had heavy echo effect (Romero, *ibid.*) Geez, they think all that artificial echo improves intelligibility? Or they just aren't thinking (gh)

Ethiopian clandestines via TDP changed from 12120 to 11840 via Samara, Russia, 250 kW, 188 degrees: V. of Oromo Liberation in Oromo: 1700-1730 Mon/Thu; V. of Ethiopian People in Amharic: 1700-1800 Tue/Sat; V. of Ethiopian National United Front in Amharic: 1700-1800 Fri/Sun; Dejen Radio in Tigrigna: 1700-1800 Wed (*DX Mix News*, Bulgaria)

**GREECE** After losing access to US relays in April and the Kavala relay in May, V. of Greece reorganized its transmissions via Avlis in June, including: 2300-0600 NAm 9420, SAm 7475; 2300-0200 Au 15650, 0200-0600 17520. The two weekly English hours also got repeats during this period: *It's All Greek to Me* (music) UT Mon 0000; *Greeks Everywhere*, UT Sun 0200 (via John Babbis, *DXLD*) a.k.a. *Hellenes Around the World*; remains on Sat at 1400, well heard in Europe on 9420, 15630 (Dave Kenny, Mike Barraclough, UK, *DXLD*) *It's All Greek to Me* still broadcast to Europe, Sunday 0905 on 9420, 12120, 15630 (Mike Barraclough, UK, Erik Køie, Denmark, *ibid.*)

And 3-minute English news is at 1157 M-F on Macedonias Radio Station, 9935, good signal here (Mike Barraclough, England, *World DX Club Contact*)

**GUIANA FRENCH** TDF has started tests of new dedicated DRM transmitter from Montsinéry on 17875 and 21645. Never more than three of the six AM transmitters are on air simultaneously, with the peak hour being 0300-0400 when there are BBC Spanish on 6110, NHK on 9660, and CRI on 9720. Ironically they have no RFI on air at this time (Kai Ludwig, Germany, *DXLD*)

**HONDURAS** HRMI, R. Misiones Internacionales, 3340, presumed with Spanish gospel songs at 0330 (Jim Ronda, OK, *NASWA Flashsheet*) Another night at 0340 barely audible and overmodulated on 5010, in Spanish, so not Madagascar (Liz Cameron, MI, *DXLD*) Sesquiharmonic of 3340 (gh)

**HUNGARY** On the June 18 mailbag show in Spanish, R. Budapest said its future would be decided in August when a new president of Hungarian Radio is chosen. The country's economic situation is not good, and there is not a good prospect for SW to continue (José Miguel Romero, Spain, *DXLD*)

**INDIA** AIR, 10330 from Bangalore heard with FM Rainbow network from 1951 until 2100\* with English-accented male DJ (the John Peel of India, based on his great voice and program content), Western Urban/rap songs backed against Indian 'Trip-Hop' vocals until Hindi from 2030. Excellent copy. It was *The Wicked Hour* per <http://allindiaradio.org/DTH-Radio/fm-rainbow.htm> (Terry L Krueger, FL, *WORLD OF RADIO*) Excellent signal in Europe until 2300. English program plays international pop music from the 50s until today. It's not clear if 10330 is from Bangalore during these hours; maybe Delhi? (Harald Süss, Austria, *BCDX*)

**IRAN** [non] From June 11, IRIB added new 7540 for German at 1730-1830, asking for reports; and new 11555 for Italian hour at 0630, both excellent here (Noel R. Green, England, *DXLD*) Different audio processing than on old frequencies, so seems to be a relay. 7540 also for French at 1830, English 1930 (Kai Ludwig, Germany, *ibid.*) And 7540 heard in Spanish at 2030 (Bernie O'Shea, Ontario, *ibid.*)

Two weeks later, the German service revealed to Uwe Volk the 7540 site: Sitkunai, Lithuania, testing for two months (Kai Ludwig, *ibid.*) As is 11555 at 0630; and 9315 in Russian at 1430-1530. Astounding that considering the large number of transmitters they have at their disposal in Iran (54 if I count correctly those listed in *WRTH*) that they should rent another in Lithuania! I guess operational costs come into the equation, as they also recently decided to reduce, their SW operations (Noel R. Green, UK, *ibid.*)

**ISRAEL** From Sept 1, IBA plans a fall frequency change for the 0330-0345 English broadcast, replacing 11590 and 13720 with 9345 and 7530 E to Eu/NAm, continuing on 17600 to As (*DX Mix News*, Bulgaria)

**ITALY** Re last month's lead item about DRM on 26 MHz: conversely, R. Maria, on 26000 was frequently heard in the UK evenings, overriding local DRM tests on the same frequency, thanks to summertime sporadic E openings (Mike Barraclough, Dave Kenny, *DXLD*) R. Maria was supposedly set up to be a DRM test itself, but still in analog? (gh) Yes (Tim Bucknall, Mike Barraclough, *ibid.*)

11 m is totally unsuitable for local use. Anyone who has used CB will know what it is like during a big SpE outbreak or at sunspot max (Andrew Tett, England, *ibid.*) Carriers of AM transmissions quickly kill a DRM signal. The WRN transmitter at London is a quite rare catch, since very often Radio Maria drowns it out with their mere 25 watts (Kai Ludwig, Germany, *ibid.*)

**KOREA NORTH** [non] Investigating Commission of Missing Japanese Probably Related to North Korea changed schedule of "Shiokaze" broadcast from June 15: 2030-2100 on 9785 all in Japanese; 1030-1100 on 9855 in Japanese, Korean, English (Takahito Akabayashi, Japan, *DXLD*) The 1030 broadcast was entirely in English on Monday, Thursday, Sunday. See <http://chosa-kai.jp/indexeng.htm> (Ron Howard, CA, *WORLD OF RADIO*) Formerly via Irkutsk, Russia, 5890, the new broadcasts are via Taiwan with 100 kW at 002 degrees of azimuth (*DX Mix News*, Bulgaria) Jamming stayed on 5890 for at least two weeks (Toshi Ohtake, *JSWC*) 9855 heard at 1045 with English ID as "Sea Breeze" (Chuck Bolland, FL, *DXLD*) In July, jamming was on daily and English was heard on Sunday, Tuesday and Friday; on July 10 the 1030 broadcast was missing. Next two days, Tuesday and Wednesday, was in English at new time and frequency 1300-1330 on 9485 (Ron Howard, CA, *ibid.*)

Freedom North Korea Broadcast, also via Taiwan, at 1000-1030 on 11750, 1700-1730 on 9760 (Toshi Ohtake, *JSWC*) 11750 poorly heard here (Scott Barbour, NH, *DXLD*) Jamming, same type as against Shiokaze, starts already at 0954, altho CNR-1 is on 11750 until 1000\* (Ron Howard, CA, *ibid.*)

**LAOS** [non] Don't you believe the item last month that Hmong Lao Radio via WHRI had moved to 11940. It remained on 11785, Sat & Sun 1300-1400 (gh)

People listening for the newer Hmong show, *Hmoob Moj Them*, scheduled UT Wed & Fri only at 0200-0230 on 15260 via Taiwan, also heard something there on other days, and after 0230 (gh) Trying for it UT Fri at 0200 I only heard CRI in Tamil on 15260 // 13600 (Patrick Robic, Austria, *DXLD*) The receptionist at *Hmoob Moj Them* verified an e-mail report in only 3 hours with a no-data e-mail from [info@mojthem.com](mailto:info@mojthem.com) indicating "the quality of the broadcast is not as good as expected." (Rich D'Angelo, PA, *DSWCI DX Window*) Hmmm, a new meaning for "receptionist" (gh)

**LIBERIA** [non] From mid-June, Star Radio cancelled its relay via VT Ascension at 2100 on 11665, but continued at 0700-0800 on 9525 (*DX Mix News*, Bulgaria)

**LITHUANIA** see IRAN [non]

**MALAYSIA** In mid-June, an inactive frequency, 6050, reappeared, heard at various times between 1141 and 1429 including *Suara Islam* Qur'an program from 1356. This had always been on 6025, but blocked by interference. 6050 had previously originated at RTM Sibul, Sarawak; however, ID jingle at 1205 was for RTM Kuala Lumpur. John Wilkins measured it at 6049.65. Alan Davies then found out that KL had been planning to move the 6025 service to 6050, via Kajang near KL, and this is evidently what has happened. Earlier the service on 6050 is a relay of Asyik FM such as at 1131-1233 with local music and singing/chanting (Ron Howard, CA, *DXLD*) *Suara Islam* signing off 6050 at 1700, similar strength to // 6175 which continued with *Suara Malaysia*. I last heard Sibul on 6050 around April 2004, when it was carrying local programs in various languages including Malay and Iban from RTM 'Sibu FM' all day (Alan Davies, Indonesia, via Howard, *ibid.*) 6050 became the most consistently well heard Malaysian.

7295, Traxx FM, all in English, is still heard, and their online streaming started to work via <http://www.traxxfm.net/> I like their *Traxx Chart Toppers*, at 11-14, moved from Saturday to Friday (Ron Howard, CA, *DXLD*)

**MALDIVES ISLANDS** [non] An audience survey commissioned by opposition-leaning Minivan Radio reported that almost a quarter of Maldivians listen regularly to it. Minivan Radio is the only alternative to the state-run Voice of Maldives (*Minivan News* via Kevin Redding, *ABDX*) Daily 16-17 on 13620 via Germany (WRMI)

**MOROCCO** On 7308, fair signal at 0950 from RTM-C, Sébaa Aïoun, with Berber songs, the 7th harmonic of 1044 (Carlos Gonçalves, SW Coast)

of Portugal, DXLD)

**SAINT HELENA** Update on the project to return R. St. Helena to SW: we intend to ship the entire station (except for the beam antenna) from England in mid-July. The beam will accompany me on the ship at the end of September. As of mid-October, I plan to be on the island and to start putting all the equipment together. The first revival broadcast is planned for the local morning of Sunday 5 November 2006, first for Japan and then to New Zealand. Donations to finance the project are still solicited. More info at <http://www.sthelenase/radioproject> (Robert Kipp via Peter Grenfell via Bryan Clark, NZ ripple mailing list) Old frequency was 11092.5 (gh)

**SAUDI ARABIA** BSKSA, Riyadh, monitored around 1300 on mixing products in the 15m hamband: 21370.7 and 21410.6 (via Ulrich Bihlmayer DJ9KR, DARC Monitoring System Intruder Watch) On the air at that hour are 21460, 21505, 21600 and 21640. 21370v would be a leapfrog from 21640 over 21505; and 21410v a leapfrog from 21600 over 21505. Any and all other combinations in the 21 MHz area are likely (gh)

**SLOVAKIA** [non] Scratch off another SW-broadcasting country. R. Slovakia International did cease SW at the end of June, and staff was reduced. English programs continued to be available on internet and satellite via WRN. Quite accidentally, without any intention by RSI, the English broadcast could still be heard on SW via WRMI, 9955, which had resumed relaying a WRN block Sats 1600-2100 including RSI at 1632, and also on WRMI's webcast. WRMI planned to maintain these WRN relays altho the schedule is subject to change as new clients arise (gh)

It's just Pete Miller and a Slovak guy whose name I can't recall (Ted Schuerzinger, *swprograms*) Some excerpts from the farewell of L'ubica Tvarožková, head of the German service: "Radio Slovakia International is a part of Slovak Radio, or should I say it was? The section responsible for broadcasts in Slovak has been dissolved entirely, and only two editors will remain for each foreign language service. The music editor and some audio engineers were fired as well. This mutilated team is supposed to still produce the same amount of broadcasts as now four, and until a few years ago even six editors per language service. I have to admit that in my opinion this plan is just impossible, or at least presumptuous. I came to the conviction that I do not want to participate in this destruction. So today I speak to you for the very last time. I'm sorry that we failed to save the shortwaves." All the German staff quit, and a new novice announcer was heard (Kai Ludwig, DXLD) Farewell to a good station with entertaining programming and caring announcers (Harold Sellers, Ontario, ODXA)

Distribution costs are a major issue. But RSI is also cutting the number of production staff without reducing the length of the daily programs. Two full-time and two part-time staff will have a hard job maintaining high quality, interesting output 365 days a year. There seems to be no allowance for holidays, illness, etc. If this adversely affects the quality of the output, they will lose listeners on all platforms, not just shortwave (Andy Sennitt, *Media Network* blog) Audio on demand archives in Slovak and Spanish were not kept up to date (José Miguel Romero, Spain, DXLD)

**SOMALIA** R. Shabele, Mogadishu, 6960, heard with beautiful internal signal, sign off at 2145 on a UT Saturday (John Wright, Cataract DXpedition, DXLD) Much later than usual, increasing chances for NAm reception into fall and winter (gh) The next day, the Somali transitional government restricted transmission of R. Shabele to Baidoa and arrested two journalists after it broadcast a report claiming Ethiopian troops had entered the country, officials said. The channel continued broadcasting to other parts of Somalia (*Sudan Tribune* via Zacharias Liangas, *WORLD OF RADIO*) Unclear if 6960 affected (gh)

**SUDAN** [non] Darfur Salaam transmitter sites for the 1700-1730 broadcast: 15515 Wofferton, 300 kW, 116 degrees; 17585 Ascension, 250 kW, 65 degrees (Wolfgang Büschel, BCDX)

Southern Sudan Interactive Radio Instruction via VT Communications, in English at 0630-0700 M-F, in mid June replaced Armavir, Russia 15535 with Dhabbaya, UAE on 15205, 250 kW, 230 degrees (DX Mix News, Bulgaria)

**TURKEY** From July, TRT Turkish to NAm at 2200-0055 replaced 7300 with 7230, 500 kW, 325 degrees (DX Mix News, Bulgaria) Moving from the edge of the 40m hamband to well inside it; why? (gh)

**U S A** Funding for Voice of America continued to be a matter of contention in June and July. The House Appropriations Committee reversed a BBG decision to cut VOA in Albanian, Bosnian, English, Hindi, Macedonian and Russian, and reversed the elimination of Croatian, Georgian, Greek, Turkish and Thai (AFGE Local 1812)

The House Appropriations Committee has given VOA News Now and the doomed language services a reprieve, at least for a year. I saw a report from the committee that specifically mentioned English and also referred to languages slated for elimination. But the appropriation would require approval of the entire House, and Senate approval, and the conference (Kim Elliott, DXLD)

Hurdles remain. Saving VOA English will require a reprogramming of funds within the BBG that were to have gone for other needs. Proposals to cut virtually all VOA English and other languages came from that management structure. VOA continues to teeter on the brink of destruction. A terrible shame, and a situation that Congress could easily rectify

through some sort of "VOA Preservation Act" that would prohibit further attempts to dismantle the Voice of America (Another VOA source)

The Senate Appropriations Committee approved \$661 million for international broadcasting activities, \$6 million below the budget request. This does not include funding to continue English radio broadcasting and several other language services. This Budget bill now had to be reconciled with a House version, which restored funding for English and other language services (Save VOA English blog)

You can bet that the BBG will be making every effort to reinstate its requested cuts and the Board has already eliminated many radio frequencies and transmitters. They have set up a situation in which it will be very difficult to maintain an audience. They will use this, if not this year, then in years to come, to justify cutting more radio broadcasts. The trick is in exposing their tactics and explaining them in plain language to lawmakers (*President's Page*, AFGE Local 1812)

Look up House Report 109-520 for all the details. Meanwhile, the *Global Online Freedom Act* was unanimously passed by House Subcommittee on Africa, Global Human Rights and International Operations. "Internet service providers could ... face fines of up to \$2 million per offense and imprisonment for blocking access to any U.S. government-sponsored Web site or content, such as Voice of America." (CNET News via kimandrewelliott.com) But - how to enforce abroad? (gh)

During a sporadic E opening, KSL Salt Lake relay faded in and out on 26190 NBFM, slope-detected, around 1500 with ABC News on hour, local news after, IDs for 1160 and 102.7, but not 26190! (Glenn Hauser, OK)

It may have changed again by now, but in mid-July WRMI expanded carriage of WRN, and thus relaying many different SW stations [and non - see SLOVAKIA], M-F at 0500-1100 on 9955, 1400-1600 on 7385, Sat & Sun 0800-1000 on 9955, Sat 1600-2100 9955. It was hoped that Cuban jamming would relent during these now English, formerly Spanish blocks. Also, direct relay of R. Prague resumed, daily 1400-1430 on 7385, and R. Praga, daily 0430-0500 9955, and Mon-Sat 1300-1330 on 9955. Combining times via WRN with its own times, WRMI became the SW station with the most airings of our *WORLD OF RADIO*: on 7385, Sat 1430; the rest on 9955: Sat 0500, 1230, 1732, Sun 0530, 0832, 2230. See also CUBA [non] (gh)

Smyrna Baptist confirms they are building a new SW station in Pensacola, Florida, to operate somewhere between 10 and 18 MHz, "to bring a new standard to fundamentalist broadcasting..." Target date August 2007 (Christer Brunström, *Christian SW Update*, HCJB DX Partyline)

[non] On Saturdays June 17 and July 1, on 15720, V. of Iranian Kurdistan was heard until 1259, and on same carrier from 1300, Voice of Joy, until 1400 in English, Japanese; plus Korean June 17 and Russian July 1, segments all about soccer (Kouji Hashimoto, *Japan Premium*) V. of Joy was scheduled on 15720 June 17, but not July 1, from somewhere in Eurasia (gh) And on July 8, 15720 had Kurdish until 1301, seemed V. of Mesopotamia // 11530, then V. of Joy in French, 1330 German as finally IDed at 1358, and before unplugged at 1400, Persian ID from Voice of Israel, "Inja Urshalim, Sedaye Esrayil" - the whole lot sounding like they came from the same transmitter (Mauno Ritola, Finland, DXLD) But whence? Israel's Persian hour from 1400 is on 15760, 13850, 11605, and is not known to use any relays (gh)

Brother Stair did follow up his previous tests via French Guiana with a regular broadcast, 1800-1900 on 17815; we found it running 90 seconds behind WWRB on 15250, so probably an internet feed (gh)

**VANUATU** 7259.52, R. Vanuatu, Emten Lagoon, 1001-1116\*, seems to be alternating with 3944.7 daily now! News, to 1015 with ID at 1009; instrumental music, talk, mentioning "messages". Conch shell blowing and nice clear ID, upcoming program notes, a political sounding interview; at 1057 R. Thailand came on; instrumental NA at 1116. Good (Dave Valko, PA, DSWCI DX Window)

**VENEZUELA** [non] R. Nacional de Venezuela (Antena Internacional), announced this schedule via Cuba: M-F 2000-2100 9550, 13680; 2300-2400 13680 for SAm (Marcelo A. Cornachioni, Argentina, *Conexión Digital*) So the announcement finally matches what we have actually been monitoring - no more broadcasts at 19, or 21, nor on weekends. 13680 still collides with China via Canada at 23 (gh)

**VIETNAM** [non] VOV via Canada, 6175, had a Vietnamese lesson for English speakers on a UT Friday at 0522 - during the Vietnamese rather than English broadcast. Now you can go for it (gh, OK)

**ZAMBIA** After completion of a rural TV project, the state-run ZNBC is replacing SW band with FM band transmitters (*Times of Zambia* via Xinhua via *People's Daily Online* via Kim Elliott, DXLD) So hear it while you can, such as: (gh) 4910, R. Zambia, 0254 with bouncy Afro-pop vocals. Fair-poor (Jim Ronda, OK, NASWA Flashsheet)

**ZIMBABWE** [and non] The government of Zimbabwe once again postponed the trial of Radio Voice of the People (VOP) journalists, trustees and board members nine months after their arrest and confiscation of their equipment. The government failed once again to produce witnesses. All the accused are out on bail and are expected back in court on the 25th of September (Association of Zimbabwe Journalists via *Media Network* blog)

Until the Next, Best of DX and 73 de Glenn!

# BROADCAST LOGS

NOTEWORTHY LOGS FROM OUR READERS

Gayle Van Horn, W4GVH  
gaylevanhorn@monitoringtimes.com

## 0003 UTC on 7345

CZECH REPUBLIC: Radio Prague. Announcer's weather and general interest news topics // 9440. Audible 11600, 2145-2150 // 15465 poor signal quality. (Joe Wood, Greenback, TN)

## 0005 UTC on 11950

EGYPT: Radio Cairo. Arabic language lessons. First time I've heard Arabic language lessons on shortwave. Station monitored on 9990, 2200-2215 with cooking program. (Wood, TN) 11950, 0100 Arabic/English language lesson. (Mike Branco, Islip, NY)

## 0030 UTC on 6875

PIRATE: The Crystal Ship (tent.) Beatle tunes *Paperback Writer*, *All My Loving*, *I Need You* and more. Signal wiped out by high static by 0040. Pirates audible: **Captain Morgan** 6925, 0043-0055; **MAC Shortwave** 6950, 0059; 0125-0144; 0159-0217. Canada's **Free Radio** 6925, 0134-0144\* (Wood, TN)

## 0200 UTC on 5950

USA: Radio Taiwan Int'l via Okeechobee, FL, relay. Segments on world economy, World Trade Organization, China/Taiwan complications and International Food Festival. RTI travel show *Trends*. (Branco, NY)

## 0226 UTC on 12035

RUSSIA: FEBA via Novosibirsk. Vernacular conversation from male/female, to brief musical bits. Fair/poor signal quality with fading. (Scott Barbour, Intervale, NH) Voice of Russia 9860, 0250 (Branco, NY) 11675, 1750 *Music and Musicians*. (Bob Fraser, Belfast, ME; Brian Bagwell, St. Louis, MO)

## 0231 UTC on 4790

PERU: Radio Atlantida (presumed). Spanish religious talk to occasional music. No ID observed amid poor signal with fading. SINPO 24222. (Jim Evans, Germantown, TN) Peruvian's monitored in Spanish: Radio Vision 4790.2, 0254-0335 (D'Angelo, PA/NASWA Flashsheet)

## 0325 UTC on 11920

MOROCCO: RTM Tangier. Arabic. Fair-good signal quality for Qu'ran recitations. (Tom Banks, Dallas, TX) **VOA Morocco** relay 15410, 1852, segment on AIDS in Africa. Morocco's **RTV Marocaine** 15345, 1859. Arabic. (Wood, TN)

## 0435 UTC on 4985

BRAZIL: Radio Brasil Central. Portuguese. Fair signal for regional briefs and announcer's station identification. (Duane Hadley, Bristol, TN) Audible 4985, 0015-018 Portuguese. (D'Angelo, PA) Brazilians monitored in Portuguese: **Radio Cultura** 9615, 2105-2109; **Radio Canção Nova** 9675, 2120-2124; **Radiodifusora do Amazonas** 4805, 2310-2320. (Manuel Méndez, Lugo Spain/Cumbre DX) **Radio Gazeta** 15325, 1924; **Radio Difusora** 4945, 1945-1950. **Radio Canção Nova** 6105, 1040-1050. (Arnaldo Slaen, Buenos Aires, Argentina)

## 0507 UTC on 15160

AUSTRALIA: Radio Australia. Two male announcer's Aussie football rules, and commentary for Kangaroos vs Tigers game. Announcer repeated mention of the sartorial splendor of the umpire and the panache with which he wore his bowler. Good signal // 15240 fair. Subsequent log 17785 at 2345. (Wood, TN) 9580, 1230 *Sunday Profile*. (Fraser, ME)

## 0712 UTC on 5019.9

SOLOMON ISLANDS: SIBC (presumed). Male/female English talk segment. Regional news at 0730 (not BBC or Radio Australia news relay). Music at 0732 for poor signal just above the noise level. Monitored similar signal just after 0800 on subsequent morning without positive identification. Haven't seen this station reported prior to 0800, but all indications this was SIBC. (Evans, TN)

## 0858 UTC on 15190

EQT. GUINEA: Radio East Africa. Lively gospel music to loud preacher's text. Recheck at 0935 to similar programming with back-to-back religious segments. No ID observed for signal at noise level. SINPO 24222 at tune-out. (Evans, TN) Eq. Guinea's **Radio Nacional-Bata** 5005, 2236-2259\*. (Barbour, NH)

## 0923 UTC on 3944.78

VANUATU: Radio Vanuatu (presumed). Program of mellow pop music with brief announcements by male announcer. Music resumed

at 0945, possibly including a hymn. Announcement at 1000 and brief talk followed by slow instrumental music. Poor signal at noise level, improved slightly after 0950. Assume this Radio Vanuatu based on freq and content, but signal too marginal for ID. (Evans, TN)

## 1030 UTC on 9855

CLANDESTINE: Shiokaze (Sea Breeze) via Taiwan. Asian language/English. Announcer over piano music at sign-on to talks of various lengths in unknown language from 1033-1050, each separated by a pop-like instrumental bit. Presumed English at 1050 by lady with positive mentions of "North Korea." Station sign-off at 1056, cut off at 1057. Poor, weak and noisy signal. (Barbour, NH) 9855, 1040-1046 Japanese, SINPO 34433. Station is a service produced by the Investigation Commission of Missing Japanese and the transmission is targeted to North Korea. (Slaen, ARG)

## 1040 UTC on 6105.48

BOLIVIA: Radio Panamericana. Station ID and announcements: Bolivia es Panamericana, Red panamericana, moderna, directa." Economic news amid strong heterodyne. Best reception in LSB mode. SINPO 33433. Bolivia's **San José** 5580, 2112 in unknown language from San José de Chiquitos. SINPO 25432 (Slaen, ARG)

## 1051 UTC on 11765

USA: KNLS Alaska. Lady's English segment on local festival, followed by male's Mandarin translation. Music tune at 1055 to Mandarin station contact info. Signal wiped out at 1059 by 11760 Radio Havana interval signal. (Barbour, NH)

## 1730 UTC on 11500

BULGARIA: Radio Bulgaria. Classic guitar tunes from the Ventures to interval signal. Schedule, freqs, and ID by lady announcer "This is Radio Bulgaria in English." (Wood, TN) 11700 //9700 at 2318. (Fraser, ME)

## 1831 UTC on 15120

NIGERIA: Voice of Nigeria. *Insight* program with discussion of drug problem in Nigeria. Several IDs as, "This is the Voice of Nigeria, Lagos." Interference from Family Radio on 15130. (Wood, TN)

## 1932 UTC on 9675

GERMANY: IBRA Radio. Vernacular language for lengthy religious text, followed by music. Contemporary instrumentals at 1926 to techno music over presumed identification at 1930. Fair signal for continued talks and music. Germany's **Deutschlandfunk** 6190, 0045-0106. (Barbour, NH)

## 2049 UTC on 11735

ZANZIBAR: Voice of Tanzania-Zanzibar. African hi-life music at tune-in to unknown language announcements. Brief Arabic conversation segment at 2057. National anthem for 2100 signal of fair-good signal quality. (Barbour, NH)

## 2103 UTC on 9710

ALGERIA: Radio Algiers via U.K. Arabic. Call to prayer at tune-in to pause for presumed freq schedule. Observed mention of "al-Kareem," (previously noted as "Idha'atu Qural al-Kareem") at 2111. Qu'ran recitations to program intro at 2118. Fair signal //7150. (Barbour, NH)

## 2130 UTC on 11940

ROMANIA: Radio Romania Int'l. Lady's feature on Romanian homeless situation. Station identification into world news. Poor signal. (Wood, TN, Hadley, TN)

## 2235 UTC on 9830

TURKEY: Voice of Turkey. Traditional ballad style Turkish music. History segment on Troy to music continued. Station ID 2249, plus schedule and station information, repetitions of interval signal until carrier off at 2257. Very good signal, SINPO 44333. (Evans, TN)

Thanks to our contributors – Have you sent in YOUR logs?  
Send to Gayle Van Horn, c/o Monitoring Times  
English broadcast unless otherwise noted.

## A Trip to the Balkans

Welcome to *Programming Spotlight* for September. I would like to thank the folks at *Monitoring Times* for giving me the opportunity to become the new editor of this monthly column, designed to give you the reader some insight into the myriad of programming choices available to you. John Figliozzi has done a fantastic job crafting this column for a number of years and has left me some awfully big shoes to fill. In my own humble way, I hope to continue to help keep you informed.

Who am I? Well, residing in Southern Ontario along the banks of the Welland Canal, I caught the shortwave listening bug almost 28 years ago to the day, as I type this. Fiddling with an old radio out of curiosity (and boredom) I pressed a few buttons, adjusted a knob slightly and was astounded to hear the announcer say it was a broadcast from Radio Sofia, Bulgaria. Since that day, I have been addicted to international broadcasting, and while I have done a fair bit of DXing, I have always been more interested in the programming content, rather than the means to hear it. So I consider the internet to be a boon, enhancing my listening opportunities. But there is still a great thrill in tuning in to a radio signal from halfway around the world.

For this, my first column, I have decided to focus the *Programming Spotlight* on the Balkans, as I did that summer day many years ago. The Balkan region is one of those places that tend to fade from focus for long periods and then explode into our consciousness. At the beginning of the century, the assassination of Archduke Franz Ferdinand in Sarajevo in 1914 plunged the empires of Europe into a devastating World War. And near the end of the century, the conflict there introduced a new term into the language: ethnic cleansing.

While the Balkans include such diverse nations as Albania, Greece, and Bulgaria, our discussion will center on the states that comprised the former Yugoslavia (FY). Yugoslavia,

which means "Land of the South Slavs," was a creation of the peace settlement following the First World War. Initially, the country was called the Kingdom of Serbs, Croats, and Slovenes. This unwieldy title was later shortened to Kingdom of Yugoslavia.

Even a cursory examination of the history of this area will show why it is such a fractious region. At different times throughout the millennia there have been occasions when a greater Serbia dominated the region. Albanians, Bulgarians, Croats, and Greeks took their turns in being the dominant power. Aggravating tensions even more, the region has been split between allegiance to the Roman Catholic Church and the Eastern Orthodox faith. Centuries of Ottoman Turk dominance, which introduced Islam to the region, caused further fractures.

The end result was a nation destined to fail, split by three religions, two alphabets,

and numerous ethnic groups all within an area about the size of Texas.

### ❖ Broadcasting from Yugoslavia

International broadcasting from Yugoslavia began in 1936 under the name Radio Belgrade.

During the German occupation (a side trip which delayed the invasion of Russia by six weeks and may have cost the Nazis a chance to capture Moscow), Radio Belgrade became Soldatensender Belgrad, and led to one of the more unusual broadcasting stories of the Second World War.

Not having any material to play on their "newly acquired" radio station, some men were sent to Vienna to "scrounge up" some records. One of the dusty old 78s they grabbed out of a station basement was a song called "Lili Marleen" sung by Lale Anderson. It was by no means a hit record, having sold only about 700 copies at the time. With not much else to play, the station, (which was well heard by the Afrika Korps, soldiers on the eastern front, and as it turned out, soldiers on the other side as well) began playing the song after the 10 pm news each evening. It became not only a smash hit with German soldiers, but so popular on the British side that the BBC was forced to come up with an English version. It also caused them to jump-start the career of their own "forces sweetheart," who turned out to be Vera Lynn.

When I first heard Radio Yugoslavia, in the late 1980s, I found it to be a very pleasant listen. It was typical of eastern bloc, state-run broadcasters, with news and some features, state accomplishments, and travel features encouraging listeners to visit places like the Dalmatian coast of Croatia. It was all very benign.

My next encounter with Radio Yugoslavia was about the time armed conflict had broken out in Slovenia, the



northernmost republic and one of the first to secede. I found it remarkable how fair and balanced the coverage was, with coverage from reporters on both sides of the conflict. As the nineties wore on and republic after republic seceded and the conflict became increasingly ugly, Radio Yugoslavia's tone perceptibly changed, to the point where it became Serbia's mouthpiece. Until NATO bombing in 1999 silenced RY, it had taken on a decidedly anti-American tone as well.

After the restoration of broadcasting following the NATO military campaign, both the country and the radio station gave up the pretense of a Yugoslav state. What was left was the Republic of Serbia and Montenegro, and the radio station became the "International Radio of Serbia and Montenegro." As a result of the independence referendum in Montenegro in 2006, they have again changed names and call themselves simply Radio Serbia.

What can you hear today from the various republics of the former Yugoslavia? Let's tour them in alphabetical order.

### BOSNIA-HERZEGOVINA

Bosnia itself has no international service. However, through the magic of the internet one can listen to BH Radio 1. Of course, its output is all in the local language; nevertheless, it's interesting to listen to. Just go to the website of the "Public Broadcasting Service of Bosnia-Herzegovina" at [www.pbsbin.ba](http://www.pbsbin.ba)

This station features music and spoken word programming in the local language. It is definitely a non-English zone, but has some very interesting local flavor and music. Some of the music has an almost middle-eastern sound, while other songs have a central European folk sound.

### CROATIA

Radio broadcasting in Croatia celebrates its 80<sup>th</sup> anniversary in 2006. Radio Zagreb went live on the air on 15 May 1926. Croatian Radio has an interesting history on its web page, which, however, glosses over some items. For instance, there is little mention of being a part of Yugoslavia, and no mention of the Second World War, during which an "independent" Croatia was allied with Germany. Still, it makes for interesting reading.

During the break-up of Yugoslavia in the early nineties, Croatia's viewpoint was well heard, perhaps, at times, more effectively than that of the crumbling central government. Croatia was routinely heard here in North America, with news and features in both English and Croatian. There was also a program called Radio Free Croatia, heard via US private sector shortwave transmitters, for a time.

While not entirely angelic in this ugly little war, Croatia managed to largely win the propaganda war.

Today one can hear Croatian radio via satellite, via transmitters in Germany and via the internet. Here in the Americas, try 9925 kHz any time after 2200 UTC. On the internet, go to [www.hrt.hr/hr/](http://www.hrt.hr/hr/)

### MACEDONIA

Macedonian Radio can be heard via the internet, provided you have the Winamp player installed. Although it is not at all clear which service of MR you are getting, it seems to be Radio Skopje from the national capital. [www.mr.com.mk/radio.htm](http://www.mr.com.mk/radio.htm)

A couple of casual tune-ins to this program brought music which would not be out of place on the neighboring Voice of Greece. At other times it was a mix of local tunes and euro pop, with an Andy Williams tune thrown in for good measure.

### MONTENEGRO

Montenegro, or Crna Gora (Black Mountain) was the last of the FY states to leave the union. Radio Televizija Crne Gore has a web presence, but that's about all. News (Vijesti) in the local language takes up most of the website, with an extensive archive. Unfortunately, no audio that I could see. [www.rtcg.org](http://www.rtcg.org)

### SLOVENIA

Slovenia is perhaps the most westernized of the former Yugoslav republics and was, in fact, among the first republics to declare its independence.

You can hear from Radio Slovenia International via shortwave (more or less) and via the internet.

While Radio Slovenia does not have an external service on shortwave of its own, they do participate as one of six countries in a program called *ICE – Insight Central Europe*.

*Insight Central Europe* is a co-production of Radio Prague, Radio Budapest, Radio Polonia, Radio Slovakia, Radio Austria and Radio Slovenia. The website and production facilities are based in Prague. Each week a number of news items from Slovenia are reported on the program and on the website.

It can be heard as follows:

Day	UTC	Freq kHz
<b>Europe; Africa</b>		
Saturday	1130 1330	6155, 13730
		1830 6155, 5945
Sunday	05:32	6155, 13730
<b>Northwest Europe</b>		
Saturday	0700	11600, 9880
<b>North Europe; South Asia</b>		
Saturday	1300	21745, 13580
<b>North-West Europe; Europe; Central Africa</b>		
Saturday	1700	5930, 17485
<b>North America</b>		
Saturday	2230	11600, 13580
Sunday	0130	9870
	0000	7345, 9440
<b>Asia &amp; Australia</b>		
Saturday	11:30	21780

Programs are also available on demand at <http://incentraleurope.radio.cz/ice/listen> (in Real format, archived back several years!)

There is a Radio Slovenia International feed on the internet. Although I would not consider myself a frequent listener, I found it to be not very interesting. Sure, there's lots of music, mostly Euro pop type stuff in

English. In fact, RSI is exactly the opposite of BH 1...only one non-English song was heard in all the time I listened. It reminded me somewhat of some of the music shows I have heard over the years out of Radio Kuwait. They also frequently use canned IDs, which sound like they were recorded in the UK. If you like that type of music, by all means give it a listen. News and events on the website are dreadfully out of date. [www.club-rsi.com/](http://www.club-rsi.com/) (click on the US/UK flag cleverly hidden near the bottom)

### SERBIA

Following the ouster of Slobodan Milosevic in 2000, Serbian radio has tried to steer a careful course. They like to point out efforts to co-operate with Europe and The Hague War Crimes Tribunal while defending Serbian government policy, Serbian independence and Serbs in general. Still, they seem to make an effort at balance.

One thing to bear in mind, if you hear Radio Serbia, or surf its website: you will hear or read references to Kosmet or Kosovo-Metohija. This is the Serbian title for Kosovo.

While they seem to have accepted the "divorce" from Montenegro, the plebiscite has caused groups in other regions – Kosovars in Kosovo (to the chagrin of the Serbs and Europe) and ethnic Serbs in the Republika Srpska semi-autonomous region of Bosnia (to the chagrin of Europe) – to start agitating for their own independence referenda. This comes through in the Radio Serbia news coverage.

According to recent reports, Radio Serbia has confined itself to broadcasting via shortwave to Europe, if indeed it is even on the air. Their choice of frequency and time has left it for all intents and purposes unheard. English is listed at 1830 UTC on 6100 kHz. However, you can hear a (brief) newscast via their website. One can also read text versions of many of the news items and features that one could once hear on the radio. I have always liked this aspect of the website. I wish more radio stations would take advantage of the technology to make this information available. Check out [www.radioyu.org](http://www.radioyu.org)

### ❖ Conclusion

Since childhood, I have seen the huge blue Yugoslav freighters sail past my house, had many friends whose background was in one of the ethnic groups of Yugoslavia, and attended many events put on locally by the Croatian club, or the Serbian Orthodox Church in Niagara Falls, or the really cool pig roasts at Slovenian Lipa Park. They are all memories of fun times, good people, and fabulous music.

These memories create a considerable disconnect to the things I have heard on the radio and seen on television over the last two decades from the region. It's very difficult to understand, just like the region itself. Hopefully this little survey might help you reach your own insights.

## September Means Better DX Conditions

Now that summer static levels are decreasing, you will notice DX conditions improving. Now is the time, if you haven't already, to get your listening post in order. Have you updated your station and country totals, and prepared a *Most Wanted List* of stations to verify this season? Radios and outside antennas should be checked and any necessary repairs made before it's too cold or icy to do so. Hopefully, you have completed any outstanding correspondence including follow-up reports before September. Now is the time to concentrate on nabbing those favorite stations and prepare for the seasonal condition changes beginning this month.

Twilight and nighttime patterns have improved and will continue to do so as longer darkness paths provide an extended time to band-

scan. Look for stations from South America, Europe, and Africa to fade in earlier, improving prior to 0000 UTC. Stations in the tropical bands (roughly 2-6 MHz), including East Asia and Indonesia, are being heard beginning at twilight in the evenings, and any time from 0900-1500 UTC, depending on your location. The Indian subcontinent's signal has improved and will peak in the winter.

South Americans begin to fade in around 0700 UTC, followed by the Papua New Guinea stations by 0800 UTC. Medium wave conditions are improving, too. Fall and winter are prime time for DXing, especially for hearing those cross country signals.

In case you haven't noticed, DX conditions are improving, and now is the time to prepare for a new DX season.

### AMATEUR RADIO

Guernsey-MU0C (IOTA EU-114) 20 meters SSB. Full data color photo card. Received in 75 days via ARRL bureau. (Larry Van Horn N5FPW, NC)

WX4NHC 14325 kHz USB. Full data QSL card signed by Julio Ripoli-WDR4. Received in six days for a SASE and SWL report for Hurricane Season 2006 On-the-air Test. Station address: National Hurricane Center, c/o Julio Ripoli, Assistant Volunteer Coordinator, 14855 SW 67 Lane, Miami, FL 33193 USA. (R.C. Watts, Louisville, KY)

### ARGENTINA

RAE 11710 kHz. Full data logo card signed by Marcela Campos-RAE Director, plus schedule and personal letter. Received in five months for an English report, applause card, three IRCs and a local Christmas post card. Have attempted to verify RAE for over ten years. Station address: C.C. 555, Core Central C1000WAF Buenos Aires, Argentina. (Joe Wood, Greenback, TN)



RADIODIFUSION ARGENTINA AL EXTERIOR  
C.C. 555 CORREO CENTRAL - FAX 325-5742/9433  
1000 BUENOS AIRES - REPUBLICA ARGENTINA



AGRADecemos SU INFORME DE RECEPCION  
Frecuencia: 8800 - 19000 - 11.710 - 15.340 kHz

QSL

### ASCENSION ISLAND

Radio Prague relay 11665 kHz. Full data (except site) Josef Bozek, part of *Czech Scientist and Inventors* series. Received in three weeks. Always enjoy receiving QSLs from Radio Prague, since it reminds me of the really interesting studio tour I received many years ago. Station address: Vinohradská 12 12099 Prague 2, Czech Republic. Website: [www.radio.cz](http://www.radio.cz) (Wendel Craighead, Prairie Village, KS)

### CLANDESTINE

Democratic Voice of Burma (via Alma Ata) 15480 kHz. Full data verification (except site) and information letter signed by Banyan

Mon. Received in 44 days for a CD postal report. Correspondence address: NCGUB, P.O. Box 6720, St. Olavs Pass N-0130 Oslo Norway Website: [www.dvb.no](http://www.dvb.no) (Edward Kusalik VE6EFK, Alberta, Canada)

Little Saigon Radio (via Taiwan) 7380 kHz. Full data multilingual colored card signed by Joe D. Dinh. Received in 63 days for an English report. Correspondence address: 15781 Brookhurst Street, Suite 101, Westminster, CA 92683 USA. Website: [www.littlesaigonradio.com](http://www.littlesaigonradio.com) (Kusalik, CAN)

Radio Chan Troi Moi (via Taiwan) 1503 kHz AM. Full data (except site) CTM logo card with personal note apologizing for the delay in responding. Report was for a logging at Bao Loc, Vietnam. QSL card is identical to cards received for RCTM SW broadcast in 2001 and 2002. Correspondence address: Correspondence Section, Radio CTM, P.O. Box 48, Nishi Yodogawa, Osaka 555, Japan. Card postmarked via Spokane, Washington. This is my third QSL for a medium wave clandestine broadcast. (Craighead, KS)

### ECUADOR

HCJB 12005 kHz. Full data card of *Galapagos Giant Tortoise*, signed by Douglas Weber, plus revised freq schedule, pocket calendar and religious pamphlet. Received in 27 days to verify the final English analog broadcast from Quito. Email report sent to: [english@hcjb.org.ec](mailto:english@hcjb.org.ec) (Kraig Krist KG4LAC, Manassas, VA)

### GERMANY

IBC-Tamil, 7315 kHz via Wertachtal. Full data email response. Received in 13 hours for an email report to: [WalterBrodowsky@t-systems.com](mailto:WalterBrodowsky@t-systems.com) for a logging at Bao Loc, Vietnam. Previous follow up reports to IBC-Tamil received no response. (Craighead, KS) T-Systems address: T-Systems International, Rundfunksendestelle Jülich, Merscher Höhe D-52428 Jülich, Germany.

### MADAGASCAR

Radio Netherlands relay 11655 kHz. Full data folder map card signed by Rahmfey Eddy-Technical Dept. Received in 137 days for an English report. Response received direct from transmitter location at: Radio Neder-

land Wereldomroep Station Relais, B.P. 404, Antananarivo, Madagascar. Station address: Radio Nederland Wereldomroep, P.O. Box 222, 1200 JG Hilversum, The Netherlands. (Wood, TN)



MADAGASCAR RELAY STATION

### MEDIUM WAVE

China National Radio 1008 kHz AM. Full data CNR card unsigned. Received for English report and no return postage. Station address: China National Radio, Audience Dept., P.O. Box 4501, Beijing 100040 PR China. China Radio International 1044 kHz AM. Full data QSL card for report to Japanese service. Station address: 16A Shijingshan Street Beijing 100040 PR China (Craig Edwards, Northern Territory, Australia).

### UNITED KINGDOM

DSWCI 50<sup>th</sup> Anniversary card 7230 kHz via Wooferton, 5975 kHz (via Radio Japan). Card received in 53 days for report to: Anker Petersen, Udbyvej 11, DK-2740, Skovlunde, Denmark. (Kusalik CAN) DSWCI Anniversary cards signed by Anker Petersen, received for Radio Japan broadcast via: Rampisham (UK) 9575, Wooferton (UK) 7230, Moyabi (Gabon) 15355, Bonaire (Netherlands Antilles) 11935, Sackville (Canada) 6145 and Yamata Japan) 9695 kHz. (Craighead, KS)

### UTILITY

KSM 6474, 12993 kHz. Full data QSL on historic Globe Wireless radiogram copy, signed by D.A. Stoops. Received in 28 days for a utility report of contact with KHRC. Station address: P.O. Box 381, Bolinas, CA 94924-0381 USA. (Watts KY)

Shannon Aeradio, 5649 kHz USB. Full data QSL folder card signed by Dennis Cannalley-Watch Manager. Received in 182 days for a utility report, one US dollar and an address label. Station address: The Irish Authority, Aviation House, Hawkins Street, Dublin 2 Ireland. (or) Irish Aviation Authority, Shannon Aeradio, Ballygirreen, Newmarket-on-Fergus, Co. Clare, Ireland. (Watts, KY)





## HOW TO USE THE SHORTWAVE GUIDE

0000-0100 twhfa USA, Voice of America 5995am 6130ca 7405am 9455af  
 ① ② ⑤ ③ ④ ⑥ ⑦

### Convert your time to UTC.

Broadcast time on ① and time off ② are expressed in Coordinated Universal Time (UTC) – the time at the 0 meridian near Greenwich, England. To translate your local time into UTC, first convert your local time to 24-hour format, then add (during Daylight Savings Time) 4, 5, 6 or 7 hours for Eastern, Central, Mountain or Pacific Times, respectively. Eastern, Central, and Pacific Times are already converted to UTC for you at the top of each hour.

Note that all dates, as well as times, are in UTC; for example, a show which might air at 0030 UTC Sunday will be heard on Saturday evening in America (in other words, 8:30 pm Eastern, 7:30 pm Central, etc.).

### Find the station you want to hear.

Look at the page which corresponds to the time you will be listening. On the top half of the page English broadcasts are listed by UTC time on ①, then alphabetically by country ③, followed by the station name ④. (If the station name is the same as the country, we don't repeat it, e.g., "Vanuatu, Radio" [Vanuatu].)

If a broadcast is not daily, the days of broadcast ⑤ will appear in the column following the time of broadcast, using the following codes:

Day Codes	
s/S	Sunday
m/M	Monday
t/T	Tuesday
w/W	Wednesday
h/H	Thursday
f/F	Friday
a/A	Saturday
D	Daily
mon/MON	monthly
occ:	occasional
DRM:	Digital Radio Mondiale

In the same column ⑤, irregular broadcasts are indicated "tent" and programming which includes languages besides English are coded "vl" (various languages).

### Choose the most promising frequencies for the time, location and conditions.

The frequencies ⑥ follow to the right of the station listing; all frequencies are listed in kilohertz (kHz). Not all listed stations will be heard from your location and virtually none of them will be heard all the time on all frequencies.

Shortwave broadcast stations change some of their frequencies at least twice a year, in April and October, to adapt to seasonal conditions.

But they can also change in response to short-term conditions, interference, equipment problems, etc. Our frequency manager coordinates published station schedules with confirmations and reports from her monitoring team and MT readers to make the Shortwave Guide up-to-date as of one week before print deadline.

To help you find the most promising signal for your location, immediately following each frequency we've included information on the target area ⑦ of the broadcast. Signals beamed toward your area will generally be easier to hear than those beamed elsewhere, even though the latter will often still be audible.

Target Areas	
af:	Africa
al:	alternate frequency (occasional use only)
am:	The Americas
as:	Asia
au:	Australia
ca:	Central America
do:	domestic broadcast
eu:	Europe
irr:	irregular (Costa Rica RFP)
me:	Middle East
na:	North America
oc:	Oceania
pa:	Pacific
sa:	South America
va:	various

### Shortwave Broadcast Bands

kHz	Meters
2300-2495	120 meters (Note 1)
3200-3400	90 meters (Note 1)
3900-3950	75 meters (Regional band, used for broadcasting in Asia only)
3950-4000	75 meters (Regional band, used for broadcasting in Asia and Europe)
4750-4995	60 meters (Note 1)
5005-5060	60 meters (Note 1)
5730-5900	49 meter NIB (Note 2)
5900-5950	49 meter WARC-92 band (Note 3)
5950-6200	49 meters
6200-6295	49 meter NIB (Note 2)
6890-6990	41 meter NIB (Note 2)
7100-7300	41 meters (Regional band, not allocated for broadcasting in the western hemisphere) (Note 4)
7300-7350	41 meter WARC-92 band (Note 3)
7350-7600	41 meter NIB (Note 2)
9250-9400	31 meter NIB (Note 2)
9400-9500	31 meter WARC-92 band (Note 3)
9500-9900	31 meters
11500-11600	25 meter NIB (Note 2)
11600-11650	25 meter WARC-92 band (Note 3)
11650-12050	25 meters
12050-12100	25 meter WARC-92 band (Note 3)
12100-12600	25 meter NIB (Note 2)
13570-13600	22 meter WARC-92 band (Note 3)
13600-13800	22 meters
13800-13870	22 meter WARC-92 band (Note 3)
15030-15100	19 meter NIB (Note 2)
15100-15600	19 meters
15600-15800	19 meter WARC-92 band (Note 3)
17480-17550	17 meter WARC-92 band (Note 3)
17550-17900	17 meters
18900-19020	15 meter WARC-92 band (Note 3)
21450-21850	13 meters
25670-26100	11 meters

### Notes

- Note 1 Tropical bands, 120/90/60 meters are for broadcast use only in designated tropical areas of the world.
- Note 2 Broadcasters can use this frequency range on a (NIB) non-interference basis only.
- Note 3 WARC-92 bands are allocated officially for use by HF broadcasting stations in 2007. They are only authorized on a non-interference basis until that date.
- Note 4 WRC-03 update. After March 29, 2009, the spectrum from 7100-7200 kHz will no longer be available for broadcast purposes and will be turned over to amateur radio operations worldwide

### MT MONITORING TEAM

Gayle Van Horn  
 Frequency Manager  
[gaylevanhorn@monitoringtimes.com](mailto:gaylevanhorn@monitoringtimes.com)

Daniel Sampson  
[danielsampson@monitoringtimes.com](mailto:danielsampson@monitoringtimes.com)

### Thank You ... Additional Contributors to This Month's Shortwave Guide:

Rich D'Angelo/*NASWA Flash Sheet*; *BCL News*; *Cumbre DX*; Adrian Sainsbury/R.NZ Intl; Daniel Sampson/*Prime Time-SW*; Anker Petersen/*DX Window*; Md. Azizul Alam Al-Amin, Rajshahl, Bangladesh; Harold Sellers/*ODXA/DX Ontario*; Larry Van Horn N5FPW, MT Asst. Editor; *Hard Core DX*; *NASWA Journal*; WWDX.

**GLENN HAUSER'S WORLD OF RADIO**  
<http://www.worldofradio.com>

For the latest DX and programming news, amateur nets, DX program schedules, audio archives and much more!

**0000 UTC - 8PM EDT / 7PM CDT / 5PM PDT**

0000	0015	vl	Cambodia, National Radio	11940as	
0000	0015		Japan, Radio Japan/NHK World		13650as
			17810as		
0000	0015	s	USA, WRMI Miami FL	9955am	
0000	0027		Czech Rep, Radio Prague	7345na	9440na
0000	0030		Australia, HCJB	15405as	15525as
0000	0030		Burma, Dem Voice of Burma	5955eu	
0000	0030		Egypt, Radio Cairo	11950na	
0000	0030		Thailand, Radio	9570va	
0000	0030		UK, BBC World Service	3915as	5970as
			9740as	9790as	11945as
			17615as		15360as
0000	0030		USA, Voice of America	7555as	
0000	0040		Lithuania, Radio Vilnius	9875na	
0000	0045		India, All India Radio	9705as	9950as
			11620as	11645as	13605as
0000	0045		USA, WYFR/Family R Okeechobee FL		17805am
0000	0057		Canada, Radio Canada Intl	11700as	
0000	0059		Canada, Radio Canada Intl	9755am	
0000	0059		Spain, Radio Exterior Espana	15385am	
0000	0100		Anguilla, University Network	6090am	
0000	0100		Australia, ABC NT Alice Springs		2310irr
			4835do		
0000	0100		Australia, ABC NT Katherine	5025do	
0000	0100		Australia, ABC NT Tennant Creek		4910do
0000	0100		Australia, Radio	9660pa	12080pa
			15240va	17715pa	17750as
			17795va		17775va
0000	0100		Canada, CFRX Toronto ON	6070na	
0000	0100		Canada, CFVP Calgary AB	6030na	
0000	0100		Canada, CKZN St John's NF	6160na	
0000	0100		Canada, CKZU Vancouver BC	6160na	
0000	0100		China, China Radio Intl	6020na	7180as
			9515as	9570na	13600eu
0000	0100		Costa Rica, University Network	5030va	6150va
			7375va	9725va	
0000	0100		Germany, Deutsche Welle	9695as	9825as
			9885as		
0000	0100	m	Greece, Voice of	7475va	9420va
0000	0100		Guyana, Voice of	3291do	15650va
0000	0100		Japan, Radio Japan/NHK World		6145na
0000	0100		Malaysia, RTM/Trax FM	7295as	
0000	0100	vl	Namibia, Namibian BC Corp	3270do	3290do
			6060do	6175do	
0000	0100		Netherlands, Radio	9845na	
0000	0100		New Zealand, Radio NZ Intl	13730pa	
0000	0100	DRM	New Zealand, Radio NZ Intl	15720pa	
0000	0100	vl	Papua New Guinea, Wantok R.Light		7120va
0000	0100		Singapore, MediaCorp Radio	6150do	
0000	0100		UK, BBC World Service	6195as	9410as
			11955as	15280as	15310as
					17790as
0000	0100	DRM	UK, BBC World Service	6010na	
0000	0100	f	UK, Bible Voice	6140me	
0000	0100	f	UK, Bible Voice	6140me	
0000	0100		Ukraine, Radio Ukraine Intl	7440va	
0000	0100		USA, American Forces Radio	4319usb	5446usb
			5765usb	6350usb	7590usb
			10320usb	12133usb	12579usb
			13855usb		13362usb
0000	0100		USA, KAIJ Dallas TX	5755na	
0000	0100		USA, KTBN Salt Lake City UT	7505na	
0000	0100		USA, WBCQ Kennebunk ME	5110na	7415na
			9330na		
0000	0100		USA, WBOH Newport NC	5920am	
0000	0100		USA, WEWN Birmingham AL	5810va	5835va
0000	0100		USA, WHRA Greenbush ME	7520na	
0000	0100	m	USA, WHRI Noblesville IN	7490am	7555am
0000	0100	twhfa	USA, WHRI Noblesville IN	9820am	13760am
0000	0100		USA, WINB Red Lion PA	9265am	
0000	0100	twhfa	USA, WRMI Miami FL	7385am	
0000	0100		USA, WTJC Newport NC	9370na	
0000	0100		USA, WWCR Nashville TN	5070na	7465na
			9985na	13845na	
0000	0100		USA, WWRB Manchester TN	3185na	5050na
			5745na	6890na	
0000	0100		USA, WYFR/Family R Okeechobee FL		6065am
			9505am	11835am	
0000	0100		Zambia, Christian Voice	4965af	
0015	0030	m	USA, WRMI Miami FL	9955am	
0030	0045	s	Germany, Pan American BC	9640as	
0030	0045	s	USA, WRMI Miami FL	9955am	
0030	0100		Thailand, Radio	5890na	
0030	0100		UK, BBC World Service	5970as	6195as
			9410as	9790as	11955as
			15310as		15360as
0030	0100		USA, Voice of America	9715va	9780va
			15185va	15205va	15290va
			17740va	17820va	15560va
0035	0100	sm	Austria, Radio Austria Intl	9870am	
0043	0058	twhfa	Austria, Radio Austria Intl	9870am	
0055	0100		Italy, RAI Intl	11800na	

**0100 UTC - 9PM EDT / 8PM CDT / 6PM PDT**

0100	0100		Cuba, Radio Havana	6000na	6060na
			9820na		
0100	0115		Italy, RAI Intl	11800na	
0100	0127		Czech Rep, Radio Prague	6200na	7345na
0100	0128		Vietnam, Voice of	6175na	
0100	0129	s	Germany, Universal Life	9480as	
0100	0130		Hungary, Radio Budapest	9590na	
0100	0156		Romania, Radio Romania Intl	9690na	11825na
0100	0159		Canada, Radio Canada Intl	9755am	13710am
0100	0200		Anguilla, University Network	6090am	
0100	0200		Australia, ABC NT Katherine	5025do	
0100	0200		Australia, ABC NT Tennant Creek		4910do
0100	0200		Australia, CVC International	7355as	
0100	0200		Australia, Radio	9660pa	12080pa
			15240va	15415va	17715pa
			17775va	17795va	
0100	0200		Canada, CFRX Toronto ON	6070na	
0100	0200		Canada, CFVP Calgary AB	6030na	
0100	0200		Canada, CKZN St John's NF	6160na	
0100	0200		Canada, CKZU Vancouver BC	6160na	
0100	0200	DRM	China, China Radio Intl	6140na	
0100	0200		China, China Radio Intl	6020na	6080na
			9570na	9580na	11870as
			13600eu	13640as	
0100	0200		Costa Rica, University Network	5030va	6150va
			7375va	9725va	
0100	0200		Guyana, Voice of	3291do	
0100	0200		Indonesia, Voice of		9525as
			15150al		11785pa
0100	0200		Japan, Radio Japan/NHK World		5960va
			11720va	11935sa	15325as
			17810as	17825va	17845as
0100	0200		Malaysia, RTM/Trax FM	7295as	
0100	0200	vl	Namibia, Namibian BC Corp	3270do	3290do
			6060do	6175do	
0100	0200		Netherlands, Radio	9845na	
0100	0200		New Zealand, Radio NZ Intl	13730pa	
0100	0200	DRM	New Zealand, Radio NZ Intl	15720pa	
0100	0200		North Korea, Voice of Korea	7140as	9345as
			9730am	11735ca	13760ca
0100	0200	vl	Papua New Guinea, Wantok R.Light		15180ca
0100	0200		Russia, Voice of	7250na	9665na
			15595na		15555na
0100	0200		Singapore, MediaCorp Radio	6150do	
0100	0200		Sri Lanka, SLBC	6005eu	9770eu
0100	0200		Taiwan, Radio Taiwan Intl	11875as	15465as
0100	0200		UK, BBC World Service	6195as	9410as
			11955as	15280as	15310as
			17790as		15360as
0100	0200	f	UK, Bible Voice	6140me	
0100	0200		USA, American Forces Radio	4319usb	5446usb
			5765usb	6350usb	7590usb
			10320usb	12133usb	12579usb
			13855usb		13362usb
0100	0200		USA, KAIJ Dallas TX	5755na	
0100	0200		USA, KTBN Salt Lake City UT	7505na	
0100	0200		USA, KWHR Naalehu HI	17655as	
0100	0200		USA, Voice of America	9885va	11705va
			11725va		
0100	0200		USA, WBCQ Kennebunk ME	5110na	7415na
			9330na		
0100	0200		USA, WBOH Newport NC	5920am	
0100	0200		USA, WEWN Birmingham AL	5810va	5835va
0100	0200		USA, WHRA Greenbush ME	7520na	
0100	0200	sm	USA, WHRI Noblesville IN	7315am	
0100	0200		USA, WHRI Noblesville IN	7315am	
0100	0200	twhfa	USA, WINB Red Lion PA	9265am	
0100	0200	s	USA, WRMI Miami FL	7385am	
0100	0200		USA, WRMI Miami FL	9955am	
0100	0200		USA, WTJC Newport NC	9370na	
0100	0200		USA, WWCR Nashville TN	3215na	5070na
			5765na	13845na	
0100	0200		USA, WWRB Manchester TN	3185na	5050na
			5745na	6890na	
0100	0200		USA, WYFR/Family R Okeechobee FL		6065va
			9505va	15195va	
0100	0200		Uzbekistan, Christian Vision	7355as	
0100	0200		Zambia, Christian Voice	4965af	
0105	0110		Pakistan, Radio	7445eu	9340eu
0105	0130	sm	Austria, Radio Austria Intl	9870am	
0113	0130	twhf	Austria, Radio Austria Intl	9870am	
0115	0130	a	Austria, Radio Austria Intl	9870na	
0115	0130	twhf	Seychelles, FEBA	7365va	
0130	0200		Iran, Voice of the Islamic Rep	7235am	9495am
0130	0200		Sweden, Radio	6010na	9435va
0130	0200	twhfa	USA, Voice of America	7405am	13740am
0133	0200	sm	Austria, Radio Austria Intl	9870na	
0140	0200		Vatican City, Vatican Radio	7335as	9650as
0143	0158	twhfa	Austria, Radio Austria Intl	9870na	
0145	0200	twhf	Albania, Radio Tirana	6115eu	7455eu
0145	0200	w	Australia, HCJB	15405as	

**0200 UTC - 10PM EDT / 9PM CDT / 7PM PDT**

0200	0215	Croatia, Croatian Radio	9925na	
0200	0230	Iran, Voice of the Islamic Rep	7235am	9495am
0200	0230	Thailand, Radio	5980na	
0200	0245	USA, WYFR/Family R Okeechobee FL		11835va
0200	0300	Anguilla, University Network	6090am	
0200	0300	Argentina, RAE	11710am	
0200	0300	Australia, ABC NT Alice Springs		2310irr
		4835do		
0200	0300	Australia, ABC NT Katherine	5025do	
0200	0300	Australia, ABC NT Tennant Creek		4910do
0200	0300	Australia, CVC International	7355as	
0200	0300	Australia, Radio	9660pa	12080pa
		13670pa	15240va	15415va
		17750as	21725va	15515va
0200	0300	Bulgaria, Radio	9700na	11700na
0200	0300	Canada, CFRX Toronto ON	6070na	
0200	0300	Canada, CFVP Calgary AB	6030na	
0200	0300	Canada, CKZN St John's NF	6160na	
0200	0300	Canada, CKZU Vancouver BC	6160na	
0200	0300	China, China Radio Intl	11870as	13640as
0200	0300	Costa Rica, University Network	5030va	6150va
		7375va	9725va	
0200	0300	Cuba, Radio Havana	6000na	6060na
		9820na		
0200	0300	Egypt, Radio Cairo	7270na	
0200	0300	Greece, Voice of	7475va	9420va
0200	0300	Guyana, Voice of	3291do	17520va
0200	0300	Malaysia, RTM/Trax FM	7295as	
0200	0300	Namibia, Namibian BC Corp	3270do	3290do
		6060do	6175do	
0200	0300	New Zealand, Radio NZ Intl	13730pa	
0200	0300	New Zealand, Radio NZ Intl	15720pa	
0200	0300	North Korea, Voice of Korea	13650as	15100as
0200	0300	Papua New Guinea, Wantok R.Light		7120va
0200	0300	Philippines, Radio Pilipinas	11885va	15270va
		17665va		
0200	0300	Russia, Voice of	9665na	9860na
		15595na		15555na
0200	0300	Singapore, MediaCorp Radio	6150do	
0200	0300	South Korea, KBS World Radio		9560na
		11810sa	15575na	
0200	0300	UK, BBC World Service	6195me	11760me
		11955as	15280as	15310as
		17790as		15360as
0200	0300	USA, American Forces Radio	4319usb	5446usb
		5765usb	6350usb	7590usb
		10320usb	12133usb	12579usb
		13855usb		13362usb
0200	0300	USA, KAIJ Dallas TX	5755na	
0200	0300	USA, KJES Vado NM	7555na	
0200	0300	USA, KTNB Salt Lake City UT	7505na	
0200	0300	USA, KWHR Naalehu HI	17655as	
0200	0300	USA, WBCQ Kennebunk ME	5110na	7415na
		9330na		
0200	0300	USA, WBOH Newport NC	5920am	
0200	0300	USA, WEWN Birmingham AL	5810va	5835va
0200	0300	USA, WHRA Greenbush ME	5850na	
0200	0300	USA, WHRI Noblesville IN	7315am	
0200	0300	USA, WHRI Noblesville IN	5875am	7490am
		9515am		
0200	0300	USA, WINB Red Lion PA	9265am	
0200	0300	USA, WRMI Miami FL	7385am	
0200	0300	USA, WRMI Miami FL	7385am	
0200	0300	USA, WTJC Newport NC	9370na	
0200	0300	USA, WWCR Nashville TN	3215na	5070na
		5765na	5935na	
0200	0300	USA, WWRB Manchester TN	3185na	5050na
		5745na	6890na	
0200	0300	USA, WYFR/Family R Okeechobee FL		5985va
		6065va	9505va	11855va
0200	0300	Uzbekistan, Christian Vision	7355as	
0200	0300	Zambia, Christian Voice	4965af	
0200	3000	Taiwan, Radio Taiwan Intl	5950na	9680na
0215	0220	Vatican City, Vatican Radio	15560oc	
0215	0230	Nepal, Radio	3230as	5005as
		7165as		6100as
0230	0258	Vietnam, Voice of	6175na	
0230	0300	Albania, Radio Tirana	6115eu	7455eu
0230	0300	Hungary, Radio Budapest	9795eu	
0230	0300	Sweden, Radio	6010na	
0245	0300	Myanmar, Radio	9730do	
0250	0300	Vatican City, Vatican Radio	7305am	9610am

**0300 UTC - 11PM EDT / 10PM CDT / 8PM PDT**

0300	0320	Vatican City, Vatican Radio	7305am	9610am
0300	0327	Czech Rep, Radio Prague	7345na	9870na
0300	0330	Belarus, Radio	5970eu	6155eu
0300	0330	Egypt, Radio Cairo	7270na	
0300	0330	Myanmar, Radio	9730do	
0300	0330	Philippines, Radio Pilipinas	11885va	15270va
		17665va		

0300	0330	UK, BBC World Service	3255af	6005af
		6035af	6190af	7160af
		12035af		9750af
0300	0330	USA, KJES Vado NM	7555na	
0300	0330	USA, Voice of America	4930af	6080af
		7340af	9885af	12080af
0300	0330	USA, WBCQ Kennebunk ME	5110na	7415na
		9330na		
0300	0330	Vatican City, Vatican Radio	9660af	
0300	0350	Turkey, Voice of	5975va	7270va
0300	0355	South Africa, Channel Africa	5960af	
0300	0400	Anguilla, University Network	6090am	
0300	0400	Australia, ABC NT Alice Springs		2310irr
		4835do		
0300	0400	Australia, ABC NT Katherine	5025do	
0300	0400	Australia, ABC NT Tennant Creek		4910do
0300	0400	Australia, CVC International	13685as	
0300	0400	Australia, Radio	9660pa	12080pa
		13670va	15240va	15415va
		17750as	21725va	15515va
0300	0400	Canada, CBC NQ SW Service	9625na	
0300	0400	Canada, CFRX Toronto ON	6070na	
0300	0400	Canada, CFVP Calgary AB	6030na	
0300	0400	Canada, CKZN St John's NF	6160na	
0300	0400	Canada, CKZU Vancouver BC	6160na	
0300	0400	China, China Radio Intl	9690na	9790na
		11870as	15110as	
0300	0400	Costa Rica, University Network	5030va	6150va
		7375va	9725va	
0300	0400	Cuba, Radio Havana	6000na	6060na
		9820na		
0300	0400	Guyana, Voice of	3291do	
0300	0400	Japan, Radio Japan/NHK World		21610oc
0300	0400	Malaysia, RTM/Trax FM	7295as	
0300	0400	Malaysia, Voice of	6175as	9750as
0300	0400	Namibia, Namibian BC Corp	3270do	3290do
		6060do	6175do	
0300	0400	New Zealand, Radio NZ Intl	13730pa	
0300	0400	New Zealand, Radio NZ Intl	15720pa	
0300	0400	North Korea, Voice of Korea	7140as	9345as
0300	0400	Oman, Radio Oman	15355as	
0300	0400	Papua New Guinea, Wantok R.Light		7120va
0300	0400	Russia, Voice of	9665na	9880na
		15425na	15455na	15555na
0300	0400	Rwanda, Radio	6055do	15595na
0300	0400	Singapore, MediaCorp Radio	6150do	
0300	0400	South Africa, Channel Africa	3345af	
0300	0400	Taiwan, Radio Taiwan Intl	5950va	15215va
		15320va		
0300	0400	UK, BBC World Service	6195va	9410eu
		11760me	15575me	
0300	0400	Ukraine, Radio Ukraine Intl	7440na	
0300	0400	USA, American Forces Radio	4319usb	5446usb
		5765usb	6350usb	7590usb
		10320usb	12133usb	12579usb
		13855usb		13362usb
0300	0400	USA, KAIJ Dallas TX	5755na	
0300	0400	USA, KTNB Salt Lake City UT	7505na	
0300	0400	USA, KWHR Naalehu HI	17655as	
0300	0400	USA, WBCQ Kennebunk ME	5110na	7415na
0300	0400	USA, WBOH Newport NC	5920am	
0300	0400	USA, WEWN Birmingham AL	5810va	5835va
0300	0400	USA, WHRA Greenbush ME	5850na	
0300	0400	USA, WHRI Noblesville IN	5860am	
0300	0400	USA, WHRI Noblesville IN	7520am	
0300	0400	USA, WHRI Noblesville IN	5875am	7315am
0300	0400	USA, WINB Red Lion PA	9265am	
0300	0400	USA, WRMI Miami FL	7385am	
0300	0400	USA, WRMI Miami FL	9955am	
0300	0400	USA, WTJC Newport NC	9370na	
0300	0400	USA, WWRB Manchester TN	3215na	5070na
		5765na	5935na	
0300	0400	USA, WWRB Manchester TN	3185na	5050na
		5745na	6890na	
0300	0400	USA, WYFR/Family R Okeechobee FL		6065am
		9505am	11740am	15255am
0300	0400	Uzbekistan, Christian Vision	7355as	13685as
0300	0400	Zambia, Christian Voice	4965af	
0300	0400	Zimbabwe, ZBC Corp	5975do	
0300	0500	UK, Sudan Radio Service	7120af	
0330	0345	Israel, Kol Israel	9345va	17600va
0330	0357	Czech Rep, Radio Prague	9445va	11600va
0330	0358	Vietnam, Voice of	6175am	
0330	0400	Belarus, Radio	5970eu	6155eu
0330	0400	UK, BBC World Service	3255af	6005af
		6035af	6190af	7160af
		12035af	15420af	9750af
0330	0400	USA, Voice of America	4930af	6080af
		9885af	12080af	15580af
0330	0400	USA, WBCQ Kennebunk ME	5110na	7415na

**0400 UTC - 12AM EDT / 11PM CDT / 9PM PDT**

0400	0427	Czech Rep, Radio Prague	6100na	
0400	0430	France, Radio France Intl	9805af	11700af

0400	0430		USA, Voice of America	4930af	4960af	
			6080af	7405af	9575af	9885af
			11835af	12080af	15580af	
0400	0445		USA, WYFR/Family R Okeechobee FL		6065va	
			6855va	9505va		
0400	0456		Romania, Radio Romania Intl	9780va	11795na	
			15110va	17780va		
0400	0458		New Zealand, Radio NZ Intl	13730pa		
0400	0458	DRM	New Zealand, Radio NZ Intl	15720pa		
0400	0459		South Africa, Channel Africa	3345af		
0400	0500		Anguilla, University Network	6090am		
0400	0500		Australia, ABC NT Alice Springs		2310irr	
			4835do			
0400	0500		Australia, ABC NT Katherine	5025do		
0400	0500		Australia, ABC NT Tennant Creek		4910do	
0400	0500		Australia, CVC International	13685as		
0400	0500		Australia, Radio	9660pa	12080pa	13670va
			15240pa	15415va	21725va	
0400	0500	twfhas	Canada, CBC NQ SW Service	9625na		
0400	0500		Canada, CFRX Toronto ON	6070na		
0400	0500		Canada, CKZN St John's NF	6160na		
0400	0500		Canada, CKZU Vancouver BC	6160na		
0400	0500		China, China Radio Intl	6020na	6080na	
			9560na	9755na	11750af	
0400	0500		Costa Rica, University Network	5030va	6150va	
			7375va	9725va		
0400	0500		Cuba, Radio Havana	6000na	6060na	
			9820na			
0400	0500		Germany, Deutsche Welle	7225af	9630af	
			12045af	15445af		
0400	0500		Guyana, Voice of	3291do		
0400	0500		Malaysia, RTM/Trax FM	7295as		
0400	0500		Malaysia, Voice of	6175as	15295as	
0400	0500	vl	Namibia, Namibian BC Corp	3270do	3290do	
			6060do	6175do		
0400	0500		Nigeria, Radio/Kaduna	6090do		
0400	0500	vl	Papua New Guinea, Wantok R.Light		7120va	
0400	0500		Russia, Voice of	9665na	9860na	9880na
			15555na			
0400	0500	vl	Rwanda, Radio	6055do		
0400	0500		Singapore, MediaCorp Radio	6150do		
0400	0500	vl	Uganda, Radio	4976do	5026do	7196do
0400	0500		UK, BBC World Service	6190af	6195eu	7120af
			9410va	11760me	12035af	15280as
			15310as	15360as	15420af	15575me
			17760as	17790as	21660as	
0400	0500	DRM	UK, BBC World Service	6010na		
0400	0500		USA, American Forces Radio	4319usb	5446usb	
			5765usb	6350usb	7590usb	7812usb
			10320usb	12133usb	12579usb	13362usb
			13855usb			
0400	0500		USA, KAIJ Dallas TX	5755na		
0400	0500		USA, KATN Salt Lake City UT	7505na		
0400	0500		USA, KWHR Naalehu HI	17655as		
0400	0500		USA, WBCQ Kennebunk ME	5110na	7415na	
0400	0500		USA, WBOH Newport NC	5920am		
0400	0500		USA, WEWN Birmingham AL	5810va	5835va	
0400	0500		USA, WHRA Greenbush ME	5850na		
0400	0500	twhf	USA, WHRI Noblesville IN	5860am		
0400	0500	sm	USA, WHRI Noblesville IN	7520am		
0400	0500		USA, WHRI Noblesville IN	5875am	7315am	
0400	0500	mtwhf	USA, WMLK Bethel PA	9265eu		
0400	0500	a	USA, WRMI Miami FL	9955am		
0400	0500		USA, WTJC Newport NC	9370na		
0400	0500		USA, WWCR Nashville TN	3215na	5070na	
			5765na	5935na		
0400	0500		USA, WWRB Manchester TN	3185na	5050na	
			5745na	6890na		
0400	0500		USA, WYFR/Family R Okeechobee FL		7780va	
			9715va			
0400	0500		Uzbekistan, Christian Vision	13685as		
0400	0500		Zambia, Christian Voice	4965af	6065af	
0400	0500	vl	Zimbabwe, ZBC Corp	5975do		
0400	5000		Netherlands, Radio	6165am	9590va	
0430	0500		Nigeria, Radio/Ibadan	6050do		
0430	0500		Nigeria, Radio/Kaduna	4770do		
0430	0500		Nigeria, Radio/Lagos	3326do	4990do	
0430	0500		Swaziland, TWR	3200af	4775af	
0430	0500		USA, Voice of America	4930af	4960af	
			6080af	7405af	9575af	11835af
			12080af	15580af		
0445	0500		Italy, RAI Intl	6110af	6145af	7235af
0459	0500		New Zealand, Radio NZ Intl	9615pa		
0459	0500	DRM	New Zealand, Radio NZ Intl	9440pa		

				15420af	17640af	17760as	17790as
				17885af	21660as		
0500	0530		Vatican City, Vatican Radio		9660af	11625af	
			13765af				
0500	0555		South Africa, Channel Africa		9685af		
0500	0600		Anguilla, University Network		6090am		
0500	0600		Australia, ABC NT Alice Springs			2310irr	
			4835do				
0500	0600		Australia, ABC NT Katherine		5025do		
0500	0600		Australia, ABC NT Tennant Creek			4910do	
0500	0600		Australia, CVC International		13685as		
0500	0600		Australia, Radio	9660pa	12080pa	13670va	
			15160va	15240va	15415va	15515va	
			17750as				
0500	0600		Bhutan, BBS	6035as			
0500	0600		Canada, CFRX Toronto ON		6070na		
0500	0600		Canada, CKZN St John's NF		6160na		
0500	0600		Canada, CKZU Vancouver BC		6160na		
0500	0600		China, China Radio Intl		6020na	6190na	
			9560na	11880as	15350as	15360af	
			15465as	17505as	17540as		
0500	0600		Costa Rica, University Network	5030va	6150va		
			7375va	9725va			
0500	0600		Cuba, Radio Havana		6000va	6060va	
			9550va	9820va	11760va		
0500	0600		Germany, CVC The Voice Africa			9430af	
0500	0600		Germany, Deutsche Welle		9630af	9700af	
			15410af	17800af			
0500	0600		Guyana, Voice of	3291do			
0500	0600	mtwhf	Italy, IRRS	5775va			
0500	0600		Japan, Radio Japan/NHK World			5975eu	
			6110na	7230eu	15195as	17810as	
			21755oc				
0500	0600		Malaysia, RTM/Trax FM		7295as		
0500	0600		Malaysia, Voice of	6175as	9750as	15295as	
0500	0600	vl	Namibia, Namibian BC Corp	3270do	3290do		
			6060do	6175do			
0500	0600		New Zealand, Radio NZ Intl		9615pa		
0500	0600	DRM	New Zealand, Radio NZ Intl		9440pa		
0500	0600		Nigeria, Radio/Ibadan		6050do		
0500	0600		Nigeria, Radio/Kaduna		4770do	6090do	
0500	0600		Nigeria, Radio/Lagos		3326do	4990do	
0500	0600	vl	Papua New Guinea, Wantok R.Light		7120va		
0500	0600		Russia, Voice of	17635oc	21790oc		
0500	0600		Singapore, MediaCorp Radio		6150do		
0500	0600		South Africa, Channel Africa		7240af		
0500	0600		Swaziland, TWR	3200af	4775af	9500af	
0500	0600	vl	Uganda, Radio	4976do	5026do	7196do	
0500	0600		UK, BBC World Service		11760me	15575me	
0500	0600	vl/ mtwhf	UK, Sudan Radio Service		9525af		
0500	0600		USA, American Forces Radio	4319usb	5446usb		
			5765usb	6350usb	7590usb	7812usb	
			10320usb	12133usb	12579usb	13362usb	
			13855usb				
0500	0600		USA, KAIJ Dallas TX	5755na			
0500	0600		USA, KATN Salt Lake City UT	7505na			
0500	0600		USA, KWHR Naalehu HI	11565as	13650as		
0500	0600		USA, Voice of America	4930af	6080af		
			6180af	7405af	12080af	15580af	
0500	0600		USA, WBCQ Kennebunk ME	5110na	7415na		
0500	0600		USA, WBOH Newport NC	5920am			
0500	0600		USA, WEWN Birmingham AL	5050va	5850va		
0500	0600		USA, WHRA Greenbush ME	6145na			
0500	0600	twhf	USA, WHRI Noblesville IN	5860am	7465am		
0500	0600	sm	USA, WHRI Noblesville IN	7315am			
0500	0600	mtwhf	USA, WMLK Bethel PA	9265eu			
0500	0600	asm	USA, WRMI Miami FL	9955am			
0500	0600		USA, WTJC Newport NC	9370na			
0500	0600		USA, WWCR Nashville TN	3215na	5070na		
			5765na	5935na			
0500	0600		USA, WWRB Manchester TN	3185na			
0500	0600		USA, WYFR/Family R Okeechobee FL		6855va		
			9355va				
0500	0600		Uzbekistan, Christian Vision	13685as			
0500	0600		Zambia, Christian Voice	4965af	6065af		
0500	0600	vl	Zimbabwe, ZBC Corp	5975do			
0505	0520	m	Austria, Radio Austria Intl	17870me			
0505	0530	as	Austria, Radio Austria Intl	17870me			
0515	0600		Germany, CVC The Voice Africa		9555af		
			15715af				
0525	0600	vl	Ghana, Ghana BC Corp		3366do	4915do	
0530	0600		Thailand, Radio	17655eu			
0530	0600	mtwhf	UK, BBC World Service		3255af	6005af	
		vl/ mtwhf	6190af	6195eu	7160af	9410af	
		as	11765af	11955as	15310as	15360as	
			15420af	17640af	17760as	21660as	
0530	0600	mtwhf	UK, BBC World Service		17885af		
0530	0600	vl/ mtwhf	Vatican City, Vatican Radio		6185va		
0535	0600	as	Austria, Radio Austria Intl		17870me		
0545	0600	twhf	Austria, Radio Austria Intl		17870me		
0545	0600	vl	Rwanda, Radio	6055do			

**0500 UTC - 1AM EDT / 12AM CDT / 10PM PDT**

0500	0507	twfhas	Canada, CBC NQ SW Service	9625na		
0500	0520		Vatican City, Vatican Radio	5885eu	7250eu	
			9645eu			
0500	0530	mtwhf	France, Radio France Intl	13680af	15160af	
0500	0530	vl	Rwanda, Radio	6055do		
0500	0530		UK, BBC World Service	6005af	6190af	
			6195eu	7160af	9410af	
			11955as	15280as	15310as	15360as

**0600 UTC - 2AM EDT / 1AM CDT / 11PM PDT**

0600	0615	as	South Africa, TWR	11640af		
0600	0630	mtwhf	France, Radio France Intl	15160af	17800af	

0600	0630		UK, BBC World Service	6005af	6190af		
			9410af 9530af 12095af 17640af	11765af	11940af		
0600	0645	mtwhf	South Africa, TWR	11640af			
0600	0645	vl/ mtwhf	Vatican City, Vatican Radio	6185va			
0600	0655		South Africa, Channel Africa	15255af			
0600	0658		New Zealand, Radio NZ Intl	9615pa			
0600	0658	DRM	New Zealand, Radio NZ Intl	9440pa			
0600	0659		South Africa, Channel Africa	7240af			
0600	0700		Anguilla, University Network	6090am			
0600	0700		Australia, ABC NT Alice Springs		2310irr		
			4835do				
0600	0700		Australia, ABC NT Katherine	5025do			
0600	0700		Australia, ABC NT Tennant Creek		4910do		
0600	0700		Australia, CVC International	15335as			
0600	0700		Australia, Radio 9660pa	12080pa	13670va		
			15160va 15240va 15415va 17750as	15415va	15515va		
0600	0700		Canada, CFRX Toronto ON	6070na			
0600	0700		Canada, CFVP Calgary AB	6030na			
0600	0700		Canada, CKZN St John's NF	6160na			
0600	0700		Canada, CKZU Vancouver BC	6160na			
0600	0700		China, China Radio Intl	11870as	11880as		
			13620as 15350as 15465as 17490eu	17505as 17540as			
0600	0700		Costa Rica, University Network	5030va	6150va		
			7375va 9725va 11870va				
0600	0700		Cuba, Radio Havana	6000va	6060va		
			9550va 9820va 11760va				
0600	0700		Germany, CVC The Voice Africa	9555af			
			15640af				
0600	0700		Germany, Deutsche Welle	6140eu	7170af		
			15275af 17860af				
0600	0700	vl	Ghana, Ghana BC Corp	3366do	4915do		
0600	0700		Guyana, Voice of	3291do			
0600	0700		Italy, IRRS	13840va			
0600	0700		Japan, Radio Japan/NHK World		11715eu		
			11740as 11760eu 13630va 15195as	17870pa 21755oc			
0600	0700		Liberia, ELWA	4760do			
0600	0700		Malaysia, RTM/Trax FM	7295as			
0600	0700		Malaysia, Voice of	6175as	9750as	15295as	
0600	0700	vl	Namibia, Namibian BC Corp	3270do	3290do		
			6060do 6175do				
0600	0700		Netherlands, Radio	9700pa			
0600	0700		Nigeria, Radio/Ibadan	6050do			
0600	0700		Nigeria, Radio/Kaduna	4770do	6090do		
0600	0700		Nigeria, Radio/Lagos	3326do	4990do		
0600	0700	vl	Papua New Guinea, Wantok R.Light	7120va			
0600	0700		Russia, Voice of	17635oc	21790oc		
0600	0700	irreg/ vl	Sierra Leone, SLBS 3316do				
0600	0700		Singapore, MediaCorp Radio	6150do			
0600	0700	vl	Solomon Islands, SIBC	5020do	9545do		
0600	0700		Swaziland, TWR	3200af	4775af	9500af	
0600	0700	as	UK, BBC World Service	17885af			
0600	0700		UK, BBC World Service	6195eu 9410eu			
			11955as 12095eu 15310as 15360as	15565eu 15575me 17760as 17790as			
0600	0700		USA, American Forces Radio	4319usb	5446usb		
			5765usb 6350usb 7590usb 7812usb	10320usb 12133usb	13362usb		
			13855usb				
0600	0700		USA, KAIJ Dallas TX	5755na			
0600	0700		USA, KTNB Salt Lake City UT	7505na			
0600	0700		USA, KWHR Naalehu HI	11565as	13650as		
0600	0700		USA, Voice of America	6080af	6180af		
			7405af 12080af 15580af				
0600	0700		USA, WBCQ Kennebunk ME	5110na	7415na		
0600	0700		USA, WBOH Newport NC	5920am			
0600	0700		USA, WEWN Birmingham AL	5050va	7570va		
0600	0700		USA, WHRA Greenbush ME	5860na	7490na		
0600	0700		USA, WHRI Noblesville IN	7315am	7465am		
0600	0700	mtwhfa	USA, WMLK Bethel PA	9265eu			
0600	0700	s	USA, WRMI Miami FL	9955am			
0600	0700		USA, WTJC Newport NC	9370na			
0600	0700		USA, WWCR Nashville TN	3215na	5070na		
			5765na 5935na				
0600	0700		USA, WWRB Manchester TN	3185na			
0600	0700		USA, WYFR/Family R Okeechobee FL	6000va			
			7780va 9680va 11530va 11580va				
0600	0700		Uzbekistan, Christian Vision	13685as			
0600	0700	vl	Vanuatu, Radio	4960do			
0600	0700		Yemen, Rep of Yemen Radio	9780me			
0600	0700		Zambia, Christian Voice	6065af			
0600	0700	vl	Zimbabwe, ZBC Corp	5975do			
0630	0645		Vatican City, Vatican Radio	4005eu	5885eu		
			6185eu 7250eu 9645eu		11740eu		
0630	0645		Vatican City, Vatican Radio	15595va			
0630	0656		Romania, Radio Romania Intl	9655va	11830va		
			15440va 17770va				
0630	0700		Bulgaria, Radio	9500eu	11500eu		
0630	0700		Nigeria, Voice of	15120af			
0630	0700		UK, BBC World Service	6005af	6190af		
			9410af 9530af 11765af 11940af	11990af 12095af 17640af			

0630	0700		Vatican City, Vatican Radio	11625af	13765af		
			15570af 15595af				
0645	0700	s	Albania, TWR Europe	11865eu			
0645	0700	s	Monaco, TWR	9800eu			
0659	0700		New Zealand, Radio NZ Intl	7145pa			
0659	0700	DRM	New Zealand, Radio NZ Intl	6095pa			

### 0700 UTC - 3AM EDT / 2AM CDT / 12AM PDT

0700	0715		UK, BBC World Service	6005af	6190af		
			11940af 11765af 15400af	17640af 17830af	15485af		
0700	0727		Czech Rep, Radio Prague	9880eu	11600eu		
0700	0745		USA, WYFR/Family R Okeechobee FL	7780va			
0700	0800	smtwhf	Albania, TWR Europe	11865eu			
0700	0800		Anguilla, University Network	6090am			
0700	0800		Australia, ABC NT Alice Springs		2310irr		
			4835do				
0700	0800		Australia, ABC NT Katherine	5025do			
0700	0800		Australia, ABC NT Tennant Creek		4910do		
0700	0800		Australia, CVC International	15335as			
0700	0800		Australia, HCJB	11750as			
0700	0800		Australia, Radio 9660pa	9710pa 12080pa	15415va		
			13630pa 15160pa 15240va 17750as				
0700	0800		Canada, CFRX Toronto ON	6070na			
0700	0800		Canada, CFVP Calgary AB	6030na			
0700	0800		Canada, CKZN St John's NF	6160na			
0700	0800		Canada, CKZU Vancouver BC	6160na			
0700	0800		China, China Radio Intl	11880as	13710eu		
			15350as 15465as 17490eu				
0700	0800		Costa Rica, University Network	5030va	6150va		
			7375va 9725va 11870va				
0700	0800		France, Radio France Intl	17800af			
0700	0800		Germany, CVC The Voice Africa	9555af			
			15640af				
0700	0800		Germany, CVC The Voice Africa	9555af			
			15640af				
0700	0800		Germany, Deutsche Welle	6140eu			
0700	0800	vl	Ghana, Ghana BC Corp	3366do	4915do		
0700	0800		Guyana, Voice of	3291do	5950do		
0700	0800		Italy, IRRS	13840va			
0700	0800		Liberia, ELWA	4760do			
0700	0800		Liberia, Star Radio	9525af			
0700	0800		Malaysia, RTM/Trax FM	7295as			
0700	0800		Malaysia, Voice of	6175as	9750as	15295as	
0700	0800		Monaco, TWR	9800eu	11865eu		
0700	0800		Myanmar, Radio	9730do			
0700	0800	vl	Namibia, Namibian BC Corp	3270do	3290do		
			6060do 6175do				
0700	0800		Netherlands, Radio	9700pa			
0700	0800		New Zealand, Radio NZ Intl	7145pa			
0700	0800	DRM	New Zealand, Radio NZ Intl	6095pa			
0700	0800		Nigeria, Radio/Ibadan	6050do			
0700	0800		Nigeria, Radio/Kaduna	4770do	6090do		
0700	0800		Nigeria, Radio/Lagos	3326do	4990do		
0700	0800	vl	Papua New Guinea, Wantok R.Light	7120va			
0700	0800		Russia, Voice of	17495oc	17635oc	21790oc	
0700	0800	irreg/ vl	Sierra Leone, SLBS 3316do				
0700	0800		Singapore, MediaCorp Radio	6150do			
0700	0800	vl	Solomon Islands, SIBC	5020do	9545do		
0700	0800		Swaziland, TWR	6120af	9500af		
0700	0800		Taiwan, Radio Taiwan Intl	5950na			
0700	0800		UK, BBC World Service	11955as	15310as		
			15575me 17760va 17790as 17885as	21660as			
0700	0800	as	UK, Bible Voice	5945eu			
0700	0800		USA, American Forces Radio	4319usb	5446usb		
			5765usb 6350usb 7590usb 7812usb	10320usb 12133usb	12579usb 13362usb		
			13855usb				
0700	0800		USA, KAIJ Dallas TX	5755na			
0700	0800		USA, KTNB Salt Lake City UT	7505na			
0700	0800		USA, KWHR Naalehu HI	11565as	13650as		
0700	0800		USA, WBCQ Kennebunk ME	5110na	7415na		
0700	0800		USA, WBOH Newport NC	5920am			
0700	0800		USA, WEWN Birmingham AL	5050va	7570va		
0700	0800		USA, WHRA Greenbush ME	5860na	7490na		
0700	0800		USA, WHRI Noblesville IN	7315am	7495am		
0700	0800	mtwhfa	USA, WMLK Bethel PA	9265eu			
0700	0800		USA, WTJC Newport NC	9370na			
0700	0800		USA, WWCR Nashville TN	3215na	5070na		
			5765na 5935na				
0700	0800		USA, WWRB Manchester TN	3185na			
0700	0800		USA, WYFR/Family R Okeechobee FL	5985va			
			6855va 9505va 9715va				
0700	0800	vl	Vanuatu, Radio	4960do			
0700	0800		Zambia, Christian Voice	6065af			
0715	0745	s	Monaco, TWR	9800eu	11865eu		
0715	0750	a	Albania, TWR Europe	11865eu			
0715	0750	a	Monaco, TWR	9800eu	11865eu		
0715	0800	f	UK, Bible Voice	5945eu			
0730	0800	as	Guam, TWR/KTWR	17665as			
0730	0800		Pakistan, Radio	15100eu	17835eu		
0730	0800		UK, BBC World Service	6190af	11765af		
			11940af 15400af 15485af		17640af		

**0800 UTC - 4AM EDT / 3AM CDT / 1AM PDT**

0800	0820	smtwhf	Albania, TWR Europe	11865eu	
0800	0820		Monaco, TWR	9800eu	11865eu
0800	0830		Australia, ABC NT Katherine	5025do	
0800	0830		Australia, ABC NT Tennant Creek		4910do
0800	0830		Liberia, ELWA	4760do	
0800	0830		Malaysia, Voice of	6175as	9750as
0800	0830		Myanmar, Radio	9730do	
0800	0830		Pakistan, Radio	15100eu	17835eu
0800	0830	f	UK, Bible Voice	5945eu	
0800	0830		Vatican City, Vatican Radio	9625na	
0800	0845	as	UK, Bible Voice	5945eu	
0800	0845		USA, WYFR/Family R Okeechobee FL		5950va
			9930va		
0800	0900		Anguilla, University Network	6090am	
0800	0900		Australia, ABC NT Alice Springs		2310irr
			4835do		
0800	0900		Australia, CVC International	15335as	
0800	0900		Australia, HCJB	11750as	
0800	0900		Australia, Radio	5995pa	9580pa 9590pa
			9710pa	12080pa	15240va
			15415va	17750as	
0800	0900		Bhutan, BBS	6035as	
0800	0900	DRM	Bulgaria, World Radio Network		13865 ei
0800	0900		Canada, CFRX Toronto ON	6070na	
0800	0900		Canada, CFVP Calgary AB	6030na	
0800	0900		Canada, CKZN St John's NF	6160na	
0800	0900		Canada, CKZU Vancouver BC	6160na	
0800	0900		China, China Radio Intl	11880as	13710eu
			15350as	15465as	17490eu 17540as
0800	0900		Costa Rica, University Network	5030va	6150va
			7375va	9725va	11870va
0800	0900		Germany, CVC The Voice Africa		9555af
			15640af		
0800	0900		Germany, Deutsche Welle	6140eu	
0800	0900	DRM	Germany, Deutsche Welle	21820af	
0800	0900	vl	Ghana, Ghana BC Corp	3366do	4915do
0800	0900		Guam, TWR/KTWR 11840as	17665as	
0800	0900		Guyana, Voice of	3291do	5950do
0800	0900		Indonesia, Voice of	9525as	11785pa
			15150af		
0800	0900		Italy, IRRS	13840va	
0800	0900		Liberia, Star Radio	9525af	
0800	0900		Malaysia, RTM/Trax FM	7295as	
0800	0900		Malaysia, Voice of	15295as	
0800	0900		New Zealand, Radio NZ Intl	7145pa	
0800	0900	DRM	New Zealand, Radio NZ Intl	6095pa	
0800	0900		Nigeria, Radio/Ibadan	6050do	
0800	0900		Nigeria, Radio/Kaduna	4770do	6090do
0800	0900		Nigeria, Radio/Lagos	3326do	4990do
0800	0900		Papua New Guinea, Catholic Radio		4960do
0800	0900		Papua New Guinea, NBC	4890do	
0800	0900	vl	Papua New Guinea, Wantok R.Light		7120va
0800	0900		Russia, Voice of	17495oc	17635oc
0800	0900	DRM	Russia, Voice of	15780eu	
0800	0900	irreg/vl	Sierra Leone, SLBS 3316do		
0800	0900		Singapore, MediaCorp Radio	6150do	
0800	0900	vl	Solomon Islands, SIBC	5020do	9545do
0800	0900		South Korea, KBS World Radio		9570as
			9640eu		
0800	0900		Swaziland, TWR	6120af	9500af
0800	0900		Taiwan, Radio Taiwan Intl		9610as
0800	0900		UK, BBC World Service	6190af	6195as
			9740as	11760me	11940af 15310as
			15360as	15400af	15485af 15575me
			17640af	17760as	17790as 17830af
			17885af	21470af	21660as
0800	0900		USA, American Forces Radio	4319usb	5446usb
			5765usb	6350usb	7590usb 7812usb
			10320usb	12133usb	12579usb 13362usb
			13855usb		
0800	0900		USA, KAIJ Dallas TX	5755na	
0800	0900		USA, KNLS Anchor Point AK	11765as	
0800	0900		USA, KTBN Salt Lake City UT	7505na	
0800	0900		USA, KWHR Naalehu HI	9930as	11565as
0800	0900		USA, WBOH Newport NC	5920am	
0800	0900		USA, WEWN Birmingham AL	5050na	7570na
0800	0900		USA, WHRA Greenbush ME	5860na	7490na
0800	0900		USA, WHRI Noblesville IN	7315am	7495am
0800	0900		USA, WTJC Newport NC	9370na	
0800	0900		USA, WWCR Nashville TN	3215na	5070na
			5765na	5935na	
0800	0900		USA, WWRB Manchester TN	3185na	
0800	0900		USA, WYFR/Family R Okeechobee FL		5985va
			6855va		
0800	0900	vl	Vanuatu, Radio	4960do	
0800	0900		Zambia, Christian Voice	6065af	
0815	0900	as	Guam, TWR/KTWR 11840as		
0830	0900		Australia, ABC NT Katherine	2485do	
0830	0900		Australia, ABC NT Tennant Creek		2325do
0845	0900	f	UK, Bible Voice	17595va	

**0900 UTC - 5AM EDT / 4AM CDT / 2AM PDT**

0900	0900		USA, WBCQ Kennebunk ME	5110na	7415na
0900	0915	vl	Ghana, Ghana BC Corp	3366do	4915do
0900	0927		Czech Rep, Radio Prague	9880eu	21745va
0900	0930	as	Guam, TWR/KTWR 11840as		
0900	1000		Anguilla, University Network	6090am	
0900	1000		Australia, ABC NT Alice Springs		2310do
			4835irr		
0900	1000		Australia, ABC NT Katherine	2485do	
0900	1000		Australia, ABC NT Tennant Creek		2325do
0900	1000		Australia, CVC International	11955as	
0900	1000		Australia, Radio	9580pa	9590pa 11880as
			15240as	15415va	
0900	1000	DRM	Bulgaria, World Radio Network		13865eu
0900	1000		Canada, CFRX Toronto ON	6070na	
0900	1000		Canada, CFVP Calgary AB	6030na	
0900	1000		Canada, CKZN St John's NF	6160na	
0900	1000		Canada, CKZU Vancouver BC	6160na	
0900	1000		China, China Radio Intl	15210oc	17490eu
			17690oc		
0900	1000		Costa Rica, University Network	5030va	6150va
			7375va	9725va	11870va 13750va
0900	1000		Germany, CVC The Voice Africa		9555af
0900	1000		Germany, Deutsche Welle	6140eu	
0900	1000	DRM	Germany, Deutsche Welle	21820af	
0900	1000		Germany, Overcomer Ministries		6110eu
			13810eu		
0900	1000		Guyana, Voice of	3291do	5950do
0900	1000		Italy, IRRS	13840va	
0900	1000		Malaysia, RTM/Trax FM	7295as	
0900	1000		Malaysia, Voice of	15295as	
0900	1000	vl	Namibia, Namibian BC Corp	3270do	3290do
			6060do	6175do	
0900	1000		New Zealand, Radio NZ Intl	7145pa	
0900	1000	DRM	New Zealand, Radio NZ Intl	6095pa	
0900	1000		Nigeria, Radio/Ibadan	6050do	
0900	1000		Nigeria, Radio/Kaduna	4770do	6090do
0900	1000		Nigeria, Radio/Lagos	3326do	4990do
0900	1000		Papua New Guinea, Catholic Radio		4960do
0900	1000		Papua New Guinea, NBC	4890do	
0900	1000	vl	Papua New Guinea, Wantok R.Light		7120va
0900	1000	vl	Rwanda, Radio	6055do	
0900	1000	irreg/vl	Sierra Leone, SLBS 3316do		
0900	1000		Singapore, MediaCorp Radio	6150do	
0900	1000	vl	Solomon Islands, SIBC	5020do	9545do
0900	1000		UK, BBC World Service	6190af	6195as
			9605as	9740as	11940af 15310as
			15360as	15400af	15485af 17640af
			17760as	17830af	17885af 21470af
0900	1000	f	UK, Bible Voice	17595va	
0900	1000		USA, American Forces Radio	4319usb	5446usb
			5765usb	6350usb	7590usb 7812usb
			10320usb	12133usb	12579usb 13362usb
			13855usb		
0900	1000		USA, KAIJ Dallas TX	5755na	
0900	1000		USA, KTBN Salt Lake City UT	7505na	
0900	1000		USA, KWHR Naalehu HI	9930as	11565as
0900	1000		USA, WBCQ Kennebunk ME	5110na	7415na
0900	1000		USA, WBOH Newport NC	5920am	
0900	1000		USA, WEWN Birmingham AL	5050na	7520am
0900	1000		USA, WHRI Noblesville IN	7315am	
0900	1000		USA, WTJC Newport NC	9370na	
0900	1000		USA, WWCR Nashville TN	5070na	5765na
			5935na	9985na	
0900	1000		USA, WWRB Manchester TN	3185na	
0900	1000		USA, WYFR/Family R Okeechobee FL		5985va
			6885va	9755va	
0900	1000	vl	Vanuatu, Radio	4960do	
0900	1000		Zambia, Christian Voice	6065af	
0905	1000	s	Greece, Voice of	9420eu	12120eu 15630eu
0930	0945		Israel, Kol Israel	13680eu	15760eu

**1000 UTC - 6AM EDT / 5AM CDT / 3AM PDT**

1000	1015	f	UK, Bible Voice	17595va	
1000	1015	as	USA, WRMI Miami FL		9955am
1000	1025	DRM	Germany, Deutsche Welle		21820af
1000	1030		Mongolia, Voice of	12085as	
1000	1030		UK, BBC World Service	6195as	9690as
			9740as	15310as	15360as 17760as
			17790as	21660as	
1000	1059		New Zealand, Radio NZ Intl	7145pa	
1000	1100		Anguilla, University Network	11775am	
1000	1100		Australia, ABC NT Alice Springs		2310do
			4835irr		
1000	1100		Australia, ABC NT Katherine	2485do	
1000	1100		Australia, ABC NT Tennant Creek		2325do
1000	1100		Australia, CVC International	11955as	
1000	1100		Australia, HCJB	15400as	15540as
1000	1100		Australia, Radio	9580pa	9590pa 11880as
			15240as	15415va	
1000	1100	DRM	Bulgaria, World Radio Network		13865eu
1000	1100		Canada, CFRX Toronto ON	6070na	
1000	1100		Canada, CFVP Calgary AB	6030na	
1000	1100		Canada, CKZN St John's NF	6160na	

SHORTWAVE GUIDE

1000	1100	Canada, CKZU Vancouver BC	6160na		
1000	1100	China, China Radio Intl	6040na	17490eu	
1000	1100	Costa Rica, University Network	5030va	6150va	
		7375va	9725va	11870va	13750va
1000	1100	Germany, CVC The Voice Africa	9555af		
1000	1100	Germany, Overcomer Ministries	13810eu	6110eu	
1000	1100	Guyana, Voice of	3291do	5950do	
1000	1100	India, All India Radio	15410as	17510as	13695oc 15020as 17895oc
1000	1100	Italy, IRRS	13840va		
1000	1100	Japan, Radio Japan/NHK World	9695as	11730as	17585va 6120na 17720me
		21755oc			
1000	1100	Malaysia, RTM/Trax FM		7295as	
1000	1100	Malaysia, Voice of 15295as			
1000	1100	Netherlands, Radio	13820as	12065as	13710as
1000	1100	Netherlands, Radio		7240eu	
1000	1100	DRM New Zealand, Radio NZ Intl		6095pa	
1000	1100	DRM Nigeria, Voice of 7255af			
1000	1100	North Korea, Voice of Korea	9335ca	9850as	6185as 6285am
1000	1100	Papua New Guinea, Catholic Radio		4960do	
1000	1100	Papua New Guinea, NBC		4890do	
1000	1100	vi Papua New Guinea, Wantok R.Light		7120va	
1000	1100	Singapore, MediaCorp Radio		6150do	
1000	1100	vi Solomon Islands, SIBC		5020do	9545do
1000	1100	South Africa, Channel Africa		9620af	
1000	1100	UK, BBC World Service		15485af	15575me 11940af
		15485af	15575me		
1000	1100	as UK, BBC World Service		15400af	
1000	1100	USA, American Forces Radio		5765usb	6350usb 5446usb 7812usb
		10320usb	12133usb	12579usb	13362usb
		13855usb			
1000	1100	USA, KAIJ Dallas TX		5755na	
1000	1100	USA, KNLS Anchor Point AK		9795as	
1000	1100	USA, KTBN Salt Lake City UT		7505na	
1000	1100	USA, KWHR Naalehu HI		9930as	11565as
1000	1100	USA, WBCQ Kennebunk ME		5110na	7415na
1000	1100	USA, WBOH Newport NC		5920am	
1000	1100	USA, WEVN Birmingham AL		5050na	
1000	1100	USA, WHRI Noblesville IN		7520am	7555am
1000	1100	USA, WINB Red Lion PA		9265am	
1000	1100	USA, WTJC Newport NC		9370na	
1000	1100	USA, WWCR Nashville TN		5070na	5765na
		5935na	15825na		
1000	1100	USA, WWRB Manchester TN		3185na	
1000	1100	USA, WYFR/Family R Okeechobee FL		5950va	
		5985va	6855va	9755va	
1000	1100	mtwhf Zambia, Christian Voice		6065af	
1030	1045	Ethiopia, Radio		5990af	9704af
1030	1057	Czech Rep, Radio Prague		9880eu	11665va
1030	1058	Vietnam, Voice of 7285as			
1030	1100	Iran, Voice of the Islamic Rep		15600as	17660as
1030	1100	UK, BBC World Service		6195as	9740as
		15310as	17760as	17790as	
1059	1100	New Zealand, Radio NZ Intl		9870pa	

### 1100 UTC - 7AM EDT / 6AM CDT / 4AM PDT

1100	1128	Vietnam, Voice of	9840as	7220as	7285as
1100	1130	Australia, HCJB	15540as		
1100	1130	Australia, Radio	5995pa	9475va	9590va
		9580pa	9590pa	11880va	15240va
1100	1130	Iran, Voice of the Islamic Rep		15600as	17660as
1100	1130	UK, BBC World Service		6190af	11940af
		15400af	15485af	17640af	17830af
		17885af	21470af		
1100	1145	USA, WYFR/Family R Okeechobee FL		9550va	
		9755va			
1100	1159	s Germany, Universal Life		6055me	
1100	1200	Anguilla, University Network		11775am	
1100	1200	Australia, ABC NT Alice Springs		4835irr	2310do
1100	1200	Australia, ABC NT Katherine		2485do	
1100	1200	Australia, ABC NT Tennant Creek			2325do
1100	1200	Australia, CVC International		13635as	
1100	1200	DRM Bulgaria, World Radio Network			13865eu
1100	1200	as Canada, CBC NQ SW Service		9625na	
1100	1200	Canada, CFRX Toronto ON		6070na	
1100	1200	Canada, CFVP Calgary AB		6030na	
1100	1200	Canada, CKZN St John's NF		6160na	
1100	1200	Canada, CKZU Vancouver BC		6160na	
1100	1200	China, China Radio Intl		6040na	11750na
		13650eu	17490eu		
1100	1200	Costa Rica, University Network		5030va	6150va
		7375va	9725va	11870va	13750va
1100	1200	Germany, CVC The Voice Africa		9555af	
1100	1200	1st a Germany, Overcomer Ministries		6110eu	
1100	1200	Italy, IRRS		13840va	
1100	1200	Japan, Radio Japan/NHK World		9695as	6120na
		11730as			
1100	1200	vi Libya, Voice of Africa		17725af	21695af
1100	1200	Malaysia, RTM/Trax FM		7295as	

1100	1200	Malaysia, Voice of 15295as			
1100	1200	Netherlands, Radio		11675na	
1100	1200	New Zealand, Radio NZ Intl		9870pa	
1100	1200	DRM New Zealand, Radio NZ Intl		6095pa	
1100	1200	Nigeria, Voice of 7255af			
1100	1200	Papua New Guinea, Catholic Radio		4960do	
1100	1200	Papua New Guinea, NBC		4890do	
1100	1200	vi Papua New Guinea, Wantok R.Light		7120va	
1100	1200	Singapore, Radio Singapore Intl		6080as	
		6150as			
1100	1200	South Africa, Channel Africa		9620af	
1100	1200	Taiwan, Radio Taiwan Intl		7445as	
1100	1200	UK, BBC World Service		11865va	15310as 15575me 17760as
		17790as			
1100	1200	Ukraine, Radio Ukraine Intl		15675eu	
1100	1200	USA, American Forces Radio		4319usb	5446usb
		5765usb	6350usb	7590usb	7812usb
		10320usb	12133usb	12579usb	13362usb
		13855usb			
1100	1200	USA, KAIJ Dallas TX		5755na	
1100	1200	USA, KTBN Salt Lake City UT		7505na	
1100	1200	USA, KWHR Naalehu HI		9930as	11565as
1100	1200	USA, Voice of America		15205va	
1100	1200	USA, WBOH Newport NC		5920am	
1100	1200	USA, WEVN Birmingham AL		5050na	
1100	1200	USA, WHRI Noblesville IN		7520am	7555am
1100	1200	USA, WINB Red Lion PA		9265am	
1100	1200	USA, WTJC Newport NC		9370na	
1100	1200	USA, WWCR Nashville TN		5070na	5935na
		7465na	15825na		
1100	1200	USA, WWRB Manchester TN		3185na	
1100	1200	USA, WWRB Manchester TN		3185na	
1100	1200	USA, WYFR/Family R Okeechobee FL		5950va	
		5985va	7780va	9625va	
1100	1200	Zambia, Christian Voice		6065af	
1115	1200	s USA, WRMI Miami FL		9955am	
1130	1159	a Germany, Universal Life		6055me	
1130	1200	mtwhfa Australia, HCJB		15425as	
				5995pa	9475va 9590va
				9580pa	9590pa 11880va
1130	1200	Bulgaria, Radio		11700eu	15700eu
1130	1200	Guam, AWR/KSDA		15435as	
1130	1200	UK, BBC World Service		6190af	11940af
		15485af	17640af	17830af	17885af
		21470af			
1130	1200	Vatican City, Vatican Radio		15595va	17515va
1157	1200	Greece, Macedonias Radio		9935eu	

### 1200 UTC - 8AM EDT / 7AM CDT / 5AM PDT

1200	1215	vi Cambodia, National Radio		11940as	
1200	1230	France, Radio France Intl		17815af	21620af
1200	1230	Malaysia, Voice of 15295as			
1200	1230	UAE, AWR Africa		15140as	15365as
1200	1245	USA, WYFR/Family R Okeechobee FL		5985am	5950am
1200	1259	Canada, Radio Canada Intl		9660as	15170as
1200	1259	New Zealand, Radio NZ Intl		9870pa	
1200	1259	Poland, Radio Polonia		9525eu	11850eu
1200	1300	Anguilla, University Network		11775am	
1200	1300	Australia, ABC NT Alice Springs		4835irr	2310do
1200	1300	Australia, ABC NT Katherine		2485do	
1200	1300	Australia, ABC NT Tennant Creek			2325do
1200	1300	Australia, CVC International		17860me	
1200	1300	Australia, Radio		5995pa	9475va 9590va
		9580pa	9590pa	11880va	
1200	1300	DRM Bulgaria, World Radio Network			13865eu
1200	1300	as Canada, CBC NQ SW Service		9625na	
1200	1300	Canada, CFRX Toronto ON		6070na	
1200	1300	Canada, CFVP Calgary AB		6030na	
1200	1300	Canada, CKZN St John's NF		6160na	
1200	1300	Canada, CKZU Vancouver BC		6160na	
1200	1300	China, China Radio Intl		9730as	9760oc 13790eu
		11760oc	11980as	13650eu	
		17490eu	17625af		
1200	1300	Costa Rica, University Network		9725va	11870va
		13750va			
1200	1300	Germany, CVC International		17860as	
1200	1300	Germany, CVC The Voice Africa		9555af	
1200	1300	Germany, Overcomer Ministries		13810eu	6110eu
1200	1300	fas Italy, IRRS		15740as	
1200	1300	Italy, IRRS		13840va	
1200	1300	vi Libya, Voice of Africa		17670af	17675af
		17680af	21695af		
1200	1300	Malaysia, RTM/Trax FM		7295as	
1200	1300	Malaysia, Voice of 6175as			
1200	1300	DRM Netherlands, Radio		7240eu	
1200	1300	DRM New Zealand, Radio NZ Intl		6095pa	
1200	1300	Nigeria, Voice of 7255af			
1200	1300	Papua New Guinea, Catholic Radio		4960do	
1200	1300	Papua New Guinea, NBC		4890do	
1200	1300	vi Papua New Guinea, Wantok R.Light		7120va	
1200	1300	Singapore, Radio Singapore Intl		6080as	

1200	1300	6150as	South Korea, KBS World Radio	9650na	
1200	1300		Taiwan, Radio Taiwan Intl	7130na	
1200	1300		UK, BBC World Service	6190af	6195as
		9740as	11865va	11940af	15310as
		15485af	15575me	17640af	17760as
		17790as	17830af	17885af	21470af
1200	1300		USA, American Forces Radio	4319usb	5446usb
		5765usb	6350usb	7590usb	7812usb
		10320usb	12133usb	12579usb	13362usb
		13855usb			
1200	1300		USA, KAIJ Dallas TX	5755na	
1200	1300		USA, KNLS Anchor Point AK	9615as	9780as
1200	1300		USA, KTBN Salt Lake City UT	7505na	
1200	1300		USA, KWHR Naalehu HI	11565as	12130as
1200	1300		USA, Voice of America	6160va	9645va
		9760va	11750va		
1200	1300		USA, WBOH Newport NC	5920am	
1200	1300		USA, WEWN Birmingham AL	5050na	
1200	1300		USA, WHRA Greenbush ME	15665na	
1200	1300		USA, WHRI Noblesville IN	9495am	9840am
		12050am			
1200	1300		USA, WINB Red Lion PA	13570am	
1200	1300		USA, WTJC Newport NC	9370na	
1200	1300		USA, WWCR Nashville TN	7465na	9985na
		13845na	15825na		
1200	1300		USA, WWRB Manchester TN	3185na	
1200	1300		USA, WYFR/Family R Okeechobee FL	17750am	17555am
1200	1300		Zambia, Christian Voice	6065af	
1205	1220	m	Austria, Radio Austria Intl	6155eu	13730eu
			17715as		
1205	1230	as	Austria, Radio Austria Intl	6155eu	13730eu
			17715va		
1215	1230	twhf	Austria, Radio Austria Intl	17715va	
1215	1300		Egypt, Radio Cairo	17835as	
1230	1258		Vietnam, Voice of	9840as	12020as
1230	1300		Bangladesh, Bangla Betar	7185as	
1230	1300		Sweden, Radio	13580va	15240na
1230	1300		Thailand, Radio	9835va	
1230	1300		Turkey, Voice of	15450eu	15535va
1235	1300	as	Austria, Radio Austria Intl	6155eu	13730eu
			17715va		
1245	1300	twh	Austria, Radio Austria Intl	6155eu	13730eu
			17715va		
1255	1258		Finland, YLE/Radio Finland	13715do	15400do

**1300 UTC - 9AM EDT / 8AM CDT / 6AM PDT**

1300	1315	w	Australia, HCJB	15405as	
1300	1320		Turkey, Voice of	15450eu	15535va
1300	1327		Czech Rep, Radio Prague	13580as	17540na
1300	1330		Australia, HCJB	15400as	
1300	1330		Egypt, Radio Cairo	17835as	
1300	1330	DRM	Netherlands, Radio	7240eu	
1300	1356		Romania, Radio Romania Intl	11845eu	15105eu
1300	1400		Anguilla, University Network	11775am	
1300	1400		Australia, CVC International	17860me	
1300	1400		Australia, Radio	5995pa	6020pa
			9580pa	9590pa	
1300	1400	DRM	Bulgaria, World Radio Network		13865eu
1300	1400	as	Canada, CBC NQ SW Service	9625na	
1300	1400		Canada, CFRX Toronto ON	6070na	
1300	1400		Canada, CFVP Calgary AB	6030na	
1300	1400		Canada, CKZN St John's NF	6160na	
1300	1400		Canada, CKZU Vancouver BC	6160na	
1300	1400		Canada, Radio Canada Intl	9515am	13655am
			17800am		
1300	1400		China, China Radio Intl	9570na	9650pa
			11760oc	11900oc	11980as
			15260na	17490eu	
1300	1400		Costa Rica, University Network	9725va	11870va
			13750va		
1300	1400		Germany, CVC International	17860as	
1300	1400		Germany, CVC The Voice Africa		9555af
1300	1400		Germany, Deutsche Welle	6140eu	
1300	1400		Germany, Overcomer Ministries		6110eu
			13810eu		
1300	1400	as	Italy, IRRS	13840va	
1300	1400	mtwhf	Italy, IRRS	15740va	
1300	1400		Jordan, Radio	11690na	
1300	1400	vl	Libya, Voice of Africa	17690af	17675af
			17680af	21695af	
1300	1400		Malaysia, RTM/Trax FM	7295as	
1300	1400		Malaysia, Voice of	6175as	
1300	1400		New Zealand, Radio NZ Intl	7145pa	
1300	1400	DRM	New Zealand, Radio NZ Intl	6095pa	
1300	1400		Nigeria, Voice of	7255af	
1300	1400		North Korea, Voice of Korea	7570eu	9335na
			11710na	12015eu	13760eu
					15245eu
1300	1400		Papua New Guinea, Catholic Radio	4960do	
1300	1400		Papua New Guinea, NBC	4890do	
1300	1400	vl	Papua New Guinea, Wantok R.Light		7120va
1300	1400		Singapore, Radio Singapore Intl		6080as
			6150as		

1300	1400		South Korea, KBS World Radio	9570na	
			9770na		
1300	1400		UK, BBC World Service	6190af	6195as
			9740as	11760me	11940af
			15310as	15420af	15485af
			15575me	17640va	17760as
			17830af	17885af	21470af
1300	1400		USA, American Forces Radio	4319usb	5446usb
			5765usb	6350usb	7590usb
			10320usb	12133usb	12579usb
			13855usb		
1300	1400		USA, KAIJ Dallas TX	5755na	
1300	1400		USA, KTBN Salt Lake City UT	7505na	
1300	1400		USA, KWHR Naalehu HI	12130as	
1300	1400		USA, Voice of America	9645va	9760va
1300	1400	w f	USA, WBCQ Kennebunk ME	9330na	
1300	1400		USA, WBOH Newport NC	5920am	
1300	1400		USA, WEWN Birmingham AL	5050na	
1300	1400		USA, WHRA Greenbush ME	15665na	
1300	1400		USA, WHRI Noblesville IN	9840am	11785am
			12050am		
1300	1400		USA, WINB Red Lion PA	13570am	
1300	1400		USA, WTJC Newport NC	9370na	
1300	1400		USA, WWCR Nashville TN	7465na	9985na
			13845na	15825na	
1300	1400		USA, WWRB Manchester TN	9385na	
1300	1400		USA, WYFR/Family R Okeechobee FL	11520va	11910va
			11560va	11830va	11865va
			17750va		
1300	1400		Zambia, Christian Voice	6065af	
1330	1400	s	Australia, HCJB	15435as	
1330	1400	twhfa	Guam, AWR/KSDA	15275as	
1330	1400		Guam, TWR/KTWR	9585as	
1330	1400		India, All India Radio	13710as	9690as
					11620as
1330	1400		Laos, National Radio	7145as	
1330	1400		Sweden, Radio	15240na	15735va

**1400 UTC - 10AM EDT / 9AM CDT / 7AM PDT**

1400	1415	th	Germany, Pan American BC	15205me	
1400	1415		Russia, FEBA	9500as	
1400	1415		Seychelles, FEBA	9500va	
1400	1430		Australia, Radio	5995pa	6080pa
			9590pa	11750as	7420va
1400	1430	DRM	Canada, Radio Canada Intl		9815eu
1400	1430		Thailand, Radio	9830va	
1400	1500		Anguilla, University Network	11775am	
1400	1500		Australia, CVC International	15795as	
1400	1500	DRM	Bulgaria, World Radio Network		11540eu
1400	1500	as	Canada, CBC NQ SW Service	9625na	
1400	1500		Canada, CFRX Toronto ON	6070na	
1400	1500		Canada, CFVP Calgary AB	6030na	
1400	1500		Canada, CKZN St John's NF	6160na	
1400	1500		Canada, CKZU Vancouver BC	6160na	
1400	1500		Canada, Radio Canada Intl	9515am	13655am
			17800am		
1400	1500		China, China Radio Intl	6100af	9560as
			11675as	11765as	11775as
			13710na	13740na	13790na
			17650eu		
1400	1500		Costa Rica, University Network	9725va	11870va
			13750va		
1400	1500		France, Radio France Intl	21620as	
1400	1500		Germany, CVC International	15795as	
1400	1500		Germany, CVC The Voice Africa		9555af
1400	1500		Germany, Deutsche Welle	6140eu	
1400	1500		Germany, Overcomer Ministries		13810va
1400	1500	a	Greece, Voice of	9420eu	15630eu
1400	1500		Guam, TWR/KTWR	9975as	
1400	1500		India, All India Radio	9690as	11620as
			13710as		
1400	1500		Italy, IRRS	9310va	
1400	1500	as	Italy, IRRS	13840va	
1400	1500		Japan, Radio Japan/NHK World		7200as
			11730as	11840oc	
1400	1500		Jordan, Radio	11690na	
1400	1500		Libya, Voice of Africa	17725af	17850af
1400	1500		Malaysia, RTM/Trax FM	7295as	
1400	1500		Malaysia, Voice of	6175as	
1400	1500		Netherlands, Radio		9345as
			11835as		9890as
1400	1500		New Zealand, Radio NZ Intl	7145pa	
1400	1500	DRM	New Zealand, Radio NZ Intl	6095pa	
1400	1500		Nigeria, Voice of	7255af	
1400	1500		Oman, Radio Oman		15140as
1400	1500	vl	Papua New Guinea, Wantok R.Light		7120va
1400	1500		Russia, Voice of	7165eu	7370as
			11755as	12055as	15605as
					17645as
1400	1500		Singapore, MediaCorp Radio	6150do	
1400	1500		South Africa, Channel Africa	9620af	
1400	1500		Taiwan, Radio Taiwan Intl	15265as	
1400	1500		UK, BBC World Service	6190af	6195as
			9740as	11940af	15310as
			15485va	15565eu	15575me
					17640va



			17760as	17790as	17830af	21470af	
			21660af				
1400	1500	as	UK, Bible Voice	15690as			
1400	1500		USA, American Forces Radio	4319usb	5446usb		
			5765usb	6350usb	7590usb	7812usb	
			10320usb	12133usb	12579usb	13362usb	
			13855usb				
1400	1500		USA, KAIJ Dallas TX		13815na		
1400	1500		USA, KJES Vado NM		11715na		
1400	1500		USA, KNLS Anchor Point AK		9795as		
1400	1500		USA, KTBN Salt Lake City UT		7505na		
1400	1500		USA, KWHR Naalehu HI		9930as		
1400	1500		USA, Voice of America		4930af	6080af	
			7125va	9760va	13795af	15185af	
			15490af	15580af	17720af	17730af	
1400	1500		USA, WBCQ Kennebunk ME		9330na		
1400	1500		USA, WBOH Newport NC		5920am		
1400	1500		USA, WEWN Birmingham AL		9955na		
1400	1500		USA, WHRA Greenbush ME		17650na		
1400	1500		USA, WHRI Noblesville IN		9840am	11785am	
			12050am				
1400	1500		USA, WINB Red Lion PA		13570am		
1400	1500		USA, WRMI Miami FL		7385am		
1400	1500		USA, WTJC Newport NC		9370na		
1400	1500		USA, WWCR Nashville TN		9985na	12160na	
			13845na	15825na			
1400	1500		USA, WWRB Manchester TN		9385na		
1400	1500		USA, WYFR/Family R Okeechobee FL		11520va		
			11560va	11830va	11910va	13695va	
			17750va				
1400	1500		Zambia, Christian Voice		6065af		
1415	1430		Nepal, Radio	3230as	5005as	6100as	
			7165as				
1430	1445	s	Germany, Pan American BC		15205as	15650as	
1430	1459	s	UK, Bible Voice		12005as		
1430	1500		Australia, Radio	5995pa	6080pa	7420va	
			9475pa	9590pa	11660va	11750va	
1430	1500	DRM	South Korea, KBS World Radio			9770eu	

**1500 UTC - 11AM EDT / 10AM CDT / 8AM PDT**

1500	1510	mtwhfa	Turkmenistan, Turkmen Radio		5015eu		
1500	1528		Vietnam, Voice of	9550va	9840va	12020va	
			13860va				
1500	1530	s	Hungary, Radio Budapest		6025eu	9690eu	
1500	1530		Mongolia, Voice of 12015eu				
1500	1530		UK, BBC World Service		9695af	11690af	
			11940af	15400af	15420af	15485af	
			17640af	17830af	21470af	21660af	
1500	1530	fs	UK, Bible Voice		13840as		
1500	1545		Germany, CVC The Voice Africa			9555af	
			15715af				
1500	1545		Russia, FEBA		7320as		
1500	1545		Seychelles, FEBA		7320va		
1500	1545	a	UK, Bible Voice		15690as		
1500	1545		USA, WYFR/Family R Okeechobee FL			15770va	
1500	1555		South Africa, Channel Africa		17770af		
1500	1557		Canada, Radio Canada Intl		11675as	15360as	
			17720as				
1500	1557		Libya, Voice of Africa		17725af	17850af	
			21695af				
1500	1559		Canada, Radio Canada Intl		9515as	13655as	
			17800as				
1500	1559		South Africa, Channel Africa		9620af		
1500	1559	w	UK, Bible Voice		15680as		
1500	1600		Anguilla, University Network		11775am		
1500	1600		Australia, CVC International		15795as		
1500	1600		Australia, Radio	5995pa	6080pa	7420va	
			9475pa	9590pa	11660va	11750va	
1500	1600	DRM	Bulgaria, World Radio Network			11540eu	
1500	1600	as	Canada, CBC NQ SW Service		9625na		
1500	1600		Canada, CFRX Toronto ON		6070na		
1500	1600		Canada, CFVP Calgary AB		6030na		
1500	1600		Canada, CKZN St John's NF		6160na		
1500	1600		Canada, CKZU Vancouver BC		6160na		
1500	1600		China, China Radio Intl		6100af	7160as	
			9785as	11965eu	13640eu	13685af	
			13740na	17490eu			
1500	1600		Costa Rica, University Network		9725va	11870va	
			13750va				
1500	1600		France, Radio France Intl		17850af		
1500	1600		Germany, CVC International		15795as		
1500	1600		Germany, Deutsche Welle		6140eu		
1500	1600		Germany, Overcomer Ministries			13810va	
1500	1600		Italy, IRRS		5785va	9310va	
1500	1600	as	Italy, IRRS		13840eu		
1500	1600		Japan, Radio Japan/NHK World			6190as	
			7200as	9505va	11730as		
1500	1600		Jordan, Radio		11690na		
1500	1600		Malaysia, RTM/Trax FM		7295as		
1500	1600		Malaysia, Voice of 6175as				
1500	1600		Netherlands, Radio		9345as	9890as	
			11835as				
1500	1600		New Zealand, Radio NZ Intl		7145pa		
1500	1600	DRM	New Zealand, Radio NZ Intl		6095pa		

1500	1600		North Korea, Voice of Korea		7570eu	9335na	
			11710na	12015eu	13760eu	15245eu	
1500	1600	vl	Papua New Guinea, Wantok R.Light			7120va	
1500	1600		Russia, Voice of		4965me	4975me	7370eu
			9660as	12040eu	15455eu		
1500	1600		Singapore, MediaCorp Radio		6150do		
1500	1600		UK, BBC World Service		5975as	6195as	
			9740as	11750as	12095eu	15310as	
			15485eu	15565eu	17640va	17790as	
1500	1600	vl/ mtwhf	UK, Sudan Radio Service		15575af		
1500	1600		USA, American Forces Radio		4319usb	5446usb	
			5765usb	6350usb	7590usb	7812usb	
			10320usb	12133usb	12579usb	13362usb	
			13855usb				
1500	1600		USA, KAIJ Dallas TX		13815na		
1500	1600		USA, KJES Vado NM		11715na		
1500	1600		USA, KTBN Salt Lake City UT		7505na		
1500	1600		USA, KWHR Naalehu HI		9930as		
1500	1600		USA, Voice of America		4930af	6160va	
			7125af	7405va	9590va	12040va	
			12150af	13795va	15105va	15195va	
			15445va	15550af	15580af	17895af	
1500	1600		USA, WBCQ Kennebunk ME		9330na		
1500	1600		USA, WBOH Newport NC		5920am		
1500	1600		USA, WEWN Birmingham AL		9955na		
1500	1600		USA, WHRA Greenbush ME		17650na		
1500	1600		USA, WHRI Noblesville IN		9840am	11785am	
			13760am				
1500	1600		USA, WINB Red Lion PA		13570am		
1500	1600	smtwhf	USA, WMLK Bethel PA		9265eu		
1500	1600		USA, WRMI Miami FL		7385am		
1500	1600		USA, WTJC Newport NC		9370na		
1500	1600		USA, WWCR Nashville TN		9985na	12160na	
			13845na	15825na			
1500	1600		USA, WWRB Manchester TN		9385na	11915na	
1500	1600		USA, WYFR/Family R Okeechobee FL		6280va		
			11830va	11910va	15750af	17750va	
1500	1600		Zambia, Christian Voice		4965af		
1500	1600	f DRM	Taiwan, Radio Taiwan Intl		9770eu		
1505	1520	m	Austria, Radio Austria Intl		13775am		
1505	1530	as	Austria, Radio Austria Intl		13775am		
1515	1530	twhf	Austria, Radio Austria Intl		13775am		
1530	1559	smhf	UK, Bible Voice		15680as	13840al	
1530	1600		Iran, Voice of the Islamic Rep		7350as	9635as	
			11650al				
1530	1600		UAE, AWR Africa		15225as		
1530	1600		UK, BBC World Service		6190af	11940af	
			15400af	15485af	17640af	17830af	
			21470af	21660af			
1530	1600		Vatican City, Vatican Radio		12065va	13765va	
			15235va				
1535	1600	as	Austria, Radio Austria Intl		13755am		
1540	1600	t	UK, Bible Voice		13590me		
1545	1600	mtwhf	Austria, Radio Austria Intl		13755am		
1545	1600	s	Germany, Pan American BC		15650me		
1545	1600	a	UK, Bible Voice		13590me		

**1600 UTC - 12PM EDT / 11AM CDT / 9AM PDT**

1600	1615		Pakistan, Radio		9375va	11570va	12105va
			15725va				
1600	1615	f	Seychelles, FEBA		9850va		
1600	1615		UK, BBC World Service		3255af	6190af	
			12095af	15105af	15400af	15485af	
			17830af	17885af	21470af	21660af	
1600	1615	mwf	UK, Bible Voice		13590me		
1600	1620	mtwhf	Moldova, Radio DMR Pridnestrovy		5965eu		
1600	1627		Czech Rep, Radio Prague		5930eu	17485af	
1600	1628		Vietnam, Voice of		7280va	9550va	9730va
			11630va	13860va			
1600	1630	sh	Germany, Pan American BC		15650me		
1600	1630		Guam, AWR/KSDA 11640as		11680as		
1600	1630		Iran, Voice of the Islamic Rep		7350as	9635as	
			11650al				
1600	1630		Jordan, Radio		11690na		
1600	1630		Myanmar, Radio		9730do		
1600	1640	f	Moldova, Radio DMR Pridnestrovy		5965eu		
1600	1645	h	UK, Bible Voice		13590me		
1600	1645		USA, WYFR/Family R Okeechobee FL		11830va		
			11865va	17750va			
1600	1650		New Zealand, Radio NZ Intl		7145pa		
1600	1650	DRM	New Zealand, Radio NZ Intl		6095pa		
1600	1700		Anguilla, University Network		11775am		
1600	1700		Australia, CVC International		15795as		
1600	1700		Australia, Radio	5995pa	6080pa	7240va	
			9475pa	9710pa	11660as		
1600	1700	DRM	Bulgaria, World Radio Network			11540eu	
1600	1700	a	Canada, CBC NQ SW Service		9625na		
1600	1700		Canada, CFRX Toronto ON		6070na		
1600	1700		Canada, CFVP Calgary AB		6030na		
1600	1700		Canada, CKZN St John's NF		6160na		
1600	1700		Canada, CKZU Vancouver BC		6160na		
1600	1700		China, China Radio Intl		6100af	9570af	
			11900af	11940eu	11865eu	13760eu	
			17490eu				

1600	1700		Costa Rica, University Network	11870va	13750va
1600	1700		Egypt, Radio Cairo	11740af	
1600	1700		Ethiopia, Radio	5990af 7110af 7165af	
			9560af 9704af 11800af		
1600	1700		France, Radio France Intl	7170af	11615af
			15160af 15605af 17605af		
1600	1700		Germany, CVC International	15795as	
1600	1700		Germany, CVC The Voice Africa		15715af
1600	1700		Germany, Deutsche Welle	6170as	9485as
			15705as		
1600	1700		Italy, IRRS	5785va	9310va
1600	1700		Malaysia, RTM/Trax FM		7295as
1600	1700		Malaysia, Voice of 6175as		
1600	1700		North Korea, Voice of Korea	9990va	11545va
1600	1700	vl	Papua New Guinea, Wantok R.Light		7120va
1600	1700		Russia, Voice of	6070as 7370eu	9405as
			11755as 11985af 12055va		12115as
			15540me		
1600	1700		South Korea, KBS World Radio		5975va
1600	1700		Swaziland, TWR	6130af	
1600	1700		Taiwan, Radio Taiwan Intl	11550as	
1600	1700		UK, BBC World Service	3915as	5975as
			6195as 7160as 9510as 11955as		
			12095va 15485eu 15565eu		17790va
1600	1700	ta	UK, Bible Voice	13590me	
1600	1700	vl/ mtwhf	UK, Sudan Radio Service	15575af	
1600	1700		USA, American Forces Radio	4319usb	5446usb
			5765usb 6350usb 7590usb		7812usb
			10320usb 12133usb		13362usb
			13855usb		
1600	1700		USA, KAIJ Dallas TX	13815na	
1600	1700		USA, KJES Vado NM	11715na	
1600	1700		USA, KTBN Salt Lake City UT	15590na	
1600	1700		USA, KWHR Naalehu HI	9930as	
1600	1700		USA, Voice of America	4930af	7405af
			15195va 12080af 13600va		15410af
			15445va 15580af 17895af		
1600	1700		USA, WBCQ Kennebunk ME	9330na	
1600	1700		USA, WBOH Newport NC	5920am	
1600	1700		USA, WEWN Birmingham AL	13615na	
1600	1700		USA, WHRA Greenbush ME	17640na	
1600	1700		USA, WHRI Noblesville IN	9840am	13760am
			15285am		
1600	1700		USA, WINB Red Lion PA	13570am	
1600	1700	smtwhf	USA, WMLK Bethel PA	9265eu	
1600	1700		USA, WTJC Newport NC	9370na	
1600	1700		USA, WWCR Nashville TN	9985na	12160na
			13845na 15825na		
1600	1700		USA, WWRB Manchester TN	9385na	11915na
1600	1700		USA, WYFR/Family R Okeechobee FL	6085va	21455va
			6085va 13695va 18980va		21455va
			2525va		
1600	1700		Zambia, Christian Voice	4965af	
1615	1630		Vatican City, Vatican Radio	4005eu	5885eu
			7250eu 9645eu		15595va
1615	1700		UK, BBC World Service	3255af	6190af
			12095af 15105af 15420af		15485af
			17830af 17885af		21470af
			21470af		
1615	1700	as	UK, BBC World Service	9695af	11690af
1615	1700	mwf	UK, Bible Voice	9430me	
1630	1700		Guam, AWR/KSDA	11975as	
1630	1700	mtwf	UK, Bible Voice	13580me	
1630	1700	as	UK, Bible Voice	9430me	
1640	1650	mtwhfa	Turkmenistan, Turkmen Radio	4930eu	
1650	1700		New Zealand, Radio NZ Intl	6095pa	
1651	1700	DRM	New Zealand, Radio NZ Intl	7145pa	

1700	1800		Italy, IRRS	5785va	
1700	1800	f	Italy, IRRS	5775va	
1700	1800		Japan, Radio Japan/NHK World		9535na
			11970eu 15355af		
1700	1800	DRM	Japan, Radio Japan/NHK World		9770eu
1700	1800		Japan, Radio Japan/NHK World		9535va
			11970eu 15355af		
1700	1800		Malaysia, RTM/Trax FM		7295as
1700	1800		Malaysia, Voice of 6175as		
1700	1800		New Zealand, Radio NZ Intl		6095pa
1700	1800	DRM	New Zealand, Radio NZ Intl		7145pa
1700	1800		Nigeria, Voice of	15120va	
1700	1800	vl	Papua New Guinea, Wantok R.Light		7120va
1700	1800		Russia, Voice of	7370eu	9405as
			11510af 11985af		9890eu
1700	1800	as	Russia, Voice of	9820eu	
1700	1800		Swaziland, TWR	3200af	
1700	1800		Taiwan, Radio Taiwan Intl		15690va
1700	1800		UK, BBC World Service		3915as 5975as
			6195eu 7160as 9410eu		9510as
			11955as 15485va		15565eu
1700	1800	vl/ mtwhf	UK, Sudan Radio Service	11705af	
1700	1800		USA, American Forces Radio	4319usb	5446usb
			5765usb 6350usb		7812usb
			10320usb 12133usb		12579usb
			13855usb		13362usb
1700	1800		USA, KAIJ Dallas TX	13815na	
1700	1800		USA, KTBN Salt Lake City UT	15590na	
1700	1800		USA, KWHR Naalehu HI	9930as	
1700	1800		USA, Voice of America	7405af	15410af
			15580af		
1700	1800		USA, WBCQ Kennebunk ME	9330na	18910na
1700	1800		USA, WBOH Newport NC	5920am	
1700	1800		USA, WEWN Birmingham AL	13615va	15220va
1700	1800		USA, WHRA Greenbush ME	17640na	
1700	1800		USA, WHRI Noblesville IN	13760am	15285am
			15665am 15785am		
1700	1800		USA, WINB Red Lion PA	13570am	
1700	1800	smtwhf	USA, WMLK Bethel PA	9265eu	
1700	1800		USA, WTJC Newport NC	9370na	
1700	1800		USA, WWCR Nashville TN	9985na	12160na
			13845na 15825na		
1700	1800		USA, WWRB Manchester TN	9385na	11915na
1700	1800		USA, WYFR/Family R Okeechobee FL	6085va	21455va
			6085va 13695va 18980va		21455va
			2525va		
1700	1800		Zambia, Christian Voice	4965af	
1730	1745	mtwhf	Israel, Kol Israel	9345va	11590va
1730	1745		UK, United Nations Radio	7170af	15495me
			17810af		
1730	1800		Bulgaria, Radio	9500eu	11500eu
1730	1800		Guam, AWR/KSDA	9385as	
1730	1800		Liberia, ELWA	4760do	
1730	1800		Philippines, Radio Pilipinas		11720va 15190va
			17720va		
1730	1800		Swaziland, TWR	9500af	
1730	1800		Sweden, Radio	6065va	
1730	1800	mtwhf	USA, Voice of America	13755af	17730af
1730	1800		Vatican City, Vatican Radio	11625af	13765af
			15570af		
1745	1800		India, All India Radio	7410eu	9445af
			9950eu 11620eu		11935af
			15075af 15155af		17670af
1745	1800		UK, BBC World Service	3255af	6190af
			11945af 12095af		15105af 15400af
			15485af 17830af		17885af 21470af

**1700 UTC - 1PM EDT / 12PM CDT / 10AM PDT**

1700	1715	t	UK, Bible Voice	13580me	
1700	1727		Czech Rep, Radio Prague	5930va	17485va
1700	1730		France, Radio France Intl	15605af	17605af
1700	1735	mwf	UK, Bible Voice	9430me	
1700	1745		UK, BBC World Service	3255af	6005af
			6190af 9630af 9740as		11945af
			12095va 15105af 15400af		
			17830af 17885af		21470af
1700	1755		South Africa, Channel Africa	15235af	
1700	1759		Poland, Radio Polonia	7220eu	7265eu
1700	1759	as	UK, Bible Voice	9430me	
1700	1800		Anguilla, University Network	11775am	
1700	1800		Australia, CVC International	13635as	
1700	1800		Australia, Radio	5995pa	6080pa
			9580pa 9710pa		9475va
1700	1800	DRM	Bulgaria, World Radio Network		11540eu
1700	1800	a	Canada, CBC NQ SW Service	9625na	
1700	1800		Canada, CFRX Toronto ON	6070na	
1700	1800		Canada, CFVP Calgary AB	6030na	
1700	1800		Canada, CKZN St John's NF	6160na	
1700	1800		Canada, CKZU Vancouver BC	6160na	
1700	1800		China, China Radio Intl	9570af	9600eu
			11900af 11940eu		13760eu
1700	1800		Costa Rica, University Network	11870va	13750va
1700	1800		Egypt, Radio Cairo	11740af	
1700	1800		Germany, CVC The Voice Africa		15715af

**1800 UTC - 2PM EDT / 1PM CDT / 11AM PDT**

1800	1815	t	UK, Bible Voice	13590me	
1800	1828		Vietnam, Voice of	5955eu	7280va 9730va
1800	1830		Austria, AWR Europe		15315af
1800	1830		South Africa, AWR Africa	3215af	3345af
			9610af		
1800	1830		UK, BBC World Service	3255af	5975as
			6190af 9510as		11945af 12095af
			15400af		
1800	1830	as	UK, Bible Voice	13590me	13810al
1800	1830	whf	UK, Bible Voice	11710me	
1800	1830		USA, Voice of America	7405af	11975af
			15410af 15580af		17895af
1800	1830	as	USA, Voice of America	4930af	
1800	1845		USA, WYFR/Family R Okeechobee FL		17535va
1800	1850		New Zealand, Radio NZ Intl	6095pa	
1800	1850	DRM	New Zealand, Radio NZ Intl	7145pa	
1800	1856		Romania, Radio Romania Intl	9635eu	11730eu
1800	1859		Canada, Radio Canada Intl	9530af	11765af
			13730af 15255af		
1800	1900		Anguilla, University Network	11775am	
1800	1900	mtwhf	Argentina, RAE	9690eu	15345eu
1800	1900		Australia, Radio	6080pa	7240pa
			9580pa 9710pa		11880pa
1800	1900	DRM	Bulgaria, World Radio Network		9310eu
1800	1900		Canada, CFRX Toronto ON	6070na	
1800	1900		Canada, CFVP Calgary AB	6030na	

1800	1900	Canada, CKZN St John's NF	6160na	
1800	1900	Canada, CKZU Vancouver BC	6160na	
1800	1900	China, China Radio Intl	9600eu	11940eu
		13760eu		
1800	1900	Costa Rica, University Network	11870va	13750va
1800	1900	Germany, CVC The Voice Africa		13820af
1800	1900	India, All India Radio	7410eu	9445af
		9950eu	11620eu	11935af
		15075af	15155af	17670af
1800	1900	f Italy, IRRS	5775va	
1800	1900	Italy, IRRS	5785va	
1800	1900	Liberia, ELWA	4760do	
1800	1900	Malaysia, RTM/Trax FM		7295as
1800	1900	Malaysia, Voice of	6175as	
1800	1900	Netherlands, Radio		6020af 7120af
		11655af		
1800	1900	Nigeria, Voice of	15120va	
1800	1900	North Korea, Voice of Korea	7570eu	12015eu
		13760eu	15245eu	
1800	1900	vi Papua New Guinea, Wantok R.Light		7120va
1800	1900	Philippines, Radio Pilipinas	11720va	15190va
		17720va		
1800	1900	Russia, Voice of	7370eu	9745af 9820eu
		9890eu	11510af	11630eu
1800	1900	Swaziland, TWR	3200af	9500af
1800	1900	Taiwan, Radio Taiwan Intl		3965eu
1800	1900	UK, BBC World Service	6195eu	9410eu
		12095eu		
1800	1900	as UK, Bible Voice	6015eu	11710al
1800	1900	USA, American Forces Radio	4319usb	5446usb
		5765usb	6350usb	7590usb 7812usb
		10320usb	12133usb	13362usb
		13855usb		
1800	1900	USA, KAJI Dallas TX		13815na
1800	1900	USA, KTBN Salt Lake City UT		15590na
1800	1900	smtwhf USA, WBCQ Kennebunk ME	7415na	
1800	1900	USA, WBCQ Kennebunk ME	9330na	18910na
1800	1900	USA, WBOH Newport NC	5920am	
1800	1900	USA, WEWN Birmingham AL	13615va	15220va
1800	1900	USA, WHRA Greenbush ME	17640na	
1800	1900	USA, WHRI Noblesville IN	13760am	15285am
		15665am	15785am	
1800	1900	USA, WINB Red Lion PA	13570am	
1800	1900	smtwhf USA, WMLK Bethel PA	9265eu	
1800	1900	USA, WTJC Newport NC	9370na	
1800	1900	USA, WWCR Nashville TN	9975na	12160na
		13845na	15825na	
1800	1900	USA, WWRB Manchester TN	9385na	11915na
		15250na		
1800	1900	USA, WYFR/Family R Okeechobee FL	7240va	
		13690va	13800af	15750va 17795va
		18980va		
1800	1900	Yemen, Rep of Yemen Radio	9780me	
1800	1900	Zambia, Christian Voice	4965af	
1815	1900	Bangladesh, Bangla Betar	7185eu	
1830	1900	Turkey, Voice of	9785eu	
1830	1900	UK, BBC World Service	3255af	6005af
		6190af	9630af	11945af 12045me
		12095af	15400af	17795af 17830af
		21470af		
1830	1900	USA, Voice of America	4930af	7405af
		11975af	15410af	15580af 17895af
1845	1900	mtwhfa Albania, Radio Tirana	7465eu	9920eu
1845	1900	Congo, RTV Congolaise	4765af	5985af
1851	1900	New Zealand, Radio NZ Intl	9630pa	
1851	1900	DRM New Zealand, Radio NZ Intl	9440pa	

**1900 UTC - 3PM EDT / 2PM CDT / 12PM PDT**

1900	1915	Congo, RTV Congolaise	4765af	5985af
1900	1920	Turkey, Voice of	9785eu	
1900	1925	Israel, Kol Israel	9400va	11590va 15640af
1900	1928	Vietnam, Voice of	7280va	9730va
1900	1929	s Germany, Universal Life	11880me	
1900	1930	Hungary, Radio Budapest	3975eu	6025eu
1900	1930	Lithuania, Radio Vilnius	9710eu	
1900	1930	Philippines, Radio Pilipinas	11720va	15190va
		17720va		
1900	1930	as UK, Bible Voice	6015eu	9775al
1900	1945	India, All India Radio	7410eu	9445af
		9950eu	11620eu	11935af 13605af
		15075af	15155af	17670af
1900	1945	USA, WYFR/Family R Okeechobee FL		6085va
1900	1950	New Zealand, Radio NZ Intl	9630pa	
1900	1950	DRM New Zealand, Radio NZ Intl	9440pa	
1900	2000	Anguilla, University Network	11775am	
1900	2000	Australia, Radio	6080pa	7240pa 9500as
		9580pa	9710pa	11880pa
1900	2000	DRM Bulgaria, World Radio Network		9310eu
1900	2000	Canada, CFRX Toronto ON	6070na	
1900	2000	Canada, CFVP Calgary AB	6030na	
1900	2000	Canada, CKZN St John's NF	6160na	
1900	2000	Canada, CKZU Vancouver BC	6160na	
1900	2000	China, China Radio Intl	7295af	9440va
		11940eu		

1900	2000	Costa Rica, University Network	11870va	13750va
1900	2000	Eqt Guinea, Radio Africa	15190af	
1900	2000	Germany, CVC The Voice Africa		13820af
1900	2000	Germany, Deutsche Welle		13780af 15620af
1900	2000	Germany, Overcomer Ministries		9860af
1900	2000	vi Ghana, Ghana BC Corp	3366do	4915do
1900	2000	Italy, IRRS	5775va	5785va
1900	2000	Liberia, ELWA	4760do	
1900	2000	Malaysia, RTM/Trax FM		7295as
1900	2000	Namibia, Namibian BC Corp	3270do	3290do
		6060do	6175do	
1900	2000	Netherlands, Radio		5905af 7120af
		11655af	17810af	
1900	2000	as Netherlands, Radio		15315na 17735na
		17660na		
1900	2000	Nigeria, Radio/Ibadan		6050do
1900	2000	Nigeria, Radio/Kaduna		4770do 6090do
1900	2000	Nigeria, Radio/Lagos		3326do 4990do
1900	2000	Nigeria, Voice of	15120va	
1900	2000	North Korea, Voice of Korea	7100af	9975va
		11535va	11910af	
1900	2000	Papua New Guinea, Catholic Radio		4960do
1900	2000	Papua New Guinea, NBC		4890do
1900	2000	vi Papua New Guinea, Wantok R.Light		7120va
1900	2000	Russia, Voice of	7310eu	9890eu
1900	2000	Sierra Leone, SLBS	3316do	
1900	2000	vi Solomon Islands, SIBC		5020do 9545do
1900	2000	South Korea, KBS World Radio		5975va
		7275eu		
1900	2000	a Sri Lanka, SLBC	6010eu	
1900	2000	Swaziland, TWR	3200af	
1900	2000	Thailand, Radio	7155eu	
1900	2000	vi Uganda, Radio	4976do	5026do 7196do
1900	2000	UK, BBC World Service		3255af 6005af
		6190af	6195eu	9410eu 9630af
		12045me	12095af	15400af 17795af
		17830af		
1900	2000	UK, Bible Voice	9405af	
1900	2000	USA, American Forces Radio	4319usb	5446usb
		5765usb	6350usb	7590usb 7812usb
		10320usb	12133usb	12579usb 13362usb
		13855usb		
1900	2000	USA, KAJI Dallas TX		13815na
1900	2000	USA, KJES Vado NM		15385na
1900	2000	USA, KTBN Salt Lake City UT		15590na
1900	2000	USA, Voice of America	4930af	4940af
		6040me	7405af	9670me 11975af
		15410af	15445af	15580af 17895af
1900	2000	USA, WBCQ Kennebunk ME	7415na	9330na
		18910na		
1900	2000	USA, WBOH Newport NC	5920am	
1900	2000	USA, WEWN Birmingham AL	13615va	15220va
1900	2000	USA, WHRA Greenbush ME	17640na	
1900	2000	USA, WHRI Noblesville IN	13760am	15285am
		15665am	15785am	
1900	2000	USA, WINB Red Lion PA	13570am	
1900	2000	USA, WTJC Newport NC	9370na	
1900	2000	USA, WWCR Nashville TN	9975na	12160na
		13845na	15825na	
1900	2000	USA, WWRB Manchester TN	9385na	11915na
		15250na		
1900	2000	USA, WYFR/Family R Okeechobee FL	7240va	
		13690va	13800va	15795va 17845va
		18930va	18980va	
1900	2000	Zambia, Christian Voice	4965af	
1900	2000	vi Zimbabwe, ZBC Corp	5975do	
1910	1930	Armenia, Voice of	4810eu	9960eu
1930	2000	s Germany, Pan American BC	9430me	
1930	2000	Iran, Voice of the Islamic Rep	6205eu	7205eu
		7540af	9800af	9925af 11860al
1930	2000	Sweden, Radio	6065va	
1930	2000	s UK, Bible Voice	9775af	
1935	1955	Italy, RAI Intl	5960eu	9485eu
1945	2000	vi Rwanda, Radio	6055do	
1950	2000	Vatican City, Vatican Radio	4005eu	5885eu
		7250eu	9645eu	
1951	2000	New Zealand, Radio NZ Intl	9630pa	15720pa
1951	2000	DRM New Zealand, Radio NZ Intl	9440pa	13730pa

**2000 UTC - 4PM EDT / 3PM CDT / 1PM PDT**

2000	2015	f Germany, Pan American BC	9430me	
2000	2020	Vatican City, Vatican Radio	4005eu	5885eu
		7250eu	9645eu	
2000	2027	Czech Rep, Radio Prague	5930va	11600va
2000	2030	mtwhfa Albania, Radio Tirana	7465eu	
2000	2030	a Germany, Pan American BC	9430me	
2000	2030	Iran, Voice of the Islamic Rep	6205eu	7205eu
		7540af	9800af	9925af 11860al
2000	2030	Mongolia, Voice of	12015eu	
2000	2030	South Africa, AWR Africa		7180af
2000	2030	Swaziland, TWR	3200af	
2000	2030	h UK, Bible Voice	9605va	
2000	2030	USA, Voice of America	4940af	4940af
		7405af	11975af	15410af 15445af

2000	2030	15580af Vatican City, Vatican Radio	9755af	11625af
2000	2045	USA, WYFR/Family R Okeechobee FL		13690va
2000	2059	Canada, Radio Canada Intl	5850eu	7235eu
2000	2059	Spain, Radio Exterior Espana	9595af	15290eu
2000	2100	Anguilla, University Network	11775am	
2000	2100	Australia, ABC NT Alice Springs		2310do
2000	2100	Australia, ABC NT Katherine	2485do	
2000	2100	Australia, ABC NT Tennant Creek		2325do
2000	2100	Australia, Radio	9500as	11650pa
2000	2100	Bulgaria, World Radio Network		9310eu
2000	2100	Canada, CFRX Toronto ON	6070na	
2000	2100	Canada, CFVP Calgary AB	6030na	
2000	2100	Canada, CKZN St John's NF	6160na	
2000	2100	Canada, CKZU Vancouver BC	6160na	
2000	2100	Canada, Radio Canada Intl	17765am	
2000	2100	China, China Radio Intl	7295as	9440va
2000	2100	Costa Rica, University Network	13750va	
2000	2100	Egypt, Radio Cairo	15375af	
2000	2100	Eqt Guinea, Radio Africa	15190af	
2000	2100	Germany, CVC The Voice Africa		9765af
2000	2100	Germany, Deutsche Welle	7130af	11795af
2000	2100	Ghana, Ghana BC Corp	3366do	4915do
2000	2100	Indonesia, Voice of	9525as	11785pa
2000	2100	Italy, IRRS	5775va	5785va
2000	2100	Liberia, ELWA	4760do	
2000	2100	Malaysia, RTM/Trax FM	7295as	
2000	2100	Namibia, Namibian BC Corp	3270do	3290do
2000	2100	Netherlands, Radio	15315af	17735na
2000	2100	Netherlands, Radio	5905af	7120af
2000	2100	New Zealand, Radio NZ Intl	15720pa	
2000	2100	Nigeria, Radio/Ibadan	6050do	
2000	2100	Nigeria, Radio/Kaduna	4770do	6090do
2000	2100	Nigeria, Radio/Lagos	3326do	4990do
2000	2100	Nigeria, Voice of	15120va	
2000	2100	Papua New Guinea, Catholic Radio		4960do
2000	2100	Papua New Guinea, NBC	4890do	
2000	2100	Papua New Guinea, Wantok R.Light		7120va
2000	2100	Russia, Voice of	9890eu	12070eu
2000	2100	Solomon Islands, SIBC	5020do	9545do
2000	2100	South Africa, Channel Africa	3345af	
2000	2100	Uganda, Radio	4976do	7196do
2000	2100	UK, BBC World Service	3255af	6005af
2000	2100	UK, Bible Voice	9405af	9630af
2000	2100	USA, American Forces Radio	4319usb	5446usb
2000	2100	USA, KJES Vado NM	15385na	
2000	2100	USA, KTBN Salt Lake City UT	15590na	
2000	2100	USA, WBCQ Kennebunk ME	7415na	9330na
2000	2100	USA, WBOH Newport NC	5920am	
2000	2100	USA, WEWN Birmingham AL	13615va	15220va
2000	2100	USA, WHRA Greenbush ME	13710na	
2000	2100	USA, WHRI Noblesville IN	13760am	15285am
2000	2100	USA, WINB Red Lion PA	13570am	
2000	2100	USA, WTJC Newport NC	9370na	
2000	2100	USA, WWCR Nashville TN	9975na	12160na
2000	2100	USA, WWRB Manchester TN	9385na	11915na
2000	2100	USA, WYFR/Family R Okeechobee FL	3230va	
2000	2100	Zambia, Christian Voice	4965af	
2000	2100	Zimbabwe, ZBC Corp	5975do	
2005	2100	Syria, Radio Damascus	9330eu	12085eu
2025	2045	Italy, RAI Intl	5970af	11875af
2030	2045	Thailand, Radio	9680eu	
2030	2058	Vietnam, Voice of	7280va	9550va
2030	2100	Belarus, Radio	7125eu	7340eu
2030	2100	Cuba, Radio Havana		7440eu
2030	2100	Turkey, Voice of	7170as	9505va
2030	2100	USA, Voice of America	4930af	7555as
2030	2100	USA, Voice of America	11975af	15445af
2030	2100	USA, Voice of America	4940af	15580af

2045	2100	India, All India Radio	7410eu	9445eu
2055	2100	Vatican City, Vatican Radio	9910oc	11620va
			9950eu	9800na

**2100 UTC - 5PM EDT / 4PM CDT / 2PM PDT**

2100	2120	Turkey, Voice of	7180as	
2100	2123	Serbia, International Radio Serbia		6185eu
2100	2130	Australia, ABC NT Katherine	2485do	
2100	2130	Australia, ABC NT Tennant Creek		2325do
2100	2130	Austria, AWR Europe	11955af	
2100	2130	Canada, CBC NQ SW Service	9625na	
2100	2130	China, China Radio Intl	11640af	13630af
2100	2130	Cuba, Radio Havana	9505va	11760va
2100	2130	Egypt, Radio Cairo	15375af	
2100	2130	Hungary, Radio Budapest	6025eu	9525eu
2100	2130	South Korea, KBS World Radio		3955eu
2100	2130	UK, BBC World Service	11675va	15390va
2100	2130	Vatican City, Vatican Radio	9800na	
2100	2145	Nigeria, Radio/Ibadan	6050do	
2100	2145	USA, WYFR/Family R Okeechobee FL	13800va	13690va
2100	2159	Canada, Radio Canada Intl	17795va	18900na
2100	2159	Spain, Radio Exterior Espana	9800na	17765na
2100	2200	Anguilla, University Network	9595af	9840eu
2100	2200	Australia, ABC NT Alice Springs	11775am	
2100	2200	Australia, Radio	4835irr	2310do
2100	2200	Australia, Radio	7240pa	9660pa
2100	2200	Bulgaria, Radio	11660pa	12080pa
2100	2200	Bulgaria, Radio	5800eu	7500eu
2100	2200	Canada, CFRX Toronto ON	6070na	
2100	2200	Canada, CFVP Calgary AB	6030na	
2100	2200	Canada, CKZN St John's NF	6160na	
2100	2200	Canada, CKZU Vancouver BC	6160na	
2100	2200	China, China Radio Intl	9600eu	9800eu
2100	2200	Costa Rica, University Network	11790eu	
2100	2200	Eqt Guinea, Radio Africa	13750va	
2100	2200	Germany, Deutsche Welle	15190af	9440af
2100	2200	Ghana, Ghana BC Corp	15210af	11865af
2100	2200	Guyana, Voice of	3366do	4915do
2100	2200	India, All India Radio	3291do	5950do
2100	2200	Italy, IRRS	11715oc	9910oc
2100	2200	Japan, Radio Japan/NHK World	5775va	5785va
2100	2200	Liberia, ELWA	6055eu	6180eu
2100	2200	Malaysia, RTM/Trax FM	21670oc	11855af
2100	2200	Namibia, Namibian BC Corp	4760do	
2100	2200	Namibia, Namibian BC Corp	7295as	3270do
2100	2200	New Zealand, Radio NZ Intl	6060do	6175do
2100	2200	New Zealand, Radio NZ Intl	15720pa	15720pa
2100	2200	Nigeria, Radio/Kaduna	13730pa	
2100	2200	Nigeria, Radio/Lagos	4770do	6090do
2100	2200	North Korea, Voice of Korea	3326do	4990do
2100	2200	Papua New Guinea, Catholic Radio	13760eu	15245eu
2100	2200	Papua New Guinea, NBC		4960do
2100	2200	Papua New Guinea, Wantok R.Light	4890do	
2100	2200	Russia, Voice of	15735sa	7120va
2100	2200	Rwanda, Radio	6055do	
2100	2200	Sierra Leone, SLBS	3316do	
2100	2200	South Africa, Channel Africa		3345af
2100	2200	Syria, Radio Damascus	13610al	9330eu
2100	2200	UK, BBC World Service	3255af	3915as
2100	2200	UK, Bible Voice	5965as	6005af
2100	2200	Ukraine, Radio Ukraine Intl	11945as	12095af
2100	2200	USA, American Forces Radio	7490eu	7490eu
2100	2200	USA, WINB Red Lion PA	4319usb	5446usb
2100	2200	USA, WTJC Newport NC	5765usb	6350usb
2100	2200	USA, WWCR Nashville TN	10320usb	12133usb
2100	2200	USA, WWRB Manchester TN	13855usb	7590usb
2100	2200	USA, KAIJ Dallas TX	12579usb	13362usb
2100	2200	USA, KTBN Salt Lake City UT		13815na
2100	2200	USA, Voice of America		15590na
2100	2200	USA, WBCQ Kennebunk ME		7555as
2100	2200	USA, WBOH Newport NC	7415na	9330na
2100	2200	USA, WEWN Birmingham AL	18910na	
2100	2200	USA, WHRA Greenbush ME	5920am	
2100	2200	USA, WHRI Noblesville IN	13615va	15220va
2100	2200	USA, WINB Red Lion PA	11610na	11765na
2100	2200	USA, WRMI Miami FL	13760am	15285am
2100	2200	USA, WTJC Newport NC	15665am	15785am
2100	2200	USA, WWCR Nashville TN	13570am	
2100	2200	USA, WWRB Manchester TN	7385am	
2100	2200	USA, WYFR/Family R Okeechobee FL	9370na	
2100	2200	Zambia, Christian Voice	9975na	12160na
2100	2200	Zimbabwe, ZBC Corp	13845na	15825na
2100	2200	Zimbabwe, ZBC Corp	15250na	
2100	2200	Zimbabwe, ZBC Corp	9385na	11915na

2100	2200	vi	Zimbabwe, ZBC Corp	5975do	
2115	2200		Egypt, Radio Cairo 9990eu		
2130	2156		Romania, Radio Romania Intl 11940va 15465va	7210va	9535va
2130	2157		Czech Rep, Radio Prague	9410na	11600af
2130	2200	mtwhfa	Albania, Radio Tirana	7465eu	
2130	2200		Australia, ABC NT Katherine	5025do	
2130	2200		Australia, ABC NT Tennant Creek		4910do
2130	2200	mtwhfa	Canada, CBC NQ SW Service	9625na	
2130	2200	DRM	Netherlands, Radio	9800na	
2130	2200		Sweden, Radio 6065va	7420va	
2130	2200		UK, BBC World Service	15390va	

### 2200 UTC - 6PM EDT / 5PM CDT / 3PM PDT

2200	2210		Syria, Radio Damascus	9330eu	12085eu
2200	2230		Belarus, Radio 7125eu	7340eu	7440eu
2200	2230	s	Belarus, Radio 7125eu	7340eu	7440eu
2200	2230		Cuba, Radio Havana	9505va	11760va
2200	2230	DRM	Germany, Deutsche Welle	9800na	
2200	2230		India, All India Radio	9910oc	11620oc
			11715oc	9950eu	11620va
2200	2230		Papua New Guinea, NBC	4890do	
2200	2235		New Zealand, Radio NZ Intl	15720pa	
2200	2235	DRM	New Zealand, Radio NZ Intl	13730pa	
2200	2245		Egypt, Radio Cairo 9990eu		
2200	2245		USA, WYFR/Family R Okeechobee FL		15770va
2200	2250		Turkey, Voice of	9830eu	
2200	2259		Canada, Radio Canada Intl	6100na	
2200	2300		Anguilla, University Network	6090am	
2200	2300		Australia, ABC NT Alice Springs		2310do
			4835irr		
2200	2300		Australia, ABC NT Katherine	5025do	
2200	2300		Australia, ABC NT Tennant Creek		4910do
2200	2300		Australia, Radio 12010va	13620as	13630pa
			15515pa	15230as	15240pa
			17795pa		
2200	2300	smtwhf	Canada, CBC NQ SW Service	9625na	
2200	2300		Canada, CFRX Toronto ON	6070na	
2200	2300		Canada, CFVP Calgary AB	6030na	
2200	2300		Canada, CKZN St John's NF	6160na	
2200	2300		Canada, CKZU Vancouver BC	6160na	
2200	2300	DRM	Canada, Radio Canada Intl	9800na	
2200	2300		China, China Radio Intl	7170eu	
2200	2300		Costa Rica, University Network	13750va	
2200	2300		Eqt Guinea, Radio Africa	15190af	
2200	2300		Germany, Deutsche Welle	7115as	9720na
2200	2300	vi	Ghana, Ghana BC Corp	3366do	4915do
2200	2300		Guyana, Voice of 3291do		
2200	2300		Italy, IRRS 5785va		
2200	2300	f	Italy, IRRS 5775va		
2200	2300		Malaysia, RTM/Trax FM	7295as	
2200	2300	vi	Namibia, Namibian BC Corp	3270do	3290do
			6060do	6175do	
2200	2300		Nigeria, Radio/Ibadan	6050do	
2200	2300		Nigeria, Radio/Kaduna	4770do	6090do
2200	2300		Nigeria, Radio/Lagos	3326do	4990do
2200	2300		Papua New Guinea, Catholic Radio	4960do	
2200	2300	vi	Papua New Guinea, Wantok R.Light	7120va	
2200	2300	irreg/ vi	Sierra Leone, SLBS 3316do		
2200	2300	vi	Solomon Islands, SIBC	5020do	9545do
2200	2300		Taiwan, Radio Taiwan Intl	15600eu	
2200	2300		UK, BBC World Service	5955af	5965as
			5975va	6195as	9740as
			12095af	15400af	
2200	2300		USA, American Forces Radio	4319usb	5446usb
			5765usb	6350usb	7590usb
			10320usb	12133usb	13362usb
			13855usb		
2200	2300		USA, KAIJ Dallas TX	13815na	
2200	2300		USA, KTBN Salt Lake City UT	15590na	
2200	2300		USA, Voice of America	7215va	7555as
			11725va	15185va	15290va
2200	2300	mtwhf	USA, WBCQ Kennebunk ME	5110na	18910na
2200	2300		USA, WBCQ Kennebunk ME	7415na	9330na
2200	2300		USA, WBOH Newport NC	5920am	
2200	2300		USA, WEWN Birmingham AL	9975va	15745va
2200	2300		USA, WHRA Greenbush ME	11610na	11765na
2200	2300	m	USA, WHRI Noblesville IN	7490am	
2200	2300		USA, WHRI Noblesville IN	9840am	13760am
			15285am		
2200	2300		USA, WINB Red Lion PA	13570am	
2200	2300	mtwhf	USA, WRMI Miami FL	7385am	
2200	2300	as	USA, WRMI Miami FL	9955am	
2200	2300		USA, WTJC Newport NC	9370na	
2200	2300		USA, WWCR Nashville TN	7465na	9985na
			12160na	13845na	
2200	2300		USA, WWRB Manchester TN	9385na	11915na
			15250na		
2200	2300		USA, WYFR/Family R Okeechobee FL	11740va	
			15195va		
2200	2300		Zambia, Christian Voice	4965af	
2205	2230		Italy, RAI Intl	11895as	
2215	2230		Croatia, Croatian Radio	9925sa	
2230	2257		Czech Rep, Radio Prague	7345na	9415af

2230	2300		Papua New Guinea, NBC	9675do	
2230	2300		USA, Voice of America	9570va	13755va
			15145va		
2236	2300		New Zealand, Radio NZ Intl	13730pa	
2236	2300	DRM	New Zealand, Radio NZ Intl	15720pa	
2245	2300		India, All India Radio	9705as	9950as
			11620as	11645as	13605as

### 2300 UTC - 7PM EDT / 6PM CDT / 4PM PDT

2300	0000		Anguilla, University Network	6090am	
2300	0000		Australia, ABC NT Alice Springs		2310do
			4835irr		
2300	0000		Australia, ABC NT Katherine	5025do	
2300	0000		Australia, ABC NT Tennant Creek		4910do
2300	0000		Bulgaria, Radio 9700na	11700na	
2300	0000	smtwhf	Canada, CBC NQ SW Service	9625na	
2300	0000		Canada, CFRX Toronto ON	6070na	
2300	0000		Canada, CFVP Calgary AB	6030na	
2300	0000		Canada, CKZN St John's NF	6160na	
2300	0000		Canada, CKZU Vancouver BC	6160na	
2300	0000		China, China Radio Intl	5990am	6145na
			13680na		
2300	0000		Costa Rica, University Network	13750va	
2300	0000		Cuba, Radio Havana	9550na	
2300	0000		Egypt, Radio Cairo 11950na		
2300	0000		Germany, Deutsche Welle	5955as	9890as
			15135as	17860as	
2300	0000	vi	Ghana, Ghana BC Corp	3366do	4915do
2300	0000		Guyana, Voice of 3291do		
2300	0000		India, All India Radio	9705as	9950as
			11620as	11645as	13605as
2300	0000		Malaysia, RTM/Trax FM	7295as	
2300	0000	vi	Namibia, Namibian BC Corp	3270do	3290do
			6060do	6175do	
2300	0000		New Zealand, Radio NZ Intl	13730pa	
2300	0000	DRM	New Zealand, Radio NZ Intl	15720pa	
2300	0000		Papua New Guinea, Catholic Radio		4960do
2300	0000		Papua New Guinea, NBC	9675do	
2300	0000	vi	Papua New Guinea, Wantok R.Light	7120va	
2300	0000		Romania, Radio Romania Intl	6140va	7265va
			9645va	11940va	
2300	0000	irreg/ vi	Sierra Leone, SLBS 3316do		
2300	0000		Singapore, MediaCorp Radio	6150do	
2300	0000	vi	Solomon Islands, SIBC	5020do	9545do
2300	0000		UK, BBC World Service	3915as	5965as
			6195as	9580as	9740as
			11945as	11955as	
2300	0000		USA, American Forces Radio	4319usb	5446usb
			5765usb	6350usb	7590usb
			10320usb	12133usb	13362usb
			13855usb		
2300	0000		USA, KAIJ Dallas TX	13815na	
2300	0000		USA, KTBN Salt Lake City UT	15590na	
2300	0000		USA, Voice of America	7215va	7555as
			11725va	15185va	
2300	0000		USA, WBCQ Kennebunk ME	5110na	7415na
			9330na	18910na	
2300	0000		USA, WBOH Newport NC	5920am	
2300	0000		USA, WEWN Birmingham AL	9975va	15745va
2300	0000	m	USA, WHRA Greenbush ME	11610na	11765na
2300	0000		USA, WHRI Noblesville IN	7490am	
2300	0000		USA, WHRI Noblesville IN	9840am	13760am
			15285am		
2300	0000		USA, WINB Red Lion PA	13570am	
2300	0000	mtwhf	USA, WRMI Miami FL	7385am	
2300	0000		USA, WRMI Miami FL	9955am	
2300	0000		USA, WTJC Newport NC	9370na	
2300	0000		USA, WWCR Nashville TN	7465na	9985na
			12160na	13845na	
2300	0000		USA, WWRB Manchester TN	9385na	11915na
			15250na		
2300	0000		USA, WYFR/Family R Okeechobee FL	11740va	
			15195va		
2300	0000		Zambia, Christian Voice	4965af	
2300	0000		Italy, RAI Intl	11895as	
2300	0000	DRM	Sweden, Radio	9800na	
2300	0000		USA, Voice of America	7260va	9570va
			13725va	13755va	15145va
2300	0000	s	USA, WRMI Miami FL	9955am	
2300	0000		Vietnam, Voice of	9840as	12020as

## “We Own the Night!”

# U.S. Military Satellites – An Overview

**“W**e Own the Night!” That motto is one that is proudly bantered around by the U.S. military, and rightfully so. Not only do they own the night on the ground, but in the skies over the battlefield as well. And a major part of that night capability is a fleet of U.S. military and intelligence community satellites.

“Satellites have always had important military roles, but in recent times dependence on satellites has grown dramatically.”

I penned those words almost 20 years ago in the pages of my book, *Communications Satellites*, 3<sup>rd</sup> Edition. And those words are just as valid now as they were when I wrote them two decades ago.

We have seen a lot of changes in our space-based posture over these last 20 years. Lower launch rates are offset by increased satellite reliability and capability. Even with all the changes that we have seen over these many years, the military missions we tasked our satellites to perform back then are still being conducted today.

Satellites are an integral component of United States military planning. Unlike earth-bound forces, satellites do not attack our enemies directly, but rather they offer what the Pentagon calls “force enhancement.” These include satellite based missions devoted to communications, missile warning, navigation, reconnaissance, and various types of space borne surveillance missions.

### ❖ Super Secret Spy Satellite Programs

The once super secret U.S. National Reconnaissance Office (NRO) designs, builds, and operates a wide variety of satellites for the U.S. intelligence community that are essential for national security. A Department of Defense (DoD) agency, the NRO is staffed by DoD and Central Intelligence Agency (CIA) personnel. It is funded through the National Reconnaissance Program, part of the National Foreign Intelligence Program.

In recent years, the NRO has declassified some of its operations. The organization itself was declassified in September 1992, followed by revealing the location of its headquarters in Chantilly, Virginia, in 1994. In February 1995, CORONA, a photographic reconnaissance program that operated from 1960 to 1972, was declassified and 800,000 CORONA images were transferred to the National Archives and Records Administration. In December 1996, the NRO announced for the first time, in advance,

the launch of a reconnaissance satellite. Today, the NRO even has a presence on the internet at their website [www.nro.gov](http://www.nro.gov).

American reconnaissance spacecraft are launched to Earth orbit by the U.S. Air Force and are known by a variety of colorful code names such as Capricorn, Keyhole, Lacrosse, Orion, Onyx, and Trumpet, to name a few. They conduct a wide variety of spy satellite missions. These include:

- Optical satellites that use a large mirror, like the one on the Hubble Space Telescope, pointed at earth to gather visible light for photography. But visible light is not the only wavelength these satellites monitor. They also record Earth based targets in the invisible infrared and ultraviolet light portions of the electromagnetic spectrum.
- Radar imaging satellites use microwave signals to peer through cloud cover and scan Earth's surface.
- A combination of radar, optical, infrared and ultraviolet instruments onboard one satellite that see wide areas of Earth's surface with more detail than each of the separate types of satellite platforms.
- Ocean observation satellites that are used to locate and determine the intent of ships at sea.
- Signal intercept and detection satellites that tune in on radio, telephone and data transmissions.



intelligence community to plan attack strategies, support covert ground reconnaissance, find high value enemy targets, monitor the movements of deployed troops, watch for threats to sea lanes, and locate the sources of intercepted radio signals.

Another member of the intelligence community that has been in the news of late, the U.S. National Security Agency (NSA), uses space based platforms to intercept message traffic from all over the world. In recent years, the NSA's mission has been complicated by the awesome increase in various communications channels being used in the 21st century. For instance, one online article recently estimated that some five million e-mails are transmitted each minute, and 35 million voice communications are completed each hour. That is a lot of traffic to sort through and signal intelligence (SIGINT) satellites play an important role in that effort.

### ❖ American Military Satellite Constellations

Here are a few brief summaries about some of the American military satellite systems in current use. In future *Milcom* columns, we will take a closer look at these and other military satellite systems.

#### Lacrosse

These are radar-imaging recon satellites. They also have been referred to by the code names Onyx, Vega, Indigo and several others. Each of these huge night watchers weighs 15 tons and is as big as a school bus. They orbit about 700 kilometers above the earth in two inclinations (57 and 68 degrees). This satellite is built around a synthetic aperture radar (SAR), which can see through clouds and send down photographic-quality images. Each satellite has a huge wire-mesh radar antenna and 150-foot solar panels to generate the electricity used by its powerful radar transmitter.



The National Geospatial-Intelligence Agency (NGA) uses imagery from NRO satellites to map and chart the globe. Spy satellite images are used by the NGA and other members of the

Information about this program became public by accident in 2000 when the NRO distributed patches to agency employees to celebrate the launch of the Titan IV rocket that carried a secret payload. This patch revealed the rocket's secret payload – Lacrosse-4. Satellite watchers used clues on the patch, including the embroidered path of the four satellites depicted on the patch, to figure out where these Lacrosse satellites orbit. "We own the night," the patch said, but the amateur visual satellite hobbyists found them in the night thanks to their incredible blunder.

### Keyhole

This series of satellites has been around since the dawn of the space age. The first Keyhole satellite series, KH-1, was code named Corona. The KH-11 and Advanced KH-11 (aka KH-12) space platforms are digital-imaging satellites. Like their radar imaging cousins above, they are the size of a school bus and weigh in at about 30,000 lbs. They are launched into sun-synchronous, polar orbit from Vandenberg AFB, California. From one of two orbital planes they can deliver very high resolution pictures in visible light and infrared. The resolution of the optical images are said to be as fine as four to six inches during daytime, and at night, infrared instruments can image as small as two to three feet.

### Defense Support Program (DSP)

Another NRO program that has seen some recent headlines, thanks to North Korea's missile launches, is the Defense Support Program (DSP) satellites. These satellites are operated by the Air Force Space Command as part of NORAD's early warning system. DSP satellites watch from their 35,700 kilometer high geostationary orbits for missile/space launches and nuclear detonations. Their infrared sensors detect heat from missile and booster rocket exhaust plumes. They can even detect and warn of the launch of small, short range missiles against any target, anywhere in the world.

### Satellite Data System (SDS)

The Satellite Data System (SDS) satellites are in highly elliptical orbits. These satellites use Molniya style orbits which have high apogees (highest point of the orbit) in the Northern hemisphere, and a low perigee (lowest point of the orbit) in the Southern hemisphere. This sort of orbit permits long communication relay durations, especially at very high Northern latitudes, which are not visible to geosynchronous satellites. Most Molniya type orbits have an inclination of 63.4 degrees and an orbital period of 12 hours. The SDS series of satellites are used for real-time data relay from reconnaissance gathering satellites (like those mentioned above) which are out of range of U.S. tracking stations. They also carry a UHF communications package.

### Defense Satellite Communications Systems (DSCS)

A wide array of commu-

nications satellites around the world are used to relay military messages and data. One type of these is the Defense Satellite Communications Systems (DSCS) satellite.

DSCS satellites are highly important to the American military establishment. Everyone from the President of the United States to special operation troops in the field relies on them for secure communications. They also carry space operations communications and early warning data from their geostationary orbital slots. In addition to their SHF communications package, each DSCS also has a single channel for broadcasting emergency action messages to nuclear forces. We are now in the third generation of satellites in this series since they began launching them in 1982.

### Milstar Satellite Communications System

The Milstar constellation of satellites makes up the most advanced military communications satellite system launched to date. From geostationary orbit, they provide secure, jam resistant, worldwide communications, linking command authorities with ships, submarines, aircraft and ground stations. Each giant Milstar, the size of a city bus, is a smart switchboard in the sky, directing encrypted voice, data, teletype and fax messages traffic anywhere on the Earth. These satellites can even link up with other Milstar platforms to forward messages satellite-to-satellite.

### Other Military Communications Satellites

Other American military communication satellites include the UHF Follow-On (UFO) milsats and Fleet Satellite Communication (FLTSATCOM) satellites. Military communications satellites from other nations include Great Britain's Skynet satellite, France's Telesat Syracuse satellite, Italy's Sicral, and the NATO-4 series. All of these satellites are used to coordinate land, sea and air forces through their UHF communications packages.

### Defense Meteorological Satellite Program (DMSP)

The Defense Meteorological Satellite Program (DMSP) has been collecting weather data for American military operations for over four decades. Weather conditions across the globe vary widely, which highlights the importance of DoD's DMSP satellites, as well as other civilian weather satellites. Weather not only affects the timing of air strikes, but also the timing of damage assessments by overflying spacecraft. At least two DMSP satellites are in polar orbits continuously, sending down visible light photos and infrared images of cloud cover. They also report atmospheric moisture and temperature.

Military weather forecasters use such data to predict regional and global weather patterns, including severe thunderstorms, hurricanes and typhoons. DMSP pictures show areas as small as 1,000 feet in diameter.

These satellites can also measure charged particles and electromagnetic fields in the ionosphere, which have an

impact on the effectiveness of ballistic-missile early warning radar systems and long-range HF communications. That same data is also used to predict global auroral activity, which affects electronics on Earth and in space. Problems such as geomagnetic storms in the space environment can adversely affect military satellites.

### Global Positioning System (GPS)

Navstar, or GPS as it is commonly known, is a constellation of more than two dozen orbiting satellites controlled by the U.S. Air Force 50th Space Wing at Schriever Air Force Base, Colorado. They transmit navigation data to military and civilian users all over the world. GPS satellites continuously transmit navigation signals as they circle Earth every 12 hours. Receivers for those signals have been built into cars, ships and airplanes as well as handheld receivers. You can receive GPS signals 24 hours a day and use them to determine the time, and calculate your location and velocity. The signals are so accurate that time can be figured to within a millionth of a second, speed within a fraction of a mile per hour, and location to within less than 100 feet.

You can learn more about some of the satellite systems we talked about above and other military space related topics via the links in the table below.

In future editions of this column we will delve deeper into some of these satellite systems. You will learn more about them, where and how to hear satellites, and even visually observe orbiting military satellites. Until next time, 73 and good hunting.

---

## Military Space Systems Fact Sheets

---

### Military Satellites

Defense Meteorological Satellite Program (DMSP)

[www.af.mil/factsheets/factsheet.asp?fsID=94](http://www.af.mil/factsheets/factsheet.asp?fsID=94)

Defense Satellite Communications Systems (DSCS)

[www.af.mil/factsheets/factsheet.asp?fsID=95](http://www.af.mil/factsheets/factsheet.asp?fsID=95)

Defense Support Program (DSP)

[www.af.mil/factsheets/factsheet.asp?fsID=96](http://www.af.mil/factsheets/factsheet.asp?fsID=96)

Global Positioning System (GPS)

[www.af.mil/factsheets/factsheet.asp?fsID=119](http://www.af.mil/factsheets/factsheet.asp?fsID=119)

Milstar Satellite Communications System

[www.af.mil/factsheets/factsheet.asp?fsID=118](http://www.af.mil/factsheets/factsheet.asp?fsID=118)

Navy UHF Follow-On (UFO) satellites

[http://enterprise.spawar.navy.mil/Uploaded-Files/muos-fs\\_2002-09.pdf](http://enterprise.spawar.navy.mil/Uploaded-Files/muos-fs_2002-09.pdf)

### Space Surveillance Systems

Ground-Based Electro-Optical Deep Space Surveillance (GEODSS)

[www.af.mil/factsheets/factsheet.asp?fsID=170](http://www.af.mil/factsheets/factsheet.asp?fsID=170)

Pave Paws Radar System

[www.af.mil/factsheets/factsheet.asp?fsID=168](http://www.af.mil/factsheets/factsheet.asp?fsID=168)

### U.S. Military Satellite Launch Vehicles:

Atlas II [www.af.mil/factsheets/factsheet.asp?fsID=80](http://www.af.mil/factsheets/factsheet.asp?fsID=80)

Delta 2 [www.af.mil/factsheets/factsheet.asp?fsID=97](http://www.af.mil/factsheets/factsheet.asp?fsID=97)

Titan 4B [www.af.mil/factsheets/factsheet.asp?fsID=128](http://www.af.mil/factsheets/factsheet.asp?fsID=128)



## Shining Some Light on the Department of Energy

**A**lthough less than 30 years old, the United States Department of Energy has a rich and diverse history with its roots in the Manhattan Project and the race to build the first atomic bomb. It's also an agency with many facilities scattered across the country that can provide some interesting monitoring opportunities. However, some of the public information on Department of Energy radio systems has begun to disappear from the Internet.

One of the big resources for radio system information has been Radio Reference. The owner of the site has a policy in place regarding federal frequency information posted on his site which states federal info will be removed at the request of the federal or military agency that operates the radio system. Some of the trunked systems at DoE sites have been removed from Radio Reference at the request of those facilities. Although nothing classified was contained in that system posting, the agencies seem to think that they are at some sort of security risk by the public having knowledge of these radio systems.

I decided to take a look at some of the radio systems in use by the Department of Energy at a few of their facilities across the country. All of the radio systems listed in this column should be audible on the APCO digital capable scanners currently available. Some of the systems utilize encryption on some sensitive talk groups or frequencies, so scanners cannot monitor those.

The Department of Energy has a tremendous number of frequencies that are allocated to their use – almost 500 frequencies according to the Grove Second Edition *Federal Frequency Directory*. That would be too many to list in the *Fed Files* column, so I will focus on some specific areas and facilities of the DoE. This is by no means a complete list of the DoE facilities across the US, but more information is available at the DoE web site, [www.doe.gov](http://www.doe.gov).

### DoE HANFORD

[www.hanford.gov/](http://www.hanford.gov/)

The Hanford Reservation is an historic Department of Energy facility near Richland, Washington, that helped start the atomic age. Hanford was one of the two facilities that the United States had during World War II that was able to produce enough radioactive material for the first atomic bombs. Since the height of the Cold War, Hanford has now assumed the role of a research facility dealing with the environmental problems of nuclear materials storage and disposal.

The Hanford facility uses several radio systems, including conventional VHF, a UHF

trunked system and what appears to be a new VHF APCO P-25 system coming on line soon. Here are some of the conventional VHF frequencies that are active at Hanford:

- 162.1000
  - 164.2250
  - 164.2750
  - 164.3250
  - 164.3750
  - 164.4000
  - 164.5250
  - 164.7500
  - 164.7750
  - 165.0250
  - 167.0750
  - 167.8250
  - 167.8500
  - 167.8750
  - 167.9250
  - 167.9750
  - 168.2250
  - 168.3000
  - 168.3250
  - 168.4500
  - 169.5000
  - 169.7250
  - 170.0750
  - 170.5750
  - 171.2000
  - 171.8250
  - 173.1000
- 192.8 pl – Hanford Operations  
Hanford DoE Paging
- 110.9 pl – Hanford Fire  
192.8 pl – Hanford Fire Dispatch
- 
- 151.4 pl – Hanford Fire (may be Dept. of Interior Fire Net)

These VHF frequencies are Department of Energy assignments nationwide, so they might be in use at other DoE facilities, but you'll notice that many of these facilities have moved to UHF trunked radio systems. The UHF trunked system at Hanford appears to be mainly used by contractors and maintenance workers. Here is the system info:

- EDACS UHF system
- 1 - 406.3500
  - 2 - 406.7500
  - 3 - 407.1500
  - 4 - 407.3500
  - 5 - 409.9500
  - 6 - 408.1500
  - 7 - 409.5500
  - 8 - 409.7500

The new VHF trunked system at Hanford will be a P-25 VHF trunked system. When I was visiting the Richland, Washington, area I was picking up a P-25 control channel on 164.4125 MHz. No activity was noted during the time I was monitoring, so I'll have to venture up to the area again in the near future and see if there's more activity.

### LAWRENCE LIVERMORE NATIONAL LABORATORY

[www.llnl.gov/](http://www.llnl.gov/)

The Lawrence Livermore National Laboratory (LLNL), Livermore, California, is a National Security science laboratory that is part of the National Nuclear Security Administration (NNSA) within the Department of Energy. LLNL has been managed by the University of California for the U.S. government since its formation in 1952.

The LLNL UHF trunked system is a Motorola SmartZone system spread out over multiple repeater sites. I suspect that this radio system also supports the Lawrence Berkley Lab, [www.lbl.gov/](http://www.lbl.gov/). Here is some system information for the LLNL trunked system:

- |                         |                        |
|-------------------------|------------------------|
| System ID: 5434         | 407.3500               |
| Livermore Lab (Site 1): | 407.7875               |
| 406.1625                | 408.5500               |
| 406.3625                | 409.4250               |
| 406.5625                | 409.6375               |
| 406.9875                | Mount Diablo (Site 5): |
| 407.5875                | 407.5500               |
| 407.9500                | Crane Ridge (Site 7):  |
| 408.3625                | 407.3875               |
| 408.5875                | 408.9625               |
| 409.5875                | Tracy (Site 8):        |
| 410.5625                | 407.1875               |
| Site 300 (Site 3):      | 407.1875               |
| 406.1875                | 407.9875               |
| 406.7875                |                        |

### BETTIS ATOMIC POWER LABORATORY

[www.nnsa.doe.gov/siteoffices.htm#pittnaval](http://www.nnsa.doe.gov/siteoffices.htm#pittnaval)

First mentioned in the March *Fed Files*, the Bechtel-Bettis Naval Reactor facility is located near Pittsburgh, Pennsylvania. They are using a somewhat unusual P-25 UHF trunked system that I first monitored last November. Here are the particulars of this trunked system:

- System ID – ffo
- 406.9750
  - 407.1875
  - 407.3875
  - 407.7875
  - 408.1750

This system is using radios and hardware sold by E.F. Johnson, but it is using an unusual method of frequency identification. For those who are familiar with trunked radio systems, this system is not set up like a "normal" APCO-25 trunked system, but it broadcasts logical channel numbers rather than frequencies. This type of trunked system can be tracked with the Radio Shack PRO-96



or PRO-2096 scanner using the "Custom Tables" feature in the radio. Also, the newer Uniden digital scanners have an "Implicit Trunking" feature that is able to track these P-25 systems that broadcast channel numbers.

## OAK RIDGE NATIONAL LABORATORY

[www.ornl.gov/ornlhome/about.shtml](http://www.ornl.gov/ornlhome/about.shtml)

Like the Lawrence Livermore facility, the Oak Ridge National Laboratory is managed for the Department of Energy by an outside group, in this case UT-Battelle. The Oak Ridge, Tennessee, facility includes a National Security Complex called Site Y-12, [www.y12.doe.gov/](http://www.y12.doe.gov/).

As with LLNL, Oak Ridge is using a UHF ASTRO Motorola SmartZone system to serve the facility. Here is the system information:

System ID - B120	408.5875
Site-1	408.9000
406.1125	409.3000
406.7750	409.4875
406.7875	409.5875
406.9875	409.7750
407.1875	409.7875
407.3000	410.1750
407.3875	410.5500
407.5875	410.7000
407.7875	Site-4
407.8625	406.9750
407.9875	407.5750
408.1875	408.1750
408.3875	409.4250
	409.8875

The Oak Ridge facility also has an older, analog Motorola trunked system that is still in use by maintenance personnel. Here is that system info:

System ID - 2927	407.5500
406.3500	407.9500
406.7500	408.7500
407.1500	409.9500

## BONNEVILLE POWER ADMINISTRATION

The Bonneville Power Administration (BPA) services the Pacific Northwest with hydroelectric, wind and nuclear power. Based in Portland, Oregon, the BPA operates a VHF repeater system for servicing their transmission lines and facilities. Here are their operating frequencies:

- 172.5000 MHz
- 172.5250 MHz
- 172.5750 MHz

Two DoE installations for which I do not have any information are the Pantex Facility in Amarillo, Texas, ([www.pantex.com/](http://www.pantex.com/)) and the Kansas City Plant in Kansas City, Missouri, [www.kcp.com/index.html](http://www.kcp.com/index.html)). If any of our readers has any info that they would like to share about what these facilities use for radio systems, please feel free to let us know at the *Fed Files*.

## NNSA and NEST

Formed in 2000, the National Nuclear Security Administration is a division within the Department of Energy. The NNSA is charged with the security of the nuclear weapons and materials

in the United States. Several of the DoE sites mentioned previously are operated under direction of the NNSA, due to the materials produced and handled there.

In Nevada, the NNSA runs the Nevada Test Site, with facilities for testing and designs of US nuclear weapons as well as for nuclear reactor technology. The Nevada Test Site operates a wide-area UHF trunked radio system. It is currently a Motorola SmartZone system using P-25 digital voice, so you can listen to unencrypted transmissions. Nellis AFB also uses parts of this system for some base and flightline operations. Here is a quick rundown of the NNSA trunked system:

Site 1 - Mercury	406.1125	Site 6 - Angel Peak	407.5625
	406.9750		407.9500
	407.3500		408.1750
	407.6375		410.1250
	408.1875		410.5500
	408.5875		411.6000
	409.3250	Site 7 - Rainier Mesa	406.1500
Site 2 - Frenchman Flat area	406.1875	Site 8 - Shoshone Peak	406.1375
	406.7875		406.4000
	406.9875		408.7000
	407.1875		409.7750
	407.3875		410.6500
	408.3875	Site 9 - Unknown location	409.6875
	408.3875		
	409.6000	Site 10 - Nellis Air Force Base	406.1625
Site 3 - Yucca Flat area	406.9250		406.7625
	407.5875		407.1625
	407.8125		407.2500
	408.0875		407.5625
	409.1250		407.9875
	409.5875		408.5625
Site 4 - Las Vegas U.S. DOE NNSA facility	406.1125		408.9625
	406.4000		409.1625
	406.9750		409.6375
	407.3500		409.7625
	408.1875		409.9625
	409.1250		410.1625
	409.7750		410.1625
Site 5 - Skull Mountain	406.6250	Site 11 - Creech AFB at Indian Springs	407.0750
	407.8875		408.1250
	408.1000		409.5250
	408.7500		
	410.1750		

A division of the NNSA is the Nuclear Emergency Support Team (NEST), [www.nv.doe.gov/nationalsecurity/homelandsecurity/nest](http://www.nv.doe.gov/nationalsecurity/homelandsecurity/nest).

**htm.** NEST is responsible for detection of and response to nuclear or radiological terrorism. NEST personnel and response teams have often been portrayed in fictional accounts of nuclear terrorism, and have often responded to mock alerts across the country. It has always been assumed that NEST communications in the field would be secure and perhaps even spread-spectrum or some undetectable method. However, in a few publicized NEST exercises, news footage shows NEST officials with what appears to be standard issue VHF or UHF hand-held radios, plus the ever-present cell phones.

In the case of NNSA Nuclear Materials Transport Convoys, their communications are also hard to pin down. NNSA security and communications teams accompany specially built semi tractor-trailers that may be hauling nuclear materials. I have seen some of these convoys in the field and, when stopped at a truck stop, the Department of Energy personnel were very strict about keep a security zone around all their vehicles. Despite the fact these convoys have communications vans with antennas for literally every mobile communications band there is, I have yet to actually catch any confirmed VHF or UHF frequencies, clear or encrypted, from these guys.

However, we do have some information on SECOM, the DoE Albuquerque-based HF Secure Communications System, courtesy of Larry Van Horn and the *Grove Shortwave Directory*:

## DOE SECOM Transportation Security Detail/Safeguard Division

Frequencies are in kilohertz (kHz) -

3335.0	Channel 1
5308.0	Channel 2
5751.0	Channel 3
5947.0	Channel 4
7700.0	Channel 5
8013.5	Channel 6
9918.0	Channel 7
11555.0	Channel 8
14657.0	Channel 9
17397.0	Channel 10

So, give some of these frequencies a try and see what you can hear! And as always, pass along any interesting frequency information to us here at the *Fed Files*. See you in November!

# FREE SPEECH RADIO

## WBCQ Shortwave

7.415 - 9.330 - 5.110 - 18.910

[wbcq.com](http://wbcq.com)

[spacetransmissions.com](http://spacetransmissions.com)



*We are the only free speech shortwave station on the planet*



## Understanding Railroad Radio Transmissions

In our last column in June, we gave an overview of the four basic rail traffic management systems. This month we'll look at what kinds of communications you can expect to hear.

### ❖ Operation on sight

During switching moves in a yard or at an industry, any backing moves where the engine is shoving several cars need to be guided by an employee on the ground to make sure all switches are lined correctly and that the train does not strike any obstruction.

The conductor, brakeman, or switchman (depending on the particular situation), will call out the distance to back up to the engineer, first in car lengths and then in feet. So, you'll typically hear the employee on the ground (or riding the last car in the string being shoved on a long move) call out "30 cars; 20 cars; 15 cars ..." and so on. When the distance gets under a car length, the distance is called out in feet.

What about when the employee guiding the move calls out, "Eight cars to a safety stop"? Though common in the past, railroads now no longer allow crew members to get on or off moving equipment except in emergencies. Similarly, railroads do not want an employee riding a car when it experiences the jolt of coupling up to another car. A "safety stop" is made to allow the employee riding the leading car to get off and then to guide the final moves from on the ground or to throw switches needed for the train movement.

As the shoving movement gets within a few feet of the cars to be coupled to, you'll hear some variation of "That'll do" before the couplers bang together. (I've heard of people asking about what "Attledoo" meant!)

After that, you're likely to hear the ground crewman ask for "three step protection." That's another fairly recent standardized safety procedure. The three steps consist of applying brakes, centering the reverser switch in neutral, and switching off power (main generator field switch to off) to the traction motors to ensure that the engine and cars do not move.

Once the engineer acknowledges that three-step protection is in effect, the ground crewman then knows that it is safe to go between cars to couple up air hoses or check on other equipment. These procedures should have been followed even before they were formalized, but the ground crewman asking

for and receiving acknowledgement of the three steps ensures that the proper safety steps have been applied.

(When making connections between passenger cars, the engineer will also inform the ground crewman that head-end power had been cut off. That's the electricity fed from an auxiliary generator on passenger locomotives to operate heating, air conditioning, and other functions in the passenger cars. Some lights in the cars will stay on, fed by batteries which are recharged when power is restored. At that point the crewman can connect or disconnect the power cables between cars.)

### ❖ TWC and Defect Detectors

We've already covered some of the basics of the dispatcher issuing track warrants to trains or work crews.

The more traffic there is on a line, the more track warrant-related radio traffic you will hear, because the dispatcher will grant each train only authority to use short segments of track. And, as soon as that segment is cleared and its track warrant given up, the dispatcher will provide a warrant to another train to enter that segment.

The track warrant form reproduced in the last installment of this column shows you some of the possible instructions that can be conveyed with track warrants. Note that there is always the option for instructions that do not fit the standardized format of the form.

Another feature you will find on track warrant control (TWC) and centralized track control (CTC) lines, because of their higher traffic densities and higher speeds, is the talking defect detector. These are automated machines that check passing trains for mechanical problems.

The most common checks are for hot bearings and dragging equipment, often combined at one location. Hot bearings can lead to an axle or bearing failure. Dragging equipment, such as a loose tie-down chain, can not only injure people at lineside but also snag on lineside equipment. And, a dragging tie-down chain can also indicate that the load on a railcar has become loose and may shift. In worst-case situations, both

hot bearings and dragging equipment could ultimately result in a derailment.

Hot bearings are detected with heat sensors. Dragging equipment is checked for by a series of vertical paddle sensors placed between and just outside the rails.

Some detectors broadcast an initial message when the train first starts passing them, indicating that they are working properly. Others broadcast only when the train has completely passed. The detector will identify itself by railroad and location (usually a milepost number, but sometimes also using a named location, such as a town). If no problems are found, it will transmit a "No defect" message.

If a problem is found, the detector usually broadcasts an alert tone, followed by a basic description of the problem, usually giving the location within the train by axle count from the front.

Less common, but also found on some lines are high-wide detectors, often located near bridges or tunnels with restricted clearances. These detectors use light beams to check for loads which exceed the allowed dimensions and broadcast a warning message if one is encountered.

Defect detectors normally have low-powered transmitters with a range of only about five miles. If a train receives a warning message from a detector, the crew has to stop the train and inspect it to find further information about the problem.

Defect detectors will alert you to train movements, though in many cases you will not

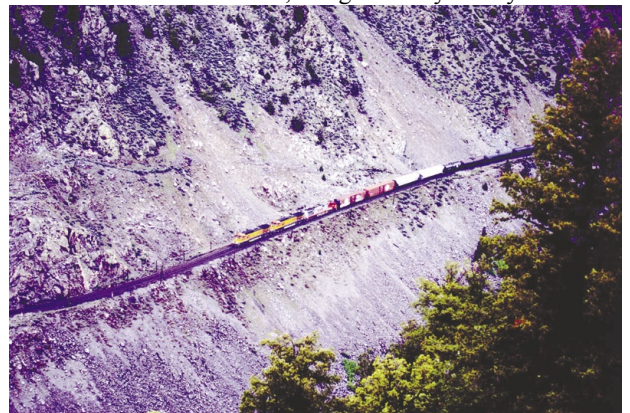

In remote Gore Canyon in western Colorado, this BNSF train is operating via trackage rights on Union Pacific tracks; therefore, the crew is using UP frequencies to communicate with the dispatcher. In this mountainous terrain, UP also uses UHF repeaters, which lets crews talk over greater distances.



*Riding the back end of a long string of grain hoppers, a BNSF employee with a portable radio is guiding an engineer more than half a mile away during a backup move at the BNSF yard at Vancouver, Wash. The bridge spans the Columbia River, the border between Oregon and Washington, and is on the line between Vancouver and Portland, Oregon.*

know in which direction the train is moving past the detector.

### ❖ CTC Operations

Though signals greatly improve both the efficiency and safety of train operations and usually also permit operations at higher speeds, they do not eliminate radio transmissions from trains.

Most railroads require their crews to call signals on the radio. "Amtrak 80 clear (green) signal at (milepost) 52.1," would be a typical transmission.

Calling signals helps keep the engine crews alert and also alerts other nearby railroad employees, including crews on other trains, to nearby train movements. Carry a scanner with you on a passenger train, and you will not only know what's going on on the train, as the conductor talks to the engineer, but you will also constantly know where you are as the engineer calls the signals.

Unlike road traffic signals that display only green, yellow, or red, railroad signals can display multiple additional aspects. For example, you may hear a train calling either "Diverging clear" or "Approach diverging" indications.

Diverging clear (red over green) authorizes a train to move over the diverging route of a switch and tells it that the blocks (track segments) ahead are clear. While the train usually has to reduce speed to go through the switch, once it has passed that location, it can resume full authorized speed.

Approach diverging (Yellow over yellow) is an advance warning. It allows the train to pass the current signal, but tells it to expect the switch at the end of the block to be lined for the diverging route – and that it needs to expect a stop (red signal) indication at the end of the following block. This situation would typically be encountered when a train is lined into a siding to await a meet with a train in the opposing direction.

The full list of possible signal indications is too long to go into here.

### ❖ Insight into Operations

Using a hand-held, vehicle-mounted, or base station scanner can help you gain insights into the complexities of railroad operations, where, as in the rest of the world, anything that can go wrong will go wrong, at one time or another. Remember, however, that railroads are private property (and inherently dangerous industrial sites) and that most railroads take trespassing extremely seriously.

The above descriptions should help you interpret much of what is happening on a line near you. The more you listen, the more you will understand about operations, as context makes other points being discussed clear.

### ❖ The Present and the Future

Almost all railroad radio conversations take place in the VHF high band on a set of 97 frequencies allocated for railroad use. Frequencies are numbered 2-98 for ease of selection on all-channel locomotive radios. The one-time channel 1 has been re-assigned to other uses. Channels 2-6 are used only in Canada and allocated to other uses in the U.S. Channel 98 is only allocated to previous users and will not be assigned to any new applicants. (You can find the full list of allocated frequencies at <http://www.monitoringtimes.com/html/mtrail.html> -ed.)

In a few rare situations, industrial switching operations (and tourist railroads) use a UHF frequency assigned to the industry. And, in a small number of cases, large railroads use UHF repeaters in difficult terrain. These repeaters pick up transmissions on a VHF railroad frequency, relay them on the UHF frequency to another repeater, which then again transmits on the VHF railroad frequency.

Amtrak trains (and VIA trains in Canada) use the frequencies of the host railroad on which they operate, with the few exceptions where Amtrak owns the tracks. In the latter case, Amtrak typically uses the frequencies historically assigned to the lines before they came under Amtrak ownership.

Small railroads may use only a single frequency, but most railroads are allocated multiple frequencies by the Association of American Railroads (AAR), the coordinating body for railroad frequencies. In many cases, existing frequencies in a particular territory are retained when railroads merge.

The multiple frequencies come in handy in large metropolitan areas, where a single railroad may have many busy lines, and by

having each line use a different frequency, radio traffic on one line does not interfere with that on other lines.

At the very least, most railroads have a road channel and a yard channel. That way, movements in a switching yard, which require lots of radio talk, do not interfere with trains operating on the nearby main line.

Some remote base stations on busy lines are also equipped to operate on multiple channels, though they normally only listen for an alert tone on the primary channel. If two railroad employees need to have an extended conversation, such as in diagnosing a technical problem, they will tell each other to go to the alternate channel so as not to interfere with normal operations on the primary channel. The dispatcher can also select the alternate channel for an extended conversation.

When a train goes from a territory using one frequency to one using another, you may hear a message such as "Going to 22-22." That means the train is switching to AAR channel 22 (for both transmit and receive), or 160.44.

### ❖ The Future

Railroads are in the early stages of testing digital communications system (in addition to using commercial cell phones for some communications). At some point, command messages, such as track warrants, will be transmitted to trains out in the field in digital text form, which the crew can then print out from an on-board computer.

These computers will also be able to display to the engine crew a variety of graphic information now conveyed by lineside signals or previously viewable only by dispatchers. Railroads are already using GPS data for some applications.

As digital radio communication is more widely used by railroads, they may also incorporate their own digital voice systems.

But for now, analog FM VHF high-band voice transmissions will not go away any time soon. Any locomotive that may run through or be detoured on the tracks of another railroad is required to have a radio capable of transmitting on all of the existing AAR channels. The many thousands of these radios on engines, in railroad vehicles and in hand-held form, will probably initially coexist with new digital systems.

Until a North America-wide standard is developed for railroad digital communications – and that's probably still a decade or two away – analog radios will continue to dominate railroad radio communications.

### Daniel Sampson's PRIME TIME SHORTWAVE

<http://www.primetimeshortwave.com>

Your guide for up-to-date English shortwave schedules sorted by time, country and frequency plus a DX media program guide and newsletter

# DXing on the High Seas

In March of 2005 Ken Maltz (New York) sent some non-directional beacon (NDB) loggings that he made while aboard a cruise ship in the southern Caribbean. We ran his loggings in a later issue of *Below 500 kHz*. Well, vacation season is upon us again and he has just returned from another cruise – this time to the area of the British Isles, Norway, and the French and Dutch coasts. He brought along his Sony 7600GR and found a quiet place on the top deck to do some listening. With his headphones plugged in, he was able to log the stations listed in Table 1. He used only the Sony's built-in ferrite rod antenna.

**Table 1. Cruise Ship LW Loggings**

Freq.	ID	Location
267	FNO	Foyno, Norway
27	VG	Vaage, Norway
310	TRL	Troll, International Waters
319	VAR	Varhaug, Norway
329	FJ	Fjoertoft, Norway
336	BTA	Bratta, Norway
337	MY	Mykinnes, Faroe Islands
344	WCK	Wick, Scotland
351	SBH	Sumburgh Head, Shetland Islands
352	ZO	Sola, Norway
355	VGA	Vigra, Norway
360	ASK	Askoe, Norway
362	BVK	Baatvik, Norway
370	KS	Kinloss, Scotland
378	RSY	Rennesoe, Norway
379	REK	Reksten, Norway
383	SHD	Scotstow Head, Scotland
395	KW	Kirkwall, Orkney Islands
395	LAY	Islay, Scotland
398	AL	Lepsoey, Norway
416	RA	Tyra East, International Waters
420	LTR	Unidentified
427	HDY	Unidentified

Ken offers the following advice to others interested in DXing while on the high seas:

"You will need to be outside on deck while listening, as the massive steel structure of a modern cruise ship attenuates signals considerably. Find a nice comfortable deck chair, and plug in your headphones to both keep out both shipboard sounds and wind noise and to be considerate of those passengers who might not care to share the sounds of your hobby.

"Dress appropriately. In sunny climes you will need to be protected from the sun; in the North Sea, pack sweaters and wind breakers; it can be very cold on the uppermost deck while cruising along at 22 knots at midnight (even if the sun is still shining)!

"Bring along a frequency/call sign reference that covers the area where you will be doing your listening. For domestic areas, Kevin Carey's *BeaconFinder* is outstanding. For international use, load Alex Wiecek's file [WWSU\\_6.2](#) into your

computer and the chore of IDing your catches will be made much easier. (Download available from [www.ve3gop.com/](http://www.ve3gop.com/) -ed)

"Be prepared to use your radio's built-in antenna, as erecting a long wire or Beverage antenna on board ship is out of the question. In my case, the Sony's ferrite loop worked very well and, being directional, it helped to get bearings on several stations."

Thank you for this advice Ken, and be sure to keep in touch as you set out on your next high seas adventure!

### ❖ SAQ Transmissions a Success

On July 2<sup>nd</sup> at 0830 and 1230 UTC, The Alexander Alternator transmitter at Grimeton, Sweden, was fired up for another of its commemorative transmissions. This transmitter is very unique, in that it uses no tubes or transistors to generate its powerful signal on 17.2 kHz. Instead, it employs an electro-mechanical AC generator that directly produces the RF fed to the station's antenna. SAQ is the last such transmitter in operating condition.

This time, 38 signal reports were received from those hearing SAQ's Morse transmissions. Several countries in Europe heard the station strongly, and reports were also received from listeners as far away as New York, New Jersey, South Carolina, and Massachusetts. The complete text sent by SAQ was as follows:

CQ CQ CQ DE SAQ SAQ SAQ

THIS IS GRIMETON RADIO/SAQ IN A TRANSMISSION USING THE ALEXANDERSON 200 KW ALTERNATOR ON 17,2 KHZ.

ONE HUNDRED YEARS AGO THIS DECEMBER, THE CANADIAN-BORN REGINALD A FESSENDEN MADE THE FIRST WIRELESS TELEPHONY BROADCAST FROM BRANT ROCK RADIO/BO IN MASSACHUSETTS, USA USING A ONE KW ALEXANDERSON ALTERNATOR.

SIGNED: THE ALEXANDER-GRIMETON VETERAN-RADIOS VAENNER ASSOCIATION  
FOR QSL INFO PLEASE SEE OUR WEBSITE: [WWW.ALEXANDER.N.SE](http://WWW.ALEXANDER.N.SE)  
DE SAQ SAQ SAQ @

### ❖ 500 kHz Progress

According to the *American Radio Relay League Letter*, Volume 25, No. 27, progress is being made on the Radio Society of Great Britain's request for assignments at both 5 MHz and 500 kHz. Regarding 500 kHz, Colin Thomas, G3PSM of the RSGB said: "Discussions were progressing on a 2004 RSGB proposal to Ofcom (the UK's wireless regulatory bureau), and he's optimistic

that the Society would be granted its first choice – an allocation between 501 and 504 kHz. He said there's also a possibility that the frequency of 500 kHz would be designated a maritime memorial frequency, but he cautions that this would depend on how long certain countries continue to use 500 kHz as a maritime emergency frequency."

The *ARRL Letter* is available free of charge from the American Radio Relay League on their website at [www.arrl.org/arrlletter](http://www.arrl.org/arrlletter). A new issue is posted each Friday, and automatic e-mail delivery is available for ARRL members.

### ❖ South Carolina Logs

Herbert Newberry Jr, of Milledgeville, Georgia, provided the logs shown in Table 2. Besides being an excellent place for LW monitoring, Milledgeville is also the childhood home of my favorite comedian, Oliver Hardy. There's no joking around here, though. Herbert's logs are a great cross-section of beacons from the Southeast U.S., many of which are not often reported. Herbert uses an Icom R-75 receiver connected to two random wire antennas that are tied together in his shack.

**Table 2. Selected Beacon Logs (GA)**

Freq.	ID	Location
204	TWL	Monroe, NC
206	GLS	Galveston, TX
216	CLB	Wilmington, NC
221	BJT	Athens, GA
224	MO	Moosone, ON
224	BH	Birmingham, AL
224	GVA	Henderson, KY
227	UZ	Rock Hill, SC
257	SQT	Melbourne, FL
260	BVQ	Glasgow, KY
266	BR	Atlanta, GA
276	TWT	Sturgis, KY
278	EOE	Newberry, SC
287	GS	Greer, SC
326	ZEF	Elkin, NC
326	UOT	Union, SC
341	HVS	Hartsville, SC
354	MKS	Monks Corner, SC
365	DYB	Summerville, SC
396	UV	Martinsville, VA
406	CKI	Kingstree, SC
417	HQT	Coats, NC
420	TU	Tupelo, MS
420	CFY	Lake City, SC
432	IZN	Lincolnton, NC
521	GMI	Greenville, SC
524	AJG	Mt. Carmel, IL

### ❖ Next Month

I have just returned from a trip to New England, and plan to share some pictures, loggings, and other tidbits with you in the October column. New England is an interesting part of the country for radio history in general, but it is especially fruitful for longwave. 73, and best LW DX!

## Elkhorn Pirate Maildrop Closes

The longtime operator of the Elkhorn pirate maildrop sent the unfortunate news that the maildrop will be closing forever, effective September 15. According to the maildrop's press release, "Too few stations and increased use of the Internet for reports and E-QSLs have made the drop 'obsolete.'" Thus, our listing of PO Box 69, Elkhorn, NE 68022 as a valid pirate maildrop will end after this month.

This startling news already has caused action on the shortwave pirate bands. For instance, Ground Zero Radio ran a special contest during the summer, with announced grand prizes of either a "grenade" AM pirate transmitter or a "Corsair" AM pirate transmitter. The contest commemorated the closure of the Elkhorn address.

The maildrop operator provides a list of various pirate stations that have used this maildrop for QSL correspondence over the years. The list is impressive. It includes pirates such as **The (Government) Mule**, **Ground Zero Radio**, **KIPM**, **KROW**, **Mystery Science Radio**, **The Purple Nucleus of Creation**, **Radio Gong (Calling)**, **Radio Time Machine**, **Seldom Heard Radio**, **Theremin Radio**, **Voice a'Da Tiki**, **Voice of the Abnormal**, **Voodoo Radio**, **WAIR (All Indie Radio)**, and **WDDR**.

After September, these stations will be looking for new addresses for purposes of pirate radio correspondence.

### ❖ Radio Insurgente Times

Some DXers are still trying to hear the extremely difficult Mexican clandestine station **Radio Insurgente**. Our own Glenn Hauser at *Monitoring Times* points out that it might be a good idea to clarify the times when this station has been heard.

Bob Wilkner confirms that he has heard them from Florida at various times between 1950 and 2110 UTC on a slightly variable frequency of 6000 kHz. As both Bob and Glenn point out, the broadcasts often start about ten minutes prior to the top of the hour on Fridays. The station



also claims to have FM repeater relays on frequencies such as 97.9, 99.7, and 100.1 MHz within Mexico.

The actual times are confusing, given shifting information on the station's own web site at <http://radioinsurgente.org/>

This voice of the Ejército Zapatista de Liberación Nacional Mexican rebels still maintains some archived streaming audio of their broadcasts on the web site. It also provides us with the alleged photo of the station's clandestine antenna that we see here this month.

During the summer and fall months, this one will be virtually an impossible DX catch from most locations outside southern Mexico. But, as the days get shorter, it may be worthwhile to check out the region of 6000 kHz around 2100 UTC.

### ❖ Oldest Pirate QSL

We continue to receive many wonderful nominations for the oldest pirate radio QSL in the collection of *MT* readers. Bob Combs points out that he has some from the late 1960s from stations like **Radio Caroline** and **Radio London**, which he heard while he was stationed in the Air Force in the UK. Frank Decker has some nice ones from the early 1980s in North America, including stations such as the **Voice of Venus**, **WART**, **Radio Free Radio** and **KQSB**. John Arendt has one from **WRVU** in North America that is dated 1971. Mike Hardester has some nice ones from 1980 that came from **Green River Radio** on 7355.7 kHz and **Moonshine Radio** on 6313.25 kHz. Mike sent his reception reports to a long since forgotten maildrop at RD2, Box 542, Wescosville, PA.

In future months we plan to continue this march down memory lane. Do you have an old pirate radio QSL in your own collection? Let us know.

### ❖ What We Are Hearing

*Monitoring Times* readers heard almost twenty different North American pirates this month. You can hear them too, if you use some simple techniques. Pirate radio stations never use regularly announced schedules, but shortwave pirate broadcasting increases noticeably on weekends and major holidays. In the United States, Labor Day will be the next upcoming major holiday under this definition. You sometimes have to tune your dial up and down through the pirate radio band to find the stations, but more than 95% of all North American shortwave pirate broadcasts are heard on **6925 kHz**, plus or minus 30 or 40 kHz.

**Captain Morgan**- Classic rock mixed with audio from old TV and movie themes and a "pirate zone" slogan is their staple fare. (None, says to send loggings to the Free Radio Network web site, and has QSLed lately)

**GM55KK**- Somebody got on the pirate bands during

the summer in Morse Code CW with this phony ham call. (None)

**Ground Zero Radio**- Dave Gunn's pirate shows are allegedly transmitted from an old ICBM missile silo, but as we discuss this month his maildrop is closing. (Used to use Elkhorn)

**Happy Halloween**- The Halloween sound effects on this one stunner many when they appeared in the middle of the summer, nowhere near Halloween. (None)

**Lizard King Radio**- Classic rock music has been the main programming on this pirate so far. (None)

**MAC Shortwave**- Paul Star is the announcer on this oldest rock station that features genuine old radio jingles on frequencies such as 6950 kHz. (Uses [macshortwave@yahoo.com](mailto:macshortwave@yahoo.com) e-mail)

**Mrs. Commander Bunny Radio**- It was inevitable. Somebody has produced a parody of the **WBNY** clandestine parody station. (None announced)

**Mystery Science Radio**- Their recent broadcasts have featured a computer generated voice. (Used to use Elkhorn)

**North Woods Radio**- They rock music, comedy, and animal sound effects from out in the woods, using a slogan of "broadcasting from the Great Lakes." (Uses [northwoodsradio@yahoo.com](mailto:northwoodsradio@yahoo.com) e-mail)

**Pirate Radio Boston**- Charlie Loudenboomer often plays local New England rock on his pirate shows. (Stoneham)

**Pirate Week Podcast**- Somebody is producing a summary of pirate news, and it occasionally gets a relay on the pirate bands. (None)

**Radio First Termer**- This old documentary about rock music broadcasts to American troops during the Vietnam war often gets relayed on the pirate bands. (None)

**Radio Free Speech**- Bill O. Rights is back with advocacy for freedom and the constitution, mixed in with comedy material. (Belfast)

**Radio Stickman Shortwave**- This relatively new pirate features oldies rock and pop as well as Three Stooges comedy. (None)

**The Crystal Ship**- The Poet operates the "Voice of the Blue States Republic" with leftist political commentary and rock or classical musing, using unusual variable frequencies such as 6875 kHz and 1710, 3320, 6854, 6925, and 9057 kHz. (Belfast and uses [tcsshortwave@yahoo.com](mailto:tcsshortwave@yahoo.com) e-mail)

**Undercover Radio**- Dr. Benway aired several broadcasts "from the middle of nowhere" with his 20<sup>th</sup> Anniversary Special. He plays rock music and discusses pirate radio history. (Merlin and uses [undercoverradio@mail.com](mailto:undercoverradio@mail.com) e-mail)

**WBNY**- Commander Bunny's rodent revolution parody of clandestine stations still features yodeling, Easter music (in and out of season), and digital slow scan TV broadcasts. (Try Belfast)

**WMPR**- Techno rock music with a "dance party" slogan makes it easy to identify this one. (None; has QSLed only at the Winter SWL Festival)

### ❖ QSLing Pirates

Reception reports to pirate stations require three first class stamps for USA maildrops or \$2 US to foreign locations, especially in Europe where the value of the US dollar has plunged considerably. The cash defrays postage for mail

Continued on page 61

# The New Tech Test and Learning Linux

July 1st, 2006, was an important event for folks wanting to join the ranks of Amateur radio. Effective July 1, 2006, the Federal Communications Commission (FCC) recognizes a new question pool for use as the basis of the Technician Class License Exam (FCC Element E2), the "Entry Level" ticket to play ham radio.

This question pool is probably the most significant update to the Technician Class test in the many iterations since the process of Volunteer Examination began in the early 1980s. The test still will be 35 questions long, multiple choice, and the VE Team will be looking for you to come up with 26 or more correct answers when they grade your answer sheet. (That's 74% for you math-challenged folks.)

The biggest change that will affect your studying for the test is that the overall question pool size has been reduced from 510 possible questions down to just 392. There has also been an effort to make the questions and answers easier to understand. Folks who recall the old FCC exams will remember that sometimes the questions and answers would present wording that would serve to trip up even someone who was well versed in the subject matter. This practice has gone the way of the spark gap, and the new question pool requires that you understand only amateur radio theory and practice and not word games.

And, since this is written to benefit folks who are just planning to become hams, I should remind you that there is no longer a CW testing requirement for Technician Class licensing and operation. (There hasn't been for quite some time now, since 1991 in fact.) You pass the Tech theory and you head to the ham store to buy your first radio; it's that simple.

With the new question pool, any dedicated future ham could probably pass the current exam with a few hours of study each evening for about two weeks. I know of many folks who have even passed after studying hard over a long weekend. So, those of you who are still on the fence about sitting for the exam are just about out of excuses. Now is the time to get your first amateur radio license!

While it is possible that you could still pass the current test using information and study guides from previous versions of the question pool, why take any chances? While much of the material is still relevant, even a change in one or two questions could be the difference between passing or needing to sit again before you can get on the air. New study guides are now available. When purchasing any study guide, be sure to check that it covers the July 1, 2006, question pool. Buying an older guide – as may be possible

at a ham fest or even a popular chain bookstore – would be a waste of time and money.

Some day I will have to tell you about studying for the old Novice Class exam using what I thought were current materials, only to find out the day before the exam that they had changed some of the Novice Class frequency allocations from the time my "up to date" study guide had been published. I am still trying to figure out how I squeaked through that test.

The first of these new Question Pool Study Guides came across my desk recently.

**TECHNICIAN CLASS**  
**FCC License Preparation for Element 2**  
**Technician Class Theory, Sixth Edition**  
By Gordon West WB6NOA  
224 Pages  
\$18.95  
ISBN 0-945053-45-2  
Master Publishing, Inc.  
6125 W. Howard Street  
Niles, Illinois 60714

There are very few folks in amateur radio as dedicated to helping people get their first ham ticket as Gordon West WB6NOA. The man even publishes his phone number in his books so you can call him for additional support and information. That is a serious commitment!

The study guide begins with an overview of the amateur radio service, covering the various activities and privileges the entry level Technician Class license has to offer. West also includes a section on the history of amateur radio regulations, including the changes the FCC brought about in 1999 to further simplify the amateur radio license structure. Even though I have an Extra Class license and hopefully will never have to sit in a VE exam again, I found this chapter informative, probably because most of the major changes occurred during the years I was sitting for the various tests to reach Extra. Back then, there were five theory tests and three code tests to get access to the Extra Class portions of the bands. Now we are down to three tests and one code test. Quite a difference from the "good old days!"

What I liked best about this exam guide is Gordon's approach to studying the new Element 2 question pool. Each pool question is examined along with any appropriate accompanying theory and practice, question by question. This seems to be a very practical way to absorb the information needed beyond simply memorizing the question

pool. West has also reorganized the question pool into a more logical sequence, to aid in learning the subject matter. It makes it much easier to understand related topics and draw on your knowledge base when you actually sit for the exam.

The study of each pool question includes highlighted key words to aid in understanding. There is also a citation to the particular section of FCC Part 97 regulations that apply to the question. While this is not needed to pass the test, it is an interesting resource for instructors or hams who want to better understand the rules and regulations behind their amateur radio practice.

Interspersed throughout the question pool study are a series of "Ham Hints" that give good practical advice to help you get off on the right foot once you have passed the exam. Also, each section of the question pool includes appropriate Internet links, called Website Resources, for further information and study. Adding Web support to the basic areas of study allows the prospective ham to delve deeper into areas of personal interest.

Gordon even includes an exhaustive chapter on studying for and passing the optional (for Techs) 5 WPM CW Exam. Code still has a lot of value, is fun, and, for now, is still required for higher class licenses. So, while WB6NOA still has your ear, he wants to help you understand that passing the code is not nearly as hard as some people make it out to be.

There is finally a chapter that goes into the process of actually sitting for the exam. West walks you through the process from last minute preparation, into the exam center and what to do when you have finished taking the test. He explains all aspects of the exam session, including the fees and paperwork. All this serves to reduce stress on exam day, making it possible for you to actually relax and enjoy the process of getting your first ham ticket.

Making the assumption that you have used the study guide to successfully pass the test, the guide includes an appendix section full of information that will help you as you grow in your ham radio career. And, as they always say on late night TV, "But wait... There's more!" Gordon has included a number of coupons that allow you to get a free trial subscription to *CQ* magazine, a free book with a new ARRL membership, and even a discount on the purchase of your first radio – premiums all well above the cover price of the study guide. Also, the study guide comes with a CD that teaches the student about the vagaries of VHF propagation. I even learned a thing or two listening to this presentation.

Gordon West's new *Technician Class* study



guide is the perfect tool to guide you into the great world of amateur radio.

If you or your ham club is planning on using Gordon's *Technician Class* study guide as the basis of a training class for new hams, there is also an excellent support manual

#### **INSTRUCTOR GUIDE FOR THE GORDON WEST 2006-10 TECHNICIAN CLASS**

By Gordon West WB6NOA  
Edited by Pete Trotter KB9SMG  
40 Pages  
\$12.00  
The W5YI Group, Inc.  
Lincolnwood, Illinois 60712  
1-800-669-9594  
[www.w5yi.org](http://www.w5yi.org)

I wish I had this study guide when I was first offering ham radio training classes. A lot of things I discovered by trial and error are covered in this guide. Everything from class planning and publicity, to picking instructors – even the best table arrangement – is discussed based upon West's years of experience guiding people toward their ham license.

The book has many great hints for supplementing the question pool with practical demonstrations of ham radio skill and technique. All these ideas make the learning fun and, more importantly, make the learning stick when it is time to sit down at the VE test session. If you or your club plans to offer a Technician Class training event, this book needs to be read before you hang your first poster.

### ❖ And now for something completely different ...

#### **Linux**

Most people who have an interest in personal computer technology have heard of it, but how many folks have had the opportunity to play with this alternative (and essentially free) operating system? Initially developed in 1991 by Linus Torvalds, Linux became a computer phenomena of the first order for both hobby and professional applications.

For hams, there are quite a few reasons to begin to understand this operating system. Many unique ham radio applications have been written to run under Linux, some that have never been ported over to the Microsoft or Apple operating systems. Further, much of the exciting work being done in the area of software derived radios (SDRs) is being done in code written to run under Linux.

Until recently, for all its advantages, Linux was difficult to learn and even more difficult to get running on a personal computer. However, there are now ways to begin to explore the Linux environment and to experiment with many of these ham radio based applications without needing to go through a complex installation process. All you need is a common PC equipped with a CD ROM.

Several distributions of the Linux operating system have been developed to run directly from a CD. All you are required to do is set your PC's BIOS to boot from CD first, and you can play with Linux to your heart's content without needing to disturb your existing operating system, programs,

or files. It is usually as simple as inserting the disk and turning your computer on. Some system's hardware may require a bit of tweaking, but this is usually little more than changing some setting while Linux boots up. Most common setup issues are addressed on support Web sites. Nothing you will encounter will be as complicated as the Linux installations of the past. The operating system has really matured to allow almost anyone to experience its advantages first hand.

One CD based distribution of Linux that I have experimented with for amateur radio use is KNOPPIX ([www.knoppix.com/](http://www.knoppix.com/))

Now in its 5<sup>th</sup> iteration, KNOPPIX runs the KDE Desktop environment and includes the Open Office Suite, the OG Vorbis audio player, and the Konqueror Web browser, among other applications. It will run on most Intel-compatible CPU systems (i486 or later) that have 32 MB of RAM for text mode, or at least 96 MB for graphics mode with KDE. Of course, you will need a bootable CD-ROM drive, or a boot floppy and standard CD-ROM (IDE/ATAPI or SCSI). KNOPPIX works with any standard SVGA-compatible graphics card.

So, now it is easy to begin to understand more about this powerful operating system and how it is having a positive impact within the amateur radio community.

Have fun! I'll see you at the bottom end of 40 meters.

#### **UNCLE SKIP'S CONTEST CALENDAR**

**ARRL September VHF QSO Party**  
1800 UTC Sept 9 - 0300 UTC Sept 11

**North American Sprint, CW**  
0000 - 0400 UTC Sept 10

**Tennessee QSO Party**  
1800 UTC Sept 10 - 0100 UTC Sept 11

**YLRL Howdy Days**  
1400 UTC Sept 12 - 0200 UTC Sept 14

**QCWA QSO Party**  
1800 UTC Sep 16 - 1800 UTC Sep 17

**South Carolina QSO Party**  
1300 UTC Sep 16 - 2100 UTC Sep 17

**Washington State Salmon Run**  
1600 UTC Sep 16 - 0700 UTC Sep 17  
and 1600 - 2400UTC Sep 17

**North American Sprint, SSB**  
0000 - 0400 UTC Sep 17

**Texas QSO Party**  
1400 UTC Sept 23 - 0200 UTC Sept 24  
and 1400 - 2000 UTC Sept 24

**CQ Worldwide DX Contest (RTTY)**  
0000 UTC Sept 23 - 2400 UTC Sep 24

**Fall QRP Homebrewer Sprint**  
0000 - 0400 UTC Sept 25

**Arkansas QSO Party**  
1400 UTC Sep 30 - 0600 UTC Oct 1  
and 1800 UTC Oct 1 - 0200 UTC Oct 2

**FISTS Coast to Coast Contest**  
1800 UTC Sep 30 - 1800 UTC Oct 1

#### **Outer Limits continued from Page 59**

forwarding and a souvenir QSL to your mailbox. Letters go to these addresses, identified above in parentheses: PO Box 1, Belfast, NY 14895; PO Box 109, Blue Ridge Summit, PA 17214; PO Box 146, Stoneham, MA 02180; and PO Box 293, Merlin, Ontario N0P 1W0.

Some pirates prefer e-mail, bulletin logs or internet web site reports instead of snail mail correspondence. The best bulletin for submitting pirate loggings with a hope that pirates might QSL is now the e-mailed *Free Radio Weekly* newsletter, still free to contributors via [yukon@tm.net](mailto:yukon@tm.net). A few pirates will sometimes QSL reports left on the Free Radio Network web site at [www.frn.net](http://www.frn.net)

#### ❖ Thanks

Your loggings and news about unlicensed broadcasting stations are always welcome via 7540 Highway 64 W, Brasstown, NC 28902, or via the e-mail address atop the column. We thank this month's valuable contributors: John Arendt, Oswego, IL; Kirk Baxter, North Canton, OH; Jerry Berg, Lexington, MA; Artie Bigley, Columbus, OH; Bob Combs, NM; Richard Cuff, Allentown, PA; Gerry Dexter, Lake Geneva, WI; Rich D'Angelo, Wyomissing, PA; Frank Decker, Rochester, NY; Bill Finn, Philadelphia, PA; Harold Frodge, Midland, MI; Dave Gunn, Elkhorn, NE; William T. Hassig, Mt. Prospect, IL; Glenn Hauser, Enid, OK; Harry Helms, Smithville, TX; Ed Kusalik, Coaldale, Alberta; Chris Lobdell, Stoneham, MA; Greg Majewski, Oakdale, CT; Larry Magne, Penn's Park, PA; Joe Miller, Troy, MI; John Poet, Belfast, NY; Ken Reitz, Brasstown, NC; Martin Schoech, Eisenach, Germany; John Sedlacek, Omaha, NE; Lee Silvi, Mentor, OH; Bryan Wade, Elizabethtown, KY; Bob Wilkner, Pompano Beach, FL; and Joe Wood, Greenback, TN.

#### **Read a Good Label Lately?**

You could learn a lot! Look at your MT label before you throw your wrapper away - it tells you how many issues you have left in your subscription. If two or less, renew right away to avoid missing an issue. Keep those MTs coming and we guarantee you'll learn a lot!

**WARNING:** If you get a neon yellow wrapper on your magazine, don't throw it away: That is your renewal notice! Cut the card out of the wrapper and send it in with your payment. You'll get two notices and then it expires. So take care, don't let your subscription die!

#### **Longwave Resources**

✓ **Sounds of Longwave** CD or Audio Cassette (please specify) featuring WWVB, Omega, Whistlers, Beacons, European Broadcasters, and more!  
**\$13.95** postpaid

✓ **The BeaconFinder** A 65-page guide listing Frequency, ID and Location for hundreds of LF beacons and utility stations. Covers 0-530 kHz.  
**\$13.95** postpaid

**Kevin Carey**  
P.O. Box 56, W. Bloomfield, NY 14585

## Catching that Elusive Signal

**Y**our antenna is your radio's interface to the rest of the world. That's an important job, and so this month let's discuss a few ideas that can often help you catch those more elusive signals that you would like to hear. For weak signals, or for those almost buried by received noise, a little help from the antenna can sometimes make the difference between good reception and unintelligible noise.

### ❖ You Can't Catch What's Not There

Before our antenna can receive a signal, there must be an incoming signal for the antenna to receive. The Shortwave Guide in *Monitoring Times* tells you who is broadcasting when. But, if you want to receive HF signals from specific locations around the world, you must take into account the variations in signal propagation (signal travel) of the signals that you want to hear. It is worth your time to check out a radio handbook and get acquainted with the basics of how signals propagate around the earth.

There are a number of computer programs that help you predict when signals from different locations in the world are likely to be receivable at your location. *Monitoring Times* runs seasonal predictions and *QST* publishes propagation predictions each month. There is less variability of signal propagation on the bands other than HF, but even on those other bands a bit of knowledge of propagation basics can be useful in catching the signals you want. (See this month's propagation feature for basics and recommended software - ed.)

### ❖ Your Antenna Catches Noise, Too

A second point to consider is the amount of received noise that is present on the frequency of the signal you want to receive. Although excessive received noise can destroy reception, an appropriate antenna can often overcome this problem. If the antenna is directional, it may be possible to orient the antenna such that the received-noise level is reduced and the desired signal emphasized to receivable levels above the noise.

Note that it is antenna *directivity*, not high antenna *gain*, which is most useful where received noise is a problem.

On VHF, UHF and microwave bands, where received noise is not the problem that it is on HF and lower frequencies, antennas with high gain can be useful for weak signal reception by raising the received signal strength above the noise generated in the receiving system.

### ❖ Look to the Signal to Catch It

Antennas, particularly beam antennas, vary in the degree to which they respond to signals arriving at the antenna from various directions. They also vary in how they respond to signals arriving at different vertical angles, ranging from the same plane as the earth on to straight up vertically. These variations in antenna response can be represented graphically as a three-dimensional pattern of the space around the antenna. This pattern also represents the manner in which the antenna will launch waves when transmit-

ing, and is usually called the antenna's "radiation pattern."

For example, in the vertical radiation pattern of fig. 1A, you can see that a grounded, vertical, quarter-wavelength antenna obviously responds well to signals arriving at relatively low, vertical angles, but responds little or not at all to signals arriving from high vertical angles or from directly overhead.

Often the way we mount our antennas affects their radiation patterns. For instance, a horizontal dipole antenna mounted a quarter wavelength above earth respond well to signals arriving at high vertical angles, whereas the same antenna mounted a half wavelength above earth responds less to signals at high vertical angles, and more to those arriving at moderately low angles.

### ❖ Polarity

Both antennas and radio signals have what is called "polarity," and this is sometimes important for reception. Polarity for both transmitting and receiving is usually determined by the orientation (vertical or horizontal) of the elements of an antenna. For practical reasons, on HF and lower frequencies we often ignore the polarity of our antennas. However, it can occasionally become important, and then having antennas in both the vertical and horizontal orientation can be helpful. Switching from one antenna to the other when fading occurs, for example, sometimes improves reception. Devices which do this switching automatically provide what is called "diversity reception."

At VHF and higher frequencies, much communication is by direct-wave propagation, and polarity is thus more predictable. Having your antenna in the correct polarization orientation on these bands becomes more significant for good reception. For instance, most mobile work uses vertical polarization, whereas American TV uses horizontal polarization.

### ❖ Placement

Lastly, remember to place your antenna as much in the clear as possible. Nearby objects such as metal buildings and hills can block signals from reaching the antenna. Usually we also want the antenna as high as possible, but as mentioned above, sometimes a lower mounting gives the vertical-radiation pattern we want.

### ❖ And So

You may already be able to receive all the HF or lower frequency signals that you want with

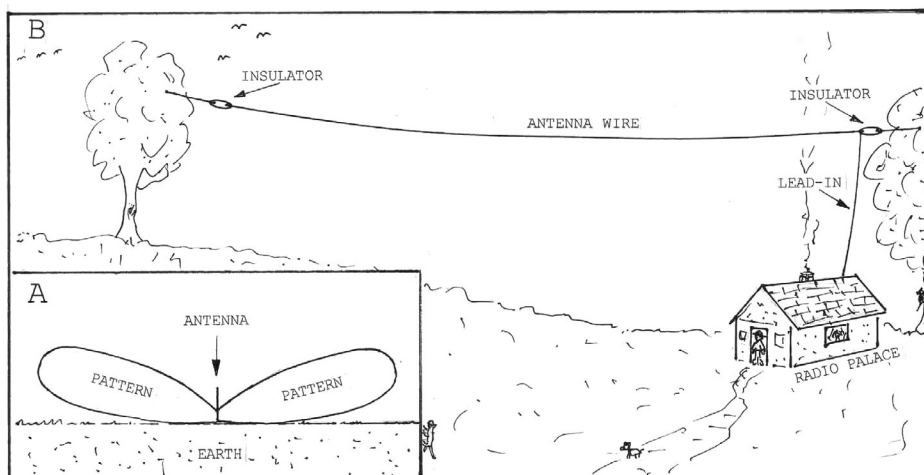

Fig. 1. RADIATION PATTERN FOR A GROUNDED, QUARTER-WAVELENGTH, VERTICAL ANTENNA, (A); A HIGH, LONG, AND IN-THE-CLEAR, RANDOM-LENGTH ANTENNA, (B).



**This Month's Interesting Antenna-Related Web site:**

If you haven't yet checked out L. B Cebik's (W4RNL) excellent antenna web site, you really should. Check all the links (bold underlined topics). He has something for everyone interested in antennas: [www.cebik.com](http://www.cebik.com)

a simple antenna such as a wire under your carpet or a wire connected to a metal window-screen frame. At VHF or higher frequencies, you may even be able to catch all the signals you want with simply a foot or so of wire. If that's the case then there's no need to consider a more elegant antenna.

But, if some of the signals that you would like to monitor are a bit more elusive than such simple sky wires will pull in, then a consideration of the ideas given above may help get the reception you want. The ARRL *Antenna Book* is perhaps the best single source of information on antennas, their performance, how to make them, and propagation of their signals. (ARRL, 225 Main Street, Newington, CT 06111; [www.arrl.org](http://www.arrl.org))

❖ **A Good All-Around Antenna**

I've had very good results at several locations with the kind of antenna shown in fig. 1B. This is simply a long wire mounted as high, long, and in the clear as practical. I've used runs of up to 200 ft with great results, but even a 30 to 50 ft length will give useful service. In each instance where I've used this design, it has performed well

in comparison to other antennas for transmitting on the amateur HF bands, and for receiving from LF through HF.

To construct the antenna, use strong wire such as antenna wire. The soft copper wire used in house wiring will eventually stretch and break when used for long spans over 30 or so feet. For receiving, the end of the antenna can be run into the radio's operating position and connected directly to the receiver's antenna input. For transmitting, an antenna tuner between the antenna and transmitter will almost certainly be necessary.

Don't forget lightning-damage protection. The easiest is to never use the antenna during weather that might lead to lightning and to disconnect and ground the antenna when it is not in use.

## RADIO RIDDLES

**Last Month:**

I said: "Who was, or were, the inventor or inventors of the quarter-wavelength vertical antenna discussed above, and of the ever-popular half-wavelength dipole antenna? Why do I group the invention of these two antennas together in this riddle?"

Well, the half-wavelength dipole was invented by Heinrich Hertz, the man who discovered the electromagnetic waves that we now call

"radio waves." And Guglielmo Marconi devised the quarter-wavelength vertical antenna by taking one half of a Hertzian dipole, placing it upright on the earth, disconnecting the other half, and substituting a ground connection for that half.

So the antennas are related: the vertical is derived from the dipole. In honor of their work, the dipole is often called a "Hertz antenna" and the grounded, vertical, quarter-wavelength is often called a "Marconi antenna."

**This Month:**

You've probably heard of today's "smart" antennas which can automatically adjust to changing conditions to maximize communication effectiveness. But have you heard of "dummy" antennas? Yes, there are such things. What are they?

You'll find an answer to this month's riddle, another riddle, another antenna-related web site or so, and much more, in next month's issue of *Monitoring Times*. Till then, Peace, DX, and 73.

**Antenna Designer**  
 New Version 2.1 for Microsoft Windows 95 and 98  
 Computer program helps you design and build 17 different antennas from common materials. Based on Antenna Handbook by W. Clem Small.  
**Only \$39.95** Send check or money order to:  
 \$5 S/H on all orders CA residents add 8.5% Shipped on CD ROM  
**Small Planet Systems**  
 623 Mangels Avenue  
 San Francisco, CA 94127  
[www.smallplanetystems.com](http://www.smallplanetystems.com) 415-337-9394

Listening is only half the fun...  
**POPULAR COMMUNICATIONS** is the other half.

If you enjoy radio communications in all its variety, you'll love *Popular Communications*  
 Since 1982 *Pop'Comm* has delivered thousands of pages of great reading for both the radio enthusiast and the professional communicator.

Name your favorite interest... *Popular Communications* is there for you. Whether you're into Short-wave Listening, Scanner Monitoring, searching out Pirate Radio broadcasters, CB Radio, Satellite Broadcasting, ACARS, or Ham Radio; you name it, we cover it, every month.

*Popular Communications*  
 Subscribe today and save up to 58% off the newsstand price. Save even more with two or three year subs!

**YES! Enter my Subscription to Popular Communications today!**

Name \_\_\_\_\_  
 Address \_\_\_\_\_  
 City \_\_\_\_\_ State \_\_\_\_\_ Zip \_\_\_\_\_  
 ( ) Check ( ) MasterCard ( ) VISA ( ) AMEX ( ) Discover  
 Card No. \_\_\_\_\_ Expires \_\_\_\_\_  
 Signature \_\_\_\_\_

	USA	Canada/Mexico	Foreign Air Post
1 Year	<input type="checkbox"/> 28.95	<input type="checkbox"/> 38.95	<input type="checkbox"/> 48.95
2 Years	<input type="checkbox"/> 51.95	<input type="checkbox"/> 71.95	<input type="checkbox"/> 91.95
3 Years	<input type="checkbox"/> 74.95	<input type="checkbox"/> 104.95	<input type="checkbox"/> 134.95

Allow 6 to 8 weeks for delivery

**FOR FASTER SERVICE FAX 1-516-681-2926** MT 01  
**Popular Communications** 25 Newbridge Road, Hicksville, NY 11801 Telephone (516) 681-2922

## Concluding the “Little Fellow” Restoration

**B**efore we begin, I’d like to thank Henry Schultz, Jr., WI3U, for his interesting e-mail. It seems that our Silvertone project radio reminded him of a little Spartan given to him as a boy. It had the same tube lineup and the same problems (bad line cord, bad filters and bypasses). Only, back in those days, replacing a resistance line cord wasn’t much of a problem. Henry just visited his favorite dealer, Uncle Dave’s Radio Shack in Albany, New York, and bought a new one.

Noting Perry Crabill’s comment (June issue) that the downtown sections of some cities had been supplied with 110-volt d.c. power, Henry was reminded of a fellow ham who lived in a building supplied only with the 250 VDC required to run the elevator. The tubes for his home brew rig had their 0.3 ampere heaters wired in series so that they would operate from this voltage.

### ❖ Cabinet Refinishing

When we left off last month, our little Silvertone had been restored to operating condition. Also, the cabinet had been stripped to a first approximation, though there were still flecks of paint and sections of the old finish in evidence and the total effect was uneven and blotchy. While the paint stripper was still wet, I had tried to wipe the cabinet down with mineral spirits as suggested in the stripper instructions. But that appeared to make things worse – spreading out the paint remnants into a kind of whitish haze that seemed embedded in the grain of the wood.

I began this month by coating each surface, in turn, with stripper, allowing it to sit for perhaps 15 minutes, then rubbing it thoroughly with a ScotchBrite cleaning pad. That really did the trick, removing all traces of the paint haze and

old finish – leaving the wood almost completely stripped.

However, I still had quite a lot of detail work to do before I could begin to apply a new finish. For some reason, the stripper hadn’t been completely effective with the paint on the thicknesses of the speaker grille, so I had some scraping and sanding to do there. Also the decorative groove that ran around the perimeter of the cabinet and the speaker grill was still full of paint, which I was able to remove using the point of a small jeweler’s screwdriver – but not before I had applied an extra coating of stripper.

When I was through with all that, I decided to get rid of any traces of the stripper by wiping down the cabinet with paint thinner and a soft rag. This also removed all the loose flecks of paint that were still clinging to the surfaces, and I was very well pleased with the results.

Looking through my little collection of wood finishing materials, I found plenty of stains but no varnishes. However, there was a small can of walnut varnish stain. That pleased me, because – I have to admit – I don’t really enjoy cabinet refinishing and this stuff would save me a step. And so, as soon as the paint thinner final wash had dried, I carefully applied a coat of the varnish stain.

### ❖ Same Loose Ends

Once the stain had dried, I cut a rectangle of new grille cloth to size and glued it behind the speaker grille opening in the cabinet. That left only one cosmetic detail to be handled: the pumpkin-colored paint that still coated the control knobs.

I was a little worried about stripping the knobs. If they were Bakelite, they’d be almost indestructible. However, I have heard that some lesser plastics used for radio parts were very easy

to damage. In fact, some radio restorers have been unpleasantly surprised when the knobs they’d left to soak began to dissolve right along with the grime being removed.

I carefully coated just a small area of one of the knobs with the stripper, crossed my fingers, and awaited developments. The result was encouraging, so I went ahead and slathered stripper over all the knob surfaces. Happily the knobs emerged from the process clean and unscathed.

Before I actually put the radio back together, I wanted to touch up the alignment. Had this been the usual superheterodyne, that would have been an involved process involving several intermediate frequency transformer trimmers, plus trimmers for the antenna and oscillator. However, with this minimal TRF, we are dealing with just two trimmers – one for the antenna circuit and the other for the r.f. amplifier. The trimmers sit atop the two-gang tuning capacitor.

To do this little alignment strictly according to Hoyle would have involved hooking up an r.f. signal generator tuned to a point in the broadcast band, setting the radio’s tuning dial to that frequency, and adjusting both trimmers for maximum output as shown on a vtvm (vacuum-tube voltmeter) or other indicator.

But in this case, the effort didn’t seem justified. For one thing, the radio’s pointer-and-scale tuning indicator is too crude for any kind of close adjustment. And so I simply tuned in a broadcast station near the middle of the dial and adjusted both trimmers for maximum volume using my ear as the output indicator. Now I was ready to reinstall the set in its cabinet.

### ❖ Radio for the Millions

Well, here I am in the awkward position of being about halfway through my column and all the way through with our project. I’m not ready to begin a new project just at this moment, so I thought I’d introduce a bit of nostalgia from my youth. During the 1940s, Popular Science Publishing Co. released a volume known as *Radio for the Millions*. It was crammed full of intriguing and colorful radio projects – most utilizing variations on a few basic circuits.

What made the radios colorful and interesting was their packaging. There was a twin-bed radio that could be tuned from either side, a kitchen radio built into a flour container, a postcard radio that could be mailed, a “week-end radio” that fit into the top of a suitcase, a midget “notebook radio” that could be carried



“Little Fellow’s” cabinet after stripping is complete (left) and, with radio installed, after application of varnish stain.



*Young people ceremoniously drink and smoke as they try out "Tiny Portable Radio Operates Anywhere" on their 1940s patio.*

to sporting events...and many more.

The projects were not only profusely illustrated from a technical point of view, but most included carefully posed photographs showing dead serious 1940s people putting the radios to use. Something about the photos captured my imagination even when I was a kid and they were current. Now that we are removed by more than 60 years from the making of these photos, the permed young ladies in saddle shoes, the deadpan suit-clad young men, and the '40s decor and surroundings take us back to a simpler age when all you needed for complete happiness was to be equipped with just the right radio for every occasion.

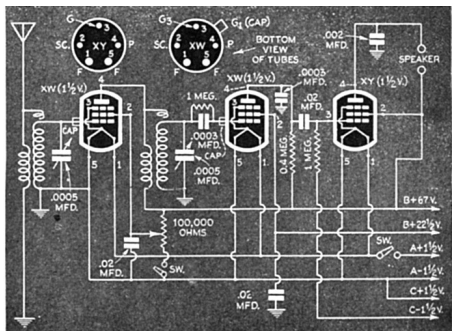

*Like our little Silvertone, the "Tiny Radio" has an r.f. amplifier stage, a detector stage, and a power amplifier.*

And so I'll use the rest of this column to present one of the projects from *Radio for the Millions*. But I highly recommend you get a copy of the book so you can enjoy them all – they are very plentiful in radio flea markets. Look for an 8-1/2" x 11" hardbound volume with orange covers. The same material is also included in two softbound comic-book sized volumes: *Popular Science Radio Annual* (green cover) and *Popular Science Second Radio Annual* (Red Cover). These are the ones I found in a drugstore comic book rack as a kid.

The radio project I'm going to show you here, "Tiny Portable Radio Operates Anywhere," doesn't have the wildly imaginative packaging

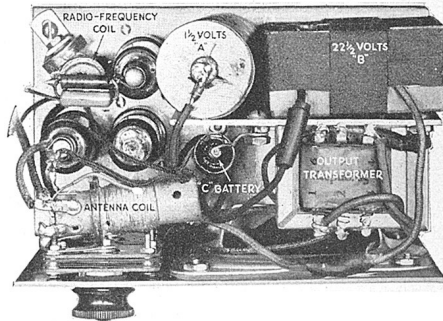

*Careful planning and custom metal fabrication combine to give the "Tiny Radio" a very compact layout. Note one of the solid-dielectric variable capacitors at lower left.*

of some of the other radios in the book. I picked it because it has a circuit somewhat similar to that of the little Silvertone we've been restoring (except, being battery operated, it lacks a rectifier tube). It's also interesting in being very diminutive for the era, utilizing three British-made miniature pentodes (two XYs and an XW) and a pair of special miniature tuning capacitors.

I'm especially tickled by the picture showing three young people enjoying the radio on the patio. One girl with her cigarette pack and ashtray, the other tuning the radio, drink in hand, and the suit-clad young man, also clutching a drink, staring at the radio as if it were some strange gadget recently arrived from outer space. The mismatched deck chairs have apparently been dragged in from different locations to make up this oh-so-impromptu garden scene.

The three British pentodes have 1-1/2-volt filaments – which are lit by a flashlight-sized battery. A switch in series with one of the battery leads turns the radio on and off. I have never heard of the British tube types, though the article claims that they are available at "any of the larger radio-parts supply houses" in this country.

The type XW r.f. amplifier is followed by an XY used as a grid-leak detector, and this is followed by an XY power amplifier. A miniature "C" battery provides 1- 1/2 volts of bias for the XY and a small "B" battery supplies plate and screen voltages. To obtain a small-enough "B" battery, the author suggests buying two miniature 45-volt batteries, cutting one of them in half, and connecting one of the halves in series with the uncut battery to obtain the necessary 67-1/2/22-1/2 volt unit.

Another unusual feature is that special ultra-thin, solid-dielectric variable capacitors are used for antenna and r.f. amplifier tuning. Since these capacitors can't be ganged, they must be tuned individually to bring in the stations.

Worthy of note is the radio's extremely compact layout – a result of very careful planning on the part of the builder. All of the aluminum chassis parts are specially cut and bent, and complete drawings of each part are supplied.

Though the radio itself is tiny, its antenna and ground requirements would tend to discourage casual mobility. A 25-foot wire is specified for the antenna. If an actual ground is not available, a 40-foot wire is to be connected to the ground terminal!

See you all next month, when we'll begin a new project.

## IR REMOTE RADIO CONTROL

Remote control your Shortwave Receiver, Scanner, or ICOM Transceiver from your easy chair with the SWL IR Remote and a Universal TV Remote control.

- ◆ SWL IR Remote for Drake R8/A/B ..... \$89.95
- ◆ SWL IR Remote for Yaesu FRG-100 ..... \$79.95
- ◆ SWL IR Remote for Yaesu FRG-8800 .... \$69.95
- ◆ SWL IR Remote for ICOM Transceiver ... \$69.95
- ◆ SWL IR Remote for ICOM IC-R75 ..... \$79.95
- ◆ SWL IR Remote for JRC NRD-535 ..... \$89.95
- ◆ SWL IR Remote for Lowe HF-225 ..... \$99.95
- ◆ SWL IR Remote for Kenwood R-5000 .... \$99.95
- ◆ SWL IR Remote for Uniden Scanners .... \$89.95

[www.swl-remotes.com](http://www.swl-remotes.com)

## Longwave Resources

✓ **Sounds of Longwave** CD or Audio Cassette (please specify) featuring WWVB, Omega, Whistlers, Beacons, European Broadcasters, and more!  
\$13.95 postpaid

✓ **The BeaconFinder** A 65-page guide listing Frequency, ID and Location for hundreds of LF beacons and utility stations. Covers 0-530 kHz.  
\$13.95 postpaid

Kevin Carey  
P.O. Box 56, W. Bloomfield, NY 14585

## JOIN THE AWA

**Antique Wireless Association**

*The original and largest historical radio-collector group*

• Publishes *The AWA Journal*, Marc Ellis, Editor, with:

- Battery and AC receiver restoration
- Vacuum-tube history and collecting
- Old-time amateur-radio contests
- Communications receivers
- Free want-sell-swap ads
- Early television
- Horn loudspeakers
- News of U.S. and foreign clubs



• Produces the famous annual Rochester meet

• Maintains unique radio-TV museum

Membership is only \$20 per year in U.S.; \$25.00 elsewhere.

Mail check to:

AWA Membership - P.O. Box 421, Dept. 2 Bloomfield, NY 14469-0421

<http://www.antiquewireless.org>

[awamembership@rochester.rr.com](mailto:awamembership@rochester.rr.com) (585) 392-3088

**FREE  
SAMPLE  
COPY!**

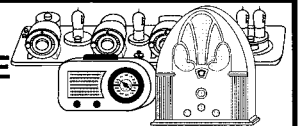

**ANTIQUE RADIO CLASSIFIED**

*Antique Radio's Largest-Circulation  
Monthly Magazine*

Articles - Classifieds - Ads for Parts & Services

Also: Early TV, Ham Equip., Books,

Telegraph, 40's & 50's Radios & more...

Free 20-word ad each month. Don't miss out!

VISA 1-Year: \$39.49 (\$57.95 by 1st Class) MASTERCARD  
6-Month Trial - \$19.95. Foreign - Write.

A.R.C., P.O. Box 802-P14, Carlisle, MA 01741

Phone: (978) 371-0512; Fax: (978) 371-7129

Web: [www.antiqueradio.com](http://www.antiqueradio.com)

## The Magic of Radio

By Jim Clarke, NR2G, [jimclarke@monitoringtimes.com](mailto:jimclarke@monitoringtimes.com)

### ❖ 'Twas the Night Before Christmas

The exact year is unclear, but I believe it was the winter of 1970 that at the age of 10, I went with my family to spend Christmas Eve with my aunt and uncle at their place. Being the only child there that evening, boredom set in quickly as the “grown-ups” talked about whatever it is they talk about. As the evening wore on, I think my uncle noticed that I needed something to keep from falling asleep. So, he stood up and signaled me to follow him into the other room.

### ❖ Introducing the HQ-129X

My uncle was an inventor and loved showing me the measuring devices he had designed, but this time, instead of going to his dresser to fetch the latest project, he sat me down in front of this large, strange-looking, dark-gray box. Its front panel was a lighter gray, had a lot of black knobs, and two dark, square, recessed windows. But, with the twist of a knob, the dark windows lit up, each revealing an opaque background, complete with curved black graduated lines, numbers, and a vertical centerline. After a few minutes of hands-on instructions, he left me with this thing he called a “short-wave” radio.

He said I would be able to hear radio stations from all over the world, just by turning one of the two large black knobs. As I first started tuning, I was disappointed; there were only a few strange noises that came from the speaker as the lines and numbers passed through the window. But then it started, station after station, some speaking English, and some not.

According to my Uncle, if the person was speaking a foreign language, many times they would identify in English on the half-hours. Imagine how quickly the time went by, every 30 minutes patiently waiting for just the possibility of an English identification! The next thing I knew, it was time to leave, but luckily for me that usually didn't happen until one o'clock in

the morning. Nevertheless, I would have to wait another year before I could “tune the world” again.

### ❖ Magic Discovered

I'll never forget those Christmas Eves. The combination of smells of the holiday, carols playing in the background, and, by just turning a knob on this big box, I was able to listen to the world, as they too celebrated the coming day.

That combination created a permanent impression that has stayed with me my entire life. For years thereafter, I couldn't wait to go to Uncle Connie's place to tune that short-wave radio. Unbeknownst to me, I had been captured by the magic of radio.

### ❖ Future History Unfolds

After two or three years, I wanted a short-wave radio of my own. I guess someone noticed how much I enjoyed listening, because I finally ended up receiving a Ross multi-band portable as a gift from my parents. Listening to the short-wave whenever I had free time showed me how little I knew and how much I needed to learn about this new hobby. It was in the process of this learning that my knowledge of world geography, and to a degree, world politics grew.

As I became more comfortable in the hobby, I began collecting different shortwave radios, dabbling in amateur radio, and becoming part of the CB “craze” in the '70s. I eventually earned my Novice amateur radio license in 1977, and proceeded to burn up the airwaves with my maximum legal-limit, 75-watt, CW signal.

However, between a new job and a new place to live, there wasn't much time for radio. Then, about a year after meeting my wife, we became the proud parents of a beautiful baby girl. Needless to say, radio was completely out of the picture, at least for a few years. But as time went by, I started to get the itch for that hobby I had come to enjoy so much.

### ❖ Magic Lost

Later, after easing back into radio, I decided to get one of the new general-coverage, no-tune-up amateur radios, the Yaesu FT-980. I can still remember setting it up, and listening to this radio that was so far removed, in technology, from my Uncle's Hammarlund HQ-129X. Although I have fond memories of the 980, the thrill I used to get when listening years ago was missing, and I

couldn't figure why. The magic had been lost.

In the years following, I chased after radios with the best specifications I could afford – thinking that would satisfy the search for the missing “thrill” – culminating in the purchase of a Watkins-Johnson HF-1000. Guess what? That wasn't it, either! I still couldn't figure out why I wasn't getting the “thrill” out of shortwave that I used to.

Don't get me wrong: the 1000 was a fantastic radio. It was like tuning around with a piece of test-equipment. I still miss it to this day – definitely one of those “I wish I would have never sold that” radios.

### ❖ Enlightenment

This was all happening around the time that I learned Kevin Carey – of *MT*'s “Below 500 kHz” fame – and I worked for the same company. After striking up a friendship, which I am thankful to still enjoy today, one of our many chats landed on this “thrill” that we both had experienced as early shortwave listeners, but lost somewhere along the way. At that time, we both had excellent radios, but they weren't able to deliver what our early radios had.

Then it happened. In the course of discussing this topic one day, one of us – I don't remember who – figured it out. After all this time, what caused us to lose the “thrill” was right in front of us – the radio's aesthetics. Not the knobs, the glow of tubes, or even the size of the radio: it was the display, the loss of the analog display.

There was something about tuning across the expanse of the shortwave spectrum and actually seeing, on the analog display, where you were. It was like traveling with a map, following a road, and visiting different sights along the way. The new digital displays, however, were just a number, like traveling from point to point with a GPS – displaying only latitude and longitude while using a list of coordinates for stops.

These new displays were boring, just a point in space, a cold number standing by itself.

### ❖ What to Do

Well, now that the great mystery had been solved, what was I going to do about it? The answer was “nothing,” at least not on purpose, and not right away. By this time, my receiving equipment was purely utilitarian, nothing you would want to sit around and tune for extended periods, let alone enjoy it.

Then, it just so happened that our finances





“near-real-time.” Unlike the 746Pro, the MSS in the ProIII sweeps repeatedly without interrupting reception.

### ❖ New Addition

After several days of operating the new radio, I discovered I was not paying any regard to the S-meter; the MSS seemed to have my full attention. And, now that I’ve learned how to change the display configuration, the frequency readout is now minimized with the scope and meter functions consuming most of the screen. I still can’t believe it: here was a feature that didn’t play any role in my decision making process, yet ended up bringing the most excitement in shortwave listening that I’ve experienced in many, many years.

Oh, and by the way, the ProIII is a superb performer, an ambassador to today’s DSP capabilities in radios of its class. Recently, I had the opportunity to put the ProIII’s receiver up against a Ten-Tec RX-340. The results: I wish I could get a ProIII in a 340-type chassis.

### ❖ Magic Found

It’s been a year now since I bought the ProIII, and I still get excited every time I sit down to operate it. The combination of its superb performance, and that MSS feature, has virtually restored what has been missing from my monitoring times for many years, the “thrill” of tuning around. Sure, I enjoy the listening part of shortwave, but for some of us, getting there is half the fun. The magic has returned.

allowed me to entertain the idea of getting a new radio. My wife recommended I get the one with the features I wanted, not just settle on something based on price. WooHoo! (At least I felt that way at first.)

As I started to research what radio to buy, it became clear it would not be an easy choice. My desire to recapture the “thrill” was causing me to lean toward an older radio with an analog display, but the technician in me, with memories of the HF-1000, had me looking at the newest DSP radios.

The results of all my reading placed the Icom IC-756ProIII at the top of my list. Once again, the specsman in me won, thinking that performance would make up for the cold digital display. So I was off to the hamfest, cash in hand, hoping one of the vendors had brought a ProIII with them. Thankfully, the only radio vendor

there had brought two, so after parting with my cash, I became the happy owner of a new “high-tech” radio. Little did I know, this time I would have both desires satisfied, and without trying.

One of the features of the ProIII is a “Mini Spectrum Scope,” or MSS, displayed on the front-panel’s main screen. While I knew of the feature from my research, for some reason I really didn’t pay much attention to it, thinking I would hardly use it, especially after seeing how it worked on the IC-746Pro. Ironically, it turned out to be the one feature that has had the most impact on my current activity in the hobby.

What I found was, it acts similar to the old analog displays, in that you are viewing your position as you move within a range of the short-wave spectrum. The bonus is you get to “see” the station you are listening to, as well as other stations that are higher and lower in frequency, in

# Uniden BCT15

**NEW AND POWERFUL BEARCAT—  
THE BCT15 BASE/MOBILE SCANNER!**



Uniden's new BCT15 base/mobile scanner presents an enormous feature list: Wide 25-512, 764-956 and 1240-1300 MHz reception; 2500 memory channels with selective lockout for up to 500 systems, plus state-by-state preprogrammed public safety channels; simultaneous trunking and conventional scanning; simultaneous scan and search; Service Search of factory-pre-programmed public safety, news, weather, ham radio, marine, railroad, military and civilian aircraft, CB, FRS, GMRS, racing, TV and FM broadcasting, and special; 16 character alphanumeric display; searches up to 10 ranges in order; scan up to 100 channels per second and search up to 300; automatically tracks all major trunking systems (Motorola Type 1 and 2, EDACS, SCAT and LTR); PC control and cloning capability; CTCSS and DCS squelch tone decoder; priority scan and selectable delay; Close Call instantly captures any nearby transmission within its frequency range and can ignore pager, broadcasting and weather channels; two-tone fire page response; automatic memory store of search-discovered frequencies; selectable alert for emergency, Close Call, tone-out, weather, and individual channels; alert-tone volume adjustment; audio AGC balances audio levels from different signals; connect your GPS for location-based scanning and searching—and those are just for starters!

This feature-packed scanner comes with AC adapter, cigarette-lighter mobile power cord, 3-wire DC power cord, mounting bracket with hardware, telescoping antenna, DB9 PC cable and full instruction manual.



**Order SCN15  
Only \$229<sup>95\*</sup>**

**GROVE**

**800-438-8155**

**828-837-9200 fax: 828-837-2216**

**WWW.GROVE-ENT.COM**

**order@grove-ent.com  
7540 Highway 64 West  
Brasstown, NC 28902**

*\* plus \$12.95 Priority Mail or UPS Ground shipping in the US*

# MT REVIEW

## MFJ's 932 Mini Loop Tuner: SWL & Ham Antenna Options for Tight Spaces

By Ken Reitz KS4Z

**R**eceiving signals on the HF bands on small antennas is easily done. Portable shortwave radios typically have a telescoping whip antenna to do the job. With that, it's possible to tune in all the big international and religious broadcasters which are melting the ether with tens of thousands of watts.

Tuning in smaller shortwave broadcasters and transmitting on the ham bands within the confines of your apartment or condo is not so easily done. There are several products on the market which can help. The MFJ-1020C Active Antenna, which I reviewed in the August 2002 issue of *MT*, is one example. It uses a small antenna together with a built-in antenna tuner and a broadband signal amplifier to improve reception. The problem with that product is that it's for reception only. What if you want to transmit, too?

Small loop antennas have been around for quite some time, especially for reception. Lately, small transmitting loop antennas have attracted quite a following among hams as an alternative antenna for small spaces. MFJ offers a series of small, high efficiency loop antenna tuners ranging in price from \$99.95 to \$329.95. I recently had the chance to use the MFJ 932 Mini Loop Tuner and here's what I found.

### ❖ Experimenting with Loops

It's not particularly fair to try testing any antenna during what seems like interminably poor propagation conditions. But, it's what we have now. I first started experimenting with the 932 using 10 feet of 10 gauge wire as suggested in the 932 manual. I put it on a shelf behind the operating position at my desk and attached it to an antenna switch so that I could compare it to signals received on an antenna I use as a reference dipole. (It's a home brew, off-center fed dipole antenna, 137 feet long and 30-ft in the air, based on the G5RV and Carolina Window designs.) I also had a portable shortwave radio nearby with only the built-in whip antenna to help confirm reception capabilities.

As stated in the manual: "...A transmitting loop antenna has a conductor length or circumference of less than 1/4 wavelength ... The small loop radiation pattern is maximum along the plane of the loop, with sharp nulls perpendicular to the plane of the loop ... Loop length (circumference) approaching a quarter wavelength and shaped as a circle is the most efficient configuration."

Efficiency also improves with elevation. The manual says it works better if you operate



**MFJ's 932 Mini Loop Antenna Tuner: For hams and SWLers confined to indoor antennas. Low power only, fairly noisy, not easy to tune. Price is \$99.95.**

portable could not receive the signal. WWV on 10.00 MHz was S1 on the dipole, just audible on the loop, and nonexistent on the portable.

For transmitting, I set up on the 15 meter BPSK31 digital frequency 21.070 MHz and tuned with the dipole. Several stations were on the frequency, but when I switched to the loop only one was copyable. With an output of just 5 watts on the 10-ft wire loop, I answered T94C's CQ call from Bosnia-Herzegovina. He came back on the second call.

I found similar results using 10 feet of 1/4-inch copper tubing, the ends of which I flattened and drilled to fit over the terminals on the back of the 932. The big advantage with the copper loop was that it was self-supporting and was easier to

on a second floor. The higher in frequency the better it works, as you get away from ground loss.

Reception, when compared to the reference dipole, was considerably less, but it did outperform the whip antenna on the portable. For example, tuning BBC's European service on 12.095 MHz at 1830UTC came in on the dipole at S9, S5 on the loop, while the

tune. Rotating the loop 90 degrees helped bring in stations and null out stronger signals from the side. Tuning any loop antenna is a process of adjusting the "tuning" and "matching" knobs for strongest signal. Small loops tend to be very sharp in tuning range, and it's easy to zip right past the point of resonance. You have to tune slowly.

Remember, too, that, when transmitting, every time you change frequency (within 5 kHz) you'll have to re-touch the tuning. However, it isn't that critical for SWLing. Still, for that reason the 932 could be a great BPSK31 antenna. If you design the right loop for, say 14.070 MHz (the 20 meter BPSK31 frequency), you could work dozens of stations from around the world without having to change frequency. Once propagation to the higher frequencies improves, a loop designed specifically for 28.120 MHz, the 10 meter BPSK31 frequency, it should be no trick at all to work the world on 5 watts via this mode using the 932 loop. The digital modes are made to order for low power contacts.

And that's the big draw of loop antenna enthusiasts: a chance to design and perfect antennas for their particular frequencies and modes.

### ❖ MFJ's Loop Tuner Tutorial

MFJ has made available on their web site a tutorial entitled "MJF Manual Loop Tuner Considerations." In it, their various loop tuner products are discussed in detail along with basic loop antenna theory, design, and general operating practices. There are details on constructing a loop holder from PVC parts, as well as pictures showing how they've built loop antennas. You can read this tutorial here: [www.mfjenterprises.com/antennatalk6.pdf](http://www.mfjenterprises.com/antennatalk6.pdf)

There is also a reference to freeware antenna modeling programs which will help improve the efficiency of your loop design. The source is from G4FPQ's extensive and very friendly site: [www.btinternet.com/~g4fqg/regp/](http://www.btinternet.com/~g4fqg/regp/).

### ❖ Safety First!

If you're using a loop antenna for reception only on an HF receiver, there is no danger.



**MFJ's 1020C Active SWL indoor antenna covers .3 to 40 MHz, easy to use, takes up very little space and improves reception for just \$79.95. Great for SWLers, but you can't transmit with it.**

However, if you're planning on using a loop antenna for transmitting, there are several safety concerns of which you need to be aware. First, even with the MFJ 932 Mini-Loop Tuner at QRP (low power levels), the loop is "hot" while transmitting. You could get a serious RF burn by coming into contact with the loop.

Secondly, because the antenna is in the same room as the operator, you'll be in the RF field generated by the antenna. MFJ advises users to become familiar with FCC OET Bulletin 65 Version 97-01 [www.fcc.gov/oet/rfsafety](http://www.fcc.gov/oet/rfsafety). This bulletin, an 84 page highly technical document, offers guidelines and suggestions for complying with human exposure to RF fields adopted, but not mandated, by the FCC. The relevant material regarding amateur radio is from pages 20 to 23.

I operated using only 5 watts, which comes well under the safety concerns; still, I would not want pets sticking their noses on the antenna while I was transmitting or having children in the area. You'll have to use your best judgment operating a loop in your home.

### ❖ Last Word

The MJF 932 Mini Loop Antenna tuner is not cheap (\$99.95 plus shipping), and you'll still have to make your own loop. For SWLers I would recommend the 1020C Active SWL indoor antenna rather than the 932. It's easier to use, takes up less desk space, improves reception even on portable shortwave radios, is effective over a broader range, and is \$20 cheaper.

Hams seeking to transmit from the cramped confines of their apartment or condo may find the 932 just the ticket. But, at low operating power it will be frustrating, to say the least. Consider other alternatives such as an MFJ 1622 Apartment Antenna, which is the same price as the 932 and removes the antenna from the immediate living space. It also comes with coax feed line, RF choke, and mounting bracket. Or, you could use the MFJ 16010 Random Wire tuner in conjunction with a random wire antenna you may already be using as an SWL antenna or with the PAR High-Performance "End Fedz" shortwave antenna.

(All photos courtesy MFJ Enterprises)

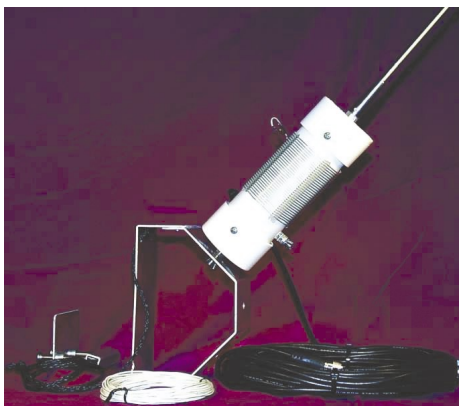

**MFJ 1622 Apartment Antenna covers 40 through 2 meters, mounts to windows or balcony railings and comes with mounting bracket, coax feed line and RF choke for \$99.95.**

*continued from page 15*

figure 9, and it wasn't surprising to see that this long circuit of nearly 12,000 km favored the higher frequencies. This was confirmed by the MUF (Maximum Usable Frequency) Chart, figure 10, which showed a median MUF of about 16 MHz at the current time-of-day (about 2100 UTC). And finally, the SNR chart, figure 11, for WWCN's 15.82 MHz frequency, predicted *good* connectivity at the current time.

Already, I was ahead of the game. I could now tune to 15.82 MHz with confidence, and the program should be heard loud and clear at my Riyadh listening post!

Who else could I hear from my Riyadh location? ACE-HF can make Reception Area displays to show areas covered from your location, and an example is shown in figure 12. This figure shows 15.82 MHz at 2100 UTC, but the display can be animated over a range of frequencies or times of day. Since the receive location was fixed, the software, in its complex scientific number crunching, effectively moves the transmitter all over the world to create a display of good reception coverage. Using an average up-to-date computer with 1.8 GHz processing speed, I ran 61 by 61 points, times 10 frequencies, times 24 hours. That equals 893,040 equivalent point-to-point circuit predictions, which only took a little over 2 minutes to complete!

Folks often ask which propagation program is the most accurate. Some years ago, the U.S. Navy funded the authors of ACE-HF to determine which HF propagation program was the most suitable for their HF networks. The resulting study selected VOACAP as the most highly validated model. During its development, every potential improvement on VOACAP was subjected to more than 500,000 circuit path-frequency hours comparisons with field data for paths at all latitudes and ranges.

If you have questions about ACE-HF PRO, you may contact Dick Buckner at [RichardPBuckner@cs.com](mailto:RichardPBuckner@cs.com). My in-depth reviews are provided at <http://hfradio.org/ace-hf/>.

### What will Sunspot Cycle 24 be like?

In March 2006, a team led by Mausumi Dikpati of the National Center for Atmospheric Research (NCAR) announced that the next cycle, 24, will be the most intense solar maximum in fifty years. They forecast that the next sunspot cycle will be 30 percent to 50 percent stronger than the previous one. If this holds true, the solar activity in just a few years will be second only to the historic solar cycle maxi-

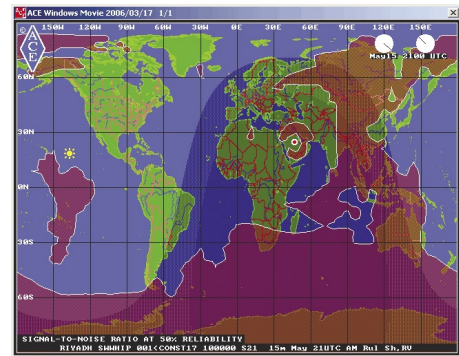
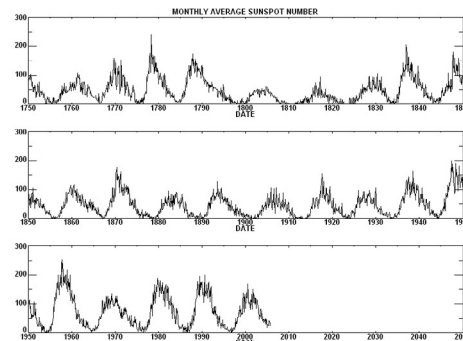

**Figure 12: What areas can be heard in Riyadh, Saudi Arabia, on 15.82 MHz? ACE-HF PRO's Animated Coverage Maps can show you.**

mum of 1958.

Veteran radio hobbyists remember that cycle, when solar activity was so strong that Aurora was sighted three times in Mexico. Propagation in the 50 MHz range was open world-wide and for great lengths of time. World-wide propagation was experienced on most of the HF spectrum, around the clock.

Next month, I will present the outlook for the rest of this year and a look into 2007. Let me know your questions and observations. Whether you are on a "fishing expedition" for any interesting catch that comes your way, or whether you are a dedicated hobbyist who enjoys sharpening your radio skills to achieve a specific goal, I hope you have found this month's discussion useful. To take the subject further, you may be interested in the space weather and radio propagation discussion at <http://hfradio.org/forums/>



**Figure 13: Sunspot cycles last an average of eleven years from start to finish. This graph shows the cycles since records were kept. Notice how the last two cycles have been less active than the one in the 1950's. The next cycle, Cycle 24, is expected to be as active as that one, making for great shortwave and low-VHF world-wide propagation. (Credit: NASA)**

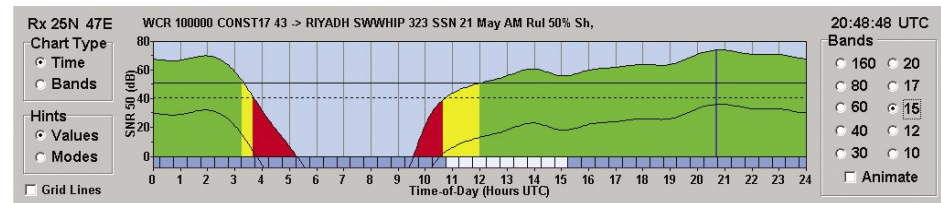

**Figure 11: The ACE-HF PRO showing the SNR on the selected frequency of 15.82 MHz during one full 24 hour period, between WCR and Riyadh, Saudi Arabia.**

# The Uniden BCT15 Bear Tracker

By Larry Van Horn, N5FPW  
Assistant Editor *Monitoring Times*

If you would like to have a scanner like the BCD996T and enjoy some of the new Uniden technology, but the \$539.95 price tag leaves you a bit breathless, then maybe you could look at a lower cost alternative – the Uniden BCT15 Bear Tracker.

Released hot on the heels of the popular Uniden BCD996T base/mobile scanner, many of the innovative features included in that scanner are incorporated into this new Uniden release.

### ❖ Case, Controls, and Antenna

If you check out our *First Look* at the BCD996T in the July 2006 issue of *MT* or on our website ([www.monitoringtimes.com](http://www.monitoringtimes.com)), then you will be comfortable with technology and terminology used on the BCT15 Bear Tracker. This radio is built on the same technology and lineage of this unit's firmware and RF construction also comes from the BCD996T.

The BCT15 case is the same size as its predecessor, measuring 7.24 (W) x 6.06 (D) x 2.20 (H) inches and it weighs in at 3.5 lbs without mounting bracket.

While the 996 had two colors to choose from for the backlight display, there is only one color (orange) on the BCT15's 1-1/8 by 2-1/8-inch (64 x 128 full dot matrix) liquid crystal display. The keyboard backlight is also orange.

Front panel controls/switches on the BCT15 include a knurl rotary encoder knob with push switch used for function operations, a volume control with power on/off switch and push switch for alert mute on/off, and a squelch control with push switch for the Bear Tracker state select.

### ❖ Looking under the Hood

Inside the radio we found a world of scanning capability. Here are some of the features that BC246T/BCD396T/BCD996T owners will be familiar with:

- Close Call RF capture technology can set the scanner so it detects and provides information about nearby radio transmissions. In a head to head test we performed between the 246/396/996, the Close Call function test results were equal to those of the 996.
- Dynamically allocated channel memory was first introduced in the BC246T. This type of scanner memory can be organized so that the scanner operation more closely matches how radio systems actually work, making it easier to program and use the scan-

ner. The BCT15 has 2,500 memory locations for programming frequencies, talkgroups, and alpha tags.

- 100 Quick keys let you quickly select systems and groups by using the keypad. This makes it easy to listen to or quickly lock out those systems or groups to scan or not to scan.
- There are 13 frequency ranges preprogrammed for searching the following radio services: Public safety, news, amateur radio, marine, railroad, military and civilian air, CB radio, FRS/GMRS, racing, TV broadcast, FM broadcast, and special searches.
- Personal computer (PC) control allows you to transfer programming data to and from the 996 and a PC, or actually control the scanner's operation using your computer. Uniden has available for download their UASD PC control/programming software and a free registration key via their company website at [www.uniden.com](http://www.uniden.com).
- The BCT15 has a wired clone function like its predecessors, but does not do over-the-air cloning. Cloning includes all programmed data, the contents of the scanner's memory, menu settings, and other parameters.
- Fire tone-out standby lets you set the scanner to sound an alert if a two-tone sequential (250.0-3500.0 Hz, 0.1Hz programmable steps) page commonly used on fire dispatch frequencies is transmitted. You can set up to 10 settings (transmit frequency, tone frequencies, tone duration and tone gap), then select one of the programmed positions for standby monitoring and alerting.
- Broadcast screen sets the scanner so it ignores Close Call or search hits on FM/TV broadcast frequencies, including known pager frequencies. The custom screen lets you input up to 10 frequency ranges that the scanner will ignore during Close Call or search operation.

Some of the other features found in the BCT15 include: Scan/Search delay, a 20 dB attenuator, repeater reverse, channel alert, search with scan operation, enhanced custom alerts, better automatic channel step selection (frequency steps of 5, 6.25, 7.5, 8.33, 10, 12.5, 15, 20, 25, 50 or 100 kHz for manual mode and search modes), text tagging, data skip, duplicate frequency entry alert,

### MT First Look Rating (0-10 scale)

Audio Quality.....	9
Audio Levels.....	9
Backlight/Display .....	9
Ease of Use .....	7
Feature Set .....	8
Keyboard/Control Layout ..	9
Overall Construction .....	10
Overall Reception.....	9
Owners Manual .....	9
Sensitivity.....	9
Selectivity.....	9
Spectrum Usability .....	8

memory backup, frequency and talkgroup auto store, and priority scan/priority channel scan.

Like many of the recently released Uniden scanner models, the BCT15 can perform a NOAA weather band search, SAME weather alert, and weather priority scan. There is also a nearly instant CTCSS/DCS tone search capability that can identify up to 50 CTCSS tones and 104 DCS codes in the scan, search and Close Call modes.

There are a lot of other BCT15 features that BCD396/996T owners will recognize, far too many to include in this review. You can get more information on all of this scanner's features by viewing a copy of the owner's manual on the Grove Enterprises website at: [www.grove-ent.com/BCT15om.pdf](http://www.grove-ent.com/BCT15om.pdf)

The multi-site trunking feature lets you share system channels across multiple trunk system sites to more efficiently use the scanner's memory. This, in the author's opinion, is the single best feature for hobbyists who do a lot of this sort of scanning, and puts the BCT15 and its cousin, the BCD996T, head and shoulders over any other trunk scanner in the marketplace.

Like the 996, this scanner has Close Call do-not-disturb that, when set, lets the unit make periodic Close Call checks whenever the scanner is not receiving audio in another mode. This eliminates annoying breaks in conversation while still allowing for Close Call functionality. It also has Close Call temporary store that temporarily saves the last 10 Close Call hits and includes them when scanning.

"Soft" search keys let you quickly search specified ranges and Quick Search lets you search from the currently-tuned frequency if you are searching a conventional system.

The temporary lockout function lets you lock out a current system, current site, or current search range in Scan or Scan Hold mode, a



MT Rating [four and 1/4 stars]





system channel, search frequency, or location data – just to name a few things you can use it for. The temporary lockout is cleared when you turn power off then on.

A record out jack, when used with the appropriate user-supplied cable and audio recording device with signal control, lets you record live audio of designated channels.

With the release of the 996, Uniden introduced a new vehicle power connector (the orange wire) that lets you connect the scanner to your vehicle's dimmer circuit to also dim the scanner's display with the vehicle's dimmer control. This BCT15 also includes this useful and creative feature.

Another innovative feature in the BCT15 is the upside down display. If you need to mount the unit upside down in your mobile for better audio quality, you can flip the display upside down so you can still read it. This is a menu selectable function.

Finally, there are the new GPS functions for use with an owner-supplied GPS receiver. Some of the GPS non-radio based features let the scanner alert you to dangerous intersections, speed alerts, and points of interest (POI) that you program into the scanner. The GPS display mode lets you display extended GPS information such as distance to a POI, direction to a POI, time to a POI, speed, position, and more.

The formats of the GPS data which the scanner can use are only the Global Positioning System Fix Data (GGA) and the Recommended Minimum Specific GNSS Data (RMC) system based on "NMEA-0183 standard, version 3.01."

## ❖ Frequency Coverage

The BCT15 can monitor signals in the following frequency ranges: 25.0-512.0, 764.0-775.9875, 794.0-805.9875, 806.0-823.9875, 849.0125-868.9875, 894.0125-956.0, and 1240.0-1300.0 MHz. A review of the modes and frequency steps used during searches reveals the BCT15 is set up to meet current bandplan standards in the United States except for the step used in the 150.8000-161.9950 MHz frequency range. It defaults to 5 kHz, while most of the band is segmented in 7.5 kHz steps. And while this will not stop you from listening to all the activity on this band, it will definitely throw off accurate frequency measurement and proper recording of new splintered frequencies.

## ❖ Trunk Tracking Capability

The BCT15 is a Trunk Tracker III™ model scanner. This lets you follow unencrypted conversations on analog Motorola, EDACS (wide and narrow), EDACS SCAT, and LTR trunk radio systems. Trunk systems in VHF, UHF, 800 and 900 MHz bands can be followed. The scanner can also scan both conventional and trunk systems at the same time. It cannot decode any of the new 700 MHz public safety trunk systems (even though the frequency coverage is present in the radio) or new UHF DoD Land Mobile Radio (LMR) digital trunk systems.

The BCT15 also does Motorola control channel scanning. If the scanner is set in this mode, the scanner tracks a Motorola trunk system using only control channel data. You do not have to program all of the system's voice channel frequencies into

memory in this mode as long as all possible control channels have been programmed in.

## ❖ What's New

There are two new features in the BCT15 that are unique to this radio.

- **The BearTracker™ system alerts you to transmissions on frequencies used by 'mobile extender' radios as well as by car-to-car, aircraft-to-car, and other special-purpose frequencies. You receive an audible (beep tone) and visual (flashing Alert light) alert whenever you are within an approximate three-mile radius of Highway Patrol/State Police units using a mobile extender unit.**
- **State-by-State Preprogrammed Channels that let you easily keep up with activity on local police, Department of Transportation, and Highway Patrol frequencies when you travel, without having to program any channels.**

## ❖ What's in the box?

In addition to the BCT15 scanner, accessories in the box include an AC adapter, cigarette lighter adapter power cord, three wire DC power cord, ISO mounting bracket and hardware, a push on type (BNC) telescopic antenna, remote PC to scanner cable (scanner plug to front of PC connector), owners manual, and other printed material. The manual is well written and should be studied to get the most out of the BCT15 and understand all of its operations.

## ❖ Overall Rating and Final Thoughts

When testing this radio, in some respects, I felt like I was working with a BCD996T. When I got into it a bit deeper at menu and control functions, I started to see some of the differences between the two. For instance, it took me some time to break myself of the habit of pressing the on/off/volume control, expecting to control the display lighting, but finding I was controlling a Bear Tracker function instead.

As in previous Bear Tracker models, I was not impressed with the Bear Tracker feature. In several weeks of testing I never saw it go off in the three states we traveled in. To be honest, I must admit that this feature has never excited me at all since its initial release several years ago by Uniden. As I told a friend several years back, if you are relying on the Bear Tracker to keep you from getting a speeding ticket, I have some nice rocky mountain land for you to plant crops on!

But those of you who have read this column in the past know that no scanner is perfect. Right off the top, there's no digital decoding. In this day and age of scanning, to me that is a show stopper. There is nothing more aggravating to a true radio hobbyist than to hear that digital stream being broadcast with no way to decode it. And, for whatever it is worth, Uniden included the new 700 MHz PS and UHF DoD LMR trunk frequencies in this radio even though you won't be able to monitor them due to the lack of digital decoding capability.

Like the 996, there is a steep learning curve with this BCT15. So let me offer three pieces of advice to those who purchase this radio – read the manual several times, use the free UASD software to program the radio, and read the manual again.

Like the 996, while the GPS capability is a neat feature, it is very labor and research intensive to get it up and operating. I am sure with time, like other aspects of the scanner hobby, information will be shared through the internet to aid hobbyists in programming location information for a variety of radio systems nationwide. But that will be at some point down the road and only a few will probably fully utilize the GPS features in this scanner in the near term.

Bottom line, however: this is a *very* nice scanner. If you live in an area that is using digital, forget it and save a little longer for the BCD996T. But if you only need an analog trunk scanner, or maybe want to have a second one for conventional frequencies or milair monitoring, this is the baby to pick up. There is a lot of scanning capability loaded into this small package. So if you are looking for one unit that does a lot, check out the baby brother of the Uniden BCD996T. You won't be disappointed.

---

*The Uniden BCT15 (SCN 15) is available from Grove Enterprises (1-800-438-8155 or [www.grove-enterprises.com](http://www.grove-enterprises.com)) for \$229.95 plus shipping.*

---

## Miscellaneous Specifications

---

Dynamic allocation capacity –

Systems: 500 maximum

Groups: 20 per system

Sites: 1000 maximum (all)/256 per system

Channels: up to 2500

Channels per trunk system: up to 250

Operating temperature –

Normal –20°C to +60°C;

Close Call –10°C to +60°C

Scan rate –

100 channels per second (conventional mode)

Search rate –

300 steps per second (5 kHz step only) maximum

Attenuation – 20dB nominal

Audio output –

2.6W nominal into 8-ohm speaker

30mW nominal into 32-ohm stereo headphone

Power Requirements –

DC 11.0V to 16.6V via Cigarette Lighter Cord or DC Cord with Orange Wire, AC Adapter (AD-1009) all included

External Jacks:

Antenna Jack –

BNC Type 50-ohm nominal impedance

Phone Jack –

3.5-mm (1/8-inch) Stereo Type

External Speaker Jack –

3.5-mm (1/8-inch) Monaural Type

Record Out Jack –

3.5-mm (1/8-inch) Stereo Type

DC Power Jack –

5.5-mm center pin positive and Orange Wire Jack: Three pin (Center Orange Wire)

Remote Interface Jack –

Four pin mini type

GPS/Remote Interface Jack –

D-sub nine pin (male type)

Note: Features, specifications, and availability of optional accessories are all subject to change without notice by the manufacturer. Information presented above was based on the test unit provided by the manufacturer. Specifications certificated accordance with FCC Rules and Regulations Part 15 Subpart C as of date of

## HF ACARS with PC-HFDL

A few months ago we looked at a VHF ACARS program. Commercial airlines and ground stations utilize this digital mode to report aircraft position and other flight information. ACARS (Aircraft Communication Addressing and Reporting System) transmissions can be found in the VHF aircraft band primarily around 131 MHz. Watching the monitor as new VHF ACARS messages are received and decoded is a fascinating and unique monitoring experience ... Well, almost unique.

There exists an ACARS mode that performs the same function on shortwave for aircraft traveling out of the range of VHF stations. This HF (high frequency) mode is used for international and intercontinental flights.

Although I have been aircraft crazy since a kid, received my pilot's license in the 1970s, have monitored shortwave and VHF/IHF voice transmissions, and have watched VHF ACARS decodes for many years, I have never tried to decode the shortwave ACARS. I was tempted a few years ago when it was mentioned in another *MT* column, but I was too busy to tackle it at the time. Now, I can say I did it and you can, too!

This month we'll look at a program, **PC-HFDL**, which decodes both shortwave and VHF ACARS signals. We'll use the new commercial version of PC-HFDL v2.031.

### ❖ PC-HFDL

If we pick apart the program name it really tells us a lot. Since it's for the PC, the first two letters are obvious. Next, the HF refers to the high frequency or shortwave spectrum. What's with the DL? Well, this mode's full name is **GlobeLink/HF** or **ARINC 635-3 HF Data-Link** protocol.

It works a bit differently from VHF ACARS. A ground station transmits a signal at 32-second intervals. These "squitter" signals "tell" listening aircraft information about the ground station's system and propagation conditions. They also perform a critical function by synchronizing the aircraft's digital clock to the ground station's.

### ❖ Timing is Everything

Every ground station has a pre-determined time-window when it transmits its squitter signal. For example, ground station Alpha always transmits its squitter at reference time plus X milliseconds, while station Beta always transmits at reference time plus Y milliseconds. (You can begin to see why system clocks need to be synchronized.)

This transmit scheduling methodology helps avoid signal "traffic jams." As important, it allows an aircraft to "listen" to different stations (which are transmitting at different times) and to select the station it is receiving best. Time Division Multiplexing (TDMA) is used to send data, and this also helps to avoid signal traffic jams.

Okay, enough technical stuff. Let's use PC-HFDL.

### ❖ Receiver Requirements

PC-HFDL recommends "a good quality USB HF receiver ... Preferably one that can support a bandwidth of 2.5 kHz." We used an ICOM IC-PCR1000 controlled by the latest version of the simple ICOM provided program. The narrow bandwidth was crucial for the PC-HFDL to operate properly. Using a longwire antenna, at our location one of the most active and strong HF ACARS frequencies was 11.348 MHz. Although we used others, this was our primary frequency.

### ❖ PC Requirements

With all the timing, data "squitter-ing," and decoding going on, it should come as no surprise that PC-HFDL requires a relatively fast PC. The program recommends a Pentium III 500 MHz as a minimum. We ran it on a Pentium III 1GHz running Windows XP. The audio from a shortwave receiver is connected to the PC via the soundcard. More on this later.

Once downloaded, the program installed quickly and easily without any problems. The program's operation revolves around one main screen. Keep in mind that PC-HFDL is only a decode program. Figure 1 displays the main screen actually receiving HF ACARS. As we can see, the screen is divided into many different sections.

### ❖ Configuring PC-HFDL

First, we need to do some configuring via the "System-Options" dropdown menu at the top left of Figure 1. Using this Soundcard Configuration sub menu, the soundcard input – either Mic or Line-in – is chosen, depending where you have connected the receiver's audio.

The program warns in its Help file that, "It may not be compatible with some sound cards; the AWE64 is particularly problematic." Once the levels were set up correctly and the input selections on the soundcard and PC-HFDL's setup menu were harmonized, my Turtle Beach soundcard worked well.

At the top of Figure 1 is the spectrum display. Here we can see the audio from the receiver tuned to 11.348 MHz broken into timing frames. Most frames display noise. However, you can see ACARS data signals in frames 4, 0 and 12.

Because it can accept two inputs, you might think it is listening in stereo, but it's better than that. A nice feature of PC-HFDL is that it can monitor both VHF and HF ACARS. One receiver's audio signal is fed into the right channel input and the other into the left channel.

The trick is, you must tell the program which is which. For example, HF ACARS signal is on the left – A channel, and VHF is on the right – B channel. This is defined via the Channel Configuration sub menu.

The Spectrum Configuration sub menu seemed straightforward. Here the user chooses which channel – A, B, A & B or none – is to be displayed at the top of the Main screen.

Be careful. Here things can get confusing. I suggest that once you have chosen a Spectrum Channel to be displayed (for example, A), you return to the Channel configuration to make sure that the same channel is selected. Input a high level audio signal into the soundcard on the channel you are going to use for HF ACARS – for example, left. I tuned to WWV and used its audio. Its tone and ticking makes for an unmistakable audio spectrum display. Now, if A is the left channel input, you should see it on the display. If not, your Channel B is your left input, not A, and you should adjust your Channel and Spectrum sub menu selections accordingly.

The signal level should be adjusted using the soundcard mixer setting and the receiver's volume control if you are connected to the external speaker connection. Another method of adjusting the input level is via the up/down arrows at the right of the spectrum display. Make the adjustments so the noise just about fills the height of the spectrum display. Then, when an

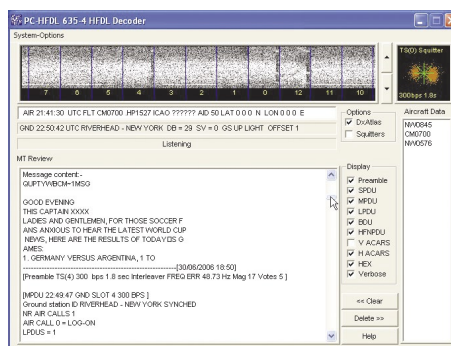

Figure 1 – PC-HFDL's main screen where it all happens – Well, almost all.

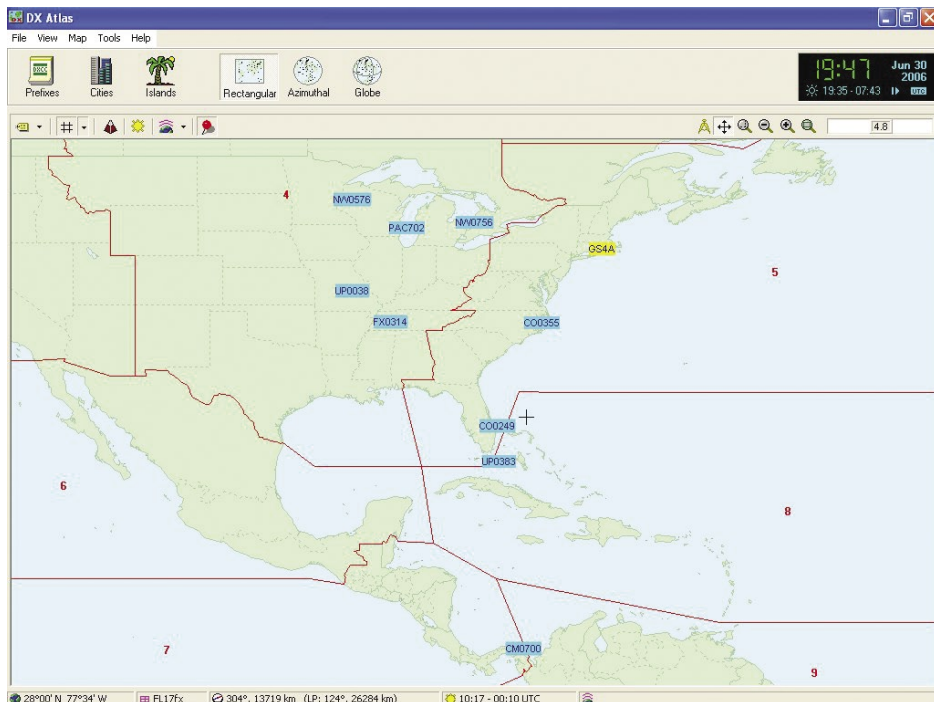

Figure 2 – Map of “heard” aircraft and ground stations.

ACARS signal is received, re-adjust so it just hits the top of the display.

### ❖ The Twelve Boxes

Near the middle right of the display in Figure 1, running vertically, are twelve boxes where the user can select what data is displayed. The program’s Help file defines box options as:

- PREAM .....Displays received preamble information
- SPDU .....Displays Squitter Protocol Data Units
- MPDU .....Displays Media Access Protocol Data
- LPDU .....Displays Link Protocol Data Units.
- BDU .....Displays Window Basic Data Units (Segmented message fragments).
- HFNPDU ...Displays the Network Data Units (one of the most interesting displays)
- V ACARS ...If a VHF channel is live it will display VHF ACARS messages
- H ACARS ...If an HF channel is live it will display HF ACARS messages
- HEX .....Displays received packets in Hexadecimal (Base 16) notation
- VERBOSE ..Displays verbose output (all the stuff you didn’t want to know)

### ❖ Look Here

As you can see, PC-HFDL really does lots of decoding. If you are going to decode both VHF and HF ACARS, both boxes must be selected. The Help file points out that HF-NPDU displays “the most interesting” things, but I found that displaying the preamble data (PREAM) helped me understand what I was about to see next on the display.

Displaying the HEX and Verbose resulted in data only useful to programmers or system engineers. If you have decoding problems, deselect these two. You will not miss anything and it may help free up your PC.

### ❖ What Are We Monitoring?

The first line under the spectrum display in Figure 1 shows the aircraft that we are monitoring, flight CM0700. The second line displays the ground station information – in this case, Riverhead, New York.

Where is Riverhead? Two of the boxes bring up new screens. Selecting “DxAtlas” displays a mapping program that shows the position of monitored aircraft. Figure 2 shows this program in action. From here we can see that the aircraft CM0700 is located between Central and South America at the bottom of the display. Also, the location of our Ground station, GS4A, can be seen east of New York City. It actually is situated on the eastern end of Long Island. The map also displays other aircraft positions, which we previously monitored and decoded.

At the center of Figure 1 is where all the checked box data is displayed. Here we can see a message concerning the World Cup score for the Germany versus Argentina match. I assure you, there were a great number of more interesting messages that PC-HFDL decoded.

### ❖ Impression of PC-HFDL

Once set up properly, the program worked very well. I believe aircraft monitoring enthusiasts will find it well worth the \$35. But be aware that to get the full ACARS experience, I recommend that you also get a package for logging, aircraft identification, message analysis and other niceties. In fact, next month we will try out a program that claims to add some of these features to PC-HFDL.

Although PC-HFDL is a decoding only program, it’s very good at what it does. The new full-featured commercial version of PC-HFDL v2.031 can be purchased on-line for \$35 and downloaded at [www.chbrain.dircon.co.uk/pchfdl.html](http://www.chbrain.dircon.co.uk/pchfdl.html). You can download the program and use it for ten minutes without charge. The

old unsupported freeware version is also still around.

### ❖ Impressions of HF ACARS

The one thing that I immediately noticed about HF ACARS as compared to VHF ACARS, was that band conditions play a dominant factor in the quantity and quality of the HF ACARS decodes. Although PC-HFDL has an amazing input range and can decode barely audible signals, if the signal is not there, there’s nothing to decode. And since it’s a digital mode, either nothing happens or the screen fills with junk and question marks.

So, as the band conditions danced around, sometimes in the middle of a transmission, junk hit the display. This is not the fault of the program, but is the nature of the HF/shortwave beast, with its ever changing propagation conditions.

As a General once told me while I was consulting on HF and satellite communications network requirements, “The good thing about HF is you don’t have to make an advanced reservation to use it, as you do with a satellite net. The bad thing is you never know if the band conditions will be there when you need it!”

All things considered, I will be monitoring HF ACARS regularly. It adds yet another dimension to anyone with monitoring and aircraft interests. And especially those of us with interests in *Computers & Radios!*

How much more enjoyable will HF ACARS be when coupled to a logging and analysis program? We’ll find out next time.

Transmit ANY Audio  
To ANY FM Receiver  
Without Wires!

FM TRANSMITTER

- Full Stereo
- PLL Digital Tuning
- 88.3-107.7 MHz
- Operates on AC Adapter (incl) or (2) ‘AA’ Batteries (opt)
- Optional Mobile Kit Available
- Available in White, Black, Silver
- \$69<sup>95</sup> Incl. FREE U.S. Shipping

FREE CATALOG!

800-522-8863 • [ccrane.com](http://ccrane.com)

# What's NEW

Tell them you saw it in *Monitoring Times*

## AM DXing Gem

We recently received the following announcement from Jim Tonne:

"I have written and posted a freebie that is being very well accepted. It is a program that shows the antenna patterns of all the AM (medium wave) stations on a given channel in Canada, USA, Mexico and Cuba. The user can select day only, night only or both. Licensed or licensed as well as applied-for. The map projection is polar (great circle) and the center of the map can be freely assigned. To assist this, you can enter a latitude and longitude, or a home city, or a home "W" or "K" call sign. Gobs of options.

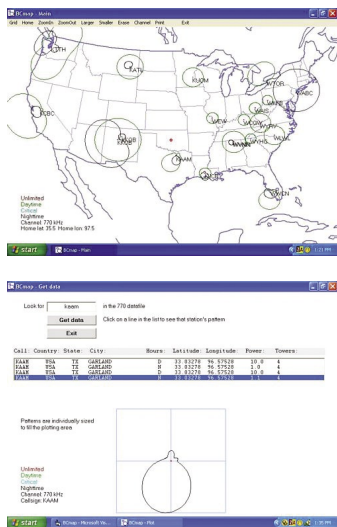

"It was written by me, for me, to explain why some station is coming in so poorly (or strongly) and why a given station's pattern is as it is. All the technical data shown is a result of examining and parsing the current FCC database.

"Since the program is so professionally done, and is so easy to use, and offers so much information, is fun and is free (gosh, I should blush!) it would be a Good Thing if you mention it in *Monitoring Times*. It is a very useful tool in the bag of tricks for those who listen to the MW AM band.

"Here is a link to try the thing: <http://tonnesoftware.com/bc-map.html> On that page is a Download button. Clicking on it gets you the executable self-extracting installation package.

"I am very pleased to be able to present this gem to the DXing world."

— Jim Tonne WB6BLD  
[www.tonnesoftware.com](http://www.tonnesoftware.com)

I immediately forwarded the information to Doug Smith, of course. His delighted response confirmed that this software is indeed a Good Thing, and you'll read about it further in his *AM Bandscan* column. Meanwhile, download and play with it yourself!

## Remote Key Operation

How would you like to operate your transmitter or send CW from 16 feet away without worrying about a cable? At Dayton this year Hannes Hiller DL9SCO introduced Palm Radio's new Infrared Link Technology. The IR Link allows for transmission of infrared wireless signals from your key or paddle to your radio.

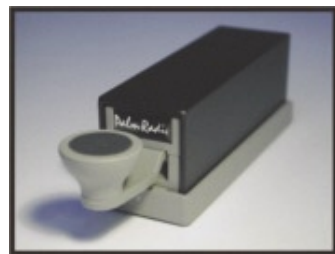

The IR Link consists of an infrared LED transmitter (stand-alone, or built into Palm's Code Cube Keyer or the PPK mini straight key), and an IR receiver which is connected to or built into the transmitter. The IR Link enabled components are:

- CCIR - Code Cube with IR Link Transmitter
- PPKIR - PPK Mini Straight Key with IR Link Transmitter
- IRTX - IR Link Transmitter for use with any straight key
- IRRX - IR Link Receiver
- IRS - IR Sensor modular receiver for building into a transmitter.

The components are sold separately, because a single IR Link Receiver can be driven by multiple keying devices.

The Palm Radio infrared system is available from Morse Express. Prices range from \$44.95 for the IR sensor module to \$99.95



for the IR enabled Code Cube. Morse Express ([www.MorseX.com](http://www.MorseX.com)) and Oak Hills Research ([www.OHR.com](http://www.OHR.com)) are operated by Marshall Emm N1FN/VK5FN, who will personally make sure you are satisfied with any of their products or services. Their full catalog is available for download in pdf format. Order on-line or call 1-877-DOT DASH (368-3274) toll free to order by phone.

## AR-ALPHA Communications Receiver



AOR has announced a new professional receiver for government use or export outside the U.S. Like the AR-ONE, the AR-ALPHA provides coverage from 10 kHz to 3.3 GHz continuous, with no gaps. Anticipated features include:

- Digital Signal Processing on IF stage and demodulate stage
- Fast frequency processing by means of FFT
- Multi mode receive: WFM (in stereo, selectable de-emphasis), NFM, AM, (Synchronous AM, diversity synchronous AM), ISB, RZSSB, USB, LSB, CW, P25, TV (FM, AM, NTSC/PAL)
- Multiple IF filters: 200 Hz, 500 Hz, 3 kHz, 6 kHz, 15 kHz, 30 kHz, 100 kHz, 200 kHz, 300 kHz
- Versatile digital processing: Digital noise filter, auto notch filter, noise blanker, IF shift, AFC, variable CW pitch, voice descrambler, voice squelch, CTCSS, DCS
- I/Q digital output (1MHz BW)
- Communication port (RS-232C, USB)
- 6" color TFT display

- Displays up to 100 MHz bandwidth

The AR-Alpha is expected to become available in late 2006 and will be carried by Grove Enterprises ([www.grove-ent.com](http://www.grove-ent.com)) or call 1-800-438-8155 for price and availability).

## Audio: The Movie

Now for something entirely different for the hobbyist wanting to continue his learning. Quality audio reproduction is very important to the enjoyment of the radio, but it's not something in which most of us are well versed. (Unless you're Bob Heil!) Here's a chance to rectify that — for only \$39!

Tracer Technologies Inc. has announced a new educational DVD called "Audio: The Movie." This college-level course helps users understand the principles of audio but bypasses most of the mathematics usually associated with such studies.

*Audio: The Movie* is loaded with practical examples that help take the edge off of complex science by relating it in a user-friendly, simple way. Chapters include Amplitude, Bit Width, Sample Rate, Frequency Domain, Aliasing, Dithering, Quantization and Compression. It also includes a test booklet to help you gauge your understanding of each chapter.

"We wanted to offer a more approachable explanation of audio that would be useful to anyone who deals with audio," said Curtis Crowe, President of Tracer Technologies. "If you own a recording studio, dabble in audio restoration, work in a Forensics lab, use popular computer audio products or just have an interest in music or sound, this DVD will be very useful for you."

*Audio: The Movie* is available for \$39 from Tracer Technologies [www.tracertek.com](http://www.tracertek.com) (3600 Board Rd., York, PA 17402. Toll Free Sales: 866-260-6376.) Email [sales@tracertek.com](mailto:sales@tracertek.com)

Books and Equipment for announcement or review should be sent to What's New, c/o *Monitoring Times*, 7540 Highway 64 West, Brasstown, NC, 28902. Press releases may be faxed to 828-837-2216 or emailed to Rachel Baughn, [editor@monitoringtimes.com](mailto:editor@monitoringtimes.com).

# AOR SR2000 Frequency Monitor

## Seeing is Believing!



**The SR2000 is an ultra-fast spectrum display monitor with a high quality triple-conversion receiver**

*AOR puts the power of FFT (Fast Fourier Transform) algorithms to work in tandem with a powerful receiver covering 25 MHz ~ 3 GHz continuous.*

*The result is a compact color spectrum display monitor that's ultra-sensitive, incredibly fast, yet easy to use. The SR2000 is perfect for base, mobile or field use and can also be used in combination with a personal computer. It's another example of why so many Federal and State law enforcement, military units, surveillance agencies, government users, hospitals, RF labs, News Media and monitoring professionals rely on AOR, the Serious Choice in Advanced Technology Receivers.*

**High Speed FFT Search – Scans 10 MHz in as little as 0.2 seconds! Instantly detects, captures and displays transmitted signals.**

- FFT (Fast Fourier Transform) high speed display
- Displays up to 10MHz of spectrum bandwidth
- 5 inch TFT color LCD display
- Waterfall (time) display function
- High speed FFT search quickly captures new signal transmissions
- Versatile color display uses state of the art digital signal processing
- Average or peak value readings
- Frequency coverage: 25MHz ~ 3GHz (no gaps)
- Ultra-stable, high-sensitivity triple-conversion receiver
- AM/NFM/WFM/SFM receive modes
- 1000 memory settings (100ch x 10 memory banks)
- Easy menu-driven operation
- PC control through serial port (or optional USB interface)

## SR2000

**Standard Accessories:**  
AC adapter, control cables



Authority on Radio Communications

AOR U.S.A., Inc.  
20655 S. Western Ave., Suite 112, Torrance, CA 90501, USA  
Tel: 310-787-8615 Fax: 310-787-8619  
info@aorusa.com http://www.aorusa.com

*Specifications are subject to change without notice or obligation. Product intended for use by government or authorized users in the USA, documentation required.*

# Stock Exchange

**LINE ADS**

NON-COMMERCIAL SUBSCRIBER RATES: \$.25 per word. All merchandise must be personal and radio-related.  
 COMMERCIAL, NON-SUBSCRIBER, AND MULTIPLE SALES RATES: \$1.00 per word. Commercial line ads printed in bold type.

Ads for Stock Exchange must be received 45 days prior to publication date. All ads must be paid in advance to Monitoring Times.  
 Ad copy must be typed for legibility.

**1-3/4" SQUARE DISPLAY AD:**

\$50 per issue if camera-ready copy or, \$85 if copy to be typeset. Photo-reduction \$5 additional charge. For more information on commercial ads, contact Beth Leinbach, 828-389-4007.

Attention all those wanting to know what's going on with ham radio in the New Orleans area, check out: <http://groups.yahoo.com/group/GNOAmateurRadio/>

For Sale: Sony ICF 77 and ICF 2010 in mint condition. Asking \$500.00 each. Call Ben (732) 238-3438

**Subscribe to MT for as little as \$15.50 (U.S. Second Class Mail)**

7540 Hwy. 64 W.; Brasstown, NC 28902  
 1-800-438-8155 US and Can.; 828-837-9200; Fax 828- 837-2216  
 e-mail [order@grove-ent.com](mailto:order@grove-ent.com)

	6 months	One Year	Two Years	Three Years
US Rates	<input type="checkbox"/> \$15.50	<input type="checkbox"/> \$28.95	<input type="checkbox"/> \$51.95	<input type="checkbox"/> \$76.95
US 1st Class	<input type="checkbox"/> \$30.00	<input type="checkbox"/> \$57.95	<input type="checkbox"/> \$112.00	<input type="checkbox"/> \$168.00
Canada Surface*	<input type="checkbox"/> \$20.50*	<input type="checkbox"/> \$39.50*	<input type="checkbox"/> \$75.95*	<input type="checkbox"/> \$112.95*
Foreign International*	<input type="checkbox"/> \$30.75*	<input type="checkbox"/> \$58.50*	<input type="checkbox"/> \$114.95*	<input type="checkbox"/> \$171.50*
Electronic Subscription		<input type="checkbox"/> \$19.95	<input type="checkbox"/> \$38.90	<input type="checkbox"/> \$57.85

\*All payments must be in U.S. Funds drawn on a U.S. Bank!

Time to Renew? Your label will tell you how many issues remain in your subscription. When it's time to renew, your MT will arrive with a bright yellow cover sheet with the renewal form. Renew by the second notice to avoid missing an issue!

Antique Radio..... 65  
 Antique Wireless..... 65  
 AOR..... Cover 2, 75  
 C Crane..... 73  
 Carey, Kevin..... 65  
 CIDX..... 76  
 Communications Electronics..... 27  
 Computer Aided Technology..... 17  
 Cumbre DX..... 76  
 Dave's Hobby Shop..... 76  
 Grove Enterprises..... 9, 67, Cover 3  
 Hauser, Glenn..... 42  
 HOGWILD..... 76  
 ICOM..... Cover 4  
 ODXA..... 76  
 Popular Communications..... 63  
 Prime Time Shortwave..... 57  
 Skyvision..... 76  
 Small Planet Systems..... 63  
 SWL-remotes.com..... 65  
 Ten-Tec..... 21  
 Universal Radio..... 25, 76  
 WBCQ..... 55  
 WiNRADiO..... 1

**WATCH OVER 175 CHANNELS  
 OF BROADBAND TV  
 WITHOUT A COMPUTER**

**NEWS SPORTS MOVIES ADULT**  
**FREE INFORMATION PACKAGE**  
 **574/233-3053**  
[www.rcdistributing.com](http://www.rcdistributing.com)

**NOAA WESAT  
 Weather Satellite  
 Receiving Equipment**  
**QHA Antennas**

 Scanning receivers, filters, pre-amps, etc  
**HOGWILD**  
 (845) 389-2874  
<http://home.hvc.rr.com/hoggwild>

**C Ku Satellite Equipment**

Big Dish • FTA Dish • Parts  
 LNBS • Switches • Feeds  
 Shortwave • Ham Gear  
 CB Radios • Scanners  
 Antennas • Cables • Accessories  
 Books • Electronic Parts  
**Dave's Hobby Shop**  
 600 Main • Van Buren, AR  
 479-471-0751  
[www.daveswebshop.com](http://www.daveswebshop.com)

**Listening In**

That's what we do and who we are!  
 Since 1974

Acclaimed worldwide as one of the top publications for radio listeners. Get a free sample of our electronic monthly magazine and see for yourself.

E-mail us and mention this ad

**Ontario DX Association**  
 155 Main St.N., Apt. 313  
 Newmarket, Ontario L3Y 8C2 Canada  
 E-mail: [listeningin@rogers.com](mailto:listeningin@rogers.com)  
[www.odxa.on.ca](http://www.odxa.on.ca)

**Join the Club!**

Open to hobbyists worldwide, the **CANADIAN INTERNATIONAL DX CLUB** is Canada's national, general coverage radio club serving members since 1962.

For a free sample of our monthly electronic newsletter, **Messenger**, please e-mail CIDX at:

[cidxclub@yahoo.com](mailto:cidxclub@yahoo.com)  
 Web: [www.anarc.org/cidx/](http://www.anarc.org/cidx/)

**HUGE 100 PAGE CATALOG**

- Shortwave & Ham Gear
- Scanners & RTTY/FAX
- Antennas & Accessories
- Radio Books & CDs.

Send \$1 to  **Universal Radio**  
 6830 Americana Pkwy.  
 Reynoldsburg, OH 43068  
 Tel. 800 431-3939  
[www.universal-radio.com](http://www.universal-radio.com)

**4DTV • C-band • Ku-band**

Systems and Parts—  
 Get it all with just one call!

**Satellite programming**

less than **\$10.00/mo.**

with annual subscription

Get our **FREE** catalog!  
[www.skyvision.com](http://www.skyvision.com)

**800-500-9275**

Cumbre DX is the world's best shortwave DX publication. We feature news and loggings that you just won't find elsewhere. But the best part about Cumbre DX is that it is absolutely

**FREE!**

Send and email to [cumbredx@yahoo.com](mailto:cumbredx@yahoo.com) or visit our website at [www.cumbredx.org](http://www.cumbredx.org) to subscribe.

# GROVE

[www.grove-ent.com](http://www.grove-ent.com)

## GRUNDIG

G4000A RCV23 \$149.95

**JRC** NRD-545 RCV21DS \$1799.95

## AOR

AR-5000A Plus 3 RCV44P \$2569.95

AR-8600II RCV11 \$889.95

**GE** SUPERADIO III RCV5 \$59.95

## SANGEAN

ATS-505P RCV7 \$109.95

ATS-909 RCV8 \$239.95

ATS-818AcS RCV18 \$199.95

**KAITO** KA1102 RCV2 \$79.95

## ICOM

R75 RCV32 \$609.95

PCR1500 RCV15 \$579.95

R1500 RCV25 \$699.95

PCR2500 RCV35 \$849.95

R2500 RCV52 \$999.95

**ETON** E1XM RCV34 \$499.95

S350 DELUXE RCV4 \$99.95

E5 RCV10 \$149.95

## Your Source for Radio Scanners, Receivers, Accessories, and Publications

Established in 1979 by well-known communications expert Bob Grove, Grove Enterprises has become a world leader in radio monitoring equipment, accessories, and publications.

If you decide you don't like a product, Grove Enterprises doesn't penalize you for it. There is NO restocking fee so long as you call our toll free number for a return authorization within fifteen days of shipment and the item is returned in new condition. Once the item is received we will give you credit toward another item or issue a full refund (less shipping charges). Software cannot be returned if opened.

That's it! No hassle! No negotiations! Just call 1-800-438-8155 and our friendly staff will assist you with a return authorization number.

**Grove means service and quality. You won't find better customer service anywhere.**

## WINRADIO

WR-G303e RCV46E \$599.95

WR-G303e w/pro demodulator RCV46EP \$699.95

WR-G303i RCV46 \$499.95

WR-G303i w/ pro demodulator RCV46-P \$599.95

WR-G313 (Internal) RCV31 \$949.95

WR-G313 (External) RCV31-E \$1149.95

WR-1550 (External) RCV47-E \$549.95

WR-1550 (Internal) RCV47-I \$499.95

WR-3150 (External) RCV48-E \$1849.95

WR-3150 (Internal) RCV48-I \$1849.95

WR-3500 (External) RCV49-E \$2395.95

WR-3500 (Internal) RCV49-I \$2395.95

WR-3700 (External) RCV50-E \$2895.95

WR-3700 (Internal) RCV50-I \$2895.95

WR-G305i RCV53 \$519.95

WR-G305i w/pro demodulator RCV53P \$619.95

WR-G305e RCV53E \$619.95

WR-G305e w/pro demodulator RCV53EP \$719.95

## WINRADIO Accessories

AX-07B flexible VHF/UHF antenna ANT47 \$24.95

AX-37A wide-band log-periodic antenna ANT28 \$389.95

AX-71C discone antenna ANT01 \$89.95

AX31-B Antenna ANT 4 \$119.95

AX-91M magnetic antenna base ANT48 \$24.95

Mounting Clamps for AX-71C ACC71 \$12.95

USB Adaptor ACC 2 \$49.95

Client Server Option-1000/1500 Series ACC 14C \$99.00

Client Server Option-3000 Series ACC14B \$399.00

Client Server Option-G313 Series ACC14D \$149.95

G303 Professional Demodulator SFT20 \$179.95

PCMCIA PC Card ACC 28 \$89.95

Data Cable for 1500/3000 receiver CBL 3 \$9.95

FSK Decoder DEC 1 \$349.95

Portable Power Supply (external units only) PWR 5 \$189.95

Digital Suite SFT 15 \$85.00

Advanced Digital Suite Upgrade SFT 15U \$85.00

Advanced Digital Suite SFT 15A \$179.95

World Radio Database Manager SFT 16 \$85.00

Trunking Software SFT 23 \$89.95

## Shipping/ Handling Charges

Total Order	Shipping Charges
\$1-\$29.99	\$3.00
\$30-\$49.99	\$6.95
\$50-\$99.99	\$8.95
\$100-\$399.99	\$12.95
\$400-\$899.99	\$16.95
\$900-\$1499.99	\$20.95
\$1500-\$1999.99	\$24.95
\$2000-\$2499.99	\$28.95
\$2500+	\$32.95

Make sure to visit us on the web to get the latest and greatest deals!

# GROVE

**(800) 438-8155**

Grove Enterprises, Inc. - [www.grove-ent.com](http://www.grove-ent.com)

(800) 438-8155; (828) 837-9200; fax: (828) 837-2216

7540 Hwy 64 W; Brasstown, NC 28902 - email: [order@grove-ent.com](mailto:order@grove-ent.com)

0.01 to 3299.999 MHz\*\* Coverage • Record and Save Audio in WAV Format • USB Cable Connection

# WHO SAYS THE WORLD IS ROUND?

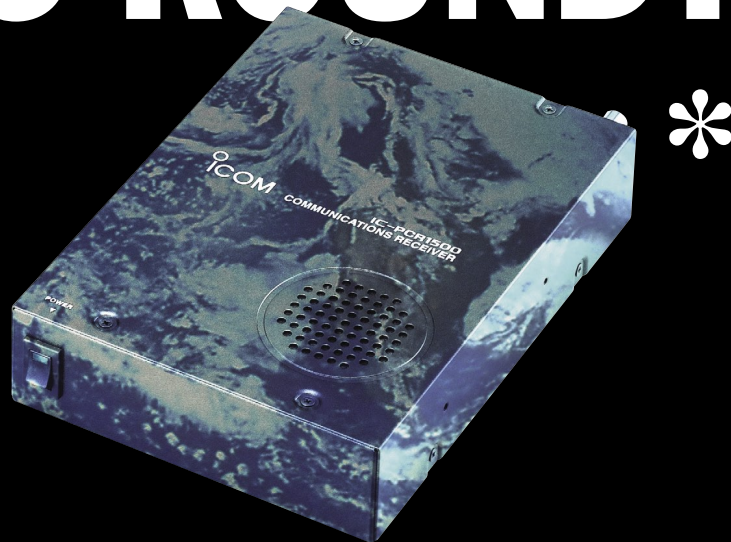

## **NEW** IC-PCR1500

PC Controlled Wideband Receiver

**NOW AVAILABLE**



Also now available: **IC-R1500**

A remote control head allows you to take the radio mobile. Cable included. No PC required, but you may connect the R1500 to a PC when not using the control head. Your choice. Visit your authorized Icom dealer today.

**For free literature:**  
425.450.6088 or  
[www.icomamerica.com](http://www.icomamerica.com)

\* Neat, look huh? It's just advertising. The radio is actually black. Very attractive, yes. But black. If we had put a black radio on this ad, the headline would not have been as quick to read. So we made up this look. Black is nice. Think of it as seeing the world from the night side. It's still there. You just can't see it. Can't get over it? If you send us \$5000.00 USD, we'll make up the radio look just like this for you. Is it worth it? Not to most people. But you're not most people. Are you? E-mail [icom@icomamerica.com](mailto:icom@icomamerica.com) with "worldPCR" in the subject line for more info. \*\* Cellular frequencies blocked.

©2006 Icom America Inc. The Icom logo is a registered trademark of Icom Inc. All specifications are subject to change without notice or obligation. 8760

  
**ICOM**<sup>®</sup>