

May, 1988

Volume 7, Number 5

\$2.50

OH 44022-2207

CHAGRIN FALLS

Postage Paid

0189

***** 3 DIGIT PRE *****

00DMAN, DAVID J.
1870 MIRAM TRAIL

MONITORING TIMES

A Publication Of
Grove Enterprises

Inside This Issue:

- ★ The Red Cross's Telecommunications
- ★ Television DXing
- ★ MT Interviews Espionage Author James Bamford
- ★ Review of the Sony SW1

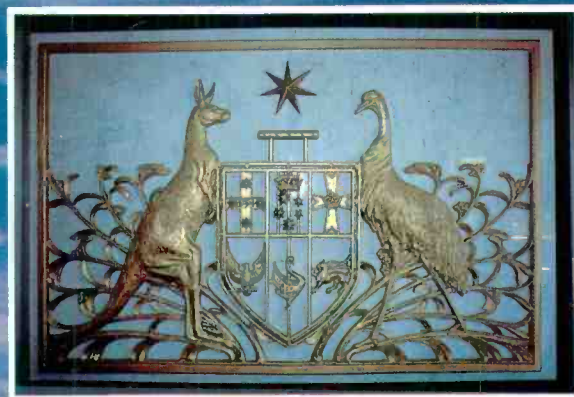

Broadcasting Down Under



Monitoring Times Goes to Australia!

SATELLIT 650 INTERNATIONAL – THE EAR TO THE WORLD



Top Class World Receivers with German Technology

Microcomputer controlled PLL-frequency-synthesizer tuning for AM and FM. Direct frequency key-in for all wave bands with automatic follow-up preselector and three-stage fading control for AM. Short Wave covering 1.6–30.0 MHz. Double superhet for exceptional selectivity and image rejection, switchable SSB/BFO section (adaptable to USB/LSB). AC 110–240V, 50/60 Hz, DC-operation 9V with batteries or external power supply.



Exclusive Licensee & Distributor of Grundig AG in USA
Lextronix, Inc.
P.O. Box 2307
Menlo Park, CA 94026
Tel. (415) 361-1611
Toll free No. 1 (800) 872-2228

GRUNDIG



MONITORING TIMES

Published by:
Grove Enterprises
Publisher:
Bob Grove, WA4PYQ
Editor:
Larry Miller
Technical Editor:
Ike Kerschner
Design and Production:
Rachel Baughn
Subscriber Services:
Linda Newton
**Advertising and
Dealerships:**
Judy Grove

Inside this Issue

- Broadcasting Down Under** by *Dave Rosenthal* 6
G'day, mate. First it was Paul Hogan pitching vacations and "shrimp on the barbie." Then it was Crocodile Dundee and the bicentennial celebrations "Down Under." Everything about Australia is up-beat. Except their international shortwave station. It's struggling. Dave Rosenthal reports from Radio Australia.
- Live and Let Live** by *Jack Buzby* 12
Most SW listeners are aware of the broadcasts of the International Committee of the Red Cross, but not so many hobbyists are aware of their extensive two-way communications network. And the Red Cross would prefer it stayed that way!
- TV DX Season is Here!** by *John F. Combs* 14
You're watching TV. Suddenly, a strange herringbone pattern fills the screen. And your local station disappears, replaced by the crystal clear image of a TV station halfway across the country. That's right. It's TV DX time again and John Combs shares the excitement.
- Whizbang and Wireless!** by *Don Jensen* 18
There was a time, long ago and seemingly far away, when radio was something truly wonderous. Boys with the right knowledge and a few cents for parts could construct working radios and end up saving sinking ships, warning towns about impending floods and generally making the world a better place. It's all in a day's work for The Radio Boys.
- Code Name: Esquire** an interview with *James Bamford* by *Jock Elliott* 20
Numbers stations. Their purpose and origin have been a puzzle to shortwave listeners for over 25 years. Monitoring Times continues to unravel this enigma with an exclusive interview with James Bamford, the author of the best-selling espionage expose, The Puzzle Palace.
- Flying with MAMA** by *Rachel Baughn* 22
MT's production manager takes a once-in-a-lifetime flight!

DEPARTMENTS

Letters	3	Frequency Section	47
Communications	4	Day to Day Shortwave	70
International DX Report - Glenn Hauser	24	"Ask Bob"	76
Broadcast Loggings - Gayle Van Horn	26	Magne Tests...the Sony ICF-SW1 - Larry Magne	78
Scanning the Nation - Bob Kay	28	Equipment: MetroWest Scanner Charger	80
Utility World - Larry Van Horn	30	What's New	82
The Federal File - Dave Jones	36	Helpful Hints	84
Domestic Broadcasting - Paul Swearingen	38	Antenna Topics - Clem Small	86
High Seas - James R. Hay	40	Technical Topics - Terry Staudt	88
On the Ham Bands - Ike Kerschner	42	Experimenters Workshop: Nondirectional Antenna	90
Outer Limits - John Santosuosso	44	Stock Exchange	94

COMING IN JUNE: Take a first-hand trip with Don Moore (originally promised for this issue) to a station deep inside Guatemala. Get that scanner ready for a little fine-tuning as Bob Kay tells you how to develop a professional monitoring style. And *MT* reveals, for the first time, the actual location of yet another spy numbers station! It's in the US!

MONITORING TIMES (ISSN 0889-5341) is published monthly for \$16 per year by Grove Enterprises, Inc., PO Box 98, Brasstown, NC 28902 (ph.1-704-837-9200). Second class postage paid at Brasstown, NC, and additional mailing offices. POSTMASTER: Send address changes to Monitoring Times, PO Box 98, Brasstown, NC 28902.

ON THE COVER: Picture Australia: Superimposed on the Australian grasslands are (clockwise from upper left) Sydney Harbor featuring the Opera House; the Great Seal of Australia in bronze and marble; Solar Spectroheliograph antenna at Culgoora Radio Observatory; close-up of an emu in the wild; 85' diameter radio telescope on rails at Culgoora. Photos by Dave Rosenthal.

uniden®

\$12,000,000 Scanner Sale

Uniden Corporation of America has purchased the consumer products line of Regency Electronics Inc. for about \$12,000,000. To celebrate this purchase, we're having our largest scanner sale in history! Use the coupon in this ad for big savings. Hurry...offer ends July 31, 1988.

★★★ MONEY SAVING COUPON ★★★

Get special savings on the scanners listed in this coupon. This coupon must be included with your prepaid order. Credit cards, personal checks and quantity discounts are excluded from this offer. Offer valid only on prepaid orders mailed directly to Communications Electronics Inc., P.O. Box 1045 - Dept. UN12, Ann Arbor, Michigan 48106-1045 U.S.A. Hurry...coupon expires July 31, 1988. Coupon may not be used in conjunction with any other offer from CEI. Limit one coupon per scanner. Add \$7.00 for shipping in the continental U.S.A.

- Regency TS2-SA2 \$269.95
- Regency TS1-SA2 \$199.95
- Regency INF1-SA2 \$139.95
- Regency INF2-SA2 \$159.95
- Regency INF3-SA2 \$119.95
- Regency INF5-SA2 \$109.95
- Bearcat 200XLT-SA2 \$262.95
- Bearcat 100XLT-SA2 \$189.95
- Bearcat 800XLT-SA2 \$249.95
- Bearcat 210XLT-SA2 \$177.95
- Bearcat 70XLT-SA2 \$154.95

★★★★ VALUABLE COUPON ★★★★★

NEW! Bearcat® 760XLT-SA3

List price \$499.95/CE price \$279.95/SPECIAL 12-Band, 100 Channel • Crystalline • AC/DC Frequency range: 29-54, 118-174, 406-512, 806-956 MHz. Excludes 823.9875-849.0125 and 868.9875-894.0125 MHz. The Bearcat 760XLT has 100 programmable channels organized as five channel banks for easy use, and 12 bands of coverage including the 800 MHz band. The Bearcat 760XLT mounts neatly under the dash and connects directly to fuse block or battery. The unit also has an AC adaptor, flip down stand and telescopic antenna for desk top use. 6-5/16" W x 1 1/4" H x 7 3/4" D. Model BC 580XLT-SA is a similar version without the 800 MHz. band for only \$219.95.

SALE! Regency® TS2-SA

List price \$499.95/CE price \$309.95/SPECIAL 12-Band, 75 Channel • Crystalline • AC/DC Frequency range: 29-54, 118-174, 406-512, 806-950 MHz. The Regency TS2 scanner lets you monitor Military, Space Satellites, Government, Railroad, Justice Department, State Department, Fish & Game, Immigration, Marine, Police and Fire Departments, Aeronautical AM band, Paramedics, Amateur Radio, plus thousands of other radio frequencies most scanners can't pick up. The Regency TS2 features new 40 channel per second Turbo Scan™ so you won't miss any of the action. Model TS1-SA is a 35 channel version of this radio without the 800 MHz. band and costs only \$239.95.

Regency® RH256B-SA

List price \$799.95/CE price \$329.95/SPECIAL 16 Channel • 25 Watt Transceiver • Priority The Regency RH256B is a sixteen-channel VHF land mobile transceiver designed to cover any frequency between 150 to 162 MHz. Since this radio is synthesized, no expensive crystals are needed to store up to 16 frequencies without battery backup. All radios come with CTCSS tone and scanning capabilities. A monitor and night/day switch is also standard. This transceiver even has a priority function. The RH256 makes an ideal radio for any police or fire department volunteer because of its low cost and high performance. A 60 Watt VHF 150-162 MHz. version called the RH606B-SA is available for \$429.95. A UHF 15 watt, 10 channel version of this radio called the RU150B-SA is also available and covers 450-482 MHz. but the cost is \$419.95.

★★★ Uniden CB Radios ★★★

The Uniden line of Citizens Band Radio transceivers is styled to compliment other mobile audio equipment. Uniden CB radios are so reliable that they have a two year limited warranty. From the feature packed PRO 810E to the 310E handheld, there is no better Citizens Band radio on the market today.

- PRO310E-SA Uniden 40 Ch. Portable/Mobile CB ... \$85.95
- PRO330E-SA Uniden 40 Ch. Remote mount CB ... \$109.95
- NINJA-SA PRO310E with rechargeable battery pack \$99.95
- B-10-SA 1.2V AA Ni-cad battery for Ninja (set of 10) ... \$20.95
- KARATE-SA Uniden 40 channel rescue radio ... \$69.95
- PRO520XL-SA Uniden 40 channel CB Mobile ... \$49.95
- PRO520XL-SA Uniden 40 channel CB Mobile ... \$59.95
- PRO540E-SA Uniden 40 channel CB Mobile ... \$119.95
- PRO640E-SA Uniden 40 channel SSB CB Mobile ... \$159.95
- PRO710E-SA Uniden 40 channel CB Base ... \$119.95
- PRO810E-SA Uniden 40 channel SSB CB Base ... \$179.95

★★★ Uniden Radar Detectors ★★★

Buy the finest Uniden radar detectors from CEI today. RD7-SA Uniden visor mount radar detector \$109.95 RD9-SA Uniden "Passport" size radar detector \$129.95 RD9XL-SA Uniden "micro" size radar detector \$159.95 RD25-SA Uniden visor mount radar detector \$59.95 RD500-SA Uniden visor mount radar detector \$79.95

NEW! Bearcat® 200XLT-SA

List price \$509.95/CE price \$299.95 12-Band, 200 Channel • 800 MHz. Handheld Search • Limit • Hold • Priority • Lockout Frequency range: 29-54, 118-174, 406-512, 806-956 MHz. Excludes 823.9875-849.0125 and 868.9875-894.0125 MHz. The Bearcat 200XLT sets a new standard for handheld scanners in performance and dependability. This full featured unit has 200 programmable channels with 20 scanning banks and 12 band coverage. If you want a very similar model without the 800 MHz. band and 100 channels, order the BC 100XLT-SA3 for only \$199.95. Includes antenna, carrying case with belt loop, ni-cad battery pack, AC adapter and earphone. Order your scanner now.

Bearcat® 800XLT-SA

List price \$549.95/CE price \$259.95/SPECIAL 12-Band, 40 Channel • No-crystal scanner Priority control • Search/Scan • AC/DC Bands: 29-54, 118-174, 406-512, 806-912 MHz. The Uniden 800XLT receives 40 channels in two banks. Scans 15 channels per second. Size 9 1/4" x 4 1/4" x 1 1/2". If you do not need the 800 MHz. band, a similar model called the BC 210XLT-SA is available for \$196.95.

Bearcat® 145XL-SA

List price \$189.95/CE price \$98.95/SPECIAL 10-Band, 16 Channel • No-crystal scanner Priority control • Weather search • AC/DC Bands: 29-54, 136-174, 406-512 MHz. The Bearcat 145XL is a 16 channel, programmable scanner covering ten frequency bands. The unit features a built-in delay function that adds a three second delay on all channels to prevent missed transmissions.

Bearcat® 175XL-SA

List price \$279.95/CE price \$156.95/SPECIAL 11-Band, 16 Channel • Weather Search Priority control • Search/Scan • AC/DC Bands: 29-54, 118-174, 406-512 MHz. The Bearcat 175XL has an automatic search feature to locate new frequencies. Priority, lock out, delay and scan speed are all included.

Regency® Informant™ Scanners

Frequency coverage: 35-54, 136-174 406-512 MHz. The new Regency Informant scanners cover virtually all the standard police, fire, emergency and weather frequencies. These special scanners are preprogrammed by state in the units memory. Just pick a state and a category. The Informant does the rest. All Informant radios have a feature called Turbo Scan™ to scan up to 40 channels per second. The INF1-SA3 is ideal for truckers and is only \$179.95. The new INF2-SA3 is a deluxe model and has ham radio, a weather alert and other exciting features built in for only \$219.95. For base station use, the INF5-SA3 is only \$129.95 and for those who can afford the best, the INF3-SA3 at \$149.95, is a state-of-the-art, receiver that spells out what service you're listening to such as Military, Airphone, Paging, State Police, Coast Guard or Press.

Regency® HX1500-SA

List price \$369.95/CE price \$179.95/SPECIAL 11-Band, 55 Channel • Handheld/Portable Search • Lockout • Priority • Bank Select Sidelit liquid crystal display • EAROM Memory Direct Channel Access Feature • Scan delay Bands: 29-54, 118-136, 144-174, 406-420, 440-512 MHz. Scan up to 55 channels at the same time. Includes belt clip, flexible antenna and earphone.



BC760XLT 800 MHz. mobile scanner Only \$279.95

★★★ Uniden Cordless Phones ★★★

A major consumer magazine did a comparison study on cordless phones. The check points included clarity, efficiency and price. Uniden was rated best buy.

XE700-SA Uniden Cordless Phone with speaker ... \$114.95

★★★ Extended Warranty Program ★★★

If you purchase a scanner, CB, radar detector or cordless phone from any store in the U.S. or Canada within the last 30 days, you can get up to three years of extended warranty service from Warrantech. This service extension plan begins after the manufacturer's warranty expires. Warrantech will perform all necessary labor and will not charge for return shipping. Extended warranties are non-refundable and apply only to the original purchaser. A two year extended warranty on a mobile or base scanner is \$29.99 and three years is \$39.99. For handheld scanners, 2 years is \$59.99 and 3 years is \$79.99. For radar detectors, two years is \$29.99. For CB radios, 2 years is \$39.99. For cordless phones, 3 years is \$34.99. Order your warranty for your merchandise today.

OTHER RADIOS AND ACCESSORIES

- HR-2510-SA Uniden 25 Watt 10 meter Ham radio ... \$239.95
 - BC 55XL-SA Bearcat 10 channel scanner \$114.95
 - BC 70XLT-SA Bearcat 20 channel scanner \$169.95
 - NEW! BC 580XLT-SA Bearcat 16 channel scanner \$98.95
 - MT5100 PLUS-SA Regency marine transceiver ... \$134.95
 - MT5500 PLUS-SA Regency marine transceiver ... \$159.95
 - R1090-SA Regency 45 ch. scanner \$119.95
 - Z80-SA Regency 60 ch. scanner CLOSEOUT \$129.95
 - UC102-SA Regency VHF 2 ch. 1 Watt transceiver \$117.95
 - BP55-SA Regency 16 amp reg. power supply \$169.95
 - MA549-SA Drop-in charger for HX1200 & HX1500 ... \$84.95
 - MA518-SA Wall charger for HX1500 scanner \$14.95
 - MA553-SA Carrying case for HX1500 scanner \$19.95
 - MA257-SA Cigarette lighter cord for HX12/1500 ... \$19.95
 - MA917-SA Ni-Cad battery pack for HX1000/1200 ... \$34.95
 - BP205 Ni-Cad battery pack for BC200/BC100XLT ... \$49.95
 - B-B-SA 1.2 V AA Ni-Cad batteries (set of eight) ... \$17.95
 - FB-E-SA Frequency Directory for Eastern U.S.A. ... \$14.95
 - FB-W-SA Frequency Directory for Western U.S.A. ... \$14.95
 - ASD-SA Air Scan Directory \$14.95
 - SRF-SA Survival Radio Frequency Directory \$14.95
 - TSG-SA "Top Secret" Registry of U.S. Govt. Freq. ... \$14.95
 - TIC-SA Techniques for Intercepting Comm. \$14.95
 - RRF-SA Railroad frequency directory \$14.95
 - EES-SA Embassy & Espionage Communications ... \$14.95
 - CIE-SA Covert Intelligenc, Elect. Eavesdropping ... \$14.95
 - MFF-SA Midwest Federal Frequency Directory ... \$14.95
 - AG0-SA Magnet mount mobile scanner antenna ... \$35.95
 - AT0-SA Base station scanner antenna \$35.95
 - USAMM-SA Mag mount VHF ant. w/ 12' cable \$39.95
 - USAK-SA 3/4" hole mount VHF ant. w/ 17' cable \$35.95
 - USAK450-SA 3/4" hole mount UHF ant. w/ 17' cable \$35.95
- Add \$3.00 shipping for all accessories ordered at the same time. Add \$7.00 shipping per radio and \$3.00 per antenna.

BUY WITH CONFIDENCE

To get the fastest delivery from CEI of any scanner, send or phone your order directly to our Scanner Distribution Center. Michigan residents please add 4% sales tax or supply your tax I.D. number. Written purchase orders are accepted from approved government agencies and most well rated firms at a 10% surcharge for net 10 billing. All sales are subject to availability, acceptance and verification. All sales on accessories are final. Prices, terms and specifications are subject to change without notice. All prices are in U.S. dollars. Out of stock items will be placed on backorder automatically unless CEI is instructed differently. A \$5.00 additional handling fee will be charged for all orders with a merchandise total under \$50.00. Shipments are F.O.B. CEI warehouse in Ann Arbor, Michigan. No COD's. Most items listed have a manufacturer's warranty. Free copies of warranties on these products are available by writing to CEI. Non-certified checks require bank clearance. Not responsible for typographical errors.

Mail orders to: Communications Electronics™ Box 1045, Ann Arbor, Michigan 48106 U.S.A. Add \$7.00 per scanner for R.P.S./U.P.S. ground shipping and handling in the continental U.S.A. For Canada, Puerto Rico, Hawaii, Alaska, or APO/FPO delivery, shipping charges are three times continental U.S. rates. If you have a Discover, Visa or Master Card, you may call and place a credit card order. Order toll-free in the U.S. Dial 800-USA-SCAN. In Canada, order toll-free by calling 800-221-3475. FAX anytime, dial 313-971-6000. If you are outside the U.S. or in Michigan dial 313-973-8888. Order today. Scanner Distribution Center™ and CEI logos are trademarks of Communications Electronics Inc.

AD #050388-SA2 Copyright © 1988 Communications Electronics Inc.

For credit card orders call 1-800-USA-SCAN



Consumer Products Division P.O. Box 1045 □ Ann Arbor, Michigan 48106-1045 U.S.A. For orders call 313-973-8888 or FAX 313-971-6000

LETTERS

Touching on a Touchy Subject

The proliferation of religious broadcasters on the shortwave bands has always been a topic that can easily create an all-night discussion among DXers. On one hand, they have the same right to be on shortwave as anyone else. On the other hand, being well-funded, they inevitably are powerful, band-blanketing operations that wipe out more challenging DX catches.

And who, we often ask, has ever truly been "saved" by listening to *DX Party Line* on HCJB? Or after listening to one of Harold Camping's endless Biblical monologues on WYFR? We'll probably never know the answer to those questions. What we did learn was that *Monitoring Times* has now matured to the point where it can handle such delicate questions in a fair, unbiased way.

Robert Molloy
Washington, DC

Ken MacHarg's article [on Voices of Faith] was darned interesting. From the cover, I thought it might be a "hatchet job," yet another mindless attack on religious stations. Then when I read the author's name, -- Reverend Ken MacHarg -- I thought it might be biased the other way. I was please to find it quite objective and very interesting.

[Withheld by request]
Johnson, Texas

I was rather happy to see that the lead article in your March issue was on religious stations. For sometime I had seen *Monitoring Times* as a rather soul-less publication, content to simply ignore those broadcasters that preached the word of God. It was refreshing to see that you had changed your course! Your souls will thank you when you meet your maker.

Robert Kimes
Coatesville, Pennsylvania

There is a word of warning worth mentioning about religious stations. That warning is that there will come a time when religious stations will dominate the bands, leaving little else

to listen to. And what do you expect will be the future of shortwave when all people can hear on their dandy new hi-tech portables, is preaching? US electronic evangelists, from Baker to Swaggart, have shown themselves for what they are. Let's not give them a shortwave rope by which they can hang themselves in front of the whole world -- enjoyable as the scenario might be.

Peter Dillingham
Los Angeles, California

To support with publicity the aims of border-blasting stations such as WYFR and its up-and-coming US colleagues such as KVOH, WMLK, KUSW and WCSN is to condone this useless waste of valuable band space. You need to be supporting stations that people listen to, not organizations that want to conquer the world with religion.

[Withheld by request]

You're way off base. First, WCSN, while run by a religious organization, devotes the majority of their airtime to some of the best, most accurate and unbiased news to be found anywhere. The news is news and religion is religion and never the two do mix. The same philosophy is used in their publishing arm, the Christian Science Monitor. And it has been awarded several Pulitzer Prizes.

Second, KUSW is a privately owned rock music station that has, to the best of my knowledge, only one religious program on the air. Third, as virtually every survey of shortwave stations has shown, people do clearly listen to religious stations. HCJB, for example, is consistently rated in the top ten most popular stations from Fort Lauderdale to Frankfurt. --ed.

A Stunned Ute DXer

I was literally stunned when I opened my *Monitoring Times* this month. There, right up front was.. a utility column. And what a column it is! From frequencies for the Iranian navy I've never, ever seen anywhere



Radio Vatican

else before to African aero channels and tons of really great loggings, author Larry Van Horn has it covered. This is truly exciting. At last, someone who understands what I want to hear -- and who tells me how to hear it! Keep it coming.

Rod Pearson
St. Augustine, Florida

I'd like to take a moment to congratulate *Monitoring Times* on its new utility column. The information is top-notch. Just one question. What took you so long?

Ed Harrington
Berea, Ohio

Above the Brown Water

Your article on the "Brown Water" Coast Guard was especially interesting. I'm at work right now and from the window down the hall, I can see riverboats passing on the Mississippi. It's a subject for me that's close to home in a very literal sense.

[Withheld by request]
Jackson, Louisiana

[More "Letters" on page 92]

Code-Free Ham License Coming to Canada?

Those of you who would like to get a ham license but couldn't be bothered with learning Morse Code might now consider moving to Canada. In order to counter amateur radio's image as "an old man's hobby," the Canadian Department of Communications (DOC) has recently announced that it is committed to an entry level, no-code amateur radio license. Under the proposal, in exchange for 40 hours of study, the new licensee would obtain lifetime privileges on all amateur modes above 30 MHz, including 2 meters. There would be a 100 watt power limitation.

Meanwhile, in the US, officials at the American Radio Relay League are carefully studying the Canadian proposal. Says ARRL West Gulf Director Jim Haynie, WB5JBP, "If it passes in Canada, we would have to take a hard look at it here [in the US]. We now realize that the 'Novice enhancement' is not the 'fix' we once thought it would be. According to Haynie, the average age of a US amateur is 47.8 years old; in Canada, only a miniscule 4.6 percent of Canadian hams are under 30 years old; sixty percent are over 50. (*W5YI Report*)

The Blimp: Coming to a Radio Near You

The Goodyear company will once again be supporting the 1988 Amateur Radio Graf-2 Communications Demonstration. Weather permitting, shortwave listeners around the world will be able to listen to and/or communicate with the blimp *Enterprise* starting at noon [EDT] on May 7th. Chuck Bachus will operate a special event station on board the airship with the temporary call letters, KA4KVI/AM.

The object of the event, which will focus on simulated emergency communications, is to "exhibit the full potential of amateur radio communications that would take place in event of disaster. Standard voice communications will be used, along with first



On May 7th, shortwave listeners around the world will have a chance to listen in on special events station KA4KVI/AM aboard the Goodyear blimp.

amateur radio television signal downlinked to a ground tracking station and packet data communications by radio.

The frequency plan is as follows: 28.450, 145.51 (secondary: 146.25), 144.50 (side band) and 432.100 (secondary: 432.185). All frequencies may not be active at all times. The 1988 Amateur Radio Graf-2 Communications Demonstration is sponsored by Kenwood Communications, ICOM Communications, Kantronics Data Communications and Hustler Antenna Corporation.

Radio Storms Coming

Solar Cycle 22 -- just under way -- is already getting rave reviews. However, according to the experts, there has been a "steep and surprisingly early" increase in magnetic disturbances on the sun. According to a recent article in the *New York Times*, this could be the beginning of "a cycle of exceptionally intense solar radiation," perhaps the most intense "since the advent of reliable record keeping in the 19th century."

Dr. Patrick McIntosh, director of solar physics research at the Space

Environmental Laboratory of the National Oceanic and Atmospheric Administration, says that the high peak of the cycle may be reached as early as this summer. If this is true, radio monitors can expect more frequent and more severe disruptions of high frequency communications. Even orbiting satellites may be in danger.

Shortwave: Tool for Educators

The International Monitoring Association for Students and Teachers (IMAST) is a newly formed group designed to promote the educational qualities of shortwave radio listening. According to director Myles Mustoe, IMAST's main goals are to "provide and international forum of ideas on the application of shortwave radio and its related technologies in the classroom, to encourage the study of geography, social science, history and language, and to provide a resource for teachers in all areas of the curriculum."

The group will also publish a bi-monthly newsletter, *The Great Circle*, containing papers and letters from

COMMUNICATIONS

students and teachers, as well as "some information on the bands." In addition, members will be encouraged to vote on outstanding programs.

You can obtain a membership application for IMAST by sending a self-addressed, stamped envelope to 2524 Sunset Highway, East Wenatchee, Washington 98802. Dues are a modest \$5.00 for students and \$10.00 for teachers.

ANARCON '88 Schedule Released

ANARCON, the annual convention of the Association of North American Radio Clubs, will be held this year in Los Angeles, California from July 13 through the 17th. Sponsored by the American Shortwave Listener's Club, the event is expected to attract over 300 people. According to ASWLC head Stewart MacKenzie, two broadcasters have registered to attend: Ian McFarland of Radio Canada International and Brent Allred of HCJB. The keynote speaker will be California-based radio talk show host Ray Briem.

Uniden Acquires Regency's Consumer Products Division

After Regency's surprise announcement that it was quitting the consumer electronics business (see February MT), it comes as less of a surprise that none other than Uniden, manufacturer of the Bearcat scanners, has picked up the tab for \$12 million.

Uniden has acquired all inventory and rights, including the Informant series of scanners and Polaris marine radios, parts, patents and trademarks. The acquisition did not include real property or personnel who expect to be retained by Regency for their remaining commercial operations.

UPS Plans 220-222 MHz Digital System

Concerned by the strides made by competing Federal Express, United Parcel Service has announced plans to

design and implement a nationwide private land mobile network to improve the efficiency of their package delivery service. UPS has already contracted with SEA Inc for rights to the necessary technology and has created a UPS subsidiary, called II Morrow, Inc., to produce their own transceivers.

Radio*Philes Reappears

*Radio*Philes*, a monthly journal of information and opinion for radio professionals, students, archivists and others interested in modern radio broadcasting has begun publishing again after an absence of several months, according to editor W.T. Koltek.

*Radio*Philes* stresses AM and FM broadcasting and contains exhaustive information on station format and call letter changes, applications for new stations, individual market reports, FCC actions, and articles. Says Koltek,

"We're back and we're ready to take on the ever more challenging task of keeping you up to date with changes in the radio business and bringing you fresh, provocative perspectives on those changes."

Subscriptions to *Radio*Philes* are available for \$22.00 from Box 3568, Alexandria, Virginia 22302.

RADIO*PHILES



Secret Frequencies!



Turn those hours of searching for secret frequencies over to the Remote Computer Scanning System. The RCSS runs on any Macintosh, and gives you complete monitoring and automatic logging of all signal activity found by your R-7000. You're no longer limited by the built-in frequency storage, search, and selections provided by ICOM. Why waste time spinning dials when the RCSS can do it for you?

- Discover new frequencies and record their activity
- Scan unlimited banks of frequencies
- Search designated frequency ranges: activities are automatically recorded
- Automated statistical frequency log maintained
- Import/Export information between the built-in database and most Macintosh databases
- Customized versions available

Complete System including Interface, Software and Manual for only \$189.95 • Dealer Inquiries Invited

Call or Write for More Information and Customized Versions

Systems and Software International, Ltd.
4639 Timber Ridge Drive • Dumfries, VA 22026

(703) 680-3559



• R-71A version available soon

From 18th century British penal colony to the unique Pacific nation it is today, the story of Australia occupies a unique category in the developing history of the world.

With Australia's 200th birthday, another chapter is opening as this country pursues a place on the international scene. Suddenly, however, new and serious forces are acting upon it -- forces which promise to bring about yet more changes as Australia's perpetual evolutionary process continues.

Broadcasting Down Under

by Dave Rosenthal

Probably no other country on this planet possesses the mystique held by Australia. This island continent, with some of the most unique flora and fauna in the world, holds a special fascination for just about everybody. Actually, the more you know about this place, the more you seem to want to go there.

This is especially true right now with Australia celebrating its 200th birthday. Throughout the rest of the year there will be festivities all over the continent as Australia and "Australiana" moves to the forefront of world attention.

For most people, their only exposure to this interesting part of the world is what's available in print or on an occasional TV show -- precious little of it in real-time. But for the shortwave listener, there is Radio Australia. We tune in to this, the only true broadcast export of this culture, and get our own vicarious feel for what it is like "down under."

Actually, most shortwave listeners who have been at the dials for any amount of time have likely come across Radio Australia's signal at one time or another. Many more are regular listeners. In the last few years, however, Radio Australia has become an increasingly difficult catch DX-wise for listeners in North America and Europe and, unfortunately, it looks like things may indeed become yet more difficult.

While worldwide interest in Australia seems to be on the rise, indications are that its overseas radio service is developing horizons far nearer to its own shores than ever before.

Why all this is happening seems to be tied to a

number of international factors - all working on the entire country but catching Radio Australia's 230 or so employees right in the middle.

When the Money Runs Out

As you might imagine, the biggest problem is money. For quite a few years, Australia enjoyed an existence seemingly far removed from all the inflationary forces we've experienced on our part of the planet. Australia was known as the "lucky country," exporting large amounts of high-value goods like minerals, wool, and grain to rich countries nearby. Recently however, the lure of the import seems to have caught up with the Australian balance of payments and suddenly they've found themselves driving Toyotas they can't afford to buy parts for.

The Australian dollar has actually become weaker than the American dollar in that part of the world. In an economy only a fraction the size of that of the U.S., currency fluctuations and the recent stock market convulsions have had quite an impact.

Such has been the case with a relatively small operation like Radio Australia. Inside the country, very few people are even aware Radio Australia exists since domestic broadcasting is dominated by the Australian Broadcasting Corporation- ABC or "auntie" as it's commonly known. To the public, the ABC is big-time and self-sufficient while Radio Australia appears as a wasteful sinkhole into which otherwise-useful government money is seemingly thrown. In the face of budget-cutting realities, it's certainly easier to take yet

another chunk of funding away from something all but invisible.

Even though Radio Australia is in fact part of the ABC, their domestic invisibility isn't doing them any good. This year the ABC's budget increased substantially but Radio Australia lost more than 3% of the funding already allocated to it. This puts it at an annual budget of about 10 million Australian dollars - the cost of about a week of electricity for the Voice of America.

There Goes the Neighborhood

Meanwhile, there's another term in this equation and that has to do with recent developments in Australia's neighborhood. Just like the economy, Australia has enjoyed excellent relationships with other governments in the South Pacific for some time. In the last few years, however, quite a few of these have turned around.

The coup in Fiji installed a regime not entirely pleasing as far as the Australians are concerned. Right next to Fiji is the island state of Vanuatu, now talking openly with the Soviets about the possibility of establishing a presence there.

Relations with oil-rich Indonesia to the north haven't been exactly cordial lately either. In 1986 a critical comment about their government in the Australian press precipitated an Indonesian cancellation of all Australian tourist visas. Since then, things have been strained, to say the least.

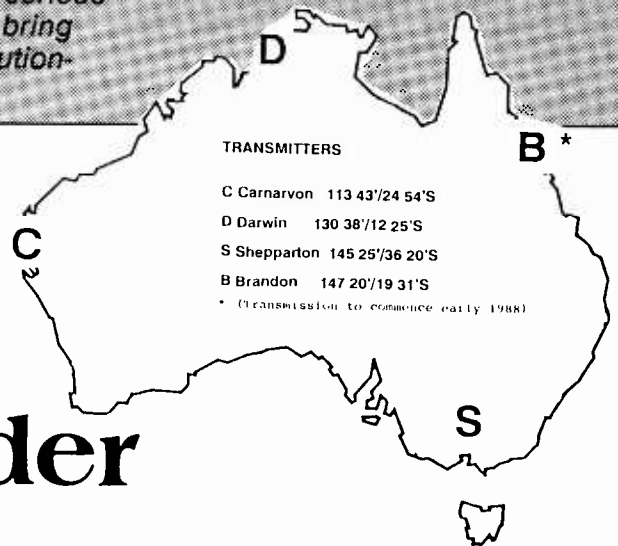

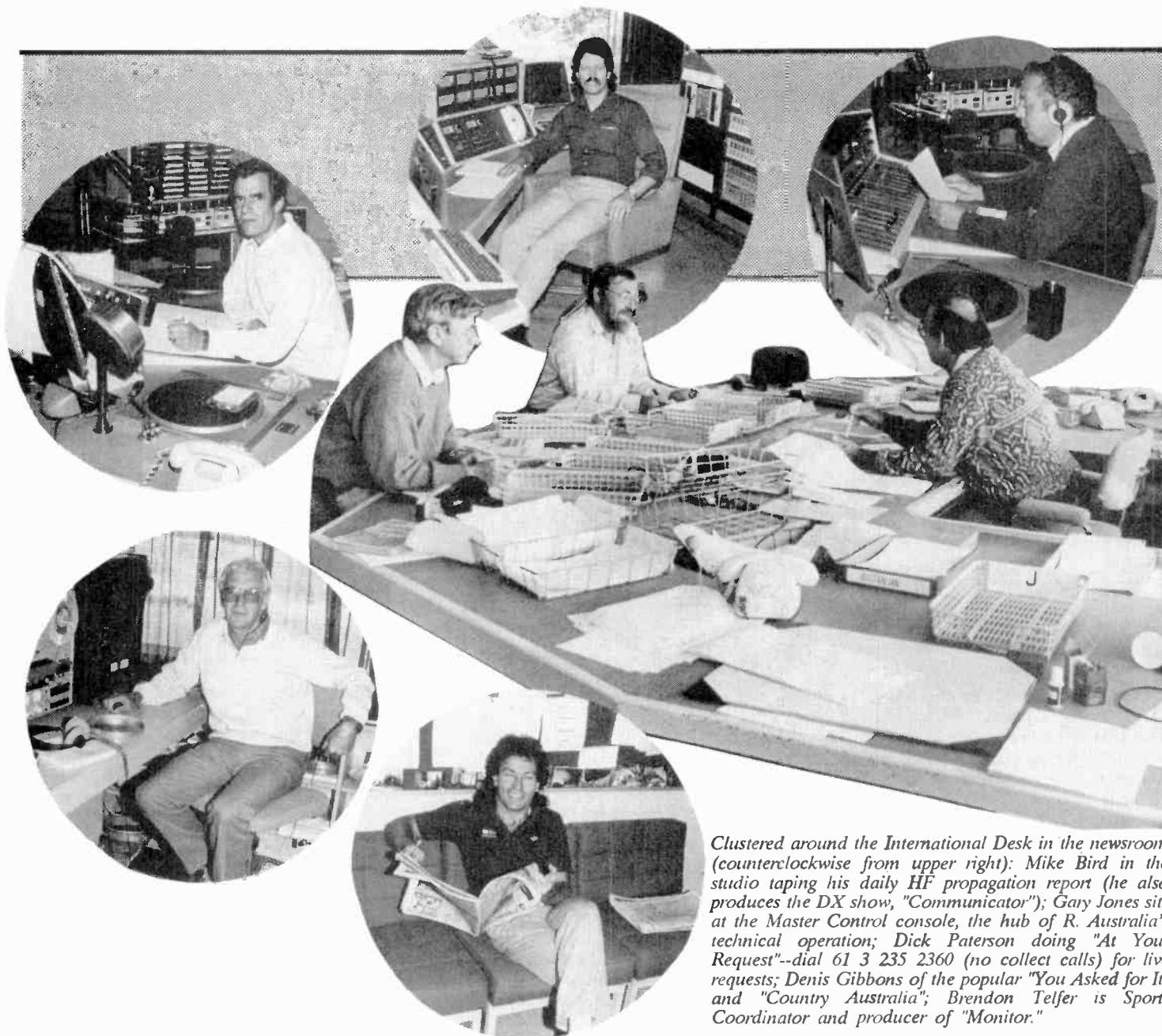

Clustered around the International Desk in the newsroom (counterclockwise from upper right): Mike Bird in the studio taping his daily HF propagation report (he also produces the DX show, "Communicator"); Gary Jones sits at the Master Control console, the hub of R. Australia's technical operation; Dick Paterson doing "At Your Request"--dial 61 3 235 2360 (no collect calls) for live requests; Denis Gibbons of the popular "You Asked for It" and "Country Australia"; Brendon Telfer is Sports Coordinator and producer of "Monitor."

Most recently, the left-wing insurgencies in the Philippines and New Caledonia plus instability in Papua New Guinea have the Australian government thinking far more defense- (or defence-) related thoughts.

**One F-18 Airplane =
3 X Radio Australia's Budget**

Because military hardware is necessarily expensive, more Australian government planners are turning to the much cheaper "hearts and minds" approach making Radio Australia suddenly more cost-effective. Emphasis now seems to be shifting to increasing the strength and presence of Radio Australia's voice in the immediate region rather than farther afield. After all, the cost of one combat-equipped F-18 can easily come to several times the entire Radio Australia budget for a whole year.

This brings us to why we're hearing - or not hearing - Radio Australia these days. The simple reality is that there is little public support for what appears a costly government operation in light of Australia's recent economic woes. At the same time, the only support for Radio Australia seems to be coming from political pragmatists mandating a stronger Australian voice in the region to minimize potential defense spending. To North American and European SWLs, this means luck will play an increasing role in monitoring Radio Australia for the foreseeable future.

All this doesn't mean Radio Australia isn't trying. To accomplish what they do on their annual budget defines the concept of "making the most of what you've got."

**Good Programs Despite
Low Funding**

A close look at their program lineup will show you a broad spectrum of programming which is still being distributed widely throughout the world. Their frequency and antenna management has been recently revamped to optimize coverage and take advantage of the increased propagation quality accompanying the rising solar activity cycle.

On the entrepreneurial side, Radio Australia now feeds its international product to Radio National, a domestic radio network. Coming on at 1 a.m., their feed is called "Radio Australia Overnight" and is intended to reintroduce their programming to a public which, only a few years ago, had very little choice in what to hear on the radio.

international shortwave radio

Radio Australia

FREQUENCIES

SOME FREQUENCIES MAY BE VARIED TO OVERCOME POOR RECEPTION

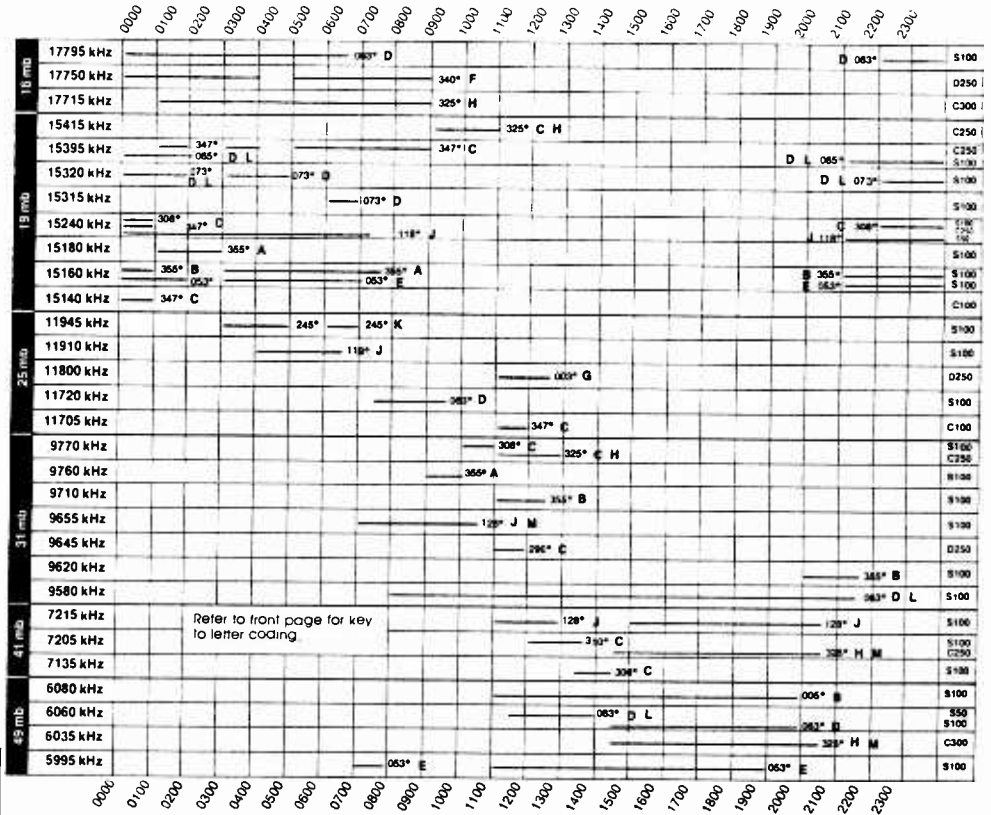

BROADCAST REGIONS

Broadcasts are directed to the following groups of countries. They may, on occasion, reach further afield.

- A Papua New Guinea
- B Papua New Guinea, Japan, The Philippines
- C Indonesia, Singapore, Malaysia, Thailand, Burma, Vietnam, Laos, Kampuchea
- D Fiji, Western Samoa, Cook Islands, Tonga, Vanuatu, New Caledonia
- E New Caledonia, Vanuatu
- F China, Hong Kong, The Philippines
- G Japan, Hong Kong, The Philippines
- H India, Pakistan, Bangladesh, Sri Lanka
- J New Zealand, South Pacific Islands
- K Tanzania, Kenya, Zimbabwe, Madagascar, Mauritius, The Seychelles
- L United States, Canada
- M United Kingdom, Europe

NORTH AMERICA

Some broadcasts can be heard in the United States and Canada. Suggested frequencies and times are:
 0800-1500 UTC on 9580 kHz
 1130-1400 UTC on 6060 kHz
 2200-0200 UTC on 15395 and 15320 kHz



Radio Australia at a Glance

Major areas served: Pacific region, Indonesia, Papua New Guinea, Malaysia, the Philippines, Thailand, Burma, Vietnam, China, Japan, Sri Lanka, India, Bangladesh, and Pakistan. North America and Europe are considered "targets of opportunity" only with long-range propagation openings responsible for reception there.

Languages: English (24 hours), French, Indonesian, Chinese, Thai, Japanese, Vietnamese, and Tok Pisin.

Transmitters: Four sites located around the continent: Shepparton (145° 25' E, 36° 20' S) near Melbourne; Darwin (130° 38' E, 12° 25' S) on the north central coast; Carnarvon (113° 43' E, 24° 54' S) on the western central coast; and Brandon (147° 20' E, 19° 31' S) near Townsville on the northeastern coast.

Primary English Service Programming: News and current affairs with bulletins of world and Australian news at the top of every odd-numbered UTC hour. Also a 27-minute weekly DX and communications program has been added recently. It's called "Communicator" and replaced the previous "Talkback" show. "Communicator" airs UTC Sundays at 0230, 0730, 1230, 1730, and 2030. Additionally, Mike Bird is now producing regular HF propagation reports airing at various times Mondays through Saturdays UTC as well as during "Communicator" on Sunday. Radio Australia's English Service also presents a wide-ranging variety of other news, information, and music programming.

At the same time, Radio Australia is packaging a daily 60-minute news and information product to be relayed via satellite to a Public Broadcasting radio network of 28 stations in California. The idea here is to present regular news of the Pacific Rim to listeners interested in an Australian perspective.

One of the most important changes to come about recently is Radio Australia's joining the well-known international broadcasting organization, the "Group of Four," making it now the "Club of Five." They're combining forces with Radios Netherlands, Sweden, Canada, and Swiss Radio International to complement the group with a view from the Southern Hemisphere.

This just happened recently and not much beyond the most general concepts of resource-sharing and inter-broadcaster cooperation have surfaced as of yet. The only concrete development thus far is Radio Australia's accessing data from a listener survey in the region currently being conducted by Radio Netherlands.

But as far as a better or more convenient Radio Australia broadcast schedule to Europe or North America, don't look for anything soon. These two regions are referred to only as "targets of opportunity" by Radio Australia's director, Peter Barnett.

Despite a tremendous worldwide interest in Australia, the impacts of simple but nonetheless tough economic realities are just beginning to be felt there. The only certainty appears to be the fact that the dedicated folks at Radio Australia will continue to produce a quality product regardless of what happens. If you're a hard core Radio Australia fan, the best advice at this point would be to cut out this up-to-date coverage and frequency schedule, set your alarm clock, and hope for good propagation.

My Australian Reception

I suppose I've been luckier than most people throughout my life in that I've been able to travel a fair amount. As an inveterate DXer, this might be considered the pinnacle of success since, actually going to the places you monitor gives you the ultimate opportunity to see for yourself whether your perceptions are valid. Besides, you get to DX from there and thus get treated to a whole new radio picture. Arguably, this in itself can be its own reward.

Spending time in Australia was rewarding from not only a DXING point of view but also from having an excellent opportunity to experience somewhere where it seems everybody wants to go. This place is special to be sure.

My wife Sharon and I spent a total of 23 days there and, during that time, we visited four of



Peter Barnett, Director of Radio Australia, speaks with Dave Rosenthal about the evolving role of his organization in the Pacific Region.

Australia's HF Inland Service

Call Sign	Frequencies (kHz)	Latitude		Longitude		Area Served	Power (watts)
		Deg	Min	Deg	Min		
VL8A	2310 4835	-23	49.0	133	50.5	Northern Terr. south	50,000
VL8K	2485 5025	-14	24.0	132	10.5	Northern Terr. north	50,000
VL8T	2325 4910	-19	40.0	134	15.5	Northern Terr. central	50,000
VLH	9680 11800 15230	-38	3.0	145	15.5	Northern Australia	10,000
VLM	4920	-27	18.5	153	36.0	Queensland	10,000
VLQ	9660	-27	18.5	153	36.0	Queensland	10,000
VLR	6150 9680	-38	3.0	145	15.5	New South Wales/S. Qld.	10,000
VLW	6140 9610 15425	-31	51.5	115	49.0	West/Northern Australia	50,000

Australia's seven states plus the equivalent of the District of Columbia in the U.S., the Australian Capital Territory at Canberra. As hectic as a trip like this might sound, this was distinctly not the case. The emphasis was on having a personal encounter with the country rather than some organized expedition tied to a rigid, rapid-fire itinerary.

We drove over 2,000 miles - mostly through the outback on dirt roads. There is little better way to learn about Australia. Major cities were on the schedule, too, as a consequence

of prior broadcasting-related contacts so, by and large, I think our exposure to both the culture and the continent was pretty good.

My overriding impression of this place is that the Australians of today are intensely interested in news and whatever else going on in the world that could affect their lives. As a consequence, there are over 365 radio and 351 TV stations scattered over the country virtually inundating you with electromagnetic radiation.

In the radio world, medium wave dominates with 256 stations - more than twice the number of FM stations which, according to the latest count, come in at 109. Australian AM station channel spacing is 9 kHz as opposed to the 10 kHz found in North America so keep this in mind if you plan to take your channelized radio there.

Australia has gone in for AM stereo in a big way with more than 50 stations using it. Also, medium wave is where commercial stations dominate - 149 of them in all.

Now, when I say commercial I *mean* commercial. If you've ever been irritated by lots and lots of commercials on AM radio, Australia is definitely *not* the place for you to monitor MW. I spent several hours listening to (and recording) Australian radio commercials and, let me tell you, it was *easy!* Most commercial MW stations feature pop music programming where you get a song or two followed by from eight to twelve commercials right on top of one another. This process seems to go on indefinitely.

In the FM world, the Australian Broadcasting Corporation and Public Broadcasting dominate with only eight commercially-owned stations. FM is almost entirely in stereo with only 21 of the 109 stations still broadcasting monaural signals.

Everywhere I went, I asked people about shortwave and the consistent answer was, "What's *that*, Mate?" There certainly are SWLs in Australia but, like in most parts of North America, they're rare. Most people are content with their fairly wide choice of radio and TV and thus aren't much concerned about shortwave. The further into the outback we got, however, the greater the shortwave awareness.

Domestic Services

Australia in fact operates a domestic shortwave service. It's what they call their "HF Inland Service" to provide the more isolated regions with relays of ABC domestic broadcasts. There are a total of eight stations located around the country with 10 and 50 kw transmitters beamed toward reception areas in the interior. Given decent propagation conditions, these are quite monitorable outside the country and you might want to try for them. See the table for call signs and frequencies.

Television is also just about everywhere in Australia. At the moment there are 351 television stations with 50 of these being commercial operations. To these 50 commercial stations, add another 143 commercial TV translators, i.e., TV equipment receiving the signal on one frequency and retransmitting it on another, and you have a total of 193 com-

mercial TV outlets distributing programming to an astonishingly huge area.

There are even more outlets if you include the 47 translators licensed under what the Australian Department of Communications (their FCC equivalent) calls the "Self-help Broadcasting Reception Scheme." This is where people in outlying areas can get government assistance bringing in TV or radio reception and distributing it via translator or cable systems.

Actually, when you're in the flat, flat outback regions, one way to spot a town in the distance is to climb on top of the car and scan the distant horizon for a tower sticking up. With binoculars you'll generally see some big UHF antennas on top with a couple of others for local signal distribution.

Of course, then there's Aussat, the ABC geostationary communications relay satellite with five separate beams covering different parts of the continent. This has been a very successful venture as far as Australia is concerned and there's talk of more satellite activity in the works now.

Now all this conventional broadcasting availability certainly didn't deter me from getting out the old receiver and doing some serious DXing. Using everything from a 50-foot long-wire dangling from my hotel room balcony in Sydney to an I-don't-know-how-long Beverage antenna made from a fence line in the outback, I monitored a total of 37 countries on my trusty Sony 2010. The ham bands were particularly interesting with Australian amateurs talking to one another as well as having QSOs with stations in North America, the Middle East, and Europe.

All in all, Australia is a fairly good place for DX with a variety of signals drifting in from every direction. The only real difference I noted was that the majority of shortwave programming I monitored was intended for that part of the world with very few signals reaching me via a long path from somewhere else. In my California QTH, I see this far more often. Of course, this may be due in part to Australia's time zones (UTC +8,9,&10) where their DX prime-time doesn't correspond to elsewhere.

I noted throughout domestic broadcasting the growing frequency of "Australian Bicentennial" references. To Australians, this is something new. When I spoke with Roger Broadbent, Executive Producer of Radio Australia's English Service, he also remarked that "Bicentennial-this" and "Bicentennial-that" seemed to be everywhere suddenly. Unfortunately, since Roger is also Radio Australia's Bicentennial Coordinator, I couldn't offer him much hope.

Facts About Australia's Domestic Medium Wave Service

Australia's Medium Wave stations are located throughout the continent and consist of a mixture of omnidirectional and directional radiation patterns. Output power ranges from 50 to 50,000 watts with the average being about 2000. Also, their frequency spacing is 9 kHz rather than the 10 kHz found in North America; keep this in mind when Medium Wave DXing.

All of Australia's Medium Wave stations have a three-character call sign coded to the state in which they're located. The first character in the call sign is a state-coded numeral followed by two letters. The states are coded as follows:

Numeric code	State
2	New South Wales
3	Victoria
4	Queensland
5	South Australia
6	Western Australia
7	Tasmania
8	Northern Territory

NOTE: FM radio stations are numerically coded in the same way but have three letters following instead of two, e.g., one MW station serving Sydney is 2BL and an FM station there is 2CBA. The only exceptions are VKW on Cocos Island (1404 kHz, 100 watts), VLU2 on Christmas Island (1422 kHz, 500 watts), and VL2NI, an FM station on Norfolk Island (93.9 MHz, 100 watts [good luck, FM DXers!]).



Dave Rosenthal is an international broadcaster and writer specializing in science journalism. He produced Skyline, a weekly science and astronomy program for several years and has recently become a science correspondent for Radio Netherlands. His written material continues to appear in several national and international publications.

Dave's educational background is in Physics and, in addition to broadcast journalism, his ongoing experience includes engineering, aviation, and photography.

National Tower Company

P.O. Box 15417 Shawnee Mission, KS. 66215

Hours 8:30-5:00 M-F

Price Subject to Change Without Notice



913-888-8864

ROHN FREE BASE STUBS WITH EACH BX SERIES TOWER

25G	10' section	\$56.50
25AG2 & 3	model 2 or 3 top section	\$66.00
25AG4	model 4 top section	\$73.50
45G	10' section	\$133.00
45AG3 & 4	model 3 or 4 top section	\$136.00
55G	10' section	\$166.50
TB3	thrust bearing	\$56.25
M200	10' mast, 2' o.d.	\$13.50
BX-40	40' self supporting [6 sq ft.]	\$196.00
BX-48	48' self supporting [6 sq ft.]	\$250.00
BX-56	56' self supporting [6 sq ft.]	\$334.50
BX-64	64' self supporting [6 sq ft.]	\$431.50
HBX-40	40' self supporting [10 sq ft.]	\$226.50
HBX-48	48' self supporting [10 sq ft.]	\$308.00
HBX-56	56' self supporting [10 sq ft.]	\$392.50
HDX-40	40' self supporting [18 sq ft.]	\$284.50
HDX-48	48' self supporting [18 sq ft.]	\$384.50

HYGAIN/TELEX ANTENNAS

HF ANTENNAS		Tribands
TH3JRS	3 element 'Junior Thunderbird'	
TH5MK2S	5 element 'Thunderbird'	
TH2MK3S	2 element 'Thunderbird'	
TH7DXS	7 element 'Thunderbird'	
TH6DXX	conversion kit to TH7DXS	
EXP 14	Explorer 14 triband beam	
QK710	30/40 M conv. Exp 14	
		Monoband
103BAS	'Long John' 3 element 10 mtr.	
105BAS	'Long John' 5 element 10 mtr.	
155BAS	'Long John' 5 element 15 mtr.	
204BAS	4 element 20 mtr.	\$299.00
205BAS	'Long John' 5 element 20 mtr.	
7-1S	'Discoverer' rotary dipole 30/40mtr.	
7-2S	'Discoverer' 2 elem. 40 meter beam.	
7-3S	converts 7-2S to 3 elem. beam.	

		Multiband Verticals
18HTS	'Hy-Tower' 10 thru 80 meters.	
14RMO	roof mt kit for 12 AVQ, 14AVQ and 18ATV/WB	
18VS	base loaded, 10 thru 80 meters	
12AVQS	trap vertical 10 thru 20 meters	
14AVQ/WBS	trap vertical 10 thru 40 meters	
18AVT/WBS	trap vertical 10 thru 80 meters	

		Multiband Doublets
18TD	portable tape dipole 10-80 meters.	
2BDOS	trap doublet 40 and 80 meters.	
5BDOS	trap doublet 10 thru 80 meters.	

VHF ANTENNAS		Beams & Verticals
23BS	2 meter 3 element beam	
25BS	2 meter 5 element beam	
28BS	2 meter 8 element beam	
214BS	2 meter 14 element beam	
64BS	4 element 6 meter beam	
V-2S	colinear gain vertical 138-174 MHz	
V-3S	colinear gain vertical 220 MHz	
V-4S	colinear gain vertical 430-470 MHz	
GP2GA	base, 2 mtr. ground plane 3 dB	

VHF & UHF Mobiles	
HR144GRI	figerglass 2 mtr. 6dB gain 3/8-24 mt
HB144GRI	HyBander 2mtr 6dB gain 3/8-24 mt
HB144MAG	HyBander 2 meter
BN86	ferrite batum for 10-80 meters.

OSCAR LINK ANTENNA	
215S	70cm. 435 MHz.
218S	Complete Oscar link system.

CUSHCRAFT ANTENNAS		
AP8	8band 1/4 wave vertical	\$152.00
A3	3 element triband beam	\$246.00
A743	7 & 10 MHz add on kit for A3	\$81.00
A744	7 & 10 MHz add on kit for A4	\$81.00
4218XL	18 element 2 mtr. 28.8' boom	\$125.00
A4S	4 element triband stainless steel	\$334.00
AV4	40-10 mtr. vertical	\$94.50
AV5	80-10 mtr. vertical	\$111.00
ARX2B	2 mtr. 'Ringo Ranger'	\$39.25
ARX450B	450 MHz 'Ringo Ranger'	\$39.25
A144-11	144 MHz 11 ele. VHF	\$50.50
A147-11	11 element 146-148 MHz. beam	\$50.50
A147-22	22 element 'Power Packer'	\$141.75
A144-10T	10 element 2 mtr. 'Oscar'	\$54.00
A144-20T	20 element 2 mtr. 'Dscar'	\$77.50
215WB	15 element 2 mtr. 'Boomer'	\$81.00
220B	17 element FM 'Boomer'	\$101.25
230WB	144-148MHz. 30 element.	\$216.00
32-19	19 element 2 mtr. 'Boomer'	\$101.25
424B	24 element 'Boomer'	\$81.00
10-4CD	4 element 10 mtr. 'Skywalker'	\$124.75
15-4CD	4 element 15 mtr. 'Skywalker'	\$145.00
20-4CD	4 element 14 MHz 'Skywalker'	\$310.50

HUSTLER ANTENNAS		
48TV	40-10 mtr. vertical	\$79.00
58TV	80-10 mtr. vertical	\$105.00
68TV	6 band trap vertical	\$124.00
ROTORS		
Alliance	HD73 [10.7 sq ft.]	\$104.00
Alliance	U110	\$47.00
TELEX	AR40 TV, 3 sq ft.	CALL
TELEX	CD45-II [8.5 sq ft.]	CALL
TELEX	HAM IV [15 sq ft.]	CALL
TELEX	T2X [20 sq ft.]	CALL

ROTOR CABLE		
[2-18 & 6-22]	4080 - per foot	\$0.18
[2-16 & 6-20]	4090 - per foot	\$0.35
1108	RG8U Mini 8 low loss foam per foot	\$0.17
	500' roll	\$79.00
1198	RG8U Columbia superflex 31/100' or 500' for	\$139.90

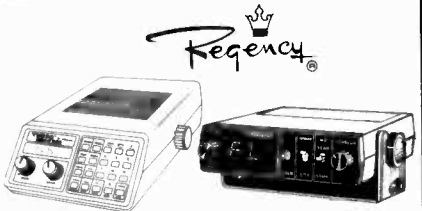

TS2... \$319.90
75 Ch 12 band, 800MHz, aircraft & weather. Turbo-Scan®. bank scanning, instant weather, programmable, accurate, permanent backup, direct access, w/AC adaptor, DC cord & mobile mt. bracket.

INF1... \$219.90
Turbo Scan®, completely pre-programmed by state to receive any type of police transmission plus instant weather. Programmed for all 50 states. Turbo-Scan® scans at 40 Ch per second. DC power.

TS1... \$229.95
Same except 35 channels 11 band.

INF2... \$259.90
Plus road & medical services & amateur radio bands.

RANGER

10 meter TRANSCIVER, 25 watt, can be programmed to split transceive, SSB, CW, AM, FM, programmable scanning, fully automatic, noise blanker, 2.3/8H, 7.34W, 11D.

AR3500... \$334.00

MIDLAND

77-202B... \$79.90
Electronic tuning, Loc/DX switch, SWR, variable mic gain, High/Low tone, ANL, PA, illuminated S/R/F/SWR meter, instant Ch 9, screw-in mic.

77-250... \$99.90
'POWER MAX' ETR tuning w/40% more sensitivity, LED bar meter, SWR, variable RF gain, mic gain, instant Ch 9 & 19, ANL, PA.

uniden

PRO540E... \$99.90
Euro-styled, tone control & Hi cut, NB, ANL, mic & RF gain, S/R/F & SWR meter, instant Ch 9 & 19, backlit front panel, PA mode.

PRO640E... \$139.90
Mobile AM/SSB, AN & NB, dim switch, RF ATT switch, Hi cut, mic gain, PA, 12 segment LED meter, TX/RX & SWR LED's, clarifier control.

ASTATIC

D104 SILVER EAGLE... \$79.90
Chrome plated base station amateur microphone. Factory wired to be easily converted to electronic or relay operation. Adjustable gain for optimum modulation.

ETS D104 SE... \$99.90
NEW, same as above with end of transmission 'Roger Beep'

TENNA PHASE III POWER SUPPLIES

PS3... \$15.90
Output 13.8V DC - 3 amp constant 5 amp surge, electronic overload protection w/instant auto reset, fuse protected.

PS4... \$19.90
Fully regulated, 13.8 VDC - 4 amps constant with surge protection, overload protection w/instant auto reset.

PS7... \$24.90
Fully regulated, 7 amp constant, 10 amp surge capacity.

PS12... \$34.90
Fully regulated, 10 amp constant 13 amp surge, electronic overload protection w/instant auto reset.

PS20... \$64.90
Fully regulated, 25 amp surge capacity, 13.8 VDC, 20 amp constant, with meter.

PS25... \$79.90
Regulated 4.5-15VDC-25 Amp constant 27 amp surge, instant auto reset, dual meter for current & voltage.

PS35... \$99.90
Same as above except, 35 amp constant, 37 amp surge, adjustable from 10 to 15 volts.

uniden

BC100XL... \$149.90
hand held 16 CH 9 band, aircraft, priority, keyboard lock, lighted LCD, display, track tuning, auto search, scan delay, Ch lockout, direct Ch access, W/AC adaptor/charger, ear-phone & carry case.

SPECIAL PACKAGE PRICE
BC50XL PLUS BATTERY PACK & CHARGER FOR \$124.90
10 ch 10 band, hand held, 2 digit LCD, keyboard lock, Ch lockout, battery-low light, memory backup, built in delay, direct Ch access, track tuning.

BC145XL... \$92.90
16 Ch 10 band, programmable, 2 digit LED, priority, review, direct Ch access, track tuning, built-in delay, memory backup, Ch lockout, weather, AC/DC.

BC760XLT... \$279.90
100 Ch 12 band w/800MHz, weather & aircraft, base/mobile, priority, Ch lockout, auto search, delay, programmable, memory lock, DC.

BC70XLT... \$159.90
20 chan, 10 band, HAND HELD

BC100XLT... \$199.90
100 Ch 11 band hand held w/battery

BC200XLT... \$299.90
200 Ch 12 band, 800MHz, hand held

BC175XL... \$159.00
16 ch, 11 band aircraft

BC210XLT... \$179.90
40 Ch, 11 band, aircraft & weather AC/DC

BC800XLT... \$239.90
40 Ch 12 band 800MHz, aircraft & weather

BC560XLT... \$99.90
16 Ch 10 band mobile

BC580XLT... \$219.90
100 Ch 11 band mobile, programmable

MAXON...\$26.95

Model 49SA - 49 MHz, FM 2-WAY RADIO
hands free operation, voice activated transmit up to 1/2 mile. Batteries optional

model 49B... \$34.95
same features as 49SA except uses 'AA' nicad batteries and comes with battery charger

RADAR DETECTORS UNIDEN

RD25... \$59.90
Compact SUPERHET, city/highway, audible & visual alarm, dash/visor.

RD500... NEW... \$79.90
Dual conversion superhet, city/hwy, LED's, audible alarm, compact.

RD9... \$119.90
2 power cords, travel case, dual conversion superhet, city/hwy, audible & LED alerts, mini size.

RD55... \$79.90
X & K band superhet, LED's, city/hwy, audio alarm, dash/visor

RD9XL... \$149.90

BEL

XKR100... \$49.90
Audible & visual alert for X & K band, dash/visor.

XKR300... \$59.90
Sequential LED alert, tone alert, X & K band, dash/visor.

972... Vista 3... \$95.95
NEW TRI-BAND, X, K & Ka, compact, visual & audible alert.

974... Vantage 3... \$128.95
NEW TRI-BAND, X, K & Ka, sequential LED's, audible alert.

976... Vector 3... \$149.95
NEW TRI-BAND, X, K & Ka, sequential LED's & city/highway setting.

FUZZBUSTER

8400... GENESIS... \$209.90
THE TALKING RADAR DETECTOR, computerized, voice has 13 functions, digital, visual alert, audible alert has volume control, pocket size.

4130... PHOENIX... \$109.90
Sequential LED's, mute, illuminated, X & K band, dash/visor.

3160... MARAUDER... \$84.90
Dual conversion superhet, LED & audible alerts, mute, dash/visor.

2101... \$67.90
Superhet with LED's, audible alert w/volume control, city/hwy

2045... \$49.90
Superhet, city/highway switch, audible & visual alarm.

MAXON

RD2A... \$49.90
Superhet, X & K band, audible & visual alert, city/highway setting.

RD1... \$59.90
Long range dual conversion, X & K band, LED's, audible alert w/volume control, antifalcing, city/hwy, dash/visor.

RD21... \$69.90
Mini size, audible & visual alert, omni-polarity guard, dash/visor.

RD25... \$89.90
Deluxe mini, same as above with sequential LED's.

★ ★ ★ ★ ★ CALL FOR PRICES ★ ★ ★ ★ ★

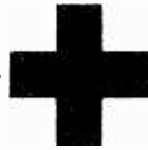

Live and Let Live

The Story of the Red Cross Telecommunications Network

by Jack Buzby

Most shortwave listeners are aware of the twice monthly broadcasts of the International Committee of the Red Cross (ICRC). They're aired from ICRC headquarters in Geneva, Switzerland, over the facilities of the Swiss PTT (the same folk that broadcast Swiss Radio International). But not so many monitors are aware that the ICRC maintains an extensive, worldwide, two-way communications network on shortwave as well.

If such a network did not already exist, it would soon have to be put in place. Consider some of the ICRC's 1986 activities: Red Cross representatives visited prisoners in a total of 719 detention centers in 37 countries. Thirty countries received a total of 82,000 tons of relief supplies. Over two million messages were exchanged between separated families. Nearly 55,000 investigations were initiated to trace missing persons.

The Red Cross was actively engaged in such trouble spots as Ethiopia, Eritrea/Tigre, the Sudan, Uganda, Angola, Namibia, Chad, El Salvador, Nicaragua, Afghanistan/Pakistan, Kampuchea, Iran, Iraq, Lebanon, the Western Sahara and several other countries. Without the network, says a Red Cross representative, the organization's activities would be "considerably reduced or brought to a standstill."

Interestingly enough, the World Administrative Radio Conference (WARC) of 1959 played a fathering role in the establishment of the ICRC's network. The conference adopted a recommendation which placed exclusive use of certain frequencies at the disposal of the Red Cross. Four years later, the Swiss government granted the Red Cross a license to set up and administer an independent radio network.

HBC88 Goes On the Air

The Geneva HQ station, HBC88, is limited to communications of a strictly humanitarian nature. Regulations forbid transmission of private or political news or information.

In actual practice, the radio communications links, while used extensively, are still called upon only when commercial lines of communications are out of service or do not exist at all.

The first two-way link between Geneva and another station was in December, 1963, when a field hospital at Udq, in the Yemeni desert, was equipped with a two-way radio.

By the end of 1981, there were 14 stations in direct link with the Swiss headquarters. That year alone, 8,620 messages were sent. The year also saw the number of stations in the net increase from 4 to 14.

The 1982 Polish situation caused an extensive radio network to be created, linking headquarters in Warsaw to the main provincial Red Cross distribution points. This provided much greater coordination of relief efforts during a period when no internal communications links were available in Poland.

New Station Opened in Versoix

The original ICRC headquarters station in Geneva has assumed a less important role since a newer headquarters station was opened at Versoix, just outside of Geneva. The Versoix station contains three automatic transmitter-receivers and can operate on any frequency between 2 and 30 MHz. There are four directional antennas in use, as well as a pair of omni-directional antennas. The newer station now handles all ordinary traffic between field operations. Daily traffic runs between four and eight thousand words.

The original headquarters station still gets used on a fairly regular basis and is now employed during emergencies and special operations. The planning, development and installation of the new station was a four year project for the ICRC's telecommunications staff.

There are eleven people on this staff. All, incidentally, are capable of not only doing the technical work but of operating on all

modes.

The network itself is a complicated arrangement which involves various high frequency links within a particular country which feed a larger station, which, in turn, may link to Geneva. There are telex lines, HF and AMTOR communications, internal and direct radio links on HF, internal VHF links and crypto links on both radio and phone lines.

Since 1971, the ICRC and its associated league of National Societies (the American Red Cross and so on) have promoted the development of further radio communications in additional areas by convincing government telecommunications authorities to grant National Red Cross permission to communicate with the ICRC in Geneva. Some 40 additional countries have now granted this permission since the effort began.

Don't Even Listen

The ICRC is, like many governments and institutions, quite touchy about radio monitors tuning in on its communications. The ICRC takes pains to inform those asking about the service that such monitoring is not welcome. Indeed, it quotes appropriate international agreements which state that "the interception by non-licensed third parties, of radio communications located within the international fixed bands, is prohibited by international agreement."

The "interception" aspect of these rules is pretty well ignored by utility DXers, at least in the US, since FCC rules are more concerned with a third party disclosing or divulging the content of what has been monitored. Most literature for the utility monitor makes this "disclosure" aspect clear.

Still, it is probably safe to say that the ICRC would not welcome reception reports on its network communications.

Considering the attitude of the ICRC in this regard (which follows the approach

taken by the Swiss Telecommunications authorities as well), it isn't surprising that ICRC communications personnel will not release the operating schedules of HBC88, nor the field stations in the ICRC network. We are asked to understand their agreement and, in effect, to please leave well enough alone.

Frequencies are Available

Fortunately, the newly released fourth edition of *The Shortwave Directory* lists several frequencies for the Red Cross network. Transmissions are noted in single side band or Morse code from "field portables" running 150 watts. Frequencies include (* means most active): 3801.5*, 6998.5, 13915, 13965, 13973, 13998.5*, 20735, 20753*, 20815, 20942, 20993.5*, 27998, and 29701.5*.

The *Directory* lists the following stations as part of the network:

- APR88 Islamabad, Pakistan
- CER88 Santiago, Chile
- CICR5 Luang Prabang, Laos
- CPCR88 Asuncion, Paraguay
- CPR88 La Paz, Bolivia
- CRC88 Lome, Togo
- CX8CRU Montevideo, Uruguay
- DKR82 Bonn, West Germany
- dug88 Manila, Philippines
- EAR88 Madrid, Spain
- HBC88 Versoix, Switzerland
- HBC88A Geneva, Switzerland
- HCR88 Quito, Ecuador
- HHR88 Port-au-Prince, Haiti
- HICR88 Santo Domingo, Dominican Republic
- HJC88 Bogota, Colombia
- HRC8 Tegucigalpa, Honduras
- HSR59 Bangkok, Thailand
- ICRC1 Dacca, Bangladesh
- JYL88 Amman, Jordan
- OAR88 Lima, Peru
- ODR88 Beirut, Lebanon
- OER88 Vienna, Austria
- PGA88 The Hague, Netherlands
- SAR88 Stockholm, Sweden
- SUR88 Cairo, Egypt
- S2C88 Dacca, Bangladesh
- TICR88 San Jose, Costa Rica
- TDR88 Guatemala
- VPR88 Nassau, Bahamas
- WA510 New Delhi, India
- XUR88 Phnom Penh, Khmere Republic
- XWR88 Vientiane, Laos

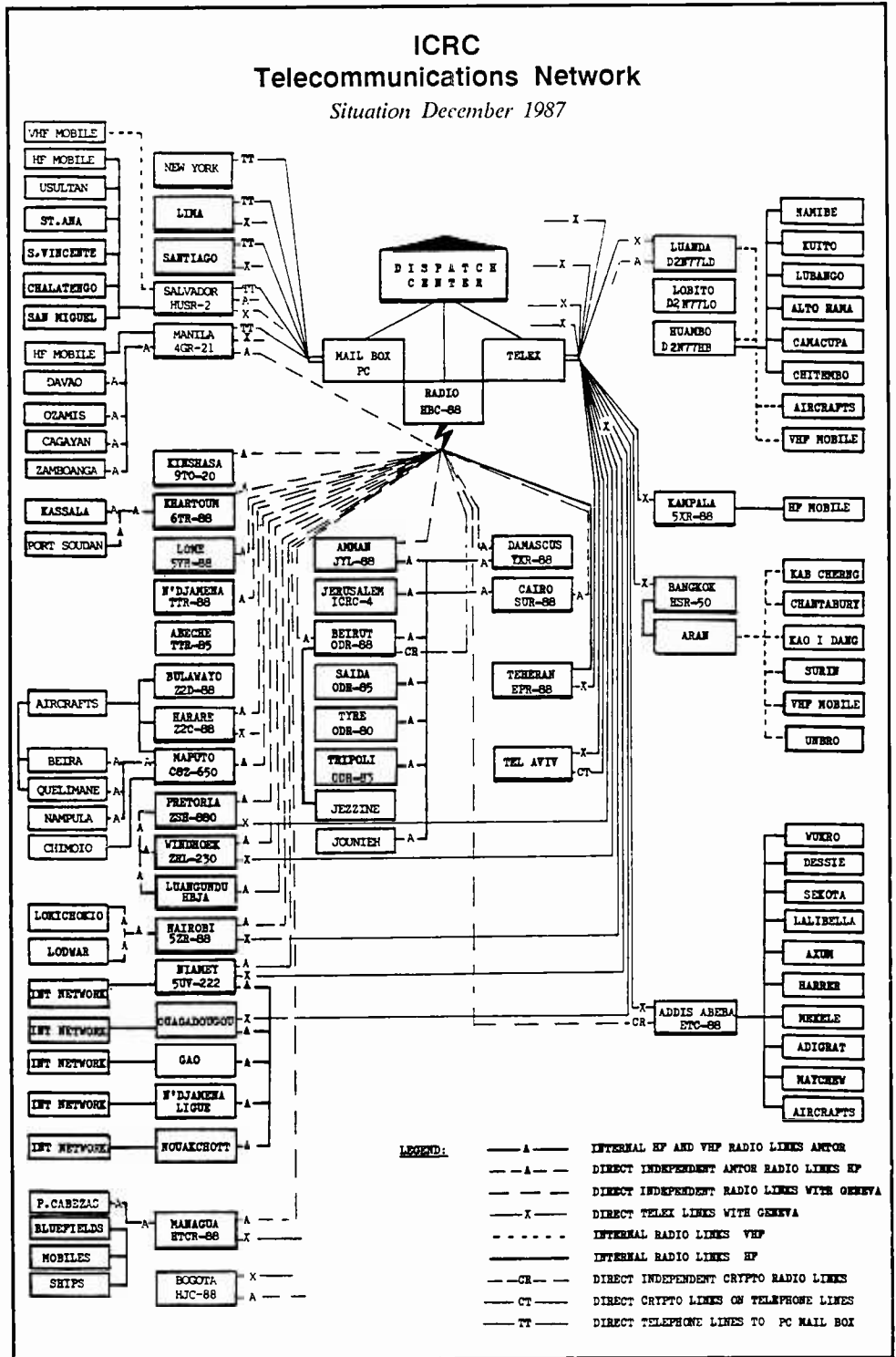

- YKR88 Damascus, Syria
- 4XR44 Jerusalem, Israel
- YNCR88 Managua, Nicaragua
- 4WA2 San'a, Yemen Arab Republic
- YVPR88 Caracas, Venezuela
- 8PRC88 Bridgetown, Barbados
- YSCR88 San Salvador, El Salvador
- 9JR88 Lusaka, Zambia

TV DX Season is Here!

Catch Those Distant Signals on Your TV!

by John F. Combs

There's no denying that we are living in a video age. The influence of television on our society is as strong as ever. Yet we have become so accustomed to the miracles of modern video technology that we take it all for granted. We are so accustomed to seeing clear, live video from satellites over 22,000 miles distant that we hardly give it a second thought.

Nevertheless, there exists within the DXing community a hardy group of hobbyists who know that achieving reception of distant *terrestrial* TV signals is where the real challenge lies!

Television DXing is nothing new. Almost from the start of commercial TV service in the late 1940s, viewers began to notice the occasional odd signal coming in on a normally vacant channels. In cities that had not yet received their own local TV station, people actually relied on DX for their only TV entertainment. The quest for TV-DX continues to this day, and we have learned a lot about the phenomenon in the intervening decades.

Howzit Possible?

There are a variety of propagation conditions responsible for TV-DX. The three most commonly encountered are sporadic E-skip, tropospheric propagation, and meteor scatter.

Sporadic E-Skip is responsible for most people's introduction to TV-DX. When an area of the E-layer becomes highly ionized, it is capable of reflecting VHF signals that would normally continue on into space. E-skip, or Es, is characterized by very strong,

about 500 to 1500 miles, with stations in the 750-1250 mile range most common. In rare instances, multiple Es clouds can be so situated as to provide multiple-hop reception of 2000-3000 miles and more!



A good example of the strength of some E-skip signals is this photo of KFSM, channel 5, Ft. Smith, AR, at a distance of 901 miles. (All photos taken by the author in Orlando, FL.)

rapidly fading signals and heavy co-channel interference. E-skip signals are often so strong that they can be seen with the simplest of antennas, even the venerable "rabbit ears!"

As the ionized "cloud" in the E-layer moves, stations in one area will fade to be replaced by other distant signals. E-skip normally affects TV channels 2-6, and sometimes the FM radio band as well. However, during extreme openings, sporadic E-skip has been noted up to channel 13. Distances run from

All of this activity peaks during the summer months and there are openings on almost a daily basis in good years. Another minor peak occurs around December and January, but Es *can* happen any day of the year!

Tropospheric propagation affects all TV channels, VHF and UHF. This type is weather-related and occurs in conjunction with such things as cold fronts, areas of stagnant high pressure, and temperature inversions. "Tropo" reception usually produces relatively stable signals, with very slow fading. Stations up to 1000 miles and farther are possible by tropo, but distances of over 500 miles are not very common.

Some tropo openings produce strong signals from 250-500 miles over a wide geographical area; others take the form of a "duct"--a tropospheric pipeline that can bring almost snow-free reception from 600-1000 miles while closer stations are weak or not seen at all. Although very strong tropo may be received on simple antennas, even indoors, serious tropo DXing requires outdoor antennas, as high above ground as

possible. Spring and fall are the best times for tropo, but, like E-skip, it can happen at any time.

Meteor scatter is the most challenging form of TV-DX. As meteors pass through the ionosphere, they can leave ionized trails that reflect VHF signals in much the same way as E-skip, but only for a very short time. A meteor "burst" can last from a fraction of a second to several seconds long. The meteor scatter DXer must hope that a burst will coincide with a test pattern, ID slide, local ad, or other means of identifying the station being received.

During major meteor showers, rates can be as high as several bursts per minute. Meteor scatter affects primarily the same channels as E-skip, but distances tend to be somewhat shorter, on the order of 400-1200 miles. A good, high gain outdoor antenna and a vacant (or nearly so) channel are essential for successful meteor DX.

Meteor scatter can be observed year-round, but the best DX can be had during the major meteor showers. The best time to look for MS is the wee hours of the morning, when local or nearby stations may be off-the-air.

There are other, rarer forms of propagation affecting TV-DX. During peaks of the solar cycle, for example, the Maximum Useable Frequency (MUF) for F₂ skip can at times rise as high as 60 MHz -- high enough to affect the lowest TV channels and bring DX from 2000-3000 miles away or more. And DXers who live within 15° of the equator may experience trans-equatorial skip (TE) which can bring fluttery VHF-TV signals from thousands of miles distant on a north-south path.

Antennas

Most TV-DXers use separate VHF and UHF antennas. On VHF, a large all-channel log-periodic is good, and separate yagi antennas for lo-band (chs. 2-6) and hi-band (7-13) will perform even better. The most popular antenna for UHF-TV DXing is the 5- or 7-foot parabolic dish, though others favor corner-reflector/yagi types or 4- and 8-bay antennas. There are probably

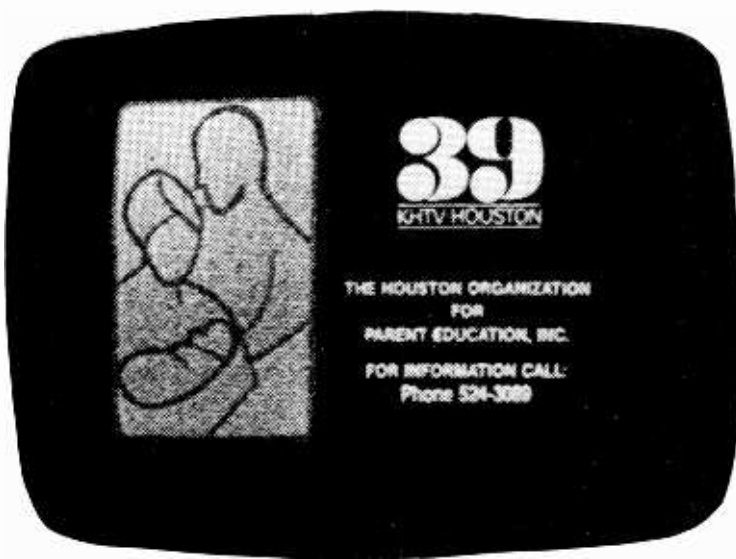

intense tropo received across the Gulf of Mexico: KHTV, channel 39, Houston, TX (857 miles).

as many opinions on antennas as there are TV-DXers, so it is good to talk to several before you buy.

A rotor is a must for outdoor antennas, in order to pinpoint the direction of the DX and maximize the signal strength. 75-ohm coaxial cable is the most popular feedline, primarily due to the ease with which it can be handled. Preamplifiers are useful and popular, especially for UHF, but may overload in areas with many strong, local TV stations.

Identifying TV-DX

U.S. TV stations are only required to identify themselves once per hour. Many Canadian stations air more infrequent IDs

and stations in Latin America seldom use call letters at all. The TV-DXer often has to piece together various bits of evidence to identify a distant signal.

Some of the factors that can help narrow the possibilities of what you're seeing are: network affiliation, direction (if you have a rotatable antenna), local ads that contain addresses or phone numbers that can be tracked down, and place names mentioned in local newscasts. A good, accurate listing of TV stations is a must. The best currently available is the *North American Television Data Base*, edited by William B. Fahber and available from the Worldwide TV-FM DX Association (more about the WTFDA later).

Out-of-state editions of *TV Guide* can be very useful in researching unidentified TV-DX. Off-sale copies of various *TV Guide* editions were once available from many regional offices of that publication, though they have not been as cooperative in recent years. Copies can be purchased on vacations, obtained

from relatives in distant states, or traded with other TV-DXers.

A Multi-Faceted Hobby

Besides merely seeing TV-DX and logging it, there are other aspects of the hobby that appeal to its various proponents. Some TV-DXers photograph the stations they receive. Best results are obtained with an adjustable 35mm SLR set at a 1/30 second shutter speed. Using ASA 400 film, the aperture should be set between f/4 and f/8, depending on the brightness of the screen. (It's a good idea to shoot a few experimental, non-DX rolls first.)

VCRs are commonplace these days, and many TV-DXers like to video-tape their

DX, both for themselves and for sharing with other DXers. Additionally, slow-motion and freeze-frame effects can be used to get a better look at that ID slide that went by too quickly to read. Many VCRs, however, have tuners that are not sensitive enough for DXing. A few DXers have obtained better results by simply aiming a video camera at the screen!

QSLs are also part of the TV-DX hobby, just like in shortwave. Many TV stations, particularly those on channels 2-6 that are frequently seen by E-skip, have their own distinctive QSL cards. Most stations will verify, and many are tickled to receive reports from DXers. (One distant UHF station was thrilled by my report since their competition claimed their signal didn't even reach the city limits!!)

A few stations will even send along bumper stickers, mugs, or even t-shirts with the station logo to particularly distant reporters. There are a few "party pooper" stations that consistently refuse to verify, but that's true of shortwave and AM stations, too! Reports should generally be sent to either the chief engineer or the program director.

Not for Loners!

No hobby is truly enjoyable unless it is shared with others with common interests. The only DX club catering exclusively to TV and FM DXers is the Worldwide TV-FM DX Association, P.O. Box 514, Buffalo, NY 14210. Their monthly bulletin, *VHF-UHF Digest*, features members' DX loggings, DX photos, technical articles, and columns to help with unidentified loggings.

The WTFDA sponsors an annual convention every August (this year's will be held in

the beautiful mountain setting of Waleska, Georgia, north of Atlanta). Annual dues are a modest \$15.00 per year.

It's almost time!

Yes, it is just about time for that summertime E-skip to begin rolling in! So keep an eye on those lower channels, and you might be surprised by what you see!

Meteor scatter can be photographed if you're quick on the trigger! This is the test pattern of WRC, channel 4, Washington, DC (760 miles). (Below) TV-DXers in the south can log stations from many Latin American countries. This is Radio-TV Dominicana on channel 4 from the Dominican Republic via E-skip (1005 miles).

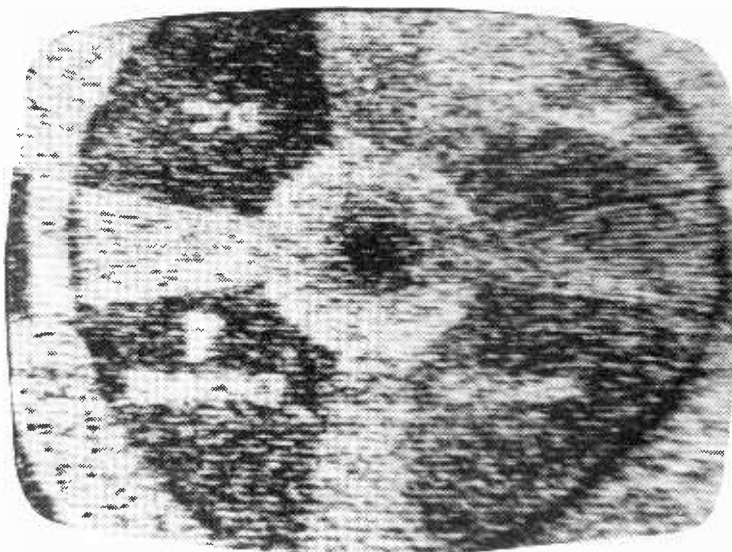

John F. Combs has been TV-DXing for over 15 years, and edits two columns in the monthly VHF-UHF Digest.

See this month's "Domestic Broadcasting" column for more on TV DXing.

"The Largest Dealer of Scanners in the World"



SCANNER WORLD, USA®

10 New Scotland Ave., Albany, NY 12208 518/436-9606



Regency
MX-3000

Special \$169.99
(\$7.00 shipping)

30 CHANNELS—MOBILE/BASE

—SCANNER WORLD EXCLUSIVE—

Features include simple programming of the following frequency ranges: 30-50 MHz, 144-174 MHz, 440-512 MHz. Digital display, priority, search, lockout, delay, dim control, top mounted speaker, one year factory warranty. Includes AC & DC cords, mobile mounting bracket, telescopic antenna. All for only **\$169.99** plus \$7.00 shipping (optional extended warranty: 3 years \$39.99; 2 years \$29.99.) MX3000 Service Manual \$5.00.

Cobra SR-15

\$209.99 (\$7.00 shipping)



100 channel pocket sized hand-held scanner (6"Hx1"Dx2 3/4"W), no crystal, portable scanner, 29.54 MHz, 118-174MHz, 406-512 MHz, bank scanning, backlit LCD display, automatic search, lockout, scan delay, priority, key lock, plus much more. Includes rubber antenna, rechargeable Ni-Cad battery pack, AC adapter charger, earphone, and carry case. optional cigarette lighter adapter #15MPC \$12.99.

BEARCAT 100-XLT Hand-Held 100 Channel	\$219.99 (7.00)
BEARCAT 70XLT Programmable Hand-Held	169.99 (6.00)
BEARCAT 50XL Programmable Hand-Held	119.99 (5.00)
AD100U AC Adapter/Charger for 50 XL	12.95 (-)
BP55 Ni-Cad Battery Pack for 50XL	13.99 (-)
VC001 Carry Case for 50XL	11.99 (7.00)
PS001 Cigarette Lighter Adapter for 50XL/100XL	12.95 (-)
BEARCAT 140 AC Programmable Scanner	94.99 (5.00)
BEARCAT 145XL AC Programmable Scanner	99.99 (5.00)
BEARCAT 175XL AC Digital Scanner	159.99 (5.00)
REGENCY TS-1 Turbo Scan AC/DC	239.99 (7.00)
REGENCY TS-2 Turbo Scan 800 AC/DC	339.99 (7.00)
BEARCAT 210XLT AC/DC Digital Scanner	199.99 (7.00)
BEARCAT 800 XLT AC/DC Digital Scanner	279.99 (7.00)
REGENCY HX-1500 Hand-Held Scanner	224.99 (7.00)
REGENCY MA-257 Cigarette cord for HX1000/1200	16.99 (-)
REGENCY MA-917 Ni-cad Battery for HX1000/1200	24.99 (-)
REGENCY HX-CASE Hwy Leath. case for HX1000/1200	19.99 (-)
REGENCY MA-549 Drop in charger for HX1000/1200	89.99 (5.00)
REGENCY MX-3000 AC/DC Digital Scanner	160.99 (7.00)
REGENCY Z-30 AC/DC Digital Scanner	129.99 (5.00)
REGENCY Z-60 AC/DC Digital Scanner w/Air	139.99 (7.00)
Mobile Mounting Bracket for Z Scanners	5.99 (-)
REGENCY ACT-R-1 AC/DC Crvs. Single Channel	75.99 (4.00)
REGENCY RH-256B High Band Transceiver	359.99 (7.75)
REGENCY UC 102 Hi-VHF Hand Transceiver	119.99 (5.50)
REGENCY RH-600B High Band Transceiver	429.99 (7.75)
REGENCY R806 AC/DC Crystal Scanner	79.99 (5.00)
REGENCY INF-1 Informant Receiver	249.99 (7.00)
REGENCY INF-2 Informant Receiver	324.99 (7.00)
REGENCY INF-3 AC Informant Receiver	249.99 (7.00)
REGENCY INF-5 AC Informant Receiver	199.99 (7.00)
REGENCY R1090 Digital AC Scanner	147.99 (7.00)
COBRA SR12 Digital Hand-Held Scanner	189.99 (6.50)
COBRA SR10 Digital Hand-Held Scanner	129.99 (6.00)
COBRA SR900 AC/DC Digital Scanner	104.99 (5.00)
COBRA SR295 AC/DC Digital Scanner	109.99 (7.00)
Book "Top Secret Registry of Gov't Frequency" 6th 13.99 (3.00)	
Book "Covert Intelligence, Electronic Eavesdropping"	8.95 (-)
Book "Betty Bearcat Frequency Directory"	14.95 (-)
Book "Rail Scan Directory"	7.95 (-)
Book "Air Scan Directory"	12.95 (-)
RCD MRP-1 Single Channel Hand-Held	38.99 (3.00)
FANON M8HLU DC Crystal Scanner	89.99 (5.00)
FANON PSK-1 AC Adapted for M8HLU	12.99 (-)
FOX BMP-1060 AC/DC Digital Scanner	129.99 (5.50)
FOX Mounting Bracket for BMP-1060	9.99 (-)
ANT-1 Magnet Mount Mobile Scanner Antenna	29.99 (3.00)
ANT-6 Base Scanner Antenna w/50' cable	29.99 (3.00)
REGENCY RD-ONE Radar Detector	39.99 (4.00)
REGENCY CB-ONE CB Radio	34.99 (5.00)

Scanner World Special

\$129.99

(plus \$7.00 shipping each)

Optional Accessories:

Cigarette Lighter Plug RGMPC . . . \$4.95
Z Mobile Bracket — Special . . . \$5.99

home or on the road. It is double conversion, super heterodyne used to receive the narrow band FM communications in the amateur, public safety and business bands: 30-50, 144-174, and 440-512 MHz. Size 10 3/4"Wx2-7/8"Hx8-3/8"D.

Sophisticated microprocess-controlled circuitry eliminates the need for crystals, instead, the frequency for each channel is programmed through the numbered keyboard similar to the one used on a telephone. A "beep" acknowledges contact each time a key is touched. The Z30 scans approximately 15 channels per second.

Any combination of two to thirty channels can be scanned automatically, or the unit can be set on manual for continuous monitoring of any one channel. In addition, the search function locates unknown frequencies within a band.

Other features include scan delay, priority and a bright/dim switch to control the brightness of the 9-digit Vacuum-Fluorescent display. The Z30 can be operated on either 120 VAC or 12 VDC. Includes one year warranty from Regency Electronics (optional 3 yr extended warranty only \$39.99, gives you a total of 4 yrs complete warranty or 2 yr extended warranty only \$29.99, gives you a total of 3 yrs complete warranty.) Z-30 Service Manual \$5.00.

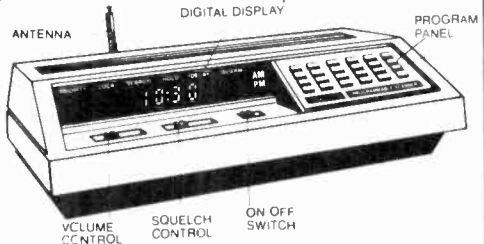

The Regency Z30 is a compact, programmable 30 channel, multi band, FM monitor receiver for use at

SCANNER WORLD SPECIAL

COBRA SR-925

\$109.99

(plus \$7.00 shipping each)



Digital programmable, 16 channel, AC/DC mobile/base, with raised button keyboard for easy programming of the following frequency ranges: 29.54mhz, 118-174mhz, 406-512mhz. Covering aircraft, marine, police, fire, weather, trains, public service, plus much more. Features include digital display, priority, scan delay, weather button, channel lockout, search, scan speed, automatic squelch, memory backup, one year factory warranty, external speaker jack. (Extended warranty 2 years extra \$29.99, 3 years extra \$39.99.)



Bearcat

BC-600 XLT

\$249.99 (\$7.00 shipping)

Digital Programmable 100 Channel Scanner

BC-600 XLT covers the following frequencies: 29.54 MHz, 118-174 MHz, 406-512 MHz. Features compact size of 6-5/16 Wx1-5/8 Hx7-3/8 D. Scan delay, priority, memory backup, channel lockout, bank scanning, key lock, AC/DC power cords, telescopic antenna, mounting bracket supplied, one year factory warranty, search, direct channel access, track tuning, service search, including pre-programmed frequencies by pushing a single button for police, fire, emergency, aircraft, weather, and marine services. Plus exclusive optional features never available on any scanner before. First is an RF receive amplifier for boosting weak signals for only \$24.99 plus a CTCSS tone board is available for only \$59.99 to make this the number one scanner available in the USA. Optional cigarette lighter plug #600MPC \$4.99.

BEARCAT BC-950XLT

Same features as BC-600XLT but also receives 800-954mhz.

\$289.99 (\$7.00 shipping)

REGENCY Z-60

Same features as Regency Z-30.

With the addition of aircraft 118-136mhz and FM broadcast 88-108mhz. Z-60 also receives a total of 50 channels.

ONLY \$139.99

(plus \$7.00 shipping each)

BEARCAT 70XLT

20 CHANNEL HAND-HELD SCANNER

Small size 6"Hx1"Dx2 3/4"W, full digital readout, priority, search, channel lockout, scan delay, key lock. Covers following frequencies: 29.54mhz, 136-174mhz, 406-512mhz. Package includes rubber antenna, rechargeable Ni-Cad battery pack, AC adapter/charger, and carry case.

SPECIAL \$169.99 (\$6.00 shipping each)

ORDERING INFORMATION

Call (518) 436-9606 to place orders by phone or mail orders to Scanner World, 10 New Scotland Ave., Albany, NY 12208. Orders will be shipped same day received by United Parcel Service. Scanner World accepts VISA, MasterCard (COD shipments by United Parcel will be for cash or certified checks only). Mail orders with personal or business checks will be held 4 weeks for bank clearance. Orders with cashiers checks or money orders shipped same day received. Prices, specifications and terms subject to change without prior notice. If items are out of stock we will backorder and notify you of delivery date. All shipments are F.O.B. Scanner World warehouse in Albany, NY. We are not responsible for typographical errors. All merchandise carries full manufacturers warranty. Bid Proposals and Purchase orders accepted from Government agencies. Free "pull line catalogue available upon request. No minimum order. New York State Residents add 7% sales tax. Any claims must be made within 7 days of merchandise receipt.

SHIPPING CHARGES

(* Add \$5) per scanner, and \$3.00* for all accessories ordered at same time. C.O.D. shipments will be charged an additional \$3.50 per package. Full insurance is included in shipping charges. All orders are shipped by United Parcel Service. Shipping charges are for continental USA only. Outside of continental USA, ask for shipping charge per scanner.

Scanner World, USA®

10 New Scotland Ave., Albany, NY 12208

(518) 436-9606

Most orders Shipped Same Day Received!

Scanner World, USA® • Albany, New York 12208 • (518) 436-9606

Scanner World, USA® • 10 New Scotland Ave. • Albany, New York 12208 • (518) 436-9606

In this time of sterile, predictable and, more often than not, "ho-hum" programs, it's hard to believe that radio once was at the cutting edge of technological and entertainment frontiers. If you take the time this summer, however, and browse through some of those yellow, musty-smelling books over in the corner at your next garage sale, you may be able to pull back the shroud of time and take a look at a time when radio was...

Whizbang and Wireless!

by Don Jensen

Radio was all the rage! The '20s were roarin' and grandpop was still just an impressionable youth, barely in his teens. Radio was the stuff of daydreams. Well maybe it wasn't as exciting as the No. 1 interest in a young man's life, but it was a whole lot easier to turn on! Besides, when it came to wireless, he could learn all about it just by reading his *Radio Boys* novels. "There's absolutely no limit," declared Bob enthusiastically. "That's what makes radio so fascinating. There's always something more to learn."

That was the sort of geewhiz prose that converted millions of kids in the 1920s. After all, what red-blooded American boy wouldn't want to share wireless adventures with Bob and his gang?

Bob Layton was one of the *Radio Boys*, a fictional quartet in a popular series of juvenile books cranked out some 60 years ago by publisher Grosset & Dunlap. With his teenage pals Joe Atwood, Herb Fennington and Jimmy "Doughnuts" Plummer, 16-year-old Bob led the group from one radio-related adventure to another.

Technically outdated and hopelessly square today, the *Radio Boys* books -- which you can often find in flea market bins and at backyard rummage sales -- offer a campy bit of nostalgia for an era that most of us never knew. Each book in the series never failed to point out what young readers would miss if they did not rush out to buy the other *Radio Boys* titles.

Strange and Thrilling Adventures!

Radio led the boys into many strange and thrilling adventures. While on a vacation stay in a seaside resort, they were able, by wireless, to aid a crippled ship. They grew so expert in science that they were placed on the program of a broadcasting station with unlooked-for results. By a curious combination of circumstances, they made a trip with the forest rangers and were nearly trapped in a woodland fire! Later on, they found themselves involved in a frightful flood caused by the bursting of a dam, in which their courage and knowledge of radio put them in good stead.

Even the titles were grabbers: *The Radio Boys First Wireless, Or: Winning the Ferberton Prize*; *The Radio Boys at Mountain Pass, Or: The Midnight Call for Assistance*; *The Radio Boys with the Iceberg Patrol, Or: Making Safe the Ocean Lanes*; *The Radio Boys Aiding the Snowbound, Or: Starvation Days at Lumber Run*, and others of like ilk.

Grandpa had little trouble identifying with our heroes and the way they got started in radio:

"The boys had received their wireless apparatus as Christmas presents a little more than a year before and immediately set them up. They learned the radio alphabet and soon were laboriously spelling out words to each other. In a few months, they had acquired a considerable addition to their vocabulary, and spoke of spark gaps, condensers and detectors with something of the ready familiarity of old timers."

Grosset & Dunlap had a real moneymaker in Bob, Joe, Herb, and Jimmy. But inexplicably, they failed to legally register the *Radio Boys* name. And soon, two other publishers cut in on their act with their own competing *Radio Boys* juvenile novels with totally different authors and characters.

Confusing? You bet! But as Bob Layton himself might have said, "More about that later, chaps!"

Try as they might, the other publishers really made little dent in Grosset & Dunlap's *Radio Boys* sales.

Most young readers of the day could have told you that the author of the series was Allen Chapman. Actually, though, Chapman was as phony as his characters, existing only in the fertile mind of a rather amazing fellow named Edward Stratemeyer.

Stratemeyer, in just over 30 years, cranked out more juvenile fiction books than anyone else, before or since. By 1906, after writing some 50 volumes himself, he found it impossible to keep up with the demand.

So he set up a syndicate, a sort of assembly line writing factory, that would make him a

millionaire by the time of his death in 1930. He wrote the plots, chapter titles, character names, descriptions and backgrounds. These "starter kits" for 800 novels were, over the years, turned over to contract writers, usually out-of-work newspaper reporters, to complete.

Though he didn't actually write more than the outlines, Stratemeyer created the characters and set the scenes for the *Radio Boys* tales.

A Fine Specimen of American Boyhood

Bob Layton, as Stratemeyer created him, was the son of a prominent pharmacist in Clintonia, a fictional city of about 10,000, not far from New York. He was described as "a fine specimen of American boyhood," whose "mental and moral qualities were on a par with his physical gifts," making him a favorite with "the best people in town."

Joe Atwood, his best friend, was equally preppy, "apt to go off like a flash of powder when he detected something that was mean or sneaking."

Mean and sneaking, that meant the cast of teenage villains that tried to thwart the *Radio Boys* in each novel. They were Buck Looker, the big hulking bully, son of the richest man in town, and Buck's two toadies, Carl Lutz and Terence Mooney, tale-bearers and sneaks, the both of them.

The other two *Radio Boys* were second stringers, comic relief. Herb Fennington was notoriously lazy and a practical joker; "Doughnuts" Plummer was the traditional fat boy with a ready reserve of snacks in his pockets.

Bob was quick to fill in his pals on the latest radio development he had read about, such as a fellow who had "thought up the wonderful idea of using his bed springs for an aerial."

Bob Amazes His Friends

"How does he make his ground connection, then?" asked Joe, still incredulous, while Herb and Jimmy regarded Bob with interest. "Tell me that, then." "Easiest thing in the

world," retorted Bob. "He makes the ground connection by means of a water pipe and a radiator in his own quarters." Herb whistled. "Pretty slick, that," he said admiringly. "Has music to sing him to sleep and everything!"

Stratemeyer produced many juvenile series besides the *Radio Boys* -- Tom Swift and the Bobbsey Twins among them -- and provided copyrighted literary pseudonyms for his no-name stable of writers. They got no royalties, merely a lump sum cash payment, usually \$100 to \$125 a book. Most were mere hacks who cranked out kid books by the score. Howard Garris, the real author of the *Radio Boys*, was the exception.

A Newark, New Jersey, newspaper reporter and freelance author, Garris was Stratemeyer's busiest ghostwriter, turning out more than 700 juvenile novels under various pen names. And, under his own name, he became famous as the creator of some 15,000 Uncle Wiggily stories for young children.

Garris could turn out a 35,000 word book in a week. He knew almost nothing about radio, but learned to handle the technical jargon. Here is a *Radio Boys* 1924 description of a then-experimental new receiver:

"Selectivity must go to the theoretical limits of science . . . giving volume from distant stations as well as selectivity. . . He was trying to improve the complicated super-heterodyne in sensitiveness and selectivity, so that anybody could have access to its wonders, regardless of whether he possessed any engineering skill.

And there was always Jack Binns--"the well-known radio expert of the *New York Tribune*," who wrote a foreword in every *Radio Boys* book--to watch for electronic glitches in Garris' writings.

Accept No Substitutes

Less successful by far were Grosset & Dunlap's rivals. A Chicago publisher, M. A. Donohue & Co. turned out a half dozen *Radio Boys* novels, supposedly written by three different authors, who seemed to have their own troubles keeping their characters straight.

Authors using the pseudonyms Frank Honeywell and J. W. Duffield, they wrote about a different set of *Radio Boys*, 16-year-old brothers, Guy and Walter Burton, dubbed the "wireless twins of Ferncliffe." Their

adventures ran along the same lines as Bob Layton's crew.

But another Donohue author, Wayne Whipple, had yet a different cast of *Radio Boys*, headed by a certain Bill Brown.

The Donohue versions of the *Radio Boys* had more than a few problems with the electronics, their technology sounding more like a snakeoil salesman's pitch. Here, for instance, is Guy Burton's explanation of his new cure for rheumatism, "wireless shoes!"

against two electrodes on the inner side of...each shoe, so that each foot gets the benefit of the wireless waves and the electric reaction.

If you buy that explanation, I've got some nice swampland in Louisiana for sale!

Now if there weren't already enough *Radio Boys* around, another New York publisher, A. L. Burt Co. had its own author, one Gerald Breckenridge, pump out another line of *Radio Boys* books for a somewhat older reading audience.

In Breckenridge's books, the heroes are Jack Hampton, Bob Temple, and Frank Merrick, recent college grads. In the 1924 novel, *The Radio Boys with the Border Patrol*, Jack, an Army flyer who doubles as an engineer-experimenter for "the radio trust," is joined by his friends in southwestern Texas.

Though his younger counterparts in the competing series seem oblivious to the fairer sex, Jack is "a manly fellow" who is attracted to a dark-eyed Latin beauty, the lovely *Senorita Rafaela*.

Alas, there's not the slightest hanky panky. *Radio Boys* don't fool around!

The Stratemeyer Syndicate survived its founder, with his daughter, Harriet Stratemeyer Adams continuing with a stable of authors who turned out juvenile books including the *Hardy Boys* and *Nancy Drew* mysteries.

When she died in 1982, the whole Stratemeyer line was acquired by Simon and Schuster publishing house, which has since brought out 1980's updated versions of *Nancy Drew* and may do the same for Frank and Joe Hardy.

But no similar fate awaits Bob, Joe, Herb and Jimmy, the *Radio Boys*. They went out of date way back in the early '30s, when, as far as juvenile publishers were concerned, the gee whiz was gone from radio.

We, of course, know better, and can agree with the *Radio Boys* and Bob Layton in this exchange with an admiring older gentleman:

"You boys seem to be in love with radio," put in Mr. Corning, smiling. "Why shouldn't we be?" replied Bob enthusiastically. "It's the greatest thing in the world!"



A BLUE STREAK CRACKLED BETWEEN THE TERMINAL AND THE BEAR'S NOSE.
The Radio Boys With the Forest Rangers.

Page 189

"Inside the heels are small induction coils. The antenna consists of a wire belt with fine, flexible wires running down inside the trouser legs and coupling. At the tops of the shoes. This antenna is sensitive to wireless waves constantly pulsing in the ether. When the connections are complete, the induction coil is thrown into action by the wireless waves received, a condition of electro-magnetism is produced...pressing the bare sole of the foot

CODE NAME: ESQUIRE

An Interview with James Bamford

by Jock Elliott

James Bamford is author of *The Puzzle Palace*, one of the most significant books on signal monitoring ever to be printed. Published in 1982 by Houghton Mifflin, *The Puzzle Palace* describes, in detail, the workings of the National Security Agency, the United State's foremost and most sophisticated agency for gathering signal intelligence. Bamford spent several years researching the NSA, which was created secretly by President Truman in 1952 and which, until the publication of Bamford's work, was virtually unknown to anyone outside government. For anyone who is interested in how governments gather intelligence by snatching signals out of the airwaves, *The Puzzle Palace* is must reading.

MT: In your book, you mention several attempts to suppress the publication of books relating to the field of signal intelligence. Did NSA try to suppress *The Puzzle Palace*?

Bamford: The NSA twice tried to have me thrown in jail. In 1979, when I began researching the book, I obtained a document from the Justice Department under the Freedom of Information Act. It was a 250 page report on an investigation the Justice Department had done on the NSA. Originally, the document had been classified "Top Secret Umbra" --which is the most sensitive signal intelligence information -- but after nine months of review, Justice released it to me with a lot of deletions. This was under the Carter administration.

In 1981, when the Reagan administration came in, suddenly NSA wanted to get the document back and persuaded the Justice Department to pressure me to do so. I met twice with people from Justice and NSA. At the second meeting, in Boston, they began asking me a whole series of questions about who had seen the document, how many copies I had made, and so forth. When I indicated that I wasn't prepared to answer those questions, they implied that the Espionage Act might be used against me. I called my lawyer in Washington. After phone discussions with the Justice people,

he said, "I'm not sure of their intentions. They could have anything in their pocket, including a warrant for your arrest. Get them to get on the phone with me, and when they do, leave." That is exactly what I did.

After that, they began writing letters that threatened me with the Espionage Act. In every case, our reply was simple: this document was declassified by the Carter administration, and the Presidential Executive Order specifically states that, once a document has been declassified, it cannot be reclassified. Eventually, the Reagan administration changed the Executive Order to read that documents *can* be reclassified.

MT: What was the second time NSA tried to have you jailed?

Bamford: When the book was about to come out, NSA tried all kinds of subterfuges to obtain an advance copy but the publisher wouldn't give them one. Once they got a copy, they sent a memo to the Justice Department to try to get them to prosecute me for espionage. But they didn't pursue it for two simple reasons: I never worked for NSA and never signed a pre-publication agreement with them, and two, all the information I obtained was through interviews or publicly available documents. I didn't obtain anything through clandestine or devious means. There wasn't anything to prosecute.

MT: You probably started looking over your shoulder a lot more often after that.

Bamford: Actually, I'm not a very paranoid person. I don't think you could be and do investigative reporting. I don't think I've been under surveillance or that my phone has been bugged. But I did find out a kind of curious thing.

MT: What was that?

Bamford: About a year after the book came out, I was doing a story for the *Washington Post*, and I decided to ask, under the Privacy Act, if the NSA had a file on James Bamford. When the NSA said



"No," I couldn't believe it. So I decided to ask them, under the Freedom of Information Act, to search their files for anything pertaining to James Bamford. It turned out they had given me a code name, Esquire, and everything was filed under that, not under my name. It filled about three-fourths of a legal file drawer. It even contained transcripts of my appearance on Ted Koppel's *Night Line*.

MT: What has been some of the other fallout of the book?

Bamford: Lots of things. *The Puzzle Palace* has been well received by other parts of the federal government. I understand it is now a standard text at the Defense Intelligence College. I was even invited to lecture at the State Department, after which I lunched in the secretary's dining room. "Palace" is now out in Japanese, German, and available in most of the English speaking world.

MT: What's new in the field of platforms

for gathering signal intelligence?

Bamford: The trend now is more and more into satellites for signal interception. In the Soviet Union, much of the communication is by microwave, so we have been moving toward more and more sophisticated satellites that can intercept those microwaves in space. The newest is the Magnum satellite, which replaces the Rhyolite. I believe the Magnum was put into orbit on the first secret space shuttle mission.

MT: What about HF interception?

Bamford: There's still a lot of that going on, but, as you know, it is risky to put monitoring posts into some of the countries surrounding the Soviet Union. We lost two important posts in Iran, but now we have a sophisticated monitoring station in the People's Republic of China.

We still have a number of listening stations throughout Europe equipped with Wullenweber antenna systems, or so-called "elephant cages." At the heart of these circular antenna arrays is a gadget called a "goniometer" which makes it possible to instantly detect the direction a signal is coming from. When two or more of these stations intercept a signal, a net control station can use the direction headings from the two stations to pinpoint the source of the signal, whether it is a submarine, aircraft, or ground station.

Sometimes, where a signal comes from is as important as what it says, particularly when you are tracking a submarine that may have surfaced for the first time in two weeks to make a 45-second burst transmission.

MT: Is the U.S. still doing monitoring from ships?

Bamford: We are, but differently. The *Pueblo* was captured by North Korea, and the *Liberty* was intentionally destroyed by the Israelis during the Six Day War. After those two disasters, we got out of the business of using what appeared to be private vessels for monitoring. Now we have outfitted U.S. Navy Destroyer Escorts, like the U.S.S. *Caron* to do the same work. Since these are our warships, they are much less likely to be attacked, but neither can they cruise innocently down a foreign coastline at three knots. In short, they are better protected, but without "stealth."

MT: Speaking of stealth, what's new in the way of aircraft?

Bamford: The SR-71 "Blackbird" is getting pretty old. There appears to be a stealth replacement for it.

I think the next big deal will be the TAV--trans-atmospheric vehicle--a space plane that we're trying to develop. Right now, there is a kind of "no man's land" between 20 and 70 miles up. Twenty miles is about the maximum altitude of the SR-71, and the Soviet Union will not tolerate us overflying their country at that height. Seventy miles is about the lowest altitude for a satellite, but the Soviets put up with that because a satellite at that altitude is in earth orbit and can't go any lower. But nobody knows what will happen when you have a space plane that can fly into orbit and then dip down, out of orbit, into that 20-70 zone above another country. It could become an interesting legal and diplomatic question.

MT: What about signal intelligence targets? Is there anything new there?

Bamford: Certainly terrorist communications must be getting a lot of attention, and, as part of that, I would think that foreign nationals within the U.S. would be getting attention under the Foreign Intelligence Surveillance Act. Another big area of interest would be economic information. What is the bank of Japan doing? Where are the Swiss moving their currencies. And so forth.

MT: How would one prepare for a career with the NSA?

Bamford: NSA seems to be interested in four key areas: engineering, languages, mathematics, and computer sciences, so if you want to make a career out of eavesdropping, you might want to get a degree in one of those disciplines. Second, there is a standard test for NSA that is given at regular intervals, and you would want to take that.

MT: What's it like?

Bamford: It's really different. For example, one question says you are an anthropologist sitting on a mountain peak among a chain of islands. From there you can see smoke signals and canoe traffic between islands, and it goes on for about half a page detailing the smoke signals and canoes that can be seen going back and forth. Then you are asked a bunch of questions like, "which island does the chief live on?" It's designed to test your innate ability to do signal traffic analysis. According to NSA, it's designed to test your cypher brain."

MT: How about these numbers stations on shortwave?

Bamford: Throughout the shortwave spectrum, there are stations that regularly transmit four or five digit groups of numbers by voice or in code. It is obvious that these are control stations for clandestine work -- anything from drugs to espionage.

MT: There has been a lot of speculation about the numbers stations. Have you had any confirmation that they are used to control spies?

Bamford: Yes. The last chapter of the paperback edition of *The Puzzle Palace* deals largely with the penetration of GCHQ, the British equivalent of the National Security Agency, by Geoffrey Prime, a Britisher turned Soviet spy.

When the truth came to light, he was found to have a false-bottom briefcase, an old reel-to-reel tape recorder, a German shortwave receiver, a small packet of single-use code sheets and invisible writing paper. At his trial, they looked like the props from a spy thriller, which they were.

MT: What was the connection with the numbers stations?

Bamford: Prime would meet occasionally with his control agent, who would give him a schedule of times and frequencies when he should listen to broadcasts from an East German numbers station. Prime would tape record the transmission and then use the one-time cipher pads to decode the instructions to him. It was all very simple, and really quite secure since you must have the one-time pads to decode the message. It is evident that a number of countries, including the U.S., are using numbers stations for similar purposes.

MT: So it appears that the story of the numbers stations is not over.

Bamford: Hardly. If I might quote from the last paragraph of the book -- "Finally, there was the strange coded message picked up by a radio operator in England on the evening of July 22, 1982, weeks after Prime had been arrested... Coming from an East German station was the monotonous sound of a woman's voice reading in English five-number code groups: '04376 74989 30300 70901 82266 68375 81377 80734 61156...' The question is, who else was listening?" ■

For more on numbers stations see MT's "Utility World" on page 30.

Flying With MAMA



by Rachel Baughn

That radio is an integral part of modern life is a fact none of us would dispute, but occasionally we encounter its use in ways which, though fascinating in themselves, we would never care to repeat -- ever.

Such was the case on Sunday evening, February 28, when after experiencing an unusual headache the majority of the day, I suffered a paralysis on my left side. Our local hospital is quite small and has only limited facilities. The doctor on duty felt it was urgent that a CAT scan be done as soon as possible to rule out a tumor or major hemorrhaging. And so MAMA (Mission Air Medical Ambulance) was called.

A Memorable Ride

In mountainous areas such as ours, the medical airlift is literally a lifesaver. Once airborne, the helicopter arrived from Asheville in 35 minutes (a trip of 2-1/2 hours on the ground). The three-man team was considerate and efficient, but I felt bundled up like a mummy as they pushed me head-first into the coffin-sized opening

in the tail for my very first helicopter ride.

My husband, meanwhile, had been busy making the necessary phone calls and arrangements, including a call to my employers, Bob and Judy Grove. Frustrated and anxious at the few details Harry had given them, Bob punched up the frequency used by the MAMA team (see sidebar) and tuned in the report radioed to Memorial Mission Hospital in Asheville... *She's regained use of speech and partial use of left side... condition stabilized...*

I heard the report, too. With an oxygen mask on, I couldn't talk and over the noise of the helicopter it would have been difficult to hear, so I received a pair of earphones as well. I not only heard the paramedic extolling the beauty of the full moon, indicating landmarks as we flew by, and checking periodically on my condition, I also heard the pilot communications and reports from another ambulance team working on a belligerent stabbing victim! (Later I discovered it was a Knoxville, TN, team sharing that frequency.)

Medical Communications

Lifesaving efforts by medical teams, whether at hospitals, in ambulances (land and air) or on an accident scene, require reliable radio communications. In the United States, these communications are in narrowband FM mode and will be heard in the VHF low, high or UHF bands.

Air ambulances are authorized to use normal 118-136 and 225-400 MHz AM air-to-ground channels and, in order to contact hospitals and police agencies, frequencies normally reserved for FM land mobile services. Wulfberg frequency-programmable transceivers are most commonly installed in these aircraft.

The following frequencies (MHz) are most commonly used for hospital/ambulance emergency communications:

155.325	155.340	155.355	155.385
155.400	462.950	462.975	463.000
463.025	463.050	463.075	463.100
463.125	463.150	463.175	

From the familiar to the exotic

We've all become accustomed to the miracle of radio -- waves that pass through matter and provide meaningful communication -- though I'm certainly not used to being the subject under discussion! But during the extensive testing I underwent to determine exactly what had happened to me, one of the most futuristic tests utilized radio waves to explore the *inside* of the body.

Called magnetic resonance imaging (MRI), it provides more detail than X-rays without the corresponding danger. It is composed of a powerful Tesla Fonar magnet which creates a strong magnetic field around the body. When hydrogen atoms (plentiful in the human body because of the high content of water) are placed in this magnetic field and exposed to radio frequency waves around 13560 kHz, they give off radio signals (resonance) which can be detected by sensitive antennas.



MAMA sits on its pad at Memorial Mission awaiting its next assignment which could be in any of several surrounding counties (photo by Harry Baughn).

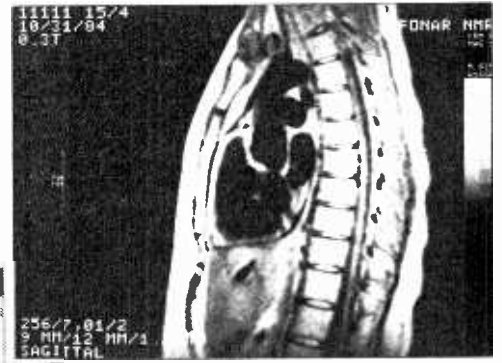
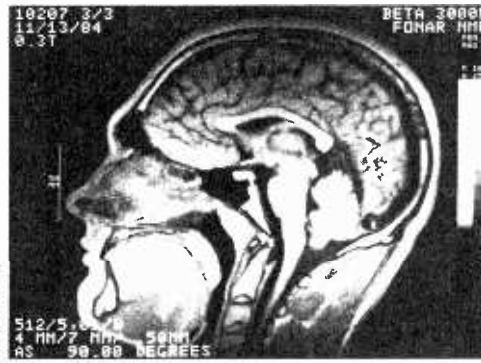

MR provides contrast and clarity in areas of the body previously difficult to define. The radio transmitter and sensitive antennae are contained within a collar or a hood placed around the area to be studied. No radiation or x-rays or injections are required. Just the ability to lie motionless in a slightly claustrophobic enclosure!

Each kind of tissue produces a different signal, and normal tissue gives off a different signal than diseased tissue. Obviously the real sophistication resides in the computer required to analyze the millions of data necessary to produce the total picture.

Oh -- in case you're wondering, the conclusive diagnosis was achieved the "old-fashioned" way. An arteriogram showed up a "spontaneous dissection of the right carotid" -- extremely rare and unlikely to happen again.

And the treatment? Take two aspirin and hope for the best. The body is still its own best healer. But I'm glad hi-technology and MAMA were there -- just in case.

Rachel Baughn is responsible for the production and design of Monitoring Times. We all wish to thank Judy Grove for stepping into the middle of the April issue and successfully completing it by deadline -- especially since editor Larry Miller was also confined to the hospital for a few days. In fact, April could have been called the issue that put the staff to bed!

We are happy to report that except for some lingering numbness in one arm and hand, Rachel is recovered and back on the job!

ISM

Industrial, scientific and medical equipment often require radio frequency energy to effect their intended purposes. Some apparatus can emit high intensity energy into the electromagnetic spectrum, often being heard for hundreds or even thousands of miles.

Examples of equipment utilizing this type of energy include induction heaters, RF welders, intrusion alarms, diathermy machines and microwave ovens.

To prevent such equipment from causing widespread interference to other users of the radio spectrum, discrete frequencies are allocated for those purposes. Tune your receiver to one or more of these channels and be treated to a symphony of cacophonous noises!

The following frequencies are authorized for ISM applications in the United States and may be received on conventional shortwave and scanner receivers: 6.78, 13.56, 27.12, 40.68 and 915 MHz.

International DX Report

Glenn Hauser
Box 1684 - MT
Enid, OK 73702

The next solar maximum may come as early as the end of this year--and the peak could be the most intense ever recorded. That's the outlook from Dr. Patrick McIntosh, director of solar physics research at the Space Environment Laboratory of NOAA in Boulder. Should this happen, the slightly denser atmosphere will cause lower earth satellites' orbits to decay more quickly, including some so massive that they will not burn up before re-entry. (New York Times, March 8, via Neil Greenidge and Rufus Jordan).

But what's a bit more space junk raining down upon us compared to the prospect of rapidly improving high frequency propagation? Those of us who remember the previous peak of 1957 are excited about worldwide TV DX on channel 2, 10 meters wide open from all over until late hours, even at peewee powers, and broadcast harmonics above 30 MHz, just to name a few consequences of such a peak.

Increasing solar activity already gives us a taste of what may come, but excellent conditions some days are balanced by depressed maximum usable frequencies other days. With Bonaire the only broadcaster above 21 MHz in the American afternoons, it's easy to assume 21, 25 and higher MHz are dead instead of wide open but with nobody transmitting.

Here are a few "beacons" your set can memorize for a quick, frequent and revealing check of true propagation conditions: 29820 kHz, more FM than AM, third harmonic of La Voz del CID, Central America; 29660 kHz, Virgin Islands FM ham repeater (input 29560 kHz). 24901 kHz, PY2AMI, 10 watt ham CW beacon from Americana, Sao Paulo, Brazil. We've heard all these quite well on good days as late as 0000 UTC.

Another target to scan for is the FM studio-transmitter link of Radio El Tiempo, CX24, Uruguay, on 47.25 MHz, revealed by Manuel Alfredo Barcia nearby in *QSN-Grama*.

Alaska. KNLS was happy to learn recently through *Review of International Broadcasting* that commentaries in Russian it broadcasts by Ivan Kolesnikov had provoked highly critical response in a Soviet publication. He's scheduled daily at 0715, 1215 and 1915.

Much KNLS programming, however, is musical -- jazz, big band, country, classical -- with gospel messages likely to interrupt once you're relaxed and receptive. The language schedule has been shuffled, combined with tentative frequencies for May through September 24 (UTC): 07 Russian 11860; 08 English 11860; 09 Russian 11820; 10 Japanese 11930; 11 Mandarin 9710; 12 Russian 9710; 13 Japanese 7355; 14 Mandarin, 15 and 16 English, 17 Russian, all on 9750; 18 English and 19 Russian on 11700; 20 Japanese and 21 Mandarin on 12025.

Austria. Radio Austria International unexpectedly retimed English to 0030 (plus *Shortwave Panorama*, yours truly participating, UTC Sundays 0100-0115) and shifted out from under WHRI to 9875. The next English remains at 0430 on 6015, but they hoped to put both on a single 9 MHz frequency for summer. English vanished from its longtime 1230 spot on 15320 when the transmission was expanded to two hours from 1100, so is English now at 1130?

Brazil. Embradex, the sixth meeting of Brazilian DXers, takes place Saturday, May 14, in the Radio Aparecida auditorium. The station's DX program the same day will issue a special QSL card to those who report correctly a "key phrase" (you don't have to know Portuguese to understand). Monitor 11855, 9630, 6135, 5035 or 820 kHz at 2200-2230.

Organizer Antonio Ribeiro da Motta has also published his computerized 1988 Brazilian MW-SW-FM station list of more than 2500 outlets, for 8 IRCs to PO Box 949, 12201 Sao Jose dos Campos, SP, Brasil.

Cameroon. The verification signer for all shortwave broadcast stations here has moved. Send your reports now to Mr. James Achanyi Fontem, Deputy Head of Programmes, CRTV (Radio) Ebolowa, South Province, Republic of Cameroon. He also welcomes contributions for CATHCA to help handicapped children. (Rowland Archer, NC, *World of Radio*)

Canada. Let CBC put some *Ideas* into your head on 6160 kHz from Newfoundland weeknights at 0005 UTC; on 6160 from Vancouver at 0405 (in between you'll hear it better on AM, FM or satellite). May 16-20 brings the 1987 Massey Lectures by Gregory Baum; Compassion and Solidarity -- the Church for Others; May 27, The Graham Spry Lecture on the CBC: Memory and Identity, by former president A.W. Johnson.

Chinas. If a ChiCom invasion of the U.S. was predicted on 5985 at 0213, it did not come from Beijing but Taipei, as relayed by Family Radio in Florida, contrary to the letter on page 93 of the April *MT*. It shouldn't be that hard to tell them apart! Radio Beijing has moved to 15455 at 11, 12, 00 and 03 hours; at 13 it's on 9635; at 03 and 04 also on 9645, 11980. Mali relays remain on 15130 and 11715 at 12; 11715 and 9770 at 00, 03 and 05; Spain relays at 05 on 9590.

Colombia. La Voz de la Resistencia (maybe not its official name), clandestine outlet of the Revolutionary Armed Forces of Colombia (FARC) was active again in March with ham equipment on USB, heard at 16 on 10257; 1640 on 7215 and 2130 on 7422; also announcing 1330 on 6835 and 23 on 14285; all Sundays only (*Media Network*).

Nothing beats a mediumwave harmonic for the ultimate in DX from abroad. La Voz del Sinu, HJAZ, was audible on 2320 (twice 1160) from 1100 until 1230 (John Bryant, OK, *Fine Tuning*). Some other possibilities may make it farther than Venezuela, where Jairo Salazar and/or Manuel A. Rodriguez heard Ondas del Ibague on 2940 at 0252; and a G.R.C. net outlet on 2240 at 0950 (*The Radio News*).

Costa Rica. Radio for Peace International is raising funds for a more powerful 40 kW transmitter. For \$20 you can join Friends of RFPI and get a newsletter from Box 10869, Eugene, OR 97440. Schedule is Monday-Friday 21-24 on 15493.5 (Tunisia interferes; may change to 13660 or 17 MHz outlet), and UTC Tuesday-Saturday 0100-0400 on 7374.8. Tests on 21555 may also resume, but at 1700-2000.

RFPI now has a weekly mailbag show, Fridays at 2130 and Saturdays at 0130, right after our *World of Radio*, which also airs Tuesdays around 23 and Wednesdays at 03. *Spiritual World News*, from Hawaii, is scheduled Wednesday 2330, Thursday 0330 and 2300, Friday 03. *New Dimensions Radio* takes up the second hour of transmission except Thursday/Friday.

Ecuador. Escuelas Radiofonicas Populares (a.k.a Radio Riobamba) has reactivated 5014.9, heard around 1130. La Voz del Upano has added a third transmitter parallel to 5040.1 and 5999.3, on 5964.4, noted at 1108-1125 (Kirk Allen, OK). 5964.4 opens at

WORLD RADIO NEWS

1050, closes around 0242 (Ron Howard, CA, North American SW Association).

On HCJB some *Passport* topics for May: 2nd, war in El Salvador; 4th, Russian women; 6th, dandelions and daisies; 9th esmog in Mexico; 11th, music from Guayaquil; 12th, Klystron tube; 13th, fish in New Zealand; 17th, CARA culture; 18th, gold fever in Zimbabwe; 20th, colors of spring; fishing in Ecuador, Lima-city of kings and exchange rates. 23rd, Peruvian pilots and their near misses; 26th, computers understanding human speech; 27th, Winnie-the-Pooh's worldwide implications; 30th, the planet Jupiter; 31st, profile of Jose de San Martin, liberator of Argentina. *Passport* can be heard after the news at 19, next UTC day 01, 0530, 10.

Finland. Radio Finland has started an in-band SSB transmission at 10-11 on 15325 to Europe (via Richard Lemke, *NASWA*). See SWEDEN.

Guatemala. Newest Indian missionary station is Radio Kekchi (pronounced keh-KEE) on 4845, heard from 1055 to 1145; call is TGDC, location Las Casas, Alta Verapaz (Kirk Allen, OK). It also IDs as La Voz Evangelica da Las Casas and closes at 0100 (Tutsuga Hirakara, Guatemala City, *Radio Nueva Mundo*).

Hong Kong. Permanent address for the BBC relay is PO Box 71688, Kowloon CPO. (John Tuchscherer, WI, via MT's Gayle Van Horn).

Hungary. From May 2 Radio Budapest reduces and reschedules English; daily 1830 and 0030; Monday-Saturday 20 and 2330 on the usual frequencies, but the DX program doubles time to Tue/Wed/Fri/Sat 0230-0245 (Edwin Southwell, England, *DX Listening Digest*).

International Waters. Radio Caroline, 6210, announces address simply as New York, NY 11518. This is actually East Rockaway, LI, where the post office confirms mail is being picked up (Christopher Crosby, KA2RAF, *World of Radio*). PO returned report with address corrected to 54 Plainfield Ave., E. Rockaway, NY 11518-1230 (Jerry Berg, *FT*).

Japan. Radio Japan's Sackville, Canada, relay is retimed to 01-02 on 5960 (and the first few days also on 9755 by mistake), but still at 11-12 on 6120. *DX Corner* is UTC Monday 0125-0144. Direct 5990 in the mornings is gone (for the summer?) but 9505 beams our way at 05-06, 15-16, 17-18, 19-1930 (via Bruce MacGibbons)

Monaco. Kurdish from TWR is retimed to 15-1515 daily, still on 12025, 500 kW (Wolfgang Buschel, W. Germany *DXLD*).

Morocco. Our wish for English from here has been fulfilled with a SW simulcast of the domestic service, Monday-Friday 1630-18; Saturday 17-18; Sunday 19-20; 17595 before 17, then 17815; and after 19 on 11920 (*Media Network*).

Netherlands. May highlights on R. Netherlands: Wed. 4th, anniversary of Liberation of Holland and 40th anniversary of Israel; Wed. 11th, musical salute to Irving Berlin on his 100th; Wed. 18th, a new series on music, The Savage Breast, such as musical education of the young and what to do with 3000 concert pianists; Thur. 26th, Media Network's Antwerp Antics about the European DX Council conference.

New Zealand. BBC and RNZ International are working on a deal to set up two 500 kW (or four 250 kW) transmitters on North Island to give BBC better coverage of the Pacific and RNZI a true external service at last (R. Australia *Communicator*).

Peru. The Radio Wuarua (or Wuaira?) previously on 6093 vari-

able is the same station heard in North America on 4700, although it announces 2475 kHz! (Pedro F. Arronategui, Lima, Peru). New on 4705.2 is Radio Imperio, Rioja, announcing 4700, sign-on 10 or 1030 (Takayuki Inoue Mozaki, Japan, *RNM*). R. Bahia, Mollende, Arequipa, heard with a remote football pickup at 2117 on 21705 (Alfredo Locatelli, Uruguay, *QSN-Grana*).

Saipan. HCJB, Ecuador, hopes to put at least one 500 kW transmitter here in a joint project with FEBC (Marlin Field, *NASWA*).

Spain. One more comment on the non-KKK QSL: the people parading in sheets were disguising themselves while protesting the Inquisition. This puts them in a more honorable light (Mike Lea, ABC Seville, via Floyd Jacobs, OK, *World of Radio*).

Sweden. Radio Sweden's 50th anniversary program, including recordings from 1938, airs May 21. On Mondays into June there's a series on classical music and composers, *Swedish Rhapsody* (Edwin Southwell, England, *Review of International Broadcasting*).

Radio Sweden's longtime SSB relays end July 1. Until then, the sked is: 05-07 on 17770; 08-09 Sat. and Sun. 17770; 09-16 21555; 16-18 15435; 18-2030 15420; also beamed due north on 17840 at 2330-24 and 02-0230, English 0230-03.

Thailand. The station on 6148.5 heard until closing at 1200 is in fact Or Sor from the Royal Palace, Bangkok, not Mor Sor from the south, per letters from both stations (David Foster, OZ-DX).

UKOGBANI. Contrary to *London Calling*, 17760 at 20-2115 is not from England but Antigua, providing excellent reception into deep North America. Six classic science fiction stories are read on *Future Imperfect* from May 8; Sundays 0215, 2209; Mondays 1445; Fridays 0945.

USA. VOA highlights in May: 1st at 1730, *Music Time in Africa* from Nubia; 8th at 1010, 1110, 1310, 1710, 0210, *Critic's Choice* also on Irving Berlin's 100th; 18th at 1030, 1230, 1530, 1930, 0230, *Magazine Show*; films of Frank Capra; 21st and 28th at 1010, 1210, 1710, 2110, 0110, *Communications World* on home satellite terminals; 29th at 1410, 2010, 0310, *Concert Hall* with the Cleveland String Quartet.

WWCR, Nashville, requested these out-of-band frequencies from the FCC: 15700, 15690, 15670, 15660, 12125, 12110, 11510, 10040, 9970, 9380, 9310, 7605, 7520, 7485, 7425. But the FCC may not approve any of them. WWCR says it has already lined up programs such as Rev. Clay Evans from Chicago; Focus on the Family with Dr. James C. Dobson; Faith for the Living, Hope for the Dying with Pam Paxton, a founder of MUDASA (Ministries United for Defense Against Satanic Attack); and Telephone Time from The Bible Speaks. Rates range from \$25 for each of five 5-minute broadcasts per week to \$290 for one hour per week. (via Bruce MacGibbon).

Vietnam. For those who still consider "South Vietnam" a separate country, three shortwave sites appear to be in that part of the country: Lam Dong, Bin Tri Thien, and the only one known active at the moment, Cia Lai-Kontum on 4710 (Mitch Sams, KS).

☆☆☆

Some of the information in this column and much more in greater detail appears in *Review of International Broadcasting* and/or *DX Listening Digest*. Samples are \$2 each in North America from Glenn Hauser, Box 1684, Enid, OK 73702. Also monitor *World of Radio* on WRNO Thursday 1515 on 11965, UTC Friday 0030 on 7355, Saturday 0300 on 6185, 2330 on 131760, Sunday 1800 on 15420.

WORLD RADIO NEWS

Broadcast Loggings

English broadcast unless otherwise indicated

0000 UTC on 6090

Luxembourg: Radio Luxembourg. Amusing British accented DJ with rock music records. Reception fair with heavy interference at 0015. (Bill Scarbrough, Knoxville, TN)

0029 UTC on 13645

USSR: Radio Kiev. Opening interval signal and station ID. Part II of "Radio Bridge" feature with Russian programming beginning at 0100. (James Kline, Santa Monica, CA)

0053 UTC on 3395

Ecuador: Radio Zaracay. Spanish. Local news on city Santo Domingo with station slogan and IDs at 0055 and 0057 UTC. (Bill Scarbrough, Knoxville, TN)

0058 UTC on 6080

Germany-DDR: Radio Berlin. Classical music and ID. Interview with museum curator from Berlin into a "travelogue" program through the sites of Berlin. (Tom Sullivan, New Orleans, LA)

0059 UTC on 9435

Israel: KOL. Israeli national headlines and news with "KOL Israel" ID, frequency schedule and 0023 sign-off. (Kerry Addison, Little Rock, AR)

0100 UTC on 7345

Czechoslovakia: Radio Prague. Station features, "Newsline" and the "Czechoslovakia Scrapbook" with a half-hour of Czech pop music. (James Kline, Santa Monica, CA)

0110 UTC on 4880

Brazil: Radio Diffusora Acreana. Portuguese. Terrific Brazilian sambas with chorus and station promotional at 0115. (Tom Sullivan, New Orleans, LA)

0130 UTC on 7430

Greece: Voice of Greece. Program begins with station schedule and international news. ID and traditional Greek music. (Tom Sullivan, New Orleans, LA)

0143 UTC on 7375

Costa Rica: Radio for Peace International. Two men discuss refugees and passport regulation. Interference at 0155 with signal fade out. (Rod Pearson, St. Augustine, FL)

0157 UTC on 7285

Germany-FDR: Deutsche Welle. Sign-on ID into newscast and commentary on South Korea's upcoming summer Olympics and the threat of terrorism. (Rod Pearson, St. Augustine, FL)

0159 UTC on 7270

Poland: Radio Polonia. Interval signal and sign-on ID with news of Europe, Poland, and USSR. Editorial on the Polish economy. (Tom Sullivan, New Orleans, LA)

0206 UTC on 4910

Honduras: La Voz de la Mosquitia. Religious program of old time gospel music and devotional. Station ID at 0200 with station address and Spanish programming beginning at 0230 UTC. (Bill Scarbrough, Knoxville, TN)

0207 UTC on 9475

Egypt: Radio Cairo. Text on recent developments in Egyptian agriculture and Arabic instrumental music. "Radio Cairo" ID, local and GMT time with news headlines. (Douglas R. Carson, Savannah, GA)

0217 UTC on 11710

Argentina: RAE. DX show with worldwide shortwave station schedules, and musical special on the "Tangos of Argentina". Program also heard on parallel frequency of 9690 KHZ. (Rod Pearson, St. Augustine, FL)

0227 UTC on 5040

Ecuador: La Voz del Upano. Spanish. Soft Spanish style melodies. Closing station ID with schedule and 0237 sign-off. (Cliff Goodlet, Chattanooga, TN)

0230 UTC on 9635

Portugal: Radio Portugal. Political news of Portugal and the Azores. Weather report and Portuguese folk music. (Rod Pearson, St. Augustine, FL)

0250 UTC on 7065

Albania: Radio Tirana. Lady announcer with editorial on Haiti's conflicts of civil rights. ID and national anthem with 0256 sign-off. Parallel frequency 9760 weak! (Tom Sullivan, New Orleans, LA)

0321 UTC on 3215

South Africa: Radio Oranje. Ragtime music followed by interesting drama story "Marching to Pretoria". Good signal. (Cliff Goodlet, Chattanooga, TN)

0326 UTC on 9770

China: Radio Beijing. Music of Chinese instrumentals. Two interesting stories on the "Golden Monkeys" of south-west China, and the highly successful wine industry of China. (Tom Sullivan, New Orleans, LA)

0329 UTC on 6005

Germany-FRG: RIAS. German. Quick monitoring while BBC is off but now Reloj interference quite bad! Rock music format with laughter and chat from German announcer. Very weak! (Tom Sullivan, New Orleans, LA)

0338 UTC on 4880

South Africa: Radio Five. Music selections from the 1960s with local weather forecast and reggae. (Rod Pearson, St. Augustine, FL)

0350 UTC on 4910

Zambia: Radio Zambia. Zambian vernaculars. Male announcer with frequency schedule. Chat with laughter from two men and lady with ID as "One Zambia" at 0400 UTC. News report and Zambian native music. (Rod Pearson, St. Augustine, FL)

0400 UTC on 4976

Uganda: Radio Uganda. Male announcer with national newscast until 0412. Poor signal with station fading by 0430. (Doug Waller, Bay Village, Ohio)

0400 UTC on 3395.6

Zimbabwe: Z.B.C. English. Lady announcer with national news of Africa. Very weak! (Rod Pearson, St. Augustine, FL)

0420 UTC on 5990

Romania: Radio Bucharest. State commentary on the benefits of socialism with "Bucharest" ID at 0425 UTC. (Mike Loran, Hollywood, FL)

0427 UTC on 4790

Peru: Radio Atlantida. Spanish. Male announcer presents Latin tropical selections, local time checks and station promotional. (Harold Frodge, Midland, MI)

0429 UTC on 4820

Botswana: Radio Botswana. Local station time check and national news covering Kenya and Botswana. Easy-listening music. (Rod Pearson, St. Augustine, FL)

0430 UTC on 6280

Lebanon: King of Hope. Arabic. Religious choral music presented by lady announcer. Continued religious programming and station ID at 0400.

0432 UTC on 6075

Austria: Radio Austria International. Comments and interviews with European students in Austria. Station ID. This 6075 frequency is a new one, not listed in RDI. (Tom Roach, San Jose, CA)

0542 UTC on 5030

Costa Rica: Radio Impacto. Spanish. 50s music from Buddy Holly with usual abundance of "Impacto" IDs. Station sign-off at 0600. (Cliff Goodlet, Chattanooga, TN)

0550 UTC on 4770

Nigeria: Radio Nigeria-Kaduna. Great signal tonight with clear ads for the "Union Bank", "Carson's Imperial Leather soap", and an ad for a local beer. (Carl Volz, Montgomery, IL)

0550 UTC on 11760

Cook Islands: Radio Cook Islands. Very weak signal of pop and South Pacific "island music" monitored. (Doug Waller, Bay Village, Ohio) Nice catch! - ed.

0551 UTC on 4940

Marshall Islands: WSZO. Good signal of pop music and lady announcer's promo for upcoming news. Local ad for a bug killer with abrupt drop of signal. (Tom Roach, San Jose, CA)

0555 UTC on 6900

Turkey: Voice of Meteorology. Turkish. Very weak signal on past listed 0600 sign-off time. Lady announcer with rather pleasant Middle Eastern vocal music. (Doug Waller, Bay Village, Ohio)

0604 UTC on 4870

Benin: ORT de Benin. French. Great signal of radio drama of man and wife argument included! (Carl Volz, Montgomery, IL)

0607 UTC on 4915

Ghana: G.B.C. Station ID and news topics on the Ghanaian sugarcane farms, Ghana's private transportation union and ongoing developments in the Central Region. (Carl Volz, Montgomery, IL)

0610 UTC on 5020

Niger: La Voix du Sahel. Arabic. Half hour of non-stop early morning prayers and recitations for Niger. Very quick ID as "Niamey". (Carl Volz, Montgomery, IL)

0615 UTC on 4815

Burkina Faso: Radio Burkina. French. Fantastic percussion and reggae. One of the best formats you'll find on a West African short-wave station. Noted they were off the air for 10 minutes and reappeared with an ad for "Yamaha". (Carl Volz, Montgomery, IL)

0623 UTC on 6248

Vatican State: Vatican Radio. Italian. Text on community involvement in local church activities. (Carl Volz, Montgomery, IL)

WORLD RADIO NEWS

Let other readers know what you're enjoying.
Send your loggings to **Gayle Van Horn**
160 Lester Drive, Orange Park, FL 32073

0648 UTC on 4845

Mauritania: ORT di Mauritania. Arabic. Upbeat Arabic music (for a change!) with short inspirational music and message. Holy Qur'an and ID at 0700 UTC (Carl Volz, Montgomery, IL)

0655 UTC on 6100

Nicaragua: Voice of Nicaragua. ID observed as "International programming of the voice of Nicaragua" and discussion on the social problems in Cuba and how they might be remedied. (Carl Volz, Montgomery, IL)

0750 UTC on 4920

Australia: ABC Brisbane. Horse racing broadcast with results and payoff on wagers. Station ID and national news at 0800. (Bill Scarbrough, Knoxville, TN)

0804 UTC on 11825

Tahiti: RFO Tahiti, French. Fantastic variety of Polynesian "island" music and occasional western tunes. Not heard in a while for me. (Carl Volz, Montgomery, IL)

0817 UTC on 4885

Brazil: Radio Clube do Para. Portuguese. Three station IDs noted as, "Radio Clube" and radio drama feature with tone-setting background music. (Carl Volz, Montgomery, IL)

0835 UTC on 7415

Pirate Radio-USA: Radio Free Will. Male announcer with transmission in progress. Tunes were mostly instrumental and noted, "only one turntable working" and "will play whatever I can find". Frequency was announced as "7416 and 7415 in the Pirate Radio Band". Station sign-off at 0901 UTC made reference to a nice QSL card and the A.C.E. club. My first Pirate Radio! (Mike Adams, Panama City, FL)

0910 UTC on 9580

Australia: Radio Australia. Special live broadcast of 'Australia Tonight' celebrating the tall ships arrival. (James Kline, Santa Monica, CA)

0920 UTC on 7259.8

Vanuatu: Radio Vanuatu. Bislama. Very weak musical program with phone-in music request and station ID at 0935. (Bill Scarbrough, Knoxville, TN)

0929 UTC on 11805

Guam: KTWR. Station ID and interval signal with religious talk show Quest and Letters from You letterbox show. Good signal until 0950 (James Kline, Santa Monica, CA)

0942 UTC on 4980

Venezuela: Ecos del Torbes. Spanish. Venezuelan guitar music with vocals. ID at 0945. Good signal. (Graham Glover, Fairfax, VA)

0944 UTC on 4865

Brazil: Radio Verde Florestas. Portuguese. Sign-on with musical interval signal. Brief religious sermonette and 0955 national anthem and ID. Brazilian guitar rhythms and news about Brazil.

0945 UTC on 4805

Brazil: Radio Difusora do Amazonas. Portuguese. Brazilian pop style music and male announcer with 0959 station ID. (Graham Glover, Fairfax, VA)

0957 UTC on 4885

Colombia: Ondas del Meta. Spanish. Popular Spanish music selections with station ID and promotional for the 'Super' network affiliation. Fair signal. (Cliff Goodlet, Chattanooga, TN)

1005 UTC on 4945

Colombia: Caracol Neiva. Spanish. Newscast from station announcers and reporters on location story. ID at 1030. (Graham Glover, Fairfax, VA)

1015 UTC on 17885

Ascension Islands: BBC relay. Station ID and classical music record review. (Juan Franco Crespo, Barcelona, Spain)

1020 UTC on 4845

Bolivia: Radio Fides. Spanish. Lovely flute music with break at 1029 by lady announcer. Station ID sounding like "Fee-dezz".

1023 UTC on 4832

Costa Rica: Radio Reloj. Spanish. Lady announcer presents newscast and ID as "Radio Reloj numero uno en Costa Rica". (Graham Glover, Fairfax, VA)

1045 UTC on 4875

Brazil: Radio Nacional-Boa Vista. Portuguese. Male announcer with 'morning show' format of chat, time checks, numerous "Nacional" IDs and rapidly read news items. (Tom Sullivan, New Orleans, LA)

1055 UTC on 3279.8

Ecuador: La Voz Del Napo. Spanish. IDs with prayers and religious sermon text, station ID and morning greeting to listeners.

1110 UTC on 21590

South Africa: Radio RSA. Numerous RSA IDs with talk and commentary on Kenya and Zimbabwe. (Juan Franco Crespo, Barcelona, Spain)

1200 UTC on 9600

USSR-Uzbek SSR: Radio Tashkent. Station ID as, "English Service of Radio Tashkent" followed by news and instrumental music. (Leslie Edwards, Doylestown, PA)

1240 UTC on 15165

Denmark: Radio Denmark. Danish. Presumed national news of Denmark and station interval signal. English ID as "Radio Denmark". (Tom Sullivan, New Orleans, LA)

1240 UTC on 3315

Papua New Guinea: Admiralty Islands. Radio Manus. Pidgin and English. Lady announcer with local Papua New Guinea time check, "Island" music and local news bits. English ID at 1245 and country and western music.

1244 UTC on 3260

Papua New Guinea: Radio Madang. Pidgin. Male announcer with program announcements, mentioned "Papua New Guinea" and plays country and western tunes.

1245 UTC on 15525

Bangladesh: Radio Bangladesh. Closing portions of international news followed by marvelous sitar music and 1245 station ID. Lady with national news of Bangladesh into rock music by Bob Seger.

1250 UTC on 15155

France: Radio France International. Editorial comments and excerpts from the Parisian newspapers. Feature story on the 'Museum and Exhibition Fair' with art works from major French museums. (ed. log)

1250 UTC on 3335

Papua New Guinea: Radio East Sepik. Pidgin. Local "island" music with talk, ID and music dedications between selections. Local time check with station fade by 1310. Good signal! (Tom Sullivan, New Orleans, LA)

1257 UTC on 3385

Papua New Guinea: Radio East New Britain. Pidgin. Friendly chat among announcers followed by pop and country and western music.

1302 UTC on 12030

Switzerland: Swiss Radio International. Commentary on terrorism threats from North Korea and the renewed debate on Swiss women and the Armed Forces. (Rod Pearson, St. Augustine, FL)

1314 UTC on 15385

Oman: Radio Oman. Arabic. Arabic style music with Islamic religious prayers (didn't sound like a Qur'an). Male announcer with station ID and sign-off at 1400. Parallel frequency of 9735 poor. (Rod Pearson, St. Augustine, FL)

1318 UTC on 4890

Papua New Guinea: N.B.C. - Port Moresby. Pop and country and western music with station ID and local evening time check for Port Moresby. (Cliff Goodlet, Chattanooga, TN)

1500 UTC on 9560

Ethiopia: Voice of Ethiopia. Health program on Vitamin A deficiency battling with interference from 9555 and 9565 KHZ. (James Kline, Santa Monica, CA)

1830 UTC on 6020

Netherlands: Radio Netherlands-Flevo. Station ID with news covering international and South American topics. (Juan Franco Crespo, Barcelona, Spain)

1915 UTC on 9510

Algeria: Radio Algeria. Lady announcer presents pop music and station news feature 'This Week in Algeria' with commentary. Heard parallel signal on 9510 KHZ. (Harold Frodge, Midland, MI)

1950 UTC on 9022

Iran: Voice of the Islamic Republic of Iran. Barely audible program with commentary on the C.I.A. at 2015. Substantial signal improvement in Arabic at 2030 UTC. (Mike Loran, Hollywood, FL)

2105 UTC on 117715

USA: KUSW-Salt Lake City. Numerous IDs as "super power KUSW from the west to the world", pop music selections, station program schedule and local commercials. (Harold Frodge, Midland, MI)

2207 UTC on 7355

USA: WRNO-New Orleans. Music from rock groups The Pet Shop Boys and Super Tramp with continued Top 30 USA show. (Lloyd Van Horn, Orange Park, FL)

2230 UTC on 15474

Antarctica: Radio Nacional LRA36. Spanish. Pop style music presented by lady announcer. (Doug Waller, Bay Village, Ohio) keep after this one Doug, they usually sign-off around 0030. ed.

2240 UTC on 11720

Bulgaria: Radio Sofia. Rather dry commentary on the "29th Anniversary of the Cuban Revolution". (Cliff Goodlet, Chattanooga, TN)

Scanning The Nation

Bob Kay
104 Bonsal Avenue
Glenolden, PA 19036

User-Programmable Transceivers on the Way Out

The FCC has ruled to phase out the manufacturing and sale of externally programmable transceivers. It seems a lot of people were programming and using frequencies without FCC approval. Shame on all those individuals that took advantage of Uncle.

Computer Chips that will Soup Up Your Scanner

We lied. There isn't a chip available that will turn your scanner into a mean scanning machine. But there is a chip designed for your car. Hypertech produces a Power Chip that installs in place of the stock data chip in your car's computer. The Power Chip retunes the information stored in the car's computer and changes the engines air/fuel ratio and spark advance for optimum performance.

Currently, there are three chips available for street, off road and racing. Now if only the scanner manufacturers would take the hint!

From Cordless Monitoring to Phone Phreaking

Computer hackers, nationwide, have tampered with Bell and American Telephone & Telegraph Corporate Telecommunications Computers.

The hackers had discovered flaws in security on the computers that control switching and billing equipment for telephone operating companies. In one situation, the hackers turned off thousands of phones to cut phone company revenues.

The main activity was called "Phone Phreaking." Hackers learned how to turn phones on or off virtually anywhere in the country. They also obtained unlisted numbers and discovered calls, times and billings of phone customers.

The main target of the Phone Phreaks were the "COSMOS" and "LMOS" computers. One hacker said that there were some "real neat" holes in the phone company security system. Another hacker said, "It was a lot of fun!"

The fun, which lasted over a few months, is estimated to have cost the phone companies millions of dollars!

The Soviets are Using Money, Sex and Psychology to Get Our Secrets

An ex-KGB agent, Major Stan Levchenko, who asked for political asylum in the United States, said that it is not easy to recruit Americans.

Levchenko stated that it was difficult to handle Americans because the FBI and other parts of American counter intelligence do a good job!

Levchenko further stated that KGB agents are not only schooled in intelligence gathering, but also in psychology and the sexual behavior of American men and women. In order to recruit one "spy," Russian agents will often secretly review and talk with as many as fifty contacts.

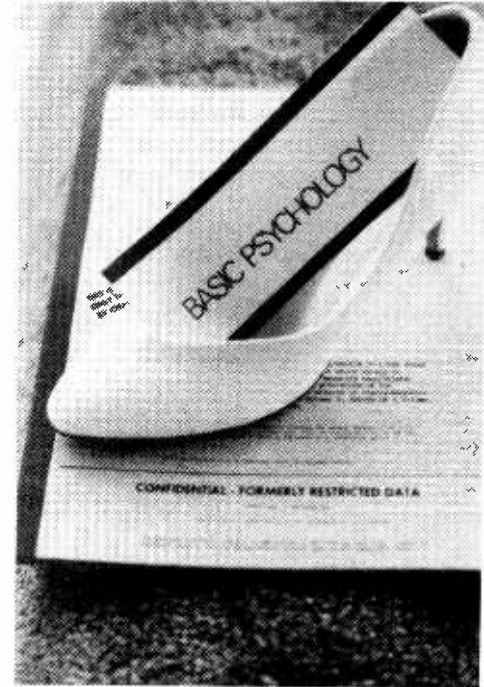

When a KGB agent does recruit a key American source, he automatically earns one of the highest awards in the Soviet Union--"The Order of Lenin."

In contrast, any Russian found guilty of giving secrets to the western world is automatically shot!

Revisiting the Unfriendly Skies

In April's column I poked fun at the Federal Aviation Association and listed some very sobering statistics on airline safety.

Afterwards, my mailbox was full of letters from concerned readers that requested and in some cases, supplied additional information. One letter in particular came from a former striking controller that had been fired by President Reagan.

Taking into consideration that the fired controller's letter could be somewhat biased, other agencies were contacted for additional information and the findings are presented below. Readers that may have been upset by April's air safety facts are advised not to read any further.

Currently, 13,000 controllers direct air traffic. Before the strike, 16,000 controllers did the same job. Of the 13,000 controllers working, only 9,300 are fully trained. Half of the 9,300 are only "developmental" controllers which cannot direct traffic without assistance. At the present, air traffic is 25 percent higher than before the strike. In relation to traffic, controller staffing is down by forty percent.

Prior to the strike, it took a controller four years to move up from trainee to full performance status. New controllers are now pushed ahead to full status in two years!

WORLD RADIO NEWS

Seventy percent of controllers believe that they handle too much traffic at peak hours. According to the controllers, overtime is 240 percent over what was worked in pre-strike times.

The Flight Safety Foundation stated: "The present controller system does not provide the same level of safety as before the strike."

According to PATCO Lives, an organization of ex-strikers, there have been problems in every air accident with the controllers. PATCO further stated that, "Controllers may not be the direct cause of an accident, but controller fatigue is a direct cause in many air accidents."

The chairman of the Eastern Airlines Pilot Association said that with the number of air planes increasing, fewer controllers and less experienced controllers simply means a decrease in airline safety.

The National Transportation Safety Board said, "Supervisors of air traffic controllers are actually handling traffic on a routine basis. The supervisor should be free to instantly fit in between controllers when they need assistance. The solution is to hire more controllers."

However, to get the needed additional 1,000 controllers, over 2,500 will have to be hired. More than half of the trainees drop out! There is also a teacher shortage. Controllers are complaining that full performance level controllers that have only held the title for as little as eight months are training new students.

The FAA responds to all of this by saying that the system is safe. It denies that there is general understaffing. The FAA stated, "The system was overstaffed *before* the strike."

An unconfirmed report hints that certain members of Congress agree that the only quick way to inject safety back into the skies is to re-hire the fired controllers.

We saved the good news for last: The Airline Pilots Association and the Federal Aviation Administration have set up an alcoholism recovery program. Why? Because over sixteen thousand pilots, both commercial and private, are flying airplanes while under the influence of alcohol.

For Government Eyes Only

To prevent unwanted users from monitoring computer signals, the Department of Defense will begin incorporating encryption functions into PC networks by late this year.

Which Way Did They Go?

The St. Louis County Police helicopter assigned to the vice-president's motorcade lost sight of the procession and was heard asking for assistance over a local helicopter frequency. After enduring a ration of embarrassing remarks by fellow helicopter pilots, the exact location of the motorcade was finally given to the police chopper. (Union, MO. Name withheld by request.)

Polaroid Wants a Piece of the Action

In April's column we mentioned that Kodak had a toll free number that provided hints on taking better quality pictures. Well, friends, Polaroid dropped us a note and asked if we would print their toll free number. Although Polaroid pics cannot be used by MT, we figured a lot of

our readers would be interested anyway. So for all the Polaroid fans out there, here's the number: 1-800-225-1206.

Moving Up

For anyone having difficulty monitoring the San Antonio Police Department, they have moved. No, not physically--electronically. The San Antonio Police are now operating between 856-860 and 898-902 MHz. (Submitted by John Carr, San Antonio, CA)

FREQUENCY LIST

Frequencies for Evansville, Indiana, are submitted by Mike Borman, Evansville, IN.

Evansville, Indiana

154.815	Police
154.89	Police
153.95	Fire
155.22	Ambulance
155.34	Ambulance
155.235	Ambulance & St. Mary's Hospital Security
467.975	Life Flight Helicopter
158.22	Gas Company
153.56	Electric Company
158.13	Electric Company
158.835	Waterworks Department
173.275	Newspaper

Indiana statewide

42.42	State Police
42.455	State Police
155.475	State Police
155.025	Civil Defense

Television Crews

161.755	WGBF Radio
161.7	WKDQ Radio
455.7	WYNG Radio
450.1125	WFIE TV, "Live Eye 14"
461.3	WEHT TV
463.225	WTVW TV
461.275	Cable TV Installers

Reply Policy

For everyone that wrote to me concerning this column, may I say, "Thank you!" For a personal reply to your letters, an SASE is required. For those individuals that are sending frequency lists, your response is also greatly appreciated.

I do pledge to review everything that arrives in the mail bag. If there is a specific area of scanning that you would like to see covered in MT, all it takes is a letter to start me writing. So drop me a note! My address is at the top of this column.

Bob Kay

Utility World

Larry Van Horn
160 Lester Drive
Orange Park, FL 32073



MONITORING TIMES

Volume 3-Number 4 BRASSFIELD, NORTH CAROLINA 27807 April, 1984

U.S. NUMBERS STATION FOUND!

...Revisited!

For more than twenty-five years, shortwave listeners and utility monitors have been puzzled by the mysterious broadcasts of so-called "number stations." The newcomer to the hobby usually finds a number station the first time he ventures outside the international broadcast or ham bands.

You hear a stilted, mechanical female voice transmitting groups of numbers for several minutes. The transmissions end abruptly with no station identification. Numbers stations transmit in a variety of languages and message formats, English and Spanish being most often noted in North America.

But what is the purpose of these stations? Over the years a number of theories have been proposed. Some have speculated that the numbers stations are used to broadcast spy messages, lottery numbers, bank account information, business data, navigation information and military messages. One author has even suggested that "They could have no purpose whatsoever."

Theories for the locations of the transmitters have been just as varied. Some of the "five digit" Spanish stations are believed to transmit from Cuba. German numbers appear to originate from Nauen, East Germany. And the United States also has number stations. Some "four-digit" number broadcasts transmitting in both English and Spanish originate right here. But still there are questions.

There have also been stories -- frightening stories of things that happen to those people who get too close to the answers. Mysterious phone calls late at night, punctuated by the sound of a gun -- hammer striking an empty chamber. The appearance of stern looking men in sunglasses and dark suits. And that overwhelming feeling of being followed.

First Transmitter Located

In April, 1984, *Monitoring Times* revealed for the first time that the location of one 4-digit number transmitter had been found by a mathematics professor from a small Connecticut college.

This *MT* reader had found, nestled in the rolling hills of eastern Virginia near Washington D.C., a series of barbed-wire-enclosed military installations. Armed with a Kenwood R-1000 receiver, he sat outside the gate of one of these installations just before the beginning of a "four-digit" number broadcast. Tuned to 9047 kHz, a local quality carrier came on the air: "Uno, dos, tres . . ." the familiar count began.

More Surprises to Come

This was only the first of two surprises. The professor also noted, slightly off frequency, the key clicks of a powerful Morse code (CW) station. Retuning his receiver, he found that the CW signal was transmitting the QRA marker signal of KKN50. KKN50 is officially assigned to the U.S. State Department.

The evidence was unmistakable. The broadcasts were coming from the very military installation he was parked next to.

Following the Trail

But what is this installation and who runs it? The sign on the gate read, "Warrenton Training Center, NCS, Station C, U.S. Army"; if there was a Station "C" there had to be an "A" and "B" stations. The "A" and "B" stations were found as well as a "D" station.

Still, that was only part of the answer. What about this NCS on the sign? And the U.S. Army? And how about the State Department radio station being at the same site?

James Bamford, the author of *The Puzzle Palace* (See the exclusive interview in this issue), in an article published in the December 4, 1983, issue of the *Washington Post* magazine, disclosed that the NCS apparently stands for "National Communication System."

Coming in Out of the Cold

One *MT* reader has come out of the cold to give us the following information on the NCS system. Our own Mr. DCA states:

By memorandum to heads of all executive departments and agencies, August 21, 1963, the National Communications system was established by the President. Its objective is to provide necessary communications for the president and the federal government under all conditions ranging from a normal situation to national emergencies and international crises including nuclear attack. The NCS was developed by linking together communications facilities and components of the various federal agencies.

Mr. DCA further states that, "The Secretary of Defense serves as the executive agent for the NCS while the director, Defense Communications Agency, is the manager."

"It would be correct to say that the efforts of all branches of the federal government, both civilian and military, are part of the overall NCS, even though each department and branch has its individual organization, methods, and procedures," Mr. DCA said.

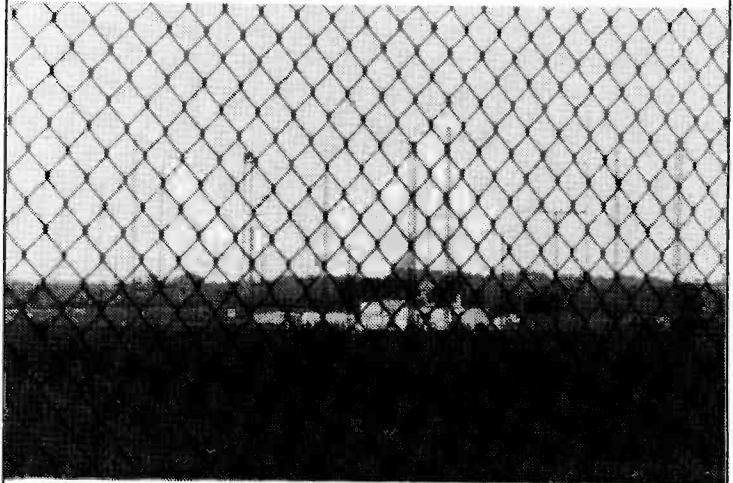

"Station C"

Next month: Exclusive to MT - Site of Florida's numbers station found plus what the messages mean!!

WORLD RADIO NEWS

Putting the Warrenton Puzzle Together

One of the more interesting aspects of this NCS puzzle is the fact that WGY915 (callsign assigned to the Federal Emergency Management Agency or "FEMA") is the FEMA part of the NCS which is located at Arlington, Va. This station transmits on FEMA channels. This same location houses the Pentagon's National Military Command Center and is headquarters for the Defense Communication Agency, manager of the NCS.

But by far the most revealing facts of the Warrenton maze is that the Warrenton training center reportedly contains a Federal Relocation Center. Relocation centers are those sites run by FEMA to which selected government personnel would go in case of nuclear war. From these sites our government could continue to function. The Warrenton site houses such a relocation bunker for an unidentified government agency.

Or is this agency unknown? We have already established the fact that State Department radio station KKN50 transmits from this site.

Victor Marchetti in his book, The CIA and the Cult of Intelligence, states: "The office of communication (CIA) . . . maintains facilities for secret communications between CIA headquarters and the hundreds of stations and bases overseas." These hundreds of stations and bases overseas are usually consulates and embassies. CIA personnel use State Department facilities as covers for their operations.

Marchetti further states, "The office of communications also provides communication services on a reimbursable basis, for the State Department and most of its embassies and consulates."

We can now infer from the above information, both operations--numbers and KKN50--at Warrenton are CIA run. The number stations broadcast are probably intended for CIA field operatives in State Department facilities and this would explain the secrecy associated with number stations over the years. KKN50 is but one station in a HF network intended as a backup to normal communications for the State Department and its embassies and consulates overseas. These CIA and State Department networks probably come under the NCS umbrella.

Chances are good that whatever federal agency has its relocation center at Warrenton would want its communications facility at the same site. More than likely the Warrenton site is the relocation center for the CIA and the NSA/CSS (National Security Agency/Central Security Service). NSA/CSS has monitoring posts located in the area of Vint Hills Farms, Virginia.

And as for the U.S. Army involvement at Warrenton?

At Winchester, VA, northwest of Warrenton, the Army Interagency Communications Agency has a communication unit supporting Mount Weather in Bluemount and other federal relocation centers in the Washington, D.C. area, of which Warrenton is one of the centers.

It would appear, to use an analogy, that NCS is the head of

TABLE ONE
NASA Malabar (Palm Bay) HF Networks

2405	Data Buoys	2622	SRB Recovery Primary
2664	Backup Mission Audio-Cape to Houston		
2678	ETR Range Control	2716	Navy Harbor Cntl-Port Canaveral
2764	SRB Recovery Channel	3024	Coast Guard Sar-Primary
3187	SRB Recovery Ships Channel	4376	Primary Recovery Zone Sar
4510	SRB Recovery Ships Channel	4856	Cape Radio/Leader
4992	Cape Radio/Coast Guard Ships	5180	NASA Tracking Ships
5187	NASA Tracking Ships	5190	ETR Primary Night Channel
5350	Launch Support Aircraft	5680	Launch Support Ships
5810	ETR-Secondary Night Channel	6720	Sar Primary Atlantic
6896	Cape Radio	6937	Cape Radio
7412	Sar Comms with Bahamas	7461	Cape Radio/Launch Support A/C
7525	NASA Ground Tracking Net	7676	Launch Support Aircraft
7765	Srb Recovery Ships	7919	Data Channel
7985	Data Channel	9022	Launch Support Aircraft
9043	Launch Support Aircraft	9132	Launch Support Aircraft
10305	Space Missile Tactical Net	10310	Malabar to Ascension Is-MUX
10780	ETR-Primary Day Channel	11104	Launch Support Ships
		11252	Launch Support Operations
11407	Srb Recovery Ships	11414	Cape Radio
11548	Cape Radio	11621	Srb Recovery Ships
		13227	Launch Support Aircraft
13237	Data Channel	13495	Data Channel
13600	Malabar to Ascension Is/MUX	13878	Launch Support Aircraft
14937	Ascension Is to Malabar-MUX		
18009	Launch Support Ships	19303	Launch Support Ships
19640	Cape Radio	19966	Ascension Is to Malabar-MUX
20186	Launch Tracking Net	20192	Malabar to Ascension Is-MUX
20198	OCC Shuttle Mission Audio	20390	ETR-Secondary Day Channel
22755	Ascension Is to Malabar-MUX	23413	Cape Radio
27065	NASA CB Radios		

TABLE TWO
US Navy Malabar Transmitter Presets

3130	Facsfac Jacksonville	5718	Atlantic Fleet Ship
6693	Atlantic (ATL) Fleet Aircraft	6708	ATL Fleet Ships/Aircraft
6723	Navy Atcom Channel	8779	ATL Fleet Ships
8972	ATL Fleet Safety of Flight Ch	8981	Navy P-3 A/C to NASA Channel
9006	ATL Fleet A/C Duplex W/11205	11205	ATL Fleet A/C Duplex W/9007
13172	ATL Fleet Ships/Aircraft	15021	ATL Fleet Ships
15051	ATL Fleet Ships	15057	ATL Fleet Ships
15067	ATL Fleet Ships Tactical	16167	Navy Fixed Net Channel
16419	Navy Fixed Net Channel	18019	ATL Fleet Aircraft
22687	ATL Fleet Ships	23224	ATL Fleet Aircraft

Also 6742 and 11252 can be substituted for 3130

the octopus and all other agencies and departments and their communication systems make up the tentacles.

So there you have it, another piece of the numbers puzzle is now in place. The existence of the NCS would explain some of the confusion about KKN50, the army, and the "four-digit" numbers stations being at the same location. While we still have many unanswered questions about number stations and the NCS, we, at least, now know about some of the agencies that are involved at Warrenton.

Monitoring NASA on HF

Spaceport, USA, is back in business, and HF utility listeners can catch some of the action.

Satellite launches using expendable rockets are again being

TABLE THREE
NASA Associated Coast Guard Channels

2103	Intra-coast Guard Usage	2182	International Distress Ch
2261	Air-to-ground Channel	2638	Non-sked Urgent & Safety B/C
2667	Intra-coast Guard Usage	2670	Sked & Nonsked Marine Info
2691	7th CG District Operations	2738	Ship-shore & Ship-ship
2830	Ship-shore & Ship-ship	3023	Intl Sar Channel
3123	Air-to-ground (USN Shares Ch)	4376	CG Sar Ch During STS-51L
5680	Intl Sar Channel	5692	Air-to-ground Helo (USN shares)
5696	Air-to-ground, Pri (USN shares)	8984	Air-to-ground, Pri (USN shares)

TABLE FOUR
NASA Reserved HF Frequencies

2505	2744	2800	2836	3120	3365	4500	4704	4714
4755	4825	4860	4900	5060	5235	5246	5436	5775
5822	6750	6753	6810	6880	6919	7313		7605
7697	7742	7804	7833	7860	7910	8077	8993	9018
9115	9138	9170	9910	10159	10215	10230	10270	10301
10327	10475	10850	10880	10905	10949	11634	11984	11988
12107	12160	12277	12876	12287	13210	13244	13380	13468
13676	13735	13742	14497	14585	14615	14650	14896	14967
15025	15064	15484	15487	15528	15560	15564	15575	15610
15698	16216	16246	17470	17490	17554	17668		
18022	18051	18196	18310	18331	18354	18434	18700	18769
18801	18990	19126	19143	19371	19390	19928	19963	20266
20272	20475	20690	21810	22683	22990	23035	23281	23325
23479	23485	23661	23840	23940	24240	24512	24530	24780
24914	25130	25161	25198	25245	25597	26356	26389	26515
26684	27720							

It is the responsibility of Coast Guard units to keep the restricted area off shore from the Cape clear of marine traffic. Table three lists the most commonly heard Coast Guard channels on HF used during launches from the Cape.

There are several backup channels that are not in current use. Most government agencies have a hard time getting new frequency allocations from the government's FCC, IRAC (Interagency Radio Advisory Committee). Consequently, agencies are very reluctant to turn in a channel even if they currently aren't using it. Table four is a complete list of assigned but dormant NASA/USAF allocations that could be used during future missions.

Updated information on NASA HF networks would be appreciated. Information is also solicited on VHF/UHF NASA related frequencies. Information should be addressed to "Project NASA", care of the address in this column's masthead.

NASA mission communications on HF can be very interesting and even exciting to listen to at times. Just ask anyone who monitored the Challenger disaster search-and-rescue communications in January of 1986. Those who chose to monitor NASA network communications will be prepared in case the unexpected or the unthinkable should happen again.

Latin America Military Comms

Several utility world monitors have reported this month Contra military communications in the frequency range from 7.5 to 8.0 MHz. Communications are in lower sideband and Spanish has been the only language heard. One frequency noted recently was 7933 kHz in the late afternoon and early evening hours.

Mexican military communications have been monitored on 11401 kHz lower sideband. The primary station noted on this frequency was heard passing radiograms by a male operator in Spanish. Radiogram traffic included such topics as military operations, personnel needs, and opposition political party intelligence.

And finally, a possible Panamanian military traffic frequency or diplomatic channel has been monitored on 10101 kHz in upper sideband. Our anonymous reporter indicates this could be a very interesting channel to monitor in the near future if you have a knowledge of Spanish.

Utility Abbreviations Used in this Column

*All times UTC, frequencies in kilohertz
All voice transmissions are English unless
otherwise noted*

AM	Amplitude Modulation
ARQ	Sitor
CW	Morse Code
FAX	Facsimile
FEC	Forward Error Correction
ID	Identification
ISB	Independent Sideband
LSB	Lower Sideband
RTTY	Radioteletype
UNID	Unidentified
USB	Upper Sideband

routinely launched from Cape Canaveral. As the launch rate continues to climb to pre-Challenger levels, so has the HF traffic used to support these missions.

Several months ago, project NASA was started by MT to map the radio spectrum that NASA and other support agencies use during space missions. A lot of MT readers have submitted information for the project and the results will be published prior to the launch of the shuttle Discovery, later this year.

Since unmanned launches have started up again, a lot of listeners would like to monitor these launches. Table one reflects current NASA/USAF HF networks in use. Listeners must keep in mind that HF frequencies are primarily backup circuits to terrestrial and satellite links therefore, don't expect a lot of activity on these channels.

Most space launches from the Cape utilize military units and communications to support launches. Three main branches of the military are involved with most space launches -- the Air Force, Navy, and Coast Guard.

In most cases, countdowns for space launches start about 48 hours prior to liftoff. Usually at this time the mission director will callup all stations involved with the launch and test all communication circuits. This is usually a good time to get a handle on what frequencies to start monitoring. Ute monitors must keep in mind that frequency circuits in use will depend on propagation from the Cape to stations in the network, not to the monitor's location.

The primary radio site for NASA communications is located at Malabar, FL. This site is maintained and leased from RCA communications. There are 20 transmitters located at this site that can be used for NASA mission support.

The Navy also has a transmitter at Malabar with 20 preset channels (see table two). Normally operators will establish contact with Navy units involved with the launch via this transmitter and direct them to channels in use from table one.

The Coast Guard plays a very large role in any NASA launch.

WORLD RADIO NEWS

Utility Loggings

- 2696.8 GLD-Land's End, England with an ARQ Idler and callsign only CW ID at 0025.
- 2716.0 USS Preble calling Naval Station Mayport (FL) for a radio check at 1334 in USB. (Gayle Van Horn, Orange Park, FL) US Navy harbor common channel-ed.
- 3245.0 Spanish female 5-digit number station with a poor signal at 0336. (Harold Frodge, Midland, MI) Welcome to the column Harold, Please report often-ed.
- 3365.0 JMJ-Tokyo, Japan with a weak FAX signal at 1028.
- 4143.6 Shore Station KCE27 working the tanker Ander with routine messages. Mentioned about a meeting with Esso officials and Alan Greenspan was due on the ship later in the week for inspection of a ship problem. Talked about the parts needed for the fix. (Gayle Van Horn)
City Blue 2033 (a barge) working a shore station giving a list of materials to pick up at Kentucky Lake docks. (Gayle Van Horn, Orange Park, FL)
- 4229.0 VIP4-Perth radio, Australia monitored at 1300 with a CW V marker.
- 4235.0 VAI-Canadian Coast Guard, Vancouver, BC heard with a CQ CW marker at 1302.
- 4245.0 VIS-Sydney radio, Australia with a CW V marker at 1306. Noted heavy interference on this channel.
- 4265.0 English female 5-digit number station noted at 0315. Each number set repeated, series started with "468 39720 95246." Repeated groups started at 0319. (Harold Frodge, Midland, MI)
- 4268.0 CKN-Esquimalt, BC, Canada heard at 1041 with a weak FAX signal.
- 4306.0 Spanish female 4-digit number station at 0320 with heavy utility station interference. (Harold Frodge, Midland, MI)
- 4350.5 WNU-slidell radio, La with a DE CW marker at 1423.
- 4355.0 WLO-Mobile radio, AL with a callsign only CW marker and ARQ Idler at 1421.
4391.5 WOM-High seas Miami radio, FL working the vessel Renegade running phone patch traffic in USB at 1419. This is ship-to-shore channel 412 and the ship side is on 4097.1.
- 4722.0 MVU-Royal Air Force Volmet West Drayton, England at 0252 in USB with aviation weather (Harold Frodge, Midland, MI)
- 4746.0 USAF GCCS-McClellan AFB, CA transmitting a skyking broadcast at 0614 in USB. (David Kammler, Ridgecrest, CA) Welcome back, David-ed.
- 5144.0 English female 3/2-digit number station noted at 0312. (Harold Frodge, Midland, MI)
- 5486.0 Foreplay forward working foreplay rear with the following message, "I need toilet paper, a bag of salt and a pay roster for the first." at 0136 in USB. (Harold Frodge, Midland, MI) Must be a military tactical channel Harold, I don't have this one on any of my lists.
- 5505.0 Volmet-Shannon Radio, Ireland noted at 0348 with a USB continuous weather broadcast. Apparent new channel for this one.
- 5547.0 Aeroradio ATC-Honolulu, HI working United 1 in USB giving arrival time at Honolulu International Airport and other flight information. (David Kammler, Ridgecrest, CA)
- 5870.0 NAR-Key West, FL at 1356 with a CW CQ marker.
- 6100.0 YVTO-Observatorio Naval Cagigal, Venezuela-noted time pips each second and time announcements each minute in Spanish at 1120. (Cliff Goodlet, Chattanooga, TN) Welcome to Utility World Cliff, Please report often.
- 6365.5 KFS-San Francisco Radio, CA heard with a CQ marker at 1403 even with WPD-Tampa Radio, FL with a CQ marker also.
- 6430.0 CFH-Canadian Forces Halifax, NS monitored with a V/CQ marker then into traffic at 1405.
- 6446.5 WLO-Mobile Radio, AL with CW traffic at 1406.
- 6477.5 KPH-San Francisco, CA heard at 1409 with a V marker in CW.
- 6484.5 WSC-Tuckerton Radio, NJ monitored with a CQ marker at 1410.
- 6495.5 KFS-San Francisco Radio, CA with a CW DE marker at 1412.
- 6577.0 Aeroradio ATC-New York, NY working American 663, Eastern 947 and Clipper (PanAm) 505 at 1507 in USB. Aircraft passing flight level and clearance information. (Gayle Van Horn, Orange Park, FL)
Cubana Airlines 818 working New York/San Juan ATC at 1440 in USB.
- 6606.0 Gander Radio Volmet at 0227 in USB with Canadian aviation weather. (Harold Frodge, Midland, MI)
- 6750.0 CUW-USAF Lajes AFB, Azores noted with a skyking broadcast at 0536 in USB.
6802.0 Spanish female 4-digit number station heard at 0115. Signal parallel with 11532 kHz.
- 6840.0 English female 3/2-digit numbers station noted at 2300. Starting at 2329 as the station started repeating the whole broadcast another station operated by a male start antagonizing repeating vulgar saying in the dead air between number groups. The agitator obviously knew a lot of information about number stations. The number station cut transmitter at 2350 leaving the number agitator alone on the channel. He said he hoped someone could hear him and wondered if someone was monitoring at the FCC field office. Wonder if this guy QSLs???
- 6870.0 Possible male numbers station noted on this frequency. Ended the broadcast with "terminate." Station was in USB at 0532.
- 6955.0 Deutsche Welle Feeder Relay noted at 0526 in USB transmitting the station's interval signal. (Gayle Van Horn, Orange Park, FL)
- 7571.8 AJE-USAF Wolvey, England noted a MUX signal and an AFRTS on LSB at 0514. Signal here parallel to 6030 kHz. (Gayle Van Horn, Orange Park, FL)
- 7600.0 HD210A-Instituto Oceanografico de la Armada, Ecuador noted time pips each second and time announcements each minute in Spanish at 2333. (Cliff Goodlet, Chattanooga, TN)
- 7892.5 SPW-Warsaw Radio, Poland with a callsign only CW marker and idler at 0402.
7935.0 Enterprise (2nd Combat Information System GRP) working Acrobat (Andrews AFB, DC) working each other on a full duplex channel. 7935 is the Enterprise side. They are located in Palmarola AB, Honduras providing autovon support to Red Horse (The USAF Seabees). Acrobat was using 7447.0 kHz for the other side of the duplex system.
- 8137.1 'U' Beacon, Mumansk, Russia noted at 0347 with a strong signal.
- 8445.5 WLO-Mobile Radio, AL heard at 1415 with ship traffic in CW.
- 8453.0 VAI-Canadian Coast Guard, Vancouver, BC monitored at 1416 with a CQ CW marker.
8525.0 WNU33-Slidell Radio, LA with a CQ CW marker at 1444.
- 8558.4 KFS-San Francisco Radio, CA heard with a CQ CW marker at 1445.
- 8568.5 XFM-Manzanillo Radio, Mexico monitored at 1446 with a CW CQ marker.
- 8586.0 WCC-Chatham Radio, MA at 1447 with a V CW marker.
- 8597.0 VIP-Perth Radio, Australia heard at 1448 with a V CW marker. Noted woodpecker interference.
- 8618.0 KPH-San Francisco Radio, CA at 1449 with a V marker in CW.
- 8630.0 WCC-Chatham Radio, MA heard at 1450 with a CW CQ marker.
- 8642.0 KPH-San Francisco Radio, CA monitored with a V CW marker at 1451.
- 8666.0 KLC-Galveston Radio, TX at 1452 with a CQ CW marker signal then into ship traffic.
- 8697.0 CFH-Canadian Forces, Halifax, NS with a CW V marker at 1453.
- 8705.5 WNU-Slidell, LA heard with a CW DE marker and ARQ Idler at 1454.
- 8707.0 WLO-Mobile Radio, AL monitored with a callsign only CW marker and ARQ marker at 1455.
- 8708.5 WPD-Tampa Radio, FL at 1456 with a CW CQ marker.
- 8709.0 KLC-Galveston Radio, TX with a CW DE marker at 1457.
- 8811.9 WOM-High seas Miami Radio, FL working the Sun Viking in USB at 0320.
- 8837.0 Two males speaking French, one asked for a Selcal check at 0328 in USB.
- 8933.0 Springbok Radio, Johannesburg, South Africa working unknown aircraft at 0317 in USB. This is a LDOC channel for South African Airlines.
- 8957.0 Shannon Aero Volmet noted here with continuous aviation weather information at 0308 in USB. Station IDed as Shannon Volmet.
- 8964.0 USAF GCCS, Hickam AFB, HI working aircraft 1513 at 0305 in USB.
- 8967.0 Unknown station noted at 0338 in USB with a skyking broadcast.
CUW-USAF Lajes, Azores at 0300 giving weather conditions and aviation forecast by a female operator in USB.
- 8972.0 7GJ working H2O at 0330 then relayed the following traffic to 3ZZ, break group count 3 W7E7T2IX5. After message 3ZZ said to standby for SQL. This is a Navy Atlantic Safety of Flight channel.
- 8988.0 MKL-Royal Air Force, Edinburgh, England noted at 0301 transmitting their CW callsign.
- 8989.0 USAF GCCS-McClellan AFB, CA noted at 0312 with a skyking broadcast in USB. Also noted at 0318 working Gold Eagle (USS Carl Vinson, CV-70). At 0333 the Vinson was working via McClellan phone patch 'Beaver' (PT Mugu, CA). Interesting to see these stations on an USAF GCCS channel.
- 9002.0 Several US Navy units heard in the clear at 0257 in USB then all units into the green (Scramble mode).
- 9027.0 Ground station "Jethro" transmitting a skyking broadcast at 0303 in USB. This is a SAC channel.
- 9118.5 GPA4-callsign only and ARQ Idler heard on this frequency at 0252. Anyone know what station in England this is?
- 9239.6 AJE-USAF Wolvey, England AFRTS feeder in USB at 0242, noted parallel to 6030. (Gayle Van Horn, Orange Park, FL)
- 9242.2 AJE-USAF Wolvey, England AFRTS feeder in LSB at 1746, noted parallel to 6030. (Gayle Van Horn, Orange Park, FL)
- 10101.0 Spanish speaking male and female talking about Panama in USB at 0255. Possible Panamanian Diplomatic or military channel.
- 10310.8 AFE71-Cape Radio FDM system signal at 0245 with a super strong signal.
- 10610.0 Unid Spanish language net heard at 0231. Male Spanish operator transmitting 5 letter groups. Transmissions in LSB.
- 10637.0 KKN50-Department of State Radio, Warrenton/Remington, VA heard at 0226 with a CW QRA marker.
- 10945.0 CFH-Canadian Forces Halifax, NS, Canada monitored at 0212 with a CW C13L (NAWS) marker.
- 11182.2 Two Spanish speaking males noted here at 1910 in USB. Signals real weak.

WORLD RADIO NEWS

- 11205.0 Romeo 4 Kilo working an unknown unit then gave a 1-10 test count at 1743 in USB. This is probably a US Navy channel.
- 11233.0 Trenton Military, Canada working an Unid Aircraft passing weather information at 1443 in USB. Edmonton military, Canada working Canforce 525 at 1841 in USB. Told the aircraft that primary is 11233 and secondary is 13257.
- 11239.0 USAF-GCCS McClellan AFB, CA working an unknown MAC flight at 1853 in USB.
- 11246.0 Backscatter, Freedom and Birdsnest working each other in USB. Female operator came and announced 6 minutes to launch at 0304. She announces time to launch every minute and then counts down the last 10 seconds. Then at launch (0310) Backscatter tells Freedom that the launch was at time one zero. Then nothing more. What is this? (Ted Powers, Columbus, GA) Ted welcome to Utility World. I monitored the same group a few days ago and they were working with a remote piloted vehicle (RPV) for a missile launch. Geo-coordinates given indicates they were in the Caribbean (probably around Puerto Rico). These are probably US Air Force units. This one bears watching-ed.
- 11288.0 Two aircraft, 330 working 428 noted on this frequency at 1436 in USB. 330 told 428 to return to scan.
- 11300.0 Aeroradio ATC-Cairo, Egypt working Air France 100F, a Concorde SST flying from Paris to Djibouti. Noted at 2339 in USB. Based on coordinates given by the aircraft, I used my HP-41CX calculator to figure the air speed at 1,118.5 knots at flight level 60,000 feet. (Ensign Michael P. Leary, NAS Pensacola, FL) Thanks for the neat intercept Mike and welcome to the column, if you want to try for a verification, you might try the following address: Air France; Compagnie Nationale Air France; 1 Square Max Hymans; 75741 Paris Codex 15, France-ed.
- 11396.0 New York/San Juan Aeroradio working Cubana 818 at 1438 in KUSB. Told the aircraft to go to 6577 KHz.
- 11401.8 Spanish speaking male sending radiograms. Other stations weak on net. After further review of the tape by John Combs, it was determined that this was a Mexican military station. Heard in USB at 0025. A bunch of thanks to Maria Tellus, John Combs and Russ Oder for their assistance in IDing this network.
- 11481.7 Unid ARQ Idler heard at 0138. No ID noted. I have no listings for this frequency. Any ideas???
- 11486.0 TUH-Abidjan, Ivory Coast heard at 0133 with a RTTY RY test tape. 50 Baud/850 HZ shift/normal sense.
- 11532.0 Spanish female 4-digit number station monitored at 0115. Transmission parallel to 6802 KHz.
- 11567.0 W200KWA noted at 0215 in LSB calling CQ. (Harold Frodge, Midland, MI) Anybody know who this is?-ed.
- 13107.0 KMI-Dixon Radio, CA working KXH4845 at 2250 in USB. This is ship-to-shore channel 1203, ship side on 12336.2.
- 13113.2 NMO-Coast Guard Communications Station, Honolulu, HI transmitting a marine weather broadcast for coastal waters around Hawaii. (David Kammler, Ridgecrest, CA)
- NMN-US Coast Guard, Portsmouth, VA monitored with a high seas weather broadcast using a new computer synthesis voice at 1600 in USB.
- 13182.4 Unid Chinese male giving what sounded like a ship callsign list or weather observations at 0109 in USB.
- 13187.6 KMI-Dixon Radio, CA working the vessel Polaris (C6CB8) at 2310 in USB. This is ship-to-shore channel 1229, ship side on 12416.8.
- 13211.0 Vigiro working Raindrop on Bravo Whiskey in USB at 1918. This is a SAC channel. Then Cotterpin noted working Greenwood at 1919 in USB. Greenwood told Cotterpin to maintain Bravo Whiskey primary and F-315 (Mystic Star) secondary.
- 13215.5 FUX-French Naval Radio, Le Port, Reunion Island at 0007 with a CW V marker. Also heard at 2250 with CW traffic.
- 13229.0-13234.0 monitored a navy link 11 transmitter at idle at 2248. These are computer data links between naval units. This was probably a shore station transmitter.
- 13257.0 Trenton Military, Canada called by aircraft 505 in USB at 2245. Nothing heard aircraft switched to 9006 KHz.
- 13261.0 Nairobi Volmet heard at 2235 in USB transmitting aviation weather.
- 13270.0 New York Volmet monitored at 2237 with aviation weather broadcast in USB.
- 13387.0 KKN39-Department of State Radio, Washington, DC with a CW QRA marker at 0001.
- 13410.0 6WW-French Naval Radio, Dakar, Senegal heard at 2232 with a CW V marker.
- 13415.0 PCW1-MFA Den Haag, Holland monitored with a CW callsign only and ARQ idler at 2230.
- 13550.9 ZXL-F-Auckland Meteo, New Zealand transmitting a weather chart of the North Pacific in the FAX mode at 2220.
- 13669.5 6VU-Dakar, Senegal transmitting FAX pics, signal very weak which made making out the pics difficult at 2220.
- 13770.0 VOA-Tangier, Morocco USIA new file monitored at 2210. 75 Baud/425 HZ shift/normal sense.
- 13920.0 AXM35-Canberra Meteo, Australia sending a FAX chart of Australia at 2200. Nice signal strength, good picture.
- 13921.0 English female C102 numbers station noted at 2353, Israeli Moshad numbers station.
- 13963.0 Unid Spanish male whistling-possible drug traffic net heard in USB at 2159.
- 13974.0 NNOICE (McMurdo Stn. Antarctica) working NNOGKF at 2352 in USB. First time to hear this one in a long time.
- 13996.7 Army MARS network-AAV6KG net control talking to Mountainer 1 Alpha. AAV6kg announced that he had tinker on the line for M1A. M1A worked on setting up telephone lines, testing frequencies, very informal net. (David Kammler, Ridgecrest, CA)
- 14383.5 NNNOVXY working NNNONXN (USS Yosemite) with phone patch traffic in USB at 2348. Us Navy afloat channel.
- 14398.0 VOA Delano, CA feeder relay channel noted with an ISB signal at 2342. Noted English on LSB, Chinese in USB. (Gayle Van Horn, Orange Park, FL).
- 14875.0 WFE34-ITT New York, NY in at 2337 with a RTTY Foxes tape: 50 baud/850 HZ shift/normal sense.
- 14989.0 TNL-Brazzaville, Congo at 2334 with an RTTY RY test tape: 50 baud/850 HZ shift/normal sense.
- 15715.0 VOA Greenville, NC feeder relay channel with an ISB signal at 2330. Noted Spanish broadcast on both sidebands. (Gayle Van Horn, Orange Park, FL)
- 15830.0 Noted a very weak FAX signal at 2328. Possible Russian Antarctica station Ruzu.
- 16363.0 KKN50-Department of State Radio, Warrenton/Remington, VA heard with a QRA CW marker at 2322.
- 16499.9 A couple of Japanese Gents yacking here in USB at 2241. Probably a couple of fishing boats.
- 16918.8 VHP-Canberra Naval Radio, Australia with a CW V marker at 2236.
- 16951.5 6WW-French Naval Radio-Dakar, Senegal at 2231 with a V CW marker.
- 16976.0 NMN-US Coast Guard Comsta Portsmouth, VA noted at 2230 with a CW CQW marker.
- 16983.2 NMR-US Coast Guard Comsta San Juan, Puerto Rico noted at 2228 with a CW CQ marker.
- 16984.0 PPR-Rio de Janeiro Radio, Brazil with a V CW marker at 2229.
- 17007.7 KLB-Seattle Radio, WA at 2225 with a
- 17045.6 LPD-General Pacheco Radio, Buenos Aires, Argentina at 2220 with a CW V marker. Heavy interference from HKC in Colombia.
- 17047.0 CLS-Havana Fishery Radio, Cuba with a CQ CW marker at 2223.
- 17064.8 FUE-French Naval Radio, Brest, France with a real weak signal at 2218. Station was transmitting a CW V marker.
- 17068.4 OXZ-Lyngby Radio, Denmark at 2216 with CQ CW marker.
- 17093.6 UMH-Baltimore Radio, MD noted with a V CW marker at 2214.
- 17117.6 WNU-Slidell Radio, LA at 2213 transmitting a CQ CW marker.
- 17146.0 CBV-DGTTTT, Valparaiso Radio, Chile noted with a CW CQ marker at 2210. 17170.0 PPL-Belem Radio, Brazil transmitting at 2208 with a CW V marker.
- 17202.0 A9M-Hamala Radio, Bahrain noted with a DE CW marker at 2146.
- 17203.5 KPH-San Francisco Radio, CA at 2145 with a V CW marker.
- 17207.5 WCC-Chatham Radio, MA in at 2144 with a DE CW marker signal.
- 17209.5 WLO-Mobile Radio, AL with a callsign only CW marker and ARQ idler at 2143.
- 17212.0 FFT82-St. Lys Radio, France at 2142 with a CW callsign only marker transmission and ARQ idler tone.
- 17230.0 PCH-Scheveningen Radio, Holland transmitting a CW callsign only marker and ARQ idler at 2138.
- 17231.0 GKQ-Portishead Radio, England at 2136 with a callsign only CW marker.
- 17325.9 WOO-Oceangate Radio, NJ man aboard ship talking to wife. Unid station kept coming on frequency with music at 2134. (David Kammler, Ridgecrest, CA) This is the shore side of ship-to-shore channel 1631, ship side is on 16553.0. All transmissions in USB.-ed.
- 17363.0 5YE-Nairobi Meteo Radio, Kenya in at 2130 with a RY RTTY test tape. 75 baud/850 HZ shift/normal sense.
- 17367.0 5YE-Nairobi Meteo Radio, Kenya with a FAX weather chart of the African continent at 2133.
- 17380.0 FUM-French Naval Radio-Papeete, Tahiti noted at 2128 with a V CW marker signal.
- 17404.0 KKN\$\$-Department of State Radio, Monrovia, Liberia in at 2127 with a QRA CW marker.
- 18245.0 GXH-Royal Navy/US Navy, Thurso, England sending a FAX chart for the northern Atlantic at 2122.
- 18408.0 ZBP-Pitcairn Island noted at 0103 in USB. Noted that all telegrams being handled direct with Wellington OR are signed by the radio officer. (Bruce MacGibbon, Gresham, OR) Thanks for the great log Bruce and welcome back to Utility World.
- 18666.0 Atlas working 10450 at 2027 in USB. Announced "The party is on." (David Kammler, Ridgecrest, CA) This is a DEA HF channel-ed.
- 19480.0 VOA-Greenville, NC feeder relay station noted with an ISB transmission at 2111. English on the LSB; French on the USB.
- 20736.0 LSA600-Associated Press, Buenos Aires, Argentina with an AP wire photo picture sent by FAX at 2103.
- 20961.6 AIR-USAF MARS headquarters station, Washington, DC sending a test transmission "VVV VVV VVV de air test" continuously at 2100.
- 21837.0 NPM-US Navy Comsta, Pearl Harbor, HI with a FAX wave chart for the eastern Pacific at 2050. Pretty strong signal.
- 22320.0 WLO-Mobile Radio, AL with a DE CW marker at 2050.
- 22404.0 OXZ-LYNGBY Radio, Denmark at 2047 with a CW CQ marker.
- 22557.0 KPH-San Francisco Radio, CA transmitting a V CW marker at 2042.
- 22755.0 AFE71-USAF Malabar, FL noted a wideband MUX signal here at 2031.

MORE VINTAGE VERIES

PROGRAM VERIFICATION
 Of Radio **WOMI** Station
 Feb 11, at 4901 M.
 PCC From
 broadcast will be on the air
 M. CST.

Where do old QSLs go where their owners are deceased or no longer interested in the hobby? Hopefully, to the Committee to Preserve Radio Verifications. Already, the committee's collection is approaching the 5000 mark. It is an all-wave project and welcomes QSLs from shortwave broadcast, medium wave, utility and other stations as well (amateur cards only if pre-1950). The collection is located at the Boston headquarters of the *Christian Science Monitor*.

Monitoring Times has been proud to display cards from the collections of Martin Croze (MN), Edward Bellington (NY), John Tweedle (NJ), George Meek (CA), and others [see April '88 MT]. If you are leaving the hobby, know someone else who is, or just want to know more, write to Jerry Berg, 38 Eastern Avenue, Lexington, MA 02173. An SASE would be appreciated.

CHINA
 L.A.R.A.C.
 ARR. H.A.R.T.S.
ХИТМА
 ОТРАЖНЫЕ СЫНЫ
 СТРАНЫ
 СОЦИАЛИЗМА

EA9
 DE LA RUEDA DEL OESTE
 MARRUECOS

Saluda a la Estación **Ed. Bellington de Brooklyn NY** y tiene el gusto de acusarte recibo del QSO celebrado el día 25 de **Junio** de 1937 a las 9:18 p.m. **EA9** significándote que su **Y** ha sido recibida con **QRK** **QSA** comprensibilidad **Y** modulación **Y** y que esta Estación ha utilizado un emisor **500 W** Output con antena "Johnson Q" y modulación Clase B y un receptor **FBX NATIONAL 20 w. foule.**

Bernardo Diaz Gomez
 aprovecha esta ocasión para ofrecerse como colega y amigo, deseándole se reptan esos Q S O tan agradables y le comunica su **QRA APARTADO, 124 TETUAN MARRUECOS ESPAÑOL**

Observaciones *Dear Ed: I like you kindly get your*

RADIO NEDERLAND
PG
 NETHERLANDS
 NETHERLANDS WORLD PROGRAMME
 P. E. F. H. I.

NATIONAL BROADCASTING COMPANY
 A RADIO CORPORATION OF AMERICA SERVICE
 CHICAGO, ILLINOIS, U. S. A.

This will acknowledge your report of reception of our broadcast on station **W 9 X F** operating on 6190 K.C., or 69.18 M., - 11.2 in group of 10 K.C.

W N 9 B X C F
 Schedule (Subject to change):
 CFT: Daily 1:00 P.M. to 1:40 P.M. and 11:00 P.M. to 1:00 A.M.
 CBT: Daily 6:00 to 9:00, and 9:00 to 1:00.

The "Happiness Boys"

Happiness Candy Stores, Inc.
 120 Hudson Avenue, Ltd. - Island City, N.Y.

RAIAR **RAIAR** **RAIAR**
 STATION OF ROME - VIA MONTELLO 5 - ROME
 7.50

Eid

WPRP
 LA VOZ DE PUERTO RICO
 1420 K.C. THE ONLY STATION IN SOUTHERN PUERTO RICO
 100-230 W

We thank you and verify your report dated **Feb. 13/37.**
 Broadcast of

BROADCASTING STATION CFRB
RYAN'S AIR GALLERIES
 215 Jarvis St., Toronto, Canada

Thank You. You can appreciate that it is as far as possible to personally reply to the many and appropriate requests of our listeners, so we ask you to accept this expression of appreciation as well as the thanks of those on the program. We will always welcome your suggestions and comments.

CFRB is owned and operated by **STANLEY RAYO M.P. OWEN LAWRENCE** and is located approximately twenty-five miles north of Toronto in the manufacturing of the famous **RYAN'S AIR GALLERIES** Radio Receiver Sets. Our Broadcasting Station is located centrally situated in **Ryan's Art Galleries, Jarvis and Wellesley Streets, Toronto, Canada.**

Sincerely yours, **CFRB**

NO BATTERIES
 NO CHEMICALS
 NO ARRIVAL

430 Garnor Drive
Suffield, OH 44260



Military Training:

In the air and on the air

The United States military is the main source of radio traffic in the 225 to 400 MHz range. The aircraft, when operating at high altitudes, can be heard for hundreds of miles. Monitoring the military then, is not limited to a local area such as a city or county but often an area covering several states. Johnny Autery of Dixon Hills, Alabama, submitted a profile on monitoring UHF military aircraft for the southeastern United States and the Gulf of Mexico that comprises this issue's federal file.

The Boeing E-3A Airborne Warning and Control System (AWACS) aircraft (based on a KC-135/707) is identifiable by the distinctive top mounted airdome that encloses its RF electronic hardware. The AWACS aircraft has the ability to radar track a multitude of airborne targets and display the data locally (at aircraft-located operator consoles) or remotely via digital RF links with ground based facilities. This capability lends itself readily to utilization in training exercises where the AWACS aircraft are used as the controller to an airborne simulated attack and defense posture network. As a result, the aircraft are used extensively during training exercises in southern Alabama and the Gulf of Mexico.

Directing Simulated Attacks

The AWACS will direct one group of fighters, designated as the defenders, against a simulated hostile force of fighters, known as the aggressors. The AWACS controller is in constant communication with the defender force informing them of the range, bearing and formation of the aggressor force during the exercise.

The AWACS role in an active setting is similar to that of the training exercise. The AWACS data, in conjunction with ground based IFF (Identify Friend or Foe) radar, would permit the detection, identification and tracking of all aircraft approaching or entering into the airspace being monitored. A commander, based upon his evaluation of aircraft not identified by IFF or from prefiled flight plans, can direct a defender fighter force to intercept unidentified aircraft for visual identification and defensive actions if required.

The training exercises are quite interesting to monitor and have been confirmed on the

following frequencies (note all frequencies are in MHz and in the AM mode unless otherwise noted):

225.800	226.000	235.200
239.400	261.200	284.800
308.000	313.000	313.600
371.000	398.200	

Fill 'er Up!

KC-135s are widely deployed aerial refueling aircraft or simply stated--tankers. The KC-135s are based on Boeing 707 type commercial aircraft. Another commonly deployed tanker is the KC-10 which is based on the McDonnell-Douglas DC-10. The tankers provide the fuel-station-in-the-sky for fighter and communications between tankers and fueling aircraft are quite imperative if the job is to be done without incident. The boom operator (a boom is used to connect the tanker with refueling aircraft and provide the path for the fuel transfer) needs to communicate with the pilot of the tanker as well as the aircraft being fueled. Table one presents the frequencies utilized during aerial refueling communications and are confirmed by Johnny Autery.

Aircraft from two wings and three groups -- the 33rd TFW (Tactical Fighter Wing) at Eglin AFB (FL); the 159th TFG (Tactical Fighter Group) at New Orleans Naval Air Station; the 187th TFG at Dannelley Field, Montgomery ANG (AL) and the 186th TRG at Key Field, Meridian ANG (MS) -- are on the air on a daily a basis.

Aircraft operating from a base or in route to a base will often utilize a Command Post channel. The Command Post (CP) channel is used by aircraft to report crew and fuel status and requests for maintenance or V.I.P. treatment when a dignitary or high ranking officer is aboard. Aircraft will also report emergencies over the CP channel informing of the nature of the emergency and special circumstances, if any, concerning the aircraft or crew. The CP frequencies and primary aircraft operating from the given location are listed as follows:

267.800	159th TFG; F-15s
286.500	187th TFG "Bama Control"; F-4Ds
287.300	117th TRW; RF-4Cs
290.900	33rd TFW "Mission Control";

292.300	F-15s 186th TRG; RF-4Cs
---------	----------------------------

The CP channels are usually referred to as channel one and the remaining nineteen channels of the twenty channel UHF radios are used for approach/departure, FAA centers and operational channels. Table two lists the channel and frequency designators for the 187th TFG at Dannelley Field, Montgomery, AL.

Active Nets

Have Quicks, also referred to as Active Nets or Active Manuals, are a scrambled form of communications via a frequency hopping scheme. The voice text is transmitted over a series of the listed Have Quick frequencies several times a second. Johnny states that if it is working correctly, which it usually is, it is very difficult to understand an entire transmission. The best way he recommends to monitor the Have Quick transmissions is by utilizing two or more scanners programmed with the frequencies for Have Quick operations. Keep the delay feature off. At best, the communications are "choppy"; at worst, unreadable. The Have Quick frequencies listed are used by the 33rd TFW, 186th TRG and 187th TFG.

The aircraft from the above-mentioned bases operate and patrol in restricted airspace on a routine basis. Warning areas are protective air space that are monitored and patrolled by the U.S. Four warning areas cover the northern half of the Gulf of Mexico, off the coasts of Louisiana, Mississippi, Alabama and Florida and are designated as W-543, W-155, W-151 and W-470 respectively. These four areas cover over 44,000 square miles of the Gulf of Mexico. The frequencies utilized by aircraft operating in the warning areas are as follows:

W-453	228.800, 251.000 and 277.400
W-151	261.100, 286.200, 327.700, 337.700, 344.500 and 351.400
W-470	261.000, 271.200, 287.500, 301.700, 311.200 and 351.300

Frequencies for W-155 are sought by Johnny.

The 33rd TFW at Eglin AFB utilizes many discrete frequencies -- frequencies that are

not assigned or issued by any ARTCC (centers). The discrete frequencies, along with the Have Quick frequencies, comprise the frequencies used during training and operational missions. The discrete frequencies are as follows:

232.150, 234.100, 237.400, 239.400, 252.525, 279.700, 292.200, 294.500, 299.500, 308.000, 314.200, 315.200, 323.200, 325.500, 333.550, 335.550, 349.500, 351.050, 354.200, 357.300 and 399.750

Table three presents the 33rd TFW frequencies and usages at Eglin AFB. Table four lists frequencies used in MOAs in southern U.S. The MOA data was compiled with material also contributed by Blaine Brooks of Tucker, GA. Blaine would like to contact other federal/military monitors in the Atlanta and GA areas and he may be reached at 1009U Oak Chase Drive, Tucker, GA 30084.

Table One

Aerial Refueling Frequencies

267.900	Pine Hill MOA (Military Operating Area)--Alabama
280.100	"
349.200	"
354.400	"
373.100	"
359.200	Gulf of Mexico
373.200	"
373.300	"
238.900	Mississippi
289.700	"
235.100	Birmingham (AL) Primary
366.300	" Secondary
139.870	" VHF Primary
260.200	Mobile (AL) to Alexandria (LA) AR tract 302
143.800	Tanker-to-tanker, Air National Guard--Knoxville, TN

Table Two

CH 1	286.500	CP--"Bama Control"
2	270.300	Clearance Delivery
3	348.600	Ground Control
4	257.600	Tower
5	319.900	Approach/Departure South
6	369.200	" " North
7	291.000	Approach
8	351.900	Atlanta Center
9	262.300	Eglin Mission Control
10	291.800	C-62 RCO Shoulder
11	347.300	C-52 RCO Darken
12	291.600	Houston Center
13	297.100	Shelby Bombing Range (MS)
14	276.100	Sentry Standard Aerial Refueling Primary
15	287.400	Have Quick (Refer to text)
16	297.600	Have Quick
17	314.300	Have Quick
18	359.100	Have Quick
19	376.000	Have Quick

THE STARTLING FACTS!

ELECTRONIC EAVESDROPPING IN AMERICA

- ★ Electronic eavesdropping is rampant in America! Anyone can become a target. **Including you!**
- ★ This candid, one-hour audio cassette, prepared by an electronics intelligence specialist, **tells you where** eavesdroppers are getting their equipment. **Learn how** they're using it against unsuspecting victims.



JUST RELEASED!

Only \$14.95

plus \$2.00 shipping/handling

- ★ In the privacy of your home or auto, listen to this explicit discussion of bugging and wiretapping. Tape recorders, "hot" telephones, miniature transmitters, baby monitors, parabolic microphones, infrared transmissions, and attacks against cordless and cellular phones are among the topics discussed.
- ★ Electronic eavesdropping is **illegal**. But it is also a fact of life in our modern technological society. Knowledge and understanding of the problem is your **best defense**.

Receive **FREE** catalog of eavesdropping countersurveillance equipment with each order.

SEND CHECK OR MONEY ORDER For just \$16.95 to:

ACM Security
P.O. Box 4021
Gaithersburg, MD 20878

Table Three

Eglin AFB UHF AC Operations

280.500	Emergency Nomad 6
290.900	Mission Control
291.900	Hurlburt Field
322.600	Approach/Departure
335.800	Ground Control
348.100	Tower
358.300	Approach/Departure
381.300	Raymond 11-TAC Net
388.900	Clearance
398.200	Radar Control

Table Four

Birmingham 1 and 2 MOAs	252.900 and 352.800
Bull Dog MOA	352.400
Camden Ridge MOA	267.900, 280.100 and 339.100
Pine Hill MOA	267.900, 280.100 and 339.100
Rose Hill MOA	288.300
Snow Bird MOA	288.800, 297.800 and 315.100

A Closet TV DXer

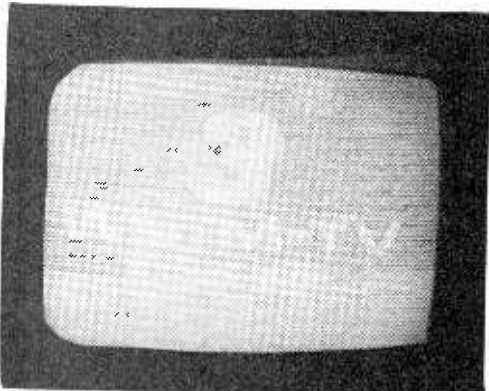

Note characteristic pattern caused by interference from a local channel to this 1,050-mile distant station.

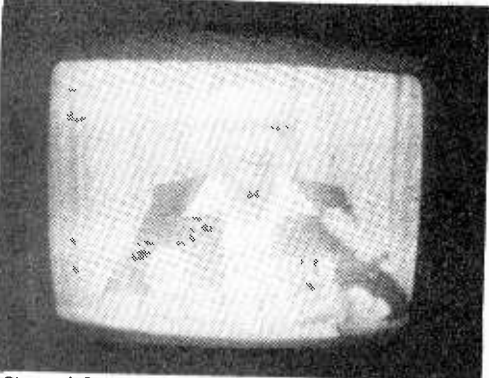

Channel 3 from Monterrey, Nuevo Leon, Mexico, is often reported during E-skip openings.



This picture was formed from a signal that traveled 335 miles via tropospheric enhancement. Tropo is most common on UHF and high (7-13) VHF.



Translator call signs include the channel number and are also quite common during tropro openings, even though they are low-powered.

Much of this column is devoted to AM (or BCB) DXing although some would like equal space for other domestic DX, including low-band, FM, and TV. Frankly, many prefer AM DX because it requires more skill, and therefore poses a greater challenge than that for other forms.

Having said that, let me reveal now that I am a closet TV DXer who takes great pride in the dozens of photos and videos of IDs I've collected. I get just as excited by the emergence of a herringbone pattern on channel 2 as I do hearing a foreign language on a split BCB frequency. The sporadic E-skip season for TV and FM is just around the corner, peaking usually around July 1, and DX techniques for TV and FM DX are similar and easily mastered.

AM DXers should be familiar with two types of BCB DX: daytime, which usually provides the same stations day after day, and nighttime, which brings somewhat predictable but changeable conditions, affected most dramatically by the aurora borealis, which can wipe out most signals from north of this location.

FM/TV DX, on the other hand, is not actually affected by the nighttime/daytime change as such but is more dependent upon weather patterns to enhance DX through what we call sporadic E skip and by tropro (tropospheric bending or enhancement).

A third type of enhancement is caused by meteor scatter, which can last from a fraction of a second to over a minute, as the ionized trails from disintegrating particles reflect FM and TV signals. Much rarer and not covered here are anomalies known as F2 skip (the same that affects shortwave DX), aurora (mostly for FM), and lightning scatter (chiefly split second bursts affecting UHF TV).

Tropro DX Toughest

Tropro probably requires the most DX skill, although until recently we really didn't know much about its cause. In an article in the April, 1987, *VHF/UHF Digest*, published by the WTFDA, Tim McVey effectively demonstrated that tropro is somewhat predictable by the DXer who understands weather patterns, as radio/TV waves are reflected by inversion "mirrors" caused by air masses with different humidities and temperatures meeting.

"Radiation inversions" can actually be observed almost any day around sunrise and sunset, although most noticeably in the summer and fall. As the sun heats dry ground and, by conduction, the air above it, a

layer of warm air rises above a secondary layer of cool air. Conversely, in the evening the ground and the air above it cool off, but more rapidly than the air higher up. The inversion layers in both cases will bend signals back to earth, usually from 50-100 miles out. I observed this phenomenon on an evening last June in central Kansas when I pulled stations in from six states, some approaching 175 miles in distance.

Tim Says, "Watch Out"

Tim says to watch out for conditions causing a thin but very moist layer of high clouds which form at night and then block the sun from warming the ground. Sometimes two inversion layers form, a warm one at the level of the clouds which enhances local stations, and a second, cool inversion below the clouds, which enhance VHF/UHF signals from as far as 400 miles out. If no weather patterns are in your area, and the sky was clear the previous day, but a sudden summertime morning overcast comes out of nowhere, you may be in for DX conditions until the clouds burn off.

The second pattern, called "subsidence inversion," is often associated with stagnate conditions causing stationary fronts. A high pressure system builds up and inversion layers take longer to dissipate until the system starts moving again. When I lived in Los Angeles, I watched for summer smog patterns to become pronounced so that I could watch Mexican TV channels, especially 33 from Tijuana.

Slow-moving weather fronts can produce spectacular DX, as during the November, 1986, Thanksgiving conditions which provided a 1,250 mile path from Oklahoma to Pennsylvania on channel 14, as well as many other catches to DXers. Two huge high-pressure areas remained almost motionless, one over Utah, the other over West Virginia on the 28th and 29th. A cool air mass from the Pacific encountered the Utah high and was forced to slide along the Canadian border, and a stationary front developed from Idaho to Maine, creating a monstrous inversion layer that lasted for two days.

FM and TV DXers in Illinois, situated ahead of the front, were able to receive enhanced signals from both the east and west. In DX terms, this situation is called a duct, that is, when DX signals may be received inside a fairly narrow area.

Weather Conditions Important

FM/TV DXers, then, would do well to learn how to interpret weather conditions that

cause DX conditions to develop and to look especially for long, straight stationary fronts.

More dramatic TV and FM DX is caused by sporadic E skip, caused by areas in the E layer of the ionosphere becoming ionized. No one has yet precisely discovered the cause of this ionization, although some postulate low pressure areas and thunderstorms as the cause. My experience has been that usually an intense thunderstorm area has formed between me and the station areas, but that doesn't entirely explain E skip conditions during low storm months such as December, although trans-equatorial conditions may have some bearing.

1500-mile reflections of signals are common during E-skip; in fact, the minimum distance for E-skip seems to be about 500 miles, according to Glenn Hauser. An E-skip opening seems to start with channel 2; look for "herringbone" interference on the lower VHF channels. Sometimes the opening will extend up past channel 6 into the FM band, and very rarely through the utility bands up to channel 7.

On TV, DX signals may overpower even nearby locals, fading in and out. Unless the E-layer patch is unusually large, normally one main signal will dominate for a period of time, but as the patch moves, other stations will fade in and out. More closely-spaced FM stations on local channels may overlap, however, and you may hear top-quality stereo signals fade in and out, perhaps as long as 30 seconds at a time. Expect E-skip to develop primarily during the morning hours from May through August, but watch for it through the afternoons, and even any day or time of the year.

With E-skip as powerful as it is, no special antenna is necessary, except perhaps to null out a local station. If you were to orient your rooftop antenna to an optimum angle, you'd have to point it 45 degrees up, and broadside to the nearest local, as E-skip patches are 65 or so miles up. As I've said before, any coat hanger will do.

However, tropo and other forms of enhancement are much weaker, and an amplified antenna becomes more of an asset, as signals are conducted to your location at a lower angle. If you live in a mountainous area, you can pretty much rule out any tropo reception in the direction of mountain ranges, but here on the Great Plains, I can consider the area from Colorado to Kentucky and Minnesota to Texas as fair game for tropo reception.

Most of my E-skip reception from Kansas has been towards the east and southeast, but I've received E-skip from Idaho, Montana, and Mexico, and possibly from California. And I can't recall any reception of under 800 miles.

Thanks for the Memories

If you plan to capture your DX, a video recorder or still camera is a must. Better still is a battery of recorders set for each channel 2-6 during E-skip openings, but most of us can't afford such a luxury. I'd suggest recording a questionable channel for later examination, and using a still camera to take pictures of the strongest signals.

At the top of the hour, when ID slides are aired, is the best time to take photos or videos, but watch also for local mail-in offers containing the station's address, or syndicated program promos, computer-generated weather information, or even technical-problem slides, all of which can contain verifiable information. I count a photo verification if I have two of the three following items: call letters, channel, and/or city of license.

Your still camera should be set at 1/30th of a second or even 1/15th if you can steady it or use a tripod. You can use either black and white or color film, but I've had the best results with 400 ASA b&w, partly because I have had my own black and white darkroom to develop and print photos. That CRT is brighter than you may think, too; I usually shot a 19-inch tube at f/8 or f/11 at three feet, depending upon the brightness adjustment.

I'd also recommend for best results using a leaf shutter, rather than a focal-plane shutter camera, for several reasons. First, the configu-

NEW COMMUNICATIONS CATALOGS From Universal Radio

• SWL Catalog •

We have just published yet another edition of our famous shortwave listener's catalog. We offer a full line of receivers from \$50 to \$8000. Extensive RTTY and FAX equipment priced for every budget. Also featured are antennas, accessories and the best selection of radio books anywhere. See everything that is new for listening! 70 pages (5 by 8" format).

Only \$1.00 postpaid

• HAM Catalog •

Universal has been serving amateur radio operators since 1942. We are an authorized dealer for all major lines including Kenwood, Yaesu, Icom, JRC and Info-Tech. Our pricing is very competitive...even with the no-service "warehouse" dealers. Whether you are a new Novice, or an old time Extra, you will like our new 44 page catalog (8.5 by 11" format).

Only \$1.00 postpaid

A Few of Our More Popular Shortwave Titles:

- 1988 World Radio TV Handbook \$18.95
- Shortwave Receivers Past & Present \$ 5.95
- Guide to Utility Stations 1988 6th Edition \$24.95
- FM Atlas & Station Directory \$ 5.88
- Shortwave Listening With the Experts \$19.95
- The World Below 500 KiloHertz \$ 4.95
- Passport To Worldband Radio RDI 1988 \$14.95

Universal Radio

1280 Aida Dr. Dept. MT
Reynoldsburg, OH 43068
Toll Free: 800 431-3939
In Ohio: 614 866-4267

Please add \$1.00 shipping per book. (Catalogs are sent postpaid). Visa, Mastercard, Discover and checks accepted. Please note that catalogs are sent free with any book order.

ration of the leaf shutter is such that the light pattern reaches the film more evenly than if you use an SLR with its horizontally or vertical travelling slit.

Secondly, you can dedicate such a camera to TV-only use because they are very inexpensive if purchased second-hand. I use a broken Konica EE-matic, whose light meter no longer works, but by setting the shutter speed to flash sync, which happens to be at 1/30th on this camera, I get perfect photos. I paid about \$5.00 for it. Another common camera is the Argus C-3; don't pay more than \$10 for an average specimen. On the other hand, get into the habit of advancing the film directly after each shot, as the C-3 has no double-exposure prevention feature.

Use the VCR to record any vacant low-band channel at the top of the hour during the E-skip season, and you may be rewarded with some rare DX experiences, especially if you have to work for a living. Oh, one word of warning: watching channel 2 can become addictive; I can now confess that I actually watched "As the World Turns" regularly into August one year, all because of monitoring that CBS channel for E-skip one summer. (I'm completely cured now, thank you; two years of eight-hours-per-day television while selling them got me unhooked!)

A few letters from readers... Mark Lawson of Lubbock, TX wonders if anyone sells crystal radio kits any more, and except for Radio Shack, I couldn't think of anyone. Perhaps one of our readers can help; does Philmore still market kits?... Steve Mittman, San Pedro, CA affirms Mike Riordan's FM E-skip reception from Montana as he pulled in KRTV-3 from Great Falls... Dave White, Cherryfield, ME has used two other booklets on crystal radios: *Radios That Work for Free*, by K. E. Edwards: Hope and Allen Pub. Co. - P.O. Box 535 - Belmont, CA 94002, and *All About Crystal Sets* by Charles Green: Allabout Books - P.O. Box 4155 - Fremont, CA 94539.

Maritime Radiolocation Beacons

... "A noise annoys an oyster"

Oysters aren't the only things annoyed by noises in the 1600-1800 kHz band. Hams, SWLs and even tropical band DXers are often accosted by the chirps and beeps of navigational markers found in the lowest part of the HF spectrum.

Radiolocation is a technology utilizing coastal transmitters to emit accurately timed pulses which, when picked up by ships at sea, provide pinpoint fixes on the vessels' positions.

Many competitive systems are in use, most notably Raydist, Hydrotract, Cubic Argo and Decca Hi-Fix. They may be recognized by their characteristic emissions when heard on a shortwave receiver with the single sideband or CW mode switched on.

Recognizing 1610-1800 kHz signal patterns:

- Decca Hi-Fix (one short, three long dashes per second)
- Cubic Argo (2-4 second burst of uneven chirps)
- Central American Aeronautical beacons (2-3 letter CW)
- Fishing beacons (one letter, three numbers CW)

Frequencies for these systems are shown below and are extracted from the new fourth edition of Bob Grove's *Shortwave Directory* (\$17.95 plus \$2.50 shipping from Grove Enterprises, PO Box 98, Brasstown, NC 28902).



Raydist Assignments (Average center frequencies shown)

Ch	Mobile	Interrogator
A	3288.5	1643.5-1644.9
B	3290.5	1644.5-1645.9
C	3294.5	1646.5-1647.9
D	3296.5	1647.5-1648.9
E	3300.5	1649.5-1650.9
F	3306.5	1652.5-1653.9

Additional Raydist Frequencies

Mobile		Relay
3281	Alaska	1640.3 1640.315/.725 1648 Delaware Bay
3320.4	Coastline	1658.425
2398	USA except Alaska	1660.015
2456	Alaska and Great Lakes	
2510	USA except Alaska	
2848	Alaska	

Hydrotrac/Argo Radiolocation Assignments

Freq	Comment
1618.5/1798.5	For lane ID
1619.64/1799.6	For lane ID
1643	US Coastline
1649	US Coastline
1718.59	US Coastline

Argo Assignments Frequency Pairs

1643.0/1798.5	1643.7/1798.5
1649.0/1798.5	1644.7/1798.5
1653.0/1798.5	1646.7/1798.5
1648.0/1798.5	1647.7/1798.5
1643.0/1799.6	1649.7/1799.6
1649.0/1799.6	1652.7/1799.6
1653.0/1799.6	1658.4/1799.6
1648.0/1799.6	1660.0/1799.6

Canada

Cubic Argo

1610	1627	1644	1715.5	1762.5	1767.5
1628.5	1645	1716	1763	1769	
1616	1630	1646.7	1746.8	1764.5	1770
1618.6	1632	1648	1750	1764.8	1771
1620	1632.5	1673	1753	1765	1772
1622.9	1638.9	1674	1757	1765.6	1785
1624	1639	1705	1759	1766	1788
1626.9	1640	1714	1761.5	1766.5	

Grove's Indoor SWL Antenna System

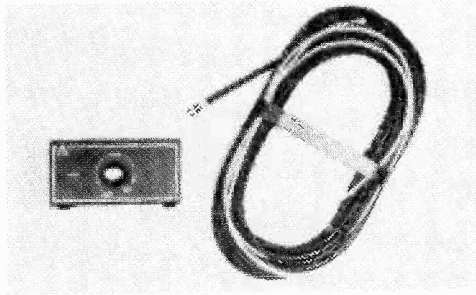

Get global shortwave reception from an antenna which hides behind a drape!

Connects to any receiver equipped with an external antenna jack

Left: Hidden Antenna, shown coiled, with optional Power Ant III and Minituner. Drawing depicts antenna in extended position, ready for use.

Our "Hidden Antenna System" is your key to exciting short wave reception without an outside antenna!

Here's the apartment dweller's dream—a high performance, amplified indoor antenna system for general coverage shortwave, medium wave and even scanner monitoring.

This 66-inch, thin profile, flexible wire antenna can be tucked in a corner, hung behind a drape—just about anywhere out of sight. And when connected to the powerful PRE-3 signal booster, you have instant total spectrum coverage from 100 kHz to over 1000 MHz!

Yes, global short wave reception will be at your fingertips, and you can operate two radios at one time!

ANT-6

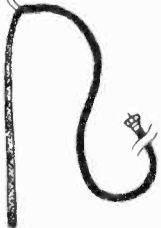

Designed for use with the Grove Power Ant III

The Grove PRE-3 Power Ant has taken all the best from its successful predecessors and combined them into one powerful signal booster for scanners, short wave and medium wave receivers, even TV and FM stereos!

Equipped with a high gain, low noise, solid state amplifier stage, the PRE-3's front panel control allows custom selection of up to 30 dB of amplification!

What you need to order:

ANT-6 Hidden Antenna
PRE-3 Power Ant III
ACC-20 AC adaptor
ACC-60 receiver cable

\$8.95 (free shipping)

\$45 (plus \$1⁵⁰ UPS, \$3 U.S. Parcel Post, \$4 Canada)

\$9.95 (free shipping with PRE-3)

\$7.50 (you specify connector or receiver model; one for each receiver)

100 kHz-1000 MHz



CALL TOLL-FREE (MC & Visa Only)
1-800-438-8155

Add the Grove Minituner for Incredible Reception!

The addition of the Grove Minituner to the ANT 6/PRE-3 combo will allow signal peaking to perfection as well as eliminate intermodulation and image interference on your general coverage receiver.

Here's what you will need in addition to the combo above:

TUN-3 Minituner
ADP-1 UHF/F adaptor
ADP-2 F/PL-259 adaptor

\$49.00 (plus \$1⁵⁰ UPS, \$3 U.S. Parcel Post, \$4 Canada)

\$5.00 (free shipping)

\$5.00 (free shipping)

100 kHz-30 MHz

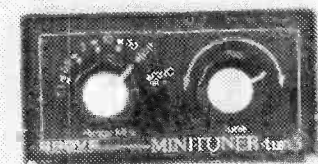

Grove Enterprises

140 Dog Branch Road
Brasstown, N.C. 28902

MC and Visa Orders Only.
Call 1-800-438-8155

Sporadic E

Sporadic E ionization (often referred to as E_s) is a condition of the earth's ionosphere that gladdens the hearts of many a radio amateur.

During an E_s opening, signals from thousands of miles can be worked on the VHF bands. Often ten and six meter signals span the Atlantic with ease and coast to coast contacts occur frequently. All of the amateur bands are affected to some extent by Sporadic E ionization, but the most enhanced bands are those between 20 and 300 MHz.

Can you imagine working a station two hundred miles away on your one or two watt handi talkie on 220 MHz? It can be done! Keep your ear peeled for those DX signals and don't be afraid to call them. Lots of hams have fun by DXing repeaters using this mode. Try it you'll like it!

Sporadic E a Mystery

At present all that is known about the Sporadic E ionization phenomenon is that it occurs at a height of about 60 miles above the earth (the same approximate height as the E layer), it consists of heavily ionized clouds that vary from 50 to 100 miles in diameter, and can produce enhanced VHF propagation for several hours before disappearing. These clouds drift about in the ionosphere and are rather unpredictable. They appear in strength during the spring and summer months. There are E_s openings during the winter, but not in the numbers the warmer months bring.

Frequently auroral (northern lights) displays accompany an E_s opening. The aurora also enhances VHF communications although they are a more difficult mode to use. Where almost any mode of communication can be used during an E_s opening, CW is preferred for communication during aurora openings. When signals take on a raspy buzz saw sound, point the beam north and switch to CW to make use of the aurora.

June VHF Contest

Each year during the early part of June the ARRL sponsors a bash called the June VHF contest. As you might imagine, since it takes place during the active part of the E_s season, working lots of VHF DX is common.

Individual hams, clubs and special VHF contest groups take to the air in large numbers. Often these folks choose superb VHF sites to set up their stations and erect large antennas and powerful transmitters. All this is in an effort to enable them to take advantage of the activity to increase their WAS, and Grid Square totals on the VHF bands.

All of this has advantages for the average VHFer, too, as these high-class stations are

able to hear the weaker signals and hand out rare DX contacts to everyone.

Get in on the fun! Write the ARRL at 225 Main St. Newington, Ct 06111 and request log forms, dupe sheets and a set of rules for the contest. But do it soon. Time is running out!

More Fun in June

The last weekend of June sends hams scurrying ant-like to the mountains, beaches, vacant lots and other remote locations to participate in a rite called "Field Day".

Perhaps the most popular contest sponsored by the ARRL, Field Day is supposed to simulate an emergency type of operation. Stations set up in remote locations are powered by emergency gas generators, solar panels, windmills, batteries, human-powered generators and whatever the inventive mind of amateurs can dream up. AC mains are not used except by a few stations who participate in the event for the fun of it and to hand out points to the other stations.

This is a fun event! While it teaches us how to operate under emergency conditions, seldom do the participants suffer a lack of food drink or shelter!

Clubs and groups plan their field days months in advance. Some folks choose to go the comfy route and operate from buildings or mobile campers while others live in tents. Whatever they choose, the objective is the same - work as many stations as you can and have a good time.

Rules change from year to year and it is a good idea to read *QST* magazine for up to date info. Or write the ARRL for full dope and log sheets at the address mentioned above.

If you have never participated in Field Day, do it this year. Go with your local club, or find a few friends to go out with on your own. If you try it one time, you will be back for more.

The Hammer

Last summer, I decided I wanted an all-band antenna that would work 160 meters through 10 and give me decent performance. I had been using a G5RV for some time on the low frequency bands and while an excellent performer it lacked punch on 160.

My first attempt was to simply double the size of the G5RV. The idea worked well enough, but I had trouble loading on both 160 and 80.

Since the antenna was installed as a drooping doublet (inverted vee), I reasoned that expanding the length of the flat top was in order. Adding three feet to each end improved the loading on 160 and 80 to where it was possible to obtain at least a 2 to 1 match

over the entire band. However, loading was critical and required a steady hand on the tuner.

The next step was to experiment with the length of the 300 ohm matching section. It was found that doubling the length to 60 feet enabled easy tuning over both bands. It is now possible to match the antenna to better than 1.5 to 1 on all bands through 15 meters. On ten meters I find it difficult to obtain better than a two to one match on the low end while using my Heath HFT-9 matcher. This has not been a problem though, as the antenna does work very well on ten.

Since I began using this antenna in October of '87, I have worked North America, South America, Europe and Africa on 80 meters and all continents on 40, 15 and 10 meters. It has also been a consistent performer on 30 meters although I do not work this band to a great extent. During the 1987 ten meter contest I worked 75 stations on all continents (except Asia) and 46 multipliers. Perhaps the most memorable contact of this period was with GI3IVJ/CT3 on the Azores on 80 meters who answered me on my first call through a pileup.

The amazing thing about all of this activity is that at no time did my output power exceed three watts! Power during the ten meter contest was two watts or less at all times. Stations up to a thousand miles were worked while running power as low as 40 milliwatts on 80 meters. On 40 meters DF1DN/EA8 (Canary Islands) when told I was running three watts commented "you are as strong as the average 100 watt signal."

The "Hammer" may not be the ultimate antenna. But for a simple to build and erect wire it sure does a fine job. Not everyone is going to be able to put up a 210 foot antenna, but if you have the room it is a tough antenna to beat at the price. The "Hammer" will help you nail down a lot of DX.

To build a Hammer simply cut two lengths of 14 gauge (or heavier) wire. Attach insulators at both ends and one in the center. At the center insulator connect either a 30 or 60 foot length of 300 or 450 ohm line and solder an SO-239 coax connector at the other end. Feed the antenna with 50 or 75 ohm coax (either is ok). Use a transmatch (antenna tuner), mine loaded on 40, 20, and 15 ok without the tuner but I got better results using one.

My antenna is 60 feet high at the center, and 25 feet high on the ends. The matching section is 60 feet of 300 ohm KW twinlead and fed with 40 feet of RG-58. I used the 30 foot section for several months, it worked ok except for touchy loading on 80 and 160; switching to the 60 foot section improved the situation a lot.

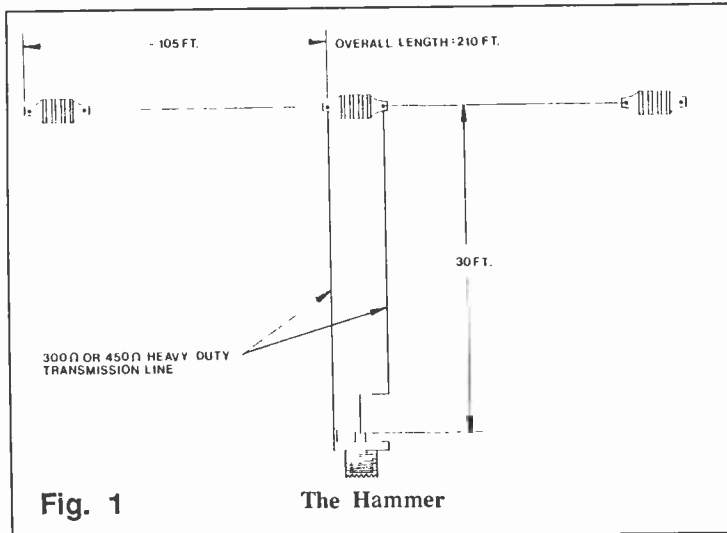

NEW! **ADVANCED™**
SEEKER™

SEEKER™ The complete system which makes your Commodore computer and ICOM R-71 a sophisticated monitoring station. EASY to use . . . UNEQUALED in performance.

A FEW OF SEEKER'S FEATURES

- NEW "VCR-like"** multiple program recording. You choose day, time, and frequencies.
- INSTANTLY DISPLAYS** broadcaster time and frequency schedules.
- STORES, DESCRIBES, PRINTS, AND SCANS** hundreds of frequencies.
- UNATTENDED** recorder control in six scanning modes.
- SELECTS** the strongest signal when you store alternate frequencies.
- ADVANCED FEATURES** explained in our FREE literature!

Send for FREE literature or include \$15 (refunded on purchase) for demo disk and Owner's Manual, to . . .

AF SYSTEMS
 Post Office Box 9145-E
 Waukegan, Illinois 60079-9145
 United States of America

Unique Special Events Station

Members of the Ohio Underwater Research Association (OURA) will operate N8HHG June 29 to July 1st, 1500z to 0100z from beneath the surface (underwater) of Lake Erie aboard a shipwreck and other submerged as well as surface locations within the Lake Erie Islands area. Suggested frequencies: 7.230, 14.245, 29.450 & 146.475 MHz (all +/- 10 kHz). For special photo QSL card send QSL (SWL letters welcomed) and SASE to: Paul Buescher - N8HHG, 1752 Stone Creek Ln., Twinsburg, Ohio 44087.

Hams Flunk Code Test

At a Florida Ham Fest, Gordon West (Radio School) tied a code player into a string of lights around his booth. With both lights and audio blasting away, not a single ham copied the message that read: "CQCQCQ CQCQCQ DE WB6NOA GORDON WEST RADIO SCHOOL. IF YOU CAN READ THIS, SEE ME FOR A \$50.00 BILL. CQCQCQ"

ARRL News

A new book of interest to hams and SWL's has just been released by the League. Its title is, *Radio Direction Finding Simplified*.

With this book you can learn how to sniff out RF interference, deal with willful interference, hunt cable TV leaks or find the "FOX" during the clubs hidden transmitter hunt. In addition the book will be of interest to rescue teams who search for downed air craft.

A lot of worthwhile information at a cost of \$18.00 plus \$2.50 S&H from ARRL Newington, CT.

Northeast VHF Conference

Sponsored by the Northeast VHF Association this conference takes place May 20 at Rivier College in Nashua, New Hampshire. Conference features hospitality room Friday evening, and talks by expert VHFers Saturday along with many other activities of interest to the VHF/UHF amateur.

To register write David Knight, KA1DT, 15 Oakdale Avenue, Nashua, NH 03062. Cost is \$20.00 and registrations should be in by May 20.

Western Sahara Status Clarified

On February 12, the ARRL Awards Committee accepted the ARRL DX Advisory Committee's recommendation that Western Sahara, (S0) be added to the ARRL DXCC countries list.

The committee announced that Western Sahara will be a "reactivation" of the deleted "Rio de Oro" (Spanish Sahara) listing. Thus Rio

de Oro is removed from the list and returns under the name Western Sahara.

QSL cards from S0RASD are acceptable for DXCC but will not be accepted before June 1, 1988.

QRP Corner

The many QRP nets have been extremely active in recent months, due in large part to the efforts of Danny Gingel, K3TKS, 3052 Fairland Rd., Silver Springs, MD 20904. Stations from all over the country and many DX countries check into the nets giving the low power operator a chance to work towards the various awards the QRP ARCI offers. In addition the nets disseminate news of QRP happenings and answer members questions.

All amateurs are invited to check into the nets, just remember to keep power to five watts maximum.

The nets meet at the following times and frequencies.

Net	Freq.	NCS	Day	UTC
Transcontinental Net (TCN)	14060	W5LXS	Sunday	2200
South East Net (SEN)**	7030	K3TKS	Wed	0000
Great Lakes Net (GLN)	3560	K2JT	Thur	0100
Western States Net (WSN)80	3558	NM7M	Sat	0300
		W6RCP		
North East Net (NEN)	7040	W1FMR	Sat	1200
Western States Net (WSN)40	7040	NM7M	Sat	1600
		W6RCP		

** If SEN is not heard on 7030 QSY to 3535 one half hour after beginning of net time. This net is actually run on two frequencies one half hour apart.

That's all for this month gang! See the Convention Calendar on page 77 for more activities.

Another Radio War?

A reader in Maryland alerted us to the fact that anti-Castro La Voz del CID has reactivated its transmissions on 7380 kHz. This service is parallel 9940 kHz. CID had abandoned 7380 because of severe utility interference, a situation which has not changed in the meantime.

Our reader offers the hypothesis that CID may be attempting the same tactic that Radio Impacto on 5030 appears to be trying. If Impacto is seeking to give Cuba's Radio Rebelde on 5025 some competition, CID's target may be Radio For Peace International on 7375. As in the case of Impacto, it seems unlikely that CID intends to jam its rival. Rather it would hope to attract some of RFPI's audience. The pro-peace, somewhat leftist themes of many of RFPI's programs are probably anathema to the folks at CID.

You should find both stations reasonable targets around 0100 or 0200 UTC. Despite RFPI's low power (1 to 2 kw) and the still extensive utility station interference in the area, many listeners have been receiving good signals from both stations.

Our Maryland reader makes another interesting observation. The 11635 kHz transmission, supposedly from Venezuela, has been observed running parallel with 9940. 9940 is said to be from El Salvador. How can this be? I can offer no explanation except to note that several months ago we were advised that some broadcasting activities of an undisclosed nature were again



Radio for Peace International provides an outlet for UN Radio - something it lost when VOA raised its rates.

taking place in Florida. Perhaps this is the explanation. Perhaps it is not.

CID has a very elaborate governing structure which it claims represents 64 exile communities. Headquarters are in Caracas, Venezuela, and it maintains several offices that will normally respond to reception reports. Spanish may get you a better reply but English is usually satisfactory. One such address is Apartado 8130, San Jose 1000, Costa Rica. You can also try Cuba

Independiente y Democratica, 10020 SW 37 Terrace, Miami, Florida 33165.

Radio for Peace International

Before leaving the subject entirely, here is some more information on Radio for Peace International. We recently heard directly from the station and they state that the facility is a joint project of World Peace University in Oregon and the University for Peace in Escazu, Costa Rica. Neither of these institutions appears to grant degrees. Instead they sponsor internships in peace studies and provide experience in telecommunications through the shortwave station located on the Costa Rican campus.

World Peace University was founded in October 1984. It claims to have been the project of an unidentified nonprofit organization. The University for Peace does not state the source of its funding. However, it does say that its creation was approved by the United Nations General Assembly in 1980.

It is interesting that this station's program schedule does list United Nations program-



LA VOZ DEL CID
Cuba Independiente y Democratica

certificado de sintonia

A JOHN SANTOSUOSSO

QUIEN NOS SINTONIZO EL DIA 23 de septiembre de 1982

DE LAS 01:02 GMT, A LAS 01:29 EMISORA: Frank Pule

EN LAS BANDAS DE 40 MTS FRECUENCIA 7,400 Khz

ming on 7375 kHz at 0330 and 15495 at 2330 UTC. It would appear to give the UN a radio voice in the western hemisphere, something it lost when the Reagan administration raised the charges on VOA transmitters to a level the UN said it could not afford. Currently RFPI is scheduled to transmit on 7375 from 0100 to 0400 and 15495 from 2100 to 0000 UTC. Programs are mostly in English with some Spanish. Reception reports may be sent to P.O. Box 188, Sweet Home, OR 97386, or Apartado 88, Santa Ana, Costa Rica.

A Final Note on UN Radio

Perhaps a final note about United Nations broadcasting would be in order at this point. The question as to exactly why the VOA increased its price to the UN has never been fully examined. The justification was that the former rate was very low and had not been raised in years. Others counter that it was not a need for revenue that prompted the change. Rather it was no secret that Washington was very unhappy with the views expressed in many of the UN broadcasts.

Recently I had the opportunity to talk to a person once very close to the VOA. In response to my question as to why there had never been much controversy about the rate hike, he remarked that the domestic media seemed totally uninterested in the matter and never made much effort to bring it to the attention of the public.



Aboard a Pirate Ship

The famous commercial off-shore pirate station based on the *Ross Revenge* is now being heard with reasonably good signals on shortwave. Tune to 6210 for a relay of Caroline's 558 medium wave service. Caroline has been logged by some around 2300 and 0000 UTC; Florida's Terry Krueger reports hearing it around 0330.

The station is a notoriously poor verifier. If you want to try anyway, Krueger suggests sending your report to the New York office and request that it forward it on to the ship. You can mail your letter to Vincent Monsey, President, RSI Communications, 25 Randall Avenue, Lynbrook, NY 11563.

There is one major puzzle about Radio Caroline. For a commercial station it runs little advertising. While in England last year I monitored it extensively and found little in the way of commercial time except occasional ads for the Canadian Lottery. It is true that some revenue is produced from religious programming transmitted on 963 kHz and leasing time to a Dutch service known as Radio Monique, also on 963. However, all of this put together would not seem to be adequate to keep Caroline on the air let alone fund its plans for expansion.

Yet Caroline, anchored off the British coast, has survived for years -- even returning to life after the sinking of its former ship the *Mi Amigo*. The question remains, how does Caroline pay its bills. Or should we be asking who pays them and why? Given an international treaty signed by most of the European nations, and various domestic laws in England and other countries, its possibility of attracting advertisers in the future is not good. Yet it goes on-- and on.

Things That Go Bump in the Night

There are always those strange oddities around that are worth monitoring, even though no one may be

**IF YOU BUY, SELL
OR COLLECT
OLD RADIOS,
YOU NEED...**

**Antique Radio's
Largest-Circulation
Monthly Magazine**



ANTIQUE RADIO CLASSIFIED

Articles - Classifieds - Ads for Parts & Services.

Also: Early TV, Ham Equip., Books,
Telegraph, 40's & 50's Radios & more...

Free 20-word ad each month. Don't miss out!

Sample - Free. 6-Month Trial - \$10.

1-Year: \$18 (\$24 by 1st Class). Foreign - Write.

A.R.C., P.O. Box 2-P2, Carlisle, MA 01741

absolutely certain what they are. From Texas, Robert Rowe reports coming across just this sort of thing.

He has listened to a three or four note warbling sound between 5300 and 5900 kHz from 0200 to 0500 UTC. After several minutes the signal is gone only to appear a few seconds later 30 or 100 kHz higher. Robert goes on to say that "sometimes when tuning slightly up or down the carrier frequency a chirping sound can be heard and once or twice I thought I heard numbers or letters buried in the signal.

We asked our good friend Havana Moon about all this. He theorizes it is probably the piccolo system used by British intelligence and the British Diplomatic Service. Piccolo converts CW or other types of transmissions into musical notes. The Russians may also use a similar system.

The "K"s and the "U"s

We have also heard again from our K and U beacon expert in Maine. Dave White says he monitors 7905 and 12150 every day between 1100 and 1200 UTC, although there is activity later in the day and evening. He believes that there is traffic or an increase in traffic when there is prominent news being made. He thinks the traffic may be an alert to monitor both newspaper and television. Unlike most persons attracted to these bizarre CW beacons, he does not feel that they are Russian. Dave continues to watch 12150 and 7905 closely even though the beacons may currently be inactive. Further information or theories on what Dave and Robert have been hearing would be welcome.

ORDER DESK HOURS (Eastern):
MONDAY-FRIDAY 10 A.M. to 5 P.M.
SATURDAY 10 A.M. to 4 P.M.
 Technical and VA orders call (703) 938-3350

Electronic Equipment Bank
 516 Mill Street N.E., Vienna, VA 22180
 Telephone (703) 938-3350

STORE HOURS (Eastern):
 Same as Order Desk Hours
 Closed Mondays
 Thursday 10 A.M. to 9 P.M.

Electronic Equipment Bank—Order Toll Free 800-368-3270

SMALL PORTABLES

DIPLOMAT 4950 \$69.95 + \$4. UPS

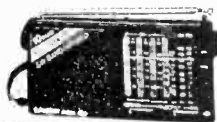

AM 550-1670
 FM 88-108
 11 Shortwave bands
 Stereo headset out.
 OPT. AC adapter
 SPA4.5 \$9.95

SONY ICF-4920 CALL

FM & AM
 7 Shortwave bands
 OPT. AC adapter
 Sony AC-39 \$19.95
 or ACW3...\$9.95

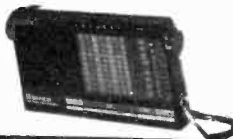

SANGEAN ATS-801 \$99.95 + \$4. UPS



25 Memories
 AM, FM, SW
 Digital readout
 Clock & timers
 OPT. AC adapter
 PA6P \$9.95

TOSHIBA RP-F11 \$89.95 + \$4. UPS

All international
 & Tropical Bands
 'S' Meter
 Safety Lock
 OPT. AC adapter
 PA6P \$9.95



SONY ICF 2003 CALL

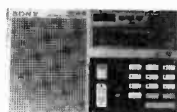

150 kHz - 30 MHz
 AM, FM
 Memories, Scanning
 24 hour clock
 OPT. AC adapter
 PA6N \$9.95

SONY ICF-7700 CALL

FM, LW, MW & 12 Shortwave bands, Clock,
 LCD readout, 15 memories. OPT AC Adapter
 PA6N \$9.95.

PANASONIC RF-B60 \$249.95

AM, FM & SW
 36 Memories, Scanning
 Keypad entry, Clock
 LCD Frequency display
 OPT. AC adapter
 PA6N \$9.95

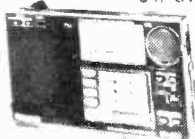

PANASONIC RF-B40 \$179.95

FM, AM & 6 SHORTWAVE BANDS
 Micro: 4 5/16 X 2 3/8 X 7/8" \$4. UPS

WORLD RADIO TV HANDBOOK

NEW 1988 EDITION!

Listen to the world...hear the voices of people making history...eavesdrop on local programs from around the globe...gain a new perspective on international events. Guides to English broadcasts. Station information including frequencies, transmitter powers, operating times, languages, addresses, etc. Stations listed by frequency in order to help you identify them more easily. The other Shortwave Listener's Bible!

ORDER: WRTVH..\$19.95 POSTPAID!

LARGER PORTABLES

ATS 803A \$189.95 + \$6. UPS



Free Radio Stand

AM, FM, SSB & CW
 LED readout.
 Clock/Timers.
 9 Memories/Scanning.
 Stereo headset out.
 Wide/Narrow switch.
 AC Adapter included!

MAGNAVOX D2935 \$199.95 + \$6. UPS

AM, FM, SSB.
 13 Shortwave bands.
 LED readout.
 Signal meter.
 Many more extras.



MAGNAVOX D2999 \$299.95 + \$8. UPS

AM, FM, SSB, CW/16 Memories.
 Continuous AM tuning 146 kHz-30 MHz.
 LCD readout/Quality 2 speaker sound!

SONY ICF-2010 CALL



AM, FM, SSB, CW & Air
 Band. 32 Memories.
 Scanning. LED readout.
 Clock/Timers.
 AC Adapter included.

GRUNDIG 400 \$399.95 + \$6. UPS



AM, FM, SSB, CW/24 Memories/Scanning.
 LED readout; 24 hr clock; timer.
 Many other features. Best portable audio!
 120/240V or Battery **Free Radio Stand**

ANTENNAS

'EAVESDROPPER'...SWL \$59.95 + \$4.

'DX SLOPER'...DXSWL \$69.95 + \$4. UPS

'DATONG ACTIVE ANTENNA' **NEW!**

AD370...\$139.95 + \$4 UPS W/AC Adapter

SONY AN1...\$89.95 + \$4 UPS W/AC Adapter

'MFJ OUTDOOR ANTENNA'

AC Adapter
 MFJ1024...\$119.95 + \$4 UPS PA1312...\$9.95

FREE EEB CATALOG!

36 Pages over 300 items for the SWLer!

NEW FOR 1988

Many items found only at EEB!

CALL OR WRITE TODAY!

GET ALL THE DETAILS!

DESK TOP RADIOS

NRD-525 \$1169.00 + \$10. UPS



90 kHz - 34 MHz. 200 Memories! Options for
 34-60, 114-174 & 423-456 MHz. 2 Clocks/Timer.
 AM, FM, CW, SSB, RTTY. Many more features.

KENWOOD R-5000 \$799.95 + \$8. UPS



100 kHz - 30 MHz. 100 Memories! Optional 108
 -174 MHz converter. AM, FM, SSB, CW, FSK.
 Scanning. 2 Clocks/Timer. Many fine features.

KENWOOD R-2000 \$579.95 + \$8. UPS

150 kHz - 30 MHz. 10 Memories. Optional 118
 -174 MHz converter. AM, FM, SSB, CW. LCD
 readout. Scanning. 2 Clocks/Timer.

ICOM R-71A \$849.00 + \$8. UPS



100 kHz - 30 MHz. 32 Memories! AM, FM (opt.),
 CW, SSB, RTTY. Scan Memory/Band. Many more
 fine features included! EEB HP Options: Call

ICOM R-7000 \$1019.00 + \$10. UPS

25-1000, 1025-2000 MHz! AM, FM & SSB. 99
 Memories. Full Scanning control. The best
 available under 15K\$! EEB HP Options: Call

YAESU FRG-8800 \$619.95 + \$8. UPS



150 kHz - 29.999 MHz. 12 Memories. Optional
 118 - 174 MHz converter. AM, FM, SSB, CW.
 LCD readout. Scanning. 2 Clocks/Timer.

YAESU FRG-9600 \$499.95 + \$7. UPS

60 - 905 MHz. 100 Memories. AM, FM & SSB.
 Scanning. 'Kuranishi' converters are
 available for 20 kHz - 60 MHz; 800 - 1300 MHz.

PASSPORT TO WORLDWIDE RADIO

NEW 1988 EDITION!

The Shortwave Listener's Bible! **NEW!**

At a glance: Data on every Broadcast station in the Shortwave spectrum! Names, Locations, Frequencies, Operating time, Language, Target area and Transmitter power. All displayed in a convenient easy to read frequency graph form. Buyers guide to more than 90 tabletop and portable receivers. Antenna recommendations. Cross index of major stations alphabetically by country.

ORDER: WBR..\$14.95 + \$1.95 UPS



- We ship world-wide
- Shipping charges not included
- Prices & specifications subject to change without notice

10 miles west of Washington, D.C.
 Sorry—No COD's
 10-5 Tues., Wed., Fri. 10-9 Thursday
 10-4 Saturday Closed Sunday and Monday



ELECTRONIC EQUIPMENT BANK
 516 Mill Street, N.E. Order Toll Free:
 Vienna, VA 22180

800-368-3270
 Technical and VA Orders (703) 938-3350

frequency SECTION

MT Monitoring Team

EAST COAST:

Greg Jordan,
Frequency Manager

1855-I Franciscan Terrace
Winston-Salem, NC 27127

Joe Hanlon, PA

WEST COAST:

Bill Brinkley, CA

0000 UTC [8:00 PM EDT/5:00 PM PDT]

0000-0015	Voice of Kampuchea, Phnom-Penh	9693	11938				
0000-0030	BBC, London, England	5965	5975	6005	6120		
		6175	6195	7135	7325		
		9515	9570	9580	9590		
		9915	12095	11955	15435		
0000-0030	Kol Israel, Jerusalem	7462	9435	9815			
0000-0030	Radio Berlin Int'l, East Germany	6080	9730				
0000-0030	Radio Korea, Seoul, South Korea	15575					
0000-0030 M	Radio Norway Int'l, Oslo	9605	9625				
0000-0030 S,M	WINB, Red Lion, Pennsylvania	15145					
0000-0050	Radio Pyongyang, North Korea	15115	15160				
0000-0055	Radio Beijing, PR China	9770	11715	15455			
0000-0100	(US) Armed Forces Radio and TV	6030	11790				
0000-0100	All India Radio, New Delhi	6055	7215	9535	9910		
		11715	11745	15110			
0000-0100	CBC Northern Quebec Service	6195	9625				
0000-0100	CBN, St. John's, Newfoundland	6160					
0000-0100	CBU, Vancouver, British Colombia	6130					
0000-0100	CFCF, Montreal, Quebec	6005					
0000-0100	CFCN, Calgary, Alberta	6030					
0000-0100	CBN, St. John's, Newfoundland	6160					
0000-0100	CBN, St. John's, Newfoundland	6160					
0000-0100	CBU, Vancouver, British Colombia	6160					
0000-0100	CFCF, Montreal, Quebec	6005					
0000-0100	CFCN, Calgary, Alberta	6030					
0000-0100	CHNS, Halifax, Nova Scotia	6130					
0000-0100	CKWX, Vancouver, British Colombia	6080					
0000-0100	CFRB, Toronto, Ontario	6070					
0000-0100	FEBC, Manila, Philippines	15445					
0000-0100	(US) Far East Network, Tokyo	3910					
0000-0100	KSDA, Guam	15125					
0000-0100 T-A	KVOH, Rancho Simi, California	9495					
0000-0100 S,M	KVOH, Rancho Simi, California	17775					
0000-0100	KYOI, Saipan	15405					
0000-0100	Radio Australia, Melbourne	15140	15160	15240	15320		
		15395	17750	17795			

0000-0100	Radio Baghdad, Iraq	6110					
0000-0100	Radio Canada Int'l, Montreal	5960	9755				
0000-0100	Radio Havana Cuba	6090					
0000-0100	Radio Luxembourg	6090					
0000-0100	Radio Moscow, USSR	6000	7115	7130	7150		
		7185	7215	7310	9530		
		9720	12050	13665	15425		
		15455	17880				
0000-0100	Radio New Zealand, Wellington	15150	17705				
0000-0100	Radio for Peace, Costa Rica	7375v					
0000-0100	Radio Thailand, Bangkok	9655	11905				
0000-0100	SBC Radio One, Singapore	5010	5052	11940			
0000-0100	Spanish Foreign Radio, Madrid	6125	9630				
0000-0100 T-S	Superpower KUSW, Utah	11665					
0000-0100	Voice of America, Washington	5995	6130	9455	9650		
		9775	9815	11580	11695		
		11740	15185	15205	17740		
0000-0100 T-A	Voice of Nicaragua, Managua	6015					
0000-0100	WCSN, Boston, Massachusetts	9852.5					
0000-0100	WHRI, Noblesville, Indiana	7400	9870				
0000-0100	WRNO New Orleans, Louisiana	7355					
0000-0100	WYFR, Oakland, California	5950	6085	9680			
0000-0100 T-A	WYFR Satellite Net, California	9505					
0030-0045	BBC, London, England*	6195	7235	9570	11820		
		15435					
0030-0055	BRT, Brussels, Belgium	5910	9925				
0030-0100	BBC, London, England	5965	5975	6005	6120		
		6175	7135	7325	9515		
		9580	9915	9590	11955		
		15435					
0030-0100	HCJB, Quito, Ecuador	9720	11775	11910	15155		

LEGEND

- * The first four digits of an entry are the broadcast start time in UTC. The second four digits represent the end time.
- * In the space between the end time and the station name is the broadcast schedule.

S=Sunday M=Monday T=Tuesday W=Wednesday
H=Thursday F=Friday A=Saturday

If there is no entry, the broadcasts are heard daily. If, for example, there is an entry of "M," the broadcast would be heard only on Mondays. An entry of "M,W,F" would mean Mondays, Wednesdays and Fridays only. "M-F" would mean Mondays through Fridays. "TEN" indicates a tentative schedule and "TES" a test transmission.

- * [ML] after a frequency indicates a multi-lingual transmission containing English-language programs.
- * The last entry on a line is the frequency. Codes here include "SSB" which indicates a Single Sideband transmission, and "V" for a frequency that varies. [ML] after a frequency indicates a multi-lingual transmission containing English-language programs.
- * v after a frequency indicates that it varies
- * Notations of USB and LSB (upper and lower sideband transmissions) usually refer only to the individual frequency after which they appear.
- * Listings followed by an asterisk (*) are for English lessons and do not contain regularly scheduled programming.

We suggest that you begin with the lower frequencies that a station is broadcasting on and work your way up the dial. Remember that there is no guarantee that a station will be audible on any given day. Reception conditions can change rapidly, though, and if it is not audible one night, it may well be on another.

HOW TO USE THE PROPAGATION CHARTS

Propagation charts can be an invaluable aid to the DXer in determining which frequencies are likely to be open at a given time. To use the propagation charts, choose those for your location (the are divided into east coast, midwest and west coast of North America). Then look for the one most closely describing the geographic location of the station you want to hear.

Once you've located the correct charts, look along the horizontal axis of the graph for the time that you are listening. The top line of the graph shows the Maximum Useable Frequency [MUF] and the lower line the Lowest Useable Frequency [LUF] as indicated on the vertical axis of the graph.

While there are exceptions to every rule (especially those regarding shortwave listening), you should find the charts helpful in determining the best times to listen for particular regions of the world. Good luck!

frequency SECTION

0030-0100	SLBC, Colombo, Sri Lanka	6005	9720
0030-0100	WINB, Red Lion, Pennsylvania	15145	
0035-0040	All India Radio, New Delhi	3925	4860
0045-0100	A Radio New Zealand, Wellington	15150	17705
0050-0100	Vatican Radio, Vatican City	6150	7315 9605 11780

0100 UTC [9:00 PM EDT/6:00 PM PDT]

0100-0103	S Port Moresby, Papua New Guinea	3295	4890	5960	5985
		6020	6040	6080	6140
		9520			
0100-0110	Vatican Radio, Vatican City	6150	7315	9605	11780
0100-0115	All India Radio, New Delhi	6055	7215	9535	9910
		11715	11745	15110	
0100-0120	RAI, Rome, Italy	9575	11800		
0100-0125	Kol Israel, Jerusalem	7462	9435	9815	
0100-0130	T-A Radio Budapest, Hungary	6025	6110	9520	9585
		9835	11910		
0100-0130	Radio Japan, Tokyo	15280	17810	17835	17845
0100-0130	Laotian National Radio	7113v			
0100-0150	Deutsche Welle, West Germany	6040	6085	6145	9565
		9815	11865		
0100-0150	Radio Baghdad, Iraq	6110			
0100-0200	(US) Armed Forces Radio and TV	6030	11790	15345	
0100-0200	BBC, London, England	5975	6005	6120	6175
		7325	9515	9590	9915
		9975			
0100-0200	CBC Northern Quebec Service	6195	9625		
0100-0200	CBN, St. John's, Newfoundland	6160			
0100-0200	CBU, Vancouver, British Columbia	6160			
0100-0200	CFCF, Montreal, Quebec	6005			
0100-0200	CFCN, Calgary, Alberta	6030			
0100-0200	CHNS, Halifax, Nova Scotia	6130			
0100-0200	CKWX, Vancouver, British Columbia	6080			
0100-0200	CFRB, Toronto, Ontario	6070			
0100-0200	(US) Far East Network, Tokyo	3910			
0100-0200	FEBC, Manila, Philippines	15445			
0100-0200	HCJB, Quito, Ecuador	9720	11775	11910	15155

0100-0200	T-A KVOH, Rancho Simi, California	9495			
0100-0200	KYOI, Saipan	15405			
0100-0200	Radio Australia, Melbourne	15160	15180	15240	15320
		15395	17715	17795	
		17750			
0100-0200	Radio Canada Int'l, Montreal	9535	11845	11940	
0100-0200	Radio Havana Cuba	6090			
0100-0200	Radio Japan, Tokyo	5960	9755		
0100-0200	Radio Luxembourg	6090			
0100-0200	Radio Moscow, USSR	6000	7115	7150	7310
0100-0200	Radio Moscow World Service	15130	15210	17825	17880
0100-0200	Radio New Zealand, Wellington	15150	17705		
0100-0200	Radio for Peace, Costa Rica	7375			
0100-0200	Radio Prague, Czechoslovakia	5930	6055	7345	9540
		9630	9740	11990	
		9655	11905		
0100-0200	Radio Thailand, Bangkok	5010	5052	11940	
0100-0200	SBC Radio One, Singapore	6005	9720	15425	
0100-0200	SLBC, Colombo, Sri Lanka	6125	9630		
0100-0200	Spanish Foreign Radio, Madrid	11665			
0100-0200	T-S Superpower KUSW, Utah	5995	6130	7205	9455
0100-0200	Voice of America, Washington	9530	9650	9775	9815
		11580	11740	15205	15425
		9680	11790		
0100-0200	Voice of Indonesia, Jakarta	9852.5			
0100-0200	WCSN, Boston, Massachusetts	15145			
0100-0200	WINB, Red Lion, Pennsylvania	7400	9870		
0100-0200	WHRI, Noblesville, Indiana	7355			
0100-0200	WRNO, New Orleans, Louisiana	5950	7440	9680	
0100-0200	WYFR, Oakland, California	9505			
0100-0200	T-S WYFR Satellite Net, California	7430	9395	9420	
0130-0140	T-S Voice of Greece, Athens	9870			
0130-0155	Radio Austria Int'l, Vienna	6080	9730		
0130-0200	Radio Berlin Int'l, East Germany	15305	15330		
0130-0200	Radio Veritas Asia, Philippines	6125	6165		
0145-0200	Radio Berlin Int'l, East Germany	7275	15375		
0145-0200	Radio Korea, Seoul, South Korea				

East Coast To Western Europe

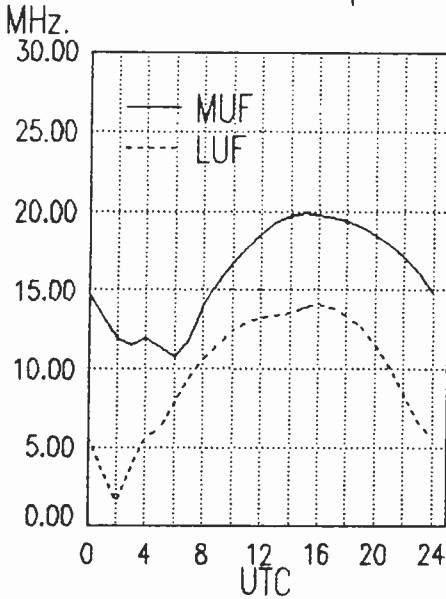

East Coast To Middle East

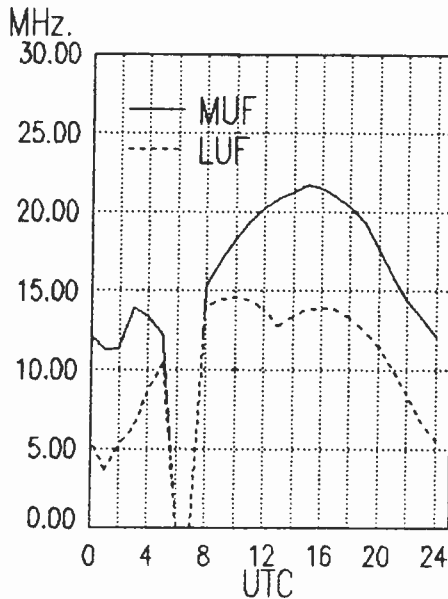

East Coast To Eastern Europe

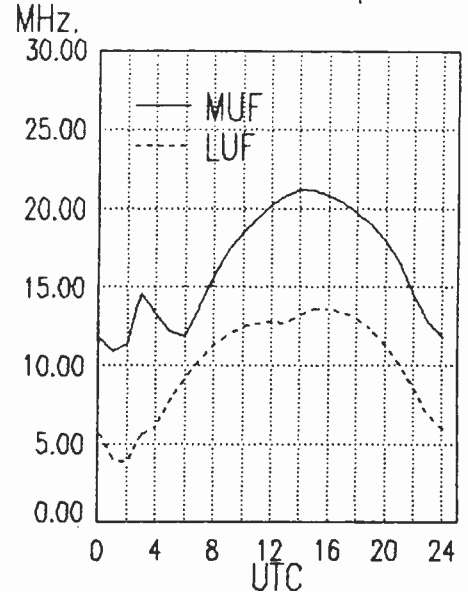

frequency SECTION

0200 UTC [10:00 PM EDT/7:00 PM PDT]									
0200-0215	Vatican Radio, Vatican City	7125	9650	0200-0300	Radio Cairo, Egypt	9475	9675		
0200-0225	Radio Budapest, Hungary	6025	6110 9520 9585	0200-0300	Radio Havana Cuba	6090			
		9835	11910	0200-0300	Radio Korea (South), Seoul	7275	15575		
0200-0230	BBC, London, England	5975	6005 6175 7325	0200-0300	Radio Luxembourg	6090			
		9410	9590	0200-0300	Radio Moscow, USSR	7115	7150 7185 7250		
		9915				7310	9580 9635 11770		
0200-0230	Burma Bcsting Service, Rangoon	7185		0200-0300	Radio Orion, South Africa	3955			
0200-0230	M Radio Austria Int'l, Vienna	9870		0200-0300	Radio for Peace, Costa Rica	7375			
0200-0230	Radio Kiev, Ukrainian SSR	6200	7165 7400 11790	0200-0300	A Radio New Zealand, Wellington	15150	17705		
		13645	15180	0200-0300	Radio Polonia, Warsaw, Poland	6095	6135 7145 7270		
0200-0230	Swiss Radio Int'l, Berne	5965	6135 9725 9885			9525	11815 15120		
		12035		0200-0300	Radio RSA, South Africa	9580	9615 11730		
0200-0230	La Voz de Mosquitia, Honduras	4910.4		0200-0300	Radio Thailand, Bangkok	9655	11905		
0200-0230	WINB, Red Lion, Pennsylvania	15145		0200-0300	SBC Radio One, Singapore	5010	5052 11940		
0200-0245	Radio Berlin Int'l, East Germany	6080	9560	0200-0300	SLBC, Colombo, Sri Lanka	6005	9720 15425		
0200-0250	Deutsche Welle, West Germany	5995	6035 7285 9615	0200-0300	T-S Superpower KUSW, Utah	11665			
		9690		0200-0300	Voice of America, Washington	5995	7205 9650 9740		
0200-0250	Radio Bras, Brasilia, Brazil	11745v				9775	9815 11580 15205		
0200-0255	Radio Bucharest, Romania	5990	6155 9510 9570	0200-0300	Voice of Asia, Taiwan	7285			
		11810	11940	0200-0300	Voice of Free China, Taiwan	5950	5985 7445 9555		
0200-0255	RAE, Buenos Aires, Argentina	9690	11710			9755	11740 11745 11860		
0200-0300	(US) Armed Forces Radio and TV	6030	11790	0200-0300	Voice of Kenya, Nairobi	6045			
0200-0300	CBC Northern Quebec Service	6195	9625	0200-0300	WCSN, Boston, Massachusetts	9852.5			
0200-0300	CBN, St. John's, Newfoundland	6160		0200-0300	WHRI, Noblesville, Indiana	7400	9870		
0200-0300	CBU, Vancouver, British Colombia	6160		0200-0300	WRNO, New Orleans, Louisiana	7355			
0200-0300	CFCF, Montreal, Quebec	6005		0200-0300	WYFR, Oakland, California	7440	9680		
0200-0300	CFCN, Calgary, Alberta	6030		0200-0300	WYFR Satellite Net, California	9505			
0200-0300	CFRB, Toronto, Ontario	6070		0215-0220	Radio Nepal, Kathmandu	5005	7165		
0200-0300	CHNS, Halifax, Nova Scotia	6130		0230-0240	Port Moresby, Papua New Guinea	3925	4890 5960 5985		
0200-0300	CKWX, Vancouver, British Colombia	6080				6020	6040 6080 6140		
0200-0300	(US) Far East Network, Tokyo	3910		0230-0245	Radio Pakistan, Islamabad	7010	11570 15115 15580		
0200-0300	HCJB, Quito, Ecuador	6230	9720 11775			17660			
0200-0300	T-A KVOH, Rancho Simi, California	9495		0230-0300	BBC, London, England	5975	6005 6175 7325		
0200-0300	KSDA, Guam	17865				9410	9515 9660 9845		
0200-0300	Radio Australia, Melbourne	15180	15240 15320 17715			9915	11955		
		17750	17795	0230-0300	Radio Netherland, Hilversum	6020	6165 9590 9895		
						15315			
				0230-0300	T-A Radio Portugal, Lisbon	6060	9635 9680 9705		

East Coast To West Africa

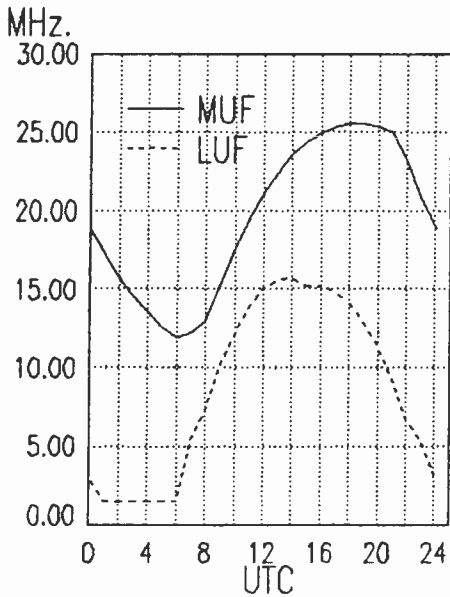

East Coast To Central Africa

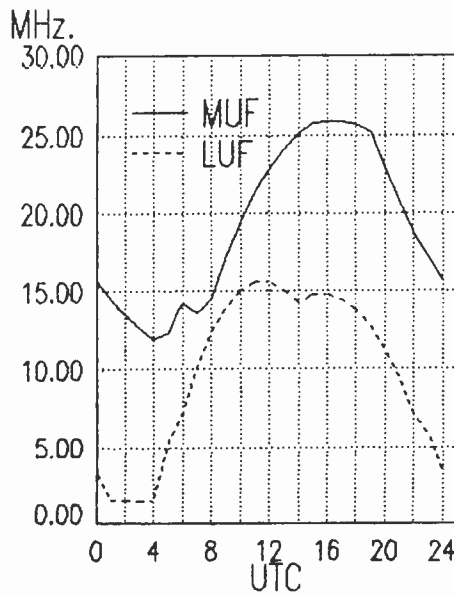

East Coast To East Africa

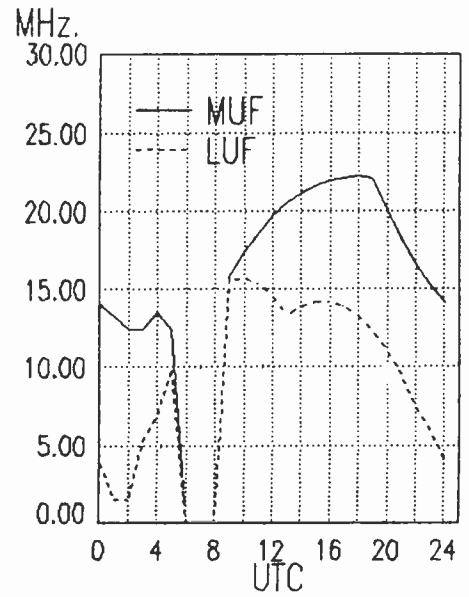

frequency SECTION

0230-0300	Radio Sweden, Stockholm	9705	11840		
0230-0300	Radio Tirana, Albania	9695	11950	[USB]	
0230-0300 S,M	WINB, Red Lion, Pennsylvania	7065	9760		
0240-0250	All India Radio, New Delhi	15145			
		3905	4860	4880	4895
		5960	5990	6110	6120
		7195	7295	9550	9610
		11830	11870	15305	
0250-0300	Radio Yerevan, Armenlan SSR	11790	13645	15180	

0300 UTC [11:00 PM EDT/8:00 PM PDT]

0300-0307	Radio Pakistan, Islamabad	5090	5930	7095	
0300-0310	CBC Northern Quebec Service	6195	9625		
0300-0315 T-A	KVOH, Rancho Simi, California	9495			
0300-0315 W,A	Radio Budapest, Hungary	6025	9520	9835	
0300-0325	Radio Netherland, Hilversum	6020	6165	9590	9895
		15315			
0300-0330	BBC, London, England	3955	5975	6005	6155
		6175	6195	7125	7325
		9410	9515	9660	9915
0300-0330	Radio Cairo, Egypt	9475	9675		
0300-0330	Radio Japan, Tokyo	11870	17825	21610	
0300-0330 S,M	WINB, Red Lion, Pennsylvania	15145			
0300-0345 A	Radio New Zealand, Wellington	15150	17705		
0300-0350	Deutsche Welle, West Germany	6010	6045	9545	9605
		9700			
0300-0350	Voice of Turkey, Ankara	9445			
0300-0355	Radio Beijing, PR China	9645	9770	11715	11980
		15455			
0300-0355	Radio Polonia, Warsaw, Poland	6095	6135	7145	7270
		9525	11815	15120	
0300-0356	Radio RSA, South Africa	9580	9615	11730	
0300-0400	(US) Armed Forces Radio and TV	6030	11730		
0300-0400	CBN, St. John's, Newfoundland	6160			
0300-0400	CBU, Vancouver, British Colombia	6160			
0300-0400	CFCF, Montreal, Quebec	6005			

0300-0400	CFCN, Calgary, Alberta	6030			
0300-0400	CHNS, Halifax, Nova Scotia	6130			
0300-0400	CKWX, Vancouver, British Columbia	6080			
0300-0400	CFRB, Toronto, Ontario	6070			
0300-0400	(US) Far East Network, Tokyo	3910			
0300-0400	HCJB, Quito, Ecuador	6230	9720	11775	
0300-0400	La Voz Evangelica, Honduras	4820			
0300-0400	Radio Australia, Melbourne	11945	15160	15240	15320
		15395	17750	17715	17795
0300-0400	Radio for Peace, Costa Rica	7375			
0300-0400	Radio Havana Cuba	6090	6140	9770	
0300-0400	Radio Moscow, USSR	6000	7115	7150	7165
		7310	9530	11790	12050
		13645	13665		
0300-0400	Radio Prague, Czechoslovakia	5930	6055	7345	9540
		9630	9740	11990	
0300-0400	Radio Sofia, Bulgaria	7115	9560	9595	11735
0300-0400	Radio Thailand, Bangkok	9655	11905		
0300-0400	Radio Tirana, Albania	7065	9755		
0300-0400	SBC Radio One, Singapore	5010	5052	11940	
0300-0400	SLBC, Colombo, Sri Lanka	6005	9720	15425	
0300-0400 T-S	Superpower KUSW, Utah	9815			
0300-0400	Trans World Radio, Bonaire	9535			
0300-0400	Voice of America, Washington	6035	7200	7280	9525
		9550	9575	9740	11835
		5950	5985	7445	9555
0300-0400	Voice of Free China, Taiwan	11745	11935	15345	
		6045			
0300-0400	Voice of Kenya, Nairobi	6100			
0300-0400	Voice of Nicaragua, Managua	9852.5			
0300-0400	WCSN, Boston, Massachusetts	9870			
0300-0400	WHRI, Noblesville, Indiana	9870			
0300-0400	WRNO, New Orleans, Louisiana	6185			
0300-0400	WYFR, Oakland, California	7440	9680		
0310-0330	Vatican Radio, Vatican City	6150			
0313-0400	Radio France Int'l, Paris	6055	6175	7135	7175
		9550	9790	9800	11995
0300-0355	Radio Finland, Helsinki	9635	11945		
0330-0340 S-F	Port Moresby, Papua New Guinea	3925	4890	5960	5985
		6020	6040	6080	6140
		9520			
0330-0400	BBC, London, England	3955	5975	6155	6175

East Coast To South Africa

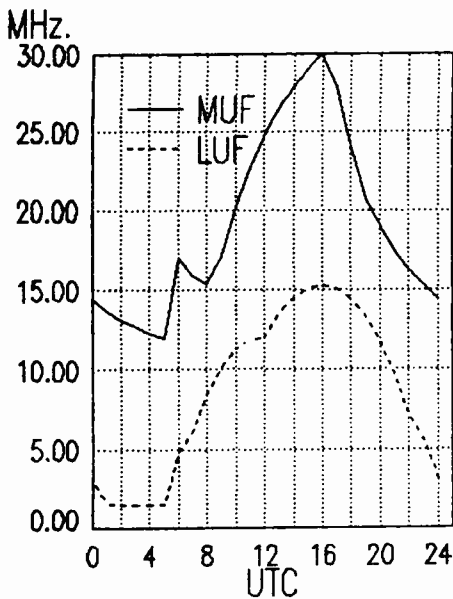

East Coast To Indian Ocean

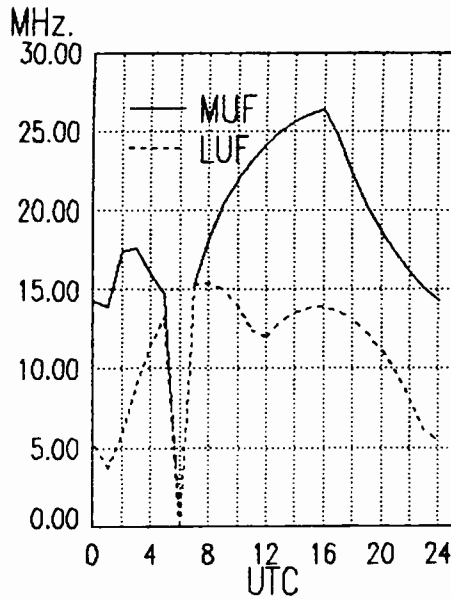

East Coast To Central Asia

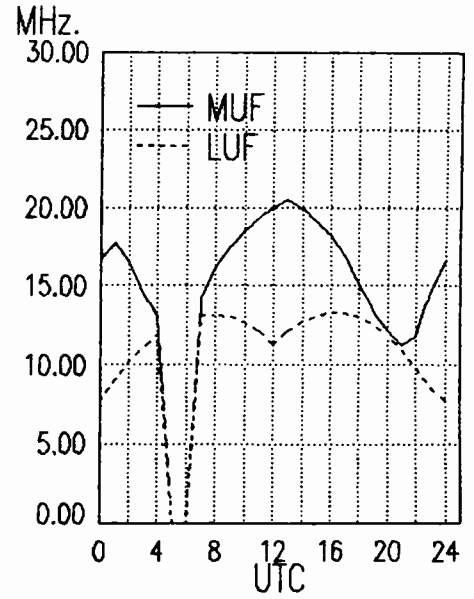

frequency SECTION

0330-0400	Radio Berlin Int'l, East Germany	6195	9410
0335-0400	Radio New Zealand, Wellington	6080	9560
0330-0400	Radio Tanzania, Dar es Salaam	11790	15150
0330-0400	Radio Tirana, Albania	9684	
0330-0400	Radio Sweden, Stockholm	7065	9755
0330-0400	United Arab Emirate Radio	11705	
0335-0340	All India Radio, New Delhi	9640	11940 15435 17775
		3905	4860 9610 11830
0340-0350 T-S	Voice of Greece, Athens	11870	11890 15305
0345-0400	Radio Berlin Int'l, East Germany	7430	9395 9420
0350-0400	RAI, Rome, Italy	5965	9620 11920
		9710	11905 15330

0400-0450	Radio Pyongyang, North Korea	15160	15180
0400-0455	Radio Beijing, PR China	9645	11980
0400-0455	RAE, Buenos Aires, Argentina	9690	11710
0400-0500	(US) Armed Forces Radio and TV	6030	11730
0400-0500	CBC Northern Quebec Service	6195	9625
0400-0500	CBN, St. John's, Newfoundland	6160	
0400-0500	CBU, Vancouver, British Columbia	6160	
0400-0500	CFCF, Montreal, Quebec	6005	
0400-0500	CFCN, Calgary, Alberta	6030	
0400-0500	CHNS, Halifax, Nova Scotia	6130	
0400-0500	CKWX, Vancouver, British Columbia	6080	
0400-0500	CFRB, Toronto, Ontario	6070	
0400-0500	(US) Far East Network, Tokyo	3910	
0400-0500	FEBC, Manila, Philippines	11850	
0400-0500	HCJB, Quito, Ecuador	6230	9720 11775
0400-0500	KYOI, Salpan	17780	
0400-0500	Radio Australia, Melbourne	11910	11945 15160 15240
		15320	17715 17795
0400-0500	Radio Moscow, USSR	6000	7150 7310 7345
		11790	12050 13645 13665
		15455	
0400-0500	Radio New Zealand, Wellington	11780	15150
0400-0500	SBC Radio One, Singapore	5010	5052 11940
0400-0500 T-S	Superpower KUSW, Utah	9815	
0400-0500	United Nations Radio, Honduras	4820	
0400-0500	Voice of America, Washington	5995	6035 7280 9525
		9575	11835
0400-0500	Voice of Kenya, Nairobi	6045	
0400-0500	WCSN, Boston, Massachusetts	9870	
0400-0500	WINB, Red Lion, Pennsylvania	15145	
0400-0500	WHRI, Noblesville, Indiana	7400	
0400-0500 M-A	WMLK, Bethel, Pennsylvania	9455	
0400-0500	WRNO, New Orleans, Louisiana	6185	
0400-0500	WYFR, Satellite Net, California	9520	
0400-0500	WYFR, Oakland, California	5950	7355 9680
0425-0440	RAI, Rome, Italy	5980	7275
0430-0455	Radio Austria Int'l, Vienna	6000	6015 6155
0430-0500	BBC, London, England	5975	6005 6155 6180
		6195	7105 9410 9510
0430-0500	Deutsche Welle, West Germany	6065	7150 7225 9565
		9765	

0400 UTC [12:00 AM EDT/9:00 PM PDT]

0400-0405	Radio Uganda, Kampala	4976	5026
0400-0410	Radio Thailand, Bangkok	9655	11905
0400-0410	RAI, Rome, Italy	9710	11905 15330
0400-0415	Kol Israel, Jerusalem	7410	9385 9435 9460
		11655	
0400-0415	Radio Berlin Int'l, East Germany	6080	9560
0400-0420	Radio Botswana, Gaborone	4820	
0400-0420 T-S	Radio Zambia, Lusaka	3345	6165
0400-0425	Radio Bucharest, Romania	6155	9510
0400-0425	Radio Netherland, Hilversum	7210	9850
0400-0426	Radio RSA, South Africa	7270	9580
0400-0430	BBC, London, England	3955	5975 6005 6155
		6175	6195 7160 9410
		9915	
0400-0430	La Voz Evangelica, Honduras	4820	
0400-0430	Radio Berlin Int'l, East Germany	5965	9620 11920
0400-0430 M	Radio Norway Int'l, Oslo	9650	9655 9730
0400-0430	SLBC, Colombo, Sri Lanka	6005	9720 15425
0400-0430	Radio Tanzania, Dar es Salaam	9684	
0400-0430	Swiss Radio Int'l, Berne	6135	9725 9885 12035
0400-0430	Trans World Radio, Bonaire	9535	
0400-0450	Radio Havana Cuba	5965	6035 6090 6140
		9770	

East Coast To
South East Asia

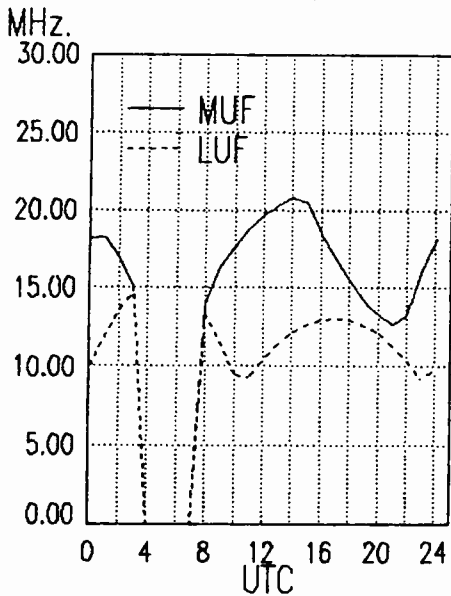

East Coast To
Far East

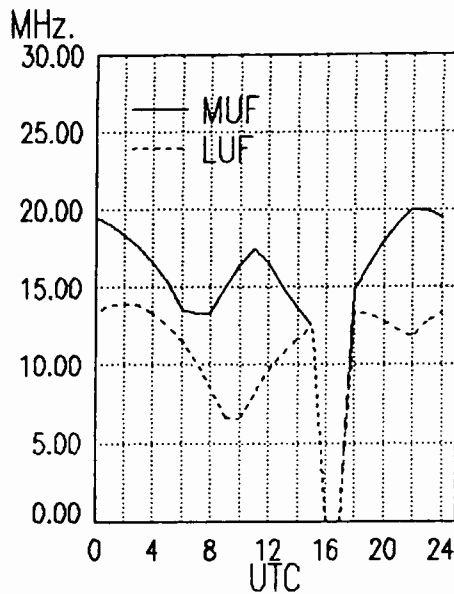

East Coast To
Pacific

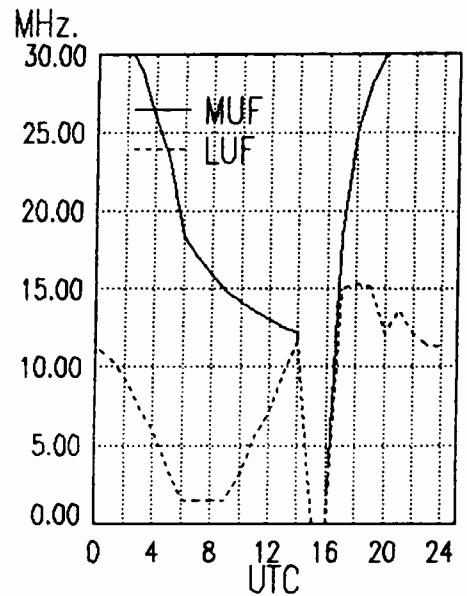

frequency SECTION

0430-0500	Radio Tirana, Albania	9480	11835		
0430-0500 S,M	Trans World Radio, Bonaire	9535			
0430-0500	Trans World Radio, Swaziland	3205	7205		
0430-0500	Voice of Nigeria, Lagos	7255			
0440-0450	Radio France Int'l, Paris	7135	7175	7280	9550
		9790	9800	11955	
0450-0500	Radio Havana Cuba	5965	6035	6140	

0500-0600	Radio Cameroon, Yaounde	4850			
0500-0600	Radio Havana Cuba	5965	6035	6090	9770
		6140			
0500-0600	Radio Japan, Tokyo	5990	15235	17810	
0500-0600	Radio Kuwait	15345			
0500-0600	Radio Moscow, USSR	7105			
		7165	7185	7195	7310
		7320	7345	9530	11790

0500 UTC [1:00 AM EDT/10:00 PM PDT]

0500-0510	CBC Northern Quebec Service	6195	9625		
0500-0510	Radio Lesotho, Maseru	4800			
0500-0510 M-A	Radio Zambia, Lusaka	3345	6165		
0500-0515	Deutsche Welle, West Germany	6065	6120	6130	9565
		9635	9765		
0500-0515 ?	Radio Garoua, Cameroon	5010			
0500-0515	Vatican Radio, Vatican City	11725	15190		
0500-0530	Deutsche Welle, West Germany	5960	6120	6130	9635
0500-0530 M	Radio Norway Int'l, Oslo	6015	11735	11865	
0500-0530 S,M	Trans World Radio, Bonaire	9535			
0500-0530	Trans World Radio, Swaziland	3205	5055	7210	
0500-0555	Radio Beijing, China	9690			
0500-0600	(US) Armed Forces Radio and TV	6030	11730		
0500-0600	BBC, London, England	3955	5975	6005	6180
		6195	7105	7160	7185
		9410	9510	11790	
0500-0600	CBC Northern Quebec Service	6195	9625		
0500-0600	CBU, Vancouver, British Columbia	6160			
0500-0600	CFCF, Montreal, Quebec	6005			
0500-0600	CFCN, Calgary, Alberta	6030			
0500-0600	CHNS, Halifax, Nova Scotia	6130			
0500-0600	CKWX, Vancouver, British Columbia	6080			
0500-0600	CFRB, Toronto, Ontario	6070			
0500-0600	(US) Far East Network, Tokyo	3910			
0500-0600	FEBC, Manila, Philippines	11850			
0500-0600	HCJB, Quito, Ecuador	6230	9720	11775	
0500-0600	Radio Australia, Melbourne	11910	15160	15240	15395
		17715	17750	17795	

0500-0600	Radio New Zealand, Wellington	11780	15150		
0500-0600	Radio Thailand, Bangkok	9655	11905		
0500-0600 S	Radio Zambia, Lusaka	11880			
0500-0600	SBC Radio One, Singapore	5010	5052	11940	
0500-0600	Spanish Foreign Radio, Madrid	6125			
0500-0600 S	Superpower KUSW, Utah	6155			
0500-0600 S	Swaziland Commercial Radio	6155	9705		
0500-0600	Voice of America, Washington	3990	5995	6035	6125
		7280	9530	9575	9670
		9740	11835		
0500-0600	Voice of Kenya, Nairobi	6045			
0500-0600	Voice of Nigeria, Lagos	7255	15120	15185	
0500-0600	WCSN, Boston, Massachusetts	9870			
0500-0600	WHRI, Noblesville, Indiana	7400			
0500-0600 M-A	WMLK, Bethel, Pennsylvania	9455			
0500-0600	WRNO, New Orleans, Louisiana	6185			
0500-0600	WYFR, Oakland, California	5950	11580		
0500-0600 T-S	WYFR Satellite Net, California	9520			
0510-0520	Radio Botswana, Gaborone	3356	4820	7255	
0530-0545	BBC, London, England*	3990	6050	6140	7210
		9750			
0530-0555	Radio Bucharest, Romania	9640	11840	11940	15340
		15380	17720		
0530-0555	Radio Finland, Helsinki	6120	9605	11755	
0530-0600	Radio Netherland, Hilversum	6165	9715		
0530-0600	Trans World Radio, Swaziland	5055	7210		
0530-0600	UAE Radio, United Arab Emirates	15435	17775	21700	
0545-0600	Radio Berlin Int'l, East Germany	15240	17880	21540	21645
0555-0600	Ghana Broadcasting Corp., Accra	4915			
0555-0600	Voice of Malaysia, Kuala Lumpur	6175	9750	15295	

East Coast To South America

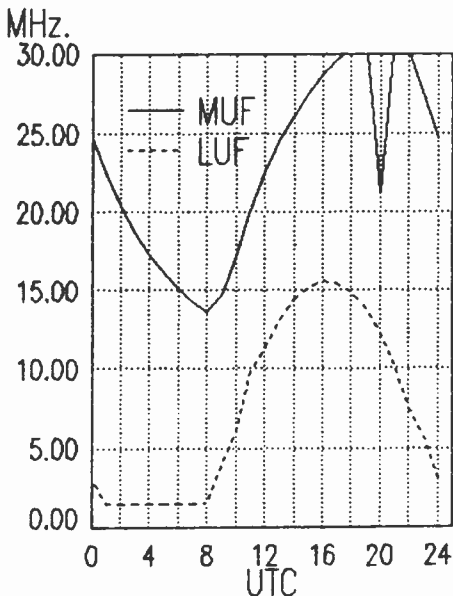

East Coast To West Coast

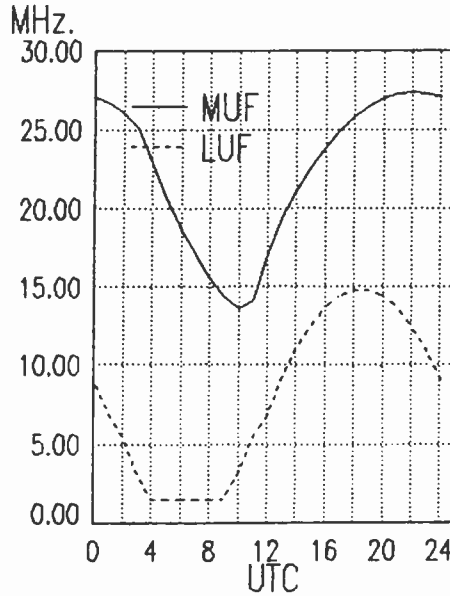

East Coast To Australia & Malaysia

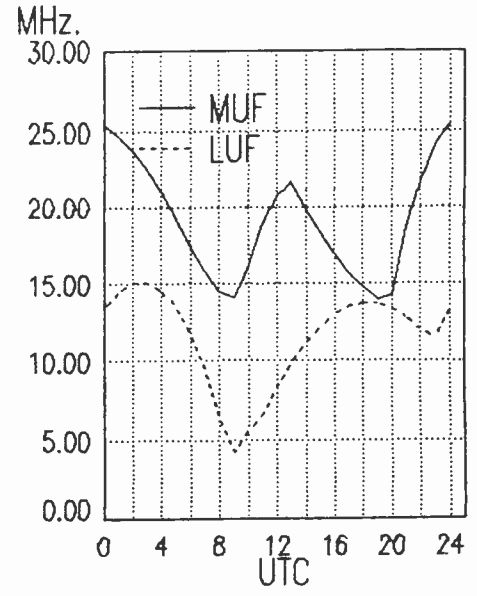

frequency SECTION

0600 UTC [2:00 AM EDT/11:00 PM PDT]

0600-0615	Radio Ghana, Accra	3366	4915		
0600-0615 M-A	Radio Zambia, Lusaka	6165	7235		
0600-0620	Vatican Radio, Vatican City	6185	9645		
0600-0625	Radio Netherlands, Hilversum	6165	9715		
0600-0630	Laotian National Radio	7113			
0600-0630	Radio Australia, Melbourne	11910	11945 15160 15240		
		15315	15395 17715 17750		
		17795			
0600-0630	Radio Berlin Int'l, East Germany	15240	17880 21540 21645		
0600-0630	Trans World Radio, Swaziland	5055	6070 7210		
0600-0630	Voice of Kenya, Nairobi	6045			
0600-0645	HCJB, Quito, Ecuador	6230	9720 11775		
0600-0645	Radio Berlin Int'l, East Germany	5965	11810		
0600-0645 S	Radio Cameroon, Yaounde	4850			
0600-0650	Radio Pyongyang, North Korea	9530	15160 15180		
0600-0700	(US) Armed Forces Radio and TV	6030	11790		
0600-0700	BBC, London, England	3955	5975 6195 7105		
		7150	9410 9600 9640		
		11835	11860		
0600-0700	CBC Northern Quebec Service	6195			
0600-0700	CBU, Vancouver, British Columbia	6160			
0600-0700	CFCF, Montreal, Quebec	6005			
0600-0700	CFCN, Calgary, Alberta	6030			
0600-0700	CHNS, Halifax, Nova Scotia	6130			
0600-0700	CKWX, Vancouver, British Columbia	6080			
0600-0700	CFRB, Toronto, Ontario	6070			
0600-0700	(US) Far East Network, Tokyo	3910			
0600-0700 F	FEBA, Mahe, Seychelles	17855			
0600-0700	King of Hope, South Lebanon	6215			
0600-0700	KYOI, Salpan	17780			
0600-0700	Radio Havana Cuba	9525			
0600-0700	Radio Korea, Seoul, South Korea	6060	7275 9570		
0600-0700	Radio Kuwait	15345			
0600-0700	Radio Moscow, USSR	7165	7310 7320		
0600-0700	Radio New Zealand, Wellington	11780	15150		
0600-0700 A,S	Radio Thailand, Bangkok	9655	11905		

0600-0700 S	Radio Zambia, Lusaka	11880			
0600-0700	SBC Radio One, Singapore	5010	5052 11940		
0600-0700 S	Superpower KUSW, Utah	6155			
0600-0700	Voice of America, Washington	5995	6035 6040 6060		
		6080			
		6125	7170 7280 7325		
		9540			
		9530	9550		
		7285			
0600-0700	Voice of Asia, Taiwan	6175	9750 15295		
0600-0700	Voice of Malaysia, Kuala Lumpur	15185			
0600-0700	Voice of Nigeria, Lagos	9495			
0600-0700	WCSN, Boston, Massachusetts	6100	7400		
0600-0700	WHRI, Noblesville, Indiana	9455			
0600-0700 M-A	WMLK, Bethel, Pennsylvania	5950	6065 7355 9815		
0600-0700	WYFR, Oakland, California	9852.5			
0615-0630	Radio Korea, Seoul, South Korea	13670			
0615-0630 M-A	Vatican Radio, Vatican City	15190	17730		
0615-0700	Deutsche Welle, West Germany	9610	9700 11765 15185		
0630-0700 A	CPBS-1, China*	11330	15550 15590 17605		
0630-0655	Radio Austria Int'l, Vienna	6000	6155 15410		
0630-0655	Radio Netherland, Hilversum	9895	11930		
0630-0700	Radio Australia, Melbourne	11945	15160 15240 15315		
		15395	17715 17750		
0630-0700	Radio Polonia, Warsaw, Poland	6135	7270 15120		
0630-0700	Radio Tirana, Albania	7205	9500		
0630-0700	Swiss Radio Int'l, Berne	12030	15430 17570		
0630-0700	Trans World Radio, Swaziland	5055	6070 7210 9725		
0630-0700 A,S	Voice of Kenya, Nairobi	7270			
0645-0700	BBC, London, England*	6150	7260 11945		
0645-0700	HCJB, Quito, Ecuador	6130	6230 9720 11775		
0645-0700	Radio Bucharest, Romania	11940	15250 15335 17790		
		17805	21665		
0645-0700 M-F	Radio Canada Int'l, Montreal	6050	6140 7155 9740		
		9760	11840 15235		
0645-0700	Radio Ghana, Accra	6130			
0650-0656	Radio Chile, Santiago (?)	7205			

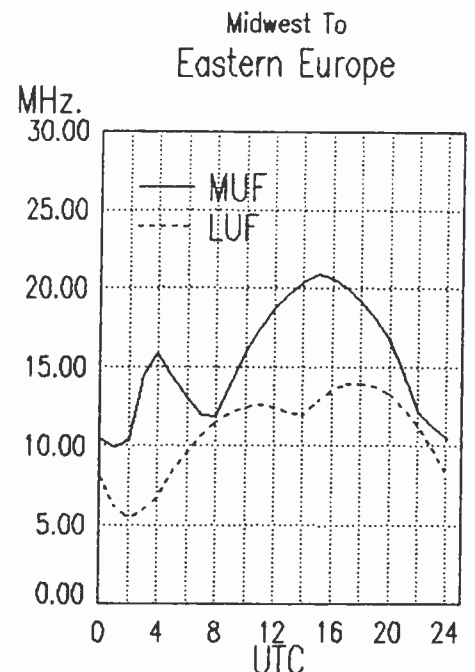
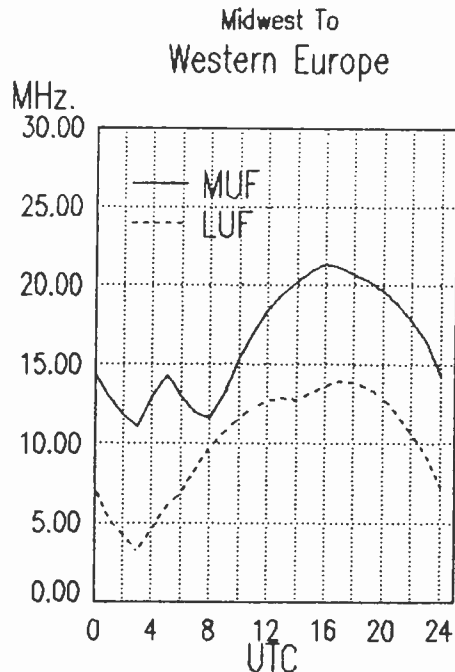
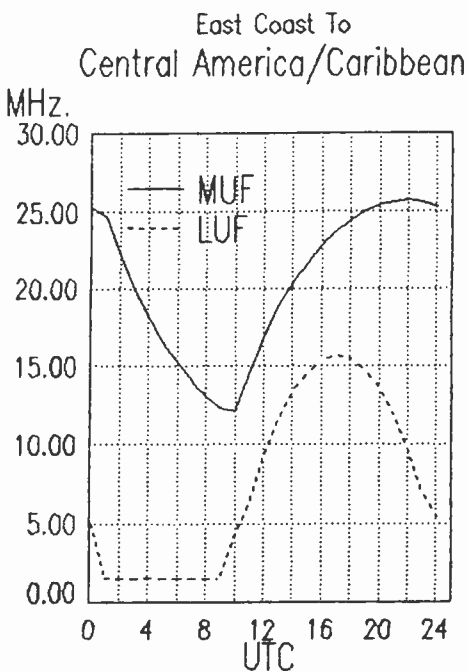

frequency SECTION

0700 UTC [3:00 AM EDT/12:00 AM PDT]

0700-0703	Port Moresby, Papua New Guinea	3925	4890	5960	5985
		6020	6040	6080	6140
		9520			
700-0710	Radio Bucharest, Romania	11940	15250	15335	17790
		17805	21665		
0700-0710	Radio Sierra Leone, Freetown	5980			
0700-0715	Radio Ghana (HS), Freetown	3366	4915		
0700-0730	BBC, London, England	5975	6195	7120	7150
		7180	9410	9600	9640
		9680	11860	15400	
		9730			
0700-0730	Burma Bcsting Service, Rangoon	9730			
0700-0730	Radio New Zealand, Wellington	11780	15150		
0700-0730	S Radio Zambia, Lusaka	11880			
0700-0745	WYFR, Oakland, California	6065	7355	9852.5	
0700-0750	Radio Pyongyang, North Korea	13750	15340		
0700-0800	CBU, Vancouver, British Columbia	6130			
0700-0800	CFCF, Montreal, Quebec	6005			
0700-0800	CFCN, Calgary, Alberta	6030			
0700-0800	CHNS, Halifax, Nova Scotia	6130			
0700-0800	CKWX, Vancouver, British Columbia	6080			
0700-0800	CFRB, Toronto, Ontario	6070			
0700-0800	ELWA, Monrovia, Liberia	11830			
0700-0800	(US) Far East Network, Tokyo	3910			
0700-0800	HCJB, Quito, Ecuador	6130	6205	9675	9745
		11835	11925		
0700-0800	King of Hope, South Lebanon	6215			
0700-0800	KYOI, Saipan	17780			
0700-0800	Radio Australia, Melbourne	5995	9655	9845	15160
		15240	15395	17715	17750
0700-0800	Radio Ghana, Accra	6130			
0700-0800	Radio Havana Cuba	9525			
0700-0800	Radio Japan, Tokyo	5990	15195	15235	17810
		21695			
0700-0800	Radio Kuwait	15345			

0700-0800	Radio Moscow, USSR	5905	6020	6095	6150
		6160	6190	7175	7290
		7345	9580		
		9655	11905		
0700-0800	A,S Radio Thailand, Bangkok	6135			
0700-0800	S Superpower KUSW, Utah	6070	9725		
0700-0800	Trans World Radio, Swaziland	5985			
0700-0800	Voice of Free China, Taiwan	7270			
0700-0800	A,S Voice of Kenya, Nairobi	6175	9750	15295	
0700-0800	Voice of Malaysia, Kuala Lumpur	15120	15185		
0700-0800	Voice of Nigeria, Lagos	9495			
0700-0800	WCSN, Boston, Massachusetts	6100	7400		
0700-0800	WHRI, Noblesville, Indiana	6065	7355	9815	
0700-0800	WYFR, Oakland, California	6040	7185	9730	21465
0715-0800	A,S Radio Berlin Int'l, East Germany	21540			
0715-0730	M-A Vatican Radio, Vatican City	11725	15190		
0715-0800	S FEBA, Mahe, Seychelles	15325	17785		
0720-0730	M-A Vatican Radio, Vatican City	6248	9645	11740	
0725-0800	Trans World Radio, Monte Carlo	7105			
0730-0800	ABC, Alice Springs, Australia	2310	[ML]		
0730-0800	ABC, Katherine, Australia	2485			
0730-0800	ABC, Tennant Creek, Australia	2325	[ML]		
0730-0800	Radio Australia, Melbourne	11720			
0730-0735	All India Radio, New Delhi	5990	6010	6020	7110
		7205	9610	9675	11850
		11935	15235	15250	17705
0730-0745	BBC, London, England*	3975	6010	7230	9915
0730-0755	Radio Finland, Helsinki	6120	9560	11755	
0730-0800	BBC, London, England	5975	9640		
0730-0800	Radio Netherland, Hilversum	9630	9715		
0730-0800	Radio Prague, Czechoslovakia	11685	17840	21705	
0730-0800	Radio Sofia, Bulgaria	9700	11720		
0730-0800	Soloman Islands Broadcasting Corp	9545			
0730-0800	Swiss Radio Int'l, Berne	3985	6165	9535	
0740-0750	W Radio Free Europe, Munich*	5985	7115	9695	9725
		11895	15355		
0745-0800	Radio Prague, Czechoslovakia	6055	7345	9505	

Midwest To Middle East

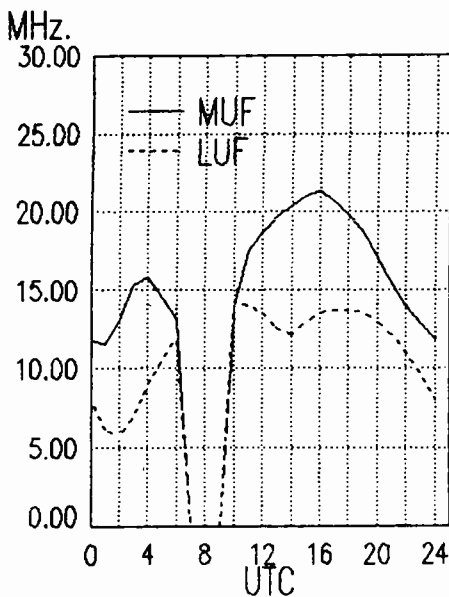

Midwest To West Africa

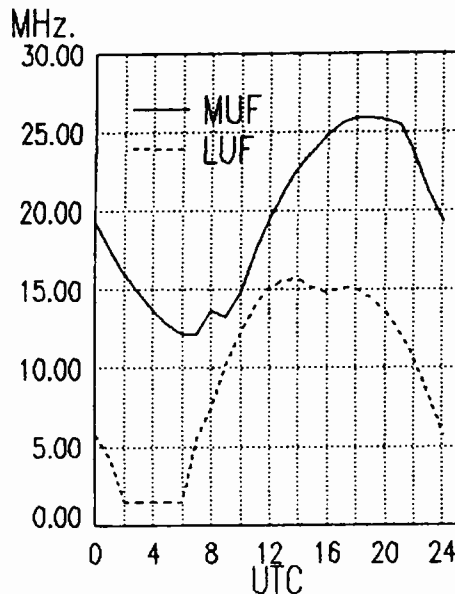

Midwest To East Africa

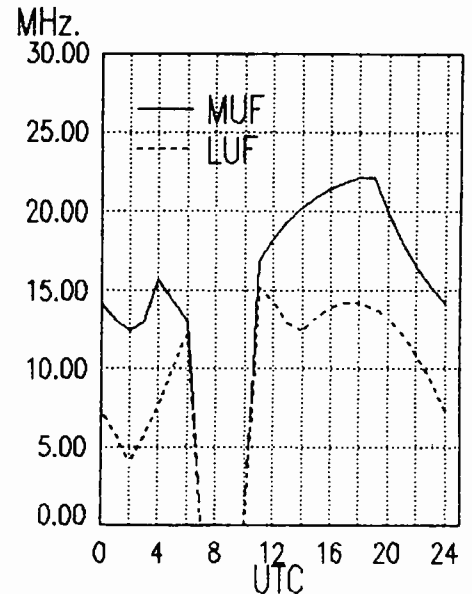

frequency SECTION

0800 UTC [4:00 AM EDT/1:00 AM PDT]

0800-0805	M-F	Port Moresby, Papua New Guinea	3925	4890	5960	5985
			6020	6040	6080	6140
			9520			
0800-0805		Soloman Islands Broadcasting Corp	9545			
0800-0815	M-A	Radio Zambia, Lusaka	6165	7235		
0800-0825	M-F	BRT, Brussels, Belgium	9860	21810		
0800-0825		Radio Netherland, Hilversum	9630	9715		
0800-0825		Voice of Malaysia, Kuala Lumpur	6175	9750	15295	
0800-0830		HCJB, Quito, Ecuador	6205	9675	9745	11835
			11925			
0800-0830		Radio Bangladesh, Dhaka	12030	15525		
0800-0830		Radio Tirana, Albania	9500	11835		
0800-0830		Voice of Islam, Pakistan	15525	17870		
0800-0835	S	FEBA, Mahe, Seychelles	15325, 17785			
0800-0835		Trans World Radio, Swaziland	6070	9725		
0800-0850		Radio Pyongyang, North Korea	9530	11830	15160	15180
0800-0900		ABC, Alice Springs, Australia	2310	[ML]		
0800-0900		ABC, Katherine, Australia	2485			
0800-0900		ABC, Tennant Creek, Australia	2325	[ML]		
0800-0900		BBC, London, England	9410	9640		
0800-0900		CBN, St. John's, Newfoundland	6160			
0800-0900		CBU, Vancouver, British Columbia	6160			
0800-0900		CFCF, Montreal, Quebec	6005			
0800-0900		CFCN, Calgary, Alberta	6030			
0800-0900		CHNS, Halifax, Nova Scotia	6130			
0800-0900		CKWX, Vancouver, British Columbia	6080			
0800-0900		CFRB, Toronto, Ontario	6070			
0800-0900		(US) Far East Network, Tokyo	3910			
0800-0900		HCJB, Quito, Ecuador	6130	9745	11925	
0800-0900		King of Hope, South Lebanon	6215			
0800-0900		KNLS, Anchor Point, Alaska	6150			
0800-0900		KTWR, Guam	11805			
0800-0900		YOI, Saipan	11900			
0800-0900		Radio Australia, Melbourne	5995	6080	9580	9655
			9710	11720		
0800-0900		Radio Korea, Seoul, South Korea	7550			

0800-0900		SBC Radio One, Singapore	5010	5052	11940	
0800-0900	S	Superpower KUSW, Utah	6135			
0800-0900		Trans World Radio, Monte Carlo	7105			
0800-0900		Voice of Indonesia, Jakarta	11790	15105		
0800-0900	A,S	Voice of Kenya, Nairobi	7270			
0800-0900		Voice of Nigeria, Lagos	7255	15185		
0800-0900		WCSN, Boston, Massachusetts	7355			
0800-0900		WHRI, Noblesville, Indiana	7355			
0800-0900		WYFR, Oakland, California	6175			
0805-0900		KTWR, Agana, Guam	11805			
0815-0830	S	Radio Austria Int'l, Vienna	6155	11915	15410	15415
			17870			
0815-0830		Radio Korea, Seoul, South Korea	9570			
0815-0845	M-F	Voice of America, Washington DC	7175	9575	9750	11710
			11915	15600	17715	21500
			[ML]			
0830-0840		All India Radio, New Delhi	5960	5990	6010	6020
			6050	6065	6100	6140
			7110	7140	7160	7250
			7280	7295	9610	11850
			15235	15250	17705	
0830-0855		Radio Austria Int'l, Vienna	6155	11915	15410	15415
0830-0855	M-A	Radio Netherland, Hilversum	9630			
0830-0900	S	Bhutan Bcating Service, Thimpu	6035			
0830-0900		FEBC, Manila, Philippines	11850	15350		
0830-0900		Radio Beijing, China	9700	11755	15440	
0830-0900		Radio Netherland, Hilversum	9630	21486		
0830-0900		Radio Prague, Czechoslovakia	11685	17840	21705	
0830-0900		Swiss Radio Int'l, Berne	9560	9885	17830	21695
0830-0900		Voice of Nigeria, Lagos	15120			
0840-0850	M-A	Voice of Greece, Athens	9855	15630		
0845-0900		Radio Berlin Int'l, East Germany	21540			
0845-0900		Radio Prague, Czechoslovakia	6055	7345	9505	
0850-0900		All India Radio, New Delhi	5960	5990	6010	6020
			6050	6065	6100	6140
			7110	7140	7150	7160
			7250	7280	7295	9610
			11850	15235	15250	17705

Midwest To
Central Africa

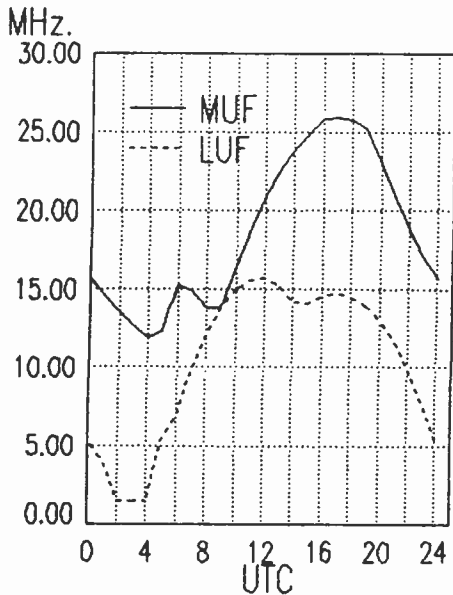

Midwest To
South Africa

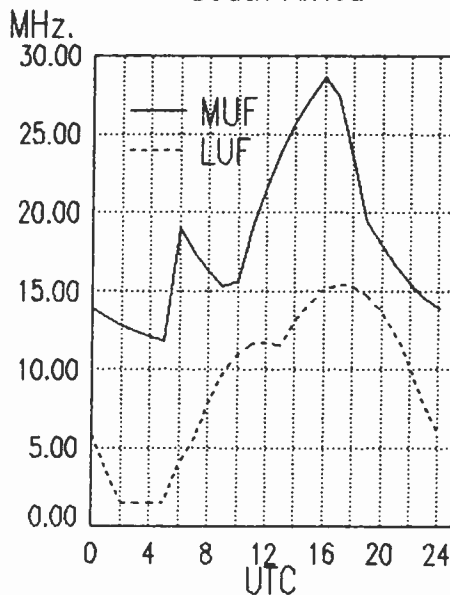

Midwest To
West Africa

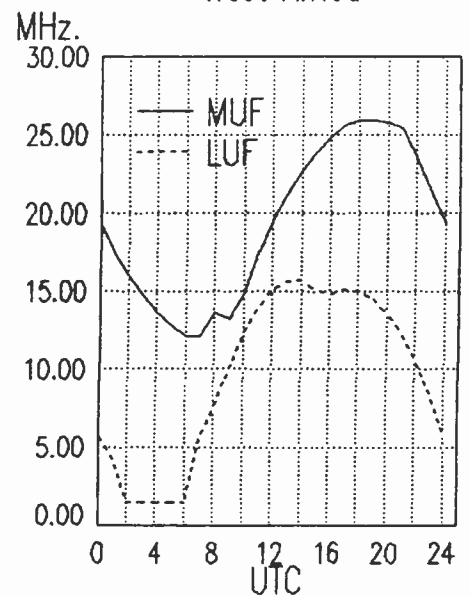

frequency SECTION

0900 UTC [5:00 AM EDT/2:00 AM PDT]

0900-0905	Africa No. 1, Gabon	7200	15200		
0900-0910	All India Radio, New Delhi	5960	5990	6010	6020
		6050	6065	6100	6140
		7110	7140	7150	7160
		7250	7280	7295	9610
		11850	15235	15250	17705
0900-0910	Port Moresby, Papua New Guinea	3295	4890	5960	5985
		6020	6040	6080	6140
		9520			
0900-0910	Voice of Lebanon, Beirut	6548			
0900-0925	M-F BRT, Brussels, Belgium	17595	21810		
0900-0930	FEBC, Manila, Philippines	11850	15350		
0900-0930	KTWR, Agana, Guam	11805			
0900-0930	Nippon Broadcasting Corp.	3925			
0900-0930	Radio Beijing, China	9700	11755	15440	
0900-0930	Radio Berlin Int'l, East Germany	21540			
0900-0930	Radio Netherland, Hilversum	21485			
0900-0930	A,S Radio Prague, Czechoslovakia	11685	17840	21705	
0900-0950	Deutsche Welle, West Germany	6160	17780	21650	21680
0900-1000	ABC, Alice Springs, Australia	2310	[ML]		
0900-1000	ABC, Katherine, Australia	2485			
0900-1000	ABC, Tennant Creek, Australia	2325	[ML]		
0900-1000	S Adventist World Radio, Portugal	9670			
0900-1000	(US) Armed Forces Radio and TV	6030	9530		
0900-1000	BBC, London, England	7180	9410	9720	9740
		9750	11860		
0900-1000	CFCF, Montreal, Quebec	6005			
0900-1000	CFCN, Calgary, Alberta	6030			
0900-1000	CHNS, Halifax, Nova Scotia	6130			
0900-1000	CKWX, Vancouver, British Columbia	6080			
0900-1000	CFRB, Toronto, Ontario	6070			
0900-1000	(US) Far East Network, Tokyo	3910			
0900-1000	HCJB, Quito, Ecuador	6130			
0900-1000	King of Hope, South Lebanon	6215			
0900-1000	KNLS, Anchor Point, Alaska	6150			
0900-1000	KTWR, Guam	11805			

0900-1000	S KUSW, Salt Lake City, Utah	6135			
0900-1000	Radio Afghanistan, Kabul	4450	6085	15435	17720
0900-1000	Radio Australia, Melbourne	5995	6080	9580	9655
		9710	9760	11720	15415
0900-1000	Radio Japan, Tokyo	11840	15235	17810	
0900-1000	Radio Moscow, USSR	5905	6020	6095	7345
0900-1000	S Radio Prague, Czechoslovakia	6055	7345	9505	[ML]
0900-1000	Radio Tanzania, Dar es Salaam	7165			
0900-1000	SBC Radio One, Singapore	5010	5052	11940	
0900-1000	Trans World Radio, Monte Carlo	7105			
0900-1000	Voice of Kenya, Nairobi	7270			
0900-1000	Voice of Nigeria, Lagos	7255	15120	15185	
0900-1000	WHRI, Noblesville, Indiana	7355			
0915-0950	M-A Radio Ulan Bator, Mongolia	9615	12015		
0930-0935	All India Radio, New Delhi	5960	5990	6010	6020
		6050	6065	6100	6140
		7110	7140	7160	7250
		7280	7295	9610	11850
		15235	15250	17705	
0930-0940	M-F Radio Canada Int'l, Montreal	5960	9755		
0930-0945	BBC, London, England*	9725	11955		
0900-0955	Radio Budapest, Hungary	9835	11910	17710	17780
		21525			
0930-0955	Radio Finland, Helsinki	6120	15245	17860	
0930-1000	CBN, St. John's, Newfoundland	6160			
0930-1000	KTWR, Agana, Guam	11805			
0930-1000	Radio Beijing, China	9700	11755	15440	
0930-1000	Radio Sweden int'l, Stockholm	9630	15390		
0945-1000	BBC, London, England*	5995	7180	9725	11955
0945-1000	M-A Radio Prague, Czechoslovakia	6055	7345	9505	

1000 UTC [6:00 AM EDT/3:00 AM PDT]

1000-1030	Deutsche Welle, West Germany	7225	9735	17765	21600
1000-1030	HCJB, Quito, Ecuador	6130	9745	11925	
1000-1030	Kol Israel, Jerusalem	9385	11700	15485	15640
		15650	17635	17685	21625
1000-1030	Radio Afghanistan, Kabul	4450	6085	15435	17720
1000-1030	Radio Beijing, China	9700	11755	15440	

Midwest To
Far East

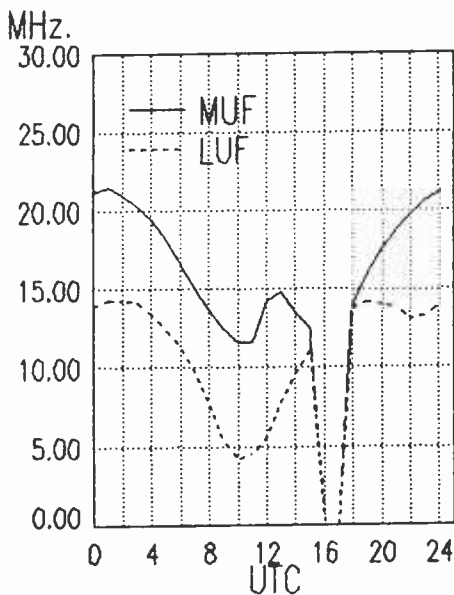

Midwest To
South East Asia

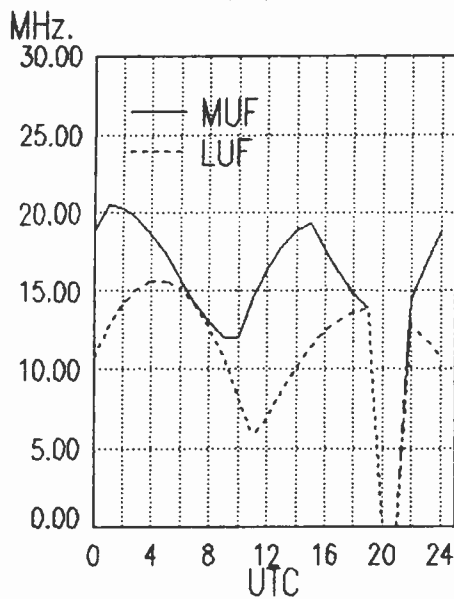

Midwest To
Central Asia

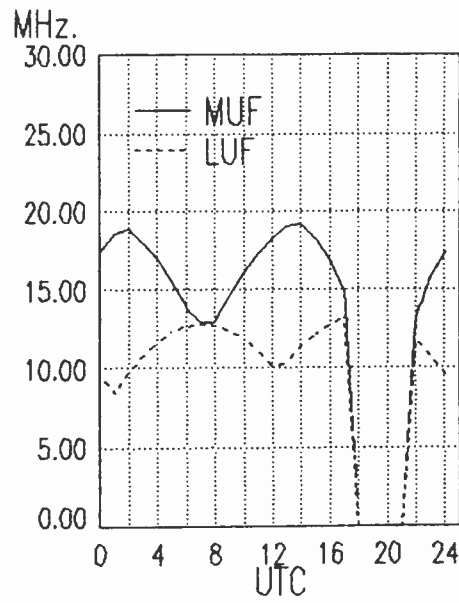

frequency SECTION

1000-1030	S	Radio Norway int'l, Oslo	9590	15180	15235	17780
			21730			
1000-1030		Radio Tanzania, Dar es Salaam	7165			
1000-1030		Swiss Radio Int'l, Berne	9560	9885	17830	21695
1000-1030		Voice of Ethiopia, Addis Ababa	9560			
1000-1030		Voice of Vietnam, Hanoi	9840	12020		
1000-1055	A	Trans World Radio, Monte Carlo	7105			
1000-1100		ABC, Alice Springs, Australia	2310	[ML]		
1000-1100		ABC, Katherine, Australia	2485			
1000-1100		ABC, Tennant Creek, Australia	2325	[ML]		
1000-1100		(US) Armed Forces Radio and TV	6030			
1000-1100		All India Radio, New Delhi	11860	11915	15130	15335
			17387	117875		
1000-1100		BBC, London, England	6195	11750	12095	
1000-1100		CBN, St. John's, Newfoundland	6160			
1000-1100		CFCF, Montreal, Quebec	6005			
1000-1100		CFCN, Calgary, Alberta	6030			
1000-1100		CHNS, Halifax, Nova Scotia	6130			
1000-1100		CKWX, Vancouver, British Columbia	6080			
1000-1100		CFRB, Toronto, Ontario	6070			
1000-1100		(US) Far East Network, Tokyo	3910			
1000-1100		KNLS, Anchor Point, Alaska	6150			
1000-1100		KTWR, Agana, Guam	11805			
1100-1200		KYOI, Saipan	11900			
1100-1200		Radio Australia, Melbourne	9580	9655	9770	15415
1000-1100		Radio New Zealand, Wellington	9540	11780		
1000-1100	S	Radio Prague, Czechoslovakia	6055	7345	9505	[ML]
1000-1100		SBC Radio One, Singapore	5010	5052	11940	
1000-1100		Superpower KUSW, Utah	6135			
1000-1100		Voice of America, Washington	5975	5985	6125	9590
1000-1100		Voice of Kenya, Nairobi	7270			
1000-1100		Voice of Nigeria, Lagos	7255	15120		
1000-1100		WHRI, Noblesville, Indiana	7355			
1000-1100		WYFR, Oakland, California	5950			
1005-1010		Radio Pakistan, Islamabad	15606	17660		
1030-1040		Voice of Asia, Taiwan	5980			
1030-1055		Radio Austria Int'l, Vienna	17870			
1030-1055		Radio Budapest, Hungary	9835	11910	17710	17780
			21525			
1030-1100		HCJB, Quito, Ecuador	6130	11925		

1030-1100	M-F	Radio Budapest, Hungary	9585	9835	11910	15160
			15220			
1030-1100		Radio Netherlands, Hilversum	6020	9650		
1030-1100	A,S	Radio Tanzania, Dar es Salaam	7165			
1030-1100		SLBC, Colombo, Sri Lanka	11835	15120	17850	[ML]
1030-1100		UAE Radio, United Arab Emirates	15435	17865	21605	
1040-1050	H	Radio Free Europe, Munich*	5985	7115	9695	9725
			11895	15355		
1040-1050	M-A	Voice of Greece, Athens	11645	15630		
1045-1100	M-A	Radio Prague, Czechoslovakia	6055	7345	9505	
1055-1100	S	Trans World Radio, Monte Carlo	7105			

1100 UTC [7:00 AM EDT/4:00 AM PDT]

1100-1105		Radio Pakistan, Islamabad	6090	7290		
1100-1105	A	Port Moresby, Papua New Guinea	3295	4890	5960	5985
			6020	6040	6080	6140
			9520			
1100-1110	S	Port Moresby, Papua New Guinea	3295	4890	5960	5985
			6020	6040	6080	6140
			9520			
1100-1115		Radio New Zealand, Wellington	9540	11780		
1100-1120		Radio Pakistan, Islamabad	15606	17760		
1100-1125		Radio Netherland, Hilversum	6020	9650		
1100-1130		HCJB, Quito, Ecuador	6130	11925		
1100-1130	TES	Radio Caroline, Offshore, Europe	5955			
1100-1130		Radio Japan, Tokyo	5990	6120	7210	17810
1100-1130		Radio Mozambique, Maputo	9525	11818	11835	
1100-1130		Radio Sweden Int'l, Stockholm	6065	9630	21690	
1100-1130		SLBC, Colombo, Sri Lanka	11835	15120	17850	[ML]
1100-1130		Swiss Radio Int'l, Berne	9885	11935	15570	17830
1100-1130		Voice of Vietnam, Hanoi	7430	9732		
1100-1150		Radio Pyongyang, North Korea	6576	9600	11735	
1100-1155		Radio Beijing, China	9665			
1100-1200		ABC, Alice Springs, Australia	2310	[ML]		
1100-1200		ABC, Katherine, Australia	2485			
1100-1200		ABC, Tennant Creek, Australia	2325	[ML]		
1100-1200		(US) Armed Forces Radio and TV	6030	6125	15430	

Midwest To
Indian Ocean

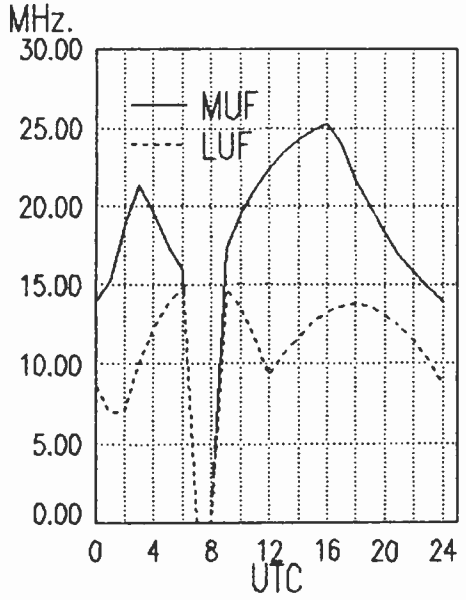

Midwest To
Pacific

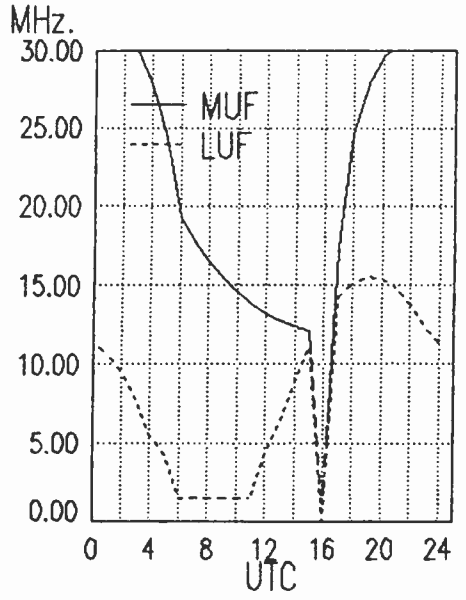

Midwest To
South America

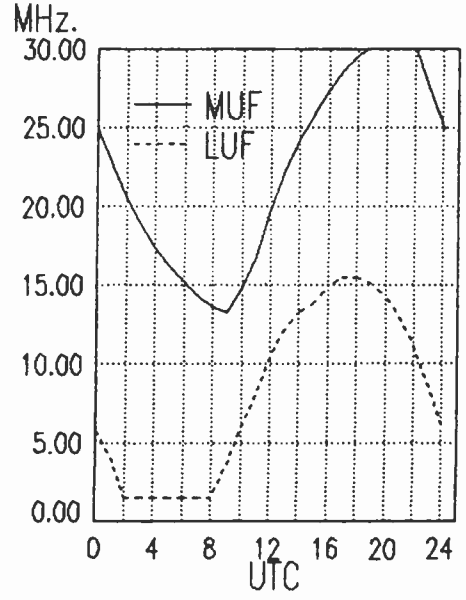

frequency SECTION

1100-1200	BBC, London, England	5965	6195	11750	11775	1130-1200	Radio Netherland, Hilversum	5995	9715	15560	17575
		15070						17605	21480		
1100-1200	CBN, St. John's, Newfoundland	6160				1130-1200	Radio Thailand, Bangkok	9655	11905		
1100-1200	CFCF, Montreal, Quebec	6005				1130-1200	Radio Tirana, Albania	9480	11855		
1100-1200	CFCN, Calgary, Alberta	6030				1135-1140	All India Radio, New Delhi	6065	7110	9610	9675
1100-1200	CHNS, Halifax, Nova Scotia	6130						11850	15320		
1100-1200	CKWX, Vancouver, British Columbia	6080				1140-1145 M-A	Vatican Radio, Vatican City	6248	9645	11740	
1100-1200	CFRB, Toronto, Ontario	6070				1145-1200	BBC, London, England*	5995	7180		
1100-1200	(US) Far East Network, Tokyo	3910				1145-1200	Radio Prague, Czechoslovakia	6055	7345	9505	
1100-1200	KYOI, Saipan	11900				1200 UTC [8:00 AM EDT/5:00 AM PDT]					
1100-1200	Radio Australia, Melbourne	5995	6060	6080	7215	1200-1205 M-A	Port Moresby, Papua New Guinea	3295	4890	5960	6020
		9580	9645	9710	9770			6040	6080	6140	9520
		11705	11800			1200-1215	BBC, London, England*	3915	6065	7275	
1100-1200	Radio Korea, Seoul, South Korea	15575				1200-1215	Radio New Zealand, Wellington	6100	9540		
1100-1200	Radio Moscow, USSR	6000	11670	11900	13790	1200-1215	Vatican Radio, Vatican City	15190	17865		
		15225	15475			1200-1215	Voice of Kampuchea, Phnom-Penh	9693	11938		
1100-1200	Radio RSA, South Africa	17755	21590			1200-1220	Radio Bucharest, Romania	17720	21665		
1100-1200 A,S	Radio Tanzania, Dar es Salaam	7165				1200-1220 M-F	Radio Budapest, Hungary	9585	9835	11910	15160
1100-1200 S	Radio Zambia, Lusaka	11880	[IRR]					15220			
1100-1200 S	Superpower KUSW, Utah	9850				1200-1225 M-F	Radio Finland, Helsinki	11945	15400		
1100-1200	Voice of America, Washington	5975	5985	5990	6110	1200-1225	Radio Polonia, Warsaw, Poland	6095	7285		
		6160	9590	9760		1200-1230 S	Radio Austria Int'l, Vienna	6155	9685	11915	15320
		5980	7445			1200-1230	Radio Netherland, Hilversum	5995	9715	15560	17575
1100-1200	Voice of Asia, Taiwan	7270						17605	21480		
1100-1200	Voice of Kenya, Nairobi	7255	15120			1200-1230	Radio Somalia, Mogadishu	6095			
1100-1200	Voice of Nigeria, Lagos	5995	11790			1200-1230	Radio Tashkent, Uzbek, USSR	5945	7275	9540	9600
1100-1200	WHRI, Noblesville, Indiana	5950	6010					11785			
1100-1200	WYFR, Oakland, California	5950	6010			1200-1230	Radio Thailand, Bangkok	9655	11905		
1110-1120 M-F	Radio Botswana, Gaborone	4820	5955	7255		1200-1230 S	Radio Zambia, Lusaka	11880	[IRR]		
1115-1200	Radio Berlin Int'l, East Germany	15445	17880	21465	21540	1200-1235 M-A	Radio Ulan Bator, Mongolia	9615	12015		
1115-1125	Radio France Int'l, Paris	6175	9790	9805	11670	1200-1236	HCJB, Quito, Ecuador	6075			
		11700	11845	15155	15195	1200-1250	Radio Pyongyang, North Korea	9600	9555	11735	
		15300	15315	15435	17620	1200-1255	Radio Beijing, China	7335	9530	9635	9665
		17850	21620					9770	11600	11715	11755
1115-1130	Radio Korea, Seoul, South Korea	7275	11740			1200-1300	ABC, Alice Springs, Australia	2310	[ML]		
1115-1130	Vatican Radio, Vatican City	11840	21485			1200-1300	ABC, Katherine, Australia	2485			
1115-1145	Radio Nepal, Kathmandu	5005									
1115-1200	Trans World Radio, Bonaire	11815									
1115-1200	Voice of Islamic Republic Iran	11790									
1130-1200	Deutsche Welle, West Germany	15410	17765	17800	21600						
1130-1200	HCJB, Quito, Ecuador	11740									
1130-1200	Radio Japan, Tokyo	5990	6120	7210							

Midwest To
Australia & Malaysia

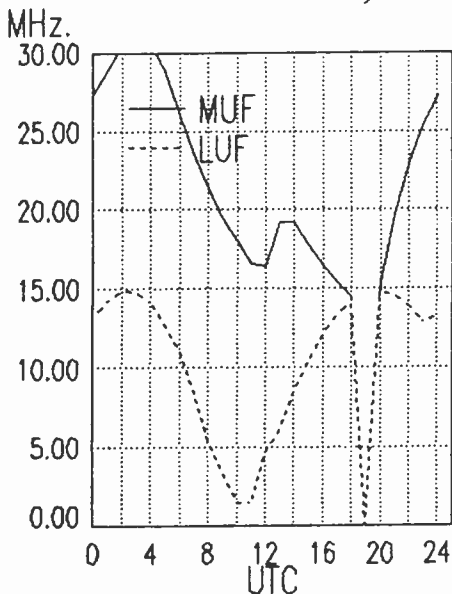

Midwest To
Central America/Caribbean

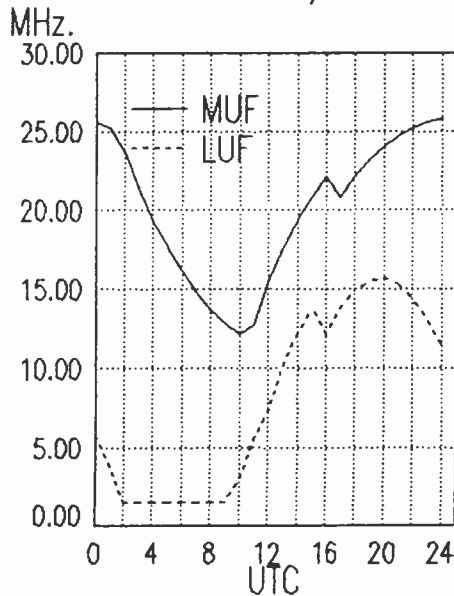

West Coast To
Eastern Europe

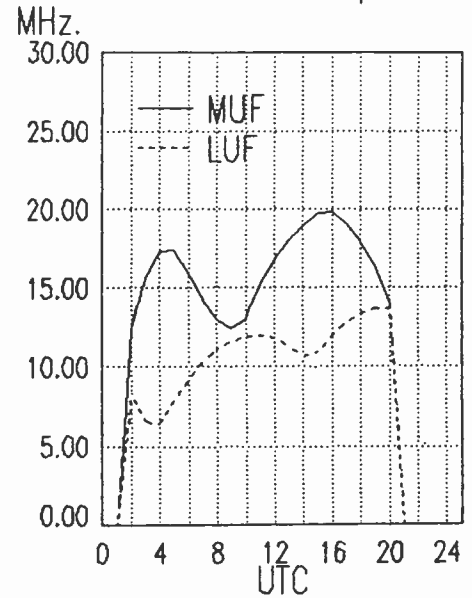

frequency SECTION

1200-1300	ABC, Tennant Creek, Australia	2325	[ML]
1200-1300	S Adventist World Radio, Africa	17890	
1200-1300	(US) Armed Forces Radio and TV	6030 6125 15430	
1200-1300	BBC, London, England	5965 6195 9740 11750	
		11775 12095 15070 18080	
1200-1300	CBN, St. John's, Newfoundland	6160	
1200-1300	CFCF, Montreal, Quebec	6005	
1200-1300	CFCN, Calgary, Alberta	6030	
1200-1300	CHNS, Halifax, Nova Scotia	6130	
1200-1300	CKWX, Vancouver, British Columbia	6080	
1200-1300	CFRB, Toronto, Ontario	6070	
1200-1300	(US) Far East Network, Tokyo	3910	
1200-1300	HCJB, Quito, Ecuador	11740 15115 17890	
1200-1300	KYOI, Saipan	11900	
1200-1300	Radio Australia, Melbourne	5995 6060 6080 7205	
		7215 9580 9645 9710	
		9770 11705	
1200-1300	Radio Moscow, USSR	6000 7135 11670 11900	
		13790 15140 15150 15225	
		15420 15460 15475 15490	
		15540 15585 15595 17655	
		17820	
1200-1300	Radio RSA, South Africa	21590	
1200-1300	A,S Radio Tanzania, Dar es Salaam	7165	
1200-1300	SBC Radio One, Singapore	5010 5052 11940	
1200-1300	S Superpower KUSW, Utah	9850	
1200-1300	Trans World Radio, Bonaire	11815	
1200-1300	Trans World Radio, Sri Lanka	11920	
1200-1300	Voice of America, Washington	6110 9760 11715	
1200-1300	Voice of Kenya, Nairobi	7270	
1200-1300	Voice of Nigeria, Lagos	7255 15120	
1200-1300	WCSN, Boston, Massachusetts	5980	
1200-1300	WHRI, Noblesville, Indiana	5995 11715	
1200-1300	WYFR, Oakland, California	5950 6175 6185	
1200-1300	WYFR Satellite Net, California	13695	
1215-1300	Radio Berlin Int'l, E. Germany	15445 17880 21465 21540	
1215-1300	Radio Cairo, Egypt	17675	
1230-1235	All India Radio, New Delhi	3905 4800 4920 7280	
		9565 9615 11620 11735	
		15120	
1230-1245	Radio Korea, Seoul, South Korea	7275 11740	

1230-1255	Radio Austria Int'l, Vienna	6155 9685 11915 15320
1230-1300	BBC, London, England*	6125 7255 6195 9635
		9660 11780 12040 15270
		15390 15435 17695
1230-1300	Radio Bangladesh, Dhaka	11750 15525
1230-1300	Radio Sweden, Stockholm	15190 15430
1240-1250	M Radio Free Europe, Munich*	5985 7115 9695 9725
		11895 15355
1245-1255	Radio France Int'l, Paris	9805 11670 11845 15155
		15195 15300 15315 15365
		21620 21645
1245-1300	Radio Berlin Int'l, E. Germany	9665 11705 11785 15170
		15240

1300 UTC [9:00 AM EDT/6:00 AM PDT]

1300-1305	Port Moresby, Papua New Guinea	3295 4890 5960 5980
		6020 6040 6080 6140
		9520
1300-1315	Radio Berlin Int'l, East Germany	21465 21540
1300-1325	Radio Bucharest, Romania	9690 11940 16405 17720
1300-1330	BBC, London, England	5965 5995 6195 7160
		9510 9740 9750 9760
		11750 11775 12095 15070
		17705 18080
1300-1330	Radio Berlin Int'l, E. Germany	9665 11705 11785 15170
		15240
1300-1330	Radio Cairo, Egypt	17675
1300-1330	Radio Finland, Helsinki	11945 15400
1300-1330	Radio Ghana, Accra	4915 7295
1300-1330	S Radio Norway Int'l, Oslo	9590 15190 15310 21700
		25730
1300-1330	Swiss Radio Int'l, Berne	6165 9535 12030
1300-1330	Trans World Radio, Sri Lanka	11920
1300-1330	Voice of Kenya, Nairobi	7270
1300-1332	A,S Trans World Radio, Bonaire	11815
1300-1350	Radio Pyongyang, North Korea	9325 9345
1300-1355	Radio Beijing, China	7335 9530 11600 11755

West Coast To
Western Europe

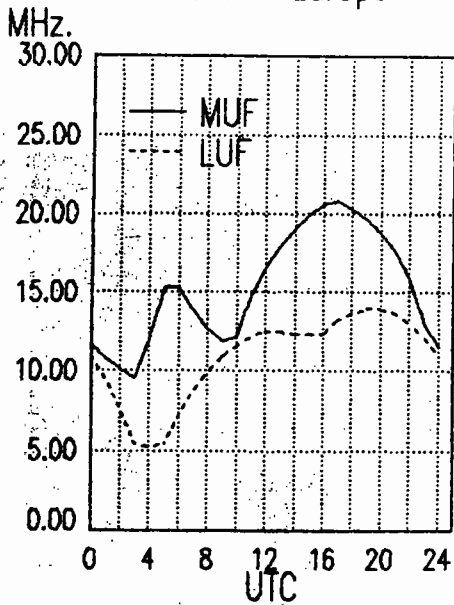

West Coast To
Middle East

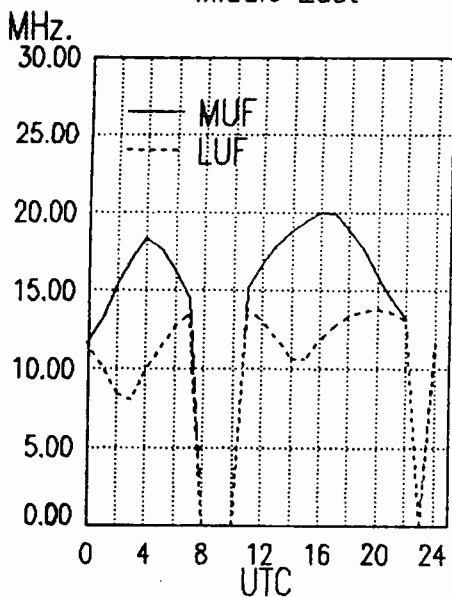

West Coast To
West Africa

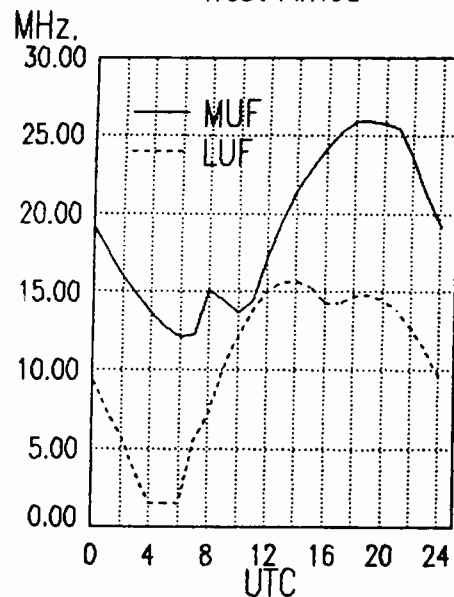

frequency SECTION

1400-1450	T	Radio Free Europe, Munich*	5985 7115 7695 9725	1400-1500	Voice of America, Washington	6110 7230 9645 9760
1400-1450		Radio Pyongyang, North Korea	11895 15355	1400-1500	Voice of Kenya, Nairobi	6100
1400-1455		Radio Beijing, China	6576 11735	1400-1500	Voice of Malaysia, Kuala Lumpur	4950
1400-1500		ABC, Katherine, Australia	11600 15165	1400-1500	Voice of Nigeria, Lagos	7255
1400-1500		ABC, Perth, Australia	2485	1400-1500	WCSN, Boston, Massachusetts	13760
1400-1500		Adventist World Radio, Italy	9610	1400-1500	WHRI, Noblesville, Indiana	9455 11790
1400-1500		All India Radio, New Delhi	7275	1400-1500	WRNO, New Orleans, Louisiana	11965
1400-1500		(US) Armed Forces Radio and TV	9545 11810 15335	1400-1500	WYFR, Oakland, California	5950 6015 6175 11580
1400-1500		BBC, London, England	6125 15330 15430	1415-1420	Radio Nepal, Kathmandu	3230 5005
1400-1500			5995 6195 7160 9740	1415-1425	T,F Radio Budapest, Hungary	6110 9535 9585 11910
1400-1500			11705 11750 12095 15070	1415-1500		15160
1400-1500		CBN, St. John's, Newfoundland	6160	1415-1500	Radio Berlin Int'l, East Germany	15240 17880
1400-1500	M-A	CBU, Vancouver, British Columbia	6160	1425-1500	S Radio Austria Int'l, Vienna	9665 12010 15320
1400-1500		CFCF, Montreal, Quebec	6005	1425-1500	S Radio Finland, Helsinki	11945 15400
1400-1500		CFCN, Calgary, Alberta	6030	1430-1455	M-A Radio Budapest, Hungary	9585 9835 11910 15160
1400-1500		CHNS, Halifax, Nova Scotia	6130			15220
1400-1500		CKWX, Vancouver, British Columbia	6080	1430-1500	F ABC, Alice Springs, Australia	2310 [ML]
1400-1500		CFRB, Toronto, Ontario	6070	1430-1500	F ABC, Tennant Creek, Australia	2325 [ML]
1400-1500	S	ELWA, Monrovia, Liberia	11830	1430-1500	Burma Broadcasting Service	5985
1400-1500		(US) Far East Network, Tokyo	3910	1430-1500	King of Hope, Southern Lebanon	6280
1400-1500		FEBC, Manila, Philippines	9670 11850	1430-1500	KTWR, Agana, Guam	9780
1400-1500		HCJB, Quito, Ecuador	11740 15115 17890	1430-1500	Radio Australia, Melbourne	6060 7205 9580
1400-1500		KYOI, Saipan	11900	1430-1500	Radio Netherland, Hilversum	5955 11735 13770 15560
1400-1500		Radio Australia, Melbourne	5995 6035 6060 6080	1430-1500		17575
1400-1500	S	Radio Canada Int'l, Montreal	7205 9580	1430-1500	Radio Prague, Czechoslovakia	9605 11685 13715 15110
1400-1500			9625 11720 11955 15440			15155 17705 21505
1400-1500			17820	1430-1500	Radio Sofia, Bulgaria	7245 9740 11735
1400-1500		Radio Japan, Tokyo	5990 7210 9695 11815	1430-1500	Radio Yugoslavia, Belgrade	7240 15240 15415
1400-1500		Radio Jordan, Amman	9560	1445-1500	Radio Berlin Int'l, East Germany	11785 15170 15255
1400-1500		Radio Korea, Seoul, South Korea	9570 9750 15575	1445-1500	M-A Radio Ulan Bator, Mongolia	9575 15305
1400-1500		Radio Moscow, USSR	5905 5920 5980 6020	1445-1500	Vatican Radio, Vatican City	6248 7250 9645 11740
			6050 6095 6185 7105			11960 15090 17870
			7135 7185 7315 7345			
			9530 9830 11670 11840			
			13790 15225 15475 15540			
			15595 17655			
			17820			
1400-1500		Radio RSA, South Africa	9655 15125 17755 21590			
1400-1500	A,S	Radio Tanzania, Dar es Salaam	7165	1500-1505	Africa No. 1, Gabon	7200 15200
1400-1500		SBC Radio One, Singapore	5010 5052 11940	1500-1510	Vatican Radio, Vatican City	11960 15090 17870
1400-1500	S	Superpower KUSW, Utah	9850			

1500 UTC [11:00 AM EDT/7:00 AM PDT]

West Coast To South Africa

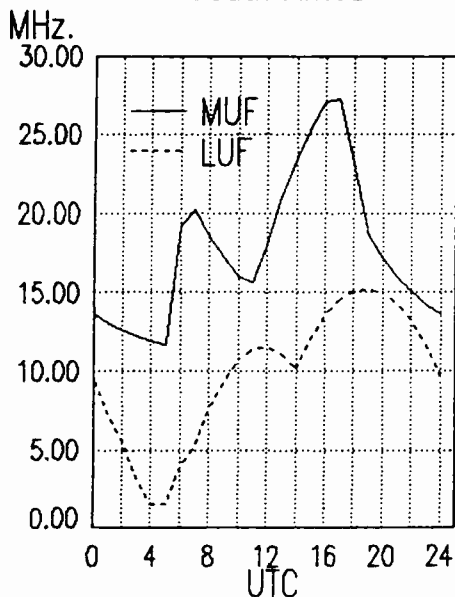

West Coast To Central Asia

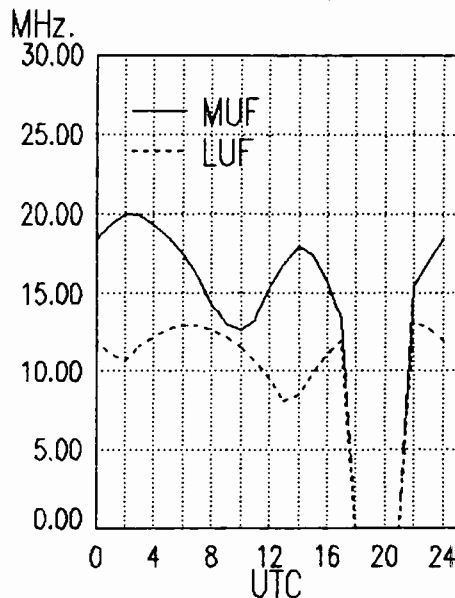

West Coast To South East Asia

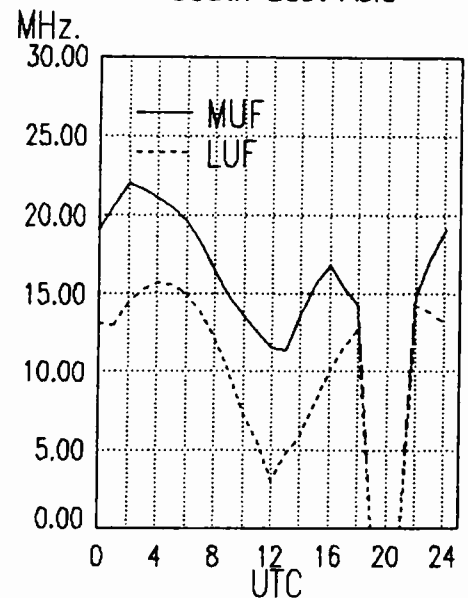

frequency SECTION

1500-1515	FEBA, Mahe, Seychelles	15325	1500-1600	KSDA, Agat, Guam	11980
1500-1520	Radio Ulan Bator, Mongolia	9575 15305	1500-1600	KYOI, Saipan	11900
1500-1525	Radio Bucharest, Romania	9510 9690 11775 11940	1500-1600	Radio Australia, Melbourne	5995 6035 6060 6080
		15250 15335			7205 7215 9580
1500-1525	Radio Netherland, Hilversum	5955 11735 13770 15560	1500-1600 S	Radio Canada Int'l, Montreal	9555 9625 11720 11915
		17575			11955 15315 15440 17820
1500-1530	Radio Berlin Int'l, East Germany	11785 15170 15255	1500-1600	Radio Japan, Tokyo	5990 7210 11815 21700
1500-1530	Radio Sofia Bulgaria	7245 9560 11735 15310	1500-1600	Radio Jordan, Amman	9560
1500-1530 A, S	Radio Tanzania, Dar es Salaam	7165	1500-1600	Radio Moscow, USSR	5905 5920 5980 6020
1500-1530	Radio Veritas Asia, Philippines	9770 15215			6050 6095 6165 7135
1500-1545	WYFR, Oakland, California	5950 6175 11830 15170			7185 7315 7345 11670
		15375 17612			11705 11840 11900 13790
1500-1550	Deutsche Welle, West Germany	7225 9735 17765 15135			15475 15585
		21600	1500-1600	Radio RSA, South Africa	9655 15125 17755 21590
1500-1550	KTWR, Agana, Guam	9820	1500-1600	SBC Radio One, Singapore	5010 5052 11940
1500-1550	Radio Pyongyang, North Korea	6576 7290 9325 9640	1500-1600 S	Superpower KUSW, Utah	9850
		9977			9000 9760 15205
1500-1555	Radio Beijing, China	11600 15165	1500-1600	Voice of America, Washington	7165 9560
1500-1600 F	ABC, Alice Springs, Australia	2310 [ML]	1500-1600	Voice of Ethiopia, Addis Ababa	11790 15150
1500-1600	ABC, Perth, Australia	9610	1500-1600	Voice of Indonesia, Jakarta	6100
1500-1600 F	ABC, Tennant Creek, Australia	2325 [ML]	1500-1600	Voice of Kenya, Nairobi	4950
1500-1600	(US) Armed Forces Radio and TV	9700 15330 15430	1500-1600	Voice of Malaysia, Kuala Lumpur	7255 11770
1500-1600	AWR, Alajuela, Costa Rica	15460	1500-1600	WRNO, New Orleans, Louisiana	13760
1500-1600	BBC, London, England	5995 6195 7160 9515	1500-1600	WYFR, Oakland, California	15105 21640
		9740 11750 12095 15070			11965
		15260 15400 15420 17705			5950 6175 13695
		17885			15170
1500-1600	Burma Broadcasting Service	5985	1500-1600 M-A	WYFR Satellite Net, California	15375 17612
1500-1600	CBC Northern Quebec Service	9625 11720	1505-1530	Radio Finland, Helsinki	13695 15375
1500-1600	CBN, St. John's, Newfoundland	6160	1515-1600	Radio Berlin Int'l, East Germany	11850 15185
1500-1600	CBU, Vancouver, British Columbia	6160	1515-1600	FEBA, Mahe, Seychelles	6115 7295 9730
1500-1600	CFCF, Montreal, Quebec	6005	1530-1545	All India Radio, New Delhi	11865 15325
1500-1600	CFCN, Calgary, Alberta	6030			3905 3925 4860 6160
1500-1600	CHNS, Halifax, Nova Scotia	6130			7160 7412 9545 9950
1500-1600	CKWX, Vancouver, British Columbia	6080	1530-1555 M-A	BRT, Brussels, Belgium	17595 15510 21810
1500-1600	CFRB, Toronto, Ontario	6070	1530-1555	Radio Austria Int'l, Vienna	6155 11780 11915
1500-1600 S	ELWA, Monrovia, Liberia	11830	1530-1600	Radio Prague, Czechoslovakia	6055 7345 9605 11665
1500-1600	(US) Far East Network, Tokyo	3910			11685 11990 15110 13715
1500-1600	FEBC, Manila, Philippines	9670			17705 21505
1500-1600	HCJB, Quito, Ecuador	11740 15115 17890	1530-1600	Radio Tanzania, Dar es Salaam	9684
1500-1600	King of Hope, Southern Lebanon	6280	1530-1600	Radio Tirana, Albania	9480 11835

West Coast To
Far East

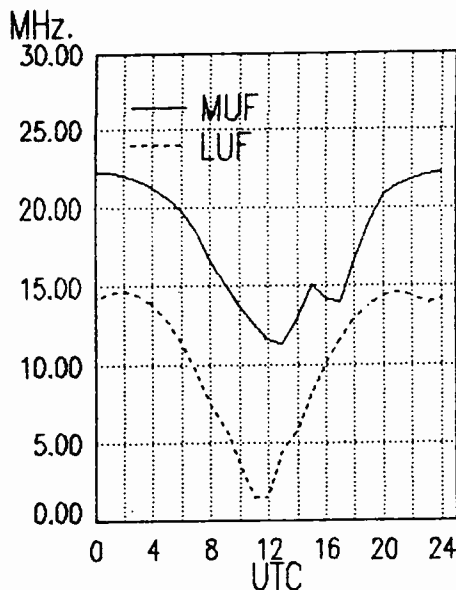

West Coast To
Pacific

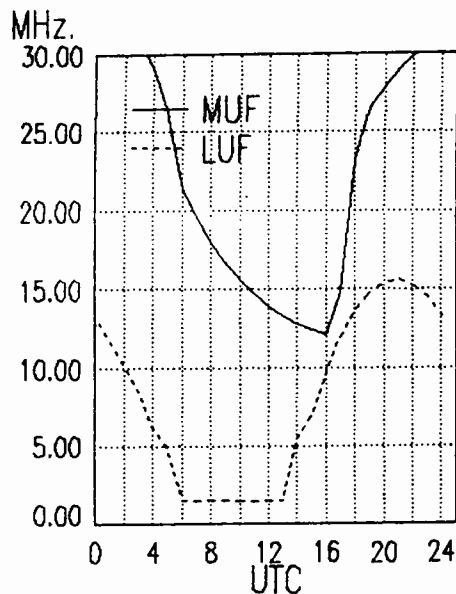

West Coast To
South America

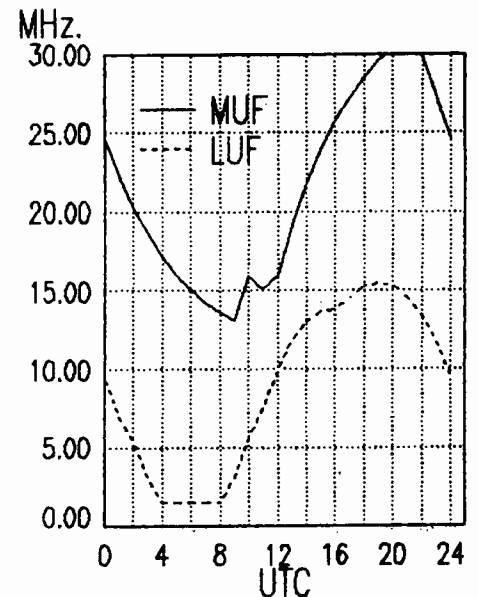

frequency SECTION

1530-1600	Swiss Radio Int'l, Berne	9885	15430	17830	13685	1600-1700	(US) Armed Forces Radio and TV	9700	15330	15430
1530-1600	Voice of Asia, Taiwan	5980	7445			1600-1700	AWR, Alajuela, Costa Rica	15460		
1530-1600	Voice of Nigeria, Lagos	15120				1600-1700	BBC, London, England	5975	5995	6195 7105
1540-1550	M-A Voice of Greece, Athens	9855	11645	15630				7180	9515	9605 9740
1545-1600	Radio Canada Int'l, Montreal	9555	11915	11935	15315			11705	11820	12095 15070
		15325	17820					15260	15400	17885
1545-1600	Radio Korea, Seoul, South Korea	7275	9870			1600-1700	CBC Northern Quebec Service	9625	11720	
1545-1600	Vatican Radio, Vatican City	11810	15120	17730		1600-1700	CBN, St. John's, Newfoundland	6160		
1550-1600	H-S KTWR, Agana, Guam	9780				1600-1700	CBU, Vancouver, British Columbia	6160		
						1600-1700	CFCF, Montreal, Quebec	6005		
						1600-1700	CFCN, Calgary, Alberta	6030		
						1600-1700	CHNS, Halifax, Nova Scotia	6130		
						1600-1700	CKWX, Vancouver, British Columbia	6080		
						1600-1700	CFRB, Toronto, Ontario	6070		
						1600-1700	(US) Far East Network, Tokyo	3910		
1600 UTC [12:00 PM EDT/9:00 AM PDT]										
1600-1610	FEBA, Mahe, Seychelles	11865	15325			1600-1700	HCJB, Quito, Ecuador	11740	15115	17890
1600-1610	Radio Lesotho, Maseru	4800				1600-1700	S KCBI, Dallas, Texas	11735		
1600-1610	SBC Radio One, Singapore	5010	5052	11940		1600-1700	Radio Australia, Melbourne	5995	6035	6060 6080
1600-1625	Radio Budapest, Hungary	6110	9585	9835	11910			7205	7215	9580
		15160				1600-1700	Radio Beijing, China	15130		
1600-1625	Radio Prague, Czechoslovakia	6055	7345	9605	11665	1600-1700	Radio Canada Int'l, Montreal	9625	11720	11955 15440
		11685	11990	15110	13715			17820		
		15110	17705	21505		1600-1700	Radio France Int'l, Paris	6175	9860	11705 11995
1600-1630	ELWA, Monrovia, Liberia	11830				1600-1700	Radio Jordan, Amman	9560		
1600-1630	S Radio Norway Int'l, Oslo	9660	11850	11870	15310	1600-1700	Radio Korea, Seoul, South Korea	5975	9870	
1600-1630	Radio Pakistan, Islamabad	7365	9465	9785	11615	1600-1700	Radio Malawi, Blantyre	3380	5995	
		11625	15125			1600-1700	Radio Moscow, USSR	5905	5920	5980 6020
1600-1630	Radio Polonia, Warsaw, Poland	6135	9540					6050	6095	6165 7105
1600-1630	M-F Radio Portugal, Lisbon	15245						7115	7135	7150 7315
1600-1630	Radio Sweden, Stockholm	6065	11855					7345	7440	9565 11670
1600-1630	SLBC, Colombo, Sri Lanka	6075	9720					11840		
1600-1630	Trans World Radio, Swaziland	5055	9525			1600-1700	Radio Riyadh, Saudi Arabia	9705	9720	
1600-1630	Voice of Asia, Taiwan	5980	7445			1600-1700	Radio Tanzania, Dar es Salaam	9684		
1600-1630	Voice of Vietnam, Hanoi	9840	12020			1600-1700	Radio Zambia, Lusaka	9580		
1600-1645	H-A KTWR, Agana, Guam	9820				1600-1700	S Superpower KUSW, Utah	15225		
1600-1645	Radio Nacional Angola, Luanda	7245	9535	11955		1600-1700	Voice of America, Washington	9575	9700	9760 15205
1600-1645	UAE Radio, United Arab Emirates	11730	15320	17865				15410	15445	15580 15600
1600-1655	Radio Beijing, China	7295	9570	11715	15130			17785	17800	17870
1600-1700	F ABC, Alice Springs, Australia	2310	[ML]			1600-1700	Voice of Kenya, Nairobi	6100		
1600-1700	ABC, Perth, Australia	9610				1600-1700	Voice of Nigeria, Lagos	7255	15120	
1600-1700	F ABC, Tennant Creek, Australia	2325	[ML]							

West Coast To
Central America/Caribbean

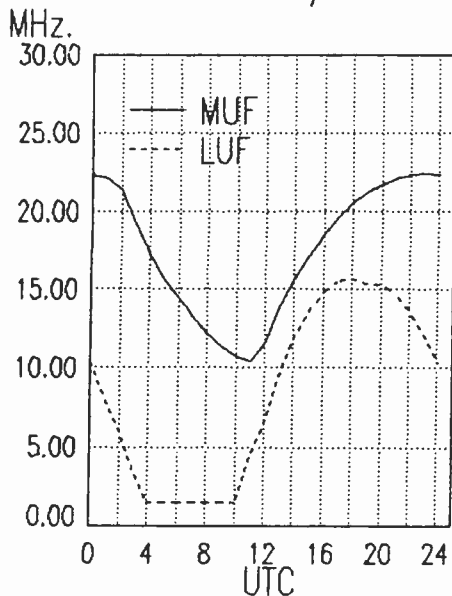

West Coast To
Australia & Malaysia

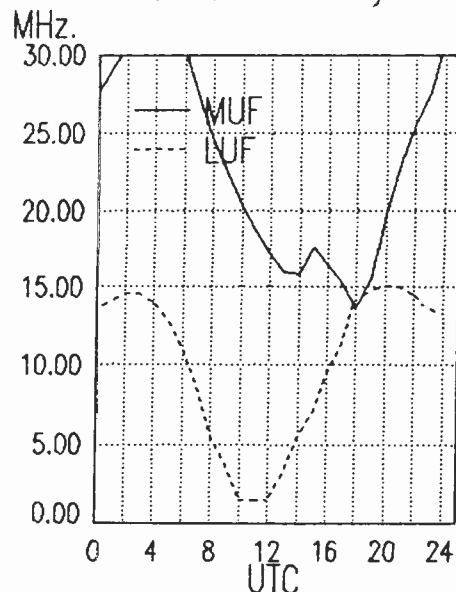

frequency SECTION

0000 UTC [7:00 PM EST/4:00 PM PST]

1600-1700	WCSN, Boston, Massachusetts	21640		
1600-1700	WHRI, Noblesville, Indiana	15105	21550	
1600-1700	WRNO, New Orleans, Louisiana	11965		
1600-1700	WYFR, Oakland, California	11830	13695	15170 15440
		21525	15566	17612 17750
		21615		
1600-1700 M-A	WYFR Satellite Net, California	13695	15395	
1602-1700	WINB, Red Lion, Pennsylvania	15295		
1610-1615 M-A	Vatican Radio, Vatican City	6248	7250	9645 11740
1610-1620 M-F	Radio Botswana, Gaborone	3356	4820	
1610-1625 M-F	FEBA, Agana, Guam	15325		
1610-1650	Deutsche Welle, West Germany	9745	11785	15105 17875
		15510		
1630-1645	Trans World Radio, Swaziland	5055	7285	9525
1630-1700 M-A	ELWA, Monrovia, Liberia	11830		
1630-1700	Radio Netherland, Hilversum	6020	15570	
1630-1700	Radio Peace and Progress, USSR	9470	9490	9515 9760
		9860	11980	12030 12050
1630-1700	Radio Polonia, Warsaw, Poland	7125	9525	11840
1630-1700	SLBC, Colombo, Sri Lanka	6075		
1630-1700	Swaziland Commercial Radio	6155		
1630-1700	Voice of Africa, Egypt	15255		
1630-1700 M-A	Voice of Namibia (Angola)	11955		
1640-1650 S	Radio Free Europe, Munich*	5985	7115	9695 9725
		11895	15355	
1645-1700	BBC, London, England*	6195	7180	9605
1645-1700	Radio Bujumbura, Burundi	3300		
1645-1700	Trans World Radio, Swaziland	7285	9525	

1700 UTC [1:00 PM EDT/10:00 AM PDT]

1700-1705	Radio Uganda, Kampala	4976	5026	
1700-1715	Kol Israel, Jerusalem	9385	9640	9925 11585
1700-1715 M-A	Voice of Namibia (Angola)	11955		
1700-1725	Radio Netherland, Hilversum	6020	15570	
1700-1730	Radio Australia, Melbourne	5995	6060	6080 7205
		9580		
1700-1730	Radio Berlin Int'l, East Germany	6115	7260	9730
1700-1730	Radio Japan, Tokyo	5990	11815	
1700-1730 S	Radio Norway Int'l, Oslo	9655	15220	15310
1700-1745	BBC, London, England	5975	5995	9515 9740
		11820	12095	15070 15260
		15400	17885	
1700-1750	Radio Pyongyang, North Korea	7290	9325	9640 9977
1700-1755	Radio Beijing, China	7295	9570	
1700-1800 F	ABC, Alice Springs, Australia	2310 [ML]		
1700-1800	ABC, Tennant Creek, Australia	2325 [ML]		
1700-1800	(US) Armed Forces Radio and TV	9700	15330	15430
1700-1800	CBC Northern Quebec Service	9625	11720	
1700-1800	CBN, St. John's, Newfoundland	6160		
1700-1800	CBU, Vancouver, British Columbia	6160		
1700-1800	CFCF, Montreal, Quebec	6005		
1700-1800	CFCN, Calgary, Alberta	6030		
1700-1800	CHNS, Halifax, Nova Scotia	6130		
1700-1800	CKWX, Vancouver, British Columbia	6080		
1700-1800	CFRB, Toronto, Ontario	6070		
1700-1800	(US) Far East Network, Tokyo	3910		
1700-1800 A,S	KCBI, Dallas, Texas	11735		
1700-1800	Radio Havana Cuba	11920		
1700-1800	Radio Jordan, Amman	9560		
1700-1800 M-F	Radio Malabo, Equatorial Guinea	9553 [ML]		
1700-1800	Radio Moscow, USSR	5920	5980	6020 6165
		7115	7135	7150 7260
		7315	7345	9470 9490
		9565	9740	9760 11840
		12050		
1700-1800	Radio Riyadh, Saudi Arabia	9705	9720	
1700-1800	Radio Tanzania, Dar es Salaam	9684		
1700-1800	Radio Zambia, Lusaka	9580		
1700-1800	SBC Radio One, Singapore	5052	11940	

1700-1800 A,S	Swaziland Commercial Radio	6155		
1700-1800 S	Superpower KUSW, Utah	15225		
1700-1800	Voice of Africa, Egypt	15255		
1700-1800	Voice of America, Washington	6110	9575	9645 11760
		11920	15410	15445 15580
		15600	17785	17800 17870
1700-1800	Voice of Kenya, Nairobi	6100		
1700-1800	Voice of Nigeria, Lagos	11770		
1700-1800	WCSN, Boston, Massachusetts	21640		
1700-1800	WHRI, Noblesville, Indiana	15105		
1700-1800	WINB, Red Lion, Pennsylvania	15295		
1700-1800 S-F	WMLK, Bethel, Pennsylvania	9455		
1700-1800	WRNO, New Orleans, Louisiana	15420		
1700-1800	WYFR, Oakland, California	11580	11830	13695 13760
		15170	17612	17845
1700-1800	WYFR Satellite Net, California	13695	15375	
1715-1730	Radio Korea, Seoul, South Korea	9870	15575	
1715-1745	BBC, London, England*	3975	6185	7165
1715-1800	Radio Berlin Int'l, East Germany	9665	15145	15255
1718-1800	Radio Pakistan, Islamabad	6210	11570	
1725-1740	Radio Suriname Int'l, Paramibo	7835v		
1725-1800	Radio New Zealand, Wellington	11780	15150	
1730-1735	All India Radio, New Delhi	4840	4860	4920 6160
		7412	9950	
1730-1800	KNLS, Anchor Point, Alaska	7355		
1730-1755	Radio Bucharest, Romania	7105	9530	9685 11790
		11940		
1730-1800	Radio Australia, Melbourne	5995	6035	6060 6080
		7205	9580	
1730-1800	Radio Berlin Int'l, E. Germany	6115	7260	9730
1730-1800	Radio Polonia, Warsaw, Poland	6135	9540	
1730-1800	Radio Prague, Czechoslovakia	9605	11685	11695 11990
		13715	15110	
1730-1800	Radio Sofia, Bulgaria	7245	9560	11735 15310
1730-1800	Radio Yugoslavia, Belgrade	5980	6100	7240 11735
1730-1800	RAE, Buenos Aires, Argentina	15345		
1734-1800	FEBA, Mahe, Seychelles	11760		
1745-1800	BBC, London, England	9515	9740	12095 15070
		15260	15400	
1745-1800	SLBC, Colombo, Sri Lanka	11800		

1800 UTC [2:00 PM EDT/11:00 AM PDT]

1800-1804	FEBA, Mahe, Seychelles	11760		
1800-1805 A	SBC Radio One, Singapore	11940		
1800-1815	Radio Cameroon, Yaounde	3970	4750	4795 4850
		5010		
1800-1815	SLBC, Colombo, Sri Lanka	11800		
1800-1825	Radio Prague, Czechoslovakia	9605	11685	11990 13715
		15110	21505	
1800-1825	RAE, Buenos Aires, Argentina	15345		
1800-1830	BBC, London, England	9740	11820	12095 15070
		15400		
1800-1830 S	Radio Bamako, Mali	4835	5995	
1800-1830	Radio Canada Int'l, Montreal	15260	17820	
1800-1830	Radio Mozambique, Maputo	3265	4855	9618
1800-1830	Radio Prague, Czechoslovakia	5930	7345	
1800-1830	Radio Sofia Bulgaria	7245	7155	9700
1800-1830	Swiss Radio Int'l, Berne	3985	6165	9535
1800-1830	Voice of Africa, Egypt	15255		
1800-1830	Voice of Vietnam, Hanoi	9840	12020	
1800-1845	Radio Abidjan, Ivory Coast	7215		
1800-1845	Trans World Radio, Swaziland	9525		
1800-1850	Deutsche Welle, West Germany	7225	9745	11785 13790
1800-1850	Radio Bras, Brasilia, Brazil	15265		
1800-1856	Radio RSA, South Africa	17880		
1800-1900 F	ABC, Alice Springs, Australia	2310 [ML]		
1800-1900 F	ABC, Tennant Creek, Australia	2325 [ML]		
1800-1900	All India Radio, New Delhi	11935	15360	
1800-1900	(US) Armed Forces Radio and TV	9700	15330	15430
1800-1900	CBC Northern Quebec Service	9625	11720	
1800-1900	CBN, St. John's, Newfoundland	6160		
1800-1900	CBU, Vancouver, British Columbia	6160		
1800-1900	CFCF, Montreal, Quebec	6005		

frequency SECTION

1800-1900	CFCN, Calgary, Alberta	6030			
1800-1900	CHNS, Halifax, Nova Scotia	6130			
1800-1900	CKWX, Vancouver, British Columbia	6080			
1800-1900	CFRB, Toronto, Ontario	6070			
1800-1900	(US) Far East Network, Tokyo	3910			
1800-1900 A,S	KCBI, Dallas, Texas	11735			
1800-1900	KNLS, Anchor Point, Alaska	7355			
1800-1900	Radio Australia, Melbourne	5995	6035	6060	6080
		7205	7215	9580	
1800-1900	Radio Jamahiriya, Libya	15450			
1800-1900	Radio Korea, Seoul, South Korea	15575			
1800-1900	Radio Kuwait, Kuwait	11665			
1800-1900 M-F	Radio Malabo, Equatorial Guinea	9553 [ML]			
1800-1900	Radio Moscow, USSR	5920	5980	7115	7135
		7150	7195	7260	7345
		9565	11840		
1800-1900	Radio New Zealand, Wellington	11780	15150		
1800-1900	Radio Riyadh, Saudi Arabia	9705	9720		
1800-1900	Radio Tanzania, Dar es Salaam	9684			
1800-1900	Radio Zambia, Lusaka	9580			
1800-1900 M-A	Superpower KUSW, Utah	15225			
1800-1900 A,S	Swaziland Commercial Radio	6155			
1800-1900	Voice of America, Washington	9700	9760	11760	15410

1800-1900	Voice of Kenya, Nairobi	6100			
1800-1900	Voice of Nigeria, Lagos	11770	15120		
1800-1900	WCSN, Boston, Massachusetts	21515			
1800-1900	WHRI, Noblesville, Indiana	13760	15105		
1800-1900	WINB, Red Lion, Pennsylvania	15295			
1800-1900 S-F	WMLK, Bethel, Pennsylvania	9455			
1800-1900	WRNO, New Orleans, Louisiana	15420			
1800-1900	WYFR, Oakland, California	11380	11580	13695	15170

1800-1900	WYFR Satellite Net, California	13695	15375		
1805-1830 A,S	Radio Austria Int'l, Vienna	5945	6155	11825	12015
1815-1825	Voice of Lebanon, Beirut	6548			
1815-1900	Radio Bangladesh, Dhaka	6240	7505		
1830-1855	Radio Austria Int'l, Vienna	5945	6155	11825	12015
1830-1855	BRT, Brussels, Belgium	5910	9860	11695	
1800-1855	Radio Polonia, Warsaw, Poland	5995	6135	7125	7285
		9525	11840		

1830-1900	BBC, London, England	9740	11820	12095	15400
1830-1900 A,S	Radio Canada Int'l, Montreal	15260	17820		
1830-1900	Radio Havana Cuba	9670			
1830-1900 MWF	Radio Mozambique, Maputo	3265	4855	9618	
1830-1900	Radio Netherland, Hilversum	6020	15175	17605	21685
1830-1900	Radio Sweden, Stockholm	11845			
1830-1900	Radio Tirana, Albania	7120	9480		
1830-1900	Spanish Foreign Radio, Madrid	7275	9765	11840	15375
1830-1900	Swiss Radio Int'l, Berne	9885	11955		
1830-1900	WINB, Red Lion, Pennsylvania	15185			

1840-1850 M-A	Voice of Greece, Athens	11645	12045	15630	
1840-1900	Radio Senegal, Dakar	4950			
1845-1855	Radio Nacional, Conakry, Guinea	4833	4900	7125	
1845-1900	All India Radio, New Delhi	7412	11620		
1845-1900	BBC, London, England*	6070			
1845-1900	Radio Berlin Int'l, East Germany	9665	119200	15255	
1845-1900	Radio Ghana, Accra	6130			
1855-1900	Africa No. 1, Gabon	4830	15475		

1900 UTC [3:00 PM EDT/12:00 PM PDT]

1900-1903	Africa No. 1, Gabon	15475			
1900-1915	Radio Bangladesh, Dhaka	6240	7505		
1900-1915	Radio Tanzania, Dar es Salaam	9684			
1900-1925	Radio Budapest, Hungary	6110	7220	9585	9835
		11910			
1900-1925	Radio Netherland, Hilversum	6020	15175	17605	21685
1900-1930 F	ABC, Alice Springs, Australia	2310 [ML]			
1900-1930 F	ABC, Tennant Creek, Australia	2325 [ML]			
1900-1930	Kol Israel, Jerusalem	7355	7462	9435	9815
		9845	9855	11655	11700
1900-1930	Radio Afghanistan, Kabul	4760	6020	9635	
1900-1930	Radio Berlin Int'l, East Germany	9665	11920	15255	

MONITORING TIMES



As Gayle Van Horn says, "Here's a card you don't see every day!" Congrats on your catch, Gayle.

1900-1930	Radio Japan, Tokyo	9505			
1900-1930	Radio Kiev, Ukraine, USSR	6010	6090	6165	7170
1900-1930 S	Radio Norway Int'l, Oslo	9590	9590	15230	
1900-1930 M-F	Radio Portugal, Lisbon	11870	15250		
1900-1930	Radio Sofia, Bulgaria	7245	9560	11735	15310
1900-1930	Radio Yugoslavia, Belgrade	5980	7240	9620	
1900-1930	Spanish Foreign Radio, Madrid	7275	9765	11840	15375
1900-1930	Voice of Vietnam, Hanoi	9840	12020		
1900-1955	Radio Beijing, China	6860	9470		
1900-2000	All India Radio, New Delhi	7412	11620	11935	15360
1900-2000	(US) Armed Forces Radio and TV	9700	15330	15430	
1900-2000	BBC, London, England	6180	9410	9740	11820

1900-2000	CBC Northern Quebec Service	9625	15720		
1900-2000	CBN, St. John's, Newfoundland	6160			
1900-2000	CBU, Vancouver, British Columbia	6160			
1900-2000	CFCF, Montreal, Quebec	6005			
1900-2000	CFCN, Calgary, Alberta	6030			
1900-2000	CHNS, Halifax, Nova Scotia	6130			
1900-2000	CKWX, Vancouver, British Columbia	6080			
1900-2000	CFRB, Toronto, Ontario	6070			
1900-2000	(US) Far East Network, Tokyo	3910			
1900-2000	HCJB, Quito, Ecuador	11790	15270	17790	
1900-2000 A,S	KCBI, Dallas, Texas	11735			
1900-2000	KNLS, Anchor Point, Alaska	7355			
1900-2000	KYOI, Saipan	9495			
1900-2000	Radio Algiers, Algeria	9509	9685	15215	17745
1900-2000	Radio Australia, Melbourne	6035	6060	6080	7205
		7215	9580		

1900-2000	Radio Ghana, Accra	6130			
1900-2000	Radio Havana Cuba	9670			
1900-2000	Radio Kuwait, Kuwait	11665			
1900-2000 M-A	Radio Malabo, Equatorial Guinea	9553 [ML]			
1900-2000	Radio Moscow, USSR	7115	7150	7195	7260
		7290	9565	9580	9865
		11840			

1900-2000	Radio New Zealand, Wellington	11780	15150		
1900-2000	Radio Prague, Czechoslovakia	5930	7345		
1900-2000	Radio Riyadh, Saudi Arabia	9705	9720		
1900-2000	Radio Zambia, Lusaka	9580			
1900-2000 M-A	Superpower KUSW, Utah	17715			
1900-2000 A,S	Swaziland Commercial Radio	6155			
1900-2000	Trans World Radio Swaziland	3205			
1900-2000	Voice of America, Washington	9700	9760	11760	15410
		15445	15580	17785	17800
		17870	21485		

1900-2000	Voice of Ethiopia, Addis Ababa	9595			
1900-2000	Voice of Kenya, Nairobi	6100			
1900-2000	Voice of Nigeria, Lagos	7255	11770		
1900-2000	WCSN, Boston, Massachusetts	21515			
1900-2000	WHRI, Noblesville, Indiana	13760	17830		
1900-2000	WINB, Red Lion, Pennsylvania	15295			

frequency SECTION

1900-2000 S-F	WMLK, Bethel, Pennsylvania	9455			
1900-2000	WRNO, New Orleans, Louisiana	15420			
1900-2000	WYFR, Oakland, California	13695	15170	15566	17612
		17845	21525		
1900-2000 M-A	WYFR Satellite Net, California	13695	15395		
1910-1920	Radio Botswana, Gaborone	3356	4820		
1920-1930 M-A	Voice of Greece, Athens	7430	9425	11645	
1930-1940	Radio Togo, Lome	5047			
1930-2000	ABC, Katherine, Australia	2485			
1930-1955	Radio Finland, Helsinki	6120	9530	11755	
1930-2000	Radio Beijing, China	6955	7480	9440	
1930-2000	Radio Bucharest, Romania	5990	6105	7145	7195
1930-2000 M-F	Radio Canada Int'l, Montreal	5995	7235	11945	15325
		17875			
1930-2000	Voice of Republic of Iran	9022	9770		
1935-1955	RAI, Rome, Italy	7275	7290	9575	
1940-2000 M-A	Radio Ulan Bator, Mongolia	9575	11790		
1945-2000	All India Radio, New Delhi	9755	11860		

2000 UTC [4:00 PM EDT/1:00 PM PDT]

2000-2005 S-F	Port Moresby, Papua New Guinea	3295	4890	5960	5985
		6020	6040	6080	6140
		9520			
2000-2005	Radio Zambia, Lusaka	3345	6165		
2000-2005 M-A	Vatican Radio, Vatican City	6190	6248	7250	9625
		9645	11700	15120	
2000-2010 A	Radio Zambia, Lusaka	3345	6165		
2000-2010	Voice of Kenya, Nairobi	6100			
2000-2015	Radio Togo, Lome	3220	5047		
2000-2015	Radio Ulan Bator, Mongolia	9575	11790		
2000-2015	Trans World Radio, Swaziland	3205			
2000-2025	Radio Beijing, China	6955	7480	9440	
2000-2025	Radio Bucharest, Romania	5990	6105	7145	7195
2000-2030	KNLS, Anchor Point, Alaska	7355			
2000-2030	Radio Australia, Melbourne	6035	7205	7215	9580
		9620			
2000-2030	Radio Ghana, Nairobi	3366	4915		
2000-2030	Radio Norway International, Oslo	6000	7125	9525	15310
2000-2030	Radio Polonia, Warsaw, Poland	7125	7145	9525	
2000-2030	Swaziland Commercial Radio	6155			
2000-2030	Voice of Nigeria, Lagos	7255			
2000-2030	Voice of Republic of Iran	9022	9770		
2000-2045	All India Radio, New Delhi	7412	9755	9910	11620
		11860			
2000-2045	WYFR, Oakland, California	9455	13695	15170	15566
		17612	17845		
2000-2050	Radio Pyongyang, North Korea	6576	9345	9640	9977
2000-2056	Radio RSA, South Africa	7270	11900	15252	
2000-2100 M-A	ABC, Alice Springs, Australia	2310	[ML]		
2000-2100	ABC, Katherine, Australia	2485			
2000-2100 M-A	ABC, Tennant Creek, Australia	2325	[ML]		
2000-2100	BBC, London, England	6005	6175	6180	7325
		9410	9580	11820	12095
		15070	15400		
2000-2100	CBN, St. John's, Newfoundland	6160			
2000-2100	CBU, Vancouver, British Columbia	6160			
2000-2100	CFCF, Montreal, Quebec	6005			
2000-2100	CFCN, Calgary, Alberta	6030			
2000-2100	CHNS, Halifax, Nova Scotia	6130			
2000-2100	CKWX, Vancouver, British Columbia	6080			
2000-2100	CFRB, Toronto, Ontario	6070			
2000-2100	(US) Far East Network, Tokyo	3910			
2000-2100	Radio Kuwait, Kuwait	11665			
2000-2100	King of Hope, Southern Lebanon	6280			
2000-2100 M-F	KVOH, Rancho Simi, California	17775			
2000-2100	KYOI, Saipan	9495			
2000-2100	Radio Baghdad, Iraq	9875			
2000-2100 M-F	Radio Malabo, Equatorial Guinea	9553			
2000-2100	Radio Moscow, USSR	5905	7115	7150	7185
		7195	7840	9735	11840
2000-2100	Radio New Zealand, Wellington	11780	15150		
2000-2100	Radio Riyadh, Saudi Arabia	9705	9720		
2000-2100	Radio Zambia, Lusaka	9580			

2000-2100	Superpower KUSW, Utah	17715			
2000-2100	Voice of America, Washington	9670	9760	11760	15410
		15445	15580	17785	17800
		17870			
2000-2100	Voice of Turkey, Ankara	7130	7165	7215	9445
2000-2100	Voice of Nigeria, Lagos	11770			
2000-2100	WCSN, Boston, Massachusetts	15390			
2000-2100	WHRI, Noblesville, Indiana	13760	17830		
2000-2100	WRNO, New Orleans, Louisiana	15420			
2003-2100	WINB, Red Lion, Pennsylvania	15295			
2005-2100	Radio Damascus, Syria	9950	11625		
2010-2100 A,S	Voice of Kenya, Nairobi	6100			
2015-2100	ELWA, Monrovia, Liberia	11830			
2015-2100	Radio Cairo, Egypt	9670			
2025-2045	RAI, Rome, Italy	7235	9575	9710	
2030-2055	Radio Polonia, Warsaw, Poland	6095	7285		
2030-2100	Radio Australia, Melbourne	9580	9620		
2030-2100	Radio Beijing, China	6955	7480	9440	9745
		11790			
2030-2100	Radio Korea, Seoul, South Korea	6480	7550	15575	
2030-2100	Radio Netherland, Hilversum	9540	9715	9895	11740
2030-2100 M-F	Radio Portugal, Lisbon	7155	9740		
2030-2100	Radio Sofia Bulgaria	7115	7155	9700	
2030-2100	Radio Tirana, Albania	9480	11835		
2030-2100	Voice of Africa, Cairo, Egypt	15375			
2030-2100	Voice of Vietnam, Hanoi	9840	12020		
2030-2100	Spanish Foreign Radio, Madrid	7275	9765		
2040-2100	Radio Havana Cuba	15230	15300		
2045-2100	All India Radio, New Delhi	7412	9550	9910	11620
		11715			
2045-2100	IBRA Radio, Malta	6100			
2045-2100	Radio Berlin Int'l, East Germany	5965	6125		
2045-2100	Radio Korea, Seoul, South Korea	5975			
2045-2100	Vatican Radio, Vatican City	9625	11700	11760	15120
2045-2100	WYFR, Oakland, California	11830	13695	15170	15566
		17612	17845		
2050-2100	Vatican Radio, Vatican City	6190	7250	9645	

2100 UTC [5:00 PM EDT/2:00 PM PDT]

2100-2105	Radio Damascus, Syria	9950	11625		
2100-2105	Radio Zambia, Lusaka	3345	6165		
2100-2110	Vatican Radio, Vatican City	6190	7250	9645	
2100-2110 A,S	Voice of Kenya, Nairobi	6100			
2100-2115	IBRA Radio, Malta	6100			
2100-2125	Radio Austria Int'l, Vienna	5945	6155	9585	9870
2100-2125	Radio Beijing, China	6955	7480	9440	9745
		11790			
2100-2125	Radio Bucharest, Romania	5990	6105	7145	7195
2100-2125	Radio Netherland, Hilversum	9540	9715	9895	11740
2100-2130	Radio Berlin Int'l, East Germany	5965	6125		
2100-2130	Radio Japan, Tokyo	5965	7140	7280	17835
2100-2130	Radio Korea, Seoul, South Korea	6480	7550	15575	
2100-2130	Radio Moscow, USSR	7115	7360	9490	11675
		11840	13665		
2100-2130	Radio Sweden, Stockholm	6065	9700		
2100-2130	Spanish Foreign Radio, Madrid	7275	9765		
2100-2130	Swiss Radio Int'l, Berne	9885	12035	15570	
2100-2135	ELWA, Monrovia, Liberia	11830			
2100-2140	Radio Havana Cuba	15230	15300	15340	
2100-2145	Radio Cairo, Egypt	9670			
2100-2150	Deutsche Welle, West Germany	7130	9765		
2100-2150	Radio Baghdad, Iraq	9770			
2100-2150	Voice of Turkey, Ankara	7215			
2100-2155	Radio Beijing, China	6860	9470	9860	
2100-2200 M-A	ABC, Alice Springs, Australia	2310	[ML]		
2100-2200	ABC, Katherine, Australia	2485			
2100-2200 M-A	ABC, Tennant Creek, Australia	2325	[ML]		
2100-2200	All India Radio, New Delhi	9550	9910	11715	
2100-2200	(US) Armed Forces Radio and TV	15330	15345	15430	
2100-2200	BBC, London, England	3995	5975	6005	6175
		6180	7325	9410	12095
		15070	15260	17760	
2100-2200	CBC Northern Quebec Service	9625	11720		
2100-2200	CBN, St. John's, Newfoundland	6160			

frequency SECTION

2100-2200	CBU, Vancouver, British Columbia	6160			
2100-2200	CFCF, Montreal, Quebec	6005			
2100-2200	CFCN, Calgary, Alberta	6030			
2100-2200	CHNS, Halifax, Nova Scotia	6130			
2100-2200	CKWX, Vancouver, British Columbia	6080			
2100-2200	CFRB, Toronto, Ontario	6070			
2100-2200	(US) Far East Network, Tokyo	3910			
2100-2200	King of Hope, Southern Lebanon	6280			
2100-2200	KSDA, Agat, Guam	11965			
2100-2200	M-A KUSW, Salt Lake City, Utah	17715			
2100-2200	KVOH, Rancho Simi, California	17775			
2100-2200	A,S Radio Malabo, Equatorial Guinea	9552.5			
2100-2200	A,S Radio Zambia, Lusaka	9580			
2100-2200	Voice of Africa, Cairo, Egypt	15375			
2100-2200	Voice of America, Washington	6040 6045 9760 11760			
		15410 15445 15580 17785			
		17800 17870			
2100-2200	Voice of Nigeria, Lagos	15120			
2100-2200	WCSN, Boston, Massachusetts	15390			
2100-2200	WHRI, Noblesville, Indiana	9770 17830			
2100-2200	WINB, Red Lion, Pennsylvania	15185			
2100-2200	WRNO, New Orleans, Louisiana	13760			
2100-2200	WYFR, Oakland, California	9852.5 15170 17845			
2100-2200	WYFR Satellite Net, California	13695 15375			
2110-2200	Radio Damascus, Syria	117651 11900			
2125-2155	S Radio Austria Int'l, Vienna	5945 6155 7205 9655			
2130-2145	BBC, London, England*	5965 7160			
2130-2200	BBC, London, England*	6030 7230 9635			
2130-2200	HCJB, Quito, Ecuador	15270 17790			
2130-2200	Kol Israel, Jerusalem	9435 9815 11605			
2130-2200	Radio Canada Int'l, Montreal	11880 15150 17820			
2130-2200	Radio Sofia, Bulgaria	9700 11720			
2130-2200	Radio Vilnius, Lithuanian SSR	6100			
2135-2150	S-F ELWA, Monrovia, Liberia	11830			
2150-2200	M-F ELWA, Monrovia, Liberia	11830			

2200-2225	Radio Finland, Helsinki	6120 9670			
2200-2225	RAI, Rome, Italy	5990 9710 11800			
2200-2225	Vatican Radio, Vatican City	6015 9615 11830			
2200-2230	ABC, Katherine, Australia	2485			
2200-2230	All India Radio, New Delhi	9550 9910 11620 11715			
2200-2230	BBC, London, England	5975 6005 6175 7325			
		9915 15260			
		9625 11720			
2200-2230	S CBC Northern Quebec Service	15280			
2200-2230	M-A KUSW, Salt Lake City, Utah	15580			
2200-2230	S Radio Norway Int'l, Oslo	9605 9525 11860			
2200-2230	Radio Prague, Czechoslovakia	6055			
2200-2230	Radio Sofia, Bulgaria	9700 11720			
2200-2230	Radio Vilnius, Lithuanian SSR	7165 7400 13645			
2200-2245	Radio Berlin Int'l, E. Germany	5965 9730 11965			
2200-2245	WINB, Red Lion, Pennsylvania	15185			
2200-2245	WYFR, Oakland, California	6085 17845			
2200-2250	Voice of Turkey, Ankara	7135 7160 9445 17760			
2200-2255	RAE, Buenos Aires, Argentina	6060 9690 11710			
2200-2300	(US) Armed Forces Radio and TV	6030 15345 15430			

2200 UTC [5:00 PM EDT/3:00 PM PDT]

2200-2205	M-F ELWA, Monrovia, Liberia	3993 11830			
2200-2210	M-H Port Moresby, Papua New Guinea	3925 4890 5960 5985			
		6020 6040 6080 6140			
		9520			
2200-2210	Radio Damascus, Syria	11765 11900			
2200-2210	Radio Sierra Leone, Freetown	5980			
2200-2215	M-A ABC, Alice Springs, Australia	2310 [ML]			
2200-2215	M-A ABC, Tennant Creek, Australia	2325 [ML]			
2200-2215	BBC, London, England*	5965 7160			
2200-2215	M-F Voice of America, Washington	9640 11740 15120 15160			
		17730			
2200-2225	BRT, Brussels, Belgium	5910			

Mrs. Leslie Edwards of Doylestown, PA, sent these attractive QSLs from Radio Kiev, HCJB, and Radio Tashkent.

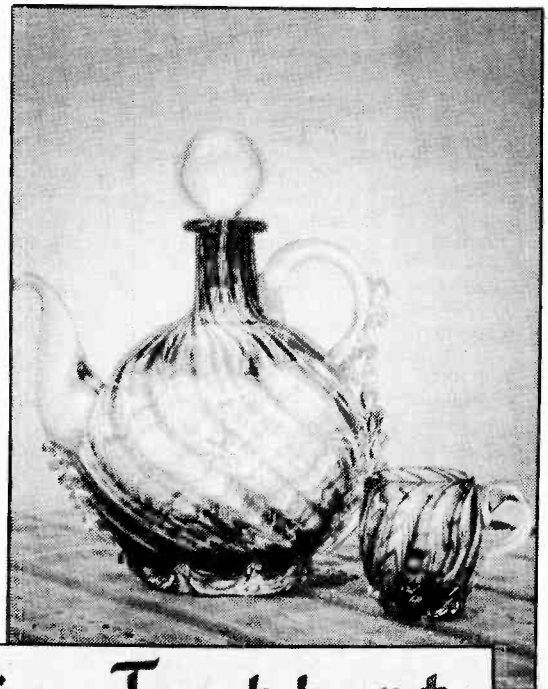

frequency SECTION

2200-2300	BBC, London, England	5975	6005	6180	7325
		9410	9915	12095	15070
		15260			
2200-2300	CBN, St. John's, Newfoundland	6160			
2200-2300	CBU, Vancouver, British Columbia	6160			
2200-2300	CFCF, Montreal, Quebec	6005			
2200-2300	CFCN, Calgary, Alberta	6030			
2200-2300	CHNS, Halifax, Nova Scotia	6130			
2200-2300	CKWX, Vancouver, British Columbia	6080			
2200-2300	CFRB, Toronto, Ontario	6070			
2200-2300	(US) Far East Network, Tokyo	3910			
2200-2300	King of Hope, Southern Lebanon	6280			
2200-2300	KVOH, Rancho Simi, California	17775			
2200-2300	Radio Australia, Melbourne	15160	15240	15320	15395
		17795			
2200-2300	M-F Radio Canada Int'l, Montreal	5960	9755		
2200-2300	Radio Havana Cuba	6165			
2200-2300	Radio Moscow, USSR	7115	7150	7185	7195
		9490	9520	13665	
2200-2300	SBC Radio One, Singapore	5010	5052	11940	
2200-2300	Voice of America, Washington	15120	15185	15290	15305
		15320	17740		
2200-2300	Voice of Free China, Taiwan	7355	9955	11805	15370
2200-2300	WCSN, Boston, Massachusetts	15300			
2200-2300	WHRI, Noblesville, Indiana	9770	17830		
2200-2300	WRNO, New Orleans, Louisiana	13760			
2215-2230	BBC, London, England*	11820	15390		
2215-2230	Radio Yugoslavia, Belgrade	5980	7240	9620	
2230-2300	BBC, London, England	5975	6005	6175	7325
		9410	9915	15070	
2230-2300	A,S CBC Northern Quebec Service	9625	11720		
2230-2300	Radio Beijing, China	3985	6165		
2230-2300	Radio Jamahiriya, Libya	7245	11815		
2230-2300	Radio Mediterran, Malta	6110			
2230-2300	Radio Polonia, Warsaw, Poland	5995	6135	7125	7270
2230-2300	Radio Tirana, Albania	7215	9480		
2230-2300	Swiss Radio Int'l, Berne	6190			
2230-2300	Voice of Vietnam, Hanoi	9840	12020		
2245-2300	All India Radio, New Delhi	6055	7215	9535	9910
		11715	11745		
2245-2300	Radio Ghana, Accra	3366	4915		
2245-2300	Radio New Zealand, Wellington	15150	17705		
2245-2300	WYFR, Oakland, California	6085	17845		
2248-2300	WINB, Red Lion, Pennsylvania	15145			

2300-2330	Radio Canada Int'l, Montreal	9755	11730		
2300-2330	Radio Mediterran, Malta	6110			
2300-2330	Radio Sofia, Bulgaria	6070	9700	11720	
2300-2330	Radio Sweden, Stockholm	9695	11705		
2300-2345	Radio Berlin Int'l, East Germany	9730			
2300-2345	WINB, Red Lion, Pennsylvania	15145			
2300-2350	Radio Pyongyang, North Korea	11735	13650		
2300-0000	All India Radio, New Delhi	6055	7215	9535	9910
		11715	11745		
2300-0000	(US) Armed Forces Radio and TV	6030	15345		
2300-0000	CBC Northern Quebec Service	9625	11720		
2300-0000	CBN, St. John's, Newfoundland	6160			
2300-0000	CBU, Vancouver, British Columbia	6160			
2300-0000	CFCF, Montreal, Quebec	6005			
2300-0000	CFCN, Calgary, Alberta	6030			
2300-0000	CHNS, Halifax, Nova Scotia	6130			
2300-0000	CKWX, Vancouver, British Columbia	6080			
2300-0000	CFRB, Toronto, Ontario	6070			
2300-0000	(US) Far East Network, Tokyo	3910			
2300-0000	M-A KUSW, Salt Lake City, Utah	15580			
2300-0000	KVOH, Rancho Simi, California	17775			
2300-0000	Radio Australia, Melbourne	15160	15240	15320	15395
		17795			
2300-0000	Radio Jamahiriya, Libya	7235			
2300-0000	Radio Japan, Tokyo	7280	11800	15195	15280
		15300			
2300-0000	Radio Moscow, USSR	7115	7150	7185	7310
		9530			
2300-0000	Radio New Zealand, Wellington	15150	17705		
2300-0000	Radio Thailand, Bangkok	9655	11905		
2300-0000	Voice of America, Washington	6045			
2300-0000	WCSN, Boston, Massachusetts	15300			
2300-0000	WHRI, Noblesville, Indiana	9770	11770		
2300-0000	WRNO, New Orleans, Louisiana	13760			
2300-0000	WYFR, Oakland, California	6085			
2315-2330	BBC, London, England*	11820	15390		
2315-0000	BBC, London, England	5975	6005	6175	7325
		9515	9590	9915	11955
		15435			
2320-2325	M-A Radio Prague, Czechoslovakia	6055	9630		
2330-0000	Radio Korea, Seoul	15575			
2330-0000	Radio Tirana, Albania	6200	7065	9762	
2330-0000	Voice of Vietnam, Hanoi	9840	12020		
2335-2345	M-A Voice of Greece, Athens	9395	11645		
2345-0000	BBC, London, England*	3915	6080	7180	9580
2348-0000	WINB, Red Lion, Pennsylvania	15145			

2300 UTC [7:00 PM EDT/4:00 PM PDT]

2300-2315 BBC, London, England 5975 6005 6175 6195

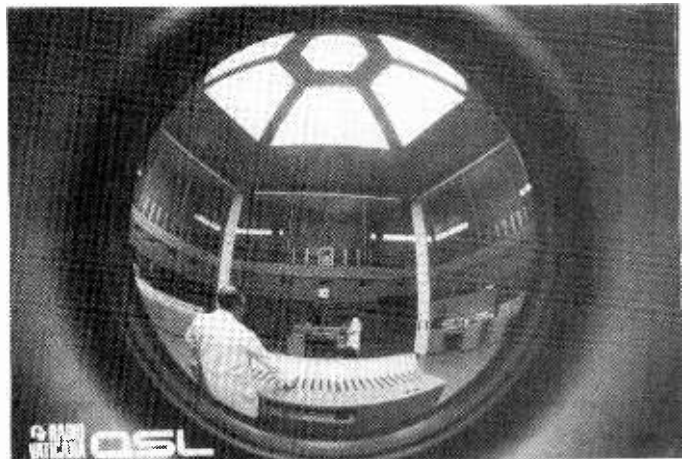
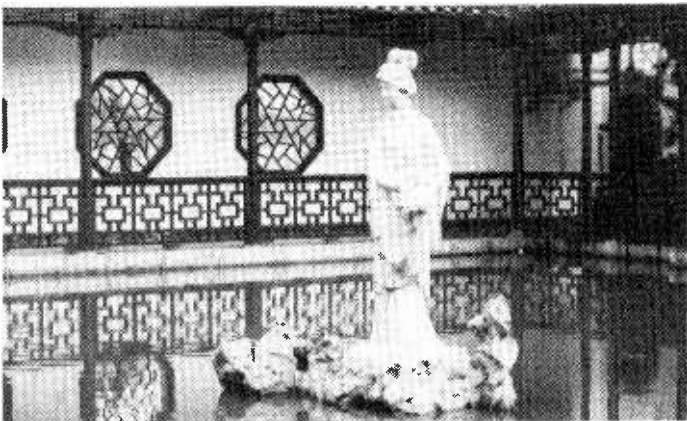

D.M. Choleva of Euclid, OH, sent this QSL of Radio Beijing's "Lady Don't-Worry" and Radio Vatican's unique view on the world. If you have a special card or two you'd like to share, send them to QSL Editor, PO Box 98, Brasstown, NC 28902; we'll copy them and return them ASAP.

Grove Promises You the World ...

... will be at your fingertips when you select one of these remarkable shortwave values!

The Fantastic ICOM

R-71A



This receiver looks as impressive as it sounds, professionally and thoughtfully laid out with easy-to-read panel legends.

Continuous tuning (100 kHz-30 MHz) with signal resolution of 10 Hz eliminates the need for RIT, even on SSB or RTTY.

A 32-channel memory (plus 2 independent VFO's) stores both frequency and mode and may be scanned or searched.

An effective noise blanker has adjustable controls for optimum reduction of a wide variety of impulse noises, from power line hash to the Russian woodpecker.

Order RCV6 ONLY \$829⁰⁰

\$10 UPS; \$20 U.S. Mail P.P.; \$30 Canada Air P.P.

Grundig: A European Tradition

Among luxury class receivers, the name Grundig has been revered for more than forty years.

Turn on the Satellit 650 and be awed by its 30 watts of power as you tune in broadcast stations from all over the world. Or listen to exciting two-way communications with the reliability of an advanced single sideband (SSB) detector which can be used for exalted-carrier (ECSS) broadcast reception as well.

Other features include 60 memory channels; continuous 510-30,000 kHz AM/SSB as well as 87.5-108 FM and 148-420 kHz longwave frequency coverage; LCD frequency and status readout panel; extendable whip antenna and internal ferrite loop antenna; dual 120/240 VAC power supply as well as internal batteries and 12 VDC connection for mobile operation; and much more!

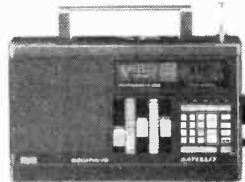

For a smaller portable without sacrificing Grundig quality, try the Satellit 400. Its 6 watts of clean sound make it more powerful than anything in its class, and you still get 513-30,000 kHz AM/SSB as well as 87.5-108 MHz FM and 148-353 kHz longwave frequency coverage.

Measuring only 11.8"W x 7"H x 2 3/4"D and weighing only 4 1/4 lbs., this superb portable features 24 memory channels; 24-hour dual time-zone clock; telescoping whip antenna and built-in ferrite antenna; and dual 120/240 VAC power supply with 12 VDC connection and internal battery operation.

Grundig 650, Order RCV 10

ONLY \$999 plus \$10 UPS

Grundig 400, Order RCV 9

ONLY \$399 plus \$5 UPS

ORDER A GRUNDIG 400
OR 650

and get a free
Passport to World Band

Radio book

\$14.95 value

Kenwood R5000



With the R5000, Kenwood has produced a communications receiver of extraordinary performance.

Built-in modes include AM, FM, USB, LSB, CW, FM, and FSK (RTTY). With continuous frequency coverage from 100 kHz to 30 MHz, the R5000 boasts: 100 memory channels which store frequency, mode and antenna selection (two inputs); keypad frequency entry as well as tuning dial; digital frequency display to 10 hertz accuracy; selectable AGC; variable IF shift and notch filter; squelch control; dual 120/240 VAC power supply; and a host of other sought-after features.

Order RCV-7

ONLY \$809⁹⁵

plus \$10 UPS Shipping; \$5 U.S. Mail P.P.; \$20 Canada Air P.P.

 **Grove Enterprises**

140 Dog Branch Road, Brasstown, N.C. 28902; Phone Toll-Free (MC & Visa only) 1-800-438-8155

(All other calls, 1-704-837-9200)

Your Guide to Shortwave Listening in May

Day to Day Shortwave

How to Use This Section

Day to Day Shortwave is your daily guide to the programs being broadcast on the international bands. Wherever possible, actual advance program details for the listed stations are included. To use this section, simply look up the day on which you are listening, check the time, and decide which program interests you. Then go to the frequency section in order to locate the frequency of the station/program on the dial.

All days are in UTC. Keep in mind that the new UTC day begins at 0000 UTC. Therefore, if you are listening to the shortwave at 7:01 PM [EST] on your local Thursday night, that's equal to 0001 UTC and therefore *Friday* UTC.

We invite broadcast stations to submit advance program details for publication in *Monitoring Times*. Copy deadline is the 10th of the month preceding publication [i.e. details for programs to be broadcast in February must be received at *Monitoring Times* by January 10th. Information can be FAXed via 1-704-837-6416 and must include the following information at the top of the first page: To: Monitoring Times, Brasstown, North Carolina. Phone: 1-704-837-9200.

We also invite readers to submit information about their favorite programs. These must be in UTC day and time and can be sent to: Program Editor, Monitoring Times, 140 Dog Branch Road, Brasstown, North Carolina 28902.

Sunday

0000 BBC: *World News*
0000 Radio Australia: *International Report*
0000 KVOH: *World News*
0009 BBC: *News About Britain*
0015 BBC: *Radio Newsreel*
0030 BBC: *Feature*
0030 KVOH: *Sportscast*
0030 Radio Australia: *Anything Goes*
0053 KVOH: *World News*
0100 BBC: *News Summary* (except 10th)
0100 Radio Australia: *World and Australian News*
0102 BBC: *Play of the Week*
0113 Radio Australia: *Boomerang*
0130 Radio Australia: *At Your Request*
0200 BBC: *World News*
0200 Radio Australia: *International Report*
0209 BBC: *The Sunday Papers*
0215 BBC: *Cannery Row*
0230 BBC: *Album Time*
0230 Radio Netherlands: *World News*
0230 Radio Australia: *Communicator*

0235 Radio Netherlands: *Newsline*
0250 Radio Netherlands: *Over to You!* (Listener letters)
0300 BBC: *World News*
0300 BBC: *World and Australian News*
0309 BBC: *News About Britain*
0313 Radio Australia: *Music of RA*
0315 BBC: *From Our Own Correspondent*
0330 BBC: *Jazz Score*
0400 BBC: *Newsdesk*
0400 Radio Australia: *International Report*
0430 BBC: *The Seven Ages of Man*
0430 Radio Australia: *Arts Roundabout*
0445 BBC: *Reflections* (Religion)
0450 BBC: *Financial Review*
0500 BBC: *World News*
0500 Radio Australia: *World and Australian News*
0509 BBC: *Twenty-Four Hours* (News Summary)
0513 Radio Australia: *Music of RA*
0530 BBC: *Big Bands - The Singers*
0530 Radio Australia: *At Your Request*
0530 Radio Netherlands: *World News*
0535 Radio Netherlands: *Newsline* (See 0235)
0545 BBC: *Letter from America* (Alstaire Cook)
0550 Radio Netherlands: *Over to You!* (See 0250)
0600 BBC: *Newsdesk*
0600 Radio Australia: *International Report*
0630 BBC: *Jazz for the Asking*
0630 Radio Australia: *3R's Plus*
0700 BBC: *World News*
0700 Radio Australia: *World and Australian News*
0709 BBC: *Twenty-Four Hours* (News Summary)
0713 Radio Australia: *You Asked For It*
0730 BBC: *From Our Own Correspondent*
0730 Radio Australia: *Communicator*
0745 BBC: *Book Choice*
0750 BBC: *Waveguide* (SWL tips)
0800 BBC: *World News*
0800 Radio Australia: *International Report*
0809 BBC: *Reflections*
0815 BBC: *The Pleasure's Yours* (Record requests)
0830 Radio Australia: *Sports Results*
0845 Radio Australia: *Music of RA*
0900 BBC: *World News*
0900 Radio Australia: *World and Australian News*
0909 BBC: *The Sunday Papers*
0913 Radio Australia: *Book Readings*
0915 BBC: *Science in Action*
0930 Radio Australia: *Southern Cross Sketches*
1000 BBC: *News Summary*
1002 BBC: *Short Story*
1015 BBC: *Classical Record Review*
1030 BBC: *Religious Service*
1100 BBC: *World News*
1109 BBC: *News About Britain*
1115 BBC: *From Our Own Correspondent*
1130 BBC: *Feature*
1200 BBC: *News Summary*
1202 BBC: *Play of the Week*
1300 BBC: *World News*
1309 BBC: *Twenty-Four Hours* (News summary)
1330 BBC: *Sports Roundup*
1345 BBC: *The Tony Myatt Request Show*
1400 BBC: *News Summary*
1430 BBC: *Jazz Score*
1500 BBC: *Radio Newsreel*
1515 BBC: *Concert Hall*
1600 BBC: *World News*
1609 BBC: *Commentary*
1615 BBC: *Feature*
1645 BBC: *Letter from America* (Alstaire Cook)
1700 BBC: *World News*
1709 BBC: *Reflections* (Religion)
1715 BBC: *Jazz for the Asking*
1745 BBC: *Sports Roundup*
1800 BBC: *Newsdesk*
1800 BBC: *My Word*
1900 BBC: *News Summary*
1902 BBC: *Classical Record Review*
1915 BBC: *Feature*
2000 BBC: *World News*
2000 KVOH: *World News*
2009 BBC: *Twenty-Four Hours* (News summary)
2012 KVOH: *Sportscast*
2030 BBC: *Sunday Half Hour*
2030 KVOH: *Unshackled* (Religious drama)
2100 BBC: *News Summary*
2100 KVOH: *World News*
2102 BBC: *Short Story*
2105 KVOH: *Wonderful Words of Life*
2115 BBC: *The Pleasure's Yours* (Record Requests)
2120 KVOH: *Sportscast*
2130 KVOH: *New Horizons*
2200 BBC: *World News*
2200 KVOH: *World News*
2209 BBC: *Cannery Row*
2220 KVOH: *Sportscast*
2225 BBC: *Book Choice*
2230 BBC: *Financial Review*
2230 KVOH: *Living by Giving*
2240 BBC: *Reflections* (Religion)
2245 BBC: *Sports Roundup*
2245 KVOH: *U.S. Presidential Message*
2300 BBC: *World News*
2300 KVOH: *World News*
2309 BBC: *Commentary*
2315 BBC: *Letter from America* (Alstaire Cook)
2320 KVOH: *Sportscast*

Your Guide to Shortwave Listening in May

2330 BBC: *Six Cities*

Monday

0000 BBC: *World News*
 0000 Radio Australia: *International Report*
 0000 KVOH: *World News*
 0009 BBC: *News about Britain*
 0015 BBC: *Radio Newsreel*
 0020 KVOH: *Sportscast*
 0030 BBC: *Religious Service*
 0030 Radio Australia: *Music of RA*
 0053 KVOH: *World News*
 0100 BBC: *News Summary*
 0100 Radio Australia: *World and Australian News*
 0102 BBC: *Feature*
 0113 Radio Australia: *Window on Australia*
 0130 KVOH: *World News*
 0130 Radio Australia: *This Australia*
 0200 BBC: *World News*
 0200 Radio Australia: *International Report*
 0209 BBC: *Commentary*
 0215 BBC: *Peeble's Choice*
 0230 BBC: *Science in Action*
 0230 Radio Australia: *International Country Music*
 0230 Radio Netherlands: *Happy Station* (Informal music/talk)
 0300 BBC: *World News*
 0300 BBC: *World and Australian News*
 0309 BBC: *News about Britain*
 0313 Radio Australia: *Music of RA*
 0315 BBC: *Good Books*
 0330 BBC: *Anything Goes*
 0330 Radio Australia: *Sports Results*
 0345 Radio Australia: *Music of RA*
 0400 BBC: *Newsdesk*
 0400 Radio Australia: *International Report*
 0425 Radio Australia: *Propagation Report*
 0430 Radio Australia: *Country Australia*
 0445 BBC: *Reflections* (Religion)
 0445 Radio Australia: *Music of RA*
 0450 BBC: *Waveguide* (Listening Tips)
 0500 BBC: *World News*
 0500 Radio Australia: *World and Australian News*
 0509 BBC: *Twenty-Four Hours* (News summary)
 0513 Radio Australia: *Music of RA*
 0530 BBC: *Nature Notebook*
 0530 Radio Australia: *Southern Cross Sketches*
 0530 Radio Netherlands: *Happy Station* (See 0230)
 0545 BBC: *Recording of the Week*
 0600 BBC: *Newsdesk*
 0600 Radio Australia: *International Report*
 0630 BBC: *Six Cities*
 0630 Radio Australia: *Just Out*
 0700 BBC: *World News*
 0700 Radio Australia: *World and Australian News*
 0709 BBC: *Twenty-Four Hours* (News summary)
 0713 Radio Australia: *Window on*

Australia
 0730 BBC: *Feature*
 0730 Radio Australia: *Australian Folk Heritage*
 0800 BBC: *World News*
 0800 Radio Australia: *International Report*
 0809 BBC: *Reflections*
 0815 BBC: *Feature*
 0825 Radio Australia: *Stock Exchange Report*
 0827 Radio Australia: *Propagation Report*
 0830 BBC: *Anything Goes*
 0830 Radio Australia: *Sports Results*
 0845 Radio Australia: *Music of RA*
 0900 BBC: *World News*
 0900 Radio Australia: *World and Australian News*
 0909 BBC: *British Press Review*
 0913 Radio Australia: *Music of RA*
 0915 BBC: *Good Books*
 0930 BBC: *Financial News*
 0930 Radio Australia: *Innovations*
 0945 BBC: *Peeble's Choice*
 1000 BBC: *News Summary*
 1002 BBC: *Feature*
 1030 BBC: *The Vintage Chart Show*
 1100 BBC: *World News*
 1109 BBC: *News About Britain*
 1115 BBC: *Tech Talk*
 1115 BBC: *Health Matters*
 1130 BBC: *Album Time*
 1200 BBC: *Radio Newsreel*
 1215 BBC: *My Word!*
 1245 BBC: *Sports Roundup*
 1300 BBC: *World News*
 1309 BBC: *Twenty-Four Hours* (News summary)
 1330 BBC: *Anything Goes*
 1400 BBC: *News*
 1405 BBC: *Outlook*
 1445 BBC: *Cannery Row*
 1500 BBC: *Radio Newsreel*
 1545 BBC: *Cannery Row*
 1600 BBC: *World News*
 1609 BBC: *Commentary*
 1700 BBC: *World News*
 1709 BBC: *Book Choice*
 1745 BBC: *Sports Roundup*
 1800 BBC: *Newsdesk*
 1830 BBC: *Multitrack 1* (Top 20)
 1900 BBC: *News Summary*
 1902 BBC: *Outlook*
 1932 BBC: *Stock Market Report*
 1945 BBC: *Peeble's Choice*
 2000 BBC: *World News*
 2000 KVOH: *World News*
 2005 KVOH: *Our Daily Bread*
 2009 BBC: *Twenty-Four Hours* (News Summary)
 2020 KVOH: *Business Report*
 2030 BBC: *Sports International*
 2030 KVOH: *World News*
 2035 KVOH: *Business Report*
 2045 KVOH: *Globalcast*
 2100 BBC: *News Summary*
 2100 KVOH: *World News*
 2102 BBC: *Network UK*

2112 KVOH: *Sportscast*
 2115 BBC: *Journey Round My People*
 2120 KVOH: *Joni and Company*
 2130 BBC: *The Vintage Chart Show*
 2130 KVOH: *World News*
 2200 BBC: *World News*
 2200 KVOH: *World News*
 2205 KVOH: *Marilyn Hickey*
 2209 BBC: *The World Today*
 2225 BBC: *Book Choice*
 2225 KV A: *Sportscast*
 2230 BBC: *Financial News*
 2230 KVOH: *World News*
 2235 KVOH: *Today with Derek Prince*
 2240 BBC: *Reflections*
 2245 BBC: *Sports Roundup*
 2300 BBC: *World News*
 2300 KVOH: *World News*
 2309 BBC: *Commentary*
 2310 KVOH: *Sportscast*
 2315 BBC: *Education Today*
 2315 KVOH: *Way of Faith*
 2330 BBC: *Multitrack 1* (Top 20)
 2330 KVOH: *World News*
 2350 KVOH: *Religion Report*

Tuesday

0000 BBC: *World News*
 0000 KVOH: *World News*
 0000 Radio Australia: *International Report*
 0005 KVOH: *Point of View*
 0009 BBC: *News about Britain*
 0015 BBC: *Radio Newsreel*
 0030 Radio Australia: *Music of RA*
 0100 BBC: *News Summary*
 0100 KVOH: *World News*
 0100 Radio Australia: *World and Australian News*
 0102 BBC: *Outlook*
 0105 KVOH: *Our Daily Bread*
 0113 Radio Australia: *Window on Australia*
 0120 KVOH: *Sportscast*
 0130 BBC: *Short Story*
 0130 KVOH: *World News*
 0130 Radio Australia: *3R's Plus*
 0200 BBC: *World News*
 0200 KVOH: *World News*
 0200 Radio Australia: *International Report*
 0205 KVOH: *High Adventure's Hall of Fame*
 0209 BBC: *Commentary*
 0215 BBC: *Network UK*
 0230 BBC: *Sports International*
 0230 Radio Australia: *On Our Selection*
 0230 Radio Netherlands: *World News*
 0235 Radio Netherlands: *Newsline*
 0250 Radio Netherlands: *Research File* (Science)
 0300 BBC: *World News*
 0300 BBC: *World and Australian News*
 0309 BBC: *News about Britain*
 0313 Radio Australia: *Music of RA*
 0315 BBC: *The World Today*
 0330 BBC: *John Peel* (Progressive rock)
 0330 Radio Australia: *Sports Results*

Your Guide to Shortwave Listening in May

- 0345 Radio Australia: *Music of RA*
 0400 BBC: *Newsdesk*
 0400 Radio Australia: *International Report*
 0425 Radio Australia: *Propagation Report*
 0430 Radio Australia: *Business Horizons*
 0445 BBC: *Reflections* (Religion)
 0445 Radio Australia: *Music of RA*
 0450 BBC: *Financial News*
 0500 BBC: *World News*
 0500 Radio Australia: *World and Australian News*
 0509 BBC: *Twenty-Four Hours* (News summary)
 0513 Radio Australia: *Music of RA*
 0530 BBC: *New Ideas* (British products)
 0530 Radio Australia: *On Our Selection*
 0530 Radio Netherlands: *World News*
 0535 Radio Netherlands: *Newsline* (See 0235)
 0545 BBC: *The World Today*
 0550 Radio Netherlands: *Research File* (See 0250)
 0600 BBC: *Newsdesk*
 0600 Radio Australia: *International Report*
 0630 BBC: *Rock Salad*
 0630 Radio Australia: *Music of RA*
 0700 BBC: *World News*
 0700 Radio Australia: *World and Australian News*
 0709 BBC: *Twenty-Four Hours* (News summary)
 0713 Radio Australia: *Window on Australia*
 0730 Radio Australia: *Monitor*
 0745 BBC: *Network UK*
 0800 BBC: *World News*
 0800 Radio Australia: *International Report*
 0809 BBC: *Reflections*
 0815 BBC: *Health Matters*
 0825 Radio Australia: *Stock Exchange Report*
 0827 Radio Australia: *Propagation Report*
 0830 Radio Australia: *Sports Results*
 0845 Radio Australia: *Music of RA*
 0900 BBC: *World News*
 0900 Radio Australia: *World and Australian News*
 0909 BBC: *British Press Review*
 0913 Radio Australia: *Music of RA*
 0915 BBC: *The World Today*
 0930 BBC: *Financial News*
 0930 Radio Australia: *Country Australia*
 0940 BBC: *Sports Roundup*
 0945 Radio Australia: *Music of RA*
 1000 BBC: *News Summary*
 1030 BBC: *Sports International*
 1100 BBC: *World News*
 1109 BBC: *News about Britain*
 1115 BBC: *Waveguide* (Listening tips)
 1125 BBC: *A Letter from Scotland*
 1130 BBC: *Citizens*
 1200 BBC: *Radio Newsreel*
 1215 BBC: *Multi-track 1* (Top 20)
 1245 BBC: *Sports Roundup*
 1300 BBC: *World News*
 1309 BBC: *Twenty-Four Hours* (News summary)
- 1330 BBC: *Network UK*
 1345 BBC: *Recording of the Week*
 1400 BBC: *World News*
 1405 BBC: *Outlook*
 1500 BBC: *Radio Newsreel*
 1515 BBC: *A Jolly Good Show*
 1600 BBC: *World News*
 1609 BBC: *Commentary*
 1615 BBC: *Omnibus*
 1645 BBC: *The World Today*
 1700 BBC: *World News*
 1709 BBC: *A Letter from Scotland*
 1715 BBC: *Citizens*
 1745 BBC: *Sports Roundup*
 1800 BBC: *Newsdesk*
 1830 BBC: *Development '88*
 1900 BBC: *News Summary*
 1902 BBC: *Outlook*
 1939 BBC: *Stock Market Report*
 1945 BBC: *Report on Religion*
 2000 BBC: *World News*
 2000 KVOH: *World News*
 2005 KVOH: *Our Daily Bread*
 2009 BBC: *Twenty-Four Hours* (News summary)
 2020 KVOH: *Business Report*
 2030 BBC: *Meridian*
 2030 KVOH: *World News*
 2035 KVOH: *Business Report*
 2045 KVOH: *Globalcast*
 2100 BBC: *News Summary*
 2100 KVOH: *World News*
 2112 KVOH: *Sportscast*
 2120 KVOH: *Joni and Company*
 2130 KVOH: *World News*
 2200 BBC: *World News*
 2200 KVOH: *World News*
 2205 KVOH: *Marilyn Hickey*
 2209 BBC: *The World Today*
 2225 BBC: *A Letter from Scotland*
 2225 KVOH: *Sportscast*
 2230 BBC: *Financial News*
 2230 KVOH: *World News*
 2235 KVOH: *Today with Derek Prince*
 2240 BBC: *Reflections*
 2245 BBC: *Sports Roundup*
 2300 BBC: *World News*
 2300 KVOH: *World News*
 2309 BBC: *Commentary*
 2310 KVOH: *Sportscast*
 2315 KVOH: *Way of Faith*
 2330 KVOH: *World News*
 2350 KVOH: *Religion Report*
- Wednesday**
- 0000 BBC: *World News*
 0000 KVOH: *World News*
 0000 Radio Australia: *International Report*
 0005 KVOH: *Point of View*
 0009 BBC: *News about Britain*
 0015 BBC: *Radio Newsreel*
 0030 BBC: *Omnibus*
 0030 Radio Australia: *Music of RA*
 0100 BBC: *News Summary*
 0100 KVOH: *World News*
 0100 Radio Australia: *World and Australian News*
- 0102 BBC: *Outlook*
 0105 KVOH: *Our Daily Bread*
 0113 Radio Australia: *Window on Australia*
 0120 KVOH: *Sportscast*
 0130 BBC: *Report on Religion*
 0130 KVOH: *World News*
 0130 Radio Australia: *Bicentennial Feature*
 0145 BBC: *Country Style*
 0200 BBC: *World News*
 0200 KVOH: *World News*
 0200 Radio Australia: *International Report*
 0205 KVOH: *High Adventure's Hall of Fame*
 0209 BBC: *Commentary*
 0230 BBC: *Citizens*
 0230 Radio Australia: *Anything Goes*
 0230 Radio Netherlands: *World News*
 0235 Radio Netherlands: *Newsline*
 0250 Radio Netherlands: *Images* (Arts)
 0300 BBC: *World News*
 0300 BBC: *World and Australian News*
 0309 BBC: *News about Britain*
 0313 Radio Australia: *Music of RA*
 0315 BBC: *The World Today*
 0330 BBC: *Discovery*
 0330 Radio Australia: *Sports Results*
 0345 Radio Australia: *Music of RA*
 0400 BBC: *Newsdesk*
 0400 Radio Australia: *International Report*
 0425 Radio Australia: *Propagation Report*
 0430 Radio Australia: *Smith's Weekly*
 0440 BBC: *Book Choice*
 0445 BBC: *Reflections*
 0445 Radio Australia: *Music of RA*
 0450 BBC: *Financial News*
 0500 BBC: *World News*
 0500 Radio Australia: *World and Australian News*
 0509 BBC: *Twenty-Four Hours* (News summary)
 0513 Radio Australia: *Music of RA*
 0530 BBC: *Report on Religion*
 0530 Radio Australia: *Interaction*
 0530 Radio Netherlands: *World News*
 0535 Radio Netherlands: *Newsline* (See 0235)
 0545 BBC: *The World Today*
 0550 Radio Netherlands: *Images* (See 0250)
 0600 BBC: *Newsdesk*
 0600 Radio Australia: *International Report*
 0630 BBC: *Meridian* (Arts)
 0630 Radio Australia: *International Country Music*
 0700 BBC: *World News*
 0700 Radio Australia: *World and Australian News*
 0709 BBC: *Twenty-Four Hours* (News summary)
 0713 Radio Australia: *Window on Australia*
 0730 BBC: *Development '88*
 0730 Radio Australia: *Bicentennial Feature*
 0800 BBC: *World News*
 0800 Radio Australia: *International Report*
 0809 BBC: *Reflections*

Your Guide to Shortwave Listening in May

- 0815 BBC: *Classical Record Review*
 0825 Radio Australia: *Stock Exchange Report*
 0827 Radio Australia: *Propagation Report*
 0830 Radio Australia: *Sports Results*
 0845 Radio Australia: *Music of RA*
 0900 BBC: *World News*
 0900 Radio Australia: *World and Australian News*
 0909 BBC: *British Press Review*
 0913 Radio Australia: *Music of RA*
 0915 BBC: *The World Today*
 0930 BBC: *Financial News*
 0930 Radio Australia: *Word of Mouth*
 0940 BBC: *Financial News*
 0945 Radio Australia: *Music of RA*
 1000 BBC: *News Summary*
 1002 BBC: *Omnibus*
 1100 BBC: *World News*
 1109 BBC: *News about Britain*
 1125 BBC: *A Letter from Wales*
 1130 BBC: *Meridian (Arts)*
 1200 BBC: *Radio Newsreel*
 1215 BBC: *Time for Verse*
 1225 BBC: *The Farming World*
 1245 BBC: *Sports Roundup*
 1300 BBC: *World News*
 1309 BBC: *Twenty-Four Hours (News summary)*
 1330 BBC: *Development '88*
 1400 BBC: *World News*
 1405 BBC: *Outlook*
 1445 BBC: *Report on Religion*
 1500 BBC: *Radio Newsreel*
 1600 BBC: *World News*
 1609 BBC: *Commentary*
 1615 BBC: *Rock Salad*
 1645 BBC: *The World Today*
 1700 BBC: *World News*
 1709 BBC: *A Letter from Wales*
 1730 BBC: *New Ideas (British products)*
 1740 BBC: *Book Choice*
 1745 BBC: *Sports Roundup*
 1800 BBC: *Newsdesk*
 1830 BBC: *Multitrack 2 (Pop music)*
 1900 BBC: *News Summary*
 1902 BBC: *Outlook*
 1939 BBC: *Stock Market Report*
 1945 BBC: *Good Books*
 2000 BBC: *World News*
 2000 KVOH: *World News*
 2005 KVOH: *Our Daily Bread*
 2009 BBC: *Twenty-Four Hours (News summary)*
 2030 BBC: *Assignment*
 2030 KVOH: *World News*
 2035 KVOH: *Business Report*
 2045 KVOH: *Globalcast*
 2100 BBC: *News Summary*
 2100 KVOH: *World News*
 2102 BBC: *Network UK*
 2112 KVOH: *Sportscast*
 2115 BBC: *Rock Salad*
 2120 KVOH: *Joni and Company*
 2130 KVOH: *World News*
 2145 BBC: *Recording of the Week*
 2200 BBC: *World News*
 2200 KVOH: *World News*
 2205 KVOH: *Marilyn Hickey*
 2209 BBC: *The World Today*
 2225 BBC: *A Letter from Wales*
 2225 KVOH: *Sportscast*
 2230 BBC: *Financial News*
 2230 KVOH: *World News*
 2240 BBC: *Reflections*
 2235 KVOH: *Today with Derek Prince*
 2245 BBC: *Sports Roundup*
 2300 BBC: *World News*
 2300 KVOH: *World News*
 2309 BBC: *Commentary*
 2310 KVOH: *Sportscast*
 2315 KVOH: *Way of Faith*
 2330 BBC: *Multitrack 2 (Pop music)*
 2330 KVOH: *World News*
 2350 KVOH: *Religion Report*
- Thursday**
- 0000 BBC: *World News*
 0000 KVOH: *World News*
 0000 Radio Australia: *International Report*
 0005 KVOH: *Point of View*
 0009 BBC: *News about Britain*
 0015 BBC: *Radio Newsreel*
 0030 Radio Australia: *Music of RA*
 0100 BBC: *News Summary*
 0100 KVOH: *World News*
 0100 Radio Australia: *World and Australian News*
 0102 BBC: *Outlook*
 0105 KVOH: *Our Daily Bread*
 0113 Radio Australia: *Window on Australia*
 0120 KVOH: *Sportscast*
 0130 KVOH: *World News*
 0130 Radio Australia: *Interaction*
 0140 BBC: *Book Choice*
 0145 BBC: *The Story of English*
 0200 BBC: *World News*
 0200 KVOH: *World News*
 0200 Radio Australia: *International Report*
 0209 BBC: *Commentary*
 0215 BBC: *Network UK*
 0230 BBC: *Assignment*
 0230 Radio Australia: *Australian Country Style*
 0230 Radio Netherlands: *World News*
 0235 Radio Netherlands: *Newsline*
 0250 Radio Netherlands: *Portraits of the Past*
 0300 BBC: *News*
 0300 BBC: *World and Australian News*
 0309 BBC: *News about Britain*
 0313 Radio Australia: *Music of RA*
 0315 BBC: *The World Today*
 0330 Radio Australia: *Sports Results*
 0345 Radio Australia: *Music of RA*
 0400 BBC: *Newsdesk*
 0400 Radio Australia: *International Report*
 0425 Radio Australia: *Propagation Report*
 0430 BBC: *Classical Record Review*
 0430 Radio Australia: *Innovations*
 0445 BBC: *Reflections*
 0450 BBC: *Financial News*
 0500 BBC: *World News*
 0500 Radio Australia: *World and Australian News*
 0509 BBC: *Twenty-Four Hours (News Summary)*
 0513 Radio Australia: *Music of RA*
 0530 BBC: *Peeble's Choice*
 0530 Radio Australia: *This Australia*
 0530 Radio Netherlands: *World News*
 0535 Radio Netherlands: *Newsline (Sec 0235)*
 0545 BBC: *The World Today*
 0550 Radio Netherlands: *Portraits of the Past*
 0600 BBC: *Newsdesk*
 0600 Radio Australia: *International Report*
 0630 Radio Australia: *Anything Goes*
 0640 BBC: *Farming World*
 0700 BBC: *World News*
 0700 Radio Australia: *World and Australian News*
 0709 BBC: *Twenty-Four Hours (News summary)*
 0713 Radio Australia: *Window on Australia*
 0730 Radio Australia: *Word of Mouth*
 0745 BBC: *Network UK*
 0745 Radio Australia: *Music of RA*
 0800 BBC: *World News*
 0800 Radio Australia: *International Report*
 0809 BBC: *Reflections*
 0815 BBC: *Country Style*
 0825 Radio Australia: *Stock Exchange Report*
 0827 Radio Australia: *Propagation Report*
 0830 BBC: *John Peel (Progressive rock)*
 0830 Radio Australia: *Sports Results*
 0845 Radio Australia: *Music of RA*
 0900 BBC: *World News*
 0900 Radio Australia: *World and Australian News*
 0909 BBC: *British Press Review*
 0913 Radio Australia: *Music of RA*
 0915 BBC: *The World Today*
 0930 BBC: *Financial News*
 0930 Radio Australia: *Matters of Faith*
 0940 BBC: *Sports Roundup*
 0945 Radio Australia: *Music of RA*
 1000 BBC: *News Summary*
 1002 BBC: *Assignment*
 1100 BBC: *World News*
 1109 BBC: *News about Britain*
 1115 BBC: *New Ideas (British products)*
 1125 BBC: *Letter from England*
 1130 BBC: *Citizens*
 1200 BBC: *Radio Newsreel*
 1215 BBC: *Multitrack 2 (Pop music)*
 1245 BBC: *Sports Roundup*
 1300 BBC: *World News*
 1309 BBC: *Twenty-Four Hours (News summary)*
 1330 BBC: *Network UK*
 1345 BBC: *Stuart Colman's Record Hop*
 1400 BBC: *World News*
 1405 BBC: *Outlook*
 1445 BBC: *Write On... (Mailbag)*
 1500 BBC: *Radio Newsreel*
 1515 BBC: *The Pleasure's Yours*
 1600 BBC: *World News*

Your Guide to Shortwave Listening in May

- 1609 BBC: *Commentary*
 1615 BBC: *Assignment*
 1645 BBC: *The World Today*
 1700 BBC: *World News*
 1709 BBC: *Letter from England*
 1715 BBC: *Citizens*
 1745 BBC: *Sports Roundup*
 1800 BBC: *Newsdesk*
 1830 BBC: *Discovery*
 1900 BBC: *News Summary*
 1902 BBC: *Outlook*
 1939 BBC: *Financial Report*
 2000 BBC: *World News*
 2000 KVOH: *World News*
 2005 KVOH: *Our Daily Bread*
 2009 BBC: *Twenty-Four Hours* (News summary)
 2020 KVOH: *Business Report*
 2030 BBC: *Meridian* (Arts)
 2030 KVOH: *World News*
 2035 KVOH: *Business Report*
 2045 KVOH: *Globalcast*
 2100 BBC: *News Summary*
 2100 KVOH: *World News*
 2112 KVOH: *Sportscast*
 2115 BBC: *A Jolly Good Show*
 2120 KVOH: *Joni and Company*
 2130 KVOH: *World News*
 2200 BBC: *World News*
 2200 KVOH: *World News*
 2205 KVOH: *Marilyn Hickey*
 2209 BBC: *The World Today*
 2225 BBC: *A Letter from England*
 2225 KVOH: *Sportscast*
 2230 BBC: *Financial News*
 2230 KVOH: *World News*
 2235 KVOH: *Today with Derek Prince*
 2240 BBC: *Reflections*
 2245 BBC: *Sports Roundup*
 2300 BBC: *World News*
 2300 KVOH: *World News*
 2309 BBC: *Commentary*
 2310 KVOH: *Sportscast*
 2315 BBC: *Seven Seas*
 2315 KVOH: *Way of Faith*
 2330 BBC: *A time for Verse*
 2330 KVOH: *World News*
 2340 BBC: *The Farming World*
 2350 KVOH: *Religion Report*
- Friday**
- 0000 BBC: *World News*
 0000 KVOH: *World News*
 0000 Radio Australia: *International Report*
 0005 KVOH: *Point of View*
 0009 BBC: *News about Britain*
 0015 BBC: *Radio Newsreel*
 0030 BBC: *Music Now*
 0030 Radio Australia: *Music of RA*
 0100 BBC: *News Summary*
 0100 KVOH: *World News*
 0100 Radio Australia: *World and Australian News*
 0102 BBC: *Outlook*
 0105 KVOH: *Our Daily Bread*
 0113 Radio Australia: *Window on*
- Australia*
 0120 KVOH: *Sportscast*
 0130 BBC: *Stuart Colman's Record Hop*
 0130 KVOH: *World News*
 0130 Radio Australia: *Monitor*
 0145 BBC: *Talking From...*
 0200 BBC: *World News*
 0200 KVOH: *World News*
 0200 Radio Australia: *International Report*
 0205 KVOH: *High Adventure's Hall of Fame*
 0209 BBC: *BBC: Commentary*
 0215 BBC: *Health Matters*
 0230 BBC: *Citizens*
 0230 Radio Australia: *Australia Makes Music*
 0230 Radio Netherlands: *World News*
 0235 Radio Netherlands: *Newsline*
 0250 Radio Netherlands: *Media Network*
 0300 BBC: *World News*
 0300 BBC: *World and Australian News*
 0309 BBC: *News about Britain*
 0313 Radio Australia: *Music of RA*
 0315 BBC: *The World Today*
 0330 BBC: *The Vintage Chart Show*
 0330 Radio Australia: *Sports Results*
 0345 Radio Australia: *Music of RA*
 0400 BBC: *Newsdesk*
 0400 Radio Australia: *International Report*
 0425 Radio Australia: *Propagation Report*
 0430 BBC: *Country Style*
 0430 Radio Australia: *Matters of Faith*
 0445 BBC: *Reflections* (Religion)
 0445 Radio Australia: *Music of RA*
 0450 BBC: *Financial News*
 0500 BBC: *World News*
 0500 Radio Australia: *World and Australian News*
 0509 BBC: *Twenty-Four Hours* (News summary)
 0513 Radio Australia: *Music of RA*
 0530 Radio Australia: *Bicentennial Feature*
 0530 Radio Netherlands: *World News*
 0535 Radio Netherlands: *Newsline* (See 0235)
 0545 BBC: *The World Today*
 0550 Radio Netherlands: *Media Network* See 0250
 0600 BBC: *Newsdesk*
 0600 Radio Australia: *International Report*
 0630 BBC: *Meridian* (Arts)
 0630 Radio Australia: *Australian Country Style*
 0700 BBC: *World News*
 0700 Radio Australia: *World and Australian News*
 0709 BBC: *Twenty-Four Hours* (News summary)
 0713 Radio Australia: *Window on Australia*
 0730 BBC: *Write On...* (Mailbag)
 0730 Radio Australia: *Arts Roundabout*
 0745 BBC: *Seven Seas*
 0800 BBC: *World News*
 0800 Radio Australia: *International Report*
 0809 BBC: *Reflections*
 0825 Radio Australia: *Stock Exchange*
- Report*
 0827 Radio Australia: *Propagation Report*
 0830 BBC: *Music Now*
 0830 Radio Australia: *Sports Results*
 0845 Radio Australia: *Music of RA*
 0900 BBC: *World News*
 0900 Radio Australia: *World and Australian News*
 0909 BBC: *British Press Review*
 0913 Radio Australia: *Music of RA*
 0915 BBC: *The World Today*
 0930 BBC: *Financial News*
 0930 Radio Australia: *Smith's Weekly*
 0935 BBC: *Sports Roundup*
 0945 Radio Australia: *Music of RA*
 1000 BBC: *News Summary*
 1015 BBC: *Seven Seas*
 1030 BBC: *Jazz for the Asking*
 1100 BBC: *World News*
 1109 BBC: *News about Britain*
 1115 BBC: *Talking From...*
 1130 BBC: *Meridian* (Arts)
 1200 BBC: *Radio Newsreel*
 1215 BBC: *Business Matters*
 1245 BBC: *Sports Roundup*
 1300 BBC: *World News*
 1309 BBC: *Twenty-Four Hours*
 1330 BBC: *John Peel*
 1400 BBC: *News*
 1405 BBC: *Outlook*
 1445 BBC: *Nature Notebook*
 1500 BBC: *Radio Newsreel*
 1600 BBC: *World News*
 1609 BBC: *Commentary*
 1615 BBC: *Science in Action*
 1645 BBC: *The World Today*
 1700 BBC: *World News*
 1709 BBC: *Letter from Northern Ireland*
 1715 BBC: *Music Now*
 1745 BBC: *Sports Roundup*
 1800 BBC: *Newsdesk*
 1830 BBC: *Multitrack 3* (Pop music)
 1900 BBC: *News Summary*
 1902 BBC: *Outlook*
 1939 BBC: *Stock Market Report*
 1945 BBC: *Personal View*
 2000 BBC: *World News*
 2000 KVOH: *World News*
 2005 KVOH: *Our Daily Bread*
 2009 BBC: *Twenty-Four Hours* (News summary)
 2020 KVOH: *Business Report*
 2030 BBC: *Science in Action*
 2030 KVOH: *World News*
 2035 KVOH: *Business Report*
 2045 KVOH: *Globalcast*
 2100 BBC: *News Summary*
 2100 KVOH: *World News*
 2102 BBC: *Network UK*
 2112 KVOH: *Sportscast*
 2115 BBC: *Business Matters*
 2120 KVOH: *Joni and Company*
 2130 KVOH: *World News*
 2200 BBC: *World News*
 2200 KVOH: *World News*
 2205 KVOH: *Marilyn Hickey*
 2209 BBC: *The World Today*

Your Guide to Shortwave Listening in May

2225 BBC: *A Letter from Northern Ireland*
 2225 KVOH: *Sportscast*
 2230 BBC: *Financial News*
 2230 KVOH: *World News*
 2235 KVOH: *Today with Derek Prince*
 2240 BBC: *Reflections* (Religion)
 2245 BBC: *Sports Roundup*
 2300 BBC: *World News*
 2300 KVOH: *World News*
 2309 BBC: *Commentary*
 2310 KVOH: *Sportscast*
 2315 BBC: *From the Weeklies*
 2315 KVOH: *Way of Faith*
 2330 BBC: *Multitrack 3* (Pop music)
 2330 KVOH: *World News*
 2350 KVOH: *Religion Report*

Saturday

0000 BBC: *World News*
 0000 KVOH: *World News*
 0000 Radio Australia: *International Report*
 0005 KVOH: *Point of View*
 0009 BBC: *News about Britain*
 0015 BBC: *Radio Newsreel*
 0030 BBC: *Personal View*
 0030 Radio Australia: *Just Out*
 0045 BBC: *Recording of the Week*
 0100 BBC: *News Summary*
 0100 KVOH: *World News*
 0100 Radio Australia: *World and Australian News*
 0102 BBC: *Outlook*
 0105 KVOH: *Our Daily Bread*
 0113 Radio Australia: *Book Readings*
 0120 KVOH: *Sportscast*
 0130 KVOH: *World News*
 0130 Radio Australia: *Australian Country Style*
 0145 BBC: *Nature Notebook*
 0200 BBC: *World News*
 0200 KVOH: *World News*
 0200 Radio Australia: *International Report*
 0205 KVOH: *High Adventure's Hall of Fame*
 0209 BBC: *Commentary*
 0215 BBC: *Network UK*
 0230 BBC: *People and Politics*
 0230 Radio Australia: *Bicentennial Feature*
 0230 Radio Netherlands: *World News*
 0235 Radio Netherlands: *Newsline*
 0250 Radio Netherlands: *Rembrandt Express* (Magazine show)
 0300 BBC: *World News*
 0300 BBC: *World and Australian News*
 0309 BBC: *News about Britain*
 0313 Radio Australia: *You Asked For It*
 0315 BBC: *The World Today*
 0330 BBC: *Business Matters*
 0330 Radio Australia: *Music of RA*
 0400 BBC: *Newsdesk*
 0400 Radio Australia: *International Report*
 0425 Radio Australia: *Propagation Report*
 0430 Radio Australia: *Monitor*
 0445 BBC: *Reflections*
 0450 BBC: *Financial News*
 0500 BBC: *World News*
 0500 Radio Australia: *World and Australian*

News
 0509 BBC: *Twenty-Four Hours* (News summary)
 0513 Radio Australia: *Music of RA*
 0530 BBC: *Personal View*
 0530 Radio Australia: *Australian Folk Heritage*
 0530 Radio Netherlands: *World News*
 0535 Radio Netherlands: *Newsline* (See 0235)
 0545 BBC: *The World Today*
 0550 Radio Netherlands: *Rembrandt Express* (See 0250)
 0600 BBC: *Newsdesk*
 0600 Radio Australia: *International Report*
 0630 BBC: *Meridian* (Arts)
 0630 Radio Australia: *Australia Makes Music*
 0700 BBC: *World News*
 0700 Radio Australia: *World and Australian News*
 0709 BBC: *Twenty-Four Hours* (News summary)
 0713 Radio Australia: *Country Australia*
 0730 BBC: *From the Weeklies*
 0730 Radio Australia: *Business Horizons*
 0745 BBC: *Network UK*
 0745 Radio Australia: *Music of RA*
 0800 BBC: *World News*
 0800 Radio Australia: *International Report*
 0809 BBC: *Reflections*
 0815 BBC: *A Jolly Good Show*
 0827 Radio Australia: *Propagation Report*
 0830 Radio Australia: *Sports Results*
 0845 Radio Australia: *Music of RA*
 0900 BBC: *World News*
 0900 Radio Australia: *World and Australian News*
 0909 BBC: *British Press Review*
 0913 Radio Australia: *Boomerang*
 0915 BBC: *The World Today*
 0930 BBC: *Financial News*
 0930 Radio Australia: *Bicentennial Feature*
 0940 BBC: *Sports Roundup*
 0945 BBC: *Personal View*
 1000 BBC: *News Summary*
 1015 BBC: *Letter from America* (Alstaire Cook)
 1030 BBC: *People and Politics*
 1100 BBC: *World News*
 1109 BBC: *News about Britain*
 1115 BBC: *Chain Reaction*
 1130 BBC: *Meridian* (Arts)
 1200 BBC: *Radio Newsreel*
 1215 BBC: *Multitrack 3* (Pop music)
 1245 BBC: *Sports Roundup*
 1300 BBC: *World News*
 1309 BBC: *Twenty-Four Hours* (News summary)
 1330 BBC: *Network UK*
 1345 BBC: *Good Books*
 1400 BBC: *News Summary*
 1402 BBC: *Album Time*
 1430 BBC: *Sportsworld*
 1500 BBC: *Radio Newsreel*
 1515 BBC: *Sportsworld*
 1600 BBC: *World News*
 1609 BBC: *Commentary*

1615 BBC: *Sportsworld*
 1700 BBC: *News Summary*
 1702 BBC: *Sportsworld*
 1745 BBC: *Sports Roundup*
 1800 BBC: *Newsdesk*
 1900 BBC: *News Summary*
 2000 BBC: *World News*
 2000 KVOH: *U.S. Presidential Message*
 2009 BBC: *Twenty-Four Hours* (News Summary)
 2015 KVOH: *Teen Scene*
 2030 BBC: *Meridian* (Arts)
 2030 KVOH: *Children's Bible Hour*
 2100 BBC: *World News*
 2100 KVOH: *World News*
 2130 BBC: *People and Politics*
 2130 KVOH: *Sportscast*
 2140 KVOH: *New Horizons*
 2200 BBC: *World News*
 2200 KVOH: *World News*
 2209 BBC: *From Our Own Correspondent*
 2215 KVOH: *U.S. Presidential Message*
 2225 BBC: *Book Choice*
 2230 BBC: *New Ideas* (New British Products)
 2232 KVOH: *Sportscast*
 2240 BBC: *Reflections*
 2245 BBC: *Sports Roundup*
 2300 BBC: *World News*
 2300 KVOH: *The Pat Boone Show*
 2309 BBC: *Commentary*
 2315 BBC: *Nature Notebook*
 2330 BBC: *Anything Goes*

FREE ONE YEAR SUBSCRIPTION!

introduce monitoring to your community!

Get a one year subscription (or extension) to *MT* by talking to your book and electronic stores, PX, etc.

Tell them about the fun of monitoring and how *MT* helps the listener. Ask them to get in touch with *MT* to receive 5 free samples.

If the dealer decides to sell *MT* in their store (minimum of 10 per month for 1 year) you get a 1 year subscription for each new dealer!

Be sure to have the store give us your name and address when they write.

MONITORING TIMES
 P.O. Box 98
 Brasstown, NC 28902
 704-8237-9200

Questions sent to MT are answered in this column as space permits. If you prefer an answer by return mail, you must include a self-addressed, stamped envelope.

Q. *What precautions should be taken during a lightning storm to prevent damage to radio equipment? (Bradford Smith, Carpinteria, CA)*

A. Disconnect the antenna cable from your receiver(s); one old-time trick is to put the connector end of the cable in an ordinary drinking glass to insulate it from surrounding metal cabinets and wiring. Unplug the radio(s) from the AC line to eliminate transient voltages from coming in that way as well as reducing the return path to ground from an overhead strike to the antenna.

It is always a good idea to mount the antenna a few feet below the top of a well-grounded metal mast or tower which can act as a lightning rod and take a direct hit.

Broadcast stations will often coil their coax about a dozen turns before running it into the building from the antenna; this acts as an RF (radio frequency) choke to the lightning, reducing inrush current on the line.

An additional precaution is to run the coax through six to ten feet of well-grounded metal pipe where it comes into the building; this trick also opposes the inrush of lightning on the line.

Of course we can't always be there when the storm comes. It is a good idea to keep equipment disconnected when not in use during storm season as well as to install lightning arrestors on antenna and rotor cables and power lines for those unexpected storms.

While no lightning arrestor can protect your equipment from a direct hit, the more precautions you take, the more likely your equipment may survive the storm season.

Q. *What frequencies are used by PTL in Charlotte, North Carolina? (Brian DeSpain, Springfield, MD)*

A. The PTL Television Network at Heritage, USA, is licensed (KB50324) as a trunked system on 816.3875, 817.3875, 818.3875, 819.3875, and 820.3875 MHz. They also have a microwave link on 7050 MHz.

Q. *How can I use an 8 ohm speaker with my HQ140XA (6 ohms) and my SX-28A (500/5000 ohms)? How old is the SX28A? (Paul Williams, Shaw AFB, SC)*

A. 6 ohms is so close to 8 ohms your radio won't know the difference. Hop down to Radio Shack and get the 273-1380 audio output transformer for the high impedance application. It will work fine stepping down the 500 ohm output to the 8 ohm speaker.

The Hallicrafters SX28A was introduced in 1944 for \$223.

Q. *My old receiver has an "antenna trimmer"; what is that for? (Brendan Mahony, Astoria, NY)*

A. This variable capacitor in series with the antenna input to your receiver attempts to resonate or match your antenna to your receiver's input impedance. Think of it as a "peaking" control and adjust it for the strongest signal.

Q. *Is there any truth to the rumor that the Realistic PRO-2004 scanner will not pick up signals in the 480-512 MHz range even though it is displayed? I had two of these receivers, neither of which heard anything there, but competitive scanners did. (Jeff Pearl, Brooklyn, NY)*

A. A call to Radio Shack's product manager for the PRO-2004 revealed that your problem has not been reported previously, and Grove Enterprises has never had such a complaint. It is quite possible that the PRO-2004s were operating properly, not responding to images or intermod which were affecting your other scanners.

You are in a very dense metropolitan area; radio signals of paralyzing strength can cause many scanners to hear signals on multiple frequencies where they are not actually transmitting. In those regions, overload interference is common on all scanners except those with up-conversion such as the PRO-2004.

Q. *A scanner ad referred to "ACSB mode"; what is this and how widely is it used? (Brian Jones, San Antonio, TX)*

A. Amplitude Compandered Sideband is an emerging technology on the VHF public service bands. It is upper sideband with a 3.5 kHz reference tone inserted for accurate "locking in" on the signal by the receiver for natural sounding voice.

Its use is still relatively minor, confined primarily to a few pilot areas around the country. No scanner is capable of ACSB reception, although tunable VHF receivers with single sideband capability (ICOM R7000, Yaesu FRG9600) are.

Q. *How can I improve indoor reception on my scanner? (Edward Warren, Lackawanna, NY)*

A. There are several possibilities. Move the scanner near an outside wall or window and adjust the whip length for best reception (18" for high band and UHF, fully extended for low band).

Use a full length indoor replacement antenna made for that purpose like the Grove Hidden Antenna; be sure to specify the proper connector for your scanner. Some rooftop antennas may be small enough to place inside the room. Use only enough coaxial cable to reach the radio, although a few extra feet won't add any noticeable loss.

You might even add a preamplifier if signals are still weak, but if they are quite strong without it, a preamplifier can cause more problems than it will solve (intermod, increased image interference, desensitization of the scanner).

Q. *How can I improve AM broadcast reception on my Sony ICF2010? It is swamped by local signals. (J. M. Sheehy, Oshkosh, WI)*

A. Most low and medium priced radios have adequate sensitivity, but inadequate selectivity and dynamic range. You need to restrict the frequencies coming into the receiver with a tunable preselector like the Grove TUN-3 MiniTuner.

CONVENTION CALENDAR

Date	Location	Club/Contact Person
May 1	Upper Darby PA	Delaware Cty ARC/Mary Ann Tatum 10 Greentree Ln, Malvern, PA 19355
May 1	Suffolk Cty NY	Suffolk Cty Radio Clb/David Potter W2GZD 51 Bayport Ave., Bayport NY 11705
May 6-8	Fresno, CA	Fresno ARC/Glen Caine, N6HEW 5957 E. Pontiac Way, Fresno, CA 93727
May 7	Cedarburg WI	Ozaukee Radio Club/James Douglas KA9DDN 101 E. Clay St., Saukville WI 53080
May 7	Owego, NY	Southern Tier ARC/Bill Thompson W2MTA RD1 Rock Rd, Newark Valley, NY 13811
May 8	Bluefield WV	East River ARC/Jim Perdue KC8NG Rt 5, Box 457, Bluefield, WV 24701
May 8	Medina, OH	Medina M2M Group/Clarence Miller WA8JLA 620 Oak St., Medina, OH 44256
May 13-15	Tulsa, OK	Broken Arrow & Tulsa ARC/Ron Gamel N5WX 8217 E. 38th St., Tulsa, OK 74145
May 14-15	Birmingham AL	AL State Conv./Mildred Cullen AA4XF 2331 Ivy Lane, Birmingham, AL 35226
May 15	Kankakee, IL	Kankakee Area Rad. Soc/Frank Dal Canton RR 1 Box 361, Chebanse, IL 60922
May 15	Athens, OH	Athens County ARS/J.A. Haas KA8ZYN 24 Woodward Av. Athens, OH 45701
May 15	Knoxville IL	Knox County ARC/Keith Watson WB9KHL 119 S. Cherry St, #3, Galesburg, IL 61401
May 15	Wrightstown PA	Warminster ARC/Chris Dahl, N13J 3417 Stafford Pl, Holland, PA 18966
May 15	Tamaqua, PA	Tamaqua Trans. Soc/Alien Breiner, K3NYX 212 Race St., Tamaqua, PA 18252
May 15	Old Westbury NY	LI Mobile ARC/Henry Wener, WB2ALW 535 Sherrad St., East Hills, NY 11577
May 15	Evansville IN	Tri State ARS/George Utley N9FMO 6017 Oakhill Rd, Evansville, IN 47711
May 20-22	S. Sioux City, NE	Midwest Division/ RW Pitner W0FZO 2931 Pierce St., Sioux City, IA 51104
May 20-22	Rochester, NY	Atlantic, NY State/Harold Smith K2HC 153 Mason Ave, Rochester, NY 14626
May 21	Godfrey, IL	Lewis & Clark RC/Harold Elmore KC9GL 5203 Dixon Dr, Godfrey, IL 62035
May 21-22	Yakima, WA	W7AQ-Yakima ARC/Dick Umberger N7HHU 1511-B Tieton Dr, Yakima, WA 98902
May 21-22	Baton Rouge, LA	Baton Rouge ARC/Chris Springer W5ISS 9490 Airtline Hwy, Baton Rouge, LA 70815
May 22	Wabash, IN	Wabash Co ARC/Don Spangler W9HNO 235 Southwood Dr, Wabash, IN 46992
May 22	Randolph, OH	Portage ARC/Joanne Solak KJ30 9971 Diagonal Rd, Mantua, OH 44255
May 22	Roanoke, VA	Roanoke Valley ARC/Ron Bratton KA4YUY 205 Wentworth Ave NE, Roanoke, VA 24012
May 27	Skaneateles, NY	Sk ARC & Sk Lions Club/Jerome Keating 7 Fennell St, Skaneateles, NY 13152
June 3-4	St Paul, MN	North Area RA/Steve Glatzel K0FHC 7400 Noble Ave, Brooklyn Park, MN 55443
June 3-5	DFW Metroplex, TX	West Gulf Div/John Fleet WA5OHG Box 25028, Dallas, TX 75225
June 4	Coeur d'Alene, ID	Kootenai ARS/Walter Hogeweide K7ETJ N.11655 Sundler La, Rathdrum, ID 83858
June 4	Columbia, MO	Ctrl MO RA/Dewey Bennett N0HKN PO Box 13 Mid Sta, Columbia, MO 65203
June 5	Princeton, IL	Starved Rock ARC/Ken Stasiak WB9ZFO Box 134, Lostant, IL 61334
June 5	Manassas, VA	Old Va Hams ARC/Art Whittum W1CRO 12212 Woodlark Court, Manassas, VA 22111
June 5	Pittsburgh, PA	Breeze Shooters/William Kristoff Jr N3BPB 205 Twin Oak Dr, Wexford, PA 15090
June 5	Salina, KS	Ctrl KS ARC/Jim McKim W0CY 1404 S. 10th, Salina, KS 67401

THE ANT FARM High Quality Antennas

G5RV

Choice of experts world wide.
Receive MW to 30 MHz.
Transmit 1.8 to 30 MHz.
Gain on frequencies above 6 MHz.
Erect horizontal or as an Inverted V.
102 feet long, center fed, coax feedline
\$49.95; Shipping free in 48 states

Sky Raider

A compact antenna for small yards
with amazing performance!
Receive MW to 30 MHz.
Transmit 3.5 to 30 MHz.
Gain above 10 MHz.
Erect horizontal or as a sloper.
51 feet long, end fed, Coax feed.
\$39.95; Shipping free in 48 states

All antennas are complete ready to erect
no measuring, cutting, soldering required.
Stainless steel hardware, high quality copper wire.

RD 1 BOX 181A KUNKLETOWN, PA. 18058

Date	Location	Club/Contact Person
June 5	Chelsea, MI	Chelsea Comm Club/Robert Schantz K8JVK 416 Wilkinson St, Chelsea, MI 4818
June 5	Newington, CT	New'ton ARL/Joel Kleinman N1BKE 225 Main St, Newington, CT 06111
June 5	Muncie, IN	Muncie Area ARC/Robert Casada KC9QY 2608 Sycamore, Muncie, IN 47302
Jun 10-11	Albany, GA	Albany ARC/John Crosby K4XA PO Box 1205, Albany, GA 31702
June 11	Midland, MI	Ctrl MI ARA/David Burdeaux WD8DII 409 Heathermoor, Midland, MI 48640
June 11	Winston-Salem, NC	Forsyth ARC/Bob Gates KJ4IC Box 60, Cedar Grove Pk, Kernersville, NC 27284
June 12	Queens, NY	Hall of Sci ARC/Stephen Greenbaum WB2KDG 85-10 34th Ave, Jackson Hgts, NY, NY 11372 144.300 simplex; 223.600 rpt; 445.225 rpt
June 12	S Dartmouth, MA	SE ARA/Pete Kodis N1EXA PO Box 9187, N Dartmouth, MA 02747
June 12	Willow Spgs, IL	Six Meter Club/James Novak WA9FIH 2337 S. 6th Ave, N. Riversdale, IL 60546
June 12	South Bend, IN	Michlana ARC/Fred Boehlein KE9FE 733 E. 4th St., Mishiwaka, IN 46544
June 18	Cortland, NY	Skyline ARC/Curt Smith WA2TOL 3673 S. Pendleton St, Cortland, NY 13045

MONITORING TIMES IS HAPPY TO RUN ANNOUNCEMENTS OF RADIO EVENTS OPEN TO OUR READERS. Send your announcement at least 60 days before the event to: Monitoring Times Convention Calendar, P.O. Box 98, Brasstown, NC 28902.

The Sony ICF-SW1 Micro-Portable

Ever since former Sony Chairman Akio Morita came up with the clever idea of Walkman audio products, Sony's engineers have been guided by the late Duchess of Windsor's pre-Buchenwald allegatum that one can never be too thin.

With the Walkman concept, radio listening has made the full evolution. What was once a collective experience around the family console is now an utterly solitary pursuit. This fits perfectly with the tenor of the times, when so much as sharing the same grind of coffee with one's mate is considered outre. In any case, Walkman's success is now the stuff of legend.

With world band radio -- which has always tended to be a highly personal activity -- the Walkman concept is especially appropriate. But the complexity and special demands of world band have made this troublesome -- until now.

Traveling Featherweight

The new Sony ICF-SW1, although not labeled a "Walkman" as such, is the height and width of an ordinary cassette tape and only slightly deeper. It's featherweight, too, weighing in at a mere 7-1/2 ounces, or 215 grams, including batteries. That's a tad more than some Walkmans, but that's because the SW1 -- unlike true Walkmans -- includes a built-in speaker.

Many Advanced Features

But that's just the beginning. While there are already a number of micro-size world band portables on the market only the SW-1 utilizes up-to-date technology. Its tuning is fully synthesized and it has many of the features you'd expect to find on much larger advanced-technology models: an LCD with digital frequency readout and a 24-hour UTC clock, keypad tuning, ten programmable-channel memories, single-speed up/down slew tuning, scanner functions, a 65-minute "sleep" function, an alarm timer to switch the set on automatically, and a useful night light for the LCD.

Too, as befits an associate of the distinguished family of Walkmans, it comes equipped with FM stereo, as well. The SW1 also tunes the longwave band -- used abroad for broadcasting -- as well as the mediumwave AM band and the entire world band range through 30 MHz (26.1 MHz in the version sold in Central Europe).

For the most part, pushbuttons are used to control the set, and some of these -- notably those on the numeric keypad -- have nice positive-action "feel," as well. There's an elevation foot, too, to allow the radio to be angled up slightly for handier operation and better sound dispersal. And for traveling, there's a power safety switch to keep the set from turning on accidentally in luggage. That switch is also useful to prevent the alarm timer from turning the radio on accidentally because you've inadvertently touched the "standby" button.

Unsurpassed Performance in its Class

The SW1's performance is superior to that of any other micro-portable. Its sensitivity, selectivity and freedom from overloading and other troubles are well above the norm for portables, regardless of size. This means not only that you have a good chance of hearing what's available, but also that you can hear stations relatively free from the howls and whooshes found with lesser models.

Packfull of Accessories-- Including the Pack

By itself, all this is no mean accomplishment. But Sony went one step further: they equipped the SW1 with an array of useful outboard accessories as standard equipment. Included are an active antenna, a remarkable 100-240V ac power supply with a worldwide adaptor plug, and a set of so-called "twin turbo" stereo earpieces. There's even a hardside carrying case, complete with strap, should you wish to cart the whole kit and kaboodle with you on a trip.

What you get, then, is not just a radio, but a complete portable receiving system. Add to this the latest *Passport to World Band Radio* -- just about the only thing this set doesn't have -- and you're ready to tackle the world.

Active Antenna Boosts Sensitivity

The SW1's active antenna amplifies distant signals and thus makes the set more sensitive. And because it can be mounted up to 12 feet, or 3.6 meters, away, it can be placed near the outdoors, where the signals are.

Indeed, with its suction cup -- which grips best if moistened with saliva -- the antenna can be secured onto a handy windowpane. Placing the element module back into your suitcase is

a snap -- the connecting wire simply reels back, like a tape measure, into the module. And the 46-inch, or 117 cm, antenna element itself collapses to 7 inches, or 17.6 cm.

The SW1's active antenna, which weighs a skotch more than the radio, consists of a tiny control module that snaps onto the side of the set, plus a larger remote antenna element that contains the four "AA" batteries needed to power the antenna's amplifier. The module contains an on/off switch, a one-step attenuator, plus a switchable high-pass filter.

This filter allows local mediumwave AM stations to be received less strongly than are world band stations, and thus helps keep the radio's circuitry from falsely mixing these local signals with world band stations. If you live near any AM stations, you may find this filter to be a real plus.

As we've pointed out in our RDI *White Paper*, "RDI Evaluates Popular Indoor Antennas", active antennas almost invariably don't provide acceptable results when used with portables. But every generalization has exceptions, and -- happily -- Sony's active antenna succeeds nicely with its SW1 partner.

The only serious shortcoming of the SW1's active antenna is that it amplifies decently only below 15 MHz. For daytime listeners, this will come as a disappointment. But below 15 MHz, where nearly all nighttime signals are found, the accessory antenna brings the radio to life, making it even more sensitive than such excellent portables as the Sony ICF-2010/ICF-2001D. And, in general, there's no overloading.

Less of a drawback is that the active antenna doesn't turn on and off automatically with the radio. Even though there's a little LED that glows when the antenna is on, it's all too easy to forget to switch off the antenna's amplifier, draining the batteries unnecessarily.

Getting DX reception from something smaller than a box of kitchen matches can be quite an eye-opening experience. The SW1's active antenna isn't designed for use with other radios, but its performance -- warts and all -- is remarkably similar to that of the Sony AN-1 active antenna.

The AN-1 is designed to be used with most Sony and even some other makes of portables, but is no longer carried by Sony in the US and many other parts of the world. However, it is still being advertised as available in

Japan. Too, some US dealers, such as Universal Shortwave and Electronic Equipment Bank, may still have some new AN-1's in stock for purchase by perfectionistic '2010 owners. Universal's latest catalog shows it at \$79.95.

Exceptional AC Power Supply

The set's outboard AC-301 ac power supply can be used in lieu of the pair of "AA" cells that otherwise powers the set. These cells are still needed to keep the memories and clock from erasing should the ac power conk out or the '301 become disconnected.

The '301 power supply is exceptional in that it operates on any current between 100-240V, 50-60 Hz. You don't even have to know what the local current is -- just plug in the '301, and it figures out everything automatically. This is not only handy, it's also valuable insurance against your ruining a perfectly good radio by setting the power supply to the wrong voltage.

The SW1 sold in North America also comes equipped with a flat-prong/round-prong ac socket adaptor. This allows the set to be used on ac in many parts of the world -- a real plus for the traveler -- although British sockets, like British roads, are different yet again. Of course, if you live in Britain this small matter is taken care of in the UK version.

Audio Quality

With any set the size of the SW1, audio quality will be seriously compromised by the necessity to use a tiny speaker. Given all this, the SW1's speaker sounds reasonable, although on FM it sounds less shrill if the single-step tone control is turned to the "news", rather than "music", position.

Where the SW1 really shines is when the ear pieces are used. Audio quality, especially on FM, then becomes top-drawer and listening can be a real pleasure -- even by the standards of much larger sets.

Great, Yes -- Ideal, No

Other micro portables simply aren't in the same league. But this doesn't mean that some beefier portables aren't as good, or even better.

For example, the mid-sized Sony ICF-2010/ICF-2001D portable, which is priced at only fifty dollars more than the SW1, has better audio, along with two features conspicuously absent on the SW1: synchronous detection and multiple bandwidths.

Synchronous detection is uniquely helpful in reducing or eliminating any racket resulting from stations on adjacent channels, plus it helps reduce the untoward effects of fading.

Multiple bandwidths -- there are two on the '2010 -- allow you to choose the degree of selectivity that's best suited to the particular station you're tuned to. The SW1, however, has only one bandwidth. It's well chosen, but a wider bandwidth can provide better fidelity at such times when the station you're hearing is

The Sony ICF-SW1 is a remarkable device -- a truly advanced-technology micro-portable smaller than a Riviera bikini.

not hemmed in by competing signals. Given the SW1's otherwise-excellent audio quality with earpieces, a second, wider bandwidth would have given the set a chance to really strut its stuff.

Too, the '2010 tunes world band in 0.1 kHz increments -- precise resolution, indeed. The SW1 tunes only in coarse 5.0 kHz increments. Given that standard channel spacing is 5 kHz, this usually suffices and also makes tuning unusually straightforward. But a few broadcasters operate "off channel", and the SW1 doesn't pick these up very well. Too, the SW1 can't be detuned slightly to help reduce adjacent-channel interference. It would have been better had Sony included a microswitch or software command to allow the user to choose between 5 kHz increments, as now, and more precise increments.

Additionally, unlike with the '2010, there's no conventional tuning knob, and the SW1 can't process single-sideband signals properly. For those listening only to world band broadcasts, the inability to process single-sideband signals is of little immediate consequence and has the virtue of simplifying operation somewhat. But this issue will have to be faced up to as the century winds down, as by then increasing numbers of broadcasters will be converting over to single-sideband operation.

A lesser annoyance is that the volume control is on the back of the set, where it is hard to see, but easy to change accidentally. There is a handy "key protect" control to prevent your changing the control settings accidentally, but this has no effect on the volume control. Too, the 24-hour clock can be read only when the radio is switched off.

A Walkman? Almost...

The SW1 does have some differences, beside the presence of a loudspeaker, from true Walkman products. First, it has awkward "turbo" ear pieces, rather than the ubiquitous foam headphones found on walkaround devices. You can hardly walk about, much less jog, with these "turbo" things, as they hang disconcertingly loose in the ear and tumble out easily. Second, the SW1 uses a firm telescopic antenna, whereas Walkmans use the headphone assembly to secrete a flexible wire antenna. Third, there's no clip-on holster to allow the SW1 to be secured to a belt or clothing.

It's a pity these Walkman characteristics weren't carried over to the SW1, as they would have worked fine, provided the present telescopic antenna were retained for use when the speaker is on. You can get around the earpiece limitation by purchasing a set of Walkman headphones, but it's not easy to cope with the other two limitations if you're bobbing about on foot.

The Bottom Line

The new Sony ICF-SW1 is a remarkable device. Smaller than the bottom of a Riviera bikini, it's the only true advanced-technology micro-portable around, and it works very well, indeed. It's also straightforward to operate and blessedly free from controls that accomplish little worthwhile purpose. At \$339.95, it's pricey, to be sure. But for that amount you also get not only advanced technology and heads-up performance, but also a whole caseful of accessories worth well over \$100. All this may not be enough to convince legions of listeners to trade in their '2010's, but it should be more than enough to tempt the fastidious weight-conscious traveler. ■

You can hear Larry Magne's equipment reviews the first Saturday night each month over Radio Canada International's popular SWL DIGEST. For North America, it's 8:10 PM Eastern Time on 5960 and 9755 kHz; for Europe, 2008 UTC on 5995, 9670, 11945, 15325, 17820 and 17875 kHz. Larry's "What's New in Equipment" is also featured various other Saturdays throughout the month, while PASSPORT editors Don Jensen and Tony Jones report on world broadcasting the third Saturday night each month.

PASSPORT'S "RDI White Paper" equipment reports are carried in the US by Imprime, EEB and Universal Shortwave; in Canada by PIF Book-by-Mail; and in Europe by Interbooks and the Swedish DX Federation. A free catalogue of the latest editions of these exhaustive laboratory and "hands-on" reports may be obtained by sending a self-addressed stamped envelope to Publications Information, International Broadcasting Services, Ltd., Box 300, Penn's Park PA 18943 USA.

MetroWest Drop-in Scanner Charger

Previously available only for commercial two-way handie-talkies and only recently adapted for hand-held scanners, drop-in battery chargers are hard to find. Regency makes expensive drop-ins for the HX1000, 1200 and 1500, but there are none to be had from Uniden, Radio Shack or Cobra.

Now a private manufacturer has announced a series of charging stands for Radio Shack and Uniden products, presently available for the PRO-30, 31, 32, and BC-100 and 100-XL. Models for the 100XLT and 200/205XLT are due shortly, as are Cobra and Regency versions.

But do they work?

As shown in the accompanying photo, the charger is stylish and low profile. It is lined with padding to prevent scratching of the radio cabinet and also assure a snug fit. Snug it is; the initial installation of a BC-100XL into our evaluation sample required some manipulation, resulting in a slight bend of the rear-panel power connector.

But this caused no harm; the plug is durable and securely mounted on an aluminum plate which accepted the repositioning with hardly a whimper. After that it was smooth sailing.

Side-plug scanners like the Radio Shack PRO series are even easier to implement; the Pro Power offers a cord which comes around from the back and is plugged into the side manually.

The basic concept behind all versions is to provide a "parking place" for a hand-held when it is not being worn by the listener. So coupled, it gradually trickle-charges the scanner which may be used while in the stand.

The charging rate is intentionally much lower than that of the plug-in wall adaptor

which accompanies the scanners; this lower rate, according to the manufacturer, will result in extended battery life since the nicads are not overcharged.

For example, the Bearcat wall charger delivers about 95 milliamperes to the cells while charging; this is twice the rating recommended by the battery manufacturer. The MetroWest Pro Power supply delivers only 15-25 milliamperes, depending upon the discharge state of the battery pack.

There is a tradeoff, however; with lower charge current, the recharge time is extended proportionately. With the original Bearcat adaptor, fully-discharged nicads can be fully recharged in as little as 7 hours; the Pro Power takes 26 hours.

But realistically, few of us operate a hand-held to the point of battery extinction and the stand-up charger is just the ticket for overnight recharging. Its open front is ideal for keypad access while charging and listening and its heavy-duty power supply exhibits no hum while monitoring.

Constructed of grey-hammertone-finish aluminum with mar-proof rubber feet, the Pro Power comes with an AC cord to plug into any convenient 120 VAC outlet. It is backed by a one year guarantee against defects and even a one month acceptance guarantee--if you decide to return it during the first 30 days, your full purchase price, including postage, will be refunded. We're willing to bet you won't return it!

(Pro Power charging stand, \$31 plus \$4 shipping for BC100XLT, BC-200/205XLT; \$26 plus \$4 shipping for all other models. From MetroWest, 822 N. Spring, LaGrange Park, IL 60525; phone 312-780-4406)

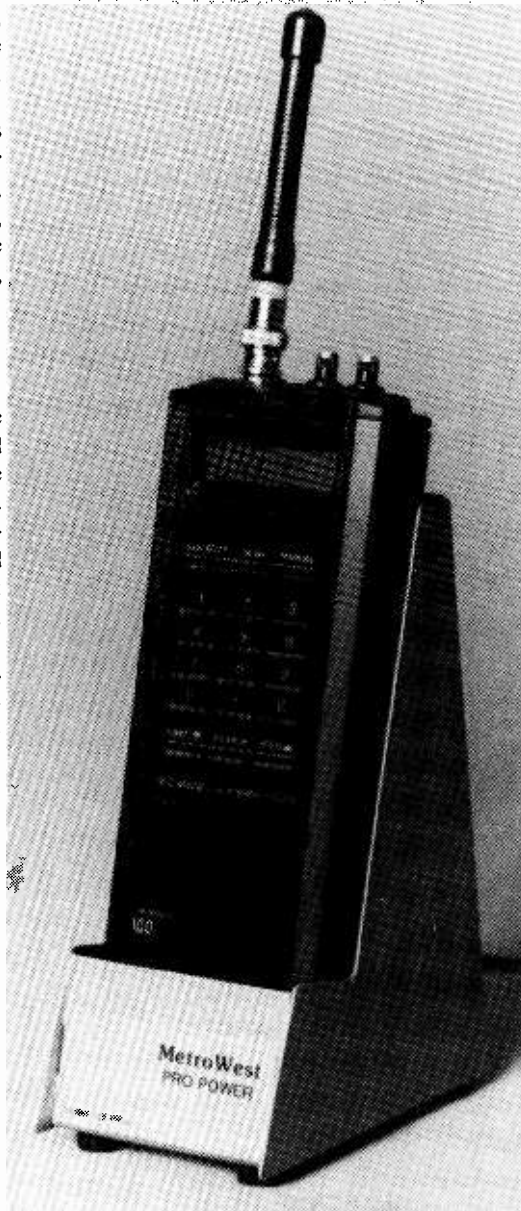

Walk Tall and Carry a Little 'Bear'

Grove has super deals on Bearcat's exciting new handhelds, with more memory channels and wider range than ever before!

Bearcat BC205XLT

New!

Finally, a high performance handheld programmable scanner which includes aircraft and all land mobile bands, including 800 MHz!

Frequency coverage is 29-54, 118-174, 406-512, and 806-960 MHz (less cellular frequencies, which we can restore for \$10 at time of order). 200 memory channels may be stored in 10 banks of 20 channels each or scanned sequentially.

This feature-packed handful offers ten priority channels, search, lockout, and delay and comes equipped with detachable Nicad battery pack, AC charger, leather holster, and BNC flex whip.

The BC205XLT is the most powerful hand-held scanner ever released to the public and is now available from Grove Enterprises at a super discount price!

CALL TOLL-FREE (MC & Visa Only)
1-800-438-8155

Extra BP205 battery packs available. Call for pricing.

Order SCN9A

Grove Discount Price

AVAILABLE IN JUNE

Retail
~~\$449⁹⁵~~

\$264⁹⁵

¹⁵ UPS Shipping
¹⁰ U.S. Mail P.P.; ¹⁵ Canada Air P.P.

Cellular restoration, add \$10.

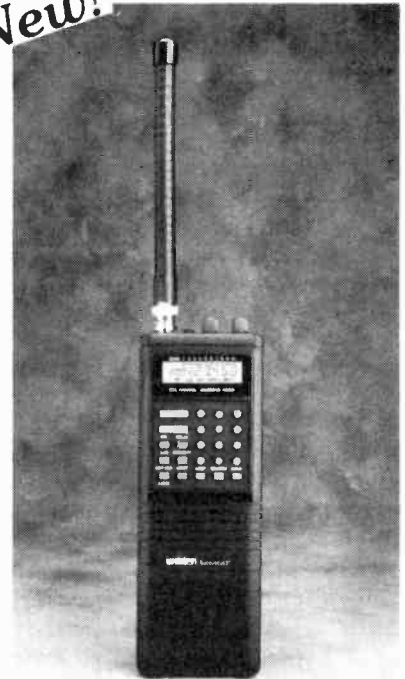

Features may vary slightly from photo

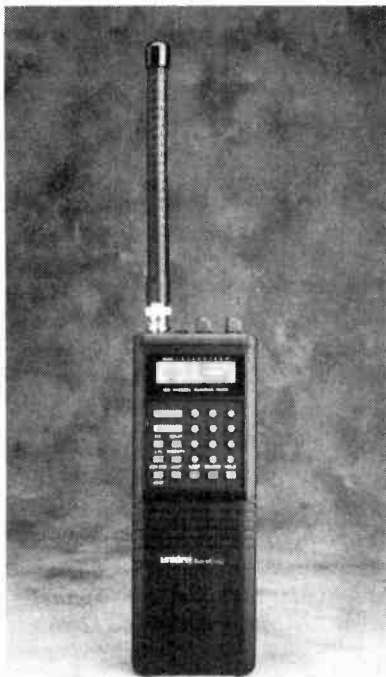

The Bearcat BC100XLT

Introducing the **BC-100XLT**, with 100 memory channels! Yes, the all-time popular Bearcat hand-held programmable scanner has aircraft reception, 100 channel memory, illuminated LCD display for night viewing, search, rapid scan (15 channels per second), direct channel access, lockout, delay, low battery indicator, priority, and keyboard lock.

Frequency coverage is 29-54, 118-174, 406-512 MHz. Accessories included: Rubber ducky antenna (with BNC base), AC adaptor/charger, Nicad batteries, earphone, and carrying case.

Handsome black case with white chrome accents.
Dimensions: 7½"H x 2⅞"W x 1⅜"D; Weight: 2 lbs., 10 oz.

See optional accessories on page 14

Order SCN10

Now Only

CALL TOLL-FREE (MC & Visa Only)
1-800-438-8155

Retail ~~\$349⁹⁵~~

\$219⁹⁵

¹³ UPS Shipping
¹⁵ U.S. Mail P.P.; ¹⁸ Canada Air P.P.

 **Grove Enterprises**

140 Dog Branch Road
Brasstown, N.C. 28902

MC and Visa Orders Only,
Call 1-800-438-8155



Border Radio:

Quacks, Yodelers, Pitchmen, Psychics, And Other Amazing Broadcasters of the American Airwaves

By Gene Fowler & Bill Crawford with a foreword by Wolfman Jack

Border Radio is a fascinating, colorful story of the mega-watt radio stations that once blasted their way from just across the Rio Grande and into the United States and around the world. These stations -- among the most powerful of their time -- captured the imagination of listeners from the 1930s through the 60s, offering them a solution to almost any ailment, physical or spiritual.

One advertiser, Crazy Water Crystals, helped clean out sluggish intestinal systems "like a ramrod," and Kolorbak eliminated the grey hair that would "cheat you out of your job and cause you a lot of worry." Perhaps the most famous of all was the pitch of Dr. John Brinkley. Brinkley, about whom the American Medical Association said "had a quality...so malevolent that it sets [him] apart from others of the human race," became fabulously wealthy by transplanting billy goat glands into "sexually weak" men. Others fought gunbattles for control of bogus cancer treatment centers advertised on the Mexican stations.

But border radio was more than medical. It was hootin' hillbilly bands, political pitches, fortune tellers and yodeling cowboys. As Wolfman Jack -- himself a border radio DJ -- says, "something like this could only have happened when it did, with the characters it did." And it's all told by authors Fowler and Crawford with verve

and an enormous sense of fun. For those who missed this unique era of broadcasting, the book even comes with a 33 1/3 RPM Evatone recording of the best of border radio.

Border Radio (ISBN: 0-87719-066-6) is highly recommended and is available in hardback from your local bookstore for \$18.95 or from Texas Monthly Press, Box 1569, Austin, Texas 78767-9990.

Shortwave Receivers Past and Present

Edited by Fred Osterman

How many times have you gone to a flea market or seen an ad for a used receiver and wondered whether it was a bargain or not? More, what was the original capability of the radio and when was it manufactured? What did it cost when new?

Fred Osterman has laboriously collected this information and more on over 200 receivers, including many presently in manufacture, in a handy reference volume. Lafayette, Hallicrafters, National, Hammarlund, Drake, McKay-Kymek, Panasonic, Sony, Collins, JRC--they're all here along with basic specs, functional controls, references to published reviews, dates and prices.

With listings from Allied through Zenith, Osterman's new receiver compendium is a handy book to carry along to your next hamfest!

(104 pages, 8-12" x 11", stapled; \$5.95 plus \$1 book rate shipping from Universal Shortwave, 1280 Aida Drive, Reynoldsburg, OH 43068)

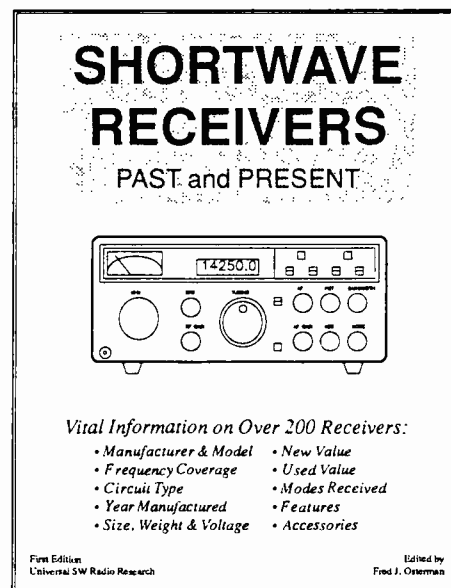

New "Special Needs" Catalogue Available from Radio Shack

The second edition of Radio Shack's popular *Selected Products for People with Special Needs* is now available. The catalogue, which runs some 40 pages, offers products of need to the elderly, blind, hearing impaired or otherwise disabled. Included are digital fever thermometers, blood pressure and biofeedback monitors, pill box timers that beep to remind the owner when its time for medication and special needs options for computers.

The catalogue is available from selected Radio Shack stores worldwide or from the Radio Shack Circulation Department, 300 One Tandy Center, Fort Worth, Texas 76102.

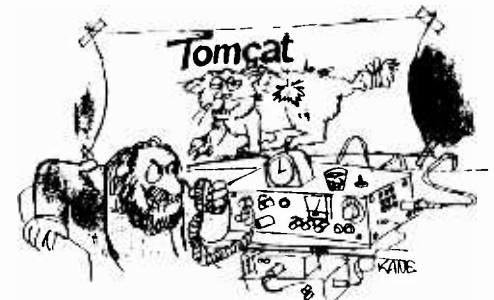

Tomcat's Big CB Handbook

By Tom Kneitel

"In 1976," says *Popular Communications* editor Tom Kneitel, "I was approached by a major publisher with the idea of bringing out a CB book. I wanted to do a no-holds barred book," he continues, "[but] when they saw [it] they saw my manuscript," he continues, "they freaked." The resulting book, says the often abrasive author, was unsatisfactory: "gentrified, mild-mannered but highly popular."

In the intervening years, the popularity of CB faded, but not Kneitel's interest in doing the CB book. The end product, which is published under his own CRB Research label, is *Tomcat's Big CB Handbook*. And while it's not half as likely to "freak" anyone as the author would have you believe, it is an interesting, bluntly accurate if not

overworked description of the world's most boring medium: CB. And it has all the traditional Kneitel trademarks: lots of old-time CB history, old-time CB cartoons, old time CB QSL cards, and so forth. It also happens to be absolutely jam-packed with information.

In his introduction, the author claims that CB has "rebounded with as much vigor and potential as ever -- it seems even better now than it was in the 1970's!" If that is true and you're back at that bodacious CB rig, good buddy, then Good Lord, you should enjoy Tomcat's book, 10-4. *Tomcat's Big CB Handbook* is available from your favorite CB dealer for \$13.95 or direct from CRB Research, Box 56, Commack, New York 11725. Add \$2.00 for postage and handling. Catch you on the backstroke, good buddy. Bye bye. We're gone!



New 7 Mode Data Controller from MFJ

MFJ's new model 1278 Multi-mode Data Controller lets you work seven digital modes: Packet, ASCII, RTTY, CW, WEFAX, SSTV, and Contest Keyer modes. The '1278 features high performance HF/VHF/CW modems, software selectable dual radio ports, precision tuning indicator, 32 RAM and a dual AC power supply. All you need supply is a standard HF or VHF rig and any computer with a serial port and terminal program.

The MFJ-1278 automatically sets itself to match your computer baud rate. In all modes it features printing, threshold control for varying band conditions, tune-up command, lithium battery back up, RS-232 and TTL serial ports, watch dog timer, FSK and AFSK outputs, output level control, speaker jack for both radio ports, test and calibration software, Z-80 microprocessor running at 4.9 MHz, 32K EPROM and socketed ICs.

Retail price is \$249.95. For more information, call MFJ at 1-800-647-1800.

To have your new product or book considered for review in *Monitoring Times*, send it to Larry Miller, 140 Dog Branch Road, Brasstown, North Carolina 28902.

LIQUIDATION SALE

This equipment was accumulated in anticipation of a monitoring service contract with a major international news agency. However, because of a reorganization, the contract did not materialize.

RACAL RECEIVERS ARE USED BY THE NSA, CIA, AND GOVT. AGENCIES. THE 6790 IS USED AT FCC MONITORING STATIONS, THE 6217 ON FCC MONITORING TRUCKS.

Subject to Prior Sale

ITEM	NEW	USED	ITEM	NEW	USED
Racal 6790RX	2950		LTV-G-133(51S1)RX	500	
Racal 6778 RX	2950	2000	Collins 51S1RX	895	
Racal 6778Q RX	2200		Hammarlund HQ-180	295	
Racal 6217 RX	1485	750	spkr RX		
Racal 6217E RX	1585	835	Hammarlund HC-10	200	
Racal 6366 SDU		1200	IF/SSB Conv		
Racal 6337 VLF Ad		155	ITT 8050 HF/SSB		
Racal 6230 Dig RX		1200	Transceiver Cover	7500	
Racal RA-153 Dual IF		800	MHz/100 mem		
Racal RA 5555			RME DB-22A	115	
VHF/UHF Receiver			Preselector		
\$40,000 list	13150		Hal 670 Telereader	225	
Racal 6001/2 Remote		1200	Javelin 9" monitor	55	
Racal 137 VLF Adap		250	for 670		
Racal 6772E RX	2000	1500	Infotech M-200 RTTY	165	
JCR NDR/NHD 515		780	Dec		
Drake R-7-A w/ Giller			Infotech M-200E	185	
mods 1.8/3/2.3		750	RTTY Dec		
R-390 RX	425		Wiltek 108 Ant	140	90
R-390A RX	400		Multicplr		
R-389 VLF RX	675		Squires-Sanders		
*Worcester AM RX	700		SS-1-R w/SS-1-V		
Icom R-70 RX	450		SDU & Noise		
Icom	695		Blanker RX	700	
R-71A/FL44/RC11 RX			CEI Watkins Johnson	600	
McKay Dymek	475		357 VLF RX		
DR33C RX			Racal 6317	300	
McKay Dymek	525		Synthesizer		
DR44 RX			Aiken HF Radio	650	
National HR0-500 RX	750		Test Set		
National HR0-600 RX	1650		Grommes G-5-M	150	
Rohde & Schwarz	700		mono mixer		
EK-07D RX			McKay Dymek Actv	125	
Rohde & Schwarz			Ant DA100		
Polarad ESV	10750		Radio West Ferrite	115	
20-1000 MHz Lab RX			Ant		
Granger Associates 2001-1-2K			Panasonic	250	
Andrews 2.85 tp 30MHz broadband			Rackmount triple		
professional transmit/receive			5" TV monitor		
antenna for commercial use			(video inputs)		
Horizontal elliptical polarization			EF Johnson DIB	550	
with 100' tower. NEW/CRATED FOB			Cellular Phone		
Denver. Lists at 32,350.			HP Dual trace	225	
Our cost 14,750			rackmount scope		
Weight is almost 3 tons!			Dynair RX-4-B	175	
			VHF/UHF Tuner for		
			off-air monitoring		
			of TV sigs		
			Astron PS-7-B	40	
			Power supply 12V		
			**Realistic 2004	375	special
			Scanner		
			(25 Available)		
			Scully 280 4 channel	1250	
			tape recorders in		
			floor cabinets		
			(Russlang)		
			Yaesu FRA-7700	50	
			Preselector		

RELAY RACKS FOR SALE
CALL FOR DETAILS

Abbreviations. RX-Receiver, SDU-Spectrum Display Unit,
RTTY-Radioteletype, Ant-Antenna, Dec-Decoder
Multicplr-multicoupler takes 1 antenna feeds to 8 RXs

BOX 2576, Montauk, NY 11954 Order Now!

RADIOFILE COMMUNICATIONS
(212)713-5558

THE TOP RATED ALPHA DELTA MODEL DX-SWL SHORTWAVE SLOPER ANTENNA

Some Notes On Its Development

• Experience gained over the years in producing high power transmitting antennas led to the introduction of the DX-SWL—the first commercially available world band sloper combining AM broadcast, tropical bands and 60 thru 13 meters.

What does transmitting experience have to do with shortwave reception? Plenty! If a transmit antenna is not designed to precise parameters, it will not pass the RF "smoke test"—there will be burned connections, shorted components, high standing waves and generally lousy performance. On the other hand, a receive-only antenna of shoddy design can go unnoticed—except by your receiver and the weak DX signal you're trying to receive. DX-SWL antennas are used daily in 2 kw transmit service, as well as for world class reception.

• We recognized early on that a **Sloper** can outperform a dipole at the same height, for many incoming wave angles. The **Sloper** really shines on weak, low angle DX signals. A **Sloper** also requires only a single, elevated support—it's easier to install than a dipole.

• The model DX-SWL is designed with specially coated 12 ga. solid copper wire elements which are 25% greater in diameter than the more commonly used 14 ga. wire. Engineers know that a larger diameter yields less resistance, and thus less loss per unit length. Even though 14 ga. wire is cheaper, it is not acceptable for use in any Alpha Delta antenna.

• Because DX-SWL antennas are used worldwide in less than ideal environments, only high quality stainless steel hardware is used. Even though it is more costly than plated hardware used in other cheaper brands, we know that you want to put an antenna up once, and forget it. Climbing great heights to replace rusted connections is no fun. Due to the direct sun, high heat environment of some DX-SWL installation sites, we use only specially selected white coil form material. Black forms used by other brands are not acceptable due to heat absorption and possible coil distortion.

• Before you buy any shortwave antenna, check out the design details and transmit capabilities thoroughly—even if you're not going to transmit. We don't want your investment to go up in smoke!

Model DX-SWL Sloper Antenna is available for **\$69.95** at your **Alpha Delta Dealer**. For direct orders send \$69.95 plus \$4.00 shipping (USA only). Call for export order prices.

ALPHA DELTA
COMMUNICATIONS, INC.

P.O. Box 571
Centerville, Ohio 45459
(513) 435-4772



HELPFUL HINTS

Modifying the Pro-2021

The Radio Shack Pro-2021 can be altered to scan 806 - 960 MHz and 68 - 88 MHz. How? Cut diodes D-45 and D-46. A local Radio Shack technician advised, however, that the radio must be realigned to receive on these bands.

Summertime DX Tip

Like DXing the Tropical Bands but get frustrated by the high atmospheric noise level brought on my summertime thunderstorms? Here's a little tip. Use your RF gain control. (On the Sony ICF-2010, for example, it's a slider located on the right side of the radio.) Common sense dictates that you push it up as high as it will go in order to bring in the most RF (signal). But common sense can be wrong in some cases. Slide the RF gain *down*. Play with it a little. It'll decrease some of the atmospheric noise. It will also decrease the strength of the station you're listening to but the loss of the accompanying noise sometimes makes that station easier to identify! The same procedure can also be used to decrease interference from co-channel stations.

Have a Broken or Dead Bearcat?

If you own a broken or dead Bearcat 220 or 250, take heed! While the old Electra Company says they'll no longer handle them, Uniden may, if they have the parts available. The fee is \$48.00 (more if major parts are required). Turnover time is six to eight weeks. And the repairs are covered by a warranty. Hurray for the "new parents" of the Bearcat scanner!

Buyer Beware!

There are new, still-in-the-box, Regency M-100-E (the "E" denotes "export") programmable scanners still being sold -- although the scanner has not been in production for several years. Buyer beware! While VHF-High and the low bands are the same as those found on most scanners, the low-band VHF is quite different from the 30 to 50 MHz most listen-

ers have come to expect. These "E" models cover 66 to 88 MHz, instead. So, if you enjoy listening to telemetry, then this is the scanner for you. Otherwise, forget it. Keep in mind that the "E" does *not* appear on the carton. You have to look for it on the owner's manual. So, look before you leap. If someone offers you a "deal" on a new M-100, watch out!

You've Heard it Before!

Sometimes we sound like a broken record. Every year, at about this time, we warn you about the nasty relationship between lightning and antennas. They like each other. And when they get together, it can kill you -- literally. It's no joke.

If you have an external antenna -- that's any antenna that is outside of your house or apartment -- disconnect it when you are through listening. And it doesn't matter if you're a shortwave listener, a scanner freak or AM listener. If you use an external antenna, it doesn't matter.

Even nearby lightning strikes can send significant amounts of power surging through your antenna, certainly enough to burn out those sensitive, solid-state components in your radio. Direct strikes can even obliterate lightning protectors. The result can range from damaged radios to fires to death.

Another way to protect your radio is to unplug it from the wall outlet during lightning storms. Lightning can also hit utility poles and, while they do have their own lightning protection, surges in power can result and your radio can be damaged or destroyed.

So, when you're done listening, disconnect your antenna from your receiver. Put the connector outside. And unplug your radio from the wall outlet. And if you do that, we'll still be seeing your name on the *Monitoring Times* mailing list next fall.

A Cheap Base Monitor Antenna

For a cheap base monitor antenna, consider the Radio Shack \$14.95 ground-plane antenna (part # 20-176). It does a fine job on Hi band and very well on UHF, too. Best of all, it can be "pruned" all the way

up into the 800 MHz range. For an additional \$12.00, a decent run of coax and the appropriate connectors can be added. Not a bad deal when you consider that all-band commercial monitor antennas are going for almost \$90.00!

Last, but not least, do not discount the "marine" antennas which do not require a "ground plane." They adapt perfectly to a base environment for both transmit and receive modes for CB and VHF. Inexpensive ham antennas also do fine duty as monitor antennas, too. Just remember to pick the one to match the bands you listen to. Whoever said that this is an expensive hobby?

Blue Angels Air Show Schedule 1988

May 1	MacDill AFB, FL
5	NAS Kingsville, TX
7-8	* Corpus Christi, TX
14-15	Charleston AFB, SC
20-21	Andrews AFB, MD
23	Naval Academy, MD
June 4-5	Westfield, MA
11-12	Portland, OR
18-19	Scott AFB, IL
25-26	Grand Forks AFB, ND
July 2-4	Traverse City, MI
9-10	Billings, MT
16	Pensacola Beach, FL
23-24	Eau Claire, WI
Aug 6-7	Seattle, WA
9-10	NAS Whidbey Is, WA
13-14	Abbotsford, BC
20-21	NAS Miramar, CA
27-28	Springfield, IL
Sept 3-5	Cleveland, OH
10-11	Boise, ID
17-18	NAS Oceana, VA
24-25	Denver, CO (front range)
Oct 1-2	Houston, TX
8-9	NAS Pt Mugu, CA
12	NAS Fallon, NV
15	Reese AFB, TX
22-23	Harrisburg, PA
Nov 2	NAS Key West, FL
5-6	Opa Locka, FL
12	NAS Pensacola, FL

Aircraft Mission ID Table

Basic Mission and Type Symbols

The basic mission and type symbols

indicate the aircraft's primary mission (see figure 1).

Modified Mission Symbols (prefix)

The modified mission symbols are used when the basic mission has been changed or added to.

Letter Mission

A	Attack
B	Bomber
C	Cargo/transport
D	Director
E	Special Electronics
F	Fighter
H	Search & Rescue (or helicopter)
K	Tanker
L	Cold weather
M	Missile carrier
O	Observation
P	Patrol
Q	Drone
R	Reconnaissance
S	Antisubmarine
T	Trainer
U	Utility
V	Staff (or VTOL/STOL)
W	Weather
X	Research
Y	Prototype

Figure 2 shows the modified mission from an F-4-E to an RF-4-E changing from a fighter to a reconnaissance aircraft. There are a few exceptions to these rules. For instance, an SR-71 would not be a reconnaissance aircraft modified for antisubmarine warfare; the 'SR' stands for Strategic Reconnaissance.

* The Series symbol designates changes in avionics, airframe, armament and/or powerplant.

Contributed by
Bob Skwirsk, Wayne, MI

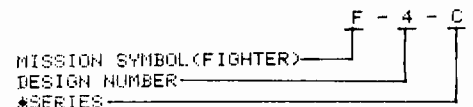

FIG. 1

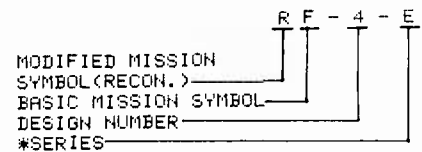
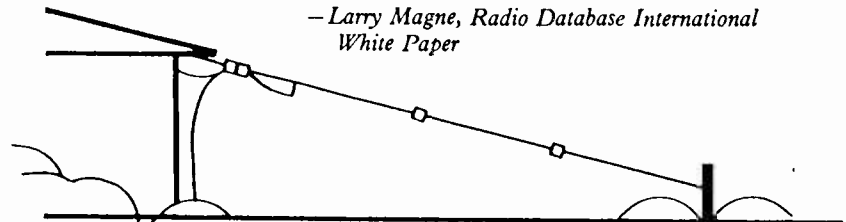

FIG. 2

Figure 1 shows the mission of an F-4-C.

"The Best Results throughout the Shortwave Spectrum."

— Larry Magne, Radio Database International
White Paper



Get world-class, multi-band reception with
ALPHA DELTA DX-SWL SLOPER ANTENNA
Just \$69.95 plus shipping from your Alpha Delta dealer!

- Fully assembled, ready to use and built for long life. So strong, it can even be used to transmit — up to 2 kW!
- Superior multi-band performance on 13, 16, 19, 21, 25, 31, 41, 49, 60, 90, 120 meters plus the AM broadcast band (.5-1.6 MHz). All in a single compact antenna. Alpha Delta first!
- Efficient multi-band frequency selection by means of special RF choke-resonators — instead of lossy, narrow band traps.
- Overall length just 60 feet. Requires only a single elevated support — easier to install than a dipole
- 50 ohm feedpoint at apex of antenna for maximum DX reception. A UHF connector is provided on the mounting bracket for easy connection to your coax.
- A top overall rating in Radio Database International's hard-hitting White Paper, "RDI Evaluates the Popular Outdoor Antennas."

ALPHA DELTA
P.O. Box 571 • Centerville, Ohio 45459

There's alot happening on the shortwave broadcast bands. Don't miss a thing by skimping on your antenna. Get world class, multi-band DX reception with the Alpha Delta model DX-SWL Sloper. Just \$69.95 plus shipping from your local Alpha Delta dealer.

Rt. 1 Box 64A
Weybridge, VT 05753

A Simple High-gain Nondirectional Antenna for VHF-UHF

This month we will discuss how to build, site, and use a nondirectional antenna with a useful amount of gain. It's called the "colinear coaxial antenna" and just for fun, let's coin a name for it right here in *Monitoring Times*. By shortening "colinear coaxial" we can call the antenna, "Coco."

The idea behind the design was first conceived by a gentleman named Franklin, a brilliant communications engineer of early radio days. Therefore, some precursors to the coco are known as "Franklin" antennas.

The "secret" of the gain obtained with the coco antenna is that the signals picked-up by each section of the antenna add together, giving a stronger signal input to your receiver or scanner than you could get with only one section. And, since the antenna is mounted with its length running vertically, each element is exposed to all directions of the compass equally. Thus, the coco is nondirectional. This fact, together with its gain, means that it is a good antenna for general monitoring of signals coming from any direction.

So, Let's Build One!

Take a look at figure one. There you see that you need a number of sections of coaxial cable, cut at the ends so that they may be joined as shown. Keep the connections as short as practical. The antenna segment lengths (A, B, and C) include the length of the connections too.

The A-length and B-length segments are made of coax, as shown, and the C-length segments are made of heavy wire or even of coax cable braid. More A-length segments may be added to the three shown, to give the antennas more gain. Since this antenna is "tailored" to the frequency on which you are going to use it, get the lengths of coax segments to use from table one. Make all measurements carefully.

Solder each connection well, and seal the connection with black electrician's tape. When you tape the joint, do it so that the tape covers the entire "joint," and overlaps the outer insulating jacket of the coax on both sides of the joint.

If you plan on mounting the antenna outside, give it a very thorough job of taping, and inspect it now and then for signs of weather damage. If weather damage starts, retape as necessary. Don't put any sealer on the joint before you put the tape on, as some sealers cause serious signal loss.

Some builders put the finished antenna inside a plastic water pipe to protect it. Others say that this degrades the signal. You may want to try to see for yourself, if you think you want more protection against the weather than the tape gives. The pipe must be sealed against moisture. You can mount the pipe at its bottom, and then guy it with light ropes to hold it erect. This means you don't need a tower to put it up. But, without a pipe to support it, you can simply hang the antenna from a tree or pole by a rope attached to its top.

Siting Considerations

The antenna should be mounted in the clear, as much as is possible. To put it next to a metal building would be to shield it from signals on the side closest to the building. To put it on the side of a building which has a metal frame would do something of the same thing. Dry wood, bricks, stone, or mortar are not so detrimental in terms of their effect on the antenna's performance, as is metal. As I almost always recommend, mount your antenna as high and as in-the-clear as is practical.

The antenna may even be mounted inside a wooden house, if you want to drill a small hole to let its length run from one room up to the next, or to the attic. In all cases, keep it well away from wiring and appliances of any kind.

Most VHF-UHF signals are vertically polarized, and therefore the antenna is mounted with its longest dimension in the vertical orientation, to give it vertical polarization too. But it is of interest to note that Franklin's early antennas, from

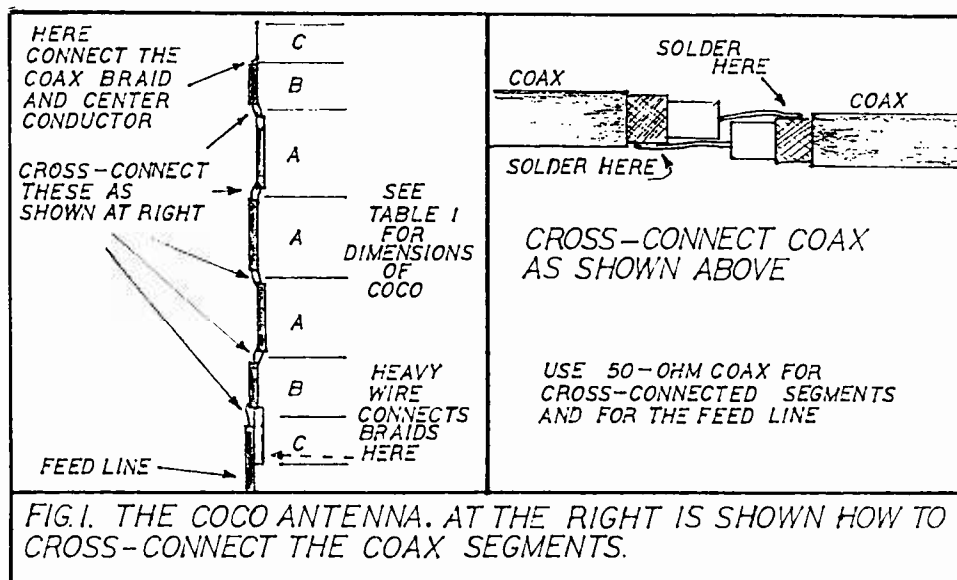

which the coco is derived, were horizontally oriented elements of the legendary "Imperial Beam Antenna."

The Imperial Beam was the antenna which the Marconi Company developed early in this century to provide the British Empire with the first reliable worldwide communication system. If you build the coco, you will be following in very famous footsteps indeed!

RADIO RIDDLES

Last Month's Radio Riddle

Last month I covered a lot of antenna names, and among them were the "lazy-H" and the "lazy-quad" antennas. The riddle then was: "Just what does it mean when we say that an antenna is "lazy"?"

Have you ever seen a "lazy-H" antenna? It looked like an "H," right? But the "H" was tilted over 90 degrees to the right, lying on it's side. So, next time you read of a "lazy" antenna, realize that it is called "lazy" only because the antenna happens to look like whatever it is named for (H, J, etc), if that namesake is rolled over on its side to rest a while.

After all, one of the quickest ways that people can get a reputation as being a "lazy bum" is to lie around like a couch potato. Should it be so different for antennas?

In Closing

A while back, a *Monitoring Times* reader wrote in to ask me if I was actually Kurt N. Sterba, a writer who has, in the past written an antenna information column for another radio communications journal, *Worldradio*.

Well, strange as it may seem, my name really is "Clem." And my writing style would seem to be quite different from Sterba's. On the other hand, the name "Kurt N. Sterba" would seem to be a pseudonym designed to bring back nostalgic memories of an antenna design which was once well-known and widely used. I understand that it can still be found at some shortwave broadcasting stations.

How many of you know what that antenna is? I'll give that answer next month, along with the answer to this month's Radio Riddle.

Table One

DIMENSIONS FOR ANTENNA SEGMENTS

Freq.(MHz)	REGULAR COAX		FOAM COAX		EITHER COAX
	A	B	A	B	C
130	2'6"	1'3"	3'1.2"	1'6.6"	1'10.7"
146	2'2.7"	1'1.3"	2'9.2"	1'4.6"	1'8.2"
160	2'0.4"	1'0.2"	2'6.3"	1.3.1"	1'6.5"
220	1'5.9"	0'8.9"	1'10"	0'11"	1'1.4"
410	0'9.5"	0'4.8"	0'11.8"	0'5.9"	0'7.2"
455	0'8.6"	0'4.3"	0'10.6"	0'5.3"	0'6.5"

TO COMPUTE DIMENSIONS, IN FEET, FOR ANY FREQUENCY

REGULAR COAX: A = 492/Freq(MHz)(.66) B = A/2 C = 246/Freq(MHz)
 FOAM COAX: A = 492/Freq(MHz)(.82) B = A/2 C = 246/Freq(MHz)

GORDON WEST'S RADIO SCHOOL

21 DAY NOVICE



- 2 code tapes
- 112 page book
- World maps
- Frequency charts
- Course certificate
- Free magazine coupon
- 50 piece literature set!

\$70 in equipment certificates from ICOM, KENWOOD, and YAESU **\$19.95**

COMPLETE NOVICE COURSE \$49.95

4 code tapes, 2 theory tapes, 2 text books, code oscillator set, examiner test packet, and \$70 discount coupons.

NOVICE TEXTBOOK \$4.95

Written by Gordon West, this 112 page book contains all Novice questions and answers.

NOVICE CODE COURSE \$39.95

6 tape stereo code course for learning the code from scratch. Includes certificates.

TECHNICIAN THEORY COURSE \$19.95

2 theory tapes & 2 textbooks.

GENERAL THEORY COURSE \$19.95

2 theory tapes & 2 textbooks.

TECHNICIAN/GENERAL COURSE \$19.95

Combined tech & general course with 4 tapes and 1 book.

THE COMPLETE GENERAL \$49.95

4 tapes & 2 books for theory plus 6 tape stereo code set for CW speed building.

GENERAL CODE COURSE \$39.95

6 tape stereo code course for CW speed building from 5 wpm to 13 wpm.

THE COMPLETE ADVANCED \$49.95

4 tapes & 2 books for theory plus 6 tape stereo general or extra class code course. (Specify which CW tapes you want.)

ADVANCED THEORY CLASS \$19.95

4 tape stereo theory course plus fully illustrated theory book.

THE COMPLETE EXTRA \$49.95

4 tapes & 2 books for theory plus 6 tape stereo code set for CW speed building 13 wpm to 22 wpm+!

EXTRA CODE COURSE \$39.95

6 tape stereo code course for CW speed building from 13 wpm to 22 wpm+.

EXTRA THEORY CLASS \$19.95

4 tape stereo theory plus fully illustrated theory book.

GORDON WEST ELECTRONICS BOOK

200 page marine electronics book plus marine mobile antenna hints. **\$19.95**

COMMERCIAL TEST PREP BOOK \$29.95

BRASS CODE KEY & OSCILLATOR \$19.95

PLASTIC CODE KEY & OSCILLATOR \$14.95

COPPER GROUND FOIL 60¢ FOOT

SINGLE CODE TAPES

\$9.95 EACH • BUY 2, GET 3rd ONE FREE

- 5 wpm Novice Tests • 5 wpm Random Code
- 5-7 Speed Build • 7-10 Speed Build • 10 Hump Jump
- 10-12 Speed Build • 12-15 Cols & Numbers
- 13 Random • 13 Test Prep • 5-15 General Quiz
- 13 Car Code • 13-15 Speed Build • 15-17 Speed Build
- 17-19 Speed Build • 20 Random • 20 Test Prep
- 20 Car Code • 10-24 Extra Quiz

Pass any upgrade & receive \$25 Kenwood rebate. ** plus a license holder & will certificate FREE! **

Slow code uses 13 wpm character speed. Same day service. Add \$3.00 UPS for courses, or \$1.00 for single tapes. 100% return policy.

GORDON WEST RADIO SCHOOL

2414 COLLEGE DR., COSTA MESA, CA 92626

Mon.-Fri. 10-4pm (714) 549-5000

Deciphering the Decibel

In any listening situation, the smallest increase in the volume of any sound that can be detected by the human ear is one fourth, or 25 percent, over a previous sound. In other words, if any two sounds have a power ratio of at least 1.25 to 1, we will detect that the former is louder.

This ratio holds true for a wide range of power regardless of the absolute power of a particular sound. If we hear two sounds whose powers are respectively 12.5 and 10 watts, we would still hear the same difference in their loudness as we heard between the sounds at 1.25 and 1 watt, since the ratio is still the same (1.25).

Bell Namesake

This is because we hear approximately in proportion to the logarithm of the intensity, rather than in direct linear response to it. The decibel has been developed as a convenient unit for expressing and measuring intensity logarithmically. Mathematically, "1 decibel" is approximately 10 multiplied by the common logarithm of the ratio, 1.25 to 1.

The factor of 10 enters the picture because the original unit used was the "Bel" (named for Alexander Graham Bell), which is the logarithm of 10 to the base 10. The decibel is actually one-tenth of a "Bel" and is used in preference to the Bel inasmuch as a change of sound intensity of 1 decibel approximates very closely the ratio of 1.25 to 1, which is the minimum change in sound intensity human ears can detect.

The decibel is used widely in audio work because it represents accurately the response of the ear to different intensities and because it can be used over a wide range of intensities. Decibels are used for current ratios, amplifier gain, hum level, loss due to negative feedback, network loss and loss in attenuator circuits, loss in transmission lines and gain in antennas.

Gain = +dB; Loss = -dB

Gain is expressed as plus dB; loss as minus dB. Ratios between currents and voltages across the same or equal resistors are also expressed in decibels. In the case of voltages or currents, the logarithm of the ratio must be multiplied by 20. This is because the decibel is basically an expression of power (wattage) which is always a function of the square of either current or voltage.

To square a number, you double its logarithm. Thus, in the case of values already expressed as powers (wattage), we multiplied the logarithms of the ratio by 10. But in the case

of values not yet expressed as powers, such as voltage or current we multiply the logarithm of their ratio by 10 doubled, or 20.

We now can state all the above in terms of these simple formulas:

$$Db = 10 \log \frac{P_2}{P_1} \quad \text{When } P \text{ is known in watts.}$$

$$Db = 20 \log \frac{E_1}{E_2} \quad \text{When } E \text{ is known in volts.}$$

$$Db = 20 \log \frac{I_1}{I_2} \quad \text{When } I \text{ is known in amps.}$$

The value of the "common logarithm" (sometimes written as \log_{10}) is easily obtained from standard tables that are included in most mathematics and technical textbooks. From then on it's a case of simple arithmetic.

The table included with this article is a short-cut aid in determining dB gain or loss. It has, in effect, already computed the logarithms of the power (and voltage and current) ratios for you. Notice that the right-hand side (fourth and fifth columns) expresses ratios in which there is a gain (1 or higher). The left-hand side (first and second columns) expresses ratios in which there is a loss (1 or lower). The center column gives you the number of decibels of either gain or loss for a given ratio.

Let us now work a few problems using both the formulas and the table.

Example: What will be the gain in dB of an amplifier whose output power rises to five times its input?

The formula tells us that for power (in wattage),

$$Db = 10 \log_{10} \frac{P_2}{P_1}$$

In this case, P_2 over P_1 is given; it is known to be 5. (In other words, the input might be 2, the output 10 resulting in a ratio of 5 to 1). The log of 5 is approximately 0.7. Multiplying this by 10, we get 7, which is the solution. In other words, this amplifier has a gain of 7 decibels. In practical terms this means that the difference in sound intensity between the input to the amplifier and the output from it would be heard by the ear as seven times the minimum change in loudness that we could detect.

Now let us use the table to work this problem. Since there is a gain involved, we refer to the right-hand portion of the table. Since the values are in terms of power (watts), we use the fifth column. The nearest figure in this column to our power ratio of 5 happens to be 5.012. This corresponds to plus 7 dB.

Let us work a problem using voltages. Example: What will be the gain in dB of an amplifier whose output voltage rises to 9 times its input (across equal resistances)? Here we must multiply the logarithm of the ratio by 20, since we are dealing with a voltage value rather than a wattage value.

The common log of 9 is 0.95. Multiplying this by 20 we get 19 dB.

Again the same answer could be obtained directly from our table. Since our ratio is expressed in voltage, we check down the fourth column. We find that the number of decibels that corresponds most closely to a voltage ratio of about 9 happens also to be 19 dB.

As long as this table is available, there is no need for the formulas or for logarithmic values of the ratios. If the table is not handy, though, the formulas and a table of common logarithms will solve any problem.

Let us now take a situation in which there is a decibel loss to be calculated. For example, an amplifier has a negative voltage feedback loop which is intended to reduce distortion at the output. This feedback voltage also reduces the over-all gain of the amplifier. But by how much? Assume that we measure 1.2 volts at the output of the amplifier with its feedback loop in operation. Then we disconnect the feedback loop and find the output measures 12 volts.

Our ratio in this case is 1.2 over 12, or 0.1. We now consult the left-hand side of our table for decibel loss. Since these are voltages we check down the column so headed. We discover that a voltage ratio of 0.1 indicates a 20 dB loss. Thus we express the feedback value in this amplifier as minus 20 dB.

Conversely, if an amplifier's specifications claim that the circuit incorporates a minus 20 dB feedback loop (or "negative feedback, 20 dB"), this means that the output of the amplifier should measure one-tenth the voltage with the loop that it does without the loop.

Another example of decibel loss: Assume that an amplifier has a rated output of 20 watts. We want to determine what its hum level is because in order not to hear the objectionable hum, its level should be very low--maybe 50 dB below the rated output of 20 watts. Here's how this is done: We apply a signal to the input of the amplifier and connect a voltmeter across its output terminals. Next we turn up the gain of the amplifier to the point necessary to produce its rated 20 watts output.

Since we are using a voltmeter at the output terminals, we must translate watts into volts. From Ohm's Law we know that power in watts is equal to the square of the voltage divided by the resistance. ($P = E^2/R$). Therefore, E equals the square root of $P \times R$. P is 20 W and R is 8. Thus E equals the square root of 160 which is approximately 12.7 volts.

Consequently, when our voltmeter - connected across the output terminals reads 12.7 volts, we have reached the amplifier's rated output of 20 watts. We now disconnect the input signal and short the input. Naturally, the voltage to be expected with no input signal would be quite small. But whatever is present will be noise and hum within the amplifier circuit itself. Again, consulting our voltmeter (still connected to the output terminals) we discover that it reads 3 millivolts (0.003 volts).

To determine the number of "minus decibels" the hum level is with respect to the 20 watts output, we must first get our voltage ratio, which is 0.003 over 12.7. This comes to approximately 0.00024. Since we are dealing with a loss in voltage, we consult the first column of our table, and we find there is no figure like our 0.00024!

Therefore we must interpolate. The nearest significant figure to our ratio of 0.00024 happens to be 0.251. This gives us minus 12 dB. But our ratio is about one thousandth, or 10^{-3} , of 0.251. We, therefore, consult the 10^{-3} value in the same column and discover we must add 60 dB to the minus 12 we already have. Thus our final answer is minus 72 dB. This means the hum level of the amplifier is 72 decibels below its rated output, which puts it well below the level at which it could be heard.

Conversely, this means that if an amplifier is rated at 20 watts output with a hum level of minus 72 dB, the actual voltage measured across the output terminals with no signal input should not exceed 0.003 volts.

Three main types of meters are used for measuring dB directly, without the need for calculating values by the use of logarithms or the table. The simplest and possibly the most familiar type is the "output meter" or the decibel scale found on many multimeters. This is actually an A.C. voltmeter calibrated to read the number of dB that expresses a ratio between the power being fed into the meter and some fixed reference level, usually 6 milliwatts. The meter calibration assumes that the voltage is measured across 500 ohms resistance. This type of meter is used in determining the relative outputs of various audio circuits and is also used in receiver alignment.

The VU meter has time-constant characteristics which determine its response to voltage peaks, such as "sound bursts" or other short time interval peaks. It is widely used in broadcasting and recording studios to monitor the output levels of programs.

A third type of decibel meter is the sound level indicator. This is actually an assembly of a microphone, an amplifier and an a.c. voltmeter calibrated to provide a dB reading which corresponds to human hearing levels. On this meter, zero dB represents the threshold of hearing. This meter is used by acoustics technicians to determine hearing conditions in auditoriums and theaters.

In summary, the decibel is used to express any ratio of power, voltage, current acoustic energy, etc. whether it be a gain relationship or a loss. It can be used to express the range of a symphony orchestra and then to determine how much amplification is needed to carry the music across lines of certain distance in order to fill a hall of a certain size or cut a particular recording. Any type of gain or loss in any circuit may be expressed in decibels which provide a quick and accurate key to the operating conditions of the circuit.

CB TABLE

Voltage or current ratio (equal Z)	power ratio	loss gain dB	voltage or current ratio (equal Z)	power ratio
1.000	1.000	0	1.000	1.000
0.989	0.977	0.1	1.012	1.023
0.977	0.955	0.2	1.023	1.047
0.966	0.933	0.3	1.035	1.072
0.955	0.912	0.4	1.047	1.096
0.944	0.891	0.5	1.059	1.122
0.933	0.871	0.6	1.072	1.148
0.923	0.851	0.7	1.084	1.175
0.912	0.832	0.8	1.096	1.202
0.902	0.813	0.9	1.109	1.230
0.891	0.794	1.0	1.122	1.259
0.841	0.708	1.5	1.189	1.413
0.794	0.631	2.0	1.259	1.585
0.750	0.562	2.5	1.334	1.778
0.708	0.501	3.0	1.413	1.995
0.668	0.447	3.5	1.496	2.239
0.631	0.398	4.0	1.585	2.512
0.596	0.355	4.5	1.679	2.818
0.562	0.316	5.0	1.778	3.162
0.531	0.282	5.5	1.884	3.548
0.501	0.251	6.0	1.995	3.981
0.473	0.224	6.5	2.113	4.467
0.447	0.200	7.0	2.239	5.012
0.422	0.178	7.5	2.371	5.623
0.398	0.159	8.0	2.512	6.310
0.376	0.141	8.5	2.661	7.079
0.355	0.126	9.0	2.818	7.943
0.335	0.112	9.5	2.985	8.913
0.316	0.100	10	3.162	10.00
0.282	0.0794	11	3.55	12.6
0.251	0.0631	12	3.98	15.9
0.224	0.0501	13	4.47	20
0.200	0.0398	14	5.01	25.1
0.178	0.0316	15	5.62	31.6
0.159	0.0251	16	6.31	39.8
0.141	0.2009	17	7.08	50.1
0.126	0.0159	18	7.94	63.1
0.112	0.0126	19	8.91	79.4
0.100	0.100	20	10.00	100.00
0.16×10^{-2}	10^{-3}	30	3.16×10	10^3
10^{-2}	10^{-4}	40	10^2	10^4
3.16×10^{-3}	10^{-5}	50	3.16×10^2	10^5
10^{-3}	10^{-6}	60	10^3	10^6
3.16×10^{-4}	10^{-7}	70	3.16×10^3	10^7
10^{-4}	10^{-8}	80	10^4	10^8
3.16×10^{-5}	10^{-9}	90	3.16×10^4	10^9
10^{-5}	10^{-10}	100	10^5	10^{10}
3.16×10^{-6}	10^{-11}	110	3.16×10^5	10^{11}
10^{-6}	10^{-12}	120	10^6	10^{12}

The advantage of using decibels is that it permits the simple addition of ratios to obtain complete gain and loss data whereas using E, I, or P ratios would involve multiplication and division. For example, it is easier to add 25 dB and 36 dB than it is to multiply the corresponding gain figures of 316.2 and 4000, to get the total gain of two amplifiers in cascade.

Another common use of the decibel is to determine the efficiency of an antenna system for radio. For example if an antenna is rated at 6 dBd (6 decibels over a dipole). We can easily determine from the table (look at the center column, now find 6 dB), looking to the right we find the power ratio to be 3.981 (about 4). This means any signal our antenna receives or transmits will be about four times louder than the same signal on a reference dipole antenna.

St. Louis's KSDK-TV Channel 5 Tames Scanner Intermod

by Gil Ludwig WA0YC

Engineering Supervisor/Technical Director

When the KSDK-TV news department wanted a better public service receiving station, I knew many obstacles lay ahead. How would it be possible to get commercial grade reception on six inexpensive consumer receivers, scan 100 plus channels in a two state, 50 mile radius, all with an antenna feedline about 600 feet long?

Competition among news services was at an all time high. KSDK needed to increase its visibility in the local and rural communities. Being first on the scene or having exclusive video always compliments the efforts of the #1 rated eyewitness news team of talented professionals.

Unfortunately, the original antenna system for our newsroom scanners -- a single, wide band multi-frequency antenna mounted at rooftop level -- was plagued with severe intermod from business band, telephone, and paging service interference. Surrounded by high-rise buildings and hundreds of transmitters operating in virtually every possible mode, we were being swamped.

Occasionally, some of the distant transmissions we wanted could be picked out of the harmony of overloading signals, but for the most part, it was like trying to talk across town on two low power handhelds. It was essential that the best possible broadband, omnidirectional-combined multicoupler antenna system be designed -- and at minimal cost.

Strong incoming signals could overdrive a high-gain amplifier, resulting in intermodulation distortion (Intermod) or nonlinear amplification. On the other hand, no amount of amplification can bring up a signal that does not make the trip to the antenna.

I immediately set out to make an evaluation of the interfering sources, plotting frequency on a spectrum analyzer and making a list of possible problem areas. It turned out many unsuspected sources were behind the mixing and first order images at the fundamental frequency. To add to the complications, isolation between the receiver oscillators was causing more interference. Mutual interference from two adjacent scanners was

stopping the scan sequence, as though a signal was being received.

Armed with my results, I approached Director of Engineering, Gene Hill. Hill, the man who would have to open the purse string for my project, is no easy touch. However, one hour in the news assignment room with its six receivers and three two-ways going was enough to convince him that something had to be done. Either that, or increase the use of aspirin to relieve the headaches from the stressful environment.

In the first stage of construction, three commercial grade Phelps Dodge gain antennas cut for 42.00 MHz, 155.00 MHz, and 460.00 MHz were ordered to replace the single 25-575 MHz antenna. A special 40 foot guyed tower was mounted on the three story building (See figure #1) that houses the KSDK studios and general offices. Keeping in mind that St. Louis has been known to produce severe weather, additional measures

Fig. 1: Six receivers and three two-ways was enough to convince the holder of the purse-strings that something had to be done! The first step was the antenna.

were taken to protect the area from something flying off the downtown rooftop.

In the second phase, a receiver multicoupler amplifier was needed to combine the three separate antennas before the 600 plus foot cable run to the news room.

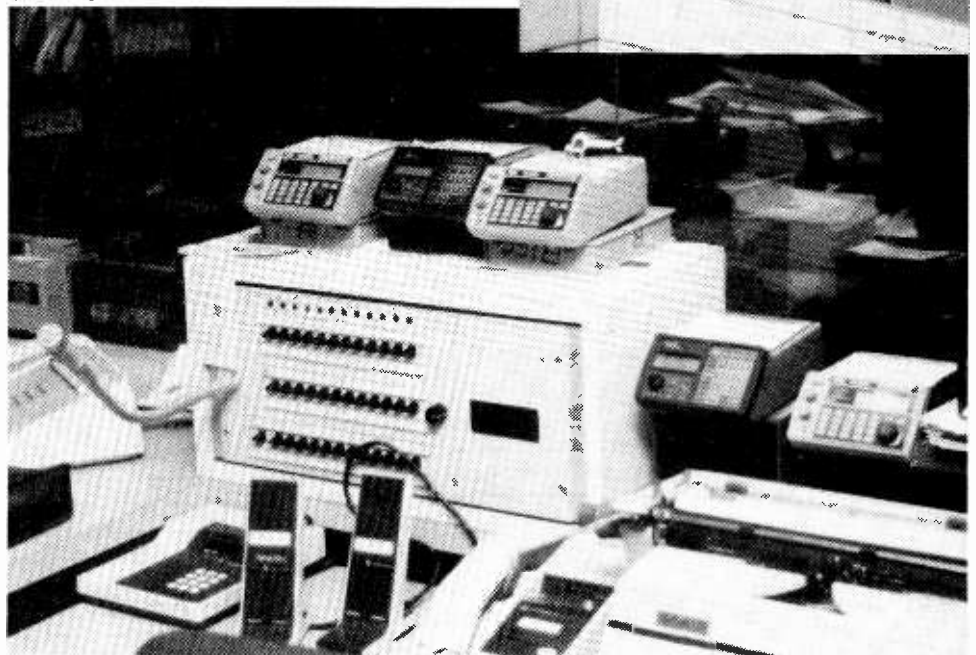
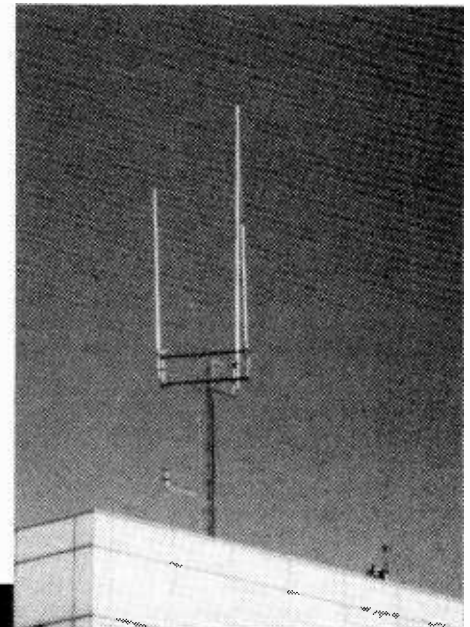

For the custom package that included expansion, I choose WI-Comm Electronics of Massina, New York, to produce a custom CRC11 multicoupler with two band reject filters for 152 MHz and 158 MHz. Not only could they provide an inexpensive system, but amplification at the antenna, where it counts. Sales Manager John Steele, and Tom Poncar of WI-Comm were extremely helpful when working with them on the phone.

Here is how the CRC11 works (See figure #2). The three antennas are fed into the VHF-Lo, VHF-High WLA-16M wideband two-way power combiner with a coupling loss of 3.4 dB. Two hybrid amplifier blocks are arranged in a feedforward configuration to complete a uniform cancellation of all distribution products (2nd, 3rd, . . . harmonic, 2nd, 3rd, and higher order intermodulation products are typically reduced by 25 dB).

The combined output is amplified in a wideband ultralinear amplifier WLA-16R. The UHF signal is first amplified in a wideband amplifier WLA-28M in a push pull configuration. Two transformers serve to split the input signal, and to combine the amplified signals from the two stages.

The VHF and UHF are then combined in a PC28-6 dB directional coupler with output to output isolation of 25 dB, and coupling loss less than 3.5 dB. Isolation between the lo and high VHF download cables will be 25 dB. Isolation between the VHF and UHF ports is greater than 20 dB, through loss (UHF in to out) is 1.75 dB, and coupling loss (VHF in to out) is less than 7 dB. The combined signals are then fed to the PD28-8 power divider at the end of the 600 plus feet of coax cable. (See figure #3).

WI-Comm not only came up with a neatly packed 19" wide enclosure suitable for rack mounting, but far exceeded the requirements specified.

The result? After several months of operation, I can honestly say that the investment was well worth it. The six receivers in the news room and one in the weather center are now hearing transmitters that were *never* heard before. About the different kinds of interference, I have had no reports of any kind since the new system was installed. All in all, it's amazing, especially when you consider our location here in RF Heaven.

Gil Ludwig is immersed in communications both on and off the job. He holds the following certifications: Advanced Class Amateur License WA0YCY, FCC General Radiotelephone with Ship Radar endorsement, NARTE Certified 1st Class Engineer, Master endorsement, NABER Certified Technician, SBE Certified Television Engineer; and he is a member of the Audio Engineering Society, Air Force MARS - AFA3NW - and a licensed private pilot.

KSDK-TV (an NBC-TV network affiliate) uses four AR-2001's and two MX-5000's in the news room; one BC-20/20 in the weather center; 13 BC-20/20's in the news vans, and the satellite uplink van uses an MX-7000!

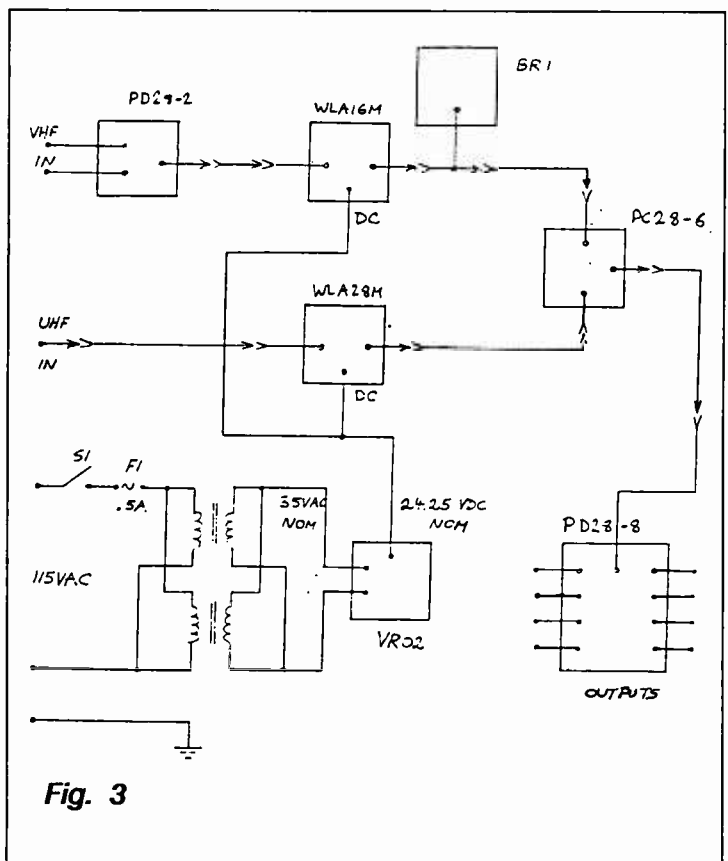
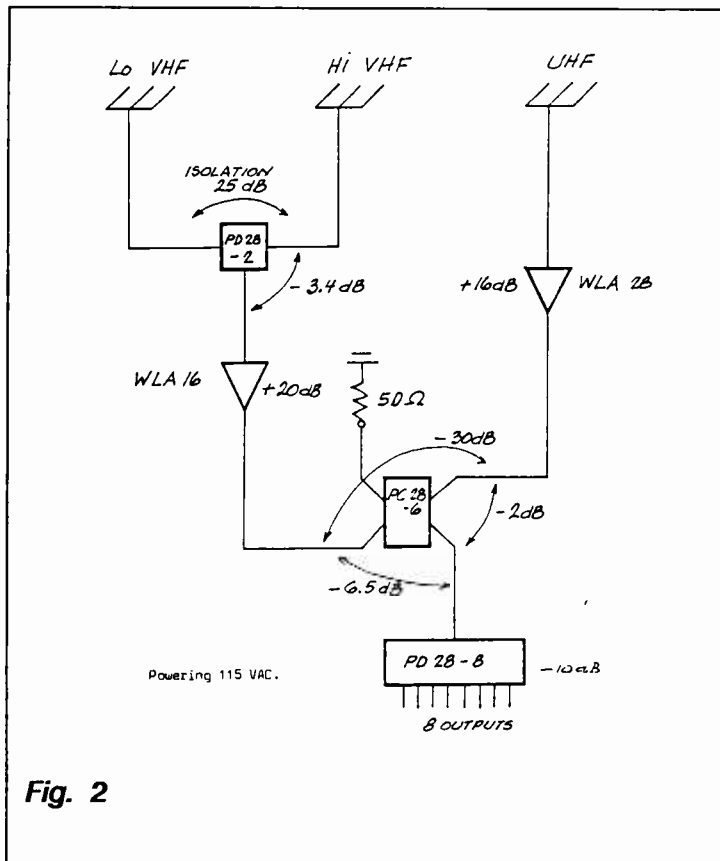

From the Publisher:

Upon Turning Fifty

I could hardly believe the calendar. There it was, February 23rd, and I had just completed my first half century! I looked at myself in the mirror, surely, this wasn't the face of a fifty-year-old man! The residual aches and pains from a recent bumpy trip down a flight of steps were due to the fall, not to my age. Certainly not.

As I have "matured" over the these fifty years, so has the electronic age. I am awed by the enormous progress spurred on by wars, the profit motive and international competition.

Sitting in a high school library in the 1950s, I read of wondrous predictions for the newly-emerging "transistor", an acronym for "transfer resistor", a device which, instead of amplifying voltages like a vacuum tube, amplified currents instead.

I read further how the cost of those laboratory curiosities had dropped to only \$64 apiece, but hopefully the prices would fall to \$32 or even less in the foreseeable future. Now we buy vastly-superior transistors for pennies, even in small quantities.

One optimistic writer ventured that transistors would someday be so plentiful that they would be on strips, removable similar to matches torn out of a matchbook! Ridiculous! Yet now we have tape-fed automatic insert machines doing precisely that.

Shortly after high school I worked as a mailroom clerk for the Chesapeake and Ohio Railway at the Terminal Tower in Cleveland, Ohio. This was shortly after I flunked out of college because I was busy chasing police and fire calls heard on my mobile receiver instead of attending classes.

During that sobering six months of having to work for a living before I re-entered college, I was introduced to the Remington-Rand UNIVAC, a forest of 6SN7 dual-triode vacuum tubes (transistors couldn't be trusted yet) which occupied several rooms of the Terminal Tower!

That machine was an analog computer, a miracle of the electronic age; yet, as impressive as the installation was, it couldn't begin to compare with the power behind my present desk-top digital marvel on which this is being typed.

Vacuum tubes slowly disappeared first from new equipment, then from replacement shelves, as the transistor proved to be an oracle of the future. The early Raytheon CK722 evolved into the more reliable RCA 2N404, then germanium capitulated to silicon and the 2N3638 was born.

A glimpse at a transistor catalog now reveals a bewildering array of type numbers, all exhibiting minor differences--a choice far more vast to today's design engineer than a tube manual would have displayed just a couple of decades ago.

Technology was on the move. Why not put several transistors into a single package? The array was born. Why stop there? How about interconnecting active components into a working circuit? Enter the integrated circuit.

I don't know about you, but I have found this first half-century dazzling, and I am eager to watch what unfolds during the second half!

Bob Grove WA4PYQ

LETTERS

continued from page three

Where to Send Clippings?

From time to time I find items of communications interest in my local paper and so forth. Where should I send them so as to get the most use?

Martin Gold
Cadaahy, Wisconsin

If an article "fits" into a specific column, we suggest that you send it directly to the author of that column. For example, if you find an article on ham radio, send it to Ike Kerschner, our ham columnist. Most MT authors put their addresses at the top of their column. If you can't decide where it should go, send it to editor Larry Miller at Box 98, Brasstown, North Carolina 28902. All such contributions are greatly appreciated.

Editorial Dreck

The idea of starting a campaign to support commercial shortwave stations sounds good. And it all makes sense. If we can show that we, as shortwave listeners, are really out there, perhaps advertisers will begin to take the medium seriously. And investments will undoubtedly follow. How about that? Capitalism does work!

Michael Smith
Barrington, Illinois

Your [March 1988] editorial, "Let's Start a Campaign," has it all backwards. Where do you get off calling programs like the Voice of America's *Press Conference USA* "government-sponsored dreck"? We need fewer stations like WRNO and KUSW, not more.

Harrel Kline
Cantonsville, Maryland

While you can find -- in many cases only after extensive searching -- something of at least moderate interest on virtually every shortwave station, probably about 85% of what's on the air is nothing more than government-sponsored dreck. Does anyone down at the VOA, to use your example, actually believe that there is high audience interest in a multi-part series on the American Constitution? Would you sit through a multi-part series on the Togolese constitution? I doubt it. What's more likely is that this sort of stuff is broadcast by government stations because it's the sort of thing that's always been broadcast on government stations. And inertia is a powerful thing in a bureaucracy.

If shortwave is ever to reach its potential as an international medium, someone, somewhere, has to begin to look at the crisis in programming. People are not stupid. They're not

fooled by propaganda. And they don't like third-rate programming.

Allow me to quote a letter from reader Rick Ansoff of San Diego, California:

"I feel both proud and relieved when [the U.S.] AFRTS (Armed Forces Radio and Television Service) announcer states that the programs from the major networks are re-broadcast 'without censorship or propagandizing.'

"About two years ago, while passing through Oslo, Norway, I was told by a local citizen that a survey sponsored by the Norwegian Government showed that the 100 watt AFRTS FM station in Oslo frequently captured (much to the embarrassment of local radio officials), about sixty percent of the local radio audience.

"I am not surprised. Local AFRTS programming typically features popular American music, as well as news and sports, presented in an uninhibited (and by European standards) direct, no nonsense fashion. In my judgment, Europeans and Americans alike listen to AFRTS to avoid the 'official' (and often dull) atmosphere of government-sponsored stations which try to be objective while, paradoxically, representing the views of a particular regime."

The whole idea of these great, big, yet overwhelmingly dull, government stations, racing to increase their power and install new relay facilities to improve their signals, reminds me of a 1849 quote from Henry David Thoreau: "We are in a great haste to construct a magnetic telegraph from Maine to Texas, but Maine and Texas, it may be, have nothing to communicate." And so it goes with shortwave.

Whatzit?

I'm a shortwave listener and a little while ago I heard a station on 13645 MHz. I heard this station at 2224 UTC. Could you tell me what it was?

Barry Rader
Fostoria, Ohio

Barry, you don't give us much to go on. Moscow's Radio Station Peace and Progress is scheduled, in English from 0730 to 1200 UTC and in an as-yet unidentified language from 1130 to 1630 UTC (both targeted to south Asia). I have nothing formally scheduled at 2224 UTC. As more and more stations prematurely climb onto the 13 MHz bandwagon, though, anything is possible. Without more detail about what you're hearing, however, I can't even hazard a guess. -- ed.

GALAXY ELECTRONICS

BOX 1202—67 EBER AVE., AKRON, OHIO 44309
(216) 376-2402



NEW BC-950 XLT
\$299.00
100ch, 29-54, 118-174,
406-512! Search, Scan, Delay,
Priority, AC/DC, SERVICE
SEARCH!! 800 mhz!! 806-956!!



MODEL TS-2
\$319
75ch, 29-54, 118-175,
406-512, 806-950!! TURBO-
SCANS 40 ch Per Second!!



SHORTWAVE RADIO

NRD-525 .09-34 mhz, 200 Memorys, Scans, Ultimate!	1165.00
ICOM ICR-71/A 100khz-30mhz, 32 Memorys, Scans...	859.00
FRG-8800 150khz-30mhz, 12 Memorys, Digital, Scans...	649.00
KENWOOD	
R-5000 100khz-30mhz, Digital, 100 Memorys, Scans.....	799.00
R-2000 150khz-30mhz, 10 Memorys, Digital, Scans.....	599.00
SONY 2010 150khz-30mhz, 76-108, 116-136mhz	319.00
SONY 2003 150khz-30mhz, 76-108, Memorys	234.00
PRO-80 150khz-216mhz, 40 Memorys, Scans	389.00

POLICE/FIRE SCANNERS

BC-800XLT 40ch, 29-54, 118-174, 406-512, 806-912	279.00
BC-600XLT 100ch, 29-54, 118-174, 406-512, S/Search	223.00
BC-100XLT 100ch, 29-54, 118-174, 406-512	225.00
BC-210XLT 40ch, 29-54, 118-174, 406-512, AC/DC.....	219.00
REGENCY	
TS-2 75ch, 29-54, 118-174, 406-512, 806-956, AC/DC.....	319.00
TS-1 35ch, 29-54, 118-174, 406-512, AC/DC	249.00
HX-850 55ch, 29-54, 118-174, 406-512, Handheld.....	239.00
Z-60 50ch, 30-50, 88-108, 118-174, 406-512, *Special*	164.00

Cordless Phones • CB Radios • Radar Detectors • Frequency Directories
True Discount Prices & Free UPS Shipping To 48 States Picture Catalog \$1.00 Refundable

MONITORING TIMES DEALERSHIPS

are available at a substantial discount.

☆☆☆☆☆

Call or write Judy Grove at
P.O. Box 98, Brasstown, NC 28902
704-837-9200.

I Beg Your Pardon

In your recent article, "DXing the Brown Water Coast Guard," the author, a Mr. James T. Pogue states that "operation on the HF [shortwave] bands in the 2nd district ended [in 1974]." There is, in fact, HF operations still in existence since I have heard Coast Guard "ComSta St. Louis."

Charles Hartz
Wilmington, Delaware

We checked with the communications officer for Coast Guard District 2, a Mr. Van Rottenbeck. The author, he confirmed, was correct, saying that indeed "there is no HF currently available in the midwest." Van Rottenberg added, however, that they are trying to "scrounge up some equipment" so that they can return to HF. Unfortunately, no formal date for the return to HF was available. --ed.

Interested in writing?

The new MT writer's guideline is now available.

Send a self-addressed, stamped envelope for your copy to

Writer's Guidelines
Monitoring Times
P.O. Box 98
Brasstown, NC 28902

STOCK EXCHANGE

NOTE: Monitoring Times assumes no responsibility for misrepresented merchandise.

NON-COMMERCIAL SUBSCRIBER RATES: \$.10 per word; **NON-SUBSCRIBER RATE:** \$.25 per word. All ads must be paid in advance to Monitoring Times. All merchandise must be personal and radio-related. Ads for Stock Exchange must be received 45 days prior to the publication date.

COMMERCIAL RATES: \$30 per 1-3/4" must accompany ad, payable to *Monitoring Times*. Send 1-3/4" square camera-ready copy, or any square copy to be reduced, or send text for typesetting.

SANGEAN ATS-803, brand new, never used - \$160 - excellent portable SW. Moneyorder; Ted Miller, PO Box 59031, Chicago, IL 60659.

JUST GOT A MICROFICHE READER! Have you got frequency microfiches that you would like to convert to cash? Give me a call at [615] 966-6728 (office) or [615] 966-6328 (home) and let's deal! (ask for Steve)

Wanted: **SHORTWAVE PORTABLES.** Doug, WB8SCD, [304] 273-5691.

Wanted: SONY CRF320A, excellent condition. Bill Cress [201] 694-5154, 28 Worcester Dr, Wayne, NJ 07470.

REGENCY RH-50 Programmable VHF (150-160 MHz), two-way 25 watt powers up but needs keyboard repair \$55 [803] 723-5061.

MOTOROLA MH-10 VHF Portable Handycam 5 watt works well, new battery and antenna \$100 [803] 723-5061.

WANTED: ICOM M-5 Marine VHF

Portable to purchase outright or trade scanners plus cash, must be in excellent condition [803] 723-5061.

For Sale: INFO-TECH M-6000 (V.5) \$650.00. Mint condition in original box. Riley Kinney, 1325 Woodgate Way, Tallahassee, FL 32312. [904] 386-5539 after 0000 UTC.

Wanted: Pair of MOTOROLA HT-220s, VHF-hi. Also want police radar speed guns. Mark Hartman, 14 Silver Lane, Kirkwood, MO 63122. Call [314] 966-3894.

HARD TO FIND PARTS for Shortwave, CB and Crystal Radios for trade, swap or whatever. Write for list of what I have. Jim Yeary, 12922 Harbor #800, Garden Grove, CA 92640.

Wanted: SONY ICF 6800 W. Frank Trumpy [515] 292-4499 between 0000 and 0300 UTC, MWF.

SCANNER, 200 Channels, all standard bands, 30-512 MHz, Realistic PRO-2021, all accessories, etc., new, mint, \$155.00 UPS PPd, GRM, W2BLL, RD2, Box 72, Boonton, NJ 07005, [201] 334-7515.

I have an EAVESDROPPER antenna, complete, new in box; paid \$59 for it and will sell for \$35 including UPS. Money Orders Only. Dan Pennington, 7511 Hetzler Rd, Middletown, OH 45042, [513] 422-6984 evenings.

For Sale: BEARCAT 100XL \$140.00; AR2002 \$400.00. Both in excellent condition in original box. [313] 463-0172 mornings.

For Sale: FRV 7700 VHF Converter 118-159 MHz and FRT 7700 tuner. All for \$59.00. Mint. Bob Floyd [704] 366-6549.

For Sale: INFO-TECH M600A with parallel printer interface, \$400. David Cook, 11649 Shasta Lane, Oklahoma City, OK 73162. [405] 755-0795 9:30 to 6:00 weekdays.

For Sale: REGENCY 10 channel crystal scanner, \$60; REGENCY D-310 programmable scanner, \$90. Matt Tyszka, [203] 693-0468.

For Sale: REALISTIC PRO-32 200 channel

handheld with nicad and charger \$225.00. PRO-2021 200 channel mobile \$225.00. BEARCAT 100 16 channel handheld with nicad and charger \$125.00. REGENCY D-310 Home unit 50 channel+ pre-programmed freq (fire, police, marine, mobile phone, etc.) \$175.00. Also have some used UHF mobile and handheld two-way radios good for GMRS use. Call Roy [301] 571-2215 8-9:30 AM or after 6:00 PM Mountain time.

Wanted: S-meter, sensitivity, scan speed, additional channel, modifications for PRO-2004, HX-1500, PRO 32, BC-205XLT, SR15, 70XL. Will pay. Any information helps. C. Bronson, 28 East Ferry La., Westport, CT 06880 [203] 227-6170.

Would like to trade my ICOM R70 (excellent condition) for an ICOM R71 or sell R70 outright - best offer. Bruce Gustafson, 10294 Atwood Road, Roscoe, IL 61073.

Wanted: ZENITH Trans-Oceanic 1000-D 2000 and 3000-I in working condition. 3000-I junker OK with complete cabinet. Harald Herp, 6615 Michele Ct, Huntington, MD 20639 [309] 855-7071.

For Sale: New 800XLT BEARCAT scanner in box \$175. H.M. Nance, 3117 Gerome, Richland Hills, TX 76118. [817] 284-4357.

For Sale: INFO-TECH M-600 ASCII/-Baudot/TOR/CW decoder \$439. ZENITH 122A monitor (amber) \$85. ICOM IC-R70 communications receiver 100 kHz-30 MHz (AM,USB,LSB,C2W,RTTY) \$410. All in excellent condition. Bruno DuBois [202] 944-6486. Call between 9:30 and 11:45 AM eastern time.

Wanted: Frequencies related to the Indy 500. Drivers, pit crew, pace car, crash, track crew, etc. Will refund postage. Timothy Rall, 12027 Summerville Dr, Sharonville, OH 45246; [513] 671-2221.

Sell: Brand new PANASONIC RF-B60 in box. Cost \$250; first certified check for \$200 plus postage received, no calls. Steve Clifton, 800 West End Avenue, New York, NY 10025.

REGENCY HX2200 hand-held, 20-channel scanner, with aircraft and 800-950 MHz coverage. Two antennas and AC power adapter. \$100. H. Corkran, 334 Milton, Dallas, TX 75205, [214] 363-4865.

For sale or trade: HALLICRAFTERS CRX-1 (30-50 MHz); PEARCE-SIMPSON Marine Transceiver (2 MHz band-crystals); HALLICRAFTERS S-95 (156-173 MHz); HALLICRAFTERS Continental (MW & 6-18 MHz); LAFAYETTE PF300 (144-172; 30-50; 450-470 MHz); REALISTIC PRO-2B (30-50, 152-174 MHz); HALLICRAFTERS S38D (MW + 1.7-30 MHz). Want: Electric trains or whatever or cash offers to: Bill Smith, RFD 238W3, Locust St, Douglas, Mass. 01516.

INDEX OF ADVERTISERS

ACM Security	37
AF Systems	43
Alpha Delta	84,85
ANTenna Farm	77
Antique Radio	45
Communications Electronics	2
EEB	46
Galaxy	93
Gordon West	87
Grove	41,69,81
Grundig	Inside covers
Icom	Back cover
National Tower Company	11
Radiofile Communications	83
Scanner World	17
Systems & Software	5
Universal SW Radio	39

Attention Apple II+, IIc,
IIe, IIgs Owners

**HAMBONE
CODE PRACTICE SOFTWARE**

Random letters, variable speed 5-20 WP, easy to use. Perfect for beginner's and upgrade tests. Fully guaranteed - Will ship within 24 hours. Send \$19.95 check or money order to:

**Chesterfield
Video & Electronics**
Gil Ludwig WA0YCY
P.O. Box 232
Chesterfield, Missouri 63006

RADIO ASTRONOMY

THE RADIO OBSERVER, a monthly 24-page "How-to-do-it" magazine. Annual 12-issue subscription \$20

Technical radio astronomy books, components, modules, and complete receivers

For a sample magazine and brochure send \$2 to:

BOB'S ELECTRONIC SERVICE
7605 DELAND AVE.
FT. PIERCE, FL 34951
PHONE (305) 464-2118

Scanner Owners

MAINE

304 page guide with 7,500 listings \$14.95 plus \$2.05 shipping

MASSACHUSETTS

384 page guide with 12,700 listings \$17.95 plus \$2.05 shipping

NEW HAMPSHIRE

Third Edition now available \$14.94 plus \$2.05 shipping

Official Scanner Guide

Post Office Box - 712
Londonderry, NH 03053

THE BEST VALUE AROUND
Monitoring Times
Commercial Stock Exchange

★ **New to Scanning?** ★

Obscure, interesting frequency list that will generate other active frequencies plus detailed lowdown on hearing cellulars.

\$2 + SASE.

PETE HAAS
P.O. Box 702
Kent, Ohio 44240



COMMODORE/AMIGA CHIPS or FAST REPAIRS for C64/128 Computer/ Peripherals at low prices (eg. C64 \$39.95 complete). 6510 Chip-\$9.55; 6526 \$9.95; 6567-\$14.75; 6581-\$12.85; PLA/82S100 \$12.50; 325572-\$10.95; 325302-\$12.95; 8721-\$12.50; 8722-\$14.75; 901 ROM Series-\$10.95, and many others...

"THE COMMODORE DIAGNOSTICIAN"
A complete diagnostic reference chart for fixing Commodore computers, etc. An absolute must for those who want to fix their own computers, and save money and down time. \$6.95 plus \$1.50/line. Heavy Duty Power Supply for C64-\$27.95+UPS.

Kasara Microsystems, Inc.
34 Murray Hill Drive
Spring Valley, NY 10977
1 800 248 2983 Nationwide
or 914 356-3131

**YOU
AINT HEARD
NOTHIN...YET!**

Largest selection of scanner frequency guides (federal, military, police, aero, etc.); AM/FM/TV broadcast directories; HF "ute" directories; Books on espionage, covert ops., bugging, wiretapping, surveillance, clandestine radio, & more!
BIG FREE CATALOG!

CRB RESEARCH
P.O. Box 56-MT
Comack NY 11725

53 issues Monitoring Times, March/April 1983 thru December 1987, in binder. Complete set only. Ship UPS \$45.00. Scott Edwards, 776 John Carroll Lane, West Melbourne, FL 32904.

RTTY Equipment for sale: HAL CT2100 Communications Terminal; HAL RS2100 RTTY Scope; HAL KG12NU green screen monitor, mint condition in original box with manuals. Cost over \$1100.00 new; asking \$420.00. Consider swap for either BEARCAT 205XLT handheld scanner or SONY PRO80. UPS delivery. John [504] 749-2962.

For Sale: INFO-TECH M6000, like new condition, used very little with cable, manual, books, \$635; SAMSUNG mono monitor, \$50. Details, Vernon [601] 896-6639.

For Sale: SONY ICF-2010, 4 months old - \$280; G.E. Digital World Monitor - \$130; RADIO SHACK PRO-2021 200 channel scanner with Serv. Cont. - \$260; PRO-31 10-Ch. scanner with AC/DC adapter - \$150; BEARCAT 100XL 16-Ch. scanner, case and AC/DC adapter - \$140. All mint condition in original boxes. Call after 5 PM EST [617] 347-3802. Package deal considered.

Will pay \$5.00 for copy of VNG, Stars and Stripes Victory on Radio Australia or Voyager 0800 to 1400 UTC Dec 24th, 1986. Call Bob Jr. collect after 5 PM at [301] 2421-4282.

SCAN ATLANTA - I am interested in forming a scanner/monitoring club in the metro-Atlanta GA area or just getting together with other "buffs." Would like to swap frequencies, codes, techniques of metro public safety depts. I've been at this for over 15 years and find few enthusiasts around. Let's get something started! Contact: Jim

Dempsey [404] 294-0013.

Wanted: Service Manual for BEARCAT 300 scanner. Frank Giuffrida, 1054 E. First St., Long Beach, CA 90802.

For sale or trade: R-2000 communications receiver, V.G. to excellent condition, 4KHz wide special AM filter; CW filter, \$425.00 neg.--Will trade for TS-130 S or SE or Icom 730 ham rig. Call for details - 4:00 pm-11 pm EST [717] 763-9047.

Wanted: SONY Earth Orbiter, Model CRV-5080, SW portable, in any condition. Louis Yadevia, 601 Church La., Upper Darby, PA 19082.

HAL-Telereader RTTY/CW CWR-6750 \$300.00. YAESU FRG-9600 VHF/UHF receiver \$300.00. YAESU FRG-8800 receiver w/converter \$325.00. [716] 693-5290.

BEARCAT 101 programmable scanner - \$75; REALISTIC DX160- \$100; PALOMAR 50 watt broadband linear amplifier - \$75; All in excellent condition with manuals. [512] 837-0729 evenings.

For Sale: REGENCY HX-1500 handheld scanner. Like New! incl. batt., charger, in original box - \$180. T. Irby, PO Box 1418, Winter Haven, FL 33880. I pay shipping in US.

Wanted to buy: CASSETTE TAPES of NYPD or LAPD during periods of heavy activity. Ed Anderson, PO Box 4492, London, Ontario, Canada, N5W5J5.

TAP Newsletter. Complete set. Over 300 pages of Telephone Phreaking, Hacking, Surveillance and Bugging. \$50 money order. J. Leonardelli, Box 722, Station A, Downsview, Ontario M3M-3A9.

CLEARANCE SALE!

Limited supply on all items

SANGEAN ATS803 shortwave receiver - new with warranty, \$140 includes UPS shipping.

MOBILE CIGARETTE LIGHTER POWER ADAPTOR CORDS for scanners - ACC19 for Regency HX1000, 1200, 1500, Radio Shack PRO30,31; ACC23 for Bearcat 50XL, 800XLT, 145XL, 140XL, Radio Shack PRO2004 and 38. \$6.95, free shipping.

OLIVETTI PR2300 INK JET PRINTER - RS232 compatible; excellent condition with extra ink cartridges and manual. \$75 includes UPS shipping.

QWIP FACSIMILE MACHINE - very good condition with manual and conversion info. \$75 includes UPS shipping.

2 TELEVIDEO 802H MICROCOMPUTERS - CP/M, 30 meg hard disk with Dataflex program, one excellent, the other won't boot properly. \$500 for both. Consider receiver or scanner in trade.

Send check or money order to:

GROVE ENTERPRISES, INC.

140 Dog Branch Road
Brasstown, NC 28902
704-837-9200

I am fairly new to the SWL and scanner scene but your Monitoring Times is right on target with information for all levels of expertise.

William J. Browne
Scottsdale, AZ

YES!

I Would Like to Subscribe to MT!

U.S.:

- 1 Year for \$16 (12 issues)
- 2 Years for \$30 (24 issues)
- 3 Years for \$44 (SAVE \$4.00!) (36 issues)

Price effective through December 31, 1988

Subscription will start with next issue; current copy \$2.50 if available

Canada and Mexico:

- 1 Year \$21.00
- 2 Years \$40.00
- 3 Years \$58.00

Foreign Subscribers:

- 1 Year \$23.00
- 2 Years \$44.00
- 3 Years \$66.00

All foreign subscriptions must be paid by International Money Order in U.S. funds drawn on a U.S. bank with federal transit numbers imprinted on check or Postal Money Order.

NAME _____

ADDRESS _____

CITY _____ STATE _____ ZIP _____

Subscribe for a friend!

NAME _____

ADDRESS _____

CITY _____ STATE _____ ZIP _____

Please send a gift card signed from _____

PAYMENT MUST ACCOMPANY ORDER!

Make checks payable to: **MONITORING TIMES**
140 Dog Branch Road
P.O. Box 98
Brasstown, NC 28902

GRUNDIG®

Yacht Boy 215/Yacht Boy 210

The World in Your Pocket

Introducing the Yacht Boys by Grundig. The AM/FM/LW/Shortwave portable that's perfect for the international traveler on the go or the first-time shortwave enthusiast. Developed from the legendary Grundig Satellit World Band Receivers, the German design Yacht Boys are compact receivers that perform.

With a size of only 8x4x1 1/2 inches, the Yacht Boys will fit

comfortably in an overcoat pocket or in the corner of a briefcase and still keep you posted on politics, finance or sports worldwide.

For the best reception, there is a telescopic antenna and a built-in ferrite antenna, each optimally tuned to their appropriate bandwidth.

Power is supplied by four AA batteries so the Yacht Boys will operate anywhere. The tuner

circuitry incorporates AFC automatic fine control that locks onto stations and minimizes frequency drift.

The Yacht boys incorporate a special widerange speaker driver and adjustable tone for unusually pleasant audio fidelity. For private listening, the built-in speaker can be switched off for headphone listening.



LEXTRONIX, INC.
EXCLUSIVE LICENSEE & DISTRIBUTOR
OF GRUNDIG A.G.
(800) 872-2228

ICOM HF Receivers



ICOM RECEIVERS

The World at Your Fingertips

Only ICOM brings the world into your living room... HF, VHF, UHF, and low band receptions. ICOM is the professional's choice to receive international broadcasts, aircraft, marine, business, emergency services, television, and government bands. Tune in with ICOM's IC-R7000 25-2000MHz* and IC-R71A 0.1-30MHz commercial quality scanning receivers for full spectrum coverage.

Incomparable Frequency Control.

Both the IC-R71A and IC-R7000 feature direct frequency access via their front keypad, main tuning dial, optional infrared remote control and/or computer interface adapter. Flexibility of this nature can only be accomplished with an ICOM!

Full Coverage, Maximum Performance. The superb IC-R71A is your front row seat to worldwide SSB, CW, RTTY, AM, and FM (optional) communications and foreign broadcasts in the 100kHz to 30MHz range. It features passband, IF Notch, low noise mixer circuits, and 100dB dynamic range. The pacesetter IC-R7000 receives today's hot areas of

interest, including aircraft, marine, public services, amateur, and satellite transmissions in the 25MHz to 2000MHz* range. It includes all mode operation low noise circuits plus outstanding sensitivity and selectivity. The combined IC-R71A/IC-R7000 pair creates a full radio window to the world!



The IC-R71A is a shortwave listener's delight. Its 32 tunable memories store frequency and mode information, and they are single-button reprogrammable independent of VFO A or VFO B's operations! This HF reception is further enhanced by a dual width and level adjustable noise blanker, panel selectable RF preamp, selectable AGC, four scan modes, and all-mode squelch.

The IC-R7000 is a high band monitor's masterpiece. Its 99 tunable memories are complemented by six scanning modes. It even scans a band and loads memories 80 to 99 with active frequencies without operator assistance! Additional features include selectable scan speed and pause delays, wide/narrow FM reception, and high frequency stability. Many professional services use IC-R7000's as calibration references.

Options. IC-R7000: RC-12 remote control, EX-310 voice synthesizer, CK-70 DC adapter, MB-12 mobile bracket. IC-R71A: RC-11 remote control, EX-310 voice synthesizer, FM module, CK-70 DC adapter, MB-12 mobile bracket, FL-32A 500Hz, FL-63A 250Hz, and FL-44A filters.

See the IC-R7000 and IC-R71A at your local authorized ICOM dealer.

* Specifications of IC-R7000 guaranteed from 25-1000MHz and 1260-1300MHz. No coverage from 1000-1025MHz

 **ICOM**
First in Communications

ICOM America, Inc., 2380-116th Ave. N.E., Bellevue, WA 98004 Customer Service Hotline (206) 454-7619
3150 Premier Drive, Suite 126, Irving, TX 75063 / 1777 Phoenix Parkway, Suite 201, Atlanta, GA 30349
ICOM CANADA, A Division of ICOM America, Inc., 3071 - #5 Road Unit 9, Richmond, B.C. V6X 2T4 Canada

All stated specifications are approximate and subject to change without notice or obligation. All ICOM radios significantly exceed FCC regulations limiting spurious emissions. RCVR5587.