

QUALITY STANDARDS FOR ASSEMBLY



COLLINS RADIO COMPANY

CEDAR RAPIDS, IOWA · NEWPORT BEACH, CALIFORNIA
TORONTO, ONTARIO, CANADA · DALLAS, TEXAS

A PUBLICATION OF
© COLLINS RADIO COMPANY

Cedar Rapids, Iowa

JUNE 1962

Printed in the United States of America

PREFACE

THE PURPOSE OF THIS MANUAL IS TO DEFINE MINIMUM STANDARDS OF ACCEPTABLE QUALITY TO BE USED AS A GUIDE IN DESIGN AND FOR CONTROL IN THE PRODUCTION OF ALL COLLINS RADIO COMPANY EQUIPMENT.

CUSTOMER SPECIFICATIONS MAY CONTAIN MORE STRINGENT REQUIREMENTS OR REQUIREMENTS THAT MAY CONFLICT WITH THIS MANUAL. IN THESE CASES THE CUSTOMER SPECIFICATIONS SHALL GOVERN FOR THE CONTRACT INVOLVED.

This manual was compiled by the QUALITY STANDARDS FOR ASSEMBLY COMMITTEE of the Cedar Rapids Division with the participation of other Divisions.

This is the first revision of this manual, which was originally published in August 1961. Significant changes are indicated by revision bars. Subsequent issues of this manual are contemplated. Each new issue will have a different color plastic binding strip for identification.

Questions and comments are invited. Suggestions for changes or additions to the manual should be accompanied by reasons and substantiating data and sent to a member of a committee.

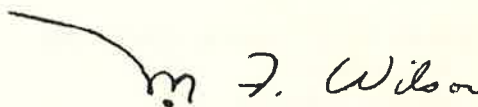

M. F. Wilson
Director of Product Assurance
Collins Radio Company

QUALITY STANDARDS FOR ASSEMBLY

CEDAR RAPIDS COMMITTEE

Chairman - E. F. Read
Vice Chairman - Donald J. Palmer
Secretary - Richard Starr

Director of Quality Assurance Division
Quality Assurance Division
Quality Assurance Division

Wiring and Cabling Subcommittee

Lloyd Ashlock, Chairman
Robert J. Walsh
Carl H. Bowles
Edward J. Ledvina
James Kuhl

Manufacturing Division
Development Division
Quality Assurance Division
Quality Assurance Division
Manufacturing Division

Electrical Components Subcommittee

Donald O. Torgler, Chairman
Arlo Goodyear
John Zimmerman

Service Division
Development Division
Manufacturing Division

Fastening Subcommittee

Clifford O. Franklin, Chairman
Arlen Blank
Norris Johnson
Robert Griswold
John Kirkpatrick

Development Division
Manufacturing Division
Manufacturing Division
Development Division
Development Division

Mechanical and Electromechanical Subcommittee

John Donahue, Chairman
Walter Koon
Carl E. Anderson
Keith L. Smith

Manufacturing Division
Manufacturing Division
Quality Assurance Division
Development Division

Printed Circuits Subcommittee

Eugene L. Cooley, Chairman
LaVerne F. Spencer
Harold Pierce

Development Division
Manufacturing Division
Development Division

QUALITY STANDARDS FOR ASSEMBLY

DALLAS DIVISION STANDARD PRACTICE COMMITTEE

Parent Committee

C. L. Carter, Jr.	Quality Assurance Division
C. O. Bethel	R & D "A"
W. J. Fisk	Quality Control Division
D. K. Jernigan	Quality Control Division
C. S. Knight	Fabrication Division

Electrical Assembly Subcommittee

D. K. Jernigan, Chairman	Quality Control Division
K. A. Love	R & D "A"
M. E. Myers	Special Products Division
S. W. Ray	R & D Technical Support
W. E. Rogers	Microwave Division

Mechanical Assembly Subcommittee

C. O. Bethel, Chairman	R & D "A"
P. L. Conant	Quality Assurance Division
J. J. Hinton	Special Products Division
E. A. Teddlie	R & D "B"

Fabrication Subcommittee

C. S. Knight, Chairman	Fabrication Division
K. M. Caldwell	R & D "D"
D. L. Kennedy	Quality Assurance Division
R. B. Seals	R & D "B"

NEWPORT BEACH

Coordinator - C. R. Manthy	Reliability
----------------------------	-------------

COLLINS RADIO COMPANY OF CANADA

Quality Standards for Assembly Committee

Bill Eason	Quality Assurance Division
Bob Herdman	Quality Assurance Division
Alex Millar	Manufacturing Division

TABLE OF CONTENTS

Section	Page
I WIRING AND CABLING	1
1.1 Wire, Electrical, Insulated	1
1.1.1 Definitions	1
1.1.2 General	1
1.1.3 Stripping	3
1.1.4 Routing	4
1.1.5 Protection	4
1.1.6 Terminating	8
1.1.7 Splicing	8
1.1.8 Cable Identification	8
1.2 Shielded Wire and Coaxial Cable	8
1.2.1 Routing and Protection	8
1.2.2 Termination	9
1.3 Cabling	9
1.3.1 Cable Tying and Lacing	9
1.3.2 Cable Routing and Securing	10
1.3.3 Cable Protection	19
1.4 Bus Wire	19
1.4.1 General	20
1.4.2 Slack	20
1.4.3 Clearance	20
1.4.4 Insulation	20
1.4.5 Rounded Edges on Tools	20
1.5 Mechanical Connections for Soldering	20
1.5.1 Definition	20
1.5.2 General Requirement	21
1.5.3 Small Wire Sizes	21
1.5.4 Lug Without a Hole for Wire	21
1.5.5 Terminal with a Hole for Wire	21
1.5.6 Location and Direction of Wrap	22
1.5.7 Contact of Wire with Terminal	22
1.5.8 Contact of Threaded Wire	22
1.5.9 Avoiding Tension on Solder	23
1.5.10 Wire Heavier than Terminal	23
1.5.11 Close Terminal Spacing	23
1.5.12 Assembly of Lug to Wire	23
1.5.13 Wire Inserted into Eyelet	24
1.5.14 Wire to Component Lead Connection	24
1.5.15 Component Leads Used as Terminals	24
1.5.16 Wrapping on Adjacent Terminals	25
1.5.17 Miniature Tube Socket Wiring	25
1.5.18 Wrapping on a Slotted Terminal	26
1.5.19 Cup-Type Terminals	26
1.5.20 Control of Clippings	27
1.6 Hand Soldering	27
1.6.1 Definition and Purpose	27

TABLE OF CONTENTS (Cont)

Section		Page
1.6.2	Preparation	28
1.6.3	Method	28
1.6.4	Flux	29
1.6.5	Choice of Solder	30
1.6.6	Wetting Action	30
1.6.7	Amount of Solder	30
1.6.8	Material Imbedded in Solder Joint	30
1.6.9	Wicking	30
1.7	Solderless Crimp-Type Connections	30
1.7.1	Approval for Use	30
1.7.2	Tool and Method	30
1.7.3	Tool Checking	30
1.7.4	Wire Variation	31
1.7.5	Fused Wire	31
1.7.6	Solid Wire	31
1.8	Sleeving	31
1.8.1	Connector Terminals	31
1.8.2	Pressure or Abrasive Action	31
1.8.3	Grade and Fit	31
1.8.4	Environmental Requirement	31
1.8.5	Cable Covering	31
1.8.6	Tolerance on Length	31
1.9	Coils	32
1.9.1	General	32
1.9.2	Insulation	32
1.9.3	Broken Strands	32
1.9.4	Slipped Turns	32
1.9.5	Minimum Inside Diameter	32
1.9.6	Coil Coating	32
1.9.7	Voids in Potted Assembly	32
1.9.8	Wiring and Soldering	32
1.9.9	Similar Coils	33
1.9.10	Securing of Coils, Leads and Terminals	33
1.9.11	Resistor Notches for Coil Winding	34
1.9.12	Damage	34
1.9.13	Winding Direction	34
1.10	Stray Material	34
1.11	Connecting 3-Wire AC Cord	34
II	ELECTRICAL COMPONENTS	37
2.1	Scope	37
2.2	Storage, Handling, and Transportation	37
2.2.1	Storage	37
2.2.2	Damage and Contamination by Handling	37
2.2.3	Damage in Transportation	38
2.2.4	Bending of Component Leads for Storage	38

TABLE OF CONTENTS (Cont)

Section	Page
2.3	Component Defects 38
2.3.1	Damage to Insulation 38
2.3.2	Illegible Component Markings 38
2.3.3	Dents and Chips 38
2.3.4	Cracks 38
2.3.5	Improper Lead Tinning 39
2.3.6	Lead Defects Reference 39
2.3.7	Bent Leads 39
2.3.8	Stray Material 39
2.4	Component Lead Forming 39
2.4.1	Changes in Ratings Due to Forming 39
2.4.2	Readability of Markings 39
2.4.3	Sharp Bends in Component Leads 39
2.4.4	Thermoplastic and Teflon Sleeving 40
2.4.5	Positioning of Lead Bends 40
2.5	Use of Tools for Wiring 41
2.5.1	Tools for Lead Forming 41
2.5.2	Tools with Sharp Edges 41
2.5.3	Control of Clippings 41
2.6	Component Positioning and Mounting 41
2.6.1	Positioning Within Boundaries 41
2.6.2	Neatness in Mounting 42
2.6.3	Crossing of Component Leads 43
2.6.4	Access to Mounting Holes and Controls 43
2.6.5	Centering of Components 43
2.6.6	Strain Relief 43
2.6.7	Component Support 44
2.6.8	Misuse of Components for Support. 44
2.6.9	Clearance from Sharp Edges 44
2.6.10	Prevention of Clatter 44
2.6.11	Mounting of Heat Dissipating Components 45
2.6.12	Mounting of Heat Sensitive Components 45
2.6.13	Mounting of Components into Tubelets 46
2.6.14	Centering of Clip-Mounted Components 46
2.6.15	Tightness of Mounting Clips 46
2.6.16	Positioning of Stud-Mounted Components 46
2.6.17	Mounting of Components Having Locating Tabs 46
2.6.18	Connections to Fuse Posts 46
2.6.19	Twist-Tab Capacitors 46
III	FASTENING 47
3.1	Machine Screws 47
3.1.1	Materials and Finishes 48
3.1.2	Countersunk Screws (Flat and Oval Heads) 48
3.1.3	Preferred Sizes and Class of Fit 49
3.1.4	Minimum Thread Engagement and Thread Inserts 49

TABLE OF CONTENTS (Cont)

Section	Page
3.1.5	50
3.1.6	50
3.1.7	51
3.1.8	53
3.2	53
3.2.1	53
3.2.2	54
3.2.3	54
3.2.4	55
3.3	55
3.3.1	55
3.3.2	55
3.4	56
3.4.1	56
3.4.2	56
3.4.3	58
3.5	60
3.5.1	60
3.5.2	60
3.5.3	62
3.6	62
3.6.1	62
3.6.2	63
3.6.3	65
3.7	65
3.7.1	65
3.7.2	66
3.7.3	66
3.7.4	66
3.8	66
3.8.1	66
3.8.2	67
3.8.3	67
3.9	67
IV	69
4.1	69
4.1.1	69
4.1.2	69
4.1.3	71
4.1.4	71
4.2	71
4.2.1	71
4.2.2	72
4.2.3	73

TABLE OF CONTENTS (Cont)

Section	Page
4.2.4	73
4.2.5	73
4.3	74
4.3.1	74
4.3.2	74
4.4	74
4.4.1	74
4.4.2	76
4.4.3	78
4.4.4	79
4.5	79
4.5.1	79
4.5.2	79
4.5.3	79
4.5.4	79
4.6	80
4.6.1	80
4.6.2	81
4.6.3	82
4.7	83
4.7.1	83
4.7.2	83
4.7.3	83
4.8	83
4.8.1	83
4.8.2	83
4.8.3	84
4.8.4	84
4.9	85
4.9.1	85
4.9.2	85
4.9.3	85
4.9.4	85
4.10	85
4.10.1	85
4.10.2	86
4.10.3	86
4.11	86
4.11.1	86
4.11.2	87
4.11.3	87
4.11.4	87
4.11.5	87
4.11.6	88
4.12	88

TABLE OF CONTENTS (Cont)

Section	Page
V	89
PRINTED CIRCUIT BOARD ASSEMBLY REQUIREMENTS	89
5.1 Printed Circuit Board Specifications	89
5.2 Eyelets, Tubelets, Terminals, and Plated-Thru Holes	89
5.2.1 Definitions	89
5.2.2 Installation and Application	90
5.2.3 Other Quality Requirements	90
5.3 Component Attachment	91
5.3.1 Components with Wire Leads	92
5.3.2 Hardware Mounted Components	92
5.3.3 "Snap-in" Components	92
5.4 Quality Requirements for Printed Circuit Board Assemblies	93
5.4.1 Component Bodies and Wire Leads	93
5.4.2 Printed Circuitry Separation	93
5.4.3 Base Laminate	93
5.4.4 Repair of Printed Circuit	94
5.5 Soldering on Printed Boards	94
5.5.1 Preparation	94
5.5.2 Fluxes	94
5.5.3 Hand Soldering	94
5.5.4 Dip-Soldering	95
5.5.5 Removal of Flux Residues	95
5.5.6 Workmanship Standards - Dip-Soldered Boards	95
5.6 Post-Coating	96
5.6.1 Cleaning	96
5.6.2 Masking	96
5.6.3 Cured Coating Requirements	96
5.7 Handling and Packaging	96
APPENDIX A	A-1
Color Codes	A-1
Typical Diode Polarity Guide	A-6a
Transistor Base Diagrams	A-6b
Part and Assembly Designations	A-7
Tables of Useful Information	A-9

LIST OF ILLUSTRATIONS

Figure		Page
1-1	Protection for Wire Through a Hole	5
1-2	Protection for Wire against Chassis Edge	6
1-3	Protection for Wire over Sharp Object	7
1-4	Acceptable Shield Terminations	10
1-5	Unacceptable Shield Terminations	11
1-6	Cable Dress and Routing	12
1-7A	Step-by-Step Tying First Part of Collins Standard Knot	13
1-7B	Final Step-by-Step Tying of Collins Standard Knot for Cable Ties	14
1-8A	Preparation for Lacing	15
1-8B	Cable Lacing	16
■ 1-8C	Special Steps for Optional Method of Cable Lacing Using "Lacing Awl"	17
1-9	Mechanical Wrap on Post.	21
1-10	Wrap for Wire Size No. 26 or Larger on a Lug with no Hole	21
1-11	Minimum Wrap for Large Wire	22
1-12	Threading Terminals with Wire	22
1-13	Avoiding Tension on Soldered Joint	23
1-14	Lug Assembled to Wire	24
1-15	Wires Connected to Component Leads	24
1-16	Component Leads as Terminals	25
1-17	Miniature Tube Socket with Shield	26
1-18	Minimum Wrap on Slotted Terminal	26
1-19	Bottoming in Cup Terminal	27
1-20	Section Showing Acceptable Limits of Solder Volume	29
1-21	Section of Unacceptable Solder Joint	29
1-22	Mounting of Ring Terminals	33
1-23	Cementing Terminals to Coil Form	33
1-24	Maximum Depth of Resistor Notches for Coil Winding	34
■ 1-25	Correct Method of Connecting 3-Wire AC Cord for 115 Volts	35
2-1	Lead Bends	40
■ 2-2	Examples of Specialized Pliers for Lead Forming	41
■ 2-3	Example of Wired Assembly	42
2-4	Mounting Layout.	43
2-5	Strain Relief	44
2-6	Typical Commercially Available Heat Sinks	45
3-1	Screw Heads in Common Use at Collins	47
■ 3-2A	Panhead Screw Recessed in Dimple in Thin Sheet Metal	48
3-2B	Using Flathead Screws on a Thin Panel	48
3-3	Screwhead Imperfections	52
3-4	Spline Socket Setscrew	54
3-5	Hexagon Socket Setscrew	54
3-6	Slotted Setscrew.	54
3-7	Setscrew Points	54
3-8	Tapping Screws	55
3-9	Nut Size Specifications	56

LIST OF ILLUSTRATIONS (Cont)

Figure		Page
3-10	Nut Thickness	56
3-11	Pem Nut Assembly	57
3-12	Hexagon Captive Nuts	57
3-13	Typical Angle Nut	58
3-14	Common Elastic Stop Nuts	59
3-15	Two Lug Anchor Rivet Type All-Metal Lock Nut	59
3-16	Right Angle Rivet Type All-Metal Floating Lock Nut.	59
3-17	Slotted Deformed End Lock Nut	60
3-18	Keys Lockwasher-Nut Assembly	60
3-19	Solid Rivets	60
3-20	Semitubular Rivet	61
3-21	Desired Clinch Allowances	61
3-22	Roll-Flanged Eyelet	62
3-23	Rolled Semitubular Rivet.	62
3-24	Split Lock Washer	63
3-25	External Tooth Lock Washer	63
3-26	Internal Tooth Lock Washer	63
3-27	Dished Flat-Rim Lock Washer	63
4-1	Cracks, Chips and Craziing around Sealed Terminals	70
4-2	Unacceptable Cracks in a Terminal Board	70
4-3	Gear Alignment	71
4-4	Gear Mesh	72
4-5	Alignment Limits for Spur Gears and for Bevel Gears	72
4-6	Separation of Sections of Loaded Gears	74
4-7	Sleeve Bearings, Properly Seated.	75
4-8	Bearings not Properly Seated	75
4-9	Incorrect Method of Mounting Bearing	76
4-10	Correct Method of Mounting Bearing on a Shaft	76
4-11	Correct Method of Mounting Bearing in a Housing	76
4-12	Improper Application of Ball Bearing with Filling Notches.	77
4-13	Typical Ball Bearing Constructions	77
4-14	Method of Retaining Ball Bearing in Housing	78
4-15	Incorrect Method for Retention of Ball Bearing on Shaft	78
4-16	Button Burnisher for Sizing Oilite Bearings	79
4-17	Contact Alignment for Low Current Applications	81
4-18	Wafer Switch Soldering and Contact Areas.	81
4-19	Exaggerated Wiping Action of Relay Contacts	82
4-20	Construction of a Sealed Relay	83
4-21	Pin Engagement and Clearance Checks	84
4-22	Distortion Caused by Improper Pinning	84
5-1	Eyelet, Tubelet and Terminal on a Board	90
5-2.	Assembled Printed Circuit Board	91
5-3	Lifted Circuitry Repairable Maximum	93

LIST OF TABLES

	Page
Wire Coding Colors	2
Allowable Conductor Defects	3
Tolerance on Over-all Length of Wire	4
Mica Capacitor Color Codes	A-1
Resistor Color Code	A-2
Mica Capacitor Color Code, MIL-C-5A	A-2
Paper Capacitor Color Code	A-3
Voltage Rating for Rectangular Capacitors	A-3
Ceramic Capacitor Color Code	A-4
Part and Assembly Designations	A-7
Conversion Tables	A-9
Incandescent Lamps for Indicator Lights	A-10
Gas Filled Glow Lamps	A-10
Standard Metal Gauges	A-11
Numbered Drill Sizes 1-36.	A-12
Numbered Drill Sizes 37-54	A-13
Dielectric Constants and Breakdown Voltages	A-14
Copper-Wire Table	A-15
Weights and Measures	A-16
Relative Resistivity of Metals.	A-16
Decimal Equivalentents of Fractions	A-17
Fractions of an Inch to Millimeters	A-17

Section I

WIRING AND CABLING

1.1 WIRE, ELECTRICAL, INSULATED

1.1.1 Definitions

- A Insulated Electrical Wire: Insulated electrical wire is a single, insulated, metallic conductor of solid, stranded, or tinsel construction which is designed to carry current in an electrical circuit. It is provided with an insulating covering but does not have a metallic covering, sheath, or shield.
- B Point-to-Point Wiring: Point-to-point wiring is wiring from one termination to another in which the individual wire is not part of a cable and the only support to the wire is supplied by the connections to the terminations.
- C Slack: Slack is that length of wire allowed for service loops and/or moving or flexing of parts during operation or maintenance of equipment.

1.1.2 General

- A The size of conductor, type of insulation, and construction of each conductor shall be consistent with the requirements of the application and specified on the assembly drawing. See Collins drawing 506 3900 003 or Component Standards Manual for wire coding.
- B All insulating materials shall provide adequate dielectric strength and leakage resistance when the equipment is operated under its designated service conditions.
- C The mechanical and electrical properties of the insulation shall not be adversely affected by exposure to temperature or other environmental extremes of the equipment specification.
- D All conductor insulation shall be of the noncombustible or slow-burning type; that is, with the insulated conductor held in a horizontal position in still air, self-sustained combustion of the insulation or lacquer shall not progress at a rate in excess of 1 inch in 1 minute.
- E Single conductor chassis wires which require coding shall be identified by colors in accordance with table I, preferably in the order given. In the code identification numbers, the first digit indicates the background color with the succeeding digits, if any, indicating the color of the stripes. All colors shall fall within the limits of the standard color chips of supplement 1 to RETMA Standard GEN-101-A.
- F The current carrying capacities of wires in conduit or bundles shall be derated to prevent the insulation from being damaged due to heat generated within the wire. The amount of derating required varies with the size of the conductor, type of insulation, and number of wires in the bundle.

TABLE I. WIRE CODING COLORS

BASE	1ST STRIPE	2ND STRIPE	3RD STRIPE	CODE IDENTIFI- CATION NO.
Black				0
Brown				1
Red				2
Orange				3
Yellow				4
Green				5
Blue				6
Violet				7
Gray				8
White				9
White	Black			90
White	Brown			91
White	Red			92
White	Orange			93
White	Green			95
White	Blue			96
White	Black	Red		902
White	Black	Orange		903
White	Black	Green		905
White	Black	Blue		906
White	Brown	Red		912
White	Brown	Orange		913
White	Brown	Green		915
White	Brown	Blue		916
White	Red	Orange		923
White	Red	Green		925
White	Red	Blue		926
White	Orange	Green		935
White	Orange	Blue		936
White	Green	Blue		956
White	Black	Red	Orange	9023
White	Black	Red	Green	9025
White	Black	Red	Blue	9026
White	Brown	Red	Orange	9123
White	Brown	Red	Green	9125
White	Brown	Red	Blue	9126
White	Red	Orange	Green	9235
White	Red	Orange	Blue	9236
White	Red	Green	Blue	9256
White	Orange	Green	Blue	9356

1.1.2.G The insulating material must be intact, but a limited amount of repaired damage is allowable. Damage to the nylon (outer) jacket of nylon coated plastic wire may be repaired, provided that the damage is limited to the outer jacket of the wire and is not larger than 1/2 inch long and not more than 1/3 the circumference of the wire. If the damage exceeds these limits, the wire must be replaced.

1.1.3 Stripping

- A Whenever practical, stripping should be done by machine at the time the wire is cut to required lengths.
- B When hand stripping is necessary, it shall be accomplished with properly adjusted stripping tools of an approved type.
- C Conductor imperfections resulting from stripping, forming, or handling of wire leads shall be classified as follows:
 1. Abrasions: An abrasion is a scraped or roughened surface finish of a conductor or strand of a conductor. It is identifiable by its lack of definite outline, shallowness, and the fact that it may extend for a relatively long distance along the conductor. Such a condition might result from bare wire being pulled through the feed fingers of a cutting machine, wire being rubbed against a rough surface, or running a straight edge over a wire to determine if excess oxidation is present on the conductor surface. Abrasions do not create any critical stress points and are considered acceptable unless aggravated enough to be considered nicks or indentations.
 2. Indentations: An indentation is a deformation of the surface of the conductor or strands of the conductor by a dull or blunt instrument. Indentations might result from pressure being exerted on bare wire during stripping. Since indentations are radiused to some extent, stress points are not as critical as they would be where sharp corners exist. Indentations with depths not exceeding 1/4 of the diameter of the conductor or strands of a conductor shall be considered acceptable. Indentations with depths exceeding 1/4 of the diameter of the conductor or strands of the conductor shall be classified as defects, and the number of allowable defects shall not exceed those shown in table II.
 3. Broken Strands: Broken strands in a wire shall be classified as defects and the number of allowable defects shall not exceed those shown in table II.
 4. Nicks: A nick is the partial severance of the conductor or strands of the conductor by a sharp instrument. Nicks normally result from improper stripping of wire by a knife or an improperly adjusted hand stripping tool. Due to the sharp corners present in nicks, very concentrated stress points are created, and nicks in solid conductor wire or in strands of stranded wire shall be classified as defects and the number of allowable defects shall not exceed those shown in table II.

TABLE II. ALLOWABLE CONDUCTOR DEFECTS

NUMBER OF STRANDS	ALLOWABLE NUMBER OF STRANDS CONTAINING DEFECTS
1 through 7	0
8 through 19	1
20 through 40	2
over 40	10%

Wiring and Cabling

- 1.1.3.D Tolerances on length of wire and length of stripped portion of wire as supplied by the Wire Cutting Section are as shown below. Departures from these tolerances must be treated as special orders.

Tolerance on Over-all Length of Wire

Over-all Length of Wire	Tolerance
1 in. to 6 in.	$\pm 1/16$ in.
6 in. to 15 in.	$\pm 1/8$ in.
15 in. to 30 in.	$\pm 5/32$ in.
Above 30 in.	Add a tolerance of $\pm 1/16$ in. for each 16 in.

Tolerance on Length of Strip

Length of Stripped Portion of the Wire	Tolerance
1/8 in.	$\pm 1/32$ in.
3/16 in. to 1-1/2 in.	$\pm 1/16$ in.

1.1.4 Routing

- A All wires shall be routed so that they will not be pinched or damaged, or be under damaging pressure when parts, covers, or subassemblies are in place.
- B Wires connected to the same terminal shall not cross over each other unnecessarily.
- C All wires in a cable connected to the same terminal shall have approximately the same amount of slack and shall be dressed (arranged) to give a uniform appearance.
- D All wires shall be routed and secured in such a manner that they cannot come in contact with moving parts such as gears, switches, relays, slug racks, shafts, dials, and tuning capacitors. See figure 1-6.
- E The minimum inside bend radius of insulated wire shall be not less than 3 times the outer diameter of the wire insulation.

1.1.5 Protection

- A Wherever wire is routed through a hole in a metal chassis, there must be some means of protection, such as a grommet or a 1/16 inch minimum radius around the edge of the hole on both sides of the chassis. Chamfers do not meet this requirement.

NOT ACCEPTABLE

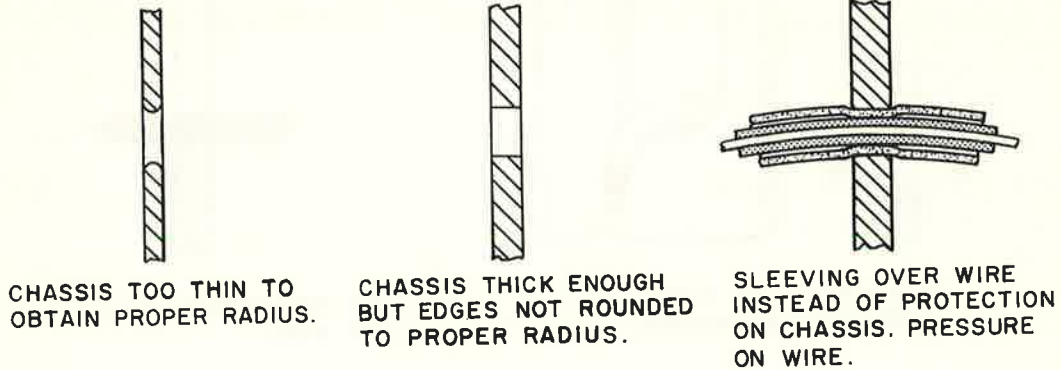

ACCEPTABLE

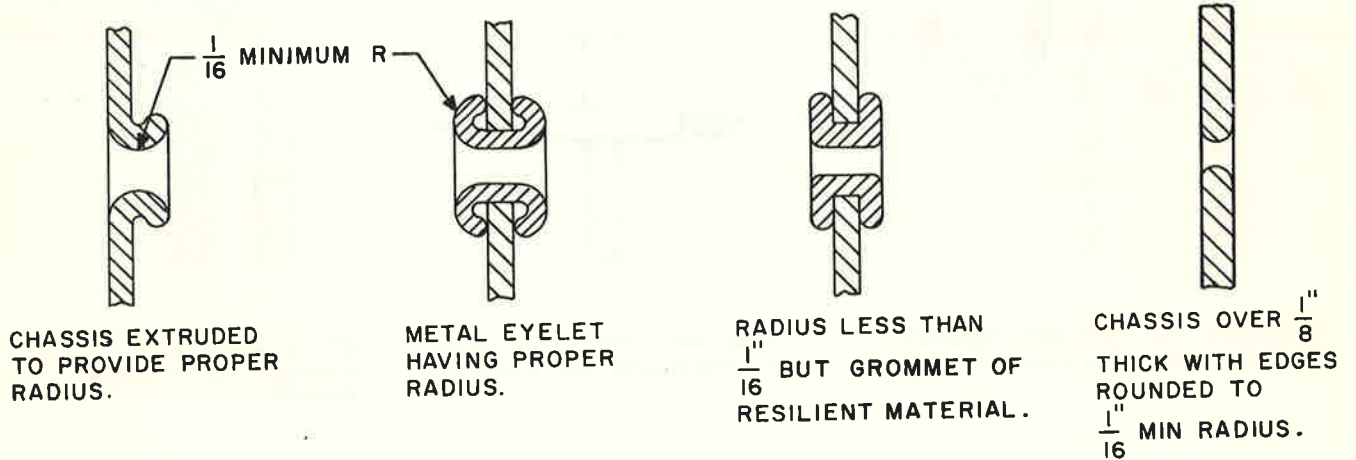
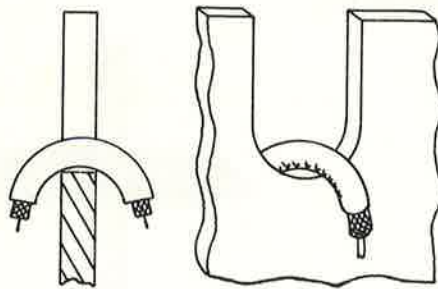

Figure 1-1. Protection for Wire Through a Hole

1.1.5. B Whenever wires are routed through a slot or against the edge of a metal chassis where pressure is exerted against the metal, the metal edges must present a minimum radius of 1/16 inch or some means of protection must be provided on the chassis. If constant pressure is not present, the use of sleeving or other suitable protective material over the wire insulation is acceptable. See figure 1-2.

NOT ACCEPTABLE



SLEEVING OVER WIRE WITH PRESSURE ON CHASSIS.

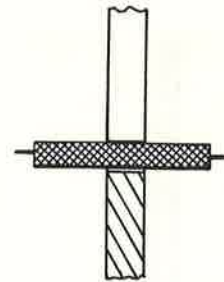

NO PROTECTION ON CHASSIS OR WIRE.

ACCEPTABLE

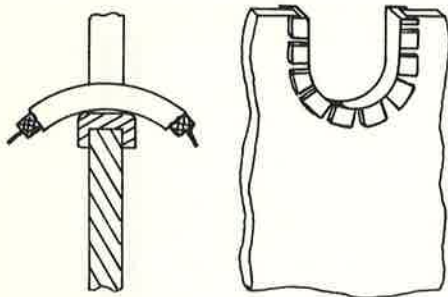

PRESSURE ON WIRE BUT CHASSIS COVERED BY RESILIENT CHANNEL.

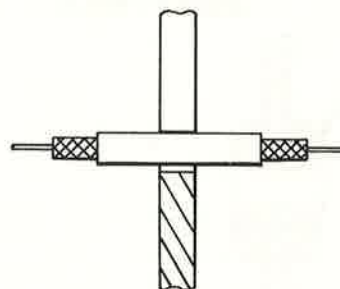

SLEEVING OVER WIRE WITH NO PRESSURE ON CHASSIS.

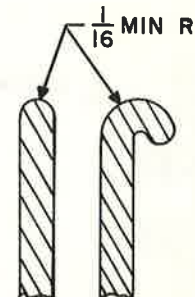

METAL EDGE ROLLED OR ROUNDED TO PROPER RADIUS.

Figure 1-2. Protection for Wire against Chassis Edge

1.1.5.C All wires should be routed and secured away from contact with sharp metal objects such as studs, screw heads, sharp corners on metal parts, and terminal ends. In cases where the wire passes over such sharp objects with no pressure exerted on the object by the wire, the use of sleeving or other suitable protective material over the wire or sharp object, at the point of contact, is acceptable. However, if continual pressure is exerted on the object by the wire, the use of sleeving over the wire is not acceptable for protection. See figure 1-3.

NOT ACCEPTABLE



WIRE OVER SHARP OBJECT WITH NO PRESSURE BUT NO PROTECTION ON WIRE.



WIRE OVER SHARP OBJECT WITH PRESSURE EXERTED AND SLEEVING ON WIRE FOR PROTECTION.

ACCEPTABLE

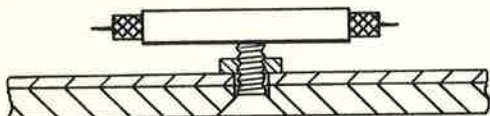

WIRE OVER SHARP OBJECT WITH NO PRESSURE EXERTED AND WIRE PROTECTED BY SLEEVING.

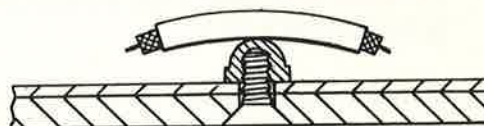

PROTECTION PROVIDED ON SHARP OBJECT RATHER THAN ON WIRE.

Figure 1-3. Protection for Wire over Sharp Object

- 1.1.5.D All insulated wires must be routed in such a manner that they are not exposed to excessive temperatures by heated or heat generating components.
- E All insulated wires must be routed so that they do not come in contact with any soldered electrical termination, which would be subject to repair.
- F When it is necessary to use added protection for a wire, the protective material shall be positioned and secured in such a manner that it always will protect the point for which it was intended.
- G All protective materials used must meet all of the requirements of the equipment specification.
- H All sleeving used for wire protection shall be of an electrical grade.

Wiring and Cabling

1.1.6 Terminating

- A All wire terminations shall meet the requirements of paragraph 1.5, Mechanical Connections.
- B When initially terminating cabled wires, sufficient slack should be left in the wire to permit three reconnections to the terminal without changing the intended routing of the wire.
- C Point-to-point wiring must contain enough slack to prevent the application of any direct stress at the point of termination as a result of flexing during operation of the equipment under its specified service conditions.
- D Point-to-point wiring of insulated stranded wire shall have no more than 1/2 inch slack.
- E Point-to-point wiring with insulated stranded wire shall not be used where the distance is over 3 inches. Wire over 3 inches long should be restrained.
- F THE REQUIREMENTS OF PARAGRAPHS 1.1.6 . B, C, D, and E SHALL NOT APPLY IF THE OPERATION OF THE CIRCUIT INVOLVED WILL BE AFFECTED, IN WHICH CASE THE ENGINEERING DRAWING SHALL SPECIFY MORE DETAILED REQUIREMENTS.
- G When terminating insulated wires to solder connections, the insulation should end not more than 1/16 inch from the terminal to which the connection is made. The insulation should not be so close to the terminal that it interferes with the soldering of the connection.
- H Terminations involving crimp-type solderless connections shall conform to the requirements of paragraph 1.7 and specified assembly procedures.

1.1.7 Splicing

Wires should not be spliced unless specifically approved by a Quality representative and an approved type of crimp splice is used which actually displaces metal between the splicing device and the wire during the crimping process. A Product Performance Manager can approve one splice on a transformer or rotating component such as a motor, synchro or gyro, or approve splices on 20% of the leads of such a component, but should get Quality Assurance Division approval for more splices than this. The added wire should have the same color code and must have insulation that is equal to or better than the original or specified insulation.

1.1.8 Cable Identification

Identically terminated cable ends (including coax) which may be subject to improper connection shall be identified to aid in making proper connections.

1.2 SHIELDED WIRE AND COAXIAL CABLE

1.2.1 Routing and Protection

- A Wires using metallic shielding unprotected by an outer insulation shall be secured, routed, or protected to prevent the shielding from touching terminals or unprotected conductors of a different potential when subjected to specified service conditions of the equipment.

1.2.1B The minimum inside bend radius of coaxial cable shall be not less than 6 times the outer diameter of the cable.

1.2.2 Termination

- A The unshielded portion of shielded wire shall be a minimum but the shield shall be terminated 1/4 inch to 1 inch from the exposed conductor, unless otherwise specified on the drawing.
- B The shield shall be connected to ground on at least one end unless it is part of an "above ground" system, unless otherwise specified by an engineering drawing.
- C The terminated end of a shield must be terminated or captivated in such a manner as to prevent fraying of the shield or damage to the conductor insulation.
- D The conductor shall not be formed against the sharp edge of terminated shielding in such a manner that the insulation will be subjected to damage.
- E For examples of terminating shielding on shielded wire or coax, see figure 1-4. Other methods must be approved by a Quality representative.

CAUTION: For crimp-type terminations, the manufacturer's recommended crimping tool must be used.

- F When shielded braid is subjected to a soldering operation and the conductor insulation is of low heat resistance, there must not be enough heat transferred to cause damage to the conductor insulation; therefore heat-resistant sleeving must be inserted as in figure 1-4D.
- G For proper assembly of coaxial cables and connectors, refer to the 580-9000-00 series of specifications.

1.3 CABLING

1.3.1 Cable Tying and Lacing

- A Wherever practical, insulated wires connecting various parts should be bundled neatly with a minimum crossing of wires and held in their intended position by tying, lacing, or equivalent means of binding at intervals of approximately 1 inch to form a cable. See figure 1-6, point A. Cable ties and lacing should be tight after cable installation. At no time should the means of holding a group of wires together cause damage to the wire insulation.
- B When a group of wires are to be bound by means of a tie, the Collins standard knot will be used. See figure 1-7.
- C When a group of wires are to be laced, the proper lacing stitch will be used. See figure 1-8.
- D When cables are to be laced, single lacing stitches may be used on cables with a diameter of 1/2 inch or less. Double lacing is required on the cable at point of wire breakout. See figure 1-6, point B. On cables of a diameter exceeding 1/2 inch, double lacing must be used, except that single lacing stitches may be used on cables up to 1 inch in diameter if the lacing is done on the cable after it is installed. At large breakouts, bends and corners, the number of laces should be increased to hold the wires in their intended position.

1.3.1 (Cont)

- E Only flat ribbon-type lacing cord, or an equivalent binding, shall be used.

1.3.2 Cable Routing and Securing

- A Cables with diameter of 1/2 inch or less should not have an inside bend radius less than the diameter of the cable. However, in no case shall the bend radius be less than 3 times the OD of the largest wire in the cable. Cables with diameter exceeding 1/2 inch but not exceeding 1 inch should not have an inside bend radius less than 3/4 the diameter of the cable. Cables with diameter exceeding 1 inch should not have an inside bend radius less than 1 inch.

ACCEPTABLE



- A Inner conductor ejected through shielding leaving pigtail for ground connection. If low heat resistant insulation is used, the minimum pigtail length shall be 1/2 inch, before wrapping and soldering.

- D Shielding cut off; teflon sleeving positioned over inner conductor between shielding and insulation. Wrap bus on shield and solder for pigtail, or, when shield is to be dead-ended, solder shield. Acceptable for wire with insulation of low heat resistance.



- B Eyelet positioned on inner conductor between shielding and insulation and soldered, acceptable only with wire that has high heat resistant insulation. Shielding can either be pigtailed or dead-ended. Small end of eyelet which is rolled in slightly must be straightened.

- E Shielding folded back without soldering. . . .



. . . . and covered with shrink sleeving.



- C Insulated shielded wire with shielding trimmed off even with outer insulation. Method must be controlled so conductor insulation will not be damaged.

- F Ferrule-type termination.

Figure 1-4. Acceptable Shield Terminations

NOT ACCEPTABLE



A Broken Strands



B Shield termination frayed, not soldered or captivated.



C Shield termination cut off and soldered leaving jagged edges.



D Loose strands which may short adjacent terminals. Also, twisted shield tinned approximately half its length.



E Insulation damaged by soldering operation. Also, sharp ends of shield exposed.

Figure 1-5. Unacceptable Shield Terminations

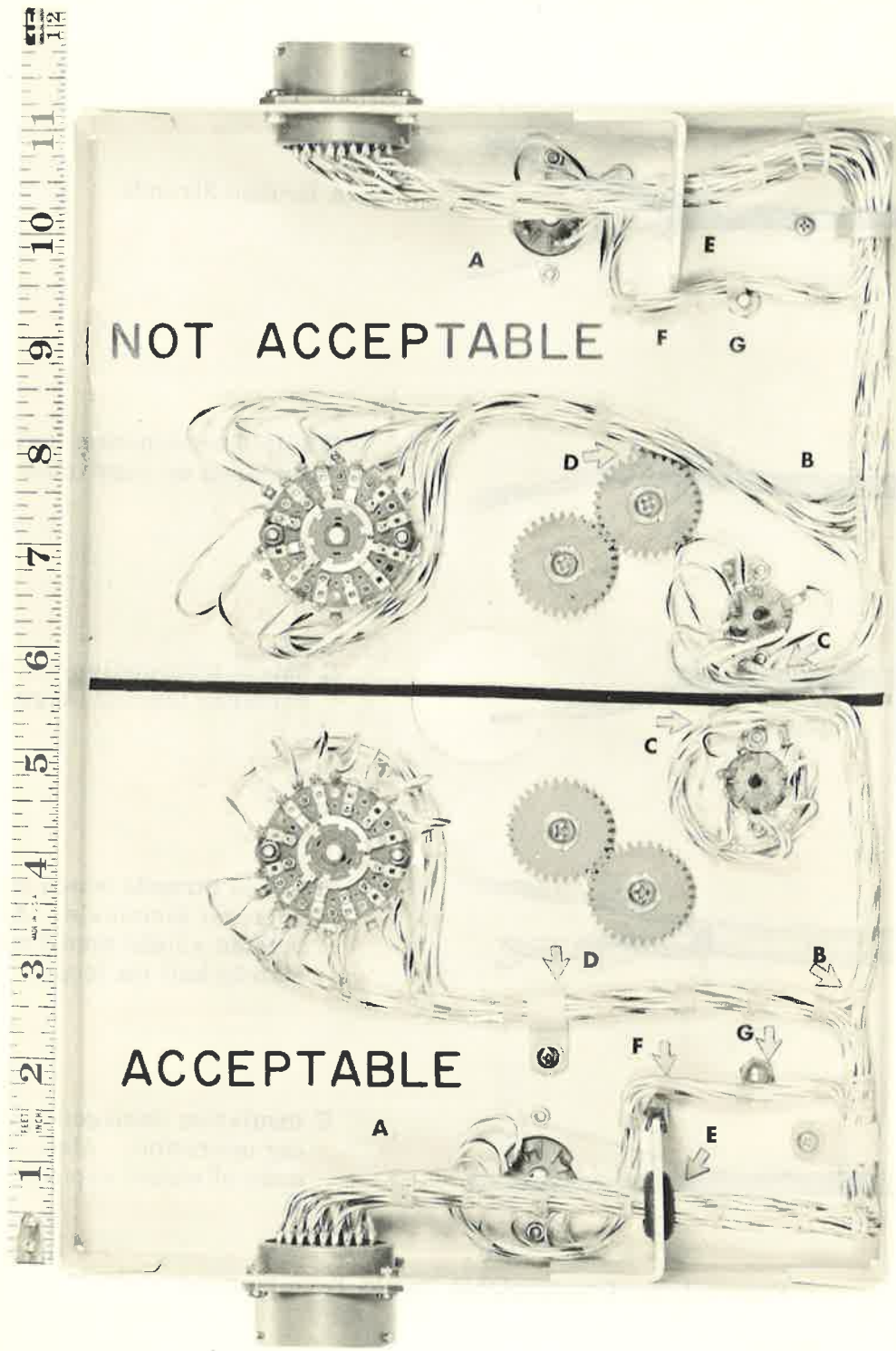
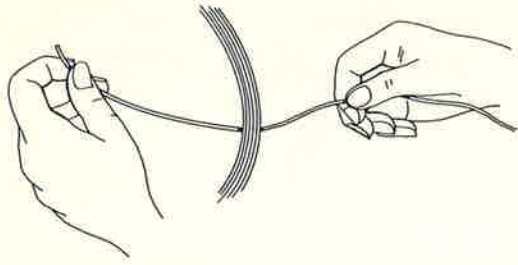
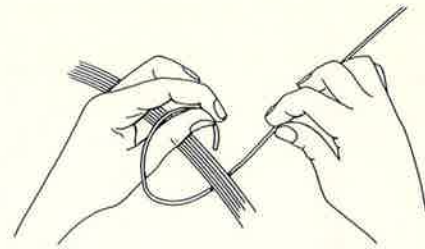

Figure 1-6. Cable Dress and Routing



Step 1



Step 2

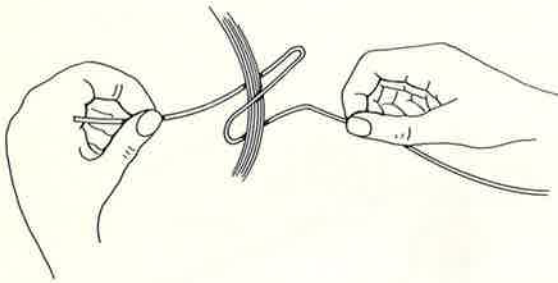

Step 3

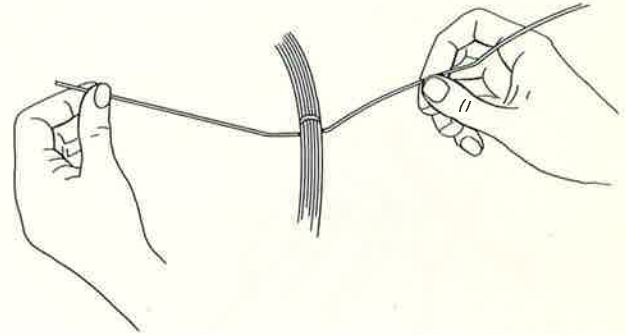

Step 4

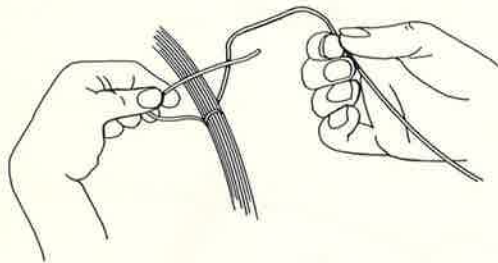

Step 5

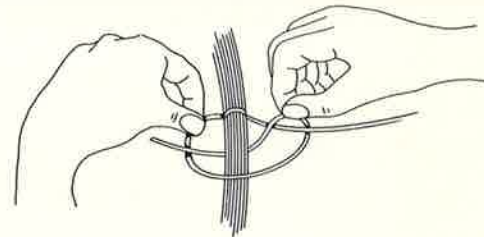

Step 6

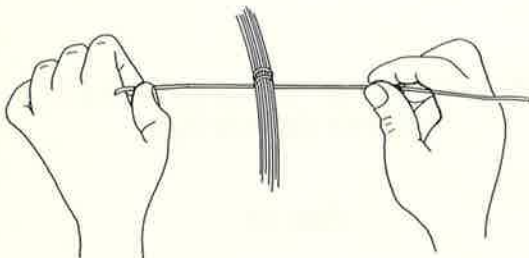

Step 7

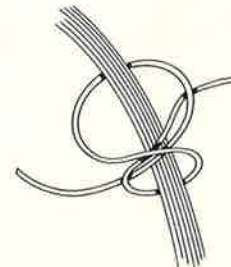

Exploded View After Step 7, as Would Be Seen From Side Against Chassis

Figure 1-7A. Step-by-Step Tying First Part of Collins Standard Knot

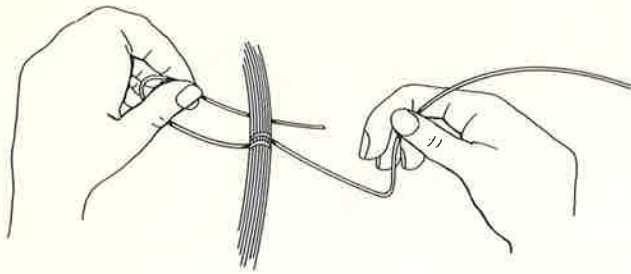

Step 8

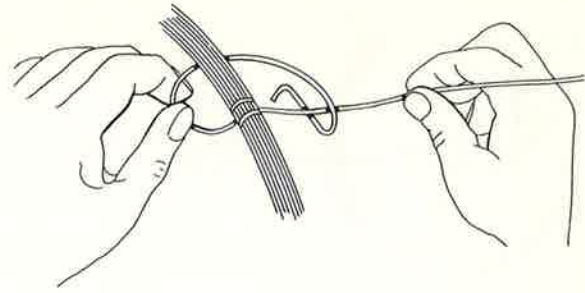

Step 9

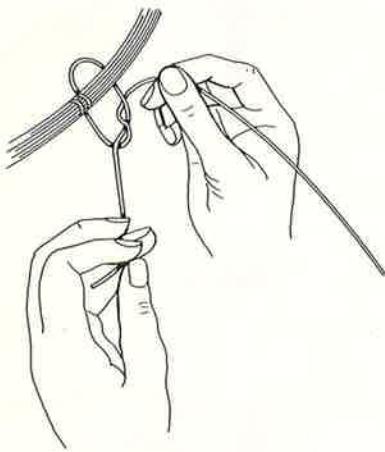

Step 10

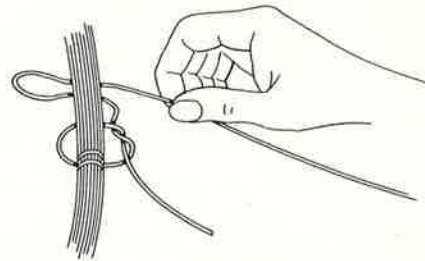

Step 11

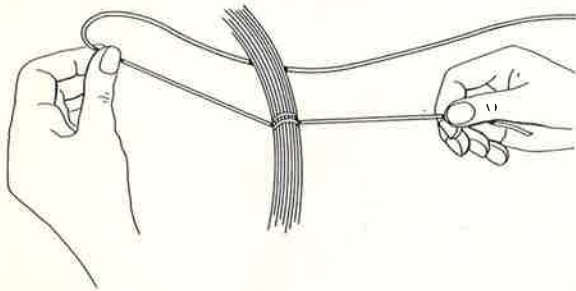

Step 12

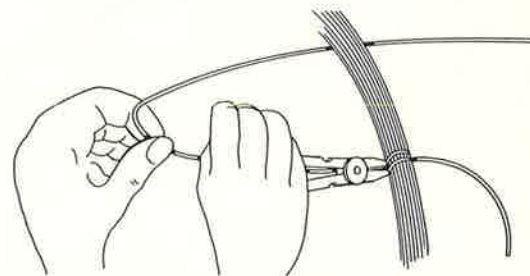

When Cutting an End of Cord, Leave
1/8 inch Outside Knot

Step 13

Figure 1-7B. Final Step-by-Step Tying of Collins Standard Knot for Cable Ties

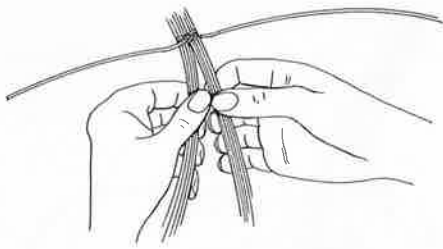

Step 1

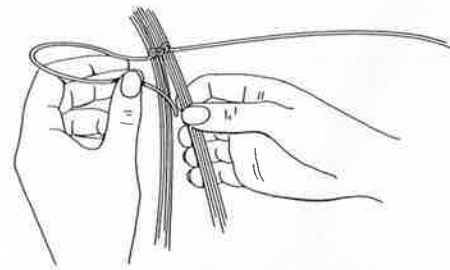

Step 2

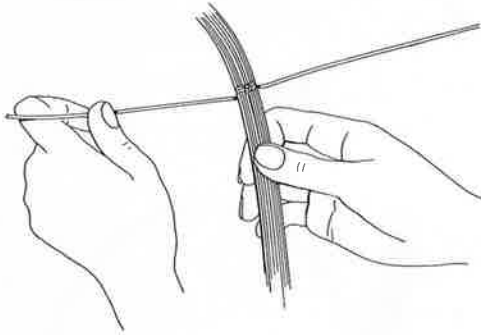

Step 3

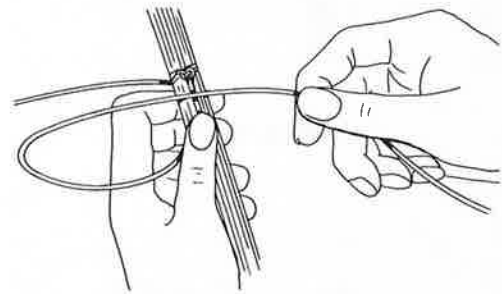

Step 4

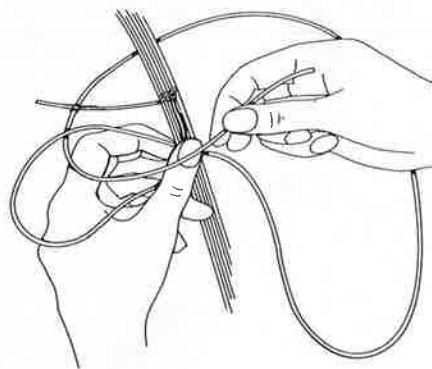

Step 5

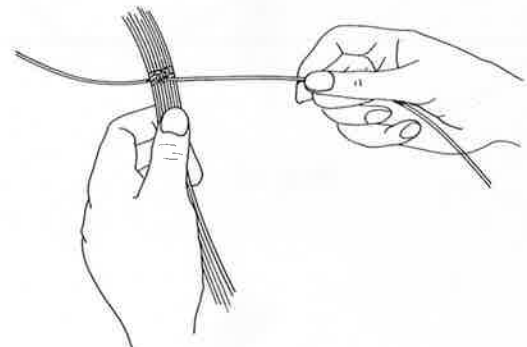

Step 6

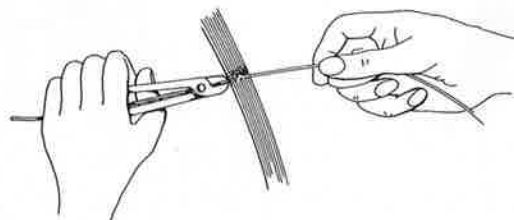

Step 7

Figure 1-8A. Preparation for Lacing

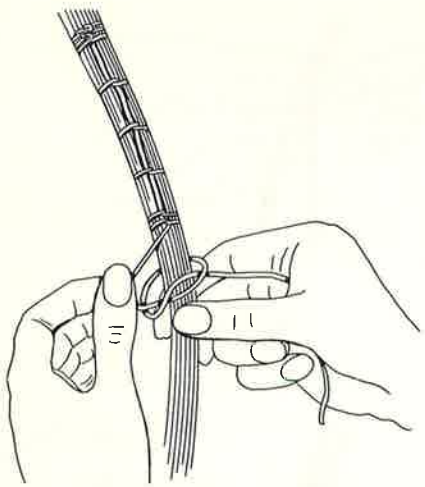

Step 8

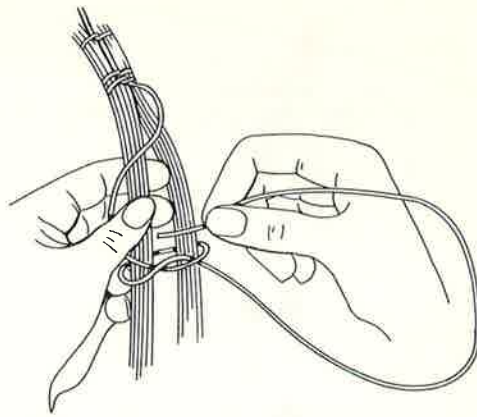

Step 9

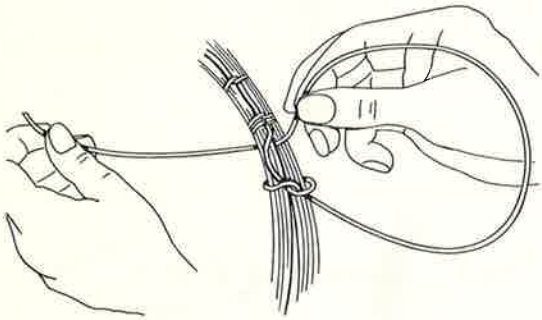

Step 10

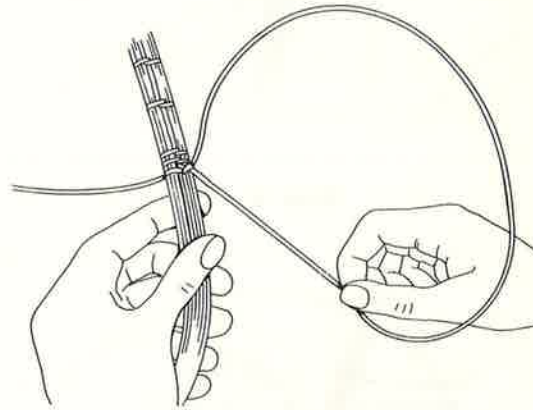

Step 11

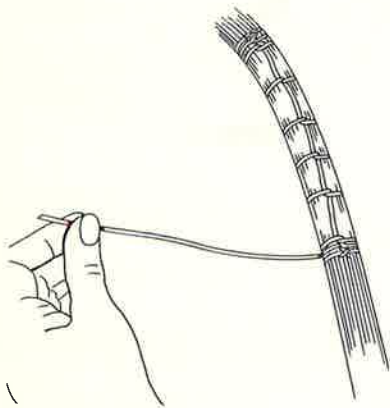

Step 12

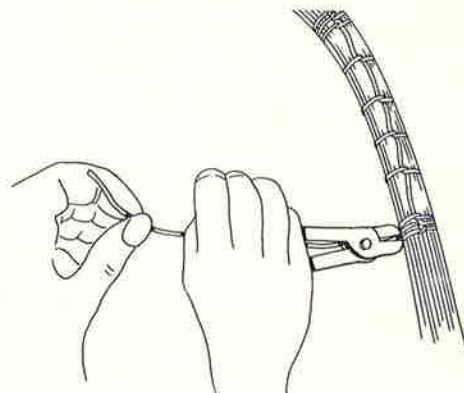

Step 13

Figure 1-8B. Cable Lacing

1. The lacing cord comes from the lacing tool, on the right in steps 1, 2 and 3 of figure 1-8A.
2. The steps A through E shown below replace steps 4, 5, 6 and 7.

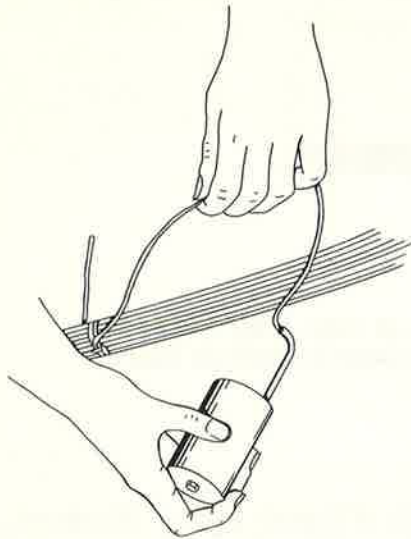

Step A. Form first loop.

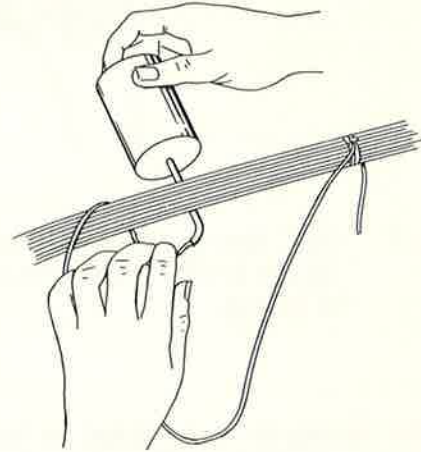

Step B. Thread tool under cable and grasp cord near tool.

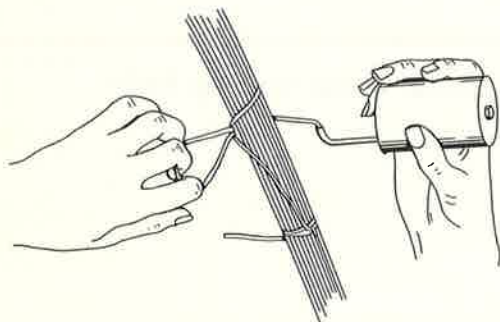

Step C. Form second loop.

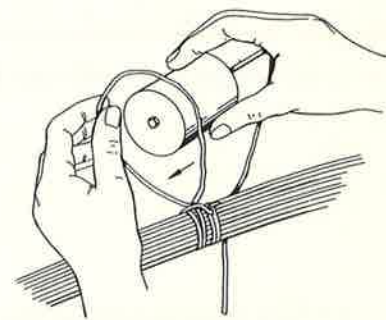

Step D. Pass entire tool through second loop.

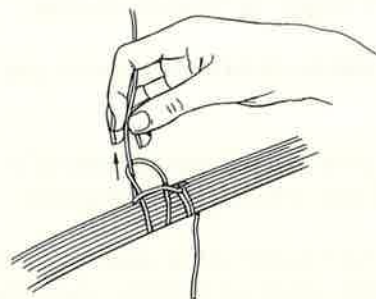

Step E. Slide stitch into position and pull it tight.

Repeat steps A through E for the required number of lacing stitches.

Figure 1-8C Special Steps for Optional Method of Cable Lacing Using "Lacing Awl"
(Sheet 1 of 2)

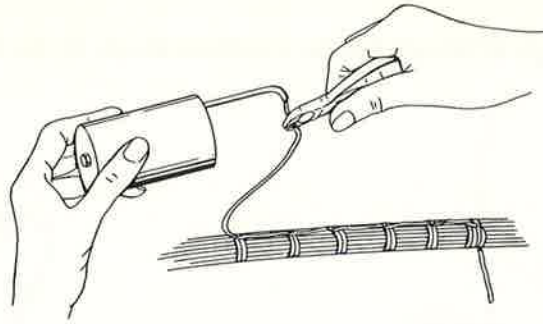

Step F. Cut, leaving enough cord to terminate as in step 8 through 13, figure 1-8B. Also cut off excess cord at Collins knot at start of lacing.

3. The lacing is terminated as in steps 8 through 13 of figure 1-8B. However, the lacing stitches will appear double as shown in Step F in place of the lacing shown in Steps 8 through 13.

The lacing can proceed from left to right as well as from right to left as shown.

Figure 1-8C Steps for Optional Method of Cable Lacing Using "Lacing Awl"
(Sheet 2 of 2)

- 1.3.2. B Cables should follow the contour of the chassis wherever possible.
- C All cables should be secured as necessary to prevent strain on the breakout wires or movement of the cables from their intended positions, and to meet the equipment specifications and shipping requirements.
- D The wire leads from a cable breakout should not be used as a means of support to the cable.
- E Wherever practical, wires should break out of a cable before the point of termination rather than beyond the point of termination. See figure 1-6, point C.
- F Cables shall be routed and secured in such a manner that they cannot come in contact with moving parts such as gears, switches, relays, slug racks, shafts, dials, and tuning capacitors. See figure 1-6, point D.
- G Cables which contain insulated wire shall be routed in such a manner that they are not exposed to excessive temperatures by heated or heat generating components.

1.3.2. (Cont)

- H Cables with a free end or ends must be retained in their connector cable clamps to maintain strain relief at all times for the wires connected to the connector terminals.
- I A pendent cable or wire (movable at one end) shall be restrained at the permanently connected end so as to prevent any chance of breakage due to flexing.
- J Mounting hardware of heavy components may be used to secure nylon cable clamps only after the heavy component is properly mounted.

1.3.3 Cable Protection

- A Wherever a cable is routed through a hole in a metal chassis, some means of protection, such as a grommet, must be used. See figure 6, point E. Cut grommets should not be used without the approval of a Quality representative. A 1/16-inch minimum radius around the edge of the hole on both sides of the chassis will be acceptable. See paragraph 1.1.5, figure 1-1.
- B Wherever unsleeved cable is routed through a slot or against the edge of a metal chassis with constant pressure, the metal edges must have a 1/16-inch minimum radius. However, if constant pressure is not present between the cable and the edge of the chassis, sleeving or an equivalent protective material will be acceptable. See figure 1-6, point F, and paragraph 1.1.5, figure 1-2.
- C All cables should be routed and secured away from contact with sharp metal objects, such as studs, screws, threads, sharp corners on metal parts, and terminal ends. In cases where the wire passes over such sharp objects with no pressure exerted on the object by the cable, the use of sleeving or other suitable protective material over the cable or sharp object, at the point of contact, is acceptable. However, if continual pressure is exerted on the object by the cable, the use of protective material subject to cold-flow, as a substitute for relieving the pressure exerted by the cable, is not acceptable. See figure 6, point G and paragraph 1.1.5, figure 1-3.
- D Where it is necessary to use added protection for a cable, the protective material must be positioned and secured in such a manner it always will provide the protection intended.
- E The protective materials to be used for cables must meet all equipment specifications.
- 1.3.3.F Cables which include conductors using metallic shielding unprotected by an outer insulation must be protected or secured to prevent the shielding from coming into contact with exposed terminals or conductors of a different potential.
- G Where cabling is employed between hinged parts, sufficient slack and protection shall be provided to prevent chafing or breaking of protective material or wires with repeated flexing.

Wiring and Cabling

1.4 BUS WIRE

1.4.1 General

All bus wire must be neat, direct, and without kinks or more bends than are necessary to give adequate clearance from adjacent parts or terminals. For details on terminating bus wire see paragraphs 1.5 and 1.6.

Imperfections and defects on bus wire shall be controlled by paragraph 1.1.3.C.

1.4.2 Slack

Enough slack shall be provided to prevent the application of any direct stress on parts involved as a result of flexing during operation of the equipment under any conditions of its specifications.

1.4.3 Clearance

Clearance between bare bus wire and any terminal or part carrying a different potential must be no less than the minimum allowable spacing between adjacent terminating connections. Length and size of unsupported and unsleeved bus shall be such that this condition can be met with the equipment subjected to any conditions of the specifications.

1.4.4 Insulation

In cases where the clearance requirement cannot be met, insulated wire should be used or the bus wire must be sleeved. Bus wire complete with extruded insulation is preferred to sleeved bus. If wire is sleeved, the sleeving must not be depended upon to protect the wire under pressure, as sleeving has a low mechanical strength and cold-flows under pressure. (Sleeving will not be required where the spacing requirement of 1.4.3 is met during time the equipment is subjected to specified vibration tests.) When sleeving is used, it must protect the intended point when it is in its worst possible position.

1.4.5 Rounded Edges on Tools

Bending and forming of bus wire shall be accomplished with tools having properly rounded edges to prevent damage to the wire.

1.5 MECHANICAL CONNECTIONS FOR SOLDERING

1.5.1 Definition

A mechanical connection is a connection before soldering designed to prohibit movement of a member in relation to its connecting member during the soldering operation. A diagram of 25%, 50%, 75%, and 100% mechanical wrap is shown in figure 1-9.

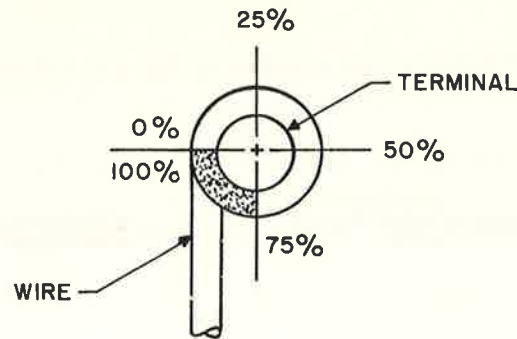

Figure 1-9. Mechanical Wrap on Post

1.5.2 General Requirement

Prior to the soldering process, the parts to be soldered shall be connected mechanically. This may be done by wrapping and crimping the wire on the terminal or inserting the wire through the hole in the terminal (where a hole is provided) and wrapping and crimping the wire. Wire larger than #28 shall contact a terminal post a minimum of 75% and a maximum of 100% of the post periphery. The shaded area of figure 1-9 represents the acceptable limits where this contact may terminate. Exceptions to the above statement shall be when a wire is soldered to a cup-type terminal such as those used in connectors, or to a hollow pin with open ends such as used in plug-in coils.

1.5.3 Small Wire Sizes

When connecting any stranded or solid wire of size no. 28 and smaller to a terminal, a minimum of 100% to a maximum of 200% wrap shall be required. If a hole is provided in the terminal, the wrap shall be made without using the hole.

1.5.4 Lug Without a Hole for Wire

When connecting stranded or solid wire of size no. 26 or larger to a terminal lug with no hole provided for the wire, the wrap shall contact a minimum of 3 sides of the lug, as in figure 1-10.

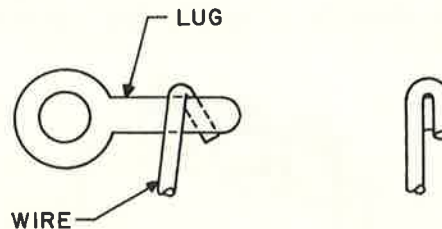

Figure 1-10. Wrap for Wire Size No. 26 or Larger on a Lug with No Hole

1.5.5 Terminal with a Hole for Wire

When connecting stranded or solid wire size no. 26 or larger to a terminal with a hole provided for the wire, the wire shall contact a minimum of 3 surfaces of the

1.5.5 (Cont)

terminal and shall prevent movement of the wire during the normal soldering operation.

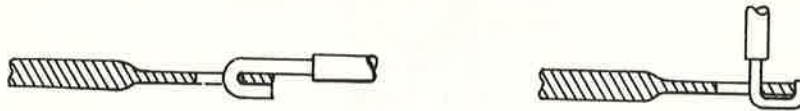

Figure 1-11. Minimum Wrap for Large Wire

1.5.6 Location and Direction of Wrap

Where a connection is made by wrapping a wire or wires around a terminal, the end of the terminal shall be flush or project above the wire wrapped. When two or three wires are wrapped on the same terminal, they should be wrapped in the same direction.

1.5.7 Contact of Wire with Terminal

Any terminal must be large enough to provide adequate contact area for every wire that connects to it. The wrapping of wire upon wire without each contacting the terminal shall not be permitted.

1.5.8 Contact of Threaded Wire

Where a series of three or more terminals are required to be connected using solid wire, threading the wire shall be permitted provided the wire contacts a minimum of 10% of the terminal contact circumference such as shown in figure 1-12. Threading shall be limited to terminals on an individual part or board to avoid stress between parts. Component leads shall not be threaded unless the first terminal (terminal closest to the component) is properly wrapped, with strain relief provided. If the distance between post terminals is more than 1/2 inch or if the wire is smaller than #22, the post terminals shall be wrapped, not threaded.

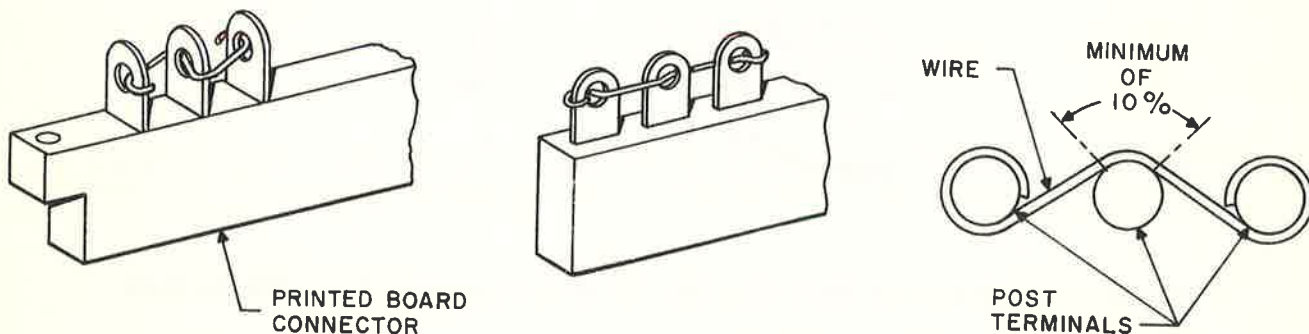

Figure 1-12. Threading Terminals with Wire

1.5.9 Avoiding Tension on Solder

Wire shall be wrapped to a terminal in such a manner that any tension on the wire shall be transmitted to the terminal and not to the solder. See figure 1-13.

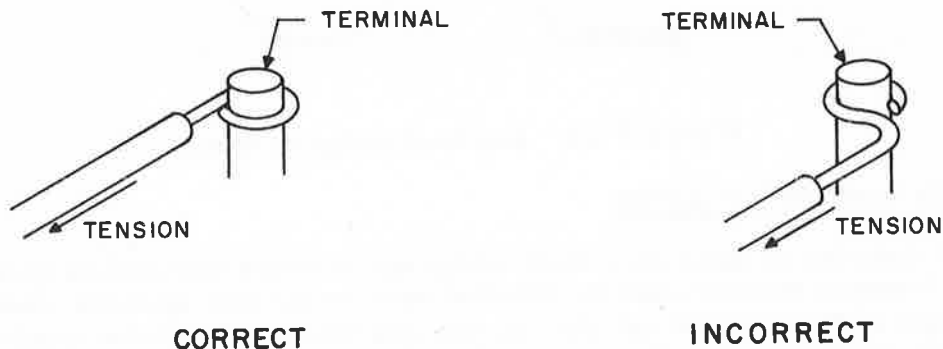

Figure 1-13. Avoiding Tension on Soldered Joint

1.5.10 Wire Heavier than Terminal

In certain instances where bus wire or strap is used which is heavier than the terminal to which it is connected, the requirements for mechanical connection may be modified with approval of the Project Engineer and a Quality Representative. Due to difficulty in handling large gage wires (usually 16 or larger) and in making mechanical connections to comparatively small terminals, such wires should be terminated with lugs or other mechanical devices. When there is no alternative, soldered connections may be used, but the wire shall be subjected to a minimum of mechanical forming.

1.5.11 Close Terminal Spacing

Where mechanical connections would cause insufficient clearance between terminals due to the design of the terminal spacing, the mechanical connection requirements may be modified with approval of the Project Engineer and a Quality Representative.

1.5.12 Assembly of Lug to Wire

Mechanical connection between a lug and the wire or wires to which it is assembled is obtained by crimping the "ears" of the lug around the wire as shown in figure 1-14. The stripped end of the wire shall protrude slightly beyond the "ears" of the lug. Where the lug used has two sets of "ears", the insulation should terminate approximately halfway between them. The "ears" adjacent to the insulation should be crimped firmly around the insulated wire after the soldering operation.

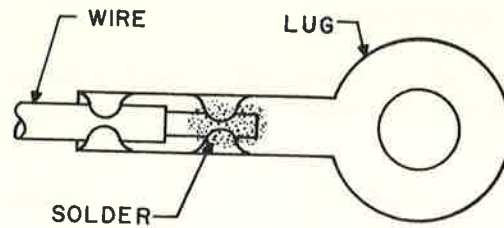

Figure 1-14. Lug Assembled to Wire

1.5.13 Wire Inserted into Eyelet

All stranded or solid wire leads which are inserted into eyelets (such as are used on terminal boards) shall be clinched over on the side opposite insertion. The length of the clinched end shall be not less than 1/16 inch nor more than 1/8 inch, when measured from the cut end of the lead to the centerline of the eyelet from which the lead emerges. A clinched lead end shall not reduce the spacing between adjacent connectors.

1.5.14 Wire to Component Lead Connection

Though not preferred, in making assemblies (other than cables) requiring wire to component lead connections, the smaller (or equal size) wire shall be wrapped a minimum of 1 complete turn around the other wire or lead as shown in figure 1-15. See section 2.6.8.

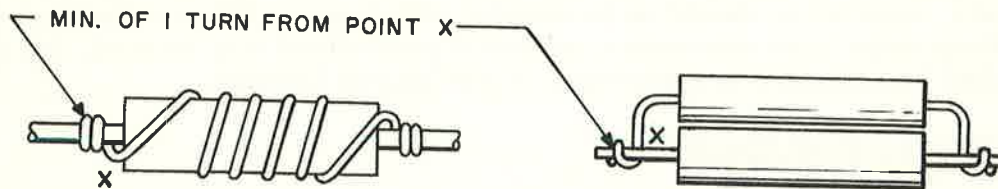

Figure 1-15. Wires Connected to Component Leads

1.5.15 Component Leads Used as Terminals

Though not preferred, if the design requires that the leads of a component as in figure 1-16 are to be used as terminals, the body of the component shall be mechanically supported and the component lead length used as a terminal shall be $3/8 \pm 1/8$ inch measured from the body of the component as shown in figure 16. The connecting wire or wires (never more than two) shall not be a larger gauge than the component lead.

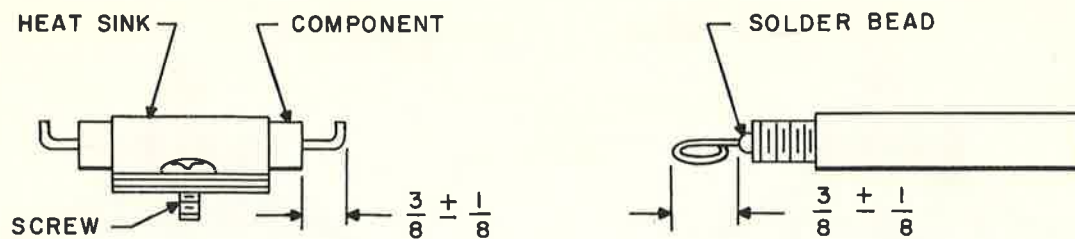

Figure 1-16. Component Leads as Terminals

1.5.16 Wrapping on Adjacent Terminals

Wires shall not be wrapped on adjacent sides of adjacent terminals where spacing will not allow 1/32-inch minimum clearance with the terminals in the worst possible position after the connection is complete. See paragraph 4.1.1.B.

1.5.17 Miniature Tube Socket Wiring

To avoid shorts and potential shorts on miniature tube socket terminals when connecting stranded or solid wire, the following procedures shall be followed.

- A Where one or two wires are terminated, both wires shall be wrapped over the top of a terminal, unless the wire diameter is too great.
- B Where more than two wires are terminated, two of the wires shall be wrapped over the top and the balance wrapped on the proper side of a terminal.

Where more than two wires are connected to adjacent terminals, the wires which are wrapped around the side of the terminal shall be wrapped on the same side.

- C It will not be necessary to wrap wires over the top of terminals 1 and 7 on a 7-terminal tube socket or terminals 1 and 9 on a 9-terminal tube socket, if the wire is wrapped on the side of the terminals next to the wide space between the terminals.
- D Where a miniature tube socket is assembled with a grounding shield, the terminals adjacent to the shield shall be twisted approximately 45° away from the shield before the connecting lead is wrapped. The mechanical connection wrap shall be over the top or on the opposite side of the terminal from the shield. See figure 1-17.

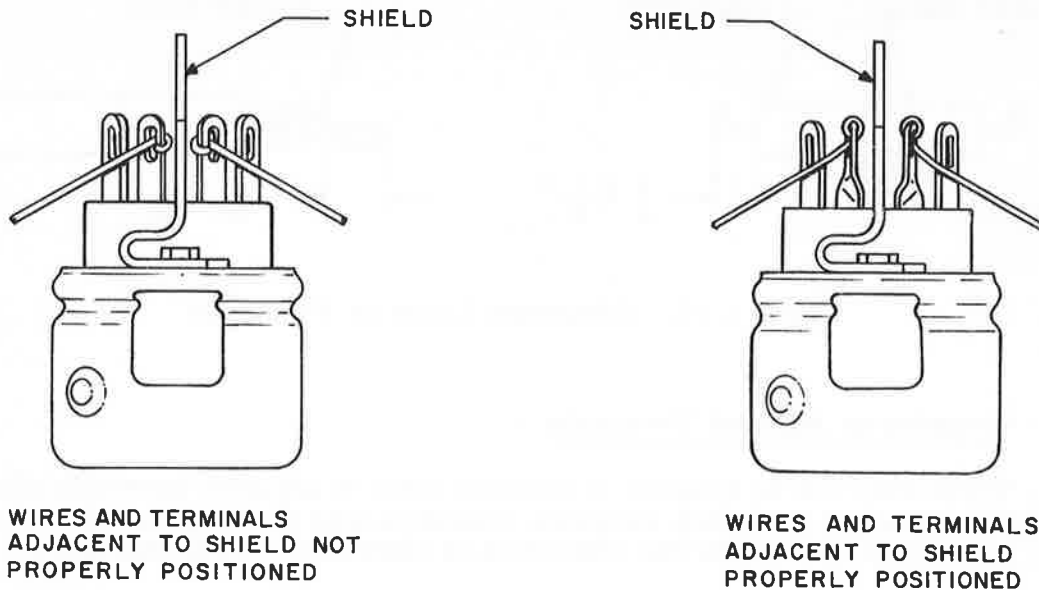

Figure 1-17. Miniature Tube Socket with Shield

1.5.18 Wrapping on a Slotted Terminal

When terminating stranded or solid wire on a slotted terminal, the wire shall contact a minimum of 3 sides of one of the members and shall prevent movement of the wire during the normal soldering operation. See figure 1-18. If a solid wire or component lead is large enough to be mechanically secure between terminal members, no wrap shall be necessary.

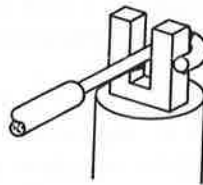

Figure 1-18. Minimum Wrap on Slotted Terminal

1.5.19 Cup-Type Terminals

- A When terminating stranded or solid wire to a cup-type terminal such as those used in connectors, mechanical connection will be impossible; however, the wire shall bottom in the solder cup as shown in figure 1-19. During the soldering operation, care shall be taken that the wire or wires and/or connector do not move during the time the solder is cooling and setting.

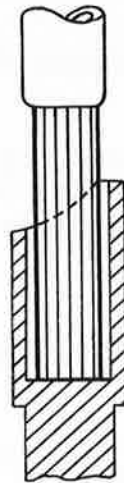

Figure 1-19. Bottoming in Cup Terminal

- B The gauge of wire terminating in a cup-type terminal shall be less than or equal to the maximum wire gauge allowable as specified on the connector specification drawing. The effective wire gauge at the point of termination with a cup-type terminal shall not be altered in any way. The use of an adapter such as 306 1000 00 or 372 8015 00, is recommended where the wire is too large for the connector cup.
- C The maximum number of wires terminating in a cup-type terminal shall be that number of wires with a combined equivalent wire diameter equal to the maximum wire diameter allowable as specified on the connector specification drawing.
- 1.5.19.D After soldering to cup-type terminals, all connector pins having float before soldering shall have evidence of float. Float shall be determined by moving the solder cup or connector pin.
- E After soldering to a miniature cup-type terminal, the spacing between adjacent terminals shall not be materially decreased due to the solder operation. A light film of solder on the outside of the cup-type terminal is allowable.

1.5.20 Control of Clippings

To keep wire clippings out of electronic equipment, Collins tool 006 1305 00 has been designed to enable the operator to cut off a wire and dispose of the clipping. This tool should be used for any trimming of #18 and lighter wire where a clipping could fall into the assembly if ordinary cutters were used.

1.6 HAND SOLDERING

1.6.1 Definition and Purpose

Soldering is the joining together of two metals by a fusible alloy. The alloy of tin and lead is called soft solder. Solder containing a small percentage of silver is sometimes used.

The purpose of soldering is to obtain a nonporous and continuously metallic connection that is not adversely affected by operational temperature extremes, that

Wiring and Cabling

1.6.1 (Cont)

withstands torsional stress and strain without rupture, and that has a constant and permanent electrical value.

Since the prime application for soldering in electronic equipment is the joining of a wire to a terminal, standards in this section will be based on that operation. The same general requirements apply to other soldering applications.

1.6.2 Preparation

- A Surfaces to be soldered shall be free of grease, dirt, oxide, scale, or other foreign materials.
- B All wires, component leads, and terminals which do not have an easily solderable coating shall be tinned before soldering.
- C All forming and trimming of leads shall be done prior to soldering.

1.6.3 Method

- A In making a proper solder joint, it is necessary that there be no movement of the members until the solder has hardened completely. Movement of the members could result in a fractured or weakened joint which would break later under strain. Prevention of this movement is the reason for making the wire mechanically secure to the terminal prior to soldering.
- B In the soldering operation, the member or members to be soldered must be hot enough to maintain the solder in a molten condition until the necessary "wetting" action takes place. It is important that the soldering iron or other source of heat be of adequate temperature and heat capacity to maintain the metal being soldered at the proper fusion temperature.
- C The soldering iron tip should be kept seated and tight within the iron and excess oxidation shall be removed at frequent intervals to ensure maximum transfer of heat from the heating element to the tip. The diameter of the tip shall be as large as practical to ensure maximum heat transfer in a minimum length of time. A bright, clean, well tinned, smooth face shall be kept on the tip; the tinned portion should extend a minimum of 1/2 inch back from the pointed end.

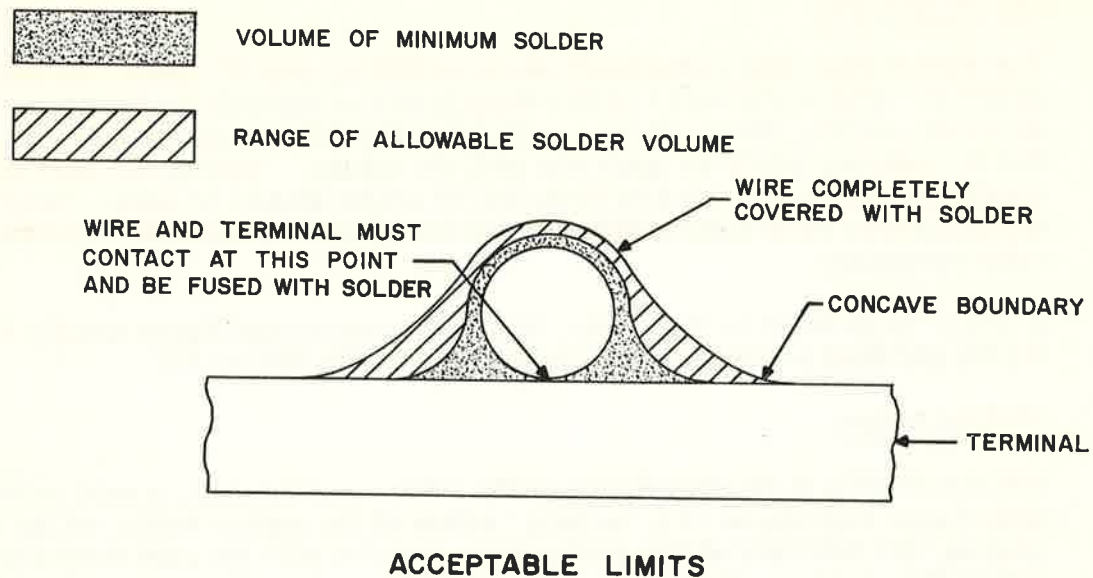

Figure 1-20. Section Showing Acceptable Limits of Solder Volume

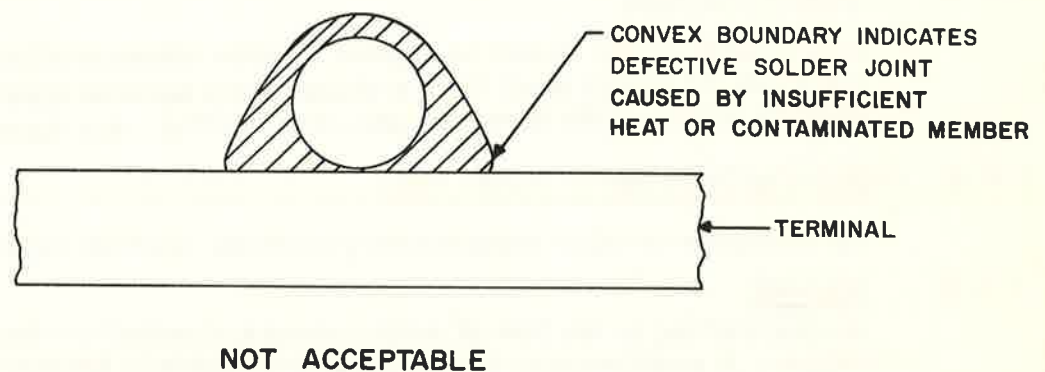

Figure 1-21. Section of Unacceptable Soldered Joint

- 1.6.3.D Heat sinks free of rosin shall be used on the leads of all components that could be damaged by the heat of normal soldering.
- E If a solder connection is to be reheated, the old solder should be removed and new solder applied, unless the reason is insufficient solder, in which case additional solder would be applied. A preferred method of removing old solder is by the use of metal shielding braid to soak up molten solder.
- 1.6.4 Flux
- A The flux employed shall be no more active chemically than necessary to obtain satisfactory solder joints. If a highly active flux is necessary, its use must be approved by a Quality representative and the residual flux must be removed or neutralized properly.
- B The soldered connection should be cleaned of excessive rosin and other residues after soldering, depending on the circuit application, customer requirements and appearance.

Wiring and Cabling

1.6.5 Choice of Solder

The solder alloy that melts most easily is 63% tin and 37% lead. Its melting point is 361°F. The solder spool or bar usually is marked with the tin percentage first, as 63/37, 60/40, 50/50, 40/60, or 30/70. The 50% tin solder melts at 464°F, but it requires 545°F to melt the 30% tin solder. Where the part or the insulation may be damaged by heat, 63/37 solder should be used, except where the equipment must meet environmental specifications that make a higher melting point necessary.

If silver is included in the solder, the silver percentage figure usually follows the tin and lead percentages and is followed by the letters AG.

1.6.6 Wetting Action

Since soldering is an alloy fusion of the solder and the part, a good solder joint should give indications of a "wetting" action of the molten solder on the base metal. That is, the boundary of the solder at its junction with the part should be concave rather than convex. See figure 1-20 and figure 1-21. The solder should appear bright with no projections or sharp points.

1.6.7 Amount of Solder

Only enough solder should be applied to allow adequate alloying action to take place but the solder shall form a visible fillet between wire and terminal. The general outline of the members should be visible. See figure 1-20.

1.6.8 Material Imbedded in Solder Joint

No insulation or other contaminating material shall be imbedded in a solder joint.

1.6.9 Wicking

Solder wicking is the flow of solder along a stranded conductor due to capillary action. A small amount of wicking is desirable to assure that the proper amount of heat and solder has been applied. However wicking should be held to a minimum.

1.7 SOLDERLESS CRIMP-TYPE CONNECTIONS

1.7.1 Approval for Use

All crimp connection devices, tools and methods must be approved by the Component Application and/or the Materials Engineering groups, whichever is responsible for the items used.

1.7.2 Tool and Method

Crimp connections shall be made with the proper crimping tool and method specified by the manufacturer of the connecting device or by an alternative specifically approved by the cognizant Component Engineer. Each crimping hand tool must be equipped with a fail-proof ratchet device that secures the tool to the wire until sufficient force has been applied.

1.7.3 Tool Checking

Crimping tools shall be checked and gauged at the specified intervals. All initial settings and any resettings required shall be performed by the tool department in accordance with the instructions of the tool manufacturer.

1.7.4 Wire Variation

Wire other than that specified for a particular crimp device shall not be acceptable without Component Engineering approval. Wire with the same AWG size might be unacceptable because of different wire material, stranding, strand finish, or insulation.

1.7.5 Fused Wire

Wire preparation for use with crimp devices shall not include fusing or tinning during or after stripping.

1.7.6 Solid Wire

The use of a crimp device with solid wire is NOT acceptable without written approval of a Component Engineer.

1.8 SLEEVING

1.8.1 Connector Terminals

The use of sleeving on connector terminals shall be limited to the prevention of voltage breakdown and/or support, except when it is required by specification.

1.8.2 Pressure or Abrasive Action

Sleeving shall not be used for electrical protection where constant pressure or abrasive action on the sleeving is present.

1.8.3 Grade and Fit

Sleeving shall be of an electrical grade and shall fit snugly on the connecting wire, connector terminal or object which it is to protect and/or support without damage to the sleeving.

1.8.4 Environmental Requirement

The mechanical and electrical properties of sleeving shall not be impaired by exposure to the temperature or other environmental extremes of the equipment specification.

1.8.5 Cable Covering

When sleeving is used to cover a cable, the sleeving shall be secured at the ends to maintain its intended position.

1.8.6 Tolerance on Length

Standard tolerance on over-all length of sleeving is as follows:

<u>Over-all Length</u>	<u>Tolerance</u>
1/8 inch through 3 inches	±1/32 inch
Over 3 inches	±1/8 inch

Squareness of cut shall be such that no portion of the over-all length shall exceed the specified tolerance.

Wiring and Cabling

1.9 COILS

1.9.1 General

- A All coils and transformer assemblies shall meet all end equipment specifications.
- B See sections 2 and 4 for information on stamping.
- C Windings must not be loose on a coil form.

1.9.2 Insulation

- A Enamel insulation on wire should not be damaged between tinned portions to the extent that the base material is exposed.
- B An assembly that has a member within 1/32 inch of another member of a different potential must have one of those members suitably insulated.

1.9.3 Broken Strands

- A No broken strands are allowed in the wire of a winding or the leads of a coil.

1.9.4 Slipped Turns

Universal-wound coils shall not have any turns which have slipped off the top of the wind during or after the winding operation.

1.9.5 Minimum Inside Diameter

- A No mold release, cement, coil dope, etc., shall be used in such a quantity or manner as to reduce the minimum inside diameter of a coil form after assembly or encapsulation.
- B The minimum inside diameter of a coil form shall be checked by a slip fit, not a press fit, on a plug gauge the size of the minimum ID. The minimum ID of a coil form must be maintained after the coil has been wound on the form.

1.9.6 Coil Coating

A coil winding on a form must be coated with an approved coil dope, cement or epoxy coating unless it is to be encapsulated or potted. The drawing shall specify the coating to be used or shall specify any change from this requirement.

1.9.7 Voids in Potted Assembly

There shall be no undesirable voids in the compound of a potted coil assembly. This may necessitate sectioning a sample potted assembly for inspection from time to time.

1.9.8 Wiring and Soldering

- A The insulated portion of the wire shall not extend into the connections.
- B See paragraph 1.1 for information on insulated wire.
- C See paragraph 1.5 for information on mechanical connections.
- D See paragraph 1.6 for information on soldering.

1.9.9 Similar Coils

Where there are several coils in an equipment that are the same except for a difference in the number of turns, some means must be used to readily distinguish between them.

1.9.10 Securing of Coils, Leads and Terminals

- A See section 3 for general information on fastenings.
- B To prevent the unwinding of a coil wire before the coil is connected to terminals, securing of the ends of the coil should not be dependent on coil dope or spot cement only.
- C When mounted on a coil form, ring-type terminals shall be approximately perpendicular to the axis of the form and shall meet the spacing requirements of the drawing or specification. In cases not controlled by the drawing or specification, the terminal shall be not more than 15° from perpendicular.

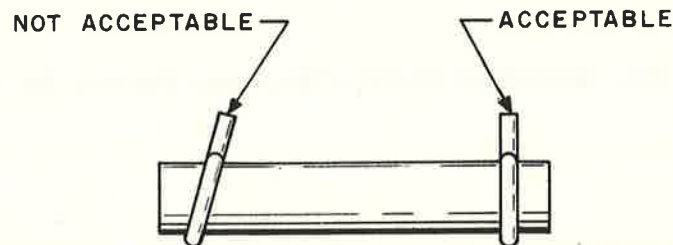

Figure 1-22. Mounting of Ring Terminals

- D Terminals shall be secured to the coil form with R313, part no. 005-0305-00, cement or equivalent if the terminals will not maintain their specified position on the form during and after winding. Cement used to secure terminals to forms shall not extend into the coil winding area of the form; the cement should be applied to the outside of the terminal rings, rather than between the rings.

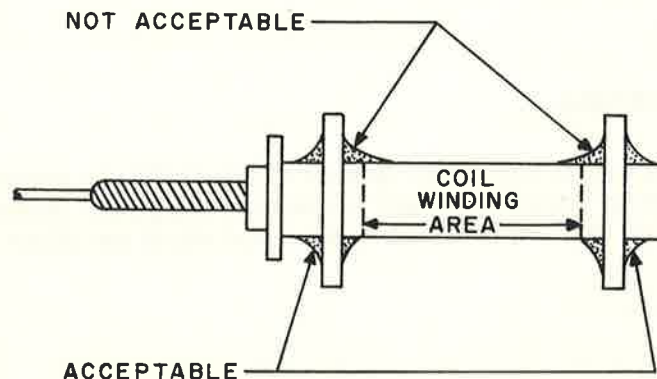

Figure 1-23. Cementing Terminals to Coil Form

1.9.11 Resistor Notches for Coil Winding

For wire smaller than no. 18, it may be necessary to grind notches in the ends of a resistor to hold coil leads in place. These notches shall be no deeper than necessary to hold the wire. Under no circumstances shall the depth of these notches exceed .020 inch.

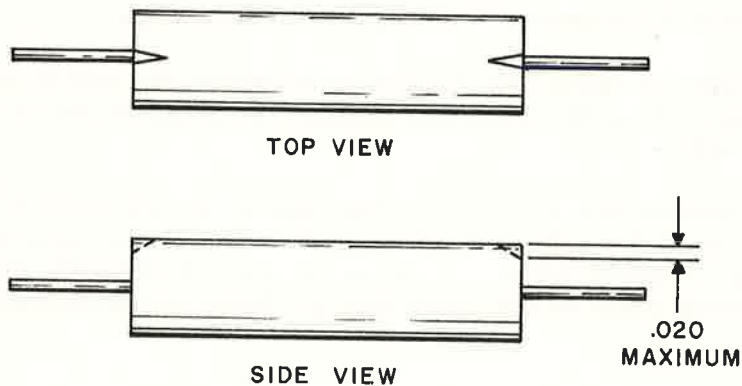

Figure 1-24. Maximum Depth of Resistor Notches for Coil Winding

1.9.12 Damage

Coil forms shall not be chipped, cracked, or otherwise damaged to the extent that the structural strength is affected.

1.9.13 Winding Direction

The drawing should specify the winding direction. Where existing drawings have not been revised to specify the direction, coils should be right-hand wound (regardless of how pictured on the drawing) because most coil winding machines are designed for only right-hand winding.

1.10 STRAY MATERIAL

Care shall be taken during all stages of assembly to prevent the entrance of solder drippings, stray lugs, wire and insulation clippings, excess solder flux, or any other material that could cause a potential short or other malfunction in the equipment.

1.11 CONNECTING 3-WIRE AC CORD

The connections shown in figure 1-25 offers maximum protection to the operator and to the equipment. It is also the plan approved in the national wiring code.

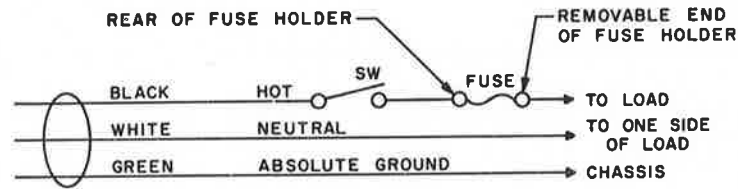

Figure 1-25. Correct Method of Connecting 3-Wire AC Cord for 115 Volts

Section II

ELECTRICAL COMPONENTS

2.1 SCOPE

The term "Electrical Components" in this section shall be defined as all items included in an equipment that provide an electrical function with the exception of wiring, cabling, and electromechanical components which are covered in other parts of this manual.

Included in the electrical component category are:

- a. Resistors, potentiometers, thermistors, etc.
- b. Capacitors
- c. Vacuum tubes
- d. Transistors
- e. Crystals
- f. Diodes
- g. Coils
- h. Chokes, inductors, toroids, etc.
- i. Transformers (r-f, i-f, audio, and power)
- j. Switches (See also section 4.6)
- k. Filters, delay lines, etc.
- l. Pilot lamps, fuses, etc.
- m. Sockets (tube, transistor, and lamp)

2.2 STORAGE, HANDLING, AND TRANSPORTATION

2.2.1 Storage

Electrical components shall be packaged and/or stored in such a manner that the surfaces are protected from contaminants such as dust, corrosive elements, and oily compounds. Components shall be stored so as to prevent damage.

Contaminated components shall be cleaned before they are used. Normal oxidation of exposed surfaces is not included in this requirement unless it is detrimental to proper functioning, soldering, or general appearance.

2.2.2 Damage and Contamination by Handling

Care shall be exercised during routine inventory and other actions requiring handling of components to prevent damage by contamination, vibration, and shock.

Examples of careless acts in handling components:

1. Throwing components from one stock bin to another
2. Dropping components onto hard surfaces
3. Handling components with dirty or oily hands

Electrical Components

2.2.2 (Cont)

Careless handling of assemblies containing delicate components also is undesirable. Such items as vacuum tubes, crystals, mechanical filters, and diodes may be extremely susceptible to damage by mechanical shock.

Components susceptible to shock damage that have been subjected to severe shock forces shall not be used in the assembly of an equipment until it has been ascertained by subsequent inspection or test that no damage had been sustained.

NOTE: A component dropped onto a hard surface, such as a concrete floor, may be subjected to shock exceeding one thousand times the force of gravity.

2.2.3 Damage in Transportation

A reasonable degree of protection shall be provided to prevent mechanical damage in normal handling and transportation.

2.2.4 Bending of Component Leads for Storage

Bending of component leads to accommodate larger volumes of parts in stock bins shall be prohibited. Damage to leads, seals, and internal elements can result.

2.3 COMPONENT DEFECTS

Since all components are not 100% inspected in receiving inspection and since a component may possibly be damaged after inspection, an assembly operator should reject an obviously defective component.

2.3.1 Damage to Insulation

The insulating or sealing material on molded or coated resistors, chokes, etc., shall not be chipped or otherwise damaged to the extent that the reliability of the component is threatened. A component damaged to this extent, though functioning at the time of final test in manufacture, eventually may fail after a short period of service.

2.3.2 Illegible Component Markings

Markings pertaining to values, tolerances, ratings, etc., placed on the component by the manufacturer as required by specification, shall be intact and legible. This is a requirement of many of our customers to simplify equipment maintenance.

2.3.3 Dents and Chips

Dents or chipped areas in component bodies that threaten the reliability of the parts shall be cause for rejection. A typical component that may exhibit this type of damage is the hermetically sealed capacitor. Such damage can result in short circuiting or leakage within the part.

2.3.4 Cracks

Cracks in electrical component bodies shall be cause for rejection.

2.3.5 Improper Lead Tinning

Component leads shall be clean and free of foreign materials and shall be tinned properly using methods prescribed by Engineering. Subsequent soldering of component leads can be extremely difficult if the leads carry contaminants, or the wrong proportions of solder elements are present in the tinned surfaces.

NOTE: Intermittents that develop in electrical circuits are many times caused by contaminants in the solder joints.

2.3.6 Lead Defects Reference

Component leads shall be free of defects to the extent specified in paragraph 1.1.3.C.

2.3.7 Bent Leads

Component leads should be reasonably straight and free of sharp kinks to simplify lead forming, maintain mounting rigidity, and provide uniformity of mounting. See paragraph 2.2.4

Care shall be exercised in straightening component leads to prevent undue strain on the component. Some diodes, capacitors, and crystals can be damaged easily by exerting excessive tension on the leads.

2.3.8 Stray Material

A component must not contain loose solder, wire clippings, stray hardware, or other material that may interfere with its operation.

2.4 COMPONENT LEAD FORMING

2.4.1 Changes in Ratings Due to Forming

Any process of straightening, cutting, bending, inserting, crimping, or clinching of wire leads which may result in changes in ratings or values, or other damage, shall not be permitted.

Whenever possible when component leads are formed, they shall be supported close to component body and formed beyond the area of support. See sections 2.4.5 and 2.5.

2.4.2 Readability of Markings

Wherever possible, component leads shall be formed in such a manner that the important markings are readable on the most easily visible surfaces when the component is in its mounted position.

2.4.3 Sharp Bends in Component Leads

Sharp bends shall be avoided unless specified in the equipment design requirements. Sharp bends are subject to breakage at the point of the bend in severe vibration environments. (See paragraph 2.5.)

2.4.4 Thermoplastic and Teflon Sleeving

When bending sleeved component leads, proper consideration shall be given the type of sleeving used. Teflon and thermoplastic sleeving, in particular, must not be used where sharp lead bends are employed. Subsequent cold flow of the material can result in exposure of the lead and shorting to adjacent circuitry or chassis surfaces. Generally, teflon and thermoplastic sleeving shall not be used if a possibility of tension on the material exists.

Bend configurations shall properly accommodate the type of sleeving used, to prevent cracks or breaks in the sleeving material.

2.4.5 Positioning of Lead Bends

Component lead bends shall not be positioned so close to the over-all body of the component (welds, solder beads, glass seal fillets, etc., included) that fracturing or other damage could result. On "top hat" type tantalum capacitors, the lead shall not be bent between the weld and the capacitor. Tantalum leads on tubular capacitors may be carefully bent over round nose pliers.

Whenever possible, a distance of at least 1/8 inch between the component body and the bend shall be maintained. The minimum distance between bend and body shall be equal to two diameters of the lead being formed. This practice will greatly reduce the possibility of damage due to fractured welds, solder beads and seals. See figure 2-1.

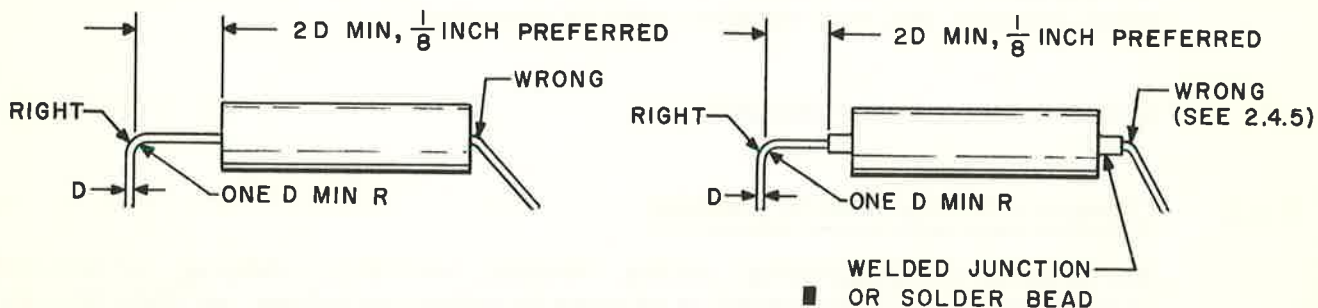

Figure 2-1. Lead Bends

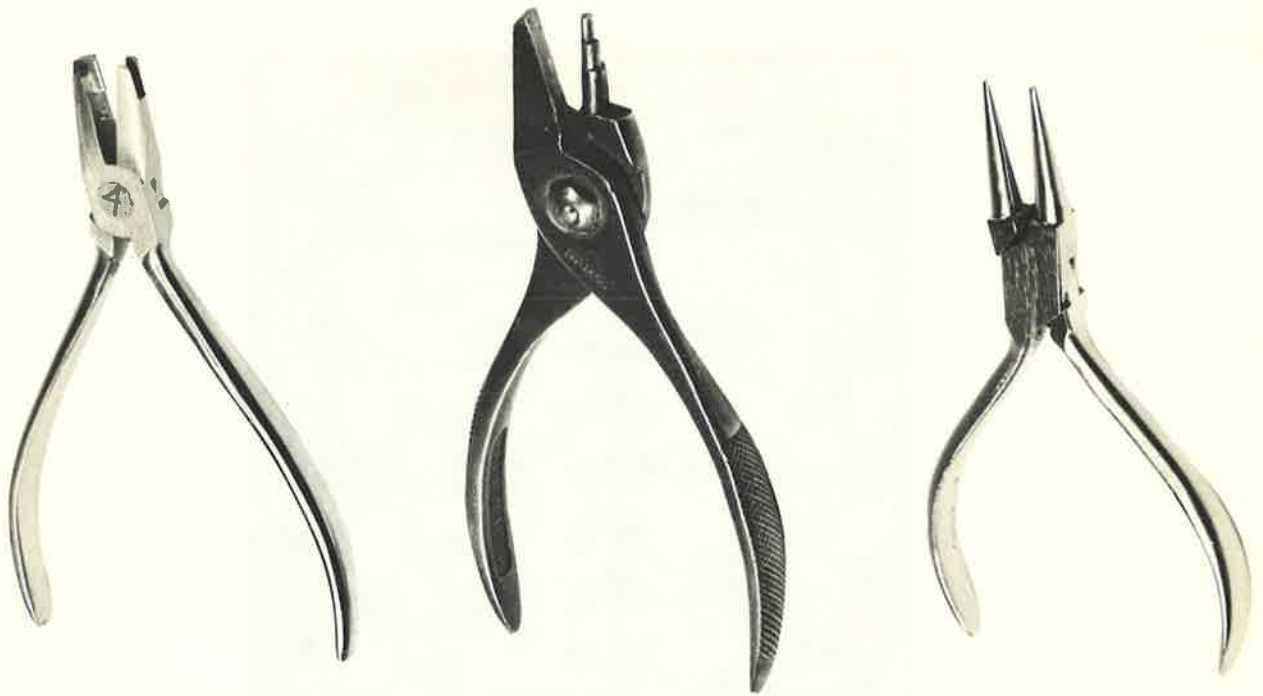

Figure 2-2. Examples of Specialized Pliers for Lead Forming

2.5 USE OF TOOLS FOR WIRING

2.5.1 Tools for Lead Forming

Assembly line operators shall acquaint themselves with the various types of tools available for the purpose of forming component leads. This information is available through supervisory personnel.

2.5.2 Tools with Sharp Edges

The forming of component leads with sharp-edged tools shall not be permitted.

2.5.3 Control of Clippings

See paragraph 1.5.20.

2.6 COMPONENT POSITIONING AND MOUNTING

2.6.1 Positioning Within Boundaries

All components should be mounted in such a manner that they are positioned within the boundaries of the unit in which they are assembled. This will eliminate the undesirable pushing of components into intended positions when closing the unit.

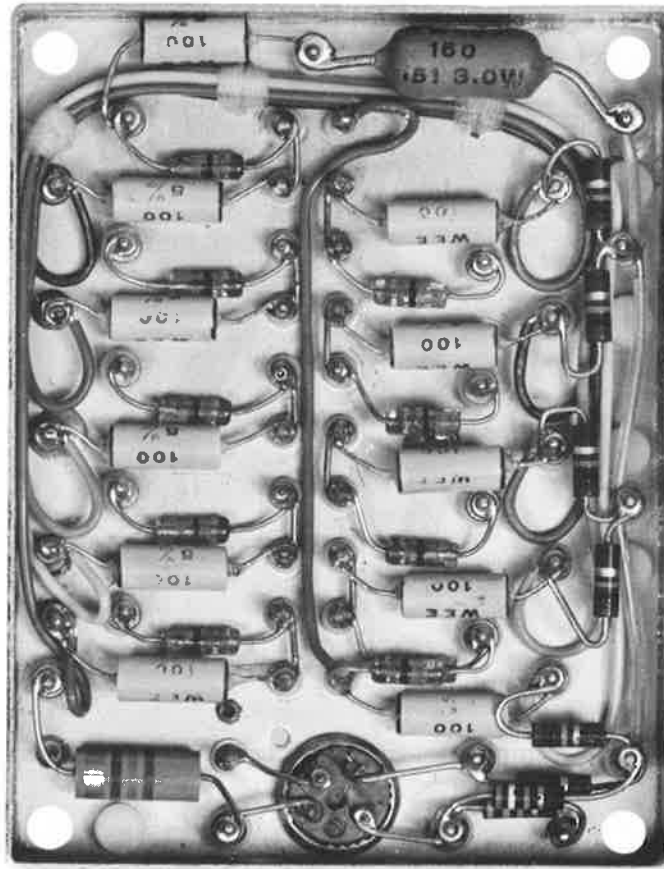

Figure 2-3. Example of Wired Assembly

2.6.2 Neatness in Mounting

Whenever practical, lead-mounted components should be positioned so that the major axis of the component is parallel to any two of the three major planes (sides) of the unit. See figure 2-2. This practice affords a much neater and, in most cases, a more reliable unit assembly.

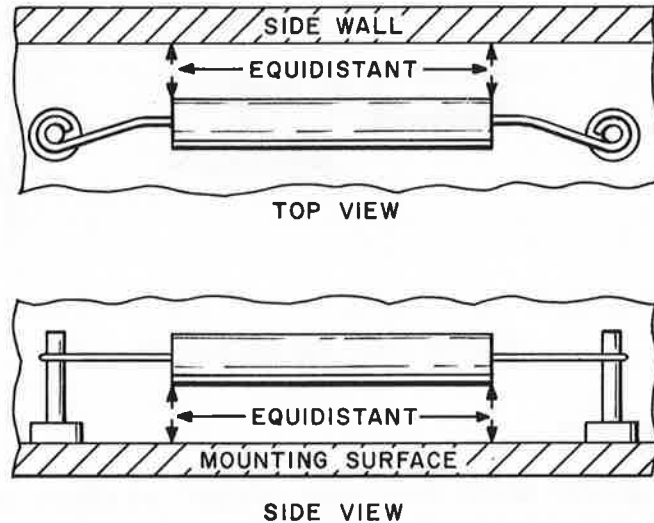

Figure 2-4. Mounting Layout

2.6.3 Crossing of Component Leads

The crossing of component leads shall be avoided if at all possible. When necessary to cross component bodies or leads, it is preferred that components shall be positioned so that the lead of one crosses the body of the other or so that the bodies cross each other. In any case where there would be a potential short, at least one of the leads shall be properly insulated

2.6.4 Access to Mounting Holes and Controls

Components shall be positioned to provide clear access to mounting holes and controls.

2.6.5 Centering of Components

Whenever possible, components should be centered between connections. This requirement affords the best weight distribution to the supporting leads and equalizes heat dissipation during the soldering operation.

2.6.6 Strain Relief

Component leads shall not be stressed between mounting points. Adequate strain relief, as recommended for the part under consideration, shall be provided to prevent damage to the component and solder joints. See figures 2-2 and 2-3 for examples. In certain cases, terminal configuration and material may provide the necessary strain relief.

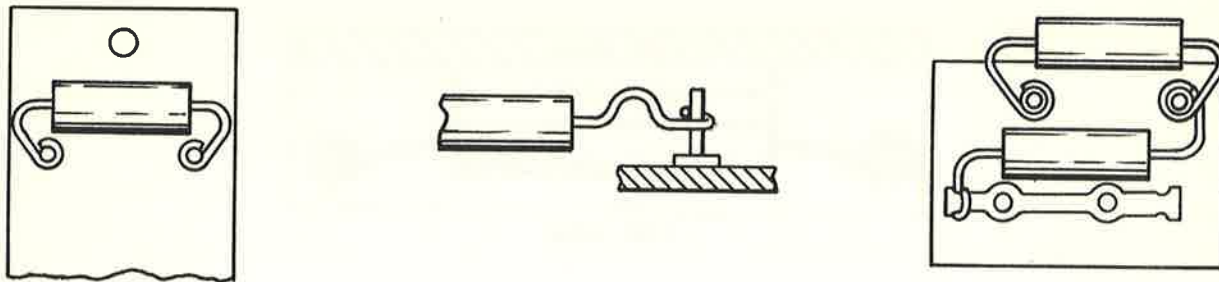

Figure 2-5. Strain Relief

2.6.7 Component Support

Components which, due to their size, weight, or shape, may be damaged or cause damage when subjected to vibration shall not depend solely upon their leads for support. A suitable means of additional support, that is, clamps or cementing compounds, shall be provided. Components weighing more than 1/2 ounce should be supported by means other than their leads.

2.6.8 Misuse of Components for Support

Lead-mounted components shall not be used as a means of support or positioning for wires, cables, or other components. To do so would add strain to the leads and may result in damage to the component. However, when approved by a Quality representative, two components may be "piggy-backed" as shown in figure 1-15. This method could be used when the terminal is too small for the leads from both components when a design change requires an added component and it is impractical to provide a larger terminal.

2.6.9 Clearance from Sharp Edges

Mounted components shall properly clear all sharp edges, mounting hardware and wiring.

2.6.10 Prevention of Clatter

All delicate lead-mounted electrical components shall be mounted in such a manner that the body of the component clears all adjacent surfaces by a distance of at least 1/32 inch. Under vibration, delicate components mounted against rigid surfaces will clatter against the surfaces and eventually will be damaged to the point of failure.

As an exception to the above requirement, where delicate components must necessarily be mounted directly against rigid surfaces, a means of preventing motion between the component and the surface must be provided. Epoxy cementing agents generally are used for this purpose.

2.6.11 Mounting of Heat Dissipating Components

Components dissipating appreciable heat, such as vacuum tubes and dropping resistors, shall be mounted with sufficient clearance from adjacent components to prevent thermal damage.

2.6.12 Mounting of Heat Sensitive Components

Special consideration shall be given to mounting heat sensitive components. Some heat sensitive components are solder sealed capacitors, transistors, rectifiers, and diodes. Generally, solder connections shall not be made closer than 1/4 inch (lead length) away from the main body of the component. All heat sensitive components require adequate heat sinks for transferring heat away from the component. Heat sinks must be kept free of rosin.



Figure 2-6. Typical Commercially Available Heat Sinks

Electrical Components

2.6.12 (Cont)

When feasible, the component arrangements should be made in the final design stage so that sufficient lead length between the component body and solder joint is assured.

2.6.13 Mounting of Components into Tubelets

Extreme care shall be exercised when mounting components into tubelets. Lead bend dimensions shall be such that minimum effort is required to position the component properly. Damage due to cracked bodies and seals may result unless these precautionary measures are observed.

2.6.14 Centering of Clip-Mounted Components

Clip-mounted components shall be centered in the clip to prevent possible loosening or shorting from lead to clip during vibration.

2.6.15 Tightness of Mounting Clips

Component mounting clips shall not be so tight that the bodies of the components are deformed or broken. Capacitors and glass envelope vacuum tubes and diodes require special consideration in this regard.

2.6.16 Positioning of Stud-Mounted Components

Stud-mounted components should have sufficient clearance from adjacent wiring and cables to prevent abrasion damage. See 1.1.4.

2.6.17 Mounting of Components Having Locating Tabs

Components with locating tabs, such as some transistors, shall be prepositioned properly over locating holes prior to the fastening operation. Distorted and damaged component bodies can result from improper locating procedure.

2.6.18 Connections to Fuse Posts

The metal structure which terminates in the cap of a post-type fuse holder shall not be connected to the "hot" side, to avoid a shock hazard.

2.6.19 Twist-Tab Capacitors

Twist-tab mounted capacitors shall be mounted firmly and securely by twisting each tab a minimum of 45° to a maximum of 90° from their original positions. Care must be taken to avoid shearing the tabs during the twisting.

Grounding of twist-tab mounted capacitors must not depend on pressure between tab and mounting surface. Grounding must be provided with wire, braid, strap, or some other form of positive electrical connection.

Section III

FASTENING

3.1 MACHINE SCREWS

Machine screws are used extensively in preference to permanent fastening, such as rivets, because they permit removal and reassembly many times during the life of an equipment without loss of structural integrity. The use of machine screws facilitates preventive and remedial maintenance; Phillips panhead screws are preferred. The Phillips head retains the screwdriver better than a slotted head, thereby reducing the possibility of screwdriver slippage and resultant damage to the surrounding area.

Head types of machine screws in common use at Collins Radio Company are illustrated below:

PREFERRED

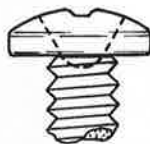

PREFERRED FOR OVERALL MACHINE SCREW USE. (GRADUALLY REPLACING ROUND AND BINDING HEAD SCREWS THROUGHOUT INDUSTRY)

PHILLIPS PAN HEAD

ACCEPTABLE

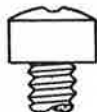

PHILLIPS FILLISTER HEAD

USED IN COUNTERBORES OR OTHER APPLICATIONS REQUIRING REDUCED HEAD DIAMETER.



PHILLIPS FLAT HEAD

USED IN COUNTERSUNK HOLES TO OBTAIN FLUSH FIT AT PERIPHERY OF HEAD.



PHILLIPS OVAL HEAD

Figure 3-1. Screw Heads in Common Use at Collins

Fastening

3.1 (Cont)

Heads with other contours and types of drives are commercially available and are sometimes used in Collins equipment in applications where they are uniquely suited. These include slotted and hexagon head machine screws, as well as hexagon and socket head cap screws.

3.1.1 Materials and Finishes

- A Stainless steel screws are preferred for general fastening applications. Although more costly than carbon steel screws, stainless steel screws have adequate strength and do not require plating or other applied finish to provide resistance to corrosion or enhance appearance. Brass screws, nickel plated, are preferred for electrical connections. (Steel screws can be used to secure an electrical connection if the screw is not necessarily part of the conductive path.) Steel fastenings must not be located in an r-f field strong enough to cause appreciable heating. Severe heat may damage the fastening components and/or adjacent parts; brass or other nonferrous fastenings are not similarly affected by an r-f field.
- B Whenever possible, fastener items in each sequence (for example, screw, lock washer, and nut) should be of the same basic material.
- C Paint or other insulating finishes must be removed to expose clean metal areas under ground terminations.

3.1.2 Countersunk Screws (Flat and Oval Heads)

- A The heads of flathead screws should seat flush, or slightly below flush, with the panel or part through which they pass. The self-centering feature of a flathead or oval-head screw in a countersunk hole increases the between-hole tolerance problem. A preferred method of achieving flushness when required is the use of a panhead screw with the head recessed in a counterbore or dimple. This provides top surface flushness while permitting generous clearance holes.

- B Whenever the lower portion of the head of a flathead screw passes completely through a panel or part and could interfere with proper seating of the next part in the sequence, one of the following practices should be followed:

1. The latter part countersunk to receive the head.
2. An undercut flathead screw used.



Figure 3-2A. Panhead Screw Recessed in Dimple in Thin Sheet Metal

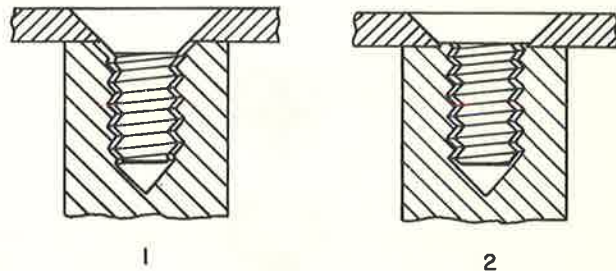

Figure 3-2B. Using Flathead Screws on a Thin Panel

3.1.2.B (Cont)

Using 100° flathead screws, which have slightly lower head height than 82° screws, minimizes the problem of bottoming out.

3.1.3 Preferred Sizes and Class of Fit

2-56 NC-2A	*10-24 NC-2A
4-40 NC-2A	10-32 NF-2A
6-32 NC-2A	1/4-20 NC-2A
8-32 NC-2A	

*Coarse threads are preferred in soft material.

3.1.4 Minimum Thread Engagement and Thread Inserts

- A The length of usable thread for tapped holes in steel or hard brass shall be at least equal to the nominal thickness of the corresponding standard machine screw nut.

Table of Standard Machine Screw Nut Thickness

<u>Screw Size</u>	<u>Nut Thickness</u>
No. 0	3/64
No. 1	3/64
No. 2	1/16
No. 3	1/16
No. 4	3/32
No. 6	7/64
No. 8	1/8
No. 10	1/8
No. 12	5/32
1/4	3/16
5/16	7/32
3/8	1/4

- B Tapped holes in ceramic parts have brittle threads that are often oversize, thus increasing the danger of stripping. Tapped holes in ceramic parts are to be avoided wherever possible. Screws threaded into ceramic material must have a minimum usable engagement equal to one screw diameter or 3/16 inch, whichever is greater.
- C Tapped holes in aluminum, magnesium, or other soft material are not permitted in applications requiring frequent disassembly and reassembly. When threads in soft material are required, the usable thread engagement should be approximately 50% greater than the engagement for steel.
- D Use of a stainless steel or cadmium plated steel thread insert is required in soft metals where relatively high strength is needed, or when frequent disassembly may occur.

Thread inserts shall be constructed and installed so as to permit firm anchoring in the aluminum alloy or magnesium alloy part. They must be replaceable in case of damage to the threads.

Fastening

3.1.4.E Holes tapped directly into aluminum alloy or magnesium alloy materials for the purpose of mounting nameplates or for other nonstructural purposes need not conform strictly to the thread engagement requirements outlined above.

3.1.5 Thread Projection

A Machine screw standard length tolerances always run to the minus side, never to the plus. Standard screw length tolerances are as follows:

Up to and including 1 inch length +0, -1/32 inch.

Over 1 inch to and including 2 inches +0, -1/16 inch.

Over 2 inches +0, -3/32 inch.

EXAMPLE: A 1/4-inch long screw is not guaranteed to be more than 7/32 inch long.

B The minimum projection of a screw or threaded stud beyond a machine screw nut, locking nut, or other tapped part should be 1-1/2 threads. To insure adequate thread engagement, a thin nut should not be substituted for a standard nut for the sole purpose of meeting the thread projection requirement. Maximum projection beyond the nut (or other tapped part) shall be limited by the shortest standard screw meeting this requirement.

C If strength requirements are met, some acceptable reasons for having less than 1-1/2 projecting threads (but not less than flush) are:

1. Where projecting threads would interfere with the placement of another part.
2. Where there is a possibility of arcing or corona discharge from the screw point.
3. Where the tapped part has an engagement of 5 usable threads. (The screw need not protrude at all in this case.)
4. When threads projecting beyond a mounting nut would be unsightly on panel mounted components such as switches and potentiometers.
5. Where an elastic stop nut is used. (An absolute minimum of 1/2 thread is required in this case.)

D The rules for minimum projection for machine screws shall apply to threaded studs on purchased components, such as transformers. Maximum projection shall be limited by the proximity of other parts.

3.1.6 Tightness

All threaded fastenings must be tight. Torque wrenches or torque screwdrivers often aid in assuring proper tightness of threaded parts and should be used where screw torque is specified. An adequate concept of "tightness" cannot be based on torque alone, however. It must be considered that torque is just the means by which tension is developed in the shank of the tightened screw. This tension must compress the parts being fastened sufficiently to withstand separation forces such as vibration or shock that may occur during the useful life of the

3.1.6 (Cont)

equipment. Over-tightening may result in broken screws, either at initial assembly or at some later date.

Many factors affect the optimum torque required for driving small machine screws to a point where the proper tension is reached but not exceeded. These factors include friction at the bearing surfaces, friction of the mating threads, length of thread engagement, presence or absence of lubrication, type of lock washer or lock nut, and hardness and surface finish of the mating parts.

Most materials commonly fastened by machine screws (including metal) are compressible, and all screws are elastic within narrow limits. A few hours or days after initial tightening, a properly tightened screw is sometimes pronounced slightly loose because of metal fatigue in the stressed screw and/or creep of the compressed material. Repeated tightening in such instances can be more detrimental than beneficial. Reliable locking devices will compensate adequately for this apparent relaxation.

Because of the many variables affecting hand-tightening, it must be stated that no simple chart of tightening torque or easily applied "rule of thumb" has yet been devised that will replace a good assembly operator's judgment and experience. However, when fasteners loosen and cause equipment failure, they usually do so, not because of failure of the locking device, but because of insufficient initial tightening.

3.1.7 Screwhead Imperfections

Slots and recesses in screwheads should present a good appearance free from defects and damage. Damage of slotted screwheads generally occurs from the use of worn screwdriver blades or careless use of the screwdriver. Flat-blade screwdrivers should be reground when necessary, with flat sides parallel or slightly hollow ground and should fit the screw slot.

Apparent defects in Phillips screwheads are of two types:

- a. Obvious damage commonly called "rounding out" of the recess, caused by:
 1. Failure to use sufficient seating force to keep the screwdriver fully engaged.
 2. Use of dull or badly worn drivers.
 3. Use of the wrong size screwdriver. Phillips drivers come in 5 sizes for use as shown below.

<u>Screwdriver Size</u>	<u>for Screw Size</u>
#0	0, 1
#1	2, 3, 4
#2	6, 8, 10
#3	12, 1/4
#4	5/16, 3/8

NOT ACCEPTABLE

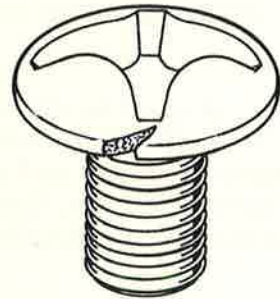
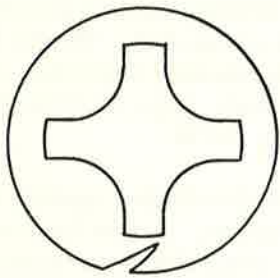

LARGE, OPEN FRACTURES
EXTENDING HALFWAY OR
MORE THAN HALFWAY
TO THE RECESS

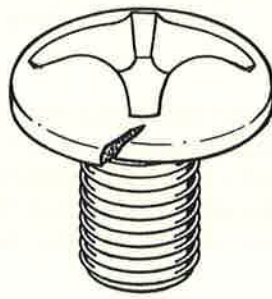
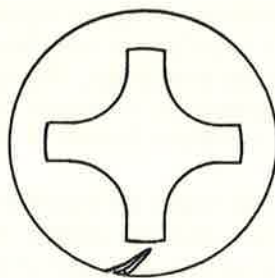

OPEN, ANGULAR
FRACTURES ON
EDGE OF HEAD

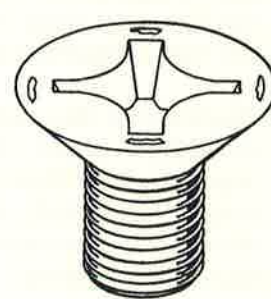
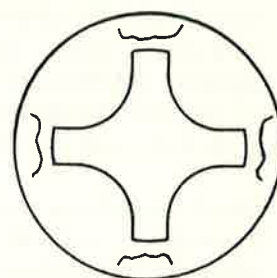

SLIVERS OR LOOSE
FLAKES ON TOP OF
HEAD

ACCEPTABLE

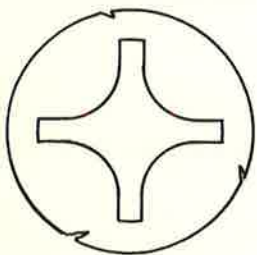

SLIGHT "FRACTURES"
NOT EXTENDING HALF-
WAY TO RECESS AND
NOT AFFECTING
USEABILITY

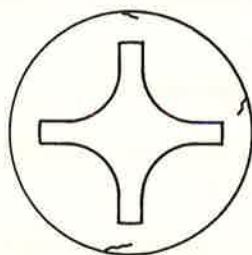

SLIGHT
HAIRLINES

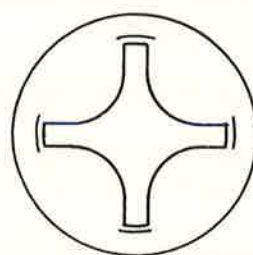

SLIGHT RECESS
FLOW LINES

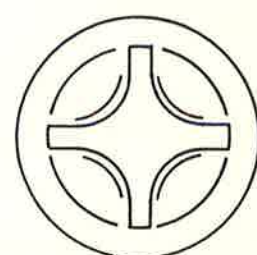

SLIGHT TOOL MARKS;
SLIGHT PIN MARKS

Figure 3-3. Screwhead Imperfections

3.1.7 (Cont)

- b. Apparent "cracks" or "fractures" which actually are portions of the head where the metal hasn't flowed freely and fused together during the cold-heading process.

Figure 3 illustrates acceptable and unacceptable imperfections.

3.1.8 Captive Screws

- A Module hold-down screws generally are of special design but should conform to standard screw requirements in all possible details. (See module standards in Component Standards Manual.) Module screws are made of 18-8 or 430 stainless steel and are often driven into stainless steel inserts or nuts in the main chassis. Similar metals in screw and nut under high unit load forces, as in a properly tightened threaded assembly, tend to gall and seize, and shall be lubricated with a dry lubricant such as Molycote M-88 (Collins part number 005-0405-00). Grease or oil shall not be used because they pick up dust and also may cause contamination of surrounding surfaces and parts.
- B Screws used for holding parts or subassemblies are often standard screws with a retaining device such as a spring sleeve (Collins part number 340-0641/0643-00) to prevent loss of the screw. Screws with undercut portions or retaining ring grooves are more costly than standard screws and require a special order.
- C Painting the heads of captive screws that are loosened or removed frequently while servicing equipment is required by military specifications. In commercial equipment, the painting operation is not required; location and general appearance of hold-down screws guide the operator in determining which screws should be removed.

3.2 SETSCREWS

3.2.1 General

Setscrews are used as semipermanent fasteners to secure items such as knobs, collars, sheaves, and gears to shafts or similar parts. Parts that are to be attached permanently to shafts shall not depend on setscrews only.

Frequently a setscrew is used as an adjustment aid prior to a pinning operation; it should be removed following the installation of the pin.

The holding power of a setscrew to resist rotational, oscillatory, or axial forces is a function of many variables such as screw size, seating torque, plating, shaft hardness, number of setscrews, and screw-point type. These variables, except for seating torque, are fixed by the design of the units. Two screws should be used to secure parts to shafts that are not flatted; they should be spaced not less than 90° nor more than 120° apart. A single setscrew may be adequate in certain low torque applications as in small knobs with tear-drop shaped shaft holes providing three point contact.

The setscrew develops its holding power through the frictional force imparted to the parts being secured to each other. Extensive tests have shown that the torsional holding power of a setscrew is almost directly proportional to the seating torque for cup, flat, and oval point setscrews. The setscrew point, by

Fastening

3.2.1 (Cont)

its penetration, can increase the holding power for a given application. Screws that are cadmium or zinc plated usually provide an increase in holding power since the plating acts as a lubricant and therefore less of the applied tightening force is needed to overcome friction at the mating threads.

3.2.2 Types of Drives

The preferred setscrew drive at Collins Radio Company is the multiple spline (fluted) socket as manufactured by the Bristol Company and shown in figure 3-4.



SPLINE (FLUTED) SOCKET DRIVE

Figure 3-4. Spline Socket Setscrew

Setscrews with hexagon sockets (figure 3-5) and slotted setscrews (figure 3-6) also are used but are somewhat less standard at Collins.



HEXAGON SOCKET DRIVE

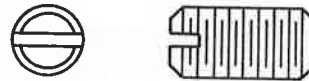

SLOTTED DRIVE

Figure 3-5. Hexagon Socket Setscrew

Figure 3-6. Slotted Setscrew

Test results on small size screws (sizes 0, 2, and 4), have shown the spline socket screw to be superior to the hexagon socket. It has been found that spline sockets are less susceptible to socket stripping and as a result can be tightened more. In all tests, the spline drive wrench yields when excessive torque is applied, thus providing a load limiting feature to prevent fracture or rounding out of the socket.

3.2.3 Point Styles

The most common setscrew point styles are shown in figure 3-7.



OVAL POINT



CUP POINT



CONE POINT

Figure 3-7. Setscrew Points

3.2.3 (Cont)

All set screws tightened on a round shaft may damage the shaft so it is difficult to remove or reposition a part. The oval point design damages the round shaft to a lesser extent than the cup point. On shafts that have a flat area for the set-screw point to seat against, either cup or oval points are satisfactory, since a burr on a flat area will not interfere with removal.

Cone point setscrews are used more often as pivots than for securing parts to shafts. They must always seat in a suitably countersunk hole.

3.2.4 Locking

Setscrews should be locked by a method shown in paragraph 3.7.1 or 3.7.3; however, liquid staking shall not be used on control knob set screws.

3.3 TAPPING SCREWS

Thread-cutting and thread-forming screws are used where construction is improved by their use. Normally they are not used where loosening or removal is required during operation or maintenance of the equipment. Chips formed by thread-cutting screws shall be removed at a very early stage of assembly (to eliminate entrance of tiny metal particles into relays or other electrical components that are to be assembled to the structure later).

Thread-forming screws may have as little as one thread engaged in steel, stainless steel, or hardened steel. Thread-cutting screws should have a minimum thread engagement approximately equal to that specified for machine screws.

3.3.1 Materials and Finishes

Preferred materials and finishes for tapping screws are:

1. Stainless steel, heat treated, plain finish.
2. Carbon steel, heat treated, cadmium plated, chromate dipped.

3.3.2 Types of Tapping Screws

Figure 3-8. Tapping Screws

NOTE: Head types for tapping screws are the same as for machine screws.

Fastening

3.4 NUTS

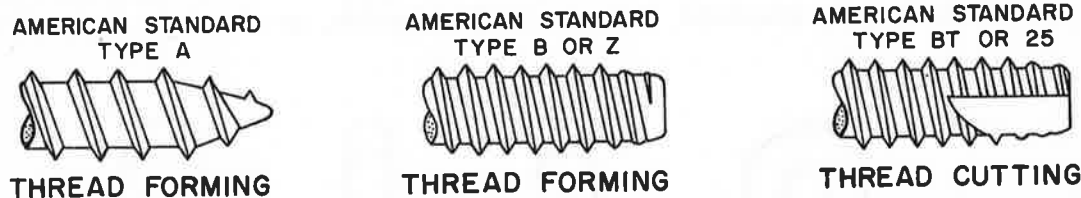
3.4.1 General

The most common type of nut used at Collins Radio Company is the hexagonal shaped American Standard machine screw nut. The internal thread of the nut usually conforms to either the fine or coarse American Standard thread form. The primary use of the nut is for fastening. It also can be used for adjustment and for transmitting motion and/or power with a large mechanical advantage. Materials and finishes used for nuts usually are the same as those used for screws as specified in paragraph 3.1.1. The basic dimensions of the nut are as illustrated below.

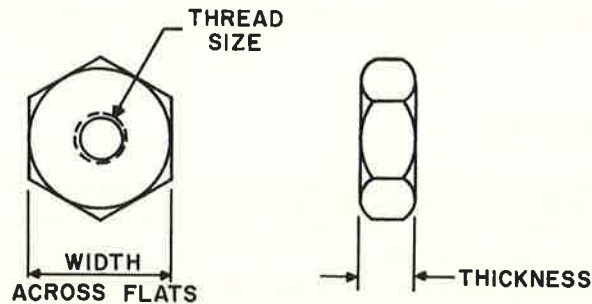

Figure 3-9. Nut Size Specifications

Application and installation of all captive nuts (nuts attached to structures by riveting or pressing operations) should be in accordance with the manufacturers' latest recommendations. There is a very great variety of nonlocking, locking, and insert types of nuts. The following paragraphs are descriptive of the most common types used at Collins Radio Company.

3.4.2 Nonlocking Nuts

- A A standard machine screw nut is a solid nut with a hexagonal base, with or without a washer face. The six essentially rectangular sides serve as wrenching flats. Above the 1/4-inch size, nuts are available in various dimensional series, such as finished hexagon and regular hexagon, and within each series, three thicknesses: standard, thin (or jam) and thick, as shown in figure 3-10.

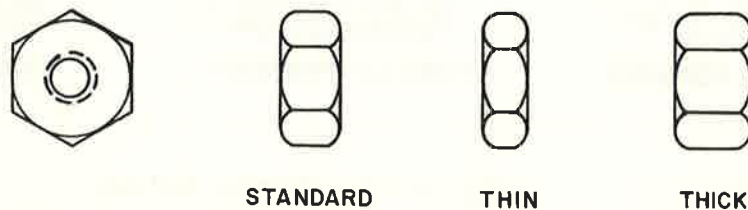

Figure 3-10. Nut Thickness

3.4.2. (Cont)

- B The Pem nut is a patented self-clinching nut made of hardened steel. The nut is pressed into a prepared hole. Flow of metal around a tapered shank and into a clinching ring locks the nut in place. Provision must be made in design to allow for edge distortion of sheet metal due to metal displacement. It may be used in applications which require a rapid assembly for either blind or accessible locations in thin metal members. Load must be applied in direction shown.

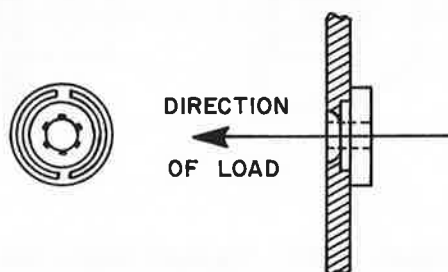

Figure 3-11. Pem Nut Assembly

- C The hexagon captive nut is used in applications similar to the Pem nut. The load should be applied in the direction shown in figure 3-12, however, informal tests have shown that it is capable of withstanding almost equal loading in the opposite direction. The proper application of this nut in application types 1 and 2 is characterized by having the round section of the nut pressed flush with the bottom surface of the metal. In application type 3, the hexagon portion is pressed flush with the top surface of metal; be careful to avoid distorting the first thread during installation. (Further application data appears in Collins Component Standards Vol. 1.)

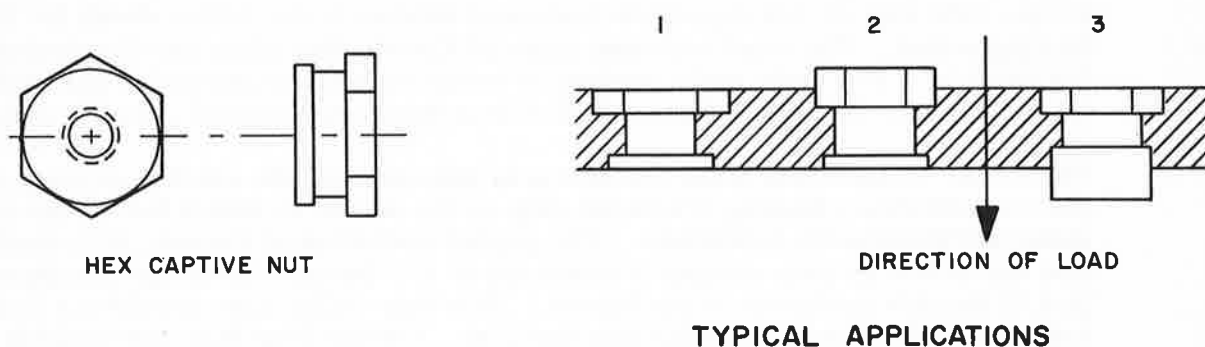

Figure 3-12. Hexagon Captive Nuts

- D Angle nuts (angle fasteners) are used in applications where the part to be attached is at right angles to the mounting surface of the nut as shown in figure 3-13. The attachment of the nut requires riveting and this should conform to acceptable riveting standards as set forth in paragraph 3.5.

3.4.2.D (Cont)

Care must be exercised in the placement of the body of the nut so that the axis of thread is perpendicular to the mounting hole in the part to be attached to prevent cross threading of the screw within the angle nut. Caution should be employed during the staking operation to prevent distortion of the threads.

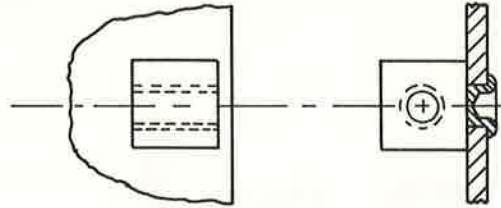

Figure 3-13. Typical Angle Nut

3.4.3 Locking Nuts

Vibration, cyclic loading, and special assembly provision are common problems that often require more than ordinary measures in fastening design to achieve a satisfactory solution. To meet these conditions, a number of practical and effective nut designs with special locking features have been developed and the most common used by Collins Radio Company are discussed in the following paragraphs.

A Elastic Stop Nuts

All Elastic Stop Nuts are prevailing torque locknuts, that is, they exert a constant constraining force on the screw threads. Unlike lock washers, prevailing torque lock nuts do not depend on sustained tension in the screw shank for their locking action. The most common types of Elastic Stop Nuts are illustrated in figure 3-14. The metal body contains a compression locking collar built into the top of the nut. The compression collar is a resilient material, usually nylon.

The collar is deformed when the screw is inserted and the elastic memory of the plastic provides a locking frictional grip on the screw to resist the forces imposed under environmental conditions. For proper operation of the nut, it is essential that the screw threads project a minimum of 1/2 thread beyond the plastic collar. (1-1/2 threads minimum is preferred.) The stop collar also provides a liquid seal for applications requiring this function. Elastic Stop Nuts are suitable for use in equipment that operates continuously up to 250°F. Miniature clinch nuts (see figure 3-14) should be of steel, cadmium plated and chromate dipped. Clinch nuts must be supported at the shoulder during installation or the top surface will be deformed resulting in close-in of the elastic collar. Distortion damage of the top surface leads to the use of extremely high screw installation torque, which can result in failure of the nut by twisting it from the sheet metal structure. Inspection after attachment should include an examination of the top surface of the nut for possible installation damage.

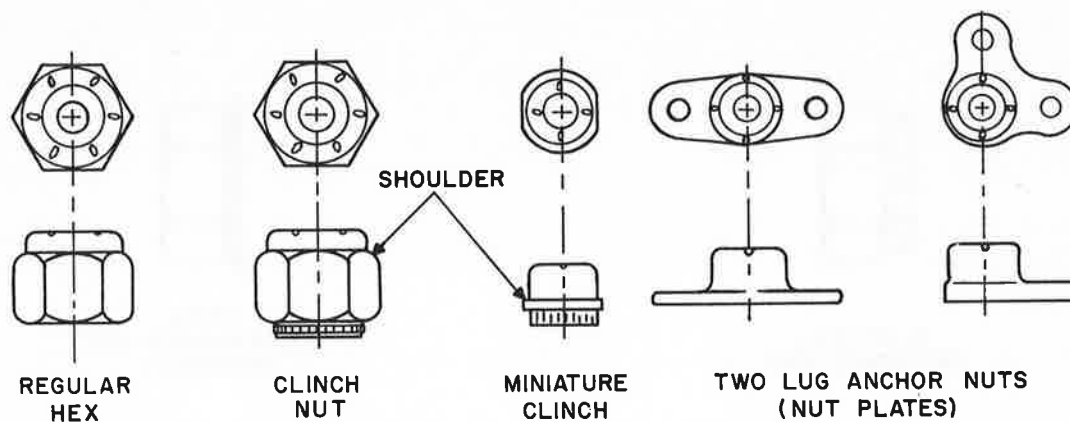

Figure 3-14. Common Elastic Stop Nuts

B All-Metal Lock Nuts

There are numerous types and forms of all-metal lock nuts. They are suitable for use at temperatures up to 900°F, depending on material and finish.

Some all-metal lock nuts obtain their locking action by the gripping action of a deformed (constricted) section of the nut (figure 3-17); others lock by interference fit of the nut by distorting the threaded section (figures 3-15 and 3-16).

The nuts illustrated in figures 3-15, 3-16 and 3-17 are called prevailing torque lock nuts because they provide a heavy drag or lock on the threads of the screw or bolt whether or not the parts being fastened are drawn up tight.

Another type of all metal lock nut is made by assembling a lock washer and nut into a single unit (figure 3-18). Its locking action depends on, and sustains, tension in the screw or bolt shank. This type of lock nut should be used in applications where external tooth lock washers are satisfactory. (See 3.6.2, D1)

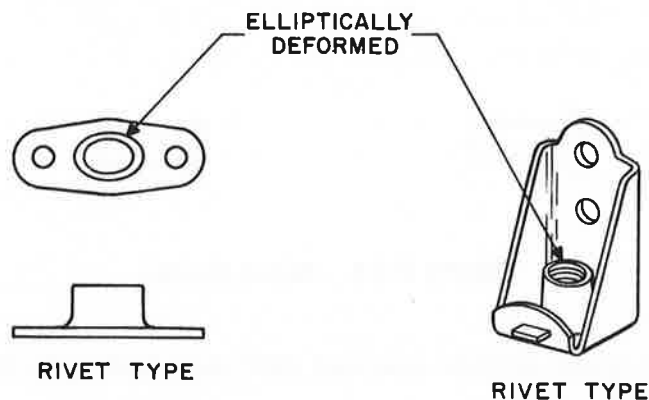
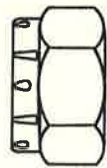

Figure 3-15. Two Lug Anchor Rivet Type All-Metal Lock Nut

Figure 3-16. Right Angle Rivet Type All-Metal Floating Lock Nut



SLOTTED-
DEFORMED END

Figure 3-17. Slotted Deformed End Lock Nut

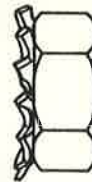

KEPS
(LOCKWASHER-NUT
ASSEMBLY)

Figure 3-18. Keps Lockwasher-Nut Assembly

3.5 RIVETS AND EYELETS

3.5.1 General

Rivets and eyelets can achieve a desirable fastening means at a favorable in-place assembled cost. Riveted assemblies normally are considered to be of a permanent nature. However, with moderate skill and standard tools, rivets and eyelets can be removed and parts reworked. An electrical connection shall not depend on riveting.

Staking, rolling, etc. are dependent, to a large degree, on the assembly operator's skill, knowledge, and interest. He must have the proper tools at his disposal and understand their use. Rivets and eyelets must be of the proper diameter, length, and type to satisfy the assembly thickness, hole sizes, and all the tolerances associated with the assembly. Rivets and eyelets must be fully seated, properly backed, and perpendicular to the assembly and retained in this attitude while they are upset.

3.5.2 Rivet Types

A Solid Rivets



Figure 3-19. Solid Rivets

Standard head types include oval and 100° included angle flathead rivets.

A solid rivet normally will increase in body diameter and fill a hole as it is upset in an assembly, thereby giving a fastening which is rigid in three planes.

A flathead rivet should be countersunk flush or slightly below the surface. Slight protrusion above the surface is permissible sometimes if interference with another part does not occur or appearance is not degraded (front panels).

3.5.2. A (Cont)

Care must be exercised in backing a flathead rivet which may be recessed so it may be properly seated during riveting.

Oval-head rivets must be backed by a proper die set if the head shape is to be retained during assembly. Also, through the use of a die set and accurately controlled rivet projection length, an oval or similar head may be made on the upset end of the rivet. However, a simple mushrooming of the projected rivet usually is satisfactory and is the preferred, most economical assembly method.

B Semitubular Rivets

Figure 3-20. Semitubular Rivet

Semitubular rivets are low in cost and may be assembled with greater ease and less upsetting pressure than solid types. The length of a semitubular rivet, due to the depth of the hole for roll-over, is extremely important and may be a critical factor in achieving a satisfactory assembly. Figure 3-21, charts the desirable clinch allowances for semitubular rivets. The depth of the hole in the rivet shank is an important consideration when selecting a rivet. The body of the rivet normally does not increase in diameter during assembly, but must rely on friction between the various parts of the assembly to hold the assembled position. Therefore, a semitubular rivet does not produce as much retaining strength as a solid rivet.

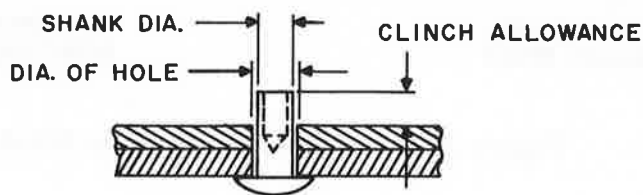

SHANK DIAMETER	.060	.065	.088	.098	$\frac{1}{8}$	$\frac{9}{64}$	$\frac{5}{32}$	$\frac{3}{16}$
DIA OF HOLE	.067	.070	.093	.104	.128	.152	.165	.196
* CLINCH ALLOWANCE	.032	.032	.045	.055	.062	.062	.062	.062

*Length of the solid portion of the rivet always must be less than the total thickness of materials being fastened when tolerances are at the worst extremes, even if clinch allowances shown cannot be met.

Figure 3-21. Desired Clinch Allowances

Fastening

3.5.2.C Eyelets



Figure 3-22. Roll-Flanged Eyelet

An eyelet may be used in an assembly in a manner similar to a tubular rivet but at reduced strength. The large range of diameters and other dimensions give eyelets a high degree of versatility. An eyelet usually is made of thin metal and may be rolled into position with moderate pressure. The hole in the eyelet is often its greatest asset and may be used to advantage in an assembly.

3.5.3 Material and Workmanship

The material and finish of a rivet or eyelet must be compatible with the materials it contacts in an assembly. Normally the rivet, as assembled, should be harder than the material it is fastening.

Rivets and eyelets shall be tight. The staking or rolling shall be uniform and reflect high quality of workmanship. Rivet heads which are not fully seated shall be rejected.



Figure 3-23. Rolled Semitubular Rivet

Cracks or splits in the rolled or flared portion of eyelets shall be permissible with the following limits:

- (1) No single part may have more than one crack or split per end.
- (2) No crack or split shall extend into the shank.

Excessive splitting usually indicates defective tooling or material.

3.6 WASHERS

3.6.1 Flat Washers

Flat washers or dished flat-rim lock washers must be used over slotted holes or holes so large that they do not present sufficient bearing surface for the fastening or part adjacent to them. A lock washer, lock nut, or liquid staking should be used as the locking device when a flat washer is used.

3.6.1 (Cont)

Flat washers or dished flat-rim lock washers must be used adjacent to paint or non-metallic parts which may be damaged by other fastening items.

A series of flat washers should not be used in place of a spacer of the necessary length. (This statement does not apply to thin precision shims.)

3.6.2 Lock WashersA Functions and Definitions

Spring lock washers or "split locks" have two functions:

- (1) Spring take-up devices to compensate for developed looseness and the loss of tension between parts of an assembly.
- (2) Hardened thrust bearings to facilitate assembly and disassembly of bolted fastenings by decreasing the frictional resistance between the bolted surface and the bearing face of the bolt head or nut.

Toothed lock washers serve to lock fasteners, such as screws and nuts, to the parts of an assembly; they increase the friction between the fasteners and the assembly.

A dished flat-rim lock washer is an internal tooth lock washer with a conical body and a flat rim. The conical body contributes spring loading to lock the teeth to the mating fastener and helps maintain tension in the screw shank. The washer shall be placed so the flat rim goes against a flat surface.

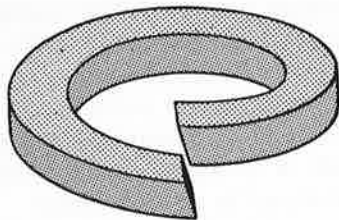

SPLIT LOCK
WASHER

Figure 3-24

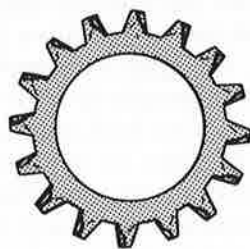

EXTERNAL TOOTH
LOCK WASHER

Figure 3-25

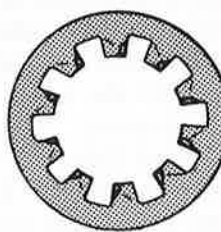

INTERNAL TOOTH
LOCK WASHER

Figure 3-26

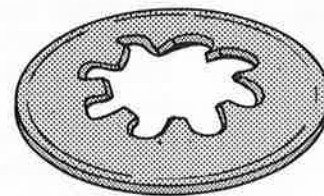

DISHED FLAT-RIM
LOCK WASHER

Figure 3-27

Lock washers are unnecessary on fastenings which secure parts that have inherent resiliency that will provide a locking force.

B Lock Washer Location

The proper location of a lock washer on a threaded fastener is:

- (1) Under the head of a screw driven into a tapped hole, or
- (2) Under the machine screw nut on a through screw.

3.6.2.C Materials and Finishes

Type 302 stainless steel is the preferred material for split lock washers in general structural use. Silicon bronze (Everdur) is the preferred nonferrous material for split lock washers. Type 410 stainless steel is preferred for toothed washers in general fastening use. Phosphor bronze is the preferred nonferrous material for toothed washers.

3.6.2.D Split Lock Washers

1. Split lock washers generally should be used in mounting items which use a number 8 or larger screw. Split lock washers allow more tension to be developed in the screw shank with a given amount of applied torque. Since heavy components are secured almost always with number 8 or larger screws, the thrust-bearing effect of split lock washers contributes to adequate tightening of these larger fastenings. The torque developed by assembly operators using hand drivers on large screws usually does not develop enough tension in the screw shank to over-stress the screw material. A possible exception to the use of split lock washers for a number 8 or larger screw is when power driving is being utilized. (A toothed lock washer helps to cause the power driver to brake to a halt when a certain torque is developed, thus not over-stressing the screw shank.)
2. Split lock washers may be used adjacent to flat washers, but a dished flat-rim lock washer would take the place of both and be preferred where applicable.
3. Split lock washers may be used adjacent to internal tooth solder lugs; however, external tooth washers are preferred for such electrical connections where the biting action of the teeth contribute to better electrical bonding.

E Toothed Lock Washers

1. External tooth lock washers should be used with number 6 or smaller screws. External tooth lock washers shall not be used adjacent to painted surfaces or other finishes the function of which might be harmed by the biting action of the teeth. External tooth lock washers shall not be used where the biting action of the teeth could interfere with wire insulation, or against a part which does not have sufficient surface area for the teeth to seat properly (for example, small pattern nuts and fillister head screws). External tooth lock washers may be used with flat washers, but a dished flat-rim lock washer is preferred and often makes the use of flat washers unnecessary. The biting action of the teeth of external tooth lock washers improves electrical connections and should be utilized in applications such as terminal boards and ground connections. An external tooth washer shall not be used adjacent to the base of a molded insulated standoff (Winchester standoff).
2. Internal tooth lock washers should be used in the mounting of single mounting hole components which have a large OD and are secured by a narrow rim chamfered nut. A single mounting hole component can utilize a closer hole tolerance, thus affording sufficient surface for the internal tooth washer to seat. An internal tooth solder lug requires the use of an additional locking device because thin phosphor bronze material lacks sufficient spring action for adequate self-locking. An external tooth lock washer is preferred for use against solder lugs.

3. Dished flat-rim lock washers are recommended for use over slotted holes and thermosetting plastic materials. The conical body provides spring loading for locking teeth to protect the unit from loosening due to vibration, or dimensional changes through temperature variation. Split lock washers and external tooth or conventional internal tooth lock washers shall not be used against relatively soft compressible material or brittle material.

3.6.3 Compressible Washers and Parts

Compressible washers must be used between fasteners (screwheads or nuts) parts made of ceramic material, or brittle thermosetting plastic when these parts are mounted on hard surfaces. Individual design requirements determine whether or not compressible washers are needed between brittle components and the chassis surface.

When mounting fragile, heat dissipating parts, mica washers or spring metal washers should be used.

Compressible washers are not necessary when mounting parts which are compressible in themselves. Prevailing torque lock nuts or liquid staking should be used to lock screws which secure non-metallic parts. Increasing the bearing area of the fastening by placing a metal flat washer adjacent to the compressible material usually is a good practice.

A nut should be used between a non-metallic material and an electrical connection in a threaded assembly.

3.7 MISCELLANEOUS FASTENING AND LOCKING PROVISIONS

3.7.1 Liquid Staking

Liquid staking can be used to prevent loosening of threaded parts, when it is impractical to use mechanical locking devices. Liquid staking differs from adhesives in that it increases the frictional drag between mating surfaces in addition to an initial adhesive bond. When liquid staking material is used for locking on mechanical devices, extreme care must be used to prevent its contaminating electrical connections or interfering with moving parts. Special electrical and/or mechanical tests may be necessary after assembly to detect such defects. Screws or studs threaded into phenolic or other thermosetting plastic must be secured by liquid staking.

A Glyptal

Blue Glyptal (GE 7526, Collins part no. 005-0133-00) is the most commonly used liquid staking material. It is recommended for general use in securing setscrews and nonmetallic screws, by applying a small amount to the screw threads. Care must be taken to leave the screwhead slot or socket accessible (free of Glyptal). Glyptal presents an undesirable appearance when used in excessive amounts, and can even cause objectionable adhesion between adjacent surfaces. Fastenings secured by Glyptal normally can be removed; however, if these fastenings are reassembled, Glyptal should be reapplied. Red Glyptal is not to be used as liquid staking material. It is primarily intended as a finish or protective coating.

B Loctite

Loctite is available in several grades to allow variations in removal torque depending upon the requirements, screw material, etc. Holding power exceeding 100% can be obtained; that is, a screw can fracture before it will break loose for

Fastening

3.7.1.B (Cont)

removal. Loctite differs from Glyptal in that it will not harden in air. Contact with most metal surfaces causes hardening but a special hardening agent is required for cadmium, zinc, or nonmetals. Hardened Loctite is virtually insoluble; therefore, selection of the proper grade for the application is paramount. Commonly used grades are distinguished by color. Colorless grades shall not be used because they impose an inspection problem.

C EC 847 (Collins Part No. 005-9042-00)

EC 847 can be used for liquid staking. Slight thinning with methyl ethyl ketone makes it easier to apply.

3.7.2 Solder Staking

Solder may be used as a staking compound where an electrical connection is made and the locking requirements can be met in no other way.

3.7.3 Self-Locking Screws

Screws with plastic pellets (usually nylon) provide adequate locking in applications where lock nuts, lock washers, or liquid staking are not desirable. Such screws generally are called by a trade name, "Nylok." Locking action occurs through the compressible forces resulting from driving the screw with its projecting pellet into a mating nut or tapped part. The amount of pellet projection above the screw thread crests may be either the manufacturer's standard or special depending on the degree of locking required in a specific application. Proper usage of Nylok screws requires the presence of an entrance chamfer in the tapped hole of the mating part or nut to keep the pellet from being sheared off as it enters the first thread.

3.7.4 Sheet Spring Nuts

Sheet spring nuts provide engagement of only one usable thread and therefore are not preferred in structural applications where breakage of the nut would allow separation of the assembled parts. Locking action occurs when a screw is tightened securely into a sheet spring nut due to the deflection in the spring members comprising the thread form. These nuts function best when used with hardened screws such as thread-forming screws.

3.8 ADHESIVE BONDING

3.8.1 Structural Adhesive Bonding

Structural adhesive bonding is sometimes preferable to mechanical fastening methods. The use of adhesives in structural applications is most beneficial when long production runs are anticipated. Working out the proper cleaning procedure, application technique, cure cycle, and inspection method usually requires more time and effort than may be justified for short run production. Destructive inspection methods sometimes are necessary and should be specified on the assembly drawing after the Development Engineer and Quality representatives concur on the test and frequency of test.

Structural bonding requires strict adherence to all of the steps specified for the application. It is mandatory that quality be assured at each step of assembly rather than to rely on postassembly inspection. Interim changes in specified processes should be made only after agreement between Industrial Engineer, Development Engineer, Materials Engineer, and Quality representative.

3.8.2 Surface Preparation for Structural Bonding

Surface preparation including cleaning, rinsing, and drying operations must be carried out meticulously as specified on drawings or referenced process specifications.

Bonding must be completed as soon as possible after surfaces are prepared. If more than 4 hours will elapse between cleaning and bonding operations, the clean surfaces must be protected suitably against contamination. (Wrapping in plastic film, applying strippable coating, or other suitable storage techniques should be employed.)

3.8.3 Adhesive Bonding, Elastomeric

The bonding of gaskets and other flexible parts to metal with rubber base adhesives usually does not require as stringent control of the process as does the use of structural adhesives. The primary considerations are:

1. The proper adhesive.
2. Clean surfaces.
3. Application to both surfaces when possible .
4. Allowing enough drying time for good "tackiness" to develop before joining parts.

3.9 Stray Hardware

In assembly, care shall be taken to prevent washers, nuts, screws, rivets or any other material from accidentally falling into an equipment. If a small part is accidentally dropped into the equipment, it should be removed at once, before it is forgotten or covered by other parts, to prevent a subsequent possible short or mechanical malfunction.

Section IV

MECHANICAL AND ELECTROMECHANICAL REQUIREMENTS

4.1 GENERAL REQUIREMENTS

4.1.1 Minimum Clearance of Moving Parts.

- A Where moving part clearance is required, the minimum clearance shall be not less than .015 inch with the parts in their worst condition unless specifically required by design. Parts must be aligned properly throughout the entire cycle. The proper clearance shall be maintained to preclude interference of parts through wear and stress of operating conditions.
- B All parts or assemblies with movable terminals such as tube sockets and connectors with floating pins, where electrical potential exists, shall be checked for minimum clearance in their worst positions and after soldering. Minimum clearance of .030 inch shall be maintained unless high circuit potentials require more clearance, in which case the drawings shall specify the increased clearance.
- C All parts which, in operation of the equipment, move from their normal position shall be free from binding or other defects which will keep them from functioning properly throughout their entire operation cycle.

4.1.2 Cracks, Chips, or Crazing in Glass or Ceramic Seals, Insulators, Terminal Boards, and Connectors.

A Definitions

Crack - A through break in the glass, ceramic, or board material with or without separation occurring.

Craze (Crazing) - Small breaks or checks existing only on the surface of the insulating material.

Working surface - The entire surface of the insulating material from which the terminal, pin, or lead extends. (See figure 4-1.)

Chip or flake - The area on a working surface from which a small fragment has been dislodged.

- B Cracks will not be allowed in the working surface of a sealed component, or other glass or ceramic seal.
- C Chipping and crazing around a sealed terminal (or on other glass or ceramic insulators) shall not extend more than 1/2 of the way to the nearest terminal (or other conducting surface). The total crazed or chipped distance between such terminals shall not exceed 1/2 the minimum working surface distance between the terminals. Excessive chips and crazing around terminals can cause leakage or voltage breakdown, especially under extreme environmental conditions.

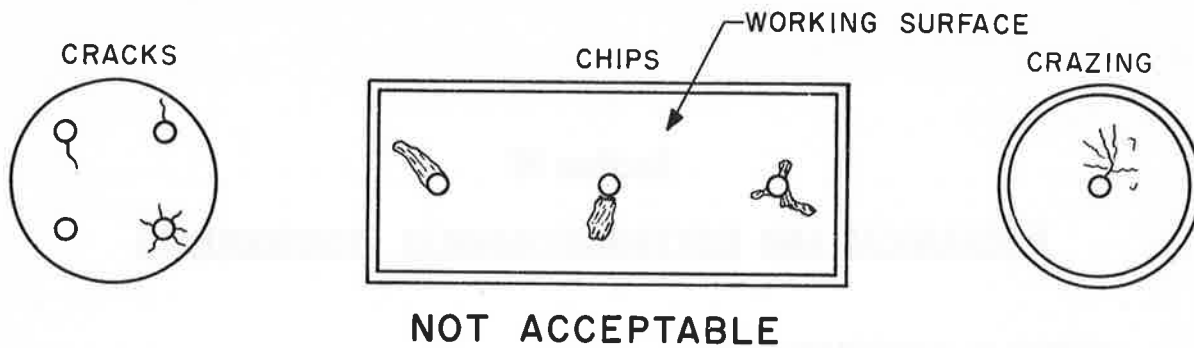

Figure 4-1. Cracks, Chips and Crazing around Sealed Terminals

4.1.2.D A sealed device shall not have a defect that destroys the intended seal, even though the defects are within limits of C above.

E Cracks, crazes, or chips on terminal boards and unsealed connectors shall be within the limits of 4.1.2.C and shall not extend more than 1/2 the distance:

- (a) from a terminal to the edge of the insulating material.
- (b) from a terminal to a mounting hole.
- (c) from a mounting hole to an edge of the board.

Defects above mentioned can seriously affect the strength of a terminal board or connector under service conditions. Note: Refer to section III, paragraph 3.6.3 for the correct method of mounting terminal boards to prevent cracking.

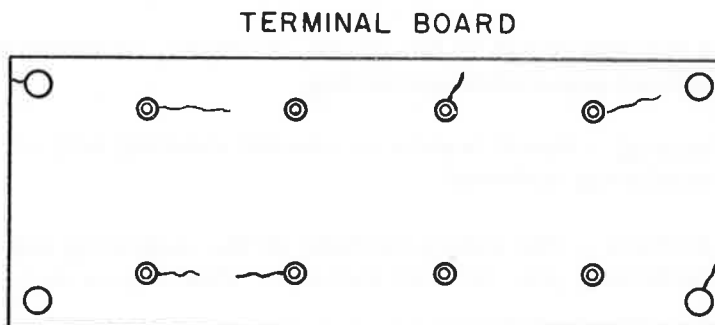

All Examples NOT ACCEPTABLE

Figure 4-2. Unacceptable Cracks in a Terminal Board

F The working surfaces of sealed devices or terminal boards shall be free of conducting material such as splatters of solder. They also shall be free of nonconducting material such as rosin that could entrap moisture and thereby cause breakdown during some environmental conditions.

4.1.3 Burrs and Sharp Edges

A Definition

For the purposes of this section a burr is defined as the rough irregular lip or edge of material formed by machining, grinding, shearing, or accidental gouging.

B Drawings shall specify critical areas which must be burr free. However all mechanical parts shall be free of burrs and sharp edges in locations where they would contribute to the following:

1. Abrasions of leads, wires, and cables.
2. Increased possibility of arcing in a high voltage application.
3. Personal injury.
4. Danger of burrs breaking loose and causing shorts, gear malfunction, etc.
5. Poor appearance.
6. Mechanical interference. For example, burrs on mating surfaces of a loaded gear may cause a locking condition.

4.1.4 Handling, Fitting, and Assembling

A Parts and assemblies shall be protected adequately during assembly, handling, and storage to prevent damage to dimension, finish, or function. Rough or careless handling shall not be tolerated.

B Severe distortion or bending shall not be used to achieve alignment or fit of parts since it can reflect poor workmanship or cause interchangeability problems or residual stress.

C Care shall be used during the assembly of mechanical parts, especially staking, riveting, or pressing, that none of the critical dimensions of the associated parts are changed or distorted beyond tolerance. The term critical dimension is used here to denote those dimensions that would affect the subsequent use, fit or reliability of the part or assembly.

4.2 GEARS

4.2.1 Definitions

Alignment - The lateral (width of tooth) engagement of mating gear teeth.

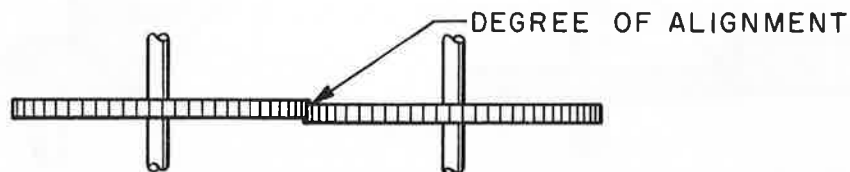

Figure 4-3. Gear Alignment

4.2.1 (Cont)

Loading - The use of spring device to eliminate backlash.

Mesh - Depth of tooth engagement of mating gear teeth. See figure 4-4.

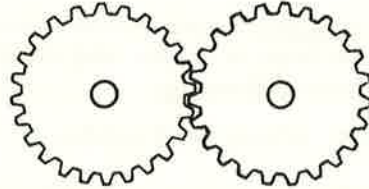

Figure 4-4. Gear Mesh

Toothiness - The irregular or rough feel of a gear train due to lack of clearance between teeth or mismatch of engaging tooth contours.

Backlash - The play or lost motion between two or more gears caused by the clearance between mating gear teeth.

Runout - The wobble evident during the rotation of a gear.

4.2.2 Gear Alignment

A Spur Gears

The width of tooth contact between mating gears shall be not less than 75% of the tooth width of the thinner gear, except that a gear thinner than .030 inch must have full width of tooth contact with a thicker gear. These requirements apply to the worst position in the gear's rotation, including allowable end play and runout and are necessary to assure a satisfactory transfer of power and proper gear life.

B Bevel Gears

Bevel gear alignment requirements are the same as for spur gears except that at least 90% of the face width must engage.

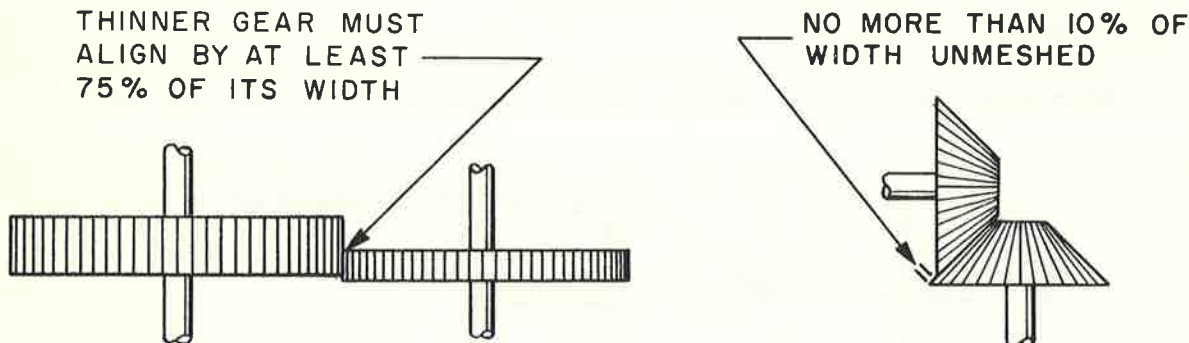

Figure 4-5. Alignment Limits for Spur Gears and for Bevel Gears

4.2.3 Gear Lubrication

Drawings of assemblies that include moving parts shall specify the type and quantity of lubrication. All gear trains shall be lubricated as called out on drawings. Where absence of lubrication on a bearing surface is intended, this shall be so specified. See also paragraph 4.9.

4.2.4 Gear Mesh

A The contacting action of the gear teeth shall be smooth and free from any interference due to improper tooth contour or lack of clearance. The action shall be uniform throughout a complete revolution of the larger gear and free of excessive irregular movements, or "toothy" effect. (Note - some toothiness is normal in a loaded gear.) These requirements are to eliminate unnecessary noise in operation, to reduce power required, to provide for smooth operation of dials and indicators, and to assure that gears can be reset accurately.

B Amount of gear mesh

In most applications, the degree or depth of gear mesh will be governed by specific design requirements; however, there shall be a minimum of 60% of full depth tooth engagement to assure adequate life and reliability of equipment.

C Backlash

Backlash will be cause for rejection when it results in excessive positioning inaccuracies or poor repeatability of function in either direction of gear train rotation. Backlash should be checked throughout the entire cycle of gear operation.

4.2.5 Gear Loading

A Loaded gears should be checked for proper amount of load as specified on assembly drawings. Excessive loading will cause accelerated wear and possible early failure. In no case shall a loading spring be fully compressed or stressed to the point of mechanical bind. Too little loading will result in backlash and inaccuracy of precision gear trains. A loaded gear shall not be meshed with more than one solid faced gear as such condition will nullify the effect of the loaded gear.

B Binding in a loaded gear assembly caused by lack of hub clearance, lack of clearance between sections, or burrs on adjacent gear teeth shall not be permitted as it may cause the loading to be ineffective.

C Direction of loading in a gear assembly shall be consistent with the design of the loading spring and call-out on the assembly drawing.

D Any separation of the sections of a loaded gear to the extent that the loading spring could become disengaged shall be cause for rejection. Maximum unintentional separation between sections of a loaded gear shall be not more than 1/2 the face width of the thinner section as observed in normal rotation.

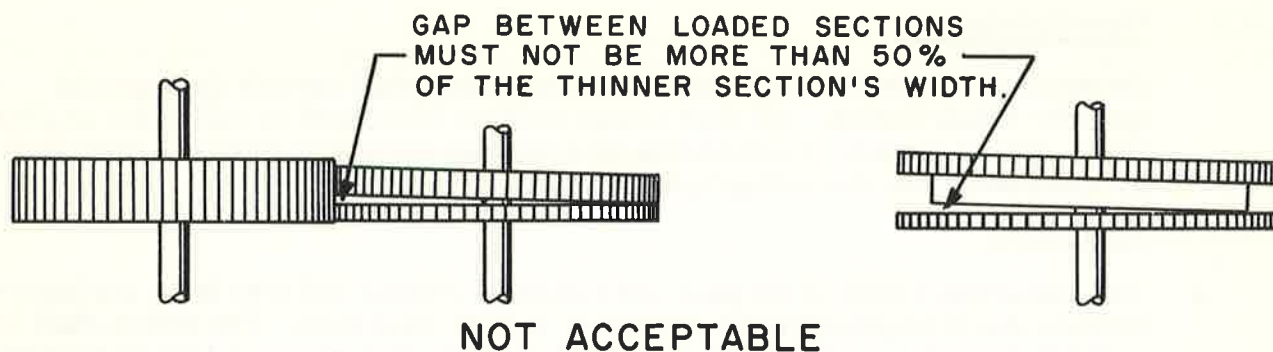

Figure 4-6. Separation of Sections of Loaded Gears

4.2.6 Clamping Adjustable Gears

On gears utilizing split hubs for the purpose of adjustment in a gear train, there are two common methods employed to tighten them to shafts: (1) a collar with two or more set screws, or (2) a split clamp with one screw. In all cases where an appreciable amount of torque is involved, method (2) should be employed. The screw through the clamp must be lubricated to prevent a false indication of tightness. It is preferable to specify a tightening torque on all such clamps. After tightening, the "lips" of the clamp must not be touching. The set screws or clamp screws should be accessible at the point of normal adjustment. Where method (1) is employed, care should be used that the screws do not engage the slot of the split hub.

4.3 DETENTS

4.3.1 Detent Action

Where detent action is involved, the detent shall snap into position with sufficient force so that it leaves no doubt as to whether or not the selected position has been reached. Action shall be checked in both directions. The combination of knob setting, panel markings and detent pitch should leave no doubt as to the selected position. Torque requirements, when considered critical, will be specified on assembly drawings.

4.3.2 Binding or Galling

Travel between selected positions shall be generally smooth and free from galling or excessive friction.

4.4 BEARINGS

4.4.1 General

A Proper Seating

Sleeve bearings should seat completely against the panel to which they are assembled. A slight chamfer of the bearing is acceptable providing the bearing is completely seated.

4.4.1A (Cont)

- a- Acceptable The bearing is completely seated and square with the plate.
- b- Acceptable The bearing flange is chamfered, but the bearing is completely seated and square with the plate.



ACCEPTABLE

Figure 4-7. Sleeve Bearings, Properly Seated

- c- Not Acceptable The bearing is not square with the plate.
- d- Not Acceptable The bearing is not completely seated.



NOT ACCEPTABLE

Figure 4-8. Bearings not Properly Seated

Sleeve bearings shall be installed with enough press so that they cannot be moved or removed by finger pressure.

B Bearings shall not exhibit objectionable roughness, noise, or excessive torque.

C Handling and Storage

Special care shall be exercised in the handling and storage of all bearings to prevent damage or contamination. Prior to assembly, lubricated bearings should be stored in the manufacturer's original containers.

Subassemblies containing exposed lubricated bearings shall be handled and/or packaged in a manner to prevent contamination of the bearings or absorption of the lubricant.

4.4.2 Ball Bearings

A Assembly

A major force should never be applied through the ball complement when mounting ball bearings (figure 4-9).

The proper procedure is:

1. When installing a bearing on a shaft, apply pressure to the inner race (figure 4-10).
2. When installing a bearing in a housing, apply pressure to the outer race, (figure 4-11).

Applying assembly force through the ball complement may cause overstressing (Brinelling) of the bearing material and subsequent malfunction or early failure.

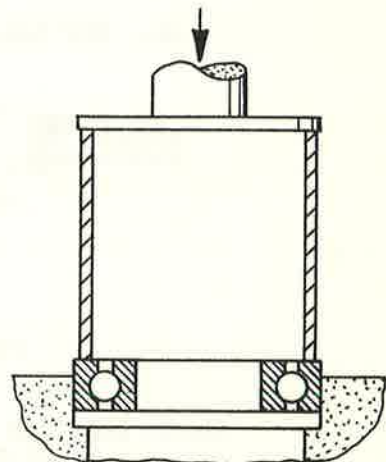
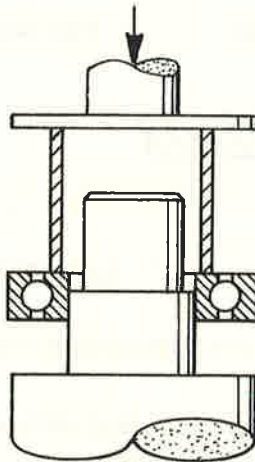
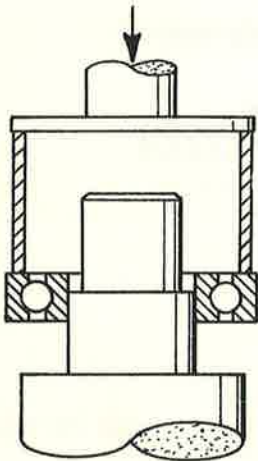

NOT ACCEPTABLE

Figure 4-9. Incorrect Method of Mounting Bearing

Figure 4-10. Correct Method of Mounting Bearing on a Shaft

Figure 4-11. Correct Method of Mounting Bearing in a Housing

B Removal of Ball Bearings

When excessive force is applied through the ball complement in removing a bearing, the bearing shall not be reused without reinspection.

C Thrust Loading

Ball bearings with filling notches in the races shall not be used where the thrust load is sufficient to cause bearing balls to hit notches during bearing rotation. Thrust loading this type of ball bearing may cause objectionable noise, rough running, and early failure. See figure 4-12.

4.4.2 (Cont)

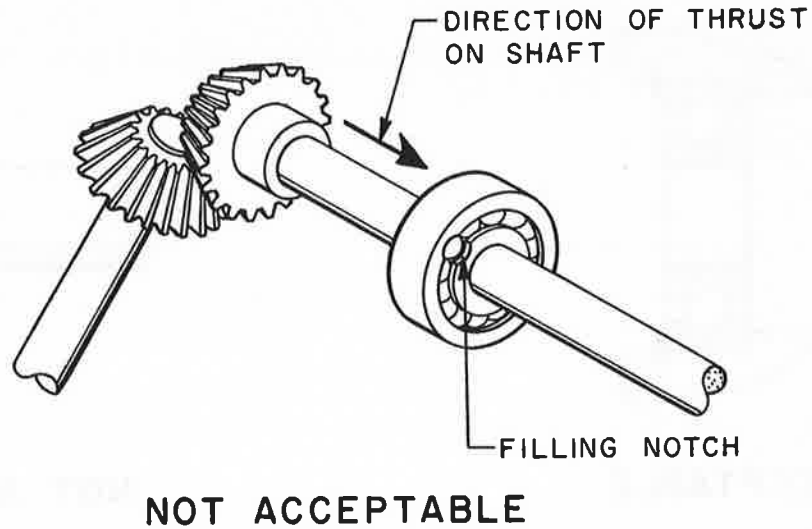

Figure 4-12. Improper Application of Ball Bearing with Filling Notches

D Shields and Seals

Ball bearings which may be subjected to excessive dust, moisture, or similar detrimental environments should be shielded or sealed to prevent contamination of the bearings and the lubricant.

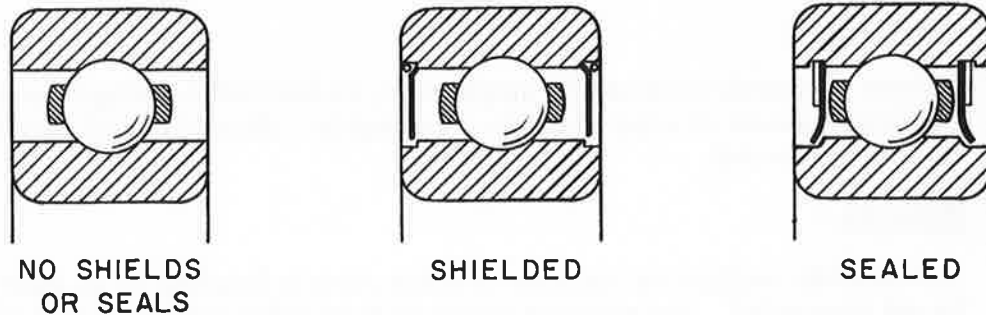
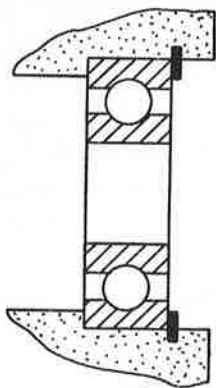

Figure 4-13. Typical Ball Bearing Constructions

E Retaining Methods

Ball bearings should be restricted from excessive axial movement, both on the shaft and in the housing bore. The device used to retain a ball bearing must not contact both inner and outer race, nor inner race and dirt shield of the bearings. See figures 4-14 and 4-15, below.

4.4.2E (Cont)



ACCEPTABLE

Figure 4-14. Method of Retaining Ball Bearing in Housing

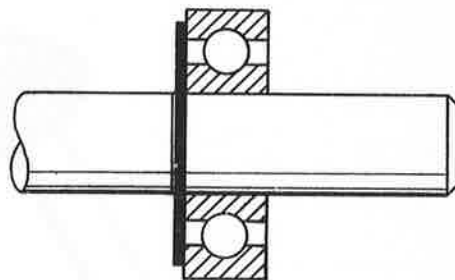

NOT ACCEPTABLE

Figure 4-15. Incorrect Method for Retention of Ball Bearing on Shaft

Miniature ball bearings usually are assembled with a slight clearance fit and therefore must be suitably retained.

Staking, spinning, bonding, and heavy press fit are not recommended means of retaining miniature ball bearings because of the possibility of damaging the bearing.

F Axial Play

Unless purposely preloaded, single row, radial ball bearings must have a perceptible amount of axial play after assembly. This play will ensure that the bearing is not overloaded.

G Rotation

Perceptible continuous rotation of outer race in housing or of shaft in inner race is not permitted. Intermittent creep is acceptable provided it is not caused by a defective bearing, and will not affect the intended function of the device.

4.4.3 Porous Self-Lubricating Bearings

A Sizing

Porous self-lubricating (Oilite) bearings may be sized by one of the following methods without destroying porosity.

1. These bearings may be reamed by taking a light, fast cut with a very sharp cutting tool using no cutting oil. Reaming, however, is not recommended for volume production unless carbide cutting edges are employed. A dull cutting tool will smear the bearing surface closing some of the pores and reducing the self-lubricating qualities of the bearing.

4.4.3A (Cont)

2. For volume production, a button burnisher (see figure 4-16 below) is recommended.

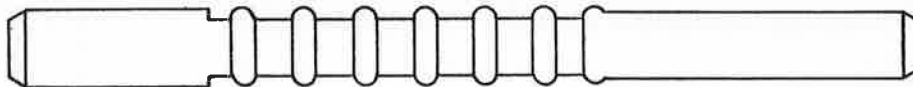

Figure 4-16. Button Burnisher for Sizing Oilite Bearings

4.4.4 Plastic Sleeve Bearings

Plastic sleeve bearings are not recommended for high speeds or extreme environmental conditions because of poor dissipation of heat generated by high speeds and dimensional changes caused by temperature and humidity conditions. When doubt exists relative to use of plastic bearings, contact the Materials Engineering Group.

4.5 TUNING SLUG RACKS

4.5.1 Alignment with Cam

Slug table rollers should ride on the cam and turn freely throughout the entire travel. A minimum of 75% of the cam thickness shall make contact with the roller when they are in their worst relative position including runout and end play. In cases where the table rides directly on the cam, with no roller, the same requirement for engagement shall apply.

4.5.2 Travel

Both ends of a slug table should start to rise at the same time and retain an equal amount of rise throughout the cycle. Movement shall be smooth with no evidence of sticking or binding.

4.5.3 Slug Positioning

Slugs shall not bind inside the sleeve. Care should be exercised in the use of varnish, liquid staking, and other assembly materials that may flow into the bore of a coil form and interfere with the intended action.

4.5.4 Slug Stud Retainers

Slug stud retaining devices must have sufficient tension to prevent movement when the equipment is subjected to vibration specified for the equipment. The retaining device must be installed in such a way that it will remain in place during, and yet not hinder adjustment. Liquid staking of slug adjustments shall not be permitted.

4.6 SWITCHES AND RELAYS

4.6.1 General

A Switch or relay contact supporting parts shall not be subjected to any stress which could be detrimental to free action or alignment. On a long rotary switch stack-up, some means shall be employed to ensure proper rigidity and radial alignment of all sections throughout the entire operation cycle.

B Contamination of Contacts

All contacts must be free of solder or other foreign material. Care shall be exercised during soldering and in the use of liquid staking, solder flux, antifungus varnish, or other materials that could flow or fume into the contact area under heat or other environmental conditions. Note: Contamination of contacts is recognized as one of the greatest causes of relay and switch failure.

C Pitting

Switch or relay contacts which are burned to the extent that they have become pitted are not acceptable. These pits can trap dirt and foreign material, causing contact failure.

D Tight Leads

Switch or relay contacts shall not be moved from their intended position due to stress from tight or stiff leads or improper installation, etc.

E Cleaning

When cleaning is necessary, switch or relay contacts must be cleaned only with burnishing tools or liquids made for this purpose. Caution: Heavy burnishing can damage contacts.

F Contact Arm Damage

Contact arms must be free of kinks or nicks which may cause stress concentrations and subsequent breakage or malfunction.

G Contact Alignment

Switch or relay contacts shall align so that in their worst relative position more than 50% of the smaller contact diameter is engaged. See illustrations below for low current applications. See also paragraph 4.6.2.D regarding disc-type rotary switch contacts.

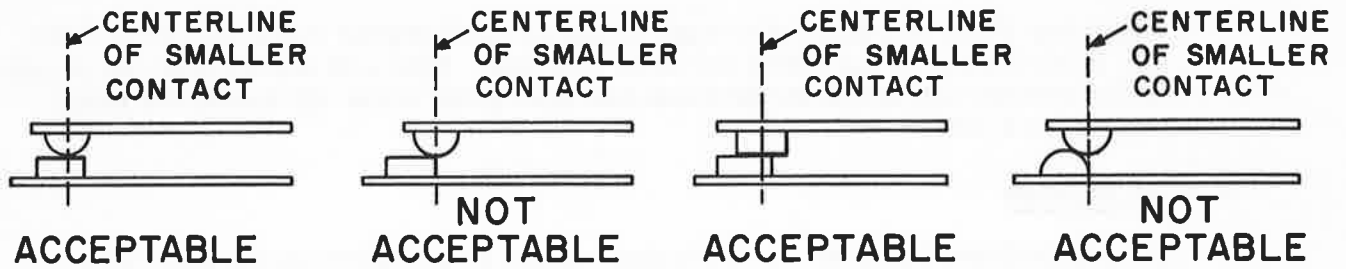

Figure 4-17. Contact Alignment for Low Current Applications

Note: In high current applications, flat button contacts must have 75% of area contacting and shall be parallel to each other.

4.6.2 Switches

A Binding

*Switches shall be free from binding or other defects which may keep them from functioning properly throughout the entire operation cycle. Torque requirements, where critical, shall be specified on the drawing or specification.

B Alignment

The locating tabs of rotary switches shall be placed in the holes provided.

C Soldering

Where a solder connection is made on the terminals of a wafer switch, the solder must not flow beyond the center of the eyelet that secures the switch contact, as this may interfere with the proper spring action. See figure 4-18.

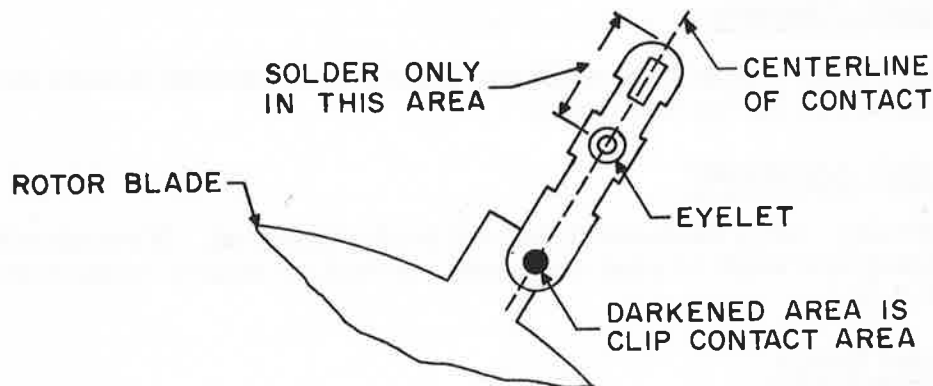

Figure 4-18. Wafer Switch Soldering and Contact Areas

4.6.2.D Rotary Switch Contact

The rotor blade of rotary disc-type switches shall engage more than 50% of the clip contact area in the worst detented position. This will ensure that the dimple in the contact clip rests on the blade and also gives some allowance for wear. See figure 4-18.

E Lubrication

Rotary switches shall not be lubricated except as specified on the assembly drawing.

4.6.3 Relays

A Adjustment of Relay and Leaf-type Switch Contacts

Properly adjusted relay contacts will have a noticeable amount of follow-through action in the closed position. This is necessary to ensure sufficient contact pressure and wiping action for self-cleaning. There may be certain relay designs where it is desirable to minimize wiping action. If doubt relative to wiping action arises, contact the Component Application Engineer.

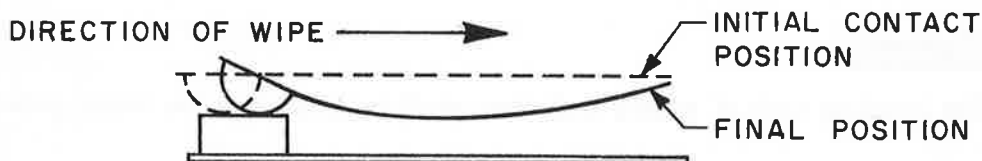

Figure 4-19. Exaggerated Wiping Action of Relay Contacts

B Contact Clearance

Open contacts must have sufficient clearance to prevent closure during vibration as specified for the equipment.

C Contact Adjustment

Normally, relay contacts should not need adjustment. If necessary, a proper bending tool shall be used which will not kink or nick the contact arm. (See 4.6.1. F.)

D Sealed Relays

Many sealed relays use solder terminals for mechanical support of contacts and contact arms; see figure 4-20. Terminals on sealed relays, therefore, shall not be bent or twisted as this may cause a break in a hermetic seal, internal breakage or an electrical short within the relay. See also general requirements for sealed electromechanical devices (4.1.2).

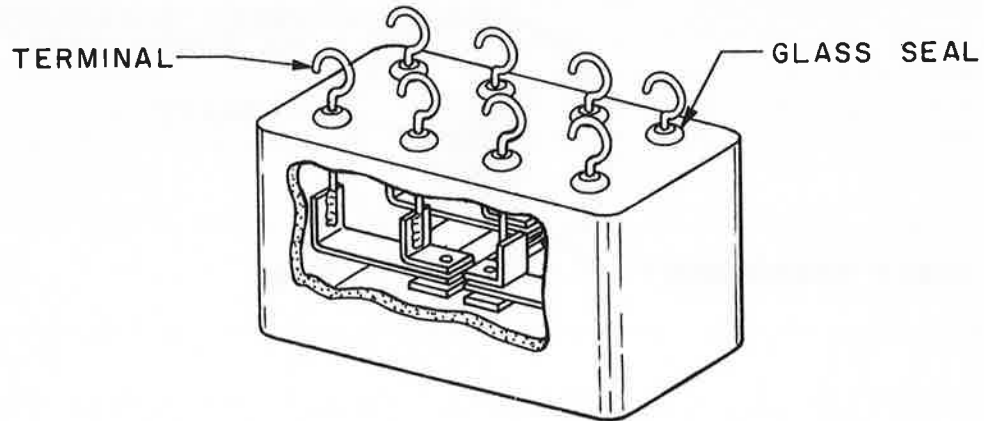

Figure 4-20. Construction of a Sealed Relay

4.7 RETAINING RINGS

4.7.1 Seating

As intended by the design of the ring, an external ring must be seated in its groove throughout its inner periphery, and an internal ring must be seated throughout its outer periphery. An "E" ring should be seated in the groove at all three points.

4.7.2 Installation

Only the chamfered (smooth) side of a retaining ring shall be installed to run against a bearing surface. The burred side (if any) could score the bearing surface and cause metal particles to drop into the mechanism.

4.7.3 Distortion

Visible distortion of a retaining ring shall not be permitted. Distortion of the retaining ring is likely to occur during assembly or disassembly. Special plier or assembly tools shall be used as recommended by the manufacturer.

4.8 PINNED ASSEMBLIES

4.8.1 Engagement with Hub

Where a hub is attached to a shaft by means of a pin, each end of the pin must engage at least 50% of the wall thickness of the hub. If the hub wall thickness is 1/16 inch or less, the engagement must be no less than 1/32 inch, or the full wall thickness on hubs of 1/32 inch or less wall thickness.

4.8.2 Protrusion from Hub

Protruding ends of pins in shaft assemblies must not interfere with other parts and must also meet clearance requirement of 4.1.1.A. This does not apply to pins whose function is to serve as a stop or actuator.

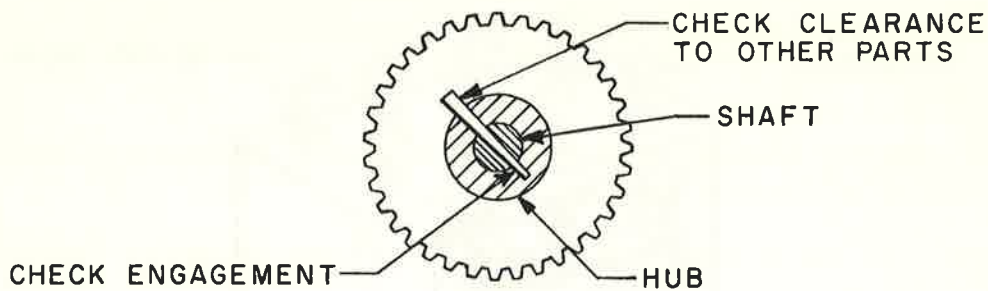

Figure 4-21. Pin Engagement and Clearance Checks

4.8.3 Tightness of Pins

Unless clearance is intended by design, the pin must be tight in both parts of the pinned assembly, as looseness can cause early failure due to excessive wear. Peening or distorting the hole or bending or flattening the pin to achieve a tight fit is not permitted.

4.8.4 Distortion by Pinning

In a pinning operation, the associated parts shall not be distorted beyond the tolerances of the individual parts where the distortion will affect the fit in further assembly, or the reliability of the end equipment.

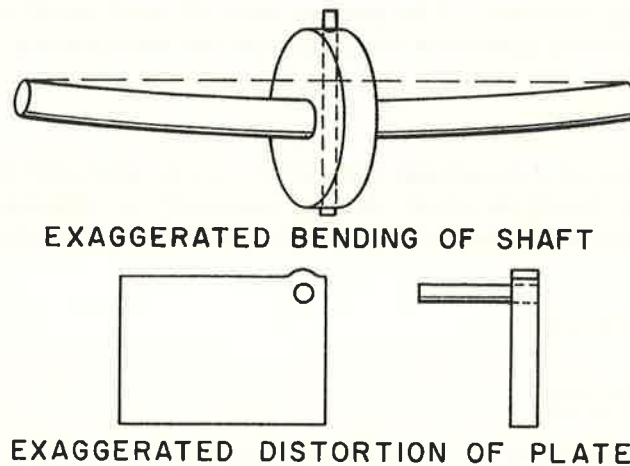

Figure 4-22. Distortion Caused by Improper Pinning

4.9 LUBRICATION REQUIREMENTS

4.9.1 General

- A All assembly drawings shall specify lubrication requirements or absence of such requirements on wear surfaces.
- B Electronic equipments shall be designed to use as few types of lubricants as possible.

4.9.2 Absence of Requirements

When obvious wear points exist and no specification for lubrication appears on the drawing or specification, Development Engineering must be contacted so that proper lubrication or omission of lubrication will be specified.

4.9.3 Lubrication Instruction Plates

Where lubrication instruction plates are specified, they shall indicate lubrication intervals, specifications for lubricant, amount to be applied, and any necessary precaution.

4.9.4 Application, Quantity and Protection

All lubrication shall be applied in a neat, consistent manner. The proper amount should be used to lubricate only the actual friction surfaces. Excessive quantities of lubricant hanging on gear trains and assemblies will not be acceptable. If the lubricant is applied with a brush, care must be used to prevent a broken bristle from remaining on such parts as gear trains. A single bristle could cause a serious malfunction. All lubricants shall be kept in closed containers to protect them from contamination. The containers (not merely the cover) shall be marked as to the type of lubricant. Special caution shall be used to avoid adding to or mixing lubricants without knowing whether they are compatible. When there is a question, old lubricant shall be cleaned out and the part relubricated. This requirement shall pertain to the lubricants in containers as well as in the bearings of equipment. Lubricated bearings should be protected per paragraph 4.4.1.C.

4.10. APPEARANCE AND CLEANLINESS

4.10.1 General Requirements

Front panels or sides exposed to frequent scrutiny must be free of blisters, scratches, dents, fractures, or objectionable material which is readily visible by normal vision at a distance of eighteen inches at any viewing angle. Appearance items which require concentrated study to detect are not to be considered defects. Screws or other fastening devices may contain minor tool marks but must not present an obviously damaged appearance. Silk screening, engraving, or other marking on front panels shall be uniform and legible. Where practical, panels shall present a balanced appearance, and alignment of controls and indicators should be uniform. Rear panels, sides not normally exposed, bottom plates, or other areas of similar exposure shall not have defects exposing bare metal but may have slight surface defects such as paint blisters, scratches, dents, or surface fractures, provided they do not appear to be careless workmanship and are not unsightly. The finish shall withstand normal handling in service without being marred.

4.10.1 (Cont)

A Plated Surfaces

Surfaces shall show no evidence of chipped, peeled, or blistered plating or other indications of lack of adhesion. Plated surfaces shall show no evidence of bleeding or corrosion due to entrapment of plating or cleaning solutions.

4.10.1.B Surface Coatings (Anodized and Chromate)

Coatings shall be free of severe scratches, nicks, gouges, or other abrasions which would indicate poor workmanship or careless handling. Extreme mismatch of chromate finish on panels, covers, and racks shall not be allowed.

C The quality of painted surfaces shall conform to appropriate grades outlined in Collins Fabrication Engineering Report entitled "Organic Finish Standards".

■ 4.10.2 Cleanliness

■ All equipments shall be clean and free of all loose material which could cause potential shorts, mechanical failure, or unsightly appearance. These include: stray hardware, solder splatters, wire strands, insulation clippings, filings, slivers, chips, and excess solder flux. Superficial cleaning with an air hose will not always be adequate as where contamination can become lodged behind cables, terminal boards, etc.

4.10.3 Special Areas of Appearance

Portions of equipment designed to be viewed during operation or items added for the sole purpose of styling and/or appearance will require a somewhat tighter control of the finish, alignment, and workmanship.

4.11 MARKINGS

4.11.1 General

Some of the methods of marking are:

Silk Screen	Etching
Rubber Stamp	Engraving
Impression Stamping	Decalcomania
Cast Marking	Tape Code
A. Raised	Stencil
B. Depressed	Self-Adhesive Label

The application of the marking shall not damage the surface to which it is applied. All marking shall be neat and legible, and shall be durable enough to withstand normal handling of the finished product and all specified environmental conditions.

Whenever the assembly permits, the identification marking should be adjacent to the referenced item, and visible in the finished assembly.

Careless marking can impart an impression of poor quality to an otherwise high quality product.

4.11.2 Decalcomanias (Decals) and Self-Adhesive Labels

A Application

In applying decals, process specification 580-5002-00 should be followed to ensure proper adhesion.

4.11.2.B Appearance

Decals, when cured, should be smooth and undamaged and free of air bubbles. Unless otherwise specified, an edge of the decal shall appear parallel with the chassis or panel edge.

C Adhesion

Twenty-four hours after application, the decal shall adhere sufficiently to the surface to withstand normal handling. The decal must not tear, peel, or show visible evidence of becoming loose when the adhesive side of pressure sensitive tape is applied to the face and edges of the decal with light finger pressure, using quick contact and removal motions of the hand and fingers. Minnesota Mining Scotch Brand tape No. 213 or equivalent approved by Materials Engineering shall be used.

4.11.3 Ink Stamping

A Appearance

All stamping must be neat and legible. The lines forming a letter must be complete, although the lines forming the letter need not be the same weight throughout. Ink must not peel or flake easily from the surface.

B Protection of Stamping

To ensure lasting legibility and durability for the service life of the equipment, ink stamping that is likely to be subjected to abrasion or handling damage shall be suitably protected with lacquer or varnish.

All ink stamping on equipments required to be fungus resistant shall be coated with a fungus resistant material, unless the stamping ink is fungus resistant. Metal etching inks may need no extra protection.

4.11.4 Cable Marking Bands

Cable marking bands, metal or otherwise, shall be applied with proper tools and must be free of burrs and sharp edges that can damage the cable. When metal bands are used, care should be used to ensure against electrical shorts.

4.11.5 Tape Code Labels

Tape code labels may be used only as an assembly aid and must be removed from the equipment prior to shipment.

This type of marking may deteriorate with age depending upon environmental conditions, and in coming loose may cause mechanical malfunction and poor appearance.

Mechanical and Electromechanical Requirements

4.11.6 Nameplates

Since the primary function of a nameplate is to supply information to the customer, it is important that all markings are clearly legible and correct in content and spelling.

Background paint or finish is of secondary importance unless the nameplate is to be mounted on the front of the unit or some other conspicuous location. The background color, if any, of Collins commercial nameplates shall be of a standard Collins color.

Markings or finish that are obviously the result of poor or careless workmanship will not be acceptable.

Approval status (ARINC, TSO, etc.) shall be stamped on the nameplate where there is space provided for it.

■4.12 LATENT CONTAMINATION

Some processes, such as those involving a gas or liquid, may result in chemical action harmful to parts or material in equipment. Harmful effects may not be evident during factory inspection but may occur after the equipment is in service. Control, therefore, must be accomplished by strict adherence to process specifications.

Section V

PRINTED CIRCUIT BOARD ASSEMBLY REQUIREMENTS

5.1 *PRINTED CIRCUIT BOARD SPECIFICATIONS

Process Specifications set forth the level of quality which must be maintained at the various stages of manufacture of printed circuit boards (including switches) intended for use in Collins electronic equipments. It is recommended that Process Specifications be used in reference in matters involving requirements in the following categories.

- (a) Printed circuit board artwork and photographic negatives
- (b) Printed circuit board fabrication
- (c) Dimensions
- (d) Plating and solderability
- (e) Plated-thru holes
- (f) Inspection and test methods
- (g) Protective coatings
- (h) Warp and twist

In the event of conflict between the requirements of this document and the referenced Process Specifications, the Process Specifications shall be the controlling documents.

5.2 EYELETS, TUBELETS, TERMINALS, AND PLATED-THRU HOLES

5.2.1 Definitions

- A The term "eyelet" shall be used herein to define a tubular metal piece having one end headed or rolled over. The second end would be similarly formed during installation in a material.
- B The term "tubelet" shall be used herein to define a tubular metal piece having one end formed in a conical flare of approximately 90 degrees included angle. The opposite end would be similarly formed during installation.
- C The term "terminal" shall be used herein to define a cylindrical piece of metal, of two or more diameters, which can be flared into a board for the purpose of connecting component leads or external wires to the board circuitry.

Printed Circuit Board Assembly Requirements

- 5.2.1.D The term "plated-thru hole" shall be used to define an electroplated, side-to-side connection for circuit boards where the thru-hole connection is an integral part of the circuitry.

5.2.2 Installation and Application

- A Roll flange eyelets shall not be used in boards having circuitry on both sides where circuit continuity is dependent upon them.

Roll flange eyelets may be used in boards as mechanical fasteners and where ground connections are used in conjunction with mechanical mounting.

- B Terminals shall be flared (see figure 5-1) with a 90-degree \pm 20-degree included angle.

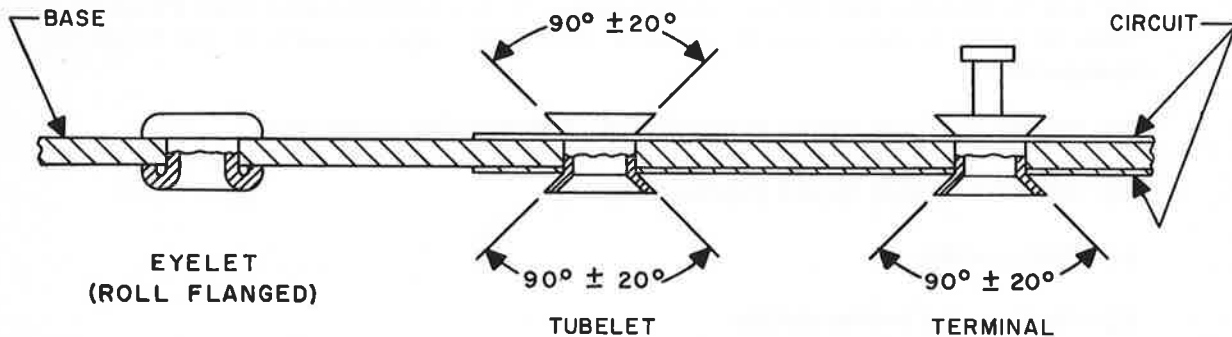

Figure 5-1. Eyelet, Tubelet and Terminal on a Board

- C Tubelets in boards having circuitry on both sides shall be installed so that both the head and flared end have a 90-degree \pm 20-degree included angle after installation.
- D Eyelets, tubelets, and terminals in boards having circuitry on one side only may be installed by rolling or flaring on the noncircuit side.

5.2.3 Other Quality Requirements

- A Cracks or splits in the rolled or flared portions of eyelets, tubelets, and terminals after installation shall be permissible with the following limitations:
- (1) No single part may have more than one crack or split per side of the board.
 - (2) No crack or split on a part may extend past the surface of the board into the hole.

Excessive splitting usually indicates defective tooling or material.

- B All tubelets and terminals installed in a printed wiring board shall be attached firmly to the board so that they cannot be moved or rotated by finger pressure before soldering.
- C The inner diameter of tubelets and eyelets after flaring or rolling shall be not less than 95% of the calculated minimum inner diameter of the part before installation.

5.2.3.C (Cont)

Example:	Tubelet	542-0811-003
	Inner Dia	.058 inch \pm .003 inch
	Minimum ID	.058 inch - .003 inch = .055 inch
	Minimum Acceptable ID after installation	.055 inch x .95 = .05225 inch or .052 inch

5.3 COMPONENT ATTACHMENT

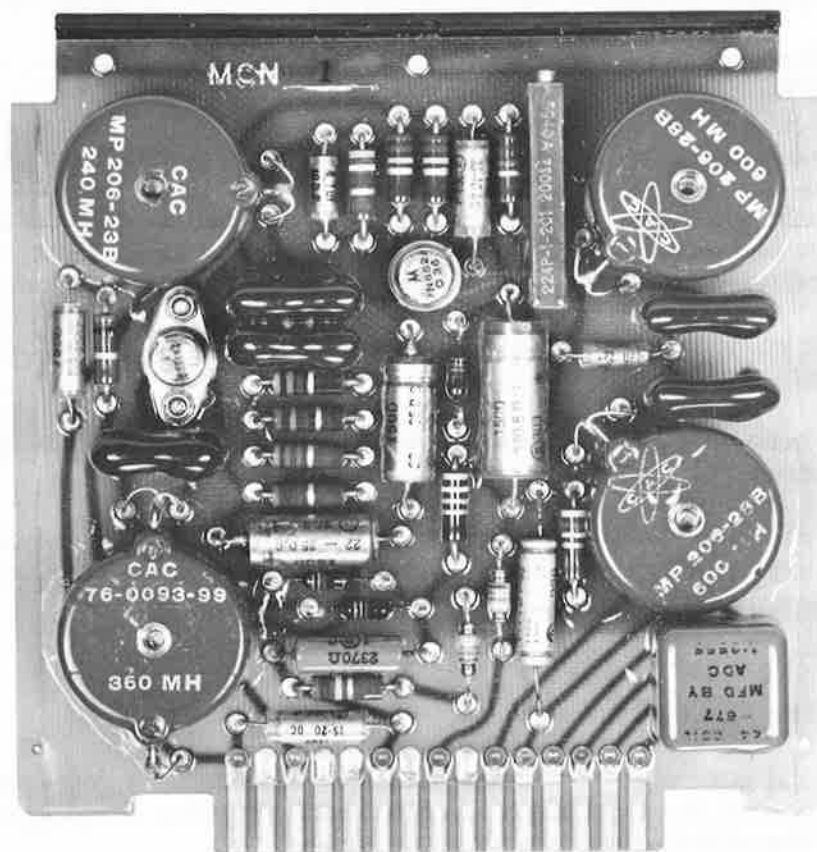

Figure 5-2. Assembled Printed Circuit Board

5.3.1 Components with Wire Leads

Electrical components with wire leads shall be prepared, inserted and clinched according to the following requirements:

- a. Component lead wires shall be reasonably straight, free of kinks, and properly cleaned and tinned before installation on printed wiring boards.
- b. All wire leads which are inserted into circuit boards shall be clinched over on the side opposite to insertion, in the direction of circuit paths where applicable. The length of the clinched end shall be not less than 1/16 inch or more than 1/8 inch, measured from the center line of the hole from which the lead emerges to the cut end. In no case shall a clinched wire end on a board be closer to a nonconnected circuit path than the minimum spacing maintained between nonconnected circuit paths on that board. The clinch shall be such that it holds the component lead perpendicular to the board. The clinched lead end shall lie against the tubelet flare through which the lead is projected.
- c. No process of straightening, cutting, bending, inserting, or clinching wire leads of electrical components shall be permitted which could result in internal damage, change of rating, or change of value of those components.
- d. Markings pertaining to values, tolerance, ratings, etc., shall be intact, legible, and readable from the most visible angle.
- e. Sharp bends in component leads shall be avoided. See section 2.5.
- f. Component lead bends shall not be positioned so close to the integral body of the component (welds, solder beads, plastic seal fillets, etc., included) that fracturing or other damage could result. (See paragraph 2.4.5.)
- g. Component leads shall be free of large indentations and fractures, cuts and nicks as specified in paragraph 1.1.3.C.
- h. Whenever possible, components should be centered between mounting points.
- i. Component leads shall not be stressed tight between mounting points. Adequate strain relief shall be provided to prevent damage to the component and solder joint. See figures 2-2 and 2-3.

5.3.2 Hardware Mounted Components

Electrical components, clamps, connectors, brackets, etc., which are to be mounted with threaded hardware shall be fastened in accordance with the requirements described in section 3 of this manual.

5.3.3 "Snap-in" Components

"Snap-in" components, such as tube sockets, transistor sockets, etc., shall be oriented and seated in the board properly. All metal tabs, spring leads, etc., which are intended for electrical connection to circuitry by soldering, shall be in contact with the circuit to which they are to be soldered.

5.4 QUALITY REQUIREMENTS FOR PRINTED CIRCUIT BOARD ASSEMBLIES

5.4.1 Component Bodies and Wire Leads

Failure to meet the requirements of paragraphs 5.3.1 through 5.3.3, or presence of any of the following defects shall be cause for rejection of the board assembly:

- a. Chipped or cracked components per paragraph 2.3.
- b. Wire leads which are fractured, broken, collapsed, or otherwise improperly inserted.

5.4.2 Printed Circuitry Separation

A lifted, separated or unbounded circuit may be identified easily by viewing the circuitry from the opposite side of the translucent laminate. An unbonded circuit will not be visible when viewed as described.

- A Circuitry lifted from the base laminate within $\frac{3}{16}$ of an inch from the edge of a pad will not necessarily constitute a reject.
- B Unbonded circuitry less than $\frac{1}{2}$ inch in length (See figure 5-2) may be made acceptable by rebonding the circuitry to the laminate with currently approved epoxy bonding materials. Bonding material shall be applied all over and beyond the lifted area for a distance of approximately $\frac{1}{16}$ inch all around. No one printed wiring path shall exhibit more than two such rebonded areas in its length.
- C Any board on which a circuit path shows lifting exceeding $\frac{1}{2}$ inch of continuous length shall be rejected and subjected to material review action.
- D There shall be no allowable separation of the cladding from the base laminate in the contact area on printed switches. Separation detectable by the unaided eye is cause for rejection.

5.4.3 Base Laminate

A scratch in the base laminate deep enough to expose the base filler material shall be repaired if it is closer than $\frac{1}{32}$ inch to adjacent circuits. Post-coating will accomplish this repair.

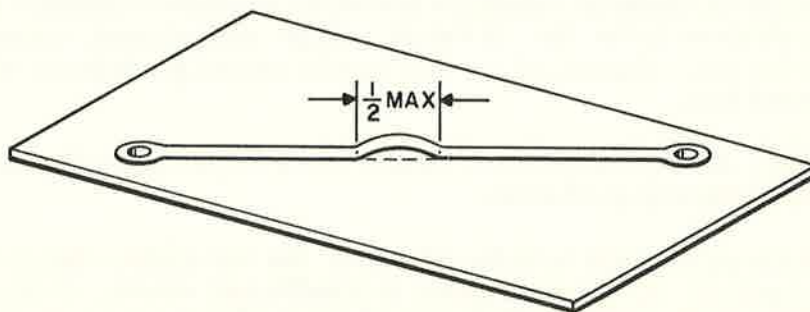

Figure 5-3. Lifted Circuitry Repairable Maximum

Printed Circuit Board Assembly Requirements

5.4.4 Repair of Printed Circuit

Limited damage to circuitry may be repaired by connecting wire from tubelet to tubelet.

5.5 SOLDERING ON PRINTED BOARDS

5.5.1 Preparation

- A Surfaces to be soldered shall be free of grease, dirt, oxide, scale, or other foreign materials.
- B All wires, component leads, and terminals which do not have an easily solderable coating shall be tinned before soldering.
- C All forming and trimming of leads shall be done prior to soldering.

5.5.2 Fluxes

- A Only currently approved solder fluxes shall be used.
- B Corrosive (chloride) fluxes shall not be used on printed wiring boards.
- C Flux may be applied to boards by spraying, dipping, or brushing. All surfaces to be soldered must be covered with flux.

5.5.3 Hand Soldering

- A In making a proper solder joint, it is necessary that there be no movement of the members until the solder has hardened completely. Movement during the soldering operation could result in a fracture or weakened joint which eventually may break under strain. Prevention of movement of members is the reason for making the wire mechanically secure to the terminal prior to soldering.
- B In the soldering operation, the members to be soldered must be hot enough to maintain the solder in a melted condition until the necessary "wetting" action takes place. It is important that the soldering iron or other source of heat be of adequate capacity to maintain the metal being soldered at the proper fusion temperature.
- C The soldering iron tip shall be kept tight within the iron and excess oxidation shall be removed at frequent intervals to ensure maximum transfer of heat from the heating element to the tip. A bright, clean, well-tinned, smooth face shall be kept on the tip. The tinned portion should extend a minimum of 1/2 inch back from the pointed end.
- D Heat sinks shall be used on the leads of all components that could be damaged by the heat of normal soldering.
- E If a solder connection is to be reheated, the old solder should be removed and the new solder applied, unless the reason is insufficient solder, in which case additional solder would be applied. Removal of solder from a joint shall be accomplished by a method that minimizes heat transfer to the component, such as the use of wire braid to soak up molten solder.

5.5.3 (Cont)

- F Only enough solder should be applied to allow adequate alloying action to take place but the solder shall be plainly visible. The general outline of the members should be visible. See figure 1-20.
- G Insulation or foreign material shall not be imbedded in a solder joint.
- H Cored solder having an approved flux or a solid wire solder used with a separate approved flux shall be used in hand-soldering.

5.5.4 Dip-Soldering

- A Circuitry other than contact areas and gold-plated areas must be coated with solder.
- B The composition of solder for dip-soldering printed circuit assemblies shall be 63% tin, 37% lead, unless otherwise specified.
- C The temperature of the molten solder for dip-soldering shall be maintained so that complete fusion of the alloy to the metal to be soldered shall result. All metal to be soldered should be covered completely and well tinned with concave fillets (radii) in evidence.
- D All tubelets, eyelets, plated-thru holes, or any other surfaces which are not to be soldered during a dip solder operation shall be suitably masked, covered, or plugged.

5.5.5 Removal of Flux Residues

- A All residues shall be removed from board surfaces and parts after soldering, using suitable cleaning agents or processes.
- B The cleaning agents or processes must not attack or degrade the board materials, component materials, color codings or silk-screened paint markings of the assembly. They shall be noncorrosive.

5.5.6 Workmanship Standards - Dip-Soldered Boards

- A The completed printed wiring board assembly shall conform to all the requirements stated. Spare parts, subassemblies, or other printed boards containing only tubelets, eyelets, and terminals also shall conform. Presence of the following defects shall be cause for rejection:
 - a. Incomplete coverage by solder of metal surfaces, component leads, tubelets, or terminals which are to be soldered.
 - b. "Cold" or fractured solder joints or nonadherence of solder to metal.
 - c. Excess solder globules, peaks, strings, or bridging of solder between adjacent parts or circuits.
 - d. Burned, scorched, or otherwise heat-damaged boards or components.
 - e. Corroded metal parts or circuits.

Printed Circuit Board Assembly Requirements

5.5.6 (Cont)

- f. Flux residues, oils, greases, or foreign materials on assembly.
 - g. Substantial damage to color codes or nomenclature of electrical components, silk-screened paint, component materials, or board materials.
- B Solder joints and solder coatings must not reduce the spacing of conductors to less than $2/3$ of the nominal spacing; where greater spacing is necessary due to high voltage, etc., the minimum spacing should be specified on the drawing. Excessive solder globules, bumps, or peaks must be removed. There must be visible evidence of the lead under the solder coating, on the side of the board opposite the component.

5.6 POST-COATING

When specified on the drawing, printed wiring boards shall be given a resinous coating on completion of the component assembly and soldering operations. The coating must protect the board surface from contamination, mechanical damage, and moisture.

5.6.1 Cleaning

Immediately before applying the coating, the surface of the printed board shall be free of any grease or residue which would lower the surface resistivity of the printed board or reduce the adhesion of the coating.

5.6.2 Masking

Terminals, sockets, connectors, and portions of the metallic pattern such as switch pads which are to be used for electrical connection, shall be suitably masked so that they do not become coated.

5.6.3 Cured Coating Requirements

The cured coating shall meet the following requirements:

- a. It shall be smooth and uniform, without excessive globules or bare spots.
- b. It shall be substantially free from bubbles.
- c. There shall be no blisters or cracks.

5.7 HANDLING AND PACKAGING

The fabricated boards shall be handled and packaged carefully to avoid scratching, chipping, or other damage during shipment, assembly, or storage.

APPENDIX A

Mica Capacitor Color Code

EIA STANDARD RS-153

MIL-C-10950

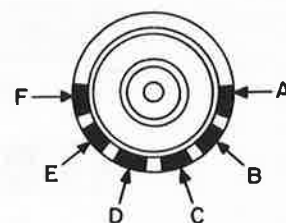
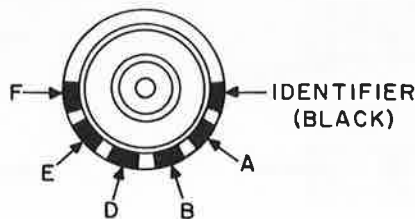
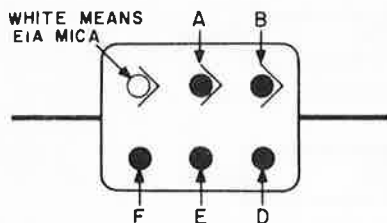

Color	Digits of Capacitance (μmf)			Multiplier D	Tolerance % E	Characteristic— See table below F
	A	B	C			
Black	0	0	0	1	± 20	A
Brown	1	1	1	10	± 1	B
Red	2	2	2	100	± 2	C
Orange	3	3	3	1,000	± 3	D
Yellow	4	4	4	10,000*	—	E
Green	5	5	5	—	± 5	—
Blue	6	6	6	—	—	—
Violet	7	7	7	—	—	—
Gray	8	8	8	—	—	—
White	9	9	9	—	—	—
Gold	—	—	—	0.1	—	—
Silver	—	—	—	0.01	± 10	—

DESCRIPTION OF CHARACTERISTIC

Characteristic	Temperature Coefficient (parts per million per °C)	Maximum Capacitance Drift	Minimum Insulation Resistance (megohms)
A	± 1000	$\pm (5\% + 1 \mu\text{mf})$	3000
B	± 500	$\pm (3\% + 1 \mu\text{mf})$	6000
C	± 200	$\pm (0.5\% + 0.5 \mu\text{mf})$	6000
D	± 100	$\pm (0.3\% + 0.1 \mu\text{mf})$	6000
E	+100 -20	$\pm (0.1\% + 0.1 \mu\text{mf})$	6000
I	+150 -50	$\pm (0.3\% + 0.2 \mu\text{mf})$	6000
J	+100 -50	$\pm (0.2\% + 0.2 \mu\text{mf})$	6000

VOLTAGE RATING

(Indicated by dimensions rather than color coding)

Maximum Inches			Style	Capacitance (μmf)	Rating (v d-c)
Long	Wide	Thick			
$5\frac{1}{64}$	$1\frac{5}{32}$	$7\frac{1}{32}$	20	5-510 560-1000	500 300
$1\frac{1}{4}$	$1\frac{5}{32}$	$7\frac{1}{32}$	25	5-1000 1100-1500	500 300
$5\frac{3}{64}$	$5\frac{3}{64}$	$9\frac{1}{32}$	30	470-6200 Over 6200	500 300
$5\frac{3}{64}$	$5\frac{3}{64}$	$3\frac{1}{8}$	35	3300-6200 Over 6200	500 300
$1\frac{1}{32}$	$4\frac{1}{64}$	$1\frac{1}{32}$	40	100-2400 2700-7500 Over 7500	1000 500 300

Mica Capacitor Color Code

Obsolete Style

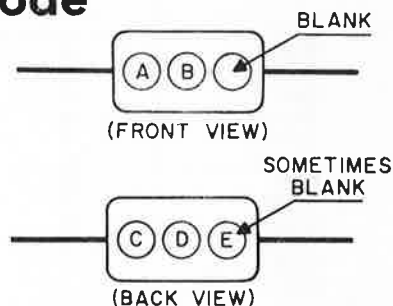
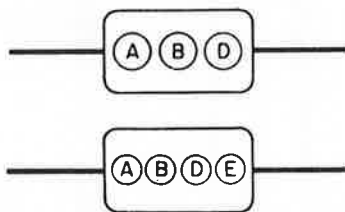
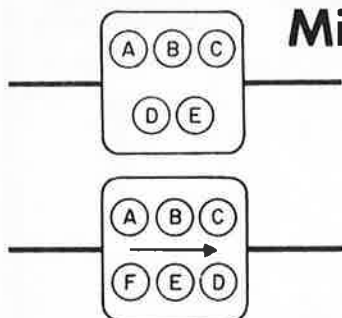

Dot Color	Digits of Capacitance (μmf)			Multiplier D	Tolerance % E	Voltage Rating (v d-c) F
	A	B	C			
Black	0	0	0	1	± 20	—
Brown	1	1	1	10	± 1	100
Red	2	2	2	100	± 2	200
Orange	3	3	3	1,000	± 3	300
Yellow	4	4	4	10,000	± 4	400
Green	5	5	5	100,000	± 5	500
Blue	6	6	6	1,000,000	± 6	600
Violet	7	7	7	10,000,000	± 7	700
Gray	8	8	8	100,000,000	± 8	800
White	9	9	9	1,000,000,000	± 9	900
Gold	—	—	—	0.1	± 5	1,000
Silver	—	—	—	0.01	± 10	2,000
No Color	—	—	—	—	± 20	500

Resistor Color Code

RETMA STANDARD RS-172, REC-117 MILITARY STANDARD MIL-STD-221A

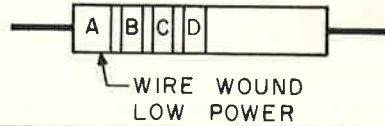
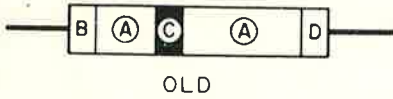
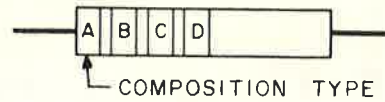
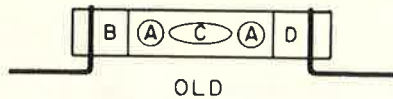

Color	1st Digit A	2nd Digit B	Multiplier C	Tolerance D
Black	0	0	1	—
Brown	1	1	10	—
Red	2	2	100	—
Orange	3	3	1,000	—
Yellow	4	4	10,000	—
Green	5	5	100,000	—
Blue	6	6	1,000,000	—
Violet	7	7	10,000,000	—
Gray	8	8	100,000,000	—
White	9	9	—	—
Gold	—	—	0.1	± 5%
Silver	—	—	0.01	± 10%
No Color	—	—	—	± 20%

OLD INSULATION CODING

RETMA: Insulated resistors with axial leads are designated by a background of any color except black. The usual color is natural tan. Noninsulated resistors with axial leads are designated by a black background color.

MILITARY (MIL): Same as RETMA with the addition of: Noninsulated resistors with radial leads designated by a black background color or by a background the same color as the first significant figure of the resistance value.

Mica Capacitor Color Code

MILITARY STANDARD

SEE MIL-C-5A, -5B

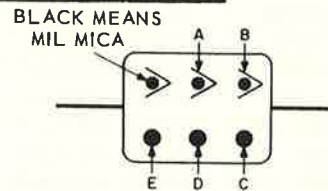

Color	Digits of Capacitance ($\mu\mu\text{f}$)		Multiplier C	Tolerance % D	Characteristic. See table below E
	A	B			
Black	0	0	1	± 20	—
Brown	1	1	10	—	B
Red	2	2	100	± 2	C
Orange	3	3	1,000	—	D
Yellow	4	4	—	—	E
Green	5	5	—	—	F
Blue	6	6	—	—	—
Violet	7	7	—	—	—
Gray	8	8	—	—	—
White	9	9	—	—	—
Gold	—	—	0.1	± 5	—
Silver	—	—	0.01	± 10	—

DESCRIPTION OF CHARACTERISTIC

Characteristic	Temperature Coefficient (parts per million per °C)	Maximum Capacitance Drift	Minimum Insulation Resistance (megohms)
B	Not specified	Not specified	7500
C	±200	±0.5%	7500
D	±100	±0.3%	7500
E	+100 -20	±(0.1% +0.1 $\mu\mu\text{f}$)	7500
F	+70	±(0.05% +0.1 $\mu\mu\text{f}$)	7500

VOLTAGE RATING

(If indicated by dimensions rather than color coding)

Maximum Inches			Style CM	Capacitance ($\mu\mu\text{f}$)	Rating (v d-c)
Long	Wide	Thick			
$\frac{35}{64}$	$\frac{5}{16}$	$\frac{7}{32}$	15	5-510	300/500
$\frac{51}{64}$	$\frac{15}{32}$	$\frac{7}{32}$	20	5-510 560-1000	500 300/500
$\frac{17}{64}$	$\frac{15}{32}$	$\frac{7}{32}$	25	51-1000	500
$\frac{53}{64}$	$\frac{53}{64}$	$\frac{9}{32}$	30	560-3300	500
$\frac{53}{64}$	$\frac{53}{64}$	$\frac{11}{32}$	35	3600-6200 6800-10,000	500 300
$\frac{11}{32}$	$\frac{41}{64}$	$\frac{11}{32}$	40	3300-8200 9100-10,000	500 300

Paper Capacitor Color Code

MILITARY STANDARD MIL-C-91A

(Commercial codes are same except as noted)

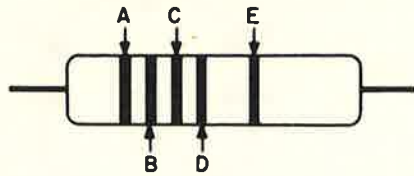

**Tubular Capacitors
(Commercial Only)**

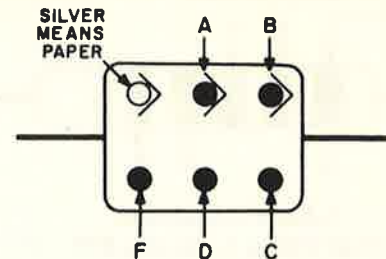

Rectangular Capacitors

Color	Digits of Capacitance ($\mu\mu\text{f}$)		Multiplier C	Tolerance % D	Tubular Voltage Rating (v d-c) E	Temp. Rating °C and Characteristic F
	A	B				
Black	0	0	1	± 20	—	85-A
Brown	1	1	10	—	100	85-E
Red	2	2	100	—	200	—
Orange	3	3	1,000	± 30	300	—
Yellow	4	4	10,000	—	400	—
Green	5	5	—	—	500	—
Blue	6	6	—	—	600	—
Violet	7	7	—	—	700	—
Gray	8	8	—	—	800	—
White	9	9	—	—	900	—
Gold	—	—	—	—	1,000	—
Silver	—	—	—	± 10	—	—

VOLTAGE RATING FOR RECTANGULAR CAPACITORS

(Indicated by dimensions rather than color coding)

Maximum Dimensions (inches)			Style CN	Capacitance ($\mu\mu\text{f}$)	Voltage Rating (v d-c)
Length	Width	Thick- ness			
$5\frac{1}{64}$	$1\frac{5}{32}$	$\frac{1}{32}$	20	1000 2000-6000 10,000	400 200 120
$5\frac{7}{64}$	$3\frac{1}{64}$	$1\frac{1}{64}$	22	2000-3000 6000-10,000 20,000	400 300 120
$5\frac{3}{64}$	$5\frac{3}{64}$	$\frac{9}{32}$	30	1000-2000 3000 6000-10,000 20,000	800 600 400 120
$5\frac{3}{64}$	$5\frac{3}{64}$	$1\frac{1}{32}$	35	3000 6000-10,000 20,000	800 600 300
$1\frac{1}{4}$	$4\frac{1}{64}$	$\frac{9}{32}$	41	3000-6000 10,000 20,000 30,000	600 400 300 120
$1\frac{15}{32}$	$4\frac{9}{64}$	$1\frac{1}{32}$	42	1000-6000 10,000-20,000 30,000 50,000 100,000	1000 600 400 300 120
$1\frac{15}{32}$	$4\frac{9}{64}$	$1\frac{3}{32}$	43	10,000 20,000-30,000 50,000-100,000 200,000	1000 600 400 120

Ceramic Capacitor Color Code

SEE EIA STANDARD RS-198

MILITARY STANDARD MIL-C-11015B,

MIL-C-20C

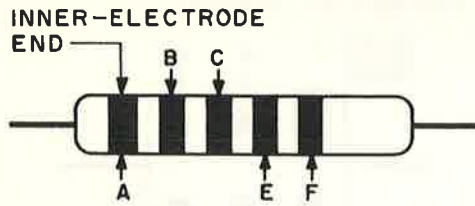

Tubular Capacitors
(Voltage rating is always 500 v.)

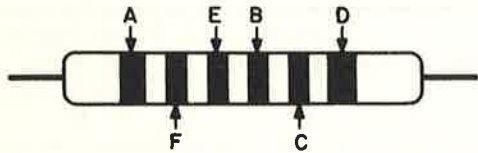

Tubular Capacitors
(Old RMA)

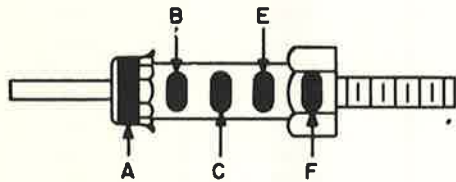

Stand-Off Capacitors
(RETMA ONLY)

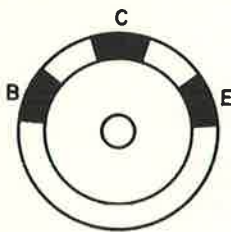

3-Dot Button Capacitors
RETMA ONLY

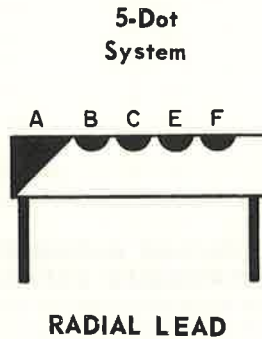

5-Dot System

RADIAL LEAD

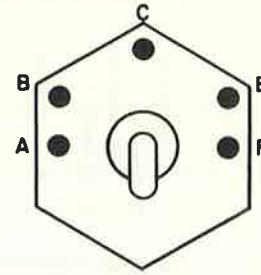

Feed Through Capacitors

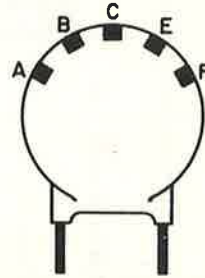

5-Dot Disc Capacitors
(EIA)
(Voltage rating is 500 v. or as marked)

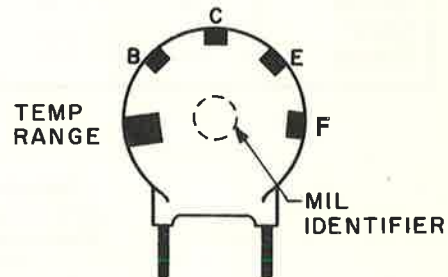

6-Dot Disc Capacitors

(Voltage rating is always 500 v.,)

Color	Digits of Capacitance ($\mu\mu\text{f}$)			Multiplier E	Tolerance F		Temp. Coef. A (Parts per million per °C.)	
	B	C	D		10 $\mu\mu\text{f}$ or less ($\mu\mu\text{f}$)	Over 10 $\mu\mu\text{f}$ (%)	EIA	MILITARY
Black	0	0	0	1	± 2.0	$\pm 20^*$	0	0
Brown	1	1	1	10	$\pm 0.1^*$	± 1	— 33	— 30
Red	2	2	2	100	$\pm 0.25^{**}$	± 2	— 75	— 80
Orange	3	3	3	1,000	—	$\pm 3^*$	— 150	— 150
Yellow	4	4	4	10,000*	—	+100.0*	— 220	— 220
Green	5	5	5	—	± 0.5	± 5	— 330	— 330
Blue	6	6	6	—	—	—	— 470	— 470
Violet	7	7	7	—	—	—	— 750	— 750
Gray	8	8	8	0.01	$\pm 0.25^*$	+80 -20*	+150 to — 1500	+ 30
White	9	9	9	0.1	± 1.0	± 10	+100 to — 750	+330*
Gold	—	—	—	—	—	—	—	+100

*EIA (formerly RETMA)

**MIL-C-20C

COLOR CODING MOLDED CHOKE COILS
MIL-C-15305B

A silver band, greater in width than the other bands, near one end of the coil is the MIL identifier. The inductance value in microhenries is indicated by three additional bands. For inductance values of 10 microhenries or more, the color code is the same as for resistors. When either the first or second of the three bands is gold, the gold band represents the decimal point for inductance values less than 10. The other two colors represent the significant figures using the same digit values as for resistors.

For small chokes, dots may be used instead of bands as above.

EXAMPLES

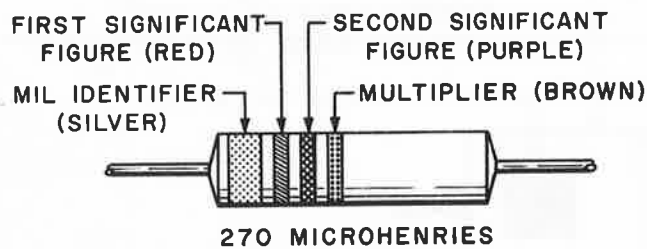
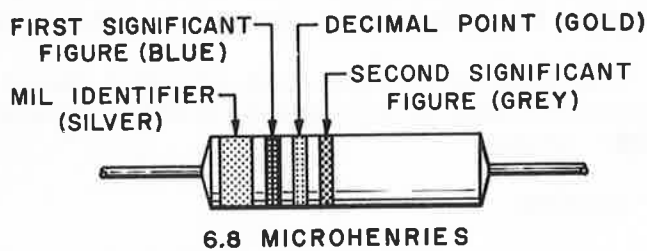

It is significant to note that there have been isolated instances when, for no apparent reason, the manufacturer has not followed this marking code. If there is any question or doubt about the value of a choke, it should be checked by actual measurement on a suitable bridge.

1N DIODE TYPE AND POLARITY
PER EIA STANDARD RS 236, etc.

Types are identified by number or by colored bands which designate the JEDEC type number. Reading from the cathode end, the digits are represented by the same colors as in the resistor color code. If necessary to show a suffix letter, a band will follow the type number as follows:

Brown	A	Yellow	D
Red	B	Green	E
Orange	C	Blue	F

Four-digit type numbers are shown by four bands followed by a fifth, black, band. If a suffix letter is required, it will be indicated as the fifth band in place of the black band.

The cathode end is indicated by a double-width band as the first band; or bands should be grouped toward the cathode end. The cathode end may be indicated by a single band or by the bar of the diode symbol: Cathode \leftarrow Anode.

Examples 2 or 3 DIGIT TYPES OF DIODES

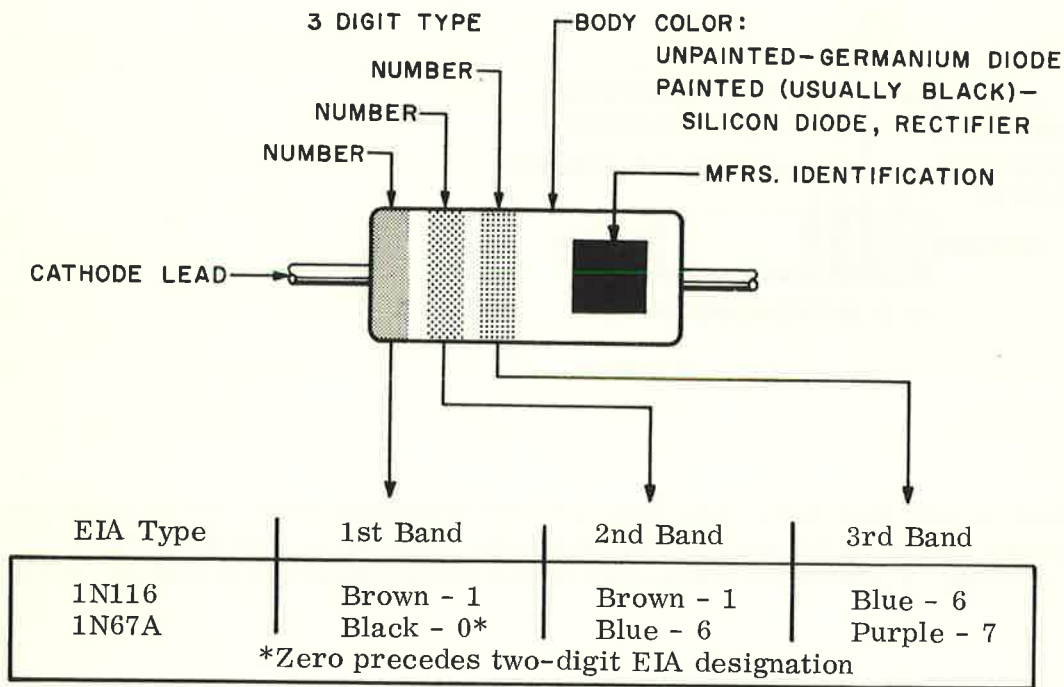

4 DIGIT TYPES OF DIODES

EIA Type	1st Band	2nd Band	3rd Band	4th Band	5th Band
1N1234A	Brown - 1	Red - 2	Orange - 3	Yellow - 4	Brown - A
1N1695	Brown - 1	Blue - 6	White - 9	Green - 5	Black - 0

TYPICAL DIODE POLARITY GUIDE

SCHEMATIC REPRESENTATION

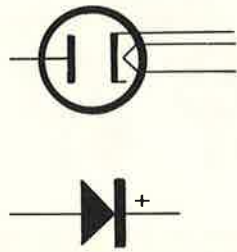

TUBE, GERMANIUM, SILICON
AND SELENIUM DIODES

PICTORIAL REPRESENTATION

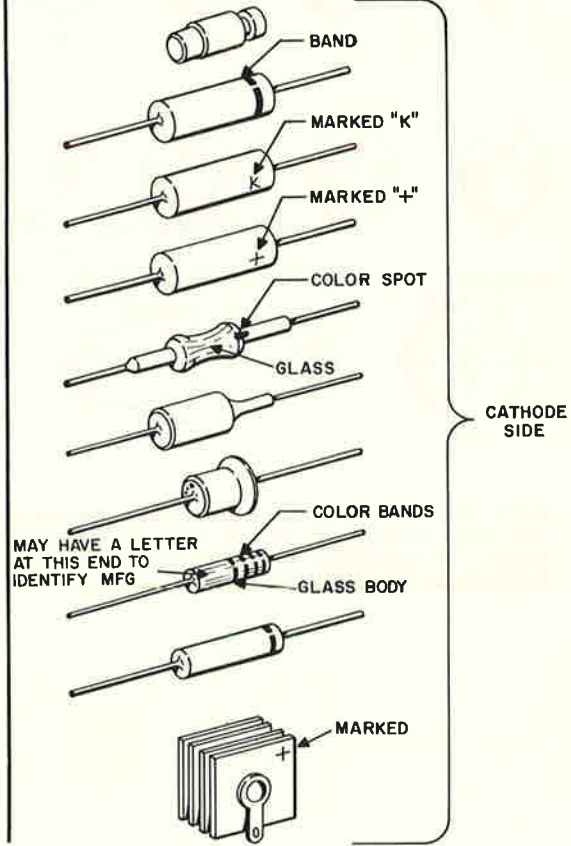

TRANSISTOR BASE DIAGRAMS

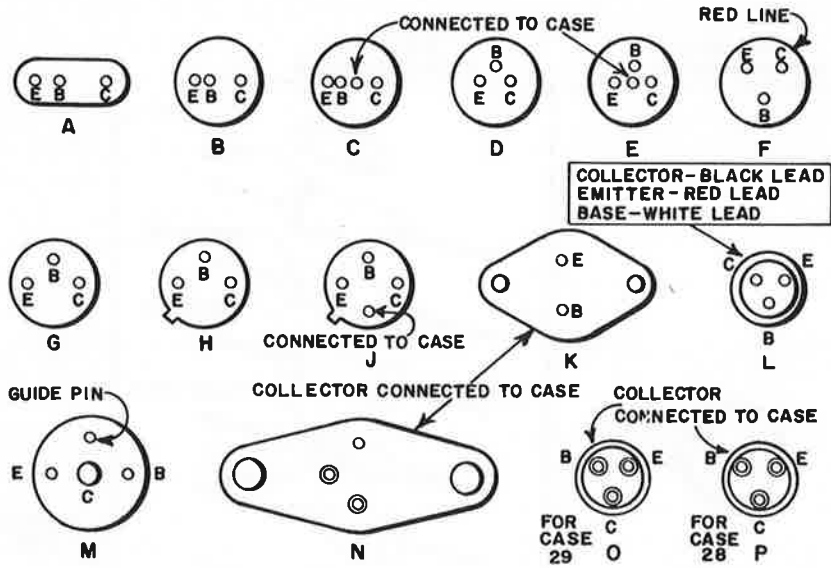

NOTE: MANY MANUFACTURERS CONNECT ONE OR ANOTHER OF THE LEADS TO THE CASE STRUCTURE, SO THE INDIVIDUAL TRANSISTOR SPECIFICATION SHEET SHOULD BE REFERRED TO BEFORE CONNECTING THE TRANSISTOR INTO A CIRCUIT, ESPECIALLY FOR BASE DIAGRAMS B, G, & H.

PART AND ASSEMBLY DESIGNATIONS

Alphabetically by Letters

General classes of parts are marked with an asterisk (*) to facilitate designation of parts not specifically included in this list. In case of doubt, a letter or letters already assigned to the class most similar in function should be used. Certain item names may apply to either a part or a subassembly. When the item is a subassembly, the letter "A" shall be used in lieu of the letters listed except in the case of wire and cable.

- *A Assembly; subassembly.
- AT Attenuator; pad; resistive termination.
- *B Blower; fan; motor; prime mover; resolver; synchro.
- BT Battery.
- C Capacitor, capacitance bushing, silicon diode voltage variable capacitor.
- CB Circuit breaker.
- CP Coupling (aperture, loop, or probe); coaxial or waveguide junction (tee or wye); adapter, connector.
- CR Crystal detector; crystal diode; crystal unit; crystal, contact or metallic rectifier; selenium cell; varistor, asymmetrical.
- D Dynamotor, converter, inverter.
- DC Directional coupler.
- DL Delay line.
- DP Diaphragm.
- *DS Indicator; miscellaneous illuminating or indicating device (except meter or thermometer) such as: alarm, annunciator; audible or visual signalling device; bell; buzzer; drop; flasher; pilot, illuminating or signal lamp; telegraph sounder; telephone set ringer; vibrator (indicating) dials.
- *E Miscellaneous electrical part such as: aerial; aluminum or electrolytic cell; antenna; armature assy, bimetallic strip; binding post; brush; carbon block; clips; cord tip; counterpoise; dipole antenna; electrical shield; electric contact; gap; individual terminal; insulator; lightning arrester; loop antenna; magnet; printed circuit boards; protector; resonator; short; slip ring; rotor; solenoid.
- EQ Equalizer.
- F Fuse; fuse cutout.
- FL Filter.
- G Exciter; generator; magneto; rotating amplifier; vibrator (interrupting), chopper.
- *H Hardware; bolts; nuts; screws; etc.
- HR Heater (element for thermostat, oven, etc.), heating lamp.
- HS Handset.
- HX Heat exchanger.
- HT Headset; hearing aid; telephone receiver.
- HY Hybrid coil; hybrid junction.
- J Connector, receptacle, electrical (with male, female, or male and female contacts and designed to be mounted on a bulkhead, wall, chassis or panel); jack; receptacle.
- K Relay (electrically operated contactor or switch).
- L Choke; inductor; loading coil; relay operating coil; retardation coil; solenoid; tuning coil; winding; reactor, filter; ferrite bead.
- LS Loudspeaker; horn; howler; siren; speaker.
- *M Meter; clock; counter (indicating device); elapsed time recorder; guage; instrument; message register; oscillograph; oscilloscope; thermometer; timer.
- MG Motor-generator.
- MK Microphone; telephone transmitter.
- *MP Miscellaneous mechanical part such as: bearing; coupling; gear; mechanical interlock; shaft; vibrator reed; gyroscope; structural part; window, observation; mounting (not in electrical circuit and not a socket); air filter.
- MR Magnetic reactor.
- MT Mode transducer.
- N Plate, identification; chart; nameplate; etc.
- O Knob.

PART AND ASSEMBLY DESIGNATIONS (Cont)

- P Connector, plug, electrical (with male, female, or male and female contacts, constructed to be affixed to the end of a cable, conduit, coaxial line, cord or wire).
- PU Pickup; erasing head; recording head; reproducing head.
- Q Transistor.
- R Resistor; shunt; resistor, variable; potentiometer; rheostat, dummy load.
- RP Repeater.
- RT Current regulating resistor; ballast tube; ballast lamp; resistance lamp; thermistor.
- RV Symmetrical varistor.
- S Switch (mechanically or thermally operated); contactor; disconnecting device; dial (circuit interrupter); electrical safety interlock; governor switch; speed regulator; telegraph key; thermal cutout; thermostat.
- T Transformer; autotransformer; IF transformer; repeating coil (telephone usage); transformer; waveguide or coaxial taper; induction coil (telephone usage).
- TB Terminal board; connecting block; group of individual terminals on its own mounting; terminal strip; test block.
- TC Thermocouple.
- **TP . . Test point.
- *U Hydraulic part.
- V Electron tube; barrier photocell; blocking layer cell; light-sensitive cell; photoemissive cell; phototube, photoconductive cell.
- VR Voltage regulator (except an electron tube).
- *W Cable; coaxial cable; guided transmission path; waveguide; wire.
- X Socket; fuseholder (see note 2) lampholder.
- Y Oscillator (excluding electron tube used as an oscillator); piezoelectric crystal; magnetostriction oscillator.
- Z Artificial line; discontinuity; tuned cavity; tuned circuit; network; mode suppressor.

Note 1. TERMINALS. The letter "E" shall not be used to identify terminals of such parts as sockets, terminal boards, transformers, etc., where terminal numbers are assigned and no confusion will result.

Note 2. SOCKETS. A socket or fuseholder which is always associated with a single particular part or subassembly, such as an electron tube, fuse, or printed circuit board (not containing a separate electrical connector), shall be identified by a composite reference designation which includes the class letter "X" and the letter (s) and number which identify the associated part. For example, the fuse holder for fuse F7 would be identified XF7, and the socket for electron tube 10V3 would be identified 10XV3, etc.

Note 3. CONNECTORS. When reference designations are required to identify cables and connectors, the reference designations of the movable connector and adapter shall be included in parentheses on drawings and diagrams, at the stationary connector marking. Whenever possible, the item number shall be the same for the stationary and the movable connectors.

Note 4. POTTED, EMBEDDED, OR HERMETICALLY SEALED SUBASSEMBLIES. A potted, embedded, or hermetically sealed subassembly ordinarily replaced as a single item of supply shall be treated as a subassembly for reference designation marking purposes.

**Not a reference designation, but included in this listing to permit usage in connection with reference designations, where required.

CONVERSION TABLES

To Convert	Into	Multiply By	Conversely Multiply By
Centigrade	Fahrenheit	X 9/5, add 32°	Sub. 32°, X 5/9
Chains	Feet	66	1.515 X 10 ⁻²
Cubic feet	Gallons (U.S.)	7.481	0.1337
Cubic inches	Gallons (U.S.)	4.329 X 10 ⁻³	231
Gallons (U.S.)	Gallons (Brit)	0.8327	1.201
Grains (for humidity)	Pounds (Avoir)	1.429 X 10 ⁻⁴	7000
Grams	Grains	15.43	6.481 X 10 ⁻²
Grams	Ounces (Avoir)	3.527 X 10 ⁻²	28.35
Inches	Centimeters	2.540	0.3937
Kilowatt-hours	Btu	3413	2.930 X 10 ⁻⁴
Knots	Miles per hour	1.1508	0.8690
Meters	Yards	1.094	0.9144
Miles per hour	Feet per minute	88	1.136 X 10 ⁻²
Ounces (fluid)	Quarts	3.125 X 10 ⁻²	32
Ounces (avoir)	Pounds	6.25 X 10 ⁻²	16
Pounds of water	Gallons	0.1198	8.347
Watts	Horsepower	1.341 X 10 ⁻³	745.7

INCANDESCENT LAMPS FOR INDICATOR LIGHTS

Size	Base Type	Commercial Number	Voltage (D. C.)	Current (Amps)
T-1	Wire Leads	680	5.0	0.060
T-1	Wire Leads	683	5.0	0.060
T-1	Wire Leads	715	5.0	0.115
T-1	Wire Leads	683AS15	5.0	0.060
T-1	Wire Leads	715AS15	5.0	0.115
T-1	Flange	682	5.0	0.060
T-1	Flange	685	5.0	0.060
T-1	Flange	718	5.0	0.115
T-1	Flange	685AS15	5.0	0.060
T-1	Flange	718AS15	5.0	0.115
T-1-3/4	Flange	338	2.7	0.060
T-1-3/4	Flange	328	6.0	0.200
T-1-3/4	Flange	330	14.0	0.080
T-1-3/4	Flange	327	28.0	0.040
T-1-3/4	Flange	328AS15	6.0	0.200
T-1-3/4	Flange	327AS15	28.0	0.040
T-2	Flange	6C	6.0	0.045
T-2	Flange	12A	12.0	0.120
T-2	Flange	24A	24.0	0.035
T-2	Flange	48C	48.0	0.042
T-3-1/4	Bayonet	48	2.0	0.060
T-3-1/4	Bayonet	47	6.3	0.150
T-3-1/4	Bayonet	1816	13.0	0.330
T-3-1/4	Bayonet	313	28.0	0.170
T-3-1/4	Bayonet	1822	36.0	0.100
T-3-1/4	Bayonet	1835	55.0	0.050
S-6	Bayonet	6S6/1DC	120	0.050
S-6	Screw	6S6/3	120	0.050

GAS FILLED GLOW LAMPS

Base Type	Commercial Number	Voltage (RMS)	External Resistance Required	Watts
Wire Leads	NE-2A	115	200,000	1/25
Wire Leads	NE-2H	230	560,000	1/4
Flange	NE-2D	115	25,000	1/4
Flange	NE-2J	230	90,000	1/25
Bayonet	NE-51	115	100,000	1/4
Bayonet	NE-51H	115	35,000	1/25
			200,000	1/25
			25,000	1/4

Further information may be found in Collins Component Standards.

STANDARD METAL GAUGES

Gauge No.	American or B & S ¹	U. S. Standard ²	Birmingham or Stubs ³
1	.2893 inch	.28125 inch	.300 inch
2	.2576	.265625	.284
3	.2294	.25	.259
4	.2043	.234375	.238
5	.1819	.21875	.220
6	.1620	.203125	.203
7	.1443	.1875	.180
8	.1285	.171875	.165
9	.1144	.15625	.148
10	.1019	.140625	.134
11	.09074	.125	.120
12	.08081	.109375	.109
13	.07196	.09375	.095
14	.06408	.078125	.083
15	.05707	.0703125	.072
16	.05082	.0625	.065
17	.04526	.05625	.058
18	.04030	.05	.049
19	.03589	.04375	.042
20	.03196	.0375	.035
21	.0284	.034375	.032
22	.02535	.03125	.028
23	.02257	.028125	.025
24	.02010	.025	.022
25	.01790	.021875	.020
26	.01594	.01875	.018
27	.01420	.0171875	.016
28	.01264	.015625	.014
29	.01126	.0140625	.013
30	.01003	.0125	.012
31	.008928	.0109375	.010
32	.007950	.01015625	.009
33	.007080	.009375	.008
34	.006350	.00859375	.007
35	.005615	.0078125	.005
36	.005000	.00703125	.004
37	.004453	.006640626	--
38	.003965	.00625	--
39	.003531	---	--
40	.003145	---	--

¹ Used for aluminum, copper, brass and nonferrous alloy sheets, wire and rods.

² Used for iron, steel, nickel and ferrous alloy sheets, wire and rods.

³ Used for seamless tubes; also, by some manufacturers for copper and brass.

OHM'S LAW AND ELECTRICAL POWER

1. I (amperes) = $\frac{E \text{ (volts)}}{R \text{ (ohms)}}$

2. $E = IR$

3. $R = \frac{E}{I}$

4. P (power) = $\frac{E^2}{R}$

5. $P = I^2R$

NUMBERED DRILL SIZES

Number	Diameter (mils)	Will Clear Screw	Use for Tapping Iron, Steel, or Brass*
1	228.0	-	-
2	221.0	12-24	-
3	213.0	-	14-24
4	209.0	12-20	-
5	205.0	-	-
6	204.0	-	-
7	201.0	-	-
8	199.0	-	-
9	196.0	-	-
10	193.5	10-32	-
11	191.0	10-24	-
12	189.0	-	-
13	185.0	-	-
14	182.0	-	-
15	180.0	-	-
16	177.0	-	12-24
17	173.0	-	-
18	169.5	8-32	-
19	166.0	-	12-20
20	161.0	-	-
21	159.0	-	10-32
22	157.0	-	-
23	154.0	-	-
24	152.0	-	-
25	149.5	-	10-24
26	147.0	-	-
27	144.0	-	-
28	140.0	6-32	-
29	136.0	-	8-32
30	128.5	-	-
31	120.0	-	-
32	116.0	-	-
33	113.0	4-36, 4-40	-
34	111.0	-	-
35	110.0	-	6-32
36	106.5	-	-

* Use one size larger for tapping Bakelite and hard rubber.

NUMBERED DRILL SIZES (Cont)

Number	Diameter (mils)	Will Clear Screw	Use for Tapping Iron, Steel, or Brass*
37	104.0	-	-
38	101.5	-	-
39	099.5	3-48	-
40	098.0	-	-
41	096.0	-	-
42	093.5	-	4-36, 4-40
43	089.0	2-56	-
44	086.0	-	-
45	082.0	-	3-48
46	081.0	-	-
47	078.5	-	-
48	076.0	-	-
49	073.0	-	2-56
50	070.0	-	-
51	067.0	-	-
52	063.5	-	-
53	059.5	-	-
54	055.0	-	-

* Use one size larger for tapping Bakelite and hard rubber.

DIELECTRIC CONSTANTS AND BREAKDOWN VOLTAGES

Material	Dielectric Constant	Puncture Voltage*
Air	1.0	19.8-22.8
Alsimag A196	5.7	240
Bakelite (paper-base)	3.8-5.5	650-750
Bakelite (mica-filled)	5-6	475-600
Celluloid	4-16	
Cellulose acetate	6-8	300-1000
Fiber	5-7.5	150-180
Formica	4.6-4.9	450
Glass (window)	7.6-8	200-250
Glass (photographic)	7.5	
Glass (pyrex)	4.2-4.9	335
Lucite	2.5-3	480-500
Mica	2.5-8	
Mica (clear India)	6.4-7.5	600-1500
Mycalex	7.4	250
Paper	2.0-2.6	1250
Polyethylene	2.3-2.4	1000
Polystyrene	2.4-2.9	500-2500
Porcelain	6.2-7.5	40-100
Rubber (hard)	2-3.5	450
Steatite (low-loss)	4.4	150-315
Wood (dry oak)	2.5-6.8	

* In volts per mil (0.001 inch).

COPPER-WIRE TABLE

Wire Size AWG (B & S)	Diam in Mills	Circular Mil Area	Turns per Linear Inch				Feet per Lb		Ohms per 1000 ft 25°C	Current Carrying Capacity at 700 Cir Mills per Amp	Diam in mm
			Enamel (Ena)	SSC	DSC or SCC	DCC	Bare	DCC			
1	289.3	83690	-	-	-	-	3.947	-	.1264	119.6 amps	7.348
2	257.6	66370	-	-	-	-	4.977	-	.1593	94.8	6.544
3	229.4	52640	-	-	-	-	6.276	-	.2009	75.2	5.827
4	204.3	41740	-	-	-	-	7.914	-	.2533	59.6	5.189
5	181.9	33100	-	-	-	-	9.980	-	.3195	47.3	4.621
6	162.0	26250	-	-	-	-	12.58	-	.4028	37.5	4.115
7	144.3	20820	-	-	-	-	15.87	-	.5080	29.7	3.665
8	128.5	16510	7.6	-	7.4	7.1	20.01	19.6	.6405	23.6	3.264
9	114.4	13090	8.6	-	8.2	7.8	25.23	24.6	.8077	18.7	2.906
10	101.9	10380	9.6	-	9.3	8.9	31.82	30.9	1.018	14.8	2.588
11	90.74	8234	10.7	-	10.3	9.8	40.12	38.8	1.284	11.8	2.305
12	80.81	6530	12.0	-	11.5	10.9	50.59	48.9	1.619	9.33	2.053
13	71.96	5178	13.5	-	12.8	12.0	63.80	61.5	2.042	7.40	1.828
14	64.08	4107	15.0	-	14.2	13.8	80.44	77.3	2.575	5.87	1.628
15	57.07	3257	16.8	-	15.8	14.7	101.4	97.3	3.247	4.65	1.450
16	50.82	2583	18.9	18.9	17.9	16.4	127.9	119	4.094	3.69	1.291
17	45.26	2048	21.2	21.2	19.9	18.1	161.3	150	5.163	2.93	1.150
18	40.30	1624	23.6	23.6	22.0	19.8	203.4	188	6.510	2.32	1.024
19	35.89	1288	26.4	26.4	24.4	21.8	256.5	237	8.210	1.84	.9116
20	31.96	1022	29.4	29.4	27.0	23.8	323.4	298	10.35	1.46	.8118
21	28.46	810.1	33.1	32.7	29.8	26.0	407.8	370	13.05	1.16	.7230
22	25.35	642.4	37.0	36.5	34.1	30.0	514.2	461	16.46	.918	.6438
23	22.57	509.5	41.3	40.6	37.6	31.6	648.4	584	20.76	.728	.5733
24	20.10	404.0	46.3	45.3	41.5	35.6	817.7	745	26.17	.577	.5106
25	17.90	320.4	51.7	50.4	45.6	38.6	1031	903	33.00	.458	.4547
26	15.94	254.1	58.0	55.6	50.2	41.8	1300	1118	41.62	.363	.4049
27	14.20	201.5	64.9	61.5	55.0	45.0	1639	1422	52.48	.288	.3606
28	12.64	159.8	72.7	68.6	60.2	48.5	2067	1759	66.17	.228	.3211
29	11.26	126.7	81.6	74.8	65.4	51.8	2607	2207	83.44	.181	.2859
30	10.03	100.5	90.5	83.3	71.5	55.5	3287	2534	105.2	.144	.2546
31	8.928	79.70	101	92.0	77.5	59.2	4145	2768	132.7	.114	.2268
32	7.950	63.21	113	101	83.6	62.6	5227	3137	167.3	.090	.2019
33	7.080	50.13	127	110	90.3	66.3	6591	4697	211.0	.072	.1798
34	6.305	39.75	143	120	97.0	70.0	8310	6168	266.0	.057	.1601
35	5.615	31.52	158	132	104	73.5	10480	6737	335.0	.045	.1426
36	5.000	25.00	175	143	111	77.0	13210	7877	423.0	.036	.1270
37	4.453	19.83	198	154	118	80.3	16660	9309	533.4	.028	.1131
38	3.965	15.72	224	166	126	83.6	21010	10666	672.6	.022	.1007
39	3.531	12.47	248	181	133	86.6	26500	11907	848.1	.018	.0897
40	3.145	9.88	282	194	140	89.7	33410	14222	1069	.014	.0799

WEIGHTS AND MEASURES

Liquid Measure

1 (U.S.) gallon = 0.1337 cu ft = 231 cu in. = 4 qt = 8 pints
 1 quart = 2 pints = 8 gills
 1 British gallon = 1.2009 U.S. gallon

Avoirdupois Weight

1 pound = 16 ounces = 7000 grains
 1 ounce = 16 drams = 437.5 grains

Troy Weight

1 pound = 12 ounces = 5760 grains
 1 ounce = 20 pennyweights = 480 grains
 1 pennyweight = 24 grains
 1 carat = 3.086 grains
 1 grain Troy = 1 grain Avoir = 1 grain Apothecaries

Apothecaries' Weight

1 pound = 12 ounces = 5760 grains
 1 ounce = 8 drams = 480 grains
 1 drams = 3 scruples = 60 grains
 1 scruple = 20 grains

RELATIVE RESISTIVITY OF METALS

Material	Resistivity Compared to Copper
Aluminum (pure)	1.70
Brass	3.57
Cadmium	5.26
Chromium	1.82
Copper (hard-drawn)	1.12
Copper (annealed)	1.00
Iron (pure)	5.65
Lead	14.3
Nickel	6.25 to 8.33
Phosphor Bronze	2.78
Silver	0.94
Tin	7.70
Zinc	3.54

DECIMAL EQUIVALENTS OF FRACTIONS

.015625	1/64	.515625	33/64
.03125	1/32	.53125	17/32
.046875	3/64	.546875	35/64
.0625	1/16	.5625	9/16
.078125	5/64	.578125	37/64
.09375	3/32	.59375	19/32
.109375	7/64	.609375	39/64
.125	1/8	.625	5/8
.140625	9/64	.640625	41/64
.15625	5/32	.65625	21/32
.171875	11/64	.671875	43/64
.1875	3/16	.6875	11/16
.203125	13/64	.703125	45/64
.21875	7/32	.71875	23/32
.234375	15/64	.734375	47/64
.25	1/4	.75	3/4
.265625	17/64	.765625	49/64
.28125	9/32	.78125	25/32
.296875	19/64	.796875	51/64
.3125	5/16	.8125	13/16
.328125	21/64	.828125	53/64
.34375	11/32	.84375	27/32
.359375	23/64	.859375	55/64
.375	3/8	.875	7/8
.390625	25/64	.890625	57/64
.40625	13/32	.90625	29/32
.421875	27/64	.921875	59/64
.4375	7/16	.9375	15/16
.453125	29/64	.953125	61/64
.46875	15/32	.96875	31/32
.484375	31/64	.984375	63/64
.5	1/2	1.	1

FRACTIONS OF AN INCH TO MILLIMETERS

	<u>mm</u>		<u>mm</u>		<u>mm</u>
1/64	.397	3/16	4.763	23/64	9.128
1/32	.794	13/64	5.159	3/8	9.525
3/64	1.191	7/32	5.556	25/64	9.922
1/16	1.588	15/64	5.953	13/32	10.319
5/64	1.984	1/4	6.350	27/64	10.716
3/32	2.381	17/64	6.747	7/16	11.113
7/64	2.778	9/32	7.144	29/64	11.509
1/8	3.175	19/64	7.541	15/32	11.906
9/64	3.572	5/16	7.938	31/64	12.303
5/32	3.969	21/64	8.334	1/2	12.700
11/64	4.366	11/32	8.731		

