

ICD 08559

FEBRUARY 1991 \$2.95

CANADA \$3.95

# MODERN ELECTRONICS

TM

THE MAGAZINE FOR ELECTRONICS & COMPUTER ENTHUSIASTS

■ How PCs Lay Out Printed-Circuit Boards

■ Build A Dual-Channel Function Generator

Also:

- An LCD Digital Compass
- A Super-Sensitive Tilt Switch For Automotive Alarms
- Exploring Electromagnetic Fields

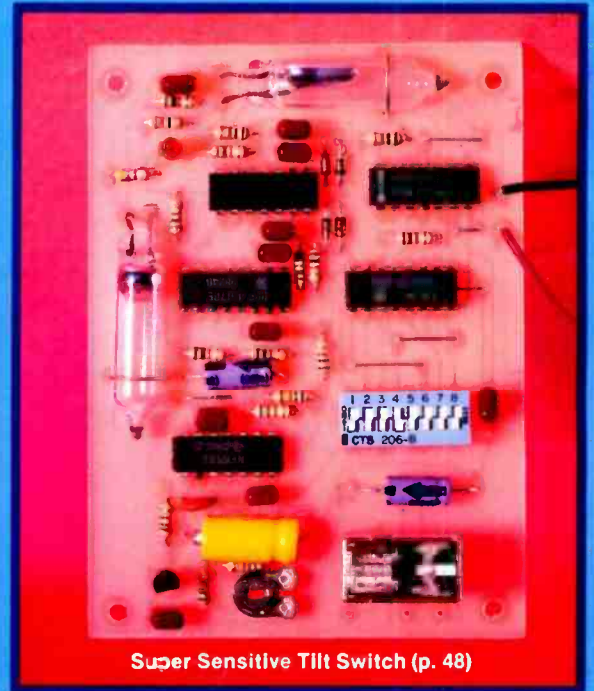

Super Sensitive Tilt Switch (p. 48)

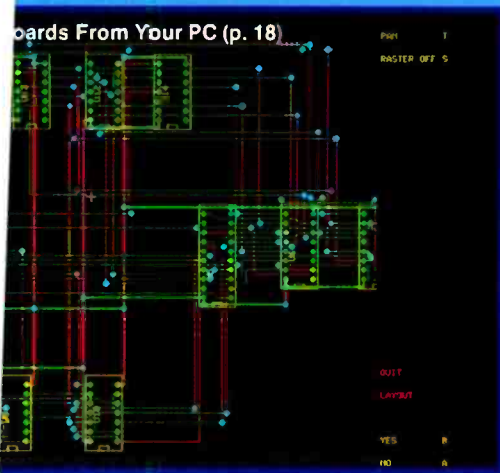

Boards From Your PC (p. 18)

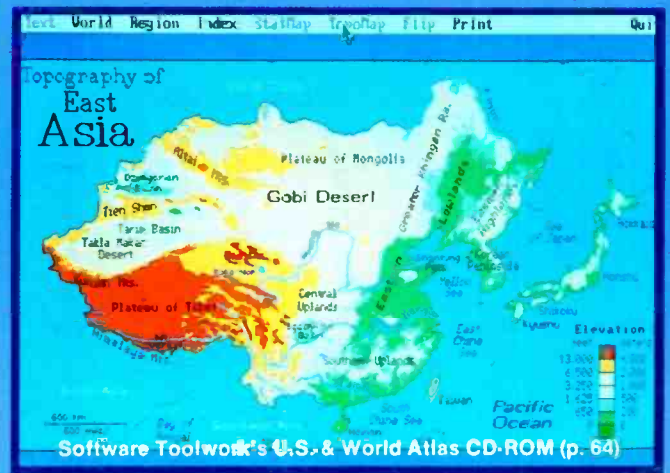

Software Toolworks's U.S. & World Atlas CD-ROM (p. 64)

Plus: Shortwave Radio's WWV and WWVH • Evaluating The \$195 Fax96 Board for PCs, NEC's CDR-35 ROM Drive, Microsoft's Bookshelf and Two From Software Toolworks • A Fast Math Coprocessor for 80386 Computers • Latest Technical Books & Literature . . . more.

3-DIGIT 137  
 03 00677405 9110 9102 AFI  
 NY 13760  
 J ZVOLD  
 324 STEIN DRIVE  
 ENDCOTT  
 FOLEY  
 VA 22172  
 to 79  
 Bulk Rate  
 U.S. Postage



LOWEST PRICES

# Electrified

QUICK DELIVERY

WE WILL TRY TO BEAT ANY PRICE ON ANYTHING FROM ANYWHERE !!!  
A TRULY PROFESSIONAL STAFF WITH A COMMITMENT TO SERVICE !!!

## PRINTER POWER

### GENICOM-5010 LASER

**10 Pages Per Minute — 300 DPI**

HP COMPATIBLE • 1.735 MB of Memory  
• Six Resident Fonts • Parallel/Serial • Includes: Toner  
1 Year Warranty From Genicom

**BRAND NEW**

List \$3695

AMAZING!!!!  
Quantity Discounts Available

**\$799**

### IBM 5182 COLOR PRINTER

Heavy Duty • Wide Carriage (132 Column)

• 200 CPS Draft • 110CPS Correspondence • 35 CPS NLQ  
• Prints Black, 4 Colors, and 8 Colors • BiDirectional Dot Matrix  
• 9 Wire-Parallel Interface • Tractor Included

**BRAND NEW**

FRONT - BOTTOM - REAR PAPER FEED  
Paper Rack Available  
Stacks Printed Paper - Only \$12.95  
Easy Change Cartridge Ribbons - Available

List \$1,995

**\$399**

### BRAND NEW CITIZEN MSP - 50 Color Optional!

300 CPS 50 NLQ - Narrow Carriage • 9-Wire • Epson/IBM  
Compatible • Push or Pull Tractor • Zero Tear Off • Top or Bottom  
Feed • Automatic Paper Loading • 8K Buffer • Parallel Interface  
18 Month Manufacturers Warranty

**MSP-50 Options**

Color Kit (7 Colors) \$59  
Serial Interface \$49  
Font Card Sans Serif/Orator \$59

Black or Color  
Ribbons Available  
- CALL

Quantity Price:  
**\$269**

## PRINTER POWER

HP Laser Jet II	New \$1249	8 PPM, w/Toner
DIABLO-D80IF	\$ 499	80 CPS-Ltr, Qty-w/Sheet Feeder-Refurbished
CENTRONICS-136B	New \$ 299	180 CPS - 34 NLQ - Wide - Heavy Duty
IBM 5182-Demos	\$ 299	200 CPS - Wide Carriage - Color Printer
BROTHER M-1509	New \$ 279	180 CPS - 45 NLQ - Wide Carriage
TOSHIBA 301(Below Cost)	New \$ 229	Laptop Printer - 24 Pin - 180 CPS
SEIKOSHA SL-80AI	New \$ 229	24 Pin - Narrow - 135 CPS - 54 NLQ
RITEMAN by C.I.TOH	New \$ 119	120 CPS - 60 CPS Exp. - Narrow Carriage

LIMITED QUANTITIES!!!

### AT&T FULL-PAGE SCANNER

List \$1190



#### MODEL SC-60 Sheet Feed Series

Includes - IBM Compatible Interface Card  
Includes - AT&T PAGE POWER SOFTWARE  
(Draw, Scan and Fax Package)  
Includes - Microsoft Runtime Windows • Resolution  
200 DPI Full-Page/400 DPI Half-Page  
Half-Tone feature for Photographs

SAVE OVER 75%

**BRAND NEW**

Microsoft Windows 3.0 Upgrade  
**FREE**

1 Year Warranty From AT&T

AMAZING ONLY **\$269**

Quantity Discounts Available

## MONITOR MANIA

### PRINCETON GRAPHICS

#### Ultra Sync 14 Color Monitor

14" Multisync - Ultra Hi-Res .28 Dot Pitch

800x600

Monitor Cards

on Special

Refurbished Mint Condition

Full 90 Day Warranty from Princeton.

List \$899

**\$399**

### IBM — VGA COLOR

13" Viewing Area - 640x480 - .31 Dot Pitch

IBM Model #7544/S01

High Performance Graphics  
90 Day Warranty

List \$1,605

**BRAND NEW**

UNBELIEVABLE VALUE

**\$399**

### AMSTRAD COLOR VGA

ULTRA-Res-12" VGA-PC-Model 12-IR

Tilt & Swivel-720x480-Anti-Glare Screen

1 YEAR WARRANTY

**.28**

DOT PITCH

**BRAND NEW**

STB-VGA Extra Card ONLY \$149

**\$299**

### AMDEK 600T — COLOR

14" -RGB - Color - 600x200

List \$550

Green/Amber Switch, Tilt & Swivel

**BRAND NEW**

ONLY **\$199**

### SPERRY - RGB COLOR

14" - Color Monitor w/Color Card

16-Colors - 640x200

90 Day Warranty - Model 3584

**BRAND NEW**

Quantity

3- \$165  
6- \$159  
12- \$155

24- \$149  
Over 24- CALL  
ONLY **\$169**

### Hi-Res AT&T CRT-327-12" TTL

800x480  
Tilt & Swivel  
90 Day Warranty

Black & White Monitor

INCLUDES AT&T 1024HP Card

**BRAND NEW**

List \$1390

Works on All IBM AT/XT's & Compatibles

6-\$115, 12-\$109, 24-\$105, Over 24-CALL ONLY **\$119**

### NCR - 15" - Green - TTL BRAND NEW

with NCR - Monitor Card 640x400

1 YEAR Lis.

Save over 75% Warranty \$438 **\$99**

## ★ ★ Electrified Discounters ★ ★

HOURS: Mon-Thurs 9AM - 7PM  
Fri-Sat 10AM - 6PM

ORDERS ONLY

(800) 678-8585

30-DAY MONEY BACK GUARANTEE!

Full Refund of HARDWARE  
Price on all Advertised Products

Catalog Sent with All Orders

Dealer Inquiries Invited

All Prices listed are Cash Discounts and 2-12% to MasterCard, Visa, or AMEX and responsible for typographical errors. Prices are subject to change without notice. Certain residents are 8% sales tax. NY Sales Tax: NY Tax. Quantities are limited. Prices do not include freight. Allow 3 weeks for personal property check over the 30% refunding fee minimum on all returns. Compatible is no guarantee. Some system options may be refurbished. IBM is a registered trademark of International Business Machines, Inc.

1066 Sherman Avenue  
Hamden, CT 06514  
FAX 203-248-8680

FAX ORDERS AND BIDS ACCEPTED!

Customer Service & Technical Support  
(203) 287-1976



# Electrified

WE WILL TRY TO BEAT ANY PRICE ON ANYTHING FROM ANYWHERE !!!  
A TRULY PROFESSIONAL STAFF WITH A COMMITMENT TO SERVICE !!!

## COMPUTER

**AMAZING ONLY \$1699 GOLDSTAR**  
— 386/20 MHz  
40 MB System & Goldstar  
VGA - Color Monitor

**FREE ALPHAWORKS SOFTWARE**

Wordprocessor, Spreadsheet, Data Base Manager, Spellchecker and Thesaurus, Communication Software and Tutorials.

**GOLDSTAR TOLL FREE CUSTOMER SUPPORT LINE**  
Goldstar XT/Turbo and 286/16 MGHZ Systems are Available - CALL



### System Includes

80386-20 MHz Computer  
1MB-High Speed DRAM-expands to 10 MB (Memory Upgrades Avail.)  
40 MB Seagate Hard Drive - 28 MS (Larger Drives Available)  
1.2 MB Floppy Drive  
VGA Monitor Card - 16 Bit

14" VGA Color Monitor- Model 1425 Plus with Tilt & Swivel; Upgrades Available  
101 Style Keyboard  
DOS 3.3 with Basic  
8 - Slots (1-32 Bit, 5-16 Bit 2-8 Bit)  
Parallel/Serial/Clock Calendar  
200 Watt Power Supply - EDC87 Socket  
Novell Certified

### WARRANTY

1-Year Parts & Warranty

## COUNTRY

**FREE 120 Day On-Site Service**

Additional On-Site Service Available

### SUPER SOFTWARE SET

For IBM or IBM Compatibles - 3 Outstanding Packages at One Amazing Price

#### DAC - EASY ACCOUNTING

Includes: G/L, A/R, A/P, Purchase Order, Billing, Inventory & Forecasting

#### PRACTIWORD - WORD PROCESSOR

Easy to use Word Processor - with Multi-Level Help System

#### PRACTIBASE - DATA BASE MANAGER

A Powerful Relational Database Manager

List Price \$269.95

**\$39.95**

## 386SX - 16MHz

512K Installed - Baby AT Case - 200 Watt Power Supply - AMI BIOS - ZERO WATT STATE - 80387SX - Socket - Up to 4MB on the Motherboard - 101 Deluxe Keyboard - 8-Slots - Reset and Turbo Buttons - Keylock 3 (1/2HT, 5 1/4") and 2 (1/2HT, 3 1/2") Drive Bays - Clock/Calendar  
**1-Year Warranty**

**\$599**

386/25 and 386/33 MHz Systems Available Now - CALL!

### SUPER SYSTEM

**NOW 10MHz**

**8088-1-TURBO**

### COMPUTER SYSTEM

1-Drive IBM Compatible System with 256K Memory!!

\* 1-Half Height, 360K, 5 1/4" Drive INSTALLED  
\* Dual Speed - 4.77 MHz and 10 MHz - TURBO  
\* 256K Installed - 8 Slots - 8087 Socket - 150 Watt Power Supply - Deluxe Keyboard - Full Size Case for 4 1/2 HT Drives - 1 Year Parts & Labor Warranty or Base Unit Produced by Trinty

**NOW 10MHz IMPOSSIBLE PRICING!!**  
Quantity Pricing Available

**\$249**

### AWESOME

**80286-TURBO 10/16 MHz**

**Fully IBM Compatible Zero Wait State!!**

512K Installed - Full Size Case - 200 Watt Power Supply Award BIOS - 101 Keyboard - Up to 4MB on Motherboard  
\* 8 V/O Slots - 80287 Socket - Reset and Turbo Button  
\* Keylock and 3 LEDs - Clock/Calendar  
**1 YEAR WARRANTY**  
Produced by Trinity

**NOW 16MHz**

**\$349**

**NOW 16MHz**

### SYSTEM OPTIONS

#### SUPER SYSTEM OPTIONS

Add a 2nd 360K 5 1/4" Drive	\$ 79	Clock Calendar Card	\$29
Add a 10MB Drive - Incl. Controller	\$149	Par/Ser/Ck/Calendar Card	\$49
Add a 20MB Drive - Incl. Controller	\$199	Memory Upgrade to 512K	\$49
Add a 30MB Drive - Incl. Controller	\$249	Memory Upgrade to 640K	\$99
Add a 40MB Drive - Incl. Controller	\$299		
(Special)	\$239		

#### 386SX/286 SYSTEM OPTIONS

512K Upgrade for 386SX/286 (1 Full Meg)	\$ 99	30MB - Hard Drive	\$199
MEMORY Upgrades Avail. for 386SX/286	CALL	40MB - Hard Drive (Special)	\$199
Controller - Dual HD FD	\$ 79	60MB - Hard Drive	\$299
1.2MB - 5 1/4" Drive	\$ 79	80MB - Hard Drive	\$499
360K - 5 1/4" Drive	\$ 79	IRWIN 20MB - Tape Back Up System	
720K - 3 1/2" Drive	\$ 79	for AT Model 125 - Below Cost!!!	\$199
1.44MB - 3 1/2" Drive - requires DOS 3.3	\$119	LAGER HARD DRIVES AVAILABLE	CALL
20MB - Hard Drive	\$169	AT Parallel/Ser/Calendar Card	\$ 29

#### 386SX or 286 or SUPER SYSTEM OPTIONS

DOS 3.1, 3.2, 3.3, 4.01	\$39.99/69.99	NCR 15" GREEN with NCR Card	\$99
Parallel or Serial Card	\$19	AT&T 12" Black & White TTL and AT&T Card	\$99
VGA Monitor and VGA Card	\$319	12" Monochrome Hi Res - TTL	\$49
14" RGB Color Monitor w/Color Card	\$149	12" Monochrome Graphics Card with Printer Port	\$69
Color Graphics w/Printer Port	\$39	DRIVE WARRANTIES VARY - -	
		CALL FOR DETAILS	

### HARD DRIVE DEALS

MINISCRIBE-3085-85MB-MFM-5 1/4"-1/2HT	\$499
MINISCRIBE 3675-62MB-RLL-5 1/4"-NEW	\$299
MINISCRIBE 8450-40MB-RLL-3 1/2"-NEW	\$199
SEAGATE-ST-138R-32MB-RLL-3 1/2"	\$199
<b>SEAGATE ST-4051-40MB-MFM-Full HT</b>	<b>\$189</b>
MINISCRIBE-8438F-30MB-RLL-5 1/2"-NEW	\$179
SEAGATE-ST-238-30MB-RLL-5 1/4"-1/2HT	\$179
TANDON-TM-262-20MB-MFM-3 1/2"	\$149
WESTERN DIGITAL-MFM-XT Ccntl. w/Cables	\$ 49
RLL Controllers for XT and AT's Available	CALL

MINISCRIBE Warranty-6 Months-NEW DRIVES  
Seagate & Tandon Warranty-90 Days-OEM Plus  
QUANTITY PRICING AVAILABLE  
CALL FOR DETAILS!

### SPEED-UP BOARD

#### DAC-EASY - BREAKTHRU 286

Make Your 8088 Computer A 80286 Computer!!

### 12 MHz SPEED-UP BOARD

List \$595 For Your 8088-Computer **SAVE 75%**

**BRAND NEW (IBM PC/XT or Compatible) BRAND NEW**

**1000% FASTER THAN A REGULAR PC**

Replace Your Old CPU with an Intel 80286 Microprocessor  
Includes a 80287 Math Co-Processor Slot with 16K Cache Memory and Zero-Wait-Access  
Easily Installed in 5 Minutes

Software Compatibility is Virtually UNLIMITED. Full Mfr. Warranty and Technical Support!

**AMAZING ONLY**

**\$149**

Substantial Quantity Discounts Available!

**FREE DAC-EASY LIGHTNING**  
A Disk Caching Program  
LIST \$69.95

### COMPUTER PRODUCTS

#### Computers

- Acer - Altos - Apple - Citizen - Compaq
- Goldstar - Leading Edge - Quadrant - Mitsuboshi
- NEC - Packard Bell - Panasonic - Samsung
- Sharp - Toshiba - Trinty - Unisys - WYSE

#### Monitors

- Amdek - Apple - AT&T - Goldstar - Hitachi
- IBM - Magnavox - Mitsubishi - NCR - NEC
- Pacard Bell - Panasonic - Princeton Graphics
- Samsung - Seiko - Sony - Tatung - Zenith

#### Printers

- ALPS - Apple - Brother - Canon - Citizen - C-ITOH
- Diablo - Diconix (Kodak) - Epson - Fujitsu - Genicom
- Hewlett Packard - IBM - Mannesmann Tally
- NEC - Okidata - Panasonic - Printronics
- Seikoshia - Televideo - Texas Instruments - Toshiba

**Call for Pricing!!!**

★ **Electrified Discounters** ★  
HOURS: Mon-Thurs 9AM - 7PM  
Fri-Sat 10AM - 6PM  
1066 Sherman Avenue  
Hamden, CT 06514  
FAX 203-248-8680  
FAX ORDERS AND BIDS ACCEPTED

ORDERS ONLY

**(800) 678-8585**

Customer Service & Technical Support  
**(203) 287-1976**

**30-DAY MONEY BACK GUARANTEE!**  
Full Refund of HARDWARE  
Price on All Advertised Products  
Catalog Sent with All Orders

Dealer Inquiries Invited

All Prices listed are Cash Discounts. Add 2 1/2% for MasterCard, Visa or AMEX. Not responsible for typographical errors. Prices are subject to change without notice. Company's add 5% sales tax. RT Sales Add RT Tax. Quantities are limited. Prices do not include freight. Allow 3 weeks for personal computers. Check clearance 20% refunding the minimum on all returns. Compatibility is not guaranteed. Some system options may be restricted. IBM is a registered trademark of International Business Machines, Inc.



## FEATURES



24

### 18 Printed-Circuit Boards From Your PC

Let your personal computer lay out your next pc board! *By T.J. Byers*

### 24 What's On WWV

What you can hear on WWV and WWVH and a couple of circuits that can make reception more exciting. *By E. Thomas Hitt III*

### 32 The Modern Electronics Computer Experimenter Lab (Part 2)

Build a Dual-Channel Function Generator *By Martin Meyer*

### 40 An LCD Digital Compass

Uses a microcontroller and other computer circuitry to display headings on an LCD panel. *By Steve Sokolowski*

### 48 Super-Sensitive Tilt Switch For Automotive Alarms

Uses mercury switches to protect against false alarms generated by ordinary vibrations. *By Walter W. Schopp*

### 54 Fax96: Low-Cost Fax For Your PC

*By Joseph Desposito*

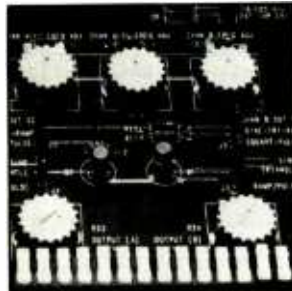

32

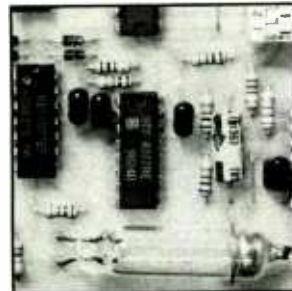

48

## COLUMNS

### 58 Electronics Notebook

Exploring for Electromagnetic Fields With a Telephone Induction Coil. *By Forrest M. Mims III*

### 64 PC Capers

More on CD ROMs; NEC-CDR-35 ROM Drive; The Microsoft Bookshelf; The PC-SIG Library; and Two From Software Toolworks. *By Ted Needleman*

### 69 Solid-State Devices

A Fast Math Coprocessor for 80386 Computers, Low-Power GFI and High-Speed GaAs SRAM. *By Joseph Desposito*

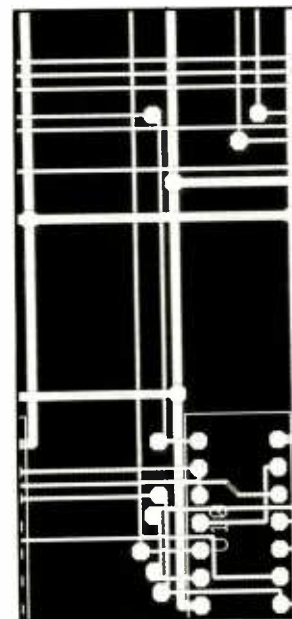

18

## DEPARTMENTS

- 6 Editorial *By Art Salsberg*
- 10 Letters
- 11 Modern Electronics News
- 12 New Products
- 72 Books & Literature
- 82 Advertisers Index

## EDITORIAL STAFF

**Art Salsberg**  
Editor-in-Chief

**Alexander W. Burawa**  
Managing Editor

**Dorothy Kehrwieler**  
Production Manager

**Emily Kreutz**  
Production

**Elizabeth Ryan**  
Art Director

**Barbara Terzo**  
Artist

**Pat Le Blanc**  
**Florence V. Martin**  
**Linda Romanello**  
Phototypographers

**Hal Keith**  
Illustrator

**Bruce Morgan**  
Photographer

**Joe Desposito, Forrest Mims III,**  
**Ted Needleman**  
Contributing Editors

## BUSINESS STAFF

**Richard A. Ross**  
Publisher

**Art Salsberg**  
Associate Publisher

**Dorothy Kehrwieler**  
General Manager

**Frank V. Fuzia**  
Controller

**Catherine Ross**  
Circulation Director

**Melissa Kehrwieler**  
Data Processing

**Carol Minervini**  
Data Processing

**Karen Nauth**  
Customer Service

## ADVERTISING SALES

### ELECTRONIC ADVERTISING

**Jonathan Kummer**  
(516) 681-2922  
FAX: (516) 681-2926

### COMPUTER ADVERTISING

**Ken L. Wood**  
(407) 264-0545  
FAX: (407) 264-0473

Offices: 76 North Broadway, Hicksville, NY 11801. Telephone: (516) 681-2922. FAX (516) 681-2926. Modern Electronics (ISSN 0748-9889) is published monthly by CQ Communications, Inc. Subscription prices (payable in US Dollars only): Domestic—one year \$18.97, two years \$36.00, three years \$53.00; Canada/Mexico—one year \$21.00, two years \$40.00, three years \$59.00; Foreign—one year \$23.00, two years \$44.00, three years \$65.00. Foreign Air Mail—one year \$76.00, two years \$150.00, three years \$224.00.

U.S. Government Agencies: Subscriptions to Modern Electronics are available to agencies of the United States government, including military services, only on a cash with order basis. Requests for quotations, bids, contracts, etc. will be refused and will not be returned or processed.

Entire contents copyright 1991 by CQ Communications, Inc. Modern Electronics or CQ Communications Inc. assumes no responsibility for unsolicited manuscripts. Allow six weeks for delivery of first issue and for change of address. Printed in the United States of America.

Postmaster: Please send change of address notice to Modern Electronics, 76 North Broadway, Hicksville, NY 11801.

CQ Communications, Inc. is publisher of CQ The Radio Amateurs Journal, Popular Communications, Modern Electronics, CQ Radio Amateur (Spanish CQ), and the CQ Amateur Radio Buyer's Guides.

# Genius Tablet GT-1212B

**\$249.50**  
+ \$10.00 Shipping

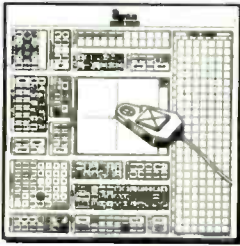

**INCLUDES:**

- Genius Tablet (12" x 12")
- AutoCad Template and Menu File
- Genius Menu Maker and Menu Library
- Dr. Halo III Software
- Up to 1000 lines per inch resolution
- Plugs into standard serial port

TABLET with Stylus ..... \$279.50

# OVER 2 Million Sold GM-6000 Genius Dynamic Mouse

List Price \$119.00

**\$29.50**  
+ \$6.00 Shipping

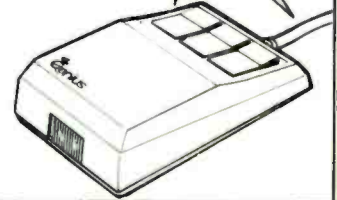

**Includes:**

- GM 6000 Mouse (Serial Mouse)
- 350-1050 DPI
- 2 or 3 Button Mouse Mode
- Dr. Genius Software
- Genius Menu Library
- User Manuals
- Genius Mouse Pocket
- Genius Mouse Pad
- 9 to 25 Pin Adapter

- GM6X - MOUSE 50-800 DPI, w/9 pin Serial & Dr. Halo .. \$ 19.50
- GMF303 - MOUSE 350-1050 DPI (top of the line) ..... 49.50
- GS4500 - HAND SCANNER 100-400 DPI ..... 129.50
- GS4500 - with Prodigy OCR Software ..... 149.50
- GSC105 - Color Hand Scanner ..... 449.50

## THE LOGITECH™ SERIES 9 MOUSE AND MICROSOFT® WINDOWS™ 3.0



Bundled ..... **\$149.50**  
+ 6.00 Shipping

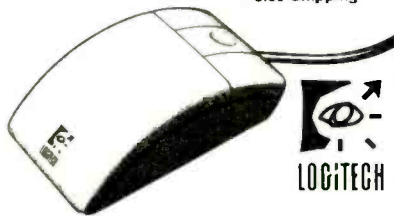

- SERIES 9 SERIAL MOUSE ..... \$69.50
- SERIES 9 SERIAL PS-2 MOUSE ..... \$74.50
- SERIES 9 BUS MOUSE ..... \$79.50

## SCANMAN™ HAND-HELD SCANNER FROM LOGITECH

- Edit scanned images with advanced graphic tools in PaintShow™ Plus, included with ScanMan Plus.
- Scan directly to the MS Windows clipboard, TIFF or PCX files with ScanMate.™



**\$164.50**  
+ \$6.00 Shipping

- Catchword OCR ..... \$128.50
- PS-2 Version Scanman ..... 219.50
- 256 Grey Level Scanman ..... 339.50
- MAC Version Scanman ..... 339.50

## OPTune

A utility that will speed up your hard disk and improve its reliability.

GET  
YOUR  
HARD DISK  
UP TO  
SPEED.

- combines the scattered file segments on your disk into complete, sequential files, thereby increasing disk speed and efficiency. This will allow your hard disk to respond at maximum speed.
- up to four times faster than before.
- your hard disk will not only respond quicker, it will also last longer.
- easy to use.

**\$49.50**  
+ \$6.00 Shipping

## TRACKMAN™

High Resolution Stationary Mouse

TrackMan is a revolutionary new input device that combines the advantages of both a mouse and a trackball.



**\$84.50**  
+ \$6.00 Shipping



- BUS Trackman ..... \$94.50

## Champ

JS-606... \$19.50

- Dual port game card ..... \$19.50  
+ \$6.00 Shipping



- Ergonomical design for quick, comfortable action
- High speed autofire on both base and handle grip buttons
- X & Y axis trim adjusters
- Switchable buttons
- Auto-centering
- 360 degree rotation for greater accuracy
- 4 stabilizing suction cups

## LANDMARK UTILITIES V2.0

Benchmark test software for PC XT, AT, 386 & 486

Determine the effective speeds of:

- CPU
- MATH CO-PROCESSOR
- VIDEO DISPLAY CIRCUITRY

Speed test is easy to use. It incorporates pull-down menus, keyboard or mouse access, and a complete on screen manual for the ultimate in ease of use.

List Price \$69.00  
**\$24.50**  
+ \$6.00 Shipping

ORDER LINE **800-344-2370**

**Technical Challenge**  
INCORPORATED

601 Oakwood Square, East Aurora, New York 14052  
716/655-0400

ESTABLISHED 1985

9 AM - 6 PM (EST)  
Mon - Fri

- Prices subject to change
- COD add \$4.00
- Pricing reflects a 2% discount for cash
- 15% for resocking
- Allow 10 business days for checks to clear
- NY add 8% sales tax
- APO/Canada/Mexico/Puerto Rico additional \$5.00 shipping
- Compatibility can not be guaranteed

## CAT Reader OCR

A Trainable, Accurate OCR Software for Hand Held Scanners

- Fully Trainable to read any font
- Monospaced, proportional, or kerned text
- Convert any scanned text to ASCII format
- Automatic Text Merging

List Price \$295  
**\$69.50**

CAT Image Enhancer ..... \$69.50  
+ 6.00 shipping

**FREE SHIPPING IN NEW YORK STATE!**

**MOST ORDERS BEFORE 2 PM (EST) WILL SHIP SAME DAY**

CIRCLE NO. 148 ON FREE INFORMATION CARD





340 E. FIRST ST.  
DAYTON, OHIO 45402

### IDLER TIRE KIT

This popular kit contains 170 of the most popular idler tires (10 each of 17 different sizes). You can save time and money by having the right tire in stock. Also included is a comprehensive cross reference listing over 80 manufacturers' assembly numbers and over 200 model numbers. (All tires are available individually for reorder.)



#MC-400-900 **\$49<sup>95</sup>**

### VCR REPAIR PARTS KIT

With this convenient kit you can do most of your VCR repair jobs the same day. Commonly used parts for RCA, Hitachi, Fisher, Sanyo, Lloyds, Panasonic, Sony, Sharp, JVC, and more. Over 45 parts in all. (All parts are available individually for reorder.)



#MC-400-950 **\$89<sup>95</sup>**

### VCR SPRING ASSMT

A wide assortment of springs used in many name brand VCRs. Clutch springs, idler springs, tension springs, etc. 11 tension springs and 5 pressure springs.



#MC-430-300 **\$1<sup>50</sup>**

### VCR WASHER ASSMT

A wide assortment of plastic washers used in VCR clutch assemblies and idlers. 150 pieces, split ring and regular.



#MC-430-305 **\$5<sup>90</sup>**

CALL  
TOLL FREE  
FREE CATALOG



**1-800-338-0531**

CIRCLE NO. 165 ON FREE INFORMATION CARD

# EDITORIAL

## At Risk

We continue to hear that our once dominant semiconductor and electronic equipment industry is at risk. There are a lot of factors given for its deterioration.

Among them is the reluctance of investors to patiently wait long enough for profits. Coupled with this, company managers seem to operate on the basis of what the next quarterly year's financial statement will look like instead of having a strategic long-term view. Another reason often given is the fuller protection of the industry offered by home governments in foreign countries. Then there is minimal cooperative research and development efforts, as practiced by foreign companies. Furthermore, our capital equipment spending to make manufacturing more efficient is said to be inadequate. Our quality control commitment is suspect, too.

Finally, our pool of new engineers is reportedly too small, and labor costs too high compared to Asian-country competitors. While it's true that income in Japan is fast catching up to that in the U.S.—the U.S. GDP per capita in 1989 was \$14,200, while in Japan it was \$12,400 (Germany's was \$15,700)—the Four Tigers (Taiwan, Hong Kong, Singapore and South Korea), with much lower income and a high-tech ability provide stiff competition to all. Their expansion rate in the electronics/computer industry is expected to climb to 19.8% in two years.

Whew! The foregoing indicates that it will not be an easy task to even hold the line against erosion of our market share. Nevertheless, things aren't quite as bad as the picture looks and shows signs of improving.

For example, we are still fairly productive compared to our competitors, with the U.S., Japan and Germany on essentially the same level of

dollar value produced per worker. This, however, can decline if proper steps are not quickly taken to improve efficiency in the semiconductor materials and equipment industry. Our plant and equipment spending greatly lags Japan's, for example, with 12.5% of our gross domestic product spent here, whereas Japan spends 23.6% of its GDP (1989 figure). Strategic alliances among U.S. companies are growing, too, although still comparatively small.

But looking into the future in just one area—education—we've got quite a challenge. Although we spend a hefty 4.5% of our GDP on education, contrasted with 3.5% for Japan, 95% of Japanese students do better on science and math examinations than the top 5% of U.S. students (1987)! Since the \$260-billion electronics industry is our country's largest manufacturing business, where science and math knowledge is especially important, this is scary.

I read recently that a major U.S. manufacturer documented that among 3,000 applicants for jobs in a cellular phone factory, tests revealed that 50% couldn't read English at a 7th-grade level or do whole-number math. Does anyone doubt that if our people aren't well-grounded in reading, math and science, we won't be able to compete satisfactorily in global competition?

Coupled with declining birthrates, it's expected that the U.S. will need 450,000 to 750,000 more engineers and scientists by the year 2000 than we expect to produce. Yet, fewer and fewer students choose electronics engineering and computer science now than in the past few years. And by the year 2000, America will require almost as many new electronics and electrical technicians as physicians, according to the Vocational Industrial Clubs of America (VICA). ▀

# Now! Experience the electronics behind the MIDI revolution as you build your own computer-controlled music center

Only NRI's innovative, at-home training in Electronic Music Technology gives you hands-on experience with the equipment that's revolutionizing the music industry—Atari ST Series computer with built-in MIDI ports, Casio HT-3000 synthesizer with advanced MIDI operations, and ingenious MIDI software that links computer keyboard to synthesizer keyboard—all yours to train with and keep!

This year, over \$1.5 billion worth of digital electronic music instruments, from keyboards to drum machines, will be sold in the U.S. alone. Enthusiasts everywhere—professional musicians and recording technicians, even people who have never touched a musical instrument before—are discovering the excitement of today's electronic music technology.

At the heart of this excitement is MIDI (Musical Instrument Digital Interface), an innovation that's transformed musical instruments into the ultimate computer peripherals...and opened up a whole new world of opportunity for the person who knows how to use, program, and service this extraordinary new digital equipment.

Now NRI's breakthrough Electronic Music Technology course puts you at the forefront of this booming new technology with exclusive training built around a MIDI-equipped computer, MIDI synthesizer, and MIDI software you keep.

## Dynamic new technology opens up new career opportunities

The opportunities are unlimited for the person who's trained to take advantage of today's electronic music phenomenon. Now you can prepare for a high-paying career as a sound engineer, recording engineer, or road technician... even start your own business selling and servicing today's high-tech musical instruments. Or simply unleash your own musical creativity with the breakthrough training and equipment only NRI gives you.

## Only NRI gives you hands-on training with today's MIDI technology

The Atari ST Series computer included in your course becomes the heart of your own

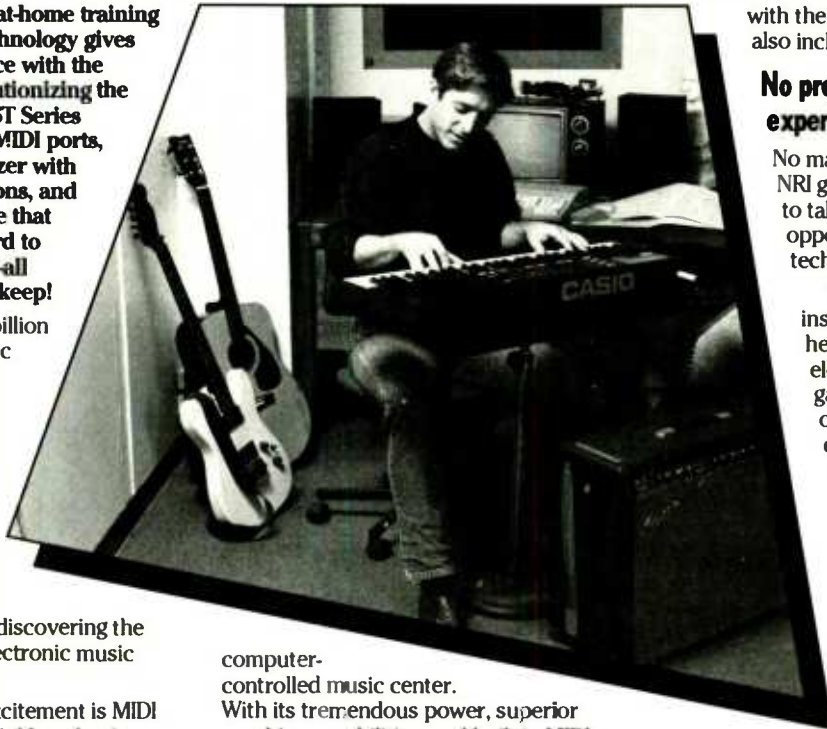

computer-controlled music center. With its tremendous power, superior graphics capabilities, and built-in MIDI interface, the 16/32-bit Atari ST has almost overnight become the computer of choice for today's most knowledgeable electronic musicians.

Your Casio HT-3000 synthesizer features a five-octave, MIDI-compatible digital keyboard with built-in monitor speakers, advanced tone editing and writing, pattern memory, keyboard split, tone and rhythm banks, chord memory, and dozens more state-of-the-art capabilities.

Plus you get ingeniously designed MIDI software that opens up amazing new creative and technical possibilities... you actually build your own 4-input audio mixer/amplifier...and you test the electronic circuits at the core of today's new equipment



*NRI training includes an Atari ST computer, Casio synthesizer, exclusive MIDI software, and much more—all yours to train with and keep! (TV not supplied)*

with the hand-held digital multimeter also included in your course.

## No previous electronics or music experience necessary

No matter what your background, NRI gives you the skills you need to take advantage of today's opportunities in electronic music technology.

With your experienced NRI instructor always available to help, you master the basics of electronic theory step by step, gaining the full understanding of electronics that's now so essential for technicians and musicians alike.

You move on to analyze sound generation techniques, digital logic, microprocessor fundamentals, and sampling and recording techniques... ultimately getting first-hand experience with today's explosive new technology as you

explore MIDI, waveshaping, patching, sequencing, mixing, special effects, and much more.

Plus, even if you've never been involved with music before, NRI gives you enough basic training in music theory and musical notation to appreciate the creative potential and far-reaching applications of today's electronic music equipment.

## Send today for FREE catalog

If the coupon is missing, write to NRI Schools, McGraw-Hill Continuing Education Center, 4401 Connecticut Avenue, NW, Washington, DC 20008.

### **NRI Schools**

McGraw-Hill Continuing Education Center  
4401 Connecticut Avenue, NW, Washington, DC 20008



#### ✓ Check One FREE Catalog Only

- |  |  |
|--|--|
| <input type="checkbox"/> Electronic Music Technology | <input type="checkbox"/> Computer Programming          |
| <input type="checkbox"/> Microcomputer Servicing     | <input type="checkbox"/> Desktop Publishing and Design |
| <input type="checkbox"/> TV/Video/Audio Servicing    | <input type="checkbox"/> Fiction/Nonfiction Writing    |
| <input type="checkbox"/> Security Electronics        | <input type="checkbox"/> Bookkeeping & Accounting      |
| <input type="checkbox"/> Basic Electronics           |  |

For Career courses approved under GI bill  check for details

Name \_\_\_\_\_ Age \_\_\_\_\_

Address \_\_\_\_\_

City/State/Zip \_\_\_\_\_

Accredited Member, National Home Study Council

4-021



# Safety, Security, Convenience, Entertainment and Energy Management

## Home Automation from Heath, the catalog that has it all...

Enter the world of Home Automation. Remote lighting and appliance controls. Security alarms and lighting. Automated thermostats. Video monitoring systems. Whole-house security systems. They're all yours in the Heath Home Automation Catalog. To receive your FREE copy, call today toll-free.

**1-800-44-HEATH**  
(1-800-444-3284)

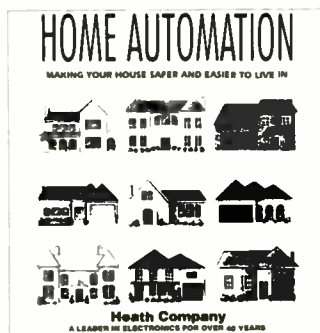

### Heath Company

Marketing Dept. 079-024  
Benton Harbor, MI 49022

CL-807

CIRCLE NO. 158 ON FREE INFORMATION CARD

## EDITORIAL...

Clearly, the opportunities represented by an electronics or computer career are there for the asking. Although starting salaries for engineers are on the high side (\$2,447 to \$2,871 per month in 1990) among occupations, some others, like accountants, catch up after a while and surpass them. Nevertheless, it still represents a good-paying, interesting career.

Hardware engineer merit salary increases (non-supervisory) for 1990 averaged 3.6% for holders of a B.S. degree; 3.35% for an M.S., 1.4% for Ph.D.'s and 1.15% for non-degreed engineers. This is based on information gathered by 891 AEA-member companies with 45,973 engineers. Increases were almost double this in 1989. Given current economic times, this is not surprising.

One might suppose that anticipated labor shortfalls noted earlier will cause big jumps in income, but this is not necessarily true. A short-

age might be filled by immigrants, for example. Anticipating this problem, in fact, is a recommendation from the National Advisory Committee on Semiconductors to Congress and the President to accelerate U.S. residency that allows foreign-born students receiving M.S. and Ph.D. degrees in engineering and science to obtain permanent residency permits within three months after graduation.

Without a doubt, there will be tough competition out there in the professional electronics and computer fields, both from without and from within. If you meet the quality standards that our manufacturers will require in increasing numbers, you will likely fare well.

*Art Salsberg*

## LETTERS

### Missing Copy

• In my article "Schematics for Your PC (Part 2)" in the January 1991 issue, some information was omitted from the end of *OrCAD/STD III* review.

TJ Byers

*You're correct, of course. A galley that tags onto the end of the published material was somehow overlooked during layout. The concluding text follows.—Ed.*

*OrCAD's* editing commands are done via blocks. To move an object, for example, you first define a block, which might be only a single desired device, then move the block. The only edit command that is object specific is delete.

This easy-to-use schematic capture program is often used as a front end for a variety of different engineering programs, although the company also offers a PCB layout program. Among the 21 output formats supported are *SPICE*, *FutureNet*, *Tango* and *EE Designer*.

*OrCAD* has two print options, one

from the screen and the other from an external utility. Copies made on a dot-matrix or laser printer from the screen option are distorted (with circles that look like eggs), whereas hard copy made from the external utility are of excellent quality. Unfortunately, you have no control over a printer or plotter from the utility; all page and drawing adjustments have to be made in the printer or plotter itself.

The program has a design check utility that removes duplicate wires, buses and junctions, plus displays warning messages advising of other duplicate objects.

*OrCAD/STD III* is undoubtedly an enduring, popular schematic capture program, and deservedly so. Its drawing and editing functions are a pleasure to use, and the netlist format is recognized by almost every PCB layout and circuit simulation program in the industry. You certainly won't get fired for buying this program.



**SERVICE DEALERS INCREASE REPAIR BUSINESS.** According to a recent study by NESDA, a professional electronics association, the ratio of service-only business compared to dealers' sales increased 13% in 1990 compared to 1989. The figures were based on responses from dealers who participated in the association's national convention.

The average number of service technicians that a dealer had was six. Interestingly, daily outside service calls decreased 33%, from an average of six per business day to four per day. Average charge per job was \$72.85. Service tech wages ranged from \$7.16 to \$14.43 per hour.

**TANDY OPENS ELECTRONIC BOUTIQUES.** Tandy Corp. launched an experimental shopping mall consumer electronics store concept called "The Edge in Electronics." Going beyond its Radio Shack stores, the new retail operations will focus on a broad selection of personal and portable electronic equipment with name brands such as Sony, Sharp, Casio, and others, as well as the Tandy brand. Initially, nine stores will be opened in home-state Texas and the greater Washington, DC area, with each store averaging about 1,000 square feet.

**FAX NEWS.** There's a lot happening in the field of fax. You can send and receive them directly through computer modem, from a service such as CompuServe for relay, or use a stand-alone fax machine, of course. A host of special fax services have sprung up, too, headed by AT&T, which offers a variety of conveniences, such as fax forwarding (even to a car phone).

CUE Network Corp. (Irvine, CA) instituted its "Telocator" FaxForward service to alert subscribers who might be in an unknown location that they received a fax. A subscriber is alerted by CUE's Message Center, which automatically signals his paging unit that there's a fax waiting at the Center. The user can retrieve it with any fax machine or laptop computer with a fax board by dialing a special 800 number and a personal security code. In essence, Telocator is a fax mailbox.

Bellcore (Bell Communications Research) researchers have been experimenting with a service that would provide access to an "on-line" phone directory, voice call, facsimile and electronic mail system through a desktop computer connected to an integrated services digital network (ISDN). In the prototype, a user gets a phone number simply by typing in a name on the experimental terminal. Along with the voice phone number, the listing that appears also includes that person's fax number and electronic mail address. By typing a command or by clicking with a mouse, a user can automatically dial the phone for a voice call, or send a message via fax or E-mail.

Incoming calls can be displayed on the screen, along with options on how they should be handled (put on hold, sent to an answering machine, etc.). Bellcore is also investigating other ISDN services such as sending visual images and joint editing capabilities.

---

For more information on products described, please circle the appropriate number on the Free Information Card bound into this issue or write to the manufacturer.

## Phone Caller Identifier

Slimline Caller ID units from Cidco Inc. (New Rochelle, NY) display the number of a telephone caller in an LCD window before you pick up your telephone receiver. This way you either know beforehand who is calling or can let a prank caller know that you have his number. These Slimline devices are usable only in areas where the telephone company provides Calling Number Delivery service.

As each call is sensed, the Slimline unit displays the number of the originating phone, as well as time and date. When you pick up the receiver, this information and a sequential



number for it are stored in internal memory. Data is retrieved by pressing one of two REVIEW keys and is erased from memory by pressing a DELETE key.

There are five basic Slimline models, including the SL-40-2 and SL-64-2, which have enough memory to store information for 40 and 64 calls, respectively. The displays of both models automatically light on the first ring for easy viewing in the dark. Other models lack backlighting for their displays. Power for all models comes from a 9-volt alkaline battery or an ac adapter (the latter optional on some models). The units enter

standby mode after 20 seconds of no activity to maximize battery life. Each Slimline unit comes with a wall-mount bracket, 6-foot telephone cord with RJ-11 connectors at each end, and 9-volt alkaline battery. \$69.95 to \$119.95.

CIRCLE NO. 105 ON FREE INFORMATION CARD

## Autoranging DMM

B&K-Precision has a 3½-digit autoranging DMM that stores its test leads when not in use and holds the probes when they are in use. The Model 2701 is a full-featured multimeter that can



operate for 800 hours on a single 9-volt battery. It has a rated basic dc accuracy of 0.5%.

Seven major functions are included. The 2701 measures to 1,000 volts dc, 750 volts ac, dc and ac current and resistance. It features a diode-check function and can freeze any displayed reading.

Its case design is said to make the 2701 especially well-suited for field service applications. One or both test probes can be held in position by the case for single-handed operation, easing measuring in hard-to-reach locations. A belt clip permits simplified continuity tests in a plant environment. When not in use, the test leads wrap around the instrument and conveniently clip into place for belt,

pocket or tool-kit storage.

All measurements appear in a high-contrast LCD display window. Other features include high/low-power ohms selector, single rotary switch operation and compact 6.9" × 3.2" × 1" dimensions. \$69.

CIRCLE NO. 106 ON FREE INFORMATION CARD

## Instant VCR Programmer

VCR Plus +™ from Gemstar Development Corp. (Pasadena, CA) makes taping TV shows on a VCR a one-step process. It makes use of the PlusCodes™ that will soon be printed alongside each TV program listing in leading newspapers and regional editions of *TV Guide*. You simply punch in the code number of the pro-



gram you wish to record, using the keypad on the front panel of the VCR Plus + device. Thereafter, the selected program is automatically recorded at the correct time.

If you attempt to program in a program whose time clashes with another already programmed in, CLASH is displayed. You can verify programming information at will. For programs that run overtime, you have the option of adding recording time in 15-minute segments as needed. A LED flashes to indicate when taping is about to start and serves as a reminder for you to load a blank tape into your VCR.

The VCR Plus + system is claimed to be compatible with any number of channels, program combinations and most wireless VCRs and cable boxes. It controls both your cable box and VCR. The device offers a



## Computer-Fax Communication Adapter

Ricoh Corp.'s DX-1 Fax Adapter and communication software for DOS, Macintosh and Microsoft Windows operating environments allow IBM PS/2, IBM PC/AT and compatibles, Apple Macintosh and laptop computers to communicate with local and remote Group 3 fax machines and permit any local Group 3 machine to serve as a computer printer and scanner. The DX-1 permits even low-cost fax machines to serve as an image scanner, optical character reader with third-party OCR software, or as a computer printer. Plain-paper fax machines become high-quality laser printers with the DX-1 system.

The DX-1 makes it convenient to send messages and graphics from a computer and provides document-distribution capabilities. Also, the Fax Adapter can serve as a fax traffic director between a local fax machine and computer, preventing lost recep-

tion due to computer memory or running out of fax paper.

Computer memory is used by the DX-1 for such other fax applications as sequential broadcasting, storage of distribution lists, and repeated and automatic polling of remote fax machines at preset times. Features include: automatic redial; send-later programming; built-in speaker; confidential transmission; and support of Modified Read and Modified Huffman compression.

The DX-1 connects to a computer via a serial port, to a local fax machine via an RJ-11 jack and to the telephone line via an RJ-45 jack. It measures 12"L x 8"W x 2.2"H and weighs 4.5 lbs.

In addition to providing fax communication functions, the software permits display of fax files on a computer screen. HiJaak File Conversion software from Inset Systems, Inc., included at no additional cost with Windows and DOS versions, permits conversion of almost all types of graphics files produced by PC appli-



cations into fax files. Run under Microsoft Windows or Apple Macintosh operating system, the software provides a mouse-driven windowed user interface. With the Macintosh version, a user can assign the DX-1 as a substitute for a printer, without first performing manual file conversion.

As stand-alone packages, the DX-1 Macintosh and Windows software are compatible with other Ricoh computer-fax products. Also, the Macintosh and Windows versions permit workstation-to-workstation communication over digital data lines. \$799, Fax Adapter; \$275 each, DX-1 software packages.

CIRCLE NO. 108 ON FREE INFORMATION CARD

number of features not currently available to VCR owners: three recording options (once, weekly and daily); storage of up to 14 programs, doubling or tripling the capacity of most VCRs; and calculation and display of how much tape is needed in the ensuing 24 hours.

The VCR Plus+ is powered by four AAA cells and features lithium battery backup. The hand-held device measures 6 1/4 x 4 1/4 x 1 inches and weighs 8 ounces with battery installed. It comes with a holder that you can sit on top of your VCR or cable box. \$59.95.

CIRCLE NO. 109 ON FREE INFORMATION CARD

## Precision Frequency Counter

The Model PM 6662 120-MHz frequency counter from John Fluke Mfg. Co., Inc. offers high accuracy, rugged construction and a variety of



features in a moderately priced instrument. Its high-resolution reciprocal counting design gives at least seven digits for a 1-second measuring time, from low-frequency signals up to 120 MHz standard on Channel A or up to 1.3 GHz optional on Channel B. A mathematically temperature-compensated crystal timebase option provides stability close to that of a costly oven-stabilized oscillator at much lower cost.

The counter's input circuitry has a 15-mV to 5-volt noise immunity range and is said to provide error-free triggering on all signals, regard-

less of waveform and duty factor. The input is protected to 350 volts peak ac.

Built-in automatic features include trigger-level setting that compensates for varying input signal duty factors and automatic selection of high- and low-frequency input. The counter also automatically detects the presence of an external 10-MHz reference signal for applications that require high accuracy. Autoranging and automated calculation of the displayed resolution are performed to match the measuring resolution.

A rugged metal cabinet provides shielding against r-f interference and protection of the circuitry in harsh environments. The counter meets the MIL-T-28800D standard for environmental conditions and has a calculated MTBF of not less than 68,000 hours. \$645.

CIRCLE NO. 110 ON FREE INFORMATION CARD

## NEW PRODUCTS...

### Remote AC Power Switch

A compact remote-control switch for turning on and off any ac-line-powered device is now available from Midland International. The Model 72-300 works through a compact transmitter and small module that plugs into an ac outlet. An electrical

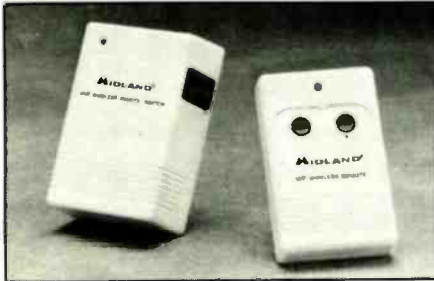

device to be controlled plugs into the module. Control range between transmitter and module is up to 50 feet. With a power-handling capacity of 1,000 watts, the control module can safely accommodate most electrical appliances and electronic devices found in the home. The transmitter is powered by a 9-volt battery and operates in the uhf radio band.

CIRCLE NO. 112 ON FREE INFORMATION CARD

### AC Line Conditioner

Tripp Lite's Model LC-1200 line conditioner is claimed to provide excellent voltage regulation and ac-power-line conditioning for computers and other sensitive electronic equipment. The conditioner provides up to 1,200 watts of power from four ISOBAR spike-protected, chassis-mounted ac receptacles. Two isolated filter banks provide maximum equipment protection. Isolation prevents equipment plugged into the conditioner from interfering with each other.

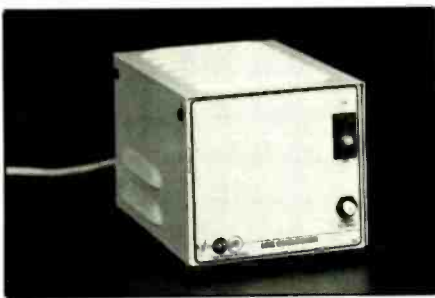

### TV Relay Device

Vidicraft's (Beaverton, OR) Vidi-View wireless TV relay device captures and transmits TV signals in the 900-MHz uhf band to any location within a radius of 120 feet, without having to run cables. The transmission signal consists of picture and sound, which can come from cable programming, pay-per-view, broadcast TV, VCR or camcorder signals from a TV receiver or monitor in the principal viewing location to any TV receiver in any other room within range.

Vidi-View consists of a small transmitter and receiver (one receiver

The UL-listed and CSA-approved conditioner features a 12-ampere circuit breaker and heavy-duty ac line cord. Voltage regulation complies with ANSI C84.1 specifications. With complete spike, line-noise and rfi/emi filtering built in, external surge suppression is unnecessary. \$249.

CIRCLE NO. 117 ON FREE INFORMATION CARD

### Sound-Level Meter

Brunelle Instruments' (Newport, VT) new Model 39 sound-level meter is a hand-held device that can be used to measure the intensities of sounds under a wide variety of conditions.

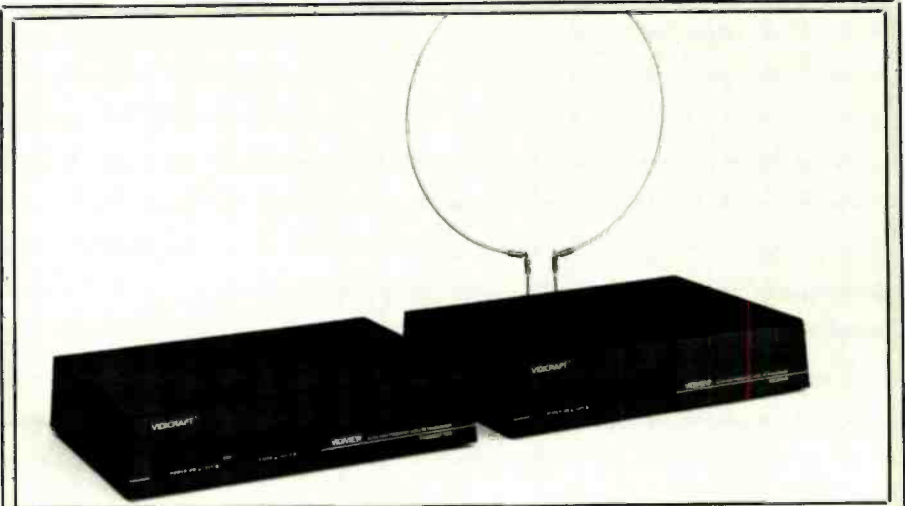

module is needed for each reception location). The transmitter connects to the video and audio outputs of the source TV receiver, VCR or camcorder, while the receiver attaches to the antenna or video inputs of the receiving TV set.

Operating frequencies for the 30mW system are 914 MHz for Channel A and 917 MHz for Channel B. Sound bandwidth is rated at 15 kHz. Inputs are baseband and Channel 3 (switch selectable), while outputs are baseband and Channel 3 simultaneously. \$149.95, one each transmitter and receiver; \$69.95 each extra receiver.

CIRCLE NO. 113 ON FREE INFORMATION CARD





Its 85-to-115-dB OSHA range makes it suitable for use in measuring noise levels in factories, road traffic, sound systems, air conditioners, motors, etc. It has a single rotary operating control that has high and low ranges, a calibration position, a battery-test position and two off positions. A small analog meter movement is used as the instrument's display and has two clearly marked scales. Power is supplied by a 9-volt battery. Supplied with the meter are a carrying case and instruction manual.

CIRCLE NO. 118 ON FREE INFORMATION CARD

### 100-MHz A/DSO Scope

Tektronix's 100-MHz Tek 2221A analog and digital storage oscilloscope offers digital acquisition capabilities in the least-expensive DSO the company offers. Custom ICs achieve a 100 MS/s sampling rate simultane-



ously on each of two channels, and an exclusive peak-detect mode captures events as narrow as 100 ns at any speed in real time.

Analog real-time or digital storage operation can be selected at the push of a button. Concurrent time and voltage cursors permit quick, accurate analysis of precise signal parameters. Stable triggering is made easy with trigger level readout and hf/lf trigger filtering. Buttons on the CRT bezel permit quick access to menu functions and storage of waveforms in up to three simultaneously displayable reference memories. Record length can be set at either 1K or 4K data points, and stopped waveforms can be expanded both horizontally and vertically.

The 2221A can capture and display signals using a variety of digitizing modes. Peak detect captures random

glitches and signal anomalies like spike and pulse overshoot as fast as 10 ns, regardless of sweep speed and record length selected. Accumulated peak detect enhances this capability by retaining signal extremes as they occur over time. Signal averaging, with selectable weighting and sweep limits, uncovers waveforms buried in random noise.

Configuration can be either GPIB or RS-232C talker/listener with

choice of optional interface. When configured, the 2221A can provide hard-copy waveform printout on Epson-compatible printers, HPGL plotters or an HP ThinkJet printer. Connection can also be made to a PC for waveform archiving, signal analysis or reference storage. Software packages for integration with a PC system are also available from Tektronix. \$3,995.

CIRCLE NO. 119 ON FREE INFORMATION CARD

## ELENCO & HITACHI PRODUCTS AT DISCOUNT PRICES

**NEW!** RSOs (Real-Time & Storage Oscilloscopes) From HITACHI **NEW!**

View, Acquire, Test, Transfer and Document Your Waveform Data

4-Channel, 100MS/s Model	Introductory Price
100MS/s (25MS/s on 4 channels simultaneously), 100MHz, 4kw x 1ch, 2kw x 2ch, 1kw x 4ch. VC-6145	\$4,695.00

**Compact, Full Feature Models**

40MS/s, 100MHz, 4kw x 1ch, 2kw x 2ch	VC-6045	\$3,049.00
20MS/s, 50MHz, 2kw x 2ch	VC-6025	\$2,295.00

**Low Cost/High Value Models**

20MS/s, 50MHz, 2kw x 2ch	VC-6024	\$2,049.00
20MS/s, 20MHz, 2kw x 2ch	VC-6023	\$1,749.00

RSOs from Hitachi feature such functions as roll mode, averaging, save memory, smoothing, interpolation, preriggering, cursor measurements, plotter interface, and RS-232C interface. With the comfort of analog and the power of digital.

**Compact Series Scopes**

Delayed Sweep  
Lightheight (1180s)  
2mV Sens  
3 Yr Warranty  
Model: V-1065  
Shown

This series provides many new functions such as CRT Readout, Cursor measurements (V-1085/1065/665), Frequency Ctr (V-1085), Sweetime Autoringing and Trigger Lock using a 6-inch CRT. You don't feel the compactness in terms of performance and operation.

V-660	60MHz Dual Trace	\$1,195
V-665	60MHz Dual Trace w/Cursor	\$1,345
V-1060	100MHz Dual Trace	\$1,425
V-1065	100MHz Dual Trace w/Cursor	\$1,695
V-1085	100MHz Quad Trace w/Cursor	\$2,045
V-1100A	100MHz Quad Trace w/Cursor	\$2,295
V-1150	150MHz Quad Trace w/Cursor	\$2,775

**Hitachi Portable Scopes**

V-212 **\$435**  
DC to 50MHz, 2-Channel, DC offset function, Alternate magnifier function  
DC to 20MHz  
Dual Channel  
V-525 Delayed Sweep \$995  
V-522 Basic Mode \$895

**20MHz Elenco Oscilloscope** **\$375**  
MO-1251

- Dual Trace
- Component Tester
- 6" CRT
- X-Y Operation
- TV Sync
- 2 p-1 Probes

**FREE DMM with purchase of ANY SCOPE**

**SCOPE PROBES**  
P-1 65MHz, 1x, 10x \$19.95  
P-2 100MHz, 1x, 10x \$23.95

**Elenco 35MHz Dual Trace Good to 50MHz** **\$495**  
MO-1252

- High luminance 6" CRT
- Int'l Sensitivity
- 80V Acceleration Voltage
- 100ns Rise Time
- X-Y Operation + Z Axis
- Delayed Triggering Sweep
- Includes 2 P-1 Probes

All scopes include probes, schematics, operators manual, and 3 year (2 yrs for Elenco scopes) world wide warranty on parts & labor. Many accessories available for all Hitachi scopes. Call or write for complete specifications on these and many other fine oscilloscopes.

**WE NOW CARRY COMPLETE LINE OF FLUKE MULTIMETERS**

**Models**  
21F 83  
23F 85  
25F 87  
27F 8050A  
73 8060A  
75 8062A  
77F + More

**CALL FOR SPECIAL PRICING**

**True RMS 1 1/2 Digit Multimeter**  
M-7000  
**\$135**  
05% DC Accuracy  
1% Resistance with Freq. Counter and deluxe case

**10 Function Multimeter**  
CM-365  
**\$65**  
AC, DC Voltage & Amps  
Resistance to 2000MQ  
Diode, Logic, & Trans test  
Capacitance to 200uF

**Digital Capacitance Meter**  
CM-1550  
**\$58.95**  
9 Ranges  
1p1-20,000uF  
5% basic acy  
Zero covered with case

**Digital LCR Meter**  
LC-1801  
**\$125**  
Measures:  
Coils 1uH-200uH  
Caps. 1p1-200uF  
Res. 201-20M

**Function Generator**  
Box  
#9600  
**\$28.95**  
Provides sine, triangle, square wave from 1Hz to 1MHz  
AM or FM capability

**Audio Generator**  
SG-9200  
**\$129**  
Low distortion (< 0.5%)  
10-10MHz  
Sine/Square Wave  
600 ohm Output impedance, High Output Voltage

**Wide Band Signal Generators**  
SG-9000  
**\$129**  
RF Freq 100K-450MHz  
AM Modulation of 1KHz  
Variable RF output

**SG-9500 w/ Digital Display and 150MHz built-in Counter \$249**

**Soldering Station**  
Temperature Controlled  
SL-30 **\$99**  
Digital display  
Temp range: 300F-900F  
Grounded tip  
Overheat protect

**Color Convergence Generator**  
SG-200  
**\$69.95**  
Finest in the industry  
10 rock steady patterns

**10MHz Oscilloscope**  
S-3000  
**\$275**  
10MHz DC or AC  
Triggered Sweep  
Calibrated Vets & Hor  
Reads Vrms & Freq

**Temperature Probe**  
M-110CF  
**\$29.95**  
Semi-conductor type  
Range 58F-302F  
Fits most digital multimeters

**Autoringing DMM**  
M-5000  
**\$45**  
9 Functions  
Memory and Data hold  
10% basic acc  
3 1/2 digit LCD

**AC Current Meter**  
ST-1010  
**\$69.95**  
1000 Amps  
Data & Peak hold  
8 Functions  
Deluxe Case

**Decode Box**  
#9610 or #9620  
**\$18.95**  
#9610 Resistor Box  
47 ohm to 1M & 100K pot  
#9620 Capacitor Box  
47pF to 10MFD

**Quad Power Supply**  
XP-580  
**\$59.95**  
2-20V at 2A  
12V at 1A  
5V at 3A  
-5V at 3A  
Fully regulated and short circuit protected  
XP-575 without meters \$39.95

**AM/FM TRANSISTOR RADIO KIT with TRAINING COURSE**  
Model AM/FM-108  
**\$26.95**  
14 Transistors • 5 Diodes  
Circuits are laid out in systematic order on an oversized PC board for easy understanding of the flow of radio signals, from antenna to speaker. Complete course includes all parts, PC board and training manual. When completed you will be proud to display your masterpiece.  
**7 Transistor AM RADIO KIT \$16.95**

**Digital Triple Power Supply**  
XP-765  
**\$249**  
0-20V at 1A  
0-20V at 1A  
5V at 5A  
Fully regulated, Short circuit protected with 2 limit control, 3 separate supplies  
XP-660 with Analog Meters \$175

**GF-8016 Function Generator with Freq. Counter**  
**\$249**  
Sine, Square, Triangle  
Pulse, Ramp, 2 to 20Hz  
Freq Counter, 1-10MHz  
GF-8015 without Freq. Meter \$179

**WE WILL NOT BE UNDERSOLD!**  
UPS Shipping: 48 States 5%  
(\$10 Max) IL Res., 7% Tax

**C & S SALES INC.**  
1245 Rosewood, Deerfield, IL 60015  
(800) 292-7711 (708) 541-0710

**15 Day Money Back Guarantee**  
**2 Year Warranty** Prices subject to change  
**WRITE FOR FREE CATALOG**

CIRCLE NO. 134 ON FREE INFORMATION CARD

# NEW PRODUCTS ...

## New Hewlett-Packard Optical Disk Drive

Hewlett-Packard's new Model HP C1716M optical-disk drive permits use of a single mechanism for write-once and rewritable-optical-subsystem or library applications. The multifunction magneto-optical drive has a 5.25-inch form factor and uses an SCSI hookup. Drive and controller are priced at \$4,300, write-once and rewritable media at \$199 and \$249.

HP's optical-disk drive identifies media type and then invokes the appropriate command set to provide data security. The write-once command set does not include commands that destroy data, such as erase and format. The rewritable command set permits unlimited writing and erasures.

Security measures built into data-storage media vary greatly with the technology of the medium. The highest level of permanency available from any storage medium is offered by write-once optical technology.

Hewlett-Packard was among a group of 14 companies in June 1990 that launched an effort to expand the current continuous-composite (CC) magneto-optical (MO) recording-format standards into a new write-once technology implementation. Using multi-level protection measures similar to those used in write-once drives, this technology provides the data security expected of write-once in a format that is compatible with CC rewritable media, making both storage options possible on one drive. Write security is built into the media and drive. Visual identifiers help ensure that the appropriate disk is inserted. The disk is correctly identified by the drive which prevents writing of data to a previously written-to block.

Write-once and rewritable disk cartridges are color-coded and labeled to reduce user identification errors. However, the major safeguards against tampering are built into the media and drive. When a disk is inserted, the CC multifunction drive identifies the media according to information manufactured into the disk. All CC MO disks have phase-encoded-part (PEP) and standard-format-part (SFP) identifier codes molded into the recording layer.

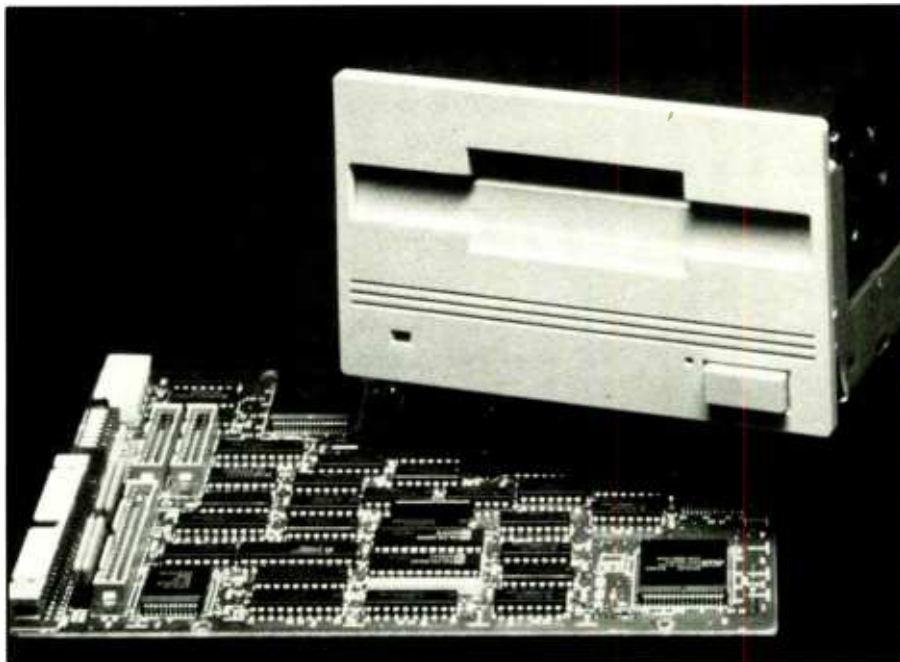

In HP's multifunction technology, these codes permanently differentiate write-once from rewritable media (see illustration). Correct media identification is also checked by disk-definition-structure (DDS) identifier bytes, which are written to the CC write-once media upon initialization.

If a CC write-once disk is inserted into a standard MO rewritable drive, the drive will not find the rewritable codes on-disk, recognize the media or read from/write to it. Once the multifunction drive has recognized the type of media, it invokes the appropriate command set.

*(Continued on page 82)*

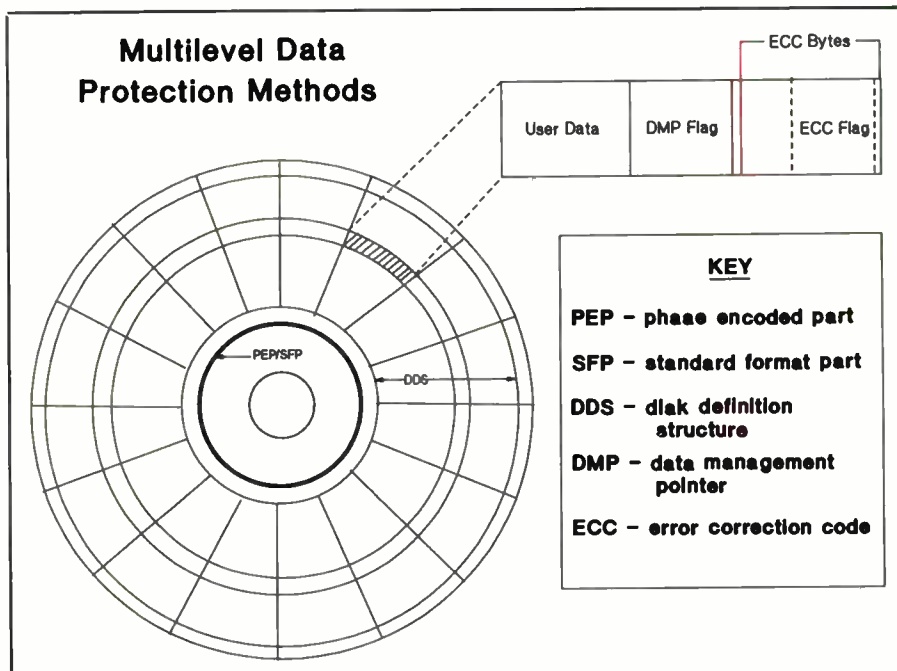



# Hard to Find, Unique PC Products at Incredible Prices!

Installs on ANY laptop or desktop in seconds!

## Connect Floppy Drives (3.5" & 5.25") To Parallel Printer Port In 30 Seconds Flat!

~~\$349~~  
**\$299!**

Adding a disk drive has never been this easy. Imagine attaching a floppy drive to your laptop or desktop computer in under 30 seconds—even on PCs with built-in disk controllers.

**Backpack** is an external floppy drive that plugs into your parallel printer port. Your printer plugs into the back of the Backpack drive. There are no interface cards to install, you never even open your computer. You can have a single 3.5" or 5.25" drive and use it on all the computers in your office just by plugging it in. Backpack drives transfer information to your computer at the same speed as ordinary floppy drives, but install in only seconds.

Connecting a high density 3.5 or 5.25 inch drive to your computer can allow you to back

up your hard disk in half the time. Backpack allows you to connect high density drives to any computer, even older PC and XT compatibles, regardless which version of DOS you use.



**backpack**

Backpack comes in four configurations:

- 5.25" 360K drive, Cat. #BACP360, \$299
- 5.25" 1.2M drive, Cat. #BACP12, \$299
- 3.5" 1.4M/720K drive, Cat. #BACP14, \$299
- 3.5" 2.8M drive (also read/writes 1.4M and 720K), Cat. #BACP28, \$399

Let Your Voice do the Work of Tedious & Repetitive Keystrokes!

## How To Talk To Your Computer

~~\$189~~  
**\$149!**

If you have trouble memorizing all those complicated "Control-Alt-Shift-Function" commands then **Voice Master Key** is just for you. Now you can simply speak the command—"bold," "zoom," etc.—into Voice Master's headset and see it done instantly.

### New Advanced Capabilities

The new Voice Master software recognizes up to 1,024 words, each of which can activate a different macro. Macros can include pre-recorded digitized speech or sound files which play back when activated.

### A Sound Development System

Ideal for experimenters and software developers, you can make sound files for spoken advisories, music/sound effects, etc. Sound files can be played through the headset or Speech Thing external speaker. All of the functions can be controlled from C, BASIC, ASM.

**Voice Master Key System II** interfaces with your PC through the parallel printer port

(you can plug your printer into the Voice Master System II box). System II also includes an external speaker and text-to-speech software.



- Voice Recognition—invokes macros w/ voice input.
- New software recognizes over 1,000 words!
- Includes developer kit for sound editing.
- Quick, simple installation.
- Includes controller card, software, and headset. Voice Master Key System II includes headset & external Voice Master. Order Today!

**Voice Master Key Cat. # VOIM, \$149.**  
**Voice Master System II, Cat. #VOIM2, \$199.**

Increase Computer Productivity!

## Price Breakthrough 512K Printer Buffer

~~\$199~~  
**\$129!**

Waiting for a file to print can be frustrating unless you have a printer buffer. This buffer quickly absorbs your file so you can get back to work fast. The buffer quietly feeds the file to your printer *without slowing down your computer!* Don't wait, order today.

- Holds about 360 double-spaced pages • Includes power supply so it will hold data even if your computer or printer is turned off • Repeat function to print extra copies • "Free Space" indicator

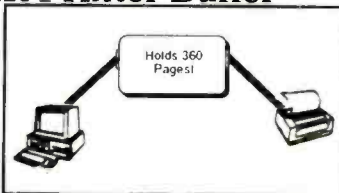

Serving Computer Users Since 1982

**30 Day Money Back Guarantee**

**1-800-456-4123**

(805) 524-4189 • 24 Hour FAX: (805) 524-4026

330 Central Avenue • Fillmore, CA 93015

Visa • MasterCard • AMEX • Discover

Add \$5.50 Shipping. CA residents add sales tax. Ad Code: 127-2

Learn to Modify ANY Software!

~~\$49!~~

## Powerful Disassembler

**Snooper** takes executable program code and turns it into assembly language source code.

Hex	File	Disassemble	Search	Point	Print	no patches	Out
mov	WORD PTR [bp+04h]	00713					
ret	00715						
call	00716						
jmp	00717						
inc	00718						
mov	00719						
push	0071a						
ret	0071b						
mov	0071c						
inc	0071d						
mov	0071e						
push	0071f						
ret	00720						
mov	00721						
push	00722						
ret	00723						
push	00724						
ret	00725						
mov	00726						
inc	00727						
mov	00728						
inc	00729						
mov	0072a						
inc	0072b						
mov	0072c						
inc	0072d						
mov	0072e						
inc	0072f						
mov	00730						
inc	00731						
mov	00732						
inc	00733						

That's not so unique, but Snooper is intelligent. It automatically comments the source code and labels jump targets. Snooper even includes a patcher to make small changes to a program without time-consuming reassembly. For more extensive changes, Snooper is compatible with Microsoft and Borland assemblers.

Snooper gives you commented source code for almost any DOS file—including COM, EXE, SYS. Its pull-down menus and on-line help make disassembly fast and easy. So what's this good for? Well it's the best way around to learn assembly language and to make changes to software when you don't have the source code. Cat. #SNPR \$49. Order today.

Please rush the following products to me right away. I understand my purchase is covered by Central's 30 day satisfaction guarantee.

I'm not ready to order now, but please make sure I'm on your mailing list.

Name: \_\_\_\_\_

Address: \_\_\_\_\_

City: \_\_\_\_\_ ST: \_\_\_\_\_ ZIP: \_\_\_\_\_

Daytime telephone: \_\_\_\_\_

CA Res. Specify County: \_\_\_\_\_

Check/Money Order enclosed.

Charge my Visa, MC, AMEX, Discover:

Card #: \_\_\_\_\_

Exp: \_\_\_\_\_ Driver's License #: \_\_\_\_\_

Signature: \_\_\_\_\_

Qty.	Cat. #	Description	Price

Subtotal

Mail To: CA Res. Add Sales Tax

Central Computer Products  
Dept. 137-2

S & H

\$5.50

330 Central Avenue  
Fillmore, CA 93015

Total

# Printed-Circuit Boards From Your PC

*Forget the decals and X-acto knife. Let your personal computer lay out your next circuit board!*

By TJ Byers

Software programs that let you draw electronic schematics using your personal computer were discussed in depth in our past two issues. To a draftsman, their ability to generate professional-quality schematics quickly and accurately is a blessing.

To the electronics professional and experimenter, however, it is but one step in a sequence of events that takes an idea from concept to a finished product. The most difficult and challenging step is designing the printed-circuit board.

Fortunately, the better schematic-drawing packages (examined last month), called schematic capture programs, can extract data from schematic drawings that can be used by printed-circuit board (pcb) design software to make printed-circuit board layouts (Fig. 1). In some cases, the pcb software is included as part of the schematic capture package, as is the case with *EE Designer* and *ProCAD*. But more often you have to purchase the pcb software separately, with prices ranging from \$99 to nearly \$2,000 and more if you load up on all the options some offer.

This month, we look at how pcb software transforms schematics into functional printed-circuit boards. Following articles will examine a host of pcb design programs for price, performance and features, and show you how to make a printed-circuit board using your PC and a printer.

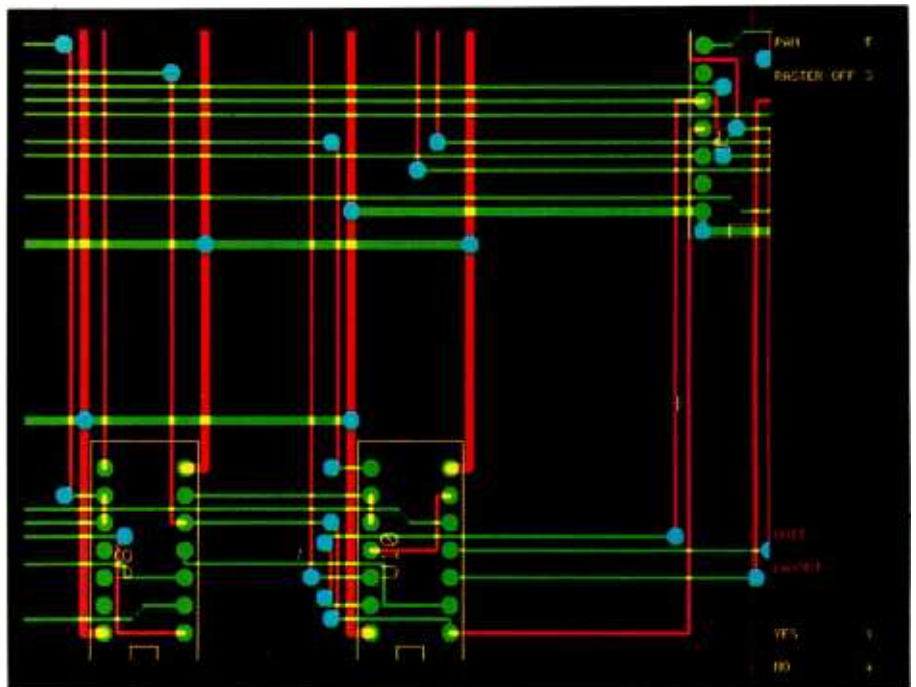

Fig. 1. PCB programs can produce professional-quality pc board layouts.

## How PCB Design Programs Work

Pcb software breaks down the making of a printed-circuit board into four steps. The first is physical placement of the components on the board itself. After the parts are in place, the copper traces that electrically connect together the components are laid down. Depending on what is included in the program, either or both processes may be automated.

Next, the printed-circuit board is inspected for conformity with mechanical and electrical specifications, using design rule checking

software, generally part of the pcb software package. Violations are corrected using the editing tools supplied by the pcb program.

After the layout is verified, final artwork is generated using a printer, pen plotter or photoplotter. The artwork is used to make the actual printed-circuit board. In addition, the pcb software produces production documentation that manufacturing needs for scheduling and inventory control.

## Netlists

Although all pcb programs let you lay out a printed-circuit board on-



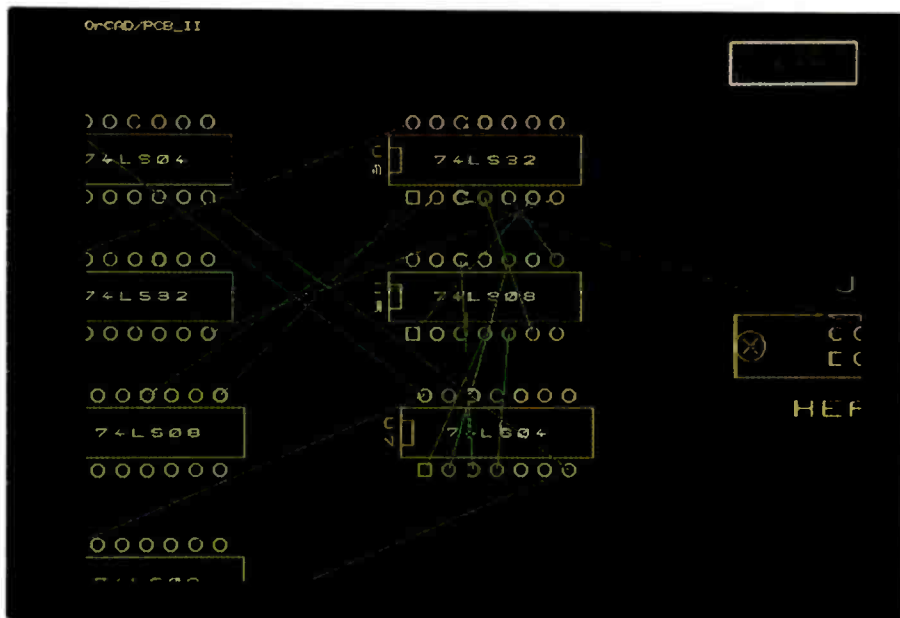

Fig. 2. Ratsnests display the wiring connections among the components.

screen by hand, as you would using transfer tape and decals on a clear plastic base or copper-clad board, their real power is their ability to interpret data generated by a schematic capture program and convert it into components and traces.

The data is contained in disk files

called *netlists*. A netlist is a grouping of related parameters that are extracted from the schematic. For example, a Bill Of Materials (BOM) netlist lists all the components used in the circuit and their circuit references, whereas a wire netlist is a table of connections used to wire the various

components together. Other netlists might include pin lists (listing only IC pin connections), design check reports or circuit-simulation files. There is no limit to the number of netlist types, and each schematic capture program has its own repertoire of netlists it can generate. These netlists are in ASCII format and, therefore, are easily edited with almost any word processor.

Each schematic capture program also has its own way of organizing and formatting the netlists—rules that must be strictly adhered to if the pcb software is to interpret the netlist data correctly. The easiest transfer between schematic capture and pcb design occurs when the two are integrated in the same package. Next best is to buy the two programs from the same vendor.

However, there are a few schematic capture programs that have been around long enough that their netlist formats are recognized as *de-facto* standards. Among them are *FutureNet* and *OrCAD*. It's not uncommon to find format translators for many popular schematic capture formats included with the pcb software package.

### Component Library

Central to the operation of the pcb program is a component library. The library is nothing more than a collection of device outlines like resistors, capacitor, ICs, etc. When a component is needed on the printed-circuit board, the user or netlist file calls the specified outline from the component library and makes it available for placement on the board.

Pcb software has no idea of the function of the part it calls from the library. It's simply a mechanical device with size and shape. For example, the outline for a 74LS00 and a 74LS02 are the same, and the pcb software treats both parts identically. Most pcb programs support a wide range of device types, including optoelectronic and r-f components.

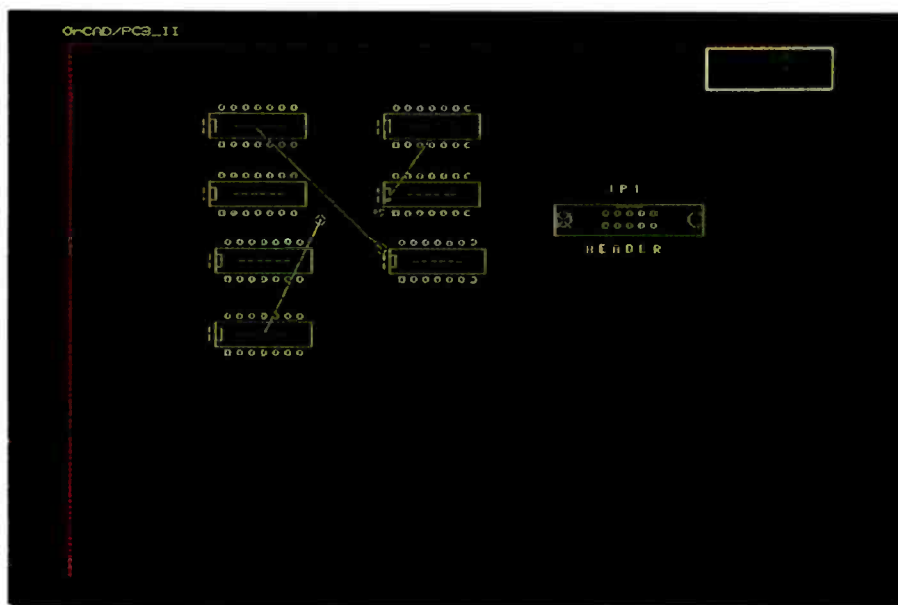

Fig. 3. Force vectors are used to show in which direction the part should be moved to minimize trace length.

Sometimes component outlines are contained in specialized library modules, such as DIP devices or connectors. Other times, the outlines are stuffed into one or two large library files. There is no advantage to one over the other, and pcb programs are evenly divided on the issue. Additional components, particularly surface-mounted-device (SMD) outlines, can often be purchased separately as either stand-alone libraries or upgrades to the main library, depending on the program.

All pcb programs have a library editor that lets you create your own components and add them to the library. New parts can be created from scratch or by modifying an existing outline. Connectors are particularly problematic because of the many custom designs available. Unlike schematic capture library editors, most pcb library editors use primitives like circles and squares to build a new component, rather than have you draw the part using a fill-in-the-dot matrix.

### Component Placement

Placing components on a printed-circuit board can be tricky. Parts have to be positioned in such a way that electrical connections can be made between each and every component. What seems like a functional layout can turn out to be a dead end—usually after you have invested a considerable amount of time trying to wire them together.

Fortunately, there are tools that can aid in the layout process, including automatic-placement programs. However, automatic-placement routines cannot achieve complete component placement. Problems with signal path length, clock skewing and traces that cannot be connected are beyond the scope of today's automatic-placement routines.

So whether you start from scratch or are modifying an existing automatic-placement pattern, much of

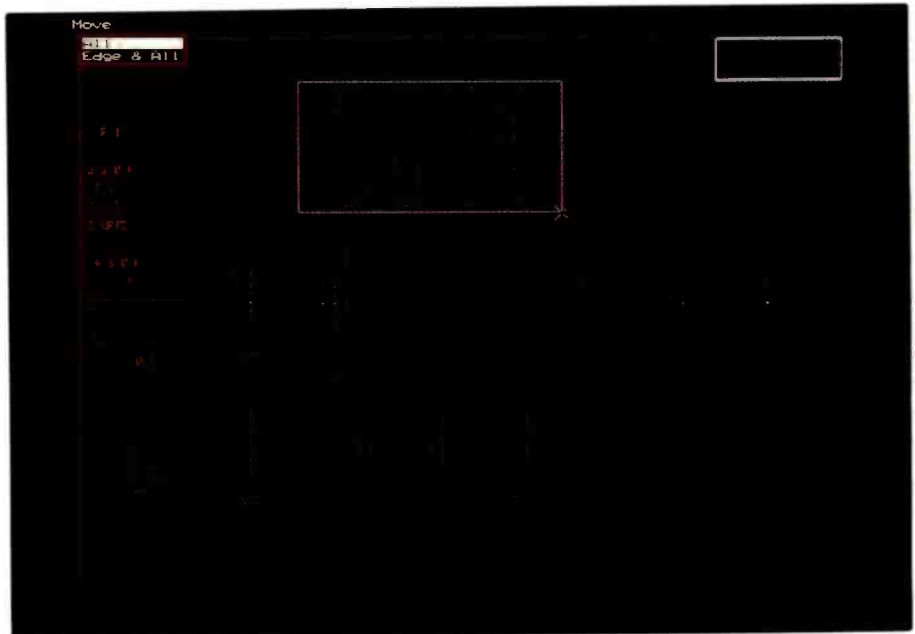

Fig. 4. Area inside the line is a block and is treated as a single object.

the layout work is done manually. Manual placement consists of dragging a part from one place to another, using the mouse and/or keyboard. Depending on the printed-circuit-board software and whether or not the automatic-placement program has been run, the parts may be

located on the board itself, outside the board's outline or stacked one atop another in a single pile from which the components are removed layer by layer, one at a time.

Manual placement can be done either as a stand-alone job or interactively with an automatic-placement

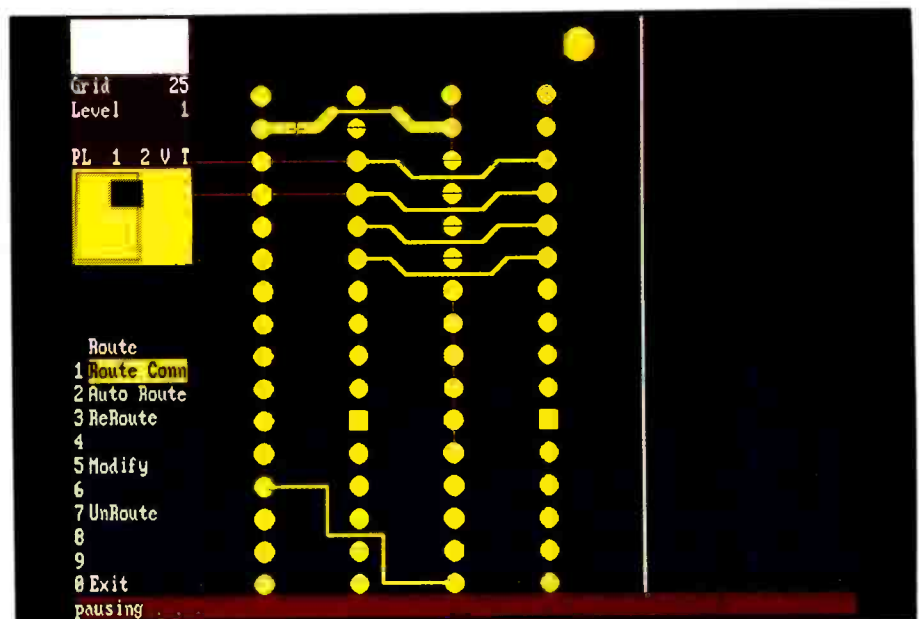

Fig. 5. Necking down reduces trace width for routing between solder pads.



# D.P. COMPUTERS

The Upgrade Specialists

90's Power  
at  
80's Prices

THE POWER OF A NEW SYSTEM...  
FOR A THIRD OF THE COST !!!

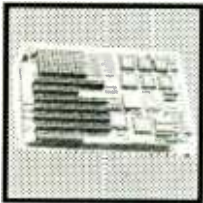

**VANTAGE  
386 25 MHz  
\$699.00**

**FEATURES:**

- Made In USA
  - 2 year warranty
  - 48 hour burn-in
  - Chips and Technology chipset
  - INTEL 386 - 25 MHz processor
  - Shadow Ram
  - AMI BIOS with built-in Diags
  - Up to 8 Megs on board (Simms)
- PERFORMANCE BENCHMARKS:**  
Landmark - 33, Norton - 28.2, MIPS - 4.33
- COMPATABILITY:**  
Supports DOS, OS/2, Windows 386, Deskview 386, UNIX, NOVELL

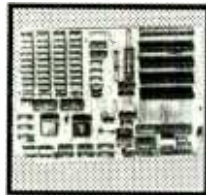

**BULLET 286  
MOTHERBOARDS**

- \* 5 or 8 slot models for PC or XT
- \* Uses your PC and XT cards, power supply and keyboard
- \* Up to 1 meg on motherboard
- \* Disk cache program built into BIOS
- \* Quadtel BIOS

- 7.2 MHz 8 slot...\$125  
8 Mhz 5 or 8 slot \$179  
10 MHz 5 or 8 slot \$179  
12.5 MHz 5 or 8 slot \$209  
16 MHz 5 or 8 slot \$299

CALL FOR RAM AND  
QUANTITY PRICES



**VANTAGE  
386 25 & 33 MHz  
CACHE BOARDS**

**FEATURES:**

- 48 Hour Burn-in
  - Discrete TTL
  - Up to 16 MB 32 bit memory
  - Shadow RAM
  - AMI BIOS with built in Diags
- PERFORMANCE BENCHMARKS:**

- 386-33c Landmark 52.3  
MIPS-7.438.....\$999  
386-25c Landmark 42.2  
MIPS-5.932.....\$799

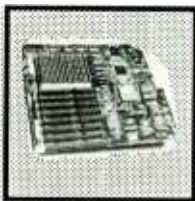

**VANTAGE  
486 25 MHz  
\$1999.00**

**FEATURES:**

- \* 80486-25 MHz CPO  
(Rev C1, Bugless Version)
  - 8 16-bit AT slots
  - 8 KB internal cache memory
  - Burst Mode support
  - Up to 16 MB onboard memory
  - 2 year warranty
  - Made In USA
- PERFORMANCE BENCHMARKS:**  
LM - 114.10, SI - 38.80, MIPS - 10.97



**VANTAGE 20 MHz SX  
\$499**

**FEATURES:**

- \* The new INTEL 386 SX 20 MHz processor..... \$599.00
  - \* XT Size
  - Up to 8 Meg onboard memory
  - \* 48 Hour burn-in
  - \* Shadow Ram
  - \* AMI BIOS with built-in Diags
- PERFORMANCE BENCHMARKS**  
LM-25.4, SI-22, MIPS-3.44
- COMPATIBILITY:**  
Same as 386-25

**D. P. DELIVERS**

Here are just a few of the satisfied customers who saved thousands of dollars for their companies by using D. P. COMPUTERS to upgrade their systems:

- \* IBM
- \* ALLIED SIGNAL
- \* NASA
- \* MOTOROLA
- \* U.S. GOVERNMENT
- \* BLUE CROSS/BLUE SHIELD

(801-532-1004)

**D. P. COMPUTERS**

FAX (801-596-1520)

735 So. 400 West, Salt Lake City, UT 84101

We accept COD, VISA, Mastercard or Personal Checks. 30 Day money Back guarantee!

CIRCLE NO. 152 ON FREE INFORMATION CARD

program. With interactive placement, the computer gives suggestions for the best location of the parts, and the designer has the option of accepting or rejecting the placement on a part-by-part basis.

To assist you in placing the components, pcb software provides an interconnectivity pattern on the screen called a ratsnest (Fig. 2). A ratsnest is simply a jumble of skewed lines that show how each part is wired to every other part in the circuit. As a part is moved about on the layout, its attached ratsnest lines follow along with it, expanding and contracting in length like rubber bands.

The concept of the ratsnest is to associate the length of the ratsnest lines with the length of a completed trace. The objective of this procedure is to place the parts so that the ratsnest lines are as short as possible.

Unfortunately, as one component is moved to minimize the length of a group of ratsnest lines, another group of lines is lengthening to accommodate the part's new position. Further complicating the picture is that the ratsnest does not take into account overlapping lines, which may make it difficult or impossible to route the connection, given the components' present layout.

One way pcb programs enhance the use of the ratsnest is to display only the signal paths and hide the power-supply lines. The reduction in the number of lines on-screen can make a seemingly impossible placement job manageable. Moreover, this tactic does not degrade the quality of placement because most multi-layered boards (of four layers or more) reserve the top and bottom layers for the power-supply traces, making power-supply routing independent of signal routing.

At least one pcb program, *OrCAD*, uses a force vector display that tells you in which direction a part should be moved for best connectivity (see Fig. 3). But like the ratsnest approach, moving one part changes the

force vector of another.

Zoom (scaling or magnifying image elements) is provided so that you can focus in on smaller areas of the printed-circuit board for accurate placement. Most programs have autotranslating that automatically moves the board up, down or sideways as you move the cursor beyond the borders of the present screen, but a few require manual scrolling of the screen.

---

### ***Placement Improvement***

---

A few pcb programs have a routine called placement improvement that is used to fine tune the printed-circuit board layout after parts are initially placed. The two most popular improvement techniques are pair swapping and logic-gate reassignment.

Pair swapping seeks to improve part placement through the interchange of neighboring components. If the exchange improves the placement value (i.e., it reduces the trace lengths), the change is made. Otherwise, components are returned to their original positions and a different pair is tried.

Another excellent way to improve pcb layout is by swapping logic gates. As a rule, the gate assignments are made in the schematic capture step of circuit design, with most programs assigning the gates to a package in the order in which they were placed on the schematic. While this ordering is quick and painless at the front end, it is not very efficient. Considerable improvement can be made in parts placement if the gates are grouped for optimum routability.

Some of the better swapping routines also permit pin swapping, which allows you to swap pins with the same function within the same gate. For example, all four input pins of a quad NOR gate are interchangeable. Generally, the program checks the pin exchange and denies swapping of pins with different functions.

However, part and gate swapping

tends to get caught up in local politics that cannot see the forest for the trees. As the distance between parts increases, the likelihood of a distant component becoming involved in a local pair swap decreases dramatically, especially as the process nears completion. One way to eliminate swapping gridlock is to use three-way or four-way interchanges. Instead of two parts exchanging positions, three or four parts are moved as a block, thus minimizing local gridlock.

---

### ***Placement Editing***

---

Placement editing is an inevitable part of designing a printed-circuit board. Even the best pcb designers have to go back to the drawing board at least once discovering that there is no way all the traces can be completed.

As a rule, pcb software lets you do anything you want when it comes to editing component placement. Parts can be moved, rotated, swapped or flipped for placement on the opposite side of the pc board (generally used with SMD devices). A pcb program that does not support all these functions severely handicaps the user.

The better pcb programs also support block editing. Block editing is a very powerful layout tool because it allows you to move several parts at a time without disrupting their relative positions to each other (see Fig. 4). Like single components, blocks can be moved, rotated, swapped or flipped for placement on the opposite side of the printed-circuit board.

Changing case outlines is another editing feature supported by most pcb programs. It is most often used to change DIP devices into SMDs. The change may be to gain board space or update an old design with a new technology.

There are two ways to change a package outline. The first involves going back into the schematic capture program and calling out a different device name for the part. The sec-



ond method has you change the package on the printed-circuit board itself by calling out another outline from the component library. The problem with this is that the pinout of the new outline is not the same as the pinout of the original outline, and you are usually required to manually assign pin numbers and manually reroute all traces to the new package. This method is only good for layouts where the number of packages to be changed is either few or of the same type (memory chips, for example). There are exceptions, though. For example, *Schema* automatically converts pin assignments from DIP to SMD when the case outline is changed.

A few pcb programs support macros. Macros are user-defined keystrokes and/or mouse clicks that are saved to memory so they can be run again. Macros are most effective when shuffling large blocks of memory or interface chips around the board, looking for an ideal location. Most macro software uses a macro recorder that remembers the sequence as you step through it, eliminating the need for you to write programming code.

After the parts are permanently in place, it is often advantageous to reassign their identification nomenclature. It is a lot easier to find *U2* next to *U3* than it is to have it nestled between *U38* and *U39*. Reassigning component identification gives order to the layout.

---

## Trace Routing

---

The next phase is trace routing—placement of copper tracks on the printed-circuit board for electrical connections. Although you can route traces manually, and will probably have to near the end of the job, most pcb programs have autorouter software that does the work for you.

Autorouter software uses the wire list netlist for its input. The autorouter

then compares the placement of the parts on the board to the netlist connections and decides which trace should go where. It makes these decisions using a built-in algorithm.

---

## Autorouters

---

The mainstay of autorouting technology is the Lee algorithm, created by C.Y. Lee in 1961. Sometimes the Lee router is referred to as a maze router or flood router. Another popular router with pcb software is the Hightower or heuristic router.

The Lee router is the more powerful of the two because it lets you enter cost functions that change its routing parameters. For example, if you want all the lines on the front of the board to run horizontally, you tell the router that the cost of a vertical line is very high, and the router will consider a vertical trace only as a last resort, trying all other options first. Other cost functions include maximum trace length, maximum number of *vias* (plate-thru connections from one side of the board to the other) and trace density.

Pcb programs usually refer to the Lee cost functions as strategy. A few examples of the Lee cost function jargon used in pcb software include normal, flexible and extensive. Each term sets a limit on trace routing, and you have to study the user's manual carefully to decipher their actions.

Lee routers have a very high trace completion rate, generally 90% or better. But get ready to pay the price for power. Lee routers are slower than most, and it is not uncommon for the router to spend hours or days on one complex printed-circuit board.

The Hightower router uses a simpler algorithm with fixed parameters. As a result, it runs much faster than a Lee router. What takes a Lee router an hour to do, the Hightower router can do in less than a minute. However, the completion rate is also less, particularly on complex designs.

A few pcb programs support both routers. Typically, you run the Hightower router first to get the bulk of the work done in a short time, then follow up with the Lee router to place the traces the Hightower missed.

---

## Rip-Up Routers

---

The shortcoming of autorouters is that they tend to box themselves in. Without the foresight to see that placing one trace will block the path of another, the program grinds to a halt, with traces left unconnected.

The solution is to use a clean-up router that can get the offending traces out of the way. The two approaches are rip-up and shove-aside.

Rip-up, sometimes called rip-up-and-retry, routers are easier to use and, though costly, not nearly as pricey as shove-asides. They are sometimes included in the pcb program. Generally, though, they are sold as separate programs, ranging in price from several hundred to several thousand dollars. As with schematic capture programs, the rip-up program must support your pcb netlist format before it will work.

The rip-up router works by searching for unconnected traces and looking for a single trace that can be removed to make its completion. The offending trace is first ripped up, the blocked trace is routed, and the program proceeds to find a new path for the deposited trace.

The strength of rip-up routing is that it can achieve very high completion rates, with a good rip-router achieving 100% completion nearly every time. However, few rip-up routers can do the job unassisted. Most require the user to identify which trace is to be removed, after which the rip-up program attempts to make the new connections. Those that can do it alone are costly and very slow.

*(Continued on page 74)*

# What's On WWV

*Demysticizing what you hear on WWV and WWVH broadcasts and a couple of circuits that can make your reception more exciting*

By E. Thomas Hitt III

You can get more than just the voice-announced time of day (Coordinated Universal Time) when you tune to WWV or WWVH on your shortwave radio. You have probably tuned to WWV or WWVH many times to get Coordinated Universal Time, but you probably wondered about what those other whistles, beeps and messages you heard meant. In this article, we will explore just what is on WWV (and WWVH). We will also look at a couple of circuits you can build to help you in further understanding lesser-known features of the broadcast signals.

## Time & Standards

Coordinated Universal Time, also

known as UTC, this is an internationally agreed-upon standard time that is essentially, but not quite, the same as Greenwich Mean Time (GMT) or Zulu (Z). UTC is based on atomic time standards that run at a very constant rate. In fact, these atomic clocks run at a more constant rate than the rotation of the Earth. In contrast, GMT is based on the rotation of the Earth.

The actual standard for time based on the rotation of the Earth is called UT1 and is determined from astronomical observations. UTC and UT1 are usually within less than 1 second of each other. A yearly variation in the difference between the two amounts to about  $\pm 30$  milliseconds, which can be ignored by most people. There also exists a continuous "creep" in the difference between the two

standards because of the slowing of the Earth's rotation. When this slowing causes the difference to reach 1 second, a "leap second" is added to UTC to keep it close to UT1.

Leap seconds must be added every year or so, usually on December 31 or June 30. International agreement makes these dates the first choices, with March 31 and September 30 and any other month the second and third choices. An example of a leap second would be to add 1 second starting at 23:59:60 on June 30 and ending it at 0:00:00 on July 1. Anything that occurs during the leap second is considered to have occurred in June.

Atomic time standards used by WWV are based on the frequency produced by transitions of electrons between two specific quantum levels in cesium-133 atoms. The second

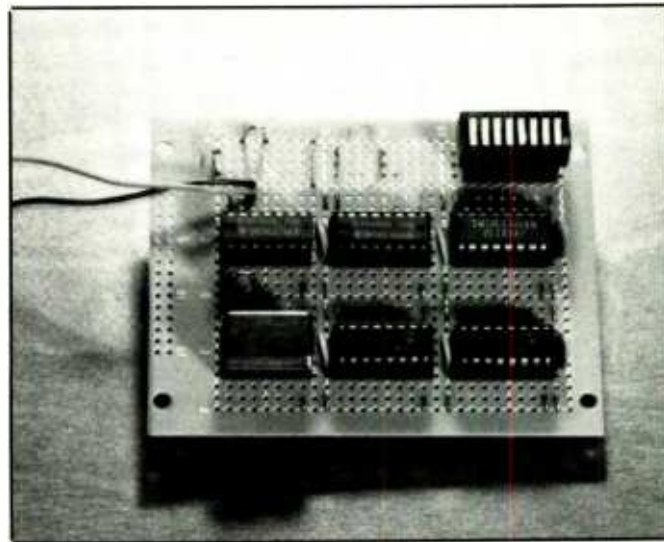
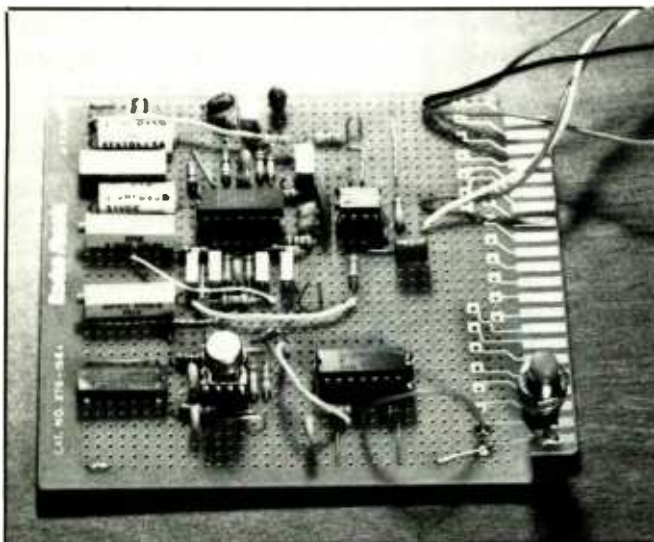

Fig. 1. Two projects built by the author to aid in viewing WWV signals on the screen of an oscilloscope: (A) a band-pass filter and (B) a 1-Hz oscillator.



measured by this type of clock was defined in 1967 by the 13th General Conference on Weights and Measures as the duration of 9,192,631,770 periods of the radiation corresponding to the transition between the two hyper-fine levels of the ground state of the cesium-133 atom. This type of clock is a primary standard and does not have to be checked against another clock. The timekeeping accuracy of the cesium-beam clock is better than one part in  $10^{12}$  (one part in a trillion), or something like comparing a dollar to the national budget.

If you need time based on the rotation of the Earth accurate to within 0.1 second and do not want to bother with decoding a time code sent by WWV or WWVH on a 100-Hz sub-carrier, you can convert UTC to UT1 by listening to the WWV broadcast and counting the double second ticks. The number of double ticks is the number of tenths of seconds that UTC differs from UT1. If the correction is to be added to UTC, there will be up to eight double ticks, starting with the first second of the minute. If the correction is to be subtracted, the double ticks start with the ninth second. For example, if only the first second tick is a double, then 0.1 second is added to UTC to obtain UT1. If the ninth through eleventh ticks are doubled, then 0.3 second is subtracted from UTC.

The second "ticks" you hear are really short tone bursts. WWV sends five cycles of 1 kHz (six cycles of 1.2 kHz for WWVH) at the start of each second, with the exception of the 29th and 59th seconds. The rising edge of the first cycle of the tone marks the beginning of the second. There is a silent period from 10 milliseconds before to 25 milliseconds after each second pulse to keep the other signals sent by WWV from interfering with the second pulses.

Along with the second pulses, two other short tone bursts are worth knowing about—the minute and hour identifiers. The beginning of a

minute is indicated by a 1-kHz tone (1.2-kHz tone for WWVH) that lasts for 800 milliseconds. Both WWV and WWVH identify the start of the hour by a 1.5-kHz tone for 800 milliseconds. The rising edge of the first cycle of these pulses, like the second pulses, corresponds to the start of their respective time periods. These tone bursts can be filtered out of the broadcast, be detected and then be used to trigger events that one wishes to occur on the hour or on the minute.

Three other audio frequencies are broadcast by WWV. For most of the hour, 500- and 600-Hz tones are sent in the first 45 seconds of alternating minutes. WWV sends the 600-Hz tone during even-numbered minutes and WWVH sends them during odd-numbered minutes. The third tone, 440 Hz, is sent for one 45-second period during each hour. This tone is sent by WWV during the third minute after the hour and by WWVH during the second.

These 500- and 600-Hz tones are occasionally preempted for voice announcements to give information on severe weather conditions, geophysical alerts and status reports on the Omega navigation system. Also, station ID transmissions are given on the hour and half hour.

Severe weather information from WWV is transmitted during minutes 8, 9 and 10 and is for the Atlantic and the eastern North Pacific. WWVH provides coverage for the eastern and central North Pacific during minutes 48, 49 and 50. This information is provided because international agreements give the United States responsibility for providing storm warnings in these areas.

These geophysical alerts (Geo-alerts) are broadcast by WWV during minute 18 and give information that is useful in determining radiowave propagation conditions. Geoalerts give such information as:

(1) The 1700Z solar flux measured at Ottawa, Canada at 2,800 MHz and is an indication of solar activity.

(2) The estimated A value for Fredericksburg, VA, which indicates the activity of the earth's geomagnetic field.

(3) The current K-index at Boulder, CO, which is another measure of geomagnetic field activity.

(4) The solar-terrestrial conditions for the previous 24 hours.

(5) The forecast for the next 24 hours.

Omega status information is broadcast by WWV during minute 16 and by WWVH during minute 47. This information is concerned with operation of a long-range navigation system that uses frequencies between 10 and 14 kHz to provide position information worldwide. The information given has to do with which stations are operating, planned maintenance, etc., and is useful to ships and some military aircraft that use the Omega system for navigation.

There are some minutes during which no audio tones or voice announcements are broadcast. These minutes generally correspond to the minutes when the other station is transmitting a voice announcement and is done to keep the tones from WWV from interfering with WWVH voice announcements, and vice-versa. If conditions are right and you listen during one of the quiet minutes, you can hear announcements coming from the other station. Elimination of the audio tone keeps it from interfering with an important voice announcement on the other station.

Another example of trying to keep the two stations from interfering with each other is the timing of the voice announcement of the UTC time. WWVH is the first to make the announcement, starting at 45 seconds and ending at about 50 seconds into the minute. The WWV announcement starts at 52.5 seconds and ends a few seconds before the minute. During the time period when the announcements are being made, both stations cease transmission of the 500- and 600-Hz tones. When propa-

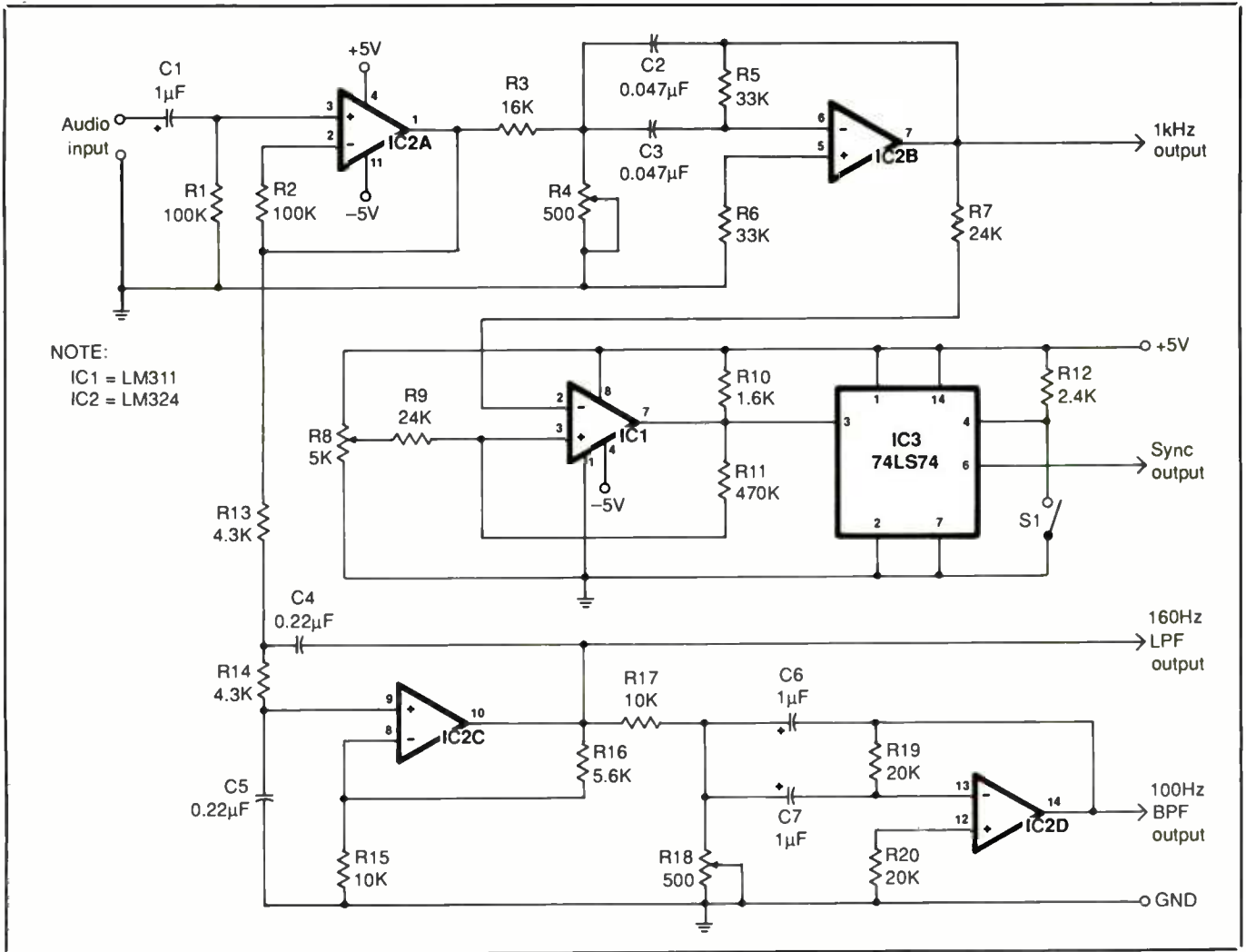

Fig. 2. Schematic diagram for bandpass filter circuit.

gation conditions are right, you can hear the female voice make the announcement from WWVH first and then the male voice from WWV.

The same atomic clocks that keep time at WWV are used to control the frequencies of the transmitters and audio tones. The r-f and modulation frequencies transmitted are guaranteed to be accurate to within one part in  $10^{11}$  and are usually better.

The frequencies you receive are not that accurate because of variations in the propagation path. A change of just 1 foot in path length in 1 second changes transit time by about a nanosecond or one part in

$10^9$ , which is 100 times greater than the variations in the transmitted signal. Even with this reduced accuracy, the received hf signal is good enough to calibrate most receivers and oscillators.

If you have a frequency reference that can approach an accuracy of one part in  $10^{11}$  and want to compare it with the National Institute of Standards and Technology (NIST, used to be called the National Bureau of Standards) reference, you can use the transmissions from hf station WWVB.

This station is also located in Fort Collins, CO, and transmits on a frequency of 60 kHz. Because propaga-

tion is more constant in this part of the spectrum, frequency variations caused by changes are smaller.

Even so, it is necessary to track the phase of the signal for hours or days to be able to compare your oscillator with theirs. This is not a trivial task, but it can give accuracies of one part in  $10^{11}$ . Fortunately, most of us have no need for anything like the accuracy available from WWVB and can stick to using WWV and WWVH.

One of the more interesting and potentially useful signals sent by WWV and WWVH is the time code. This is transmitted using a 100-Hz subcarrier with a code that consists



## WWV Time Standard Plug-In for PCs

A plug-in Model CTS-10 WWV time standard card from Coordinated Time Link, Inc. synchronizes the clocks in IBM PCs/XTs/ATs and compatible computers to the world atomic time standard from WWV/WWVH National Institute of Standards and Technology (formerly the National Bureau of Standards) radio signals to any application running on the PC to provide the correct time. The CTS-10 plugs directly into an open slot in a PC to maintain the computer's clock. It incorporates a radio receiver, digital signal-processing circuitry, bus interface and several proprietary applications on a single board and runs under DOS 2.1 or later. Menu-driven software simplifies installation.

The CTS-10 automatically accommodates daylight saving time, leap year, leap seconds and other anomalies. Time-zone selection, 12/24-hour selection, adjustable on-screen display and color selection are provided. On-board battery back-up maintains correct time during power interruptions, and remote diagnostics (via modem) and a built-in log provide evaluation and troubleshooting capabilities. The user also has a choice of Standard Time or Universal Coordinated Time selection.

Time accuracy is rated to be within 20 milliseconds of Coordinated Universal

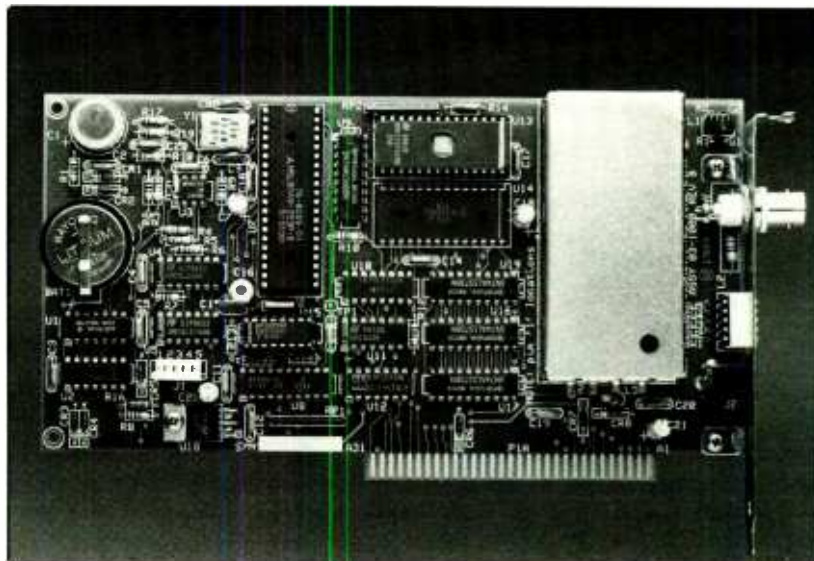

Time, and time to acquire is 3 minutes minimum with strong WWV signals, with 5 minutes typical. The receiver is a single-conversion, crystal-controlled superheterodyne design that operates on 10 MHz with a sensitivity of less than 0.2 microvolt input via its 50-ohm BNC antenna connector.

For interfacing the CTS-10 to the PC, there are 32 port addresses from which to choose, ranging from 207 to 3F7 and four

interrupt levels (IRQ3, IRQ4, IRQ5 and IRQ7). Operation of the card is in polled mode.

Power requirements for the plug-in card are 100 milliamperes at 12 volts dc, from the computer's bus or an external power supply. The card measures 8"L x 5"H x 1"D. Price for the CTS-10 is \$225, and it is available from Coordinate Time Link, 3442 De La Cruz Blvd., Santa Clara, CA 95054 (tel.: 408-980-1305).

of tone bursts of 17 and 47 cycles of 100 Hz to represent 0 and 1, respectively. The actual time data is sent in binary-coded-decimal (BCD) format. Data rate is one pulse per second with the least-significant bit (LSB) of each BCD digit sent first.

One complete frame of the time code is sent each minute. The code contains UTC time, day of the year, whether or not daylight savings time is in effect and a correction for UT1 time. The encoded time is the time at the start of the frame so that once the complete frame is decoded, about 1 minute must be added to obtain current time. The code is sent in groups

consisting of nine data and a position identifier pulses. Data pulses are usually divided into two BCD digits that are separated by a dummy pulse that carries no information.

### *Examining the Signals*

If you are interested in taking a closer look at the second, minute, hour and time code pulses with an oscilloscope, we present here simple circuits you can build to be able to see them better. You might even be able to think of useful things to do with some of these signals. Construction is fairly simple, as can be seen in Fig. 1.

The first circuit, shown schematically in Fig. 2, is a second-order 1-kHz active bandpass filter. This filter has a bandwidth of 200 Hz to make it an approximately matched filter for the 5-millisecond long seconds pulses. Using the radar rule of thumb about the bandwidth being the reciprocal of the pulse-width, a 200-Hz bandpass filter is matched for a 5-millisecond pulse. This filter allows you to use the seconds pulses for synchronizing an oscilloscope.

To use the Fig. 1 circuit, connect the output of the filter to an oscilloscope to view the seconds pulses. Adjust *R2* to tune the filter for the largest

signal excursion on the oscilloscope screen. The filtered pulses do not look like the pulses sent by WWV; they have an approximate Gaussian shape caused by the filtering.

A digital storage oscilloscope would be ideal for examining the seconds pulses, but you can see them reasonably well on a standard oscilloscope. The main advantage of a digital oscilloscope is that it can display what happened just before the sweep was triggered.

The next filter is a 160-Hz second-order Butterworth low-pass section followed by a 100-Hz bandpass section that has a Q of about 6. This filter separates the time code from the other tones. The Q of the bandpass section is fairly low to help reduce ringing of the filter. The schematic configuration for this filter is shown

in the lower part of Fig. 2. To tune this filter, you adjust *R18* for maximum output.

If you use the filtered seconds pulses to synchronize your scope and examine the 100-Hz filter output, you will see the three different 100-Hz pulses lengths. You will also see that the first 30 milliseconds, three cycles of 100 Hz, is suppressed. Depending on reception conditions and other tones that may be present, you might get a better picture of the 100-Hz time-code pulses at the output of the low-pass filter, rather than at the output of the bandpass filter. Because the low-pass filter has a wider bandwidth than the bandpass filter, time-code pulses look more like square bursts of 100 Hz.

Another circuit you will find useful for examining WWV signals is a

1-Hz generator that can be synchronized to the seconds pulses. With this circuit, you can make a standard oscilloscope produce the same type of display of the seconds pulses as you would get from a digital oscilloscope.

The schematic diagram for such a circuit is shown in Fig. 3. This circuit uses a 4-MHz crystal oscillator that is divided to 100 Hz with a string of counters. The decision to use a 4-MHz oscillator was based on crystals I had on hand and selecting a frequency that could be easily divided to 100 Hz with binary and decade dividers. You can use a crystal with a different frequency and modify the divider to obtain a 100-Hz output.

Once it is obtained, the 100-Hz signal goes to the 74LS160A decade counters that are the last two stages in the chain. These counters produce

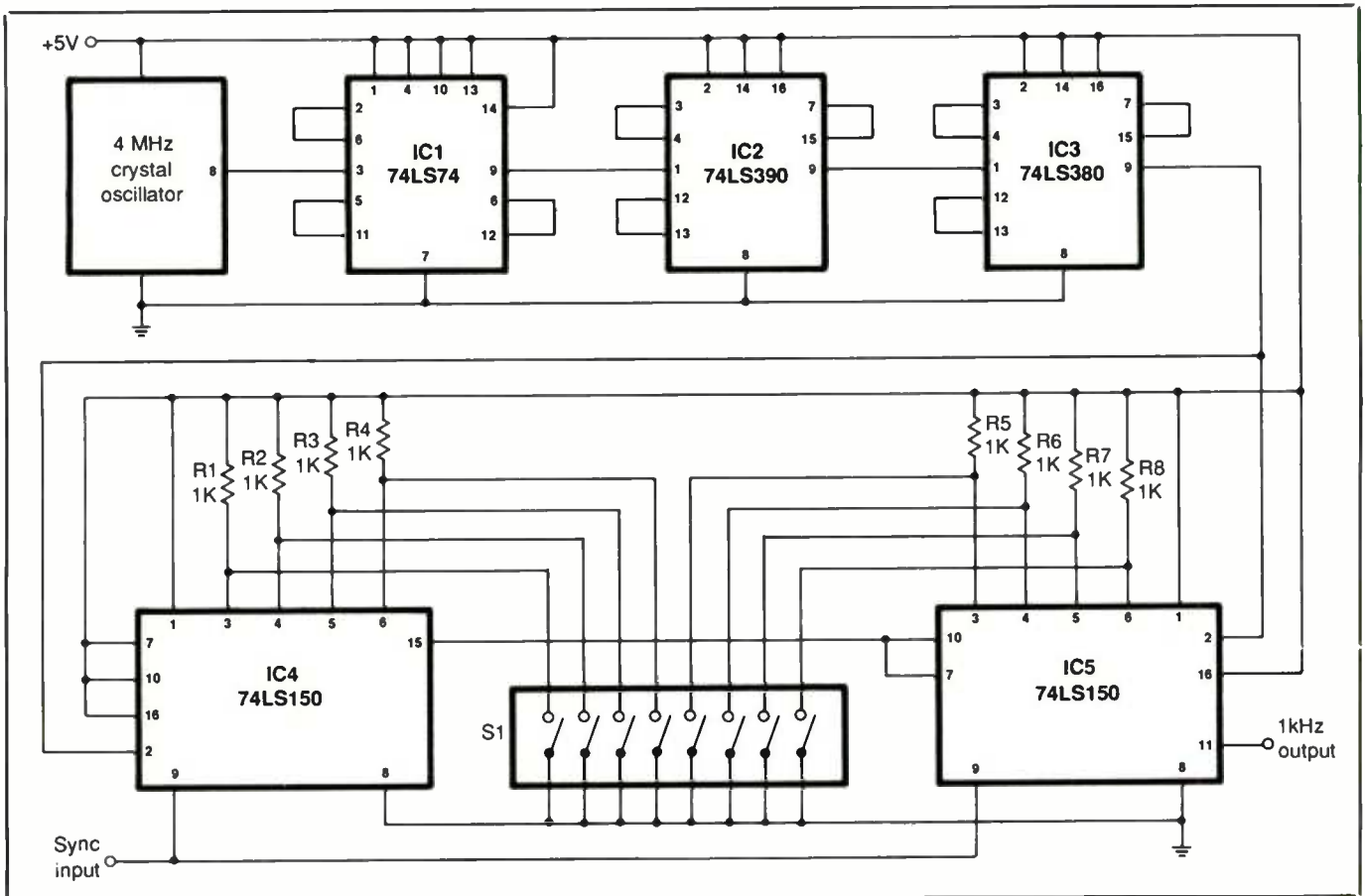

Fig. 3. Schematic diagram for 1-Hz oscillator circuit.



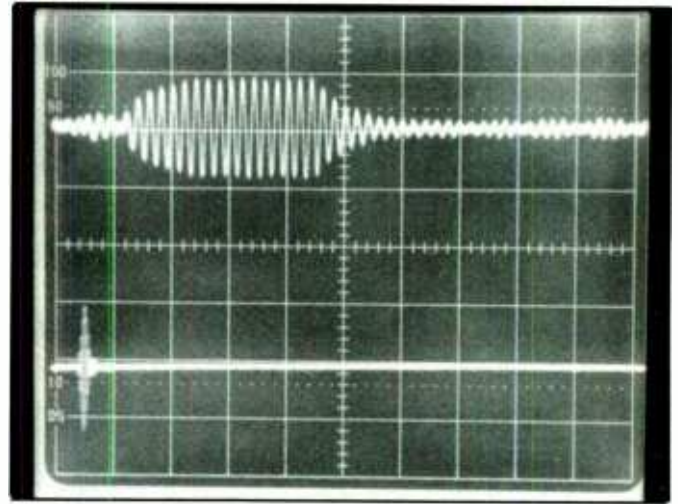
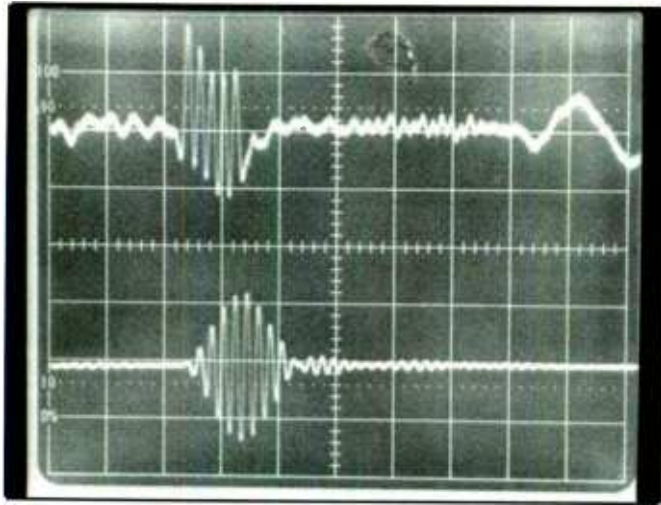

Fig. 4. Screen photos taken using bandpass and oscillator circuits with scope sweep controls set for (A) 5 ms/div. and (B) 50 ms/div.

the 1-Hz output and can be started at a preset count determined by DIP switch *S2*. The crystal oscillator is stable enough to keep the 1-Hz output of the timing generator close to the timing of the seconds pulses for many minutes.

Synchronization of the 1-Hz generator to the seconds pulses is handled by a comparator and D-type flip-flop shown at the top in Fig. 2. The SYNC OUT of the flip-flop connects to the Preset Enable (PE) input of the two 74LS160As and is normally high. This allows the counter to count cycles of the 100-Hz input from the rest of the divider chain. If pushbutton switch *S1* is pressed and released, the output of the flip-flop goes low and causes the 74LS160As to halt and to load the number set via DIP switch *S2*.

When the next seconds pulse arrives, it is converted into a TTL pulse train by the comparator and fed to the Clock (CK) input of the flip-flop. Clocking the flip-flop causes the output to go high again, allowing the 74LS160As to start counting.

If *S2* is set to load 0001 into the first counter and 0000 into the last, it will take 0.99 second (99 cycles of 100 Hz) for the counter to reach a count of 00 again. At this point, output QD

goes low and triggers the oscilloscope. The next seconds pulse arrives 10 milliseconds later and is easily visible on the oscilloscope. Potentiometer *R1* sets the threshold of the comparator so that it responds to the high level of the seconds pulses but not to low-level random noise.

Viewing the signals from WWV with the 1-Hz generator synchronizing the oscilloscope gives you a better idea of what the signals are like. Fig. 4(A) was made with a sweep speed of 5 milliseconds per division. The upper trace shows the seconds pulse directly from the receiver, lower trace the filtered pulse. You can see that the transmitted pulse is square and the filtered one is Gaussian in shape.

The upper trace in Fig. 4(A) also shows the start of a time-code pulse at the far-right. The photo in Fig. 4(B) was made with a sweep speed of 50 milliseconds per division. The upper trace here shows a filtered time-code pulse, the lower trace a filtered seconds pulse.

If you are interested in WWV trivia, the station went on the air in 1923 and is located at 40° 40' 49" N, 105° 02' 27" W, more commonly known as 2000 East County Rd. 58, Fort Collins, CO 80524. The antennas used at WWV are omnidirectional vertical

half-wave dipoles radiating 10 kW on 5, 10 and 15 MHz, and 2.5 kW on 2.5 and 20 MHz.

WWVH went on the air in 1948 and is located at 21° 59' 26" N, 159° 46' 00" W. Its mailing address is P.O. Box 417, Kekaha, Kauai, HI 96752. Radiated power for WWVH is 5 kW on 5 MHz and 10 kW on 5, 10 and 15 MHz. The antennas at WWVH for 5, 10 and 15 MHz are vertical half-wave dipole arrays fed to give cardioid patterns with maximum radiation to the west. The antenna for 2.5 MHz is omnidirectional.

I hope the foregoing has given you a better idea of what is transmitted by WWV and some ideas about making use of the time and frequency information. If you are interested in learning more about WWV, I recommend two references: *Reference Data for Radio Engineers* (Howard W. Sams) and NBS Special Publication 432 titled "NBS Time & Frequency Dissemination Services." The Sams book is probably available in your local library; the NBS publication can be obtained from the U.S. Government Printing Office in Washington, DC or from Frequency-Time Broadcast Services Section, Time and Frequency Division, NIST, Boulder, CO 80302. **ME**

# The Modern Electronics Computer Experimenter Lab

## Part 2 of a Series

### *Build a Dual-Channel Function Generator*

By Martin Meyer

Last month, we presented a Digital Storage Oscilloscope project, which is the heart of our "Computer Experimenter Laboratory." This month, we'll build a Dual-Channel Function Generator that produces sine, square, triangular and ramp waveforms. The system is also capable of generating a wide variety of modulated signals. We include a second channel that generates the same range of sine, triangle and square waves that can be used as a second independent signal source or a means to modulate Channel A.

The system can generate AM-modulated, suppressed-carrier AM modulated, FM-swept or -modulated or FSK-modulated signals that range from 10 Hz to 100 kHz. These signals will be used in lab experiments that deal with analog circuits and sensors that will later be connected to a personal computer.

Next month we'll present an 8088-CPU-based Digital Signal Generator on this same board (left-hand side) that produces up to 20 different simultaneous digital signal trains from a built-in library of experiments or from programs downloaded from an IBM PC or compatible. This generator will have a complete set of 8088 bus signals for use in conjunction with a prototyping station as a base for computer experimenter projects.

Although many people view a PC as a device that is mainly used to manage data, the full power of the



computer can be unleashed when analog events of the real world are connected to it for processing and controlling analog events. Using a PC to manage analog events is the challenge and opportunity of the 90s. This project will help you learn about analog technology necessary to build interfaces that will connect analog sensors and circuits to the PC and PC outputs to analog controls (Fig. 1).

The four instrument amplifiers shown in the block diagram are de-

signed to be connected to sensors that collect analog data. A multiplexer, controlled by the PC, selects which input it wants to read. The multiplexer output feeds various analog circuits, such as filters, sample-and-hold circuits, peak detectors, mathematical operators, digital signal processors and amplifiers. The analog signal is then processed by the analog-to-digital converter, which feeds a parallel input port and, thus, inputs the data to the  $\mu$ P. The data is then



analyzed, compared to other data, re-filtered, etc., as prescribed by the software program.

The values of data collected prompt a response that is output from the computer via an output port to a D/A converter and then, finally, to analog control devices through a power amplifier. The Analog control device could be for a motor, robot, etc. Note that the  $\mu$ P also provides digital control signals that select and direct both input and output signals.

This project will help you learn how to design and use the analog circuits that will attach your  $\mu$ P so that it performs real-world applications, which we all know is analog and not digital. This will enable us to explore the following during this series:

- (1) Velocity and acceleration transducers
- (2) Position and proximity sensors
- (3) Temperature transducers
- (4) Light, color and infrared sensors
- (5) Voice and ultrasonic sensors
- (6) Medical sensors
- (7) Operational amplifiers
- (8) Instrument amplifiers
- (9) Sample-and-hold circuits
- (10) Peak detectors
- (11) Comparators/window comparators
- (12) Power amplifiers
- (13) Servo motors
- (14) Sampling and multiplexing circuits
- (15) Mathematical operator circuits . . . multipliers, adders, etc.
- (16) Filter and signal conditioning circuits
- (17) Signal analysis circuits . . . fast Fourier transforms, etc.
- (18) Stand-alone digital signal processing circuits

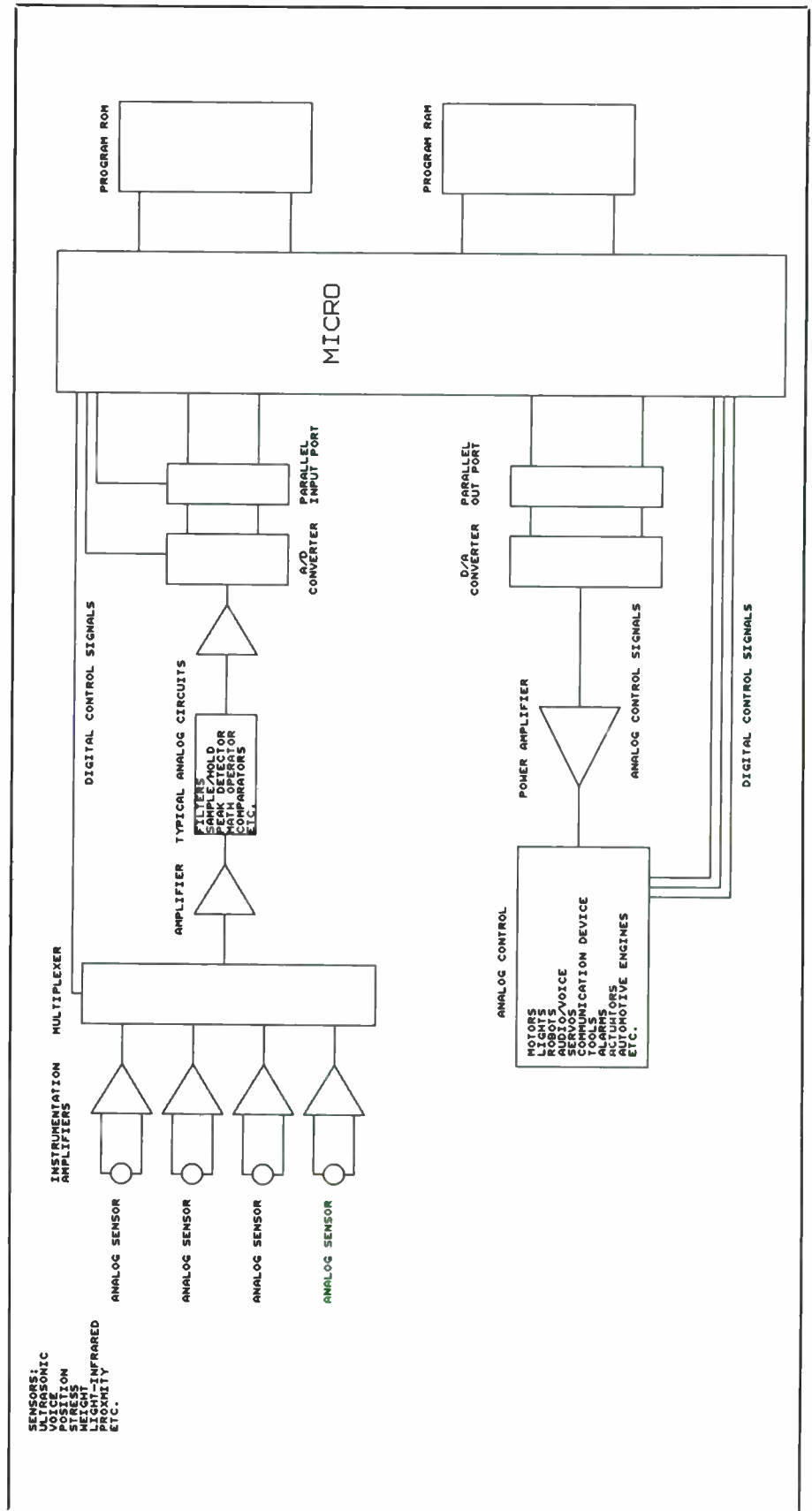

Fig. 1. A typical analog control arrangement using a microprocessor.

- (19) Power supply designs
- (20) Various A/D converters . . . dual-slope, flash, successive approximation
- (21) Various D/A converters . . . including waveform generators
- (22) Transformer designs
- (23) Power control circuits
- (24) Data analysis programming
- (25) Analog control programming

As you can see we have a lot of challenges and enjoyment ahead.

### The Dual-Channel Function Generator

The design illustrated here uses two EXAR XR-2206 monolithic function generator chips. A single chip produces sine, square, triangle and ramp waveforms that can be either amplitude or frequency modulated.

The XR-2206 chip consists of five basic circuits, as shown in Fig. 2. These include:

- **A Voltage-Controlled Oscillator (vco).** This basic emitter-coupled multivibrator produces square-wave and triangle outputs. A simplified schematic diagram of this circuit is shown in Fig. 3(A). Capacitor *C* is alternately charged and discharged through *Q1* and *Q2*. The frequency is determined by current *i*. The output waveform between the transistor collectors is a square wave. The waveform at the emitters is as shown in Fig. 3(B). Note that the triangle waveform is formed by simply subtracting *V2* from *V1*. The value of *i* is determined by external timing resistors *R1* and *R2* in Fig. 2.

Frequency of oscillation is a function of the values of *C* and the timing resistors, using the formula:  $F_o = 1/(RC)$ . Sweep and frequency modulation is controlled by the values of the timing resistors or the voltage at the timing resistor terminals.

- **Vco Current Switches.** As shown in Fig. 2, you can select, via the level at the FSK (frequency-shift keying) in-

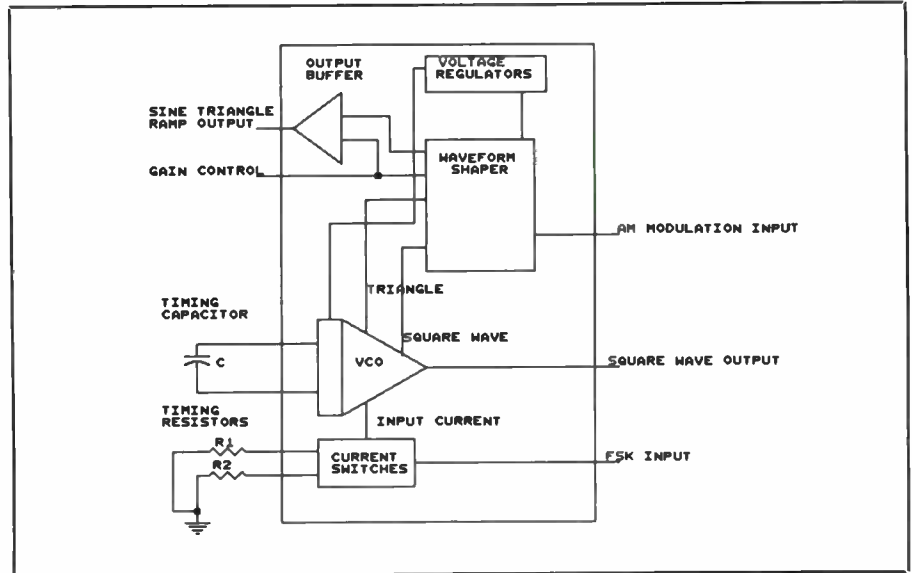

Fig. 2. Internal details of XR-2206 function generator chip.

put, which timing resistor will control the vco. If this input is high, the current switch selects *R1* to control the vco. Conversely, if the FSK input is low, *R2* controls the vco.

- **Sine Waveform Shaper and AM Modulator.** Generating the sine waveform is a little more involved. The sine shaper uses the gradual cut-off characteristics of a basic differen-

tial gain stage (see Fig. 4). As the input triangle waveform reaches the peaks, *Q3* or *Q4* is brought near the cutoff point. This results in the peaks becoming rounded, which creates a waveform that approaches that of a sine wave. With careful matching, trimming of the emitter coupling resistor and current selection, total harmonic distortion (THD) is less

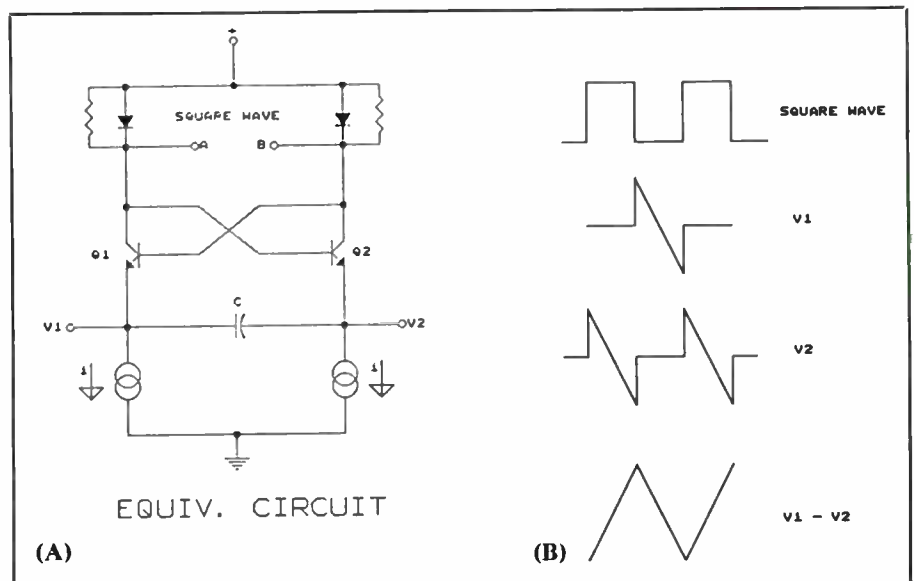

Fig. 3. Simplified diagram (A) of the basic multivibrator used in XR-2206's voltage-controlled oscillator and waveforms (B) at emitters of the transistors.



than 0.5%. AM modulation is also performed in this circuit block. The amplitude of the output varies as a function of the voltage applied to the AM input.

- **Output Amplifier.** The output of the waveform generator is buffered to provide a low-impedance output.

- **Voltage Regulators.** The chip also includes internal voltage regulators that ensure frequency stability and low distortion over a wide range of supply voltages. Basic chip specifications are given in the XR-2206 Specifications table.

### Circuit Description

The printed-circuit board shown in the lead photo includes the circuits of both the Dual-Channel Function Generator and the Digital Signal Generator that will be presented next month. For now, ignore the left-hand side of the photo.

As stated above, the Function Generator is built around two EXAR XR-2206 ICs. The circuits for Channels A and B are identical, except that Channel B has no ramp or modulation circuits, as shown in Fig. 5.

Range selectors *J7* and *J8* permit various timing capacitors to be connected to the vco. Frequencies ranging from 10 Hz to 100 kHz in four steps have been provided for. Provisions are also made for adding an external timing capacitor, via SIGNAL connector *J1*, in the event you wish to extend the range down to 0.01 Hz.

The vco timing resistors are set up to permit approximately a 10:1 range when adjusting FREQUENCY ADJ. controls *R18*, *R19* and *R20*.

Gain (OUTPUT LEVEL) is set by *R21* and *R22*. The triangle and ramp outputs generate a maximum of 6.0 volts peak-to-peak. Maximum sine-wave output amplitude is 2.3 volts peak-to-peak, while square-wave output amplitude is 10 volts peak-to-peak. The 5,100-ohm resistors center the output at the midpoint of the supply voltage.

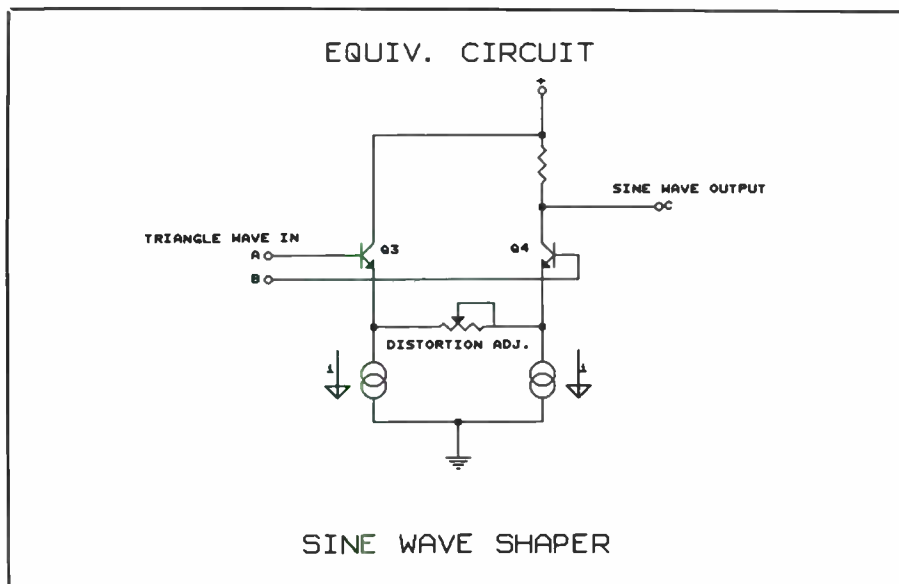

Fig. 4. Sine wave-shaper circuit details for XR-2206 chip.

Each channel has provision for adjusting the balance or symmetry of the output via BALANCE controls *R14* and *R16*. Each also has a control to minimize sine-wave distortion via DISTORTION ADJ. controls *R15* and *R17*. These controls are adjusted while viewing the output on the screen of an oscilloscope.

The Type of signal you wish to generate is selected by configuring mode and output selector jumpers *J2* through *J5*.

Each channel has an output transistor and output level control. The outputs always have a positive dc bias. If you wish an ac-coupled out-

put, simply connect a suitable capacitor between the Generator and load. Select the signal desired by setting the RANGE, MODE and OUTPUT selectors and adjust the output level control for the desired amplitude.

### Tests & Adjustments

Connect the system to a 12-volt power supply (observe correct polarity!). Set RANGE selectors *J7* and *J8* to the 0.1-to-1-kHz range.

Set FREQUENCY ADJ. controls *R18*, *R19* and *R20* fully clockwise. This produces a 1-kHz signal. Set BALANCE and DISTORTION controls *R14*

### XR-2206 Specifications

Sine-wave distortion	<0.5 percent
Temperature stability	20 ppm/°C
Supply voltage	10 to 26 volts
Frequency range	0.01 Hz to 1 MHz
FM distortion	0.1% ± 10% deviation
Amplitude modulation	100
Carrier suppression	55 dB
Distortion	<2% for 95% modulation
Square-wave risetime	<250 ns

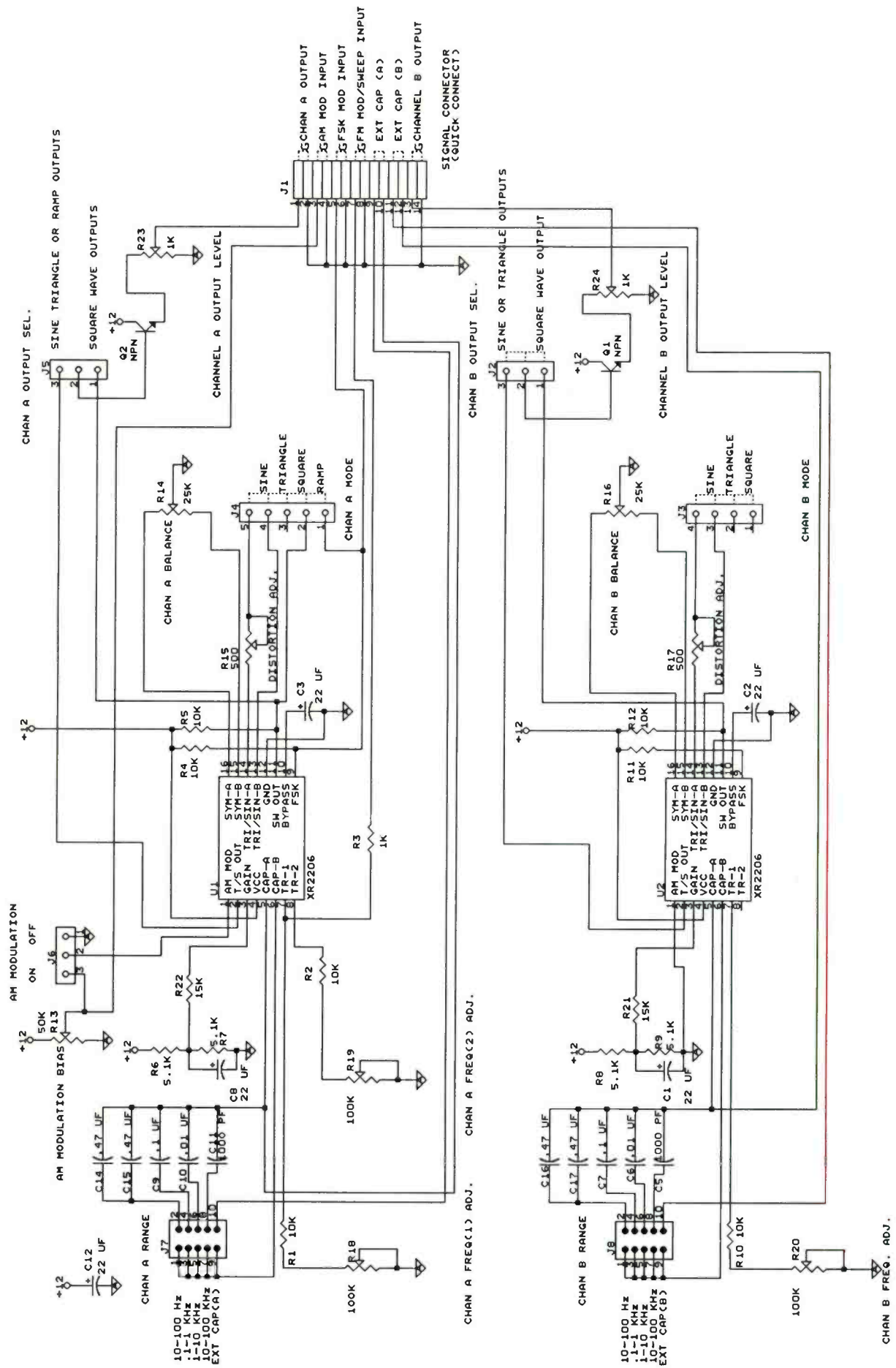



## PARTS LIST

### Semiconductors

U1,U2—XR-2206  
Q1,Q2—Npn silicon transistor

### Capacitors

C1,C2,C3,C8,C12—22- $\mu$ F, 16 volt electrolytic  
C5,C11—1,000-pF  $\pm$  10% disc  
C6,C10—0.01- $\mu$ F monolithic ( $\pm$  10%)  
C7,C9—0.1- $\mu$ F monolithic ( $\pm$  10%)  
C14,15,16,17—0.47- $\mu$ F ( $\pm$  10% Mylar)

### Resistors (1/4-watt, 5% tolerance)

R1,R2,R4,R5,R10,R11,R12 — 10,000 ohms  
R3—1,000 ohms  
R6,R7,R8,R9—5,100 ohms  
R13—50,000-ohm pc-mount potentiometer  
R14,R16—25,000-ohm pc-mount potentiometer  
R15,R17—500-ohm pc-mount potentiometer  
R18,R19,R20—100,000-ohm pc-mount potentiometer  
R23,R24—10,000-ohm pc-mount potentiometer

### Miscellaneous

J1—14-position quick-connect terminal block  
J4—5-position SIP header  
J3—4-position SIP header  
J2,J5,J6—3-position SIP header  
J7,J8—6-position DIP header  
Printed-circuit board; DIP IC sockets (2); jumper shunts (7); suitable chassis box (see Note); machine hardware; hookup wire; solder; etc.

**Note:** The following items are available from Netronics R&D Ltd., 333 Litchfield Rd., New Milford, CT 06776 (tel.: 203-355-2659): Complete kit of parts for Dual-Channel Function Generator, \$69.95 + \$4 S&H; double-sided silk-screened pc board, \$39.95 + \$4 S&H; 5-volt and  $\pm$  12-volt power-supply kit, \$34.95 + \$4 S&H; black steel chassis, \$37.50 + \$4.50 S&H. MasterCard and Visa orders accepted. Connecticut residents, please add state sales tax.

through *R17* to middle of rotation and OUTPUT LEVEL controls *R23* and *R24* fully clockwise for maximum output). Position the MODE-select jumpers *J3* and *J4* for TRIANGLE waveforms and OUTPUT SEL. jumpers *J2* and *J5* to SINE, TRIANGLE OR RAMP so that *U1* and *U2* are set up to produce triangle waves and connect the output terminals to the proper points in the circuit.

Connect an oscilloscope to the CHANNEL A OUTPUT terminals of *J1*. Set the scope's timebase to 0.1 ms/div. and vertical input to ac-coupled at 1 volt/div. You should now see a triangular waveform displayed on the CRT screen. Adjust vertical gain and position controls to center the displayed waveforms.

Now adjust BALANCE controls *R14* and *R16* for a symmetrical signal. To do this, rotate the controls from one end to the other. Note the points at which clipping occurs when you leave the center location. Set both channels so that the controls are midway between the points at which clipping begins. Output amplitude should be approximately 6.0 volts peak-to-peak.

Connect the scope to the CHANNEL B OUTPUT of *J1* and repeat the above procedure for Channel B. Figure 6(A) shows the waveform you should obtain during this procedure.

Change MODE selector *J3* to generate sine waves. Now adjust DISTORTION ADJ. control *R17* to obtain a balanced sine wave, as shown in Fig. 6(B). Note that when this control is set fully clockwise, the displayed signal waveform approaches a triangle; when it is set fully counterclockwise, the amplitude drops to a very low level. Set *R17* close to middle of rotation and OUTPUT LEVEL control *R24* for an approximately 2.5-volt peak-to-peak signal excursion.

If you have a distortion analyzer, you can set these controls using it. Before continuing, try all range, frequency and output level controls on both channels. Note that the Channel

A FREQUENCY ADJ. control *R19* has no effect on the displayed waveform at this time.

Once all the adjustments have been made, you can test the square, ramp and various modulation signals. Set OUTPUT SEL. jumpers *J2* and *J5* and MODE jumpers *J3* and *J4* to the SQUARE-wave positions and RANGE jumpers *J7* and *J8* to the .1-1-KHZ position. With OUTPUT LEVEL controls set to maximum, the output should be a square wave at 10 volts peak-to-peak, as shown in Fig. 6(C).

Next, set Channel A MODE jumper *J4* to RAMP and OUTPUT SEL. jumper *J5* to SINE, TRIANGLE OR RAMP. Set CHAN A FREQ(1) and CHAN A FREQ(2) controls *R18* and *R19* for minimum frequency. Observe that the Channel A output waveform is close to a triangle shape. Now advance *R18* to the maximum-frequency position. The signal generated will be an inclining ramp, as in Fig. 6(D). Advancing *R19* and decreasing *R18* will generate a declining ramp. The ratio of rise-to-fall time should be 10:1.

A frequency-modulated (FM) signal is generated when the current controlling the vco is changed. To demonstrate, this set Channels A and B to generate 1-kHz and 500-Hz signals, respectively. Connect a 0.22- $\mu$ F capacitor from the output of Channel B to the FM MOD input at *J1*.

Start with the CHANNEL B OUTPUT LEVEL control at zero. Set your scope to display eight to ten cycles of the Channel A signal. Now slightly increase the Channel B output. Note the frequency of the carrier (Channel A) shifts to generate a signal that is both higher and lower in frequency than the original carrier-signal frequency, as shown in Fig. 6(E). The frequency shifts because the voltage from Channel B changes the current at pin 7 of *U1*. This has the same effect as varying the resistance of *R18*.

An amplitude-modulated (AM) signal is generated by changing the voltage at pin 1 of *U1*, as illustrated in Fig. 7. This results in changes in

Fig. 5. Complete schematic of Dual-Channel Function Generator circuitry.

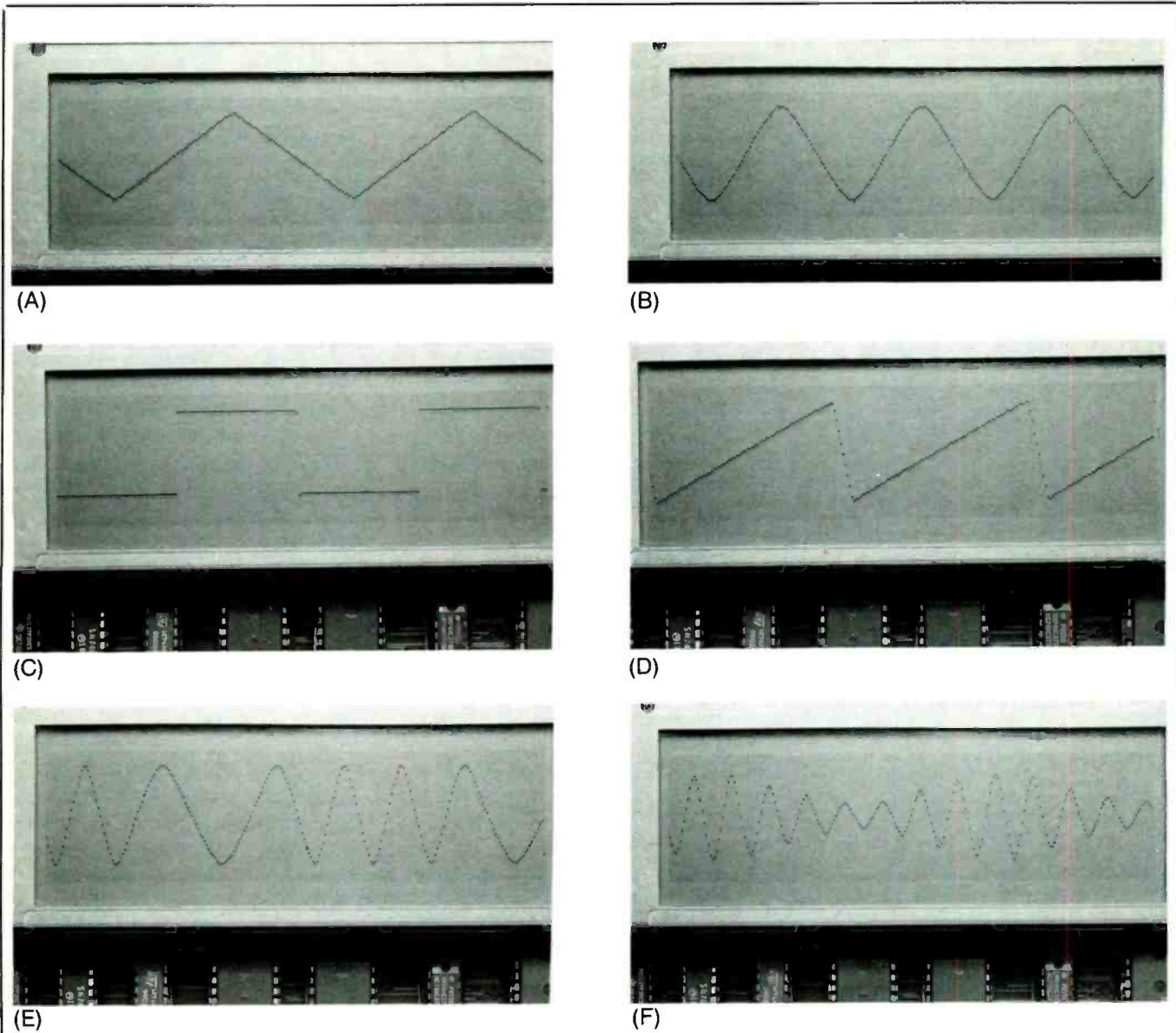

Fig. 6. Scope displays of Function Generator's: (A) triangle, (B) sine, (C) square, (D) inclined-ramp, (E) FM-modulated and (F) AM-modulated waveforms.

the output voltage. When carrier Channel A is not being modulated, pin 1 of *U1* is connected to ground. This produces the maximum output. When the carrier is to be modulated, you inject a bias voltage via *R13* into pin 1 of *U1*. If you set the bias to 4 volts, using AM MODULATION BIAS control *R13*, the carrier output will be reduced by 50%.

If you connect the modulating signal to pin 1 of *U1*, to permit you to

vary this input from 2 to 6 volts, the output of the carrier will vary from full to zero, as illustrated in Fig. 7.

To test this feature, set carrier Channel A to 1 kHz and for a sine-wave output. Set OUTPUT LEVEL control *R23* for maximum amplitude. Place the jumper on *J6* to select ON. Now adjust AM MODULATION BIAS control *R13* about a quarter turn from the minimum (CCW) position, so that 4 volts is applied to pin 1 of

*U1*. If you do not have a voltmeter, set *R13* so that the carrier is reduced by 50 percent.

Now adjust the Channel B output for a frequency of about 300 Hz. Connect the CHANNEL B OUTPUT to the AM MOD INPUT terminal through a 0.22- $\mu$ F capacitor at *J1* and adjust the Channel B output until the carrier changes amplitude, as in Fig. 6(F).

To Experiment with suppressed-carrier AM modulation, disconnect  
(Continued on page 75)



# A Shocking Offer!

Now for the first time in CIE's 56 year history you do not have to be enrolled at CIE to receive our introductory Electronic and Electricity Lesson Modules. Available for a limited time to non-students for the shockingly low price of only \$99.50.

With CIE's patented AUTO-PROGRAMMED method of learning you'll quickly learn and then master the basics of electronics and electricity and then move on to... DC/AC circuit theories, fundamentals of bi-polar junction transistors (BJT), field effect transistors (FET), wiring, diagram and schematic readings, component identification, soldering techniques... and much, much, more.

Your commitment to CIE ends with your payment, but CIE's commitment to your success just begins when you receive your

39 lessons, exams, binders and equipment. This special introductory price includes all the benefits and assistance CIE normally extends to its students and graduates. You'll be entitled to unlimited access to CIE's faculty and staff to assist you in your studies via a toll free 800 number six days a week, 24-hour turnaround on grading your submitted exams, CIE Bookstore privileges, a patented learning method, reference library, a student, faculty

and alumni electronic bulletin board and a free issue of CIE's school newspaper The Electron. All this knowledge and support will put you on the road to understanding digital electronics, microprocessing principles, computer systems, telecommunications, and much, much, more.



**All This and Much More  
For ONLY!**

# \$99<sup>50</sup>

- Free issue of The Electron
- Build your personal burglar alarm
- Instructors available 6 days a week
- 20 lesson books containing 39 theory and hands-on training lessons and exams.

- Bookstore Privileges
- Patented Learning Method
- Electronic Bulletin Board
- 24-Hour Grading

Yes, send me CIE's 39 Introductory Electronic and Electricity Lessons and Equipment.

Name: \_\_\_\_\_

Address: \_\_\_\_\_

City: \_\_\_\_\_ Apt. #: \_\_\_\_\_

State: \_\_\_\_\_ Zip: \_\_\_\_\_

Age: \_\_\_\_\_ Phone ( \_\_\_\_\_ ) \_\_\_\_\_



**BOOKSTORE**

1776 East 17th Street  
Cleveland, Ohio 44114  
(216) 781-9100

BK01

Total Merchandise: ..... \$99.50

Ohio Residents add 7% Sales Tax: \_\_\_\_\_

California Residents add 6-1/2% Sales Tax: \_\_\_\_\_

Total this order: \_\_\_\_\_

Method of Payment: Amount Enclosed . . . \$ \_\_\_\_\_

Personal Check or Money Order

Master Card  Visa

\_\_\_\_\_

Card Expiration Date: \_\_\_\_\_

Signature \_\_\_\_\_



**CHARGE BY PHONE!**



9 AM to 4:30 PM Eastern Time; from Ohio 1-800-523-9109  
from all other states 1-800-321-2155

# An LCD Digital Compass

*Built around a sensitive miniature magnetic sensor, this compass uses a microcontroller and other computer circuitry to display headings on a liquid-crystal display panel*

By Steve Sokolowski

In the August issue, we introduced you to a device called a Digital Compass Sensor made by Dinsmore Instrument Co. of Flint, MI. This tiny sensor that accurately detects and measures the minute geomagnetic field of the Earth was the heart of an electronic compass that displayed compass headings via discrete light-emitting diodes. This time around, we use the same sensor in a more sophisticated electronic compass that uses computer circuitry to display compass headings in plain-English legends on an inexpensive LCD panel.

Our Digital Compass uses a commonly available microcontroller and support RAM and EPROM chips to display the eight cardinal compass headings in the display. The Compass is designed to work on dc power, making it ideal for installation in any motor vehicle, boat or airplane that provides a source of clean 12-volt dc power (an automobile's cigarette lighter will do fine).

## About the Circuit

To make this discussion of the Digital Compass as easy as possible to follow, the schematic diagram is shown here in a series of five function blocks. Each builds on the preceding block discussed.

Shown in Fig. 1(A) is the schematic diagram for the microcontroller and RAM and EPROM portion of the



project. Controller IC1 can be an 8052AH BASIC or 80C52. Static RAM to the tune of 8K is provided by IC4. The chip that holds the compass program is IC5. Details for connection of this chip into the previous circuit are shown in Fig. 1(B).

Because the 8052 chip operates with BASIC-type program material, a means of translation into "computer talk" must be provided. This internal translation program is called a BASIC interpreter, which occupies almost all available on-chip memory space. Hence, additional external

memory must be provided. In Fig. 1, IC3 provides this additional memory. (For an in-depth look at how the 8052 chip and its associated components operate, see "Microprocessor Control with BASIC" in the April and May 1989 issues of *Modern Electronics*.)

Figure 1(C) shows the details for wiring the Hitachi LCD module used to display Compass information to the 8052 chip at address 4000 hex. The Hitachi module is a 1-line by 16-character device that displays more than 100 numerals, alphabetic char-



# RADIO SHACK PARTS PLACE

SM

## YOUR SOURCE FOR PROJECT AND REPAIR ESSENTIALS

### PARTS HOTLINE

Your nearby Radio Shack store has a huge selection of popular electronic components. Plus, we can special-order 10,000 items from our warehouse—ICs, tubes, semiconductors, phono cartridges and styli, even SAMS® manuals. Service is fast and there's no minimum order or postage charge.

### BATTERY HOTLINE

In addition to our large in-store stock, Radio Shack can now supply almost any currently manufactured consumer-type battery—for cordless phones, computer memory, camcorders, transceivers, pagers and more. No postage charge!



**1991 Semiconductor Reference Guide.** A "must" for electronics building and repair. This new edition gives you a 95,000-item semiconductor substitution guide plus detailed data on Radio Shack ICs, SCRs, LEDs, diodes, transistors and optoelectronics. #276-4014 ..... 3.99

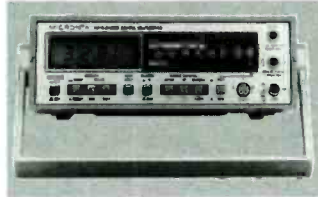

**Bench/Portable LCD Digital VOM.** Our best multimeter! Displays transistor gain directly and has diode-check, memory and continuity functions. Autoranging or manual modes. Measures to 1000VDC, 750VAC, 10 amps AC/DC and resistance. #22-195 ..... 99.95

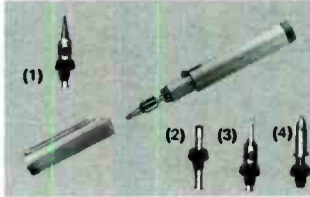

**4-in-1 Soldering Tool.** Operates anywhere on standard butane lighter fuel. Refills in seconds. #64-2161 ..... 29.95  
**(1) 1.0 mm Tip.** #64-2163 ..... 9.95  
**(2) Blow Torch Tip.** #64-2168, **(3) Heat Blower.** #64-2169, **(4) Hot Knife.** #64-2170 available on special order ..... Each 9.95



**Bright Krypton Bayonet-Style Lamps for Flashlights.** Use in place of standard lamps for super brightness. For example, K4 replaces standard PR4. Each 79¢

Type	Volts	mA	Cat No
K4	2.33	480	272-1169
K1	2.4	600	272-1156
K2	2.4	830	272-1157
K3	3.6	800	272-1158
K15	4.8	700	272-1162
K12	6.0	650	272-1163
K18	7.2	700	272-1164

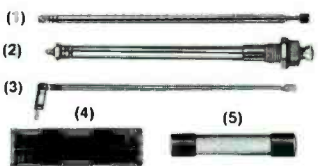

**Replacement Rod Antennas.** For cordless phones, radios, portable stereos, walkie-talkies and your own custom projects. 16 styles in stock!  
**(1) 30 1/2".** #270-1401 ..... 2.99  
**(2) 13".** #270-1407 ..... 2.79  
**(3) 23 1/8".** #270-1417 ..... 3.49

**Battery Holders.** Ideal for projects, for replacement or for building external power packs. Our store near you has 15 different styles in stock!  
**(4) Holder for 8 "AA" Cells.** 9V-type snap connector. #270-407, 1.29

**Replacement Fuses.** For appliances and vehicles. Over 60 values in stock!  
**(5) 10-Amp Fuse for Microwave Ovens.** #276-1256 ..... Pkg. of 2/1.29

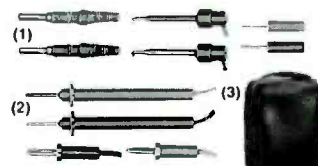

**(1) Mini-Clip Test Leads.** 48" long. Mini test clip at one end, banana plug at the other. Includes pin-type plug adapters. #278-1160 ..... Pair/3.99  
**(2) Test Probes With Coiled 6-Ft. Leads.** #278-750 ..... Pair/4.99  
**(3) Deluxe Soft Carrying Case.** Perfect for multimeters. #22-149 ..... 7.95

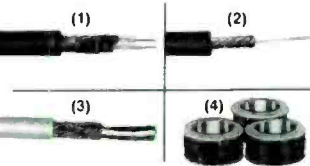

**(1) Dual Mike Cable.** For balanced hookups. 30 ft. #278-1281 ..... 19.95  
**(2) Super-Flex Mike Cable.** Extra-supple. 30 ft. #278-1282 ..... 14.95  
**(3) 4-Conductor Double-Shielded Cable.** 30 feet. #278-777 ..... 7.95  
**(4) Magnet Wire Assortment.** 22, 26, 30 gauge. #278-1345 ..... 4.99



**Mercury Bulb Switch.** Just the thing for experiments and alarms. Contacts rated 5 amps at 125VAC. Style may vary. #275-027 ..... 1.29



**Surface-Mount Resistors.** 200-piece assortment! Popular values, rated 1/8 watt, 5%. #271-313, Set 4.99



**Six-Outlet Power Strip With Spike Protector.** Noise filter, breaker. Rated 15A. #61-2780 ..... 29.95



**(1) Precision Thermistor.** Range: -50 to +110°C. #271-110 ..... 1.99  
**(2) High-Speed 12VDC Motor.** Up to 15,200 RPM at no load. About 2" long (with shaft). #273-255 ..... 2.99  
**(3) 12VDC Brushless Micro Fan.** Ideal for cooling mobile equipment and hum-sensitive circuits. 4.6 CFM, 150 mA. #273-244 ..... 17.95

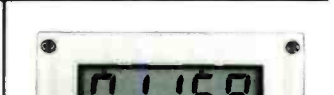

**Electronic Counter Module.** Pre-wired! Great for a traffic or event counter. Counts up to 99,999. Advanced (or reset) by external switch closure or digital circuit. Accepts count rate up to 7 Hz. Has 1/2" liquid crystal display. Requires "AA" battery. Low current drain—only 4 µA. With data. #277-302 ..... 16.95



**10-Amp Plug-In DPDT Relays.**  
**With 12VDC Coil.** #275-218, 5.99  
**With 125VAC Coil.** #275-217, 5.99  
**Relay Socket.** #275-220, 1.79



**Piezo Speaker.** Only 1 3/32" dia. by 5/64" thin. This high-efficiency device can be driven by ICs. 500 Hz to 20 kHz. 1200 ohms. #273-091 ..... 2.49

Since 1921 Radio Shack has been the place to obtain up-to-date electronic parts as well as quality tools, test equipment and accessories at low prices. Over 7000 locations to serve you—NOBODY COMPARES

Prices apply at participating Radio Shack stores and dealers. Radio Shack is a division of Tandy Corporation

**Radio Shack**  
**AMERICA'S TECHNOLOGY STORE™**

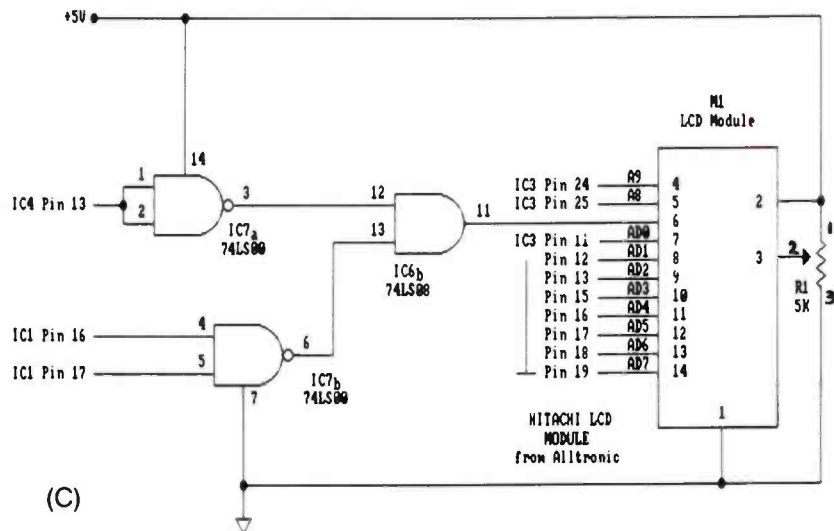
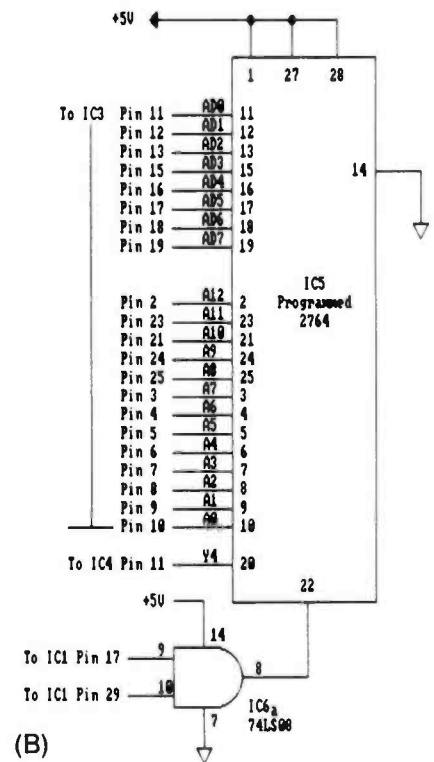
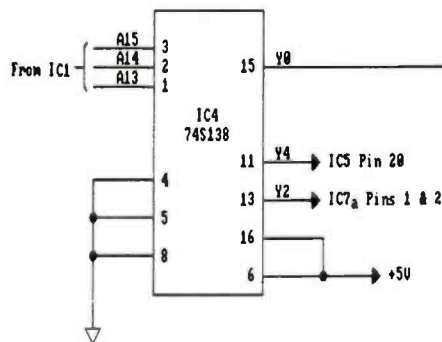
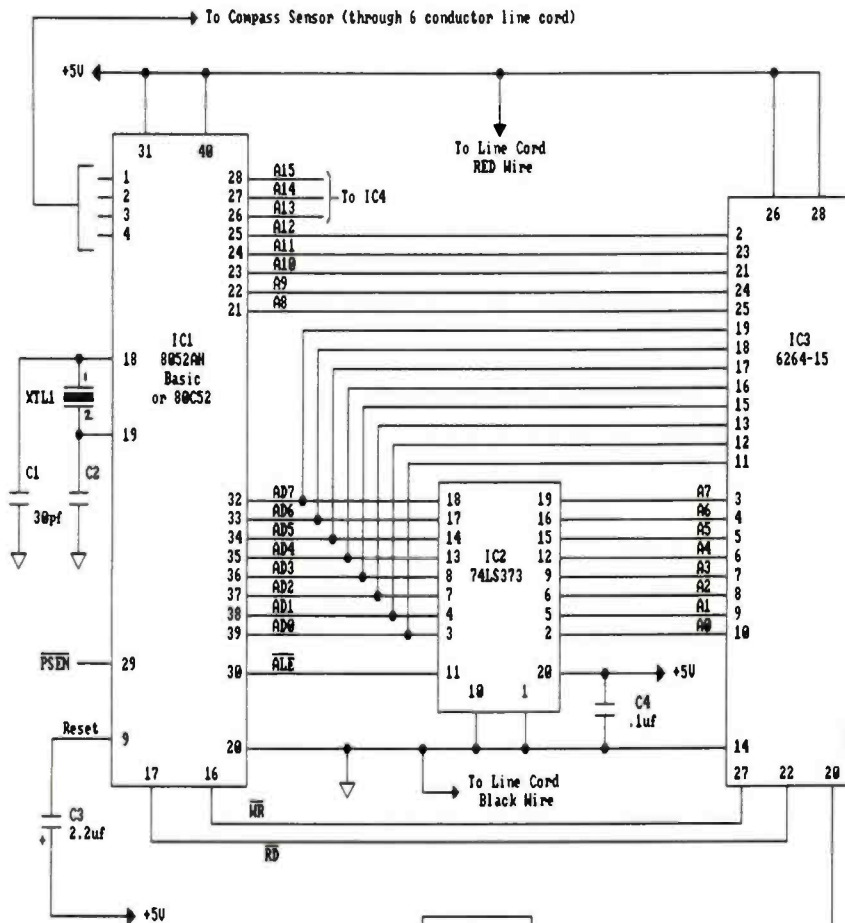



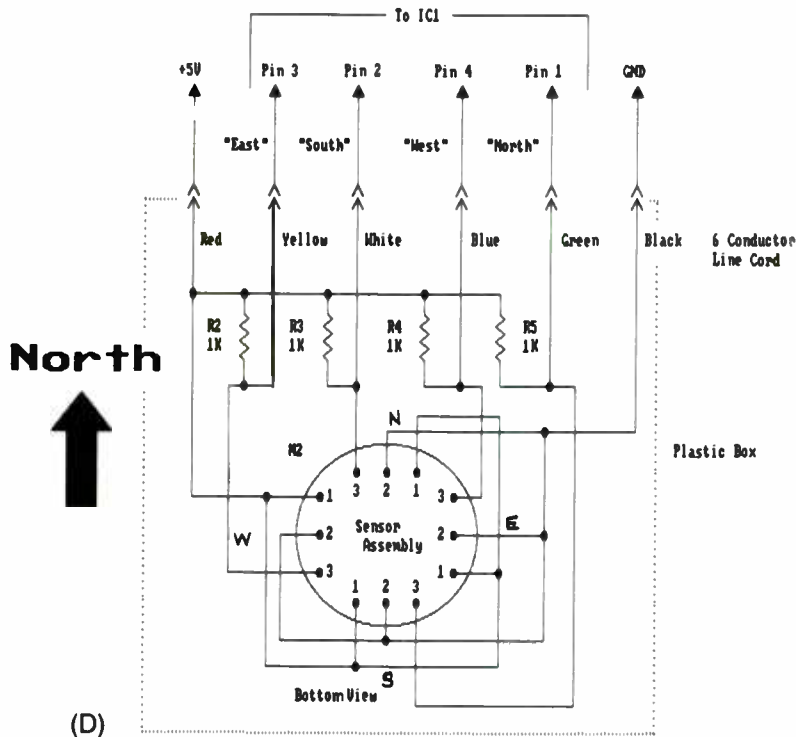

(D)

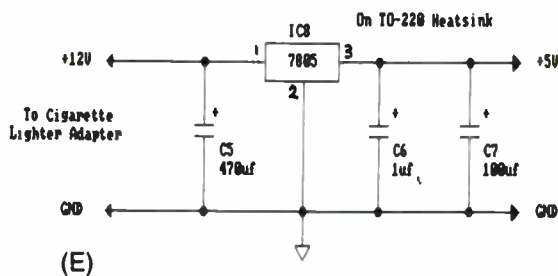

(E)

### PARTS LIST

#### Semiconductors

- IC1—8052AH-BASIC or 80C52 micro-controller (see text)
- IC2—74LS373 octal D-type latch
- IC3—6264-15 SRAM
- IC4—74S138 3-to-8-line decoder/demultiplexer
- IC5—2764 EPROM (programmed—see text)
- IC6—74LS08 quad 2-input AND gate
- IC7—74L00 quad 2-input NAND gate
- IC8—7805 fixed +5-volt regulator

#### Capacitors

- C1, C2—30-pF ceramic disc
- C3—2.2-µF, electrolytic
- C4—0.1-µF ceramic disc
- C5—470-µF, 35-volt electrolytic
- C6—1-µF, 16-volt tantalum
- C7—100-µF, 16-volt electrolytic

#### Resistors (1/4-watt, 5% tolerance)

- R2 thru R5—1,000 ohms
- R1—5,000-ohm, pc-mount trimmer potentiometer

#### Miscellaneous

- DET1—Dinsmore magnetic sensor (see text)
  - M1—LCD module (see text)
- Printed-circuit boards or perforated boards with holes on 0.1" centers and suitable Wire Wrap or soldering hardware (see text); sockets for all DIP ICs; suitable enclosures (see text); six-conductor cable (see text); twisted-pair automotive cigarette-lighter adapter cord; double-sided thick foam tape; tape labeler; hookup wire; solder; etc.

**Note:** The following items are available from Suncoast Technologies, P.O. Box 5835, Spring Hill, FL 34606: 80C52, \$27.50; programmed 2764 No. COMP-1 for Hitachi or No. COMP-2 for Philips LCD module, \$7.50; Dinsmore sensor, \$15; 6-ft. six-conductor cable, \$1.50; all of preceding items (with choice of 2764), \$49.50. Include \$2.50 P&H per order. Florida residents, please add state sales tax.

LCD modules are available from Alltronics Electronic Surplus, 2300 Zanker Rd., San Jose, CA 95131; tel.: 408-943-9776.

acters and mathematical symbols. It uses a 5 × 7-dot matrix format to create displayable characters.

Wiring for the Dinsmore Compass Sensor is illustrated in Fig. 1(D). Mounted in its own plastic box with an attached six-conductor cable, the sensor connects directly to the PORT1 terminals of the 8052 computer chip. Not having a tri-state output of its own, the Compass sensor cannot be connected directly to the data line of the 8052. Therefore, it requires an interfacing chip, such as the 74245 octal bus transceiver. To keep the wiring and cost as low as possible, the sensor is connected to pins 1 through 4 of IC1.

Also note in Fig. 1(D) that the normal "up means north" does not apply in this case. North is at the bottom of the sensor, south at the top, east on the left and west on the right.

Through closer examination of Fig. 1(D), you will notice that all pins 1 of the sensor are tied together, as are all pins 2. To provide power for operation of the compass, +5 volts is delivered to all pins 1, as well as one side of load resistors R2 through R5. Being that the four outputs of the sensor are open-collector, a load resistor must be included to permit the outputs to swing freely between normal logic 1 and logic 0. The four pin 2 termination points are connected to the common ground of the circuit. Because the Dinsmore sensor is a voltage-sensitive device, incorrect voltage polarity on pins 1 and 2 can destroy the sensor.

Schematic details of the simple power supply needed by the Digital Compass are shown in Fig. 1(E). Because the Compass is most likely to be installed in a vehicle, termination of the cable to the input of the power supply should be a cigarette-lighter adapter.

Voltage regulator IC8 in Fig. 1(E) steps down the incoming +12 volts from the electrical system of the vehicle to the +5 volts required by the Digital Compass circuitry. This 7805

Fig. 1. Complete schematic diagram of Digital Compass circuitry is shown in five parts to simplify wiring and understanding of its operation.

	D3	D2	D1	D0	Decimal Equiv.
North	●	●	●	○	254
South	●	●	○	●	253
East	●	○	●	●	251
West	○	●	●	●	247
North East	●	○	●	○	250
North West	○	●	●	○	246
South East	●	○	○	●	249
South West	○	●	○	●	245

● = Logical "1" or + Voltage

Fig. 2. Relationships of binary-coded output from sensor to eight cardinal compass headings.

Fig. 3. Wiring details for six-conductor cable that ties sensor to main circuit-board assembly.

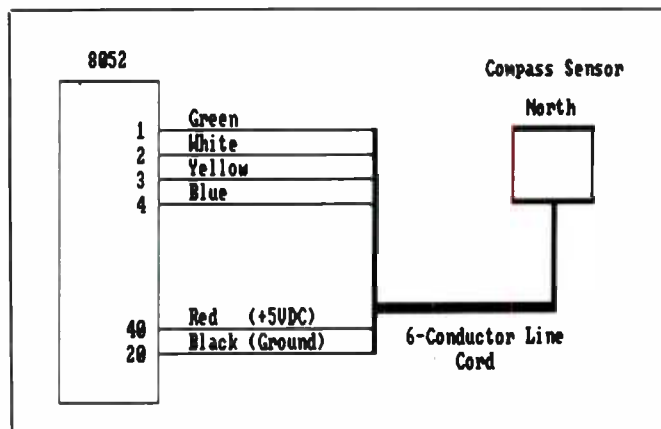

regulator normally becomes hot while the project is in use. Therefore, to prevent destruction of IC8 due to heat, a heat sink must be used.

Operation of the Digital Compass is relatively simple and straightforward. By applying any one of the eight binary codes available at the output of the compass sensor (see Fig. 2) to the PORT1 pins of the 8052 chip, the program stored inside the 2764 EPROM converts the code into its equivalent compass heading. The heading is then displayed on the LCD Module. Figure 3 shows all eight compass headings that can be sensed by the Dinsmore sensor. Each displayed heading is centered in the display and remains there until the Compass senses a change in direction. When a new heading is sensed, it replaces the old one.

### Construction

This Digital Compass is obviously a complicated device that uses some sophisticated components. Therefore, before discussing actual construction, we digress for a moment to consider availability of some specialized components. The following

should help you obtain fairly inexpensive components while maintaining high quality. Except for the 8052 and the programmed EPROM, B.G. Micro of Dallas, TX can supply all ICs used with the Digital Compass. The 6264-15 memory chip, sold by other companies for as much as \$9, is available from B.G. Micro for \$1.40 each.

The 80C52 is a pin-for-pin substitute for the 8052AH BASIC. The "C" in its part number stands for the CMOS technology used in fabricating the chip, which allows this processor to run cooler and draw less current than the standard Intel 8052AH BASIC part. The 80C52 and required EPROM can be purchased from Suncoast Technologies, Spring Hill, FL. Two versions of the EPROM are available. Version 1 is for use with the Hitachi LCD Module, Version 2 for use with the Phillips Module. Though the two LCD modules may look alike, each has different initialization programming and character display requirements. So when ordering the EPROM, indicate which LCD Module you will be using.

You can purchase the Hitachi LCD from Alltronics, San Jose, CA

for about \$8, though the company has a \$12 minimum per-order charge. If you prefer, you can purchase a Philips LCD module from Digi-Key Corp. for \$18.40. If you decide to use the Philips module, you *must* also purchase EPROM COMP-2 from Suncoast Technologies.

Now that the component-availability issue has been taken care of, let us proceed to construction details for the Digital Compass.

There is nothing critical about component layout or routing of conductors. If you are ambitious, you can design and fabricate a printed-circuit board on which to mount and wire together the components. Such a pc board would be very complex, however, due to the large number of conductors that must be routed between various components. Therefore, a more practical approach would be to use perforated board that has holes on 0.1-inch centers and measures 6 × 4½ inches and suitable Wire Wrap or soldering hardware.

Plan component layout carefully, with an eye toward neatness and minimizing the lengths of conductor runs. Though there is nothing critical with regard to locating the various



## Master Wiring List\*

components and running wires between them, keep the assembly neat and make wire runs as short and direct as possible.

Once you know how you want the board to lay out, begin construction by mounting the various IC sockets and fit the other components into place to produce a neat layout without crowding that can lead to wiring errors. Do *not* plug the ICs into the sockets until after you have run preliminary voltage checks and are certain that the circuit-board assembly has been properly wired. Plug regulator *IC8* directly into the board

Before you begin interconnecting the various components, make a photocopy of all sections of Fig. 1 and the Master Wiring List. Strike off each conductor run as you make it on the appropriate photocopies, using a red or other easy-to-see color marker or pencil.

Referring to the photocopies, start wiring the circuit-board assembly with the connections from the *IC1* socket to the rest of the circuitry. Continue in turn to the sockets for *IC2* through *IC7*. Double-check all pin counts and polarities of electrolytic capacitors and the basing of *IC8* before finalizing connections. To simplify pin counting, mark all pin 1 locations near the appropriate pins of the various IC sockets on the wiring side of the board before starting any assembly. Alternatively, fix adhesive-backed labels that number each pin on the wiring side.

The only parts of the circuit that do not mount directly on the circuit-board assembly are the LCD display module, potentiometer *R1*, four resistors and the Dinsmore sensor. Therefore, when it comes time to wire these into the circuit, simply leave 6-inch-long wires connected to the circuit-board assembly for the conductors that go to the LCD module and *R1*.

When you are done wiring the circuit-board assembly, examine it carefully to check your wiring and solder-

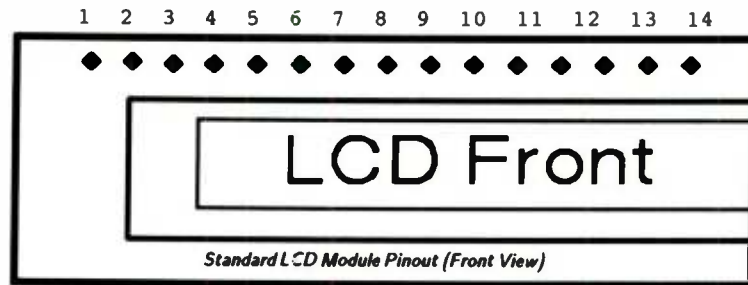

From	To
IC1 pin 1	DET1 pin 3(S),R5
pin 2	DET1 pin 3(N),R3
pin 3	DET1 pin 3(W),R2
pin 4	DET1 pin 3(E),R4
pin 9	C3(+)
pin 16	IC3 pin 27,IC7 pin 4
pin 17	IC3 pin 22,IC6 pin 9,IC7 pin 5
pin 18	XTAL(1),C1
pin 19	XTAL(2),C2
pin 20	GND,C1,C2
pin 21	IC3 pin 25
pin 22	IC3 pin 24
pin 23	IC3 pin 21
pin 24	IC3 pin 23
pin 25	IC3 pin 2
pin 26	IC4 pin 1
pin 27	IC4 pin 2
pin 28	IC4 pin 3
pin 29	IC6 pin 10
pin 30	IC2 pin 11
pin 31	+5V
pin 32	IC2 pin 18,IC3 pin 19
pin 33	IC2 pin 17,IC3 pin 18
pin 34	IC2 pin 14,IC3 pin 17
pin 35	IC2 pin 13,IC3 pin 16
pin 36	IC2 pin 8,IC3 pin 15
pin 37	IC2 pin 7,IC3 pin 13
pin 38	IC2 pin 4,IC3 pin 12
pin 39	IC2 pin 3,IC3 pin 11
pin 40	+5V
IC2 pin 1	GND
pin 2	IC3 pin 10
pin 5	IC3 pin 9
pin 6	IC3 pin 8
pin 9	IC3 pin 7
pin 10	GND
pin 12	IC3 pin 6
pin 15	IC3 pin 5
pin 16	IC3 pin 4
pin 19	IC3 pin 20
pin 20	+5V,C4
IC3 pin 2	IC5 pin 2
pin 3	IC5 pin 3
pin 4	IC5 pin 4
pin 5	IC5 pin 5
pin 6	IC5 pin 6
pin 7	IC5 pin 7
pin 8	IC5 pin 8
pin 9	IC5 pin 9
pin 10	IC5 pin 10
pin 11	IC5 pin 11,M1 pin 7
pin 12	IC5 pin 12,M1 pin 8
pin 13	IC5 pin 13,M1 pin 9
pin 14	GND,C4
pin 15	IC5 pin 15,M1 pin 10
pin 16	IC5 pin 16,M1 pin 11
pin 17	IC5 pin 17,M1 pin 12
pin 18	IC5 pin 18,M1 pin 13
pin 19	IC5 pin 19,M1 pin 14
pin 20	IC4 pin 15
pin 21	IC5 pin 21
pin 23	IC5 pin 23
pin 24	IC5 pin 24,M1 pin 4
pin 25	IC5 pin 25,M1 pin 5
pin 26	+5V
pin 28	+5V
IC4 pin 4	GND
pin 5	GND
pin 6	+5V
pin 8	GND
pin 11	IC5 pin 20
pin 13	IC7 pins 1&2
pin 16	+5V
IC5 pin 1	+5V
pin 14	GND
pin 22	IC6 pin 8
pin 27	+5V
pin 28	+5V
IC6 pin 7	GND
pin 11	M1 pin 6
pin 12	IC7 pin 3
pin 13	IC7 pin 6
pin 14	+5V
IC7 pin 7	GND
pin 14	+5V
IC8 pin 1	+12V,C5(+)
pin 2	GND,C5(-),C6(-),C7(-)
pin 3	C6(+),C7(+), +5V bus
M1 pin 1	GND,R1(3)
pin 2	+5V,R1(1)
pin 3	R1(2)
DET1	Tie together all pins 1 and connect to +5V,R2,R3,R4,R5
IC3 pin 2	Tie together all pins 2 and connect to GND
+5V	C3(+),R2,R3,R4,R5,red-insulated conductor of cigarette-lighter cable
GND	Black-insulated conductor of cigarette-lighter cable; circuit ground

\*Note: Pins to which no connections are made are not listed.

ing. If you missed a connection, solder it, and if any connection appears suspicious, reflow the solder on it and add solder if needed. Check for solder bridges between the pins of the IC sockets. If you locate any, clear them away with a vacuum-type desoldering tool or desoldering braid. Then set aside the circuit-board assembly.

Select an enclosure for your Digital Compass. This can be any type that is large enough to accommodate the circuit-board assembly and has sufficient front-panel space on which to mount the LCD panel. A typical enclosure is shown in the lead photo.

Machine the enclosure as needed. That is, cut the slot in the front panel through which the LCD display window will show and drill mounting holes for the circuit-board assembly and exit holes for the power cable and six-conductor cable that goes to the sensor unit. When you are done, deburr all holes and the slot if drilled through metal to remove sharp edges and place a small rubber grommet in the sensor cable hole.

Mount the LCD module to the front panel, orienting it so that the connection points are located at the upper-left of the window when viewing the project from the front. Return to the Master Wiring List and Fig. 1(C) to wire the module into the circuit, referring also to the detail drawing that accompanies the Master Wiring List.

Strip  $\frac{1}{4}$  inch of insulation from the free ends of a twisted-pair two-conductor cable terminated in an automotive cigarette-lighter adapter. Tightly twist together the fine wires of each conductor and sparingly tin with solder. Pass this end of the cable through the entry hole drilled for it in the enclosure and tie a strain-relieving knot in it about 8 inches from the unfinished end inside the enclosure. Connect and solder the two conductors to the appropriate points on the circuit-board assembly.

Determine how long must be the

six-conductor sensor cable and cut it to length. The length of the cable will be determined by how far apart in your vehicle the main unit and sensor module will be mounted. The cable itself can be a standard six-conductor telephone extension cable, which is available in lengths ranging from 6 to 25 feet. The cable should be terminated at one end in spade lugs and left raw at the other end. The color-coding in Fig. 1(D) reflects the colors of the insulation used on the conductors of the telephone cable.

Route the unprepared end of the cable into the enclosure through its hole. Tie a strain-relieving knot in the cable about 8 inches from the end inside the enclosure, and, referring to the Master Wiring List and Fig. 3, connect and solder the various conductors to the appropriate points on the circuit-board assembly.

Use  $\frac{1}{2}$ -inch spacers and 4-40  $\times$   $\frac{3}{4}$ -inch machine screws, lockwashers and nuts to mount the circuit-board assembly into place.

Referring to the detail drawing that accompanies the Master Wiring List to identify the pinouts of the LCD module, connect and solder the free ends of the wires coming from the circuit-board assembly to the appropriate points on the module. Then tie a strain-relieving knot in the sensor cable 6 to 8 inches from the board end and route the free end of the cable through its exit hole.

Now prepare the sensor module as follows. First, rough-mount the Dinsmore sensor and  $R2$  through  $R5$  on a small piece of perforated board and determine where to mount the six screws that will be used to make connections to the cable. Remove the sensor and resistors from the board, and drill appropriate-size holes in the screw locations. Return the sensor and resistors to the board and, referring to Fig. 1(D) and the Master Wiring List, wire together the sensor, resistors and screws.

The enclosure in which you mount the sensor assembly need be not

much larger than the assembly itself and should be made of plastic. Do *not* use a steel or any other metal enclosure. The only thing you need do to prepare the enclosure is drill an entry hole for the cable. This done, route the free end of the cable through the hole and tie a strain-relieving knot in it about 2 inches from the end of the plastic jacket. Make the cable connections to the board via the screws and spade lugs on the individual conductors. Do not mount the sensor module at this time.

### ***Checkout & Installation***

At this point, there should still be no DIP ICs plugged into the sockets on the circuit-board assembly. Clip the common lead of a dc voltmeter or multimeter set to the dc-volts function to a convenient point in the circuit that is at ground potential. Plug the power cable into the cigarette-lighter receptacle in the dashboard of your vehicle.

Now touch the "hot" probe of the meter to pins 31 and 40 of the  $IC1$  socket, pin 20 of the  $IC2$  socket, pins 26 and 28 of the  $IC3$  socket, pins 6 and 16 of the  $IC4$  socket, pins 1, 27 and 28 of the  $IC5$  socket, pin 14 of the  $IC6$  and  $IC7$  socket, pin 2 of the LCD module and pin 3 of  $IC8$ . In all cases, you should obtain a reading of approximately +5 volts.

If you fail to obtain the proper reading at any given point, immediately power down the project and troubleshoot it. Do not proceed until you have rectified the problem.

When you are certain that the project has been properly wired, power down and install the ICs in their respective sockets. If you are using the 80C52 chip, handle it with the same care you would any other MOS device. Make sure you properly orient the ICs and that no pins overhang the sockets or fold under between ICs and sockets.

Power up the project once again and note the message in the display



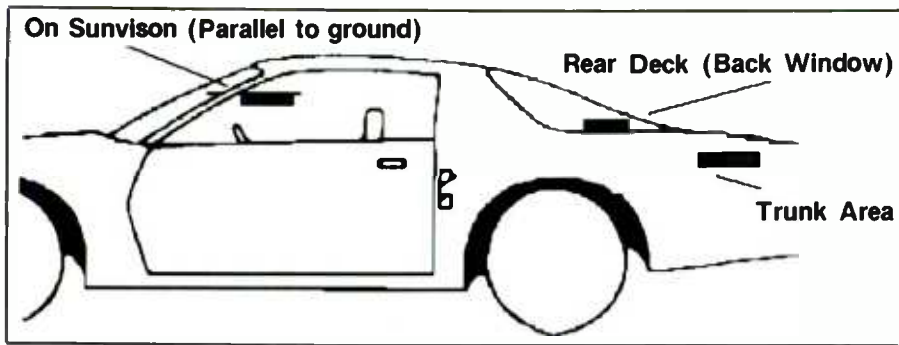

Fig. 4. Suggested locations for mounting sensor assembly where magnetic anomalies will have least effect on readings obtained.

as it scrolls from right to left. If everything is okay, the message: "Suncoast Technologies' DIGITAL COMPASS is now READY..." should scroll across the display. Following this, one of the eight cardinal compass headings should be displayed. If needed, adjust R1 for the proper contrast.

After a heading appears in the LCD display, place the circuit-board assembly inside its enclosure, hold the assembly parallel to the ground and slowly rotate it in a clockwise direction. As you do this, observe the display, which should change in normal clockwise compass sequence through the eight cardinal headings as you describe a full 360° of rotation. If you have a mechanical compass, place it on a flat surface and allow the pointer to stabilize. (If you do not have a mechanical compass, just remember that north is 90° counterclockwise from the east where the sun rises.)

Note the direction toward which the north end of the pointer points. Then rotate the sensor assembly of the Digital Compass until NORTH appears in the display window. Temporarily place the cover on the sensor box and affix to it a label with the legend NORTH at the end that points in the same direction as the pointer of the compass does.

Power down the project. Then use thick double-sided foam tape to secure the sensor circuit-board assembly in place inside its enclosure and

fasten the lid to the enclosure, making sure the NORTH legend is at the north end of the assembly, as determined above.

Most vehicles are composed mainly of steel. So bear in mind that they can be magnetized. If this occurs, it can be a problem for the Digital Compass. So take care in locating the sensor assembly inside your vehicle. If you stand outside your vehicle and point the compass sensor toward north and then do the same from inside your vehicle and obtain two different heading readings, you must select a different location for the sensor inside your vehicle.

Shown in Fig. 4 are a variety of possible locations inside a car where the distortion of the earth's magnetic field is minimal or does not exist. Try any or all of these to determine the best location for the sensor assembly in your particular vehicle: (1) the rear deck, just under the window; (2) inside the trunk; and (3) on the sun visor. If you select the sun-visor location, make certain that the sensor is positioned so that it is parallel with the ground.

An alternative location for the sensor is at the very nose of the car. If the front bumper of your vehicle is made of a soft plastic material (so-called "rubber"), this may be the ideal location for the sensor.

With the Digital Compass installed in your vehicle, you can hit the road, confident that you will be heading in the right direction at all times. **ME**

## REMOVE IC's FASTER!!

THE 7 SECOND IC REMOVER



with this simple invention than any other method, including \$6,000 vacuum desoldering stations. Speed up your repairs and salvage hundreds of good IC's per hour from junk boards. Won't damage IC's or circuit board. This is a money making, labor saving tool. Fits Radio Shack or Ungar soldering irons — soldering iron not included.

Complete set of 8 desoldering bits (Remove 6 thru 40 pin IC's) ... **\$ 89.95**

Complete set of 10 desoldering bits (Remove 6 thru 64 pin IC's) ... **\$114.95**

### LEARN THE SECRETS OF HOW TO FIX ELECTRONIC EQUIPMENT FASTER ON OUR REPAIR TECHNIQUES ON VIDEOTAPE

Learn our techniques and make more money repairing electronic equipment. These tapes are packed with much practical information that will save enough of your valuable time to quickly pay for the tapes.

Learn from an expert what fails, why it fails, how to find it faster, and how to fix it faster.

Much of this information is available nowhere else.

These tapes start at the beginning for beginners, but cover each subject so thoroughly that even old pros will learn valuable new techniques and skills.

SEND PAYMENT WITH ORDER AND WE WILL PAY SHIPPING. ORDER 14 TAPES FOR \$499.95 OR SEND \$575.00 FOR ALL 16 TAPES.

How to use a Voltmeter (1 hr. 51 min.)	.... \$39.95
How to use a logic probe and logic pulser	.... \$39.95
All about resistors and their failure modes (1 hr.)	..... \$39.95
All about capacitors and their failure modes (1 hr. 28 min.)	..... \$39.95
All about inductors and their failure modes, Part I. Includes inductors, transformers, flybacks, pinball coils, solenoids	..... \$39.95
All about inductors and their failure modes, Part II. Includes magnetic clutches, relays of all types, other devices (58 min.)	..... \$39.95
All about diodes and their failure modes. Includes rectifiers, SCR's, Zeners, triacs, LED's (55 min.)	..... \$39.95
All about transistor failure modes (56 min.)	.... \$39.95
How to solder like a pro — with lots of time saving circuit board repair techniques, including some of the fastest ways to change IC's you ever saw (1 hr. 30 min.)	..... \$39.95
All about electrical contacts, connectors, connections and their failure modes, common and uncommon problems, symptoms, good cures.	..... \$39.95
How to use the oscilloscope (to track down digital failures)	..... \$39.95
How to read schematics and use them for troubleshooting, Part I. Covers monitors, how to find monitor problems with wiring diagrams, gives symptoms, where to look, covers both raster scan and X-Y monitors (56 min.)	..... \$39.95
How to troubleshoot digital integrated circuits — includes microprocessors, what goes wrong and how to find it, how to use the best literature on IC's and where to get it (1 hr. 45 min.)	..... \$39.95
Job opportunities and money making opportunities in electronics (45 min.)	..... \$39.95
Troubleshooting and locating component failures (1 hr. 10 min.)	..... \$39.95
Power Supplies — Linear and Switching (42 min.)	..... \$39.95

### VRS ELECTRONICS

P. O. BOX 813-ME -- SELMER, TENNESSEE 38375  
TELEPHONE (601) 287-1594

CIRCLE NO. 84 ON FREE INFORMATION CARD

# Super-Sensitive Tilt Switch For Automotive Alarms

*Uses mercury switches to protect against false alarms generated by ordinary vibrations*

By Walter W. Schopp

**A**utomotive alarm tilt/motion switches usually consist of a spring-steel blade attached to a fixed block and a weight on opposite ends. Any motion other than unauthorized entry or an attempt to tow the vehicle is likely to trigger the alarm. Such a sensor installed in a truck that has heavy-duty springs requires a thief to weigh at least 300 to cause enough motion to trip the alarm. Such a sensor installed in a small car that has weak springs can trigger the alarm if a gust of wind buffets the car. Also, the exposed contacts under the hood are vulnerable to oxidation or coating with oil and/or grime, either of which can prevent contact and cause the alarm to fail to sound.

Sensitive mercury switches can make excellent sensors for motion detection, assuming some inherent problems can be overcome. Because mercury switches had to always be open before the alarm could be triggered, if you parked on a grade, one

or both switches were likely to close, negating the utility of the alarm. This is not the case with our Super-Sensitive Tilt Switch.

It makes no difference if the mercury switches around which this project is built are open or closed when the alarm is armed. The project establishes the status of the switches and then senses only a *change* in status after arming. So, regardless of whether a switch is open or closed, closing or opening it generates a trigger pulse. Mounting two mercury switches 90° with respect to each other, permits motion to be detected in two different directions. This is a considerable improvement over the single-direction sensing of blade-type switches.

Our Super-Sensitive Tilt Switch has a clocked control circuit that triggers to permit a number of false alarms to occur within a predeter-

mined time without setting off the alarm. When the alarm is armed, a relay energizes for a time that is adjustable from 10 seconds to 2 minutes 30 seconds and then resets. A relay provides contacts that permit the Tilt Switch to be used with alarms that are normally open and close to trigger an alarm or normally closed and open to trigger an alarm condition. You simply wire your present alarm system to the project via the appropriate relay contacts.

## About the Circuit

The complete schematic diagram of the Super-Sensitive Tilt Switch circuitry is shown in Fig. 1. This circuit operates on an internal clock that produces a pulse signal that releases the stored input disturbance signal. The same signal divided by 10 provides a reset signal for the time window that

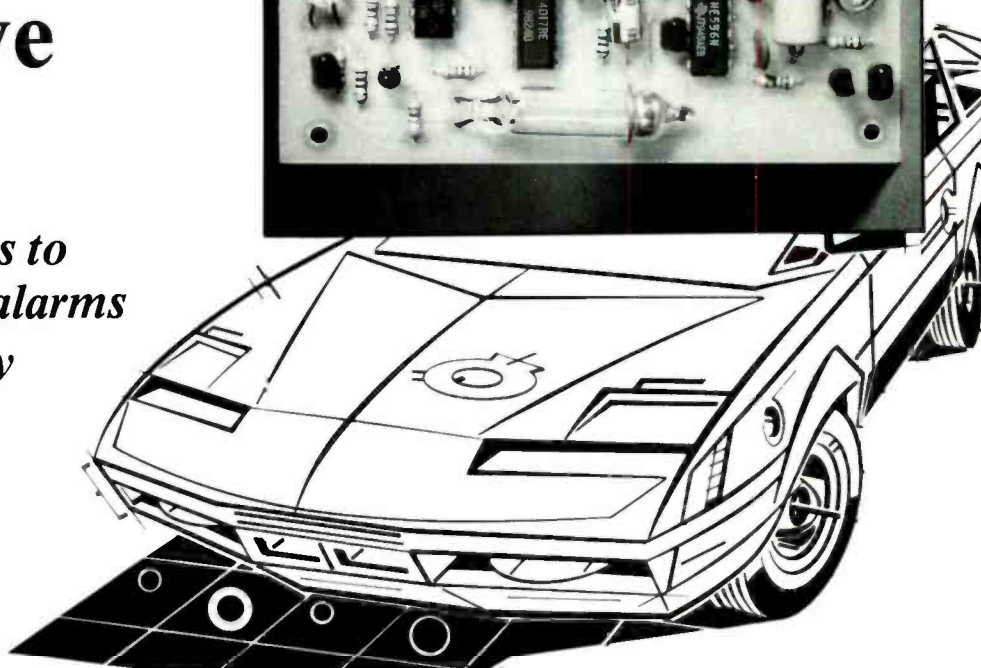
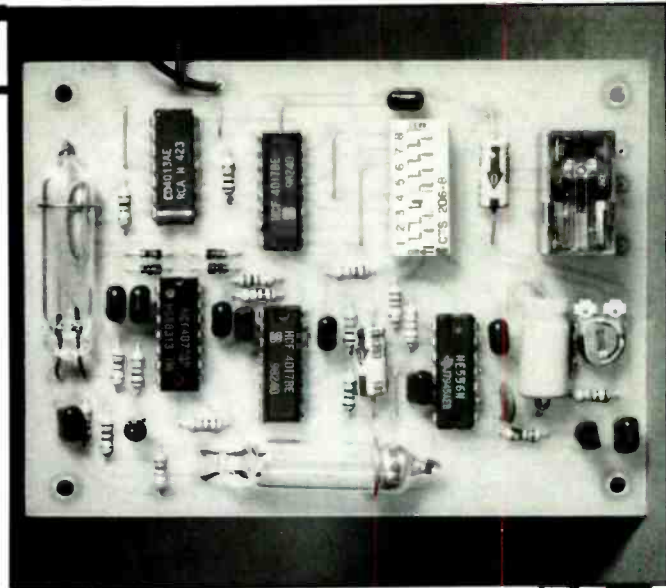



permits a certain number of disturbances to be recognized in a timed period before the alarm actually responds. The same integrated circuit is also used to provide the timed output for the alarm.

Each time mercury switch *S1* or *S2* opens or closes, one of the gates to which it connects produces a positive-going output. This positive-going output couples through the corresponding capacitor (*C2*, *C3*, *C13* or *C14*) to its respective diode (*D1*, *D2*, *D3* or *D4*). The diodes prevent the positive spike from being attenuated by a negative charge on one of the capacitors from the other gates. When the unit is turned on, the status of the switches is established in the "as-is" condition.

When the status of one mercury switch changes, the positive pulse from one of the *IC1* gates is fed to "one and only one" flip-flop configuration *IC3*. The input of *IC3* is pulled down by *R18* so that it will respond only to positive pulses. The input pulse sets the first flip-flop in *IC3*, which remains set until a clock signal is received, at which time an output pulse is transferred to the next stage and the one and only one is reset. This prevents the circuit from responding to a large number of pulses produced when the vehicle is rocked once and produces only a single disturbance signal during the 1-second clock period.

The output from *IC3* is one clock pulse long and is applied to the input of decade counter *IC4*. Each time *IC4* is clocked by a disturbance of the mercury switches, its output is advanced one step. The 0 to 7 outputs of *IC4* are brought out to DIP switch *S3*. Setting of this switch permits the first to the eighth output to be recognized. The 1-second clock pulses used to trigger *IC3* are divided by 10

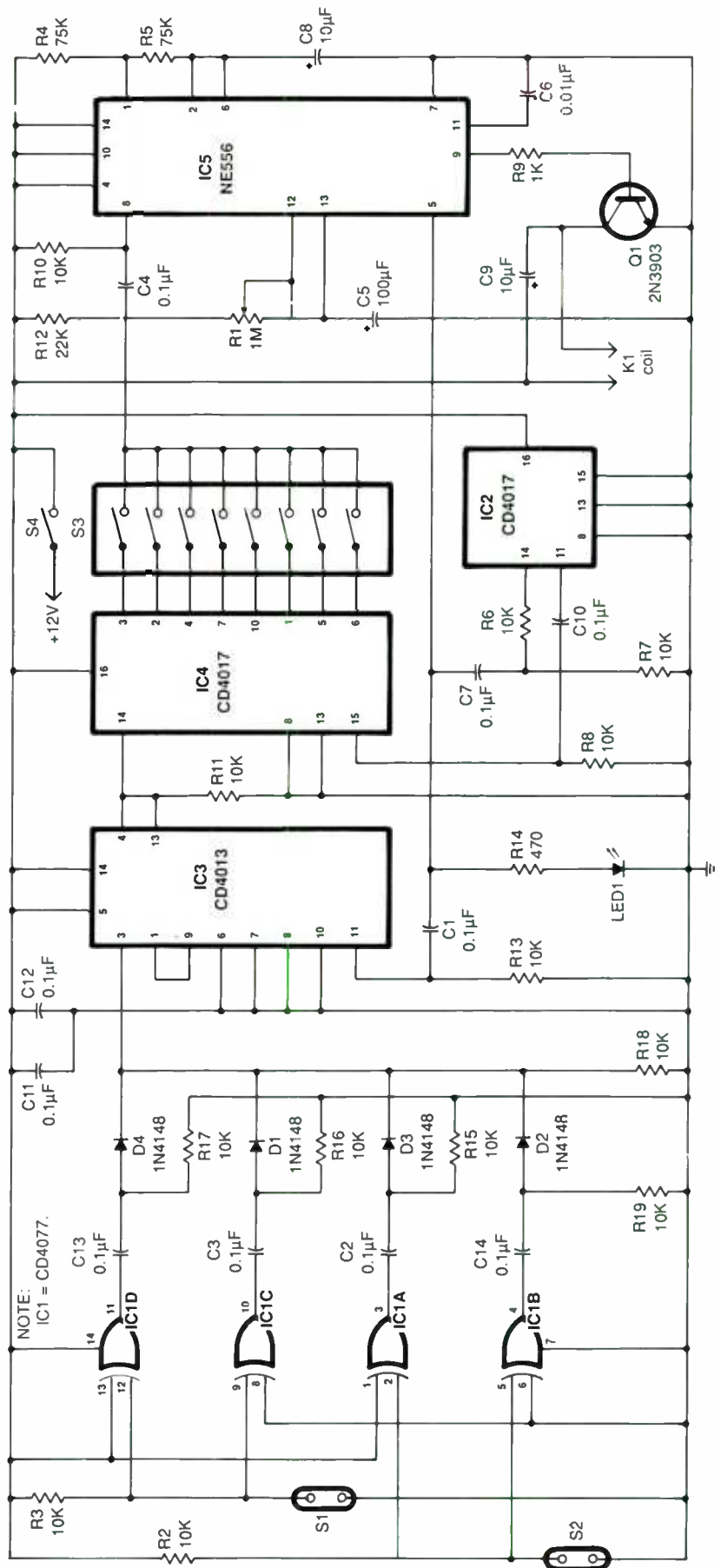

Fig. 1. Schematic diagram of circuitry used in Super-Sensitive Tilt Switch.

## PARTS LIST

### Semiconductors

D1 thru D4—1N4148 or 1N914 signal diode  
 IC1—CD4077 quad XOR gate  
 IC2, IC4—CD4017 decade counter  
 IC3—CD4013 dual-D flip-flop  
 IC5—NE556 dual timer  
 LED1—Any light-emitting diode  
 Q1—2N3903 or similar general-purpose npn silicon transistor

### Capacitors

C1 thru C4, C7, C10 thru C14—0.1- $\mu$ F, 50-volt ceramic disc  
 C5—100- $\mu$ F, 16-volt electrolytic  
 C6—0.01- $\mu$ F, 50-volt ceramic disc  
 C8, C9—10- $\mu$ F, 25-volt electrolytic

### Resistors (1/2-watt, 10% tolerance)

R2, R3, R6, R7, R8, R10, R11, R13, R15 thru R19—10,000 ohms  
 R4, R5—75,000 ohms  
 R9—1,000 ohms  
 R12—22,000 ohms  
 R14—470 ohms  
 R1—1-megohm, pc-mount trimmer potentiometer (Digi-Key Cat. No. K4A16 or similar)

### Miscellaneous

K1—12-volt dpdt relay (Aromat No. HB212—Jameco Cat. No. HB212)  
 S1, S2—Mercury switch (available from

Electronic Enterprises for \$10 per pair ppd.)

S3—Eight-position DIP switch

S4—Key switch (see text)

Printed-circuit board or perforated board with holes on 0.1" centers and suitable Wire Wrap or soldering hardware (see text); suitable enclosure (optional); sockets for all ICs; automotive crimp-on splice connector (optional—see text); foam plastic tape or silicone adhesive (see text); rubber grommets; spacers; ring or spade lugs and outside-tooth lock-washers (see text); machine hardware; stranded and solid hookup wire; solder; etc.

### Component Sources

#### Digi-Key Corp.

701 Brooks Ave., P.O. Box 677  
 Thief River Falls, MN 56701-067  
 Tel.: 1-800-344-4539

#### Electronic Enterprises

3305 Pestana Way  
 Livermore, CA

#### Jameco Electronics

1355 Shoreway Rd.  
 Belmont, CA 94002  
 Tel.: 415-592-8097

by IC2, with the resulting signal used to reset IC4 every 10 seconds.

The output from the counter is pulse coupled through C4 to one half of dual timer chip IC5. The timer input is pulled up by R10 and responds to only negative pulses. This prevents the timer from responding to the counter when it is reset and a positive output is applied to the 0 output of the counter. When the disturbance signal causes the output of the counter to move from its 0 to the 1 output, a negative-going signal is produced that triggers the timer.

When the timer is tripped, a positive output is applied to the base of Q1 through R9. This sends Q1 into conduction and energizes relay K1. The relay remains energized for a period determined by the time constant

of R1, R12 and C5. Resistor R12 sets the minimum timer period.

The other half of dual timer IC5 generates the 1-second clock pulse. Timing of this pulse is determined by the values used for R4, R5 and C8. Light-emitting diode LED1 provides visual indication that the 1-second clock is operating. Thus, it can be used to adjust this timing. Adjustment is done by changing the resistance values of R4 and R5 or by changing the capacitance value of C8. The frequency of the generator is determined using the formula  $F = 1.44 / [(R4 + 2R5) \times C8]$ .

When position 1 of S3 is closed, the alarm triggers on the first mercury-switch disturbance. With S3 in this condition, ultimate sensitivity is achieved. This mode can be used in

situations where there is no possibility of movement unless it is authorized. This mode could trigger many false alarms caused by wind gusts when used on a automobile or trailer. If position 8 of S3 is closed, the circuit permits seven disturbances of the mercury switches within a window time of 10 seconds without the alarm going off. On the eighth disturbance, the alarm triggers. Any closing of positions 2 through 7 of S3 provides a reliable system free of false alarms.

## Construction

There is nothing critical with regard to building the Super-Sensitive Tilt Switch. Therefore, you can use any wiring technique with which you feel comfortable, though printed-circuit assembly is recommended in the rigorous automotive environment.

If you wish to assemble your circuit on a pc board, use the actual-size etching-and-drilling guide shown in Fig. 2 to fabricate the board. Alternatively, if you prefer point-to-point wiring, use perforated board that has holes on 0.1-inch centers and suitable Wire Wrap or soldering hardware. Whichever wiring technique you use, it is a good idea to socket all DIP ICs. Use premium sockets that provide sure-grip seating for the chips.

From here on, we will assume you are assembling your circuit on a pc board. With this in mind, refer to Fig. 3 for details on where to install the various components and how they are to be oriented. (If you go the point-to-point wiring route, use Fig. 3 as a rough guide to component layout and refer back to Fig. 1 for wiring details.)

Begin wiring the board by installing and soldering into place the wire jumpers at the locations indicated in Fig. 3. Seven jumpers in all must be installed. You can use solid bare or insulated hookup wire for the jumpers. Note that the sockets for IC3 and IC4 fully or partially cover two of the jumper wires previously installed.



Do *not* plug the ICs into the sockets until after you have conducted voltage checks and are certain that the board is properly wired.

Once the jumpers are in place, install and solder into place the five IC sockets. Make sure when soldering the pins of these sockets to the copper pads on the bottom of the board that you do not create any solder bridges. Clear any solder bridges as you go along with a vacuum-type desoldering tool or desoldering braid.

Next, install and solder into place the resistors. This done, install and solder into place the capacitors and diodes, making sure that the electrolytic capacitors and diodes are properly polarized before soldering their leads into place. Making sure you properly orient the LED, plug its leads into the holes provided for them in the board and position the LED so that the bottom of its case is approximately  $\frac{1}{8}$  inch above the surface of the board. Solder both leads to the copper pads on the bottom of the board.

Install and solder into place trimmer resistor *R1* and set it for about middle of rotation. Then install and solder into place the relay, and follow up with the transistor. Make sure the latter is properly based before soldering its leads into place.

Strip  $\frac{1}{8}$  inch of insulation from one end and  $\frac{1}{2}$  inch of insulation from the other end of separate 6-foot lengths of red- and black-insulated stranded hookup wires. Do the same for three more 6-foot lengths of any other color insulation stranded hookup wires. Tightly twist together the exposed fine conductors at both ends of all wires and sparingly tin with solder.

Plug the free end from which the  $\frac{1}{8}$  inch of insulation was removed from the black-insulated wire into the hole labeled GROUND and solder into place. Repeat the procedure with the red-insulated wire and the hole labeled +12V. Then plug the ends from which the  $\frac{1}{8}$  inch of insulation was removed from the remaining wires into

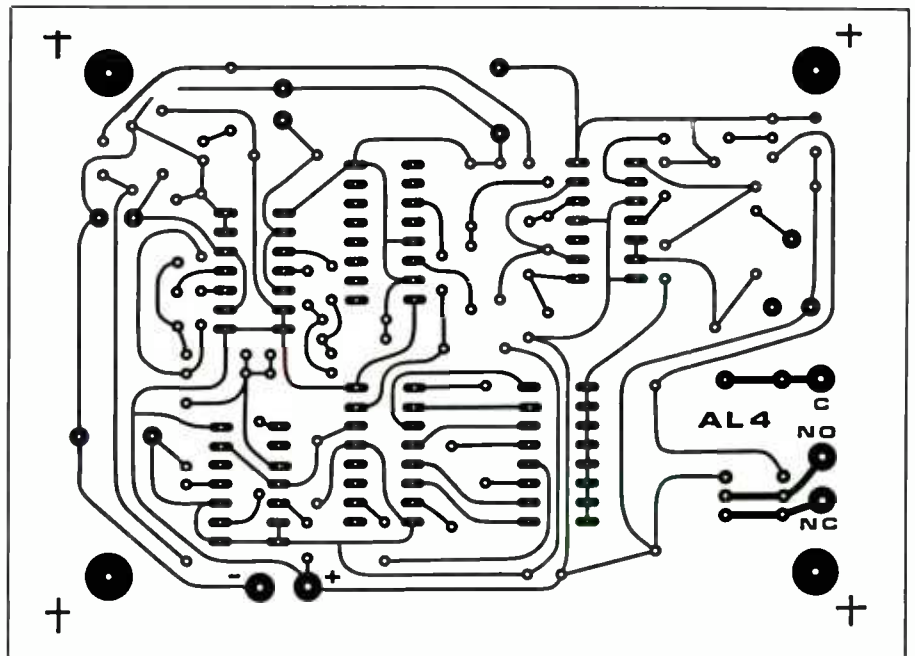

Fig. 2. Actual-size etching-and-drilling guide to use for fabricating printed-circuit board.

the holes labeled COM, N.C. and N.O. and solder these into place.

The last items to be installed on the circuit-board assembly are the mercury switches. When handling these, use care to prevent shattering them and releasing the toxic liquid mercury. Any mercury switch can be used in this project, as long as it fits into the limited space provided on the circuit-board assembly.

Cut two strips of foam plastic tape to dimensions of  $1\frac{1}{4}$  long by  $\frac{3}{8}$  wide. Peel away the protective strip and use the adhesive backing to secure the two pieces of tape to the board in the areas where the mercury switches are to mount.

Next, gently bend the leads on both switches to form a  $90^\circ$  angle to the glass envelopes. Plug the leads of the switches into the appropriate holes on the board but do not solder into place yet. Plug the ends of a 4-inch length of bare solid hookup wire into the holes provided for *S1* so that the wire crosses the glass envelope. While holding the wire against the envelope, loosely twist together the free ends of the wire on the other side

of the board. Do *not* make the wire cinch tight enough to cause the switch to press hard into the foam tape. It should gently hold the switch in place. Solder the wires to the pads on the bottom of the board and clip away the excess. Then solder the leads of the switch to their pads. Repeat the procedure for *S2*.

It is important that you do not omit the cinch wires. Not only do these wires mechanically secure the switches into place, they also provide electrical paths that complete the wiring on the solder side of the board. The foam-tape strips provide shock mounting for the switches. If you wish, you can substitute beads of silicone adhesive for the foam tape.

If you wish, you can mount the circuit-board assembly inside an enclosure that comfortably accommodates it. You can use an all-plastic or all-metal enclosure or an enclosure that is basically plastic and has a metal panel. Machine the enclosure to provide mounting holes for the circuit-board assembly and entry/exit holes for the wiring. If you use a metal enclosure, deburr the holes

drilled for the cables to remove sharp edges and line them with small rubber grommets.

### Checkout & Installation

Make sure no ICs are plugged into the sockets. Clip the common lead of a dc voltmeter or multimeter set to the dc-volts function to circuit ground. Connect the power leads of the project to a source of 12-volt dc power. This can be either a bench power supply or the electrical system of your motor vehicle.

Touch the "hot" probe of the meter to pin 8 of the IC1 socket, pin 16 of the IC2 and IC4 sockets, pins 5 and 14 of the IC3 socket, and pins 4, 10 and 14 of the IC5 socket. In all cases, you should obtain a meter reading of approximately +12 volts. If you fail to obtain this reading at any point mentioned, disconnect power from the project and rectify the problem before proceeding.

When you are certain that the board has been properly wired, disconnect power from it. Plug the ICs into their respective sockets, handling them with the same care you

would exercise for any other MOS device. Make sure each IC is properly oriented and that no pins overhang the socket or fold under between IC and socket.

Mount the circuit-board assembly inside the enclosure, using 1/4-inch spacers and 4-40 x 1/4-inch machine screws, lockwashers and nuts. Tie strain-relieving knots about 6 inches from the circuit-board assembly in the power and signal cables and feed the free ends of the cables through their holes in the enclosure.

Power up the project once again and check LED1 to determine if the 1-second clock is working. Check pin 15 of IC4 for a positive pulse every 10 seconds or 10 clock pulses. If this clock signal is present, the Tilt Switch is functioning properly. Closing position 1 of S3 should cause the relay to energize on the first clock pulse after the disturbance. When using this Tilt Switch, make sure only one position of S3 is set to "on" and all other positions are set to "off." Otherwise, the Tilt Switch will respond to the lowest setting of the DIP switch.

Once you have ascertained proper operation of the Tilt Switch, select a

mounting location for the project. This can be in a convenient location inside the engine well or in the passenger compartment behind the dashboard or other concealed location. Just make sure that you have access to the electrical system of the vehicle where power to it cannot be cut without triggering an alarm and the existing alarm inputs.

Mount the project in the selected location so that it is level, with the top of the circuit-board assembly facing up. Make sure the vehicle is level to obtain best operating conditions.

Connect and solder spade or ring lugs to the ground, N.O. and N.C. leads from the project. Do not at this time terminate the +12V lead. Use an existing screw in your vehicle or trailer to secure the ground leads to chassis ground, using an existing screw in your vehicle or trailer. After removing the screw, sand the area around the hole with fine emery cloth to obtain shiny bare metal. When securing the two spade or ring lugs into place with the screw, sandwich an outer-tooth lockwasher between the chassis and lower lug to assure a solid electrical connection.

Determine the requirements of the input to your alarm. If the alarm requires a switch closure to trigger, use the normally-open (N.O.) lead from the project to make the connection. If it requires a switch to open to trigger an alarm, use the normally-closed (N.C.) lead.

Switch S4 shown in Fig. 1 is used for arming the Tilt Switch by supplying 12-volt power from the electrical system of your vehicle. This can be an externally mounted key switch that you turn on after the vehicle or trailer has settled down. The best location for the switch is the rear of the hood on the driver's side or on the panel between the door and the hood. On a trailer, mount this switch in any location where it can be accessed without disturbing the trailer.

Once the arming switch has been mounted, crimp and solder the free

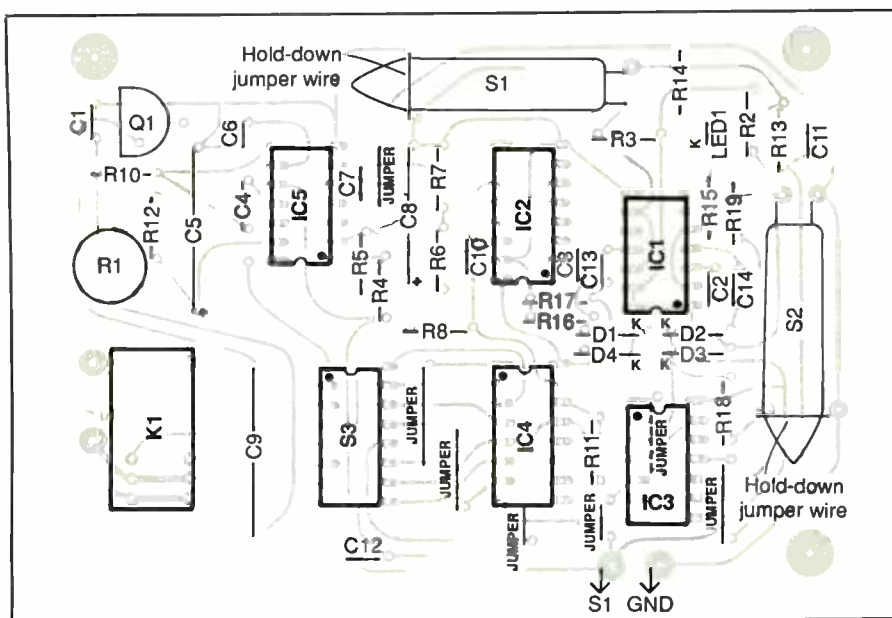

Fig. 3. Wiring guide for pc board. Use this as a rough guide component layout if you point-to-point wire the circuit.



end of the + 12V wire from the project to one of its lugs. Then use another length of stranded hookup wire, prepared as described above, to bridge between the other lug of the switch and an electrical line that is live with + 12 volts at all times, regardless if the ignition is switched on or off. Make the connection to this line using an automotive splice connector or directly by soldering it to the + 12-volt wire. If you go the latter route, cut the + 12-volt line of the vehicle's electrical system and strip 3/8 inch of insulation from both cut ends. Tightly twist together the cut ends and the free end of the wire coming from S4. Solder the connection and completely insulate it with electrical tape.

With the Super-Sensitive Tilt Switch installed in your vehicle or trailer and connected to its alarm system, you can be sure of solid protection against unauthorized intrusion and towing—without the annoyance of false alarms.

**ME**

## LEARN ELECTRONICS FROM VHS VIDEO TAPES!

*At  
Ucando  
your Success  
is our  
Business!*



**Our Video Tapes  
Are Designed  
To Make Learning Electronics  
Fun and Easy!**

- |   |  |
|---|--|
| <ul style="list-style-type: none"> <li>• <b>PART 1-DC, 53 min.....\$32.95</b><br/>Electronics and You—VT-201</li> <li>• <b>PART 2-AC, 71 min.....\$32.95</b><br/>Electronics and You—VT-202</li> <li>• <b>PART 3-SEMICONDUCTORS,<br/>47 min.....\$32.95</b><br/>Electronics and You—VT-205</li> <li>• <b>PART 4-POWER SUPPLY<br/>55 min.....\$32.95</b><br/>Electronics and You—VT-206</li> </ul> | <ul style="list-style-type: none"> <li>• <b>PART 5-AMPLIFIERS<br/>52 min.....\$32.95</b><br/>Electronics and You—VT-207</li> <li>• <b>PART 6-OSCILLATORS<br/>54 min.....\$32.95</b><br/>Electronics and You—VT-208</li> <li>• <b>VCR MAINTENANCE &amp; REPAIR<br/>VT-203—54 min.....\$32.95</b></li> <li>• <b>INTRODUCTION TO VCR REPAIR<br/>VT-204—110 Min.....\$59.95</b></li> </ul> |
|---|--|

**ORDER  
NOW!**

CALL TOLL FREE AT

**1-800-678-6113**

OR

mail check or money order to:

**UCANDO VIDEOS**

**P.O. BOX 928 • GREENVILLE, OH 45331**

**VISA  
AND  
MASTERCARD  
ACCEPTED**

CIRCLE NO. 123 ON FREE INFORMATION CARD

## REFUNDS



*"There's nothing worthwhile videotaping."*

SCHOCKET

## LEARN TO CLEAN/MAINTAIN/REPAIR FAX MACHINES

**HUGE NEW UNTAPPED MARKET!**



**EARN  
\$65/HR!**

**Over 8 million Fax machines in homes/  
offices - predictions are for over 25 million  
by 1992!**

- Work from your home/van
- Home study program gets you started servicing fax machines in 2 weeks!
- No special tools/equipment needed
- Earn additional profits selling fax supplies!
- Fax machines are not cheap - therefore, you can get good \$\$ for the repair
- Average Fax machine requires professional service every 18 months.
- Home study training program includes full instructions on EVERY ASPECT of Fax maintenance/repair. FULL COVERAGE of how to set up your home-based service business

FREE DETAILS

CALL 1-800-537-0589

Or Write To: Vlejo Publications, Inc.

5329 Fountain Ave., Dept. ME/FX

Los Angeles, CA 90029

CIRCLE NO. 85 ON FREE INFORMATION CARD





EC.BAT file to bring the Fax96 program up in background mode every time you start your computer.

As shown in the figure, you can bring a fax up on the screen to review it, or you can print it out. All commands are performed in the same way—you type the first letter of the command shown on the screen. Whenever you send a fax, the program prompts you for information for a cover letter and then automatically puts the name and address into a phone book, an excellent feature. You can send faxes to one person or to a number of people. If you often send to a group of people, you can save the group of names under a single name on the phone list. Whenever you want to send to the group, you simply recall the name of the group. Fax96 also keeps a log of fax activity.

To help you save a phone line, Fax96 includes a program called *1-liner*. This lets you connect a fax, phone, answering machine and modem on the same line. Whenever you receive a call, the program listens for the fax tone. If it hears one, it cuts in to receive the fax; if not, it allows the call to come through. Another program called *FarFetchFax* is of great help when you're on the road and need to keep in touch with your faxes. This program lets you call your computer from a Touch Tone phone and route any recent faxes to a fax machine that's near you.

The two short manuals that come with the program are cleverly written, with humorous comments throughout. The only failings I noticed were the manual's placement of the installation procedure and a lack of any screen shots. A single-page quick reference is nicely done.

Fax96 can send ASCII, .TIF and .PCX files. It first converts these files to fax form, which takes about 20K of disk space for a one-page fax and cover letter. The program lets you send multiple files at once. If you're sending faxes long distance, the program includes a "scheduled fax send" feature that lets you send faxes at off-peak hours. To use this feature, you simply type in the time you want the fax sent on the fax cover letter.

### Faxography: A New Way To Fax

Fremont Communications has a new kind of software that lets Fax96 users improve output quality of their fax messages. Named *Frecom WYPIWYF LQ* (What You Print Is What You Fax) software, it translates the output of popular PC applications software into fax images that can be sent to any Group III fax machine. The result is very-high-quality output that is noticeably superior to messages that have been scanned by a fax machine.

Fremont's first *WYPIWYF* program provides full-letter quality (LQ) dot-matrix printer and 24-pin graphics emulation. Any PC application program (word processing, spreadsheet or database programs, for instance) that supports Epson, IBM or similar printers can generate letter-quality fax messages, including graphics, with Fremont's *WYPIWYF LQ* software.

You set up the application software for Epson printer formatting controls, but instead of printing a hard copy, you select the "print to disk" or "print to file" command. Fremont's *WYPIWYF* software then converts that file into fax

format. When transmitted to another fax machine, it will be printed in the specified resolution. Both Group III resolutions—high (200 × 200-dpi) and regular (200 × 100-dpi)—are included. Fax versions of all LQ fonts (regular, bold and italic versions of two type styles in eight sizes, plus five styles of proportionally spaced type for each style) are included with the software. There are actually 643 fonts available in *WYPIWYF LQ*, when you include outline, shadow and the double-wide and double-high versions.

Ninety-five percent of the crispness of faxed documents is lost by the relatively crude scanning and paper-handling devices used in stand-alone fax machines. Faxography, using the Fax96 board and the *WYPIWYF* software, lets you fax directly from your computer without scanning. Documents have bold face, underline, italics and important font changes that people are accustomed to seeing with LQ and other dot-matrix printers. *WYPIWYF LQ* has a suggested retail price of \$99.95 for the complete package.

### Conclusions

By itself, Fax96 works perfectly. It can send ASCII, .TIF and .PCX files and receive faxes at 9,600 baud without a hitch. However, if you want to have the full functionality of a stand-alone fax machine, you may run into problems. Fax96 takes up an expansion slot, and it supports just six scanners directly, all from Chinon. When you compare this to a product like The Complete Communicator from the Complete PC (fax, modem, answering machine and scanner port all on one board), you'll realize that a board with a single device on it wastes precious expansion slot space.

My first suggestion to Frecom is to increase the number of scanners it sup-

ports. Secondly, I believe the company should go one step further and provide a port on the board for a scanning device, either one of its own make or one made by another company.

Fax96 is for people who want a really low-cost way to do fax communications from their PC. If your PC has an empty slot for a fax board, and you own a Chinon scanner, you can set up a system that works just like a fax machine. If this is the case, I can heartily recommend Fax96. If not, you'll have no problem receiving faxes, but sending them may be a problem. If you want to send faxes just as though you had a fax machine, you won't be able to do it with Fax96—I suggest you shop around for another brand instead.

CIRCLE NO. 127 ON FREE INFORMATION CARD

## Exploring for Electromagnetic Fields With a Telephone Induction Coil

By Forrest M. Mims III

For those of us who sometimes experiment with high-voltage coils and transformers, the phrase "induction coil" might conjure up an image of a crackling, popping transformer or a coil generating bluish arcs and copious quantities of ozone. While induction coils are certainly capable of such feats, it's important to remember that all coils are inductors. That some inductors serve as resonators for radio-frequency signals and others as high-voltage generators illustrates the remarkable versatility of one of the simplest and oldest of all electronic components.

The telephone induction coil was developed so that telephone conversations could be conveniently recorded without having to make a direct electronic connection to the telephone line. Later in this column, I'll explore this topic and its legal ramifications. But first let's examine some of the many other fascinating applications for this simple, inexpensive device.

### Telephone Induction Coil

Shown in Fig. 1 is a drawing of a typical telephone induction coil. This device consists of a coil of very fine wire wound around an iron core. The coil is installed in

a protective plastic housing fitted with a suction cup to permit it to be conveniently attached to the receiver end of a telephone handset. While the suction cup is handy for this purpose, it does impose additional separation between coil and receiver.

Most telephone receivers incorporate an electromagnetic audio transducer that contains a wire coil and an iron core. The combination of a telephone receiver and the induction coil forms a transformer. Audio-frequency signals circulating in the receiver's coil induce an identical signal in the nearby induction coil. This principle is illustrated in Fig. 2. The signal in the induction coil can then be amplified and recorded.

It's important to note that some newer telephone receivers use a piezoelectric receiver element instead of the older electromagnetic type. The signal passing through this kind of receiver won't be coupled into a telephone induction coil.

Knowing that the feeble signals radiated by a telephone receiver can be easily coupled into a telephone induction coil, it's simple to conclude that electromagnetic fields from other sources can also be coupled into such a coil. This is certainly the case. Connect an induction coil to any audio amplifier, and you'll have a highly

sensitive electromagnetic probe that transforms oscillatory, audio-frequency magnetic fields into their respective sound frequency.

### Induction-Coil Amplifier

Virtually any audio-frequency amplifier can be used to transform into sound the signals induced into a telephone induction coil. If you wish to build your own, the schematic diagram for a suitable circuit is shown in Fig. 3. If you build this circuit, keep the battery leads reasonably short to prevent oscillation. Although the circuit doesn't show any bypass capacitors, it's usually best to connect a 0.1-microfarad bypass capacitor between each of the power supply pins of the two integrated circuits and ground. Be sure to keep the speaker and its leads away from the circuit's input leads. Otherwise, oscillation might occur.

You can replace the speaker with an earphone, if you prefer. Be sure to keep the earphone cord away from the input of the circuit and the induction coil to prevent possible oscillation.

Whether you build your own amplifier or use a commercial unit, be especially careful when using an earphone to listen to the signals detected by the coil. If the

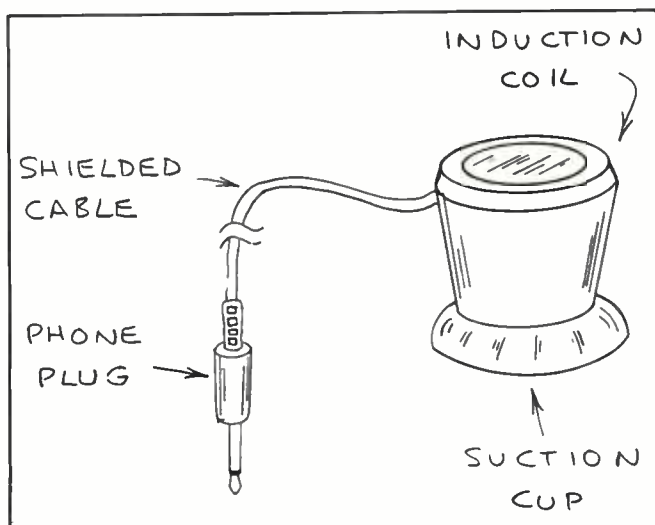

Fig. 1. Details of a typical telephone induction coil.

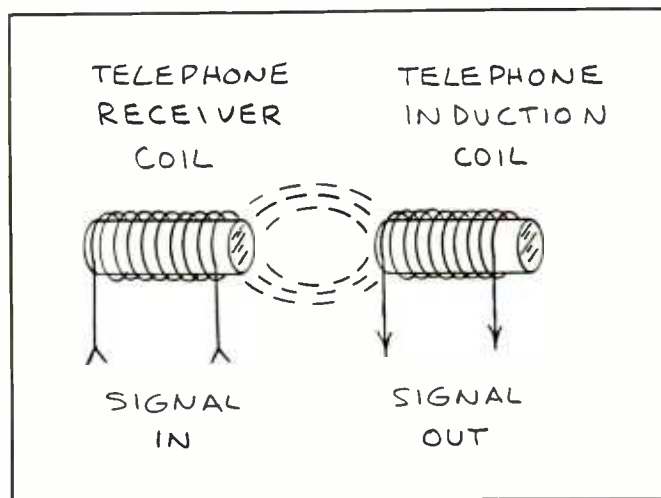

Fig. 2. How an induction coil picks up field from a telephone receiver.



volume is set too high, the sound level caused by some sources may damage your hearing.

### Exploring the 60-Hz Electromagnetic Environment

Once you've acquired an amplifier for your induction coil, it's time to go exploring. For starters, find a utility pole outdoors and explore the region around it with your probe. You should hear a constant background hum that grows in intensity as you approach the pole or the power line. The pole near my office and home serves as a terminal for several underground power lines. Therefore, it radiates a particularly strong 60-Hz field. The 60-Hz field from the power line itself is induced into a nearby metal farm gate, barbed wire fence and metal mail box. A 60-Hz field will also be induced into the metal body of an automobile that is parked near the line.

While you're below a power line, rotate the induction coil to notice its directional response. When the coil's iron core is parallel to the power line, the hum should be very weak. Rotate the coil 90° so its core is perpendicular to the line, and the level of the hum will increase substantially. If your results differ, check your surroundings. Maybe you're too close to a power line in a nearby building.

Next, go indoors and place the induction coil next to a light switch. When the switch is off, you may or may not hear a very weak 60-Hz hum. Flip the switch, and you should hear a hum. The hum produced by a fluorescent lamp should be considerably louder than that produced by an incandescent lamp.

Listen carefully, and you should hear a weak 60-Hz hum inside virtually any building that contains electrical wiring. As you move the probe along walls, the hum will rapidly increase in intensity as it passes near power lines. The level of the hum may suddenly increase or decrease if an appliance is switched on or off while you're listening. The 60-Hz field may even be induced into various metal objects and fixtures, like cabinets and desks. Just place the probe near such ob-

jects to see if the hum level increases.

You'll find that fluorescent lamp fixtures radiate exceptionally strong 60-Hz fields. Move the induction coil along the fixture; you'll discover that the sound is loudest when the probe is directly over the ballast transformer.

Line-powered appliances are also good 60-Hz radiators, especially those that have power transformers. You can find out for yourself by placing the probe anywhere near a switched-on microwave oven, TV receiver or radio.

Do you have an electric blanket? Switch it on and try using the induction coil to trace the wiring inside the blanket.

As you may know, in recent years there has been considerable controversy over the possible adverse effects of low-frequency electromagnetic fields on human health. The Earth's magnetic field is many times stronger than the average 60-Hz field received by most people. Therefore, it was generally assumed that man-made fields were perfectly safe.

Recently, however, the Environmental Protection Agency released the results of a two-year study that showed a possible linkage between fields from transmission lines and even household appliances with cancer. Many scientific papers have recently been published on this same subject. While the combination of an induction coil probe and an amplifier doesn't provide a quantitative measurement of the intensity of such fields, it does give accurate information about their location. If you're concerned about the possible effect on a sleeping child of the field from wiring concealed inside a wall, you can easily determine if such a field exists with the simple system described here.

### Non-60-Hz AC Fields

The picture tube in a TV receiver or computer video monitor radiates a very strong field. If you place a telephone induction coil near the edge of the tube, you'll hear a very strong buzz. Move the coil to the center of the screen, and the amplitude of the buzz will fall sharply.

You may be able to detect this signal at a considerable distance from a TV receiver

Courteous Service • Discount Prices • Fast Shipping

# ALL ELECTRONICS

P.O. Box 567 • Van Nuys, CA 91408

**" New " FLASH UNIT**

This NEW compact flash unit comes from a U.S. manufacturer of cameras. Unit operates on 3 Vdc and measures 2 1/2" X 1 1/4". Ideal for use as a strobe, warning light or attention getter. Complete with instruction on how to wire.



CAT# FSH-1 \$3.75 each 10 for \$35.00

### Special New Reduced Price PHOTOFLASH CAPACITOR

Rubicon CE photoflash capacitor. 0.79" dia. X 1.1" high. These are new capacitors that have been prepped with 1.4" black and red wire leads soldered to the terminals.



210 Mid 330 Volt CAT# PPC-210 \$1.25 each • 10 for \$11.00 • 100 for \$100.00

Large quantities available. Call for pricing

### FLASHING L.E.D.

Diffused L.E.D. with built in flashing unit. PULSE RATE: 3 Hz @ 5 Volt/20 ma. Unit continually flashes when 5 Volts is applied. Operates between 4.5 Volts and 5.5 Volts. T 1 3/4 size. IDEAL AS AN INDICATOR.

RED CAT# LED-4  
GREEN CAT# LED-4G  
YELLOW CAT# LED-4Y

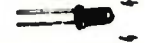

\$1.00 each • 10 for \$9.50 • 100 for \$90.00

### HEAVY-DUTY NICKEL CADMIUM "C" BATTERY

Yuasa 1800C

Special purchase of new, rechargeable nickel-cad batteries. 1.2 volts, 1800 mA.H.

PRICE REDUCED ON 10 OR MORE.

CAT# HDNCB-C

10 pieces for \$42.50 (\$4.25 each)

100 pieces for \$375.00 (\$3.75 each)



### POWER SUPPLIES

#### 5Vdc 3 AMP

ACDC Electronics #5N3-1

New, prepped power supply with wires and connectors soldered to the inputs and outputs. Open frame style. 4.94" X 4.03" X 2". Input: 115 Vac. UL and CSA listed. Regulated.

CAT# PS-53 \$10.00 each



#### 12 Vdc 5 AMP

ACDC Electronics # 12N5 or equiv.

Input: 100-240 Vac (wired for 115 Vac)

Output: 12 Vdc @ 5 amps. Open frame style.

7" X 4 3/4" X 3" high. Regulated.

CAT# PS-125 \$37.50 each

#### 24 Vdc 2.4 AMP

Power-One Inc. #HC-24-2.4

Input: 115/230 Vac (wired for 115 Vac)

Output: 24 Vdc @ 2.4 amps. Open frame style.

5.62" X 4.87" X 2.50" CSA listed.

CAT# PS-2424 \$30.00 each

### TOLL FREE ORDER LINES

**1-800-826-5432**

CHARGE ORDERS to Visa, MasterCard or Discover!

TERMS: Minimum order \$10.00. Shipping and handling for the 48 continental U.S.A. \$3.50 per order. All orders including AK, HI, PR or Canada must pay full shipping. All orders delivered in CALIFORNIA must include state sales tax (6%, 6 1/2%, 7%). Quantities Limited. NO C.O.D. Prices subject to change without notice.

Call Toll Free, or clip this coupon

FREE 60 Page Catalog

Containing over 4,000 ITEMS

**ALL ELECTRONICS CORP.**

P.O. Box 567 • Van Nuys, CA • 91408

Name \_\_\_\_\_

Address \_\_\_\_\_

City \_\_\_\_\_

ME291

State \_\_\_\_\_

Zip \_\_\_\_\_

# Organize and Protect Your Copies of

## **MODERN ELECTRONICS**

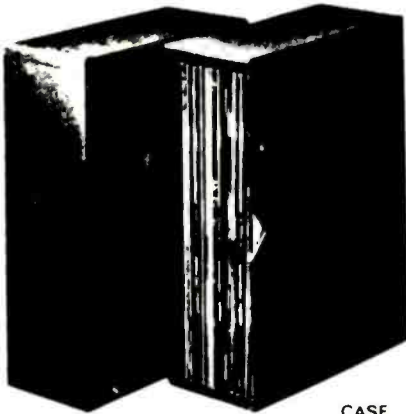

CASE

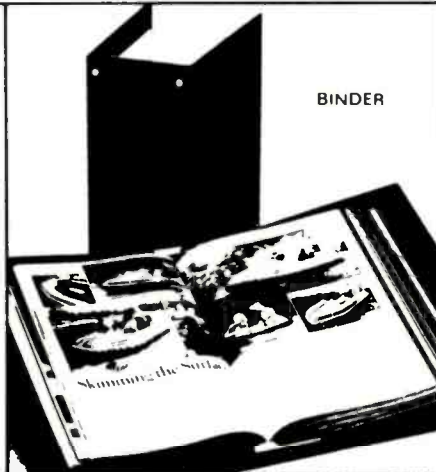

BINDER

Now there's an easy way to organize and keep copies of your favorite magazine readily available for future reference.

Designed exclusively for **ME** by Jesse Jones Industries, these custom-made titled cases and binders provide the luxury look that makes them attractive additions to your bookshelf, desk or any location in your home or office.

Whether you choose cases or binders, you'll have a storage system that's durable and well organized to help protect your valuable copies from damage.

- Cases and binders designed to hold a year's issues (may vary with issue sizes).
- Constructed of heavy reinforced board, covered with durable leather-like material.
- Title hot-stamped in gold.
- Free personalization foil for indexing year.
- Cases V-notched for easy access.
- Binders have special spring mechanism to hold individual rods which easily snap in. This allows magazines to be fully opened for easy readability.

**MODERN ELECTRONICS**  
Jesse Jones Industries, Dept. Mod-E  
499 East Erie Avenue, Philadelphia, PA 19141

Please send \_\_\_\_\_ cases; \_\_\_\_\_ binders  
for Modern Electronics Magazine.

- Enclosed is \$ \_\_\_\_\_
- Charge my: (Minimum \$15)
- American Express     Visa
- MasterCard     Diners Club

Card # \_\_\_\_\_ Exp. Date \_\_\_\_\_

Signature \_\_\_\_\_

Charge Orders: Call TOLL FREE 7 days, 24 hours 1-800-972-5858

Print Name \_\_\_\_\_

Address \_\_\_\_\_

No P.O. Box Numbers Please

City/State/Zip \_\_\_\_\_

PA residents add 6% sales tax

**SATISFACTION GUARANTEED**

Quantity	Cases	Binders
One	\$ 7.95	\$ 9.95
Three	\$21.95	\$27.95
Six	\$39.95	\$52.95

Add \$1 per case/binder postage  
and handling. Outside USA  
\$2.50 per case/binder. (U.S.  
funds only.)

er or video monitor. Notice how the position of the coil influences the amplitude of the buzz.

When you place the induction coil near line-powered appliances that incorporate digital circuitry, you'll usually hear tones of various frequencies superimposed over the ever-present 60-Hz hum. The segments or digits of electrofluorescent displays are driven in rapid sequence, and this multiplexed signal provides one characteristic signal. The clock circuit that provides timing for microprocessors and other controllers also generates a signal. Even if the clock frequency is above the range of human hearing, you may hear harmonics of the fundamental clock frequency or various other frequencies that have been divided from the original.

You can use an induction coil to quickly find the location of the power transformer inside a sealed, unshielded enclosure. You can also make a map of the field radiated by an instrument such as a computer.

### ***Battery-Powered Devices***

Figure 4 is an outline view of the top of the laptop computer into which this column was typed. Note how a scan with the induction coil probe reveals that particular portions of the computer radiate exceptionally strong signals. The signal can be easily picked up when the induction coil is a meter or more away from the computer. One reason for the sharp changes in the signal level is the fact that computers must be shielded to meet the requirements of the Federal Communications Commission.

While making the field map of the computer shown in Fig. 4, it was necessary to move the computer some distance away from the nearby VGA monitor. The monitor generates a much stronger field, which swamps out most of the signals emitted by the laptop.

Many other battery-powered circuits and instruments also radiate signals that can be intercepted by an induction coil. A quartz-regulated clock on my wall incorporates a low-power motor that kicks the second hand once each second. When an



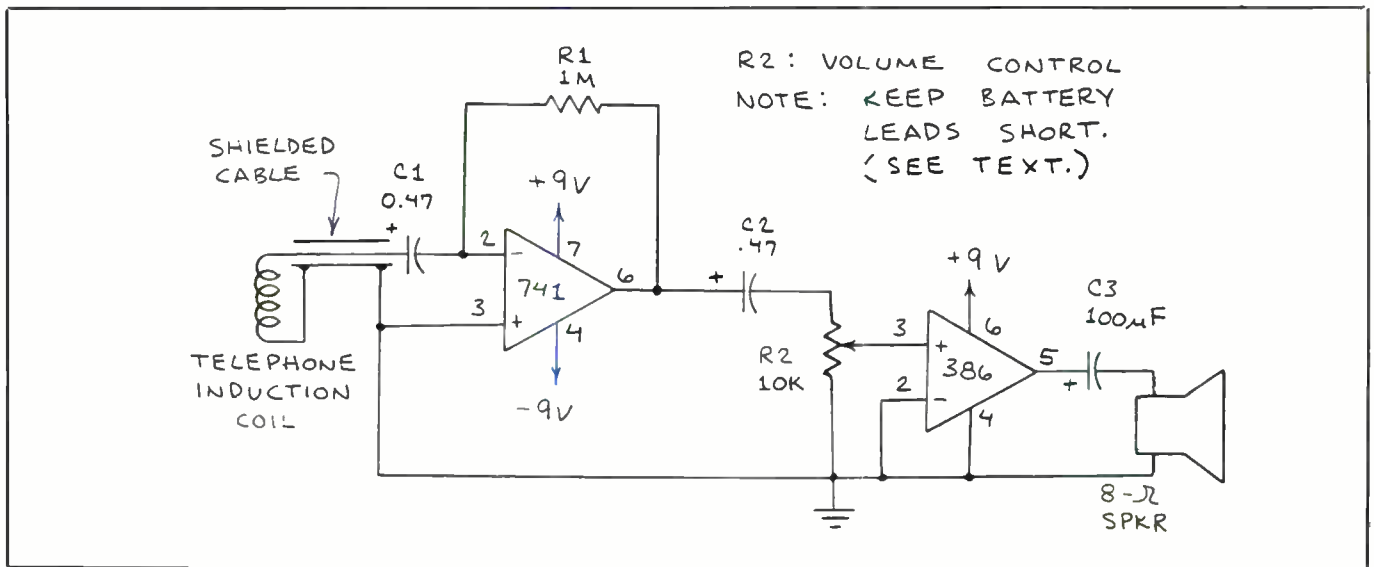

Fig. 3. Schematic details of a telephone induction coil amplifier.

induction coil is placed near the center of the clock, a very closely spaced pair of "pocks" is heard once each second. Presumably, the first pock represents the rising edge of the pulse that drives the motor, the second pock the falling edge of the same pulse. The radiated signal is much stronger than that from a clock or watch with a liquid-crystal display since the pulsating signal flows through the motor's coil, which, in turn, emits a magnetic field.

The motor in a tape recorder produces a very characteristic sound when the induction coil is placed nearby. You can even locate the motor's position by moving the coil around the recorder's case.

Digital calculators include a clock circuit that synchronizes the central processor, display and keyboard scanner. The signal radiated by a Hewlett-Packard HP-28 scientific calculator is quite strong. That radiated by a tiny solar-powered Texas Instruments TI-25 scientific calculator is considerably weaker but easily detectable.

Most remote-control transmitters for TV receivers, radios and Compact Disk players transmit a beam of near-infrared radiation. They also radiate an electromagnetic field that can be easily heard by

placing an induction coil near the transmitter while its buttons are pressed.

### Some Experiments

One of the first things you'll discover when you go searching for magnetic fields is that the amplifier produces a loud, pure tone when the induction coil is placed near the amplifier's speaker. If you're using an earphone, the same thing will occur if the coil is placed near the phone or, in some cases, the phone's cord. The origin of this tone is the same kind of positive feedback that causes audio amplifiers to squeal and howl when a microphone is placed too close to a speaker or when the gain is set too high. Feedback produced by an induction coil, however, results in a much purer tone. The feedback takes place because of the inductive coupling between the induction coil and the voice coil of the speaker (or the coil of the earphone).

An interesting demonstration that capitalizes on the feedback phenomenon is to swing the induction coil back-and-forth over the amplifier's speaker. Each time the coil swings past the amplifier, a loud chirp will be produced. A similar effect can be obtained by swinging an earphone

past the induction coil.

You can make a simple musical instrument by installing a magnet under a taut steel wire and placing an induction coil on the other side of the wire. Pluck the wire and it will slice through the magnet's field at an audio-frequency rate. This induces an identical audio-frequency signal into the coil. Voila, a one-string steel guitar.

Want an electronic drum? Place a small magnet on a table a few centimeters away from the induction coil. Stretch out a steel paper clip and hold one end of the wire on the surface of the table so the wire is between the magnet and the coil. When you pluck the free end of the wire, you'll hear very realistic drum-like thumps. You can alter the sounds by changing the free length of the wire.

If the magnet jumps over and clings to the wire, use tape or a clamp to hold it to the table. But first experiment with this new arrangement. When the magnet rotates around the wire or swings back and forth, you'll hear various kinds of interesting sounds.

You might want to try this experiment with several pieces of steel piano wire cut to different lengths and tightly clamped into place. Some hobby and craft shops sell piano wire. You might also want to

experiment with different magnets. Plucking the free ends of the wires should result in a wide range of musical sounds.

## Tape Recording

Telephone induction coils are ideally suited for taping radio broadcasts and recordings from other recorders when it's not possible to make a direct electrical connection between the tape recorder and the instrument being recorded. Usually, a microphone is used when a direct connection isn't possible. But a microphone will pick up any room noise that's present and superimpose it on the signal being recorded.

To record a radio signal, simply place the induction coil near the radio's speaker. If you don't want to hear the broadcast being recorded until later, just place the coil near an earphone connected to the radio. Use the same technique to copy a tape recording. First, however, be sure the coil doesn't pick up the source recorder's motor noise. If this is a problem, connect an earphone to the source recorder and place it and the induction coil together some distance away from the recorder.

Now we have come full circle, for the taping of telephone conversations is the purpose for which telephone induction coils are sold. The process is simple: just attach the suction cup to the receiver end of the telephone handset and press RECORD. But is it legal?

During my 20 years as a free-lance writer, I've only rarely used a tape recorder to record an interview. In each of those few cases, I asked permission to record the conversation. I've also recorded a number of radio talk shows on which I was a guest. Other than these instances, I've never recorded anyone's conversation over the telephone, with or without their knowledge.

However, while working on an assignment for a major magazine a year or so ago, I found myself in an emergency situation in which it seemed only prudent to be prepared to record conversations without first asking permission. It also seemed prudent to first visit a library to find out what the law said about taping

telephone conversations.

According to the United States Code ("Wire and Electronic Communications Interception and Interception of Oral Communications," Title 18, Chapter 119, Section 2511, (d), "It shall not be unlawful under this chapter for a person not acting under color of law to intercept a wire, oral, or electronic communication where such person is a party to the communication or where one of the parties to the communication has given prior consent to such interception unless such communication is intercepted for the purpose of committing any criminal or tortious act in violation of the Constitution or laws of the United States or of any State."

Simply put, this 80-word sentence says it's okay to record a conversation if at least one party knows the recording is being made or has given permission. The recording cannot be made for unlawful purposes.

Since this law clearly permits the practice, my recorder was ready when the anticipated emergency did indeed occur. Later, however, I found the following passage in a telephone directory: "It is a crime under federal and state law for any person, including a telephone subscriber, to unlawfully wiretap or otherwise intercept a telephone call . . . Under federal law, the penalty for illegal wiretapping can be imprisonment for 2-20 years, a \$10,000 fine or both."

This warning seems fairly clear and blunt. But it clashes with the United States Code. Not wanting to risk violating any laws, I decided it would be best to erase the important ferrous-oxide record produced by the recorder. First, I was curious to find out more about the obvious contradiction between the U.S. Code and the warning in the telephone directory. Therefore, I telephoned the Federal Communications Commission and spoke with an attorney with the Common Car-

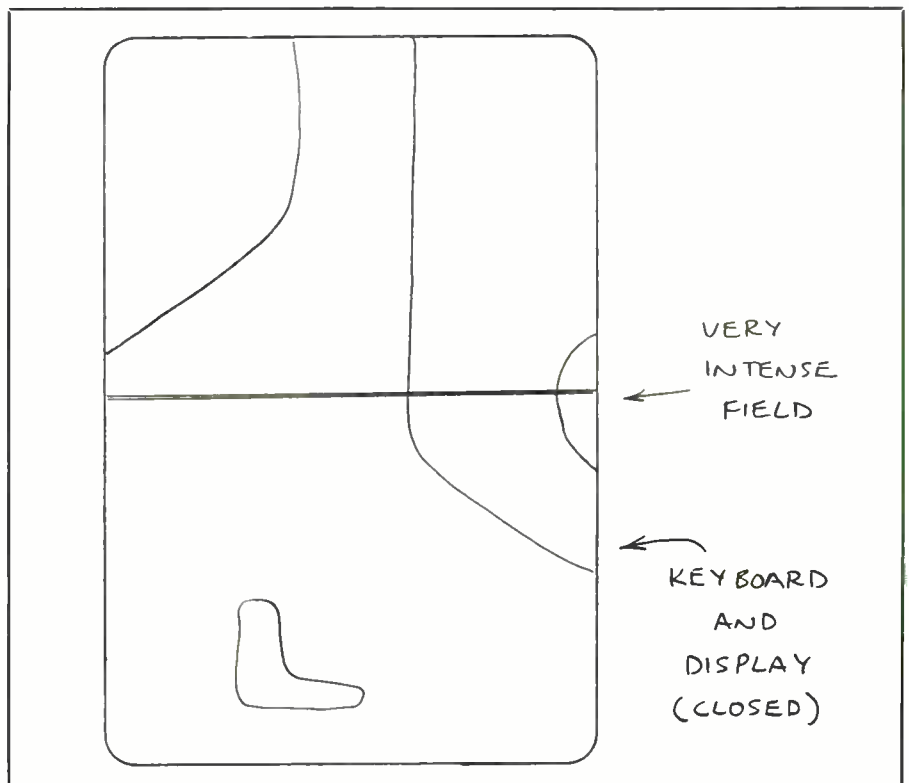

Fig. 4. Magnetic-field map of a laptop computer.



rier Bureau. He sent me a report titled "Use of Recording Devices in Connection with Telephone Service" from Federal Communications Record (FCC 86-570, Docket No. 20840, pp. 502-506).

Adopted December 23, 1986, this report explains how the telephone company tariff requires subscribers to use a beep tone device or to request prior consent before a telephone conversation is recorded. "In other words," the report observes, "our telephone recording policies are applied to the general public through a tariff mechanism and to the telephone company itself through a Commission rule."

This report goes on to observe that "... Congress has placed responsibility for enforcing telephone privacy in the courts and that the courts have found that one party consent recordings are not unlawful." The report also notes then "even if a recording does violate the tariff and the tariff is subsequently enforced, the recording may still be admissible in court."

The report also observes that "In many instances, the mere threat of service suspension will be enough to deter future misconduct... the very existence of a regulation, albeit largely unenforceable, is enough to induce compliance." The report notes that "The penalty for violation of the tariff provision is possible discontinuance of telephone service." It concludes with a statement in which the FCC retains the mutual consent and beep-tone requirements in the tariff.

Confused? So was I. Therefore, I asked some attorneys to explain the apparent contradiction between a law that permits a practice restricted by a regulation and the warning in the telephone directory. The key word in the telephone directory warning is "unlawful." The attorneys said that the United States Code prevailed and that it's lawful to tape a conversation without informing the other party. However, the telephone company might threaten to discontinue service if it learned of the practice. Also, a party whose conversation is recorded might take legal action if the recording is used in an unlawful manner.

Since *Modern Electronics* and I aren't attorneys, you shouldn't consider any of this as legal advice. Furthermore, it's especially important to remember that the laws of some States prohibit the recording of any telephone conversations without mutual notification. My personal opinion is that one should never record a telephone conversation without informing the other party unless there's a clear emergency and an attorney has approved the procedure. In my case, the ferrous-oxide record saved by a tape recorder, coupled with good legal advice, made possible the publication of three of the most important magazine articles of my career.

### Going Further

One can only wonder if the companies that make telephone induction coils realize just how versatile are these devices. The applications and experiments described here are only some of the many possibilities. No doubt you'll think of and discover many others once you begin experimenting and exploring.

Calvin R. Graf, a friend of mine, wrote *Listen to Radio Energy, Light and Sound* (Howard W. Sams & Co., Inc., 1978), a book that included a section on uses for telephone induction coils. This book may be out of print, but it's worth looking it up in a library. In addition to some of the applications described here, Cal describes how to use an induction coil to "hear" flashlight switches, neon lamps and pilot lights. He also describes how to monitor various electrical devices on an automobile with a telephone induction coil and how to communicate through a wall by means of an earphone for a transmitter and an induction coil for a receiver.

If you want to find out more about the possible hazards of low-frequency electric and magnetic fields, see "Power Play" by David Noland in *Discover* (December 1989, pp. 62-68) and "Power Lines and Cancer: The Evidence Grows" by Louis Slesin in *Technology Review* (October 1987, pp. 53-59). Dozens of technical papers on the subject have been published in the scientific literature. **ME**

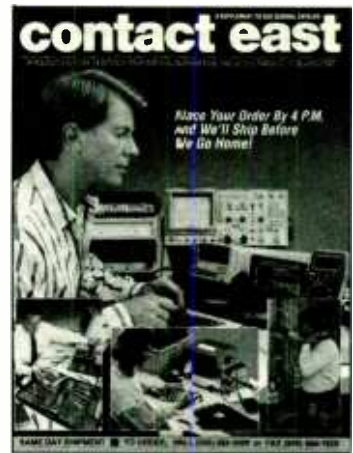

## FREE CATALOG TEST INSTRUMENTS & HARD-TO-FIND TOOLS

Packed with over 10,000 quality products for testing, repairing, and assembling electronic equipment. A full selection of test instruments, power protection equipment, precision hand tools, tool kits, soldering supplies, and much more. Products are shown in full color with detailed descriptions and pricing. All products come with a 100% satisfaction guarantee. SAME-DAY shipment program.

In a hurry to receive your catalog?

Call (800) 225-5370

In Massachusetts call (508) 682-2000

Contact East, Inc., Dept. R484  
335 Willow St., No. Andover, MA 01845

CIRCLE NO. 125 ON FREE INFORMATION CARD

## Be an FCC LICENSED ELECTRONIC TECHNICIAN!



**Earn up to  
\$30 an hour  
and more!**

Learn at home in spare time.  
No previous experience needed!

No costly school. No commuting to class. The Original Home-Study course prepares you for the "FCC Commercial Radio-telephone License." This valuable license is your professional "ticket" to thousands of exciting jobs in Communications, Radio-TV, Microwave, Maritime, Radar, Avionics and more...even start your own business! You don't need a college degree to qualify, but you do need an FCC License.

**No Need to Quit Your Job or Go To School**  
This proven course is easy, fast and low cost! **GUARANTEED PASS**—You get your FCC License or money refunded. **Send for FREE facts now. MAIL COUPON TODAY!**

**COMMAND PRODUCTIONS**  
FCC LICENSE TRAINING, Dept. 206  
P.O. Box 2824, San Francisco, CA 94126  
Please rush **FREE** details immediately!

NAME \_\_\_\_\_  
ADDRESS \_\_\_\_\_  
CITY \_\_\_\_\_ STATE \_\_\_\_\_ ZIP \_\_\_\_\_

## *More On CD ROMs: NEC CDR-35-1 ROM Drive; The Microsoft Bookshelf; The PC-SIG Library; and Two From Software Toolworks*

By Ted Needleman

Last month, I started off a discussion of CD-ROM with a look at the technology and several reviews of ROMs for the Apple Macintosh computer. This month, I'll look at the ROM drive I use on my PC and examine a few of the many available CD-ROM products available for it.

CD-ROM, for those readers who missed my last column, is an adaptation of audio compact-disk technology. An audio compact disk digitizes music and stores it on a 3-inch disk in the form of 1s and 0s. The digitized musical information is "burned" into a master with a laser, and the pits created by this process can be transferred to copies similar to the way a vinyl record is pressed.

When played on a CD player, a low-power laser beam scans the surface of the disk and is reflected differently from the surface than from a pit. These two states of reflectance (surface or pit) easily translate back into 1s and 0s. The two big advantages this binary digital technology offer computer users are that computer data and files are essentially binary (all computer data is comprised of bits—binary digits—whether in RAM or stored on disk or tape) and the huge storage potential that the CD format offers (between 250 and 800 megabytes, depending on the material and how it's coded).

There are three major limitations of the technology. One is that it's read-only (though there are re-writeable optical-disk drives available). Two is that it's still relatively expensive. A ROM drive can vary in price from about \$500 to almost \$1,000, and the CD-ROMs themselves can be more expensive than their floppy-disk equivalents. Finally, CD-ROM drives have considerably slower access times and data-transfer rates than those of even floppy disks.

By the way, all products mentioned this month and last, except for the Apple-brand ROM drive, are available from a number of sources, including the Bureau of Electronic Publishing, Inc. Despite its

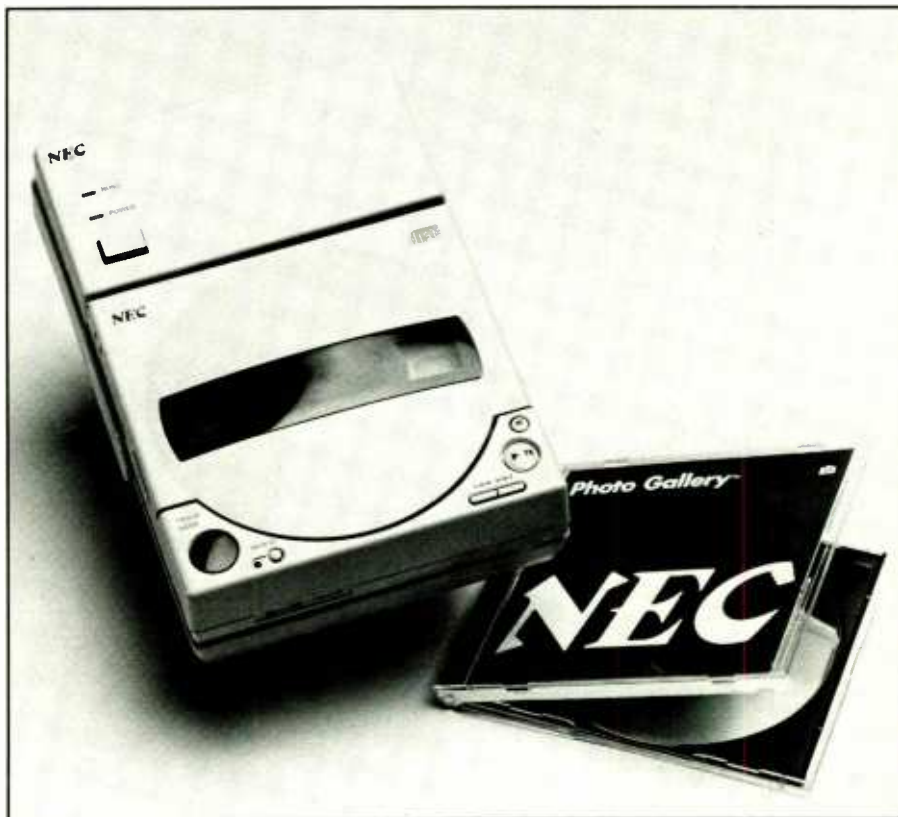

official sounding name, the Bureau is a mail-order firm that specializes in CD-ROM and carries a very large stock and the newest releases. Its catalog, published quarterly, makes fascinating reading. You can contact the company by calling 201-808-2700 or in writing at 141 New Road, Parsippany, NJ 07054.

### ***NEC CDR-35-1 ROM Drive***

Given the relatively small size of the market, CD-ROM drives are available from numerous vendors. Major names in this area are Sony, Hitachi, Toshiba, Philips, Denon and NEC, though the drives themselves are primarily manufactured by Philips, Hitachi and Sony. The drive I used for last month's reviews was Apple's own, but the NEC CDR-35-1 drive I used for the PC products also works with the

Macintosh. The CDR-35-1 is the smallest and lowest-priced ROM drive NEC offers, with a list price ranging from \$599 (Mac version) to \$699 (PS/2 version). The XT/AT version I reviewed lists for \$649. The only difference between the three versions is the interface.

The CDR-35-1 is a SCSI device, which means that it only needs a SCSI cable to hook up to the Mac. With the PC or PS/2, a SCSI interface board is needed, which makes these versions a bit more expensive (the PS/2's MicroChannel even more so than the XT/AT's standard ISA bus). All three versions come with the appropriate software; a driver for the Mac version and a driver and extensions to MS-DOS for the XT/AT and PS/2 versions. Installing the software is easy. On the Mac, just drag the driver icon over to the System folder. On the PC versions, a



program automatically installs the software. The PC interface board, however, has jumpers that are used to set the board's base address and interrupt. These might have to be reset, depending on what other equipment you have in your system.

The drive itself is very small, not much larger than a Sony Walkman, and fits into a base that provides the cable connection and a socket for the included ac power supply. You can also purchase a battery pack for the unit for about \$80, which is handy if you want to play audio CDs through the included headphone jack. Even though the CDR-35-1 has the ability to play audio CDs, don't plan on listening while jogging. The unit is meant to be used in place, not on the go.

The small size (about 6 by 2.5 by 8.75 inches) and light weight (2 pounds) make this an attractive unit, but the CDR-35-1 does have one major shortcoming—it's painfully slow. CD-ROM readers aren't fast devices to begin with, but the CDR-35 is even slower than most. Its average access time is 1,500 ms, or about a second and-a-half. For contrast, most other CD-ROM drives boast access rates of 350 to 500 ms. When switching from one drive to another, this access rate difference is very noticeable.

Yet the CDR-35-1 is very much worth considering. It can be used with both PCs and Macs and is one of the very few drives that's completely portable. If you need a drive to occasionally use with a laptop computer, this might be the one (though your laptop will need a standard XT expansion slot to accommodate the SCSI interface card). Given my druthers (and a fatter wallet), I'd choose a faster drive. But in the real world, where I use the drive only occasionally, I can put up with the drive's lack of speed to gain its value and portability.

### ***The Microsoft Bookshelf***

One of the most useful CD-ROMs you can own is Microsoft's *Bookshelf*. The *Bookshelf* is a collection of reference

sources that can be accessed in a stand-alone mode or from a variety of word processors. Microsoft tends to push this product toward writers and other journalists, and it's true that as a professional writer I find it invaluable. But it's also extremely helpful to anyone who has to produce literate word-processed documents.

In fact, if you do any amount of writing or extensive word processing, you may already have some or most of these reference works on your bookshelf. The ROM contains *The American Heritage Dictionary*, *Roget's II: Electronic Thesaurus*, the *World Almanac and Book of Facts* (the *World Almanac* is the 1987 version, already somewhat out of date), *Bartlett's Familiar Quotations*, the *Chicago Manual of Style*, the *Houghton Mifflin Spelling Verifier and Corrector*, *Forms and Letters*, a U.S. ZIP Code Directory, the *Houghton Mifflin Usage Alert* and *Business Information Sources*.

Many of these works will already be familiar to you. The two that most likely aren't are the *Forms and Letters* and *Business Information Sources*. *Forms and Letters*, as the title implies, is a large collection of boilerplated "standard" forms, letters and outlines. As all of the *Bookshelf* "books" are accessed through your word processor, these letters and forms can be directly imported into a word-processor document and edited to your requirements. I have to admit, though, that I haven't used this particular feature very much. I don't have much use for the forms, and I generally prefer my own letters (which I've saved over the years into a boilerplate collection) to those boilerplated in the *Bookshelf*.

I do use the *Business Information Sources* database quite frequently, though. This is a collection of organizations, publications, agencies and government offices that's cross-referenced to subject keywords. When I'm researching a particular subject, pulling up this particular reference quickly lets me check for alternate sources of information. This database is pretty much restricted to finance, economics, management and

## Earn Your B.S. Degree in ELECTRONICS or COMPUTERS



### **By Studying at Home**

Grantham College of Engineering, now in our 41st year, is highly experienced in "distance education"—teaching by correspondence—through printed materials, computer materials, fax, and phone.

No commuting to class. Study at your own pace, while continuing on your present job. Learn from easy-to-understand but complete and thorough lesson materials, with additional help from our instructors.

Our Computer B.S. Degree Program includes courses in the BASIC, PASCAL, and C languages — as well as Assembly Language, MS DOS, CADD, and more.

Our Electronics B.S. Degree Program includes courses in Solid-State Circuit Analysis and Design, Control Systems, Robotics, Analog/Digital Communications, and more.

An important part of being prepared to *move up* is holding the right college degree, and the absolutely necessary part is knowing your field. Grantham can help you both ways—to learn more and to earn your degree in the process.

Write or phone for our free catalog. Toll free, 1-800-955-2527, or see mailing address below.

•  
Accredited by  
the Accrediting Commission of the  
National Home Study Council

•  
**GRANTHAM**  
**College of Engineering**  
Grantham College Road  
Slidell, LA 70460

## PC CAPERS...

marketing; so it may be of limited use to you if your main areas of research tend to be in the technical areas.

*Bookshelf* works with just about every popular word processor (over a dozen are listed), and doesn't require any special installation, other than starting it (by typing BOOKS) before you start your word processor. It's accessed from your word processor by pressing the ALT and left Shift keys together, which brings up a *Bookshelf* menu bar. Pick the reference you need, and the selected reference is loaded. Each work in the *Bookshelf* operates somewhat differently—so I'm not going to detail operations here—but the manual that accompanies the ROM is well written and makes it easy to use *Bookshelf*.

*Bookshelf* requires a full 640K of RAM when used with floppy-based systems and 512K if you have a hard disk. It also requires that you be using DOS 3.1 or later and works with just about any video adapter and monitor. At \$229, it isn't an inexpensive purchase. On the other hand, I paid over \$40 just for my copy of the *Chicago Manual of Style*, and the ROM version is many times easier to use.

In truth, if my CD-ROM drive stopped working, I think the thing I'd miss most would be Microsoft's *Bookshelf*. It's been that useful.

### The PC-SIG Library

Shareware and public-domain software has, over the last several years, become big business. Not only are there numerous companies that will supply you with the software for several dollars a disk, but some of the companies that produce the software have become major players in the industry. For example, QuickSoft's *PC Write* word processor probably has many more users than some of the better-known commercial products (though, unfortunately, many of these users never send in the registration fee). And Jim Button's *PC-File* is an extremely popular database-management system. There are shareware and public-domain

## They're Here!

# MODERN ELECTRONICS

## FUN PROJECT BOOKS

You'll want these two exciting project books, packed with complete plans for building a wide variety of useful electronic devices. The *First and Second Books of Modern Electronics Fun Projects*, both Howard W. Sams publications, are now available.

You'll find all the how-it-works information, schematics, photos, drawings, printed-circuit guides and the parts sources to make it a snap to build almost 50 useful, unique electronic devices at modest cost.

Discover how these circuits and modern electronic devices perform their magic. Learn practical electronic technology the painless way and enjoy doing it!

All projects are based on material published in *Modern Electronics*, with updates and revisions. They've been built and tested by the original authors. Chapters are divided into; Intro To Electronic Projects, Home Electronics, Audio/Video Electronics, Security Electronics, Computers, Test Equipment, and Electronic Designing. There's something for everyone!

Look at what you can build and take pride in:

- \* Digital voltmeter accessories—high-frequency ac probe, true-rms adapter, temperature probe
- \* Car projects—anti-theft alarms, engine tachometer
- \* Life-saving detectors—gases & microwave leaks

Order both books and pay only \$22.95 plus shipping.



- \* Computer system power controller
  - \* Dual-pulse generator
  - \* Surround-sound audio enhancer
  - \* Security—telephoned status reporter, alarm control center
  - \* Home convenience—selectable phone ringer musical tunes, touch-sensitive light controller.
- ... and so much more.

The Fun Projects are capped by introductory information on building projects and kits (tools needed, parts sources, etc.) and advanced design techniques that illustrate how a designer thinks and plans when putting together a practical end product.

From beginning to end, MODERN ELECTRONICS FUN PROJECT BOOKS are for you! Order them today for a fast start in the world of electronics.

MODERN ELECTRONICS  
76 N. Broadway, Hicksville, NY 11801

Name \_\_\_\_\_  
 Address \_\_\_\_\_  
 City \_\_\_\_\_  
 State \_\_\_\_\_ Zip \_\_\_\_\_  
 ( ) Check ( ) MasterCard ( ) VISA  
 Card No. \_\_\_\_\_  
 Expires \_\_\_\_\_  
 Signature \_\_\_\_\_

(Signature required on all charge orders)

Order Date: \_\_\_\_\_

QTY	Title	Price	Total
	First Book of Modern Electronics Fun Projects	\$12.95 ea.	
	Second Book of Modern Electronics Fun Projects	\$12.95 ea.	
	Both Books	\$22.95	
		*Shipping	
		Total	

Order both books and pay only \$22.95 plus shipping.

\*Shipping charges \$2 per order. Orders processed day received, but please allow 30 days for delivery.



software packages for just about any application you can think of, and many of these are equal to (or even better than) high-priced applications sold in computer stores.

PC-SIG is one of the older companies that supply shareware/public-domain software for MS-DOS users. And it has collected its entire library on one CD-ROM disk. There are a number of other CD-ROM collections of this type of software available, but at \$465, the *PC-SIG Library* is both the most expensive and unique in at least one way.

One of the major problems in using any huge collection of software, such as the Macintosh collections detailed last month, is figuring out exactly what you have on the ROM. QL TECH (the ROMs reviewed last month) and many other vendors put a listing directly on the ROM as a separate file. But these are generally just a listing of the program's title within a general category.

PC-SIG does things differently. Along with the CD-ROM and a booklet that instructs you on how to access the software and use the included search engine is a large 600-page *Encyclopedia of Shareware*. This book is available separately from the PC-SIG and is somewhat of a catalog that details the different programs available in various areas and describes in a paragraph or two what each program actually offers.

While such a short description doesn't begin to tell you about all the features a particular program may actually offer, it does provide an excellent filter for helping you narrow down the programs you're most interested in taking a look at. This "encyclopedia" alone justifies the much higher price of the PC-SIG ROM and is a feature I'd like to see the industry as a whole adopt, though the amount of work and time that obviously went into this book will preclude many smaller firms from offering a similar guide.

If you're just starting out with PCs, or don't have much of a budget for software, a collection of shareware packages offers a great way to build your library at

a reasonable cost. Whether or not you have any intention of buying PC-SIG's ROM Library, its encyclopedia, at \$22.95, is something you should own. The programs are available separately on floppy disks from both PC-SIG and numerous other sources, such as user's groups and electronic bulletin boards. The encyclopedia is essential for anyone getting into shareware, and PC-SIG's CD-ROM, even at its over \$400 price, is an excellent way to build your software library in one easy shot.

### **Two From The Software Toolworks**

The Software Toolworks is probably one of the largest, least-known software suppliers around. It offers a wide variety of

useful and entertaining computer programs, including the *Life & Death* medical simulation reviewed in the November 1990 column, a typing tutor (*Mavis Beacon Teaches Typing*), games (such as *The Hunt For Red October* and those on the game ROM reviewed a bit later on), utilities (like *Word for Word*, which lets you convert from one word-processor format to another), educational software and even a package that lets you access the *AccuWeather* database, the same used by professional weather forecasters.

The Toolworks also offers a number of CD-ROM products. Two that I found of particular interest are *World Atlas* and the *CD Game Pack*.

*World Atlas* is very similar in both concept and execution to the *PC-Globe* software I reviewed a couple of issues back. It

**SUBSCRIBER SERVICE**  
**CHANGE OF ADDRESS**

Planning to move? Please let us know six weeks in advance so you won't miss a single issue of **MODERN ELECTRONICS**

Attach old label and print new address in space provided. Also include your mailing label whenever you write concerning your subscription to insure prompt service on your inquiry

**Modern Electronics**  
76 N. Broadway,  
Hicksville, NY 11801

**ATTACH LABEL HERE**

**NEW ADDRESS HERE** **PLEASE PRINT**

NAME \_\_\_\_\_

ADDRESS \_\_\_\_\_

CITY \_\_\_\_\_ STATE \_\_\_\_\_

DATE \_\_\_\_\_ ZIP \_\_\_\_\_



**CONSOLIDATED ELECTRONICS**  
VOLUME I - TEST EQUIPMENT

**CONSOLIDATED ELECTRONICS**

Get two of the most valuable electronic catalogs ever! These 2 catalogs contain over 16,000 hard to find electronic parts & equipment. VOL. I - features 112 pages of high quality test equipment. VOL. II - features 144 pages of electronic parts, tools & cross references. Send \$5 check or money order, or call today & use your VISA or MasterCard.

**1-800-543-3568**



**CONSOLIDATED ELECTRONICS**  
VOLUME II - PARTS & ACCESSORIES

CONSOLIDATED ELECTRONICS, INCORPORATED 705 WATERVLIET AVENUE DAYTON, OHIO 45420-2599  
FAX: 1-513-252-4066 / TEL: 1-513-252-5682 / TELEX: 288-229 / COMPUSERVE: 76057, 3347 / EASYLINK: 62850013

CIRCLE NO. 126 ON FREE INFORMATION CARD

# PC CAPERS...

presents a map of the world and lets you select an area to zoom in on. You can see major population centers, a topographic map and rivers, and obtain a large variety of statistical information of the area selected. It's a lot of fun and informative, and a great teaching and learning tool if you have children.

I wondered about the \$159 price of the CD-ROM version of the Toolworks *World Atlas*, since the company offers a floppy-disk version for \$100 less (\$59). I didn't receive the floppy version, so I can't vouch that the two are exactly the same. However, phoning a company representative to discuss this, I was informed that this version will be discontinued.

By the time you read this, the company will have out a CD-ROM that com-

bines *US Atlas* and *World Atlas* for only \$109.95. At this price, I can give it a buy recommendation.

The *CD Game Pack* is a different story. For \$99, it's a great value and loads of fun. The five games it contains are *Life & Death*, *ChessMaster 2000*, *Gin King\** *Cribbage King*, *Beyond the Black Hole* and *Bruce Lee Lives*. *Life & Death* and *ChessMaster 2000* have both been reviewed in this magazine before (*Life & Death* in this column, *ChessMaster 2000* in Software Focus). I didn't look at *Gin King\** *Cribbage King*, as I'm not much of a card player (solitaire and crazy eights are about it for me), but Software Toolworks' simulations are about the best there is. *Beyond the Black Hole* is a pretty standard "shoot-'em-up" action game,

but with a twist—it's in 3-D. Wearing cardboard glasses (supplied), with one clear lens and one red lens, actually produces a pretty nifty 3-D effect, which makes the game even more fun to play.

*Bruce Lee Lives* pits the late martial-arts master against the minions of the evil drug lord Master Po. The program analyzes your fighting techniques, and your opponents gradually adapt to your style and become more difficult to defeat.

One of the things that I really like like about The Software Toolworks' products is the little booklets the company includes. *Life & Death* comes with a history of surgery, a cardboard beeper/pager and even a surgical mask. *Beyond the Black Hole* has a history of the development of 3-D in print and movies, and *Bruce Lee Lives* has a biography written by his wife. None of these are really necessary to use or enjoy the particular program, but they make interesting reading, and I appreciated having them.

At \$99, the *CD Game Pack* is considerably less expensive than the cost of the five programs purchased separately (about \$250) and is one purchase I'd recommend to anyone who owns a PC and CD-ROM player. **ME**

## SUPER LONG PLAY TAPE RECORDERS

**12 Hour Model — USES 120 TAPE \$119.00\***



Modified Panasonic Slimline high quality AC-DC provide 6 continuous hours of quality recording & playback on each side of cassette for 12 hours total. Includes • Voice level control • Digital counter, etc. TDK - 120 Cassette Furnished.

---

### PHONE RECORDING ADAPTER

Records calls automatically. All Solid state connects to your telephone jack and tape recorder. Starts recording when phone is lifted. Stops when you hang up. **\$28.50\*** FCC APPROVED

---

### VOX VOICE ACTIVATED CONTROL SWITCH

Solid state. Self contained. Adjustable sensitivity. Voices or other sounds automatically activate and control recorder. Uses either recorder or remote mike. **\$28.50\***

\*Add for ship & hold. Phone Adapter & Vox \$1.50 ea. Recorders \$4.00 ea. Cal. Res. add tax. Mail order, VISA, MIC, COD's OK. Money Back Guarantee. Qty. disc. avail. Dealer Inquiries invited. Free data.

**AMC SALES INC.** Dept. M 9335 Lubec St. Box 928, Downey CA 90241  
Phone (213) 869-8519 FAX (213) 923-1478

CIRCLE NO. 30 ON FREE INFORMATION CARD

## RACK CHASSIS FOR THE CONSTRUCTOR

CONSTRUCTED OF ALL ALUMINUM PARTS THE FRONT & REAR PANELS ARE CLEAR BRUSHED ANODIZED THE BALANCE OF THE PARTS ARE BLACK BRUSHED ANODIZED



SEND FOR FREE CATALOG OF SHEET METAL BOXES, RACK CHASSIS, RING PANELS, SHEET METAL PUNCHES, PRESS ON LETTERING, HAND PUNCH TOOL AND PUNCH BITS AND OUR LINE OF OVER 300 PROFESSIONAL AND SEMI-PROFESSIONAL AUDIO PROJECTS, WAXTRAC AND VISA ACCEPTED. ORDER DIRECT FROM THE FACTORY. SHIPPED UPS GROUND FREE. MONDAY THROUGH FRIDAY 9AM TO 5PM EST DAILY AIR 0630

MODEL	SIZE (H,W,D")	PRICE
1RU5	1.75 x 19 x 5	28.00
1RU7	1.75 x 19 x 7	30.00
1RU10	1.75 x 19 x 10	32.00
2RU5	3.50 x 19 x 5	30.00
2RU7	3.50 x 19 x 7	32.00
2RU10	3.50 x 19 x 10	34.00
3RU5	5.25 x 19 x 5	38.00
3RU7	5.25 x 19 x 7	40.00
3RU10	5.25 x 19 x 10	42.00

**SESCOM, INC.**  
2100 WARD DR.  
HENDERSON, NV. 89015 U.S.A.  
(702)-565-3400 FAX (702)-565-4828

CIRCLE NO. 139 ON FREE INFORMATION CARD

## Cable TV Descramblers

If you find a better deal, we'll better our deal.

\*Jerrol \*Tocom \*Hamlin \*Oak  
\*Scientific Atlanta \*Zenith

Ask about our extended warranty program.

COD, Visa, M/C welcome.  
Free Call — Free Catalog.

**Video Tech 800-562-6884**  
3702 S. Virginia St., Ste. 160-304  
Reno, NV 89502.

CIRCLE NO. 140 ON FREE INFORMATION CARD

### PRODUCTS MENTIONED:

**Microsoft Bookshelf**  
Microsoft Corp.  
One Microsoft Dr.  
Redmond, WA

**The PC-SIG Library**  
Encyclopedia of Shareware  
PC-SIG  
1030D East Duane Ave.  
Sunnyvale, CA 94086  
800-245-6717

**US & World Atlas**  
**CD Game Pack**  
The Software Toolworks  
60 Leveroni Ct.  
Novato, CA 94949  
415-883-3000



## *A Fast Math Coprocessor for 80386 Computers, Low-Power GFI and High-Speed GaAs SRAM*

By Joseph Desposito

This month, we take a look at a new coprocessor that can help speed up technical applications on 80386 PCs. Then we examine a new ground-fault interrupter that will help manufacturers of personal-care products to comply with a new law. We end with a new gallium-arsenide chip that points out this technology's advantages over silicon.

### **80387-Compatible Processor**

Cyrix Corporation (1850 N. Greenville Ave., #184, Richardson, TX 75081) has introduced its flagship high-performance math processor for 80386 PCs. Called the FasMath EMC87 processor, the new device reportedly delivers up to five times the application performance of the Intel 80387 for tuned programs (programs designed for use with the chip) and runs all existing 80386/80387 programs 20% to 300% faster without modification.

The new FasMath EMC87 is socket-compatible with the 121-pin extended math coprocessor socket found in most 386 PCs. Simplifying the development of new highly tuned programs for the EMC87 is the 386/DOS-Extender from Phar Lap Software, compiler products from MetaWare, MicroWay and Silicon Valley Systems, plus a variety of programming and application tools to serve the CAD market, including Intusoft *SPICE* and Evolution Computing's *FastCAD 3D*.

The FasMath EMC87 combines improved performance and full compatibility for existing 80386/80387 applications with a high performance parallel interface that delivers a 2x to 3x performance boost to tuned applications. The FasMath family obtains improved performance by implementing its floating point primitive operations in hardware and by using new, proprietary algorithms for computing math functions. This approach allows FasMath processors to perform floating point operations in far fewer clock cycles than the 80387. Fewer clock cycles per operation result in faster execution of numerics-oriented application programs.

The FasMath EMC87 implements a full extended double-precision IEEE754-1985 architecture with parallel adder, multiplier and exponent units to provide ultra-high performance. In addition, the chip automatically selects one of two interface modes in response to the instruction being executed: the EMC either emulates 80387 style execution or, for maximum speed, executes in EMC mode using its parallel command/data interface.

The FasMath EMC87 device is fabricated using a 1.0-micron gate length, double-layer metal CMOS process. This permits the FasMath EMC87 to operate at clock rates of 20 MHz, 25 MHz and 33 MHz. State-of-the-art ESD protection and latch-up prevention circuits are incorporated into the EMC87 design. The chip is supplied packaged in a ceramic 121-pin grid array package.

Availability of a fully integrated, high-accuracy, high-performance math processor for 80386-based systems opens up the desktop to more computationally intensive applications. These include image processing, circuit simulation, finite element analysis, digital signal processing, IC design and verification, process instrumentation, forecasting, modeling, graphics and statistical analysis.

Suggested retail prices of the Cyrix FasMath EMC87 are \$994 for the 33-MHz version, \$865 for the 25-MHz version and \$774 for the 20-MHz version. Single-unit pricing includes Cyrix's utility diskette containing test programs, demos and utilities for the programmer to assist in tuning applications to use the advanced parallel command/data interface. The package also includes complete reference and installation manuals.

The Cyrix FasMath EMC87 is available through Cyrix's nationwide dealer network and international dealer/distributors. You can call 1-800-FasMath for information on the source nearest you.

*Tuned software* for the Cyrix FasMath EMC87 can be developed and executed under any of three system environments: DOS, DOS extenders and Virtual 86 monitors. Development using a DOS extender provides the greatest ease of use, requiring only recompiling existing pro-

grams with an EMC supportive compiler. DOS-Extender products (*386/DOS-Extender*, *386/VMM*, *386/LINK* and *386/ASM*) are available from Phar Lap Software, Inc. Compiler products are offered by MetaWare, Inc. (*High C*); MicroWay, Inc. (*NDP Fortran* and *NDP C*) and Silicon Valley Systems (*SVS Fortran*).

The lowest-cost development alternative is to use standard 80386/80387 compilers from Microsoft, Borland and others. This approach requires use of a Virtual 86 mode monitor program such as *CEMM* from Compaq Computer Corp. Cyrix's EMC87 utility diskette provides *CEMM* support to allow the user to enable EMC-mode operation and a set of macros to convert assembly-language source output from the compilers to EMC MOV instructions. Easing such conversion, only the most-time-critical portions of a program need be adapted to use the parallel command/data interface; non-critical portions can remain in 80386/80387 form for execution in compatible mode. All tools used to develop programs for standard 80386/80387 configurations can be used to produce code for the EMC87 processor to execute in compatible mode.

*Application programs* emphasizing the improved performance of the EMC87 are available from Evolution Computing, maker of *EasyCAD 2* and *FastCAD*. A new version of *FastCAD—FastCAD 3D*—tuned to use the EMC87's parallel command/data interface is available. Intusoft, a developer of *SPICE* programs for PCs, is creating a version of its highly regarded *PSPICE* program for use with the EMC87.

Cyrix EMC87 processors are available now and fully supported for use in Compaq 80386 systems, Epson 80386 systems and Micronyx-based 80386 systems. Cyrix continuously tests additional systems for compatibility and support of the EMC87. Contact Cyrix for the latest information.

### **Low-Power Ground-Fault Interrupter**

Raytheon Co., Semiconductor Division

# SOLID-STATE DEVICES...

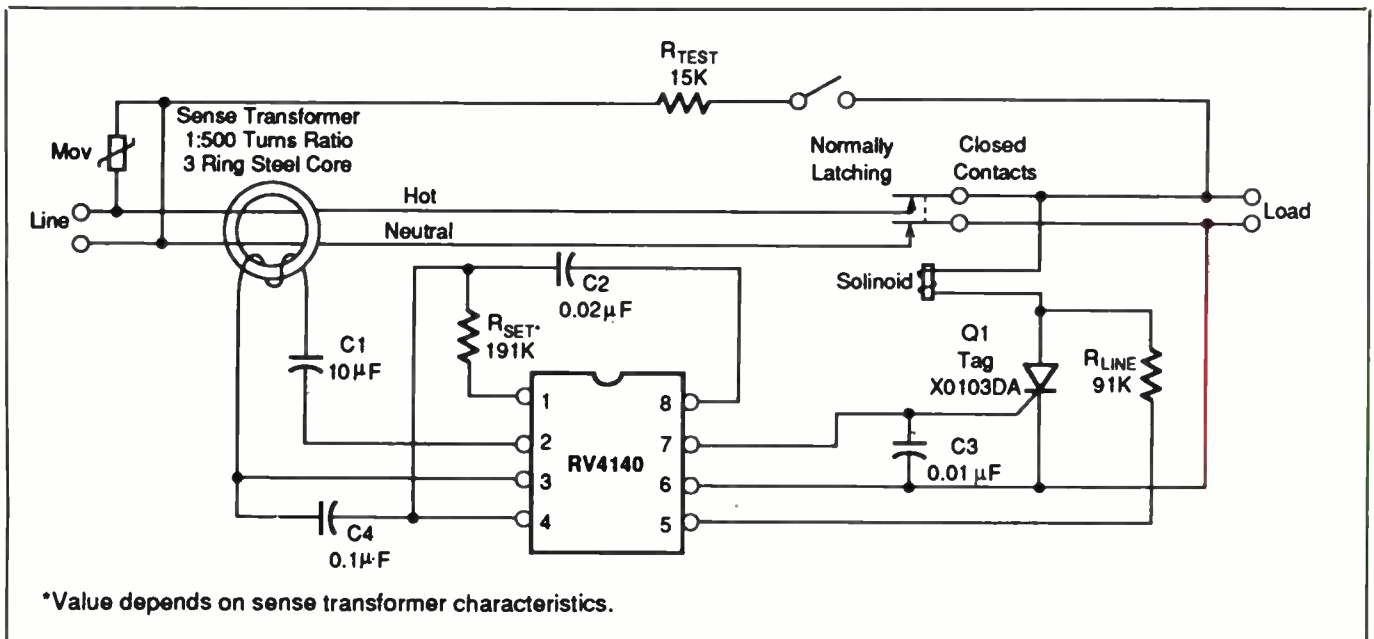

Fig. 1. Schematic details of a typical appliance leakage detector circuit application.

(350 Ellis St., P.O. Box 7016, Mountain View, CA 94039) has augmented its line of ground-fault interrupter (GFI) controller ICs with the RV4140, a low-power, two-wire GFI. The RV4140 is for use in home appliances such as hair dryers and curling irons, where it detects hazardous current paths to ground and prevents electrical shock.

Raytheon's existing line of GFIs is widely used in electrical wall receptacles in bathrooms, kitchens and outdoors around swimming pools. A new law, which goes into effect January 1991, will require electrical personal-care products used in bathrooms to include a leakage-detection device to prevent electrical shock. The RV4140 provides the control portion of a leakage-detection device.

The RV4140 has taken many of the external components typically found in GFI controllers and included them internally. Internal components of the RV4140 include a diode bridge rectifier, a 6.5-volt zener shunt regulator, an op amp, time-delay circuit, latch and SCR driver. External components include a sense transformer, SCR, relay, two resistors and four capacitors.

The following is a description of how a typical GFI works (Fig. 1). The RV4140 contains a 6.5-volt zener diode as part of an internal bridge rectifier. This is divided to create an internal reference of 2.9 volts connected to pin 3. The secondary of the sense transformer is ac coupled to the inverting input of an internal sense amplifier at pin 2; the noninverting input is referenced internally to pin 3. A current feedback loop around the sense amplifier ensures a virtual ground will be presented to the secondary of the sense transformer. In this manner, it acts as a current transformer instead of a voltage transformer. In this mode, transformer characteristics are very predictable.

The sense transformer has a toroidal core made of laminated steel rings or solid ferrite material. The secondary of the transformer is 500 to 1,000 turns of No. 40 wire wound through the toroid. The primary is one turn made by passing the ac "hot" and neutral wires through the center of the toroid. When a ground fault exists, a difference occurs between the current flowing in hot and neutral wires. The difference primary current, divided by the number of secondary

turns, flows through the secondary wire of the transformer.

The ac-coupled transformer secondary current then flows through the sense amplifier's feedback loop, creating a full-wave rectified version of the secondary fault current. This current passes through the RSET input at pin 1, generating a voltage that is compared with the reference voltage at pin 3.

If the voltage at pin 1 is greater than that at pin 3, an internal comparator charges C2 through a 29- $\mu$ A current source at pin 8. If the voltage at pin 1 exceeds that at pin 3 for longer than a specified delay time, a 400- $\mu$ A current pulses between pins 6 and 7 and triggers the SCR's gate.

If the voltage at pin 1 exceeds that at pin 3 for less than the delay time, the SCR will not trigger. The fault current at which the controller triggers the SCR is dependent on the value of RSET and the time delay determined by the value of C2.

UL 943 requires that the circuit interrupter trip when the ground fault exceeds 6 mA and not trip when the fault current is less than 4 mA.

The RV4140 has a built-in diode bridge



rectifier that provides power to the chip that is independent of ac-line polarity. This eliminates the external rectifier required for previous GFI controllers.

The SCR used in the circuit must have a high  $dV/dt$  rating to ensure that line noise (generated by electrically noisy appliances) does not falsely trigger the SCR. Also, the SCR must have a gate drive requirement that is less than  $200 \mu A$ . Noise filter  $C3$  prevents high-frequency line pulses from triggering the SCR.

The relay solenoid used should have a 3-ms or shorter response time to meet the UL 943 timing requirement. Magnetic Metals Corp. (Camden, NJ) supplies a full line of ring cores and transformers designed specifically for GFI and related applications.

The RV4140 is available over the industrial operating temperature range in an 8-lead plastic DIP and an 8-lead plastic small-outline package. Pricing in 100-piece quantities starts at 68 cents.

### High-Speed GaAs SRAM

Vitesse Semiconductor Corp. (741 Calle Plano, Camarillo, CA 93010) has announced the VS12G478, high-speed, gallium-arsenide 4,096-bit, read/write self-timed SRAM. The 478 is organized as 2,048 words by 2 bits and features a "clear-all-bits-to-zero" purge capability that is critical in high speed multiprocessing/multitasking systems. The VS12G478, which is F100K ECL I/O compatible, is designed for high-performance computer applications, such as register files, writable stores, cache RAMs, cache tag RAMs and addressable translation look-aside buffers.

The 478 showcases gallium-arsenide's inherent advantage over silicon by offering not only speed, but also low power consumption and the ability to place needed memory system control logic in the critical speed path.

The 478 has a maximum read or write cycle time of 5 ns. Purge capability of the 478 is especially useful in multitasking systems with cache tags, which require a validity bit purge in a very short time. All

inputs are registered and all outputs are latched. A diagnostic serial scan mode is also supported, which allows examination and modification of internal register states. In addition, system timing problems are eased via on-chip circuitry, which creates an internal write pulse.

The 478 Purge SRAM, requiring only a

standard -2.0-volt power supply, has a typical power dissipation of less than 1 watt. Packaged in a 28-pin leaded ceramic chip carrier, the 478 operates over the commercial temperature range of  $0^{\circ}$  to  $70^{\circ}C$ . The 478 is available in 5- and 7-ns versions, priced at \$94 and \$59, respectively, in quantities of 100 or more. **ME**

**107 SPECTRUM PROBE™ \$249.**  
 converts any scope into a  
**100MHz spectrum analyzer**  
 60dB display dynamic range  
**SMITH DESIGN** 30 day refund, VISA/MC  
 1324 Harris, Dresher, PA 19025 (215) 643-6340

**REMOTE CONTROL KEYCHAIN**  
 Complete w/mini-transmitter and +5 vdc RF receiver  
 Fully assembled including plans to build your own auto alarm  
 Quantity discounts available  
 Check, Visa or M/C  
 Add \$3 shipping  
**ONLY \$24.95**  
 VISITECT INC. BOX 5442, 50 SAN FRAN, CA. 94080  
 (415) 872-0128 Fax (415) 872-2635

**LEARN VCR**  
**CLEANING/MAINTENANCE/REPAIR**  
 EARN UP TO \$1000 A WEEK, WORKING PART TIME FROM YOUR OWN HOME!

Secrets Revealed!  
 NO Special Tools or Equipment Needed.

**EARN UP TO \$60 AN HOUR AND MORE!**

**THE MONEY MAKING OPPORTUNITY OF THE 1990'S**

IF you are able to work with common small hand tools, and are familiar with basic electronics (i.e. able to use voltmeter, understand DC electronics) ...

IF you possess average mechanical ability, and have a VCR on which to practice and learn ... then we can teach YOU VCR maintenance and repair!

FACT: up to 90% of ALL VCR malfunctions are due to simple MECHANICAL or ELECTRO-MECHANICAL breakdowns!

FACT: over 77 million VCRs in use today nationwide! Average VCR needs service or repair every 12 to 18 months!

Viejo's 400 PAGE TRAINING MANUAL (over 500 photos and illustrations) and AWARD-WINNING VIDEO TRAINING TAPE reveals the SECRETS of VCR maintenance and repair—"real-world" information that is NOT available elsewhere!

Also includes all the info you'll need regarding the BUSINESS-SIDE of running a successful service operation!

**FREE INFORMATION**  
 CALL TOLL-FREE 1-800-537-0589  
 Or write to:  
**Viejo Publications**  
 5329 Fountain Ave., Dept. ME  
 Los Angeles, CA 90029

**CABLE TV DESCRAMBLER**  
 How You Can Save Money on Cable Rental Fees

**US Cable will Beat Anyone's Price Advertisd in this Magazine!**

1 Unit 5+	
Jerrold SB w/Tri-Bi.....	\$99 .....\$70
SuperTri-Bi (TBM).....	\$109.....\$75
Jerrold 450 combo.....	\$189.....\$139
Scientific Atlanta.....	\$109.....\$75
SA 8536.....	\$259.....\$195
Pioneer.....	\$109.....\$79
Oak KN12 (w/VS).....	\$109.....\$65
Hamlin MLD 1200.....	\$89.....\$59
Toocom.....	\$169.....\$129
Stargate converter.....	\$89.....\$69
Panasonic TZPC145.....	\$99.....\$79

**30 Days Money Back Guarantee**  
**Free 16 page Catalog**  
 Visa, M/C, COD or send money order to:  
**US Cable TV Inc. Dept. KME2**  
 4100 N. Powerline Rd., Bldg F-4  
 Pompano Beach, FL 33073  
**1-800-445-9285**

**For Our Record**  
 I, the undersigned, do hereby declare under penalty of perjury that all products purchased, now and in the future, will only be used on Cable TV systems with proper authorization from local officials or cable company officials in accordance with all applicable federal and state laws. FEDERAL AND VARIOUS STATE LAWS PROVIDE FOR SUBSTANTIAL CRIMINAL AND CIVIL PENALTIES FOR UNAUTHORIZED USE.  
 Date: \_\_\_\_\_  
 Signed: \_\_\_\_\_

**No Florida Sales!**

**Understanding Electronic Photography.**  
By John J. Larish. (Tab Books. Softcover.  
271 pages. \$24.95.)

The author presents the reader with a comparison of the products and technologies now available for capturing, processing and transmitting photographic images produced with electronic still video cameras. He does so with basically non-technical text that even most people who are not involved in the technology can easily understand. Thus, this book is neither a technical text that explains the theory of imaging, nor is it a how-to user's guide. Rather, it is a fairly detailed description of what is available for electronic photography purposes and how

this equipment is currently being used and can be put to use.

The book begins with an overview of electronic still photography and how the technology matured into its present level of sophistication. Having laid the foundation, the book discusses the means for capturing images using NTSC camera signal processing, CCDs, new sensors, photosensitive elements, tube-based cameras, scanning technology and video cameras. Next, it discusses transmitting and receiving electronic photographs, storing images and display and output of images. Later chapters deal with the electronic darkroom and tomorrow's electronic images may be generated, trans-

mitted, received and stored.

Each of the seven chapters that make up this book concludes with at least one application story that tells how electronic photography is already being used in business and industry. Also, a glossary of terms used in the field is provided at the end of the book.

Well illustrated with photos, drawings, tables and other visual aids, this book provides a fascinating tour through a colorful technology. Eight pages of color photography captured and recreated by the equipment detailed by the author are also bound into the book, vividly illustrating what electronic video cameras can produce.

## NEW LITERATURE

**DSO Literature.** RAG Electronics is offering a colorful brochure that details the Hitachi VC-6145, VC-6045/VC-6025, VC-6024/VC-6023, VC-6145, VC-6045/VC-6025 and VC-6014/VC-6023 line of real-time and digital storage oscilloscopes. The 10-page brochure provides a photo of each scope and details the special features to be found in each. Full tabular listings, color coded for easy reading, compare the scopes at each level of performance.

CIRCLE NO. 94 ON FREE INFORMATION CARD

**Metal Detector User Newsletter.** Fisher Research Laboratory's latest issue of the "Fisher World Treasure News" is available free to respondents. The 16-page newsletter features the professional and hobby use of land and underwater metal detectors. Special sections include "Treasure Hunters and the Law," "Metal Detectors and Archaeology" and "Underwater Treasure."

CIRCLE NO. 95 ON FREE INFORMATION CARD

**Battery Brochure.** A new brochure from Tauber Electronics, Inc. (San Diego, CA) includes a "Specifier's Checklist" to help design engineers more closely specify their battery-pack requirements. When an engineer returns the completed checklist to the company, Tauber's designers structure a free cost quote and recommendations on power-pack design and construction. The brochure describes how Tauber works, lists its global network of battery suppliers and pro-

vides a silhouette chart of battery-pack configurations.

CIRCLE NO. 96 ON FREE INFORMATION CARD

**Thermocouple Application Note.** A 21-page application note that describes thermocouples and how they are used in temperature measurement can be obtained from National Instruments. The "Thermocouples and Temperature Measurement" note describes and illustrates basic concepts, guidelines, experimental cases, sources of measurement errors and error-minimizing techniques. It begins with the background and basic uses of thermocouple circuits and explains cold junction compensation using software methods. The remaining information describes how to use the company's data-acquisition plug-in boards and signal-conditioning accessories to make thermocouple measurements. Other topics covered include single-ended and differential measurements, input filtering, broken thermocouple detection and data linearization.

CIRCLE NO. 97 ON FREE INFORMATION CARD

**Test & Measurement Catalog.** The full-color, 44-page 20th Anniversary Catalog from Exttech Instruments (Waltham, MA) describes digital hand-held and bench-top instruments for plant maintenance, test, engineering and the food and water quality fields. Items listed include: a Mini Rangemaster multimeter, insulation testers, ac and dc clamp-type amme-

ters, tachometers, light and sound meters, thermometers, pH and conductivity meters, and indicators, controllers and transmitters for the process industry. New listings include a Digilog Series of multimeters; simulators for temperature, current loops, pH and conductivity; a clamp-on multimeter with frequency and temperature functions; and hand-held computers and peripherals.

CIRCLE NO. 98 ON FREE INFORMATION CARD

**Relay Guidebook.** "How to Repair and Adjust Relays" is the title of a 20-page booklet available from P.K. Neuses, Inc. (Rolling Meadows, IL). The illustrated publication covers all aspects of mechanical relays used in telephone, vending-machine, elevator and utilities industries. In addition to providing information on the relays themselves, the booklet provides details on the tools used in adjusting these devices. Single copies are available at no charge.

CIRCLE NO. 99 ON FREE INFORMATION CARD

**Fiber-Optic Handbook.** The "Fiber Optic Installation Handbook" from Integrated Communications Inc. provides information on the skills, equipment and methods needed to effectively perform fiber-optic cable installation, connection and testing. Areas covered include: an introduction to fiber optics, cable preparation, fiber preparation, connector attachment, slicing fiber optics, testing, technical charts and a glossary of terms.

CIRCLE NO. 100 ON FREE INFORMATION CARD



- Confused by today's electronics?
- Looking to learn and develop your building skills?
- Want to explore beyond Amateur communications?

**CALL  
TOLL FREE  
(800) 457-7373**

**Collector's Edition**

# COMMUNICATIONS QUARTERLY

THE JOURNAL OF COMMUNICATIONS TECHNOLOGY

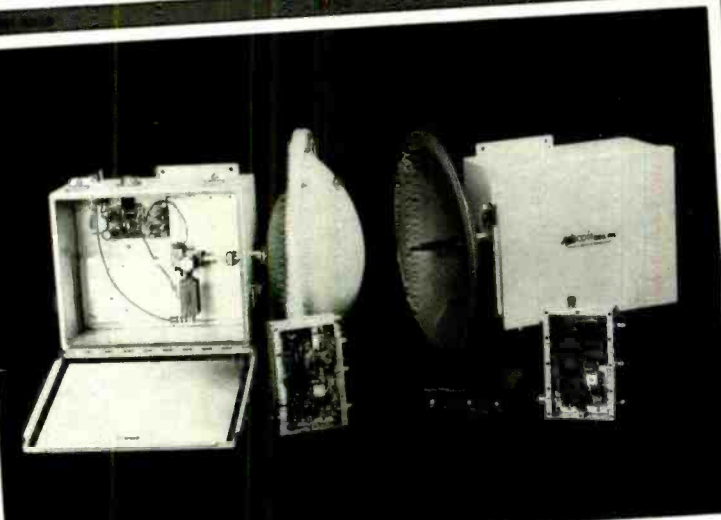

- A Communications System Using Gunnplexer Transceivers
- Digital Signal Processing: Working in the Frequency Domain
- The Enhancement of HF Signals by Polarization Control
- High Dynamic Range Receiver
- Basic Concepts of Scattering Parameters
- Transmitter IMD Measurements on Utility-Grade Spectrum Analyzers
- Interface Your Computer to the "Poor Man's Spectrum Analyzer"
- Super Narrowband Techniques Equalize Power Inequity on 1750 Meters

Just \$27.95 for a one year charter subscription (USA only.\*)  
Save \$2.00 off the regular yearly rate.

COMMUNICATIONS QUARTERLY will push the technical envelope to the limit. Articles will be selected from only the very best available. State-of-the-art electronics like direct digital synthesis, digital signal processing and computer control will be fully investigated and explained so that you can take advantage of these new technologies. COMMUNICATIONS QUARTERLY will also have articles that cover high speed data communications, the latest in antennas using computer designed models, plus much more. COMMUNICATIONS QUARTERLY is the publication you've been looking for. Challenge yourself technically. Stay up-to-date with all the latest developments in the fast paced world of electronics.

**Act now. Subscribe Today!**

\*Foreign surface \$39.95 per year.  
Air mail rates upon request.



**COMMUNICATIONS QUARTERLY**

a publication of CQ Communications Inc., 76 North Broadway, Hicksville, NY 11801 USA

### Hardware Requirements

Like schematic capture programs, pcb software requires high-resolution screen graphics. Although a few pcb programs support IBM's old CGA and EGA resolutions of  $640 \times 350$  or less, no less than VGA graphics with  $640 \times 480$  resolution in at least 16 colors should be considered for pcb layouts that are very complex. The reasons are two-fold.

First, and most important, is that when working with a software package that can locate and place an IC or a trace with a tolerance of 1 mil (one thousandth of an inch), trying to display that on a screen of less than VGA resolution is an exercise in futility. And with high-density designs, even superVGA screen resolutions of  $800 \times 600$  and  $1,024 \times 768$  may even be pushed to the limit. Most VGA boards support at least one superVGA mode but require a multi-

sync monitor to display resolutions beyond VGA.

Second, pcb software uses color to identify the numerous drawing layers needed in the layout of a printed-circuit board. Beyond the obvious copper layers (which can number up to 64), there are additional drawing layers used for nomenclature, solder masks and vias.

Pcb design software is also more memory-intensive than schematic capture programs, with many programs requiring or supporting LIM 4.0 expanded memory. When working with boards containing 50 or more chips, expect to have at least 1.5MB of RAM installed.

Hard-disk requirements are the same, with most pcb programs requiring 2MB to 5MB of hard disk space. A math coprocessor is also recommended, as is a mouse.

Shove-aside routers move traces, rather than destroying them. They are most useful when a trace has a path to its destination, but does not have enough room for the track. However, no popular pcb program presently offers a shove-aside router as an option. The most popular shove-aside router on the market, *MaxRoute*, sells for a hefty \$6,000.

### Trace Editing

After all automatic trace routing avenues are exhausted, the designer must resort to manual routing and editing. Manual editing is also used to fix design rule violations and to make design changes in a printed-circuit board already in production. Several trace routing editing tools are available.

Route and delete are the most often used. Route takes many forms, depending on the pcb program, but usually it is a straight line whose path is defined by a mouse. Although the trace is usually made up of straight segments with angular turns, a few

pcb programs let you place curved tracks, like the kind needed for laying out analog circuits.

Delete is most often used during the final stages of routing to remove a trace that blocks the way of another trace. Like traces that have yet to be placed, deleted traces are replaced with their ratsnest counterpart, so that you do not forget which traces still must be connected.

Some pcb programs can modify traces without deleting them. This editor lets you push and shove the trace, place and delete vias and move segments from one layer to another while maintaining the validity of the original connection.

The width of single traces can also be adjusted to be wider or narrower as the situation demands. A useful width function is necking down, which lets you narrow a short portion of a trace so that it may squeak between the pads of an IC without shorting to other traces (Fig. 5).

Manual editing is also required for defining ground planes, protected zones and most nomenclature. Find,

search and jump locate particular modules or reference designators on the printed-circuit board.

### Design Rule Checking

Design verification is a very important step because mistakes that pass through here end up as mistakes on the printed-circuit board, which are costly to correct. The verification process checks to see that the tracks, vias and pads have been placed according to a set of rules that you have established. The process is known as design rule checking.

Design rule checking software first loads the wire list netlist, then checks to see if all the nodes in each net are connected. If they are not, an error message is generated for each missing connection and placed in a design rule netlist file. The software also checks to see if there are any extra pins to contend with.

A check is then made of the traces, pads and vias. Traces and pads that are too close together or touching are identified and marked for display. Most pcb programs highlight the affected area on-screen plus display an error message indicating coordinates of the problem areas.

### Artwork & Output Files

The ultimate goal of a pcb program is to produce artwork that can be used to make a functional printed-circuit board. The output is placed in netlists files of three different types: artwork, drawings and documentation.

First and foremost are the artwork files, which contain the trace patterns for the printed-circuit board. Each layer of the board has its own separate trace pattern; multi-layer patterns are aligned using placement holes drawn on each layer at the beginning of the pcb design process.

Artwork can be printed out using a dot-matrix or laser printer, pen plotter or photoplotter. Photoplotters, which are akin to phototypesetters, are the preferred choice because of



their high resolution and accuracy. Regrettably, photoplotters are very expensive to own and operate; so most companies send their artwork files to a photoplotting service that converts them into photographic transparencies suitable for pcb manufacturing. Gerber-format photoplotting produces the most accurate pcb transparencies and is supported by virtually every pcb program and photoplotting service.

Other artwork produced by pcb software include solder masks (that apply an epoxy film on the printed-circuit board prior to flow soldering to prevent solder bridges from forming between adjacent traces) and silk-screen mats for board nomenclature. Many pcb programs also support Excellon's N/C drill file format that robotic drilling machines use to locate and drill properly sized holes in the printed-circuit board.

Pcb software also produces a flur-

ry of documentation needed for manufacturing. These packages include schematics, parts placement drawings and engineering change orders (ECO), among others. Most of the documents can be printed on a dot-matrix or laser printer.

Last but not least is the back annotation netlist that contains all the changes made to the design during the pcb layout procedure. Included are logic gate reassignments, pin swaps and revised component identification, all of which must be reported back to the schematic capture program for correction.

*More To Come: In a following issue, we will examine a host of pcb design programs for price, performance and features. Afterwards, another issue will present a construction article that shows you how to make an actual printed-circuit board on your PC and printer.*

## Function Generator *(from page 38)*

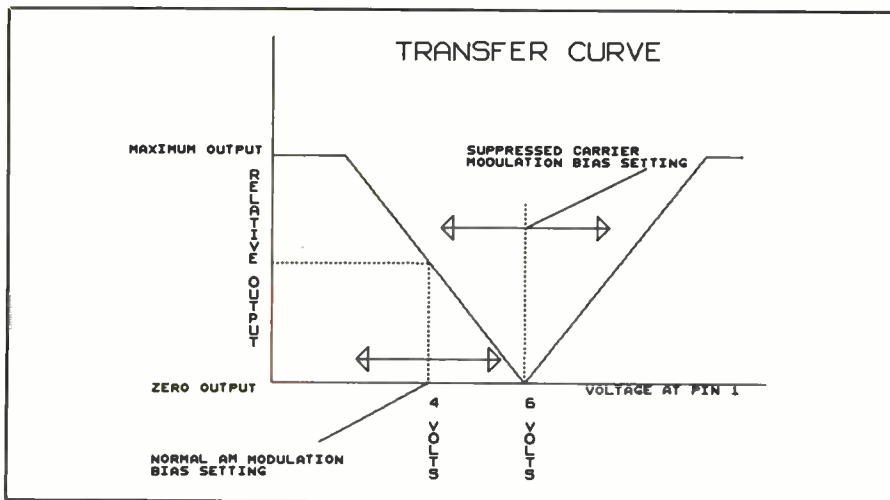

Fig. 7. Details of how an amplitude-modulated signal is generated by changing the voltage on pin 1 of the XR-2206 chip.

the modulating voltage and set the BIAS control so that the carrier disappears. This will be at about middle of rotation for R13. Reconnect the modulating voltage, again through

the 0.22- $\mu$ F capacitor, and adjust the OUTPUT LEVEL control to obtain a suppressed-carrier modulated wave.

The last mode of modulation is FSK (frequency shift keying). To use

## DIGITAL VIDEO STABILIZER ELIMINATES ALL VIDEO COPYGUARDS



While watching rental movies, you will notice annoying periodic color darkening, color shift, unwanted lines, flashing or jagged edges. This is caused by the copy protection jamming signals embedded in the video tape, such as Macrovision copy protection. DIGITAL VIDEO STABILIZER: RXII completely eliminates all copy protections and jamming signals and brings you crystal clear pictures.

### WARNING

The Digital Video Stabilizer: RXII is intended for private home use only. It is not intended to copy rental movies or copyrighted video tapes that may constitute copyright infringement.

### FEATURES

- Easy to use and a snap to install
  - The best and the most exciting Video Stabilizer in the market
  - State-of-the-art micro-chip technology
  - 100% automatic - no need for any troublesome adjustments
  - Works on all types of VCRs, TVs, and Monitors
  - Light weight (8 ounces) and Compact (1x3.5x5")
  - Beautiful deluxe gift box
  - Uses a standard 9 Volt battery which will last 1-2 years.
  - Similar units sold elsewhere for \$99 or more!
  - UNCONDITIONAL 30 DAYS MONEY BACK GUARANTEE
  - FAST UPS DELIVERY
- Air Shipping available

To Order: 1-800-445-9285 or 516-568-9850

**\$49.95 ea + \$4 for p&h**

Visa, MC, COD M-F: 9-6 (battery not included)  
SCO Electronics Inc.  
Dept. CME2, 581 W. Merrick Rd.,  
Valley Stream, NY 11580

CIRCLE NO. 136 ON FREE INFORMATION CARD

this, set CHANNEL A FREQ(1) ADJ. control R18 for a frequency of 1 kHz. Adjust CHANNEL A FREQ(2) control R19 for a frequency of 100 Hz. (fully CCW). Now connect a normally-open, momentary-action pushbutton switch across the FSK MOD INPUT terminals of J1. When you close this switch, the output of the Function Generator will be 100 Hz. Opening the switch causes the output to become a 1-kHz signal. This type of modulation is used by modems and other data link-ups.

With your Dual-Channel Function Generator and the Digital Storage Oscilloscope presented last month, you are well on your way to completion of the Modern Electronics Computer Experimenter Lab. Tune in next month for an 8088-based Digital Signal Generator project you can build right on the same board as your function generator to round out the system.

ME



### PICKS UP A WHISPER 50 FEET AWAY!

The model WAT-50 miniature FM transmitter uses a 4-stage circuit NOT to be confused with a simple wireless microphone. Simply snap the unit on top of a 9V battery and you can hear every sound in an entire house up to 1 mile away! Use with any FM radio. Tunes to any frequency from 70mhz - 130mhz. Easy to assemble kit includes all parts and instructions. Only 29.98 tax incl.

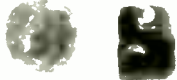

The WIRELESS TELEPHONE TRANSMITTER model WTT-20 is only about the size of a dime, yet transmits both sides of a telephone conversation to any FM radio with crystal clarity. Completely automatic. Uses power from the telephone line itself - never needs a battery! Up to 1/4 mile range. Tunes from 70mhz - 130mhz. Easy to assemble kit includes all parts and instructions. Only \$29.98 tax incl.

Call or send MO, VISA, MC for immediate delivery. Single kit orders include \$1.50 S&H. FREE SHIPPING on orders of 2 or more. All orders shipped by U.S. Mail. COD add \$4.00. Personal checks allow 21 days.

DECO INDUSTRIES

BOX 607, BEDFORD HILLS, NY 10507  
914-232-3878

CIRCLE NO. 156 ON FREE INFORMATION CARD

### CABLE TV CONVERTERS Attention Cable Viewers!

Jerrold, Zenith, Oak, Scientific Atlanta, Hamlin, Tocom, and many others.

**BEST PRICES!** • 1-800-826-7623

B&B Inc. • 4030 Beau-D-Rue Dr., Eagan, MN 55122

**CABLE TV  
DESCRAMBLERS**  
ALL TYPES 800-582-1114  
FREE CATALOG  
M.K. ELECTRONICS • 7958 Pines Blvd  
Suite 276 • Pembroke Pines, FL 33024

### SURVEILLANCE TELEPHONE

Monitor room conversations \$175.00  
Monitor room & telephone conversations \$275.00  
Dialer tap, calls you when phone is used \$305.00



Available  
in the telephone  
or small plastic  
case

Range Unlimited - 5 month warranty - Phone Tap Catalog \$3.00  
LISTEN ELECTRONICS, 603 Elgin, Muskegon, OR 74041  
1-800-633-TAPS

### Surface Mount Chip Component Prototyping Kits— Only \$49.95



CC-1 Capacitor Kit contains 365 pieces, 5 ea. of every 10% value from 1pf to .33µf. CR-1 Resistor Kit contains 1540 pieces, 10 ea. of every 5% value from 10Ω to 10 megΩ. Sizes are 0805 and 1206. Each kit is ONLY \$49.95 and available for immediate One Day Delivery!

Order by toll-free phone, FAX, or mail. We accept VISA, MC, AMEX, COD, or Pre-paid orders. Company P.O.'s accepted with approved credit. Call for free detailed brochure

**COMMUNICATIONS SPECIALISTS, INC.**  
426 West Taft Ave. • Orange, CA 92665-4296  
Local (714) 998-3021 • FAX (714) 974-3420

Entire USA 1-800-854-0547

CIRCLE NO. 172 ON FREE INFORMATION CARD

# MODERN ELECTRONICS MART

**Classified Commercial Rates:** \$1 per word, 15-word minimum (\$15.00) prepaid. (Word count includes name and address; ZIP code and abbreviation each count as one word; P.O. Box number and telephone number count as two words each.) Indicate free category heading (**Computers, Communications, Electronics, Video or Miscellaneous**). A special heading is available for a \$6 surcharge. First word only is set boldface caps at no charge. Add 20% for additional boldface words.

**Non-Commercial Rates:** FREE to subscribers, as space permits; maximum 15 words. A recent MODERN ELECTRONICS mailing label must accompany ad.

(All advertisers with P.O. Box addresses must supply permanent address and telephone number. Copy is subject to publisher approval.)

**Mailing Information:** Copy must be received by the publisher by the 25th of the third month preceding the cover date. Send Advertising material with check or money order or credit card information (Visa or MasterCard only) with number and expiration date to: MODERN ELECTRONICS, Classified Department, 76 N. Broadway, Hicksville, NY 11801.

## VIDEO

T.V. NOTCH FILTERS, PHONE RECORDING EQUIPMENT, BROCHURE \$1.00. MICRO Thinc., BOX 63/6025, MARGATE, FL 33063 1-(305) 752-9202.

VHS-VCR Repair Solutions Sets I, II, III, IV, V, VI. Each contains 150 symptoms and cures, updated cross reference chart, free assistance, \$11.95 each all six \$59.95. Eagle Electronics Box A, 52053 Locks Lane, Granger, IN 46530.

PROJECTION TV . . . Convert your TV to project 7 foot picture . . . Easy! . . . Results comparable to \$2,500 projectors . . . PLANS AND 8" LENS \$27.95 . . . Professional Systems available . . . Illustrated Catalog FREE . . . MACROCOMA, 15ME Main Street, Washington Crossing, Pennsylvania 18977. Creditcard Orders 24 HRS. (215) 736-3979.

## ELECTRONICS

**FREE CATALOG.** Save hundreds on sought after electronic, electro mechanical, and computer related hardware and components—including hard-to-find items. Call toll free: 1-800-776-3700. American Design Components/Dept. 112-021, 815 Fairview Avenue, Fairview, NJ 07022.

**SURVEILLANCE/COUNTERSURVEIL—**LANCE equipment catalog, transmitters, detection equipment, phone caller identification, \$10.00, EDE, P.O. Box 337, Buffalo, NY 14226.

**SURVEILLANCE—**Audio/Video/Infra-red/Laser Equipment. Industrial or Private. 500 Item Catalog \$7.00. Security Systems, 3017D Hudson, New Orleans, LA 70131.

**CALLER ID** displays phone number of person calling you after first ring-stores phone numbers of 14 recent calls \$89.95 ppd., EDE, P.O. Box 337, Buffalo, NY 14226 (716) 691-3476.

**DIGITAL AUDIO SAMPLER.** Digitally record and playback any audio source with special effects. Microprocessor controlled electronic project. For detailed plans, send \$10.00 to: P.O. Box 341, Dearborn Hts., MI 48127.

**KINETIKITS** from KINETICO: electronic kits outputting light or sound. Free catalog: KINETICO, P.O. Box 1634, NY, NY 10114-0508.

**MINIATURE FM TRANSMITTERS!** Tracking Transmitters! Voice Disguisers! Bug Detectors! Phone Devices! More! Available in kits or assembled and tested! Catalog \$2.00: XANDI ELECTRONICS, Box 25647, "B8", Tempe, AZ 85285-5647.

**SURVEILLANCE / COUNTERSURVEIL—**LANCE devices catalog. Cameras, bug detectors, video camera detectors, transmitters, communications, and much more. Catalog \$3.00. DSP, P.O. Box 1275-ME, Redondo Beach, CA 90278.

**SURVEILLANCE - COUNTERSURVEIL—**LANCE. Guaranteed lowest prices! Unbelievable, Detectors, Jammers, Transmitters, Phone Security, Cameras, Personal Protection, Books, More! Huge catalog \$5.00 (Refundable) PROTECTOR P.O. Box 520294-B, Salt Lake City, UT 84152.

**50W SUBWOOFER.** Add awesome bass to your home stereo system. This is an excellent performing component, not cheap junk. Complete plans \$18.00. C. Rotthoff, Box 70, Atlanta, GA 30274.

**BUILD** from easy-to-follow schematics: audio mixers/equalizers (stage, studio, business, home, basic to sophisticated), feedback controllers, active filters, guitar super-fuzz box, loudspeaker enclosures (including car/van), power supplies, more. vSSE reliability. Send \$5.00 for descriptions. Reasonable prices. von Sprecken Sound Engineering, Dept. C, Box 1315, Clinton, MS 39060.

**SPEAKER** enclosure design booklet. Equations not found elsewhere, crossover/coilwrapping information: \$3.00. Dennis Lance Ent., P.O. Box 5986, Station L, Edmonton, AB., Canada T6C 4G5.

**REMOTE CAR STARTER** Complete Devices, or Plan. Plan includes Auto, Device Schematics, PCB Template, Parts/Suppliers List, Diagrams, Instructions, Photos. \$19.90. 414 Alva Dr., Grand Prairie, TX 75051 (214) 642-0338.



# Now with NRI's new training you can enjoy the rewards of a career in computer programming

A top-paying career in computer programming is no longer out of your reach. Now you can get the practical training and experience you need to succeed in this top-growth field.

It's training that gives you real-world programming skills in **four** of today's hottest computer languages: BASIC, Pascal, C, and COBOL. Hands-on training that includes a powerful IBM AT-compatible computer, modem, and programming software you train with and keep. Comprehensive, at-home training that gives you the competitive edge to succeed in one of today's leading industries. The kind of experience-based training only NRI can provide.

As a trained computer programmer of the '90's, you can enjoy long-term career success. In fact, the Bureau of Labor Statistics forecasts that during the next 10 years job opportunities will increase by 71.7 percent for the skilled computer programmer. With NRI training you can be one of the increasing number of computer programmers using their skills to build a top-paying career—even a business of their own—in this professionally and financially rewarding high-tech field.

## ▼ The only programming course that includes a powerful AT-compatible computer system and programming software you keep

Right from the start, NRI training gets you actively involved in the challenge of real-world computer programming. You learn how to create the kinds of full-featured, powerful programs today's employers and clients demand. And, unlike any other school, NRI lets you experience first-hand the power of an IBM PC/AT-compatible computer system with modem, a full megabyte of RAM, disk drive, and monitor—all yours to train with and keep.

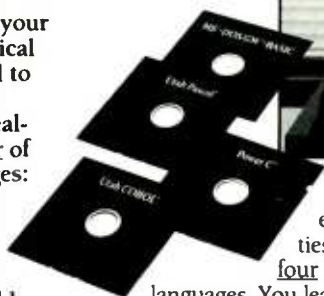
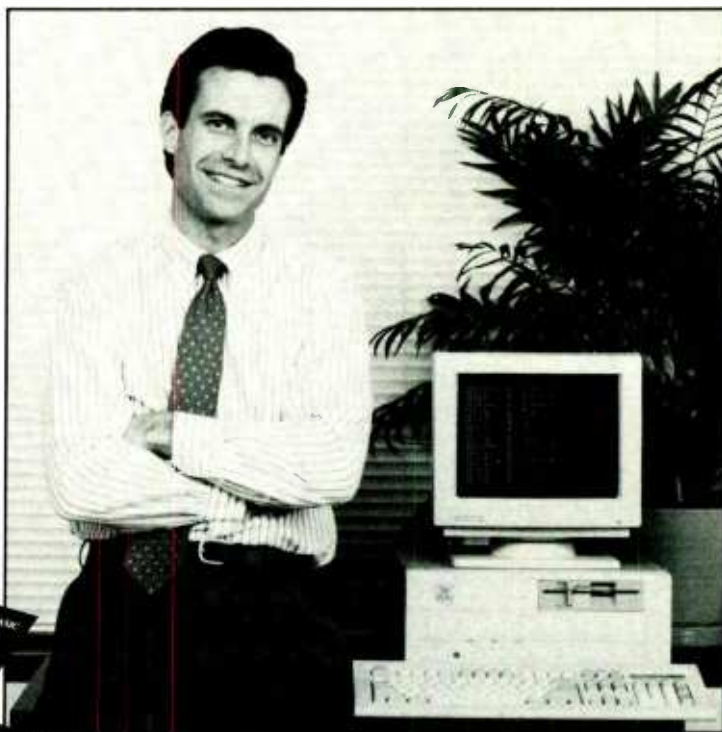
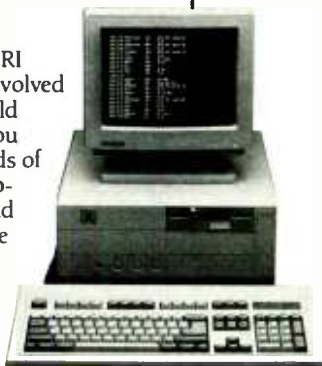

Plus you explore the extraordinary capabilities of not one or two but **four** in-demand computer languages. You learn to design, code, run, debug, and document programs in BASIC, Pascal, C, and COBOL. In the process you become uniquely prepared for the wide variety of programming opportunities available today.

## ▼ No previous experience necessary

Immediately, you start getting the money-making job skills you need to secure a future in computer programming—no matter what your background. With NRI training you move easily from computer novice to computer professional with step-by-step lessons covering program design techniques used every day by successful micro and mainframe programmers.

You'll find no heavy textbooks to plow through. No night classes to attend. Instead, NRI's at-home, step-by-step training covers all the bases, guiding you from the impor-

tant fundamentals to real-world methods and techniques. With the help of your NRI instructor—offering one-on-one, personal guidance throughout your course—you quickly gain the skills you need to handle with confidence a wide variety of programming applications. You even use your modem to "talk" to your instructor, meet other NRI students, and download programs through NRI's exclusive programmers network, PRONET.

## ▼ Send today for your FREE catalog

Now you can have the professional and financial rewards of a career in computer programming. See how NRI at-home training gives you the experience, the know-how, the computer, and the software you need to get started in this top-paying field. Send today for your FREE catalog.

If the coupon is missing, write to us at the NRI School of Computer Programming, McGraw-Hill Continuing Education Center, 4401 Connecticut Avenue, NW, Washington, DC 20008.

## NRI Schools

McGraw-Hill Continuing Education Center  
4401 Connecticut Avenue, NW, Washington, DC 20008



### Check one free catalog only

- |  |  |
|--|--|
| <input type="checkbox"/> Computer Programming            | <input type="checkbox"/> Microcomputer Servicing       |
| <input type="checkbox"/> PC Systems Analysis             | <input type="checkbox"/> Desktop Publishing and Design |
| <input type="checkbox"/> PC Software Engineering Using C | <input type="checkbox"/> Word Processing Home Business |

Name \_\_\_\_\_ Age \_\_\_\_\_  
(please print)

Address \_\_\_\_\_

City \_\_\_\_\_ State \_\_\_\_\_ Zip \_\_\_\_\_

Accredited Member, National Home Study Council

5414-021

**CABLE TV DESCRAMBLERS!  
BARGAIN HEADQUARTERS!**



•JERROLD™ •TOCOM •HAMLIN  
•OAK •ZENITH  
•SCIENTIFIC ATLANTA

6 month warranty! We ship C.O.D.!  
Lowest retail/wholesale prices!

**FREE CATALOG:**

Global Cable Network  
1032 Irving St. Suite 109  
S.F., CA 94122  
NO CALIFORNIA SALES!!!

**ORDER TODAY! 800-327-8544**

CIRCLE NO. 163 ON FREE INFORMATION CARD

**CABLE-TV BOXES**

**Descramblers • Converters  
FREE CATALOG**

**TRANS-WORLD CABLE CO.**  
12062 Southwest 117th Ct., Suite 126  
Miami, Florida 33186  
800-442-9333

**Cable Converters And  
Descramblers**

Why Pay a High Monthly Fee?  
For FREE Catalog Call or Write

**CABLE CONNECTION**

1304 E. CHICAGO ST.-SUITE 301  
ALGONQUIN, IL 60102  
(708) 658-2365  
No Illinois Orders

**BIG PLANS ...**

**SMALL BUDGET ??**

Development Tools for  
6805, 68HC05, 68HC11



In-circuit Emulators for Motorola HC05 & HC11 from ..... \$995  
Various configuration options available

MCPM-1 Programmer for Motorola MC68705P1, P5, U3, U5, R3, R5  
Fully assembled w/driver program ..... \$325  
Fully assembled w/driver, assembler, simulator/debugger ..... \$449

MCPM-3 Programmer for Motorola MC68HC705C8, 805C4  
Fully assembled w/driver program ..... \$380  
Fully assembled w/driver, assembler, simulator/debugger ..... \$495

EVM Driver Software for Motorola EVM, EVB, EVS ..... \$99  
Easy-to-use productivity enhancer

Rt. #3 Box 8C Barton, VT 05880 USA  
TEL: (802) 525-3458 FAX: (802) 525-3451  
Toll Free (800) 336-8321

The Engineers Collaborative

CIRCLE NO. 145 ON FREE INFORMATION CARD

**LEARN** Computer Chips, kit \$18.00. Yacub Saafir, PO Box 3138, Atlanta, GA 30302. It is easy and rewarding!

**CABLE Converters & ScramDeblers • ALL MAJOR BRANDS •** For information & orders call 1-800-782-0552 • **FREEWAY, INC.** s.m.p. P.O. Box 5036, Burnsville, MN 55337.

**COMPUTERS**

**EQUIPMENT** assortment. Electronic, computer, test, descrambler. Catalog \$3.00. Refundable. B & R Enterprise, P.O. Box 662, Portage, MI 49081.

**PROTOQUICK Z8**, single board computer with prototype area, \$69.00. Software Science, 3750 Roundbottom Road, Cincinnati, OH 45244 (513) 561-2060.

**AMIGA, MACINTOSH, ATARI XL/XE/ST** communications, electronic PD software \$4.00/disk. SASE specifying computer for catalog! KDown, Box 1646, Orange Park, FL 32067-1646.

**COMMUNICATIONS**

**HUGE COMMUNICATIONS CATALOG.** 88 pages including amateur, shortwave and scanner equipment. Universal Radio, 1280 Aida Drive #ME, Reynoldsburg, OH 43068.

**PAN-COMM INT'L CATALOG.** Over 350 Kits, Plans, Books about Licensed/unlicensed AM/FM broadcasting, Ham/CB/SW/DX amplifiers, 1750M transmitters, Surveillance devices, Computers/Software, Science Projects, MORE. \$1.00 refundable. Box 130-ME2, Paradise, CA 95967.

**MORSE Code? No Problem.** You can increase your speed, no matter how many times you've failed before. **Results guaranteed** when you follow the instructions. **PASS Publishing's CW Mental-Block Buster** program helps you **explode mental blocks** that hold you back. Based on 40 years of research, the **CW Mental-Block Buster** uses guided meditation, dynamic visualizations, and powerful affirmations to blast through mental blocks. **You can do code!** That means new bands, more contacts, more fun! (This is not a CW practice tape.) The **CW Mental-Block Buster** audio cassette and practice booklet are only \$24.95 ppd. in the US (NY residents add \$1.87 sales tax). (Quantity discounts available for classes.) **PASS Publishing, P.O. Box 570, Stony Brook, NY 11780.**

**PRO-2004/2005/2006 OWNERS!** Restore cellular telephone, add-on S meter, add 6,400 channels, increase scanning speed, auto tape record, etc! Manual includes 10 modifications with detailed instructions and schematics. Only \$8.95 from the **ENGINEERING WORKSHOP, P.O. Box 4176, Fullerton, CA 92634-4176.**

**COMMUNICATION AT ITS BEST AR-900** \$234, AR-1000 \$453, BC-200XLT \$269, BC-100XLT \$215, BC-800XLT \$266, BC-760XLT \$290, BC-210XLT \$199, plus low prices on CB's and **RADAR DETECTORS. TURBO ELECTRONICS, PO Box 8034, Hicksville, NY 11802. Questions Welcomed (516) 938-1946.**

**BUILD** your own low power FM radio station. Easy to construct and meets FCC regulations. For complete plans send \$2.95 to **ANESCO, P.O. Box 54322, Jacksonville, FL 32245.**

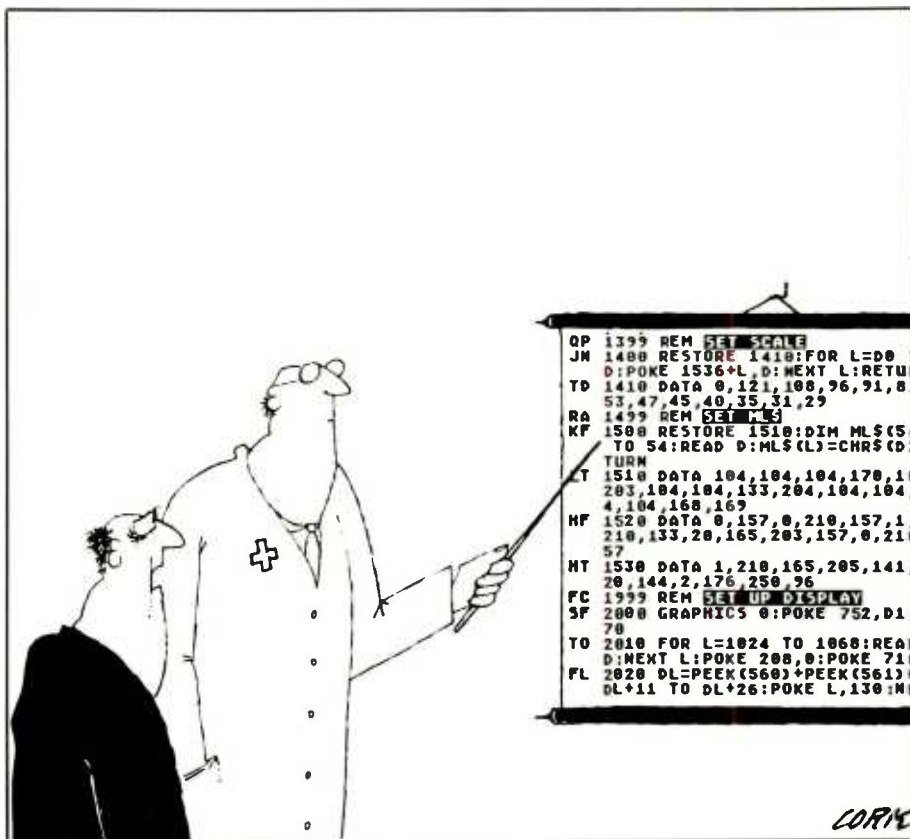

```

QP 1399 REM SET SCALE
JM 1400 RESTORE 1410:FOR L=00
D:POKE 1536+L,D:NEXT L:RETU
TD 1410 DATA 0,121,108,96,91,8
53,47,45,40,35,31,29
RA 1499 REM SET ML
KP 1500 RESTORE 1510:DIM MLS(54
TO 54:READ D:MLS(L)=CHR$(D)
TURN
LT 1510 DATA 104,104,104,170,110
203,104,104,133,204,104,104,
4,104,168,167
MF 1520 DATA 0,157,0,210,157,1
210,133,20,165,203,157,0,210
57
NT 1530 DATA 1,210,165,205,141
20,144,2,176,250,96
FC 1999 REM SET UP DISPLAY
SF 2000 GRAPHICS 0:POKE 752,D1
70
TO 2010 FOR L=1024 TO 1068:READ
D:NEXT L:POKE 200,0:POKE 710
FL 2020 DL=PEEK(560)+PEEK(561)*
DL+11 TO DL+26:POKE L,130:IN
    
```



### CABLE

**TOCOM VIP TEST CHIP.** For Models 5503 VIP and 5507. Unlike any other turn-on, this one works! Easily installs in just seconds. \$50.00 each. No Calif. sales. Call (213) 867-0081.

**CABLE DESCRAMBLERS** - Jerrold 400, 450, Tri-Bi SB-3. Scientific Atlanta, Oak, Tocom. Lowest Prices. Example: Jerrold from \$25.00. No Calif. Sales. Call us last and see! (213) 867-0081.

**ZENITH Z-Tac.** Special "test" board installs easily in minutes, and turns-on decoder for all modes. Great for "flashing" problems. Only \$50. No Calif. Sales. Call (213) 867-0081.

### FOR SALE

**DESCRAMBLERS.** All brands. Special: Combo Jerrold 400 and SB3 \$165. Complete cable descrambler kit \$39. Complete satellite descrambler kit \$45. Free Catalog. MJO INDUSTRY, Box 531, Bronx, NY 10461-0208.

### CABLE TV EQUIPMENT

**CABLE.** TV converters and descramblers discount center. Jerrold, Tocom, Hamlin, Scientific Atlantic, Oak, Zenith. Order yours today 800-962-6836.

### ELECTRONIC SURVEILLANCE

**ELECTRONIC SURVEILLANCE.** 40+ complete construction plans from America's #1 designer of electronic spy equipment. **FREE CATALOG.** Wilson-E, P.O. Box 5264, Augusta, GA 30906.

### CABLE TV EQUIPMENT

**CONVERTERS** All major brands. Information orders 1-800-782-0552. Freeway, Inc. SMP, P.O. Box 5036, Burnsville, MN 55337.

### CABLE EQUIPMENT

**CABLE TV SECRETS** — the outlaw publication the cable companies tried to ban. HBO, Movie Channel, Showtime, Descramblers, Converters, etc. Suppliers list included. \$9.95. Cable Facts, Box 711-ME, Pataskala, Ohio 43062.

### SOLAR ENERGY

**FREE ELECTRICITY FROM THE SUN!** GUIDE WITH PLANS \$10.00. ZAUGG-WATT, 3812 SOUTH COUNTRY CLUB WAY #1, TEMPE, AZ 85282.

### MISCELLANEOUS

**ASIAN LADIES** want correspondence for friendship, marriage. **SUNSHINE INTERNATIONAL-Dept. TW,** Box 5500, Kailua-Kona, Hawaii 96745. (808) 325-7707.

**THAILAND Women Seek Marriage,** 100 Photo Brochure \$2.00. Club Thai, Box 0974M, Miami, FL 33233.

**ATTRACTIVE ORIENTAL LADIES** seeking correspondence, marriage. Professional introductions since 1984. Asian Experience, Box 1214TZ, Novato, CA 94948. (415) 897-2742.

# ATTENTION! ELECTRONICS TECHNICIANS



## EARN YOUR B.S.E.E. DEGREE THROUGH HOME STUDY

Our New and Highly Effective Advanced-Placement Program for experienced Electronic Technicians grants credit for previous Schooling and Professional Experience, and can greatly reduce the time required to complete Program and reach graduation. No residence schooling required for qualified Electronic Technicians. Through this Special Program you can pull all of the loose ends of your electronics background together and earn your B.S.E.E. Degree. Upgrade your status and pay to the Engineering Level. Advance Rapidly! Many finish in 12 months or less. Students and graduates in all 50 States and throughout the World. Established Over 40 Years! Write for free Descriptive Literature.

## COOK'S INSTITUTE OF ELECTRONICS ENGINEERING



4251 CYPRESS DRIVE  
JACKSON, MISSISSIPPI 39212

CIRCLE NO. 159 ON FREE INFORMATION CARD

### CABLE DESCRAMBLERS OAK M35B COMBO \$39.95

Jerrold, Zenith, Hamlin, Sci. Atlanta, Pioneer & MORE! OUR PRICES ARE BELOW WHOLESALE!

#### CABLE+PLUS

14417 Chase St. #481-C Panorama City, CA 91402  
1-800-822-9955 • Other Info. 1-818-785-4500  
NO CALIF. SALES — DEALERS WANTED

AC/DC VOLTAGE  
AC/DC CURRENT  
DIODE TEST  
LOGIC TEST  
LED TEST GOOD/BAD  
5 FREQ RANGES  
5 CAPACITANCE RANGES  
LOW BATTERY Warning  
CONTINUITY TEST/BUZZER  
TRANSISTOR CHECKER  
**20 MHZ FREQ COUNTER**

**PRO 400**  
Stock No. 990092  
**\$69.95**

**30 DAY MONEY BACK GUARANTEE!**

**KELVIN Electronics**  
7 Fairchild Ave., Plainville, NY 11803  
(516) 349-7620 1(800) 645-9212  
FAX (516) 349-7830

★★★★ PRESENTING ★★★★★  
**CABLE TV  
DESCRAMBLERS**  
★★★★ STARRING ★★★★★  
**JERROLD, HAMLIN, OAK**  
AND OTHER FAMOUS MANUFACTURERS

- FINEST WARRANTY PROGRAM AVAILABLE
- LOWEST RETAIL / WHOLESALE PRICES IN U.S.
- ORDERS SHIPPED FROM STOCK WITHIN 24 HRS.
- ALL MAJOR CREDIT CARDS ACCEPTED

FOR FREE CATALOG ONLY 1-800-345-8927  
FOR ALL INFORMATION 1-818-709-9937

**PACIFIC CABLE CO. INC.**  
7325 1/2 RESEDA BLVD., DEPT. 1207  
RESEDA, CA 91335

USE  
YOUR  
FREE  
INFORMATION  
CARD

## Protel Easytrax 2™

### Outstanding value in Printed Circuit Board/CAD for your Macintosh and PC

Protel Easytrax 2 is a new, low-cost design package for PC and Macintosh users that includes everything required to produce professional quality Printed Circuit Board artwork.

Our easy-to-learn menu-driven design system breaks the 'expert barrier'-you'll be designing in minutes, not hours. Our comprehensive tutorials guide you through the program's extensive features that take the tedium out of board layout.

- Comprehensive library of Through-hole devices
- Gerber photoplotting and N/C drill tapes
- On-the-fly library components creation
- Intelligent Pad to Pad autorouting
- Switchable Metric/Imperial grid
- Auto-panning
- PostScript™ printing
- Powerful user-definable Macros
- Independent print/plot program
- Multi-layer boards of up to 32 X 32 inches.

At Protel, we offer free technical support, 24-hour BBS, and 30-day money back guarantee. Prices start at

**Free Evaluation Package**  
**Toll Free: 800-544-4186**

**\$450**

**Protel Technology, Inc.**  
50 Airport Parkway, San Jose, CA 95110  
Tel: 408-437-7771 Fax: 408-437-4913



CIRCLE NO. 167 ON FREE INFORMATION CARD

## ADVERTISERS' INDEX

RS#		Page #
30	AMC Sales.....	68
133	All Electronics.....	59
-	B & B Electronics.....	76
134	C&S Sales.....	15
-	Cable Connection.....	80
-	Cable-Mate Inc.....	82
-	Cable Plus.....	81
154	Central Computer Products.....	17
-	Cleveland Inst. of Elec.....	39, Cov. III
-	Command Productions.....	63
-	Communications Quarterly.....	73
172	Communications Specialists.....	76
126	Consolidated Electronics.....	67
125	Contact East.....	63
159	Cook's Institute.....	81
156	Deco Industries.....	76
152	DP Computers.....	21
135	Electrified Discounters.....	Cov. II, 1
159	Global Cable Network.....	80
-	Grantham.....	65
158	Heath Co.....	10
-	Kelvin Electronics.....	81
10	Kenwood.....	Cov. IV
164	Klockit.....	82
-	Listen Electronics.....	76
-	M.K. Electronics.....	76
-	NRI Schools.....	9, 79
-	Pacific Cable Co., Inc.....	81
165	Parts Express International.....	6
167	Protel Technology.....	81
86	Radio Shack.....	41
136	SCO Electronics.....	75
139	Sescom, Inc.....	68
-	Smith Design.....	71
148	Technical Challenge, Inc.....	5
-	Trans World Cable Co.....	80
123	Ucando.....	53
84	VRS Electronics.....	47
140	Video Tech.....	68
85, 19	Viejo Publications.....	53, 71
-	Visitect Inc.....	71

We'd like to see your company listed here too. Contact Jonathan Kummer at 516-681-2922 (Electronic Advertising) or Ken Wood at 407-264-0545 (Computer Advertising) to work out an advertising program tailored to suit your needs.



### Free Product Information

Readers can obtain free information on products advertised by the above companies, as well as for some editorially mentioned products. Simply circle the appropriate number printed below an advertisement onto the Modern Electronics "Free Information Service" card bound into this issue. After filling in your name and address, just mail the postpaid card. Your request will be forwarded directly to the advertiser with a mailing label prepared by our reader-service department to ensure speedy response.

### CABLE-MATE, INC.

#### Are You Tired of Paying Outrageous Fees?

All makes and models of cable equipment shipped within 24 hrs. Quantity discounts. For free catalog send S.A.S.E. to: Cable-Mate, Inc., 450 Shag Bark Algonquin, IL 60102 C.O.D. orders accepted

CALL FOR PRICES TODAY!!

800-422-0525

(708) 658-2121

\*No Illinois orders

Hours—8:00 am-5:00 pm central time



### Easy-To-Install Time and Weather Instruments



Dependable in rain or shine, these high-quality weather instruments are great for mounting in wood.

Klockit is a great source for clockmaking components and heirloom type clock kits. Also marine and mini weather instruments.

Call today.

**KLOCKIT**

P.O. Box 636, Dept. ME21

Lake Geneva, WI 53147

1-800-556-2548

CIRCLE NO. 164 ON FREE INFORMATION CARD

## NEW PRODUCTS

(from page 16)

Protective flags in the recorded data prevent the drive from over-writing a previously written-to data block by signaling that the data block already has received data. The flag is set in the data-management pointers (DMP) section of the block when data is written. The drive will not write to a flagged block. Absence of a flag signals that a block is ready to accept data.

If reading of the flag is marginal, the drive performs a more detailed analysis and invokes several more stages of data and error correction code (ECC) inspections. This blank-checking process is among the most thorough of any write-once drive. Because each of the three stages is invoked only if necessary, data integrity is protected with minimal impact on performance.

According to HP, file-format standards being proposed by an ANSI-accredited committee will make optical media an important method of data interchange by allowing users to transfer large amounts of data between dissimi-

lar systems without cumbersome conversion utilities. While optical media can be moved from one device to another, the exchange of information stored on the media is currently not automatic.

The method used to control and access data on a storage device is called a file system. Each operating system uses its own file system to manage stored data. Native file systems generally are not compatible across computer architectures. The standards committee is working to develop volume and file-interchange standards for optical disks for various operating systems to share data stored on optical disks. Once the file-format standard is finalized, HP plans to offer an implementation of the code for a fee.

A logical file-interchange standard requires that three hardware standards be established. For data interchange to occur between dissimilar operating systems, standards for cartridge compatibility, media compatibility and defect management must underlie the file system. Such standards have been ratified by ANSI and the International Standards Organization (ISO) for 5.25-inch rewritable media.

Cartridge design, dimensions and mechanisms must be standardized, as must the basic control information for optical media, for drives to interchange media. Thus, synchronization, error-correction and sector-identification marks, plus the encoding scheme, must be compatible. If a drive cannot read sectors from the disk, interpretation of data by a file system is impossible.

Interchange requirements include: write-once and rewritable media support; high performance; efficient disk space use; adaptability to many environments; simplicity; security; advanced functionality; and alternative character set handling. Also desirable is the ability to boot the operating system from the optical device.

To ensure that the file system is transportable, the approach advocated by HP is to require only the basic information needed for interchange in the standard. A method to store host-specific parameters (extended attributes) has been designed into the system. An optical file system, therefore, could be implemented on a variety of systems.

CIRCLE NO. 155 ON FREE INFORMATION CARD



# CIE Gives You The Training You Need to Succeed... At Your Own Pace...& In Your Own Home!

Discover Your Career Potential In The  
Fast-Growing Field Of High-Tech Electronics!

If you're anxious to get ahead...and build a *real* career...you owe it to yourself to find out about the Cleveland Institute of Electronics!

CIE can help you discover your career potential in the fast growing field of high-tech electronics. A career that will challenge and excite you every day...reward you with a powerful feeling of personal accomplishment...and deliver a level of financial security you may have only dreamed of before!

As the leading school in home-study electronics, CIE has helped over 150,000 students in the U.S.A. and over 70 foreign countries get started in this exciting field. To find out how CIE could be helping you...read on...then send for a CIE catalog TODAY!

## A Growing Need For Trained Professionals!

The career opportunities shown here are only a few of the challenging, high-paying careers you could enjoy as an electronics technician.

You could be the "brains" behind the scenes of an exciting TV broadcast...trouble-shoot life-saving medical equipment...design exotic new aeronautics systems...CIE's job-oriented programs offer you the quickest possible path to the career of your dreams! And CIE also features military and union re-training, to build on what you already know.

## Dozens Of Fascinating Careers To Choose From!

Even if you aren't sure which career is best for you, CIE can get you started with core lessons applicable to *all* areas of electronics. As you advance, CIE makes job opportunities available to you through the bimonthly school paper, *The Electron*.



Data Communications

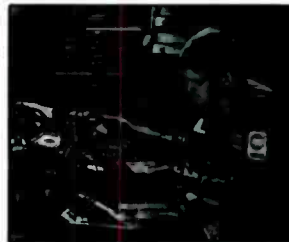

Automotive Electronics



Avionics



Computer-Assisted Manufacturing

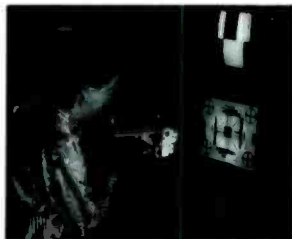

Consumer Electronics



Military Electronics

## Personal Training From A Renowned Faculty.

Unlike the impersonal approach of large classroom study, CIE offers you one-on-one instructional help 6 days a week, toll-free. Each CIE lesson is authored by an independent specialist, backed by CIE instructors who work directly with you to answer your questions and provide technical assistance when you need it.

## Practical Training... At Your Own Pace.

Through CIE, you can train for your new career while you keep your present job. Each course allows a generous completion time, and there are no limitations on how fast you can study. Should you already have some electronics experience, CIE offers several courses which start at the intermediate level.

## "State-Of-The-Art" Facilities & Equipment.

In 1969, CIE pioneered the first electronics laboratory course, and in 1984, the first Microprocessor Laboratory. Today, no other home study school can match CIE's state-of-the-art equipment. And all your laboratory equipment is included in your tuition cost. There is no extra charge—it's yours to use while you study at home and on the job after you complete your course!

## Earn Your Degree To Become A Professional In Electronics!

Every CIE course you take earns you credit towards the completion of your Associate in Applied Science Degree, so you can work towards your degree in

stages. And CIE is the only school that awards you for fast study, which can save you thousands of dollars in obtaining the same electronics education found in four-year Bachelor's Degree programs! Write for details today!

**Send For Your  
Catalog Today!**



## CIE World Headquarters

Cleveland Institute of Electronics, Inc.  
1776 East 17th St., Cleveland, Ohio 44114

**YES!** Please send me your independent study catalog (For your convenience, CIE will have a representative contact you—there is no obligation.)

Print Name \_\_\_\_\_

Address \_\_\_\_\_ Apt # \_\_\_\_\_

City/State/Zip \_\_\_\_\_

Age \_\_\_\_\_ Area Code/Phone No. \_\_\_\_\_

Check box for G.I. Bill bulletin on educational benefits:  Veteran  Active Duty

**Mail This Coupon Today!**

A003





# KENWOOD

## Hear it All!



### R-5000 R-2000 High performance receivers.

Scan the world bands with Kenwood's R-5000, R-2000 and RZ-1. Listen in on foreign music, news, and commentary. Monitor local police, fire, and other public safety services, as well as the Marine channels, and the many other services.

*(The VHF converter options must be used in the R-5000 and R-2000.)*

#### R-5000

The R-5000 is a high performance, top-of-the-line receiver, with 100 memory channels, and direct keyboard or main dial tuning—makes station selection

super easy! Other useful features include programmable scanning, large, built-in speaker, 110 volt AC or 12 volt DC operation (with optional DCK-2 cable), VHF capability (108-174 MHz) with the VC-20 option, dual 24-hour clocks with timer, and even voice frequency readout with the VS-1 option.

#### RZ-1

Wide-band scanning receiver

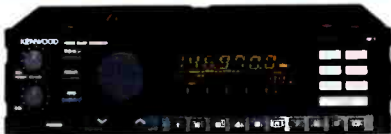

The RZ-1 wide-band, scanning receiver covers 500 kHz-905 MHz, in AM, and narrow or wideband FM. The automatic mode selection function makes listening

easier. One hundred memory channels with message and band marker, direct keyboard or VFO frequency entry, and versatile scanning functions, such as memory channel and band scan, with four types of scan stop. The RZ-1 is a 12 volt DC operated, compact unit, with built-in speaker, front-mounted phones jack, switchable AGC, squelch for narrow FM, illuminated keys, and a "beeper" to confirm keyboard operation.

**Optional Accessory**  
• PG-2N Extra DC cable

#### R-2000

The R-2000 is an all band, all mode receiver with 10 memory channels and many deluxe features such as programmable scanning, dual 24-hour clocks with timer a I-mode squelch and noise blankers, a large, front-mounted speaker, 110 volt AC or 12 volt DC operation (with the DCK-1 cable kit), and 118-174 MHz VHF capability with VC-10 option.

#### Optional Accessories R-2000:

- VC-10 VHF converter
- DCK-1 DC cable kit for 12 volt DC use.

#### R-5000:

- VC-20 VHF converter
- VS-1 Voice module
- DCK-2 for 12 volt DC operation
- YK-88A-1 AM filter
- YK-88SN SSB filter
- YK-88C CW filter
- MB-430 Mounting bracket.

#### Other Accessories:

- SP-430 External speaker
- SP-41 Compact mobile speaker
- SP-50B Mobile speaker
- HS-5 Deluxe headphones
- HS-6 Lightweight headphones

KENWOOD U.S.A. CORPORATION  
COMMUNICATIONS & TEST EQUIPMENT GROUP  
P.O. BOX 22745, 2201 E. Dominguez Street  
Long Beach, CA 90801-5745  
KENWOOD ELECTRONICS CANADA INC.  
P.O. BOX 1075, 959 Gana Court  
Mississauga, Ontario, Canada L4T 4C2

# KENWOOD

...pacesetter in Amateur Radio

CIRCLE NO. 10 ON FREE INFORMATION CARD

Specifications, features, and prices are subject to change without notice or obligation.