

ICD 08559

DECEMBER 1990 \$2.95

CANADA \$3.95

MODERN ELECTRONICS™

THE MAGAZINE FOR ELECTRONICS & COMPUTER ENTHUSIASTS

Using Computers To:

- Draw Schematics
- Design & Test Circuits

Party-Goers Special!

- Personal Breath Tester Shows Alcohol Level

Holiday Fun & Games Projects:

- Countdown Timer For Board Games
- Electronic Spinner For Lotto Numbers
- Treat Listeners On Phone Hold To AM Or FM Radio Broadcasts

Blood Alcohol Concentration Tester (p. 24)



Plus: 1990 Annual Article Index



Cassette Recorder Controller (p. 32)



Digital Audio Recorder Substation (p. 53)



Plus: Forrest Mims Experiments With Surplus Goodies • Inexpensive Ways To Speed Up Your PC • Cassette Recorder Controller Gives On-Cue Theatrical Sound Effects • Evaluations Of Epson's ES-300C Image Scanner & Multisoft's "Super PC-Kwik" • New Electronic & Computer Products . . .more.



YOU EXPECT THE WORLD FROM ICOM RECEIVERS

ICOM's IC-R71A and IC-R7000 are the professional's choice for receiving international broadcasts, aircraft, marine, business, emergency services, television, and government bands. These people demand the finest in communications and so do you. ICOM puts the world at your fingertips with the IC-R7000 25-2000MHz* and IC-R71A 0.1-30MHz commercial quality scanning receivers.

Incomparable Frequency Control. Both the IC-R71A and IC-R7000 feature **direct frequency access** via their front keypad, main tuning dial, optional infrared remote control and/or computer interface adapter. **Incredible Flexibility!**

Full Coverage, Maximum Performance. The superb IC-R71A is your key to world-wide SSB, CW, RTTY, AM and FM (optional) communications plus foreign broadcasts in the 100kHz to 30MHz range. It features IF Notch, low noise mixer circuits and a 100db dynamic range. The pacesetter **IC-R7000** receives today's hot areas of interest, including aircraft, marine, public services, amateur, and satellite transmissions in the 25MHz

to 2000MHz* range. It includes **all mode operation** low noise circuits plus outstanding sensitivity and selectivity. The IC-R71A/R7000 combination is your window to the world!



The IC-R71A is a shortwave listener's delight. Its **32 tunable memories** store frequency and mode information, and they are single-button reprogrammable **independent of VFO A or VFO B's operations!** Dual width, an adjustable noise blanker, panel selectable RF preamp, and selectable AGC combined with **four scan modes** and all-mode squelch further enhance the IC-R71A's HF reception!

The IC-R7000 features 99 tunable memories and **six scanning modes**. It even scans a band and loads memories 80 to 99 with active frequencies without

operator assistance! Additional features include selectable scan speed pause delays, wide/narrow FM reception and high frequency stability.

Options. IC-R7000: RC-12 remote control, EX-310 voice synthesizer, CK-70 DC adapter, MB-12 mobile bracket. IC-R71A: RC-11 remote control, EX-310 voice synthesizer, CK-70 DC adapter, MB-12 mobile bracket, FL-32A 500Hz, FL-63A 250Hz and FL-44A filters.

See these quality ICOM receivers at your local authorized ICOM dealer today.

*Specifications of the IC-R7000 guaranteed from 25-1000MHz and 1260-1300MHz. No coverage from 1000-1025MHz.

ICOM America, Inc., 2380-116th Ave. N.E., Bellevue, WA 98004
Customer Service Hotline (206) 454-7619
 3150 Premier Drive, Suite 126, Irving, TX 75063
 1777 Phoenix Parkway, Suite 201, Atlanta, GA 30349
 ICOM CANADA, A Division of ICOM America, Inc.,
 3071 - #5 Road, Unit 9, Richmond, B.C. V6X 2T4 Canada

All stated specifications are subject to change without notice or obligation. All ICOM radios significantly exceed FCC regulations limiting spurious emissions. Receivers 89

ICOM
 First in Communications

RADIO SHACK PARTS PLACESM

WHERE SANTA STOCKS HIS WORKSHOP!



PARTS HOTLINE

Radio Shack has a huge selection of popular electronic components. Plus, we can special-order 10,000 items from our warehouse—ICs, tubes, semiconductors, phono cartridges and styli, even SAMS® manuals. Service is fast and there's no minimum order or postage charge.



BATTERY HOTLINE

In addition to our large in-store stock, we can now supply almost any currently manufactured consumer-type battery—for cordless phones, computer memory, camcorders, transceivers, pagers and more. Service is fast and there are no postage or handling charges.



Studfinder. Ends guessing, easy to use! Senses changes in wall density to find wooden studs fast—also wires, conduit, pipes. Battery extra. #64-2825 **19.95**



Super Calculator! The EC-4035 makes electronics math a snap. Displays and computes with electrical units—V, A, mA, mW. 110 functions. #65-983 **39.95**



16-Piece Precision Tool Kit. Top-quality jeweler's-type philips, blade and nutdrivers plus hex keys and a torque bar. Fitted molded case. #64-1961 **10.95**



100-Watt Soldering Gun. Pull the trigger for full temperature in seconds. Built-in light. The comfort-molded handle stays cool. UL listed AC. #64-2193 **10.95**



NEW! Semiconductor "Sub" Book. Our 1991 edition lists over 95,000 types and the Radio Shack replacements. #276-4014 **3.99**

Getting Started in Electronics. By Forrest Mims III. The perfect introduction to project building. 128 pages. #276-5003 **2.49**

ELECTRONICS STOCKING STUFFERS!



Engineer's Mini-Notebook Series. By Forrest Mims III. Great gifts! Project ideas and useful data in Mims' famous, friendly style—big diagrams, handlettered text. With tips and suggestions for further experiments.

- NEW! Science Projects.** #276-5018 ... **1.49**
- Timer ICs.** 555/556 ICs. #276-5010 ... **99¢**
- Op Amp ICs.** #276-5011 **1.49**
- Optoelectronics.** #276-5012 **1.49**
- Basic Circuits.** #276-5013 **1.49**
- Digital Logic Circuits.** #276-5014 **1.49**
- Communications Projects.** #276-5015, **1.49**
- Formulas and Tables.** #276-5016 **1.49**
- Schematic Symbols.** #276-5017 **1.49**

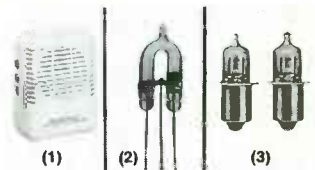

(1) Mini Audio Amp/Speaker. Ideal testbench amp, also great for computer voice/music synthesis. Battery extra. #277-1008 **11.95**

(2) Long-Life Xenon Strobe Tube. With data. #272-1145 **3.29**

(3) Halogen Flashlight and Lantern Bulbs. HPR50. 6-volt. #272-1189. HPR52. 3V. #272-1190 .. **Each 3.95**



Pocket-Size Digital Multimeter With Autoranging. Super gift for anyone working with electronics. This tester folds, with its probes, to fit a shirt pocket. Features easy-to-read LCD display, continuity sounder. Measures to 400 volts AC/DC, 2 megohms resistance. 4 1/4 x 2 1/8 x 5/16". #22-171 **39.95**

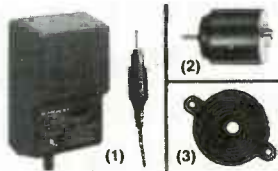

(1) Universal AC Adapter. 3, 4.5, 6, 7.5 or 9VDC output. With 6-piece Adaptaplug® set. #273-1650 **12.95**

(2) 1 1/2-3VDC Motor. About 1 1/2" long. #273-223 **99¢**

(3) DC Pulsing Buzzer. Extra loud! #273-066 **4.29**

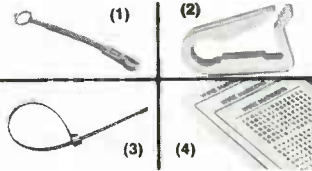

(1) NEW! Reusable Cable Ties. #278-1622 **Pkg. of 10/4.99**

(2) "Universal" Cable Clips. #278-1647 **Pkg. 10/2.79**

(3) NEW! In/Outdoor Wire Ties. #278-1652 **Pkg. of 30/2.99**

(4) Markers. 630 stick-on letters. #278-1650 **Set/1.79**

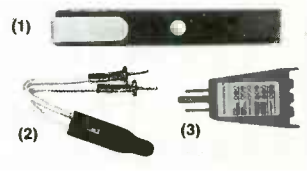

(1) NEW! AC Sensor. Indicates presence of 70 to 440VAC without direct electrical connection. Safety first! #22-103 **9.95**

(2) NEW! Circuit Tester. 90-300V AC/DC. #22-102 **1.99**

(3) AC Outlet Fault-Finder. 3-prong for grounded outlets. #22-101 .. **5.95**

Since 1921 Radio Shack has been the place to obtain up-to-date electronic parts as well as quality tools, test equipment and accessories at low prices. Over 7000 locations to serve you—NOBODY COMPARES

Prices apply at participating Radio Shack stores and dealers. Radio Shack is a division of Tandy Corporation

Radio Shack[®]

AMERICA'S TECHNOLOGY STORE™

CIRCLE NO. 113 ON FREE INFORMATION CARD

FEATURES

16 Schematics From Your PC
For as little as \$49, you can have your personal computer draw schematics. *By TJ Byers*

20 Circuit Breadboarding With Imaginary Parts
How software can put an electronics lab into your PC to eliminate the need for actual components, test gear, etc. *By Art Salsberg*

24 The Breath-O-Meter
Sophisticated solid-state device tests blood alcohol concentration to warn against driving while intoxicated. *By Anthony J. Caristi*

32 Cassette Recorder Controller
Lets you record theatrical sound effects and control pulses on stereo cassette tape for on-cue playback and automatic stop. *By David Ponting*

69 Article Annual Index

Fun & Games For the Holidays

38 Electronic Spinner
Electronically determines number of places to move on a board game. *By Charles Shoemaker*

40 A Unique "Time's Up" Game Timer
Electronically automates the timing required for many games. *By Kirk Carter*

46 Phone "Hold" With Music
Lets callers hear music while on hold. *By Crady Von Pawlak*

COLUMNS

48 Electronics Notebook
Experimenting With Surplus Goodies. *By Forrest M. Mims III*

53 Solid-State Devices
New Solid-State Speech Recorder, Data Acquisition on a Chip & Undervoltage Sensing ICs. *By Joseph Desposito*

58 PC Capers
Epson's ES-300C Desktop Image Scanner. *By Ted Needleman*

62 Software Focus
Inexpensive Ways to Speed Up Your PC. Microsoft Corp. *Super PC-Kwik (p. 64)*
By TJ Byers

DEPARTMENTS

- 7 Editorial**
By Art Salsberg
- 8 Modern Electronics News**
- 9 Letters**
- 10 New Products**
- 82 Advertisers Index**

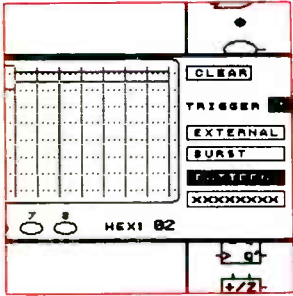

20



32

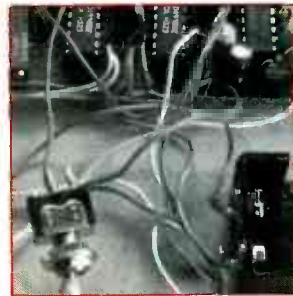

40

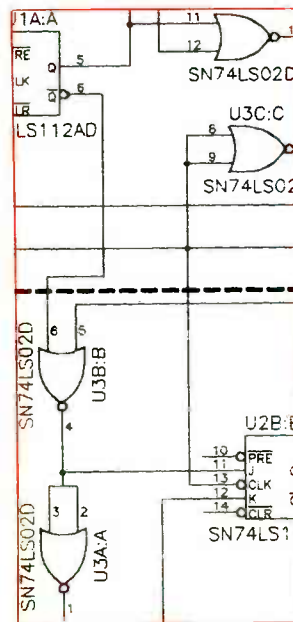

16

EDITORIAL STAFF

- Art Salsberg**
Editor-in-Chief
- Alexander W. Burawa**
Managing Editor
- Dorothy Kehrwieler**
Production Manager
- Elizabeth Ryan**
Art Director
- Barbara Terzo**
Artist
- Pat Le Blanc**
Florence V. Martin
Linda Romanello
Phototypographers
- Hal Keith**
Illustrator
- Bruce Morgan**
Photographer
- Joe Desposito, Forrest Mims III,**
Ted Needleman, Curt Phillips
Contributing Editors

BUSINESS STAFF

- Richard A. Ross**
Publisher
- Art Salsberg**
Associate Publisher
- Dorothy Kehrwieler**
General Manager
- Frank V. Fuzia**
Controller
- Catherine Ross**
Circulation Director
- Melissa Kehrwieler**
Carol Minervini
Data Processing
- Karen Nauth**
Customer Service

SALES OFFICE

- Modern Electronics**
76 North Broadway
Hicksville, NY 11801
(516) 681-2922
FAX: (516) 681-2926
- Jonathan Kummer**
Advertising Manager
- Emily Kreutz**
Sales Assistant

Offices: 76 North Broadway, Hicksville, NY 11801. Telephone: (516) 681-2922. FAX (516) 681-2926. Modern Electronics (ISSN 0748-9889) is published monthly by CQ Communications, Inc. Subscription prices (payable in US Dollars only): Domestic—one year \$18.97, two years \$36.00, three years \$53.00; Canada/Mexico—one year \$21.00, two years \$40.00, three years \$59.00; Foreign—one year \$23.00, two years \$44.00, three years \$65.00. Foreign Air Mail—one year \$76.00, two years \$150.00, three years \$224.00.

U.S. Government Agencies: Subscriptions to Modern Electronics are available to agencies of the United States government, including military services, only on a cash with order basis. Requests for quotations, bids, contracts, etc. will be refused and will not be returned or processed.

Entire contents copyright 1990 by CQ Communications, Inc. Modern Electronics or CQ Communications Inc. assumes no responsibility for unsolicited manuscripts. Allow six weeks for delivery of first issue and for change of address. Printed in the United States of America.

Postmaster: Please send change of address notice to Modern Electronics, 76 North Broadway, Hicksville, NY 11801.

CQ Communications, Inc. is publisher of CQ The Radio Amateurs Journal, Popular Communications, Modern Electronics, CQ Radio Amateur (Spanish CQ), and the CQ Amateur Radio Buyer's Guides.

Electronics Workbench™

The electronics lab in a computer

MS-DOS VERSION
NOW IN COLOR
EGA/VGA
Also available
for Macintosh

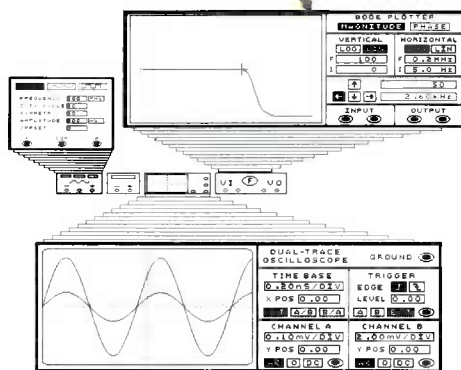

An example of the unique on-screen test instruments:

- Bode plotter
- Function generator
- Multimeter
- Dual-trace oscilloscope

“Electronics Workbench is pretty amazing.”

Jerry Pournelle, InfoWorld

Electronics Workbench is simple and intuitive to use, yet powerful:

- Build circuits easily with the mouse-driven graphical interface.
- Simulate both analog and digital circuits.
- Test circuits with on-screen simulated instruments.

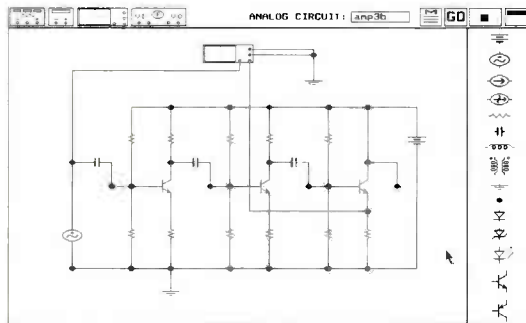

Analog Module

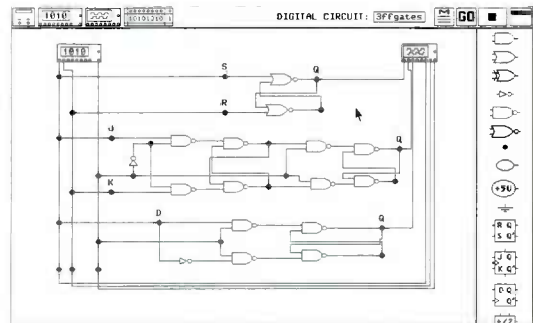

Digital Module

Special Offer* — Electronics Workbench for only \$495 with this ad!

Regular price \$650.00 — save over \$150 NOW!

Method of Payment

Cheque Visa MasterCard Amex

Card Number _____ Expiry Date _____

Name on Card _____

Signature _____

Name: _____

Title: _____

Organization: _____

Address: _____

City: _____ State: _____ Zip: _____

Tel: () _____ Fax: () _____

MS-DOS 5.25" MS-DOS 3.5" Macintosh

Item	Amount
Special offer ___ x \$495.00 (shipping and handling @ 2% of order)	
Evaluation version ___ x \$10.00 (shipping and handling included)	
Total	

Send order form and payment to:

Interactive Image Technologies Ltd.
908 Niagara Falls Boulevard,
North Tonawanda, NY 14120-2060

* THIS OFFER EXPIRES ON MARCH 31, 1991

Tel: (416) 361-0333 Fax: (416) 368-5799

CIRCLE NO. 119 ON FREE INFORMATION CARD

Sams Is Your Guide to Safe and Successful Electrical Repair and Design

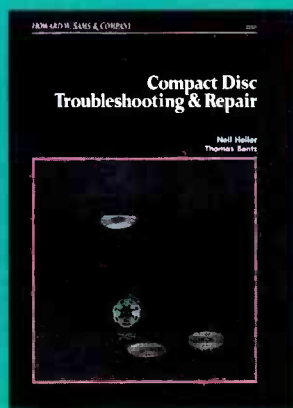
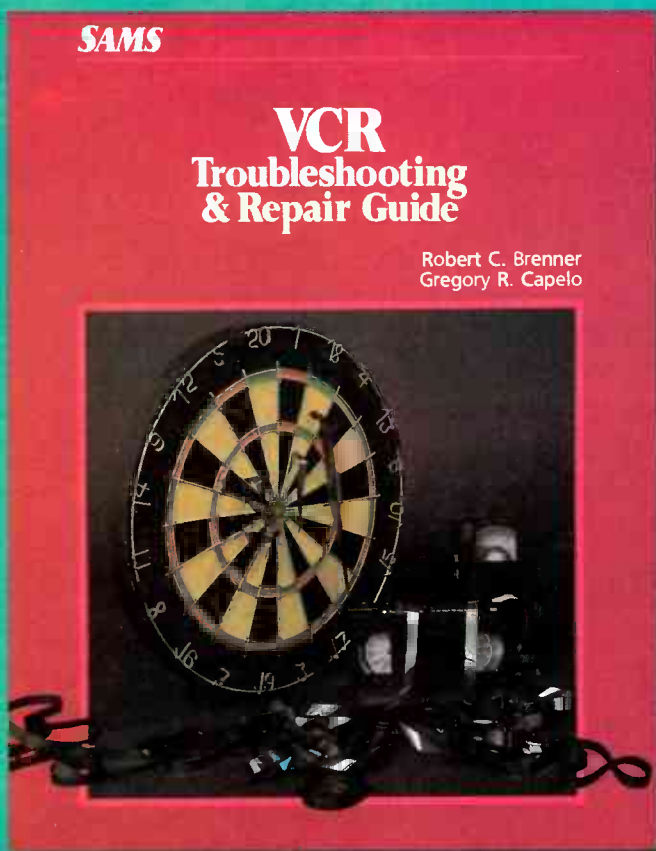

VCR Troubleshooting & Repair Guide
0-672-22507-7
\$19.95 USA

Compact Disc Troubleshooting & Repair Guide
0-672-22521-2
\$19.95 USA

CMOS Cookbook, Second Edition
0-672-22459-3
\$18.95 USA

TTL Cookbook
0-672-21035-5
\$16.95 USA

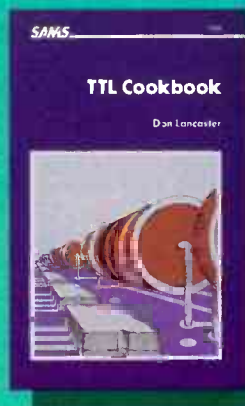
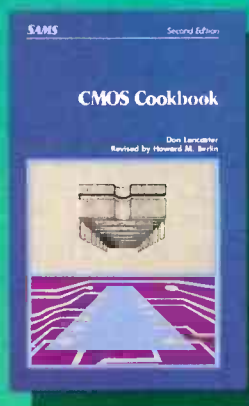

Find Sams Books At These Locations

California

SANDY'S ELECTRONICS
Canoga Park CA
818-346-8353

TOWER BOOKS-SUNRISE
Citrus Heights CA
916-961-7202

MARVAC ELECTRONICS
Costa Mesa CA
714-650-2001

SAV-ON ELECTRONICS
Garden Grove CA
714-530-0555

HENRY RADIO
Los Angeles CA
213-820-1234

ITC ELECTRONICS
Los Angeles CA
213-388-0621

OPAMP TECHNICAL BOOKS
Los Angeles CA
213-464-4322

ELECTRONICS CENTER
Oceanside CA
619-722-5855

DOW RADIO & ELECTRONICS
Oxnard CA
805-486-6353

PANORAMA ELECTRONICS
Panorama City CA
818-894-2248

TOWER BOOKS-WATT AVE
Sacramento CA
916-481-6600

STACEY'S BOOKSTORE
San Francisco CA
415-421-4687

ACTIVE ELECTRONICS
Santa Clara CA
408-727-4550

Colorado

FISTELL'S ELECTRONICS SUPPLY CO.
Denver CO
303-629-1312

GATEWAY ELECTRONICS
Denver CO
303-458-5440

PUEBLO WINTRONICS
Pueblo CO
719-542-1924

Florida

DOWNTOWN BOOK CENTER
Miami FL
305-377-9939

If you need reference material or advice on designing circuitry, or even how to properly clean your VCR—turn to Sams. Sams' successful electronics titles cover a wide spectrum of topics—and provide complete reference material for proper electronics use. Look for these titles—and more—to guide you through all aspects of electronics!

SAMS

Find Sams Books At These Locations

Georgia

OXFORD BOOK STORES
Atlanta GA
404-262-3333

Illinois

B B & W
Berwyn IL
708-749-1710

TRI-STATE ELECTRONIC CORP.
Mount Prospect IL
800-445-0896

Massachusetts

BARILLARI BOOKS
Cambridge MA
617-864-2400

MIL ELECTRONICS
Walham MA
617-891-6730

ACTIVE ELECTRONICS
Woburn MA
617-932-4616

Maine

H & R DISTRIBUTORS
Portland ME
207-713-2552

Michigan

A 1 CAMPUS ELECTRONICS
Ann Arbor MI
313-662-0201

TEL VAN ELECTRONIC SUPPLY
Dearborn Heights MI
313-561-6080

ELECTRONIC PARTS CO.
Detroit MI
313-893-3228

S-F ELECTRONIC SUPPLY INC.
Grand Rapids MI

T & W ELECTRONICS, INC.
Grand Rapids MI
616-241-3645

WARREN RADIO CO.
Grand Rapids MI
616-456-5385

FULTON RADIO SUPPLY
Jackson MI
517-784-6106

WARREN RADIO CO.
Kalamazoo MI
616-381-4203

FULTON RADIO SUPPLY
Lansing MI
313-394-5020

NORWEST ELECTRONICS
Livonia MI
313-261-4551

WARREN RADIO CO.
Madison Heights MI
313-588-3327

REMCOR ELECTRONICS
Oak Park MI
313-541-5666

K 40 ELECTRONICS
Warren MI

THE ELECTRONIC CONNECTION
Westland MI
313-595-6655

Nevada

SANDY'S ELECTRONICS
Las Vegas NV
702-383-8353

New York

ACTIVE ELECTRONICS
Bohemia NY
516-471-5400

OHM ELECTRONICS
Ithaca NY
607-273-8406

McGRAW-HILL BOOKSTORE
New York NY
212-512-4100

SALINA ELECTRONICS
Syracuse NY
315-422-2336

Ohio

BOOK & CO.
Dayton OH
513-298-6540

WILKIE NEWS SOUTH
Dayton OH
513-434-8821

Texas

TAYLORS TECHNICAL BOOKS
Dallas TX

BROWN BOOK SHOP
Houston TX

ELECTRONIC PARTS OUTLET
Houston TX
713-784-0140

Washington

ACTIVE ELECTRONICS
Bellevue WA
206-881-8191

Washington DC

REITER'S SCIENTIFIC & PROFESSIONAL BOOKS
Washington DC
800-537-4314

Canada

ACTIVE COMPONENTS
Mississauga Ontario
416-238-8825

ACTIVE COMPONENTS
Montreal Quebec
514-731-7441

EDITORIAL

Energy

Energy, in one form or another, becomes newsworthy from time to time. Right now, oil has pushed the subject into the forefront due to the Middle East crisis. As a result, there's more talk and writing about energy conservation, fossil fuel, nuclear energy, solar power, et al, than there has been in a long time.

There was a brief period, during the mid-1970s oil crisis, when the prospect of energy through solar power was thrust into the public's consciousness. Then it subsided. Remnants of that period remain in my neighborhood: a few homes have solar panels on the roof to heat water; some others installed wood-burning furnaces into their fireplace openings to heat much of the home. (But, then, one of my neighbors has a nuclear-bomb shelter with air ducts, etc., from an even earlier period.)

So it's with a feeling of *deja vu* that I view today's rising concerns about energy. Solar power, in particular, is a very appealing energy source since it's free (though the conversion certainly isn't), it's available everywhere, and it's as clean as one could hope for. Consequently, I was pleased to learn that there's a joint effort related to solar-cell development between Iowa State University and 3M. They're working under the corporate banner of The Center for Amorphous Semiconductors.

The project—developing a new form of photovoltaic cell to transform light into electricity from silicon-based semiconductors—focuses on developing solar cells based on a new technology. The heart of it consists of a thin coating of photosensitive amorphous silicon material deposited on flexible polyimide film.

The material, which acts like a whole bank of conventional solar cells, is said to be no thicker than a human hair. Most solar cells used today, in contrast, are made of *crystal* silicon covered by a glass face. Consequently, they're brittle. Moreover, they're made up of silicon wafer sections, whereas in the new technology the photovoltaic surface is over a continuous area. As a result, the "film" is conformable. It can be wrapped around curved surfaces. It can be unrolled like a window shade, rather than being a rigid panel.

Expected applications include power for a portable radio, smoke detector, electric shaver, charging car and boat batteries, highway communication systems, community power systems, and even space satellites.

In another power-source advance, Duracell Inc. announced a new user-replaceable, long-life portable power system that targets certain applications dependent upon Ni-Cd cells requiring ac recharging, such as in portable cellular telephones, hearing aids, pagers, etc.

It's a zinc/air 1.4-volt stackable cell with the capacity of a C-size alkaline cell, but at less than one-third its size. Duracell calls it an "Activair" battery. In a 5-watt portable transceiver, Ni-Cd battery packs supported by zinc/air cells will allow a 5-watt portable transceiver to operate for 71 hours before replacement of the zinc/air battery is required, rather than requiring Ni-Cd recharging in just a few hours without it.

(Continued on page 68)

SAMS

ABOVE-AVERAGE HIRING ANTICIPATED. According to a recent national survey by Management Recruiters International (Cleveland, OH), employment projections for the electric and electronic products industry are above the national average for increases in hiring for the second half of 1990. Of executives polled for the 25th in a series of surveys conducted by MRI, 37.7% indicated plans to increase their middle management and/or professional staffs. An additional 47.8% planned to maintain their current staff sizes, while 14.2% planned staff reductions.

LOW-END APPLE MACS. Three new Macintosh computer models change the complexion of the company's product line-up. Replacing Apple's Mac IIcx, which has three expansion slots, two of the new models (IIsi and IILC) have only one expansion slot. The third model, the Mac Classic, which supplants the old Mac Plus, has none at all. The reduction in open architecture was made because Apple's research revealed that the average number of slots used by Mac owners was only 1.1.

NI-CD BATTERY MEMORY MYTH. According to research by Gates Energy Products, the "memory" problem with nickel-cadmium batteries does not exist. Memory here refers to Ni-Cd cells "remembering" the amount of discharge when it is recharged and giving up only that amount even when called on to deliver their full capacity. Gates' testing used batteries by two different makers, and three battery categories were cycled and compared. One set was subjected to zero discharge, a second group was discharged at a fixed rate for a fixed time giving 25% discharge depth and then recharged, and a third group was completely discharged and completely recharged each cycle. No significant difference in delivered capacity was noted between any of the cells.

ELECTRONICS SERVICE NEWS. IBM announced personal computer software to make processing warranty claims and ordering spare parts more efficient for small to medium-size consumer electronics service centers. Called Electronics Service Management/2 (ESMS), it is said to be an easy-to-use system to put managers and owners in firm control of their business. The software package will track counter drop-off, work in progress status, warranty claims, as well as allowing users to print receipt/invoice. It's designed for use with DOS 3.3 or higher, at least a PC-XT computer with 640K memory and a hard disk drive with at least 4MB available, and a color display terminal (VGA, EGA, CGA or MCGA).

According to IBM, there are about 15,000 to 20,000 independent consumer electronics equipment service/repair centers in the U.S.. Some 15 percent are considered to be medium size with 4 to 15 technicians; 5 percent as large, with 16 or more technicians, and 70 percent as small with 1 to 3 technicians.

The recent National Professional Electronics Convention (NPEC) in Las Vegas drew more than 600 attendees and 59 exhibition booths. NPEC '91 will be held August 5-10, 1991 at the Nugget Hotel in Sparks (Reno) Nevada. Early registration, before January 31, offers savings of up to \$80 per person. For more details, call 817-921-9061.

Parts Sources

• I would like to build the "Single-Channel Sound Exploder" that appeared in the October issue. However, I cannot locate a source from which to buy the TDA-1524 and TDA3810 chips required for the project. Do you know of a source of supply?

Charles E. Matlack
Sunnyvale, CA

These chips are available from a number of OEM suppliers. Another source is Atronix, P.O. Box 221393, Sacramento, CA 95822, which sells them for \$5 each (no minimum order required).—Ed.

Switching Problem Solved

• The wiring scheme for the "Dual-Polarity Power Supply" published in the March issue of *Modern Electronics* appears to have one or more errors in it. The update given in the Letters column of the July issue did not completely clear up the problem. Are there any updates that will help me get this project working properly?

J.A. Biscardi
Brooklyn, NY

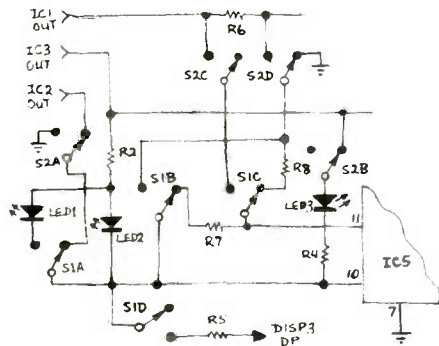

Use the partial schematic shown here to rewire the switching arrangement. The only portions of the switching arrangement that should go directly to circuit ground should be the left pole of S2A and right pole of S2D. Make sure the toggles of S1A and S1B do not go to circuit ground as originally shown.—Ed.

Change of Address

• Apparently a lot of readers are still interested in building my MC68701 Microcomputer Chip Programmer featured in the May issue. Since this article was published, I moved and was unable to handle orders for several months. My company name and address changed, as well as the

price for the kit. The new price is \$37.50 for the minimal EP701 kit, which includes the pc board, EPROM, documentation and shipping. If you are ordering, please make checks payable to Lucid Technologies.

Brian Beard
Lucid Technologies
7439 Hwy. 70 S., #297
Nashville, TN 37221

Reader Booster

• I am a long-time subscriber to *Modern Electronics* magazine and have always enjoyed reading and learning from the Forrest Mims "Electronics Notebook" columns. These columns are always very interesting and provide first-class and practical technical material. Although I cannot keep all the full issues of *ME* from the past, I try to cut from each and keep the Mims column. My loose sheets, however, do make a pretty sloppy and incomplete compilation.

I feel sure that other readers feel as I do and would like to see all of the "Electronics Notebook" columns neatly compiled into a single publication that could be issued, say, yearly. I certainly would be a buyer!

William Winters
Bethesda, MD

Long-Float Devices

• In "Add Light-Meter Modules to Any Digital Voltmeter" in the September 1990 issue, the author states, "Vactec is apparently still making selenium photocells." In fact, our name changed about seven years ago to EG&G Vactec, and we discontinued manufacturing selenium photocells in September 1989.

The author also states that, "... plenty of International Rectifier's famous No. B2M 'sun batteries' should still be floating around." I was the manager of the light-sensitive device line at International Rectifier when the last selenium photocell was manufactured—in 1969. Somehow, I doubt that there a lot of these devices still "floating around" after 21 years.

Denis Hartley
Sales Manager
EG&G Vactec
St. Louis, MO

Parts Express
International Inc.

340 E. FIRST ST.
DAYTON, OHIO 45402

IDLER TIRE KIT

This popular kit contains 170 of the most popular idler tires (10 each of 17 different sizes).



save time and money by having the right tire in stock. Also included is a comprehensive cross reference listing over 80 manufacturers' assembly numbers and over 200 model numbers. (All tires are available individually for reorder.)

#MP-400-900 **\$49⁹⁵**

VCR REPAIR PARTS KIT

With this convenient kit you can do most of your VCR repair jobs the same day.



Commonly used parts for RCA, Hitachi, Fisher, Sanyo, Lloyds, Panasonic, Sony, Sharp, JVC, and more. Over 45 parts in all. (All parts are available individually for reorder.)

#MP-400-950 **\$89⁹⁵**

VCR SPRING ASSMT

A wide assortment of springs used in many name brand VCRs.



Clutch springs, idler springs, tension springs, etc. 11 tension springs and 5 pressure springs.

#MM-430-300 **\$1⁵⁰**

VCR WASHER ASSMT

A wide assortment of plastic washers used in VCRs.



clutch assemblies and idlers. 150 pieces, split ring and regular.

#MP-430-305 **\$5⁹⁰**



CALL TOLL FREE
FREE CATALOG

1-800-338-0531

CIRCLE NO. 111 ON FREE INFORMATION CARD

For more information on products described, please circle the appropriate number on the Free Information Card bound into this issue or write to the manufacturer.

PC Prototyping Kit Card

Signal-Systems' (Portland, OR) DSPerato real-time signal processing IBM PC/XT expansion card prototyping kit features a Motorola 56001 DSP chip. The 56001 DSP runs at 20 MHz and includes pipeline instruction fetches, parallel data moves to

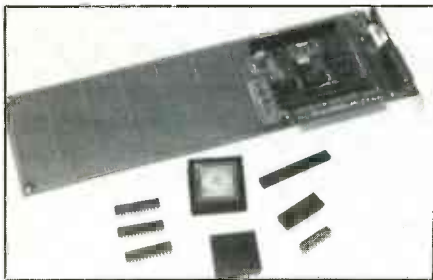

three separate 24-bit X data, Y data and program memories and easy host computer interfacing. The chip is capable of 10 MIPS.

DSPerato contains a full-length IBM PC prototyping card with bus decode and buffers. The remainder of the card has uncommitted 0.100" center plated-through holes with power buses and pads. Two optional high-performance video and audio A/D and D/A converter boards attach to the DSP card via 0.1000" center pin headers. The 16-bit audio board uses Motorola's advances 56ADC 55-Hz 16-bit sigma-delta converter, and the high-performance eight-bit video card uses Sony 20-MHz eight-bit semi-flash converters. Either or both converter options can be attached to the DSP card, which can also be used without the converter boards.

Parts needed to populate the DSP and converter kits are included. These include all chips, sockets, resistors and capacitors, plus the 56001 DSP and 8K × 24-bit, 45-ns static RAM chips. Assembly instructions and schematics needed to connect the

DSP and converters are included, as is a Signal-Tools software disk that provides real-time spectrum analysis, digital oscilloscope and waveform-capture and generation. The software features a keyboard- or mouse-driven pull-down menu interface. Also available is an optional MACRO-DSP software development kit that contains the 56001 macro assembler, debugger and linkable object modules. DSPerato, \$299; audio and video converters, \$149 each; MACRO-DSP, \$99.

CIRCLE NO. 156 ON FREE INFORMATION CARD

Pen-Type DMM

Beckman Industrial Corp. has added the hand-held pen-type Model DM73 to its line of digital multimeters. This new meter features a 3½-digit display that yields a 0.5% accuracy on the 2-volt dc range. With built-in autoranging, only one control is provided—a slide switch for selecting functions. Other features include a data-hold function, audible continuity checking, a buzzer that sounds when



functions are changed, built-in scabbard for the ground lead and display of selected function.

With full autoranging, the DM73 provides 12 measurement ranges. It can measure up to 500 volts dc, up to 250 volts ac and resistance up to 2 megohms. Dual-slope integrating analog-to-digital conversion is used for making measurements. \$69.95.

CIRCLE NO. 157 ON FREE INFORMATION CARD

VCR Programming System

VCR Plus +™ from Gemstar Development Corp. (Monterey Park, CA) is a programming system that allows



users to program their VCRs in one easy step. Programming is accomplished by entering a code number printed in TV listings into a programming device. The system can store up to 14 programs.

Because the system is wireless, no installation is required. It is compatible with any number of channels and program combinations and any type of wireless VCR/cable box and includes cable programming capabilities. Time and date and amount of tape required for recording during the next 24 hours are displayed in the LCD window built into the VCR Plus +. Recording options include, once, weekly and daily. Additional recording time, review and cancel keys are provided. The Review key recalls all stored programs in chronological order by date and time.

Power for the device is provided by four AAA cells. Lithium-cell backup is provided to guard against loss of settings when the AAA cells are replaced or power is interrupted for any other reason. A LO BATTERY legend appears in the display when it is time for replacement of the cells.

The system comes with controller and holder. The hand-held unit measures 6¼"L × 4¼"W × 1"H and weighs 0.6 lb. with battery. \$59.95.

CIRCLE NO. 158 ON FREE INFORMATION CARD

Motion-Sensing Lighting Controls

New to the Heath Zenith line of Reflex Group Brand devices is a series of motion-sensing lighting controls for indoor use. Three items make up the new introductions: the Model SL-6105B (\$14.97) that works with single-switch installations; the Model

NEW

Only NRI gives you a 27" high-resolution stereo color TV you build to prepare you for today's video servicing careers.



You Build a 27" Stereo TV
During the assembly process of your state-of-the-art Heath/Zenith 27" TV, you learn to identify and work with components and circuits as they actually appear in commercial circuitry. Then through tests, adjustments, and experiments you quickly master professional troubleshooting and bench techniques.



Become one of America's most sought-after technicians . . . put your talents and spare time to work for you in the "explosive-growth" world of home entertainment electronics.

Train in state-of-the-art video/audio servicing and become a fully qualified service professional the uniquely successful NRI way. It's hands-on training, at home . . . designed around the latest electronic equipment you build and keep as part of your training.

The High-Tech Revolution in the Home Is Just Starting

Sweeping changes are taking place in our homes, changes brought about by the phenomenal growth of home entertainment electronics. Already available are high resolution TV, TVs with stereo sound, simultaneous multi-channel viewing, projection TV, Camcorders, 8 mm video cassettes, and compact disc players.

And the revolution has spread to the business sector as tens of thousands of companies are purchasing expensive high-tech video equipment used for employee training, data storage, even video conferencing.

Join the Future or Be Left Behind

Today the consumer electronics industry represents a whopping \$26 billion opportunity for the new breed of consumer electronics technician.

Today's consumer electronics revolution is creating huge servicing and repair mar-

kets that are just starting to boom.

Here is your chance to become a fully qualified professional the way tens of thousands have trained with NRI.

Totally Integrated Hands-On Training

Since NRI training is built around "learn by doing," right from the start you conduct important experiments and tests with your professional digital multimeter. You assemble the remarkable NRI Discovery Lab and perform a complete range of demonstrations and experiments in the process.



NRI's commitment to you goes beyond providing you with equipment appropriate to the latest technology. Best of all, we ensure that in the learning process you acquire the very skills that will make you a professional service technician on the job.

Inside Your TV

The Heath/Zenith 27" TV has all the features that allow you to set up *today* your complete home video center of the future. Flat screen, square corners, and a black matrix to produce dark, rich colors . . . even a powerful remote control center that gives you total command of video and audio operating modes.

NRI has purposely designed your training around equipment that has the same high-tech circuitry you'll encounter in commercial equipment. That means your training is real-world training.

SEND COUPON TODAY FOR FREE NRI CATALOG!

NRI SCHOOLS
McGraw-Hill Continuing Education Center

4401 Connecticut Avenue, NW, Washington, DC 20008

We'll give you tomorrow.

CHECK ONE FREE CATALOG ONLY

For Career courses approved under GI Bill check for details.

- | | |
|--|--|
| <input type="checkbox"/> TV/Audio/Video Servicing | <input type="checkbox"/> Basic Electronics |
| <input type="checkbox"/> Computer Electronics | <input type="checkbox"/> Air Conditioning, Heating and Refrigeration |
| <input type="checkbox"/> Robotics Technology | <input type="checkbox"/> Electrician |
| <input type="checkbox"/> Telecommunications | <input type="checkbox"/> Small Engine Repair |
| <input type="checkbox"/> Digital Electronics Servicing | <input type="checkbox"/> Locksmithing |
| <input type="checkbox"/> Security Electronics | <input type="checkbox"/> Writing |
| <input type="checkbox"/> Electronic Circuit Design | <input type="checkbox"/> Bookkeeping and Accounting |
| <input type="checkbox"/> Computer Programming | |

Name (Please print) _____ Age _____

Street _____

City/State/Zip _____ 4-120

Accredited Member National Home Study Council

NEW PRODUCTS...



SL-6107 (\$19.97) that works in three-way installations; and the Model SL-6120 (\$29.97) security and convenience light switch. The last offers a va-

riety of security features, including a random security timer and the ability to flash room lights when an unauthorized intrusion occurs.

The SL-6105B is ideal for installation in high-traffic areas, where it offers the convenience of a standard switch plus the safety and security of motion sensing. It replaces any standard two-way wall switch and can handle up to 300 watts of incandescent lighting.

The wall switches feature PIR motion sensors that automatically turn on and off lights. Time-on period can be adjusted so that lights remain on for as long as 5 minutes or as short as 5 seconds once motion is detected. A daylight control can be set so that the wall switches operate during daylight hours in dark areas.

CIRCLE NO. 152 ON FREE INFORMATION CARD

2,000-Channel Receiver Covers 1 MHz to 1.5 GHz

Ace Communications' new Model AR-2500 receiver offers 2,000 channels and covers a range of from 1 MHz to 1,500 MHz at 36 channels per second. It also has a built-in



RS-232 interface for unattended programming control and frequency logging with a computer.

According to Ace, the receiver is designed to provide an extremely high level of image rejection and a sensitivity that is typically better than $0.35 \mu\text{V}$ at 12 dB SINAD in narrow-band FM from 10 MHz to 1.5 GHz. AM sensitivity in the 5-MHz to 1-GHz range is rated at better than $1.2 \mu\text{V}$ for 10 dB S/N. Tuning increments are user-selectable at 5 kHz, 12.5 kHz and 25 kHz. A BFO for SSB/CW reception is included.

The receiver is capable of scanning 62 banks of 32 frequencies each for a total of 1984 scanned frequencies. An additional 16 memory locations are set aside for beginning and ending search limit frequency pairs. Bank 1 can be designated as priority to give higher priority to as many as 32 different frequencies. The scan rate of 32 channels or increments per second automatically slows to compensate for tuning lags if adjacent frequencies are located more than 30 MHz apart.

This compact receiver measures just $6\frac{1}{2}''\text{D} \times 5\frac{3}{8}''\text{W} \times 2\frac{1}{4}''\text{H}$, permitting it to be operated on a table top or under the dashboard of a motor vehicle. \$499.

CIRCLE NO. 154 ON FREE INFORMATION CARD

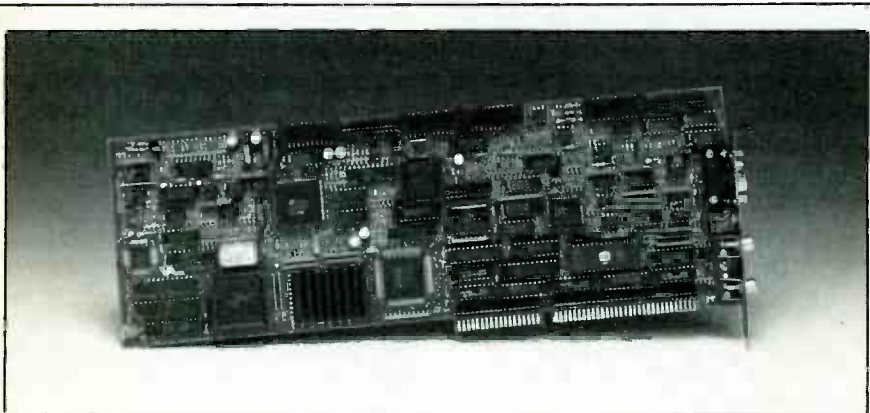

Sound/Graphics Syncer

Video Associates' (Austin, TX) MicroKey/A® System lets anyone create more effective computer-based slide shows with sound without requiring one to be a programming expert. It synchronizes sound to such popular presentation graphics software as Harvard Graphics, Autodesk Animator and Lotus Freelance Plus and then outputs onto video tape the combined audio/visual results.

MicroKey/A operates on 100% IBM AT VGA hardware and BIOS and requires no additional graphics

cards. It is also compatible with standard VGA and multi-sync monitors. Extended VGA graphics modes include 640×480 with 256 colors, 800×600 with 256 colors and $1,024 \times 768$ with 16 colors. Its 1-MB graphics memory permits two pages of graphics images to be stored simultaneously. The system employs adaptive differential pulse-code modulation (ADPCM) audio encoding and offers 8-, 16- and 32-kHz audio sampling rates. Video output is analog RGB, composite or S-VHS in NTSC or PAL format.

CIRCLE NO. 153 ON FREE INFORMATION CARD

Vacuum Pen For Inserting/Extracting SMTs

A new Vacuum Pen designed for insertion and extraction of plastic quad



flat pack (PQFP) and small-outline IC (SOIC) chip packages has been announced by Emulation Technology, Inc. (Santa Clara, CA). Any of

three provided cup sizes can be screwed onto the tool to handle specific IC packages. Pressing a plunger at the end of the Vacuum Pen creates a vacuum between tool and chip to hold the latter firmly in place. No external hoses or other equipment is needed. The body of the Vacuum Pen is stainless steel, and the pick-up cups are rubber. \$55.

CIRCLE NO. 155 ON FREE INFORMATION CARD

Audio Signal Processor

The Pioneer Electronics Model SP-91D combines two digital signal processors that add a new dimension to high-fidelity listening. It incorporates Dolby Pro-Logic surround-sound and true multi-channel 18-bit digital-to-analog converters. Together, the two are said to provide a "live" musical experience by creating the sonic ambience of a real per-



formance. The digital signal processors allow for 60 reflections for simulations of such sound fields as concert halls, jazz clubs, discos, stadiums and churches through digital recreation of reflections and reverberations from the walls, ceiling and floor in each environment. Preprogrammed into the unit are 16 room settings, and another 16 can be user-created and stored. Also incorporated into the unit are true 18-bit four-channel independent D/A converters, 8x oversampling digital filters and high-accuracy A/D conversion.

(Continued on page 81)

Professional Tool Case

SPECIAL \$59.95
Reg. \$80.00

Makes a Great Holiday Gift!

Model MEIM5

- Two removable pallets hold over 60 tools
- Case top has built-in document holder
- Case bottom is partitioned into 3 areas

A handsome black case to organize and transport your valuable tools and instruments. This is the same quality case used by literally thousands of professional field engineers. Case is made of high impact polypropylene, and has snap-action key locks and a padded handle.

Size: 17½" x 12½" x 5".

Tools are not included.

Offer expires January 31, 1991.

To order call:
1-800-225-5370

In MA: (508) 682-2000

Same Day Shipment!
Money Back Guarantee!

Terms: Visa, MC, Amex;
P.O.'s from qualified firms accepted.
Add \$5.50 for packing and delivery

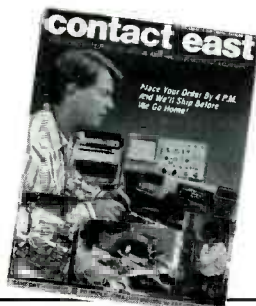

FREE CONTACT EAST CATALOG

Contains thousands of products for testing, repairing & assembling electronic equipment. To get your free catalog, call (508)682-2000.

CIRCLE NO. 106 ON FREE INFORMATION CARD

Say You Saw It In Modern Electronics

Protel Easytrax 2™

Outstanding value in Printed Circuit Board/CAD for your Macintosh and PC

Protel Easytrax 2 is a new, low-cost design package for PC and Macintosh users that includes everything required to produce professional quality Printed Circuit Board artwork.

Our easy-to-learn menu-driven design system breaks the 'expert barrier'-you'll be designing in minutes, not hours. Our comprehensive tutorials guide you through the program's extensive features that take the tedium out of board layout.

- Comprehensive library of Through-hole devices

- Gerber photoplotting and N/C drill tapes
- On-the-fly library components creation
- Intelligent Pad to Pad autorouting
- Switchable Metric/Imperial grid
 - Auto-panning
 - PostScript™ printing
- Powerful user-definable Macros
- Independent print/plot program
- Multi-layer boards of up to 32 X 32 inches.

At Protel, we offer free technical support, 24-hour BBS, and 30-day money back guarantee. Prices start at

\$450

Free Evaluation Package
Toll Free: 800-544-4186

Protel Technology, Inc.

50 Airport Parkway, San Jose, CA 95110

Tel: 408-437-7771 Fax: 408-437-4913



CIRCLE NO. 112 ON FREE INFORMATION CARD

December 1990 / MODERN ELECTRONICS / 15

Schematics From Your PC

For as little as \$49, you can have your personal computer draw schematics

By TJ Byers

No matter what area of electronics piques your interest, it shares an element common to all electronic disciplines: the ubiquitous schematic diagram. Like a blueprint, a schematic lets engineer, technician and hobbyist alike communicate electronic ideas and designs.

Many in this group are involved in creating schematics for professional, educational or personal applications, or would like to do so without having to develop mechanical drafting skills. Fortunately, there a host of personal computer programs that can handle all the drawing chores. Very-low-cost ones are called schematic design or drawing programs, such as BSOFT Software's (Columbus, OH) *Auto Skem*. The more sophisticated and costlier ones also extract data from schematics in the form of "net lists" to allow printed-circuit boards to be laid out by PCB software. They are commonly known as schematic capture programs.

Such microcomputer packages range in price from \$49 to nearly \$1,000. The top-priced ones also combine printed-circuit board layout capabilities. They all relieve the user of physically drawing a schematic and, in varying degrees, can save a lot of time by making it easier to manipulate drawing changes and reducing drawing errors.

This first of a series focuses on schematic capture and design software, explaining how it works and discussing what features to look for

in a program. Articles following examine a host of popular schematic capture programs for price, performance and features, and show you how to convert your screen schematic into an actual printed-circuit board using your PC and a printer.

CAD in Disguise

Schematic capture programs are basically CAD (computer-aided drafting or design) programs that, over the years, have evolved into special-purpose drawing applications. One of the first PC programs to offer schematic capture support was *EnerGraphics*, a business graphics charting program with drawing capabilities. Soon to follow were add-on utility programs that allowed CAD programs like *AutoCAD* and *Generic CADD* to also create schematic diagrams. These beginnings matured into the dedicated CAD-like schematic capture programs we have today.

As previously cited, what sets a schematic capture program apart from a general-purpose drawing program is the ability to produce net lists. This is a file that contains information on the schematic's components, pin connections, nets, and more for interfacing to other programs that layout PCBs and simulate circuit action, produce Bills of Material, etc. Additionally, all schematic capture programs contain extensive component libraries as an integral part of the package. (Some general-purpose programs offer add-on symbol libraries.)

You may think of a component li-

brary as nothing more than a collection of symbols that is created using the CAD kernel of the program and saved as a block. When a component is needed in a schematic, it can be called from the library as a block, rather than having to draw it element-by-element from scratch (which can also be done).

Schematic capture programs also differ in the way they place and manipulate objects on the video display screen of the computer. Unlike full-featured CAD programs, most schematic capture programs limit drawing functions to just those related to schematic generation. For example, most do not have fill, stretch or component-sizing capabilities. Furthermore, they are two-dimensional, whereas some very costly general-purpose drawing programs offer 3D for computer-aided-manufacturing (CAM) purposes.

Schematic capture software has the usual collection of CAD editing tools, like move and delete, but they, too, are honed for the tasks of editing a schematic. In addition, there are special editing functions, like bus management and global replacement of device types, not found in standard CAD programs.

Hardware Requirements

With but a couple of exceptions, hardware requirements for a schematic capture program are the same as for a drawing or a CAD program.

Topping the list of needs is a high-resolution video screen display. Screen resolution is measured in pix-

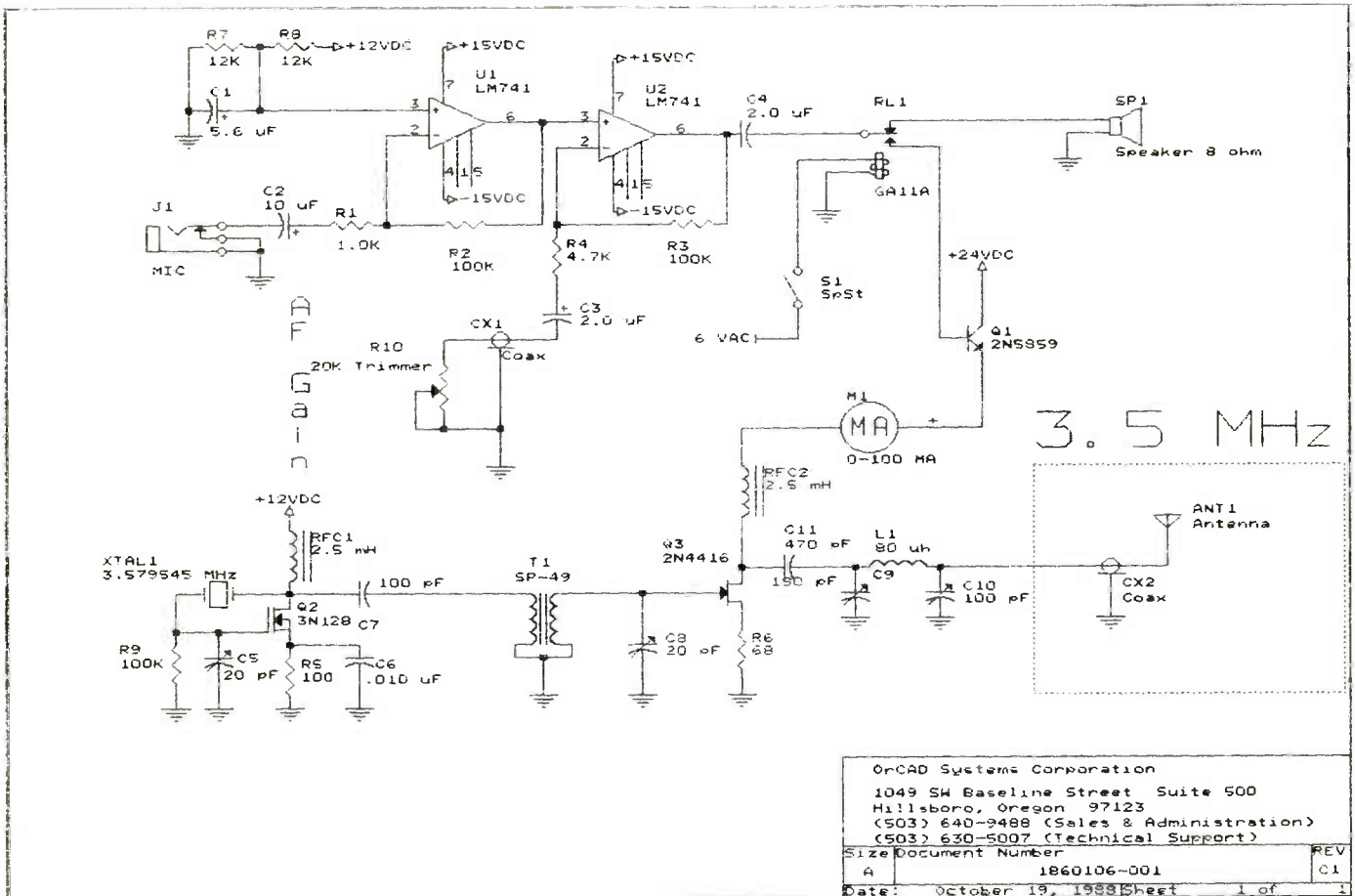

Fig. 1. Schematic capture programs can produce professional-quality schematics.

els, with resolution increasing as the pixel count increases. IBM's EGA and VGA video modes are both excellent choices for use with schematic capture drawings, with the VGA having the edge over EGA in higher resolution. Furthermore, many VGA adapter boards also support an 800 x 600-pixel screen that has 35 percent better resolution than VGA. But to use the higher-resolution mode, you need a multisync monitor and a special software driver that must be supplied by the capture program.

Screen colors are also important to schematic capture because the program makes extensive use of color if it is available. Components are displayed in one color, connecting wires in another and nomenclature in yet another. Using colors to identify

areas of a circuit make it easier to choose editing tools when doing drawing changes. Users who have monochrome displays will find that, even though their high-resolution screens excel in sharpness, information is not as easily distinguished as on a multi-color screen.

Schematic capture programs also require a lot of hard-disk space. You need anywhere between 1MB and 5MB of disk space for the program itself and its libraries, plus space for the schematic files you make (each of which can range from 5K to 500K per schematic, depending on its size). Because most schematic capture operations are math intensive, the program benefits greatly when a math coprocessor chip is installed in the PC. Typically, a math coproces-

sor can at least double program operation speed under normal conditions and by as much as ten-fold when doing a screen redraw.

Unlike CAD hard-copy output, which demands expensive pen plotters, schematic capture programs also can be used with an inexpensive dot-matrix or laser printer, with the latter more desirable, of course.

Component Library

Generally, the library is made up of smaller, specialized library modules that are linked together. For example, one module might contain nothing but symbols for analog ICs, while another might hold the symbols for CMOS devices. Modular libraries are more versatile than a single large library because the architecture allows

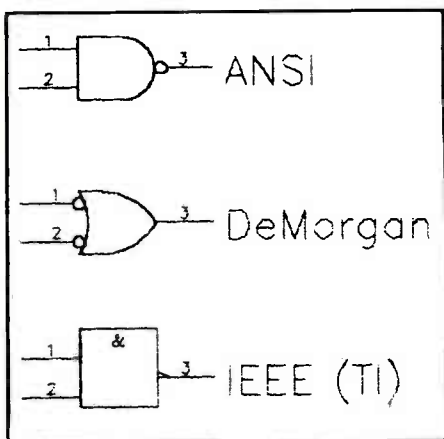

Fig. 2. Some schematic capture programs support ANSI, IEEE/TI and DeMorgan symbols. This gives a designer more flexibility in implementing a logic circuit.

you to easily expand the capacity of the library by simply adding new modules. Modular architecture is also a great way to save disk space because you have to load only those modules you normally use, leaving the remainder on the disks.

Each schematic capture program has its own way of identifying devices in the component library. Most programs try to name the component by its generic identifier, such as 74LS27. But this is not always possible. For example, Schema calls a 16-pin resistor package DRPAC16, a name few people would associate with that device. Fortunately, all programs have either an on-screen device menu or a component catalog that describes the library symbols and their names; many have both.

For components not included in a library, the schematic capture package has a component editor that lets you roll your own. New components can be created from scratch or by modifying an existing component. Most libraries use bit maps for the component design, which means you have to fill in a matrix dot-by-dot when building new components. However, there are a few programs that have more advanced library

editors that permit you to build components from such primitives as circles and squares.

Drawing Features

Components are called from the library using a display editor. First, the editor accesses the library and then calls the component by name. As a rule, display commands are accessed from pull-down menus, using a combination of mouse clicks and keyboard strokes. With some programs, the process can be automated, using macros (user-defined keystrokes stored in memory) that render the task of entering a complex routine to a single keystroke.

After a component is selected from the library, the editor places it on the drawing. Common to all schematic capture programs is a grid of dots (which may be either visible or invisible) that overlays the drawing page. The grid is used to position the cursor at exactly spaced intervals on the screen. If you try placing the cursor in a position not allowed by the grid, the program moves the cursor to the nearest grid position, a move called "grid snap."

Grid snap ensures that the component attaches precisely to lines and components already on the schematic, with no misalignment. The density of the grid determines the resolution of the drawing. The finer the mesh, the smoother the cursor movement and the more latitude you have over placement of lines and components. Some schematic capture programs permit you to set the size of the grid, while others use a fixed grid. And while most programs let you turn the grid snap off, the software may refuse to recognize two wires as being connected in this mode, even though they appear to be properly aligned.

All schematic capture programs have the ability to change the orientation of a component when placing it on the screen. Some programs do this

through component rotation, while others store the different orientations in the component library. OrCAD's editor, for example, allows you to rotate a part a full 360 degrees in 90-degree increments, plus generate mirror images of the object in any orientation. Schema, on the other hand, stores different orientations under separate component names in the component library.

Most schematic capture programs support ANSI/IEEE symbols. Some also feature DeMorgan logic symbols; a few support the new IEEE/Texas Instruments symbols (Fig. 2). DeMorgan logic differs from ANSI logic only in the way input logic relates to. ANSI inputs are true when they are positive, whereas DeMorgan inputs are true when inputs are negative. Although an ANSI 74LS02 behaves just like a DeMorgan 74LS02, use of DeMorgan logic can give the designer insight that may ultimately result in a simpler circuit. Some programs let you toggle between ANSI and DeMorgan from the screen, while others store the symbols in the component library under separate names.

After components are placed on the page, they are interconnected using lines to represent conductors. Most schematic programs also support buses (cables that contain several conductors) that are drawn as heavier lines. Almost without exception, conductors drawn on a schematic run strictly horizontally and vertically. If you try to take a diagonal path, the drawing editor automatically converts it to one direction or the other. In the parlance of CAD, these perpendicular lines are called "ortho" lines (short for orthographic). Diagonal lines can be drawn when ortho mode is disabled, but the practice is not recommended because conductors may be tricky to connect.

Since schematic capture programs are designed to imitate hand-drawn schematics, several other parameters are permanently fixed. For example, sizes of components are usually pre-

defined, as they would be if drawn on paper using a template. The size of the sheet is also limited to the standard drafting sizes, which range from size A (8½ by 11 inches) up to size E (34 by 44 inches). Standard drafting borders and title blocks are usually—but not always—included.

For schematics that are too large for a single sheet, the drawings can be stacked in hierarchical fashion. Some programs also support a linked hierarchy that lets you draw the circuit as a block diagram on a cover sheet. Each block is then drawn in detail, using a stack of sheets that define the circuits within the block. While each block has its own independent stack of drawings, they are linked together so that you can move from one block to another, without having to change files. All the sheets are listed under a single file name.

Zoom (scaling or magnifying image elements) is provided so that you can view the worksheet for composition, but it is difficult to edit at this magnification. For most work, you have to use the normal zoom mode, which shows only a portion of the schematic. Many programs have autopanning that automatically moves the worksheet up, down or

sideways as you move the cursor beyond the borders of the present screen, but a few require manual scrolling of the screen.

Editing Features

While it is nice to have a software program that takes the drudgery out of drawing schematics, the real advantage of a schematic capture program is its ability to modify the circuit from the screen.

As hand-drafted schematics take so long to create and tend to accumulate new errors with each revision, they are usually redrawn only when the number of design changes exceed a certain percentage or after the design is finalized. Schematic capture programs eliminate both problems by allowing you to make the changes on the screen as they become necessary. Several schematic editing tools are used for this task.

Delete and repeat are probably used most. When using delete, you are generally required to specify and verify the device or line to be deleted to avoid removing something by accident. Repeat and delete are often used together so that you can delete a number of lines without having to go

through the menu for each line or device to be deleted. If you make an error in deleting something, it can usually be restored using an undo command. Some undo commands restore only the last deleted object, while others remember the deletion path you used and can undo your changes all the way back to square one.

Moving components is another popular editing recreation. Components are moved for a number of reasons, but usually because connections to other components change. When a component is moved on the screen, you can retain all its original connections using an editing feature called "rubberbanding." As the name implies, rubberbanding is a technique in which the conductors that connect two components stretch to accommodate the new position of a device, as illustrated in Fig. 3.

However, rubberband lines are not ortho, which means you have to reroute them using a clean-up editor that puts the skewed lines back into ortho perspective. Some programs do this automatically, while others are manually driven. Either way, though, you may still have to go into the schematic and manually delete

(Continued on page 71)

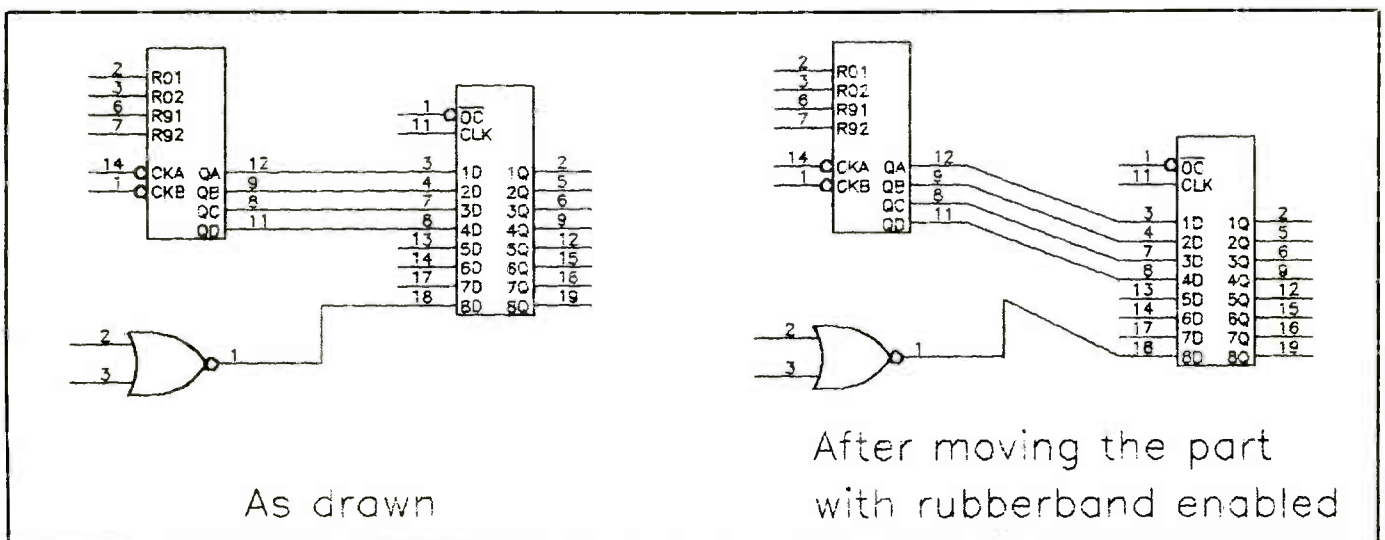

Fig. 3. Results of moving a component with rubberband enabled.

Circuit Breadboarding With Imaginary Parts

How software can put an electronics lab into your IBM PC, PS/2 or compatible computer to eliminate the need for actual components, test instruments, etc.

By Art Salsberg

You don't necessarily need a workbench brimming with test instruments, electronic components, solder equipment, power supplies, etc., to create working circuits. There are computer programs that allow you to do this right on the video display monitor of a personal computer, observing "live" circuits you create.

One such program we examined recently is called *Electronics Workbench* and subtitled, "The electronics lab in a computer." It's a four-disk (5¼-inch, 360K) package that comes with a three-ring-binder user manual.

The program runs on an IBM PC/XT/AT or PS/2 or compatible with at least 512K of RAM, a mouse (Microsoft, Logitech or IBM PS/2), MS/PC-DOS 2.1 or later and Hercules/CGA/EGA/VGA graphics. There are also versions for the Macintosh Plus, SE, SE30 and Mac II. *EWB* can be used with a variety of drive configurations: dual 360K floppy disk drives, one 1.2M high-density floppy, one 1.44M 3½-inch diskette, or a hard-disk drive.

Electronics Workbench (Version 1.5) was developed by Interactive Image Technologies Ltd., Toronto, Canada (Tel.: 416-361-0333) for use in educational institutions' study courses up to lower university level,

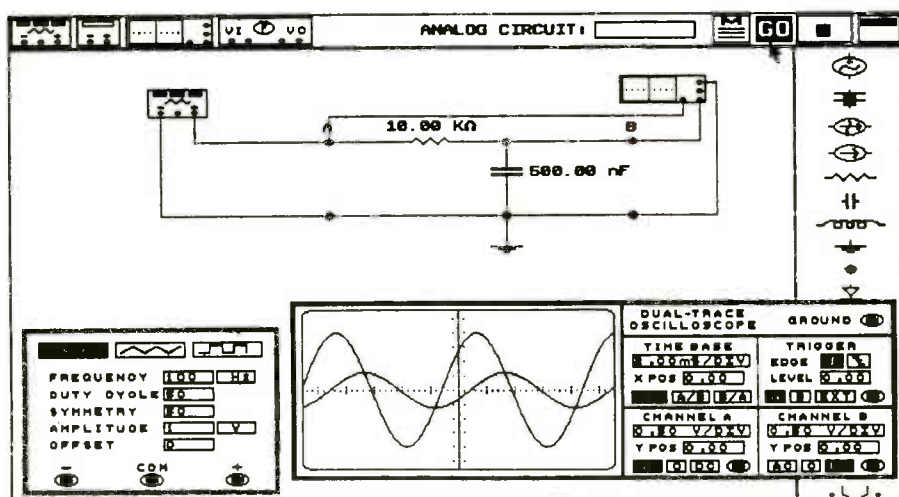

Example of an analog circuit with signal generator and oscilloscope selected. Parts Bin selections are shown in window at right.

and for job training and self-instruction. The full program costs \$650, while an evaluation disk, in IBM or MAC format, costs \$10.

An Interactive Learning Tool

EWB does not present electronics lessons. Instead, it permits the user to approach electronic circuit design, both analog and digital, in a free-wheeling manner. Therefore, it is a complimentary tool to textbooks, laboratory manuals and home-study courses. Electronics instructors among our readers can, of course, create interactive lessons.

The Help program can be customized, too, by using a text editor with

plain ASCII files. There's an extensive Help file already built in that can be activated at any time by pointing to an object and pressing Function key F1 or, if not pointing, a table of contents window that provides Help information.

Whether choosing the analog or digital module (both can be in the same file), the program appears on screen with a group of test-instrument icons at the top-left of the display; this is part of your work bench "Shelf." Also on the Shelf, at the top-right, are Program controls, such as pull-down menu and scrolling buttons. A narrow vertical section along the right side of the screen is called the "Parts Bin." Electronic

component symbols are lined up here. The large central area that's left over is your work space. Here's where you'll breadboard your circuit and position test instruments.

What the user will be doing with the program is "building" a circuit by using the mouse to select components and power, choose parts values and labels, wire connection points and select instruments to apply signals and measure the results. He can save the electronic schematic he develops to disk and print it (a deep variety of printer drivers is included), while automatically creating and printing a Parts List.

Circuits can be combined into a macro block to essentially form an integrated circuit. You can move drawings, rotate them, magnify sections (zoom), label them, cut parts out of the circuit, save them, etc.

A key element of *EWB* is its array of simulated electronic test instruments. These include a multimeter, bit-pattern word generator, dual-trace oscilloscope, logic analyzer, truth table/symbolic converter, function generator and Bode graphics plotter.

Setting instrument controls and viewing results are simplified by reproducing a large replica of the face of the instrument in a window that's opened by the user. Controls mimic those on real instruments, with buttons and spin selectors that emulate dials and rotary switches. For the dual-channel scope, settings include timebase, trigger edge and level, and vertical sensitivity, among others. For analog simulation, a Preferences dialog box (F10) permits you to derive great scope control, such as choosing time-domain analysis, precision, points per cycle and grid size.

Time Base allows values from 0.1 nanosecond to 0.5 second per horizontal division to be chosen, as an example of the wide range provided by the program's test gear. Underscoring the quality of these simulated instruments, the Bode plotter has mov-

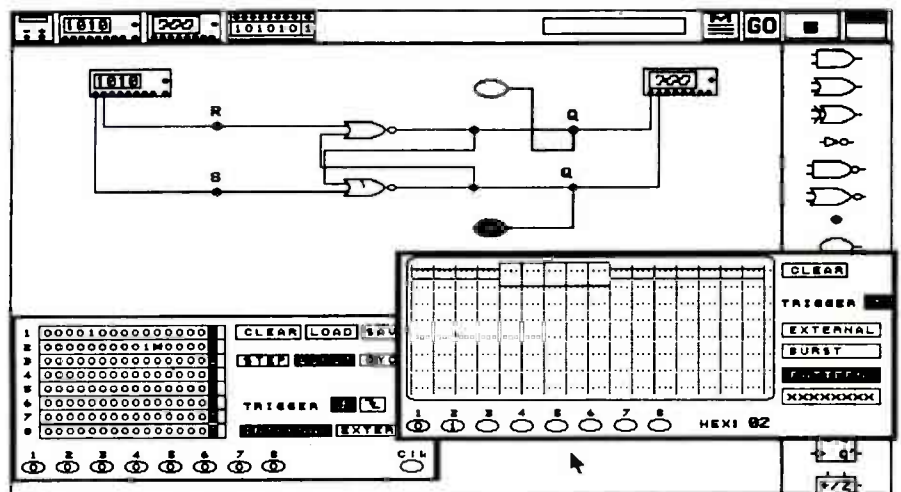

Example of a digital circuit with pulse generator and frequency counter selected. Parts Bin selections are shown in window at right.

able crosshairs to provide direct readout of frequency and amplitude at any display point. The Function Generator's frequency (sine, square and triangular waveforms are available) ranges from 1 Hz to 999 kHz, with selectable duty cycle from 1 to 99 percent. The automatic Truth Table converts logic circuits among logic gates, truth table and Boolean expressions. Moreover, the last is performed by the more sophisticated Quine-McCluskey method, instead of the limited Karnaugh mapping technique.

Digital and analog modules use different parts-bin components and instruments, of course. The digital module provides TTL voltage (+5 volts), AND, OR, XOR, NOT, NAND, NOR gates, RS/JK/D flip-flops, a half-adder, ground and connectors. Displays here include an LED probe and a seven-segment numeric display.

In comparison, the analog module's bin of parts includes resistor, capacitor, inductor, transformer, npn and pnp transistor, diode, zener diode, op amp, battery, ground, voltage and current ac sources, LED, connector point, etc.

Unlike one's typical box of parts, there is a limitless supply of any com-

ponent in the Parts Bin, whether analog or digital, for the user to employ. Passive analog components do not have default values. The user must apply values to such components through use of dialog boxes, which can be activated by pressing F6. Components can be given names, too, such as R1, C3, etc.

In-Use Comments

The entire program was loaded onto the 40M hard disk of a 386SX-based computer that has a plain-vanilla VGA card. A Mitsubishi VGA 1429C (28-mm dot) color monitor and Logitech Trackball mouse were used. With the program all in one file (C:\EBA), I typed `ewba -s <pathname>` per the manual's optional command-line suggestion and pressed ENTER. (The pathname actually typed was `\EWB`, which was my filename for the entire program.) The screen quickly came alive with the program's logo, *et al.* Loading from dual 360K floppies takes much more time, naturally, which is the reason that more and more people have turned to hard-disk drives.

Barely moving the trackball on my mouse, which loaded automatically through a batch file, changed the dis-

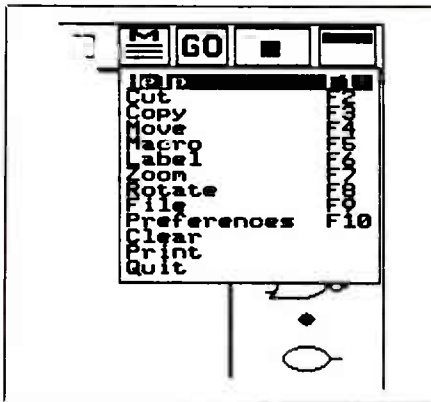

Command choices are made by clicking and holding on M in Command window.

play to the *Electronics Workbench* analog circuit screen. (If I had typed ewbd instead of ewba in the command line, the digital circuit module would have been activated.)

No setup at all was required. The program automatically uses the highest-resolution display available. One simply starts the program without any delay. When choosing Print, you have an opportunity to set the proper printer driver by clicking on the dialog box's Configuration. You can then scroll through some 150 dot-matrix and laser printer choices, choosing what you need.

The screen display appeared in white on black. The program is monochrome, I learned. However, one can choose color foregrounds and backgrounds by adding a few parameters to the command line. The colors red, green and blue can be varied for foreground, background and tracking, each having value choices of 0 to 3. Experimenting with the parameters, I set up for a medium blue background with bright white tracker and lines. I found it to be easier on the eyes than white on black.

Type fonts on the main menu are on the small side. Amplifying this shortcoming, word choices are set tightly, one above the other. Some space between them would have been helpful. One gets used to this, though, and the function keys noted in a right-hand column help matters.

The User Manual offers Analog and Digital tutorials, taking the newcomer through each step of the way to familiarize him with the workings of the program. I followed them, culminating in developing a circuit, saving it in a file and printing the schematic on a nine-pin dot-matrix printer and an H-P LaserJet printer. Reproduction quality on the dot-matrix printer wasn't too good, while the laser printer's output was satisfactory. Print speed was surprisingly good.

I also elected to have a Parts List automatically compiled and printed, which the program did. As in the main menu, more space between lines would be highly desirable in the Parts List.

The above criticisms aside, the main program worked just fine. You pick up a component, say, a resistor, by moving the mouse arrow to its symbol in the Parts Bin, which causes the icon to be highlighted. Then you press the first button on the mouse and hold it while you drag the icon by moving the mouse (in my case, rotating the trackball) to any location you want on the workspace area. Releasing the button plants the resistor at that location.

You can pick up and position any component in this manner. Wiring together components is also a simple matter. Just move the mouse pointer to the end of a component—you'll see a small highlighted box form at this point—hold down the first mouse button and move the arrow toward the other component.

You'll see a slightly jagged line or wire being pulled out of the component's terminal. This is called "rubber-banding." Continue this action while holding down the button until it touches the other component's terminal, which is also highlighted when contact is made. Then release the button. The wire will straighten out beautifully and find the best route automatically (auto routing). That is, you might drag a wire from one

component to another in a straight line that might cross some other object. When the button is released, though, the wire will automatically route itself to be nice and neat with 90-degree turns, etc.

Some components don't have terminals. In this case, you have to pick up a connector (a round dot) from the Parts Bin and attach it to the component or wire on the schematic to make a "solder joint" there. Connectors have four terminals, which highlight off-center when pointed to.

Components and instruments can be repositioned whenever you want to by touching the item with the mouse arrow (an object gets brighter whenever this is done to indicate it's ready for action of some kind), holding down the mouse's first button and dragging the object to another location. If you have a problem unkinking a wire that's drawn with square-wave-like bumps, one way to correct it is to move a component so that it lines up evenly with the other component to which it is connected. Another solution might be to use the program's rotate function.

Do the same to pick up and move an instrument from the top shelf to any location on the workspace. The instruments highlight, too, when touched by the mouse arrow. Each instrument has only one unit that can be used, unlike parts in the bin, which have an endless supply. Pointing to the instrument placed in the workspace and pressing function key F7 zooms (magnifies) another image of the instrument face that appears on the display's lower-left corner. You can drag the face anywhere you want after this by pointing and holding down the first mouse button.

Instrument settings can be made on the face of the model by either clicking on buttons or pressing the first button and moving the mouse to simulate moving a dial or switch. In the latter case, the numbers chosen change continuously until the value you want is reached.

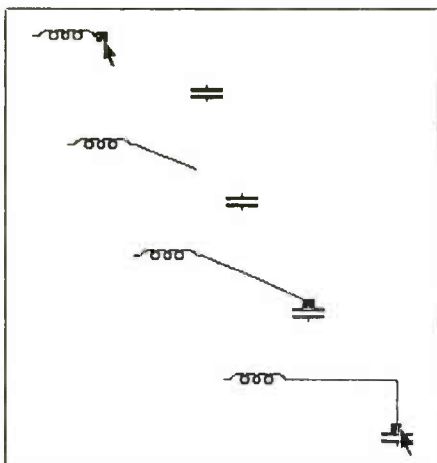

Component connections are made by drawing a line from one to the other. When done, program automatically squares off conductor line.

You'll have to take various other actions, such as labeling components with a name, such as C1, and a value, such as 100 pF. To do this, you touch the component with the mouse arrow and click the *last* button. You then move the mouse tracker to the Shelf area at the top-right of the screen so that it highlights the icon "M." Hold down the first button and a drop-down menu will appear. Still pressing the button, move the arrow down the menu's list. Each item in turn highlights. When you reach the action word you want, simply release the button and a window opens that displays a dialog box or a chosen action will occur.

In this case, you would release the button on the menu word, Label. A small box will appear that enables you to type in the value and/or name of the component you had clicked on previously with the last mouse button. Follow this by moving the tracker to "Accept" (or "Cancel" if you change your mind) and click the first button.

To make this value or name appear on the component in the schematic, pull down the menu again and choose "Preferences." A number of choices will be shown. You'll want to click on the "Yes" next to "Show Values"

and "Show Labels" to get them on the schematic. Doing this and clicking on "Accept," the window disappears and the name and value appear next to the component in the schematic. When you're through, move the arrow to an area not occupied by anything else and click the first button to deselect the component(s) you were working with.

When everything is set—you have your entire circuit made up and instrument controls set—you'll want to turn on the circuit and observe it in action. To do this, simply move the mouse arrow to the GO icon on the top-right row and click the first button. The simulation will then start. You might see a resulting action immediately or have to wait awhile, depending on values you chose and the complexity of the circuit.

In the case of the analog circuit tutorial I mentioned earlier, the dual-channel scope quickly displayed the formation of sine waves being drawn when I clicked on GO. According to the manual, it should have shown two sine waves, one smaller in amplitude than the other and a bit out-of-phase with it. My sine waves, however, did not emulate those shown in the manual. One was decidedly wrong. Checking the settings on the scope, I saw that one channel was set with an incorrect value. Changing this, the sine waves quickly replicated the ones shown in the manual.

When in the digital portion of the

(Continued on page 82)

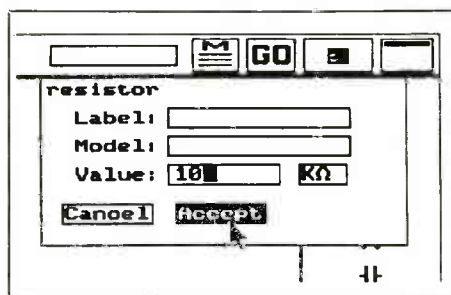

You can label components by type, value and model. Click on M, make selection and click on Accept.

Which symbol represents a variable inductor?

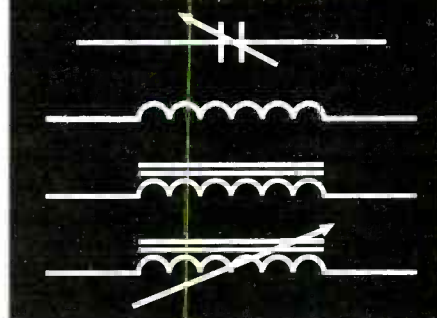

What is the principle disadvantage of neon lights?

What are out-of-phase signals?

Heath Video Courses speed your learning curve!

Learn basic electronics at home at your own pace with four, 60-minute video tapes. Know the variable inductor symbol. Recognize a PN junction. Understand oscillator fundamentals. Clearly SEE what most basic electronic books can only describe.

DC ELECTRONICS. Covers electron movement to troubleshooting and repairing a simple electronic circuit. **EV-3101-A.**

AC ELECTRONICS. Follow-up to DC Electronics. Covers the principles of AC, voltage and electrical measurement. Includes motors, generators and test instrument meter movements. **EV-3102-A.**

SEMICONDUCTORS. Complete the DC/AC videos and you're ready to learn how semiconductor devices are made, plus the principles of discrete devices, integrated circuits & optoelectronic devices. **EV-3103-A.**

ELECTRONIC CIRCUITS. Complete the basic course with amplifier configurations, biasing, coupling, audio amplifiers, closed-loop vs. open-loop operation and more. **EV-3104-A.**

An activity-filled workbook and explanation of how to solve each problem comes with each tape so you learn three ways — video, workbook and hands-on!

Order today!
Call Toll free,
24-hours a day.
1-800-253-0570.

We accept VISA,
MasterCard, American
Express and Heath Revolving
Charge card. Use Order Code 601-045

VIDEO TAPES
\$39.95
EACH

Heath®

Benton Harbor, MI

Call for a FREE catalog 1-800-44HEATH.

*Price does not include shipping and handling, or applicable sales tax. ©1990, Heath Company Subsidiary of Bull Data Systems, Inc.

CIRCLE NO. 110 ON FREE INFORMATION CARD

The Breath-O-Meter

This sophisticated solid-state device tests blood alcohol concentration to warn against driving while intoxicated



By Anthony J. Caristi

Blood alcohol concentration, or BAC, is a measure of the amount of ethyl alcohol in the blood and is usually specified as a percentage. This measurement is a reliable indication of the impairment of human senses due to ingesting alcoholic beverages. Therefore, law-enforcement agencies are permitted to use it to determine whether or not a person is legally drunk while driving a motor vehicle and results from it are admissible in court. An example of such a device for your personal use is the Breath-O-Meter project described here.

Our Breath-O-Meter uses a sensor that responds to minute quantities of alcohol in the breath of anyone who has had even one drink within an hour or so of using the project. LEDs give visual indication if BAC exceeds 0.02, 0.05 and 0.1 percent. (Many states set the legal definition of inebriation at 0.1-percent BAC. Even so, at just 0.02 percent, impairment can be great enough that no one whose BAC is at this level should get behind the wheel of a vehicle.) The project is easily and accurately calibrated using a technique similar to that employed on law-enforcement breath analyzers.

When using the Breath-O-Meter, keep in mind that the amount of alcohol any individual consumes in a given period of time before significant impairment occurs varies from person to person. Therefore, it can sometimes be difficult to know when too much alcohol has been consumed by any given individual. The bottom line, though, is that after taking just one or two drinks, reaction time and other senses can be affected enough to adversely affect the ability to drive or to operate any kind of machinery.

About the Circuit

The complete schematic diagram of the Breath-O-Meter circuitry is shown in Fig. 1. The heart of the circuit is organic vapor sensor *DET1*. This TGS822 device responds to minute quantities of alcohol present in the air. It consists of a tin-dioxide element formed on a ceramic tube upon which two gold electrodes are printed. A heater coil inside the tube raises the temperature of the assembly to a predetermined level.

The resistance between the two electrodes of the sensor between pins 1 and 4 or pins 3 and 6 varies inversely with the concentration of alcohol or

other organic vapor in the air that enters the sensor chamber. When no vapor is present, sensor resistance is high, averaging about 60,000 ohms. When alcohol vapor is detected, sensor resistance decreases in accordance with the concentration of vapor. By connecting the sensor electrodes in series with *R1* and driving the circuit from a dc source, the change in voltage across *R1* can be used as a measure of alcohol concentration in the breath sample.

Sensor resistance typically changes linearly from about 60,000 to 1,000 ohms for alcohol vapor concentrations ranging from 50 to 5,000 parts per million (ppm). The sensor also responds to other organic compounds.

To provide the portability a breath analyzer warrants, the project is powered by a Ni-Cd or alkaline battery made up of six cells. Since the terminal voltage of battery *B1* decreases with use, circuit accuracy and stability could suffer. To guard against this, fixed 5-volt regulator *IC1* maintains a constant voltage on the circuitry until battery potential falls too low to sustain regulation.

When an alcohol-laden breath sample enters *DET1*, the potential across *R1* will vary from less than 1

PARTS LIST

Semiconductors

D1, D2, D3—1N4148 or similar diode

IC1—LM7805CT fixed +5-volt regulator

IC2—LM339N quad comparator

LED1—Green light-emitting diode (2 volts at 20 mA)

LED2, LED3, LED4—Red light-emitting diode (2 volts at 20 mA)

Capacitors

C1—10- μ F, 25 volt electrolytic

C2, C3, C4—0.1- μ F, 50-volt ceramic disc

Resistors

R1—5,110-ohm, 1% tolerance metal-film

R2—41,200-ohm, 1% tolerance metal-film

R3, R5, R8, R11—10,000-ohm, 1% tolerance metal-film

R4, R14, R15, R16—220-ohm, $\frac{1}{4}$ -watt carbon

R7, R10—475,000-ohm, 1% tolerance metal-film resistor

R13—221,000-ohm, 1% tolerance metal-film

R17, R18—1 megohm $\frac{1}{4}$ -watt carbon

R6, R9, R12—1-megohm pc-mount cermet trimmer potentiometer

Miscellaneous

B1—7.2-volt Ni-Cd or 9-volt alkaline battery (see text)

DET1—Figaro TGS822 sensor

F1— $\frac{1}{4}$ -ampere fuse

S1—Spst toggle or slide switch

Printed-circuit board or perforated board with holes on 0.1" centers and suitable Wire Wrap or soldering hardware; suitable enclosure; seven-pin miniature tube socket; battery holder or clamps (see text); fuse holder; socket for IC2; lettering kit and clear spray acrylic; transfer jack (see text); small-diameter heat-shrinkable tubing; materials for calibration (see text); spacers; wire; solder; etc.

Note: The following items are available from A. Caristi, 69 White Pond Rd., Waldwick, NJ 07463: ready-to-wire pc board, \$11.95; Figaro TGS822 sensor, \$27; LM7805CT, \$1.95; LM339N, \$1.95; set of nine metal-film resistors, \$4.95. Add \$2.50 P&H per order. New Jersey residents, add state sales tax.

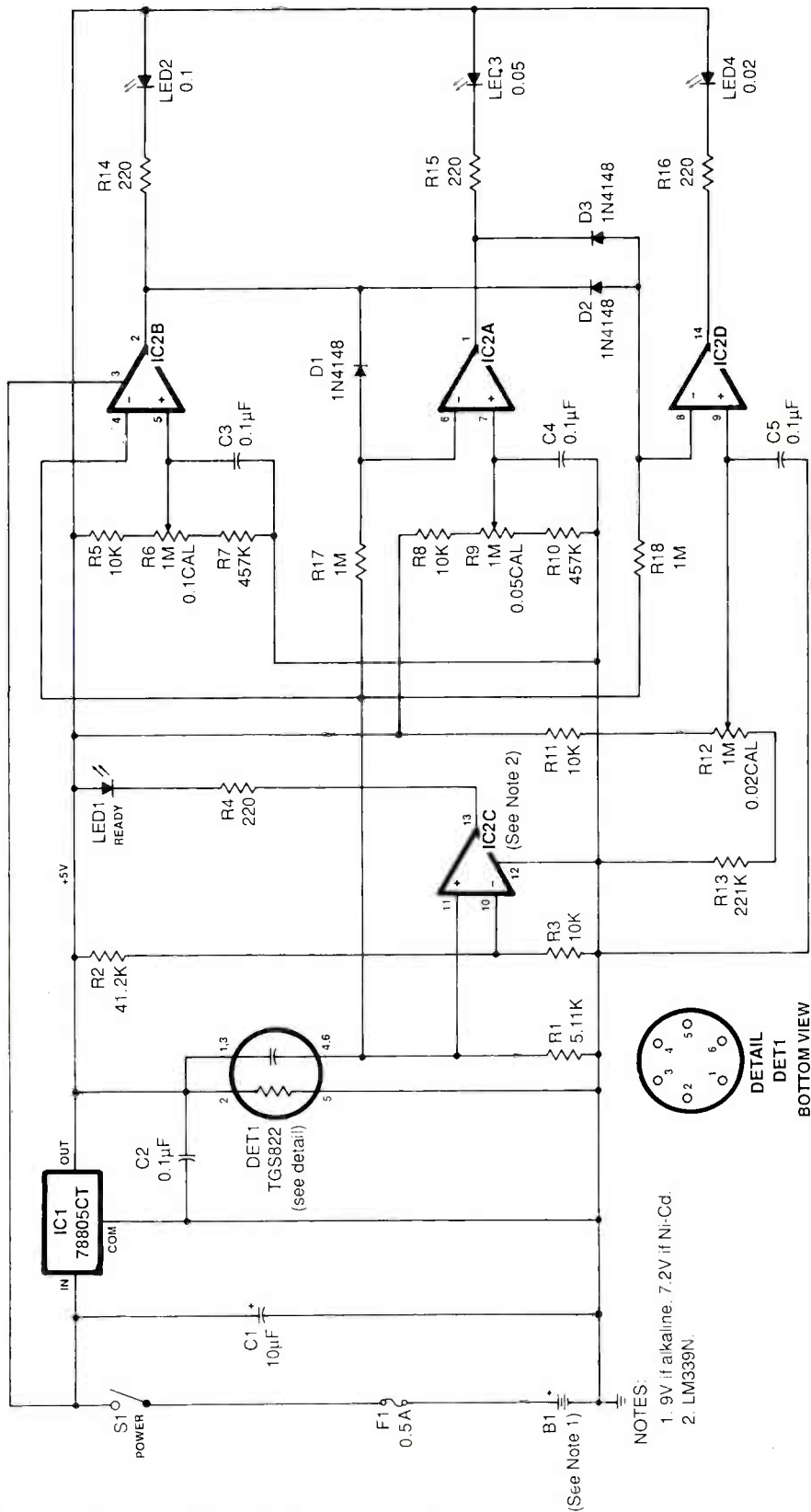

Fig. 1. Complete schematic diagram of Breath-O-Meter circuitry.

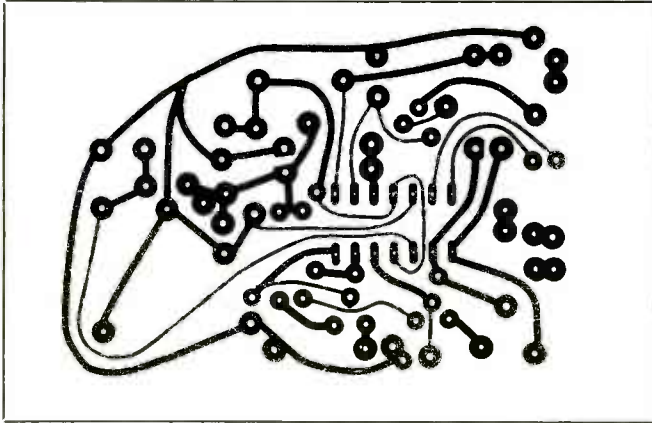

Fig. 2. Actual-size etching-and-drilling guide for fabricating printed-circuit board.

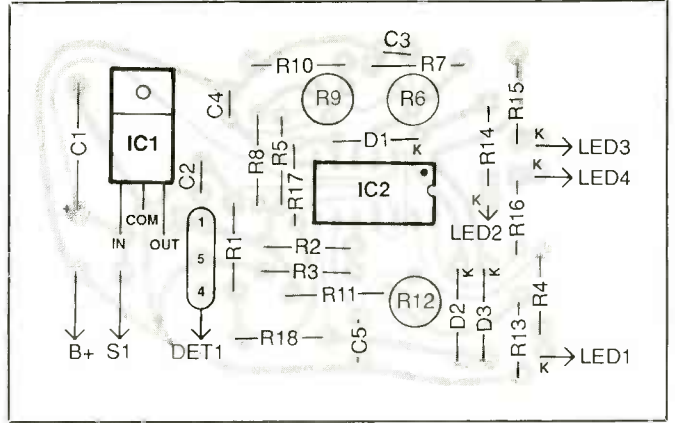

Fig. 3. Wiring guide for pc board. Use this as a layout guide if you point-to-point wire the circuit.

volt at standby to 4 volts or greater, depending on the concentration of alcohol in the sample. Additionally, the sensor always requires a warm-up period that depends on the elapsed time since the project was last operated. When powered up, sensor resistance drops sharply, whether or not alcohol vapor is present. This resistance increases until it reaches a stable value, at which time the Breath-O-Meter is ready for use.

Voltage comparator *IC2C* is used to provide a drive signal for visual indication when the circuit has stabilized after the project is first turned on and after a breath test has been made. Visual indication is provided by READY light-emitting diode *LED1*.

A fixed reference voltage of about 1 volt is applied to the noninverting (+) input at pin 10 of *IC2C*. When the potential across *R1* exceeds the 1-volt level, output pin 13 goes high and cuts off *LED1*. As the sensor reaches equilibrium, the potential across *R1* decreases. When it falls below 1 volt, pin 13 of *IC2C* goes to 0 volt. This turns on *LED1* to provide visual indication that the circuit is ready to take a breath measurement.

The three remaining stages in *IC2* are also used as voltage comparators. Each has a reference voltage fed to the noninverting input through calibrating potentiometers *R6* for *IC2B*,

R9 for *IC2A* and *R12* for *IC2D*. The reference voltages are set to levels that represent 0.1-, 0.05- and 0.02-percent BAC, respectively, as detected by the sensor.

Sensor output voltage developed across *R1* is fed to the negative inputs of each comparator. If this voltage exceeds the calibration voltage when the sensor is exposed to a breath sample, the comparator output is driven to 0 volt and, in turn, energizes the associated LED.

To obviate ambiguity when the BAC is great enough to turn on more than one LED, diodes *D1*, *D2* and *D3* are used to prevent turn-on of more than one LED at a time. This is accomplished by using the output of *IC2B* or *IC2A* to pull the appropriate inverting (-) input of *IC2A* and/or *IC2D* to almost 0 volt. This negates the comparator function and, as a result, the lower level BAC LED is extinguished when a higher indication is required.

Construction

Most of the circuitry of Breath-O-Meter can be mounted on a printed-circuit board. You can fabricate this board yourself using the actual-size etching-and-drilling guide shown in Fig. 2 or purchase it ready for populating from the source given in the

Note at the end of the Parts List. Alternatively, you can mount the components on a perforated board that has holes on 0.1-inch centers using suitable Wire Wrap or soldering hardware. Whichever way you go, though, be sure to use sockets for the DIP ICs.

From here on, we will assume you are using a pc board. Referring to Fig. 3, install and solder into place the IC sockets. Do *not* plug the ICs into the sockets until after you have done voltage checks and are certain that the board is properly wired.

Continue populating the board by installing and soldering into place the resistors and diodes. Make sure you properly orient the latter before soldering their leads to the copper pads on the bottom of the board. Next, install and solder into place the capacitors, making sure the electrolytics are properly polarized before soldering their leads into place. Then install and solder into place the trimmer controls and voltage regulator *IC1*. Again, be sure *IC1* is properly based before soldering it into place.

Strip ¼ inch of insulation from both ends of twelve 6-inch-long hookup wires. If possible, use color-coded wires for the LEDs and power input. If you are using stranded wire, tightly twist together the fine conductors at all ends and sparingly tin with

solder. Plug one end of these wires into the LED holes, red-insulated to anode (not labeled) and black-insulated to cathode (K), and solder into place. Do the same for the sensor and power-lead wires. Slide a 1-inch length of heat-shrinkable tubing over the ends of the LED wires.

Identify the cathode lead of *LED1* and clip it to 1/2 inch. Form a small hook in the end of the stub. Crimp and solder the free end of the black-insulated *LED1* wire. Repeat the process for the anode lead and red-insulated wire for *LED1*. Slide the tubing up over the connections until it is flush with the bottom of the LED case and shrink into place. Repeat the entire procedure for the remaining LEDs and wire ends. Temporarily set aside the circuit board.

You can use any size and shape enclosure that will accommodate the circuit-board assembly and battery. A typical example is shown in the lead photo. Machine the enclosure as needed. That is, drill mounting holes for the battery holder, fuse holder, circuit-board assembly, POWER switch and LEDs in suitable locations. Then drill the mounting hole for the socket into which the sensor will mount. If you do not have a large enough drill bit to make the appropriate-size hole, use a tapered reamer to enlarge a smaller hole. Also, if you plan on using Ni-Cd cells to supply power to the project, drill a mounting hole for a jack to permit recharging the cells.

When you are done machining the enclosure, deburr all holes drilled through metal to remove sharp edges. Clean the enclosure with mild detergent and allow to completely dry. Then use a dry-transfer lettering kit to label the positions of the POWER switch and LEDs. Protect the legends with two or more light coats of clear acrylic spray. Allow each coat to dry before spraying on the next.

Mount the battery holder into place on the floor of the enclosure with suitable machine hardware if

you are using alkaline cells. If you are using Ni-Cd cells, secure these in place with double-sided foam tape and suitable clamps. When you are done, solder short lengths of solid hookup wire between the Ni-Cd cells to form a series string. Insulate each connection of this string with silicone adhesive to obviate any possibility of a short circuit. Even partially discharged cells can deliver enough current to damage printed wiring and burn flesh!

Next, mount the fuse holder and POWER switches in their respective locations. Mount the circuit-board assembly into place with 1/2-inch spacers and machine hardware. Crimp and solder the free end of the TO S1 wire coming from the board to one lug of *S1*. Then use a suitable length of hookup wire to bridge from the remaining lug of *S1* to one lug of the fuse holder.

If you are using alkaline cells as a power source, crimp and solder a length of hookup wire from the other lug of the fuse holder to the positive (+) lug of the battery holder. Then crimp and solder the free end of the B1- wire coming from the circuit-board assembly to the negative (-) lug of the battery holder.

Use of Ni-Cd cells requires wiring to a transfer jack to permit recharging the cells without having to remove them from the project. Therefore, wire from the other lug of the fuse holder to the transfer lug of the jack. Use another length of wire to bridge from the tip lug of the transfer jack to the + contact of the battery arrangement. Solder one end of a suitable length of hookup wire to the - contact of the battery arrangement and crimp the other end to the ground lug of the transfer jack. Also crimp the free end of the B1- wire coming from the circuit-board assembly to this lug and solder the dual connection.

Wiring details for the transfer jack are shown in Fig. 4. Note that the + end of the Ni-Cd string must go to the

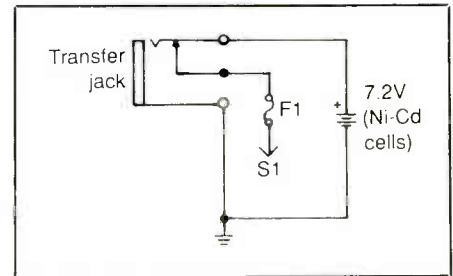

Fig. 4. Wiring details for transfer jack to be used for recharging Ni-Cd cells, if used to power project.

upper standard tip lug of the jack, the connection to *F1* to the center transfer lug. Do not transpose these connections. Otherwise, when the recharger is plugged into the jack, power will be applied to the circuit and not the battery.

Now mount the socket for the sensor in its location and terminate the free ends of the SENSOR wires coming from the circuit-board assembly at the appropriate lugs of the socket. Refer back to Fig. 1 for pinout details for the sensor and socket. Lug 4 of the socket is not used. Lugs 4, 5 and 6 of the sensor must connect to pins 5, 6 and 7, respectively, of the socket.

Initial Checkout

Place a 1/2-ampere fuse in the holder in the project and alkaline cells in the battery holder. If you are using Ni-Cd cells to supply power, give them a full charge before proceeding. (Note: Because current drawn by the circuit is almost 200 milliamperes, best results will be obtained when using D-size alkaline or Ni-Cd cells. C-size cells can be used if you wish to keep project dimensions small, but the smaller-size cells will require more frequent replacement or recharging. A fresh set of alkaline D cells provide about 13 hours of use, while C cells last about 4 hours. Since the Breath-O-Meter will probably be used only a few minutes at a time, battery life should be reasonably long, even with the smaller C-size cells.)

Make sure *IC2* and the sensor are not plugged into their sockets. Clip the common lead of a dc voltmeter or multimeter set to the dc-volts function to the - lug of the power source. Set *S1* to "on," and touch the "hot" probe of the meter to pins 1, 2 and 3 of the sensor socket and note if you obtain a reading of approximately +5 volts. Then touch the "hot" probe to pin 3 of the *IC2* socket and note if you obtain a reading of approximately +9 volts if you are using alkaline cells or +7.2 volts if you are using Ni-Cd cells.

If you fail to obtain the proper reading at the sensor socket pins, touch the "hot" probe to the OUT pin of *IC1*. If you fail to obtain a +5-volt reading here, the regulator is bad or not sufficient voltage is reaching its input from the battery.

Assuming the wiring from the battery through the fuse and POWER switch is okay, failure to obtain a +9- or +7.2-volt reading at the IN pin of *IC1* or pin 3 of the *IC2* socket indicates that the alkaline cells must be replaced or the Ni-Cd cells must be recharged. Regardless of its cause, correct any problem before proceeding with calibration.

Calibration

Set the trimmer controls *R6*, *R9* and *R12* to about mid-rotation and set *S1* to "on." Measure the voltage between pins 1, 2 and 3 of the sensor socket and circuit common (battery negative terminal). Normal indication is between 4.75 to 5.25 volts. Now set *S1* to "off" and plug the sensor and *IC2* into their sockets.

Because the sensor is bidirectional, you can plug it into its socket in either of two orientations. The IC, however, must be plugged into its socket in only the proper orientation. Make sure that no pins overhang the socket or fold under between IC and socket.

Apply power to the circuit. Immediately upon power-up, *LED1* should light momentarily and then

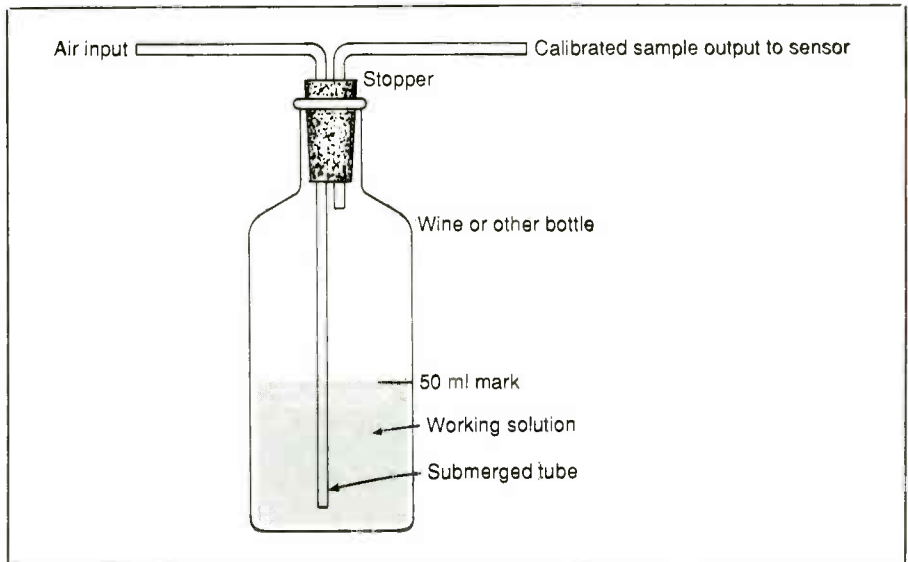

Fig. 5. Details of arrangement to use to calibrate Breath-O-Meter.

extinguish as the sensor initializes. During this time the other LEDs may or may not light. When the sensor is energized for the first time, it may require several minutes before the green LED comes on again.

Connect your voltmeter across *R1*. When the circuit is first powered, the potential across *R1* will slowly increase to some level less than 5 volts. It will then decrease to less than 1 volt. At this time, *LED1* should be lit because the output of *IC2C* is zero.

Adjust *R12* so the the potential at pin 9 of *IC2* is about 1.5 volts, measured with respect to circuit ground. Similarly, adjust *R9* and *R6* so that the potentials at pins 7 and 5 of *IC2* are about 2.0 and 2.5 volts, respectively.

Check circuit operation by exposing the sensor to the open end of a bottle of ordinary rubbing alcohol. Make absolutely certain, however, to prevent any of the liquid alcohol from getting on the sensor element. When you do this, *LED1* should turn off and the remaining LEDs should turn on, one at a time in rapid sequence as the potential across *R1* increases to beyond 2.5 volts.

When the alcohol fumes are removed from the vicinity of the sen-

sor, the potential across *R1* should decrease to less than 1 volt as the LEDs turn on in reverse order. Finally, *LED1* should be on and all other LEDs should be off.

If the project operates as just described, proceed to actual calibration. Otherwise, power down and correct any problem, especially the orientations of the ICs and polarizations of the LEDs, diodes and electrolytic capacitors. If all appears to be okay here, check the voltages at each comparator input to ascertain that they are correct.

The principle of measuring blood alcohol concentration is based on a discovery in 1803 by British chemist William Henry. He stated that there is a fixed ratio between the concentration of a volatile compound, such as alcohol, in water and its concentration in air. This ratio is constant for a given temperature and atmospheric pressure. This physical law applies to the concentration of alcohol in the blood and its counterpart, the exhaled breath. Henry's law provides the means by which the Breath-O-Meter can be calibrated to a reasonable accuracy.

Calibration of the Breath-O-Meter is accomplished in three discrete

steps by simulating human breath with BACs of 0.02, 0.05 and 0.1 percent and feeding the air sample to the sensor. This is accomplished using a few readily obtainable materials.

Figure 5 illustrates the calibration apparatus to be used. It consists of an ordinary wine or similar glass bottle, a length of plastic tubing and a cork or rubber stopper drilled for a tight fit for two hoses. An accurate thermometer is required to measure the temperature of the solution.

Using the Fig. 5 arrangement, three separate calibrations are to be performed. Each requires a properly prepared solution for 0.02-, 0.05- and 0.1-percent BAC.

In accordance with Henry's law, simulation of human breath can be accomplished by pumping air through a solution of alcohol and water that has been warmed to 34°C (93.2°F), so that the alcohol-vapor/air mixture in the head space of the bottle is forced out a small tube at the top of the bottle. This air exhaust is representative of a breath sample.

In the Fig. 4 test arrangement, the air is forced out the top of the bottle by gently blowing into a plastic tube submerged into the solution. You make the calibrating solution in two steps. First, you make a "stock" and store it in a well stoppered bottle. From this, you make the calibration solutions by diluting it with water. After each calibrating step, you discard the diluted solution.

The calibration accuracy of the Breath-O-Meter is a function of the accuracy of the apparatus and procedure used. If possible, use a graduated beaker or cylinder, which can be obtained from laboratory supply houses, to aid in accurately measuring liquid quantities. Use the following procedure:

(1.) Prepare the stock solution by pouring about 50 milliliters (1.7 ounces) of water into a thoroughly washed graduated beaker or cylinder. Add to this 19.3 ml (0.65 oz.) of ordinary 80-proof vodka. Make sure

the label on the bottle states that the vodka is 80 proof. Add sufficient water to bring total liquid volume to 100 ml. Pour this solution in a clean, sealable bottle. Label it "stock solution."

(2.) Thoroughly wash and drain an ordinary wine or other similar glass bottle. Measure exactly 500 ml (16.9 ozs.) of water into the bottle and mark on the bottle the level the liquid has reached. Use this mark as a reference level as you make each working solution.

(3.) To make a working calibration solution, start with a thoroughly clean and drained marked bottle. Pour water to fill to about half the marked height. Then add 1 ml (0.034 oz.) of stock solution for each 0.01 percent of desired BAC. For example, for 0.02-percent calibration, use 2 ml of stock solution; for 0.05 percent, use 5 ml; and for 0.1 percent, BAC use 10 ml. Add enough water to bring the solution level to the 500-ml mark on the bottle. Insert the prepared stopper and hoses.

(4.) Every time you make a new calibrating solution, discard the old solution. Then repeat Step 3 above to make a new solution, using the proper amount of stock solution.

To calibrate the Breath-O-Meter, measure and record the voltage developed across *RI* as simulated breath samples are fed to the sensor. Once you obtain this data, adjust *R6*, *R9* and *RI2* to set the reference voltage fed to the positive inputs of the

comparators. Use the following procedure to accomplish this:

(1.) Connect your meter, set to measure about 5 volts dc, across *RI*. Apply power to the project and wait for the meter reading to drop to less than 1 volt. At this time, *LED1* should be on.

(2.) Prepare a working solution for 0.02-percent BAC, using 2 ml of stock solution. Make sure that the solution temperature is as close as possible to 34°C (93.2°F). One way to do this is to use water that is close to the correct temperature and set the bottle of working solution in a large container of water that has been warmed to slightly more than 34°C. By allowing at least a 30-minute soak time, as the temperature of the water bath falls to 34°C, the solution will reach the correct temperature.

(3.) Place the open end of the exhaust hose of the test apparatus close to the center of the sensor. After taking a deep breath, blow very gently but steadily into the open end of the submerged tube to force the head space air out of the bottle and into the sensor. A steady, uninterrupted stream of air of about 15 seconds duration is needed to obtain a peak voltage reading.

(4.) Monitor the meter during this procedure, and record the highest reading obtained with a steady flow of air. Normal indication is a peak reading in the 3-to-4-volt range.

(5.) Discard the 0.02-percent solution.
(Continued on page 75)

Drinking & Blood Alcohol Levels										
Body Wt.	Number of 0.5-Ounce Drinks of Pure Alcohol Per Hour									
	1	2	3	4	5	6	7	8	9	10
100	0.038	0.075	0.113	0.150	0.188	0.225	0.263	0.300	0.388	0.375
120	0.031	0.063	0.094	0.125	0.156	0.188	0.219	0.250	0.281	0.313
140	0.027	0.054	0.080	0.107	0.134	0.161	0.188	0.214	0.241	0.268
160	0.023	0.047	0.070	0.094	0.117	0.141	0.164	0.188	0.211	0.234
180	0.021	0.042	0.063	0.083	0.104	0.125	0.146	0.167	0.188	0.208
200	0.019	0.038	0.056	0.075	0.094	0.113	0.131	0.150	0.169	0.188
220	0.017	0.034	0.051	0.068	0.085	0.102	0.119	0.136	0.153	0.170
240	0.016	0.031	0.047	0.068	0.078	0.094	0.109	0.125	0.141	0.156

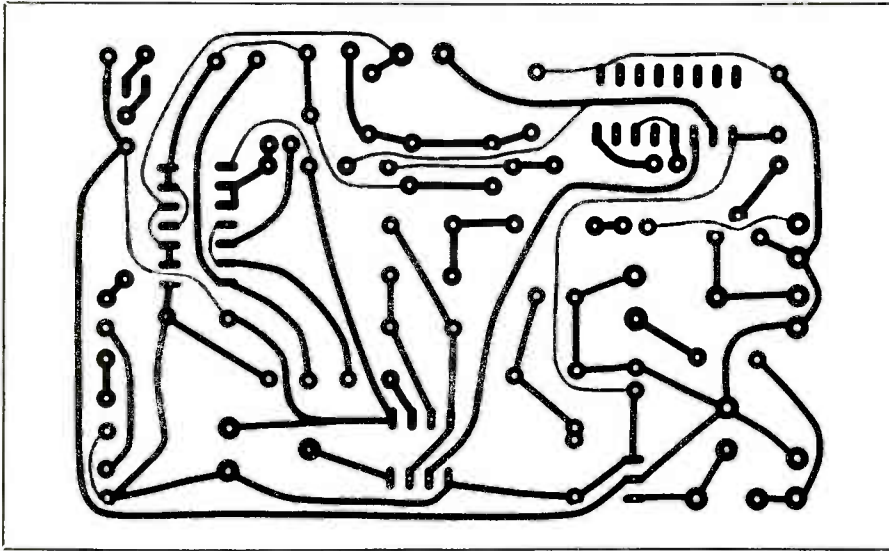

Fig. 3. Actual-size etching-and-drilling guide for project printed-circuit board.

the same for the *K* wire for *LED2* and the cathode lead of the green LED.

Next, trim the anode leads of the LEDs to 1/2 inch and repeat the entire operation for the anode (A) wires and anode leads of the LEDs. When the connections cool, slide the tubing up over them until it is flush with the bottoms of the LED cases and shrink into place. Temporarily set aside the circuit-board assembly.

You can use any type of enclosure that is large enough to accommodate the circuit-board assembly and power transformer and has sufficient panel space on which to mount the LEDs, switches and jacks. Drill mounting holes for the circuit-board assembly, power transformer and fuse holder and an entry hole for the ac line cord through the rear panel. Then drill mounting holes for the

jacks along the top of the front panel and for the switches and LEDs along the bottom of the front panel, arranging the layout as shown in the lead photo.

When you are done with the machining operation, deburr all holes drilled through metal to remove sharp edges. Line the hole for the ac cord with a rubber grommet.

Label the front panel as needed, using a dry-transfer lettering kit. Protect the legends with two or more light coats of clear spray acrylic. Allow each coat to dry before spraying on the next.

When the acrylic spray has completely dried, mount the switches in their respective locations. Reserve mounting the LEDs until after you have conducted preliminary tests and are satisfied that the circuit is operating properly.

Feed the unprepared end of the ac line cord through its grommet-lined hole into the enclosure. Tie a strain-relieving knot in it about 8 inches from the end inside the enclosure. Tightly twist together the fine wires in each conductor and sparingly tin with solder. Separate the conductors a distance of 5 inches and slip over the free end of each a 1-inch length of heat-shrinkable tubing.

Mount the power transformer in place with machine hardware. Then mount the fuse holder and power switch *S4* in their respective locations. Crimp and solder one conductor of the ac line cord to one lug of the switch. Similarly, crimp and solder one primary lead of the transformer to one lug of the fuse holder. Then bridge the free lugs of the switch and fuse holder with a length of hookup wire. Crimp and solder together the remaining ac line cord conductor and transformer primary lead. When the connections have cooled, slide the tubing over them to provide full insulation and shrink into place.

Plug the free ends of the transformer secondary leads into the holes labeled T1 in Fig. 5 and solder both

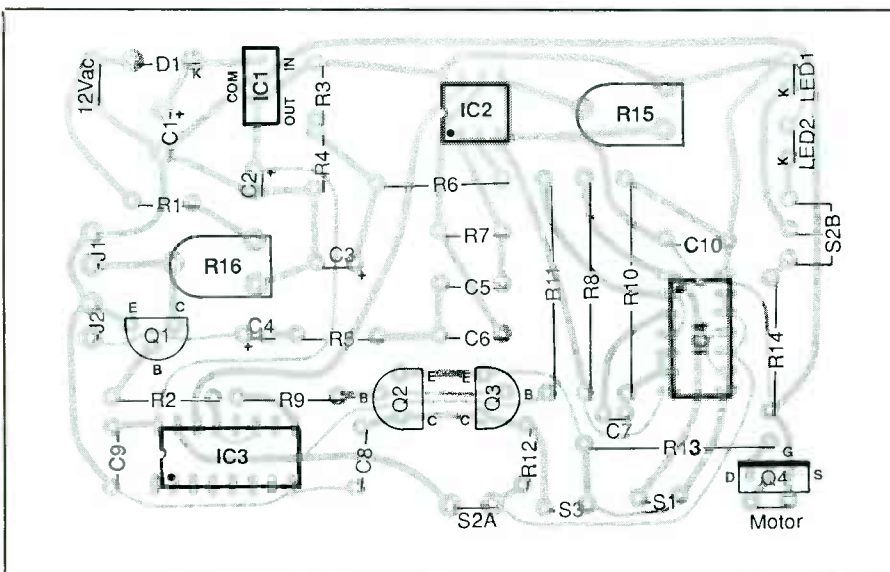

Fig. 4. Wiring guide for pc board. Use this as rough layout for components when using perforated-board assembly.

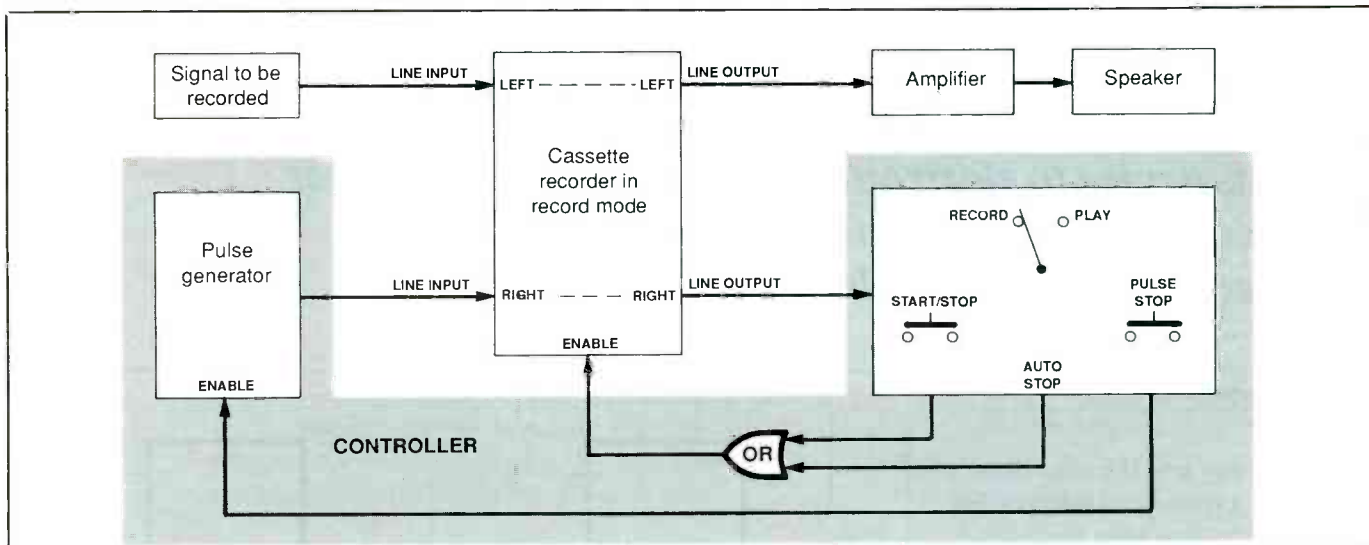

Fig. 5. Typical setup to use when recording sound effect onto a master tape using a signal source, recorder and Controller.

connections. Crimp and solder the free ends of the remaining wires coming from the circuit-board assembly to the lugs of the various switches and jacks, referring to both Fig. 1 and Fig. 5. Place the circuit-board assembly on an insulated surface and make sure it does not touch the enclosure if it is made of metal and plug a fuse into its holder.

Checkout

At this point, the only IC that should be on the circuit-board assembly is *IC1*. Clip the common lead of a dc voltmeter or multimeter set to the dc-volts function to circuit ground. Plug the line cord of the project into an ac outlet and set the POWER switch to "on." Turn on your meter, and use its "hot" probe to touch pin 8 of the *IC2* socket, pin 16 of the *IC3* socket and pin 14 of the *IC4* socket. In all cases, you should obtain a reading of +12 volts.

If you fail to obtain the proper reading at any specified location, power down the project and correct the problem. Do *not* proceed until you have done so.

When you are certain that the project has been properly wired and is

still powered, switch to the ac-volts function on your meter. While touching the "hot" probe of the meter to the wiper lug of *R16*, adjust this trimmer control for a reading of 0.75 volt rms. This done, power down the project and install the DIPs in their respective sockets. Make certain each is properly oriented and that no pins overhang the sockets or fold under between ICs and sockets. Also handle the ICs with the usual precautions required for MOS devices.

Set *S2* to RECORD and power up again. The red LED should light. The potential at pin 11 of *IC4* should be either 0 volt or 12 volts. Whichever it is, operating *S3* should make it toggle to the other condition and reverse each time you operate the switch. At this time, operating *S1* should have no effect on the state of pin 11 of *IC4*.

Setting *S2* to PLAY should cause the green LED to light. Pressing *S3* should still cause pin 11 of *IC4* to change and *S1* to have no effect.

If all tests confirm proper system operation, power down and mount the circuit-board assembly inside the enclosure, using 1/2-inch spacers and 4-40 machine hardware. Plug the domes of the LEDs into their respective holes. If they do not remain in

place by friction, use fast-setting epoxy cement or silicone adhesive to secure them. Then assemble the enclosure.

Open your cassette recorder and make the modifications detailed above. Locate a clear area on the cassette deck on which you can mount a phono jack and carefully drill a mounting hole for it. Mount the jack in place. Then use ordinary hookup wire for the connections that are to go from the motor back to the project. The line that will terminate at the collector of *Q4* in the Controller *must* go to the center contact of the jack. Use the ground lug of the jack to make the ground connections between the two units.

Use ordinary audio cable terminated at both ends in phono plugs to make the connections between the Controller and cassette recorder. This done, power up both project and recorder, place a blank cassette in the recorder and set the recorder up for recording in the pause mode.

Set the switch on the Controller to RECORD and operate *S3* to verify that it starts and stops the cassette recorder motor. Of course, you will not see the tape move because the recorder is in pause mode, but you should be

(Continued on page 72)

Electronic Spinner

Use this device to electronically determine the number of places to move on a board game and to select numbers for Win 3 or Win 4 Lotto

By Charles Shoemaker, D.Ed.

Many board games require a spinner or a throw of dice to determine the number of moves a player can make on his turn. In this article, we give details for building an Electronic Spinner that can be used in place of the mechanical ones found in such games. Additionally, our Spinner can be used to select numbers for playing Win 3 or Win 4 Lotto.

Our Electronic Spinner works in a manner similar to mechanical devices. However, instead of spinning a pointer on its spindle, you press and release a pushbutton switch. Internal circuitry then generates a series of pulses that are counted by a decade counter connected to a series of 10 numbered LEDs. The LEDs flash in sequence until the circuit times out, at which point only one LED remains lit. The LED that remains lit at the end of each time-out cycle will be different, due to the random nature of circuit operation, and tells the player how many moves to make.

About the Circuit

Shown in Fig. 1 is the complete schematic diagram of the circuitry used in the Electronic Spinner. In this circuit, closing *S1* applies power to the circuit. However, until SPIN switch *S2* is pressed and released, nothing happens. Operating *S2* causes two of the NAND gates inside *IC1*, configured as a low-speed clock oscillator, to generate a series of pulses at its output and couples them to input pin

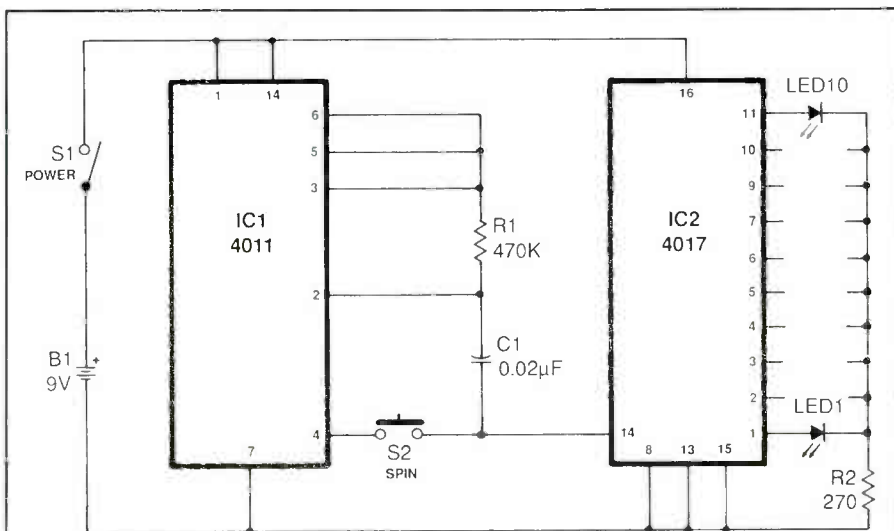

PARTS LIST

- | | |
|---|---|
| B1—9-volt alkaline battery | S1—Spst slide or toggle switch |
| C1—0.02-µF ceramic disc or polyester capacitor (see text) | S2—Spst normally-open, momentary-contact pushbutton switch |
| IC1—CD4011 quad 2-input NAND gate | Misc.—Printed-circuit board or perforated board with holes on 0.1" centers and suitable Wire Wrap or soldering hardware (see text); suitable enclosure (see text); DIP sockets for ICs; snap connector and holder for B1; dry-transfer or tape labeling kit; spacers; machine hardware; hookup wire; solder; etc. |
| IC2—CD4017 decade counter | |
| LED1 thru LED10—Red jumbo light-emitting diode | |
| R1—470,000-ohm, ¼-watt, 10% tolerance resistor | |
| R2—270-ohm, ¼-watt, 10% tolerance resistor | |

Fig. 1. Complete schematic diagram of circuitry used in Electronic Spinner.

14 of decade counter/decoder *IC2*.

By utilizing a 0.02-microfarad capacitor for *C1* and 470,000-ohm resistor for *R1*, the frequency generated by the clock oscillator causes all LEDs connected to the output pins of *IC2* to blink. This prevents the user from determining the order in the flash sequence for the LEDs. If you wish to observe the order in which the

LEDs come on, you can replace *C1* with a 1-microfarad capacitor. Of course, this defeats the randomness of the LED flashes and the purpose of the Spinner. However, even with the greatly slowed-down flashes, release timing of *S2* would make choice of a predetermined number LED coming on a difficult proposition.

With each incoming pulse at pin

14, IC2 outputs positive-level signals sequentially on pins 1 through 7 and 9 through 11. Thus, the LEDs wired to these 10 outputs flash on whenever the pins of IC2 to which they are wired go high.

Construction

There is nothing critical about component layout or conductor routing. Therefore, you can use any method of construction you prefer. However, because of the circular nature in which the LEDs should be arranged to give the least-ambiguous effect, printed-circuit construction is recommended.

If you go the point-to-point wiring route, simply lay out the LEDs in a rough circle on perforated board that has holes on 0.1-inch centers. Use suitable Wire Wrap or soldering hardware, of course, to aid in mounting components and wiring them together. Also, use sockets for the ICs, regardless of the method of construction used.

If you wish to use a pc board on which to mount and wire together the components, use the actual-size etching-and-drilling guide shown in Fig. 2 to fabricate it. Once the board is ready, mount the IC sockets, as shown in the Fig. 3 wiring diagram. Do *not* plug the ICs into the sockets until after you have conducted voltage tests and are certain that your wiring is correct.

Next, install and solder into place the resistors, capacitor and LEDs. Position the LEDs so that their cases are approximately 1/4 inch above the top surface of the board. Also, make certain that the LEDs are properly polarized before soldering any of their leads into place.

Strip 1/4 inch of insulation from both ends of three 4-inch-long wires. If you are using stranded hookup wire, tightly twist together the fine conductors at both ends and sparingly tin with solder. Plug one end of these wires into the holes labeled S1

and S2. Solder all three wires to the pads on the bottom of the board.

Terminate the free ends of the wires coming from the S2 holes at the lugs of a normally-open, momentary-action pushbutton switch and the free end of the remaining wire at one lug of a slide or toggle spst switch. Crimp and solder the red-insulated lead of a 9-volt battery snap connector to the other lug of this switch. Then plug the black-insulated connector lead into the hold labeled B1- and solder it into place.

The enclosure in which you house the project should be a plastic box with removable cover and be large enough to accommodate the battery in its holder and circuit-board assembly without crowding. If the enclosure has a metal top panel, remove this and use it as a guide to making a replacement cover from 1/8-inch-thick or so clear or transparent red plastic. Then drill mounting holes for the

switches through this plastic cover at the lower-left and lower-right corners.

Now machine the enclosure to provide mounting holes for the circuit-board assembly and battery holder. Mount the circuit-board assembly in place, using 1/2-inch spacers and 4-40 x 3/4-inch machine screws, nuts and lockwashers and the battery holder with appropriate hardware. Snap a fresh 9-volt alkaline battery into its connector and plug it into its holder.

The reason for using the clear or transparent red plastic top panel on this project is to give an unobstructed view of the LEDs as they flash. Clear gives a high-tech view of the entire innards of the project. Red is more practical for increasing contrast so that the lit LEDs can be seen even under bright ambient lighting conditions.

There is one more step to perform to complete construction. That is label the switches and LEDs on the top panel. Use the legend POWER or ON

(Continued on page 77)

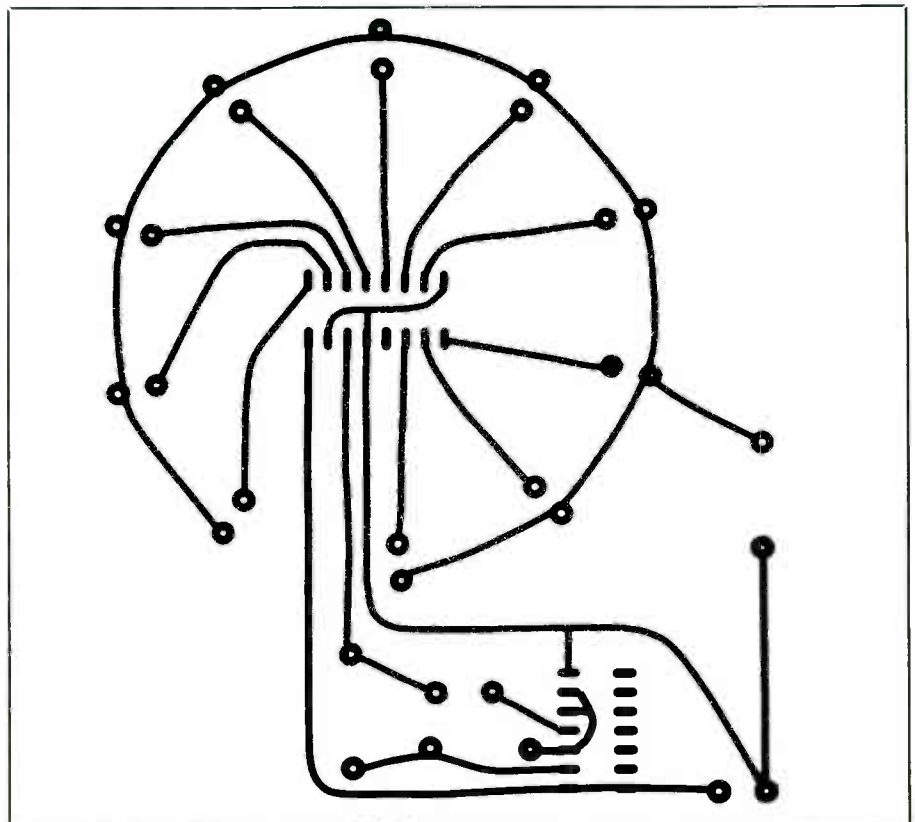

Fig. 2. Actual-size etching-and-drilling guide for project.

A Unique "Time's Up" Game Timer

Electronically automates the timing required for many games

By Kirk Carter

Whether board, card or chess, many games require timers of one sort or another. Some, like board games, come with hourglass timers that a player is supposed to use when it is his turn to play. Problems arise, though, when a player forgets to start the timer, action is completed before the time is up or when no one notices that the time has run out. The Time's Up Game Timer described here eliminates such problems.

For games in which a card is drawn to begin each turn, Time's Up completely automates the timing function.

This project fastens to the side of the game's card box in such a way that each new card must be drawn through an optical-interrupter. Doing this starts a 60-second countdown, marking each second with a tick from a built-in speaker. If a turn is completed before the minute is over, the next player needs only draw another card to reset the timer and initiate another 60-second countdown sequence. After 60 ticks, a distinctive alarm warble sounds to inform the player that time is up.

In use, Time's Up allows all players to pay attention to the game, rather than the timer. The ticks verify that the timer has been triggered and add a sense of immediacy to game play. The time-out warble is unusual enough to be heard over the roar of a lively game, without needing to be excessively loud.

Manual start and stop controls are

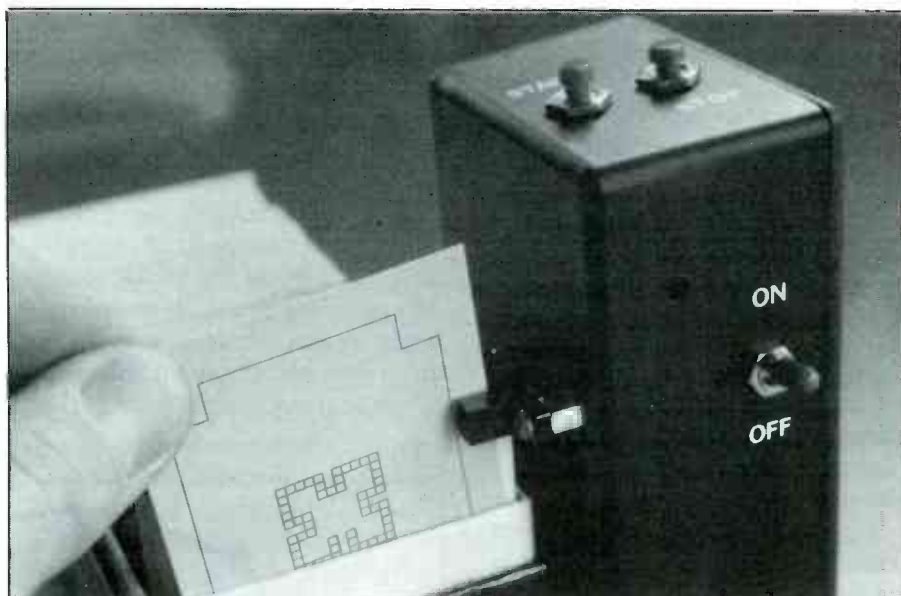

also provided for such games as chess and Scrabble, which do not use cards. You can quickly change the duration of the timing cycle in 1-second increments from 1 second to 4 minutes and 15 seconds.

Finally, you can build either or both of two versions of the project—one with a piezoelectric sounder and the other with a power-amplifier IC and loudspeaker—at low cost from readily available components.

About the Circuit

Shown in Fig. 1 is the complete schematic diagram of the Time's Up Game Timer circuitry, minus its choices of audio output circuitry. When power is applied by closing POWER switch S4, the LED inside op-

tical sensor *IC1* turns on and illuminates the internal photoelectric transistor. As a result, input pin 5 of *IC2A* is pulled low.

As shown, *IC2A* makes up half of a one-shot multivibrator, configured so that it is non-retriggerable by connecting pins 4 and 6 together (pins 4 and 6 make up the Q output of this stage). All one-shot circuits in this project are configured so that they are non-retriggerable to avoid false triggers due to noise. Hence, during their timing cycle, new triggers will have no effect.

Fig. 1. Schematic diagram of basic Time's Up Game Timer circuitry, minus its audio output section.

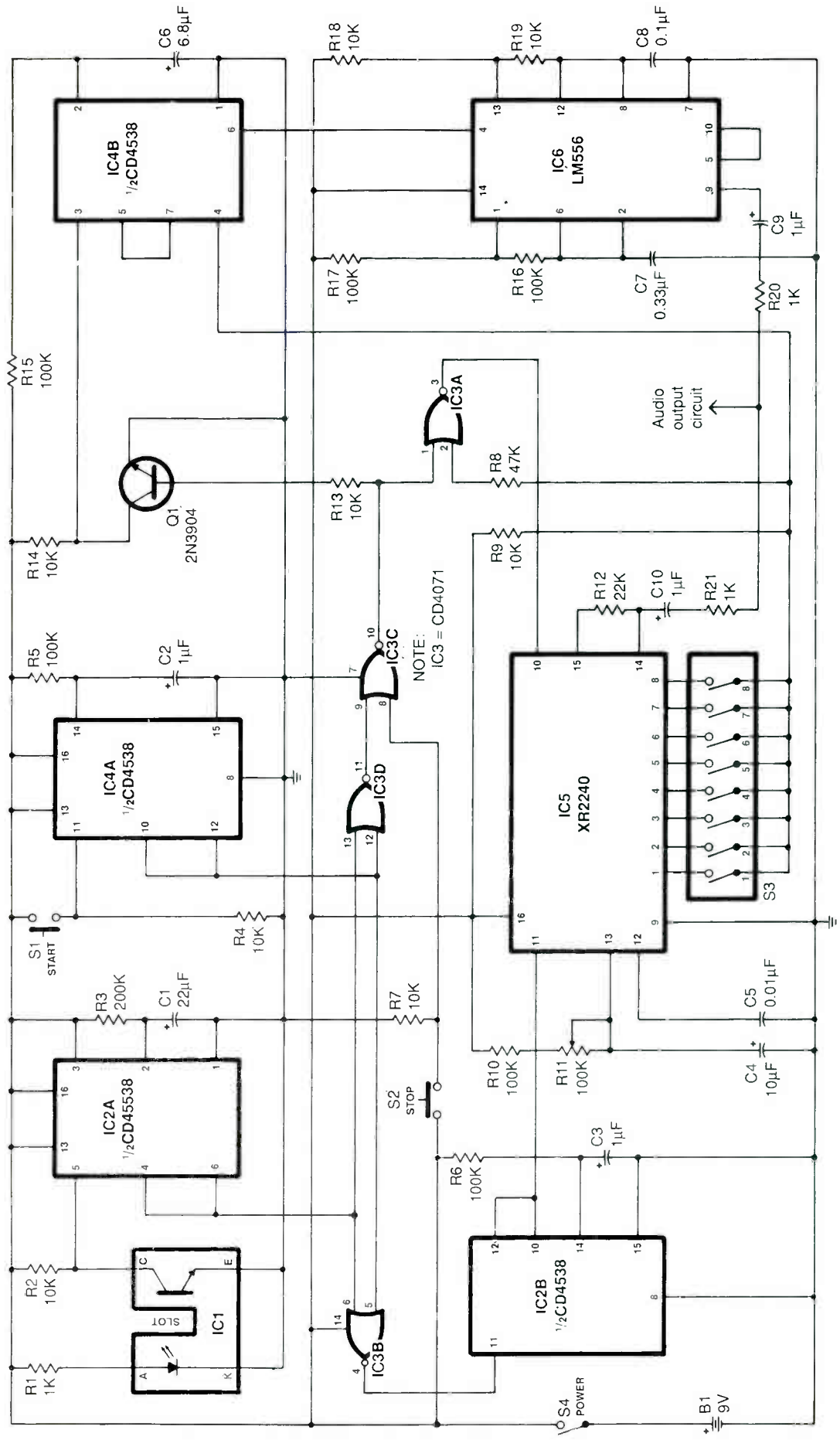

PARTS LIST

Semiconductors

IC1—Slot-type optical interrupter (Digi-Key Cat. No. OR504, or equivalent)
 IC2, IC4—CD4538 dual CMOS monostable multivibrator
 IC3—CD4071 quad CMOS OR gate
 IC5—XR2240 programmable timer
 IC6—LM556 dual timer
 IC7—LM386 Audio Amplifier
 Q1, Q2—2N3904 or similar npn small-signal transistor

Capacitors

C1—22- μ F, 16-volt electrolytic
 C2, C3, C9, C10—1- μ F, 16-volt electrolytic
 C4—10- μ F, 16-volt electrolytic
 C5—0.01- μ F, 25-volt ceramic disc
 C6—6.8- μ F, 16-volt electrolytic
 C7—0.33- μ F, 16-volt electrolytic or ceramic disc
 C8—0.1- μ F, 25-volt ceramic disc
 C11—220- μ F, 16-volt electrolytic

Resistors (1/4-watt, 10% tolerance)

R1, R20, R21—1,000 ohms
 R2, R4, R7, R9, R13, R14, R18, R19—10,000 ohms
 R3—200,000 ohms
 R5, R6, R10, R15, R16, R17—100,000 ohms

R8—47,000 ohms
 R12—22,000 ohms
 R23—10,000 ohms
 R24—1,000 ohms
 R11—100,000-ohm pc-mount 10-turn trimmer potentiometer
 R22—10,000-ohm pc-mount trimmer potentiometer

Miscellaneous

B1—9-volt alkaline battery
 PB1—Piezoelectric buzzer
 S1, S2—Spst momentary pushbutton switch
 S3—8-position DIP switch
 S4—Spst slide or toggle switch
 SPKR—Miniature 8-ohm loudspeaker
 Printed-circuit board or perforated board (preferably with copper pads surrounding each hole) with holes on 0.1" centers and suitable Wire Wrap or soldering hardware (see text); sockets for all DIP ICs; snap connector and holder for B1; 5/8" \times 2 3/4" \times 1 3/4" or larger plastic enclosure (see text); silicone adhesive; dry-transfer lettering kit; clear acrylic spray; small-diameter plastic tubing; adhesive-backed Velcro® fastener; spacers; machine hardware; hookup wire; solder; etc.

Capacitor *C1* and resistor *R3* determine the timing period for *IC2A* and, with the values specified, yield about a 5-second delay. If you prefer a longer or shorter delay period, use the formula $T = RC$, where *T* is pulse width in seconds; *R* is resistance in ohms and *C* is capacitance in Farads.

Pulling a card through the gap in *IC1* interrupts the beam from the internal LED to the phototransistor. This cuts off the phototransistor and allows *R2* to pull high pin 2 of *IC2A*. Nothing occurs during the period the card is still in the slot because pin 5 of *IC2A* is the negative-edge triggered input to multivibrator *IC4A*. The required negative transition occurs when the card leaves the slot. Thus, if extra cards slide into the slot with the desired card and stay there, the timer will not start.

Stage *IC2A* triggers as the phototransistor inside *IC1* turns on again. This sends a logic high to *IC3D*, *IC3C*, *IC3A* and *IC5*. This is the reset signal which prepares *IC5* for the start signal.

The 5-second high state from *IC2A* also goes through *IC3B* and *IC2B*. Pin 11 of *IC2B* is the negative-edge triggered input. No action occurs until the end of the pulse, when pin 11 is brought low. This gives *IC5* sufficient time to reset. If you reduce the 5-second delay, be sure you do not reduce it zero because *IC5* needs 20 microseconds to reset.

The timing period for *IC2B* is set at about 1 second by the values specified for *C3* and *R6*, though the length of this period is not critical. Stage *IC2B* sends the 1-second pulse to pin 11 of *IC5* to start game timing.

You can manually start the timer by pressing and releasing START switch *S1*. When this is done, a high-to-low transition occurs on pin 11 of *IC4A*, which triggers this stage to output a 1-second pulse on pin 10. The leading edge of this high pulse resets *IC5*. The trailing edge triggers *IC2B*, in turn starting *IC5* to counting seconds of play. The values of *C2* and *R5* are not critical, but they must yield a delay period of at least 20 microseconds.

Pressing STOP switch *S2* manually stops and resets the Time's Up Game Timer. Resistor *R7* holds low pin 8 of *IC3C* until *S2* brings it high. The resulting high pulse goes through *IC3C* and *IC3A* to reset *IC5*. It also turns on *Q1*, which brings low pin 3 of *IC4B* for the period during which the switch is held closed. This is essential to prevent *IC4B* from triggering on each manual reset pulse. During the period of the manual reset pulse, the outputs of *IC5* go low as well (otherwise, they would trigger *IC4B* and sound the alarm).

The period of the internal timebase oscillator of *IC5* is determined by the values of *R10*, *R11* and *C4*. By adjusting *R11*, a timebase period of very close to 1 second can be achieved. The timebase is available on open-collector output pin 14 of the XR2240. Resistor *R12* serves as a pull-up to the internally-regulated power for *IC5*. The timebase signal, coupled through *C10* to one side of the passive audio mixer section formed by *R20* and *R21*, provides audible time ticks.

Pins 1 through 8 of *IC5* are the open-collector outputs of an internal binary counter that is driven by the 1-second timebase. The DIP switches inside *S3* make it possible to make a wired-OR connection to *R9*, which is the pull-up resistor for all of the *IC5* outputs. The Table illustrates the effect of each switch in *S3* on the game timing cycle. Capacitor *C5* keeps pin 12 of *IC5* at a constant potential to prevent variations in the timebase period.

During game time countdown, the IC3 binary counter outputs pull low. When timing is complete, these outputs turn off to permit R9 to bring the voltage on the output line high. This high transition goes to reset pin 10 of IC5 via R8 and IC3A. It also triggers IC4B via pin 4 to start a 0.667-second duration timing pulse that is output at pin 6 of this chip. This is the alarm turn-on signal that enables the first timer inside IC6 to oscillate.

Short bursts are generated by the first timer inside IC6. In turn, these bursts enable the second timer inside IC6. The values of R16, R17 and C7 set burst timing, while those of R18, R19 and C8 control the frequency of the beep tone. The output of the second IC6 timer at pin 9 is coupled through C9 the mixer network made up of R20 and R21.

Shown in Fig. 2 are the schematic diagrams for two audio output options. For a low-volume output, use the Fig. 2(A) circuit. With this circuit, ticks and alarm tones from the mixer section turn on and off Q3, in turn, enabling and disabling V+ power for piezoelectric buzzer PBI. A single short pulse sounds like a "tick," while the alarm tone switches on and off the buzzer so quickly that it creates a "beep" sound.

In the high-volume circuit shown in Fig. 2(B), timebase pulses and the alarm warble are amplified by IC7, a simple LM386 operational amplifier, and are coupled to the speaker through C11. Potentiometer R22 serves as a VOLUME control.

The Time's Up Game Timer can be powered by a 9-volt alkaline battery, as shown in Fig. 1. Alternatively, if you do a lot of game playing and would like to avoid having to frequently replace the battery, you can substitute a plug-in type 9-volt dc power supply for B1. Just make sure that the cord from the plug-in power supply is extra long to reach to where you normally play board games.

You can eliminate programming

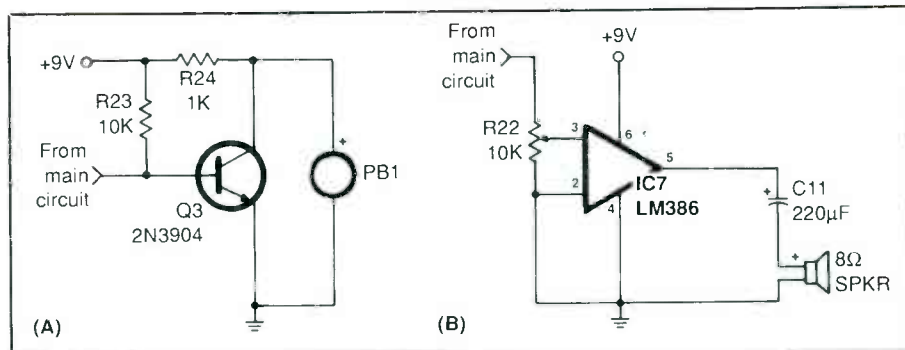

Fig. 2. Schematic diagrams of (A) a low-volume audio output section for quiet game play and (B) a high-volume audio output section for games where the action becomes too boisterous for players to hear the Timer.

DIP switch S3 if you wish to save board space and make the Timer as small as possible. You do this simply by selecting which of the DIP switches you would close for the desired game timing period and hardwiring the corresponding pins of IC3 to R9, R8 and pin 4 of IC4.

Construction

The prototype of the Time's Up Game Timer, shown in the lead photo, was assembled and wired on a 1 3/8 x 4 7/8-inch piece of pad-per-hole perforated board and housed inside a 5 1/4 x 2 3/4 x 1 1/4-inch plastic enclosure. A 9-volt battery holder, the switches and all the circuitry required for the low-volume version can easily be accommodated by this size enclosure. If you plan to build the louder version, allow extra room for the circuitry on your circuit board. One way to gain some real estate is to hardwire the programming pins of IC5, saving the space DIP switch S3 would otherwise occupy.

If you wish, you can design and fabricate a printed-circuit board on which to mount the components and wire them together. Alternatively, you can use perforated board that has holes on 0.1-inch centers and suitable Wire Wrap or soldering hardware. If you go the latter route, it is a good idea to use pad-per-hole board that has a thin ring of copper

cladding surrounding each hole. This type of board makes mounting components easier and facilitates solidly soldered connections with better mechanical strength. Whichever way you go, use sockets for all ICs.

Begin construction by cutting and shaping the board to fit inside the enclosure to assure sufficient room above it to accommodate the tallest axial-lead capacitors you will use. If you are using perforated-board construction, establish the power bus by threading a length of plated bus wire down through the hole nearest the top left corner and then up through the top right corner, pull it tight and bend the ends around the edge of the board to keep it in place.

Tack solder the bus wire at the corners of the board and along its run on the board at about five-hole intervals. Do not solder the battery snap connector to this bus just yet. Also, save installation of all off-board component wires until after the circuit-board assembly is fully wired. Create a ground bus along the lower edge of the board in the same manner.

Now install the IC sockets. Then, referring to Fig. 1 and whichever version of Fig. 2 you are planning to use to install and solder into place the resistors and capacitors. The photo shown in Fig. 4 should give you a rough idea of how to lay out the components that make up the low-volume version of the project on perfor-

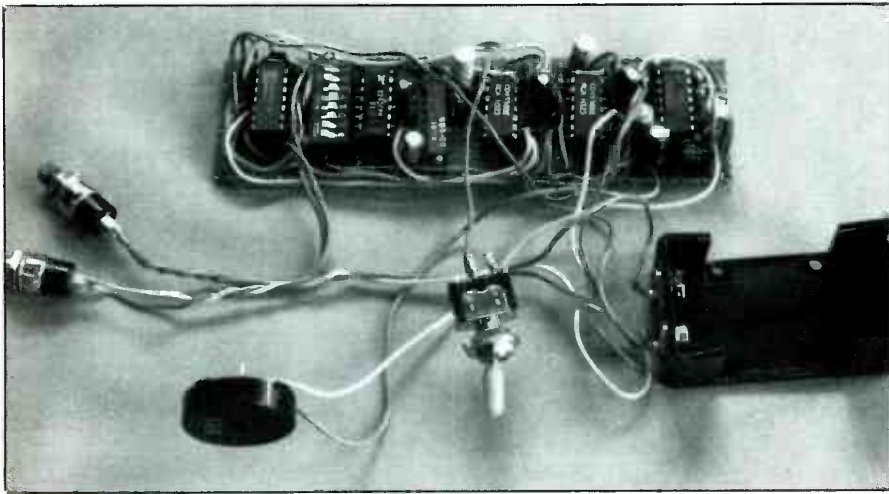

Fig. 3. Only optical interrupter, switches, battery and piezoelectric buzzer in low-volume output version mount off circuit-board assembly.

ated board. Note that the far left and right columns of holes are left unoccupied to permit the board to slide into slots on the inside of the enclosure. To make calibration easier, set *R11* to about middle of rotation before installing and soldering it into the circuit.

When building the amplifier section using the high-volume circuit shown in Fig. 2(B) run the input wire to the audio amplifier chip as far as possible from the output wire to prevent feedback effects when operating the project at high volume settings.

Once you have the circuit-board assembly wired, strip ¼ inch of insulation from both ends of eight 4- to 6-inch lengths (11 lengths if you are using the high-volume audio output version). If you are using stranded hookup wire, tightly twist together the exposed fine conductors at both ends of all wires and sparingly tin with solder.

Connect and solder one end of three of these wires to the points in the circuit for the optical interrupter. It is a good idea to identify anode lead A, collector lead C and cathode/emitter lead K/E for easy identification later when the free ends are wired to *IC1*. Connect and solder one end of the remaining wires to the locations in the circuit for *S1* (two

wires), *S2* and +9-volt bus (one wire). If you are using the Fig. 2(B) circuit, also connect and solder the three wires that will terminate at the lugs of the VOLUME control that will mount on the top of the enclosure.

Decide where on the back of the enclosure to mount the optical-interrupter and how far away from the back panel it will be. With the enclosure set up near the card box of the game with which the project will be used, mark the locations of the mounting holes for the optical interrupter. Add one more marking for a hole between the mounting holes for the wires that will tie the device to the main circuitry. Then decide on where the piezoelectric buzzer or speaker will mount and drill holes for it. Next, decide where to drill the mounting holes for the POWER, START and STOP switches. If you are using the Fig. 2(B) circuit, also decide on where to mount the VOLUME control. Finally, determine where to mount the battery holder. Mark all hole locations.

Drill suitable size holes at all marked locations. If you are using a metal enclosure or drilled holes through a metal panel, deburr them to remove sharp edges. Use a dry-transfer lettering kit to label the switch and control positions according to function. When you are done, spray

two or more light coats of clear acrylic over the legends to protect them from wear. Allow each coat to dry before spraying on the next.

Hold the optical-interrupter module horizontally in front of you so that you are looking down into the slot and the arrows embossed on the top of the unit are pointing to the left. In this orientation, the phototransistor element will be on your left with the collector and emitter lugs at the top and bottom, respectively. The cathode and anode leads of the LED inside the module are at the top and bottom, respectively. Place a small piece of masking tape with the legends C and E in the appropriate locations on the left side of the case and K and A in the appropriate locations on the right side of the case.

Mount the switches, battery holder and potentiometer control in their respective holes. Then use suitable hardware or silicone adhesive to mount into place the piezoelectric buzzer or speaker.

Place the circuit-board assembly alongside the open cavity of the enclosure and, referring back to Fig. 1 and Fig. 2, crimp and solder the free ends of the wires coming from the board to START switch *S1* and STOP switch *S2*. Locate the wire coming from the +9-volt bus on the circuit-board assembly and crimp and solder its free end to one lug of POWER switch *S1*. Crimp and solder the red-insulated lead of a 9-volt battery snap connector to the other lug of the POWER switch, and solder the black-insulated lead to any ground point on the board. If you are using the high-volume option, crimp and solder the free ends of the *R22* wires to the lugs of the potentiometer control.

Route the free ends of the three remaining wires through the center hole over which the optical interrupter is to mount. Slide a 1-inch length of small-diameter insulated plastic tubing over the A and C wires. Crimp and solder these two wires to the appropriate lugs on the module, A to A

(Continued on page 76)

Game Timer *(from page 44)*

and C to C. Strip an additional $\frac{1}{4}$ inch of insulation from the remaining K/E wire. Thread this through *both* the K and E lugs on the module and carefully solder into place. When all connections have cooled, slide the plastic tubing over the two connections until it is flush with the bottom of the optical interrupter case.

Use suitable spacers and 4-40 machine hardware to mount the optical interrupter to the enclosure via the holes you previously drilled for this purpose. Make the spacers just long enough to have the interrupter hang over the card box of the game so that as each card is drawn it naturally passes through the slot in the module.

Checkout & Use

At this point, there should be no integrated circuits plugged into the sockets. Snap a fresh 9-volt alkaline battery into its connector. Clip the common lead of a dc voltmeter or multimeter set to the dc-volts function to circuit ground. Set the POWER switch to "on." Now touching the "hot" probe of the meter, you should obtain a reading of about +9 volts at pins 13 and 16 of the IC2 and IC4 sockets, pin 14 of the IC3 and IC6 sockets and pin 16 of the IC5 socket. If you are using the high-volume output version, you should also obtain a +9-volt reading at pin 6 of the IC7 socket.

Check the optical-interrupter by measuring the voltage at pin 5 of IC2. You should obtain a very low reading with nothing blocking the light path in the slot. When you place a card in the slot, the voltage reading should suddenly rise.

If you fail to obtain the proper reading at any cited point, disconnect the meter from the circuit and power down. Then carefully examine your work to make sure that all components are in their correct locations in the circuit and that electrolytic capacitors are properly polarized.

Check each conductor run and

your solder connections. If you missed soldering any connection, solder it now. If any connection looks suspicious, reflow the solder on it and add more solder if needed. Check for solder bridges as well, especially between the closely spaced pins of the IC sockets. If you locate any, remove them with a vacuum-type desoldering tool or desoldering braid. Do not proceed until you have corrected any problem.

Once you are certain that the project is properly wired, power down and plug the ICs into their respective sockets. Make sure each IC is properly oriented and that no pins overhang the socket or fold under between IC and socket. Bear in mind that the CD4538s and CD4071 are CMOS devices and require appropriate handling to avoid damaging them with static electricity.

Once the ICs are in place, slide the circuit-board assembly into the enclosure. If you built the low-volume version of the project and are using the enclosure specified in the Parts List, your project should look like that shown in Fig. 4 just before sealing it up.

Turn on power and press and release the START switch. Ticking

should begin about 1 second after you release the switch. It should stop immediately when you press the STOP button. Let the timing cycle run its course to check for proper alarm operation. If the alarm sounds upon pressing the STOP button, Q2 is not operating properly. If you only hear one tick before the timer stops (without sounding the alarm), all switches in S3 are set to off. Set a few of them to "on" and try again.

If the project emits a steady tone, the battery may be near terminal. If you hear no sound at all from the high-volume version, adjust the setting of the VOLUME control.

To check the optical interrupter, draw a card through its slot. About 5 seconds after doing this, you should hear the ticks. While the circuit is still timing out, draw another card through the interrupter slot to determine if the automatic reset function works. The ticks should stop as soon as the second card enters the slot and start again 5 seconds after it leaves the slot.

For a 1-minute game timing period, set only sections 3, 4 and 5 of S3 to "on" (see Table for details on selecting other time periods).

Calibrating the timebase is easy to do with or without an oscilloscope. If

(Continued on page 77)

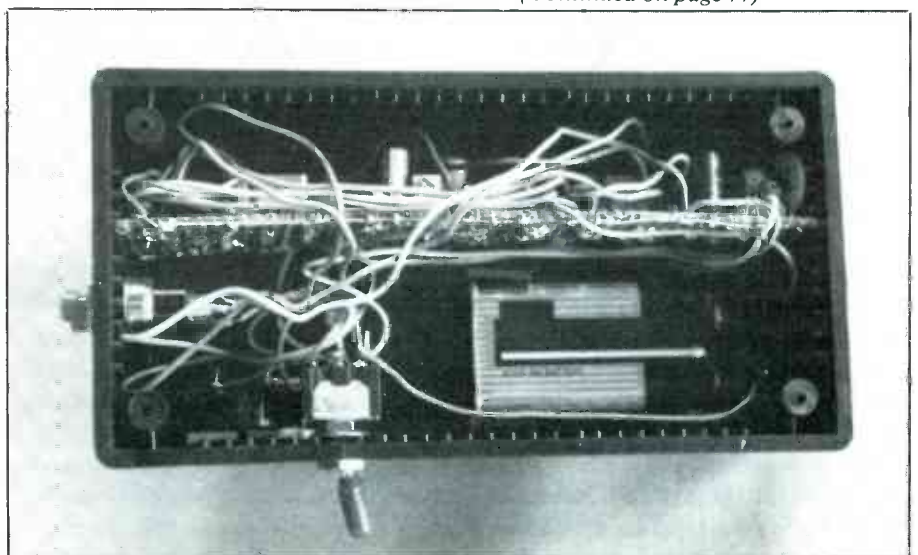

Fig. 4. Low-volume version nests neatly inside common plastic enclosure that has room inside for piezoelectric buzzer, battery and circuit-board assembly.

Phone ‘Hold’ With Music

By Crady Von Pawlak

You’ve doubtlessly asked many people you had a telephone conversation with to hold the wire for a minute. It would be much better if you treated the other party to music, as many businesses do, instead of dead silence. You can do this inexpensively with just a few components and a cheapie AM or FM radio. It can be added to a phone that already has a mute hold function, too.

The Circuitry

Before you install the circuit described here, you must determine the correct polarity of your telephone line. This is easy to do with a dc voltmeter or multimeter set to the dc-volts function to read on-hook voltage across the red and green conductors at the phone wall jack. Normal polarity is for a +48-volt reading with the common (black) meter lead connected to the green wire and the “hot” lead connected to the red wire. If you obtain a -48-volt reading when you do this, you must transpose the two wires to obtain the correct polarity. Do this at every wall box in your home.

Shown in Fig. 1 is the schematic diagram of a circuit that represents the simplest and least-expensive means of adding a music-on-hold feature to a telephone. Physically small, it can be installed inside the base of the telephone, eliminating the need for a separate enclosure and giving quick access to the switch.

To activate the system during a call, close *S1* and hang up the handset. When you want to resume talking to the party at the other end of the line, lift the handset off-hook, open

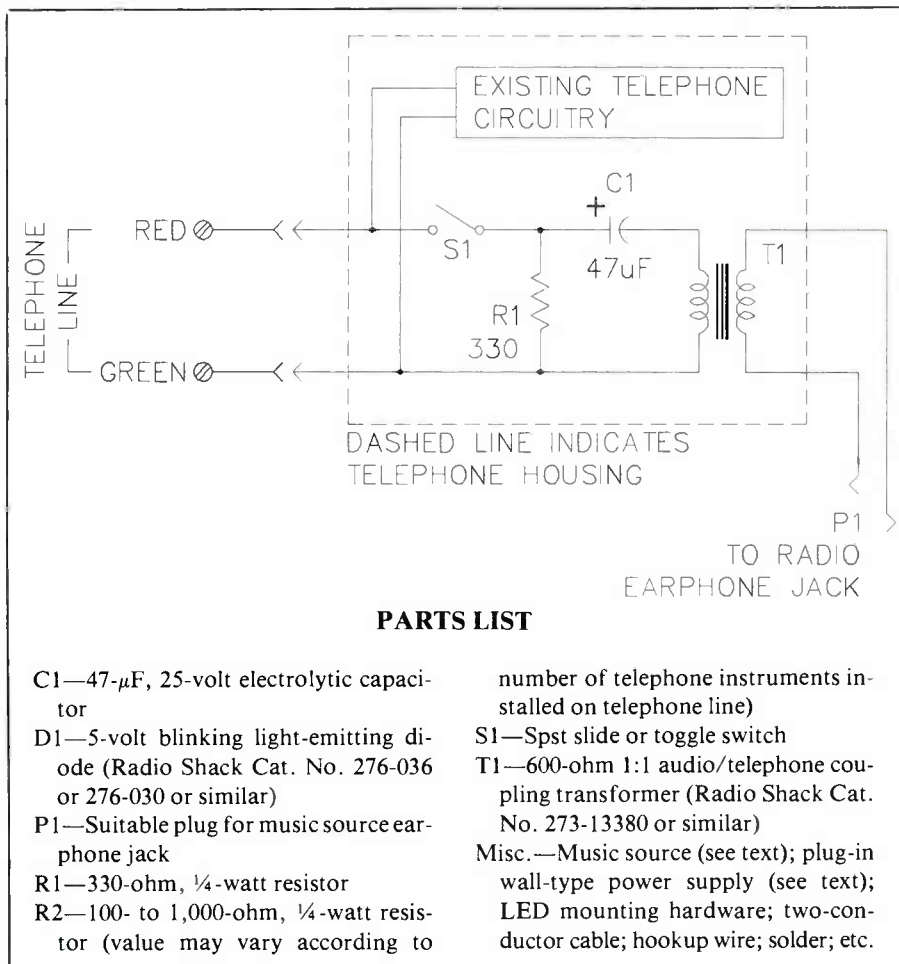

PARTS LIST

- | | |
|---|---|
| <p>C1—47-μF, 25-volt electrolytic capacitor
 D1—5-volt blinking light-emitting diode (Radio Shack Cat. No. 276-036 or 276-030 or similar)
 P1—Suitable plug for music source ear-phone jack
 R1—330-ohm, 1/4-watt resistor
 R2—100- to 1,000-ohm, 1/4-watt resistor (value may vary according to</p> | <p>number of telephone instruments installed on telephone line)
 S1—Spst slide or toggle switch
 T1—600-ohm 1:1 audio/telephone coupling transformer (Radio Shack Cat. No. 273-13380 or similar)
 Misc.—Music source (see text); plug-in wall-type power supply (see text); LED mounting hardware; two-conductor cable; hookup wire; solder; etc.</p> |
|---|---|

Fig. 1. Basic circuitry for the music-on-hold feature consists of very few components plus a portable radio.

the switch and start talking.

When activated, this circuit simulates another telephone instrument being taken off-hook. This permits you to hang up the receiver without disconnecting the party at the other end of the line. Resistor *R1* provides a low-impedance load to the line to maintain the connection, and capacitor *C1* and 600-ohm coupling transformer *T1* provide the interface between the radio and telephone line.

A telephone-line-powered flashing

visual indicator can be added to the Fig. 1 arrangement, as shown in Fig. 2. It consists of flashing light-emitting diode *D1* and dropping resistor *R2*.

Once you’ve installed the circuitry (locate the LED, if used, where it will be easily seen), set the volume level of the music from the radio that will be fed to the telephone line. To do this, plug the cable from the music-on-hold circuit into the phones jack on the radio. Turn on the radio and lift

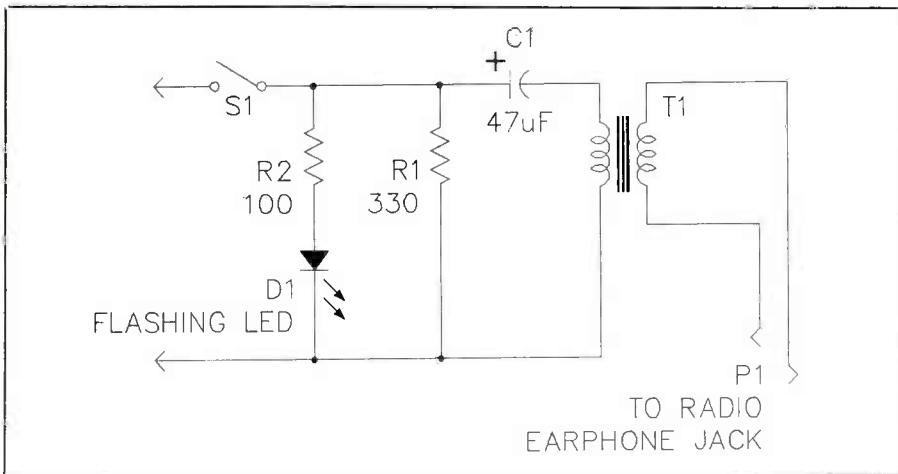

Fig. 2. Adding blinking LED and dropping resistor to basic circuit provides a visual indication whenever project is engaged.

the handset from the cradle. Close *S1* and listen as you select a station that plays pleasant-sounding music—a “mood” music station is a good choice—and adjust the volume for a

comfortable background level.

Leave *S1* set to “on,” and hang up the handset. Pick up the handset and listen on an extension phone. If the music is too loud or too low, readjust

the volume of the radio accordingly. When the sound level at the extension phone is about right, hang up the handset and return to the original instrument. Lift the handset, open *S1* and hang up here as well. Adjustment is complete.

The radio you use can be an inexpensive pocket portable powered by a 9-volt battery. To have music always available for your listeners, replace the battery with an ac-powered plug-in wall-type power supply and leave the radio turned on at all times. Though the basic circuitry is maintenance-free, you should periodically check the tuning of the radio to correct for any frequency drift.

Keep in mind that piping music through your system is allowable for personal use only. It may not be if it’s for a business phone. So check this out with the broadcast source if this will be your application. **ME**

Over 75,000 active amateurs in over 125 countries throughout the world read and enjoy a different kind of ham magazine every month. They read CQ.

It’s more than just a magazine. It’s an institution.

SUBSCRIBE TODAY!



CQ The Radio Amateur’s Journal
76 N. Broadway, Hicksville, NY 11801

Please send me CQ for Life 3 Years 2 Years 1 Year

New Renewal Start with _____ issue

1 year - 12 issues \$22.95
Save \$12.45

2 years - 24 issues \$43.00
Save \$27.80

3 years - 36 issues \$63.00
Save \$43.20

Name _____ Call _____

Street _____

City _____ State _____ Zip _____

Charge My Order To: Payment Enclosed \$ _____

MasterCard My account number is _____

VISA

MasterCard

VISA

Experimenting with Surplus Goodies

By Forrest M. Mims III

If the surplus market is cyclical in nature, then we must now be near a peak buying opportunity. Never before have I seen such a wide variety of motors, lasers, integrated circuits, optical systems and sophisticated electronic components and systems being sold at such low prices.

This month I'll describe experiments that I've been conducting with some recently purchased surplus goodies. First, however, it's important for you to understand that the quality of surplus goods varies widely. A poly bag stuffed with transistors may be a bargain at 99 cents, and all transistors in it might even work. But it's likely the transistors failed to meet one or more specifications; so you might be better off to use an in-spec transistor if the application is important or critical.

On the other hand, lots of surplus items are in perfect condition. A company might produce more components or systems than it can sell, or a buyer that placed an order might have gone out of business. In either case, the manufacturer or creditor is stuck with a supply of perfectly good items that it is forced to dump on the market for as little as pennies on the dollar. Savings are then passed along to the surplus buyer, you and me, and small manufacturer. Dealers who sell this stuff range from major companies that have been in business for more than 50 years to garage operations that are here today and gone tomorrow.

Having been forewarned that the quality of surplus stuff and the dealers selling it varies, here are some typical surplus bargains I found while browsing through a stack of current electronics magazines, catalogs, fliers and bulletins:

- Used 0.8-milliwatt helium-neon laser tubes in working condition for \$18, postage paid.
- Fifty 1N4148 small signal diodes for \$1.
- Two-milliwatt helium-neon lasers and power supplies for \$70.
- New Intel 27128A-20 EPROMs for \$4 and new Intel 2732A-3 EPROMs for \$2.
- Red LEDs for 6 cents each in quantities of 100.

- A Hewlett-Packard 7035 X-Y recorder for \$200.
- One-megabyte by 1-bit DRAMs (80-nanosecond) for \$6.39 each.
- Sharp LT022MC 780-nanometer, 5-milliwatt laser diodes, the kind used in many CD players, for \$8.95 each.

Please don't write and ask for the addresses of the suppliers of these bargains since they may have long since been sold by the time you read this. Instead, check the ads in *Modern Electronics* and other electronics magazines for surplus dealers, request their catalogs and fliers and find out what's currently available. I guarantee you won't be disappointed.

Now that you have at least some idea of what you can buy on the surplus market, I'll devote the remainder of this column to several surplus goodies that I recently purchased. Assuming these items might still be available, I include the names and addresses of the companies that sold them to me. If the items are no longer available, just get on some surplus company mailing lists. Chances are that if these items don't turn up soon, something better will.

Elapsed-Time Indicators

The Curtis Instruments' Indachron or Elapsed Time Indicator (ETI) is a non-volatile, long-range timer. It consists of a glass capillary tube filled with a thin column of mercury. A narrow gap in the mercury column is filled with a tiny droplet of an electrolytic liquid. When a voltage is applied across the opposite ends of the column, electrolysis transfers mercury from one side of the gap to the other. The net result is that the gap moves up the column whenever a voltage is applied.

In the August 1990 installment of this column, I described Curtis ETIs and how they are used. That column was prepared with the help of several 10,000-hour ETIs that I selected from a box at an electronics store. Some of those ETIs, which cost \$1.50 each, were obviously defective, and the scales of all of them were water stained. Nevertheless, they were much cheaper than new units and all but one of those I selected worked.

Recently, I was surprised to see ETIs listed for only \$1.25 each in a catalog from Marlin P. Jones & Associates (P.O. Box 12685, Lake Park, FL 33403-0685). I ordered some of them (catalog number 3080-ME) and was even more surprised to discover that these Indachrons appear to be unused and in new condition. These devices are the Model 120-LC and are designed to operate with a forward current of 0.641 microampere.

These devices might be just what you need if you want to keep track of how long an appliance, computer or automobile has been operated. You can even use them for long-term studies of the number of hours the sun shines or the temperature is above or below a certain point. One way to accomplish both tasks is to connect the ETI to the output of a comparator that is switched on by light or whenever the temperature falls below or rises above a preset value. Use a regulated power supply to power the comparator, and place a series resistor between the comparator and the ETI to keep the current through the ETI at the proper level. For more information about these nifty timers, see my August 1990 "Electronics Notebook" column.

Electroluminescent Panels

Electroluminescent panels are used as night lights and to provide illumination in aircraft cockpits. They can be made thin and flexible by depositing a suitable phosphor on a foil substrate. This assembly is then laminated between sheets of transparent plastic. While the resulting light is not particularly bright, it originates from a very large, thin and flexible source. The most important drawback is that the panel must be powered by an alternating current at a potential of around 100 or more volts.

There are many applications for electroluminescent panels. They can be used as backlights for liquid-crystal displays. Or they can be cemented to an extension hood to provide illumination for an instrument panel. They can be used as interior night lights and as outdoor warning lights. They can even be attached to a vest

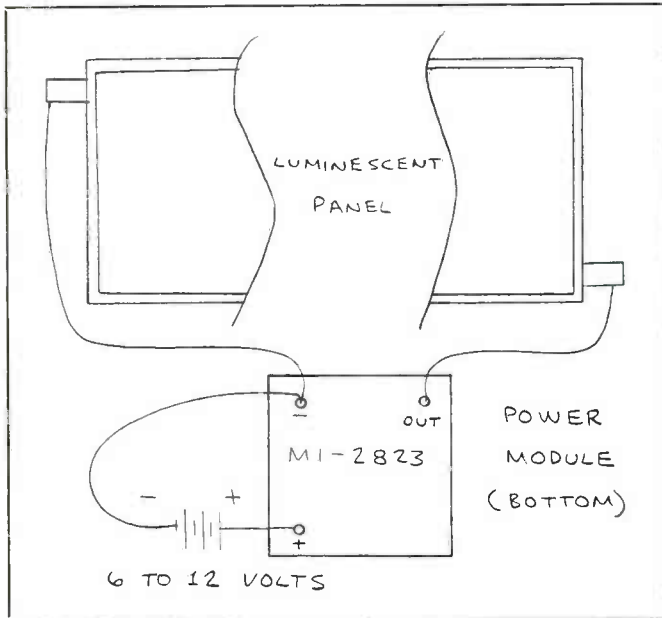

Fig. 1. Details for connecting a power module to an electroluminescent panel.

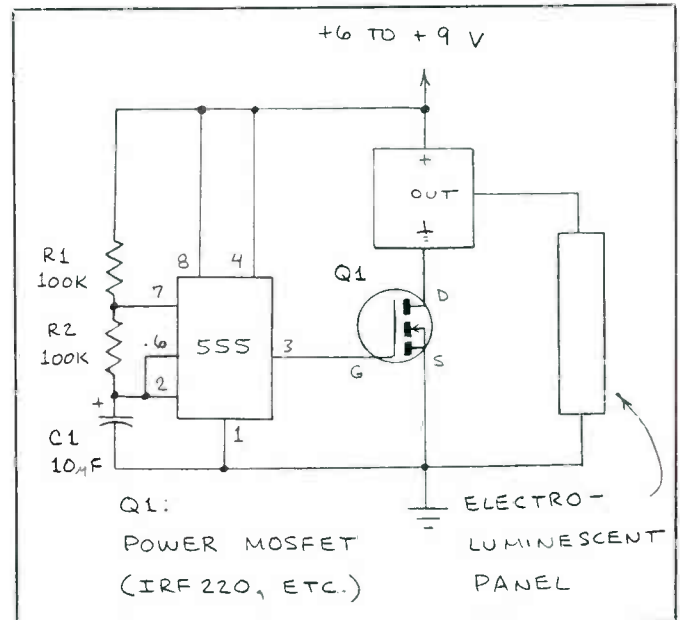

Fig. 2. Schematic diagram of an electroluminescent panel flasher circuit.

to provide a large-area safety light for runners and cyclists. Hundreds of other applications can come to mind.

Several surplus companies now sell electroluminescent panels, together with miniature power-supply modules, for as little as \$5. The set I purchased from Marlin P. Jones & Associates (Cat. No. EL-2910) cost \$7. The panel measures 2.4 inches (6 centimeters) wide and 11.6 inches (29.5 centimeters) long. The active area of the panel is around 0.12 inch (3 millimeters) less than these dimensions. The panel I purchased is equipped with copper-foil electrodes at opposite ends of its long dimension.

The power supply provided with the panel is specified to deliver 80 to 115 volts of 400-Hz alternating current when powered by a 6- to 12-volt direct current. The supply is installed in an encapsulated plastic block that occupies just under a cubic inch (around 16 cubic centimeters) and is about the size of a standard refrigerator ice cube.

Figure 1 shows how the power-supply module connects to the flexible electroluminescent panel. *Caution:* Before you actually try this circuit, remember that

the module is capable of delivering a hefty shock. I was prompted to include this reminder by an event that occurred shortly before these words were typed. While seated at my work bench, I inadvertently touched a clip lead connected to the "hot" side of an electroluminescent panel while I was changing a capacitor in a flasher circuit described below. The jolt caused both my arms to fly up and to launch into space a plastic tray that prior to that moment had been filled neatly with capacitors.

To avoid receiving such a shock yourself, exercise great caution when working with this and similar power-supply modules. Also, be sure to carefully insulate all connections between the module and the electroluminescent panel.

When power is not applied, the panel has a yellowish color. When the module is powered by a 6-volt lantern battery, the panel emits a greenish glow. Under close inspection, the glowing surface of the panel is granular in appearance and not perfectly uniform. Inspection with a magnifying lens reveals that the granulation is caused by individual electroluminescent crystals.

When powered by a 6-volt lantern battery, current consumption of the power supply I ordered is 160 milliamperes and output potential is 72 volts. When the panel is disconnected from the module, current consumption rises to 200 milliamperes and output potential increases to 170 volts. The device also emits a high-pitched hum, indicating that its frequency of oscillation has increased substantially over its normal 400 Hz.

This inexpensive electroluminescent assembly has several practical applications. For example, it can be mounted under the dashboard inside a car to provide a map reading light. The soft glow from the panel should provide adequate illumination without having to switch on the bright, harsh dome light. Another application that comes to mind is to use the panel as a miniature light table for inspecting minerals and photograph negatives and even for making tracings.

Still another possible application is to use the panel as a backlight for a stenciled sign. The panel can be made to flash on and off by means of the simple 555 circuit shown schematically in Fig. 2. In operation, the 555 switches at a rate of around 1

ELECTRONICS NOTEBOOK...

Hz. This frequency can be slowed down by increasing the capacity of $C1$. With the values shown, the off and on times are nearly equal. These times can be adjusted by changing the value of $R2$.

Thus far, I've described only applications for the electroluminescent panel when operated together with its power-supply module. It's important to realize that both devices can be operated independently. For example, the panel can be powered by other kinds of supplies and even directly powered by household line current. **Warning:** You must properly insulate the connections to the panel if you choose to power it from household line current! One possibility might be to insert the panel between two sheets of acrylic plastic to protect the panel and help insulate its connections.

As for the power supply, it has far more applications than merely driving electroluminescent panels. It can, for example, easily drive one or more neon or argon glow lamps. Indeed, it provides enough voltage for this task when powered by as little as 3 volts. As shown in Fig. 3, be sure to insert a series resistor of a few hundred thousand ohms between

the module and the lamp to limit current through the lamp to a safe value.

The power-supply module can also be used to charge the capacitor in a capacitive-discharge pulse power-supply system. Small (say, 0.01- or 0.02-microfarad) capacitors charged to from around 75 to a few hundred volts are used to provide exceedingly brief spikes (50 to 200 nanoseconds) of a few tens of amperes to drive high-power pulsed infrared laser diodes. Large (a few hundred microfarads or so) capacitors are discharged through xenon flashtubes to provide brilliant flashes of light.

Be sure to monitor the current consumed by the power supply module when using it for applications other than that for which it is designed. Since no specifications were supplied with the module I purchased, it seemed only prudent to keep the current below the level consumed when the module powered an electroluminescent panel.

60-Hz Oscillator Module

Cheap digital watches can be had for only a few dollars. Indeed, I recently pur-

chased a Chinese digital watch for just \$1. Some of the controls on the case were fake, but the watch has a functional liquid-crystal display and it provides the basic time-keeping functions.

Digital watches are cheap because they're produced in enormous volume. Such was not always the case with ordinary 60-Hz oscillators, even though they are much simpler circuits. One approach to making a 60-Hz oscillator is to combine an MM5369 timebase chip with a 3.579545-MHz color-burst crystal and some assorted resistors and capacitors. The 17 stages in the MM5369 divide the signal from the crystal until a 60-Hz signal is produced. This provides a precision timebase for making countdown timers, digital stopwatches, telephone timers and many other circuits.

For some time, several manufacturers have offered modular oscillator circuits that combine a quartz crystal and the necessary electronics in a hermetically sealed or plastic dual in-line integrated-circuit package. These modules were once very expensive.

Recently I purchased some 60-Hz and 10-MHz modular oscillator circuits from

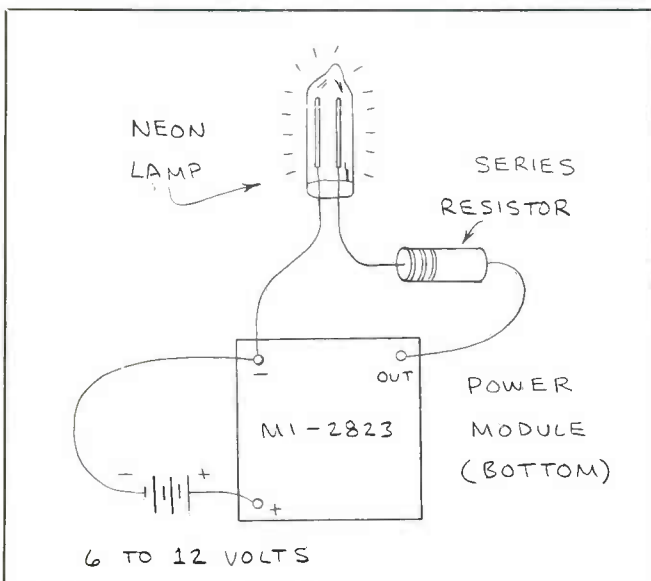

Fig. 3. Details for using a power-supply module to drive a neon lamp.

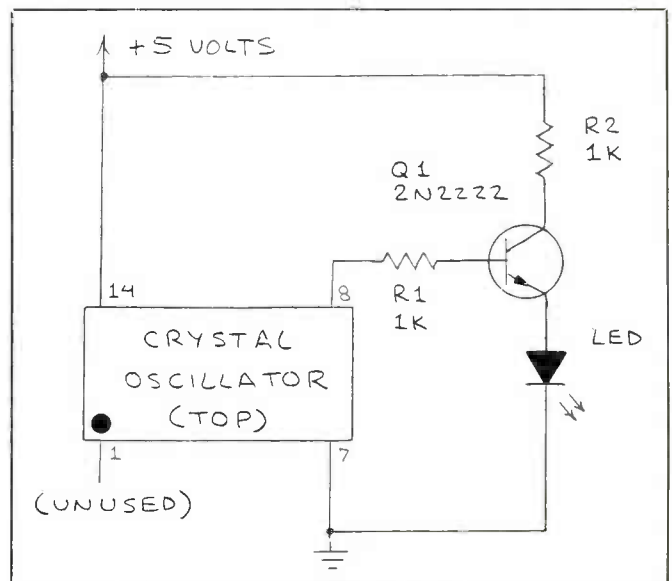

Fig. 4. The procedure for driving a light-emitting diode with a modular oscillator.

Marlin P. Jones & Associates for only \$3 each. The oscillators have a stability of 0.01 percent and are designed to be powered by a 5-volt supply. They can drive both TTL and CMOS circuits. With only 4 pins, they're easily inserted into a standard 14-pin socket.

Having breadboarded many crystal-oscillator circuits over the years, it was a pleasure to use these oscillator modules. There was no need to solder leads between the delicate crystal and the necessary outboard capacitors and resistors, nor was it necessary to incorporate a trimmer capacitor and to use it to calibrate the oscillator.

The modules are supposed to drive directly both TTL and CMOS. Figure 4 shows how to use a driver transistor to modulate a light-emitting diode at the oscillator frequency.

A 10-MHz oscillator module I purchased makes a handy calibration marker for a shortwave radio, especially when the signal from radio station WWV cannot be received. Just power the module from a 5-volt supply and connect pin 8 to a short length of wire to serve as an antenna. The module I used produced a strong 10-MHz carrier directly superimposed on the 10-MHz signal from radio station WWV.

In the March 1990 installment of this column, I described the Spectrum Probe, a clever product from Smith Design (1324 Harris Rd., Dresher, PA 19025) that transforms an oscilloscope into a 1-to-100 MHz spectrum analyzer. When the Spectrum Probe was placed near the 10-MHz oscillator, without any wire connections between the two, the scope trace revealed a series of very sharp spikes, the first of which was the 10-MHz fundamental signal from the oscillator.

When the probe was placed close enough to the module's short antenna to indicate a signal level of 30 dB at the 10-MHz fundamental, the signal level at the 32-MHz harmonic, the highest harmonic visible on the screen of the oscilloscope, was slightly more than 20 dB. The signal level of the 54-MHz harmonic was around 17 dB. The remaining harmonics at 20, 43, 64, 73, 82, 92 and 103 MHz all

had signal levels of around 10 dB.

Some modular oscillators incorporate a screwdriver adjustment slot for calibration purposes. While those I purchased didn't have such a slot, they appear to have a fairly high precision as indicated by the readout of a frequency counter.

Event Recorder

A chart recorder makes a permanent record of the status of a signal by dragging a pen or other kind of marking device across a moving strip of paper. An event recorder is a modification of the standard chart recorder in which the presence or absence of a signal is indicated by one of two positions of a pen. In other words, chart recorders record analog (variable) signals, while event recorders record digital (on/off) signals.

If you're a regular reader of this column, you may recall some of the installations in which I describe how to use a computer as a chart or event recorder. While I have managed to collect large quantities of information about gases in the earth's atmosphere and other kinds of data by means of various computerized data-acquisition systems, I often use a traditional chart recorder when very high resolution analog recording is required. Chart recorders are easy to use and set up, and their operation is very easy to monitor.

For the above and other reasons, I have long wanted to acquire a multi-channel paper event recorder. The application I have had in mind is monitoring the output from four Geiger counters to find the near simultaneous events that characterize particle showers caused by cosmic rays.

One of the cheapest event recorders of which I am aware is the Rustrak® Model 292 four-channel event recorder. Shown in Fig. 5 is a representative pattern of traces produced by this compact recorder.

The Rustrak Model 492 event recorder has a list price of more than \$300. That's why I quickly placed an order when I recently found the Model 292 on sale for only \$82.50 in the Herbach & Rademan catalog (401 East Erie Ave., Philadelphia, PA 19134-1187).

Put Professional Knowledge and a **COLLEGE DEGREE** in your Technical Career through **HOME STUDY**

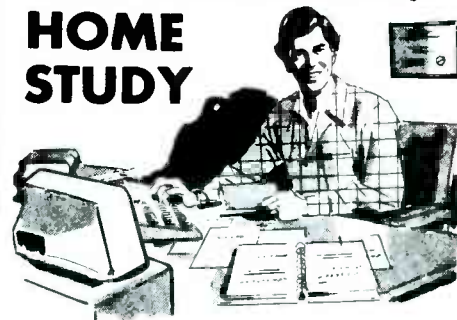

Add prestige and earning power to your technical career by earning your Associate or Bachelor degree through directed home study.

Grantham College of Engineering awards accredited degrees in
electronics and computers.

An important part of being prepared to *move up* is holding the right college degree, and the absolutely necessary part is knowing your field. Grantham can help you both ways—to learn more and to earn your degree in the process.

Grantham offers two degree programs—one with major emphasis in **electronics**, the other with major emphasis in **computers**. Associate and bachelor degrees are awarded in each program, and both programs are available completely by correspondence.

No commuting to class. Study at your own pace, while continuing on your present job. Learn from easy-to-understand lessons, with help from your Grantham instructors when you need it.

Write for our free catalog (see address below), or phone us at toll-free 1-800-955-2527 (for catalog requests only) and ask for our "degree catalog."

Accredited by
the Accrediting Commission of the
National Home Study Council

GRANTHAM
College of Engineering
250 Frontage Road
Slidell, LA 70460

LEARN VCR

CLEANING/MAINTENANCE/REPAIR

EARN UP TO \$1000 A WEEK, WORKING PART TIME FROM YOUR OWN HOME!



Secrets Revealed!

NO Special Tools or Equipment Needed.

EARN UP TO \$60 AN HOUR AND MORE!

THE MONEY MAKING OPPORTUNITY OF THE 1990'S

IF you are able to work with common small hand tools, and are familiar with basic electronics (i.e. able to use voltmeter, understand DC electronics) . . .

IF you possess average mechanical ability, and have a VCR on which to practice and learn . . . then we can teach YOU VCR maintenance and repair!

FACT: up to 90% of ALL VCR malfunctions are due to simple MECHANICAL or ELECTRO-MECHANICAL breakdowns!

FACT: over 77 million VCRs in use today nationwide! Average VCR needs service or repair every 12 to 18 months!

Viejo's 400 PAGE TRAINING MANUAL (over 500 photos and illustrations) and AWARD-WINNING VIDEO TRAINING TAPE reveals the SECRETS of VCR maintenance and repair—“real-world” information that is NOT available elsewhere!

Also includes all the info you'll need regarding the BUSINESS-SIDE of running a successful service operation!

FREE INFORMATION
CALL TOLL-FREE 1-800-537-0589

Or write to:
Viejo Publications
5329 Fountain Ave., Dept. ME
Los Angeles, CA 90029

CIRCLE NO. 117 ON FREE INFORMATION CARD

FREE CATALOG!

1-800-648-7938

JERROLD HAMLIN OAK ETC CABLE TV DESCRAMBLERS

- Special Dealer Prices!
- Compare our Low Retail Prices!
- Guaranteed Prices & Warranties!
- Orders Shipped Immediately!

REPUBLIC CABLE PRODUCTS, INC.

4080 Paradise Rd., #15, Dept. 905
Las Vegas, NV 89109

For all other information (702) 362-9026

CABLE-MATE, INC.

Are You Tired of Paying Outrageous Fees?

All makes and models of cable equipment shipped within 24 hrs.

Quantity discounts. For free catalog send S.A.S.E. to:

Cable-Mate, Inc., 450 Shag Bark
Algonquin, IL 60102

C.O.D. orders accepted

CALL FOR PRICES TODAY!!

800-422-0525

(708) 658-2121

*No Illinois orders

Hours—8:00 am-5:00 pm central time

ELECTRONICS NOTEBOOK . . .

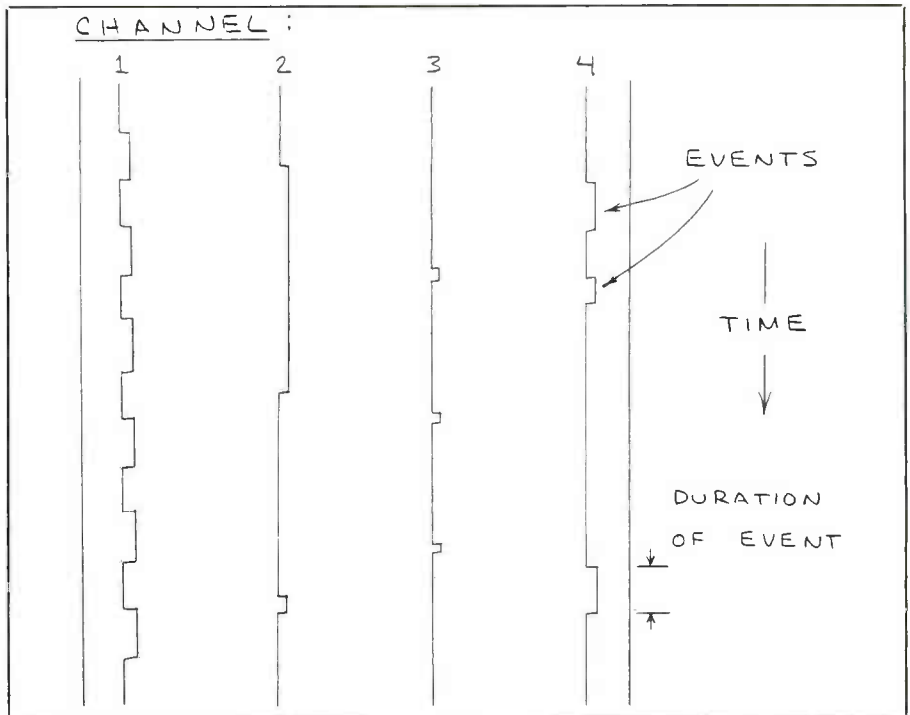

Fig. 5. Typical chart from a RustrakR® event recorder.

The Herbach & Rademan catalog, the first I've seen in many years, stated that the recorder was in "used, good condition." I was pleasantly surprised a week or so later when the unit I ordered came packaged in an unopened factory carton. The recorder inside the package appeared to be perfectly new. It came loaded with a roll of paper, a spare roll, instructions and a connector, all in unopened envelopes or boxes. Perhaps the recorder was factory reconditioned. No matter, Rustrak recorders are so well made that the unit I received is, for all practical purposes, factory new.

Your Turn

That event recorder from Herbach and Rademan reminds me of the first time I ordered some surplus items from a mail-order company in 1965. The items were strips of three silicon solar cells that were apparently leftover from a satellite program. Those cells, some of which still re-

side in a drawer marked "Solar Cells," were used as detectors in various kinds of lightwave communication receivers and in a miniature near-infrared travel aid for the blind. The company from which I ordered those cells was the same Herbach & Rademan that sold me the four-channel event recorder.

Though 25 years have elapsed between my first and most recent transaction with Herbach & Rademan, in the meantime I've made countless purchases of surplus electronic components and systems from many other dealers. Like those solar cells, many of those purchases helped provide the foundation that enabled me to learn much more about electronics.

Now it's your turn. Take a few minutes to order some catalogs from the companies that advertise in this and other electronics magazines. When they arrive, scan them carefully for the bargains many of them contain. You, too, can greatly enhance your knowledge of electronics by buying and experimenting with some of these surplus goodies. **ME**

A New Solid State Speech Recorder, Data Acquisition on a Chip, and Undervoltage Sensing ICs

By Joseph Desposito

Recording voice in RAM or on disk has always been troublesome because of the large amount of memory required. However, a new device from Dallas Semiconductor may solve this problem.

Solid-State Speech Recorder

A digital audio recording subsystem from Dallas Semiconductor (4350 Beltwood Pkwy. S., Dallas, TX 75244), the DS2270 Speech Recorder Stik, can reproduce high-fidelity sound at bit rates as low as 8 kilobits per second (kbps). This device, whose block diagram is shown in Fig. 1, is smaller and more durable than mechanical tape-based recorders.

Telephone-grade speech normally consumes 64 kbps, a rate too costly to store in semiconductor RAM. However, with digital compression techniques, the standard for good-quality sound reproduction has been 32 kbps. Dallas Semiconductor claims to have cut that 75% by developing an advanced speech-compres-

sion algorithm that maintains excellent sound quality even at 8 kbps. With this lower bit rate, memory storage requirements are reduced by 87%, making it economical to store speech in solid-state silicon, rather than rotating magnetic media.

The Stik records by picking up sound from a microphone or telephone line. That analog sound is then converted to digital data at a rate of 64 kbps and compressed with a 20-million instruction-per-second ADPCM processor, which is a special digital signal processor (DSP) chip. A second Dallas Semiconductor computer mounted on the Stik, the DS5000 soft microcontroller, stores data in nonvolatile SRAM and keeps track of messages.

To play back the message, the microcontroller retrieves the sound data and forwards it to the DSP chip to expand the compressed message back to 64 kbps. The decompressed data is converted back to analog audio, which can be reproduced through a speaker.

The DS2270 includes 64K × 8 of non-

volatile SRAM that stores program and speech data for 10 years in the absence of main power. Of the storage area in this nonvolatile SRAM, 40K provides approximately 40 seconds of speech storage capacity at 8 kbps. Additional external memory can be easily attached for increasing recording time. Optional Dallas Semiconductor interface chips connect to standard DRAM or SRAM memories to expand recording time indefinitely. Dallas also offers SIP Stik integrated memories that hook directly to the DS2270.

Unlike tape recorders, this chip-based recorder can randomly select sound segments and concatenate them efficiently. For example, the numbers one, two and three can be recorded once, taking up about 5 seconds, and pieced together to make any number instantly available. With this feature, messages can be generated for data-dependent applications like time and temperature call-in services.

In addition to its normal record and playback capabilities, the Speech Recorder Stik generates and detects dual-

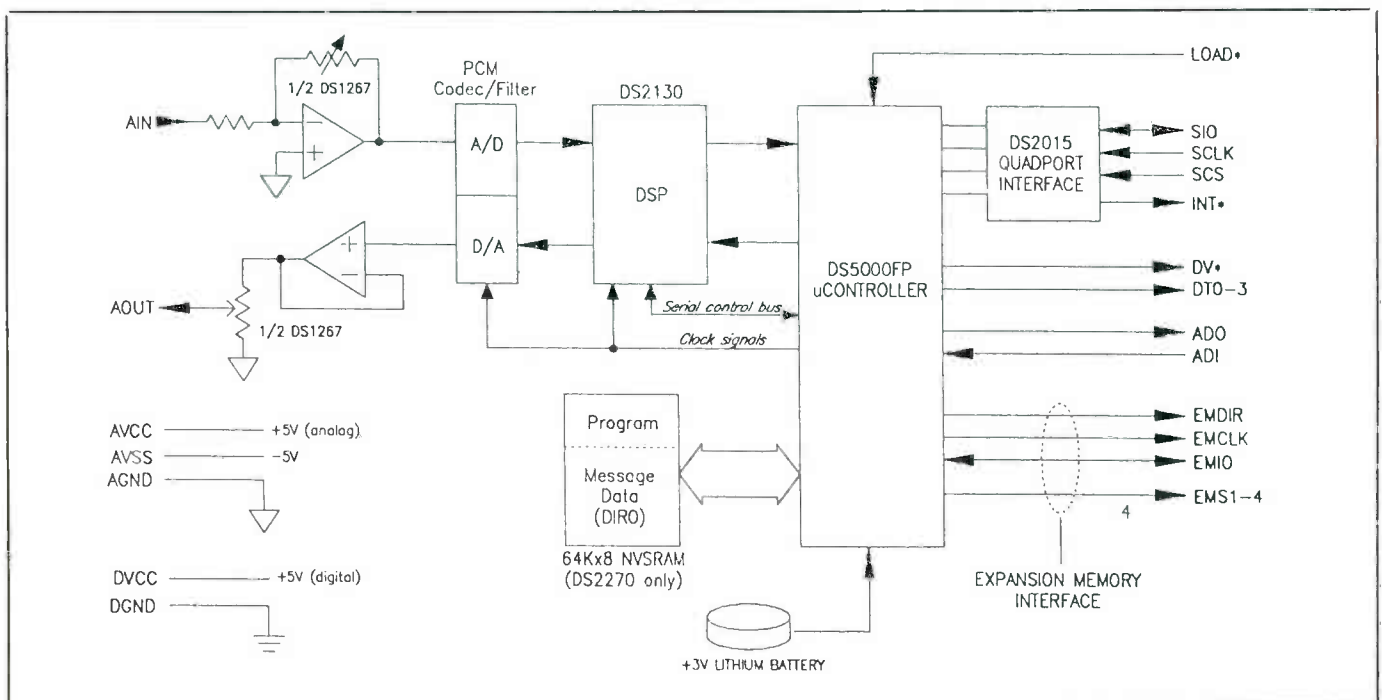

Fig. 1. Block diagram of Dallas Semiconductor DS2270 Speech Recorder Stik for digital audio subsystems.

SOLID-STATE DEVICES...

tone, multi-frequency (DTMF) digits, making it appropriate for phone systems that use voice response to prompt users to press a keypad and move through menus.

The Speech Recorder Stik offers a number of solid-state recording functions. First, the user can choose a compression rate from 32 to 8 kbps to trade off audio fidelity against storage capacity. Second, gains for the audio input and output are software-programmable for optimum record and playback levels. The device also features digital level monitoring—knowing how strong the signal is enables voice-actuated recording.

Packaged to be easily embedded into equipment, the snap-in Speech Recorder Stik features a space-saving, 35-pin SIMM connector. The unit is about the size of a stick of chewing gum.

The key components of the Stik are

available as a chip set specifically designed for incorporation into personal computer architectures. The chip set consists of the DS2130 voice messaging processor for compressing speech, the DS1267 dual digital potentiometer for adjusting volume settings and the DS5001FP 128K micro chip that interfaces directly to the data bus of the PC. To complete the function, a small amount of EPROM or SRAM (for firmware storage) and a CODEC (for digitizing the voice signal) are needed.

An emerging application for this chip set in the PC is the addition of voice messaging capability to laptop computers. Verbal as well as written (keystroked) notes can be conveniently stored, typically in unused space of a hard disk. For example, the voice recording feature could be turned on during a meeting to record

the conversation for later editing and summary. At the highest compression rate of 8 kbps, an hour's worth of conversation can be recorded and stored in less than 4 megabytes of memory, according to Dallas Semiconductor.

Equipment fitted with the Stik can voice coach an operator to make the unfamiliar easy. As an example, a fax machine can talk a new user through the process of sending a fax. Other applications include high-feature answering machines, local or remote annunciators to tell what is going on in equipment, voice mail and automatic operator services for phone systems.

The DS2270 Speech Recorder Stik is priced at \$96.25 in 500-piece quantities. The chip set containing the key components of the DS2270 is priced at \$18 in quantities of 10,000 sets.

Data Collection on a Chip

The C-MART-1000 from Verdure Industries (P.O. Box 24886, Omaha, NE 68124) is a stand-alone asynchronous digital receiver/transmitter. The two-chip set (Fig. 2) is capable of functioning as a complete data-acquisition system, an integral component at the board level under microprocessor control, or as part of a subsystem in local-area networking.

The C-MART-1000 can be custom configured by pin selection to perform a number of data-acquisition tasks without the need for hardware or software; yet it functions well under simple computer control. A total of 48 bits are available for the user to configure in any of several combinations. Of the first 16 bits, four bits are always compared. The user can elect to compare all or part of the remaining 12 bits; collect data from the 12 bit-counter and 32-bit counter; or use all 16 bits for parallel data and collect data from the 32-bit counter only.

Both counters collect data independently and can collect data simultaneously. These features enable the user to monitor or collect data from several different events at one time, poll the C-MART-

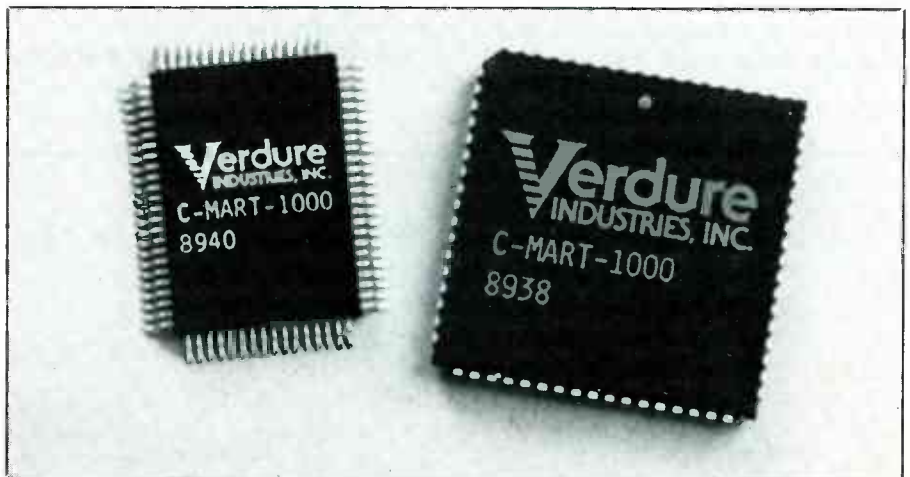

Fig. 2. Verdure Industries' C-MART-1000 stand-alone asynchronous digital receiver/transmitter can function as a complete data-acquisition system, integral component at board level under microprocessor control or part of a subsystem in a local-area network.

1000 for the data or have the data automatically transmitted out.

For a secure remote control application (see Fig. 3) the 16-bit parallel input of one C-MART-1000 is connected to a bank of switches (wire bonds can be made or broken) to set the ID code, and the corresponding number of data bits to be transmitted is selected. The external trig-

ger is connected to a momentary-action switch, and the serial pulse-width modulated data output is connected to an r-f transmitter. The coded trigger and 16-bit serial pulse-width modulated (PWM) input is selected with a second C-MART-1000 and connected to an r-f receiver.

The number of data bits to be compared is set to match the number of data

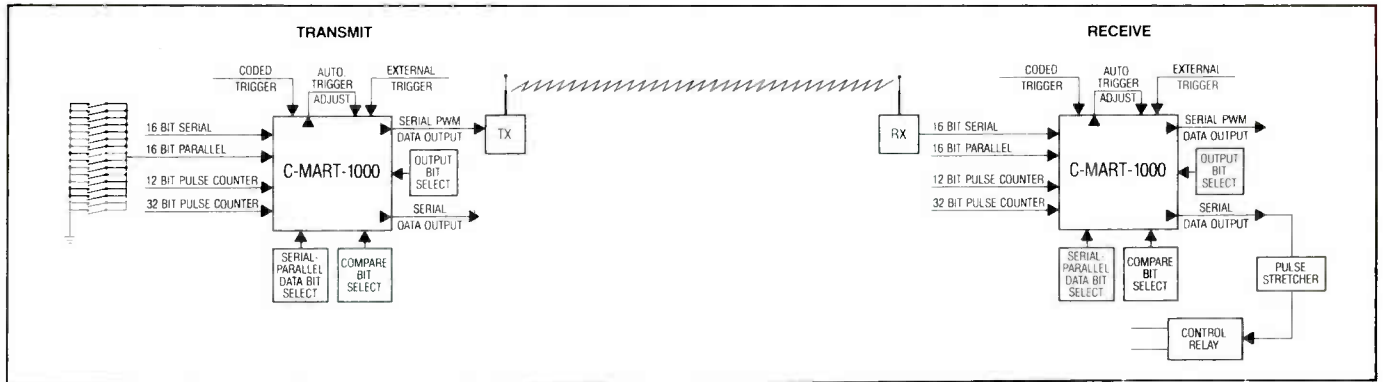

Fig. 3. For secure remote-control applications, C-MART-1000's 16-bit parallel input connects to a bank of switches to set ID code and corresponding number of data bits to be transmitted. Coded trigger and 16-bit serial PWM input is selected on second C-MART-1000 and connected to an r-f receiver.

bits selected with the first C-MART-1000 at the transmitter. The corresponding number of data bits to be transmitted out by the second C-MART-1000 is set, and the serial data output is selected. This

output is fed to a simple pulse stretching circuit and used to trigger a control relay. Or the serial PWM data output can be used and the pulse widths adjusted to overlap and create one long pulse that can

be used to trigger the relay, eliminating the pulse-stretching circuit. Typical applications for the C-MART are garage door openers, remote control and security access and control.

Undervoltage Sensing ICs

Motorola (2100 E. Elliot Rd., Tempe, AZ 85284) has introduced an MC34164/33164 series of micropower undervoltage sensing ICs (Fig. 4) for use as reset controllers in portable MCU/MPU systems. These devices provide an economical solution for low-voltage detection with a single external resistor. This sensing and reset function is very beneficial for systems that use any brand or model of microcontroller or microprocessor and is required by many, including the Motorola MC68HC11 family.

Devices are available to monitor either 3- or 5-volt power supplies. The low power consumption of these devices make them ideal for applications in which extended battery life is required, such as consumer products and hand-held electronic equipment.

The MC34164 series features a band-gap reference, comparator with precise thresholds and built-in hysteresis and an open-collector reset output and is guaranteed to operate down to a 1.0-volt input with extremely low standby current. The MC34164 series provides a required function for the Motorola MC68HC11

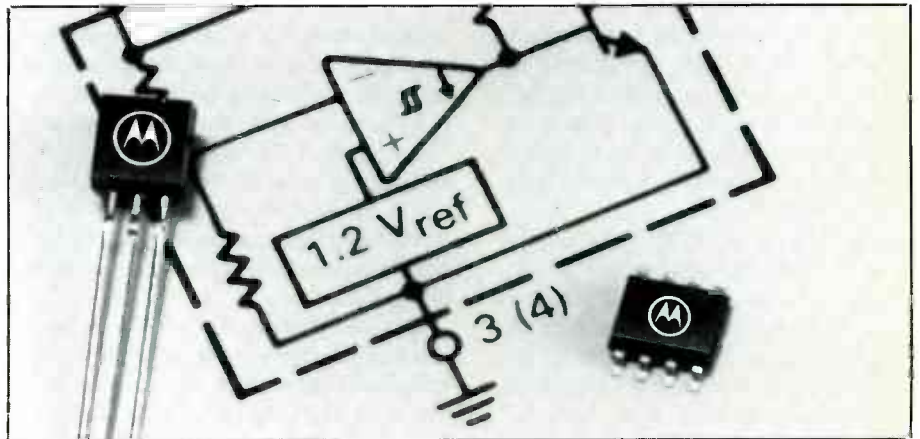

Fig. 4. Motorola's micropower under voltage sensing ICs serve as reset controllers in portable MCU/MPU systems.

family and the MC68HC805C4 microcontroller units and a beneficial function for the entire MC68HC05 family.

These microcontrollers find broad application in automobiles, industrial controls, medical equipment, computers, consumer products, the cable TV industry and electrical appliances. Typical thresholds of 2.7 and 4.3 volts were chosen for use with 3-volt $\pm 5\%$ and 5-volt $\pm 10\%$ power supplies.

This series of undervoltage sensing circuits is available in a three-pin T0-D226AA (T0-92) package with P-3 or P-5 suffixes, and in an eight-pin surface-mount package with D-3 or D-5 suffixes. Devices are specified over two temperature ranges. The MC34164 series is designed to function reliably from 0° to $+70^\circ$ C, the MC33164 series from -40° to $+85^\circ$ C. Prices range from 43 to 55 cents each in quantities of 10,000. **ME**

Epson's ES-300C Desktop Image Scanner

By Ted Needleman

Over the last few years, I've had the opportunity of reviewing a number of image scanners. I've looked at both hand and sheet-fed scanners and, by and large, I've been impressed with what you get for the money. With image capture and manipulation a particular interest of mine, I do try to keep up with what is going on in both hardware and software.

As with most areas of technology, the last few years have produced an increasingly sophisticated array of devices at an ever-decreasing cost. Most recently, the scanners I've been examining seem to all be gray-scale devices. Over the last several months, I examined four or five of these scanners, all in the \$1,500 to \$2,000 range, and except for one surprise, found them pretty much the same.

The surprise was Epson's ES-300C image scanner. I tend to see a lot of Epson equipment, primarily because the company has always been very helpful to those of us who write about computers. And, as I've mentioned here before, it's always easier to write about something if the vendor provides access to the equipment and information.

By and large, I liked the Epson equipment I've had the opportunity to play with, but I haven't been all that impressed with its technical sophistication or price. Epson products, such as the Equity LT-386SX computer I reviewed a few columns back, tend to perform well but aren't revolutionary in design or execution. They also tend to be priced a bit high for what you receive (though they are usually sold at a significant discount, making them well worth consideration).

The ES-300C scanner is different. In fact, it's the first Epson product I've seen since the company's MX-80 printer that I consider to be ahead of the competition. Physically, the ES-300C appears little different from most other desktop scanners. A flatbed unit (where the paper is placed on a fixed platen), the ES-300C measures a compact 12.6"W x 20.1"D x 4.8"H and weighs just under 20 pounds.

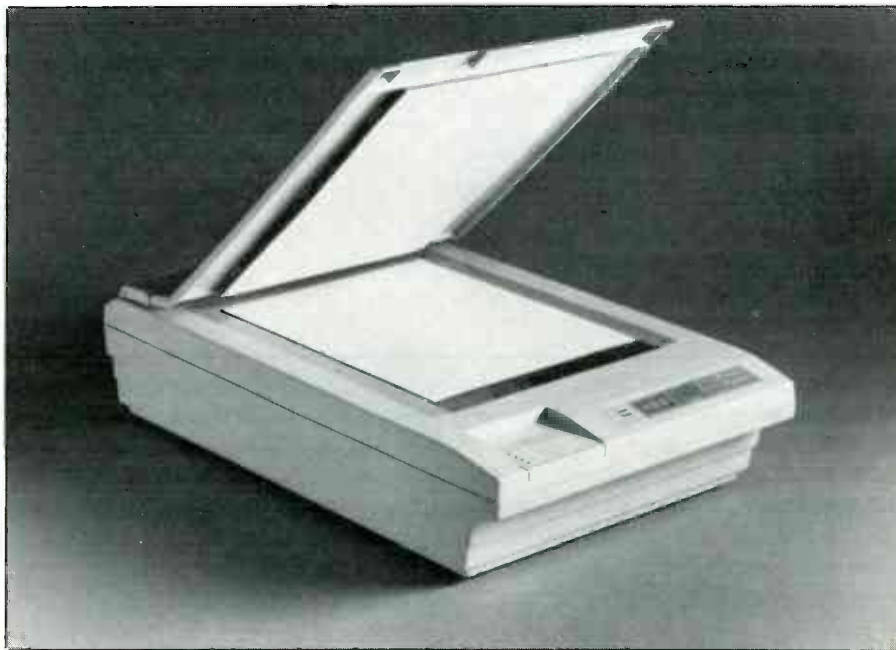

This sameness is deceiving, though, as the Epson does something only a few other scanners in its class can do. Not only is it a black-and-white scanner capable of differentiating 256 levels of gray, it can also scan in color. At 300 dots per inch (DPI), the ES-300C can provide up to 24 bits of color information per pixel, which translates into approximately 16.7-million colors.

It accomplishes this with a unique three-color scanning bar with red, blue, and green light sources. Most color scanners use a white-light source and scan the image three times, each time with a different color filter interposed between the image being scanned and the scanner's pickup head. The Epson makes one pass down the image regardless of whether it is making a monochrome or color scan, though it handles these two types of scans somewhat differently.

When the scanner is making a monochrome scan (this is controlled by the software being used), all three color bars are turned on, and the light source makes a single pass down the document being imaged. For a color photo, however, the different colors are turned on and off se-

quentially as the scan head is passed under the document. This slows down the scanning process slightly but nowhere near as much as it would if three scans had to be performed.

This Epson unit is also a bit different from its contemporaries in the way it interfaces to a PC. When used with a Macintosh, Epson recommends either a serial or SCSI interface. The scanner itself comes with both parallel and serial interface ports. The scanner's Macintosh interface kit, however, provides the SCSI interface that the Mac requires as well as Macintosh-specific software. Most gray-level scanners in this price class use SCSI interfacing, whether they're being used with a Mac or a PC. SCSI tends to be pretty fast.

When you are using the ES-300C with a PC, however, Epson recommends the use of a bidirectional parallel interface, and the company's PC interface kit provides one that can be addressed as LPT2. The parallel interface that the scanner hooks up to must be bidirectional, as data flows both ways (control signals are sent to the scanner, whereas scanned data is received from it.) Most IBM PS/2 models already

have bidirectional parallel ports, but many other PCs don't, which is why Epson includes one in the PC interface kit.

The ES-300C also provides a control panel, something that's often missing on gray-level scanners and a feature I really liked. These controls let you set the zoom (amount of enlargement or reduction) when you use the scanner with a software package that doesn't support this feature. It also lets you take advantage of Epson's Direct Print feature. By connecting an Epson LQ-860, LQ-2550 or Hewlett-Packard PaintJet printer to the port on the scanner, you can immediately obtain a color printout of the image just scanned.

The Epson unit also has power-on diagnostics, activated by holding down the plus or minus switch used by the Zoom control when turning on the unit. Depending on the button held down, this activates either a single pass of the head with all three light bars turned on or three sequential passes with a different bar turned on for each pass.

It took me about 45 minutes to set up the ES-300C. The first step was to set up the bidirectional interface card in the PC. The board has jumpers that must be set to an unused parallel port and IRQ (interrupt). In most cases, the defaults (LPT and IRQ5) will be fine. They were in my installation, but just to be safe, I checked first with *System Sleuth*, a program from Delrina Technology that I'll be covering in a future column. There are lots of other diagnostic and test programs that will also give you this information, such as *CheckIt* from TouchStone Software, which was reviewed in this column last year, and the company's new package, *PC Test*.

One thing I didn't appreciate was that the parallel cable needed to make the connection between this interface board and the scanner isn't included. Epson states that most standard parallel printer cables will work, but some that don't have all the necessary pins connected won't. The cable I used worked fine, but if it hadn't, I don't think I would have been too pleased with having to run the computer

LEARN ELECTRONICS FROM VHS VIDEO TAPES!

At *Ucando* your Success is our Business!



Our Video Tapes Are Designed To Make Learning Electronics Fun and Easy!

- | | |
|---|--|
| <ul style="list-style-type: none"> • PART 1-DC, 53 min.....\$32.95
Electronics and You—VT-201 • PART 2-AC, 71 min.....\$32.95
Electronics and You—VT-202 • PART 3-SEMICONDUCTORS, 47 min.....\$32.95
Electronics and You—VT-205 • PART 4-POWER SUPPLY 55 min.....\$32.95
Electronics and You—VT-206 | <ul style="list-style-type: none"> • PART 5-AMPLIFIERS 52 min.....\$32.95
Electronics and You—VT-207 • PART 6-OSCILLATORS 54 min.....\$32.95
Electronics and You—VT-208 • VCR MAINTENANCE & REPAIR VT-203—54 min.....\$32.95 • INTRODUCTION TO VCR REPAIR VT-204—110 Min.....\$59.95 |
|---|--|

ORDER NOW!

CALL TOLL FREE AT

1-800-678-6113

or

mail check or money order to:

UCANDO VIDEOS

P.O. BOX 928 • GREENVILLE, OH 45331

VISA AND MASTERCARD ACCEPTED

CIRCLE NO. 114 ON FREE INFORMATION CARD

Double your income! Computer maintenance/service — a \$10 billion industry.

If you are presently servicing office machines or any other electronic equipment, computer repair can **double your income**.

National research results indicate that computer technicians bill out at double the hourly rate of office machine technicians.

Tech-Serv can put you into computer repair quickly, economically and efficiently and with a complete support program including a **proven marketing plan**.

We provide:

RECOGNITION

Nationally recognized trademarks and logos give you immediate recognition as a professional computer repair specialist by being a Tech-Serv Authorized Computer Repair Center in your market area.

DOCUMENTATION

We provide manuals, schematics, documentation and advanced diagnostic software.

NEW HARDWARE

CPU's: IBM, Apple, Compaq, and others.
Printers: Okidata, Epson, HP Lasers and others at huge discounts.

PARTS & BOARD REPAIR

Single source for parts and board repair.
24-hour express turnaround.

TRAINING

Hands on training: IBM, Compaq, Apple, and compatibles at 3 separate levels:
Level 1: 8086-8088 Based Machines
DOS System Configuration and upgrades
Level 2: 80286/80386 Machines, Letter Quality and Laser Printers
Level 3: System Networks Configuration, Installation and Repair

FINANCING

Available for qualified businesses.

OVER 125 DEALERS WORLDWIDE

Find out why more and more electronic professionals are adding computer repair to their businesses or starting their own computer repair businesses.

Call Tech-Serv at (212)967-1865 now.

techserv AUTHORIZED DEALER
SM
SERVICING THE WORLD OF MICROS

©1989 Tech-Serv Corp.

253 West 28th Street, New York, NY 10001

CIRCLE NO. 115 ON FREE INFORMATION CARD

CONSOLIDATED ELECTRONICS



VOLUME I - TEST EQUIPMENT

CONSUMER & INDUSTRIAL ELECTRONICS - 18TH EDITION
\$5.00

"Volume I-Test Equipment"

112 pages packed with specifications on the most popular test equipment like B&K, Beckman, ARI, Simpson, Mercer, Soar, Goldstar and Vector/Viz. Choose from hundreds of multimeters, oscilloscopes, frequency counters, function generators, power supplies & more. Send \$5.00 check or money order, or call 1-800-543-3568 today & use your Mastercard or Visa. Consolidated Electronics, Incorporated
705 Watervliet Avenue., Dayton, Ohio 45420-2599

NAME _____

ADDRESS _____

CITY _____

STATE _____

ZIP _____

CIRCLE NO. 105 ON FREE INFORMATION CARD

ATTENTION! ELECTRONICS TECHNICIANS

EARN YOUR
**B.S.E.E.
DEGREE**

THROUGH HOME STUDY

Our New and Highly Effective Advanced-Placement Program for experienced Electronic Technicians grants credit for previous Schooling and Professional Experience, and can greatly reduce the time required to complete Program and reach graduation. No residence schooling required for qualified Electronic Technicians. Through this Special Program you can pull all of the loose ends of your electronics background together and earn your B.S.E.E. Degree. Upgrade your status and pay to the Engineering Level. Advance Rapidly! Many finish in 12 months or less. Students and graduates in all 50 States and throughout the World. Established Over 40 Years! Write for free Descriptive Literature.

COOK'S INSTITUTE
OF ELECTRONICS ENGINEERING



4251 CYPRESS DRIVE
JACKSON, MISSISSIPPI 39212

CIRCLE NO. 107 ON FREE INFORMATION CARD

PC CAPERS...

store to find one that did. It would make more sense for Epson to charge another \$25 for the interface kit and include a cable that the buyer knows will work.

The last step is to install the scanner software and test out the printer. At this stage, you have some choices to make. Unlike the case with many other scanner vendors, Epson supplies in the PC interface kit, four different software packages, including *Picture Publisher Plus* from Astral Development, *HALOScan Color* from Media Cybernetics, *Color-Lab ES-300C* from Computer Presentations and *Image-In Scan, Paint, Plus* by CPI. Of the four, *Picture Publisher Plus* offers the most features. Having used an earlier version of it, *Picture Publisher Plus* was the one I installed.

For those of you who missed last year's review of the original version of *Picture Publisher*, it was one of the first grayscale editing and image-manipulation packages available for the PC. Running under Microsoft's *Windows* operating environment, it allows you to edit and manipulate a 256-level grayscale image, even on a monitor that can display only 64 levels of gray or less. At the time, I thought that it was a powerful package that offered all the tools that one might need to be able to accomplish darkroom-quality image touch-ups and compositions, but that it had a long learning curve, and the documentation could have been substantially improved.

Astral Development is now into release 2 of the product, and *Picture Publisher Plus* is a further extension of this release. Both run under both the older version 2.1 and the new *Windows 3.0* environments. Release 2 doesn't really add any new tools to the wide variety that the original provided, but it does add support for device drivers. This makes adding a scanner, video capture board or high-resolution output device a snap.

The new release also makes using some of the functions that *Picture Publisher* offers much simpler. For example, the original version of *Picture Publisher* permitted construction of a calibration map that would modify the grayscale output for a particular output device. Unfortunately, I couldn't really figure out exactly

what the the company meant by this last year, much less puzzle out how to construct such a calibration map.

This year, in release 2, in addition to greatly expanding the documentation, Astral includes a number of input and output calibration maps with the product and makes it easy to choose them from the scanner control menu. This allows the scan to be tailored for the devices that will be used. While the software already supplies a calibration map for the Epson scanner, you can easily modify it or construct a new one. There is a special card with a graduated grayscale printed on it. By scanning this card and deciding where in the overall grayscale you want certain shades to fall, you can build a custom input map that matches the scanning you perform most often.

The output calibration maps allow you to scan with the resolution of the eventual output device in mind. For most users, the 300-dpi laser printer map will be the one used, but other output devices, such as a Linotronic, are also supported.

The "Plus" version of *Picture Publisher* does add a significant feature to the software: the ability to scan and edit in color. While I found no problems in performing color scans, I found the discussion in the documentation regarding the color "model" that *Picture Publisher* uses very confusing. I'm sure that some experimenting would have cleared up at least some of the confusion, but due to some printing problems detailed a bit further on, I was unable to translate my experiments into color output.

Many users will never use some of these features. For those who wish to just scan in a photo, crop it and possibly retouch certain areas of the image before importing the file into a desktop-publishing package, *Picture Publisher* may represent a bit of overkill. This is the reason why Epson supplies several other packages with fewer features and less of a learning curve. All of these packages allow you to perform a color (or gray-level black-and-white) scan and save the image in one or more of the common file formats, such as TIF or PCX. However, none provide the extensive editing and manipulation that *Picture Publisher* of-

Manufacturer Address

ES-300C Color Scanner
Epson America, Inc.
 23530 Hawthorne Blvd.
 Torrance, CA 90506
 Tel.: 213-539-9140

fers and which you may want once you get heavily into scanning.

Epson surprised me with the ES-300C. Its three-color light source and high-speed parallel interface is about a half step in front of the competition. At \$1,995, plus another \$495 for the PC interface kit that includes the parallel card and four software packages, it's not inexpensive, though. At the same time, compared to most of the other scanners I've looked at recently, it's a very good buy at that price. The only other scanner that comes close in features is the MicroTek 300Z, which is also a grayscale and color scanner. MicroTek recently added a new software bundle to the scanner package that I have not yet had the opportunity to look at.

I did experience a few problems in using the ES-300C, and they point out a potential problem for most users of color scanners. The first one occurred—despite a heavy-duty setup consisting of a Compaq DeskPro 486 with 8MB of RAM and a NEC PS-Mate color PostScript printer—I was unable to get a color print-out of photo I had on hand. Saved as a 24-bit full-color TIFF file, the scan takes up 5.5MB of space, and when I tried to import it into *PageMaker* to print it out, the 486 diddled around for about 10 minutes before giving me an "Insufficient Memory" message. All indications point to this being the fault of using *PageMaker* 3.0 with *Windows* 3.0, but until my upgrade to *PageMaker* 3.01 arrives, I won't know for sure.

This also points up the second problem in performing color scans. When saving files in true 24-bit color format, you had better have large amounts of disk space available. Even a black-and-white grayscale scan of an 8-by-10 photo can take up 1.5MB of space. I've taken to storing

scans off-line on floppies, unless they're needed immediately, and use Gazelle System's *BackIt* back-up utility to split the files onto multiple floppies and restore them onto the hard disk when I want to place them in a document.

In the interim, I'm using the ES-300C

primarily as a black-and-white grayscale scanner and really enjoying it. However, I'm also anxiously looking forward to the day when I see my first color printout of a scan roll from the NEC color printer. When it happens, I'll let you know, and what it took to make it happen. **ME**

ELENCO & HITACHI PRODUCTS AT DISCOUNT PRICES

NEW! RSOs (Real-Time & Storage Oscilloscopes) From HITACHI **NEW!**

View, Acquire, Test, Transfer and Document Your Wavelength Data

The RSO - its the new solution

4-Channel, 100MS/s Model	Introductory Price
100MS/s (25MS/s on 4 channels simultaneously), 100MHz, 4kw x 1ch., 2kw x 2ch., 1kw x 4ch.	VC-6145 \$4,695.00
Compact, Full Feature Models	
40MS/s, 100MHz, 4kw x 1ch., 2kw x 2ch.	VC-6045 \$3,049.00
20MS/s, 50MHz, 2kw x 2ch.	VC-6025 \$2,295.00
Low Cost/High Value Models	
20MS/s, 50MHz, 2kw x 2ch.	VC-6024 \$2,049.00
20MS/s, 20MHz, 2kw x 2ch.	VC-6023 \$1,749.00

RSOs from Hitachi feature such functions as roll mode, averaging, save memory, smoothing, interpolation, pretriggering, cursor measurements, plotter interface, and RS-232C interface. With the comfort of analog and the power of digital.

V-212 Hitachi Portable Scopes
\$435 DC to 50MHz, 2-Channel, DC offset function, Alternate magnifier function
 V-525 CRT Readout, Cursor Meas. \$1,025
 V-523 Delayed Sweep \$995
 V-522 Basic Model \$895

V-422 40MHz Dual Trace \$795

Compact Series Scopes

Delayed Sweep
 Lightweight (13lbs)
 2mV Sens
 3 Yr. Warranty
 Model V-1065 Shown

This series provides many new functions such as CRT Readout, Cursor measurements (V-1085/1065/665), Frequency Ctr (V-1085), Swepttime Autotriggering and Trigger Lock using a 6-inch CRT. You don't feel the compactness in terms of performance and operation.

V-660	60MHz Dual Trace	\$1,195
V-665	60MHz Dual Trace w/Cursor	\$1,345
V-1060	100MHz Dual Trace	\$1,425
V-1065	100MHz Dual Trace w/Cursor	\$1,695
V-1085	100MHz Quad Trace w/Cursor	\$2,045
V-1100A	100MHz Quad Trace w/Cursor	\$2,295
V-1150	150MHz Quad Trace w/Cursor	\$2,775

Elenco 35MHz Dual Trace \$495
 Good to 50MHz
 MO-1252

- High luminance 6" CRT
- 1mV Sensitivity
- 6KV Acceleration Voltage
- 10ns Rise Time
- X-Y Operation = Z Axis
- Delayed Triggering Sweep
- Includes 2 P-1 Probes

20MHz Elenco Oscilloscope \$375
 MO-1251

- Dual Trace
- Component Tester
- 6" CRT
- X-Y Operation
- TV Sync
- 2 p-1 Probes

FREE DMM with purchase of ANY SCOPE

SCOPE PROBES
 P-1 65MHz, 1x, 10x \$19.95
 P-2 100MHz, 1x, 10x \$23.95

All scopes include probes, schematics, operators manual, and 3 year (2 yrs for Elenco scopes) world wide warranty on parts & labor. Many accessories available for all Hitachi scopes. Call or write for complete specifications on these and many other line oscilloscopes.

WE NOW CARRY COMPLETE LINE OF FLUKE MULTIMETERS Models

21F	83
23F	85
25F	87
27F	8050A
73	8060A
75	8062A
77F	+ More

CALL FOR SPECIAL PRICING

True RMS 4 1/2 Digit Multimeter M-7000 \$135

05% DC Accuracy
 1% Fluorescence with Freq. Counter and deluxe case

10 Function Multimeter CM-345 \$65

AC + DC Voltage & Amps
 Resistance to 2000kΩ
 Diode, Logic, & Trans Test
 Capacitance to 200µF

Digital Capacitance Meter CM-1550 \$58.95

9 Ranges
 1µl-20,000µF
 .5% basic accy
 Zero control with case

Digital LCR Meter LC-1801 \$125

Measures:
 Caps 1µl-200µl
 Res. 0.1-20M

Function Generator Blox #9600 \$28.95

Provides sine, triangle, square wave from 1Hz to 1MHz AM or FM capability

Audio Generator SG-9200 \$129

Low distortion (< 05%)
 10-1MHz
 Sine/Square Wave
 600 ohm Output Impedance, High Output Voltage

Wide Band Signal Generators SG-9000 \$129

RF Freq 100K-450MHz
 AM Modulation of 1KHz
 Variable RF output

Wide Band Signal Generators SG-9000 \$129

RF Freq 100K-450MHz
 AM Modulation of 1KHz
 Variable RF output

Soldering Station Temperature Controlled SL-30 \$99

Digital display
 Temp range: 300F-900F
 Grounded tip
 Overheat protect

Color Convergence Generator SG-200 \$69.95

Finest in the Industry
 10 rock steady patterns

10MHz Oscilloscope S-3000 \$275

10MHz DC or AC
 Triggered Sweep
 Calibrated Volt & Freq
 Reads Volts & Freq

Temperature Probe M-110CF \$29.95

Semiconductor type
 Range
 -50F-300F
 Fits most digital multimeters

AC Current Meter ST-1010 \$69.95

1000 Amps
 Data & Peak hold
 5 Functions
 Deluxe Case

Decode Blox #9610 or #9620 \$18.95

#9610 Resistor Blox
 47 ohm to 1M & 100K pot
 #9620 Capacitor Blox
 47pF to 10MFD

Quad Power Supply XP-580 \$59.95

2-20V @ 2A
 12V @ 1A
 5V @ 3A
 -5V @ 5A
 Fully regulated and short circuit protected
 XP-575 without meters \$39.95

AM/FM TRANSISTOR RADIO KIT with TRAINING COURSE Model AM/FM-108 \$26.95

Makes a great school project

14 Transistors + 5 Diodes
 Circuits are laid out in systematic order on an oversized PC board for easy understanding of the flow of radio signals, from antenna to speaker. Complete course includes all parts, PC board and training manual. When completed you will be proud to display your masterpiece.

Digital Triple Power Supply XP-765 \$249

Fully regulated, Short circuit protected with 2 limit control, 3 separate supplies
 XP-660 with Analog Meters \$175

GF-8016 Function Generator with Freq. Counter \$249

Sine, Square, Triangle Pulse, Ramp, 2 to 2MHz
 Freq Counter 1-10MHz
 GF-8015 without Freq. Meter \$179

AM/FM TRANSISTOR RADIO KIT with TRAINING COURSE Model AM/FM-108 \$26.95

Makes a great school project

14 Transistors + 5 Diodes
 Circuits are laid out in systematic order on an oversized PC board for easy understanding of the flow of radio signals, from antenna to speaker. Complete course includes all parts, PC board and training manual. When completed you will be proud to display your masterpiece.

7 Transistor AM RADIO KIT \$16.95

WE WILL NOT BE UNDERSOLD!
 UPS Shipping: 48 States 5%
 (\$10 Max) IL Res., 7% Tax

C & S SALES INC.
 1245 Rosewood, Deerfield, IL 60015
 (800) 292-7711 (708) 541-0710

15 Day Money Back Guarantee
 2 Year Warranty Prices subject to change
WRITE FOR FREE CATALOG

Inexpensive Ways To Speed Up Your PC

By TJ Byers

Did you know that there's untapped power lurking under the hood of your PC? No matter whether your PC is a 4.77-MHz original or a 33-MHz speedster, you're probably not getting the full potential your PC has to offer.

You can tap that power through software. Here we show you how to gain the most speed from your PC using software you already have on hand, generally in DOS, or tell you how to obtain the software at little cost.

Hard-Disk Drives

Among the bottlenecks in a PC is, surprisingly, the hard-disk drive. Fortunately, there are several ways to improve the speed of the hard disk without spending a bundle of money.

The biggest reason for the hard disk's sluggish performance is the way the data is organized on the disk in thousands of storage areas called sectors. To keep track of which sector belongs to which file, the hard disk uses a special look-up chart commonly known as the file allocation table (FAT).

Each time a file is requested, the hard disk must go through a time-consuming procedure of first moving the recording head to the FAT area, reading the FAT and then moving the head to the sectors listed by the FAT. Obviously, much time could be saved if the head didn't have to move around so often.

- **FASTOPEN.** An easy way to reduce the number of times the FAT is accessed is with the FASTOPEN program found in DOS (3.3 or later). FASTOPEN is a memory-resident (TSR) program that remembers the sector locations of the most-recently-used files. The first time you access a file, FASTOPEN records (in a memory buffer) the path taken to get to the file sectors. On the next file request, the PC first examines the contents of the FASTOPEN buffer for the file location. If the file is on FASTOPEN's list of locations, the FAT read step is bypassed and the sector is accessed directly. If the file is not in the buffer, the FAT is read and the

Listing 1. BACKCOPY Program

```
C:
cd\
attrib +a C:\*.* /s
echo insert first diskette
pause
:start
echo insert next diskette
erase a:.
xcopy *.* a:/s/m
if errorlevel 4 goto start
:end
echo backup complete
```

This batch file is a generic DOS back-up program. Essentially, the program tags all files in the C: drive for back-up and copies them one by one to floppy diskettes. When the first diskette is filled, the program asks for another blank, formatted diskette (make sure you have enough on hand). The procedure continues until all files are backed up. If you wish to back up another drive, simply modify the first line to identify the drive.

path is added to FASTOPEN's list of files.

FASTOPEN can be installed only once per boot and is normally placed in the AUTOEXEC.BAT file. However, in the FASTOPEN command statement you can enter as many disk drives as you wish to monitor. For example, if you have C: and D: drives, you can request that FASTOPEN keep tabs on both drives by using the command statement:

```
FASTOPEN C: D:
```

FASTOPEN can also be used with the two floppy drives, A: and B:, but the speed gain is so slight that you won't even notice any speed-up.

You can also specify the number of files you want FASTOPEN to remember for each drive. The minimum is 10, the maximum is 999 files. For example, if we wanted FASTOPEN to remember the location of 100 files on the C: drive, you would enter it as:

```
FASTOPEN C: = 100
```

When specifying the number of files, be aware that FASTOPEN counts subdirectories as files. If the file you're looking

for happens to be in "c: \ dir1 \ dir2 . . . \ dir10," FASTOPEN will use 10 of its allocated file entries to store the path to the subdirectory where the file resides.

Be careful that you don't specify too many FASTOPEN files per drive. The more files the buffer holds, the longer it takes to search them. If the number of files accessed exceeds the capacity specified for FASTOPEN, the least-often used files are deleted and their buffers are used to hold the newest file information.

A rule of thumb for determining the optimum number of FASTOPEN files is to count the number of files you use on a regular basis and triple that figure. If no file count is specified, FASTOPEN defaults to 35 files.

- **BUFFERS.** Another way to speed up the hard disk is to reduce the number of times it repeatedly accesses the same data sectors. This is done by copying the data from the most commonly used sectors into RAM. There are several utilities that can do this, including DOS's own BUFFERS program.

BUFFERS is a TSR utility that the PC uses to store data when reading from or writing to a disk. When a program requests data, DOS always checks if that data is already in the BUFFERS area. If the data is in a buffer, DOS simply transfers it to the application's RAM area without reading it from the disk. Otherwise, DOS reads the data from the disk into the buffer and then transfers it to the application program. Consequently, the buffer area always contains the most recently used data. By adding more buffers to your system, you can increase the speed of the hard disk because the odds of finding the data in the buffer is increased by the larger number of buffers holding data.

Unlike FASTOPEN, you don't have to load BUFFERS because it's automatically loaded by DOS when the system is turned on or booted. The number of buffers used depends on the DOS version you have. DOS 3.0 and 3.1 default to 3 buffers, while DOS 3.3 and later use 15 buffers. However, you can alter the number of buffers by placing the

```
BUFFERS = X
```

command in the CONFIG.SYS file, where *X* is the number of buffers you want installed. Up to 99 buffers are permitted.

The improved performance gained by adding buffers to the system depends on the type of application you're using and the number of buffers. Applications that read and write records in a random fashion, such as database programs like *dBASE III* gain the most, while programs that do sequential reads and writes like word processors benefit very little from added buffers. Furthermore, if you have too many buffers, you can actually degrade performance because DOS always searches the buffers for data before going to the disk.

So how many buffers are best? For general purpose use, 32 buffers seems about right. Heavy database users may wish to increase that number to 40, and those using mostly word processing might do well to reduce it to 10.

- *Disk Caching.* Disk speed can be increased even more by using software to cache the data rather than relying on the buffers. Software disk caching is more efficient because it's smarter than the DOS buffers and there's no limit to the size of the cache other than the RAM capacity of the system itself. Typically, accessing data from a software disk cache is five to ten times faster than accessing the same data from the disk using buffers.

Dozens of disk-caching programs exist, including public-domain programs that can be found on many bulletin boards. The quickest disk cache we've run across is *Super PC-Kwik* from Multi-soft Corp. (See the "Speed Up Your PC With Disk Caching Software Box" for a review of *Super PC-Kwik*).

All disk caching programs are TSR memory resident and consume a certain amount of RAM, which depends on the size of the cache. Users usually have to walk a tight-rope on cache size to determine the best compromise between cache performance and available program memory. If you have a system with 512K of RAM running under DOS 3.3 and you use 128K of that RAM for the cache, for example, you're left with about 315K of operating RAM—which isn't enough to

run many applications programs.

If you have more than 640K RAM in your PC, you may be able to use it for caching, saving your system RAM for applications. But you must be careful that this memory isn't already being used by the PC or another application. For example, the PC might use additional RAM memory for relocating the BIOS that's stored in a slower ROM IC. This is often called shadow RAM. Memory beyond 640K is also a popular haven for print spoolers and expanded memory managers. If there's a memory conflict, the system could lock up. Fortunately, good

disk-caching programs let you map the exact area where you want the cache installed, which means you can work around RAM already claimed by other utility programs.

The issue of how much disk cache is optimum is a matter of debate. Some experts claim that bigger is better, while others say that small disk caches are as effective as larger ones for most applications. It's commonly agreed that 256K is an efficient minimum amount of cache memory, however.

Disk caching isn't without its problems. For example, programs that re-

Listing 2. Keyboard Accelerator

```
10 TOTAL.%=0
20 RESTORE:OPEN "KEYSPEED.COM" AS #1 LEN=1
30 FIELD #1, 1 AS KEY.BYTE.$
40 FOR I.%=1 TO 181
50   READ KEY.DATA.%
60   TOTAL.#=TOTAL.# + KEY.DATA.%
70   LSET KEY.BYTE.$ = CHR$(KEY.DATA.%)
80   PUT #1
90 NEXT I.%
100 IF TOTAL.#=20223 GOTO 110 ELSE PRINT "ERROR IN DATA.
CHECK DATA ENTRIES AND TRY AGAIN.":END
110 CLOSE #1
120 PRINT "KEYBOARD ACCELERATOR FILE CREATED."
130 DATA 190, 129, 0, 51, 219, 172, 60, 32
140 DATA 116, 251, 114, 38, 254, 200, 36, 223
150 DATA 44, 64, 115, 3, 78, 235, 6, 60
160 DATA 31, 119, 44, 134, 195, 172, 60, 32
170 DATA 116, 251, 114, 14, 44, 49, 114, 31
180 DATA 60, 3, 119, 27, 177, 5, 210, 224
190 DATA 10, 216, 176, 243, 232, 79, 0, 227
200 DATA 9, 134, 195, 232, 72, 0, 227, 2
210 DATA 205, 32, 186, 80, 1, 235, 3, 186
220 DATA 97, 1, 80, 9, 205, 33, 205, 32
230 DATA 104, 97, 114, 100, 119, 97, 114, 101
240 DATA 32, 101, 114, 114, 111, 114, 13, 10
250 DATA 36, 118, 97, 108, 105, 100, 32, 112
260 DATA 97, 114, 97, 109, 101, 116, 101, 114
270 DATA 115, 32, 97, 114, 101, 32, 65, 45
280 DATA 90, 44, 32, 116, 104, 101, 110, 32
290 DATA 49, 45, 52, 13, 10, 36, 250, 134
300 DATA 196, 51, 201, 228, 100, 168, 2, 224
310 DATA 250, 227, 32, 134, 196, 230, 96, 51
320 DATA 201, 228, 100, 168, 2, 224, 250, 227
330 DATA 18, 51, 201, 228, 100, 168, 1, 225
340 DATA 250, 227, 8, 228, 96, 60, 250, 116
350 DATA 2, 51, 201, 251, 195
360 SYSTEM
```

This BASIC program creates a keyboard accelerator file called KEYSPEED.COM. Directions for its use are listed in the text. However, the utility will not work with the original PC, which has a fixed typematic rate.

Speed Up Your PC With Disk Caching Software

Regardless of the speed of your PC, moving data to and from a disk—even a hard disk—is often not sufficiently fast enough to suit the user. Fortunately, there are software solutions called disk caching that significantly speed up disk access time by moving often-used data from the disk to RAM memory.

This eliminates the time-consuming mechanical aspects of disk drives. Such RAM can be conventional, expanded or extended memory. Conventional or real memory is anything up to 1MB, but DOS can use only 640K of it directly for applications. Extended memory is RAM above 1MB that can be used as a RAM disk. RAM between 640KB and 1MB is set aside for system use. Expanded memory, in contrast, is additional RAM that conforms to LIM (Lotus/Intel/Microsoft) 3.2 or 4.0 specifications. Expanded memory uses a 64KB chunk between 784KB and 1MB so that the extra memory above 1MB can work with DOS if it were within the 640KB limit. PCs and compatibles with 8088 and 8086 microprocessors do not support extended memory because they cannot address more than 1MB.

As data is read from disk by an application program such as *Lotus 1-2-3*, the disk-caching program stores that data in a special area of RAM that's been set aside just for caching use. The next time the application asks for data from the hard disk, the caching program first looks in the cache. If it finds the requested data, it forwards it considerably faster to the program from the cache instead of from the disk.

If the information is not found in the caching RAM, the caching program reads it from the disk and places it in the cache for future use. For most applications, which often access the same data over and over, the cache can increase hard-disk performance five- to ten-fold.

Super PC-Kwik (Multisoft Corp., 15100 SW Koll Pkwy. Beaverton, OR 97006; tel.: 503-644-5644) is a disk-

```

Super PC-Kwik(TM) Disk Accelerator, Version 3.32, S/N 203642
Copyright 1986, 1989 Multisoft Corporation, All Rights Reserved.
Program licensed exclusively for use on a single computer.
Subset of program (SUPERPCK.SB2) loaded.
Following is a list of the parameters in effect:
  /D+ Advanced support of diskette transfers.
  /H+ Advanced support of hard disk transfers.
  /B+ Perform batch copies to/from cache.
  /O- Standard algorithm for advanced support.
  /Q- Return DOS prompt normally.
  /T+ Track buffering using a 25-sector buffer.
  /U+ Use volume change hardware.
  /W+ Check write requests for redundancy.
  /E+ 384K Extended memory cache at 1824K has been set up as follows:
      Conventional      Extended
DOS/Resident          95K             0K
PC-Kwik                46K            384K
Available              500K           0K
Total                  640K           384K
Super PC-Kwik program successfully installed. Type "SUPERPCK /?" for help.
    
```

Printout of opening window of *Super PC-Kwik* from Multisoft Corp.

caching program that enhances the performance of most drive types, including hard- and floppy-disk drives of all sizes, and Bernoulli boxes. It can be purchased as a stand-alone program for \$79.95, or as part of a \$129.95 package called *PC-Kwik Power Pak*. The latter contains four additional utilities that speed up other PC operations, including the keyboard, printer and screen.

Super PC-Kwik lets you choose the type of memory you wish to use for your disk cache: expanded, extended or conventional. The program automatically scans your PC's memory for a cache location, beginning with expanded, then extended and finally conventional RAM. The cache is set up in the first available RAM found. It also recognizes when another application requires the same RAM space and adjusts the cache location so that the two don't conflict. You can also manually specify the RAM type and cache location.

Super PC-Kwik is a transparent utility that you can forget about once you perform the setup routine. Setup is via a simple menu-driven screen that requires only the location of the boot drive. The setup program then takes charge, to the extent of modifying the AUTOEXEC.BAT and CONFIG.SYS files (with your permission) so that *Super PC-Kwik* is activated on power-up. How-

ever, no other options are available from the menu, leaving you with *Super PC-Kwik*'s default values.

Although the default values are acceptable, they need to be tweaked if you want maximum performance from the disk cache. Without doubt, you'll want to change the size of the cache because the setup program defaults the cache size to the amount of RAM available. This is a small 64KB when using conventional RAM and can be as large as 15MB with extended RAM—neither of which are optimal values.

Another parameter of interest is the optional advanced read algorithm that gives read transfers priority over write transfers. The *Super PC-Kwik* manual explains that this option may either speed up or slow down data transfers, depending on your hard disk, and that you should do some experimenting to find the best setting.

An interesting feature that is not installed as a default is one that returns you to the DOS or program prompt while the cache is still writing to disk. This gives you cursor control before it's normally available and reduces your waiting time. But I can see where such control might lead to catastrophic consequences if not treated with respect. All changes to *Super PC-Kwik* are done by editing the AUTOEXEC.BAT file.

Once installed, the disk-caching operations are transparent and quickly forgotten. In fact, you'd never know *Super PC-Kwik* is on the job—until you remember how long it used to take for the disk drive light to extinguish. I highly recommend it if you do not use Microsoft's *Windows 3.0*, which contains its own caching utility (*SmartDrive*) and could cause a software conflict if used with another such program.

Optimizing Cache Size

All disk-caching programs are terminate-and-stay-resident (TSR) programs that consume a certain amount of RAM. The amount of RAM used depends on the size of the cache. The issue of how much disk cache is optimum is hotly debated. Some experts claim that bigger is better, others say small disk caches are as effective as larger ones for most applications.

I put this question to the test using *Super PC-Kwik* with several popular programs and discovered that there is indeed an optimum size: it's 256K. Time trials using several different types of applications with both large and small files show a linear increase in speed as the cache approaches 256K. After 256K, the speed increase slows considerably, with the peak somewhere near 512K. Beyond 512K speed declines. So why did we choose 256K as optimum when 512K is slightly faster? Because 256K just fits in shadow RAM, the extended memory above 640KB of 80286, 80386 and 80386SX computers with 1MB of RAM. To have a 512K cache would require a costly RAM expansion board beyond 1MB. Therefore, the price-to-performance ratio just isn't there if you have to buy the above-1MB RAM board just for disk-caching use. Of course, if your computer has more than 1MB, 512K is the caching size you should use.

CIRCLE NO. 127 ON FREE INFORMATION CARD

quire specific areas of RAM, particularly games, can cause the system to crash if that area happens to be part of your disk cache. Some hard disks, usually those with hardware-caching controllers, can't work with disk caching because their interrupts don't match. And you'll run across an occasional PC, like the Tandon 386/33, that just plain refuses to run disk-caching software because of drive or BIOS incompatibility.

One final point: When using software disk caching it may pay to reduce the number of BUFFERS to three and eliminate the FASTOPEN command. It's recommended that you experiment with this because DOS looks through these buffers before it does the cache, which slows performance.

- *Hard-Disk Housekeeping.* As a hard disk ages, its file-access time grows longer. This isn't because of any mechanical deterioration, but because of the way DOS writes files to the disk.

When DOS writes to a freshly formatted disk, the data is assigned to sectors sequentially, beginning with sector number one and continuing until all the needed sectors are filled. The next file begins where the first file left off, and so the process continues.

As files are deleted or changed in size, however, sectors are cleared of data. This leaves gaps between files. Each time DOS writes a file to the disk, it begins its search for empty sectors from square one, and the first empty sector it finds gets used. This creates a break in the continuity of the file, called fragmentation, that causes the head to dart about picking up the scattered sectors in the proper sequence—and consuming precious time in the process. With use, fragmentation grows worse.

One way to restore sequential order to a fragmented disk is to use a disk organizer utility, such as *Disk Optimizer* from SoftLogic Solutions. *Disk Optimizer*, like most disk organizers, is a simple-to-use program that goes about the task of putting your files back in sequence by moving maverick sectors to a small working area a few at a time and shuffling them about until order is restored. The

procedure is akin to unscrambling Rubik's Cube, and so is the time involved. Plan on doing this during your lunch or after hours.

Another way to de-fragment files, and one that kills two birds with one stone, is to back up everything that's on the hard disk, file by file, reformat the hard disk, then restore all files and directories. The process is relatively cheap and simple, and in the deal you get back-up copies of your files—something most of us put off doing until it's too late. Although you can buy special drives and programs to do the back-up for you, it's a lot cheaper to roll your own back-up program using the DOS batch file listed in Listing 1. (*Do not be tempted to use DOS's BACKUP and RESTORE commands for this procedure—it could end in disaster.*)

A quick way to tell if there are fragmented files on your hard disk is to use the command:

CHKDSK * *

Keep in mind that this command checks only one directory at a time, so you must run the command from the DOS prompt within each subdirectory on the disk to get a clear picture of the extent of the fragmentation. Focus on the directories you most commonly use because they'll be the first to fragment.

- *Virtual Disk Drives.* Try as you might, there's no way you can overcome the mechanical limitations of a disk drive. It takes a finite amount of time to move the head from one location to another, regardless how much you buffer or refine the process.

However, a drive doesn't have to be physical. You can simulate a disk drive in RAM using a RAM-disk software utility. A RAM disk is considerably faster than a disk drive because you don't have to search a mechanical platter looking for the desired sector. A RAM disk simply looks through the memory addresses to find a data sector, doing so at electronic speed. Speed increases of ten-fold and more aren't uncommon with a RAM disk.

Several RAM-disk programs are available, including those bundled with multi-purpose PC utility packages like *PC-*

Kwik Power Pak and AST's *SuperPak Utility Software*. However, there's no need to look any further than DOS to find a RAM-disk program; it's under the guise of *VDISK.SYS*. This program installs in the *CONFIG.SYS* file using the command:

```
DEVICE = VDISK.SYS
```

Just make sure that you specify the path to the *VDISK* program, or place the program in the root directory.

Although RAM disks seem like the ideal solution to pokey hard disks, they're far from perfect. Typically, the largest RAM disk you can install on a PC without extended memory is about 128K—a size that's smaller than many data files and far too small to load any serious application. This is the same dilemma the disk cache faces, except that the disk cache has an advantage over the RAM disk in that it's not rigidly structured. Because the RAM disk works and behaves like a hard disk, the disk must have enough room to accommodate an entire file or application. The disk cache, on the other hand, rids itself of lesser-used data to make room for newer data.

On one hand, we have a super-fast electronic disk drive with access to complete files and all the amenities a hard drive has to offer. On the other, we have a flexible data cache that changes its data contents with every whim but seldom contains an entire file or program. Because most PCs have a RAM capacity of 1MB or less, the disk cache wins hands down.

If you're among the many PC AT and AT-compatible owners who bought a "fully loaded" system, complete with an extended memory card of 2MB or better, a RAM disk may be just what you need to take advantage of that RAM. If you can create a working RAM disk of 700K or more, you'll find that it outperforms a disk cache by more than two to one.

But beware. RAM-disk data is volatile and will disappear the moment you reset the system or lose power. It's your responsibility to make sure the data is periodically backed up. Disk caches, on the other hand, automatically save file changes to the hard disk as they're made.

Massaging the Keyboard

Another area where you can gain a sizable amount of speed is with the keyboard. The PC keyboard is a very complex instrument that contains a relatively powerful microprocessor of its own. Basically, the keyboard analyzes keystrokes and translates them into signals that the PC recognizes as characters or control commands.

• *Keyboard Accelerators*. An easy way to gain keyboard speed is to install a keyboard accelerator. If a key is pressed and held down for any length of time, the keyboard interprets this to mean that you want that keystroke repeated. Keyboard accelerators let you control the speed at which repeated key characters are transferred to the PC, thereby improving the speed of cursor movements on the screen.

Both the length of time the key is pressed before it's recognized as being held down and the rate at which the repeated character is sent to the PC are ad-

justable (except for the original PC, which has a fixed keyboard rate). In a normal DOS system, the delay time (time before a held key is detected) is 0.5 second, and the typematic rate (the speed at which the character is sent to the PC) is nine characters per second.

Keyboard accelerators are less common than RAM disks, but can be found in several bundled packages like *PC-Kwik Power Pak* and on many bulletin boards. *PC-Kwik's* keyboard accelerator is typical of most in that it lets you adjust both the delay time and typematic rate. Most commercial keyboard accelerators also have graduated acceleration, where the typematic rate gains in speed the longer the key is held down to prevent overrun on a short string of characters.

Using the BASIC program shown in Listing 2, you can create your own keyboard accelerator at no cost. After you've entered and saved the BASIC program, type RUN. This creates a *KEYSPEED.COM* file that becomes your keyboard

Listing 3. Keyboard Programmer

```
10 CLS: CLEAR: KEY OFF
20 A$ = "[0;"
30 C$ = " ;'"
40 E$ = "';13p"
50 OPEN "FKEY" FOR OUTPUT AS 1
60 GOTO 120
70 '-----another key subroutine-----
80 CLS
90 LOCATE 10,20: INPUT "DO YOU WISH TO CHANGE ANOTHER
KEY"; K$
100 IF K$="N" OR K$="n" OR K$="NO" OR K$="no" THEN 190
110 IF K$="" THEN PRINT CHR$(7): GOTO 90
120 '-----program begins-----
125 CLS
130 LOCATE 10,15: INPUT "ENTER THE KEY CODE OF THE FUNCTION
KEY YOU WISH TO PROGRAM."; B$
140 CLS
150 LOCATE 10,15: INPUT "ENTER YOUR DOS COMMAND"; D$
160 X$ = A$ + B$ + C$ + D$ + E$
170 PRINT #1, CHR$(27); X$
180 GOSUB 70
190 CLOSE #1
200 SHELL "TYPE FKEY"
210 CLS
220 LOCATE 10,32: PRINT "CHANGE COMPLETE"
230 SYSTEM
```

To run the keyboard programmer program, you must have *ANSI.SYS* installed in the *CONFIG.SYS* file. The key codes for the function keys are listed in Table 1. After the file is created, run the file each time you boot the PC using the command: *TYPE FKEY*.

accelerator. To use KEYSPEED.COM, use the command:

KEYSPEED [typematic rate] [delay]

The typematic rate is expressed as a letter between A and Z, with A being equal to 30 characters per second and Z equal to 2 characters per second. Delay time is adjustable in four numerical steps between 0.25 and 1.25 second, with step 1 being the fastest. For example, a command of

KEYSPEED A1

would set the keyboard speed at 30 characters per second with a 0.25-second delay period. Default is 10 characters per second and 0.5 second of delay.

But watch yourself. If keyboard speed outruns your reaction time, you'll find yourself spending more time using the backspace key than any other. We suggest you build up to top speed gradually.

- *Programming Function Keys.* Perhaps the most overlooked speed option a keyboard has to offer are its function keys. Software applications make extensive use of these time savers, but few people are aware that they can program these keys to speed up DOS operations.

Programming the keyboard is done using the ANSI.SYS command found in DOS. ANSI.SYS contains a look-up table that tells the PC how each keystroke is to be interpreted. In its original format, the table lists commands for only six function keys, F1 through F6. By adding to the table, you can define DOS functions for the remaining 42 function keys (34 if you have an older 84-key keyboard).

The function keys can be defined using the simple BASIC program given in Listing 3. To define a key, you must supply the program with two simple facts. First is the code of the key you wish to define. A complete list of function key codes is shown in Table 1. Notice that by using the Alt, Ctrl, and Shift keys together with the function keys, you can turn 12 function keys into 48.

Next, you're asked for the DOS command you wish to assign to that key. This can be any DOS or software application command, and it can contain any switch or parameter attachments the command

Table 1. Function Key Codes

	F1	F2	F3	F4	F5	F6	F7	F8	F9	F10	F11	F12
Base	59	60	61	62	63	64	65	66	67	68	133	134
Shift	84	85	86	87	88	89	90	91	92	93	135	136
Ctrl	94	95	96	97	98	99	100	101	102	103	137	138
Alt	104	105	106	107	108	109	110	111	112	113	139	140

requires. For example, if you wish to have one of the keys do a directory display with pauses between screens, you could use the command:

DIR/MORE

Your only limitations are that the command fits on one line and it doesn't exceed 255 characters, spaces included.

To invoke operations that involve more than one command, you can create a batch file containing the string of commands you wish to use and program the batch file name into the desired function key. For the function key to work as expected, you must be careful of how you define the function key and begin the batch file. First, the function key's command must contain a complete path to the batch file. Second, the first line of your batch file must contain the letter of the drive on which the batch file resides, and the second line must contain the name of the directory preceded by the CD command. For example, a typical function key command might read:

C: \ WORD \ START

This means that the batch file you want to invoke is named START, which is located in the WORD directory on the C: drive. Since you may be in the XYZ directory of the F: drive when you press the function key, the opening lines of the batch file must read

```
:C:
CD \ WORD
```

That will land you in the batch file directory, from which you can begin your routines. If you don't move DOS operations to the batch file's directory, you may find

yourself somewhere in downtown Peoria with no ticket home.

After defining one function key, the program asks you if you wish to define another function key. If you do, continue with the process until you've defined as many function keys as you wish. When you're finished, the program creates a file called FKEY and programs the function keys as you requested. You have to create this file only once. However, each time you boot the PC you must run the FKEY program using the command:

TYPE FKEY

It's a good idea to place this command in the AUTOEXEC.BAT file. Make sure that ANSI.SYS is installed in the CONFIG.SYS file or the keys won't program and that the FKEY file is in the current directory or has a path specified.

To make changes to the FKEY program, you can run the BASIC file again, but be certain you define each key you want to use again. Running FKEY erases all previous function-key programming. Minor command changes to the FKEY file can be made using a line editor, in which case, previous keyboard programming isn't lost.

Printers

Your printer is undoubtedly the slowest part of your PC. However, most of us don't use it often enough to notice the time it wastes, which makes us complaisant about its sluggishness. Generally, we find it a good excuse to step away from the desk. But for users who must contend with constant printer chatter, it becomes quite the bottleneck.

Fortunately, there are ways to speed up

SOFTWARE FOCUS ...

the printer—not physically, but through the use of printer buffers and print spoolers. The difference between a printer buffer and a print spooler is that printer buffering requires you to first save the file to disk, then queue the file for printing; a print spooler intercepts the printer output from the application, stores it in RAM or on disk, queues it for printing, and then does the files out to the printer at a rate it can accept.

Both are background applications that let you use the PC while the printer runs in the background. However, to pull this off, the printer software must time-share the PC with your application, causing unavoidable delays in one process or the other. But at least both are running at the same time, albeit at a slower pace than normal—which isn't a real problem, considering that your PC spends most of its time waiting for you to input something from the keyboard. The occasional hesitation may be annoying to some users.

The alternative is a hardware print spooler with its own RAM that plugs into the printer port or an adapter slot.

DOS itself contains a printer buffer program called PRINT that queues files stored on the disk for printing. Of course, the files must be in the proper printer format; otherwise, you get garbage. Default size of the printer buffer is 512 bytes, but the buffer is expandable to the limit of available RAM.

As mentioned, printer buffers require that you save a file to disk, then queue it for printing. A faster method is to use a print spooler, another utility found in the *PC-Kwik Power Pak* and other commercial products. Print spoolers have the advantage that you don't have to quit your application to queue files for printing. The spooler intercepts your printer output and does the queuing for you without you having to quit your application. But get ready to pay the price in RAM.

Unlike printer buffers, which use very

little RAM, a print spooler is more like a disk cache in that you have to assign a block of RAM to it. Fortunately, the RAM used by a spooler doesn't have to be as large as that used by a disk cache, and 32K is adequate for most purposes because files that are larger than the spooler are saved to disk for later access.

Let's Get Started

The best part about using software programs to boost the speed of your PC is that they work on all makes and models of computers. Whether you have an original 4.77-MHz PC or a 33-MHz speedster, or even a 486 machine, you can enhance your computer's performance. And when you consider that some of these speed-up programs are either included with DOS or ready to be keyed in as BASIC programs, there's no excuse for not speeding up your PC right now.

ORGANIZE AND PROTECT YOUR COPIES OF MODERN ELECTRONICS

Custom-made titled cases and binders, designed to hold a year's issues, provide the storage system to help protect your valuable copies from damage. Reinforced board covered with durable leather-like material in (color), title hot-stamped in (gold/silver), cases V-notched for easy access, binders have special spring mechanism to hold individual rods which easily snap in.



Cases: 1—\$ 7.95
3—\$21.95
6—\$39.95

Binders: 1—\$ 9.95
3—\$27.95
6—\$52.95

MODERN ELECTRONICS
Jesse Jones Industries, Dept. Mod-E
499 East Erie Avenue, Philadelphia, PA 19141

Please send _____ cases; _____ binders

Enclosed is \$ _____

Charge my: (Minimum \$15)
 American Express Visa
 MasterCard Diners Club

Card # _____ Exp. Date _____

Signature _____

Charge Orders. Call TOLL FREE 7 days, 24 hours #1-800-972-5858

Print Name _____

Address _____

No P.O. Box Numbers Please

City/State/Zip _____

PA residents add 6% sales tax

SATISFACTION GUARANTEED

Add \$1 per case/binder postage and handling. Outside USA \$2.50 per case/binder. (U.S. funds only.)

EDITORIAL ... (from page 7)

The new cells share the heavy loads with Ni-Cds, provide low-current standby power, and recharge the Ni-Cd cells. The novel power device includes a control circuit to prevent overcharging Ni-Cds and an end-of-life sensor to indicate when the zinc/air battery needs replacing.

As you can see, we've got some welcome advances in generating energy for the coming years. Unfortunately, the big ones—heating oil and gasoline—will still be old technology for some time. Nevertheless, let's count our blessings for the small improvements.

Art Salsberg

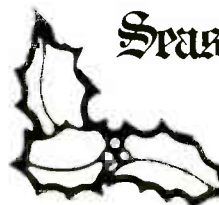

Seasons Greetings from
the Staff of
Modern Electronics

Article Cumulative Index

January 1990 Through December 1990

Columns & Departments

Communications

- Scanners and Scanner Antennas
by Curt Phillips.....Jan
Ace Model AR900 Portable Scanner
by Louis A. Smith.....Feb
Citizens Band Update by Curt Phillips...Apr
New No-Code Ham License Proposed
by Curt Phillips.....Jul
Antenna Grounding Basics
by Joseph J. Carr.....Aug

Editorial

- By Art Salsberg
Automotive Electronics.....Jan
Long-Term Commitments.....Feb
Trying It Out.....Mar
Repair Work.....Apr
Thanks For the Memories.....May
Career Upgrading.....Jun
On the Waning Edge.....Jul
Embedding It.....Aug
Never Buy a Zero.....Sep
Beating the Drums.....Oct
Modern Electronic Drafting.....Nov
Energy.....Dec

Electronics Notebook

- By Forrest M. Mims III
Experimenting With Conductive Ink....Jan
Experimenting With a Geiger Counter...Feb
Experimenting With an R-F Spectrum Analyzer.....Mar
More About Superconductors.....Apr
Experimenting With Incandescent Lamps.....May
High-Power Infrared Light-Emitting Diodes.....Jun
High-Power Visible Light-Emitting Diodes.....Jul
Nonvolatile Event Timers and Totalizers.....Aug
The Power MOSFET.....Sep
A High-Sensitivity Lightwave Receiver..Oct
Analog Arithmetic.....Nov
Experimenting With Surplus Goodies...Dec

PC Capers

- By Ted Needleman
PC Flight Guide & MacPrint Software...Jan
Diagnostics & CAT Reader OCR Software Packages.....Feb
The Winter 1989 COMDEX Report....Mar
Hands-On Look at the Hewlett-Packard LaserJet IIP.....Apr
Laser Wars: Hewlett-Packard's New LaserJet III Laser Printer.....May

- A Replacement Battery, Hand-Held Scanner and Trackball.....Jun
Good News for Laser Printers.....Jul
Epson's Laptop Features Removable Hard-Disk Drives.....Aug
The Real Windows Finally Arrives.....Sep
A Cautionary Tale.....Oct
Life & Death and The Mouse Pen.....Nov
Epson ES-300C Desktop Image Scanner..Dec

Product Evaluations

- AST Premium Workstation/386SX
by TJ Byers.....Feb
Racal-Vadic V.23 Modem by TJ Byers...Mar
Logitech's Trackball by Art Salsberg...Oct

Software Focus

- Getting Organized With Agenda
by Art Salsberg.....Jun
PC Shareware by Art Salsberg.....Jul
A Financial-Planning Tool: MoneyPlans
by Art Salsberg.....Aug
PC Paintbrush IV by Joseph Desposito..Sep
Quattro Pro by Joseph Desposito.....Oct
Metro Software LaserTwin
by Joseph Desposito.....Nov
Inexpensive ways to Speed Up Your PC
by TJ Byers.....Dec
Multisoft Super PC-Kwik by TJ Byers...Dec

Solid-State Devices

- By Joseph Desposito
Power Semiconductors and How *Not* to Mount Them & New Super-Blocks From National Semiconductor.....Jan
A 12-Bit Daisy-Chain CMOS A/D Converter.....Feb
Analog-to-Digital Converters.....Mar
JFET-Input Op Amps.....Apr
Filters, FIFOs and Other Devices.....May
Designing a Buck-Boost Voltage Regulator.....Jun
New Static RAMs for High-Speed Caching.....Jul
An Ultrasonic Sensor, Photoelectric Smoke Detector, Giant LEDs and Two Flash Converters.....Aug
A Low-Cost Instrumentation Amplifier, Visible LED Lasers and a Bidirectional FIFO.....Sep
Comparators, Clocks and Clock Drives..Oct
Error Detection & Correction, Lithium "Kickstarter," Improved PROM and SPROM Chips.....Nov
A New Solid-State Speech Recorder, Data Acquisition on a Chip, Undervoltage Sensing ICs.....Dec

Articles

Computing

- AB Switch for PC Keyboards, Electronic
by Adolph A. Mangieri.....Aug
AC Interface, Computer-Controlled
by George F. Stockman IV.....Nov
AST Premium Workstation/386SX
by TJ Byers.....Feb
Circuit Breadboarding With Imaginary Parts
by Art Salsberg.....Dec
Frame Grabber, A Real-Time Video
by Crady VonPawlak.....Oct
Hewlett-Packard's New HP 48SX Scientific Calculator by Joseph Desposito.....May
Logitech's Trackball by Art Salsberg...Oct
MathCAD V 2.5, Derive V 1.60 & CMP-CALC4 Math Software
by Joseph Desposito.....May
Microcomputer on a Chip
by Brian B. Beard.....Apr
Microprocessor Control With BASIC
by Jan Axelson & Jim Hughes
.....Apr/May 89
Correction.....Mar 90
NEC's MultiSync Monitors by TJ Byers..Jan
PC-to-VICmodem Interface, A
by Jim Stephens.....Jul
Programmer, An MC68701 Microcomputer Chip, by Brian B. Beard.....May
Racal-Vadic V.23 Modem by TJ Byers..Mar
Video Adapter, Non-Composite
by Steve Pence.....Sep

Features

- Answering Machines, Telephone
by Stephen J. Bigelow.....Mar/Apr
DC-to-DC Converters
by Anthony J. Caristi.....Nov
DC Voltmeters, Using
by Robert G. Middleton.....Feb
Filters, Deep-Notch Resonant
by Douglas A. Kohl.....Sep
Hewlett-Packard's New HP 48SX Scientific Calculator by Joseph Desposito.....May
Interfacing 555 Timers
by Joseph J. Carr.....May
MathCAD V 2.5, Derive V 1.60 & CMP-CALC4 Math Software
by Joseph Desposito.....May
Memory Lane, Down, by Joseph J. Carr..Feb
Correction.....Apr
Microcomputer on a Chip
by Brian B. Beard.....Apr

NEC's MultiSync Monitors by TJ Byers .Jan
 Oscillators, Designing
 by Joseph J. Carr Jun
 Update Sep
 Oscilloscope in Electronics Troubleshooting,
 Using an, by Robert G. Middleton Mar
 PC Boards, Quick and Easy
 by Bill Eubank Apr
 Project Boxes, Thermally Machine
 by Adolph A. Mangieri Nov
 Square-Wave Generators, Designing
 by Joseph J. Carr Jul
 Stepping Motors by Stephen J. Bigelow .Jan
 Update Mar

Projects

AB Switch for PC Keyboards, Electronic
 by Adolph A. Mangieri Aug
 AC Interface, Computer-Controlled
 by George F. Stockman IV Nov
 Alarm, An Infinite Snooze
 by Ron Peterson Sep
 Altimeter, An Electronic
 by Anthony J. Caristi Jan
 Answering-Machine Interface, Two-Line
 Telephone, by Anthony J. Caristi Feb
 Correction May
 Alarm, Car Back-Up
 by C.R. Ball & W.K. Ball Oct 89
 Correction Jan 90
 Audio Test Box, Stereo
 by Irving E. Farnham Nov
 Biofeedback Monitor & Lie Detector
 by John Iovine Aug
 Breath-O-Meter, The
 by Anthony J. Caristi Dec
 Clock, A Tide, by Joseph P. O'Connell. Mar
 Compass, A Digital
 by Steve Sokolowsky Aug

Communication System, A Ground
 by Joseph P. O'Connell Sep
 Converter/Display, BCD-to-Hex
 by Lloyd W. Redman Mar
 Counter Display, "Big Score,"
 by Walter W. Schopp Feb
 Correction Jun
 Dialer, Area-Code Speed
 by Dave Wysock Nov
 Event Counter, Infrared-Detector
 by Jan Axelson Jun
 Update Aug
 Exposure Meter, Darkroom
 by Maurice P. Johnson Aug
 Fone Mate by Steve Sokolowski Jul
 Fone Sentry by Steve Sokolowski Jan
 Frame Grabber, Real-Time Video
 by Crady VonPawlak Oct
 Game Timer, Unique "Time's Up,"
 by Kirk Carter Dec
 Gas Detector, Super-Sensitive
 by Anthony J. Caristi Apr
 Inverter, Full-Screen Video
 by Adolph A. Mangieri Sep 89
 Correction Jan 90
 I/O Add-On Enhances Micro-Sys
 by Michael Swartzendruber Sep
 Light Controller, Home Security Porch
 by Emerson J. Huff Jun
 Light Meter Modules to Any DVM, Add
 by Thomas R. Fox Sep/Oct
 Line Monitor, AC
 by Thomas R. Fox Jul
 Microprocessor Control With BASIC
 by Jan Axelson & Jim Hughes
 Apr/May 89
 Correction Mar 90
 Modem Protection, Fast-Acting
 by T.T. Petruzzillis Dec
 Motor Protector, Three-Phase
 by Fernando Garcia Viesca Apr

Oscilloscope, Solid-State
 by Jeff T. Williams Nov 89
 Update Jan 90
 PC-to-VICmodem Interface, A
 by Jim Stephens Jul
 Power Supply, Dual-Polarity
 by Tim Swogger Mar
 Correction Jul
 Power Supply, A Precision
 by Dennis Eichenberg Nov
 Processing Analyzer, Color Film
 by Maurice P. Johnson Feb
 Programmer, An MC68701 Microcomputer
 Chip, by Brian B. Beard May
 Project Boxes, Thermally Machine
 by Adolph A. Mangieri Nov
 PROM Burner, A Stand-Alone
 by Walter W. Schopp Oct
 Recorder Controller, Cassette
 by David Ponting Dec
 Remote Controller, Power On/Off IR
 by James Melton Oct
 Remote-Control System, Extended-Play
 by Crady Von Pawlak Apr/May
 Update Aug
 Ring Director by Mark V. Lukas Aug
 Security System, Dual-Application
 by Anthony J. Caristi Jun/Jul
 Slide Projectors, Electronic Controller for
 by David Ponting May
 Correction Aug
 Sound Exploder, Single-Channel
 by Michael Swartzendruber Oct
 Spinner, Electronic
 by Charles Shoemaker Dec
 Super Tunes for Telephones
 by Walter W. Schopp Sep
 Thermometer Accessory, An Infrared
 by Thomas R. Fox Nov
 Temperature Controller, Darkroom Chemical
 by Maurice P. Johnson Jan
 Correction Jun
 Variable-Load Box and Power-Transistor
 Tester by David H. Bevel Jun
 Video Adapter, Non-Composite
 by Steve Pence Sep
 Voltage Detector, Maximum/Minimum
 by Jan Axelson Apr
 Correction Jun
 Water Detector Sensor, Wide-Coverage
 by Brad Thompson Jun
 Correction Aug

Test & Service

Audio Test Box, Stereo
 by Irving E. Farnham Nov
 DC Voltmeters, Using
 by Robert G. Middleton Feb
 Light-Meter Modules to Any DVM, Add
 by Thomas R. Fox Sep/Oct
 Oscilloscope in Electronics Troubleshooting,
 Using an, by Robert G. Middleton Mar
 Variable-Load Box and Power-Transistor
 Tester by David H. Bevel Jun
 Voltage Detector, Maximum/Minimum
 by Jan Axelson Apr

Order Back Issues of



QR Ham Radio Bookstore, Main St., Greenville, NH 03048-0498 800-457-7373

ORDER FORM

Please send me the following issues @ \$3.50 each:

Month(s) & Year(s): _____

Number ordered @ \$3.50 each: _____ Total Payment Enclosed: _____

NAME: _____

ADDRESS: _____

CITY: _____ STATE: _____ ZIP: _____

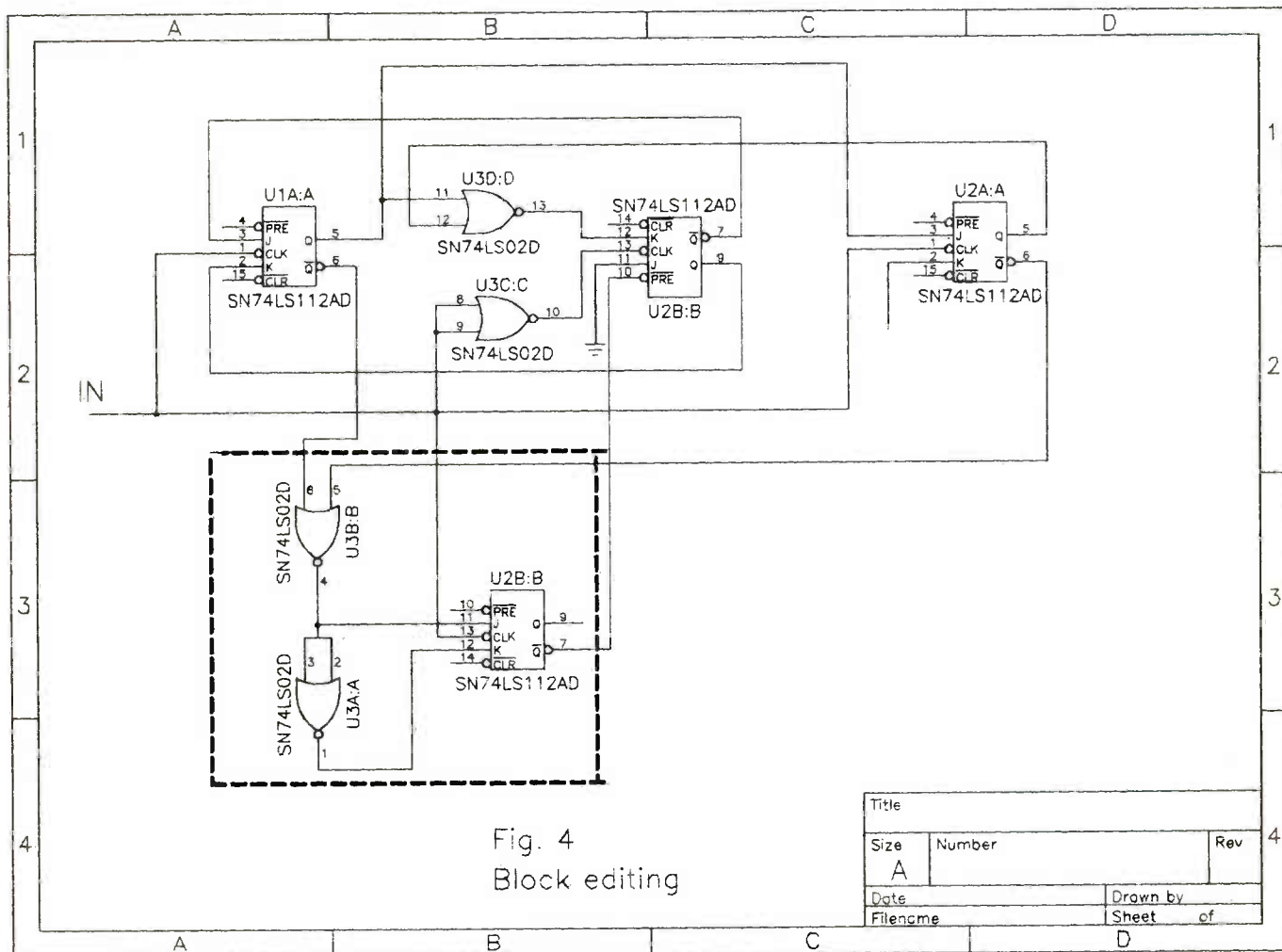

Fig. 4. Area inside broken lines is a block and is treated as a single object.

the rubberband line and replace it with a new line because of the position change. If you wish to move a component without retaining its previous connections, the rubberband feature can be turned off, in which case you end up with having to deal with dangling conductors.

One of the more powerful schematic editing tools is the block editor. A block is a user-defined area on the drawing that the software treats as a single entity, no matter how many elements it may contain (Fig. 4). Blocks can be moved, deleted or replicated. Some programs allow you to save blocks to a file, where they can be called up for use in another drawing. Block editing is a handy way of dealing with component sym-

bols and customized patterns not found in the component library.

The find or search command locates components on a schematic by name and is most helpful when you are trying to find a component in a complex hierarchical drawing. The find function can also be used to tag key spots on the drawing for quick panning to a desired area.

A few schematic capture programs support macros. Macros are user-defined keystrokes and/or mouse clicks that are saved to memory so that they can be run again. Some programs have a macro recorder that remembers the sequence as you step through it, while others have you save the sequence in a macro programming language.

Printing & Plotting

The ultimate goal of a schematic capture program is to produce a schematic drawing using a printer or plotter. Two types of drawings are normally generated by the program: draft quality and finished quality.

Draft-quality schematics are used during drafting of the schematic because they can be quickly generated on a dot-matrix or laser printer. The draft document diagram is then circulated among engineers and quality-control personnel for them to examine for errors before they become a permanent part of the design.

Schematics done on a printer are limited in size simply because there is no printer made that is large enough

(Continued on page 75)

able to hear the motor start and stop as you repeatedly press and release the switch.

With the motor running, press and release *S1*. If you have a VU recording meter or a row of LEDs that serve as a recording level indicator, you should see a "kick," and the motor should stop. Pressing *S1* again should have no effect, nor should a "kick" be seen until *S1* is pressed after *S3* has restarted the motor.

If the "kick" does not stop the motor, check that pin 7 of *IC2* is high, adjust *R15* and try this test again. If the system is working correctly, there will be quite a wide range of positions for the wiper of *R15* that leave pin 7 of *IC2* high but output square waves at this pin when the 60-Hz sine wave is fed into *J2*.

When *R15* is correctly adjusted, switch RECORD/PLAY switch *S2*, to PLAY while keeping the cassette recorder paused in the record mode. The recording display should now indicate a constant value. Adjust *R15* to bring the indication to the 0-dB mark on the display. If the cassette recorder you use automatically sets recording levels without use of an indicator, the adjustment you made to set the output at *J1* to 0.75 volt rms will give good results. This completes the setup procedure.

To put the project into service, connect the cassette recorder and Controller as described above. Set the RECORD/PLAY switch on the Controller to RECORD. Place the master tape that will have on it all required effects in the required sequence in the cassette recorder. Set the recorder up in the record mode. Run the recorder in this mode until the leader on the tape is well past the record head. Then press *S1* to record the first pulse and stop the machine.

Whatever the origin of each sound effect (these can be played from any source, provided the output is at line level), run the first one to set correct recording level on the right channel. Then back it off and place the source

machine in pause so that it is at the start of the first required effect.

Release the PAUSE control on the source machine as you simultaneously press *S3* to record that effect on the master tape. As soon as the effect comes to an end, press *S1* to record a pulse and stop the machine. Set up the source of the next required effect, check its recording level (if your machine has an indicator) and repeat the process until all the effects have been recorded in sequence.

Do not press *S1* while recording an effect because, on playback, the cassette deck will "wind down" at that point. Record the stop pulse only in the silence at the end of an effect. If you wish a shorter effect, fade or switch it out before recording its stop pulse.

Whatever the source of each sound effect, feed it into the cassette recorder at line level. So if make an effect using a microphone, record it in advance using another machine whose output you then use to provide a line-level input into the master machine.

Using the System

In the mono system, the left track of a stereo recording cassette carries the required sound effect, the right track a pulse that is recorded at the same time the sound effect was recorded. The control pulse on the right track is used to stop the cassette deck after the effect has been played and immediately before the next one.

The arrangement for recording sound effects and control pulses with the Cassette Recorder Controller and an ordinary stereo cassette deck is illustrated in Fig. 5. Here, the Controller RECORD/PLAY switch is set to RECORD.

Suppose the mono signal to be recorded is the opening music for the show from a compact-disc player. The output from the CD player goes to the LEFT LINE INPUT of the cassette recorder. When the recorder is paused in the record mode, this signal

emerges from its LEFT LINE OUTPUT and is heard through the speaker. To use this arrangement, set up the CD player and place it in pause with the required music just about to start. Release the CD player from pause while simultaneously pressing the START/STOP switch to record the music onto the master tape.

When recording is complete, press the PULSE STOP switch on the Controller to enable the pulse generator and pass the pulse to the RIGHT LINE INPUT, where it is recorded on the right tape channel. The same pulse emerges from the RIGHT LINE OUTPUT and is detected by the Controller. This cuts it off at the correct length and, via the automatic circuit, stops the cassette recorder, while continuing to hold the machine in the record mode.

You are now ready to record the second effect by repeating the above steps. Note that the START/STOP switch serves as a "toggle" that starts the recorder if the machine is stopped and stops the recorder (without recording a pulse) if it is running.

When you are finished recording all effects in the correct sequence onto the master tape, rewind the tape to its beginning. Then, with the RECORD/PLAY switch on the Controller set to PLAY, run the cassette player. When it gets to the first pulse, the Controller detects it and stops the recorder, holding it in play mode until the time comes for the first cue. At this point, pressing the START/STOP switch on the Controller sets the cassette deck in motion and plays the first cue.

Immediately at the end of the cue, the cassette deck stops and is cued up at the start of the second sound effect. Simply press the START/STOP switch at the right time to play the second cue, and so on until all cues have been played at the correct times.

With the RECORD/PLAY switch on the Controller set to either position, the START/STOP switch starts and stops the cassette player. However,

Breath-O-Meter (from page 31)

no pulse is recorded when the machine is stopped by the START/STOP switch. With the RECORD/PLAY switch set to PLAY, the PULSE STOP switch is inoperative and, hence, has no function in the playback process.

The method used to detect the pulse in play mode allows the cassette recorder to fast-forward or rewind in search mode, without stopping the tape at the end of every cue. If you are using this part of the article to check out the play procedure on your first recorded tape, you will find that you must use the START/STOP switch to start and stop the tape once while the leader is being "played" to reset the system and allow it to read the first pulse. If you do not do this, the controller will ignore all pulses. (If you wish to expand the sound to give a stereo effect, you can build and use the "Single-Channel Sound Exploder" featured in the October 1990 issue—Ed.) **ME**

PC Schematics (from page 71)

to handle an E-size sheet of paper. Consequently, the software divides the drawing into pages of 8½ by 11 inches that have to be taped together to get the full picture. Some programs let you fit the schematic to the paper by reducing the size of the drawing. But there is a limit to how small you can reduce an object before it becomes indistinguishable, and a size-E drawing printed on standard printer paper is not acceptable.

Plotters, on the other hand, are available in sizes from A through E; hence, no splicing of pages is required. Moreover, drawings made using a pen plotter are much sharper than those done on a printer. But get ready to pay the piper because plotters are very slow and the large-size ones are very expensive.

Next month, we look at a bevy of schematic capture packages and evaluate them for price, performance and features.

tion. Repeat Steps 1 through 4 for 0.05- and 0.1-percent BAC. Note that using the greater BAC-level solutions result in a greater value of peak voltage across *R1*.

(6.) Connect the meter from pin 9 of *IC2* to circuit ground. Adjust *R12* so that the reading obtained is equal to that recorded earlier for 0.02 percent BAC.

(7.) Repeat Step 6 for 0.05- and 0.1-percent BAC by adjusting *R9* and *R6*, respectively, while monitoring the positive input voltages of *IC2A* and *IC2B*.

Using the Project

For an accurate measure of BAC, the subject should not have ingested alcohol or smoked for at least 15 minutes before testing. Turn on the Breath-O-Meter and allow it to stabilize. During this period, any of the red BAC LEDs may turn on. When the green LED lights after being off for a few seconds, the project is ready for the breath test.

If the project fails to light the green LED, momentarily extinguish it as the circuit stabilizes, and then turn it on and maintains it in that state, the battery is probably low. Using a depleted battery will not provide any meaningful results.

Have the subject take a very deep breath, enough for about 15 seconds of exhale time. Have the subject use a soda straw to slowly blow exhaled air into the center of the sensor. The green LED should extinguish and one of the red LEDs should light if the BAC present is greater than 0.02 percent. The LED that lights indicates the BAC threshold level that has been exceeded. For example, if the 0.05% LED is lit, the BAC is between 0.05 and 0.1 percent.

To repeat the test, allow the green LED to turn on and then perform another breath test.

Although a BAC level of 0.02 or 0.05 percent is not sufficient for a person to be declared legally drunk,

such a person should never attempt to drive a motor vehicle. The Table shown elsewhere in this article shows the blood alcohol concentration that results after taking the specified number of 0.5-ounce alcohol drinks. One 12-ounce can of beer, one 4-ounce glass of dry wine and one highball each equals one drink.

The human body can metabolize about 0.5 ounce of alcohol per hour. So while a person is drinking, the body burns the alcohol at a constant rate. To use the Table, locate the point at which body weight and number of drinks intersect. Determine how many hours have elapsed since the first drink was taken. Subtract one drink for each hour. The corresponding figure in the Table indicates the approximate BAC.

Since different people metabolize at different rates, the value shown in the Table may not agree exactly with the results of the Breath-O-Meter test. If you calibrated the project with care, though, believe its results, and *don't drive* if your BAC is 0.02 percent or greater! **ME**

***** PRESENTING *****

CABLE TV DESCRAMBLERS

***** STARRING *****

JERROLD, HAMLIN, OAK

AND OTHER FAMOUS MANUFACTURERS

- FINEST WARRANTY PROGRAM AVAILABLE
- LOWEST RETAIL/WHOLESALE PRICES IN U.S.
- ORDERS SHIPPED FROM STOCK WITHIN 24 HOURS

FOR FREE CATALOG ONLY 1-800-345-8927
FOR ALL INFORMATION 1-818-709-9937

PACIFIC CABLE CO. INC.
7325½ RESEDA BLVD., DEPT. 1205
RESEDA, CA 91335



Cable TV Descramblers

If you find a better deal,
we'll better our deal.

*Jerrold *Tocom *Hamlin *Oak
*Scientific Atlanta *Zenith

Ask about our extended warranty
program.

COD, Visa, M/C welcome.
Free Call - Free Catalog.

Video Tech **800-562-6884**
3702 S. Virginia St., Ste. 160-304
Reno, NV 89502.



CIRCLE NO. 116 ON FREE INFORMATION CARD

A Shocking Offer!

Now for the first time in CIE's 56 year history you do not have to be enrolled at CIE to receive our introductory Electronic and Electricity Lesson Modules. Available for a limited time to non-students for the shockingly low price of only \$99.50.

With CIE's patented AUTO-PROGRAMMED method of learning you'll quickly learn and then master the basics of electronics and electricity and then move on to... DC/AC circuit theories, fundamentals of bi-polar junction transistors (BJT), field effect transistors (FET), wiring, diagram and schematic readings, component identification, soldering techniques... and much, much, more.

Your commitment to CIE ends with your payment, but CIE's commitment to your success just begins when you receive your

39 lessons, exams, binders and equipment. This special introductory price includes all the benefits and assistance CIE normally extends to its students and graduates. You'll be entitled to unlimited access to CIE's faculty and staff to assist you in your studies via a toll free 800 number six days a week, 24-hour turnaround on grading your submitted exams, CIE Bookstore privileges, a patented learning method, reference library, a student, faculty and alumni electronic bulletin board and a free issue of CIE's school newspaper *The Electron*. All this knowledge and support will put you on the road to understanding digital electronics, microprocessing principles, computer systems, telecommunications, and much, much, more.



**All This and Much More
For ONLY!**

\$99⁵⁰

- Free Issue of *The Electron*
- Build your personal burglar alarm
- Instructors available 6 days a week
- 20 lesson books containing 39 theory and hands-on training lessons and exams.

- Bookstore Privileges
- Patented Learning Method
- Electronic Bulletin Board
- 24-Hour Grading

Yes, send me CIE's 39 Introductory Electronic and Electricity Lessons and Equipment.

Name: _____

Address: _____

City: _____ Apt. #: _____

State: _____ Zip: _____

Age: _____ Phone (____) _____



BOOKSTORE

1776 East 17th Street
Cleveland, Ohio 44114
(216) 781-9400

BK01

Total Merchandise: \$99.50

Ohio Residents add 7% Sales Tax: _____

California Residents add 6-1/2% Sales Tax: _____

Total this order: _____

Method of Payment: Amount Enclosed . . . \$ _____

Personal Check or Money Order

Master Card Visa

□ □

Card Expiration Date: _____

Signature _____



CHARGE BY PHONE!



9 AM to 4:30 PM Eastern Time; from Ohio 1-800-523-9109
from all other states 1-800-321-2155



Programming the XR2240

Pin Number	DIP Switch Section	Time (Seconds)
1	1	1
2	2	2
3	3	4
4	4	8
5	5	16
6	6	32
7	7	64
8	8	128

Selected timing period is sum of time in seconds for all DIP switch sections closed.

(from page 45)

you have a scope, monitor pin 14 of IC5 with the sweep set to 0.2 second/division as you adjust R11. Adjust until the negative "tick" pulses occur exactly five divisions apart.

If you do not have an oscilloscope, use a clock that ticks loudly (or a stopwatch) to calibrate the circuit. Press and release the START button and listen for any difference in the period between the ticks from the two sources. Adjust R11 and listen again. If it is not the same in both cases, adjust the setting of R11 until you have the ticks occurring as close as possible to the same interval from the two sources.

Before each game, you must line up the optical interrupter slot with the first card in the box. To make this easy, use Velcro® pads on the project enclosure and card box so that as soon as the two are mated the optical interrupter is positioned as needed. Then show all players how cards must be drawn from the box, through the slot. Emphasize that only one card at a time must be drawn through the slot on the interrupter. Let the Time's Up Game Timer run through a complete cycle to familiarize the players with how it operates.

Considering how much Time's Up adds to the enjoyment of games like *Pictionary* and its low components cost, it can make a thoughtful holiday gift for anyone who likes to play timed games. **ME**

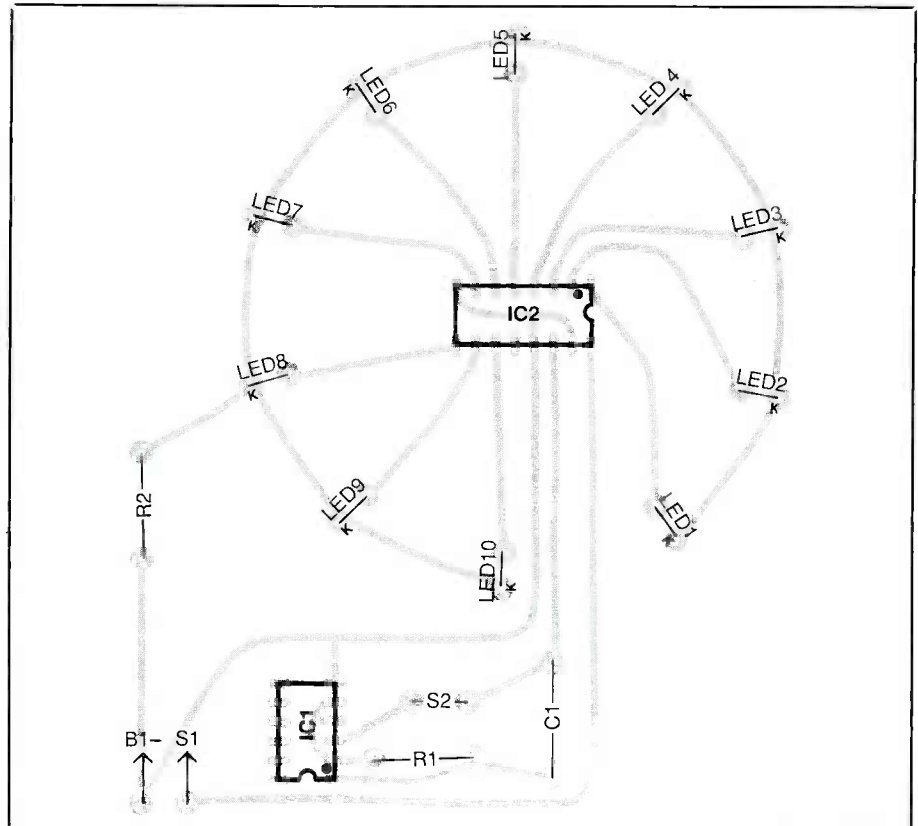

Fig. 3. Wiring guide for pc board. If you use perforated board and point-to-point wiring, use this as a rough guide to component layout.

for S1 and the legend SPIN for S2. You can label the LEDs in any way you see fit. For example, you can begin at the 12 o'clock position with a 1 and go clockwise in consecutive legends. Alternatively, you can randomly number the LED positions.

The best way to label the panel is with a dry-transfer lettering kit, though the legends will have a tendency to wear off if they are not protected. Alternatively, you can use a plastic tape lettering machine for making self-adhering labels.

Checkout & Use

Connect the common lead of a dc voltmeter or multimeter set to the dc-volts function to any convenient point in the circuit that is supposed to be at ground potential. Set S1 to on and touch the "hot" probe of the meter to pins 1 and 14 of the IC1

socket and pin 16 of the IC2 socket. At all three pins, you should obtain a reading of approximately +9 volts. If not, power down and correct any problem before proceeding.

Once you are certain that the circuit has been properly wired, plug the ICs into their respective sockets. Make certain each is properly oriented and that no pins fold under between ICs and sockets. Then mount the switches in their respective holes in the top panel and assemble the enclosure.

To power up the Spinner, set S1 to "on." Then press SPIN switch S2 to start the LEDs flashing. Shortly after releasing S2, the flashing should cease and leave just one LED lit. This signifies the number of moves to make in your board game. The next player presses and releases the push-button switch to find out how many moves he is to make. That is all there is to operating this Electronic Spinner.



PICKS UP A WHISPER 50 FEET AWAY!

The model WAT-50 miniature FM transmitter uses a 4-stage circuit NOT to be confused with a simple wireless microphone. Simply snap the unit on top of a 9V battery and you can hear every sound in an entire house up to 1 mile away! Use with any FM radio. Tunes to any frequency from 70mhz - 130mhz. Easy to assemble kit includes all parts and instructions. Only 29.98 tax incl.



The **WIRELESS TELEPHONE TRANSMITTER** model WTT-20 is only about the size of a dime, yet transmits both sides of a telephone conversation to any FM radio with crystal clarity. Completely automatic. Uses power from the telephone line itself - never needs a battery! Up to 1/4 mile range. Tunes from 70mhz - 130mhz. Easy to assemble kit includes all parts and instructions. Only \$29.98 tax incl.

Call or send **MO, VISA, MC** for immediate delivery. Single kit orders include \$1.50 S&H. **FREE SHIPPING** on orders of 2 or more. All orders shipped by U.S. Mail. COD add \$4.00. Personal checks allow 21 days.

DECO INDUSTRIES
BOX 607, BEDFORD HILLS, NY 10507
914-232-3878

CIRCLE NO. 108 ON FREE INFORMATION CARD

CABLE TV CONVERTERS Attention Cable Viewers!

Jerrold, Zenith, Oak, Scientific Atlanta, Hamlin, Tocom, and many others.

BEST PRICES! • 1-800-826-7623
B&B Inc. • 4030 Beau-D-Rue Dr., Eagan, MN 55122

REMOTE CONTROL KEYCHAIN

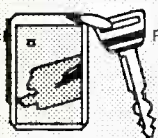

Complete w/mini-transmitter and +5 vdc RF receiver Fully assembled including plans to build your own auto alarm. Quantity discounts available.

Check, Visa or M/C Add \$ 3 shipping

ONLY \$24.95

VISITECT INC. BOX 5442, SO. SAN FRAN., CA. 94080
(415) 872-0128 Fax (415) 872-2635

Surface Mount Chip Component Prototyping Kits— Only \$49.95



CC-1 Capacitor Kit contains 365 pieces, 5 ea. of every 10% value from 1pf to .33uf. CR-1 Resistor Kit contains 1540 pieces; 10 ea. of every 5% value from 10Ω to 10 megΩ. Sizes are 0805 and 1206. Each kit is ONLY \$49.95 and available for Immediate One Day Delivery!

Order by toll-free phone, FAX, or mail. We accept VISA, MC, AMEX, COD, or Pre-paid orders. Company P.O.'s accepted with approved credit. Call for free detailed brochure.

COMMUNICATIONS SPECIALISTS, INC.
426 West Taft Ave. • Orange, CA 92665-4296
Local (714) 998-3021 • FAX (714) 974-3420

Entire USA 1-800-854-0547

CIRCLE NO. 104 ON FREE INFORMATION CARD

MODERN ELECTRONICS MART

Classified Commercial Rates: \$1 per word, 15-word minimum (\$15.00) prepaid. (Word count includes name and address; ZIP code and abbreviation each count as one word; P.O. Box number and telephone number count as two words each.) Indicate free category heading (**Computers, Communications, Electronics, Video** or **Miscellaneous**). A special heading is available for a \$6 surcharge. First word only is set boldface caps at no charge. Add 20% for additional boldface words.

Non-Commercial Rates: FREE to subscribers, as space permits; maximum 15 words. A recent MODERN ELECTRONICS mailing label must accompany ad.

(All advertisers with P.O. Box addresses must supply permanent address and telephone number. Copy is subject to publisher approval.)

Mailing Information: Copy must be received by the publisher by the 25th of the third month preceding the cover date. Send Advertising material with check or money order or credit card information (Visa or MasterCard only) with number and expiration date to: MODERN ELECTRONICS, Classified Department, 76 N. Broadway, Hicksville, NY 11801.

VIDEO

T.V. NOTCH FILTERS, SURVEILLANCE EQUIPMENT, BROCHURE \$1.00. D. K. VIDEO, BOX 63/6025, MARGATE, FL 33063 1-(305) 752-9202.

DESCRAMBLERS, converters, lowest prices, guaranteed, best quality, free catalog. CNC Concepts Inc., P.O. Box 34503, Minneapolis, MN 55434, 1-800-535-1843.

ELECTRONICS

KINETIKITS from KINETICO: electronic kits outputting light or sound. Free catalog: KINETICO, P.O. Box 1634, NY, NY 10114-0508.

MINIATURE FM TRANSMITTERS! Tracking Transmitters! Voice Disguisers! Bug Detectors! Phone Devices! More! Available in kits or assembled and tested! Catalog \$2.00: XANDI ELECTRONICS, Box 25647, "B6", Tempe, AZ 85285-5647.

SURVEILLANCE / COUNTERSURVEILLANCE devices catalog. Cameras, bug detectors, video camera detectors, transmitters, communications, and much more. Catalog \$3.00. DSP, P.O. Box 1275-ME, Redondo Beach, CA 90278.

LASERS. 1mw to 2kw, worlds largest selection of new and used surplus. FREE CATALOG. MWK Industries, 1269 Pomona Rd., Corona, CA 714-278-0563.

SURVEILLANCE - COUNTERSURVEILLANCE. Guaranteed lowest prices! Unbelievable. Detectors, Jammers, Transmitters, Phone Security, Cameras, Personal Protection, Books, More! Huge catalog \$5.00 (Refundable) PROTECTOR P.O. Box 520294-B, Salt Lake City, UT 84152.

50W SUBWOOFER. Add awesome bass to your home stereo system. This is an excellent performing component, not cheap junk. Complete plans \$18.00. C. Rothhoff, Box 70, Atlanta, GA 30274.

POWERFUL single-chip FM room transmitter, size of a postage stamp, transmits to any FM radio up to one mile away. Complete kit \$19.95 postpaid. Hertz Microdevices, P.O. Box 41771, Los Angeles, California 90041.

RECEIVE all cordless telephones on your scanner. Send \$2 for frequencies to: Adler Electronics, 5253 Eagle Dale Avenue, Unit #3A, Los Angeles, California 90041.

SURVEILLANCE—Audio/Video/Infra-red/Laser Equipment. Industrial or Private. 500 Item Catalog \$7.00. Security Systems, 3017D Hudson, New Orleans, LA 70131.

GOLFERS, find physical distances on any course using measuring device attached to your golf cart. Send \$5.95 for plan #901 to: Treeline Associates, P.O. Box 232, West Seneca, NY 14224.

CABLE CONVERTERS - ALL MAJOR BRANDS—Info & Orders 1-800-782-0552, Freeway Inc. s.m.p., P.O. 5036, Burnsville, MN 55337.

CALLER ID displays phone number of person calling you after first ring-stores phone numbers of 14 recent calls \$89.95 ppd., EDE, P.O. Box 337, Buffalo, NY 14226 (716) 691-3476.

FREE CATALOG. Save hundreds on sought after electronic, electro mechanical, and computer related hardware and components—including hard-to-find items. Call toll free: 1-800-776-3700. American Design Components/Dept. 112-120, 815 Fairview Avenue, Fairview, NJ 07022.

SURVEILLANCE/COUNTERSURVEIL—LANCE equipment catalog, transmitters, detection equipment, phone caller identification, \$10.00, EDE, P.O. Box 337, Buffalo, NY 14226.

CROSSOVER, Build your own low cost three way component crossover. For car, home. Easy plans include Parts List, Schematics \$5.00. Shelton Enterprise, P.O. Box 50098, Ft. Wayne, Indiana 46805.

LASERS HeNe 1.8 MW \$35, Laser P/S. 24VDC input \$10, S&H \$5. PDP, 9906 4th Ave., So. Minneapolis, MN 55420.

COMPUTERS

EQUIPMENT assortment. Electronic, computer, test, descrambler. Catalog \$3.00. Refundable. B & R Enterprise, P.O. Box 662, Portage, MI 49081.

PROTOQUICK Z8, single board computer with prototype area, \$69.00. Software Science, 3750 Roundbottom Road, Cincinnati, OH 45244 (513) 561-2060.

FREE IBM SOFTWARE CATALOG 2000 + Disks Toll Free 1-800-345-2983 24 Hours! In Colorado Please Call: (303) 934-5507 **MEGA-BYTE INC. PC SOFTWARE SUPPLY**, 3601 Morrison Road., Denver, CO 80219 FAX: (303) 936-7049.

AMIGA, MACINTOSH, ATARI XL/XE/ST communications, electronic PD software \$4.00/disk. SASE specifying computer for catalog! KDware, Box 1646, Orange Park, FL 32067-1646.

ANALOG TO DIGITAL converter. Software, parts list, schematic \$1.00. **COMPLETE KIT** \$19.95. Gary Bach, P.O. Box 9131ME, Dayton, Ohio 45409.

COMMUNICATIONS

HUGE COMMUNICATIONS CATALOG. 88 pages including amateur, shortwave and scanner equipment. Universal Radio, 1280 Aida Drive #ME, Reynoldsburg, OH 43068.

GRE Super Converters 8001 \$60.95, 8002 \$75.95 P.P.D. Send remittance Woolf Mail Order Box 630306 Ojas, FL 33163 FL 6%.

PAN-COMM INT'L CATALOG. Over 350 Kits, Plans, Books about Licensed/unlicensed AM/FM broadcasting, Ham/CB/SW/DX amplifiers, 1750M transmitters, Surveillance devices, Computers/Software, Science Projects, MORE. \$1.00 refundable. Box 130-ME12, Paradise, CA 95967.

MORSE Code? No Problem. You can increase your speed, no matter how many times you've failed before. **Results guaranteed** when you follow the instructions. **PASS Publishing's CW Mental-Block Buster** program helps you **explode mental blocks** that hold you back. Based on 40 years of research, the **CW Mental-Block Buster** uses guided meditation, dynamic visualizations, and powerful affirmations to blast through mental blocks. **You can do code!** That means new bands, more contacts, more fun! (This is not a CW practice tape.) The **CW Mental-Block Buster** audio cassette and practice booklet are only \$24.95 ppd. in the US (NY residents add \$1.87 sales tax). (Quantity discounts available for classes.) **PASS Publishing**, P.O. Box 570, Stony Brook, NY 11780.

NEW "Voice Activated Dialing Telephone" dials the number by your voice's command! \$139.99. Info \$2.00. B.E. Collection Catalog, Box 25239, Newark, New Jersey 07101.

PRO-2004/2005/2006 OWNERS! Restore cellular telephone, add-on S meter, add 6,400 channels, increase scanning speed, auto tape record, etc! Manual includes 10 modifications with detailed instructions and schematics. Only \$8.95 from the **ENGINEERING WORKSHOP**, P.O. Box 4176, Fullerton, CA 92634-4176.

CABLE

CABLE DESCRAMBLERS - Jerrold 400, 450, Tri-Bi SB-3. Scientific Atlanta, Oak, Telecom. Lowest Prices. Example: Jerrold from \$25.00. No Calif. Sales. Call us last and see! (213) 867-0081.

AC/DC VOLTAGE **PRO 400**
AC/DC CURRENT
DIODE TEST Stock No. 990092
LOGIC TEST **\$69.95**
LED TEST GOOD/BAD
5 FREQ RANGES
5 CAPACITANCE RANGES
LOW BATTERY Warning
CONTINUITY TEST BUZZER
TRANSISTOR CHECKER
20 MHZ FREQ COUNTER VISA M/C
30 DAY MONEY BACK GUARANTEE!
KELVIN Electronics
 7 Fairchild Ave., Plainview, NY 11803
 (516) 349-7620 (1800) 645-9212
 FAX (516) 349-7830



SURVEILLANCE TELEPHONE

This is a normal functioning telephone! EXCEPT it has a secret built in monitor. Only YOU can call and monitor all conversations, using a secret code, and never be detected! **Range Unlimited**
 \$175.00 - 6 month Warranty - Phone Tap Catalog \$3.00
 LISTEN ELECTRONICS, 603 Elgin, Muskogee, OK 74401
 1-800-633-TAPS



Cable Converters And Descramblers

Why Pay a High Monthly Fee?
 For FREE Catalog Call or Write

CABLE CONNECTION

1304 E. CHICAGO ST.-SUITE 301
 ALGONQUIN, IL 60102
 (708) 658-2365
 No Illinois Orders



FREE INFORMATION SERVICE

For further information on products, dealers, or literature in this issue, circle the appropriate numbers below. Be sure to include your name and address before mailing.

1	2	3	4	5	6	7	8	9	10	11	12
13	14	15	16	17	18	19	20	21	22	23	24
25	26	27	28	29	30	31	32	33	34	34	36
37	38	39	40	41	42	43	44	45	46	47	48
49	50	51	52	53	54	55	56	57	58	59	60
61	62	63	64	65	66	67	68	69	70	71	72
73	74	75	76	77	78	79	80	81	82	83	84
85	86	87	88	89	90	91	92	93	94	95	96
97	98	99	100	101	102	103	104	105	106	107	108
109	110	111	112	113	114	115	116	117	118	119	120
121	122	123	124	125	126	127	128	129	130	131	132
133	134	135	136	137	138	139	140	141	142	143	144
145	146	147	148	149	150	151	152	153	154	155	156
157	158	159	160	161	162	163	164	165	166	167	168
169	170	171	172	173	174	175	176	177	178	179	180

Insert issue date here

(month) (year)

(must be completed to process)

Name _____

Company Name _____

Address _____

City _____ State _____ Zip _____

Phone _____

Say You Saw It In Modern Electronics

QUALITY PARTS • DISCOUNT PRICES • FAST SHIPPING

ALL ELECTRONICS CORP.

P.O. Box 567 • Van Nuys, CA • 91408

12 VDC GEAR MOTOR

Soho# GBL 35-DH-21080-10Y

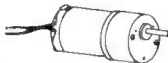
Powerful little gearhead motor. 
 40 RPM @ 12 Vdc. (no load).
 32 RPM with load. Operates at lower voltages with reduced speed and torque.
 6.3 pound inches torque. Stall: 27 pound inches. 3.1" long X 1.375" diameter.
 Shaft: 0.187" dia. CAT# MOTG-14
 \$11.50 each • 10 for \$100.00

OPTO-ISOLATORS

Clairex# CLM-6000 
 LED-photoconductor Isolator. Off resistance: 500 ohms. On resistance: 500K ohms. 2000 volt isolation. Forward voltage: 2 Vdc. CAT# CLM-6000
 \$2.50 each • 10 for \$22.00

Sigma# 301T1-12B1. Signal applied to the input is coupled by means of light to isolated photo conductive cell. High reliability switching. 12 Vdc. CAT# OP-301 \$1.50

OPTO SENSOR

U shaped package with mounting ears. 1/8" opening. 
 3/4" mounting ears. CAT# OSU-6
 50c each • 10 for \$4.50 • 100 for \$40.00

INSTRUMENT ENCLOSURES

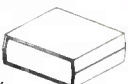
Molded ABS instrument enclosures. Matching front and rear panels. 
 Integrated PC board standoffs and two sets of vertical mounting slots for front and rear sub panel PC boards. All enclosures are 6" wide X 6 1/4" deep. Available in black, ivory, blue, and beige. Specify color.

FRONT & REAR PANEL HEIGHT

2 1/4" CAT# MB-A \$7.50 each 10 for \$65.00
 2 5/8" CAT# MB-B \$7.75 each 10 for \$67.50
 3" CAT# MB-C \$8.00 each 10 for \$70.00

PHOTOFLASH CAP.

Rubicon CE 210 MFD 330 V 
 0.79" dia. X 1.1" high. New, prepped with 1.4" black and red wire leads soldered to the terminals.
 CAT# PPC-210 \$2.50 each
 10 for \$22.50 • 100 for \$200.00

STEPPING MOTOR

Airpax# C82711-M1 
 17 Vdc 23.25 ohm dual coil P.M. motor.
 7.5 degrees per step.
 2.25" dia. X .91" thick.
 0.25" dia. shaft .6 wire leads.
 CAT# SMT-6 \$6.00 each • 10 for \$50.00

ORDER TOLL FREE 1-800-826-5432

FAX (818) 781-2653 Terms: Phone orders must be charged to Visa, MasterCard, or Discover. Minimum order \$10.00 • CA residents add sales tax • 48 Continental States Add \$3.50 for shipping/handling - All orders Including AK and HI pay full shipping • Quantities limited • No C.O.D.
CALL TOLL FREE FOR A FREE 60 PAGE CATALOG!

CIRCLE NO. 102 ON FREE INFORMATION CARD

**CABLE TV DESCRAMBLERS!
BARGAIN HEADQUARTERS!**



- JERROLD™ •TOCOM •HAMLIN
- OAK •ZENITH
- SCIENTIFIC ATLANTA

6 month warranty! We ship C.O.D.!
Lowest retail/wholesale prices!

FREE CATALOG:
Global Cable Network
1032 Irving St. Suite 109
S.F., CA 94122
NO CALIFORNIA SALES!!!

ORDER TODAY! 800-327-8544

CIRCLE NO. 109 ON FREE INFORMATION CARD

CABLE-TV BOXES

**Descramblers • Converters
FREE CATALOG**

TRANS-WORLD CABLE CO.
12062 Southwest 117th Ct., Suite 126
Miami, Florida 33186
800-442-9333

**CABLE DESCRAMBLERS
OAK M35B COMBO \$39.95**

Jerrold, Zenith, Hamlin, Sci. Atlanta, Pioneer
& MORE! OUR PRICES ARE BELOW WHOLESALE!

CABLE+PLUS

14417 Chase St. #481-C Panorama City, CA 91402
1-800-822-9955 • Other Info. 1-818-785-4500
NO CALIF. SALES — DEALERS WANTED

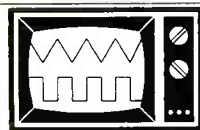

FINALLY!

An interesting and worthwhile project. This EASY-TO-BUILD circuit lets you use any regular TV set as a simple OSCILLOSCOPE. No modifications to TV! Tiny, 9v battery powered. Goes anywhere! Order now! Ask for our FREE CATALOG of other plans and kits!

DETAILED PLANS: \$7.95
TV-SCOPE
PENN RESEARCH, Box 3543
Williamsport, PA 17701

**REMOVE
LEAD
VOCALS**

Build this kit for under \$60 which removes lead vocals from standard stereo records, CD's, tapes or FM broadcasts. Easily connects to any home component stereo. Perform live with the backgrounds. You can be the lead singer of your favorite band. Detailed Plans. \$4.95

Weeder Technologies
14773 Lindsey Rd.
Mt. Orab, Ohio 45154

From Records & CD's

**USE YOUR FREE
INFORMATION
CARD**

CABLE

TOCOM VIP TEST CHIP. For Models 5503 VIP and 5507. Unlike any other turn-on, this one works! Easily installs in just seconds. \$50.00 each. No Calif. sales. Call (213) 867-0081.

ZENITH Z-Tac. Special "test" board installs easily in minutes, and turns-on decoder for all modes. Great for "flashing" problems. Only \$50. No Calif. Sales. Call (213) 867-0081.

FOR SALE

LOTTERY—IBM COMPUTER DISK FOR ALL LOTTERIES \$10.00. ROBERTS, Box 63/6025, MARGATE, FL 33063.

DESCRAMBLERS. All brands. Special: Combo Jerrold 400 and SB3 \$165. Complete cable descrambler kit \$39. Complete satellite descrambler kit \$45. Free Catalog. MJO INDUSTRY, Box 531, Bronx, NY 10461-0208.

CABLE TV EQUIPMENT

CABLE. TV converters and descramblers discount center. Jerrold, Tocom, Hamlin, Scientific Atlantic, Oak, Zenith. Order yours today 800-962-6836.

CABLE EQUIPMENT

CABLE TV SECRETS — the outlaw publication the cable companies tried to ban. HBO, Movie Channel, Showtime, Descramblers, Converters, etc. Suppliers list included. \$9.95. Cable Facts, Box 711-ME, Pataskala, Ohio 43062.

CABLE TV

CABLE TV Brokers and Distributors. High volume of DESCRAMBLERS Jerrold SB-3 refurbished or as is, **CONVERTERS** Jerrold Models DRX-400, JRX and Hand Remote Control (no Canada sales for Descramblers). AFFITECH, ask Daniel Perreault, (514) 656-9150.

ELECTRONIC SURVEILLANCE

ELECTRONIC SURVEILLANCE. 40+ complete construction plans from America's #1 designer of electronic spy equipment. **FREE CATALOG.** Wilson-E, P.O. Box 5264, Augusta, GA 30906.

FOR SALE

CHEAP Ham Gear. Send stamp for list. WA4DSO, 3037 Audrey Dr., Gastonia, N.C. 28054.

ZENITH DESCRAMBLERS

ZENITH cable boxes will work where others failed. All units are warranted with remote control \$175.00. Call (213) 478-2506.

MISCELLANEOUS

ASIAN LADIES want correspondence for friendship, marriage. SUNSHINE INTERNATIONAL-Dept. TW, Box 5500, Kailua-Kona, Hawaii 96745. (808) 325-7707.

SILVERPLATING simple easy inexpensive method for complete guide \$9.95 to Plating, 900 Old Richton Road, Petal, MS 39465.

STUDIO Monitor Speaker. Full-size furniture plan. This is by no means a small base-reflex speaker, when built from my plans! (17" D x 24" W x 52" H) Suggested places of use: Theaters, Reception halls, Concerts, Recording live music, etc. Send \$12.00 check or money order to: Morrison Originals Design Service, 784 Marlborough, Box 15272, Dept. ME-1, Detroit, MI 48215-2949.

GUARANTEED home business making \$12 an hour part or full time. Send \$4 SASE, Hobby Shop, Box 1008, Grove Hill, AL 36451.

ATTRACTIVE Latin, Oriental ladies seek friendship. Free photo brochure. "Latins", Box 1716-MT, Chula Vista, CA 92012.

CLASSIFIED ADVERTISING ORDER FORM

Mail this form with payment to MODERN ELECTRONICS, Classified Dept., 76 N. Broadway, Hicksville, NY 11801.

Name: _____

Street Address: _____

City: _____ State: _____ Zip: _____

Check category you wish to be listed under or note a special heading (\$6 additional) you want.

- () Audio () Communications () Computers () Electronics () Video
() Miscellaneous () Wanted () Special Heading _____

PRINT EACH WORD SEPARATELY. Note that P.O. Box numbers* and telephone numbers must be counted as two words each. Circle additional words you wish boldfaced at 20% more each (initial boldface word is free). Minimum charge is for 15 words.

Free Boldface	2	3	4
5	6	7	8
9	10	11	12
13	14	15 (\$15)	16 (\$16)

NEW PRODUCTS ... (from page 15)

The user can customize his listening with five parameters that comprise the structural factors of the sound field. Initial delay, room size, liveliness, reverberation time and high-frequency reverb are adjustable for each of the stored environment settings. Fine tuning for individual tastes is possible with a seven-band digital equalizer that can be set separately for each front, front-and-rear and surround-rear channel pair.

CIRCLE NO. 159 ON FREE INFORMATION CARD

Two center-channel outputs are provided for use with large-screen monitors to eliminate vertical shifts in the sound image. Seven other surround modes are built in. Finally, the unit comes with a wireless remote-control system that provides test-tone, balance-adjustment and equalizer selection, and a seven-ganged volume control allows for level adjustment simultaneously within the sound field. \$1,000.

Hand-Held Logic Analyzer

Trace-Tek's (Carrollton, TX) Logic Boy is a full-featured 16-channel hand-held logic analyzer with a 50-MHz range. It features 50-MHz operation on all 16 channels, nonvolatile system setups and system memory, built-in IBM-compatible printer port for printing timing diagrams and state information and a BNC trigger output connector. The last allows one to use Logic Boy as a 16-bit, four-level word recognizer when connected to the external trigger input of an oscilloscope.

Both TTL and CMOS compatible, Logic Boy also features 1K x 16 capture and reference memory, state and timing analysis, four-level combinational event sequencing, synchronous or asynchronous clocking, clock qualifier and a user-programmable trigger delay.

The Analyzer makes extensive use of menus for user prompting and system setups. All state information, timing information and menus are displayed on the built-in Super-Twist LCD panel. While in state display mode, all channels are simultaneously in the format specified in the format menu. Differences between acquisition and reference memory are displayed in reverse-field format for each analysis. In timing mode, 12 channels of either acquisition or ref-

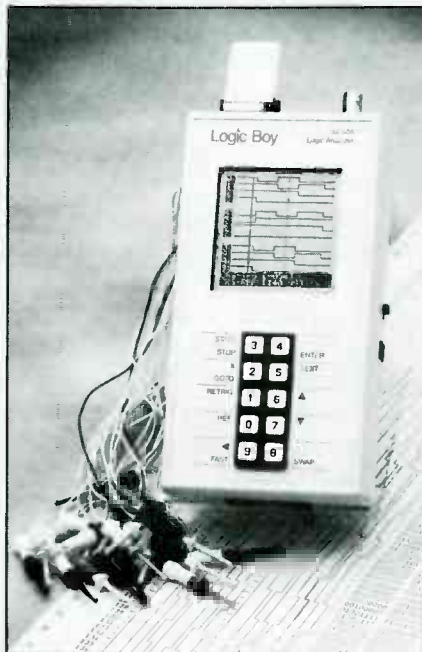

erence memory are displayed simultaneously in waveform format. Measurements are made by marking a reference point with the cursor and then moving the cursor with arrow keys on the keypad. Time delta is automatically updated as the cursor moves across the display. The remaining four channels are displayed by scrolling up or down.

The Analyzer measures 7.6"H x 4"W x 1.8"D and weighs just 21 ounces with Ni-Cd battery installed. (The battery supplies up to 6 hours of continuous operation.) \$1,795.

CIRCLE NO. 160 ON FREE INFORMATION CARD

LEARN TO CLEAN/MAINTAIN/REPAIR FAX MACHINES

HUGE NEW UNTAPPED MARKET!



Over 8 million Fax machines in homes/offices - predictions are for over 25 million by 1992!

- Work from your home/van
- Home study program gets you started servicing fax machines in 2 weeks!
- No special tools/equipment needed
- Earn additional profits selling fax supplies!
- Fax machines are not cheap - therefore, you can get good \$\$ for the repair
- Average Fax machine requires professional service every 18 months.
- Home study training program includes full instructions on EVERY ASPECT of Fax maintenance/repair FULL COVERAGE of how to set up your home-based service business

FREE DETAILS

CALL 1-800-537-0589

Or Write To: Viejo Publications, Inc.
5329 Fountain Ave., Dept. ME/FX
Los Angeles, CA 90029

CIRCLE NO. 118 ON FREE INFORMATION CARD

Be an FCC LICENSED ELECTRONIC TECHNICIAN!



No costly school. No commuting to class. The Original Home-Study course prepares you for the "FCC Commercial Radiotelephone License." This valuable license is your professional "ticket" to thousands of exciting jobs in Communications, Radio-TV, Microwave, Maritime, Radar, Avionics and more...even start your own business! You don't need a college degree to qualify, but you do need an FCC License.

No Need to Quit Your Job or Go To School
This proven course is easy, fast and low cost! **GUARANTEED PASS**—You get your FCC License or money refunded. **Send for FREE facts now. MAIL COUPON TODAY!**

COMMAND PRODUCTIONS

FCC LICENSE TRAINING, Dept. 206
P.O. Box 2824, San Francisco, CA 94126
Please rush FREE details immediately!

NAME _____
ADDRESS _____
CITY _____ STATE _____ ZIP _____

program, the focus is on logic relationships. Consequently, its Shelf does not have an oscilloscope and its multimeter measures voltage for detecting only high or 1 (5 volts) or low or 0 (0 volt). Also, components are not given values. The remaining Shelf test instruments—word generator, logic analyzer and truth table—are very sophisticated simulators. For instance, the word generator inputs bit patterns to your circuit and can hold up to 16 eight-bit words. These can be injected into the circuit as Step, Burst or Cycle transmissions.

Conclusions

I am very favorably impressed by *Electronics Workbench*. The program can be very quickly mastered, unlike those of databases, word processors and the like. It is also a well-behaved program.

More importantly, you can actually build a host of circuits on the computer's screen and observe simulated results. Change values or components, and you'll see what effect it has on the output. The digital module also provides a few error messages. It's a great way to hone your electronics skills.

The program works speedily (with a hard-disk drive and a 16-MHz microprocessor) and screen representations are satisfactory. Simulations are done very well. A 38-page section on Technical Exposition is included in the manual that shows some of the mathematical models and techniques used to simulate circuit activity. Analog simulation uses Spice algorithms; digital simulation employs algorithms that use ideal gates and flip-flops in combinational and in sequential circuits. More advanced students and electronics educators will appreciate all this.

For hardware, we'd recommend using as a minimum system an AT-type computer with 640K of RAM, 40M hard disk and VGA graphics. If you don't have a laser printer, plan on using a 24-pin—not a 9-pin—dot-matrix printer. For software, DOS 3.1 or later is suggested as well.

In sum, with *EWB* there's no investment in costly test instruments or components and no extra time and money spent breadboarding circuits. Component values can be quickly changed to see what the results are, and you can even put in faults for troubleshooting training. Sure we'd like to see the program have full color, a larger components library, better fonts, and so on. As it is, though, we have to conclude that *Electronics Workbench* is a marvelous learning and teaching tool for the study of electronics. **ME**

CIRCLE NO. 126 ON FREE INFORMATION CARD

Order Back Issues of

MODERN ELECTRONICS

ADVERTISERS' INDEX

RS#		Page #
101	AMC Sales	82
102	All Electronics	79
-	B & B Electronics	78
-	CQ Buyer's Guide	68
103	C&S Sales	61
-	Cable Connection	79
-	Cable-Mate Inc.	52
-	Cable Plus	80
-	Cleveland Inst. of Elec.	76, Cov. III
-	Command Productions	81
104	Communications Specialists	78
105	Consolidated Electronics	60
106	Contact East	15
107	Cook's Institute	60
108	Deco Industries	78
109	Global Cable Network	80
-	Grantham	51
110	Heath Co.	23
-	ICOM	Cov. II
119	Interactive Image Technology	5
-	Kelvin Electronics	79
10	Kenwood	Cov. IV
-	Listen Electronics	79
-	NRI Schools	13
-	Pacific Cable Co., Inc.	75
111	Parts Express International	9
-	Penn Research	80
112	Protel Technology, Inc.	15
113	Radio Shack	3
-	Republic Cable	52
-	Sams Books	6, 7
115	Tech Serv.	59
-	Trans World Cable Co.	80
114	Ucando	59
116	Video Tech.	75
117, 118	Viejo Publications	52, 81
-	Visitect Inc.	78
-	Weeder Technologies	80

We'd like to see your company listed here too. Contact Jonathan Kummer at 516-681-2922 to work out an advertising program tailored to suit your needs.

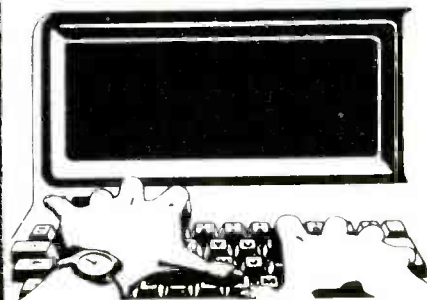

Free Product Information

Readers can obtain free information on products advertised by the above companies, as well as for some editorially mentioned products. Simply circle the appropriate number printed below an advertisement onto the Modern Electronics "Free Information Service" card bound into this issue. After filling in your name and address, just mail the postpaid card. Your request will be forwarded directly to the advertiser with a mailing label prepared by our reader-service department to ensure speedy response.

SUPER LONG PLAY TAPE RECORDERS

12 Hour Model — USES 120 TAPE \$119.00*

Modified Panasonic Slimline, high quality AC-DC provide 6 continuous hours of quality recording & playback on each side of cassette for 12 hours total. Includes • Voice level control • Digital counter, etc. TDK - 120 Cassette Furnished.



PHONE RECORDING ADAPTER

Records calls automatically. All Solid state connects to your telephone jack and tape recorder. Starts recording when phone is lifted. Stops when you hang up. **\$28.50*** FCC APPROVED



VOX VOICE ACTIVATED CONTROL SWITCH

Solid state. Self contained. Adjustable sensitivity. Voices or other sounds automatically activate and control recorder. Uses either recorder or remote mike. **\$28.50***



*Add for ship & hdg. Phone Adapter & Vox \$1.50 ea. Records \$4.00 ea. Cal. Res. add tax. Mail order, VISA, M/C, COD's OK. Money Back Guarantee. Qty. disc. avail. Dealer inquiries invited. Free data.

AMC SALES INC. Dept. M 9335 Lubec St. Box 928. Downey, CA 90241. Phone (213) 869-8519. FAX (213) 923-1478

CIRCLE NO. 101 ON FREE INFORMATION CARD

Discover Your Career Potential In The Fast-Growing Field Of High-Tech Electronics!

CIE Gives You The Training You Need to *Succeed...*
At Your Own Pace...& In Your Own Home!

If you're anxious to get ahead...and build a *real* career...you owe it to yourself to find out about the Cleveland Institute of Electronics!

CIE can help you discover *your* career potential in the fast growing field of high-tech electronics. A career that will challenge and excite you every day...reward you with a powerful feeling of personal accomplishment...and deliver a level of financial security you may have only dreamed of before!

As the leading school in home-study electronics, CIE has helped over 150,000 students in the U.S.A. and over 70 foreign countries get started in this exciting field. To find out how CIE could be helping you...read on...then send for a CIE catalog TODAY!

A Growing Need For Trained Professionals!

The career opportunities shown here are only a few of the challenging, high-paying careers you could enjoy as an electronics technician.

You could be the "brains" behind the scenes of an exciting TV broadcast...trouble-shoot life-saving medical equipment...design exotic new aeronautics systems...CIE's job-oriented programs offer you the quickest possible path to the career of your dreams! And CIE also features military and union re-training, to build on what you already know.

Dozens Of Fascinating Careers To Choose From!

Even if you aren't sure which career is best for you, CIE can get you started with core lessons applicable to *all* areas of electronics. As you advance, CIE makes job opportunities available to you through the bimonthly school paper, *The Electron*.



Data Communications

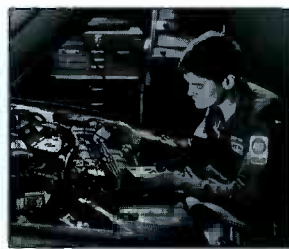

Automotive Electronics



Avionics

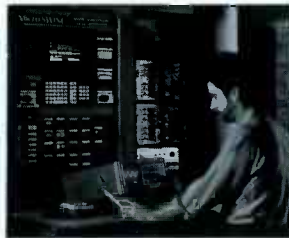

Computer-Assisted Manufacturing



Consumer Electronics



Military Electronics

Personal Training From A Renowned Faculty.

Unlike the impersonal approach of large class-room study, CIE offers you one-on-one instructional help 6 days a week, toll-free. Each CIE lesson is authored by an independent specialist, backed by CIE instructors who work directly with you to answer your questions and provide technical assistance when you need it.

Practical Training... At Your Own Pace.

Through CIE, you can train for your new career while you keep your present job. Each course allows a generous completion time, and there are no limitations on how fast you can study. Should you already have some electronics experience, CIE offers several courses which start at the intermediate level.

"State-Of-The-Art" Facilities & Equipment.

In 1969, CIE pioneered the first electronics laboratory course, and in 1984, the first Microprocessor Laboratory. Today, no other home study school can match CIE's state-of-the-art equipment. And all your laboratory equipment is included in your tuition cost. There is no extra charge—it's yours to use while you study at home and on the job after you complete your course!

Earn Your Degree To Become A Professional In Electronics!

Every CIE course you take earns you credit towards the completion of your Associate in Applied Science Degree, so you can work towards your degree in

stages. And CIE is the only school that awards you for fast study, which can save you thousands of dollars in obtaining the same electronics education found in four-year Bachelor's Degree programs! Write for details today!

Send For Your Catalog Today!

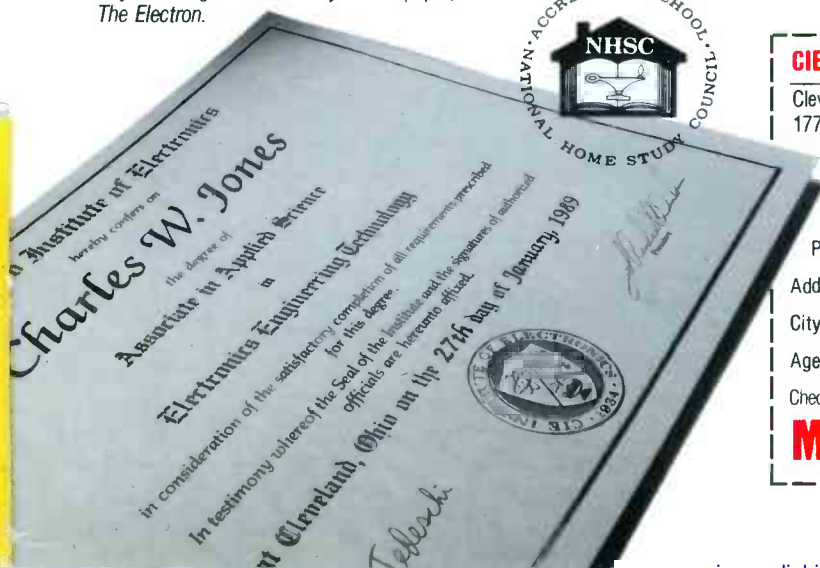

CIE World Headquarters

Cleveland Institute of Electronics, Inc.
1776 East 17th St., Cleveland, Ohio 44114

YES! Please send me your independent study catalog (For your convenience, CIE will have a representative contact you—there is no obligation.)

Print Name _____
Address _____ Apt # _____
City/State/Zip _____
Age _____ Area Code/Phone No. _____

Check box for G.I. Bill bulletin on educational benefits: Veteran Active Duty

Mail This Coupon Today!

AM0-181

KENWOOD

Hear it All!



R-5000
R-2000
High performance receivers.

Scan the world bands with Kenwood's R-5000, R-2000 and RZ-1. Listen in on foreign music, news, and commentary. Monitor local police, fire, and other public safety services, as well as the Marine channels, and the many other services.

(The VHF converter options must be used in the R-5000 and R-2000.)

R-5000

The R-5000 is a high performance, top-of-the-line receiver, with 100 memory channels, and direct keyboard or main dial tuning—makes station selection



The R-2000 is an all band, all mode receiver with 10 memory channels and many deluxe features such as programmable scanning, dual 24-hour clocks with timer, all-mode squelch and noise blankers, a large, front-mounted speaker, 110 volt AC or 12 volt DC operation (with the DCK-1 cable kit), and 118-174 MHz VHF capability with VC-10 option.

Optional Accessories R-2000:

- VC-10 VHF converter
- DCK-1 DC cable kit for 12 volt DC use.

R-5000:

- VC-20 VHF converter
- VS-1 Voice module
- DCK-2 for 12 volt DC operation
- YK-88A-1 AM filter
- YK-88SN SSB filter
- YK-88C CW filter
- MB-430 Mounting bracket.

Other Accessories:

- SP-430 External speaker
- SP-41 Compact mobile speaker
- SP-50B Mobile speaker
- HS-5 Deluxe headphones
- HS-6 Lightweight headphones

KENWOOD U.S.A. CORPORATION
COMMUNICATIONS & TEST EQUIPMENT GROUP
P.O. BOX 22745, 2201 E. Dominguez Street
Long Beach, CA 90801-5745
KENWOOD ELECTRONICS CANADA INC.
P.O. BOX 1075, 959 Gana Court
Mississauga, Ontario, Canada L4T 4C2

KENWOOD

...pacesetter in Amateur Radio

RZ-1

Wide-band scanning receiver



The RZ-1 wide-band, scanning receiver covers 500 kHz-905 MHz, in AM, and narrow or wideband FM. The automatic mode selection function makes listening

super easy! Other useful features include programmable scanning, large, built-in speaker, 110 volt AC or 12 volt DC operation (with optional DCK-2 cable), VHF capability (108-174 MHz) with the VC-20 option, dual 24-hour clocks with timer, and even voice frequency readout with the VS-1 option.

easier. One hundred memory channels with message and band marker, direct keyboard or VFO frequency entry, and versatile scanning functions, such as memory channel and band scan, with four types of scan stop. The RZ-1 is a 12 volt DC operated, compact unit, with built-in speaker, front-mounted phones jack, switchable AGC, squelch for narrow FM, illuminated keys, and a "beeper" to confirm keyboard operation.

- Optional Accessory
- PG-2N Extra DC cable

Specifications, features, and prices are subject to change without notice or obligation.