

ICD 08559

MARCH 1988 \$2.50
CANADA \$3.50

MODERN ELECTRONICS™

THE MAGAZINE FOR ELECTRONICS & COMPUTER ENTHUSIASTS

- Home Experiments With Superconductors
- A Speed Reader/Comparator for 16K to 512K EPROMs

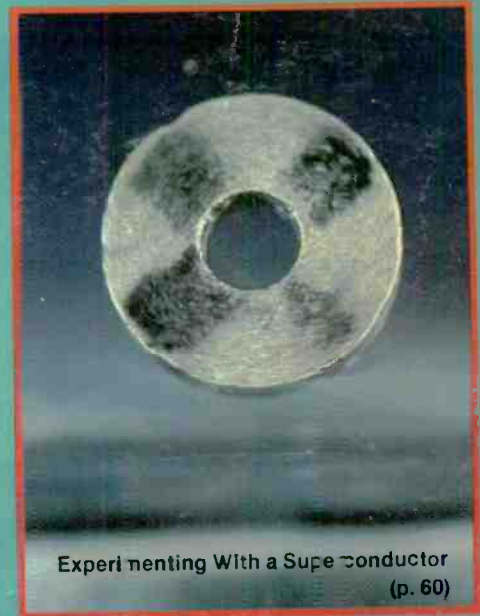

Full Construction Plans:

- Make an Electronic Electric-Blanket Controller
- A Visual Indicator for Incoming Telephone Calls
- An In-Circuit Bipolar Transistor Tester

Plus: ■ SMD Circuit Repairing ■ A New Look at Complex Linear Mixing
 ■ Experimenting With Audio Circuits

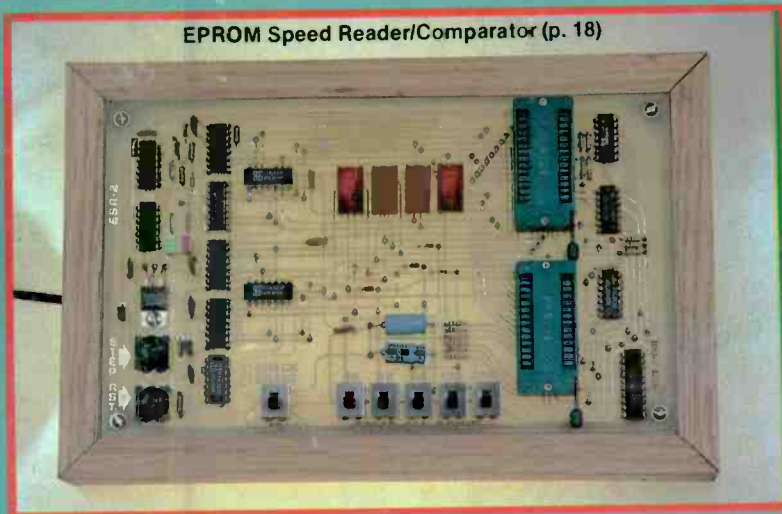

Also: Using Computer Spreadsheets for Technical Calculations • Solid-State Developments • Winter 1988 English-Language S/W Broadcasts • Clone Compatibility • Evaluating a High-Speed Test Searcher • Latest Technical Books & Literature • Electronic & Computer News ... more.

OPTOelectronics inc

**NEW
POCKET SIZE**

**SIZE: 4" H x 3.5" W x 1" D
MADE IN USA**

**FREQUENCY
COUNTERS
TO 1.3 GHZ**

**8 LED DIGITS • 2 GATE TIMES
ANODIZED ALUMINUM CABINET
INTERNAL NI-CAD BATTERIES INCLUDED
AC ADAPTER/CHARGER INCLUDED**

**EXCELLENT SENSITIVITY
& ACCURACY**

**AC-DC • PORTABLE
OPERATION**



#1200H 1.2 GHZ

#AC-1200
AC ADAPTER
CHARGER

Small enough to fit into a shirt pocket, our new 1.2 GHz and 1.3 GHz, 8 digit frequency counters are not toys! They can actually out perform units many times their size and price! Included are rechargeable Ni-Cad batteries installed inside the unit for hours of portable, cordless operation. The batteries are easily recharged using the AC adapter/charger supplied with the unit.

The excellent sensitivity of the 1200H makes it ideal for use with the telescoping RF pick-up antenna; accurately and easily measure transmit frequencies from handheld, fixed, or mobile radios such as: Police, firefighters, Ham, taxi, car telephone, aircraft, marine, etc. May be used for counter surveillance, locating hidden "bug" transmitters. Use with grid dip oscillator when designing and tuning antennas. May be used with a probe for measuring clock frequencies in computers, various digital circuitry or oscillators. Can be built into transmitters, signal generators and other devices to accurately monitor frequency.

The size, price and performance of these new instruments make them indispensable for technicians, engineers, schools, Hams, CBers, electronic hobbyists, short wave listeners, law enforcement personnel and many others.

STOCK NO:

- #1200HKC Model 1200H in kit form, 1-1200 MHz counter complete including all parts, cabinet, Ni-Cad batteries, AC adapter-battery charger and instructions \$ 99.95
- #1200HC Model 1200H factory assembled 1-1200 MHz counter, tested and calibrated, complete including Ni-Cad batteries and AC adapter/battery charger \$137.50
- #1300HC Model 1300H factory assembled 1-1300 MHz counter, tested and calibrated, complete including Ni-Cad batteries and AC adapter/battery charger \$150.00

ACCESSORIES:

- #TA-100S Telescoping RF pick-up antenna with BNC connector \$12.00
- #P-100 Probe, direct connection 50 ohm, BNC connector \$18.00
- #CC-70 Carrying case, black vinyl with zipper opening. Will hold a counter and accessories \$10.00



1.3 GHZ

#1300H

ORDER FACTORY DIRECT

1-800-327-5912



AVAILABLE NOW!

OPTOelectronics inc

**5821 N.E. 14th Avenue
Ft. Lauderdale, Florida 33334**

Orders to US and Canada add 5% of total (\$2 min., \$10 max)
Florida residents add 5% sales tax. COD fee \$2.



FEATURES

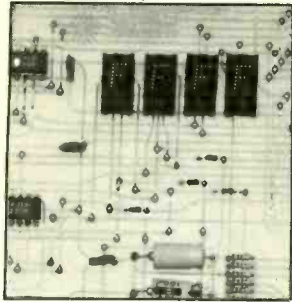

18

- 18 An EPROM Speed Reader/Comparator**
Checks 16K to 512K EPROMs for complete erasure and compares a copy with an original EPROM in seconds. *By Walter W. Schopp*

- 30 Mixing Frequencies: A New Look**
Photos help explain complex linear mixing to amateur radio operators and others. *By John Wannamaker*

- 34 Experimenting With Audio Circuits**
Using op amps to build a variety of professional audio circuits to suit different requirements. *By Joseph J. Carr*

- 40 Automatic Telephone Flasher**
Add-on accessory gives you visual indication of an incoming telephone call. *By Anthony J. Caristi*

- 46 A Solid-State Electric Blanket Controller**
Provides greater efficiency and better heating comfort than is possible with electromechanical controllers. *By Joseph O'Connell*

- 53 Surface-Mount-Device Repair**
How to remove flat-packaged SMDs using soldering tools. *By Victor Meeldijk*

- 54 An In-Circuit Transistor Tester**
Low-cost bench/portable instrument tests bipolar transistors in- and out-of-circuit. *By Jules H. Gilder*

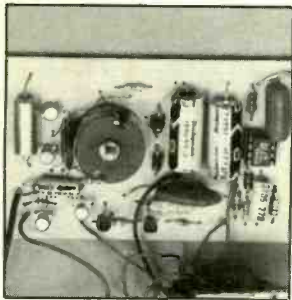

40

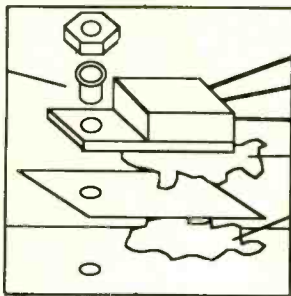

46

- 60 Electronics Notebook**
Experimenting With a Superconductor. *By Forrest M. Mims III*

- 66 Solid-State Devices**
A new switching regulator, an improved BCD-to-7-segment decoder, another buzz word and more. *By Harry Helms*

- 70 Communications**
Sampling of Winter 1988 English-Language International Shortwave Broadcasts. *By Gerry L. Dexter*

- 76 Electronics Omnibus**
Computer spreadsheets for technical calculations and Car compact disc player considerations. *By Curt Phillips*

- 78 PC Capers**
Clone compatibility; making car signs; computer "mice." *By Ted Needleman*

- 84 Software Focus**
GOfer—A High-Speed Text Searcher. *By Art Salsberg*

DEPARTMENTS

- 6 Editorial**
By Art Salsberg

- 7 Letters**

- 8 Modern Electronics News**

- 14 New Products**

- 58 Books & Literature**

- 90 Advertisers Index**



53

EDITORIAL STAFF

Art Salsberg
Editor-in-Chief

Alexander W. Burawa
Managing Editor

Dorothy Kehrwieler
Production Manager

Elizabeth Ryan
Art Director

Barbara Scully
Artist

Pat Le Blanc
Florence V. Martin
Phototypographers

Hal Keith
Illustrator

Bruce Morgan
Photographer

Joseph Desposito, Leonard Feldman,
Forrest Mims III
Contributing Editors

BUSINESS STAFF

Richard A. Ross
Publisher

Art Salsberg
Associate Publisher

Dorothy Kehrwieler
General Manager

Frank V. Fuzia
Controller

Arlene Caggiano
Accounting

Catherine Ross
Circulation Director

SALES OFFICES

Modern Electronics
76 North Broadway
Hicksville, NY 11801
(516) 681-2922

Eastern Advertising Representative
Peter Conn

Sales Assistant
Cheryl Chomicki
76 North Broadway
Hicksville, NY 11801
(516) 681-2922

Midwest & West Advertising Representative

Market/Media Associates

1150 Wilmette Ave.
Wilmette, IL 60091
(312) 251-2541
Ted Rickard
Greg Morin
Kevin Sullivan

Offices: 76 North Broadway, Hicksville, NY 11801. Telephone: (516) 681-2922. Modern Electronics (ISSN 0748-9889) is published monthly by Modern Electronics, Inc. Application to mail at second class rates pending at Hicksville, NY and other points. Subscription prices (payable in US Dollars only): Domestic—one year \$17.97, two years \$33.00, three years \$48.00; Canada/Mexico—one year \$20.00, two years \$37.00, three years \$54.00; Foreign—one year \$22.00, two years \$41.00, three years \$60.00. Foreign Air Mail—one year \$75.00, two years \$147.00, three years \$219.00.

Entire contents copyright 1988 by Modern Electronics, Inc. Modern Electronics or Modern Electronics, Inc. assumes no responsibility for unsolicited manuscripts. Allow six weeks for delivery of first issue and for change of address. Printed in the United States of America.

Postmaster: Please send change of address notice to Modern Electronics, Inc., 76 North Broadway, Hicksville, NY 11801.

Radio Shack Parts Place™

PARTS FOR PROJECTS ARE NEIGHBORHOOD CLOSE

Save With Hotline Order Service

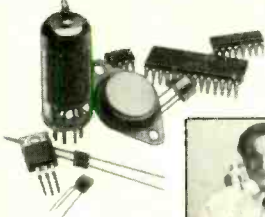

Over 200,000
Substitutions
Available



Your Radio Shack store manager can instantly phone in a special order for a wide variety of parts and accessories not shown in our catalog—tubes, ICs, phono styli, diodes, crystals and much more. No postage or handling charges, no minimum order! Please give us a try!

Audio Amp With Speaker

11⁹⁵

- Makes an Excellent Test Amp
- Perfect for Computer-Sound Output

Dozens of uses—get one for your test bench. Ready-to-use audio amplifier features a high-gain IC design and 200-mW output. Rotary on/off volume control. 1/8" input jack and 1/8" output jack for connecting an external speaker or headphone. Battery extra. #277-1008



Sale! Voice-Synthesizer Team

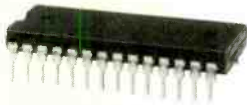

9⁹⁵

Speech Synthesizer. Cut 23%. Easy to interface with most computers. Requires 3.12 MHz crystal. Reg. 12.95. #276-1784 Sale 9.95

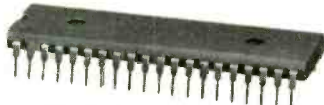

11⁸⁸

Text-to-Speech IC. 30% Off. Use with synthesizer chip (above) for RS-232 hookup. Req. 10 MHz crystal. Reg. 16.95. #276-1786 Sale 11.88



12-Tune Melody Synthesizer IC

- With On-Chip Audio Preamp
- Programmed With 12 Tunes

UMC3482. Just the thing for musical doorbells, games, clocks, telephone music-on-hold and novelty applications. Tunes include Happy Birthday, Oh My Darling Clementine, London Bridge, Home Sweet Home, Row-Row-Row Your Boat, more. Operates on 1.5 VDC. 16-pin DIP with data and circuit examples. #276-1797 2.99

Irresistables

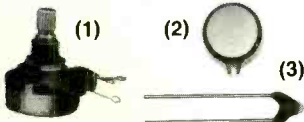

- (1) 5-Watt, 25-Ohm Rheostat. For lots of projects. #271-265 2.99
(2) Knob for Above. 1/4" shaft. With red insert. #274-433 Pkg. 2/99c
(3) Thermistor. Resistance changes with temperature. #276-110 1.99

Hard-to-Find Parts



- (4) 335 pF Variable Cap. Two-section, PC-mount. #272-1337, 4.95
(5) 6-50 pF Trimmers. Low peaking, PC-mount. #272-1340 Pkg. 2/1.59
(6) TV Colorburst Crystal. Precision 3.579545 MHz standard. #272-1310 1.69

Antennas

Replacements for cordless phones, walkie-talkies and portable radios.

Sections	Extends to	Cat. No.	Each
5	30 1/2"	270-1401	2.99
4	34 3/8"	270-1402	3.49
3	39 1/2"	270-1403	3.59
5	28"	270-1405	2.99
5	15 1/2"	270-1406	2.59
5	13"	270-1407	2.59
6	72"	270-1408	3.99
6*	17 3/4"	270-1409	2.49

*#270-1409 has L-mounting bracket.

Builders' Helpers

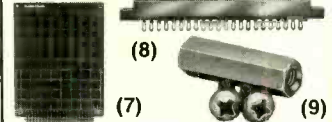

- (7) Plug-In PC Board With Ground Plane. #276-188 4.99
(8) 44-Position Card-Edge Socket. #276-1551 2.99
(9) PC Board Standoffs With Screws. #276-195 Pkg. 4/99c

Test Lead Sets

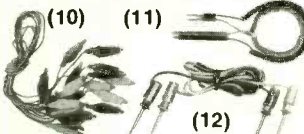

- (10) Set of Ten Color-Coded Test Cables. Gator clips. #278-1156, 3.99
(11) Coiled 6-Foot Leads. Probe at one end, banana plug at the other. #278-750 Pair/4.39
(12) Mini-Clip Jumper. 20" long. #278-016 Pair/3.49

FM Receiver IC



Combines RF mixer, IF and demodulator in a single IC. Makes receiver projects a cinch to build; and with 70KHz IF, no coils are required. Built-in mute circuit reduces spurious reception. With application notes. #276-1304 5.95

Buzzer & Lamps

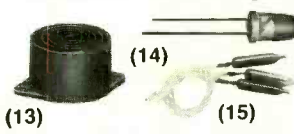

- (13) Tri-Sound Siren/Buzzer. Three different, extra-loud 80 db sounds. Requires 3 VDC. #273-072 5.95
(14) Super-Bright Red LED. 300 mcd at 20 mA. #276-066 1.19
(15) 12V Flashing Lamps. Yellow, red, green. #272-1097, Pkg. of 3/99c

Classy Touches



- (16) Aluminum Chassis Box. With screws. 2 3/4 x 2 1/8 x 1 1/8". #270-235 1.79
5 1/4 x 3 x 2 1/8". #270-238 2.49
4 x 2 1/8 x 1 1/8". #270-239 1.99
(17) Heavy-Duty Toggle Switch. DPDT, 10 amps at 125 VAC. UL. #275-1533, 1.79
(18) Lighted Pushbutton Switch. SPST, 5 amps at 250 VAC. UL. #275-678, 5.95

AC Spike Protectors

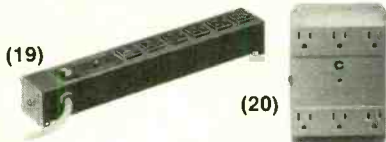

- (19) Power Strip. Built-in noise filter and circuit breaker. Lighted on/off switch. Rated 15 amps at 120 VAC. UL listed. #61-2780 29.95
(20) Cordless Power Outlet. Plugs into wall. With circuit breaker, noise filter. Rated 13 amps at 120 VAC. UL listed. #61-2786 24.95

Solderless Breadboard



Our finest! The 2 1/4 x 6 1/2" universal board is mounted on a 4 x 7" "stay-put" steel base with rubber feet. Accepts DIPs, discrete components and up to 22-gauge wire. Has 640 plug-in tie points and three binding posts for external power connections. #276-169 19.95

Especially Designed for Students, Hobbyists, Designers

Bench LCD Multimeter



99⁹⁵

Low As \$15 Per Month*

The 31-segment analog bar graph display makes input peaks and trends easier to follow. With autoranging, autopolarity, min/max hold, transistor checker (h_{FE}), diode checker, buzzer continuity checker. Measures AC/DC voltage/current, resistance. Batteries extra. #22-195

Over 1000 items in stock: Binding Posts, Books, Breadboards, Buzzers, Capacitors, Chokes, Clips, Coax, Connectors, Fuses, Hardware, ICs, Jacks, Knobs, Lamps, Multimeters, PC Boards, Plugs, Rectifiers, Resistors, Switches, Tools, Transformers, Wire, Zeners, More!

*Revolving credit from Radio Shack. Actual payment may vary depending on your account balance.

Radio Shack®

A DIVISION OF TANDY CORPORATION

Prices apply at participating Radio Shack stores and dealers

The DAT Saga

The digital audio tape (DAT) machine saga continues into 1988 as hardware makers jockey among themselves and their record-industry opponents.

At one end, the machine makers are showing prototype models. But only consumers in Japan and Europe can buy these super-quality audio tape machines. At the other end, the U.S. record industry continues to oppose DAT machines unless they have anti-copying provisions to ensure copyright protection. It brought its case to Congress, and we're all awaiting legislation on this.

Meanwhile, the plot thickened recently. Sony, a major Japanese DAT machine manufacturer, agreed to buy the giant CBS record division. CBS, you probably know, is in the forefront of opposing digital audio tape machines that can record and developed an integrated circuit, Copycode, to prevent such recording with DAT. Which side of the coin does Sony come down on now?

At the same time, N.V. Philips, which developed the original audio cassette,

and is also a major record producer (PolyGram Records) as well as a hardware manufacturer, has introduced another anti-copying scheme called "Solo." But this system does allow one to make a digital tape copy of a digital compact disc! What it does not permit is copying the tape!! This is said to foil making volume-quantities of master-quality tape.

An alternative to copying source material has always been with us, of course: Adding a tax to the tape recorder or to blank tape that would wend its way to the recording artists and record industry.

Summing up the DAT story to date, the Japanese DAT machine manufacturers are champing at the bit, awaiting Congressional action on machines that copy or cannot copy digital compact discs and tapes. The record industry is trying once again to get rewards for copyright material after losing their "case" with analog tape and video tape. And we consumers all sit here awaiting an audio tape system that can reproduce sound at least equal to that of a compact disc,

which may or may not have a capacity to record near-perfect duplicates.

My feelings on all this remain the same. They are as follows: The record industry would not be earning as much money from prerecorded material as they are from prerecorded video tape sales and rentals and record sales if the video and audio machines did not have a recording facility! Simply put, I wouldn't buy a playback-only tape machine. I think much fewer would be sold, with accompanying decreases in prerecorded sales and rentals.

In fairness, though, digital audio tape machines are admittedly different. Whereas there's a generational loss of quality when standard video or audio source material is recorded, DAT copies are essentially indistinguishable from the originals. In my view, therefore, there could well be a loss of revenue for record companies in this case. As a result, it seems equitable to do something that would reward the record industry for a likely loss of some revenue as a conse-

IBM XT Compatible Computer System

Includes:

- 10MHz 8088-1 Motherboard
 - 640K RAM
- 2 serial ports, 1 parallel port, and 1 game port
- Clock calendar w/battery
 - 2 Toshiba 360K drives
- AT Style Enhanced Keyboard
 - CTX 14" tilt/swivel amber monitor
- CGA/Mono-Hercules Graphics
 - 8 slots w/7 available
 - 150 Watt Power Supply
 - DTK/ERSO BIOS
 - Microsoft MS-DOS v. 3.3
 - FCC Class 8 CERTIFIED

PRICE: \$1065.00

**386
COMPUTERS
ALSO
AVAILABLE**

**CALL FOR
INFORMATION**

IBM AT Compatible Computer System

Includes:

- 8MHz 0 Wait Motherboard w/640K RAM (Expandable to one Meg)
 - 2 Serial, 1 Parallel and 1 game ports
 - Clock calendar w/Battery
- WA2 Floppy/HD controller
 - 2 Toshiba 360K Drives
- CGA/Mono-Hercules Graphics
 - CTX 14" Amber Monitor with Tilt and Swivel
 - 200 Watt Power Supply
- AT Style Enhanced Keyboard
 - 8 Slots w/7 available
 - Microsoft MS-DOS v. 3.3
 - FCC Class A CERTIFIED

PRICE: \$1450.00

Competitive Computer Solutions, Inc.

5721 Bayside Rd., Suite A • Virginia Beach, VA 23455

Phone: Voice - (804) 460-XTAT • Modem - (804) 363-BAUD



quence of recording DAT machines.

However, I shudder at the CBS solution: a device that prevents all recording. Everyone loses! The Philips anti-copying scheme that permits CD-to-digital tape copying, but not digital tape-to-tape is much more desirable. Be assured, however, that pirates will break the code.

My conclusion, therefore, is that there should not be anti-copying schemes at all, but a tax should be levied on blank digital audio tape. It might be untraditional, but it seems to be the neatest solution. We pay sales tax on most purchases and we pay Federal Excise Tax on some things. So why not pay a tax on blank DAT? The amount would be minuscule and we'll all come out ahead. After all, how many people will spend big bucks on a digital tape recorder that has recording hindrances?

Art Salsberg

HP Calculator Info

• Thanks for a very interesting article on the HP-28C calculator in the October 1987 issue. I will probably get one of these machines or a more programmable relative of it if HP designs it. For the time being, I will be an HP-71B and an HP-41C/CV/CX (on each) user.

Readers of your magazine who are interested in small computers such as the HP-71B or calculators like the HP-28C and HP-41 series might be interested in a new publication done in newsletter style. It is *HPX Exchange*. Articles are submitted by members and there is no compensation.

To inquire about HPX membership, send a business-sized SASE with 39 cents postage attached. I will return photocopies of the table of contents of the first two issues of the *Exchange*, pages 1 and 2 of both issues, membership application form, and one article on the machine that most interests you (specify HP-41, HP-71B or HP-28C). Or contact the editor/publisher direct at: Handheld Program-

ming Exchange, P.O. Box 566727, Atlanta, GA 30356 (tel. 404-391-0367 evenings/weekends).

James C. Cave
P.O. Box 298
Princeton, TX 75077-0928

Project Updates

• Figures 12 and 13 of "The Versatile LM723" (February 1987) both show an npn 2N2222 (my error) where a 200-mA 2N3906 or a more robust 600-mA 2N4403 pnp transistor should be for the constant-current source. The 723 is a very robust device but it *must* be installed in a properly designed circuit. It is very prone to damage with even the slightest short circuit to any pin.

J. Daniel Gifford

• In "An FM Wireless Microphone" (January 1988), the value of C1, C2 and C7 is shown as 0.1 μ F in the schematic but is stated as 0.01 μ F in the Parts List.

(continued on page 59)

AT Components

AT base unit w/200 watt power supply, 10 MHz 0 wait motherboard, 512K RAM. W.D. WA2 controller, 1.2 meg floppy, and AT style keyboard. \$1092.00

Great Wall AT w/2 ser., 1 par., clock-cal., 200 watt power supply, 8 MHz 0 wait motherboard, 640K RAM front panel diagnostic display, and front panel controller. \$742.50

AT case	\$76.95
AT motherboard 10 MHz 0 wait	\$432.00
AT 200 watt power supply	\$87.75
AT WA2 hard/floppy controller	\$175.50
AT 2.5 meg RAM card w/OK	\$76.95
AT EMS card	\$103.95
ATI/O	\$51.30
AT serial/parallel card	\$45.90
AT RA2 AT Hard RLL Disk Controller	\$185.00

Software

Paragon-Integrated accounting	\$940
Reflex 1.4-data base management	\$121
dBase kit + programmable d/B mgt.	\$593
Paradox-semi-program. d/b/spreadsheets	\$660
FrameworkII-prog. d/b/spreadsheets. wrdproc.	\$560
MixC compiler Editor, C Trace	\$17ea.
TurboGhostwriter-Pascal apps gen	\$270
WordPerfect-word processing	\$305
Volkswriter 3-word processing	\$230
SuperCalc4-intg'td sprdsht. d8 mgl	\$380
BLAST-mni, micro and en/1 connection	\$201
Bookmark-saves Interrupted work	\$81
SuperKey-"Hot Key", secures data	\$54
EasyFlow-flow charting	\$202
Harvard Total Project Management	\$400
Diagnostics-disk troubleshooting	\$52
HARVEY-computerized UPS'ing	\$235
HowardSoft's Tax Preparer updatable	\$275
MIDI SCORE-music interface software	\$543
CSS Designer-CAD software	\$80
Drafrix.Drafrix 30 & Design CAO	\$265ea.

Monitors, Keyboards

CTX CGA 14" .43 mm dot pitch	\$306.45
CTX CGA 14" .39 mm dot pitch	\$346.95
CTX EGA 14" .39 mm dot pitch	\$432.00
CTX EGA 14" .31 mm dot pitch	\$468.45
Tilt and swivel for above CTX monitors add:	\$22.00
CTX Monochrome with tilt and swivel	\$147.50
CTX 14" multisync .31 dot pitch tilt and swivel	\$621.00
Magnavox 14" CGA .42mm dot pitch	\$295.00
Magnavox 14" EGA .39mm dot pitch	\$415.00
Samsung 12" monochrome tilt/swivel	\$103.95
Samsung 14" CGA	\$310.50
Samsung 14" EGA	\$457.65
Generic 101 keyboard w/key click	\$76.95
BTC KB101 Keyboard clone	\$72.23
Keytronic 101 Keyboard	\$121.50
Keytronic 5150 Keyboard	\$108.00
Keytronic 5151 Keyboard	\$171.45
Keytronic 5153 Keyboard	\$297.00

Solutions are our business. Competitive Computer Solution, Inc. is a computer firm offering our clients custom programming, consulting, mailing, list management plus. The plus is the attention to quality in our products, our sales and our services. Our products guaranteed for one year including parts and labor. Any problem can be solved and we are happy to offer our IBM compatible solutions at a competitive price. To order, write, use the free reader service card, or dial 1-804-460-XTAT. Modem users call 1-804-363-BAUD. All items prepaid. Sorry, no COD's.

XT Components

XT slide-out case	\$33.75	Mono card	\$37.80
AT jr. style XT case w/reset, turbo switch, keyboard lock, power LED, hard drive indicator	\$41.85	Printer card	\$16.20
XT 10 MHz Bare bones box w/AT jr. case, 150 watt power supply, 10 MHz 8088-1 motherboard, OK RAM, DTK/ERSO BIOS, 8 expansion slots	\$236.25	I/O PlusII ser/par/clk-cal/game	\$49.95
XT 8 MHz base unit w/slide-out case, 150 watt power supply, 8 MHz 8088-2 motherboard, OK RAM, AT style keyboard, Phoenix BIOS, 8 slots	\$249.75	Multi I/O and display ser/par/gam/clk-cal/CGA/MGA/FDC	\$120.15
Mono graphic half card w/printer port	\$54.00	RAM Card 640K w/OK	\$36.45
Color graphic card w/printer port	\$168.75	XT speaker	\$1.36
EGA graphics adapter	\$236.25	Floppy Controller - 1 port	\$25.65
ATI autoswitch adapter	\$236.25	Floppy Controller - 2 port	\$31.05
Multi I/O half card ser/par/gam/clk-cal/floppy cont.	\$63.45	Floppy Controller - 360K/1.2 Meg	\$52.65
		Combination floppy/hard controller 5220	\$114.75
		Hard Disk controller 6210	\$91.80
		Clock card	\$22.95
		RS-232 card 2 ports	\$32.40
		RS-232 card 1 port	\$25.65
		Game I/O card	\$14.85
		XT turbo motherboard 10 MHz	\$118.80
		RLL XT Hard Disk Controller	\$135.00

Drives and Printers

Toshiba 360K XT/AT Beige drive	\$93.15	Star LV1215 120/140 cps + NLQ	\$235.00
Toshiba 360K XT drive	\$91.80	Star LV1215 120/140 cps 136 column	\$350.00
Toshiba 1.2 Meg drive	\$122.85	Star LV1615 160/180 cps + NLQ	\$425.00
Toshiba 3-1/2" drive	\$122.85	Star LV2015 200/220 cps + NLQ	\$565.00
Seagate ST225 w/W.D. RLL controller 20 Meg	\$364.50	Star NX 1000 144 cps	\$225.00
Seagate ST251 40 meg AT drive	\$553.50	Star NX 1000C 144 cps color	\$245.00
Seagate ST4038 30 meg AT drive	\$648.00	Star NB24-10 24 pin 216/72 cps	\$594.00
Seagate ST238 w/W.D. RLL controller 30 Meg	\$438.75	Star NB24-15 24 pin 216/72 cps 136 column	\$799.00
Citizen 1200 120/36 cps	\$200.00	Brother M1509 180/45 cps 136 column	\$450.00
Seikosha SP1200A1 120/25 cps	\$250.00	Brother M1709 240/50 cps 136 column	\$525.00
Seikosha SL80A1 135/54 cps	\$350.00	Brother HR40 44 cps Daisy Wheel 136 column	\$650.00
Seikosha MP5300A1 136 column 300/50 cps	\$515.00	Brother M1724L 216/72 24 pin 136 column	\$700.00
Seikosha MPI300A1 300/50 cps	\$540.00		
7 color option for MPI300A1	\$125.00		

Competitive Computer Solutions, Inc.
5721 Bayside Rd., Suite A • Virginia Beach, VA 23455
Phone: Voice - (804) 460-XTAT • Modem - (804) 363-BAUD

IBM, XT and AT are registered trademarks of International Business Machines Corp.
Microsoft, MS-DOS and GW-Basic are registered trademarks of Microsoft Corporation.

RADAR DETECTOR ADVANCES. Uniden's new "Uniden Talker" radar detector lets the user program a warning in his own voice (or someone else's) that's activated whenever a radar signal is detected. The X/K band device is also equipped with a conventional buzzer....Maxon's micro-size RD-XL X/K-band radar detector uses a self-contained battery to eliminate the power cord. The cordless device employs a Gallium Arsenide Field-Effect Transistor circuit.

ACTIVE LOUDSPEAKER SYSTEM. A unique remote-controlled loudspeaker system with 1,400 watts of power from ten amplifiers has been introduced by Altec Lansing. The new Model 550, which consists of a pair of speaker systems with swiveling drivers, uses a remote control panel that allows the systems' amplifiers to be adjusted ± 6 dB in 2-dB increments, with each change marked by a LED indicator. Additionally, a remote volume control adjusts the overall response curve and L/R balance can be made. Double-cabinet construction is used, with upper bass, lower midrange, upper midrange drivers and tweeter housed in separate, swiveling cabinets. Subwoofers remain stationary since their frequency is non-directional. Total harmonic distortion is said to be only 0.08% at 1 watt to rated power, from 35 Hz to 20 kHz. The amplified speaker system retails for \$12,000 per pair.

CORPORATE CHANGES. Some interesting name and ownership changes were seen in 1987. The venerable General Instrument MicroElectronics name was changed to Microchip Technology Incorporated, for example....IBM announced selling off of its shares in Intel, the company that designed and produced the microprocessors for IBM's line of personal computers to date....CBS Records was sold to Sony, the latter saying that this should have little immediate effect on the current legislative DAT [digital audio tape] battle. (Wanna bet!)

BAR-CODING SKYROCKETING. The boom in bar coding continues, with 10.2% of non-using companies saying they'll be installing systems this year, according to a nationwide survey conducted by Cormier & Church, Ltd. for Texlon Corp. The current marketplace is said to be around \$500-million annually, and only 18.4% of companies contacted in the survey are currently using bar coding or another form of electronic point-of-origin data gathering. The grocery business really gave birth to bar-code scanning here about 15 years ago, spreading rapidly, as supermarket shoppers know....Bar code leader INTERMEC has introduced a new bar code, CODE 49, named by its developer, Dr. David Allais, who also invented the widely-used CODE 39. The new symbology has a two-dimensional format that encodes all 128 ASCII characters and can be intermixed with and discriminated from other bar codes. The new symbology reduces the length of bar-codes to 1/16th of that encoded with the popular CODE-39 symbols.

JAPANESE TECH LANGUAGE COURSE. MIT will be starting a workshop for electrical engineers and computer scientists to learn technical aspects of the Japanese language so that they can read technical information published in Japanese. According to an MIT spokesman, Japanese counterparts often read technical English fluently and can therefore gather much information easily. The workshop (June 6 to July 29) will be limited to 20 people, with a tuition of \$3,000. For more information, call MIT at 617-253-8095.

NEW! CB Radios & Scanners

Communications Electronics,™ the world's largest distributor of radio scanners, introduces new models of CB & marine radios and scanners.

NEW! Regency® TS2-RA

Allow 30-90 days for delivery after receipt of order due to the high demand for this product.

List price \$499.95/CE price \$339.95
12-Band, 75 Channel • Crystalless • AC/DC
Frequency range: 29-54, 118-174, 406-512, 806-950 MHz
The Regency TS2 scanner lets you monitor Military, Space Satellites, Government, Railroad, Justice Department, State Department, Fish & Game, Immigration, Marine, Police and Fire Departments, Aeronautical AM band, Paramedics, Amateur Radio, plus thousands of other radio frequencies most scanners can't pick up. The Regency TS2 features new 40 channel per second Turbo Scan™ so you won't miss any of the action. Model TS1-RA is a 35 channel version of this radio without the 800 MHz. band and costs only \$239.95.

Regency® Z60-RA

List price \$299.95/CE price \$148.95/SPECIAL
8-Band, 60 Channel • No-crystal scanner
Bands: 30-50, 88-108, 118-136, 144-174, 440-512 MHz
The Regency Z60 covers all the public service bands plus aircraft and FM music for a total of eight bands. The Z60 also features an alarm clock and priority control as well as AC/DC operation. Order today.

Regency® Z45-RA

List price \$259.95/CE price \$139.95/SPECIAL
7-Band, 45 Channel • No-crystal scanner
Bands: 30-50, 118-136, 144-174, 440-512 MHz
The Regency Z45 is very similar to the Z60 model listed above however it does not have the commercial FM broadcast band. The Z45, now at a special price from Communications Electronics.

Regency® RH256B-RA

List price \$799.95/CE price \$329.95/SPECIAL
16 Channel • 25 Watt Transceiver • Priority
The Regency RH256B is a sixteen-channel VHF land mobile transceiver designed to cover any frequency between 150 to 162 MHz. Since this radio is synthesized, no expensive crystals are needed to store up to 16 frequencies without battery backup. All radios come with CTCSS tone and scanning capabilities. A monitor and night/day switch is also standard. This transceiver even has a priority function. The RH256 makes an ideal radio for any police or fire department volunteer because of its low cost and high performance. A 60 Watt VHF 150-162 MHz. version called the RH606B-RA is available for \$459.95. A UHF 15 watt, 10 channel version of this radio called the RU150B-RA is also available and covers 450-482 MHz. but the cost is \$439.95.

Bearcat® 50XL-RA

List price \$199.95/CE price \$114.95/SPECIAL
10-Band, 10 Channel • Handheld scanner
Bands: 29.7-54, 136-174, 406-512 MHz
The Uniden Bearcat 50XL is an economical, handheld scanner with 10 channels covering ten frequency bands. It features a keyboard lock switch to prevent accidental entry and more. Also order the new double-long life rechargeable battery pack part # BP55 for \$29.95, a plug-in wall charger, part # AD100 for \$14.95, a carrying case part # VC001 for \$14.95 and also order optional cigarette lighter cable part # PS001 for \$14.95.



PC 22

NEW! Scanner Frequency Listings

The new Fox scanner frequency directories will help you find all the action your scanner can listen to. These new listings include police, fire, ambulances & rescue squads, local government, private police agencies, hospitals, emergency medical channels, news media, forestry radio service, railroads, weather stations, radio common carriers, AT&T mobile telephone, utility companies, general mobile radio service, marine radio service, taxi cab companies, tow truck companies, trucking companies, business repeaters, business radio (simplex) federal government, funeral directors, veterinarians, buses, aircraft, space satellites, amateur radio, broadcasters and more. Fox frequency listings feature call letter cross reference as well as alphabetical listing by licensee name, police codes and signals. All Fox directories are \$14.95 each plus \$3.00 shipping. State of Alaska-RL019-1; Baltimore, MD/Washington, DC-RL024-1; Chicago, IL-RL014-1; Cleveland, OH-RL017-1; Columbus, OH-RL003-2; Dallas/Ft. Worth, TX-RL013-1; Denver/Colorado Springs, CO-RL027-1; Detroit, MI/ Windsor, ON-RL008-2; Fort Wayne, IN/Lima, OH-RL001-1; Houston, TX-RL023-1; Indianapolis, IN-RL022-1; Kansas City, MO/ KS-RL011-2; Los Angeles, CA-RL016-1; Louisville/Lexington, KY-RL007-1; Milwaukee, WI/Waukegan, IL-RL021-1; Minneapolis/St. Paul, MN-RL010-2; Nevada/E. Central CA-RL028-1; Oklahoma City/Lawton, OK-RL005-2; Pittsburgh, PA/Wheeling, WV-RL029-1; Rochester/Syracuse, NY-RL020-1; Tampa/St. Petersburg, FL-RL004-2; Toledo, OH-RL002-3. A regional directory which covers police, fire ambulance & rescue squads, local government, forestry, marine radio, mobile phone, aircraft and NOAA weather is available for \$19.95 each. RD001-1 covers AL, AR, FL, GA, LA, MS, NC, PR, SC, TN & VI. For an area not shown above call Fox at 800-543-7892 or in Ohio 800-621-2513.

Regency® Informant™ Scanners

Frequency coverage: 35-54, 136-174 406-512 MHz.
The new Regency Informant scanners cover virtually all the standard police, fire, emergency and weather frequencies. These special scanners are preprogrammed by state in the units memory. Just pick a state and a category. The Informant does the rest. All Informant radios have a feature called Turbo Scan™ to scan up to 40 channels per second. The INF1-RA is ideal for truckers and is only \$249.95. The new INF2-RA is a deluxe model and has ham radio, a weather alert and other exciting features built in for only \$324.95. For base station use, the INF5-RA is only \$199.95 and for those who can afford the best, the INF3-RA at \$249.95, is a state-of-the-art, receiver that spells out what service you're listening to such as Military, Airphone, Paging, State Police, Coast Guard or Press.

Regency® HX1500-RA

List price \$369.95/CE price \$218.95
11-Band, 55 Channel • Handheld/Portable Search • Lockout • Priority • Bank Select Sidelit liquid crystal display • EAROM Memory Direct Channel Access Feature • Scan delay
Bands: 29-54, 118-136, 144-174, 406-420, 440-512 MHz
The new handheld Regency HX1500 scanner is fully keyboard programmable for the ultimate in versatility. You can scan up to 55 channels at the same time including the AM aircraft band. The LCD display is even sidelit for night use. Includes belt clip, flexible antenna and earphone. Operates on 8 1.2 Volt rechargeable Ni-cad batteries (not included). Be sure to order batteries and battery charger from the accessory list in this ad.

Bearcat® 100XL-RA

List price \$349.95/CE price \$178.95/SPECIAL
9-Band, 16 Channel • Priority • Scan Delay Search • Limit • Hold • Lockout • AC/DC
Frequency range: 30-50, 118-174, 406-512 MHz
Included in our low CE price is a sturdy carrying case, earphone, battery charger/AC adapter, six AA Ni-cad batteries and flexible antenna. Order your scanner now.

★★★ Uniden CB Radios ★★★

The Uniden line of Citizens Band Radio transceivers is styled to compliment other mobile audio equipment. Uniden CB radios are so reliable that they have a two year limited warranty. From the feature packed PRO 540e to the 310e handheld, there is no better Citizens Band radio of the market today.

PRO310E-RA Uniden 40 Ch. Portable/Mobile CB... \$85.95
NINJA-RA PRO310E with rechargeable battery pack \$99.95
B-10-RA 1.2V AA Ni-cad batt. for Ninja (set of 10) ... \$20.95
PRO520E-RA Uniden 40 channel CB Mobile... \$59.95
PRO540E-RA Uniden 40 channel CB Mobile... \$119.95
PRO710E-RA Uniden 40 channel CB Base... \$119.95
PC22-RA Uniden remote mount CB Mobile... \$99.95
PC55-RA Uniden mobile mount CB transceiver... \$59.95

★★★ Uniden Marine Radios ★★★

Now the finest marine electronics are available through CEI. The Unimetrics SH66-RA has 50 transmit and 60 receive frequencies with 25 or 1 watt power output. Only \$169.95. The Unimetrics SH88-RA is a deluxe full function marine radiotelephone featuring 55 transmit and 90 receive channels and scanning capability for only \$259.95. The Unimetrics SH3000-RA is an excellent digital depth sounder, good for 300 feet. It has an LCD continuously backlit with red light display and a 5 ft. or 10 ft. alarm. Only \$189.95. Order today.

CIRCLE NO. 151 ON FREE INFORMATION CARD

Bearcat® 800XLT-RA

List price \$499.95/CE price \$289.95/SPECIAL
12-Band, 40 Channel • No-crystal scanner Priority control • Search/Scan • AC/DC
Bands: 29-54, 118-174, 406-512, 806-912 MHz
The Uniden 800XLT receives 40 channels in two banks. Scans 15 channels per second. Size 9 1/4" x 4 1/2" x 1 1/2"

OTHER RADIOS AND ACCESSORIES

Panasonic RF-2600-RA Shortwave receiver... \$179.95
RD55-RA Uniden Visor mount Radar Detector... \$98.95
RD9-RA Uniden™ Passport™ size Radar Detector... \$169.95
NEW! BC 70XLT-RA Bearcat 20 channel scanner... \$168.95
BC 140-RA Bearcat 10 channel scanner... \$92.95
BC 145XL-RA Bearcat 45 channel scanner... \$98.95
BC 175XL-RA Bearcat 16 channel scanner... \$156.95
BC 210XLT-RA Bearcat 40 channel scanner... \$196.95
BC-WA-RA Bearcat Weather Alert™... \$35.95
R1080-RA Regency 30 channel scanner... \$118.95
R1090-RA Regency 45 channel scanner... \$148.95
UC102-RA Regency VHF 2 ch. 1 Watt transceiver... \$117.95
P1412-RA Regency 12 amp reg. power supply... \$189.95
MA549-RA Drop-in charger for HX1200 & HX1500... \$84.95
MA518-RA Wall charger for HX1500 scanner... \$14.95
MA553-RA Carrying case for HX1500 scanner... \$19.95
MA257-RA Cigarette lighter cord for HX12/1500... \$19.95
MA917-RA Ni-Cad battery pack for HX1000/1200... \$34.95
SMMX7000-RA Svc. man. for MX7000 & MX5000... \$19.95
B-4-RA 1.2 V AAA Ni-Cad batteries (set of four)... \$9.95
B-8-RA 1.2 V AA Ni-Cad batteries (set of eight)... \$17.95
FB-E-RA Frequency Directory for Eastern U.S.A... \$14.95
FB-W-RA Frequency Directory for Western U.S.A... \$14.95
ASD-RA Air Scan Directory... \$14.95
SRF-RA Survival Radio Frequency Directory... \$14.95
TSG-RA "Top Secret" Registry of U.S. Govt. Freq... \$14.95
TIC-RA Techniques for Intercepting Comm... \$14.95
RRF-RA Railroad frequency directory... \$14.95
EEC-RA Embassy & Espionage Communications... \$14.95
CIE-RA Covert Intellegent. Elect. Eavesdropping... \$14.95
MFF-RA Midwest Federal Frequency directory... \$14.95
A60-RA Magnet mount mobile scanner antenna... \$35.95
A70-RA Base station scanner antenna... \$35.95
MA548-RA Mirror mount Informant antenna... \$39.95
USAMM-RA Mag mount VHF ant. w/ 12' cable... \$39.95
USAK-RA 3/4" hole mount VHF ant. w/ 17' cable... \$35.95
Add \$3.00 shipping for all accessories ordered at the same time.
Add \$12.00 shipping per shortwave receiver.
Add \$7.00 shipping per radio and \$3.00 per antenna.

BUY WITH CONFIDENCE

To get the fastest delivery from CE of any scanner, send or phone your order directly to our Scanner Distribution Center™ Michigan residents please add 4% sales tax or supply your tax I.D. number. Written purchase orders are accepted from approved government agencies and most well rated firms at a 10% surcharge for net 10 billing. All sales are subject to availability, acceptance and verification. All sales on accessories are final. Prices, terms and specifications are subject to change without notice. All prices are in U.S. dollars. Out of stock items will be placed on backorder automatically unless CE is instructed differently. A \$5.00 additional handling fee will be charged for all orders with a merchandise total under \$50.00. Shipments are F.O.B. Ann Arbor, Michigan. No COD's. Most products that we sell have a manufacturer's warranty. Free copies of warranties on these products are available prior to purchase by writing to CE. Non-certified checks require bank clearance. Not responsible for typographical errors.

Mail orders to: Communications Electronics,™ Box 1045, Ann Arbor, Michigan 48106 U.S.A. Add \$7.00 per scanner for R.P.S./U.P.S. ground shipping and handling in the continental U.S.A. For Canada, Puerto Rico, Hawaii, Alaska, or APO/FPO delivery, shipping charges are three times continental U.S. rates. If you have a Discover, Visa or Master Card, you may call and place a credit card order. Order toll-free in the U.S. Dial 800-USA-SCAN. In Canada, order toll-free by calling 800-221-3475. FTCC Telex anytime, dial 825333. If you are outside the U.S. or in Michigan dial 313-973-8888. Order today. Scanner Distribution Center™ and CE logos are trademarks of Communications Electronics Inc.
† Bearcat is a registered trademark of Uniden Corporation.
‡ Regency and Turbo Scan are registered trademarks of Regency Electronics Inc. AD #080187-RA
Copyright © 1987 Communications Electronics Inc.

For credit card orders call
1-800-USA-SCAN

**COMMUNICATIONS
ELECTRONICS INC.**

Consumer Products Division
P.O. Box 1045 □ Ann Arbor, Michigan 48106-1045 U.S.A.
Call 800-USA-SCAN or outside U.S.A. 313-973-8888

NEW

Only NRI gives you a 27" high-resolution stereo color TV you build to prepare you for today's video servicing careers.



Become one of America's most sought-after technicians . . . put your talents and spare time to work for you in the "explosive-growth" world of home entertainment electronics.

Train in state-of-the-art video/audio servicing and become a fully qualified service professional the uniquely successful NRI way. It's hands-on training, at home . . . designed around the latest electronic equipment you build and keep as part of your training. You start from scratch and "discover by doing." You conduct key experiments . . . perform vital tests . . . build your own systems . . . and do it all at the pace that suits you best.

There's no stopping the incredible boom in consumer electronics. Soaring sales, new and improved video products, entirely new technologies have opened up new opportunities for the trained technician as never before.

Now at \$26 billion in annual sales, the consumer electronics industry is creating a whole new servicing, installation, and repair market. This year, TV sales alone are expected to hit 16.2 million units. Every day, sales of home



VCRs, a product barely conceived of 10 years ago, reach 20,000 units. Every day!

And the revolution has spread to the business sector as tens of thousands of companies are purchasing expensive high-tech video equipment used for employee training, data storage, even video conferencing.

The Video Revolution Is Just Starting

Already, disc players can handle audio CDs and laser video discs. And now there are machines that will accommodate laser computer disks as well. Camcorders are becoming smaller, lighter, and more versatile . . . 8 mm video equipment produces high-resolution pictures and digital audio. By 1990 our TVs will become interactive computer terminals, giving us entertainment, information, and communications in one sophisticated video/computer/audio system.

Join the Future or Be Left Behind

Can you see the opportunity? The servicing and repair market that's there already . . . and the enormous future need created by the millions upon millions of electronic devices yet to come? If you're looking for a high-potential career . . . if you'd like to get started in a field that's still wide open for the independent businessperson . . . even if you'd like to find a way to make extra money part-time, look into NRI at-home training now.

Start Right and There'll Be No Stopping You!

NRI training in video/audio servicing is the perfect way for you to profit from the new explosive growth in consumer electronics. You study at home in your spare time at your own pace. No classroom pressures, no night school grind.

Even if you've never had electronics training, NRI prepares you properly with a thorough grounding in the fundamentals . . . a foundation that you build on to achieve advanced electronics skills. With this kind of understanding and practical bench experience built into NRI's exclusive training methods, you're on your way to take advantage of the new opportunities opening up every day.

Totally Integrated Hands-On Training

Since NRI training is built around "learn by doing," right from the start you conduct important experiments and tests with your professional digital multimeter. You assemble the remarkable NRI Discovery Lab and perform a complete range of demonstrations and experiments in the process.

Hands-On Training As You Build a 27" Stereo TV

In just hours you assemble an exceptional state-of-the-art TV receiver using easy to follow, step-by-step instructions. During this assembly process, you learn to identify and work with components and circuits used in actual commercial circuitry. Then through tests, adjustments, and experiments you quickly master professional troubleshooting and bench techniques.

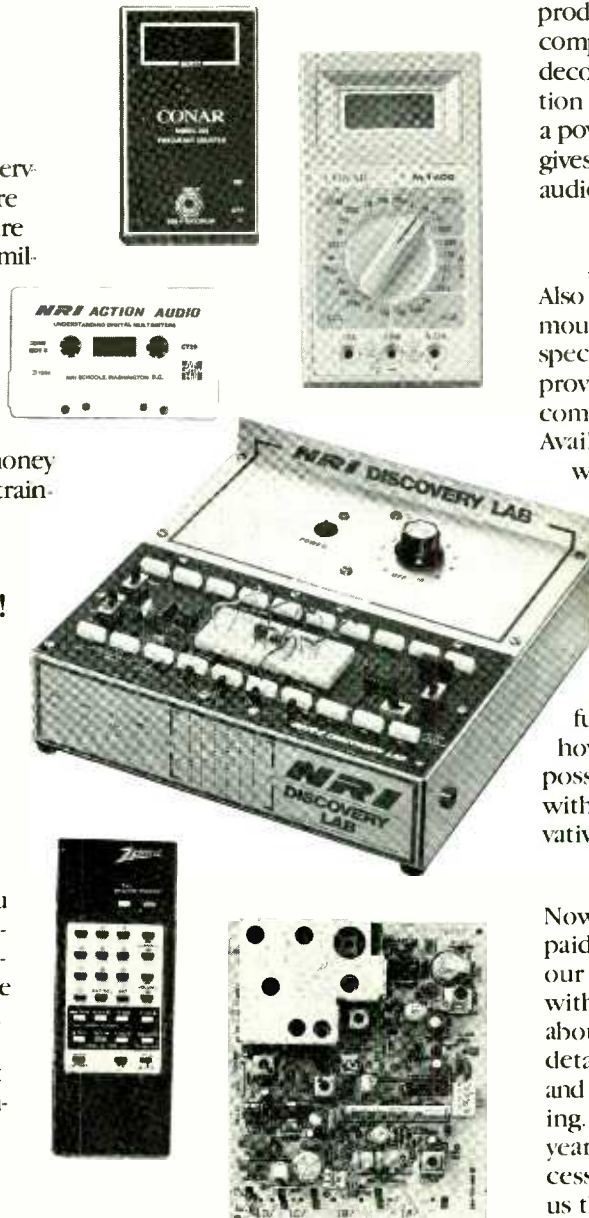

NRI has purposely designed your training around equipment that has the same high-tech circuitry you'll encounter in commercial equipment. That means your training is real-world training. And *that's* unique.

Inside Your TV

This new state-of-the-art Heath/Zenith 27" TV included with your training has all the features that allow you to set up *today* your complete home video center of the future. Flat screen, square corners, and a black matrix to produce dark, rich colors. Cable-compatible tuning, built-in stereo decoder to give you superb reproduction of stereo TV broadcasts . . . even a powerful remote control center that gives you total command of video and audio operating modes.

Your NRI Training Has Another Special Element

Also built into your training is the enormous experience of NRI development specialists and instructors. Their long-proven training skills and enthusiasm come to you on a one-to-one basis. Available for consultation and help whenever you need it, your instructors ensure your success both during your course and after graduation.

Step Into the Future Today

The richest reward you gain from your NRI video/audio training is a firm grip on the future. Your knowledge and know-how provide you with the soundest possible foundation for keeping up with the rapidly evolving, highly innovative video industry.

Send For Free Catalog

Now is the time to act. Send the post-paid card to us today. You'll receive our 100-page catalog free. It's filled with all the facts you'll want to know about our training methods with full details on the equipment you'll use and keep as part of your hands-on training. You'll see how our more than 70 years of experience in uniquely successful at-home career training makes us the leading technical school today. (If someone has already used the card, write to us at the address below.)

NRI's commitment to you goes beyond providing you with equipment appropriate to the latest technology. Of equal importance is our dedication to training techniques that let you master TV, video and audio troubleshooting and repair quickly and easily. Best of all, we ensure that in the learning process you acquire the very skills that will make you a professional service technician on the job.

NRI Schools
McGraw-Hill Continuing
Education Center
3939 Wisconsin Avenue, NW
Washington, DC 20016



For more information on products described, please circle the appropriate number on the Free Information Card bound into this issue or write to the manufacturer.

Hand-Held DMMs

Two new hand-held digital multimeters that have both 3 3/4-digit numeric and 71-segment analog LCD displays are now available from Simpson. The "human-engineered" Models 487 and 488 DMMs feature full autoranging, 0.41-inch numeric

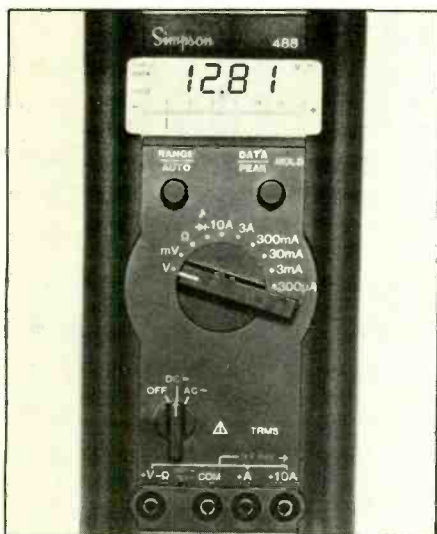

display digits and recessed test-lead jacks. The Model 488 is a true-rms-reading instrument on all ac voltage and current ranges: up to 750 volts ac and 10.0 amperes. Resistance ranges to 30 megohms and an audible diode/continuity test indicator are included.

Data and peak hold for all functions and ranges aid in troubleshooting and circuit analysis. The 71-segment analog bargraph display permits accurate peak and null adjustments to be made. The 20-kHz frequency response of both models makes these instruments valuable tools in audio servicing. Overload protection, a wide temperature/humidity operating range and rugged construction assure long service from these DMMs.

Both DMMs can measure from 300 millivolts to 1,000 volts dc, 300 millivolts to 750 volts ac, 300 microamperes to 10 amperes dc and ac and 300 to 30M ohms, all full-scale. Power is provided by a single 9-volt battery. The compact instruments measure 7.28 x 3.86 x 1.85 inches and weigh about 1.1 lb. \$219 for Model 487; \$275 for Model 488.

CIRCLE NO. 101 ON FREE INFORMATION CARD

Microcontroller With BASIC in ROM

The Vitrax IX Microcontroller from Sintec Co. (Frenchtown, NJ) is a compact stand-alone microcontroller designed for digital-control automated analog measurement, sensor monitoring and data acquisition. Driven by a high-speed CMOS Z80-compatible processor, it is claimed to

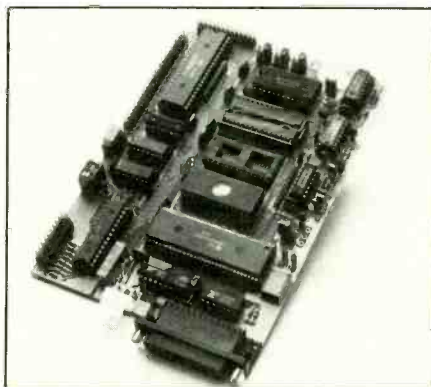

provide features and performance most often required in industrial and commercial real-time applications. The single-board microcontroller contains a full-featured floating-point BASIC in ROM, up to 16K of EPROM-based user code and CMOS static RAM that can be expanded to 32K. Vitrax IX also features a built-in EPROM programmer to simplify code generation for autostart operation.

For ease in interfacing, the unit provides 24 bidirectional I/O lines, two full-duplex asynchronous RS-232 channels that operate at up to 18.2K baud, a Centronics parallel printer port and an optional 8-chan-

nel, 10-bit CMOS A/D converter. A real-time clock/calendar can also be added for time-dependent applications. The entire unit operates from a single 5-volt dc power supply and draws less than 150 mA. It mounts on a 6.5 x 4.5-inch printed-circuit board and is available in both factory-wired and kit forms. \$139.50 in kit form; \$39.50 for 8-channel, 10-bit CMOS A/D converter; \$34.50 for CMOS real-time clock/calendar.

CIRCLE NO. 102 ON FREE INFORMATION CARD

Video Recording Accessories

Three new products from RCA can help videophiles make better video home movies. The Model VDC050 portable 12-volt dc light that operates on battery power or from a car's electrical system is said to insure dramatically brighter and sharper pictures. It has a special 50-watt multi-mirror lamp that maximizes light output and reduces power consumption and heat build-up. \$69.95.

The Model WM002 wireless microphone is designed to capture sound at distances up to 100 feet away. It consists of two pieces: a microphone/transmitter arrangement that the person speaking carries and a small receiver that snaps onto the top of the camera. \$134.95.

A character generator, Model CGA020, can give a "professional" touch to home video movies by adding names, dates, movie credits and other useful information to his



tapes. Characters can be displayed in four sizes and can be made to scroll off-screen, just as they do in professional moving pictures. In addition, the character generator can create "curtain" and "window" effects, and titles can be added to a tape without the need for a camera. \$249.95.

CIRCLE NO. 103 ON FREE INFORMATION CARD

Instant-Mount Antenna

A new antenna that has suction cups for instant mounting on glass or any other smooth surface where drilling a hole is not possible is available from Electronic Processing, Inc. (Medford, NY). The Vak-Tenna can receive 30 to 500 MHz signals and can be used for transmitting from 50 to 250 MHz at up to 50 watts. It can

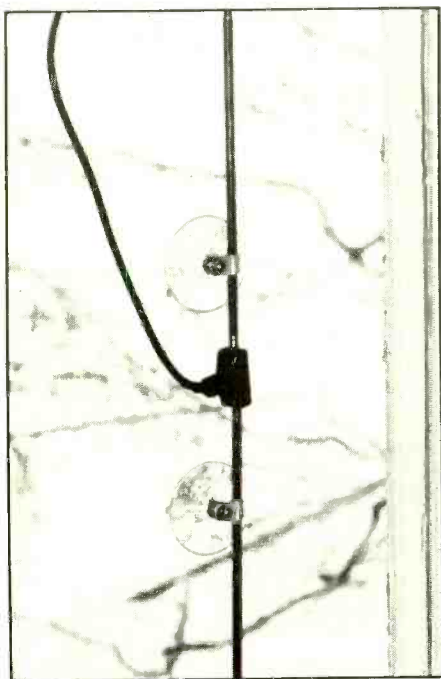

be mounted vertically or horizontally, as desired.

When mounted via its powerful suction cups, the antenna is held 1 inch from the glass to clear the frames of most windows. Its elements hinge to allow use with bay windows and at unusual angles. Two telescoping elements extend from 20 inches to 79 inches. Supplied with the antenna is a 15-ft. 50-ohm RG-58 ca-

ble. Standard connectors are PL259, BNC, Motorola and F; others are available on special order. From \$29.95.

CIRCLE NO. 104 ON FREE INFORMATION CARD

Ribbon Cable Labeler

"Cabelabel" from The DATAK Corp. (N. Bergen, NJ) provides a clever approach to labeling flat ribbon cables that do not usually "take" to traditional labels. Each

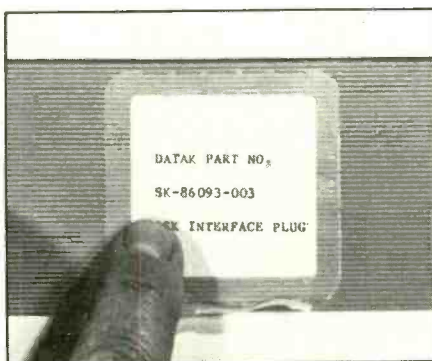

Cabelabel has a white write-on area that accepts pencil, pen, typewriter or computer printer legends. A clear vinyl cover securely seals the label to the ribbon cable or other surface and protects the label from dirt, abrasion, etc. What makes Cabelabel so different is that it is made from a soft, flexible material that conforms to the corrugated cable and stretches as the cable is bent. It uses an acrylic adhesive that permanently sets over a period of several hours. The labels are designed to bear up to temperature extremes as low as -55 and as high as +125 degrees C, though some yellowing may occur at temperatures above 110 degrees C.

Cabelabels are available in sizes ranging from 1.8 x 1.8 to 1.8 x 0.25 inches. Label quantities vary from 36 to 108 per set, depending on size. \$7.50 per set.

CIRCLE NO. 105 ON FREE INFORMATION CARD

Low-Cost PC LAN

LANtastic from Artisoft, Inc.'s (Tucson, AZ) PC local-area network system is designed for high speed. Its

on-board 10-MHz coprocessor provides a transfer rate of 2M bits per second and works with a dedicated 100-ns 32K buffer RAM. The coprocessor works in parallel with the host computer's CPU to permit computing tasks and networking tasks to occur simultaneously. A Starter Kit consists of two LANtastic network adapters, 15 feet of cable, two network terminator plugs and software. Its NETBIOS software is completely implemented by the coprocessor, allowing it to run with the IBM PC Networks program, Novell's Advanced NetWare or any network operating system that uses the NETBIOS interface.

Each Kit includes a Single Server License to the LANtastic Network Operating System, LANmark™, which provides the software link between computers using LANtastic adapter cards. Users create volumes on the Server's hard disk that can be shared across the network. LANmark allows read-only, read/write and exclusive access to volumes. Se-



curity is provided by disk-access passwords. Printer spooling and electronic mail are also supported.

For most network applications, LANmark can be used instead of network software. It does not require a dedicated Server. Artisoft's optional BIT TRACY™ hardware security card can be used with LANtastic to give completely controlled access, and a DES Encryption chip can be added to encrypt volumes in the Server.

LANtastic employs bus topology

NEW PRODUCTS...

which requires no additional hardware for interconnecting 32 PCs. Multiple adapters can be installed in each PC to be used as Gateways. Male and female adapters on each adapter card provide for easy daisy-chaining, and network lengths of more than 500 feet are possible. No I/O port locations are used, so no conflict exists with existing I/O cards; and no DMA channels are used by the system.

LANtastic Starter Kit, \$399; LANtastic Network Adapter, \$199; BIT TRACY, \$149; DES Encryption chip, \$75.

CIRCLE NO. 106 ON FREE INFORMATION CARD

No-Contact Voltage Detector

A.W. Sperry's (Hauppauge, NY) new Model VH-600 "Volt Hound" test device is a no-contact voltage detector that can sense and indicate ac potentials in the range of 100 to 600 volts with reference to ground. To operate it, the user simply grasps the

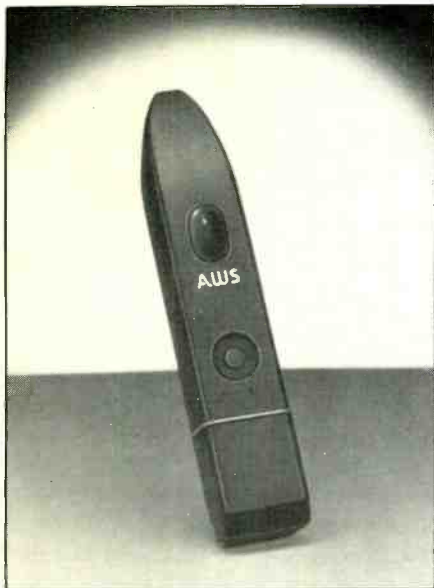

Volt Hound in his hand and places its tip near a live wire. If the wire is indeed "live," an audible tone is sounded and a light turns on. The 1-ounce Volt Hound comes with two 1.5-volt button-type cells that should power it for about a year.

CIRCLE NO. 107 ON FREE INFORMATION CARD



Six-Disc CD Player

A new CD player that can play up to six compact discs has been announced by Sansui. The Model CD-X310M CD player comes with a special magazine that provides the multiple-disc play capability. Up to 32 randomly programmed selections can be distributed among the six discs in any order desired. Features include Automatic Music Program Search (AMPS) that permits you to skip to the next or previous track; Audible Manual Search for fast forward and reverse; and a Repeat function that permits repeating the track being played, all discs or all tracks programmed into memory.

CIRCLE NO. 108 ON FREE INFORMATION CARD

In-Flight Headphones

Jetset is a new portable audio system for comfortable in-flight listening to movies and stereo music from Executive Travelware (Chicago, IL). It is claimed to offer a major improvement over airline-provided air-pipe headsets and can be used by wearers of in-ear hearing aids.

A patented sound pickup is made up of a pair of sensitive condenser microphone elements mounted in a specially designed seat connector. Acoustic correction baffles on the microphones filter excess hiss and sibilance from the sound. The microphones convert the acoustical signals into electronic signals that are then amplified by a patented "Airdaptor" module that drives the sup-

plied lightweight or personal-stereo headphones. Frequency response is stated as being 30 Hz to 20 kHz. Power for the module is supplied by two AAA cells. The amplifier module is short-circuit and reverse-polarity protected.

Frequency response of the player is rated at 2 Hz to 20 kHz, S/N at greater than 93 dB, harmonic distortion at 0.008 percent (at 1 kHz) and wow and flutter at unmeasurable level. The player measures 16.5"W x 13"D x 3.5"H and weighs 11.2 lbs. \$400.



plied lightweight or personal-stereo headphones. Frequency response is stated as being 30 Hz to 20 kHz. Power for the module is supplied by two AAA cells. The amplifier module is short-circuit and reverse-polarity protected.

For convenience and longest battery life, power to the module automatically switches off when the headset is not plugged in. The Air-dapter module is small enough to fit into a shirt pocket, measuring only $3 \times 2\frac{3}{8} \times \frac{1}{2}$ inches. \$19.95.

CIRCLE NO. 109 ON FREE INFORMATION CARD

DB-9 PC Aids

Two new products from Telebyte Technology, Inc. (Greenlawn, NY) support computers that use DB-9 connectors. The Model 52 is a Jumper Box, the Model 55 a Minipatch Box.

The Model 55 Minipatch box (upper photo) is a standard breakout-box arrangement configured for 9-pin connectors and has a male and female DB-9 connector at opposite ends of its plastic enclosure. It comes with jumper wires for fast reconfiguration and has two patching areas for applications where many signals must be patched together. \$16.

Users can customize interfaces be-

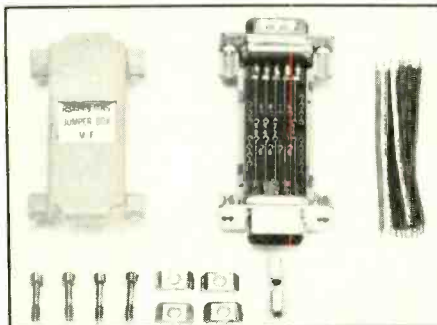
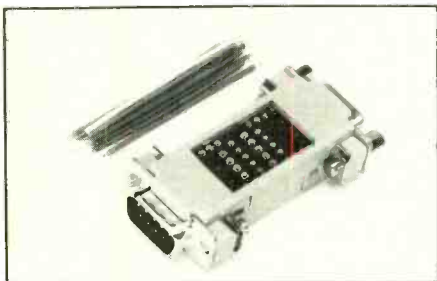

tween two DB-9 based devices with the Model 52 Jumper Box (lower photo). This item features a solder-masked pc board with each of the female and male connectors at opposite ends terminated in plated-

through holes. Pre-stripped jumper wires are supplied for soldering into the board's holes. Once configured, the assembly is housed inside a snap-closed plastic box, after which any needed polarization hardware (supplied) is attached. \$12.

CIRCLE NO. 110 ON FREE INFORMATION CARD

Battery Backup System

A new 325-watt battery backup system for computer and other electronics equipment users was introduced by Tripp Lite (Chicago, IL). In addition to offering protection against power failures, the Model BC-325



features full brown-out protection and a built-in filtering network that guards against transient spikes and line noise when operating on ac power.

A complete power-protection system, the Model BC-325 includes a 26-ampere-hour gel-cell battery that requires no maintenance, a regulated battery charger and an alarm with reset function. On the front panel are four grounded ac outlets, separate BATTERY POWER and LINE POWER indicators, an ALARM ON/OFF switch, a push-to-reset circuit breaker and a large POWER ON/OFF/RESET switch. The system supplies 60 minutes of emergency power at half load and 25 minutes of power on full load—enough time to allow safe shutdown of a computer or other electrical device connected to it. The battery backup system is housed in a beige cabinet with black front panel that blends into virtually any environment. \$479.

CIRCLE NO. 111 ON FREE INFORMATION CARD

HAM RADIO IS FUN!

It's even more fun for beginners now that they can operate voice and link computers just as soon as they obtain their Novice class license. You can talk to hams all over the world when conditions permit, then switch to a repeater for local coverage, perhaps using a transceiver in your car or handheld unit.



Your passport to ham radio adventure is TUNE-IN THE WORLD WITH HAM RADIO. The book tells what you need to know in order to pass your Novice exam. Two cassettes teach the code quickly and easily.

Enclosed is my check or money order for \$15.00 or charge my

() VISA () Mastercard () Am. Express

Signature _____

Acct. No. _____

Good from _____ Expires _____

Name _____

Address _____

City _____ State _____ Zip _____

THE AMERICAN RADIO RELAY LEAGUE
225 MAIN ST.
NEWINGTON, CT 06111

CIRCLE 41 ON FREE INFORMATION CARD

An EPROM Speed Reader/Comparator

Checks 16K to 512K EPROMs for complete erasure and compares a copy with an original EPROM in just seconds

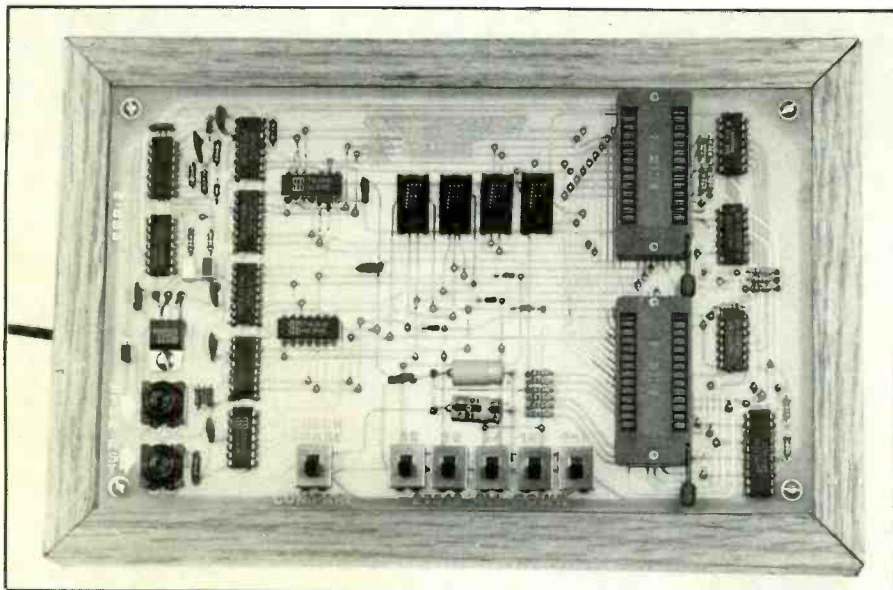

By Walter W. Schopp

Getting half-way through programming an EPROM only to find that a supposedly erased one still contains unwanted data can be a frustrating and time-consuming experience. The same applies to a duplicate EPROM you have made that does not work. If you have ever been in either of these situations, you will certainly appreciate the EPROM Speed Reader to be described. This handy unit is actually two test devices in one. It not only "reads" every memory address location in any 2716 (16K) through 27512 (512K) EPROM in seconds to determine whether or not every cell has been erased, it also compares a

copied EPROM against a master to check it for an accurate "take."

Our EPROM Speed Reader is a perfect accessory to the Stand-Alone EPROM Programmer featured in the February and March 1987 issues and the EPROM Eraser featured in the May 1987 issue of *Modern Electronics*. The project uses a double-sided printed-circuit board, zero-insertion-force test sockets and LED displays. You can etch and drill your own pc board (though you probably will not be able to plate-through the holes) or purchase a ready-to-wire board (see Parts List). Cost category for building this project is moderate but well worth the investment if you do a lot of erasing or/and programming of EPROMs.

About the Circuit

Simply by examining the pinouts of the various members of the 27XX and 27XXX family of EPROMs, you can readily see that all devices in this family are more or less pin-compatible. The differences in pinouts are confined mainly to pins 1, 2, 21, 24, 27 and 28. By switching addresses and voltages on these pins, the entire 27XX/27XXX family of EPROMs can be accommodated by a single test unit, as is done with our EPROM Speed Reader. In this project, the five switches labeled 16, 32, 64, 128 and 256 in Fig. 1(A) are used to accomplish address/voltage switching to accommodate 2716, 2732, 2764, 27128 and 27256 EPROMs. Note that, due to its large size, the main schematic diagram for the EPROM Speed Reader is shown in four parts, designated Figs. 1(A) through 1(D).

Address lines to both the master and copy EPROM are fed from the outputs of cascaded counters *IC1* through *IC4* in Fig. 1(A). The counters are driven by a square wave generator composed of two inverting buffers in the *IC6* package. The output of the generator is applied to the counter through another inverting buffer in *IC6*.

Signal inversion by the feeder inverting buffer puts the correct polar-

Fig. 1. Complete schematic diagram of project is shown here in four parts.

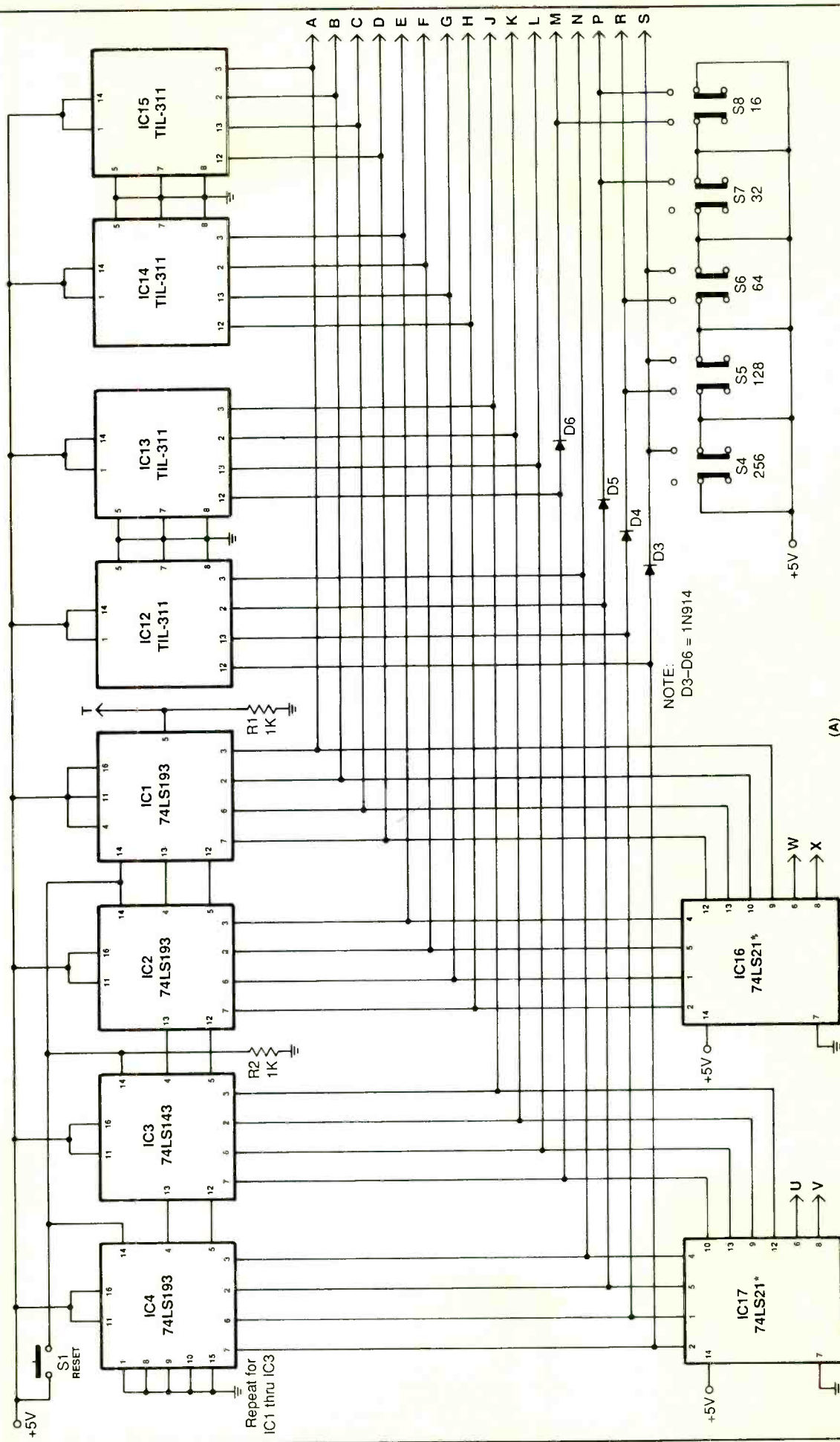

(A)

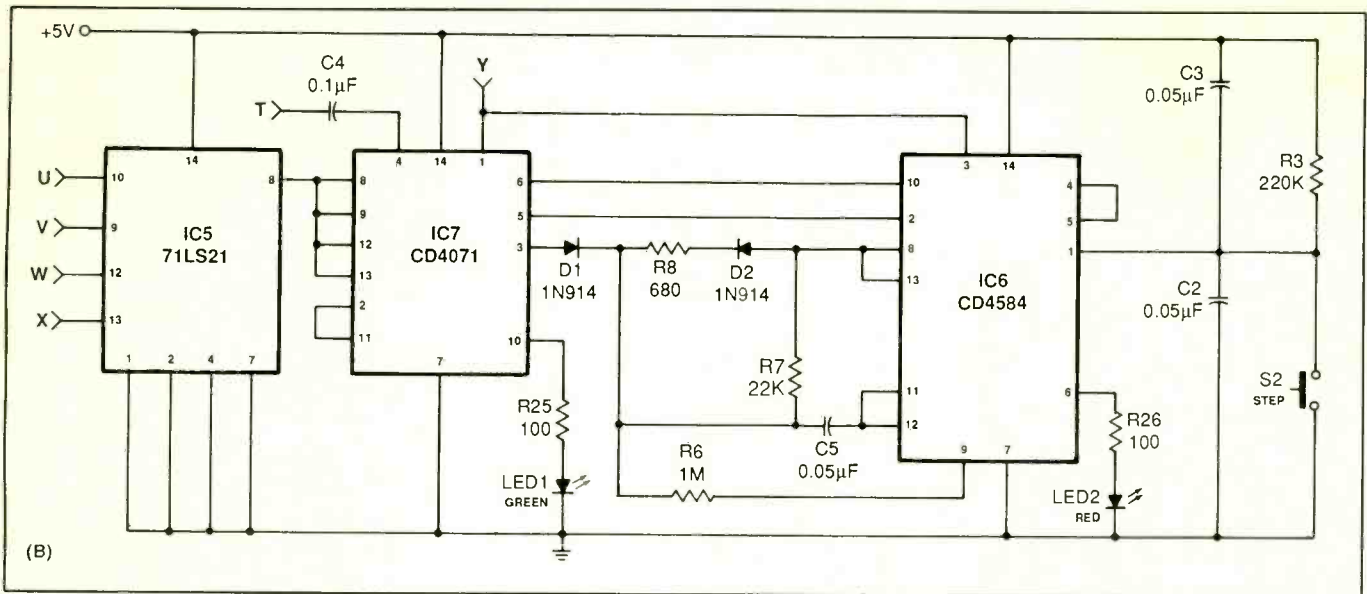

ity on the input of the counter so that when the counter is stopped by an error or completion of a count sequence, it can be retriggered from STEP pushbutton switch *S2* shown in Fig. 1(B).

Timing for the square-wave generator is controlled by the RC network composed of *C1* and *R7*. If a slower or faster sweep time is desired, the values of these components can be juggled, using the formula $1/(2.2RC)$. Values specified for *C1* and *R7* were chosen to allow you to see the Reader in operation instead of having to wait for it to run the course of a test or compare or have everything done just as you release RESET pushbutton switch *S1* in Fig. 1(A).

Using 1N914 switching diodes *D1* and *D2* permits the generator to be stopped when a positive voltage is applied to *D1* from an OR gate in *IC7*. This OR gate allows the generator to be halted from two different sources. One of the gate's inputs is fed from the output of the comparison circuit, which supplies a positive output on detecting an error in an EPROM read operation. The other input is fed from the output of dual 4-input AND gates *IC16* and *IC17*. The outputs from these four gates are fed to 4-input NAND gate *IC5*.

PARTS LIST

Semiconductors

D1 thru D6—1N914 switching diode
 LED1—Green T-1 3/4 light-emitting diode
 LED2—Red T-1 3/4 light-emitting diode
 IC1 thru IC4—74LS193 binary counter
 IC5, IC16, IC17—74LS21 dual 4-input NAND gate
 IC6—CD4584 hex Schmitt-trigger inverting buffer
 IC7—CD4071 quad 2-input OR gate
 IC8—CD 4068 8-input NAND gate
 IC9, IC10—CD4077 quad 2-input exclusive-NOR gate
 IC11—74C244 octal tri-state buffer
 IC12 thru IC15—TIL311 hexadecimal decoder/driver/display
 IC18—7805 +5-volt regulator (optional—see text)

Capacitors (10 WV or higher)

C1, C2, C3—0.05- μ F disc
 C4, C7 thru C14—0.1- μ F disc
 C5, C6—100- μ F, 16-volt electrolytic

Resistors (1/4-watt, 5% tolerance)

R1, R2—1,000 ohms
 R3—220,000 ohms
 R4, R5—Not assigned
 R6—1 megohm
 R7—22,000 ohms
 R8—680 ohms
 R9 thru R24—10,000 ohms
 R25, R26—100 ohms

Miscellaneous

S1, S2—Spst momentary-action normally-open pushbutton switch (Digi-

Key Cat. No. P9951—see Addresses below)

S3 thru S8—Dpdt pc-mount slide switch (C&K Cat. No. 1201-M2-CQE—see Addresses below)
 SO1, SO2—28-pin zero-insertion-force socket (Jameco Cat. No. 228-3345—see Addresses below; also see text for option)

Printed-circuit board (see text); 6-volt dc, 300-mA plug-in power supply (see text); materials for building enclosure (see text); machine hardware; No. 6 \times 1/2-inch wood screws (8); hookup wire; solder; etc.

Note: A ready-to-wire, double-sided printed circuit board with plated-through holes, No. ESR-2, is available for \$22.50, including P&H, from: Electronic Enterprises, 3305 Pestana Way, Livermore, CA 94550.

Addresses:

C&K Components

15 Riverdale Ave.
 Newton, MA 02158-1082
 Tel.: 617-964-6400

Digi-Key Corp.

P.O. Box 677
 Thief River Falls, MN 56701
 Tel.: 1-800-344-4539

Jameco Electronics

1355 Shoreway Rd.
 Belmont, CA 94002
 Tel.: 415-592-8097

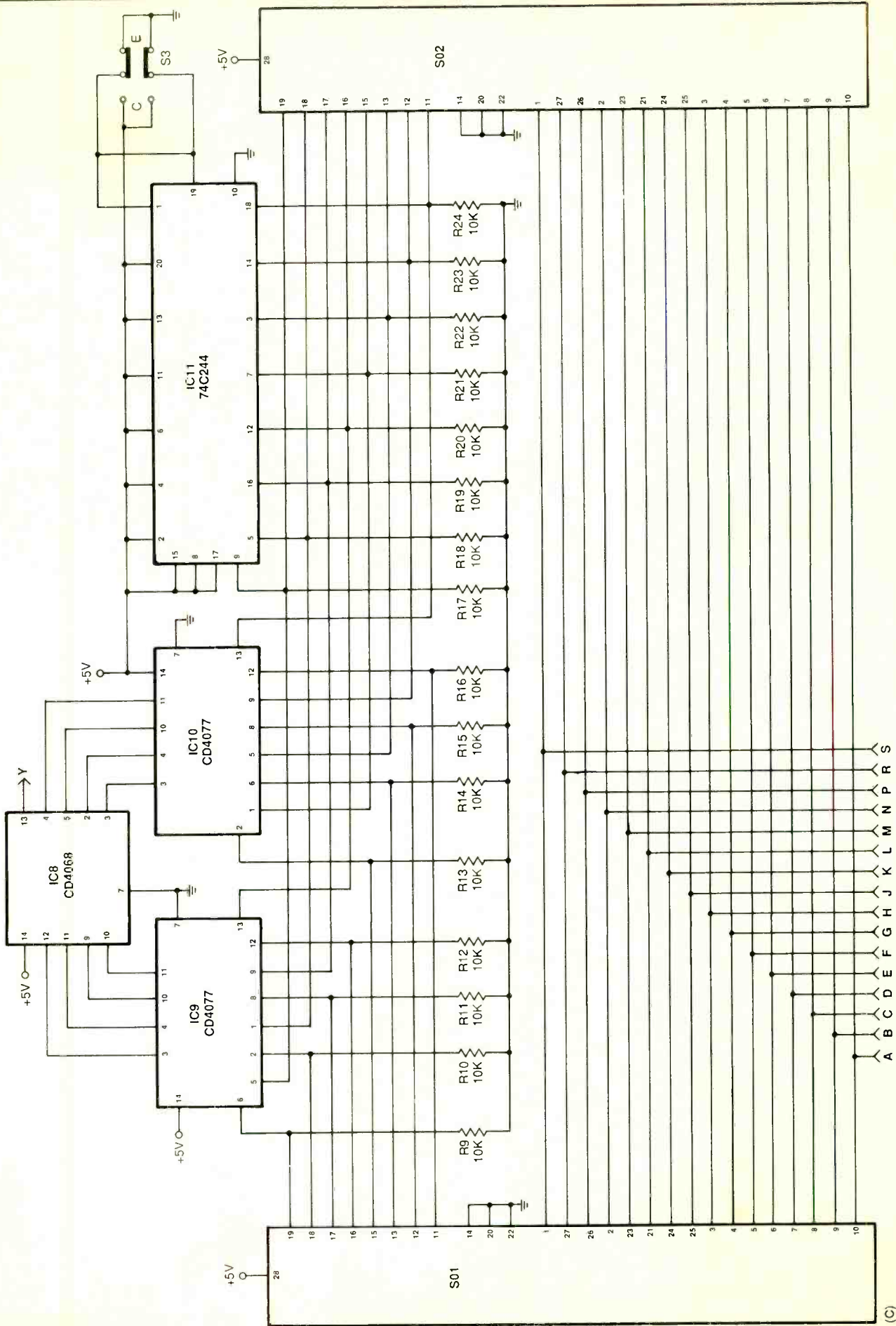

(C)

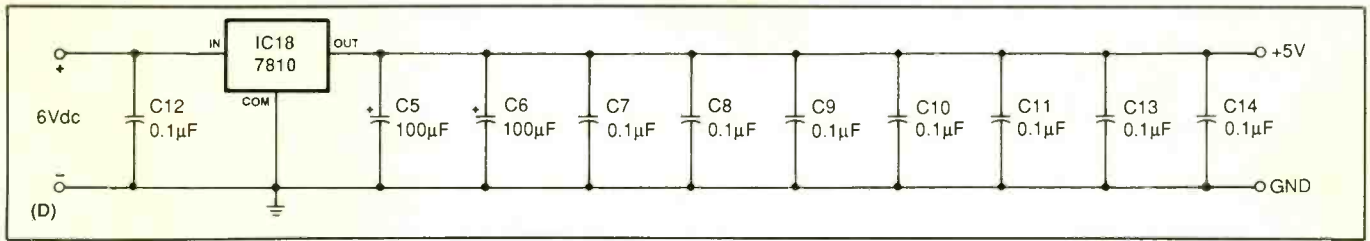

A positive output from *IC5* occurs when all counters, *IC12* through *IC15* indicate FFFF. This gives the counter a capacity for 65,535 counts on the address lines. When the counter makes one complete pass through all address lines, the square-wave generator stops and green light-emitting diode *LED1* lights to indicate that the pass has been completed and no errors were detected.

To accommodate 2764, 27128 and 27256 EPROMs, 28-pin zero-insertion-force (ZIF) sockets were chosen for *SO1* and *SO2*, as shown in Fig. 1(C). To check a 2716 or 2732, the EPROM must be placed in the sockets with an offset so that its pins plug into the ZIF sockets starting at pin 3 and ending at pin 26. This means that pins 1, 2, 27 and 28 of *SO1* and *SO2* will not be occupied when these 24-pin EPROMs are tested and compared. See Fig. 2 for details.

The circuit is wired so that when type select switches *S4* through *S8* in Fig. 1(A) are set to either 16 or 32, positive voltage is applied to pin 26 of *SO1* and *SO2*. This supplies the V_{cc} bus to the 2716 or 2732 EPROM, which normally require a V_{cc} potential on pin 24.

Diodes *D3* through *D6* block dc voltage from the counters and decoder/driver/display system during address line switching when *S3* through *S6* are toggled from one position to the other.

When type select switches *S3* through *S6* are set up for a 2764, 27128 or 27256 EPROM, pin 26 of both *SO1* and *SO2* becomes another address line and pin 28 is tied to the V_{cc} bus.

As the counter sweeps through the

addresses, the outputs of the master and copy EPROMs are compared, address for address and output for output, by putting identical EPROM outputs on the two inputs of exclusive-NOR (XNOR) gates *IC9* and *IC10*. Since each gate in these two ICs is driven by the identical outputs of the master and copy EPROMs, if the outputs are the same, regardless if they are 1s or 0s, a positive output is present at each gate output.

There is one gate for each EPROM output. The outputs from all gates are fed into 8-input NAND gate *IC8*. With all inputs to this gate positive, indicating a proper comparison, there is a zero output from *IC8*. However, if an error is detected in the comparison, one of the outputs from the NOR gates will be negative, making one of the inputs to *IC8* negative. This will produce a positive output from *IC8*, which is fed back to the square-wave generator through *IC7*. When this occurs, the counter will stop at the address at which a mismatch was detected. The defective address can then be read off hex counters *IC12* through *IC15*.

Erase check of an EPROM is made by putting a positive voltage on one side of all XNOR gates in *IC9* and *IC10* and comparing the outputs of the erased EPROM with this address. If the EPROM has been properly erased, all outputs should be at logic 1 at all addresses. Hence, any address output that shows a 0 indicates that that bit location has not been erased and will be detected as an error. Positive voltage is applied to *SO2* when *S3* is set to E (check erase).

The EPROM to be checked for erasure is placed in *SO1*. The positive

voltage is applied to *SO2* through octal tri-state noninverting buffer *IC11*. When a positive voltage is applied to pins 1 and 19, the outputs of the buffer float and the positive voltages at the inputs of the buffers is not present on the outputs. Grounding pins 1 and 19 turns on the buffers and the positive voltage at the buffer inputs is present at the buffer outputs. This applies the positive voltage to one side of all XNOR gates in *IC9* and *IC10*.

When an error signal is detected, the generator stops and the red light-emitting diode *LED2* turns on. This indicates that the counter has stopped at the defective address and the defective address can be read off the displays on *IC12* through *IC15*.

When the counter goes to its maximum count of FFFF, green *LED1* turns on and the counter stops, indicating that the addresses have all been checked and that no errors were detected.

Power for the circuit is supplied by a standard 6-volt dc plug-in power supply rated to deliver at least 300 milliamperes. The power supply schematic diagram is shown in Fig. 1(D). The incoming 6 volts dc is regulated down to the 5 volts dc required by the circuit by +5-volt regulator *IC18*. The 5-volt dc output from *IC18* is smoothed and stabilized by filter capacitors *C5* and *C6*. The remaining capacitors, identified as *C7* through *C14*, are bypass devices used to keep noise off the V_{cc} bus.

Construction

Every part of the EPROM Speed Reader, except the 6-volt dc power supply, mounts directly on a single

circuit board. Because of the great number of interconnecting runs required to assemble the circuit, a printed-circuit board is recommended. If you wish, though, you can build the circuit on perforated board that has holes on 0.1-inch centers, using Wire Wrap hardware. However, make certain that you mark off each wire run as you make it on the schematic diagram or a photocopy of it to avoid wiring errors.

Notice in the actual-size etching-and-drilling guides for the project in Fig. 3 that a double-sided printed-circuit board is needed for the project. Ideally, this board should have plated-through holes, which are beyond the means of the typical home builder to make. You can still home-fabricate the pc board, though, by avoiding the use of molded IC sockets and carefully bridging conductors that must continue from one side of the board to the other with lengths of *solid* bare hookup wire.

If you prefer not to fabricate your own board, you can purchase a board with plated-through holes from the source given in the Note at the end of the Parts List.

Before you begin to plug components into a home-fabricated pc board, install the bridging wires as follows. Locate and mark the locations for all wires. These are shown in Fig. 4 as heavy black dots on the

top view of the board. There are 96 such dots.

Next, place the board on a sheet of corrugated cardboard on your work surface, component side up, and plug one end of the bare solid wire into one of the marked holes and push until the wire penetrates the cardboard by about 1/16 inch. Solder the wire to the copper pad on the top of the board and clip it close to the board's surface. Repeat for all remaining marked locations. Make sure as you solder these pads and those for the IC sockets that you do not create solder bridges to nearby pads or copper-trace runs.

After soldering the bridging wires to all 96 pads on the component side, flip over the board and solder the wire stubs to the pads on that side. Work quickly, heating the wires and pads only long enough to flow the solder and make good mechanical and electrical connections. Again, clip any excessive-length wires close to the board's surface. When you have done this, use an ohmmeter set to its lowest range or an audible continuity tester to ascertain that all bridging wires are properly soldered to the conductive pattern on both sides of the board. Touch the meter or tester probes to the copper traces — *not* the soldered connections.

Double check all bridging wire locations against Fig. 4. It is easy to

mistake a component hole for a bridging hole.

Regardless of whether you are using a home-fabricated board or the commercial plated-through-hole version, it is a good idea to use sockets for all ICs except voltage regulator *IC18*. If your board does not have plated-through holes, you cannot use standard molded sockets. Instead, use Molex Soldercon® socket strips, which give you soldering access on both sides of the board.

Divide the Soldercon strips into the number needed for each IC. Without removing the metal strip along the tops of the strips, plug one strip into each IC location as shown in Fig. 4 and solder to the pads on *both* sides of the board. Use a fine-pointed soldering iron and only enough solder to make good connections. Work carefully to avoid creating solder bridges to nearby pads and conductors.

You can plug in and solder into place the remaining Soldercon strips for the ICs in the same manner. However, if you have old ICs, it would be better to use them to make sure the second strip in each case is properly aligned with the first. To do this, plug the second strip into its holes in the board and then plug the IC into the receptacle ends of the Soldercons and carefully solder the pins to the copper pads on the bottom of

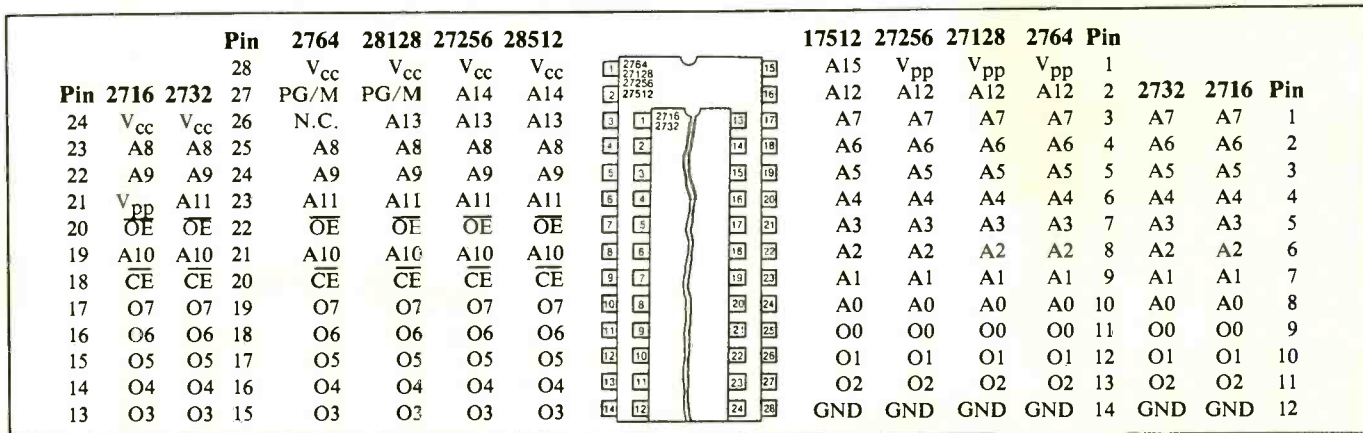

Fig. 2. Connection details for various members of 27XX/XXX family of EPROMs to test sockets and pin address and output identifications.

the board. This done, remove the IC and set it aside. Flex the metal connecting strip on both rows of Soldercons until it parts from the receptacle pins. Then replace the IC and solder the Soldercons to the pads on the component side of the board. Repeat with the remaining strips.

You will notice that no holes are provided for pins 6, 9 and 11 of IC12 through IC15. Therefore, no Soldercons (or socket pins) must be installed in these locations. The best way to handle this is to plug the pins of an ordinary 14-pin IC into two strips of seven Soldercons, flex away the metal connecting strips and remove the Soldercons from pins 6, 9 and 11. Then plug the Soldercons into the holes in the board and solder them to the pads on the bottom of the board, remove and set aside the IC and solder the Soldercons to the pads on the top of the board. (If you are installing the sockets on a board with plated-through holes, simply clip pins 6, 9 and 11 from each of four 14-pin sockets.)

For SO1 and SO2 you have two options. You can use Wire Wrap sockets that can be spaced far enough above the surface of the board to provide soldering access. Alternatively, you can use solder-tail sockets that plug into parallel rows of Soldercons as you did for the ICs. If you use Wire Wrap sockets, place a rectangle of single-ply corrugated cardboard under the sockets to raise them enough to provide soldering access on the component side of the board. The cardboard "shim" should be 1/4 inch narrower than the distance between the rows of pins on the socket and long enough to fit under both sockets and to protrude about 1/2 inch from the pin 14/15 end of SO2.

With the shim in place, tack solder the four corner pins of both sockets to the pads on the component side of the board. Flip over the board and solder the pins to the pads on the bottom of the board. If desired, clip

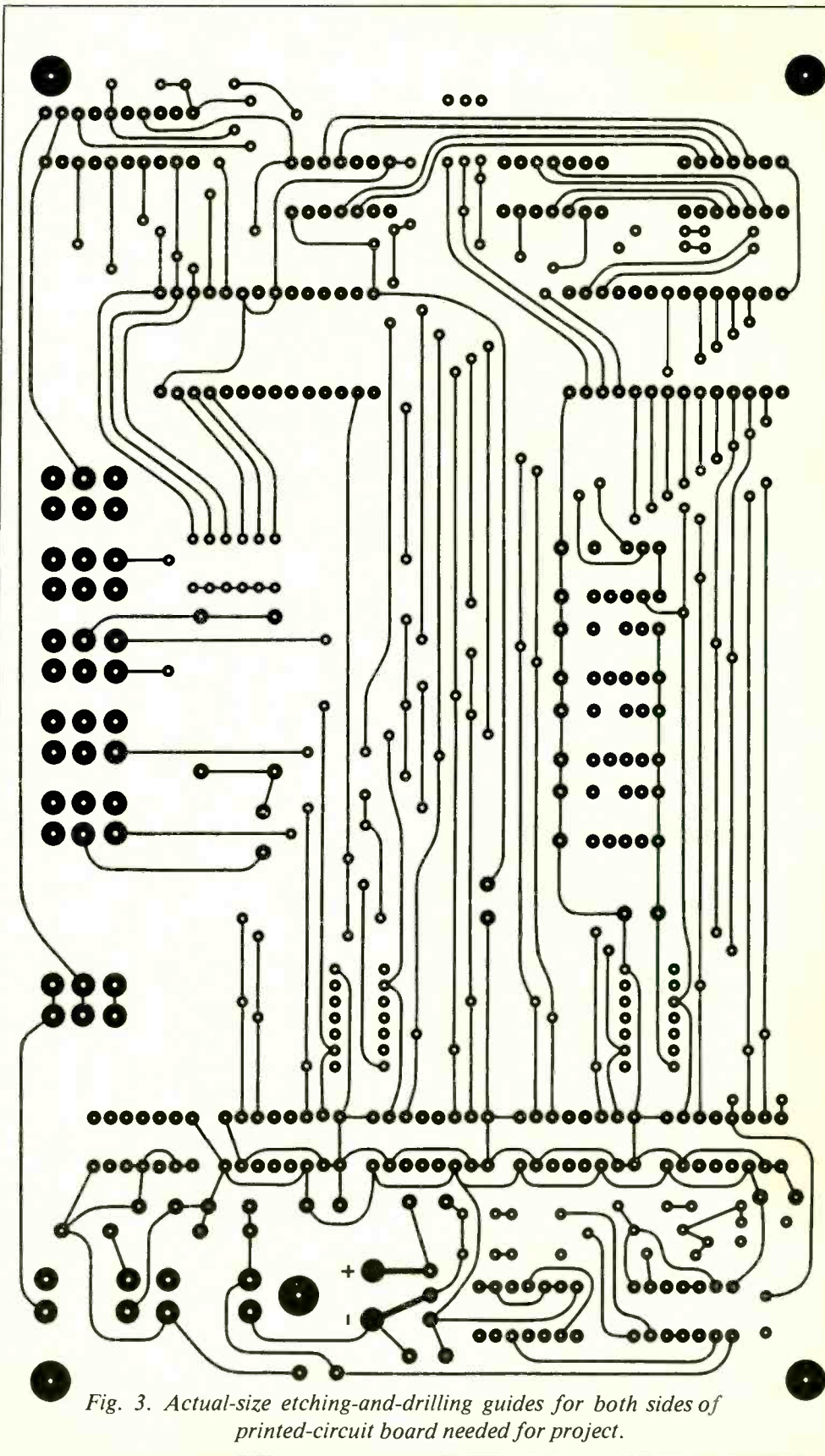
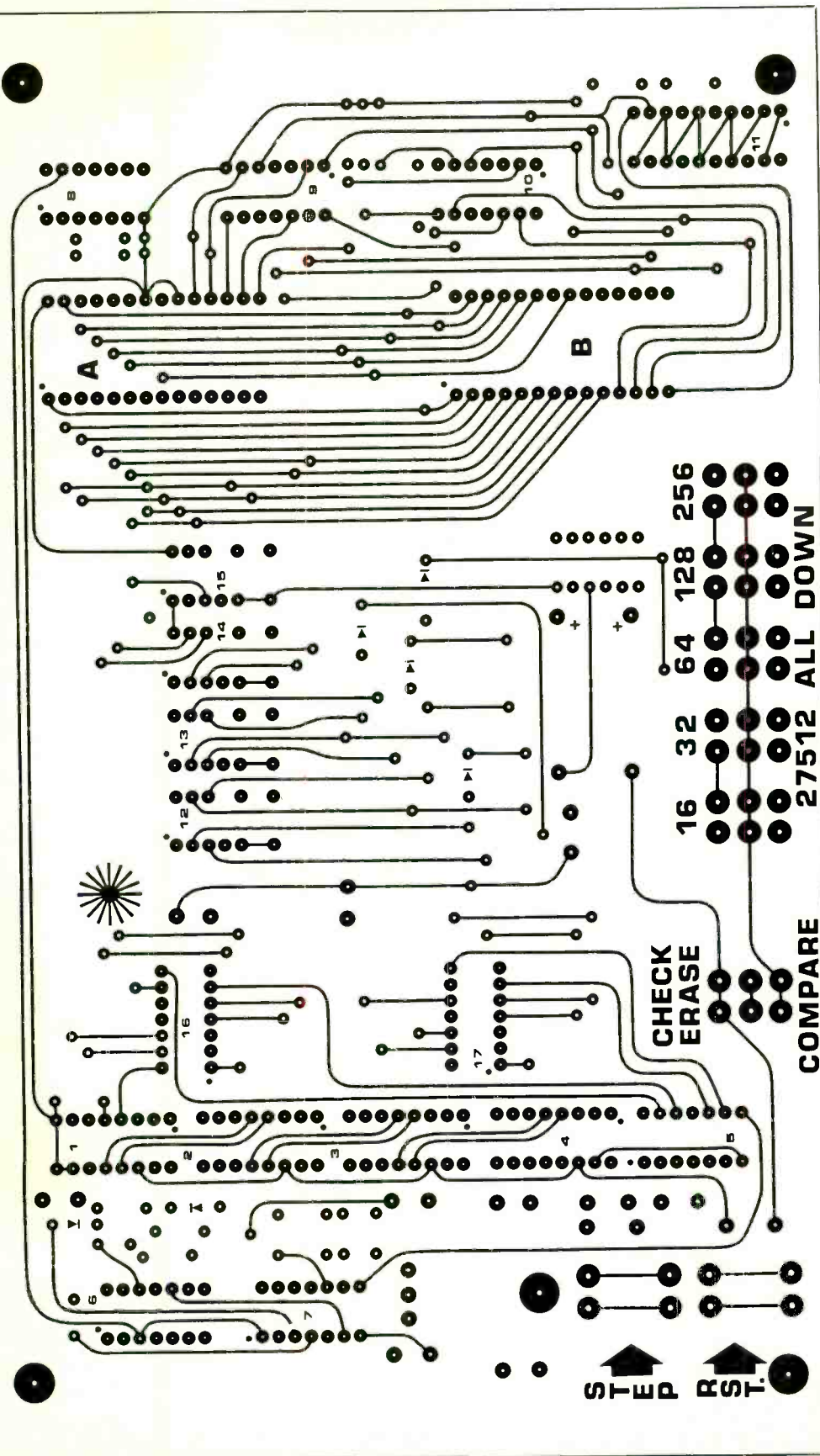

Fig. 3. Actual-size etching-and-drilling guides for both sides of printed-circuit board needed for project.



each pin close to the board's surface. Then flip over the board once again and carefully solder the remaining pins to the pads on the component side of the board. You can leave the cardboard shim in place if you wish or gently but firmly pull it from under the sockets. If you run into any snags, compress the cardboard with the blade of a screwdriver through the slots in the tops of the sockets.

Now mount the resistors in their respective locations, soldering their leads to the pads on both sides of the board. Do the same for the diodes, making sure you properly orient them. Then install and solder into place in the same manner the capacitors, making sure you properly polarize C5 and C6.

Plug the lugs of the switches into the holes in the board in their respective locations and solder the lugs first to the pads on the *component* side of the board and then to the pads on the bottom of the board. It may be necessary to have only a small fraction of an inch of lug protruding through the holes in the bottom of the board to accomplish soldering to the pads on the component side. If you cannot get soldering access with your switches, try to find switches that do provide such access, either with longer lugs or pins that exit from the sides of the switches. In the S4 through S8 group, install S6, then S5 and S7 and end with S4 and S8

Bend the pins of voltage regulator IC18 at a 90-degree angle toward the rear of the IC. Plug the pins of the regulator into the holes in the board and secure the IC to the board with a 4-40 x 1/4-inch machine screw, lock-washer and nut. Solder the pins to the pads on both sides of the board.

Plug the leads of LED1 and LED2 into their respective holes in the board (make sure they are properly polarized) and push the LEDs down until the bottoms of their plastic cases are about 1/4 inch from the surface of the board. Carefully solder the leads to the pads on the compo-

ment side of the board. Flip over the board and solder the leads to the pads on the bottom of the board. Clip away any excess lead lengths.

Perhaps the easiest method of housing the EPROM Speed Reader is to mount it in a wood frame made from 1 × 2-inch pine cut to length to make a box just large enough into which to drop the circuit-board assembly. Hence, the inner dimensions of the box should be 8½ inches wide by 5½ inches deep. You can either butt- or miter-join the corners of the frame. Use a 1 × 1-inch pine cleat at each corner, recessed about ¼ inch from the top and about ¼ inch from the bottom to allow the circuit-board assembly and a sheet of Masonite to be dropped into place on top and bottom, respectively.

Decide on whether you want to be able to plug the 6-volt dc power supply into the project for use and unplug it when not in use or you want a permanent hookup arrangement. If the former, you need a mating jack for the plug on the end of the supply's feeder cord. If the latter, cut off and discard the plug on the end of the cord, separate the conductors by about 1 inch and trim ¼ inch of insulation from each conductor. Twist together the fine wires in each conductor and tin with solder.

Drill an entry hole for the cord from the 6-volt dc power supply in the rear wall of the enclosure frame. If you plan on using a plug/unplug arrangement with a power jack, make the hole large enough to accommodate the jack mounted on a piece of sheet metal or thin plastic. Otherwise, make the hole only large enough to pass through the cord and tie a knot in the cord about 4 inches from the prepared end inside the box.

Making sure that the bare conductor wires do not touch each other, plug the power supply into an ac outlet and use a dc voltmeter set to read 10 volts or so full-scale to determine the polarity of the supply's conductors. Mark the +5-volt conductor

Fig. 4. Component installation guide for pc board.

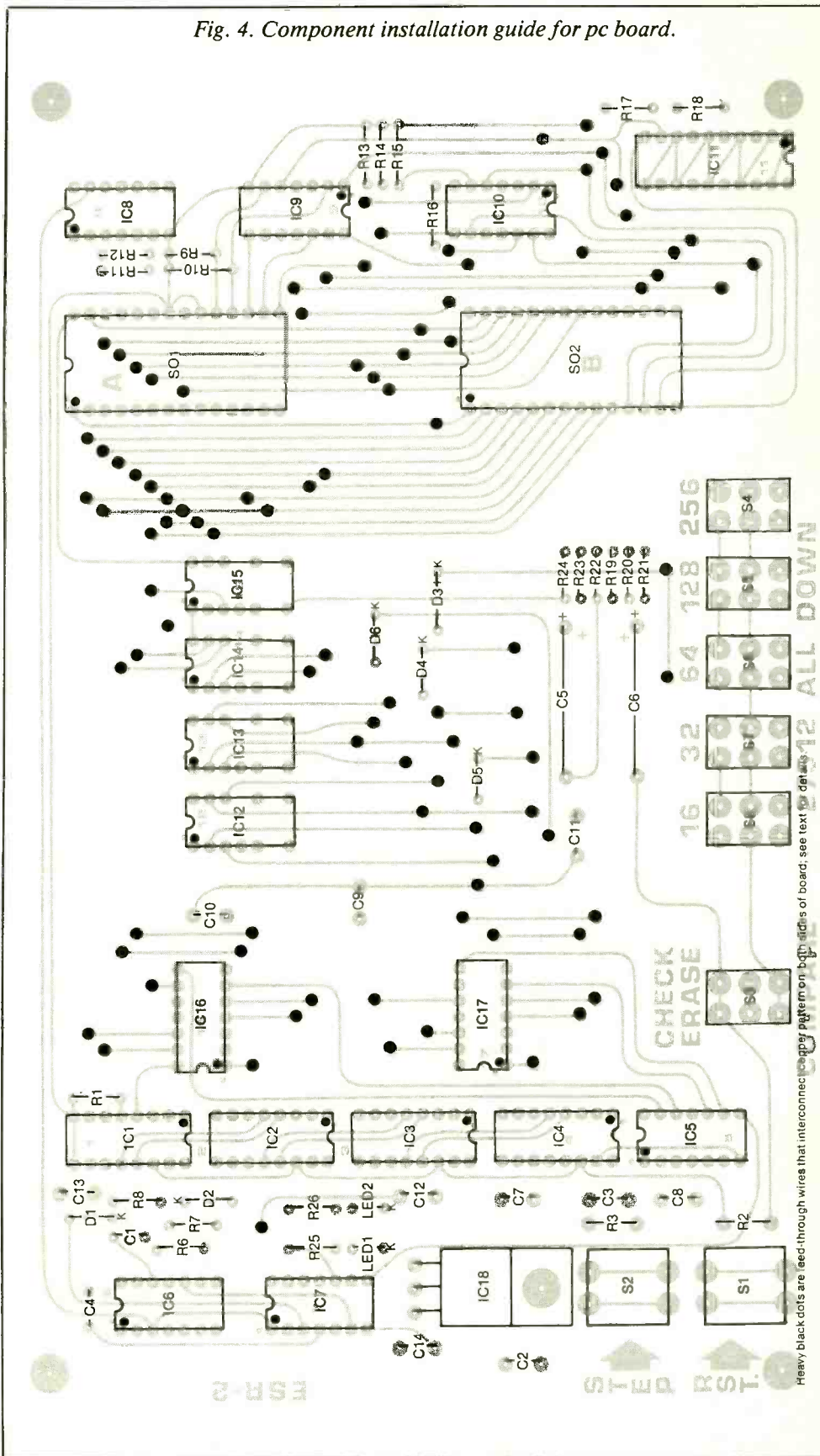

Heavy black dots are lead-through wires that interconnect components; pattern on bottom side of board; see text for details.

for easy reference. Disconnect the supply from the ac outlet. Then connect and solder the +5-volt conductor directly to the + pad and the unidentified conductor to the - pad on the board.

When using the plug/unplug arrangement, interconnect the power jack with the board with color-coded hookup wires.

If you wish, you can even combine the EPROM Speed Reader in the same enclosure used for the Stand-Alone EPROM Programmer featured in the February and March 1987 issues of *Modern Electronics*, rather than build a separate enclosure for it. This would probably be a more convenient way to go, since the two units are generally used together. If you go this route, the regulated 5 volts dc from the EPROM Programmer can be used to power the EPROM Speed Reader and voltage regulator *IC18* can be omitted from the latter.

At this point, the only integrated circuit that should be installed on the board should be regulator *IC18*. Do *not* install the other ICs in their sockets until after you have completed initial voltage checks.

Checkout & Use

Before you plug any IC into its socket, you must perform a preliminary voltage check, especially if you Wire Wrapped the project, to ascertain that the circuit has been correctly wired and that all points in the +5-volt bus are indeed connected to the bus if you used a pc board with no plated-through holes. For this step, all you need is a dc voltmeter or a multimeter set to read dc on a range that will easily accommodate the maximum +6 volts that should appear in the circuit.

Clip the meter's common lead to circuit ground at the negative (-) lead of either *C5* or *C6*. Plug the 6-volt dc power supply into an ac outlet (and its output cable into the jack on the rear of the enclosure if this is the

arrangement you opted for). Now touch the meter's "hot" probe to pin 16 of all 16-pin ICs, pin 14 of all 14-pin ICs, pin 20 of *IC11* and pin OUT of *IC18*. The readings in all cases should be the same +5 volts. Touching the hot probe to pin IN of *IC18* should yield a reading of approximately +6 volts. If you do not obtain the proper reading in any case, power down the circuit and correct the problem before proceeding.

Once you are satisfied the project is wired properly, disconnect it from the ac line and wait a few minutes to allow *C5* and *C6* to discharge. Then, referring back to Fig. 4, install the ICs in their respective sockets. Make sure each is properly oriented and that no pins overhang the socket or fold under between IC and socket as you push each home. Also, since these are CMOS devices, handle them with the same precautions as you would any other MOS device to avoid inflicting damage to them from static electricity.

To use the EPROM Speed Reader to compare the data programmed into a master and a copy EPROM, plug the two EPROMs to be compared into either socket. It does not make any difference which socket is used for which EPROM, but make sure you properly install the EPROMs, both as regards to orientation and offset, if any. That is, if you are comparing 2716s or 2732s that have only 24 pins, place them in the sockets so that the upper two receptacles on both sides of both sockets are unoccupied.

Set *S3* to C (compare) and *S4* through *S8* according to the type of EPROMs being compared. Only one of these switches should be in the up position: *S8* for 2716s, *S7* for 2732s, *S6* for 2764s, *S5* for 27128s or *S4* for 28256s. All other switches should be in the down "off" position. The only exception to this rule is that when comparing or checking 27512 EPROMs, *all* switches must be in the off position.

Keep in mind that there is no way that an EPROM can be reprogrammed or erased by the EPROM Speed Reader. Always begin a read/compare operation with the counter reset to zero by pressing and releasing RESET switch *S1*. Counting begins as soon as *S1* is released.

When or if the counter stops counting as a result of a detected error in the comparison, the error can be recorded and the counter can be single stepped to the next address by pressing and releasing STEP switch *S2*. If no error is present at this address, the counter will resume counting until it detects another error or the count is complete. As mentioned earlier, a detected error stops the counter and turns on the red LED. If no error is detected, the counter will sweep from start to finish, stop counting and light the green LED. The whole process takes only a few seconds.

To check erasure of an EPROM, simply plug the erased device into *SO1* and set *S3* to E (check erase). Set *S4* through *S8* according to the type of EPROM being tested and reset the counter by pressing and releasing *S1*. The procedure for checking erasure is the same as for comparing EPROMs except that you compare the erased EPROM with all 1s on one side of XNOR gates *IC9* and *IC10*. The results will pop up in seconds.

If an error is detected, the red LED will turn on. If the counter runs through the complete range of addresses with no detected error, the green LED will light.

If you do a lot of programming of supposedly erased EPROMs, our EPROM Speed Reader will save you a lot of time and frustration. Its dual-function operation perfectly complements whatever programmer you are using, whether it is the one for which the project was built or a commercial unit. With this project, you will know if an erased EPROM is fully erased *before* you attempt to reprogram it and if a copy is the same as the original. **ME**

Mixing Frequencies: A New Look

Photos help explain complex linear mixing to amateur radio operators and others

By John Wannamaker

One of the easiest ways to grasp a complex linear mixing situation is through a good illustration. Ink drawings that are particularly well presented help explain simpler results, but anything that involves manually summing many cycles of several frequencies has simply been too tedious a task to render by hand. Now we have photographs that offer more insight than can be explained with the proverbial 10,000 words. Some of these appear in print here for the first time, and all are accompanied by an explanation and comments to appeal to readers of various technical backgrounds.

If you currently have or have ever had difficulty understanding AM radio and sidebands, the material presented here may be just what you need to clear up any confusion in this area. Even experienced single-sideband operators may discover something new or clear up some point.

To create these photos, summing (linear mixing) was done with an operational amplifier. A special device was used to generate up to four sine waves simultaneously, each with independently adjustable frequency, amplitude and phase shift. Frequencies of the four oscillators I used were in the low audio range, but they can be reasonably projected upward to represent what happens at radio frequencies.

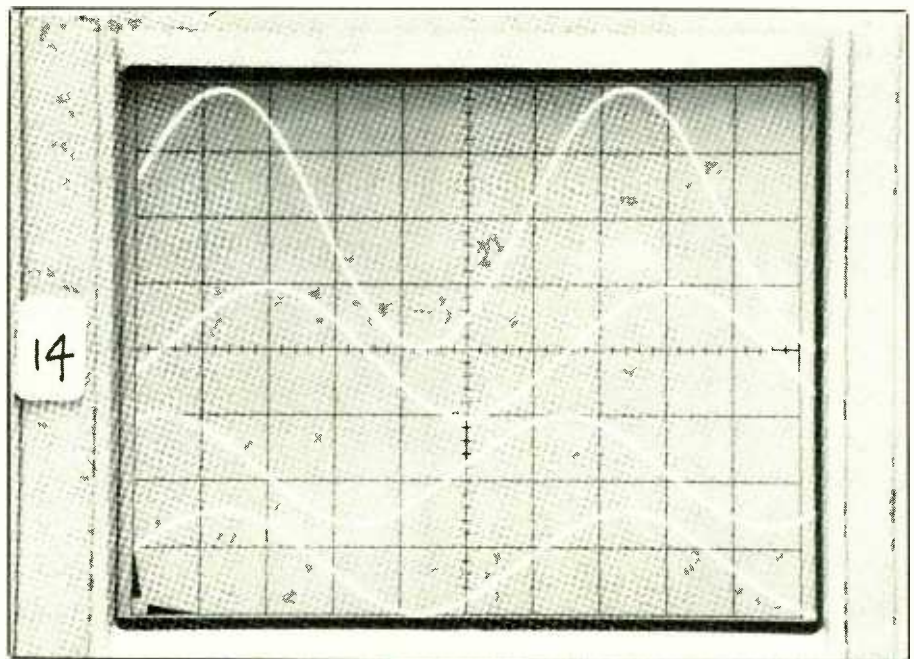

Fig. 1. Three sinusoidal waveforms (bottom) sum into a resultant waveform (top) of identical frequency.

Sine Waves Only

Figure 1 illustrates something that can be done only with sine waves. Here three sinusoidal waves of the same frequency (bottom trace), differing in amplitude and phase relationship, are summed to produce a sine wave (top trace) of the identical frequency. The only time the output could be otherwise is when the inputs sum to zero by precisely canceling each other out.

Summing of sine waves with different frequencies results in a com-

plex waveform. Figure 2 shows how a fundamental frequency and its third, fifth and seventh harmonics combine (top trace) to begin formation of a square wave. In theory, the perfect square wave contains an infinite number of odd harmonics. (Apologies to readers who notice here that the fifth harmonic's amplitude is too low. Final press time was reached before it could be corrected for publication.) The slight variation in lateral symmetry of the resultant is due to a bit of distortion of the fundamental frequency.

In Fig. 3, a ramp can be seen taking shape. This ramp is composed of a fundamental frequency and its second, third and fourth harmonics. All harmonics, both odd and even, would be required to form a ramp waveform. Incidentally, this "recipe" must also specify amplitudes and phase relationships, properties that could change the shape if not selected correctly.

The heart of waveform analysis is this: If sine waves can be combined to form other waveshapes, then other waveshapes, no matter how they are generated, can be thought of as specific combinations of sine waves. This theory is supported by the photos in Figs. 2 and 3.

Anything that causes even the slightest distortion in an otherwise pure sine wave must by that very act

create one or more additional frequencies. This is known as "harmonic distortion," where two frequencies are mixed nonlinearly. Amplitude modulation, where fairly large amounts of power are involved, is an example of this. AM creates sum and difference frequencies that become the upper and lower sidebands, respectively.

Figure 4 shows an often-used com-



Fig. 2. Making of a square wave involves addition of fundamental frequency with odd harmonics. Third, fifth and seventh harmonics shown here are on the way toward making a square wave.

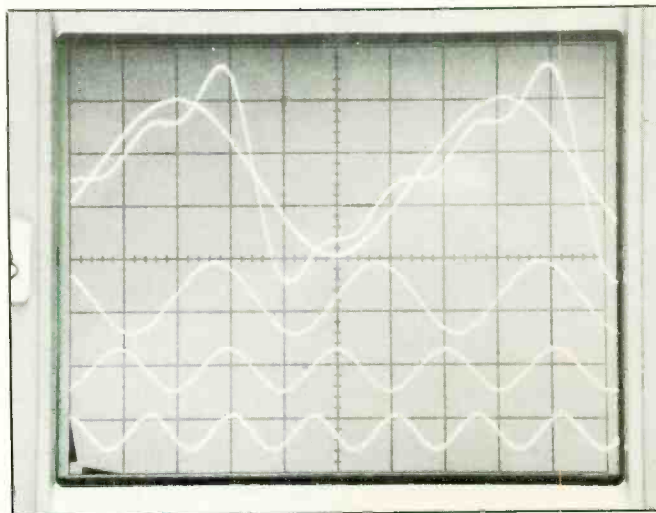

Fig. 3. Adding fundamental frequency and all harmonics produces a ramp waveform. Second, third and fourth harmonics shown here are on the way toward making a sawtooth-like ramp waveform.

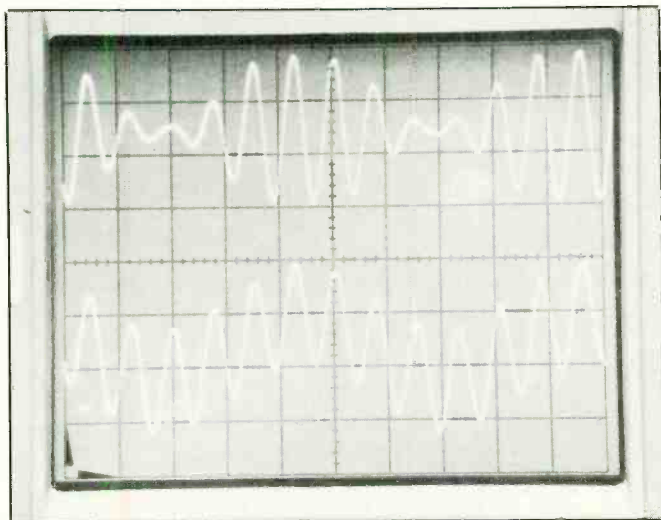

Fig. 4. Waveforms typically shown to represent heterodyning (top) and linear mixing (bottom).

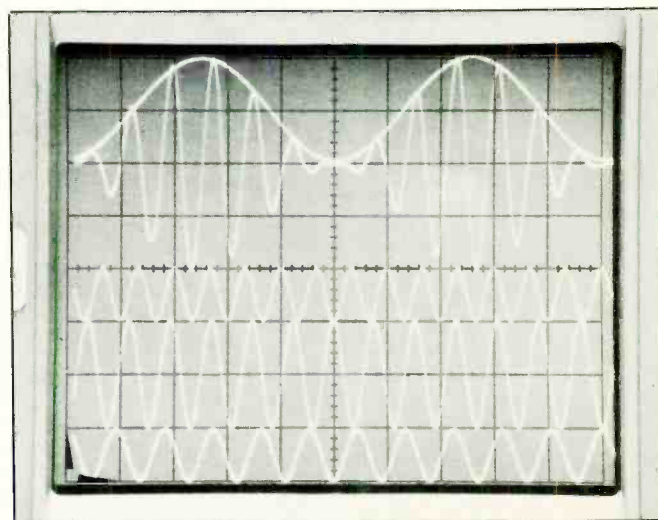

Fig. 5. Simulated carrier and sidebands mixed to reconstruct a nonexistent modulated waveform.

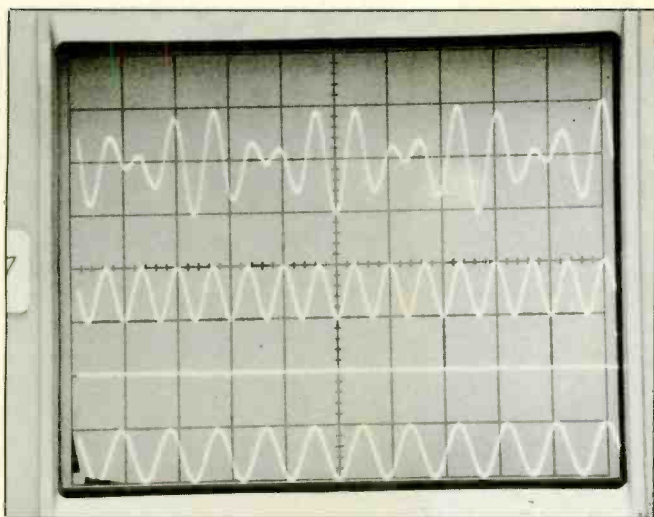

Fig. 6. With carrier reduced to zero, sideband reacts with sideband and introduces a frequency that is twice that of the true audio component.

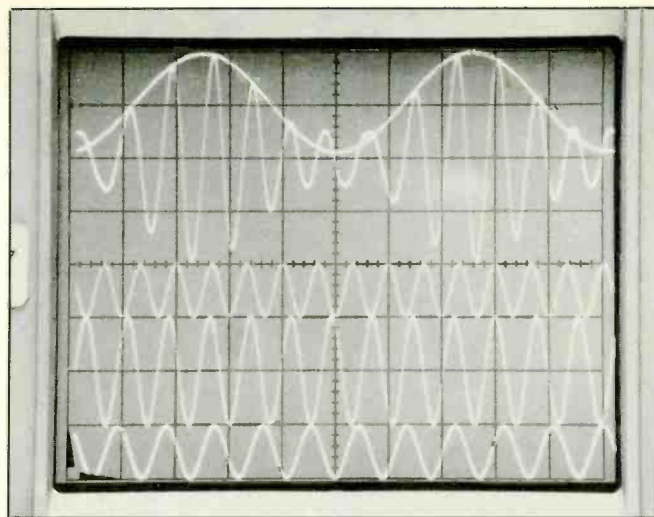

Fig. 7. This photo illustrates the effect on the modulation envelope when the carrier has been shifted in phase by approximately 30 degrees.

parison between linear mixing (bottom trace) and nonlinear mixing or heterodyning (top trace). In this case, linear mixing even looks easy to analyze.

If the highest frequency is filtered out, only the lowest remains and vice-versa. However, the modulated waveform needs some explanation. This waveform is the result of linearly mixing the component frequencies

at the output of a nonlinear (heterodyning) circuit, and not even quite that because the lowest frequency component—call it the audio—is not included. Its effects can be seen, but it is not part of the summed values. Simple visual examination reveals that it is not possible to tell that sum and difference frequencies play any part in the waveform's shape.

Figure 5 shows a lower sideband

(bottom trace), a carrier and an upper sideband as each might be separately received as an incoming signal. The receiving antenna acts as the linear mixer that sums these tuned-in frequencies (top trace). Collectively, they "recreate" a modulated envelope that never actually existed, since separate oscillators were used to generate them.

The audio that outlines the upper

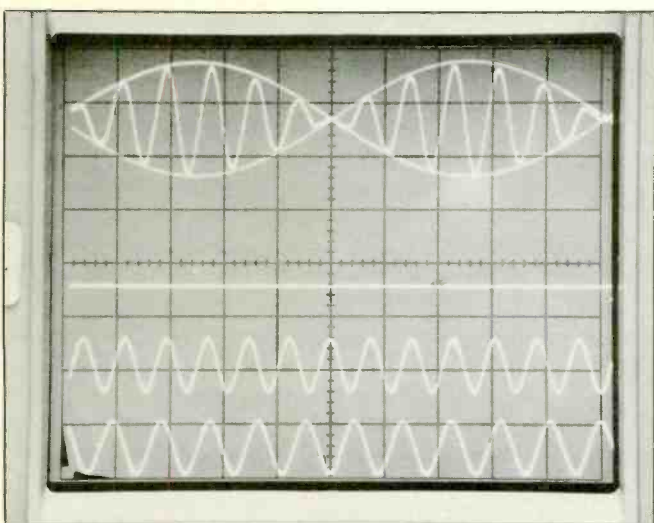

Fig. 8. Shown here is what the antenna presents to the receiver from a single-sideband reduced-carrier transmission (equal amplitudes).

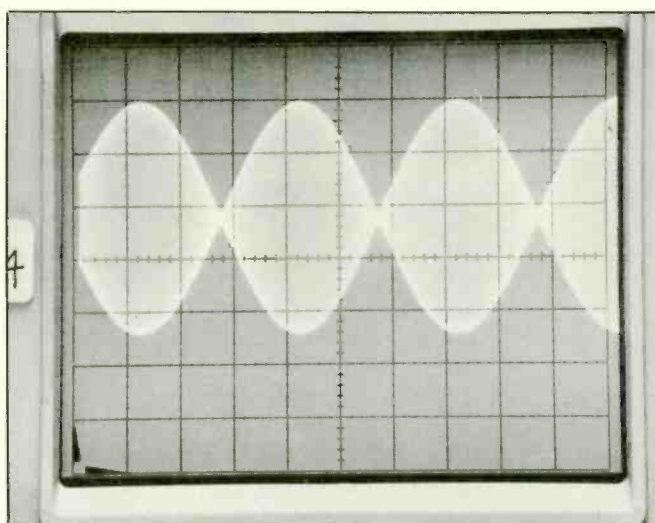

Fig. 9. Frequencies of 600 kHz and 602 kHz are shown here received with equal strengths; the results are similar to those illustrated in Fig. 8.

modulation envelope shown in Fig. 5 has been added for purposes of clarity. Although linearly mixed, each component frequency would be heterodyned with a receiver's local oscillator to produce its own intermediate frequency (i-f) . . . and combine linearly.

The following observations are worth making at this point:

(1) Carrier and sidebands do not vary in their peak-to-peak amplitudes and are true CW signals as long as the same modulation continues.

(2) While the phase relationship between the three signals is constantly changing, there is a repetitive pattern to this change that occurs at the frequency of the audio component.

(3) Both sidebands are in-phase with the carrier to form the modulated peaks, and both sidebands are out-of-phase with the carrier to form the valleys.

Nonsinusoidal Factors

When the carrier is completely eliminated, the receiving antenna has only the sidebands with which to work and combines them into the shape shown in Fig. 6. This modulation envelope has variations at twice the frequency of the true audio component, which can be seen for reference in Fig. 5. Not so noticeable here is the fact that the variations are not sinusoidal, the relatively few "r-f" cycles not being able to outline the shape clearly. (The single sideband photo shown in Fig. 9 gives a better idea of the pulsating waveform.)

When a signal that is equivalent in frequency and phase to the original carrier is inserted by the receiver, a modulation envelope more like the original is created when it combines with the sidebands. If its amplitude is insufficient, some of the second harmonic shown in Fig. 6 is revealed. If its amplitude is twice that of either sideband, a 100-percent modulated envelope will appear. If its amplitude

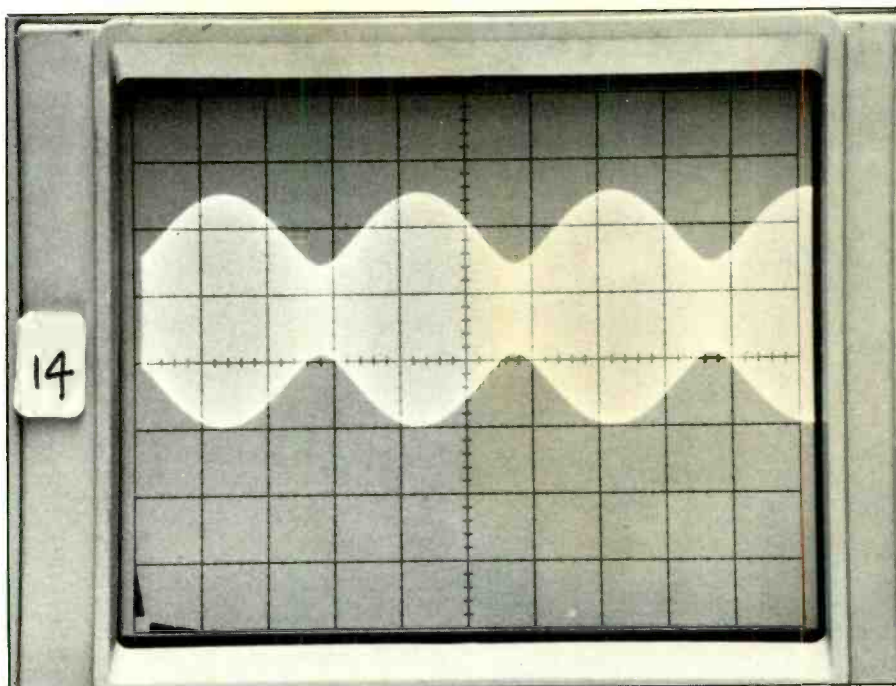

Fig. 10. Improved single-sideband envelope, where carrier has twice the amplitude of the sideband.

is greater than this, something less than 100 percent modulation is recreated, but any detected audio would be essentially the same in peak value as under 100-percent modulation.

What happens to the recreated modulation envelope if a reintroduced carrier is shifted approximately 30 degrees from its proper phase is illustrated in Fig. 7. This apparent "filling in" of the envelope valleys continues to increase with phase shifts up to 90 degrees and the beat note between sidebands begins to become apparent. With a 90-degree shift, what would otherwise have been 100-percent modulation appears to be less than 20-percent modulation, and distortion is severe.

When a conventional receiver is receiving a single sideband with reduced carrier, both of the same amplitude, the signal illustrated in Fig. 8 is the best reconstruction that the receiver can manage. It is easy to confuse what the true audio component should be when examining this

photo. Ideally, it would be the same as the audio shown in Figs. 5 and 7.

By covering the entire bottom half of the modulated signal, the true shape of the demodulated audio is revealed. What would be the negative peak of a sine wave is a very sharp peak, indeed. The recovered audio would (and did) look very much like the output of an unfiltered full-wave rectifier. What appears to be and actually is two overlapping sinusoidal waves are exactly one-half of the true frequency of the audio. This is not something that can be recovered, nor would it be desirable to recover it when voice or music is being transmitted.

Results shown in Fig. 8 seemed to be so very bad that they were double checked by actually transmitting and receiving CW signals of 600 and 602 kHz. The signals were followed through an old vacuum-tube receiver as they were "superheterodyned" in-

(Continued on page 90)

Experimenting With Audio Circuits

Using op-amps to build a variety of professional audio circuits to suit different requirements

By Joseph J. Carr

Perennial favorites with electronics experimenters and hobbyists, audio projects are both useful and well-behaved. Though vhf radio circuits and home computers may require special expertise to build successfully, even a newcomer to electronics can quickly assemble almost any audio circuit and have it work the first time out. In this article, we will discuss some of the types of audio circuits that have become popular over the years. Perhaps one or more of these circuits will fill a specific need you have.

Because most easily built audio projects are based on the ubiquitous operational amplifier, we will discuss a little op amp theory preliminary to getting into the projects portion of this article.

Setting the Stage

Shown in Fig. 1 are the schematic representations of the classical inverting and noninverting op-amp configurations that are in common usage. In Fig. 1(A) is the inverting follower amplifier configuration, while in Fig. 1(B) we see the noninverting amplifier configuration. Output from the Fig. 1(A) circuit is exactly the opposite of the input (inverted 180 degrees). Conversely, the Fig. 1(B) circuit's output is the same as its input signal (no inversion). In either case, the output can be lower or higher in amplitude than the input signal or the same amplitude as the

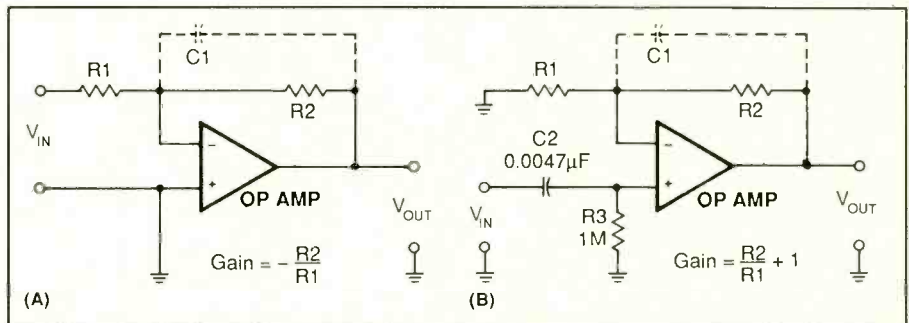

Fig. 1. Inverting follower (A) and noninverting follower (B) op-amp circuit configurations.

input signal, depending on the values selected for $R1$ and $R2$.

Gain of the Fig. 1(A) inverting amplifier is merely the ratio of feedback resistor $R2$ to input resistor $R1$ and is derived from the formula $\text{Gain} = -(R2/R1)$. The minus sign in the equation simply means that a 180-degree inversion has taken place. The value of input resistor $R1$ is usually kept at a minimum of 10 times the output impedance of the signal source to minimize loading effects.

For most low-impedance sources (low-impedance microphones, other amplifiers, etc.), the value of $R1$ should be 10k ohms or more. For high-impedance sources, $R1$'s value should be at least 10 times the source's impedance. For example, a microphone specified to have a 50k-ohm impedance would require a value for $R1$ of $50\text{k ohms} \times 10 = 500\text{k ohms}$.

Figure 1(B)'s noninverting amplifier uses the noninverting (+) input of the operational amplifier and has

an input impedance equal to the value of input resistor $R3$. In this example, the input impedance of the amplifier is 1 megohm. Gain of this configuration is given by the formula $\text{Gain} = (R2/R1) + 1$.

In both circuits in Fig. 1, optional capacitor $C1$ across the $R2$ feedback resistor tailors the upper end -3-dB point in the frequency response of the circuit. For example, if you wish to design an amplifier for use as a microphone preamplifier in a communications system, you would want to limit the frequency response from a lower limit of 300 Hz to an upper limit of 3 kHz. These are the frequencies at which gain drops off by 3 dB below the center band's gain.

Capacitor $C1$ sets the upper -3-dB point, while capacitor $C2$ in Fig. 1(B) sets the lower -3-dB point. In both cases, the required values of the capacitors are calculated from the respective desired -3-dB frequencies and associated resistances. The formula for calculating these capaci-

tances is $C = 10^6 / (6.28FR)$, where C is in microfarads, F is the required -3 -dB frequency and R is the value of the associated resistance (R_2 or R_3 in this circuit).

In Fig. 1(B), 0.0047-microfarad capacitor C_2 is shown associated with 1-megohm resistor R_3 . If you plug these values into the equation, you will find that this combination of values gives a lower -3 -dB frequency of 34 Hz.

Suppose, as an example, you have a feedback resistor— R_2 in Figs. 1(A) and 1(B)—of 220k ohms. What value of shunting capacitor C_1 will yield a 3-kHz upper -3 -dB point in the frequency-response curve? You would solve for this value as follows:

$$C = 1,000,000 / (6.28R_2F)$$

$$C = 10^6 / (6.28 \times 220,000 \times 3,000)$$

$$C = 0.000240 \text{ microfarad}$$

As you can see the final required capacitance value needed would be 240 picofarads.

Power Supply Considerations

Operational amplifiers and other linear ICs frequently require a dual-polarity dc power supply to operate properly. The $V+$ supply must be positive and the $V-$ supply must be negative with respect to circuit ground or common. In most audio projects, these supplies will be $+6$ and -6 volts to $+15$ and -15 volts dc. In other applications, supply potentials down to 1.5 and up to 22 volts are used. Keep in mind, however, that special types of devices are needed for operation at potentials below and above the ± 6 - to ± 15 -volt range.

Shown in Fig. 2 are the classical methods of connecting a bipolar power supply to an operational amplifier. Decoupling and bypassing shown on the dc power-supply lines is common to most audio linear IC devices, not just op amps. Each power-supply line is bypassed by two capacitors: a 4.7-microfarad electrolytic (usually tantalum) and a 0.1-mi-

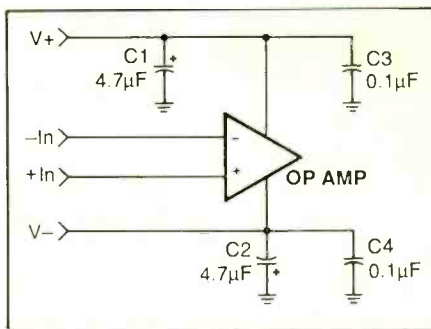

Fig. 2. Details of bipolar power-supply connections to typical op amp with high- and low-frequency decoupler/bypass capacitors.

crofarad Mylar or other type. The higher-value electrolytic provides low-frequency decoupling, while the lower-value capacitor provides high-frequency decoupling.

At this point, you might be wondering why two capacitors are used for decoupling/bypassing, especially when a high and a low value capacitor are connected in parallel with each other. The reason for using both capacitors is that electrolytics are almost useless at higher frequencies. Hence, at frequencies where a high-value electrolytic capacitor would be virtually useless, the low-value capacitor comes into play.

For maximum effectiveness, these capacitors should be mounted as close as possible to the body of the IC they are to serve. If space limitations require a tradeoff, place the 0.1-microfarad capacitors closer to the IC than the electrolytics, but do not al-

low any capacitor to be positioned too far from the IC or its effect will be virtually useless.

Audio Mixers

An audio mixer is a circuit that combines audio signals from two or more inputs into a single-channel output. Application examples for mixers include multiple microphone public-address systems, multiple guitar systems and radio-station console service where inputs from tape players, record players and two or more microphones are combined into a single line that goes to the transmitter's modulator input.

Shown in Fig. 3 is an example of a simple audio mixer in which an op amp is used for combining signals from three separate sources. The audio input lines are identified as AF1, AF2 and AF3. Each source is applied to the inverting ($-$) input of the op amp, and each "sees" gains of R_4/R_1 , R_4/R_2 and R_4/R_3 , respectively. Because all resistors have values of 100k ohms, the gains for all three channels are 1 or unity.

Gain on any given channel can be customized to the requirements of each source simply by using the appropriate value of resistance in each case. Gain of any given channel will be 100k ohms/ R , where R is the value of input resistance R_1 , R_2 or R_3 , depending on the channel to be customized. When calculating values to use, however, be careful to avoid reducing the input resistance to a

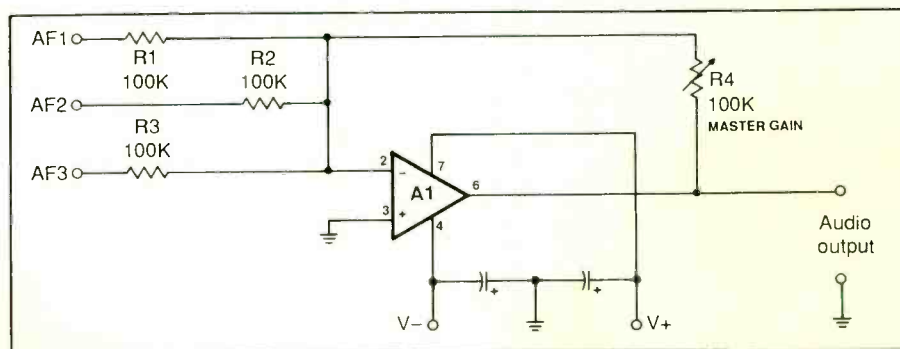

Fig. 3. Simple audio mixer circuit.

value that is too low to prevent loading the signal source.

If the signal source is another operational-amplifier preamp (or other voltage amplifier), input resistance can be reduced to several thousand ohms without causing problems. However, if the source is a high-impedance phono cartridge or some similar device, use a minimum of 50k ohms for the resistor's value.

In some cases, it might be beneficial to increase the value of the feedback resistor to 1 megohm or so to make the corresponding input resistances greater for any given gain. Keep in mind that the input impedance seen by any single channel is the value of the input resistance.

Master gain control *R4* is used as the feedback resistor in the Fig. 3 circuit. By using a potentiometer here, feedback resistance can be varied from 0 to 100k ohms. If no control over gain is required, *R4* would be a fixed-value resistor.

If an application calls for a one-time set-and-forget gain adjustment (as might be the case in radio station applications), make *R4* a trimmer potentiometer. Otherwise, the feedback potentiometer should be a panel-mounted unit that is adjusted via a standard control knob.

Almost any good operational-amplifier integrated circuit that has a gain bandwidth (GBW) that is sufficient for your proposed application can be used in the mixer circuit

shown in Fig. 3. Because gain is unity, and GBW of more than 20 kHz will suffice, all op amps except those in the 741 family will suffice in communications applications.

An improved audio mixer circuit design is shown schematically in Fig. 4. This one is based upon the RCA CA3048 amplifier array IC, which provides approximately 20 dB of gain for each channel. The CA3048 is a 16-pin DIP IC that contains four independent ac amplifiers. Offering a gain of 53 dB with a typical GBW of 300 kHz, the CA3048 has a 90k-ohm input impedance and 1k-ohm output impedance. It produces a maximum low-distortion output signal of 2 volts rms and can accommodate inputs of up to 0.5 volt rms.

Each dc power supply can be up to 16 volts. Notice that there are two V+ and two ground pins on the CA3048. These multiple connections reduce internal coupling between amplifiers. The two V+ pins and two ground pins tie together externally as shown. The V+ pins are bypassed with two capacitors, *C5* and *C6* for high- and low-frequency bypassing, respectively. These capacitors must be mounted as close as possible to the body of the IC, with *C5* taking precedence over *C6*, since high-frequencies are more critical.

RC network *R3/C2* from the output to ground stabilizes the amplifier and prevents oscillation. Like the power supply bypass/decoupling ca-

pacitors, these components must be mounted as close as possible to the body of the IC.

Only one channel is shown in detail in Fig. 4; each of the other three channels is identical and all are joined together with the circuitry shown at the input side of *C4* as shown. Each channel has its own *R1* level control, which also provides a high input impedance for the mixer.

600-Ohm Audio Circuits

Professional audio applications generally use a 600-ohm balanced line between the devices in a system. As an example, a remote preamplifier will have a 600-ohm balanced output and will connect to the next stage through a three-conductor line. Such a system uses two "hot" lines and a ground line to provide interstage connections.

An amplifier with a 600-ohm balanced output is called a line-driver amplifier, while an amplifier with a 600-ohm balanced input is a line receiver. Of course, some amplifiers function as both line drivers and line receivers.

Shown in Fig. 5 is the schematic diagram of a line receiver amplifier built around an LM301 op amp operated with unity gain input via the noninverting input terminal. Input to the circuit is through line transformer *T1*. If *T1*'s turns ratio is other than 1:1, "gain" is essentially the

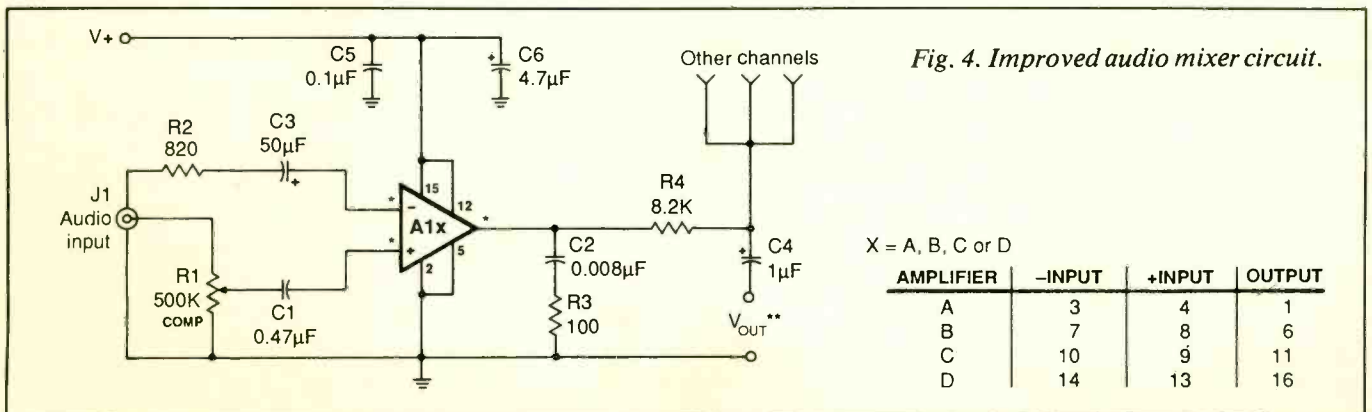

Fig. 4. Improved audio mixer circuit.

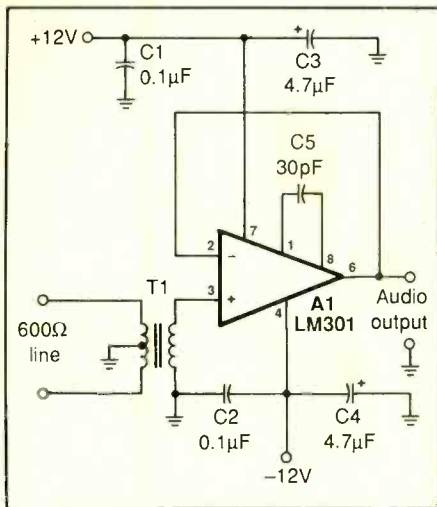

Fig. 5. A 600-ohm line receiver amplifier circuit.

turns ratio of the transformer. Suppose, for example, a 600-ohm input, 10k-ohm output transformer is selected. This transformer will have a secondary/primary impedance ratio of approximately 17:1. Turns ratio is the square root of 17, or about 4.1. This means that the voltage applied to the input of the op amp in this case would be 4.1 times greater than would be the case if a 600-ohm 1:1 line transformer had been used.

Like most op-amp circuits, the

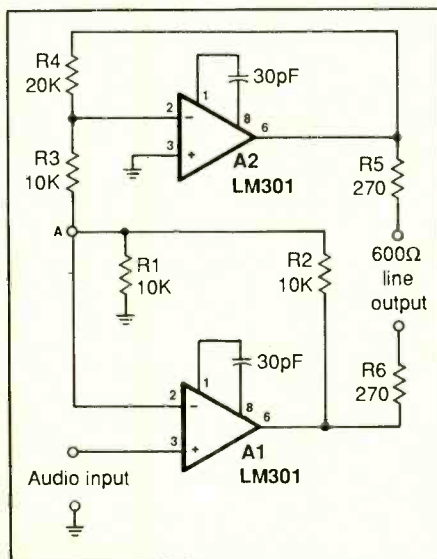

Fig. 6. A 600-ohm line driver amplifier circuit.

Fig. 5 circuit requires a dual-polarity dc power supply feeding its V+ and V- terminals. These power supplies can typically provide between +6 and +15 volts. Each supply line must be decoupled by high- and low-frequency bypass capacitors C1 and C3 with the same considerations as in the Fig. 4 circuit.

Output from the Fig. 5 circuit is an ordinary single-ended voltage, as is the case in other op-amp circuits. Hence, the output will typically have a very low impedance. It is possible to get away with a 600-ohm 1:1 transformer if the natural output impedance of the op amp is on the order of 50 ohms or so. A general rule of thumb in this regard is that the primary impedance of any transformer selected should be 10 times the natural output impedance of the device for best voltage transformation.

Another way to make a 600-ohm line-input amplifier is to use the simple differential dc circuit shown in Fig. 6. Make sure that input resistors R5 and R6 have values of 300 ohms, though. (Note: A 270-ohm value is shown for these resistors because this is the closest standard value that can be easily obtained from most sources. In most cases, derating the values to 270 ohms will have no discernible effect on circuit performance.)

Figure 6 shows a line driver based on a pair of ordinary operational amplifiers, with power connections deleted but all pinouts the same as in Fig. 5. The output circuitry is balanced because it is made from two single-ended op amps that are driven 180 degrees out-of-phase with each other. The low output impedance of the operational amplifier plus the 270-ohm series resistances make the balanced output impedance a total of approximately 600 ohms.

The Fig. 6 circuit is a good example of clever usage of one property of the ideal op amp. Applying a voltage to one input causes the same voltage to appear at the other input. In this

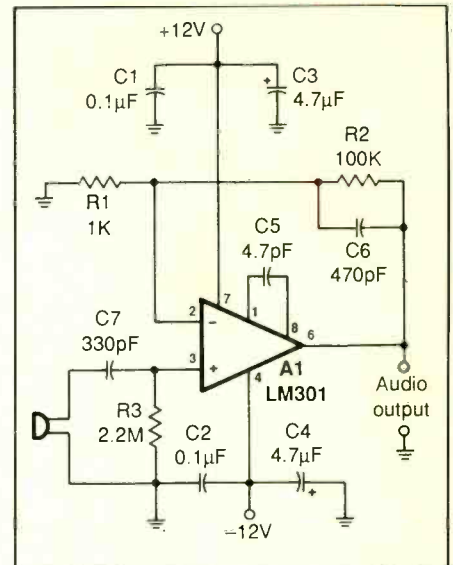

Fig. 7. Simple microphone preamplifier circuit suitable for use in communications and restricted-frequency PA applications.

case, the audio input signal voltage applied to the noninverting input of amplifier A1 also appears at the inverting input of the same amplifier. Thus, V_{in} appears at both inputs and point A, which allows point A to feed the other half of the balanced circuit made up of amplifier A2.

Because A1 is a noninverting gain-of-2 circuit and A2 is an inverting gain-of-2 circuit, the two sides of the circuit are 180 degrees out-of-phase with each other. This is the condition required of the two "balanced" output lines.

Preamplifier Circuits

A preamplifier is an audio amplifier that gives some initial amplification to the signal before passing it to another circuit for additional amplification and processing. For example, a microphone has a low-level output of several millivolts to 0.2 volt. A preamplifier typically boosts this low-level signal to between 100 millivolts and 1 volt before applying it to the input of a power amplifier that drives a loudspeaker or the input of a transmitter's modulator.

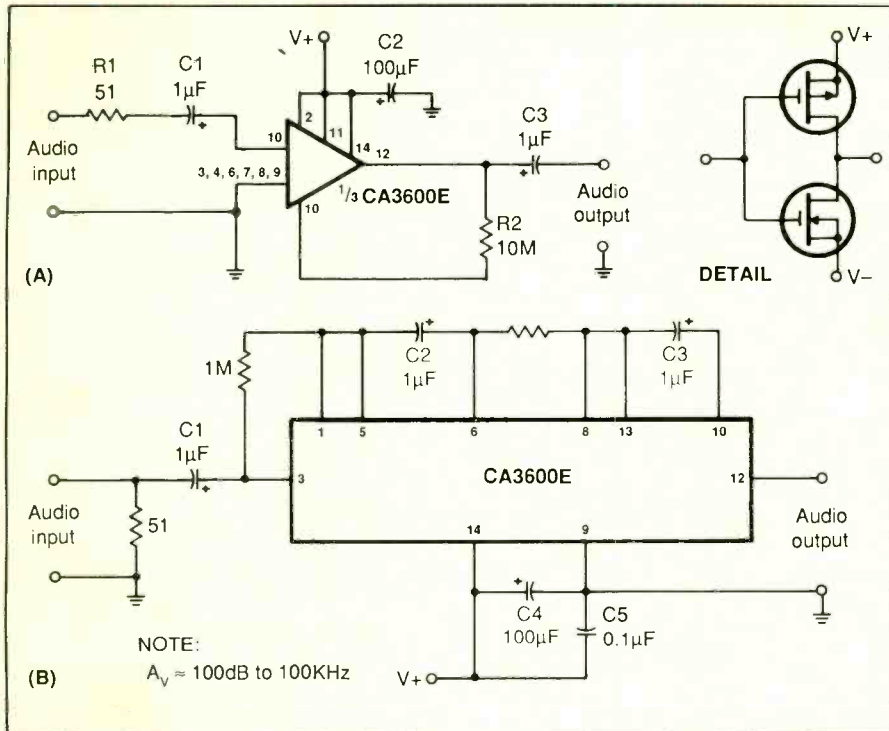

Fig. 8. Single- (A) and multiple-stage (B) general-purpose preamplifier circuits suitable for use in hi-fi applications.

A schematic diagram of a simple microphone preamplifier is shown in Fig. 7. This circuit is suitable for PA and communications use but not for high-fidelity applications because of its narrow bandwidth. Built around a common LM301 op amp wired in a noninverting follower configuration

and using the values shown for input and feedback resistors $R1$ and $R2$, the circuit has a gain of 101.

A microphone is capacitively coupled to the noninverting input of the op amp. To keep the op amp's input bias currents from charging $C7$ and thereby latching up the op amp, 2.2-

megohm resistor $R3$ is placed between the op amp's noninverting input and circuit ground.

This circuit can be made less complicated if a dynamic microphone is used to drive it. This type of microphone uses a high- or low-impedance coil that is permanently connected into the circuit. In this arrangement, $R3$ and $C7$ are omitted and the microphone is connected between pin 3 of $A1$ and circuit ground. If you anticipate having to disconnect the microphone from the circuit, however, keep $R3$ in the circuit to prevent the op amp's output from saturating at or near $V+$ when the noninverting input is left open.

Frequency response of this circuit is tailored by $C5$ and $C6$. With the values shown for these capacitors, the upper -3 -dB point in the response curve will be slightly beyond 3 kHz and will roll off at about 6 dB/octave beyond this frequency.

Two general-purpose preamplifiers based on RCA's CA3600E IC are shown schematically in Fig. 8. The CA3600E is a complementary COS/MOS transistor array device. Single- and multiple-stage designs are shown in Fig. 8(A) and (B), respectively. The internal transistor array equivalent for one transistor pair is shown in the inset in Fig. 8(A). This design

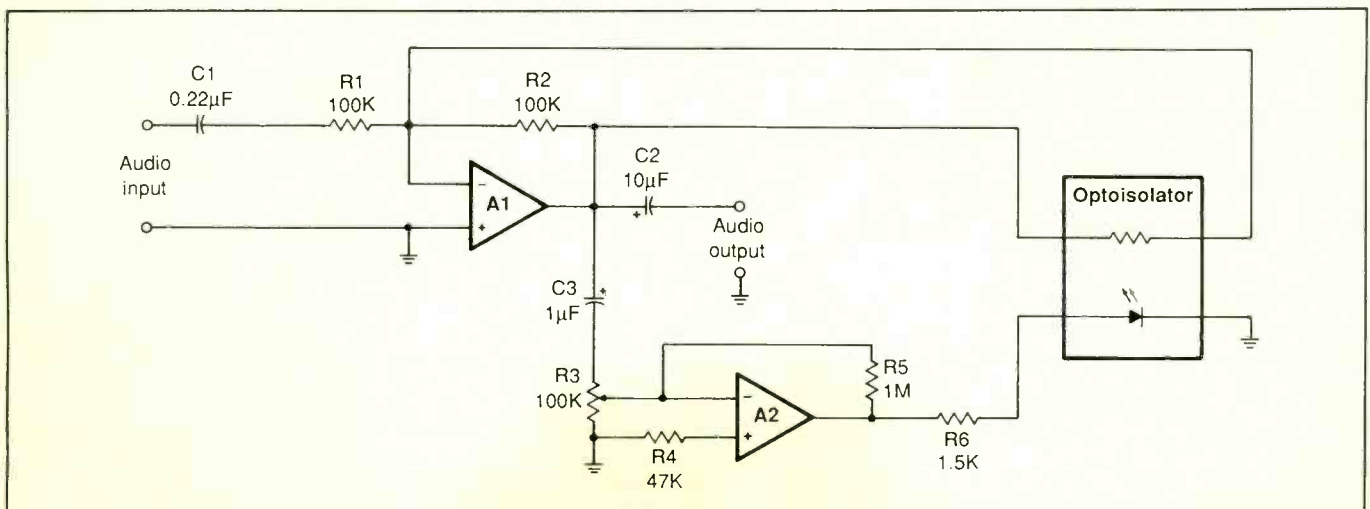

Fig. 9. A typical compression amplifier circuit.

is capable of up to 30 dB of gain at a $V+$ of 15 volts dc, slightly more at lower potentials but only at a sacrifice of the 1-MHz - 3-dB point in the response curve.

Figure 8(B)'s multi-stage design is capable of gains up to 100 dB at frequencies up to 1 MHz, assuming a 10-volt dc supply (gain drops to 80 dB when a +15-volt supply is used). This gain and frequency response are very useful in audio and other applications. However, it must be approached with caution when you actually build the circuit. Be sure to keep the power supply decoupling capacitors as close as possible to the body of the IC.

Unless a preamplifier stage with a higher impedance is provided, the 50-ohm input impedance of the Fig. 8(B) circuit takes this amplifier out of the audio-amplifier category because audio amplifiers expect to "see" higher impedances.

Compression Amplifier

An amplifier that reduces its gain on input signal peaks and increases gain in signal valleys is known as a "compression" amplifier. Such a circuit is usually used by electronic musicians and broadcasters to raise the average power in the signal without creating appreciable distortion. Shown in Fig. 9 is the schematic diagram of a typical compression amplifier circuit.

Amplifier *A1* is any good audio op amp, such as the LM301 (see earlier circuits for power supply and compensation details). Circuit gain is set by input resistor *R1* and a feedback resistance composed of *R2* and the optocoupler's output resistor element. Resistance of the optocoupler is set by the intensity of the light-emitting diode's brightness, which is, in turn, set by the amplitude of the signal fed to the LED from *A2*.

Because the output signal from *A2* is proportional to the output signal from *A1*, overall gain reduces itself, or compresses. Any high-resistance output device, such as those from

Clairex, or an H11A1 optocoupler that uses a JFET for the resistance element can be used in this circuit.

Assembly Notes

Any one or all of the circuits discussed here can be quickly and easily assembled using any of a variety of wiring techniques. If all you want to do is experiment, you can build the circuits on a solderless breadboarding block. For more permanent circuitry, you can mount and wire the components on small printed-circuit boards of your own design or perforated board with holes on 0.1-inch centers and suitable hardware.

There is nothing really critical about layout of the components in any of these circuits. However, to be on the safe side, always keep inputs and outputs as far apart as possible. It is also a good idea to use a socket for any integrated circuit used in a given circuit. **ME**

NEW SUPER LONG PLAY TAPE RECORDERS

12 Hour Model — \$105.00*
USES D-120 TAPE

Modified Panasonic Slimline, high quality, AC-DC Recorders provide 6 continuous hours of quality recording & playback on each side of cassette for a total of 12 hours. Built-in features include:
• Voice level control. • Digital counter, etc. TDK DC 120 Cassette Furnished.



PHONE RECORDING ADAPTER

Records calls automatically. All Solid state connects to your telephone jack and tape recorder. Starts recording when phone is lifted. Stops when you hang up. **\$24.50*** FCC APPROVED



VOX VOICE ACTIVATED CONTROL SWITCH

Solid state. Self contained. Adjustable sensitivity. Voices or other sounds automatically activate and control recorder. Uses either recorder or remote mike. **\$24.95***



*Add for ship & hdg. Phone Adapter & Vox \$1.50 ea. Recorders \$4.00 ea. Cal. Res. add tax. Mail order, VISA, MIC, COD's OK. Money Back Guarantee. Qty. disc. avail., Dealer Inquiries invited, Free data. © **AMC SALES INC.** Dept. M 9335 Lubec St., Box 928, Downey, CA 90241 Phone (213) 869-8519

CIRCLE 2 ON FREE INFORMATION CARD

Buy five MOVIE TIME CONVERTERS at the advertised price and get one

FREE



V-7200 or V-7500



MOVIE TIME

72 Channel Wireless Remote Cable Converter

with • **VOLUME** and • **MUTE** controls — Fine Tuning — • **AUDIO** and • **VIDEO** outputs — 2/3 or 3/4 switch — 90-minute Sleep Timer
*No. Vol. or A/V output EVERYTHING

V-7200 79.95
V-7500 109.95

V-7800

78 Ch. Wireless Remote. Parental Control built-in. 10dB Amp. Favorite Channel Memory. Fine Tuning. 89.95

CALL
Tel.: 1-305-652-1981
1-800-843-9845

COUPON			
NAME	ADDRESS		
CITY	STATE	ZIP	
TELEPHONE 1	Exp. Dt.		
COD <input type="checkbox"/> AMEX <input type="checkbox"/> CHECK <input type="checkbox"/> SIG	Am. Ex. =		
QTY	ITEM	PRICE	TOTAL
Send to:	Shipping	5.50	
MOVIE TIME	FL 5% Sales Tax		
20203 NE 15 Ct.	TOTAL		
Miami, FL 33179			

CIRCLE 39 ON FREE INFORMATION CARD

Automatic Telephone Flasher

Add-on accessory gives you visual indication of an incoming telephone call

By Anthony J. Caristi

Have you ever missed an important call because you didn't hear your telephone ring? Perhaps you were listening to music at high volume through headphones, or you or a member of your household is hearing impaired. For situations like these, a visible alerter like the Automatic Telephone Flasher to be described provides a practical solution. The Flasher can be used in conjunction with your instrument's "bell" or alone simply by switching off the latter.

Completely self-contained in its own enclosure, the Automatic Telephone Flasher uses a pulsed photo-flash unit as the alerting device. The project connects to the telephone line only to sense the ring signal generated by an incoming call. Because the ring signal has very little energy, two standard D cells power the project's flashtube circuitry and are called on to deliver power to the circuit only when the ring signal is present on the line. Hence, battery life is extremely long—up to a year or more, depending on the number of calls you receive in a year.

About the Circuit

As shown in the complete schematic diagram of the project in Fig. 1, the telephone flasher consists of two major sections—a telephone ring-signal detector and a dc-to-dc converter power supply that generates a high voltage required to trigger a xenon

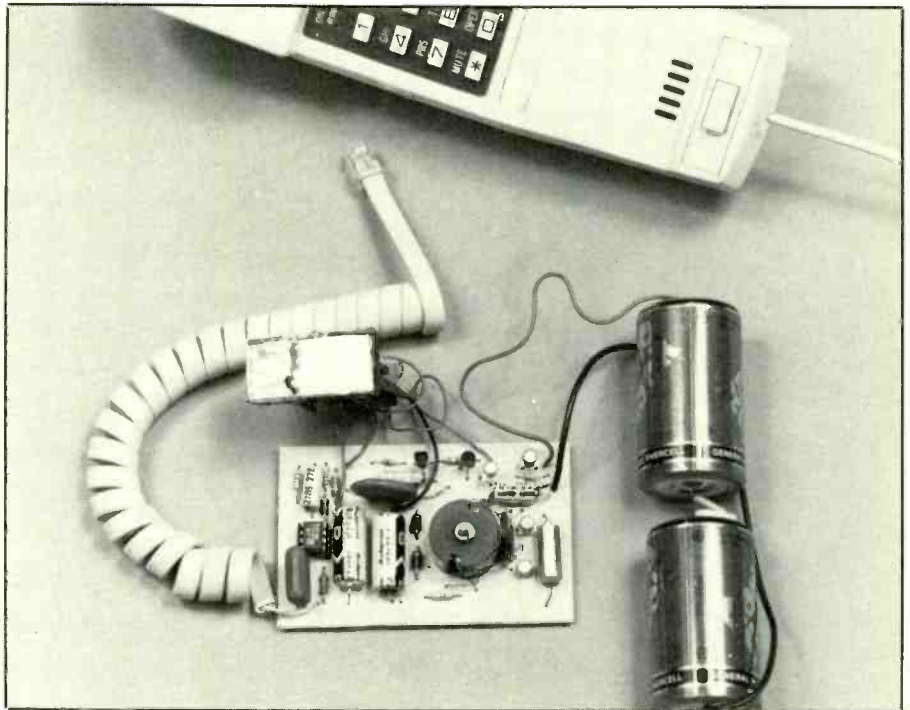

flashtube. These two sections are coupled to each other by an electronic switch made up of n-channel enhancement-mode field-effect transistor *Q3* and silicon bipolar transistor *Q6*.

Telephone ring detector *IC1* and its associated components are used to detect the ring signal when it appears on the telephone line from the phone company when a caller attempts to get through. Included in *IC1* is a bridge rectifier, 5-volt regulator and transient suppression circuitry that prevents damage to the integrated circuit and false operation that might otherwise occur if a large

transient voltage appears across the telephone line.

Drive for *IC1* is provided directly from the 90-volt, 20-Hz ring signal that appears across the line to announce an incoming call. During standby, *IC1* presents a very high impedance to the telephone line. Also, this chip in no way affects incoming and outgoing calls. Its only purpose is to generate a regulated output voltage at pin 4 in response to the ring signal. Capacitor *C2* stores the energy of the signal to power the regulator circuit so that it produces a 5-volt dc output between pins 4 and 7 of the integrated circuit.

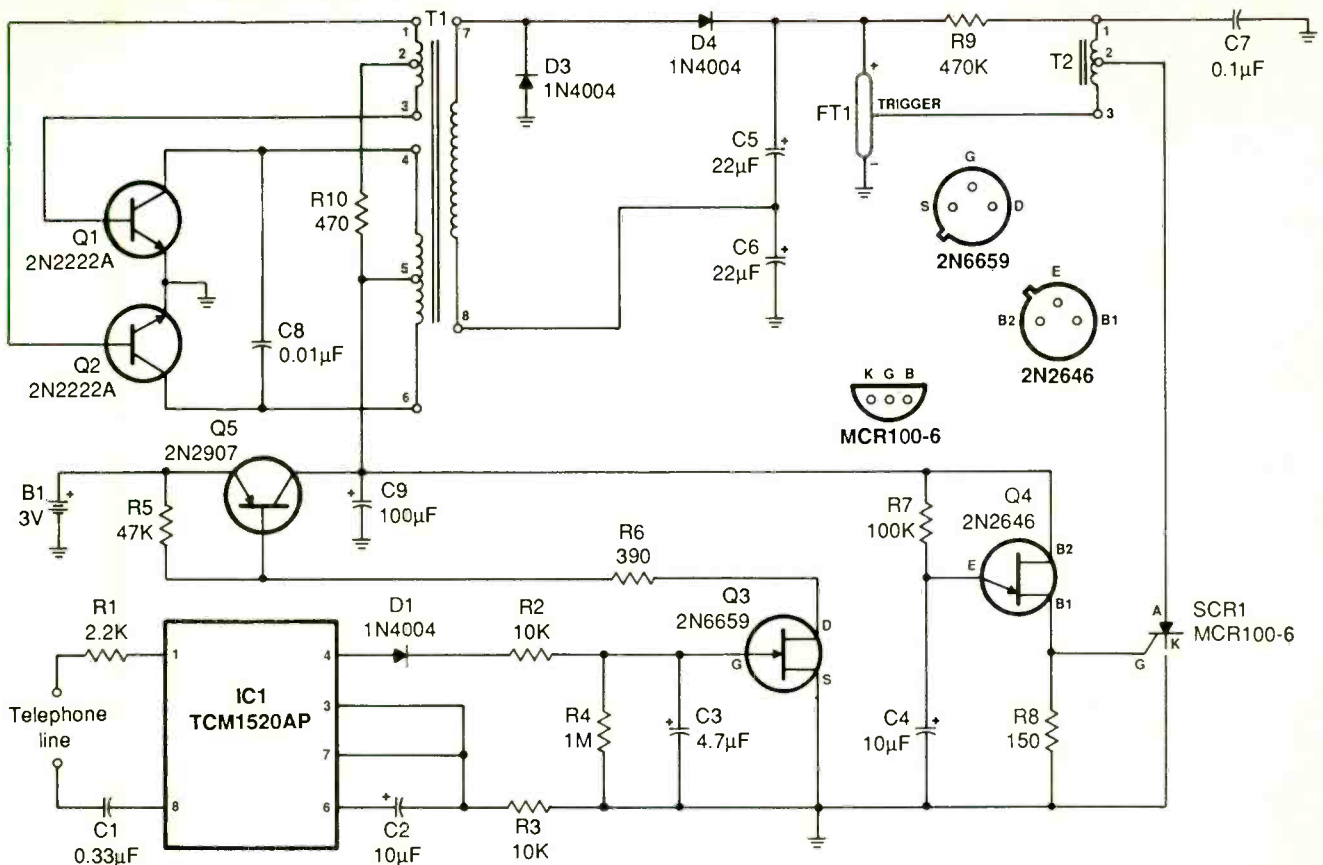

PARTS LIST

Semiconductors

D1, D2, D3—1N4004 or equivalent 400 PIV silicon diode
 IC1—TCM1520AP telephone ring detector (Texas Instruments)
 Q1, Q2—2N2222A or similar npn silicon transistor
 Q3—2N6659 or equivalent n-channel enhancement-mode field-effect transistor
 Q4—2N2646 unijunction transistor
 Q5—2N2907 pnp silicon transistor
 SCR1—MCR 100-6 silicon-controlled rectifier (Motorola)

Capacitors

C1—0.33- μ F, 250-volt Mylar
 C2, C4—10- μ F, 50-volt electrolytic
 C3—4.7- μ F, 25-volt electrolytic
 C5, C6—22- μ F, 150-volt electrolytic
 C7—0.1- μ F, 500-volt ceramic disc

C8—0.01- μ F, 250-volt ceramic disc
 C9—100- μ F, 10-volt electrolytic

Resistors (1/4-watt, 10% tolerance)

R1—2,200 ohms
 R2, R3—10,000 ohms
 R4—1 megohm
 R5—47,000 ohms
 R6—390 ohms
 R7—100,000 ohms
 R8—150 ohms
 R9—470,000 ohms
 R10—470 ohms

Miscellaneous

B1—Two 1.5-volt high-energy or alkaline D cells in series (see text)
 FT1—250-volt Xenon flashtube (Radio Shack Cat. No. 272-1145 or similar—see text)
 T1—Hand-wound transformer (requires TDK pot core and bobbin No.

H5AP2213Z52H or similar and Nos. 30 and 36 enameled wire—see text)
 T2—Trigger transformer with 300-volt primary and 6,000-volt secondary (Triad No. PL-10 or similar)
 Printed-circuit or perforated board with holes on 0.1" centers and suitable solder or Wire Wrap hardware (see text); socket for IC1; double D-cell holder for B1; standard telephone cord with modular connector at one end; thin tape; suitable enclosure (see text); machine hardware; hookup wire; solder; etc.

Note: The following items are available from A. Caristi, 69 White Pond Rd., Waldwick, NJ 07463: Pc board, \$7.75; pot core and bobbin, \$8.75; 2N2222A, 2N6659 and MCR 100-6, \$2.25 each; 2N2646 and 2N2907, \$3.00 each; and TCM1520AP, \$3.95. Add \$1 P&H. New Jersey residents, please add state sales tax.

Fig. 1. Complete schematic diagram of automatic telephone flasher.

Since its gate-to-source voltage is zero, *Q3* remains in cutoff during standby. The resistance between the drain and source is virtually infinite, which prevents any base current from flowing in *Q5*. As a result, *Q5* is also in cutoff, meaning that no current can flow from battery *B1* to the rest of the circuit.

When a ring signal appears across the telephone line, the 5-volt dc output from *IC1* biases *Q3* into conduction. The resulting low resistance now between *Q3*'s drain and source causes *Q5* to switch on at full saturation. This powers the circuit and allows the dc-to-dc converter to oscillate and trigger xenon flashtube *FT1*.

Since the time constant of *Q3*'s gate circuit, controlled by the values of *R4* and *C3*, is about 5 seconds, the forward bias on *Q3* is sustained during the 4-second interval between telephone ring pulses so that *FT1* continues to flash.

When the ring signal ceases, the bias on *Q3* decays to zero, which cuts off both this transistor and *Q5*. When this occurs, *FT1* extinguishes.

About 250 volts is needed to trigger the flashtube. This high voltage is provided by the dc-to-dc converter power supply composed of bipolar transistors *Q1* and *Q2*, transformer *T1* and the associated components. These components make up an oscillator circuit that operates at a frequency of 3 to 4 kHz. The collectors of the two transistors are connected in push-pull fashion to alternately drive each half of *T1*'s primary with the battery voltage.

The bases of *Q1* and *Q2* are driven by the feedback winding to assure that the dc-to-dc converter will oscillate as it should. Each transistor alternately conducts and is cut off, causing the transformer's primary to be driven by a 10-volt peak-to-peak square wave. The step-up turns ratio of the secondary winding produces a high ac voltage at pins 7 and 8 of *T1* that is used to drive a full-wave voltage doubler. The doubler charges *C5*

and *C6* to about 125 volts each. Since these capacitors are connected in series with each other, the sum of the voltages—about 250 volts—is used to trigger the gas inside the flashtube to ionize and, in so doing, emit a bright flash of light.

Although *FT1* is connected across the output of the power supply, it does not conduct current and flash until it is triggered by a very-high-voltage pulse fed to its trigger electrode. This electrode is simply a wire that wraps around the flashtube near its middle.

To generate the very-high-voltage spike (it is almost 6,000 volts) needed to trigger the flashtube into operation, a second, trigger, transformer (*T2* in Fig. 1) is used. This circuit is very much like that used in the typical capacitive-discharge (CD) electronic ignition system used in motor vehicles.

Unijunction transistor *Q4* and its associated components make up a re-

laxation oscillator that operates at a frequency of about 1 Hz. Timing capacitor *C4* is charged by current through *R7*. When the charge reaches about 1.5 volts, *Q4* suddenly conducts and dumps the charge stored in *C4* into emitter resistor *R8*. When this occurs, the voltage produced across *R8* is sufficient to trigger silicon-controlled rectifier *SCR1* into conduction.

During the time *C4* charges to 1.5 volts, *C7* is charged to about 250 volts through *R9* and the high-voltage supply. When *SCR1* is suddenly triggered into conduction, the energy stored in *C7* flows into the primary of *T2*. Step-up action causes the approximately 6,000-volt output at the secondary of *T2* to be presented to *FT1*'s trigger electrode, causing the flashtube to conduct and the energy stored in *C5* and *C6* to be converted into heat and light.

Although the energy in a single flash of *FT1* is dissipated in about

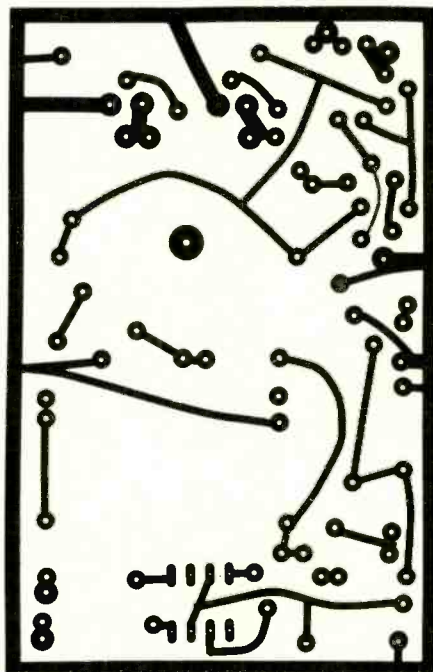

Fig. 2. Actual-size etching-and-drilling guide for project's printed-circuit board.

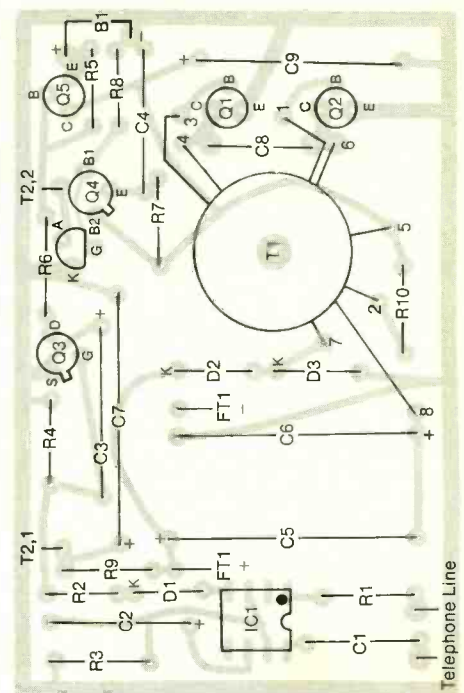

Fig. 3. Wiring guide for pc board. Use this as rough layout guide if you wire project on perforated board.

0.001 second, the flash produces enough light—similar to that of a photoflash used with cameras—to be easily seen. As *FT1* flashes, *C5*, *C6* and *C7* quickly recharge to await the next pulse from *C4*. The cycle repeats as long as the ring signal is present on the telephone line.

Although trigger transformer *T2* produces an output of about 6,000 volts, no potential shock hazard exists because there is no power (current) behind this very-high voltage. However, it is always a good idea to respect any high voltage, whether from *T1* or *T2*, since you will get an electrical shock if you place any part of your body in contact with the circuitry.

Construction

As shown in the lead photo, the entire circuit, with the exception of the battery and flashtube, can be wired on a small single-sided printed-circuit board that measures only 3.5 × 2.25 inches. Since there is nothing critical about either wiring or component location, you can assemble the circuit on a similar-size perforated board that has holes on 0.1-inch centers and use suitable soldering or Wire Wrap hardware to make wiring interconnections. Just be sure that the secondary of *T1* and the primary of *T2* do not cross over the low-voltage circuits of the transistors and related components. If you do not heed this advice, the circuit can fail should a voltage breakdown occur between the high-voltage supply and the sensitive low-voltage components. The advantage of using a printed-circuit board is that it precludes such a breakdown.

You can fabricate your own pc board using the actual-size etching-and-drilling guide shown in Fig. 2, or you can purchase a ready-to-wire board from the source given in the Note at the end of the Parts List. Once the board is ready, refer to Fig. 3 and mount and solder into place a

socket in the *IC1* location. Do *not* install *IC1* in its socket until after preliminary checks have been made.

Install and solder into place the resistors, diodes and capacitors. Then do the same for the transistors (except *Q3* and *Q5*, which will also be installed after preliminary checks have been made) and *SCR1*. Observe polarity with the diodes and electrolytic capacitors and basing for the transistors and silicon-controlled rectifier. (Note: If you wire the project on perforated board, use the layout shown in Fig. 3 as a rough guide to component placement and orientation.)

The flashtube and trigger transformer *T2* can be obtained from the sources given in the Parts List. Alternatively, you can salvage these items from an old camera photoflash unit. Wire these components to the circuit board as indicated in Figs. 1 and 3; observe polarity for the flashtube.

Since this project contains voltages that are not normally encountered in modern solid-state circuits, be sure to follow the voltage ratings of the components indicated in the Parts List when selecting them. Do *not* use components with voltage ratings less than those indicated. If you do, one or more of the components is likely to break down. If this occurs, the circuit will not operate and other components are likely to be damaged.

Use a standard telephone cord that is terminated in a modular plug to make connection to the telephone line. This is both an FCC requirement for telephone accessories and a convenience that will let you move the project to another telephone if you desire to do so. Since the circuit is ac coupled to the telephone line through *CI*, you need not be concerned with polarity. Connections are made to the red and green conductors of the telephone line; the black and yellow conductors are not used and can be disregarded.

Switching transformer *T1* must be

hand wound by you. This is not as difficult a task as you might imagine. In addition to the pot core/bobbin assembly specified in the Parts List, you will need a small quantity of No. 30 and 36 enameled (so-called “magnet”) wire and some thin insulating tape. Mylar tape will do nicely. It is mandatory that you perform the winding procedure exactly as follows to ensure proper phasing of the primary and feedback windings.

Start with the feedback winding, identified by terminals 1, 2 and 3 in Fig. 1. Use No. 30 enameled wire for this winding. Wind a total of 10 turns of this wire on the bobbin, making a center tap at the fifth turn. Starting with a 36-inch length of wire, wind five turns around the bobbin, leaving a 4-inch-long “leader.” Bring the wire out of the bobbin, at one of the openings provided, fold the wire over into a 4-inch U shape wind five more turns on the bobbin in the *same* direction as you wound the first five turns. Secure the feedback winding in place on the bobbin with a single layer of tape to insulate it from the next winding. Allowing about a 4-inch leader at the end of the wire, clip off any excess. Use masking tape to label the start, center tap and end of this winding with the numbers 1, 2 and 3, respectively.

Next, wind the transformer’s primary turns in bifilar fashion to achieve the tightest possible coupling between the two halves of the winding to minimize voltage spikes that will appear at the collectors of *Q1* and *Q2*. Use two 30-inch lengths of No. 30 enameled wire for this winding. Label the same ends of these two wires 4 and 5. Place these two ends together and, leaving a 4-inch leader in both cases, wind nine turns around the bobbin in the *same* direction as the feedback winding was wound. Secure this winding with a layer of tape. Clip all but 4 inches from what remains of these wires.

Use an ohmmeter set to a low-ohms range or a continuity tester to

identify the unmarked ends of the primary. Label the wire that gives continuity with the end labeled 4 with a 5. The other wire then gets a label with a 6 on it.

The secondary winding of the transformer simply consists of 250 turns of No. 36 enameled wire wound in either direction. When you have finished winding the wire onto the bobbin, secure it in place with a couple of layers of tape. Then trim the leads to about 4 inches in length and label them with the numbers 7 and 8.

Assemble the bobbin inside the pot core halves, being careful to avoid getting any dirt or other foreign debris on the polished surfaces of the core. Use tape to secure the two halves of the pot core together. Then carefully scrape away about 1/4 inch of enamel insulation from the ends of all transformer leads, including the center of the U loop on the center tap of the feedback coil, after first clipping open the center of the U. Tin each lead end with a thin layer of solder.

Mount the transformer on the circuit-board assembly in the location shown in Fig. 3. Use a No. 6 machine screw and nut and a plastic or fiber washer if you have one. Be very careful to avoid over-tightening the hardware or you will crack the very brittle ferrite pot core, rendering it useless.

Plug the transformer's leads into the appropriate holes in the pc board and solder into place. Remember that there will be *two* leads that go into holes 2 and 5. Be very careful to connect the transformer's leads into the circuit properly; a wiring error at this stage will result in an inoperative circuit.

You can install the entire project in a suitable plastic or metal enclosure. Mount the flashtube so that it will be readily seen when it flashes. If you use a clear plastic enclosure, you can locate the flashtube inside it.

Since power for the circuit is provided by two 1.5-volt D cells in series

with each other to provide 3 volts, it is best to use heavy-duty or alkaline cells for longest operating life. This battery is called upon to deliver current only when the telephone rings; hence, its service life can approach that of its shelf life. Just keep in mind that the circuit is designed to give a flash rate of about once per second. When you notice that the frequency of flashes is much less than this, it is time to replace the cells with fresh ones.

Checkout & Use

It is best to check operation of the dc-to-dc converter section first. Make sure that *IC1*, *Q3* and *Q5* are *not* installed on the circuit-board assembly. Use a bench-type dc power supply set to deliver 2.5 volts or two C or D cells in series as a power source. Current drawn from the source will be in the 100- to 300-mA range.

Use a dc voltmeter or a multimeter set to dc volts to measure the output voltage from the dc-to-dc converter circuit. The meter must have an input resistance of 1 megohm or more and be set to measure at least 300 volts. Be very careful not to touch any of the wiring during and after the test because high voltage will be present in the circuit.

Before powering the circuit, connect the meter's "hot" probe to the positive (+) side of *C6* and common probe to the negative (-) side of *C6*. Then connect the dc power source across *C9*, again observing polarity. You may now hear a faint 3- or 4-kHz tone as the circuit oscillates, and the voltmeter's reading should slowly rise toward 250 volts. As the flashtube fires, the indicated voltage should suddenly drop toward zero and begin to rise toward 250 volts. This charge/discharge cycle should continue to repeat about once each second for as long as power is applied to the circuit.

Once you obtain the proper indications, disconnect the power source from the circuit and use a low-value,

say, 1,000-ohm, resistor to carefully discharge *C5* and *C6* by temporarily bridging each capacitor's leads. Be careful to avoid touching the resistor's leads!

If you do not obtain a dc voltage reading on the meter, the circuit is probably not oscillating as it should. Disconnect the power source from the circuit and check the basings of *Q1* and *Q2* and the orientations of *D3*, *C5* and *C6* against Fig. 3. If all seems to be okay, the 1 and 3 feedback leads of *T1* may be incorrectly phased. Transpose these two leads and try again. If this does not work, return the leads to their original holes, and carefully review the transformer winding instructions to ascertain that you have properly performed the procedure.

If you obtain 250 volts or more but the flashtube fails to fire, *Q4* may not be oscillating. In this case, check the orientation of *C4* and basing of *Q4*. Connect the voltmeter across *C4* and ascertain that the reading indicated slowly rises to about 1.5 volts, then suddenly drops to near zero and repeats about once per second.

If *Q4* is oscillating, check the wiring of *T2* and *SCR1*. If possible, try using another flashtube. Do not proceed to final assembly until you have cleared up any problems encountered during checkout.

When you are finished with checkout, disconnect the power source from the project and once again carefully discharge *C5* and *C6* with the bridging resistor. Then plug *IC1* into its socket, making sure to properly orient it as shown in Fig. 3 and that no pins overhang the socket or fold under between socket and IC. Install and solder into place *Q3* and *Q4*, checking for proper basing before soldering the leads of these transistors to the copper pads on the bottom of the board.

Place two D-size cells in a two-cell holder and wire them in series with each other. Then wire this "battery" into the circuit as shown in Figs. 1

and 3. With the cells connected into the circuit as shown, there should be no project activity.

For your final test, plug the modular connector at the end of the project's cord into a telephone jack (use a duplex adapter if only one jack is present at the telephone box) along with your existing telephone instrument. Have a friend place a call to your number. When the telephone rings, the flashtube should fire at a rate of about once per second, even during the 4-second interval between rings. When you pick up your phone's handset to answer the call, flashing should continue a few more times and then cease.

You can now proceed to final installation. Simply leave the project plugged into the telephone line but locate the automatic telephone flasher where its flashing light will easily be seen from anywhere in the room.

ME

To preserve your copies of

MODERN ELECTRONICS

THE MAGAZINE FOR ELECTRONICS & COMPUTER ENTHUSIASTS

Cases: Each case holds 12 issues.

**Price per case \$7.95; three for \$21.95;
six for \$39.95**

Binders: Each binder holds 12 issues.

**Issues open flat. Price per binder \$9.95;
three for \$27.95; six for \$52.95**

*(Canadian and foreign requests should also include
an additional \$2.50 per item for shipping costs.)*

To: Jesse Jones Industries (Since 1843)

P.O. Box 5120, Dept. MOD, Philadelphia, PA 19141

I enclose my check or money order for \$_____.

Please send me _____ MODERN ELECTRONICS

Files. Binders. *(Please Print)*

Name _____

Address _____

City _____

State _____

Zip _____

Please allow approximately 4 weeks for delivery.

INNOVATIVE PROJECTS FROM THE PAGES OF "MODERN ELECTRONICS"

320 WATTS PEAK STEREO POWER!

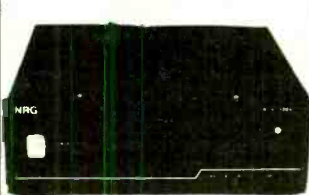

NEW!! 110 VAC Powered Amp Compact Size 10"x10"x3"

LINE LEVEL INPUTS THAT LESS THAN 0.5% EXCEPTIIONALLY TRANSPARENT SOUND! IT TAKES A DIGITAL AMPLIFIER TO DELIVER THE POWER FROM TODAY'S NEW DIGITAL RECORDINGS. THE NRG 320 USES POWER MOVING SWITCHES AT OVER 250 KILOHERTZ. SPEAKERS ARE DRIVEN WITH A CONSTANT FREQUENCY SQUARE WAVE USING PULSE WIDTH MODULATION AND PEAK CURRENT AVERAGING.

**320 AC Amplifier Kit \$150.00
Assembled \$200.00**

Dec '87 Article

320 WATTS PEAK POWER FOR YOUR CAR STEREO



FROM DEC 87 ISSUE
"MODERN ELECTRONICS" ARTICLE
15.8 VDC POWERED
COMPLETE STEP-BY-STEP ASSEMBLY INSTRUCTIONS
DIGITAL AMP DESIGN
COMPACT SIZE 10"x10"x4"

**320 DC AMPLIFIER KIT.....\$150
ASSEMBLED AND TESTED.....\$200**

T-100 ELECTRONIC THERMOMETER WORKS WITH ANY VOLTMETER



**\$39.95 Assembled & Calibrated
\$19.95 KIT**

NRG FAN DELAY Purges Cold Air From AC System for \$100/yr Savings (Typ)



ADJUSTABLE TIME OPERATES SYSTEM FAN FOR PRESET TIME PERIOD AFTER COMPRESSOR STOPS
GOOD AIR CONTINUES TO ENTER ROOMS FOR SEVERAL MINUTES
FIRST YEAR SAVINGS ON A MEDIUM SIZED HOUSE WILL TYPICALLY EXCEED \$100

KIT \$19.95 ASSEMBLED \$39.95

SPEED UP YOUR PC BY 30% WITH THE PC ACCELERATOR

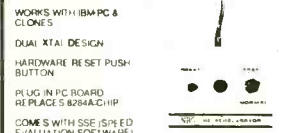

**PCA KIT.....\$29.95
PCA ASSEMBLED.....\$49.95**



JUMBO 6 DIGIT LED CLOCK

12/24 HOUR DISPLAY
QUARTZ TIME BASE
8.25" X 6" RED LED DIGITS
STYLISH PLEXIGLAS CASE
BATTERY BACK UP
110V AC 12V DC OPERATION

\$69.95 KIT \$99 ASSEMBLED

NRG ORDER BY MAIL, PREPAID OR COD FROM NRG ELECTRONICS, PO BOX 24138
FT. LAUDERDALE, FL 33307 OR BY PHONE (305) 971-3823
INCLUDE SHIPPING FL RESIDENTS ADD SALES TAX.

CIRCLE 48 ON FREE INFORMATION CARD

At KELVIN... Price, Service & Quality for over 42 years.

**B & K · FLUKE · UNGAR
HITACHI · WELLER
BECKMAN · DREMEL
STANLEY · MAKITA
X-ACTO · KEPRO · XCELITE**



LISA HADAR
EXECUTIVE VP, CPA

METERS/OSCILLOSCOPES

B & K	2120	20Mhz Dual Trace	\$ 395*
Beckman	9020	20Mhz Dual Trace	425

Hitachi	V212	20Mhz	\$365
---------	------	-------	--------------

Fluke	73	3 1/2" Digit DMM
Fluke	75	3 1/2" Digit DMM
Fluke	77	3 1/2" Digit DMM

SPECIAL

*PLUS Shipping & Insurance. Prices subject to change without notice.
WE HAVE IT ALL...
• COMPONENTS • TOOLS • KITS • SECURITY • SEMI-CONDUCTORS • ELECTRICAL SUPPLIES • SOLDER EQUIPMENT • KELVIN KITS • TSM KITS • DRAFTING SUPPLIES

Volume Quotes, Industrial & School Bids Welcome.
ORDER TOLL FREE 1-800-645-9212 FOR INQUIRES & N.Y.S. 516-349-7620

KELVIN ELECTRONICS

NEW ADDRESS:
7 Fairchild Avenue • Plainville, NY 11803 • FAX: 516-349-7830

VISA/MASTER CARD ACCEPTED

CIRCLE 49 ON FREE INFORMATION CARD

A Solid-State Electric-Blanket Controller*

Eliminates problems usually encountered with electromechanical controllers and provides greater efficiency and better heating comfort

By Joseph O'Connell

Standard electromechanical controllers vary the average heat output of an electric blanket by repeatedly cycling on and off the embedded heating elements in a more or less "digital" manner in response to changing ambient temperatures. The solid-state replacement controller to be described continuously controls the blanket's temperature in an *analog* manner by varying the amount of power delivered to the heating elements, rather than switching between only full-off and full-on. This eliminates temperature fluctuations and provides more comfortable heating.

Our electronic controller also eliminates the bright dial light and contact clicking common to electromechanical controllers. Instead of a dial light, the electronic controller employs a multi-color light-emitting diode whose color gives an indication of the amount of power being delivered to the blanket's heating elements at any given moment. With this arrangement, you do not even have to read the numbers off a dial. Though bright, the LED is a small point source that will not be annoying—yet it can be "read" in the dark

*Adapted from *Twenty Innovative E Projects for Your Home* by Joseph O to be published July 1988 by Tab Box Blue Ridge Summit, PA 17214.



even from across a room. All "switching" is done in complete silence by electronic means.

About the Circuit

The major distinction of our electronic blanket controller is that it controls the power supplied to the heating elements with a triac that interrupts the ac line voltage at different points on its waveform by a

process called "phase control." (See the "How Phase Control Works" box for a detailed description of the circuit.)

Outputs from typical electromechanical and electronic controllers are compared in Fig. 1. You can readily see that although both controllers produce the same average temperature, the electronic phase-controlled version exhibits none of the long-term fluctuations exhibited by the electromechanical version.

The amount of power supplied by the solid-state controller depends on the ratio of the on time to the off time. To simplify setting the controller—especially in the dark—light-emitting diode *LED1* in Fig. 2 indicates this ratio. When the output of the controller is zero (no power delivered to the blanket), *LED1* glows green. As the heat control is turned up, *LED1*'s color goes to yellowish-green and then to fully yellow at the half-power setting. Further power increases to the blanket cause *LED1* to go through shades of orange until it becomes fully red at full power. Hence, a single multi-color light-emitting diode gives at-a-glance indication of the heat setting. For convenience, during construction, *LED1* is placed at the index of HEAT control *R2* so that the latter can be easily located in the dark.

Note also in Fig. 2 that this controller also has a special FAST WARM switch, *S2*, that makes it easy to

SOLID STATE CONTROLLER:

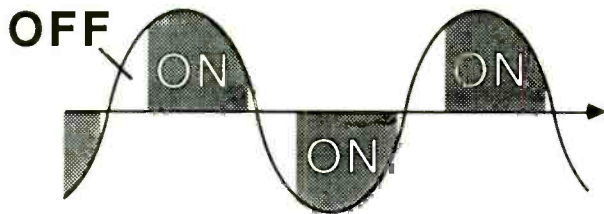

Each ON-OFF cycle = 1/60 sec.

ELECTRO-MECHANICAL CONTROLLERS:



ON-OFF cycling takes minutes.

Fig. 1. Solid-state controllers have none of the long-term output variations that characterize electromechanical controllers.

warm up a cold bed quickly. Setting this switch to "on" bypasses the control circuitry and sends the full 117 volts of the ac line to the blanket. Although the HEAT control set to MAXIMUM does the same thing, a separate switch eliminates the need to frequently reset *R2*. Red light-emitting diode *LED2* flashes to let you know when the FAST WARM function has been selected.

Electromechanical controllers that the Fig. 2 circuit replaces have a rudimentary form of temperature compensation. The power they send to the blanket's heating elements varies in response to ambient room temperature and the dial setting. By building in temperature compensation, these controllers allow you to go to bed when the ambient temperature is still comfortable but drops to an uncomfortable level later on. It automatically increases power to the blanket as the room becomes colder.

In most cases, temperature compensation is not needed. Located inside the controller's housing, the temperature sensor cannot monitor the temperature of the sleeper. Thus, it cannot take into account the amount of insulation the bed provides or the amount of heat produced by the body. So even at best, this type of temperature compensation will be inaccurate.

Another reason why temperature compensation is not necessary in most cases is that changes in room temperature throughout a sleep period are usually slight in most homes. But the most important reason is the body itself. During sleep, the body regulates its own temperature throughout a wide range of ambient temperatures. Hence, the human body is remarkably tolerant of temperature variations.

The solid-state controller circuit shown in Fig. 2 is built around triac

Q1, resistors *R1* and *R3*, potentiometer *R2* and capacitors *C2* and *C3*. Operation of this circuit is similar to that of a conventional lamp dimmer. Setting of the desired heating level is accomplished with HEAT control *R2*.

Three leads are provided on dual light-emitting diode *LED1*, one for the cathodes that are internally tied together and one each for the anodes of the red and green LEDs inside the device's molded plastic case.

At minimum setting of *R2*, *Q1* does not conduct, but current does flow through *S1*, *D1*, *R4* and the electric blanket's heating element to light the green LED element inside *LED1*. At this time, the red LED element remains off due to the triac's high resistance. However, when the setting of *R2* is turned up slightly, *Q1* begins to conduct for a brief period of time at the beginning of each half-cycle. For this short time, the green LED is shorted by *Q1* and power is switched to the red LED. Both LED elements inside *LED1* are never on simultaneously. The eye's image persistence combines a comparatively long interval of green and a short interval of red to resolve a yellowish-green color.

As the setting of the HEAT control is turned up, the red LED element remains on for longer portions of the ac waveform, the green LED element for shorter periods. This yields first a yellow, then an orange and, finally, a red perception of colors.

With *S2* set to FAST WARM, full ac line power bypasses *Q1* and is delivered directly to the blanket's heating element. When *S2* is in this position, *LED1* is switched out of the circuit and only *LED2* is switched in. Built into *LED2* is a CMOS chip that operates from a 3- to 7-volt power-supply potential. The dc supply for *LED2* is provided by *R6*, *D3* and *C7*.

Bypass capacitors *C1*, *C4*, *C5* and *C6* suppress arcing and radio-frequency emission in the circuit. Though the controller circuit will operate without these capacitors, the switches

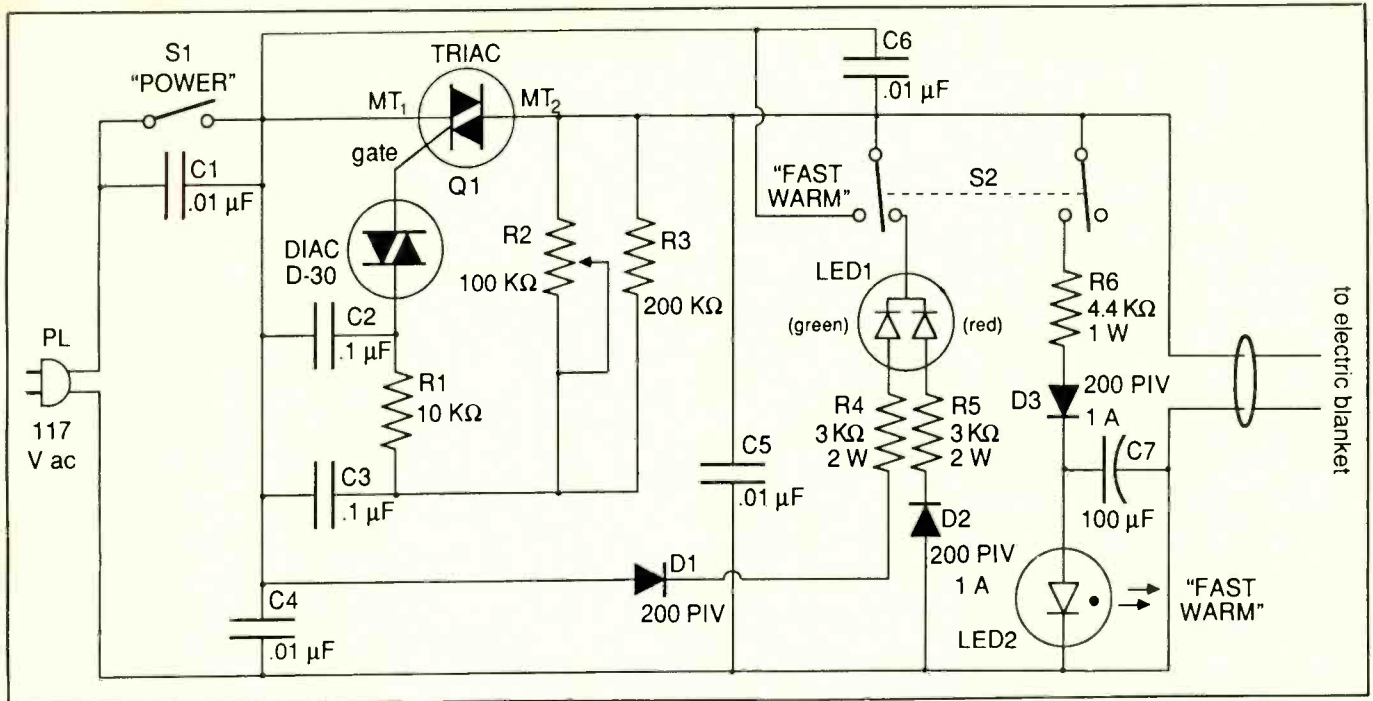

Fig. 2. The complete schematic diagram of all-electronic solid-state electric-blanket controller.

will soon wear out and nearby radios may pick up noise generated by the switching action of the triac.

Construction

A suitable enclosure for this project is one of the plastic project boxes that come with an aluminum faceplate. If you use such a box, mount the control, switches and LEDs in holes drilled through the box's plastic bottom and use the aluminum plate as the base of the box and the heat sink on which you mount the triac. When the project is fully assembled, affix four small anti-skid plastic feet to the metal plate.

Almost half of the components that make up this project mount on the plastic portion of the box and the aluminum faceplate. Those that do not mount directly to the box can be supported by terminal strips to which whatever wiring is needed is made. This being the case, the project is more suited to point-to-point wiring than it is to printed-circuit or perforated board wiring.

Components that mount directly to the plastic portion and aluminum faceplate of the box, include the LEDs, switches, potentiometer and triac. The point-to-point wiring ar-

angement is illustrated in Fig. 3. Solid black dots identify connections that are made without the aid of terminal-strip lugs. Circles with Xs in them indicate points where terminal-

PARTS LIST

Semiconductors

D1 thru D3—200-PIV, 1-ampere rectifier diode

D4—D-30 or equivalent (available from Active Electronics, P.O. Box 9100, Westborough, MA 01581; tel.: 1-800-343-0847)

LED1—Two-color light-emitting diode with three leads

LED2—Flashing red light-emitting diode (Radio Shack Cat. No. 276-036 or equivalent)

Q1—200-volt, 2-ampere triac

Capacitors

C1, C4, C5, C6—0.01- μ F, 200-volt or better disc (value not critical)

C2, C3—0.1- μ F, 200-volt or better disc

C7—100- μ F, 10-volt electrolytic

Resistors (10% tolerance)

R1—10,000 ohms, $\frac{1}{4}$ watt

R3—200,000 ohms, $\frac{1}{4}$ watt (or whatever value gives smoothest control response

over entire range of R2 when project is tested with incandescent light)

R4, R5—3,000 ohms, 2 watts (3,300-ohm, 2-watt resistor in parallel with a 33,000-ohm, $\frac{1}{4}$ -watt resistor)

R6—4,400 ohms, 2 watts

R2—100,000-ohm linear-taper potentiometer

Miscellaneous

PL1—Ac line cord with plug

S1—5-ampere spst miniature toggle switch

S2—5-ampere dpdt miniature toggle switch

Suitable enclosure (see text); terminal strip (see text); rubber grommets (2); small-diameter heat-shrinkable or plastic tubing; mica washer and shoulder fiber washer for Q1 (see text); fast-set clear epoxy cement or hot-melt glue; lettering kit; machine hardware; hook-up wire; solder; etc.

strip solder lugs are needed. Any terminal strip used should be mounted on the aluminum faceplate of the box with machine hardware.

As shown in Fig. 3, you need at least three terminal-strip solder lugs to wire the circuit. Keep in mind that not every connection indicated by an X in a circle requires a separate solder-lug tie point. For example, no separate tie point is needed between R5 and D2. You simply connect and solder together one lead of R4 and the cathode lead of D2 and then connect the anode lead of D2 to the solder lug to which PL1, C4, cathode lead of LED2 and one output conductor tie together.

When you connect to the lugs on the terminal strip, be sure not to use any that are electrically connected to the strip's mounting tab(s).

As you install each component and solder it into place, it is a good idea to use a red pen to indicate what you did on the Fig. 3 illustration or a

photocopy of it. This reduces the possibility of wiring errors and shows you your progress. To make wiring even simpler, you might consider numbering the tie points on both the schematic diagram and the solder lugs.

Machining of the enclosure is quite simple. You need a separate 1/8-inch hole for each LED and suitably sized holes for mounting the switches and potentiometer on the plastic portion of the box. You also need an entry hole for the ac line cord entry and blanket cord exit. Arrange the holes for the potentiometer and switches in a pattern that you will readily recognize in the dark (see lead photo).

Mount the LEDs, potentiometer and switches in their respective holes. Secure the LEDs in place with clear fast-set epoxy cement or hot-melt glue. Then line the hole for the ac line cord and electric blanket cord with a rubber grommet.

Cut the blanket cable from the electromechanical controller that was originally supplied with the electric blanket. Separate the conductors at the cut end a distance of about 1 1/2 inches and trim from each about 1/4 inch of insulation. Tightly twist together the fine wires in each conductor and sparingly tin with solder. Prepare the free end of the ac line cord in the same manner.

Pass the free ends of both cords through the rubber grommet into the box and tie a knot in both about 4 to 5 inches from the ends inside the box to serve as a strain relief. Referring to Fig. 3, crimp but do not solder one ac line cord conductor to one lug of S1 and repeat for the other conductor and the tie point identified with the X in the circle at the bottom of the illustration. Then crimp but do not solder the output cable to one lug of S2 and the same tie point to which you crimped the second ac line cord conductor.

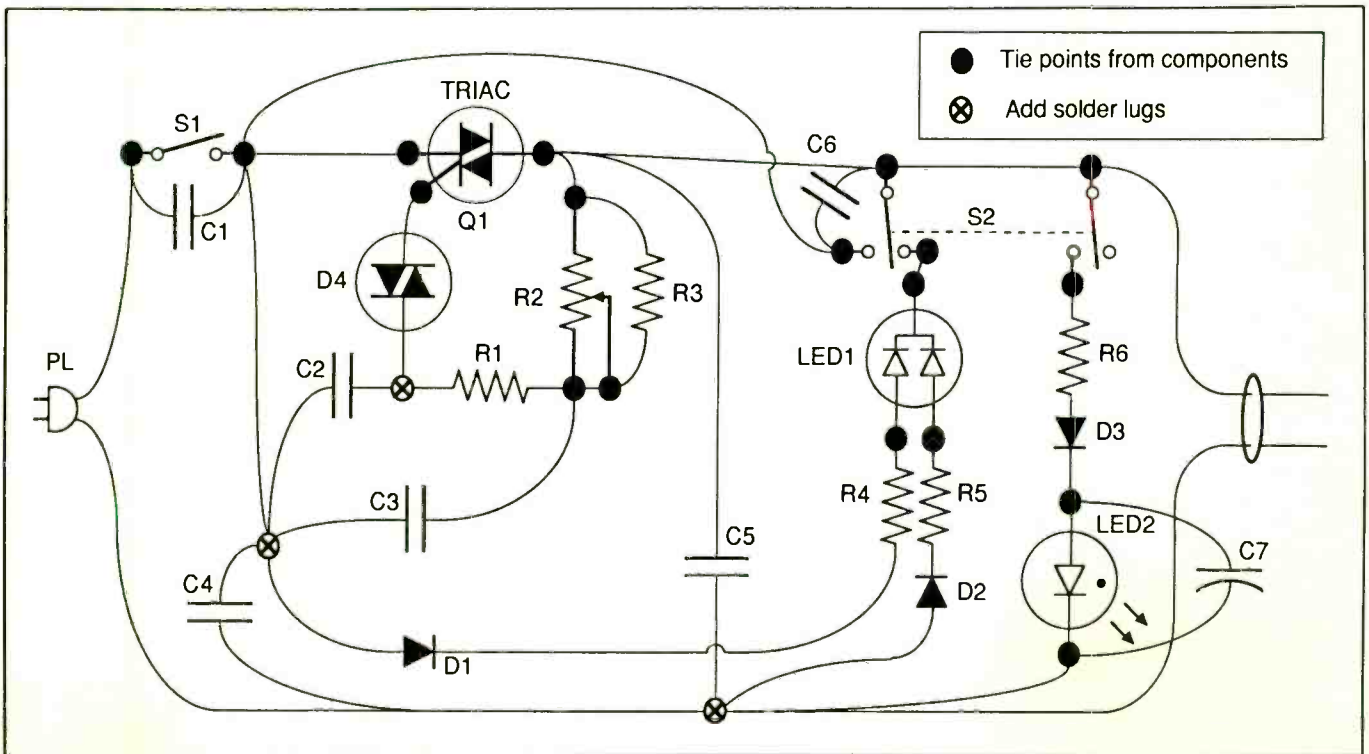

Fig. 3. The wiring guide for controller. Components are wired between each other's lugs/leads and a few added tie points, the latter indicated by Xs in circles.

How Phase Control Works

When controlling a large electrical device, it is more efficient to have it turned all the way on or all the way off, rather than in between. For the load to receive less than full power, the controlling circuit would have to dissipate the excess as heat. That would be inefficient. This is why high-power loads are controlled by rapidly switching them on and off. The average power the load receives can be any fraction of its full power, but at every instant it is either fully on or fully off.

A common and efficient way of controlling large ac loads is by means of phase control. Most phase-control circuits make use of the fact that ac already switches on and off twice in each cycle. To vary power, the circuits interrupt a selected part of each waveform and keep it from reaching the load. A typical output would show the ac waveform chopped into sections that are either fully on or fully off, as shown in Fig. 1 of the main article.

Switching is usually performed electronically, rather than electromechanically, with a triac whose gate pulse is derived in some way from the ac waveform itself. This assures that the control pulses are automatically synchronized with the power that is being switched on and off.

Shown in Fig. A is a phase-control circuit of the type commonly used in lamp dimmers and some motor speed controllers. There are two series RC phase-shift networks in this circuit: one made up of $R1$ and $C1$ and the other made up of $R2$ and $C2$.

When ac is applied to a series-connected resistor and capacitor, as in the two cases in this circuit, an ac voltage appears at the top of the capacitor. This ac voltage lags the applied voltage by a phase difference of from 0 to 90 degrees, depending on the setting of the potentiometer in the first RC network. If you could see both the applied ac voltage and the voltage across $C1$ on an oscilloscope, you would see the ac line voltage and, following it, a second delayed voltage.

With a 100,000-ohm potentiometer,

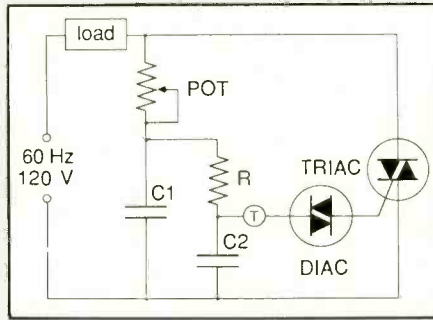

Fig. A. A full-wave phase-control circuit typically used in light dimmers and motor speed controllers.

the phase shift is variable from 0 at minimum setting (where the output is electrically connected to the input) to a maximum of about 75 degrees. The $R2/C2$ network extends the total phase shift range from 0 to 180 degrees at point T in Fig. B by varying the setting of the potentiometer. The phase-shifted signal at point T is used to trigger the triac that controls power to the load.

The diac in Fig. A is a two-way voltage threshold switch that is needed here because the gate sensitivity of a triac is not symmetrical. A diac's triggering

voltage is the same in both directions and is well in excess of the triggering voltage of the triac. Use of a diac makes the triac equally sensitive in both polarities of gate signals since the triac must wait for the diac to conduct before it fires. The diac used in the project described in the main article will conduct when 30 volts appears across its terminals in either direction.

In Fig. B, the point at which the voltage at T reaches ± 30 volts determines the point at which the triac begins to conduct power to the load. However, bear in mind that the voltage present at point T is the delayed sine wave. Relative to the main ac waveform, the time at which point T reaches 30 volts can be varied by the potentiometer in Fig. A. Consequently, the point where the triac begins to conduct can be varied to take place over a 0-to-180-degree range in the ac waveform. Once the triac triggers into conduction, it remains conducting until the zero-crossing point in each half-cycle is reached. Therefore, what the potentiometer is actually controlling is the interval during which the triac remains on. This interval is the amount of on time to off time and is responsible for the amount of power the load receives.

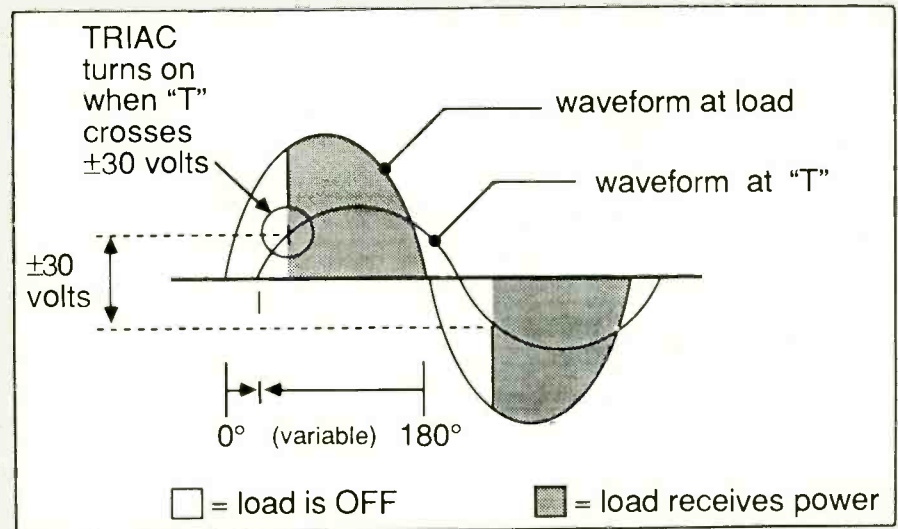

Fig. B. Large-excursion ac waveform is output to load; smaller-excursion waveform that appears at point T in Fig. A can be "moved" left or right by the potentiometer.

In the following procedure, hook-up-wire lengths are given for a small enclosure box. If you use a larger box, adjust the lengths as needed. Also, always trim all component lead lengths so that, when mounted, the components cannot sag and possibly cause unwanted short circuits. Wherever possible, use small-diameter heat-shrinkable tubing or plastic tubing to insulate bare wire leads and connections. In any case where a component's lead length is insufficient to bridge two points, you can lengthen the lead with insulated hookup wire. The best way to do this is to cut the component's lead to $\frac{1}{2}$ inch long and crimp and solder it to the hookup wire. Then insulate the connection with tubing.

Crimp the anode lead of *D2*, one lead of *C4* and *C5* and the cathode lead of *LED2* to the tie point to which you crimped the line cord and output cable conductors. Before soldering, heat sink *D2* and *LED2* and solder all six leads to the terminal strip solder lug.

Crimp the other lead of *C4*, a 3-inch insulated wire from which you have stripped $\frac{1}{4}$ inch of insulation from both ends, and one lead of *C2* and *C3* and the anode lead of *D1* to a second lug on the terminal strip. Heat sink the diodes and solder the four leads and one wire to the solder lug. Crimp the free end of the wire to the unoccupied lug of *S1*.

To the third and final lug on the terminal strip, crimp but do not solder the other lead of *C2* and one lead of *D4* and *R1*. Once again, heat sink the diac and solder all three leads to the lug.

After trimming them to appropriate length, if needed, crimp but do not solder the leads of *C1* to the lugs of *S1* and *C6* to the appropriate lugs of *S2*. Then interconnect the specified switch lugs by crimping an appropriate length of hookup wire as shown. Trim $\frac{1}{4}$ of insulation from both ends of a 3-inch hookup wire and crimp one end to the specified

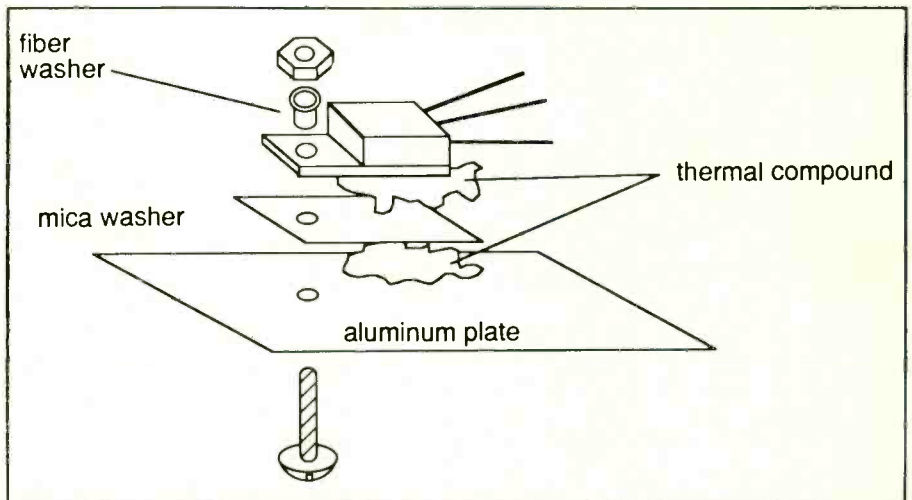

Fig. 4. The proper way to isolate the triac from the project box's metal faceplate heat sink.

lug of *S1* and solder the capacitor lead and all three wires to the lug.

Now crimp but do not solder a hookup wire to the specified outer lug on *R2*. Crimp the leads of *R3* and the free leads of *C3* and *R1* to the other outer lug of *R2*. Pass a bare solid wire from the lug to which *C3*, *R1* and *R3* are crimped to the center lug on the potentiometer. Solder the center-lug connection and trim away any excess wire length that might possibly short to the third lug. Then solder the two outer lug connections of *R2*.

Crimp one end of a 4-inch hookup wire to the toggle lug of *S2* to which *C6* is crimped. Pass a bare solid wire through both toggle lugs of *S2* and solder the connections at both lugs of the switch.

Carefully twist the leads of *C7* around those of *LED2* (observe polarity). Solder both connections. Then solder the cathode lead of *D3* to the junction of *C7* and anode lead of *LED2*. Solder the anode lead of *D3* to one lead of *R6* and crimp and solder the other lead of *R6* to the appropriate lug on *S2*.

Identify the anode lead for the green LED element in *LED1* and connect and solder to it one lead of *R4*. Do the same for the red LED ele-

ment and *R5*. Connect and solder the free leads of *R4* and *R5* to the cathode leads of *D1* and *D2*, respectively. Then crimp and solder the common cathode lead of *LED1* to the appropriate pole lug of *S2*.

Drill a hole for mounting triac *Q1* on the aluminum faceplate. When mounted, make sure that neither the triac nor its mounting hardware make electrical contact with the aluminum plate. To assure this, use thermal grease or paste and a mica washer between the triac and metal plate and an insulating shoulder fiber washer between the machine hardware and the triac's mounting tab, as illustrated in Fig. 4.

Once the triac is mounted into place, carefully connect and solder the free ends of wire coming from *S1* to *Q1*'s MT1 terminal. Use a 1-inch length of tubing to insulate the connection. Connect the free end of the wire coming from the potentiometer and the free lead of *C5* to the triac's MT2 terminal. Finally, connect and solder the free lead of *D4* to the GATE terminal of the triac, again using tubing to insulate the connection. This completes wiring the circuit. Place a control knob on the potentiometer.

Shown in Fig. 5 is a photo of the fully wired project inside a small

plastic project box that has an aluminum faceplate.

Checkout & Use

With the project completely wired and double checked for poor soldering and incorrectly connected or oriented components, particularly with regard to the triac, test it before putting it into service. To do this, you need an incandescent lamp to use as the load instead of the blanket itself. Using a lamp gives an immediate visual indication of circuit operation.

A convenient way to connect the lamp to the output of the project is to temporarily solder a zip cord terminated in an ac receptacle to one tog-

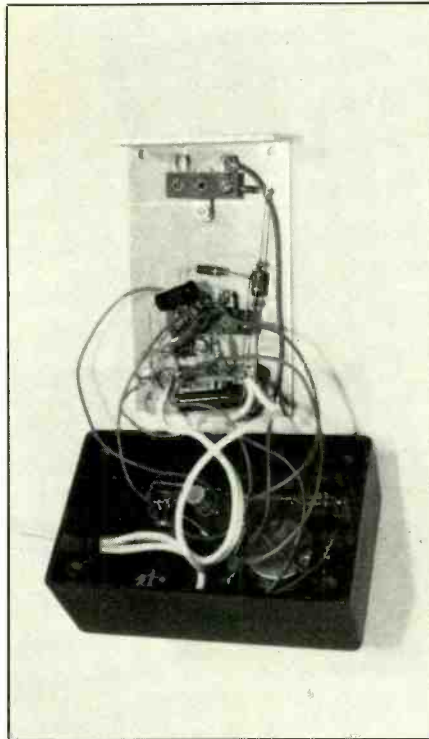

Fig. 5. Interior view of completed project.

ly, at full power, to all red. Simultaneously, the lamp should begin to glow and become brighter as the control is turned up. At full output power *LED1* should be glowing red and the lamp should be at full brightness.

Once you obtain the above results, the circuit is working properly. Unplug the project from the ac outlet and desolder the test cable from *S2* and the terminal strip lug. Finally, mount the aluminum faceplate on the box and fix to it four small anti-skid rubber feet. Label the switches, LEDs and control, as shown in the lead photo.

As mentioned previously, this controller is a direct replacement for the electromechanical controller originally supplied with your electric blanket. Once you have made the substitution, use your blanket as you normally would, controlling it with this project instead of its original unit. Lack of temperature cycling and silent operation will not be noticed, except by their absence, but other features can be appreciated more readily.

The FAST WARM function is useful on those cold days when you want to quickly warm your bed before getting into it. Set both switches to "on" about 5 minutes before you plan to retire to use this function.

Take care not to leave *S2* on too long, especially if your electric blanket is covered or folded. Even though all electric blankets come with built-in thermal cutoffs; and no fire hazard exists, too much heat is not good for the blanket's fabric.

Once your bed is warmed sufficiently in the FAST WARM mode, set *S2* to "off" and adjust the setting of HEAT control *R2* for a comfortable heat setting. Use two-color *LED1* as a guide to temperature setting. With a little experience, you will quickly come to know what setting is best for you simply by observing the color of the LED as you adjust the control setting.

ME

Order Back Issues of

**MODERN
ELECTRONICS**

FREE! New Catalog of Hard-To-Find Precision Tools



Jensen's new catalog is packed with more than 2000 quality items. Your single source for hard-to-find precision tools used by electronic technicians, scientists, engineers, schools, instrument mechanics, laboratories and government agencies. This popular catalog also contains Jensen's world-famous line of more than 40 tool kits. Send for your free copy today!

JENSEN TOOLS INC.

7815 S. 46th St., Phoenix, AZ 85044
(602) 968-6241 TWX 910-950-0115

CIRCLE 47 ON FREE INFORMATION CARD

gle lug of *S2* and the terminal strip lug to which one conductor of the ac line cord is connected. Plug the lamp's cord into the ac receptacle. Then turn on the lamp and make sure *S1* and *S2* are set to "off" and *R2* is set for minimum output. Plug the project's line cord into an ac outlet; neither LED should be on.

Setting POWER switch *S1* to "on" should cause *LED1* to glow green. If this occurs, setting FAST WARM switch *S2* to "on" should cause *LED2* to light and flash and the lamp to turn on at full brilliance. If you do not obtain these results, power down the project and recheck all wiring. Do not proceed until you have corrected the problem.

With *S1* on and *S2* off and *R2* set for minimum output, *LED1* should be glowing green and the incandescent lamp should be off. Slowly adjusting the setting of *R2* toward full output should cause *LED1* to change color to first yellow, then orange and final-

Surface-Mount-Device Repair

How to remove flat-packaged SMDs using soldering tools

By Victor Meeldijk

In a manufacturing facility, replacement of surface-mount integrated circuits, such as the 80-pin flat package pictured, would be accomplished with either a conduction soldering iron, which heats all soldered connections at once and lifts the part up with its tong-like tips, or a convection soldering machine. The convection uses low-pressure hot air directed at both the top of the component and the circuit card's underside. When all connections are molten, the device is lifted off the pc board using tweezer tongs.

While these are rapid and efficient methods for production work, such repairs can be accomplished using common soldering tools for occasional SMD removal.

(Continued on page 90)

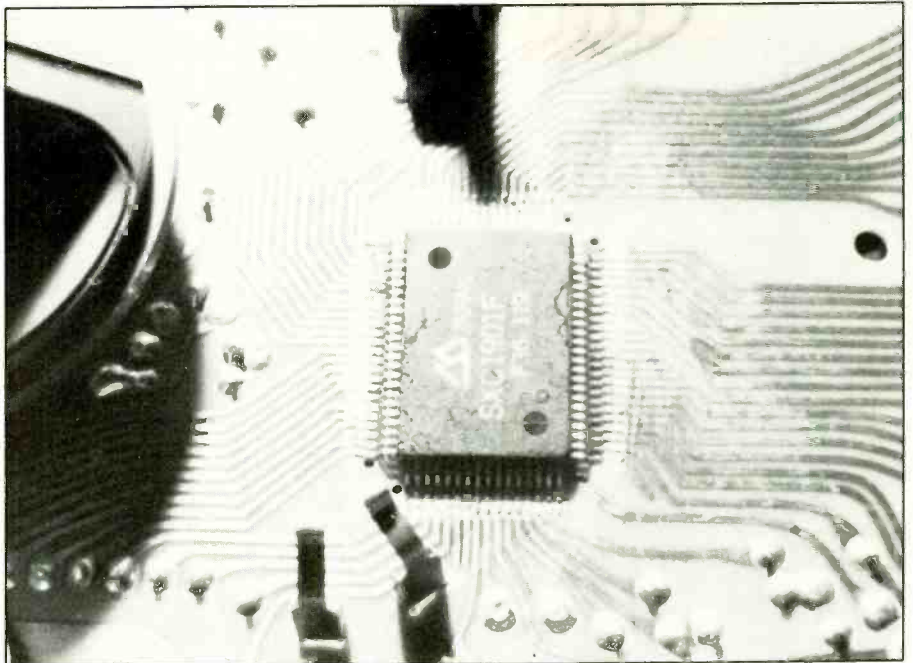

An 80-pin surface-mount flat package device to be replaced.

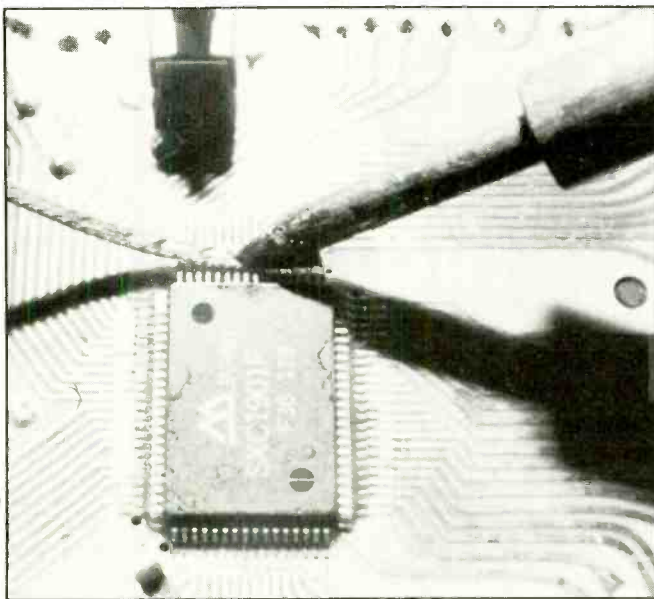

Use desoldering braid to remove solder from all device connections. Be sure to employ a grounded soldering iron and wear an ESD wrist strap while doing such work to prevent electrostatic damage to the IC.

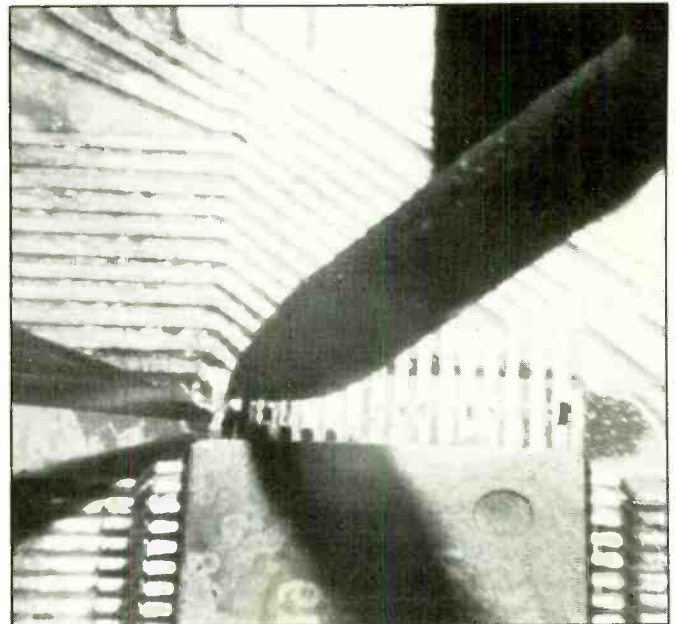

While heating IC connections with a soldering iron (left), free them from the circuit card by using a sharp-pointed hobby knife.

An In-Circuit Transistor Tester

A low-cost bench/portable instrument for testing bipolar transistors in- and out-of-circuit

By Jules H. Gilder

Even if you have good electronic troubleshooting skills and can zero in on a defective circuit section, you are still faced with confirming your suspicion that a transistor is bad. To do this, you will likely have to remove the device from a crowded area and test it with either a transistor tester or an ohmmeter. If your guess proves wrong, you will have to solder the device to the printed-circuit board land, risking excessive-heat damage to the transistor and possibly to the pc foil . . . then repeat the process with another suspect.

A much better way to troubleshoot transistorized circuits is provided by an *in-circuit* transistor tester, which eliminates the foregoing problems and saves a lot of time and frustration. You can build the one to be described for about \$25 or less, including the enclosure. It is worth its weight in gold.

Our In-Circuit Transistor Tester's test clips make it easy to connect it directly to the leads of any bipolar transistor, even if the transistor is on a densely packed pc-board assembly. Using a pair of light-emitting diodes, one each for npn and pnp transistors, the Tester indicates when a suspect transistor is good or bad and simultaneously identifies it by type. If either LED lights, the transistor is good. On the other hand, if the two



LEDs alternately flash or do not flash at all during a test, the transistor is bad.

About the Circuit

Shown in Fig. 1 is the complete schematic diagram of the In-Circuit Transistor Tester. Its simple, straightforward design makes use of a single CMOS NAND-gate Schmitt trigger

integrated circuit, identified as *IC1*. This 4093 IC is a bistable device that does not respond directly to an input signal. Rather, its snap action response, known as "hysteresis," creates a dead band that is useful for cleaning up slow and noisy digital signals.

The dead band is the result of the fact that a Schmitt trigger's input

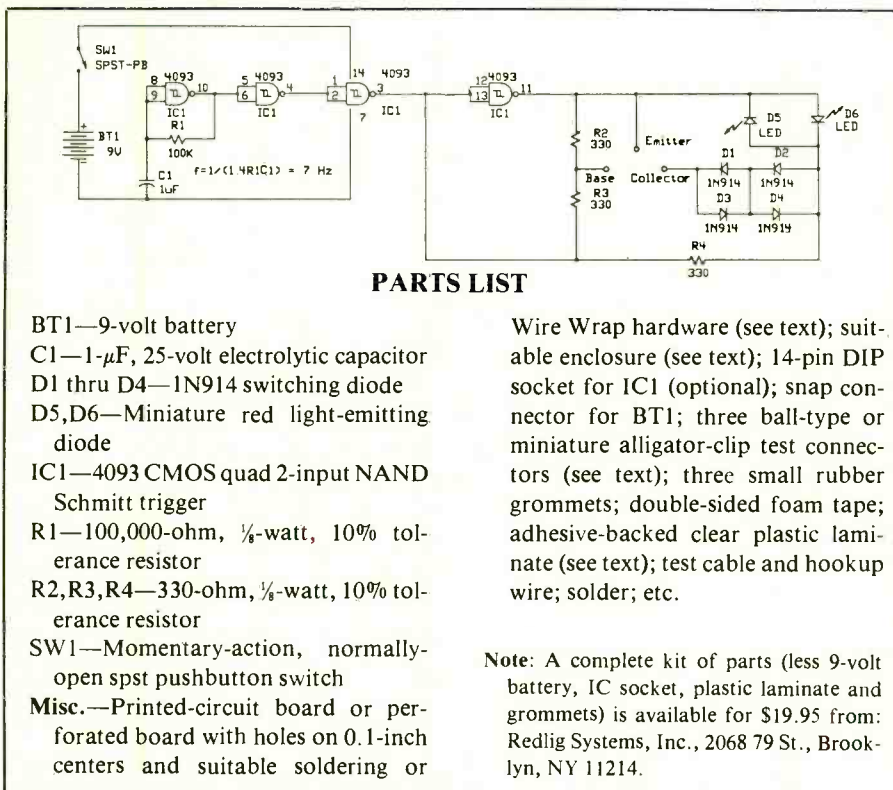

Fig. 1. Complete schematic diagram of In-Circuit Transistor Tester.

voltage must rise above a certain level, known as the high trip point, before the output voltage can change. Similarly, the input voltage must drop below a certain level, which is lower than the high trip point, before the output can change once again. Any change that occurs within the dead band itself has no effect on the output.

Built-in hysteresis makes it possible to design and build an astable oscillator with just a single gate, as shown for the gate at the left, capacitor *C1* and resistor *R1* in Fig. 1. Frequency of oscillation is calculated using the formula $f = 1/(1.4RC)$. With the component values shown in the schematic diagram and specified in the Parts List for *R1* and *C1*, oscillator frequency is approximately 7 Hz.

All remaining gates in *IC1* are used simply for inversion and buffering. The first of these gates following the oscillator isolates the latter from the

rest of the circuit to prevent frequency drift as a result of loading. The remaining two gates are used to produce the complementary outputs needed to enable testing of both npn and pnp transistors.

Note that both inputs of each of the four gates that make up *IC1* are tied together. This is done because only the Schmitt trigger inversion—not the normal NAND—function is required in this project. Although a 4584 hex inverter Schmitt trigger could have been used to accomplish the same results, a 4093 (with the circuit modifications shown) is much more readily available from consumer sources.

The complementary outputs produced by the final two gates in *IC1* are connected to light-emitting diodes *D5* and *D6* through current-limiting resistor *R4*. Only one current-limiting resistor is needed in this arrangement because only one of the

LEDs will normally be on at any given time.

The LEDs are connected in a reverse condition that is often referred to as anti-parallel. That is, the anode of one is connected to the cathode of the other and the remaining two leads are tied together. With this arrangement, when a logic high voltage appears at pin 11 of *IC1* and the voltage at pin 3 is at a logic low voltage, *D5* is held in reverse bias while *D6* conducts and the LED lights. With no transistor connected to the circuit, the outputs at pins 3 and 11 of *IC1* change at a frequency of about 7 Hz, allowing the LEDs to blink on and off alternately.

In addition to being connected to the LEDs, the complementary outputs at pins 3 and 11 of *IC1* are applied to the resistor network composed of *R2* and *R3*. The junction of these two resistors is brought out as a test point and is connected to the base of the transistor under test. The emitter of the transistor connects directly to pin 11 of *IC1*, while the collector connects to the *D1* through *D4* parallel diode arrangement and *D5* and *D6* anti-parallel LED arrangement.

An important purpose is served by the strange diode arrangement. When a transistor under test has an internal short circuit between its collector-base or base-emitter junctions, the good half of the transistor acts like an ordinary diode and will normally conduct and indicate a "good" transistor. When either *D1* and *D2* or *D3* and *D4* are conducting, a drop of about 1.2 volts appears across the operating pair. This voltage adds to the voltage dropped across the transistor being tested. If the transistor is good, the drop will be about 0.1 volt, and the total drop across the LEDs will be 1.3 volts for the half cycle that the transistor is conducting.

On the other hand, if the transistor being tested has a base-emitter or base-collector short, the 1.2-volt drop across the diodes adds to an-

other 0.6-volt drop across the bad transistor to produce a drop of 1.8 volts. This is enough to turn on the LED. Therefore, internal short circuits will cause both LEDs to alternately flash.

Construction

Because the circuitry for this project is very simple, just about any wiring technique can be used to build the project. For example, you can etch and drill your own printed-circuit board using the actual-size etching-and-drilling guide shown in Fig. 2 (or purchase a complete kit of parts that contains a ready-to-wire board from the source given in the Note at the end of the Parts List). Alternatively, you can assemble the circuit on perforated board with holes on 0.1-inch centers using suitable soldering or Wire Wrap hardware. The following describes pc construction.

With the pc board component side up and oriented as shown in Fig. 3, start populating it by installing and soldering into place a 14-pin DIP IC socket in the IC1 location. Be careful to avoid creating solder bridges between the closely spaced copper pads on the bottom of the board. (Note: A socket is optional but highly recommended should the 4093 IC ever have to be replaced. If you do not use a socket for this IC, do *not* install the 4093 itself at this stage of construction.)

Next, install diodes *D1* through *D4* on the lower left of the board, taking care to properly orient each. Then flip over the board and solder all leads to the copper pads.

Install and solder into place the resistors, once again clipping off excess lead lengths. Making sure to properly polarize the electrolytic capacitor as shown, plug its leads into the specified holes in the board.

Prepare three 18-inch lengths of miniature test-lead wire by stripping from both ends of each ¼ inch of insulation. Tightly twist together the

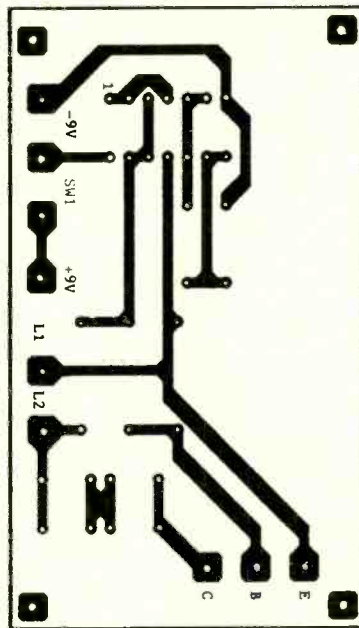

Fig. 2. Actual-size etching-and-drilling guide for fabricating printed-circuit boards.

fine wires at both ends of each wire and sparingly tin with solder. Plug one end of these wires into the holes labeled E, B and C in the upper-left of the board and solder into place.

Prepare four 6-inch lengths of hookup wire as you did for the test-lead wires and plug these into the holes labeled L1, L2 and SW1. Crimp the anode lead of one LED to the cathode lead of the other and then crimp together the remaining two LED leads. Solder the crimped con-

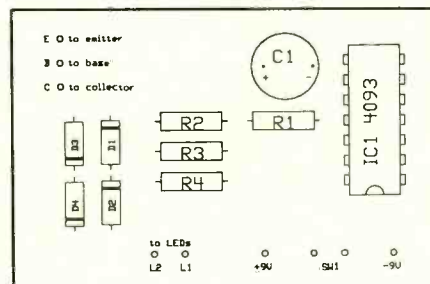

Fig. 3. Wiring guide for pc board. Use this layout as a general guide to component placement if you build circuit on perforated board.

nections, making sure to use soldering heat judiciously, and heat sink the LEDs to prevent heat damage.

Connect and solder the LED connections to the free ends of the L1 and L2 wires. Then connect and solder the free ends of the SW1 wires to the lugs of the normally-open spst pushbutton switch.

Tightly twist together the fine wires of both conductors of the 9-volt battery snap connector and sparingly tin with solder. Plug the red-insulated wire into the hole labeled +9V and the black-insulated wire into the hole labeled -9V.

You can use any suitably sized project box as an enclosure for the project. An ideal enclosure to use is a project box that has an aluminum front panel and measures 5 inches long by 2.5 inches wide by 1.5 inches deep. Only the front panel requires machining to prepare it for housing the project.

If possible, make a same-size photocopy of the actual-size artwork shown in Fig. 4 to use as a machining template for the project's front panel. Trim the photocopy to the outline border and tape it to the front panel. Using a center punch or sharp nail, gently detent the metal panel in the locations indicated by the six dots to prepare it for drilling the holes for the LEDs, switch and exits for the test leads.

Remove the template and use a 1/16-inch bit to drill the hole for the switch and test leads. Then use a 1/8-inch bit to drill the holes for the LEDs. Deburr all holes to remove sharp edges.

You can use either the actual artwork shown in Fig. 4 or a photocopy of it as a finished front panel for the project. The latter is recommended, since you will avoid any possibility of print on the opposite surface of the paper from "bleeding" through when the artwork is mounted to the panel.

Trim the artwork to about ¼ inch wider and longer than shown. Then

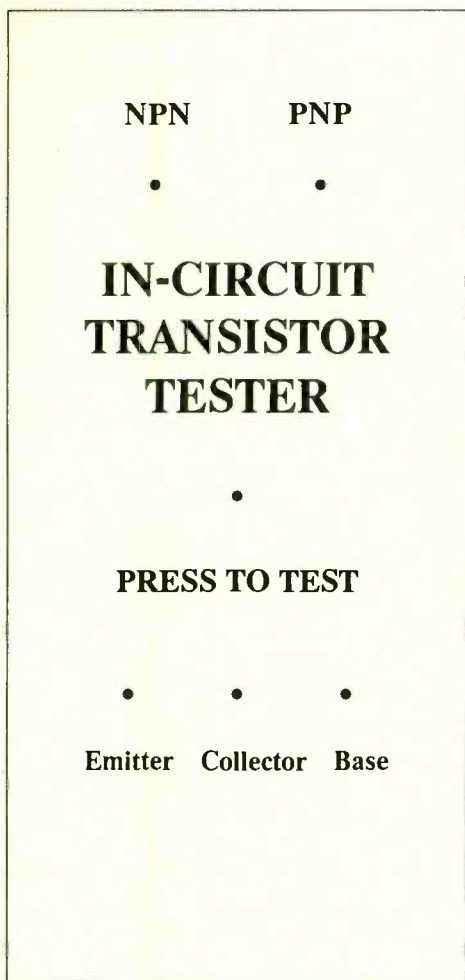

Fig. 4. Actual-size front-panel artwork. Use this or a same-size photocopy also as a machining template for front panel of project box.

face it with clear adhesive-backed plastic laminate (available from photographic, art-supply and most stationery stores) to protect it from damage as you use the project. Work carefully to avoid wrinkling the artwork as you lay on it the plastic laminate. After the laminate is completely down on the artwork, place the assembly laminate side up and solidly burnish it to the paper. Then trim the artwork to the exact dimensions of the metal front panel plate.

Coat the rear surface of the artwork and outer surface of the front panel with rubber cement and allow both to dry until they are tacky to the

touch. Then very carefully place the artwork on the panel, starting from one corner. Once again, burnish the artwork to the panel.

Working *very* carefully with a sharp hobby knife, cut the artwork away from all holes. Work on the *artwork* side of the panel as you do this and be as neat as you possibly can. Gently work small rubber grommets into the EMITTER, COLLECTOR and BASE holes in the front panel from the artwork side to avoid lifting the artwork. Then mount the pushbutton switch in its hole in the center of the panel.

Tie a strain-relieving knot in each of the test-lead wires about 5 inches from the circuit-board end. Pass the free ends of these wires through the appropriate grommet-lined holes in the panel. Refer to both Fig. 3 and Fig. 4 to identify the test leads and the holes they are to exit the box.

You have a choice of either ball-type connectors like those shown in the lead photo or ordinary miniature alligator clips with insulated boots for terminating the test leads. The ball-type connectors are preferable because they provide more positive electrical contact and a more solid mechanical grip and present very little bare metal to short against points in a circuit that should not enter into a test.

Checkout & Use

Snap a fresh 9-volt battery onto the connector. Touch the common lead of a dc voltmeter, set to indicate at least 10 volts, to the pin 7 connector and the "hot" lead to the pin 14 connector of *ICI*'s socket. Press the switch's pushbutton and note the reading on the meter. If you do not obtain a reading of approximately 9 volts, release the switch and carefully check all components for proper orientations (diodes, LEDs and electrolytic capacitor) and all soldering for bridges and poor connections. Correct the problem before proceeding.

Once you obtain the proper 9-volt dc reading between pins 14 and 7 of the IC socket, release the switch's pushbutton and install the 4093 in the IC socket. Make sure you orient the IC as shown and take care to avoid having any pins overhang the socket or fold under between socket and IC body as you push the 4093 home. Exercise the usual precautions for MOS devices when handling the IC. If you are soldering the IC directly on the board, use a soldering iron with a grounded tip.

With the IC installed, press and hold down the switch's pushbutton and observe the activity of the LEDs. If everything is working properly, the two LEDs will alternately flash on and off. If both LEDs flash in step with each other, the two are not properly connected in anti-parallel with each other. In this event, power down the circuit and transpose the leads of one LED. If neither LED flashes, you have an error in construction and must recheck your wiring to correct the problem.

Having obtained proper flashing, release the switch's pushbutton and connect to the test leads a good transistor (you can use either a pnp or an npn transistor). Once again, press and hold the switch's pushbutton and note which LED lights. Mount this LED in the appropriate hole in the front panel of the enclosure. That is, if you are using an npn transistor for this test, the LED that lights goes into the NPN hole in the panel. The other LED then goes in the remaining LED hole. If the LEDs tend to fall out of their holes, secure them in place with either clear nail enamel or fast-set epoxy cement.

Cut a piece of double-sided foam tape to the approximate length and width of the the circuit-board assembly and another to the approximate length and depth of the 9-volt battery. Peel the protective backing from one side of the larger piece of foam tape and affix the tape to the

(Continued on page 90)



CTM

The magazine for Computerist & Amateur Radio
Your #1 source of Packet info.

... received my moneys worth with just one issue ...
—J. Trenbick

... always stop to read CTM, even though most other magazines I receive (and write for) only get cursory examination ...
—Fred Blechman, K6UGT

U.S.A.	\$18.00 for 1 year
Mexico, Canada	\$32.00
Foreign	\$43.00 (land) - \$68.00 (air)
(U.S. funds only)	
Permanent (U.S. Subscription)	\$150.00
Sample Copy	\$3.50

CHET LAMBERT, W4WDR
1704 Sam Drive • Birmingham, AL 35235
(205) 854-0271

CIRCLE 11 ON FREE INFORMATION CARD

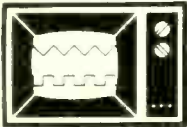

FINALLY!

An interesting and worthwhile project. This EASY-TO-BUILD circuit lets you use any regular TV set as a simple OSCILLOSCOPE. Build for less than \$10. NO MODIFICATIONS TO TV! Single or dual trace. Send for FREE CATALOG of other plans and kits.

DETAILED PLANS: \$4.95

TV-SCOPE

PENN RESEARCH, Box 3543
Williamsport, PA 17701

Be an FCC LICENSED ELECTRONIC TECHNICIAN!



Earn up to \$30 an hour and more!

Learn at home in spare time. No previous experience needed!

No costly school. No commuting to class. The Original Home-Study course prepares you for the "FCC Commercial Radiotelephone License". This valuable license is your "ticket" to thousands of exciting jobs in Communications, Radio-TV, Microwave, Computers, Radar, Avionics and more! You don't need a college degree to qualify, but you do need an FCC License.

No Need to Quit Your Job or Go To School
This proven course is easy, fast and low cost! **GUARANTEED PASS** - You get your FCC License or money refunded. Send for **FREE facts now. MAIL COUPON TODAY!**

COMMAND PRODUCTIONS
FCC LICENSE TRAINING, Dept. 220
P.O. Box 2223, San Francisco, CA 94126

Please rush **FREE** details immediately!

NAME _____
ADDRESS _____
CITY _____ STATE _____ ZIP _____

BOOKS

How to Build Your Own IBM PC-Compatible Computer by Gordon McComb. (Comprehensive Guides, 7507 Oakdale Ave., Canoga Park, CA 91306. Soft cover. 106 pages. \$12.95.)

Written to guide the person who wants to assemble an IBM PC compatible computer, this book provides general details needed to do the job. Coverage begins with an introduction to PC technology and the hardware that makes up a true PC clone. The author then discusses where to buy clone parts and subsystems, and three levels of PC clones (a starter system, a basic business system and an enhanced business system). Assembly of the components that make up each is detailed step by step so that even someone with no knowledge of electronics or computers will understand how to put together the system of his choice. Following assembly comes testing of the system and installation of add-ons.

There are no photos in the book. Instead, an array of drawings guide the reader through assembly, setup and testing. Frankly, the drawings are easier to follow and less prone to lead the reader to interpretation errors than is the case with photos.

Despite a handful of typographical errors (none of a nature to cause problems), this is a worthwhile book to have if you are seriously considering putting together a PC-compatible computer. Its appendices provide such important technical details as specifications, connector pinouts, installation of a hard disk, troubleshooting charts, using the turbo motherboard and, always important, schematic diagrams.

The Benchtop Electronics Reference Manual by Victor F.C. Veley. (Tab Books. 620 pages. \$34.95 hard cover, \$24.95 soft cover.)

Handbooks like this one are always popular among electronics technicians and hobbyists alike because they provide a one-stop source of valuable information on a wide variety of topics. Though this book is encyclopedic in nature, it is by no means arranged in dictionary-like fashion. Rather, it is written more along the lines of a traditional textbook, with explanatory text, lucid illustrations, schematic diagrams and a host of mathematical formulas. The contents are of a fairly technical nature instead of being a

simple overview, as is the case with many such books.

Divided into five parts, the book contains 160 topic chapters on direct current, alternating current solid-state devices and circuits, vacuum tubes and circuits and radio communications. Succeeding chapters build upon the material presented in previous chapters. Each chapter contains a brief but fairly complete description of the material to be covered. Wherever applicable, mathematical derivations are provided. At the end of each chapter there are one or more examples that show how the material covered is put to practical use, using real component values. This makes possible using the manual for laboratory experiments. Following each example is a detailed solution that reinforces the point or points being made.

Though basic solid-state devices and circuits are covered, vacuum-tube circuits, still a part of the radio communications scene, are discussed in more detail than usual. In fact, taking all the communications topics together, this book covers most of the requirements for the FCC Commercial General Radiotelephone Operator's License. The book concludes with eight appendices, all of which supplement the material presented in the communications section. In all, this thick book (it measures almost 2 inches between its covers) deserves a prominent place on your bookshelf.

NEW LITERATURE

Instruments/Accessories Catalog. An all new 164-page catalog that lists and describes some 2,000 items of interest to electronics enthusiasts and professionals is available from Fordham Radio. Among the items listed are: test instruments and accessories; CATV, CCTV and MATV equipment and accessories; tools and assembly aids; CB radios, car stereos and auto accessories; replacement components; security devices; video equipment and accessories; radar detectors; and an assortment of consumer electronic and entertainment products. All items listed are illustrated and fully described with specifications and applications data and show discount pricing. For a free copy, write to: Fordham Radio, 260 Motor Parkway, Dept. ME, Hauppauge, NY 11788.

LETTERS...

(from page 7)

Test Equipment Catalog. A new catalog that lists and describes new and custom-reconditioned electronic test instruments available at savings of up to 70 percent has been announced by Accutest Instruments. Listed are a wide range of models of ac and dc power supplies, recorders, plotters, X-Y recorders, oscillators, pulse and function generators, oscilloscopes, component testers, calibration instruments, r-f and microwave sources and accessories, counters, timers, line conditioners, logic and spectrum analyzers, DVMs, analog meters and environmental chambers. Products from most major manufacturers are represented. For a free copy, write to: Accutest Instruments, Inc., P.O. Box 130, Rte. 526, Clarksburg, NJ 08510.

Cellular Telephones Antenna Catalog. ORA Electronics' new catalog contains listings for more than 20 different models of cellular telephone antennas. Included in the catalog are listings for through-glass, disguise, motorized, 3-dB gain and 5-dB gain antennas for a variety of applications. Special-purpose antennas for marine and briefcase applications are also listed, as are control head mounting kits, antenna mounts, a signaling horn, tools, connectors and cable. Provided are complete performance specifications, applications information, descriptive text and a photo for each antenna listed. For a copy, write to: ORA Electronics, 20120 Plummer St., P.O. Box 4029, Chatsworth, CA 91313.

Ceramic Filter Catalog. A new selection guide to ceramic filters that takes the mystery out of emi filter specification is available from Sprague. Descriptions of circuit configurations and functions, with a filter selection flow chart, installation guidelines, definitions of terms, and a look at military test procedures make it possible for a reader to make an informed choice for almost any application. The catalog is divided into dc rated and ac/dc rated sections. Subcategories are defined by circuit configuration (function). Within each general circuit category, devices are shown in order of current rating and then voltage rating. For a copy of Ceramic Emi/Rfi Filters Catalog No. FD-129, write to: Sprague Electric Co., Technical Literature Service, P.O. Box 9102, Mansfield, MA 02048-9102.

Which is correct? Shouldn't the resistor symbol shown for C2 in the schematic be a capacitor symbol? Also, where does C7 go in the schematic?

Jerry A. Phelps
Louisville, KY

The correct value for C1 and C2 is 0.1 μ F. You're right about the capacitor symbol for C2. Omit C7 from the Parts List; it was a typographical error.—Ed.

• Please make the following corrections to "A Delayed-Trigger Accessory for Oscilloscopes" (January 1988). On page 22, the first paragraph under "Checkout & Use" should read: "Then touch the 'hot' meter lead to pin 8 of the IC1 socket, pin 14 of the IC2 socket and pin 16 of the IC3 socket . . . Touching the hot lead to pin 4 of the IC1 socket should yield a reading

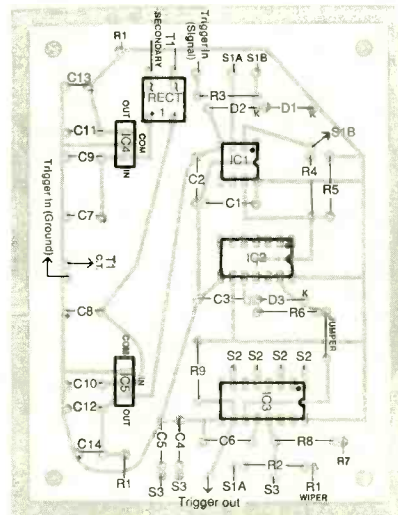

of -15 volts." Turn the page upside-down for correct orientation of the photos in Fig. 1. The trace in (A), now lower-right, is triggered on the rising edge of the square pulse. The manufacturer of the ICM7250 chip is Intersil. Finally, use the corrected wiring diagram shown here instead of the one shown in Fig. 6.

Jan Axelson

• In Fig. 1 of "A miniature LED Beacon" (January 1988), the internal connections going to pins 8 and 2 of the LM3909 should be reversed.

Dan Becker

• To avoid any confusion, please transpose the illustrations (not the captions) for Figs. 3 and 4 in "Choosing Op Amps for Specific Applications" (November 1987).

Charles R. Fischer

Put Professional Knowledge and a COLLEGE DEGREE in your Technical Career through HOME STUDY

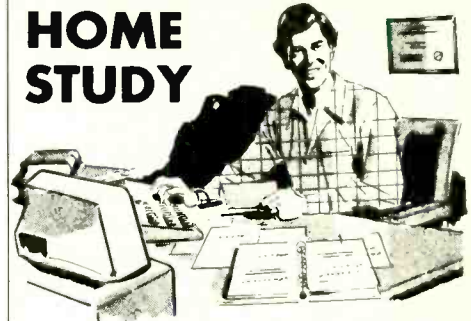

Add prestige and earning power to your technical career by earning your Associate or Bachelor degree through directed home study.

No commuting to class. Study at your own pace, while continuing on your present job. Learn from easy-to-understand lessons, with help from your Grantham instructors when you need it.

Grantham College of Engineering is a specialized institution catering to adults who are employed in electronics and allied fields such as computers. These fields are so enormous that opportunity to *move up* is always present. Promotions and natural turn-over make desirable positions available.

An important part of being prepared to *move up* is holding the proper college degree, but the essential part is *really knowing your field*. Grantham offers two B.S. degree programs — one with major emphasis in *electronics* and the other with major emphasis in *computers*. Both programs are offered by correspondence.

Write for our free catalog (see address below) or telephone us at (213) 493-4421 (no collect calls) and ask for our "degree catalog."

Accredited by
the Accrediting Commission of the
National Home Study Council

GRANTHAM
College of Engineering
10570 Humbolt Street
Los Alamitos, CA 90720

Experimenting With a Superconductor

By Forrest M. Mims III

The Nobel prize for physics is generally awarded years after an important discovery is announced. However, in 1987, the prestigious prize was awarded only a year after its two recipients announced the development of a remarkable new kind of superconductor. Equally remarkable is that low-cost samples of this new kind of superconductor have been available from several sources since the fall of 1987. This means that anyone can now experiment with what many people are calling one of the most significant discoveries of this century.

I have recently experimented with a disc of superconducting material. I will describe some of my observations later. Let's first explore the background of the momentous discoveries that led to the 1987 Nobel prize in physics.

Traditional Superconductors

A superconductor is a substance that possesses absolutely no resistance to the flow of electrons. A current induced in a coil of superconducting wire will continue to flow even after the power source has been removed. This property makes possible several important applications. For instance, electromagnets made from superconducting wire are substantially more powerful than conventional electromagnets. A junction of two superconductive materials, called a Josephson junction, is among the fastest of all switches.

Other applications for superconductors include levitated trains, highly efficient motors and zero-resistance long-distance power transmission lines and telecommunications links. Unfortunately, however, present superconductors are not suitable for these and a host of other fascinating applications since they do not exhibit superconductivity unless they are first cooled to very low temperatures.

This brings us back to the 1987 Nobel prize for physics. Prior to 1986, the best superconductors had to be cooled down to around 30 degrees above absolute zero (30 degrees Kelvin) in order for them to

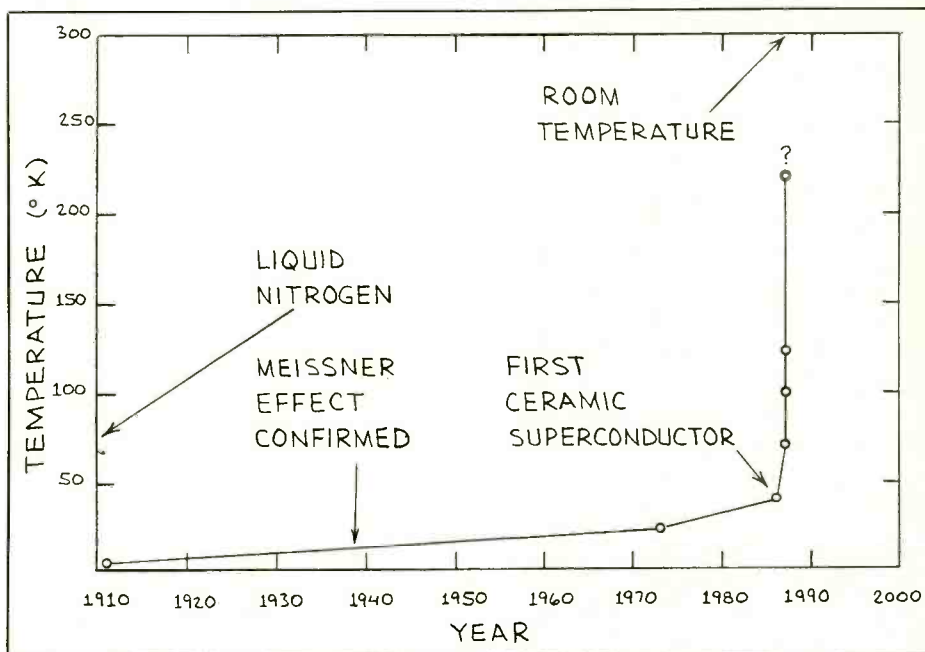

Fig. 1. Major advances in superconductivity.

exhibit superconductivity. This was not a significant improvement over the state of the art in 1911 when Dutch physicist Kamerlingh Onnes first discovered superconductivity in mercury. When Onnes cooled a sample of mercury to the temperature of liquid helium (about 4 degrees Kelvin), he was amazed to find that the resistance of the mercury suddenly fell to zero. He later coined the word "superconductivity" to explain this previously unknown phenomenon.

Superconductivity was later discovered in lead, zinc, aluminum, tin and other metals and a variety of metal alloys. Applications for superconductors, however, remained limited due to the requirement that they be cooled with liquid helium by specialized cryogenic refrigerators. Besides being difficult to produce and rather expensive, liquid helium is tricky to store and use. Cryogenic refrigerators are expensive and have limited cooling capacity.

Ceramic Superconductors

Because of their enormous potential, a few scientists have stubbornly attempted

to devise materials that would exhibit superconductivity at warmer temperatures, especially at the temperature of liquid nitrogen (77 degrees Kelvin) and above. Most scientists were skeptical that superconductivity would ever be achieved at warmer temperatures. But in 1986, K. Alex Muller, a physicist at an IBM research facility in Zurich, Switzerland, startled even the skeptics when he and J. Georg Bednorz announced the discovery of superconductivity in a ceramic compounded of various metallic oxides. It was necessary to cool the new material to 35 degrees Kelvin before it would exhibit superconductivity. But even that frigid temperature was 12 degrees Kelvin warmer than the highest temperature achieved with previous metallic materials.

In April 1986, Muller and Bednorz submitted a paper that summarized their results to a physics journal. When the paper was published in September 1986, it was generally viewed with skepticism. But Ching Wu "Paul" Chu at the University of Houston and a team of Japanese scientists soon duplicated Muller's and Bednorz's feat. When the Japanese team reported its results at a meeting of

the Materials Research Society in Boston, those in attendance quickly realized that Muller and Bednorz had indeed made a momentous discovery.

What followed over the next few months can only be described as near-pandemonium. Normally conservative, staid physicists rushed back to their laboratories to begin concocting metallic-oxide ceramics.

Duplicating Muller's and Bednorz's results was surprisingly easy to do. The ingredients were simply ground together using a mortar and pestle and then were fired in a furnace. Thanks to the simplicity of this procedure, over the next six months more progress was made in superconductor technology than in the previous 75 years.

At first, most researchers used Muller's and Bednorz's ingredients. Then, after achieving superconductivity, they modified their recipes and increased the temperature at which superconductivity could be achieved. By the end of January 1987, Chu's group at the University of Houston achieved superconductivity at more than 90 degrees Kelvin, which is well above the temperature of liquid nitrogen (77 degrees Kelvin).

The frantic pace of new superconductor developments caused organizers of the American Physical Society to add a special session on the subject at their annual meeting. On March 18, some 1,800 people jammed the 1,200-seat ballroom at New York City's Hilton Hotel. A few thousand more watched the proceedings via closed-circuit television.

Normally, scientific papers are received with a few yawns at worst and polite applause at best. Those in attendance at the APS special session, however, cheered, laughed and applauded as they listened to the papers being presented. The session, which ended at 3:00 a.m., lasted some eight hours. It was so unusual that *Science* called it a "happening." A cover story in *Time* quoted Bell Labs physicist Michael Schluter as describing the meeting as the "Woodstock of physics."

Figure 1 graphically illustrates the pace of developments in superconductivity. Even if the present trend slows down,

eventual development of room-temperature superconductors appears to be a distinct possibility.

Applications for New Superconductors

Liquid nitrogen is much easier to use and costs only a 50th of the price of liquid helium. Therefore, until room-temperature superconductors become available, materials that exhibit superconductivity at the temperature of liquid nitrogen can be used in many practical applications. The ultimate goal, of course, is superconductors that operate at room temperature and even above. Already, several scientists and research laboratories have reported tantalizing evidence of superconductivity at and even above room temperature. In the meantime, here are some of the applications that will greatly benefit from availability of materials that become superconductors at or above the temperature of liquid nitrogen:

- **Communications.** In theory, a superconducting wire can carry a modulated signal with zero loss. While preparing this column, it occurred to me that a steady current through a superconducting wire can be digitally and possibly analog modulated by applying an external magnetic field anywhere along the length of the wire. This is because a superconductor begins to exhibit resistance in the presence of a sufficiently strong magnetic field. While this capability makes possible new modulation methods, it also means that the signal carried over a superconducting wire can be jammed by applying a sufficiently great magnetic field anywhere along its length.

- **Power Transmission.** Conventional high-voltage transmission lines typically lose 20 percent of their power to electrical resistance and leakage to ground. A superconductive transmission line could, in theory, reduce this loss to near zero. Besides reducing the cost of electricity, power plants could be located farther away from metropolitan areas.

- **Electronics.** Superconducting Josephson junctions can switch an electrical signal in 1 picosecond. This is some 10 times

faster than the best conventional electronic switches. Hypress, Inc., an IBM spinoff, uses Josephson-junction arrays to make the PSP-1000, the world's fastest oscilloscope and signal processor. The PSP-1000 can display a signal that has a risetime of only 5 picoseconds, making it useful in radar and lightwave communications.

- **Transportation.** The levitated train has long been the dream of transportation engineers. Japanese National Railways has tested a prototype train that floats on the magnetic field generated by magnets wound with conventional superconducting wire cooled with expensive liquid helium. Availability of wire that becomes superconductive at or above the temperature of liquid nitrogen might finally make the levitated train a practical reality. Motors wound with superconductive wire would greatly increase the efficiency of electrically powered cars and ships.

- **Research.** The United States government is presently planning to build the world's largest particle accelerator, the Superconducting Super Collider (SSC). The SSC will incorporate some 10,000 superconducting magnets around the length of a circular tunnel that has a circumference of 53 miles. Projected cost of the project is from \$6 billion to \$8 billion. If the new generation of high-temperature superconductors can be fabricated into practical magnets, operating cost of the SSC could be significantly reduced. Availability of powerful liquid-nitrogen-cooled superconductive magnets would be useful in many other kinds of research as well.

Recent Developments

Superconductive ceramics are so easy to make that several high school students have managed to make their own samples. A typical recipe requires that the ingredients be mixed, ground and heated to around 1,000 degrees Celsius. The mixture is then reground and reheated. Finally, the material is pressed into pellets and is reheated for several hours. Variations in the temperature and length of the

heating cycles can greatly affect the superconducting properties of the finished pellet.

Pellets by themselves have few applications beyond research use and classroom demonstrations. For practical applications, the materials must be formed into wires and other shapes. Already, scientists at IBM, Bell Labs and other institutions have made superconducting wires and tapes from the new materials. They have also developed various ways to apply thin films of superconductive ceramics to conventional wires and other materials.

Much more progress must be made before the new superconductors can be used in practical applications. Since ceramics are inherently brittle, superconducting wires may have to be bonded to the surface of conventional wires or formed inside hollow wires.

The current-carrying capacity of the new materials must also be greatly increased. Conventional niobium superconductors cooled with liquid helium can carry up to 500,000 amperes per square centimeter. As this is being written, the best new ceramic superconductors can carry around 1,100 amperes per square centimeter. Above this level, the superconductivity of the material is quenched.

Experimenting With a Superconductor

Superconductivity manifests itself by zero electrical resistance and the repulsion of a magnetic field (the Meissner effect). In ceramic superconductors, the latter is much easier to demonstrate than the former. Besides a superconducting pellet, all that is required is a strong magnet, a foam-plastic cup and some liquid nitrogen.

Superconductive ceramic pellets are already available from several sources. According to a front-page item in *The Wall Street Journal* (October 19, 1987), Arthur Ellis, a chemist at the University of Wisconsin, has developed a \$25 superconductor kit for the Institute for Chemical Education. This kit includes a ceramic superconductor, magnet and instruc-

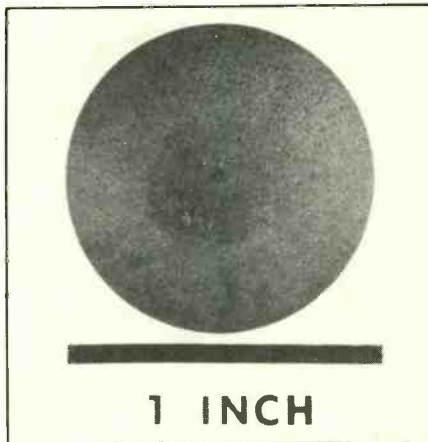

Fig. 2. A ceramic superconducting pellet.

tions for making superconductors. The article also reported that recipes for do-it-yourself superconductors have been published in *Johns Hopkins Magazine* and *New Scientist*.

I obtained a superconductor pellet from the manufacturer that supplies pellets to Edmund Scientific Co. (101 E. Gloucester Pike, Barrington, NJ 08007). The pellets are available from Edmund for \$20 (Cat. No. A37,446). They become superconductive at 83 degrees Kelvin. The pellet I received, shown photo-

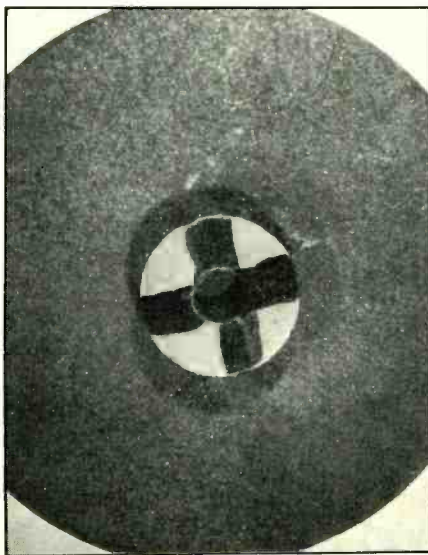

Fig. 3. A samarium-cobalt magnet resting on a superconductor pellet.

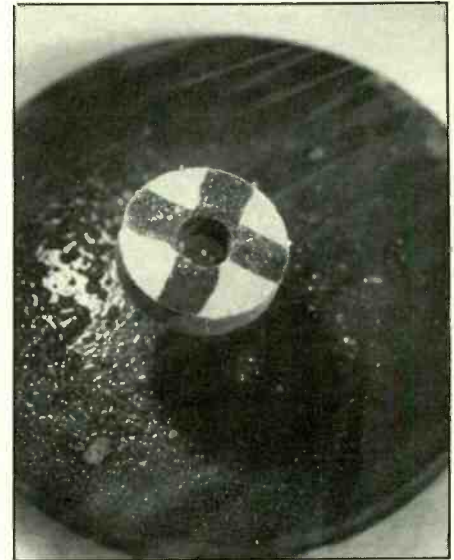

Fig. 4. A samarium-cobalt magnet floating above a superconductor pellet cooled with liquid nitrogen.

graphically in Fig. 2, is $\frac{1}{16}$ inch in diameter and $\frac{1}{4}$ inch thick.

Ordinary magnets are not strong enough to demonstrate the Meissner effect. For best results, you must use a samarium-cobalt magnet, which is expensive when purchased individually. Edmund Scientific Co., for example, sells a high-quality samarium-cobalt magnet for \$35 (Cat. No. A37,447). Fortunately, you can obtain a pair of small samarium-cobalt magnets by disassembling a suitable pair of earphones. Be aware, though, that not all earphones are equipped with samarium-cobalt magnets; so be sure to check the specifications printed on the phones' package. I purchased a pair of phones that came with samarium-cobalt-magnet elements for about \$6.

Prepare the demonstration by slicing the bottom $\frac{1}{2}$ inch or so from the bottom of a foam-plastic cup. If one is handy, you can use half of a foam-plastic fast-food container. Place the ceramic superconductor pellet in the center of the container and then place the magnet on top of the pellet. Next, slowly pour enough liquid nitrogen into the container to just cover the pellet and magnet. The nitro-

gen will immediately and violently boil when it strikes the comparatively warm objects in the container. After 10 or 20 seconds, the boiling will slow to a simmer and the liquid nitrogen will begin to seep over the edges of the pellet. After a few more seconds, the nitrogen will encircle the magnet. Just as it touches the magnet, the magnet will rise above the pellet.

Figures 3 and 4 show the results I obtained when I performed this experiment. In Fig. 3, the magnet is resting atop a superconductor pellet at room temperature. In Fig. 4, the magnet is floating above the pellet. (I placed a cross mark on the magnet to better visualize its rotation.)

As the liquid nitrogen evaporates, the ceramic eventually warms to the point where it no longer superconducts. The magnet then gently descends to the surface of the pellet. The fact that the magnet doesn't touch down until there is a fine layer of frost on the pellet proves that the pellet superconducts at least a few degrees Kelvin *above* the temperature of liquid nitrogen.

Depending on the power of the magnet and quality of the superconductor, the magnet will float about $\frac{1}{16}$ to $\frac{1}{8}$ inch above the surface of the pellet. Unlike two magnets that repel each other, the floating magnet will not violently fly away or flip over. Instead, it will float in place in virtually any position you place it. Moreover, it will spin. Indeed, the turbulence caused by the nitrogen vapor rising from the container may cause the magnet to start spinning. Or you can spin it with a gentle nudge from a pencil or your fingertip.

Figure 5 shows a magnet hovering above a superconductive pellet. Notice the layer of frost formed from water vapor in the air. In Fig. 6, I have spun the magnet with a gentle nudge from a fingertip. Figures 7 and 8 show the same effects when the magnet has been gently tilted to one side.

The behavior of a magnet floating in free space above a superconducting pellet is unlike anything I have observed. On witnessing the Meissner effect for the first time, an engineer at one company is

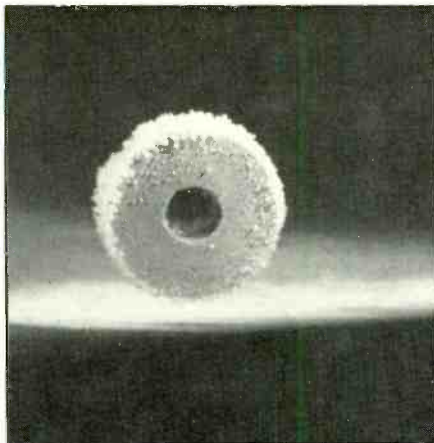

Fig. 5. A perfectly stationary magnet floating above a superconductor pellet.

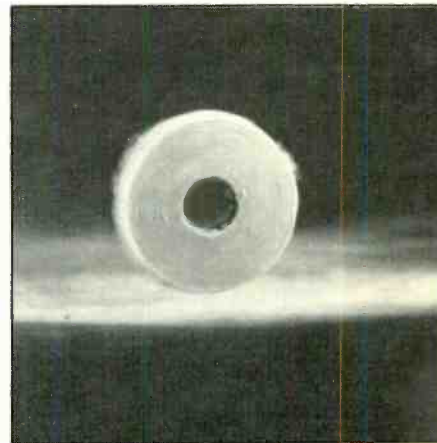

Fig. 6. The magnet rapidly spinning after given a gentle nudge.

said to have labeled the phenomenon as "counter-intuitive." Once set in motion, the spinning magnet will continue to revolve for many minutes. Apparently, only the resistance of the surrounding air slows down and eventually halts the magnet's rotation.

The position of the floating magnet, whether spinning or not, remains highly stable. To the unaided eye, the magnet appears to be perfectly motionless. I attempted to detect perturbations in the position of the magnet by reflecting the beam of a helium-neon laser from the shiny edges of a spinning magnet toward a white card several inches away. The position of the reflected spot remained very stable. I also observed the shadow of a spinning magnet illuminated by a laser beam. Again, the magnet appeared to remain precisely in position.

Recall that an electromotive force (emf) is generated in a coil adjacent to a magnet when either the coil or the magnet is moved. I connected a telephone induction coil to the input of an audio amplifier and then placed the coil near the spinning magnet. If an emf was being produced, it would be indicated by a rushing sound from the earphone. No sound was heard.

When a small fragment of a broken samarium-cobalt magnet was attached to the spinning magnet, a very soft sound

was detected each time the magnet completed a revolution. The mass of the off-set magnet, however, quickly slowed rotation of the main magnet.

Some recent publications that describe the Meissner effect either state or imply that a superconductor is a perfect reflector of a magnetic field. This is misleading since some of an impinging mag-



Fig. 7. The floating magnet has been pushed to one side and its rotation has stopped.

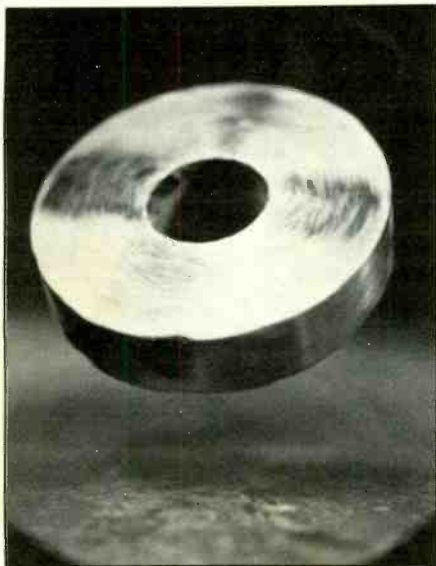

Fig. 8. The tilted floating magnet has again been nudged to spin.

netic field will indeed penetrate a superconductor.

You can easily demonstrate this by placing a very weak magnet *under* a foam-plastic container that holds a ceramic superconductor and a levitating magnet. The floating magnet will drop to the surface of the ceramic, where it can be moved around simply by moving around the lower magnet. A magnet isn't even necessary; the container can be placed on a steel plate and the floating magnet will move closer to the surface of the ceramic.

Incidentally, you can easily use a small magnet to manipulate the position of the floating magnet. Just be sure not to bring the second magnet too close to the floating magnet or the latter will cease floating and fly over to join itself to the first magnet.

Unfortunately, demonstrating zero resistance in a ceramic superconductor is much more difficult than demonstrating the Meissner effect. My efforts to measure the resistance of the Edmund Scientific disk were unsuccessful.

First I used a strong clamp to force two copper electrodes against opposite sides of the disk. When this arrangement,

shown in Fig. 9, was immersed in liquid nitrogen, the resistance of the disk typically *increased* an ohm or two. The increase was probably due to a slight relaxation of the clamp's pressure under the cooling influence of the liquid nitrogen.

Next, I attached a pair of ordinary alligator clips to opposite sides of the disk. This time, the results were unpredictable. Sometimes the resistance increased a few ohms, but twice the resistance appeared to fall completely to zero.

Finally, I used a silver-based conductive adhesive to attach wire leads directly to the disk, as shown in Fig. 10. After the adhesive cured overnight, I measured a resistance of 0.2 ohm. When I poured liquid nitrogen over the disk, its resistance *increased* to 1 ohm. After the disk warmed to room temperature, I repeated the measurements and obtained similar results. Eventually, the room-temperature resistance increased to around 4 ohms. When the disk was immersed in liquid nitrogen, its resistance always *in-*

creased about 1 ohm above its resistance at room temperature.

After many unsuccessful efforts to observe zero resistance, I contacted an engineer at the firm that manufactures the ceramic disks for Edmund Scientific. He acknowledged that establishing good electrical contact with the ceramic disk is difficult. He recommended that gold electrodes be fired onto the disk. Perhaps such electrodes could be offered for an additional fee.

Just before this column was to be mailed, I learned about the availability of superconducting ceramic disks equipped with electrodes. The disks are made by Fluoramics, Inc. (103 Pleasant Ave., Upper Saddle River, NJ 07458; tel. 1-800-922-0075). The electrical resistance of these disks falls from about 0.2 ohm at room temperature to zero or near zero resistance at just below 90 degrees Kelvin. A disk equipped with 19K gold wires and painted gold electrodes costs \$100. A disk equipped with copper wires and

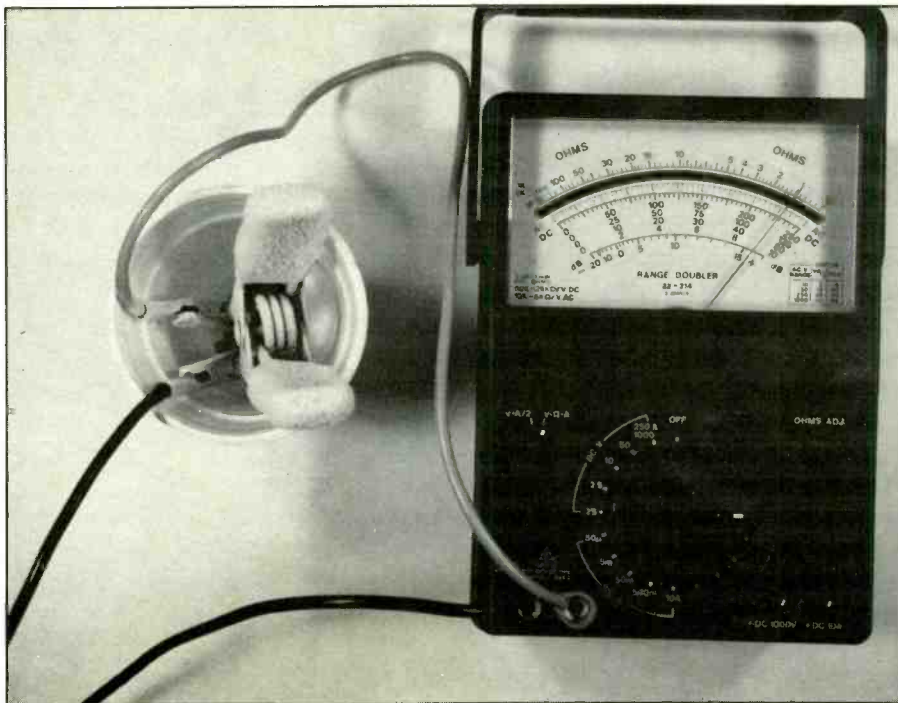

Fig. 9. An unsuccessful attempt to measure the resistance of a ceramic superconductor immersed in liquid nitrogen.

painted nickel electrodes costs \$85. Two disks without electrodes cost \$100. Quantity discounts are available.

How to Obtain Liquid Nitrogen

It was much more difficult for me to obtain liquid nitrogen than it was to obtain a pellet of superconducting ceramic. That's because I live in a rural area. Fortunately, I was able to purchase liquid nitrogen and to rent a large dewar from a man whose business is artificial insemination of cattle. I paid \$30 for 30 liters of liquid nitrogen and \$20 to rent the dewar for three days.

A dewar is a cryogenic flask that has an evacuated double-wall construction. Often, the flask is lined with an insulating blanket of foam plastic. An ordinary thermos bottle is a dewar. The dewar I rented is called a liquid-nitrogen refrigerator. It will store a full load for as long as 150 days. Some dewars will store liquid nitrogen for as long as six months.

You need only a liter or two of liquid nitrogen to cool a superconducting pellet. You might be able to buy small quantities of liquid nitrogen from a welding shop for about \$1 or \$2 per liter. You might also be able to obtain liquid nitrogen from some doctors (particularly podiatrists), hospitals and research laboratories. If one of these sources is willing to sell you some liquid nitrogen, ask for the name of their supplier. Better yet, contact the physics department of a nearby university. Chances are they will be as excited as you are for the opportunity to experiment with a ceramic superconductor.

Unless you are able to borrow or rent a dewar or liquid-nitrogen refrigerator, you will be unable to transport the liquid nitrogen. One possibility is to have the supplier fill a 1-quart thermos bottle with the liquid and perform your experiments nearby. Perhaps the supplier will be interested in observing your experiments. (**Caution:** Under no circumstances should you place a stopper in the mouth of a thermos bottle containing liquid nitrogen! The pressure of evaporating nitrogen gas will become exceedingly

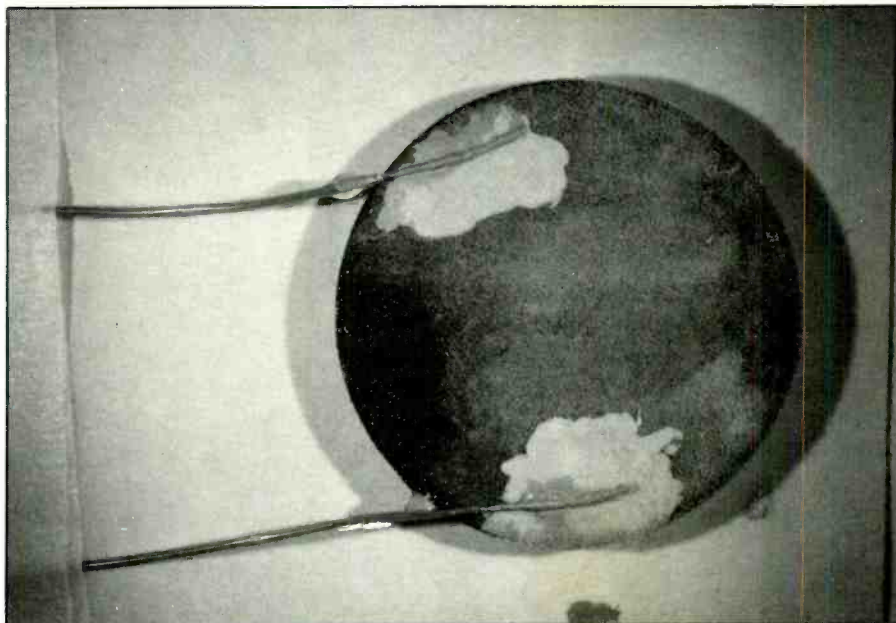

Fig. 10. Wire electrodes bonded to a ceramic superconductor with silver-impregnated conductive adhesive.

high, causing the bottle to *explode!* You can place cotton in the mouth of the bottle and/or place a foam-plastic cup over the mouth of the bottle to reduce evaporation of the liquid.)

An ordinary 1-quart or 1-liter evacuated glass thermos bottle that costs \$5 to \$10 will easily store liquid nitrogen for a day or so.

Safety Precautions

Some 80 percent of the air we breathe is composed of nitrogen. However, while free nitrogen is safe, liquid nitrogen can be *very* dangerous. It can cause almost instant frostbite on exposed skin. Also, its vapor can quickly develop extremely high pressure inside a closed container. Therefore, you must exercise reasonable care when using liquid nitrogen:

(1.) *Never* place liquid nitrogen in a tightly sealed container. If you do, the container *will* explode!

(2.) Do not transport an open container of liquid nitrogen in a vehicle.

(3.) Wear eye protection when pouring liquid nitrogen.

(4.) Because liquid nitrogen boils violently when it is poured into a container

that is at room temperature, make sure to stand clear to avoid being splashed.

(5.) If liquid nitrogen splashes onto your clothing, quickly grasp a *dry* section of fabric and pull the wet area away from your skin. The liquid will soon evaporate from your clothing.

(6.) Once again, *never* attempt to store liquid nitrogen in a tightly closed container!

Going Further

If you've read this far, you might be wondering why I haven't commented on how the new ceramic superconductors lose their electrical resistance. Frankly, I haven't the slightest idea. Several theories have been suggested by researchers in the field, but it's safe to conclude, at least for now, that there is not yet general agreement on the details of how superconducting ceramics work.

Numerous articles about superconductors have appeared in both the popular press and scientific journals. For additional information, visit a good library and check the periodicals section for publications dealing with this subject, beginning around March 1987. **ME**

A new switching regulator, an improved BCD-to-7-segment decoder, another buzz word and what's new

By Harry L. Helms

Few types of integrated circuits have become as useful as the so-called "three-terminal" linear voltage regulator devices. These devices, such as the classic 723 and 78XX series, quickly became popular among hobbyists and design engineers as a result of their low cost and ease of use. Besides, designing a good linear voltage-regulation circuit was no easy task. Versatile as they are, however, these regulator ICs are generally not suitable in applications where high output voltage and current are needed because these demands require high power dissipation capabilities that are beyond the rated maximum of most three-terminal devices. Exceed the dissipation limits and you soon have a fried (and dead) voltage regulator on your hands.

One popular solution to high-output-demand situations has been the *switching* voltage regulator. In this circuit, an out-board "pass" transistor is used in conjunction with an integrated-circuit or discrete-component voltage regulator. The pass transistor supplies whatever current the regulator itself can't. To maximize the power dissipation capabilities of the pass transistor, it is rapidly switched between saturation and an open circuit. Switching is done quickly (in excess of 50 kHz in many cases) to produce an easily smoothed and filtered output. The result is a high-efficiency regulator with excellent high-current-handling ability.

Designing a switching voltage regulator has generally not been an easy task. Most regulator ICs have required several external components to implement a switching design, and the resulting circuits have not been easy to "tame" for desired operation. However, Linear Technology Corp. recently introduced a new switching regulator IC that has the potential to make switching regulators as commonplace as conventional linear regulators. The LT1070 is a rugged device capable of supplying up to 5 amperes of output current while accepting inputs ranging from 3 to 60 volts. It can deliver

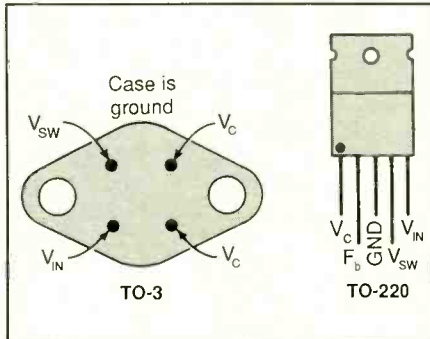

Fig. 1. Package configurations and pin identifications for LT1070 switching regulator IC.

load power up to 100 watts without requiring external devices.

The LT1070 is available in TO-3 and TO-220 packages (see Fig. 1). An internal 5-ampere, 75-volt pnp switching transistor serves as the pass transistor for the regulator. Output voltage control is obtained by using the output of a voltage-sensing error amplifier to set the current trip limit.

The LT1070 might be referred to as a "five-terminal" regulator. In addition to the usual input-voltage (V_{in}) and ground (GND) pins, it has compensating-voltage (V_c), feedback (F_b) and output- or switching-voltage (V_{sw}) pins. The extra pins make the LT1070 more complex to

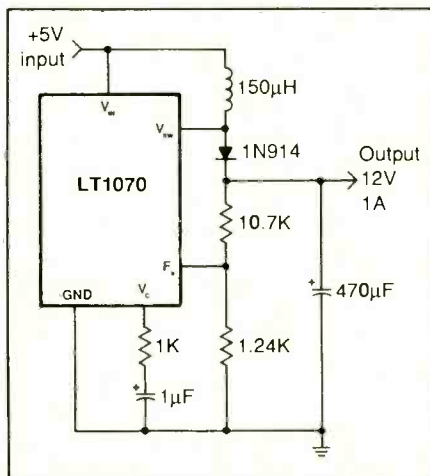

Fig. 2. A 5- to 12-volt boost converter.

use than ordinary three-terminal regulators, but they also provide the means for using these devices for some interesting applications that are difficult or impossible to implement using conventional regulator ICs.

Figure 2 shows the LT1070 being used in a circuit that is capable of taking a +5-volt input and producing a +12-volt, 1-ampere output. This is known as "boost-mode" operation. The configuration shown produces about 22 watts of output power. Output power levels up to 100 watts in this mode are possible, depending on the input voltage and values of components selected. The diode should be a general-purpose switching type that is capable of safely handling over 5 amperes and switching at a 60-Hz or better rate.

Linear Technology explicitly warns against using common diodes with lower ratings in their literature with the following statement: "The LT1070 will *eat* 1N914 and 1N4001 diodes and not even burp." How's *that* for making a point clear! However, diodes such as the 1N4001 can be used in LT1070 circuits if current through them is limited by resistors or other means.

The LT1070 is capable of boosting and inverting input voltages, as shown in Fig. 3. This circuit is an example of the "buck-boost mode," which is similar to the boost-mode regulator except that the load is referred to the inductor side of the input instead of the switching side. In the Fig. 3 circuit, the ground pin of the LT1070 is switched back and forth between the positive input and the negative output.

Substantial output voltages can be obtained from the LT1070 at lower currents. For example, Fig. 4 shows a circuit that can deliver 100 volts at 300 mA from a 15-volt input. The crucial component in this circuit is inductor L , which has a total inductance of 4 mH. It consists of five bifilar, or interleaved, turns of No. 14 wire on a core or form that is capable of handling at least 5 amperes. The winding is tapped as shown at the third turn. The form should be a "permalloy" type, al-

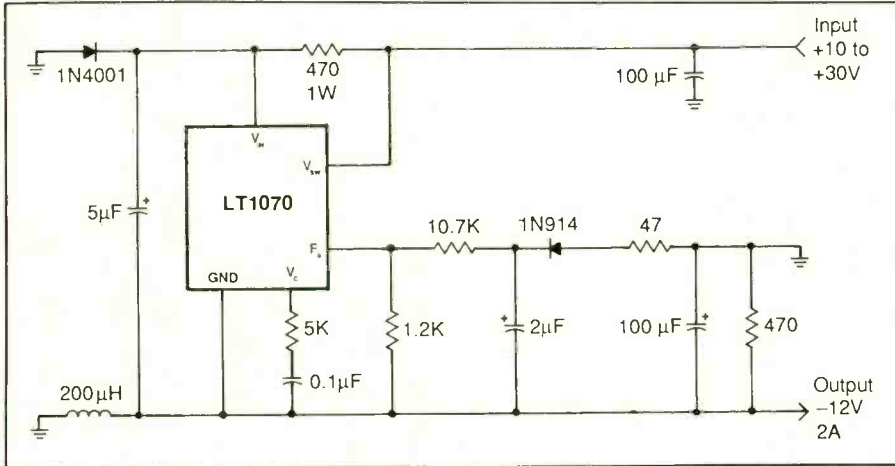

Fig. 3. A Positive-to-negative boost converter circuit.

though powdered iron can be used if lower efficiency is acceptable.

Building circuits with the LT1070 requires some precautions that must be closely observed. Obviously, the voltages and currents that appear at the outputs of these circuits are substantial and have the potential to cause serious damage or injury. (Caution: Don't attempt to build or use these circuits unless you are experienced in working with high-voltage and high-current circuits!)

High switching speeds can also produce some of the problems normally found in high-speed digital circuits. For

example, long component leads or/and wires connected to the LT1070 will act as inductors at high switching rates, usually causing unpredictable operation. When selecting components such as diodes and inductor cores, be conservative and use those parts with ratings well above the levels you expect to encounter.

I have only scratched the surface of possible LT1070 applications here. Linear Technology has put together a 72-page *LT1070 Design Manual* that is packed with applications circuits and design tips. This Manual, Application Note No. 19, is available upon request on pro-

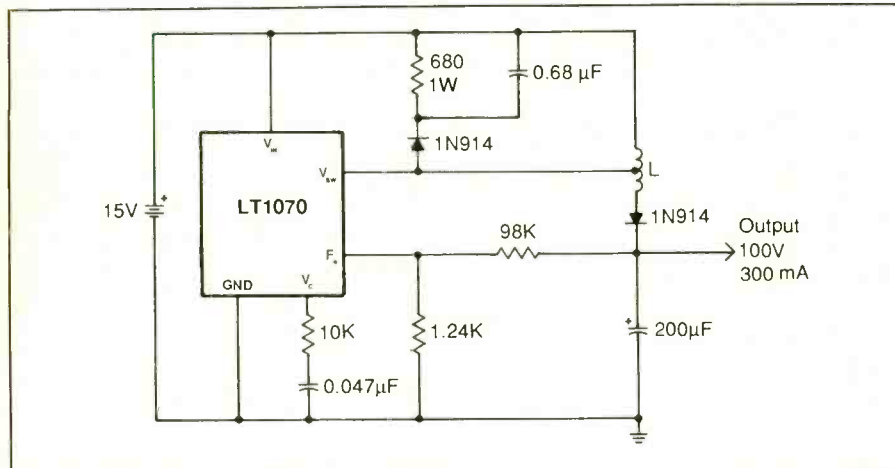

Fig. 4. A high-voltage output converter circuit.

HITACHI SCOPES

15-25% Discount



V1060
100MHz
\$1375

V660 60MHz Dual Trace \$990
V422 40MHz Dual Trace \$699
V212 20MHz Dual Trace \$475

ELENCO PRODUCTS AT DISCOUNT PRICES!



\$498
MO-1252

Scopes

MO-1253 40MHz Dual Trace \$550
Delayed Sweep 12KV HV, More
MO-1252 35MHz Dual Trace \$498
MO-1251 20MHz Dual Trace \$349
w/ Two 1x, 10x 100MHz probes, manual
S-3000 10MHz fully calibrated \$239

GF-8016 Function Generator with Freq. Counter



\$239.95

Sine, Square, Triangle
Pulse, Ramp, .2 to 2MHz
Frequency .1 thru 10MHz

GF-8015 without Freq. Meter \$179

Digital Triple Power Supply

Model XP-765

\$239.95



0-20V @ 1A
0-20V @ 1A
5V @ 5A

Fully Regulated, Short Circuit Protected
with 2 Limit Cont. 3 Separate Supplies
XP-660 w/ Analog Meters \$169.95

Multi-Function Counters F-1000

1.2GHz

\$259.95



F-100

120MHz

\$179.95

Frequency, Period, Totalize, Self Check with High-Stabilized Crystal Oven Oscillator, 8 Digit LED Dis

Digital LCR Meter

\$138.00

Model

LC-1800

Measures
Inductors,
Capacitors,
Resistors



Multimeter with Cap. and Trans. Tester

\$59.95

Model

CM-1500A

8 Functions
with Case



C&S Sales Inc., 1245 Rosewood
Deerfield, IL 60015 (312) 459-9040
800-292-7711 ASK FOR CATALOG

15 Day Money Back Guarantee

2 Year Limited Guarantee

Add 5% for Postage (\$10 max)

IL Res.. 7% Tax



CIRCLE 46 ON FREE INFORMATION CARD

SOLID-STATE DEVICES...

professional or business letterhead by writing to the company at 1630 McCarthy Blvd., Milpitas, CA 95035-7487.

An Improved BCD-to-7-Segment Decoder

Devices that decode a BCD address and drive seven-segment LED displays are popular among designers and hobbyists alike. However, most require current-limiting resistors to be used on the outputs to prevent damage to display seg-

ments. The new GE/RCA CA3161 from GE Solid State provides a constant 24 mA of current at the outputs, eliminating the need for resistors on the outputs. In addition, the CA3161's +5-volt inputs are compatible with TTL and CMOS logic levels. The device is also pin compatible with other industry-standard decoders.

A complete data sheet for the CA3161 can be obtained from GE Solid State, Rte. 202, Somerville, NJ 08876. When writing, ask for File No. 1079.

LT1070 Specifications

Maximum supply/input: 60 volts
Maximum switch output: 75 volts
Maximum output power: 100 watts
Maximum switching current: 5 amperes
Maximum quiescent mode current: 6 mA
Prime vendor: Linear Technology Corp.

SUBSCRIBE NOW & SAVE!

DOES YOUR DIGITAL CAPACITANCE METER DO THIS?

FULL 4 DIGIT 0.5 INCH LCD DISPLAY COMPLETELY AUTORANGING WITH 10 RANGE MANUAL CAPABILITY

- AND THIS**
RANGE OF 0.0 pF to 1 FARAD (999.9 mF)
0.5% BASIC ACCURACY UP TO 100 uF
- AND THIS**
READS DIELECTRIC ABSORPTION
- AND THIS**
EXTENDED PSEUDO 5 DIGIT
RESOLUTION ON SOME RANGES ONLY
- AND THIS**
ABILITY TO ZERO LARGE CAPACITANCE
VALUES UP TO 99.99 uF
- AND THIS**
CALCULATES TRUE CAPACITANCE
IF CAPACITOR IS LEAKY
- AND THIS**
DIODE CLAMP AND FUSED
PROTECTED INPUT.
DISCHARGE RESISTOR IN OFF
POSITION AT TERMINAL INPUTS.
POWERED BY 9V BATTERY
- ONE YEAR PARTS &
LABOUR WARRANTY**

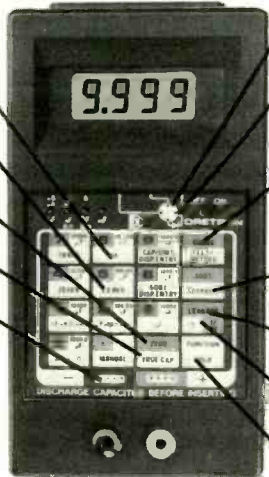

- AND THIS**
IDENTIFIES TRANSISTORS (NPN, PNP)
AND THEIR LEADS (E, B, C, ETC.)
- AND THIS**
TESTS ZENER DIODES AND RECTIFIERS.
UP TO 20V ZENER WITH AC ADAPTOR,
ZENER VOLTAGE WITH 9V BATTERY
DEPENDS ON ITS CONDITION
- AND THIS**
AUTOMATICALLY CALCULATES LENGTHS
OF CABLES IN FEET, METRES, MILES,
KILOMETRES (THEORETICAL RANGE
OF 9,999 MILES)
- AND THIS**
ABILITY TO SORT CAPACITORS IN
MANY DIFFERENT MODES
- AND THIS**
ABILITY TO READ LEAKY CAPACITANCE
(INSULATION RESISTANCE OR CURRENT)
- AND THIS**
CALCULATES TIME CONSTANTS WITH
USER DEFINED RESISTANCE VALUES
- AND THIS**
HOLD FUNCTION FREEZES DISPLAY

FOR ONLY THIS

\$169.95

MODEL
MC300 Approx. Size
7" x 4" x 1 1/2"
DAETRON
a division of Bergeron Technologies Inc.
935 THE QUEENSWAY, BOX 641
TORONTO, ONTARIO M8Z 5Y9
CANADA (416) 676-1600

SHIPPING INSTRUCTIONS:

All units shipped out F.O.B. Buffalo NY via United Parcel Service (except Hawaii & Alaska) unless otherwise indicated (in which case shipments will be F.O.B. Canada)

PLEASE SEND ME	U.S. FUNDS
(QUANTITY) MC300(S) @	\$169.95 \$ _____
CARRYING CASE	\$ 16.95 \$ _____
AC ADAPTOR	\$ 9.95 \$ _____
SHIPPING AND HANDLING @ \$5.00 PER INSTRUMENT	\$ _____
<input type="checkbox"/> CHECK <input type="checkbox"/> MONEY ORDER	\$ _____
<input type="checkbox"/> VISA <input type="checkbox"/> MASTERCARD	TOTAL \$ _____
<input type="checkbox"/> CARD NO.	
EXPIRY DATE _____	SIGNATURE _____
NAME _____	TELEPHONE _____
ADDRESS _____	
CITY _____ STATE _____	ZIP CODE _____

DEALER ENQUIRIES INVITED
CIRCLE 42 ON FREE INFORMATION CARD

POACHers???

Add another acronym to those already in vogue in electronics: "POACH," which stands for "PC on a Chip." This refers to a technique whereby custom application-specific ICs (ASICs) are used in 80286 PC AT-compatible systems in place of the standard "merchant" ICs used in the original PC AT computer from IBM. The result of POACH technology is a dramatic savings in component count and space.

How big are these savings? VLSI Technology recently introduced a five-chip CMOS set that cuts the number of non-memory chips on a PC AT motherboard from 110 to just 16! The resulting motherboard occupies less than half the physical space of a conventional PC AT version. Other manufacturers offering chip sets for AT systems include: Chips and Technologies, Faraday, G2, Logicstar and ZymOS.

Short Takes

Speaking of ASICs, National Semiconductor has added analog function cells to its library of standard digital design cells. These functions include comparators, op amps, a voltage reference, an analog switch and resistors. This is part of a trend in ASICs to allow designers to combine linear and digital functions on the same chip . . . Siemens is offering *SMD Technology: An Introduction to Surface Mounting*, a guide to surface-mount devices and their applications. It is profusely illustrated in full color. Request Publication No. B3-B3289-Q-1-7600 from Siemens computers, Special Products Div., 186 Wood Ave. S., Iselin, NJ 08830. **ME**

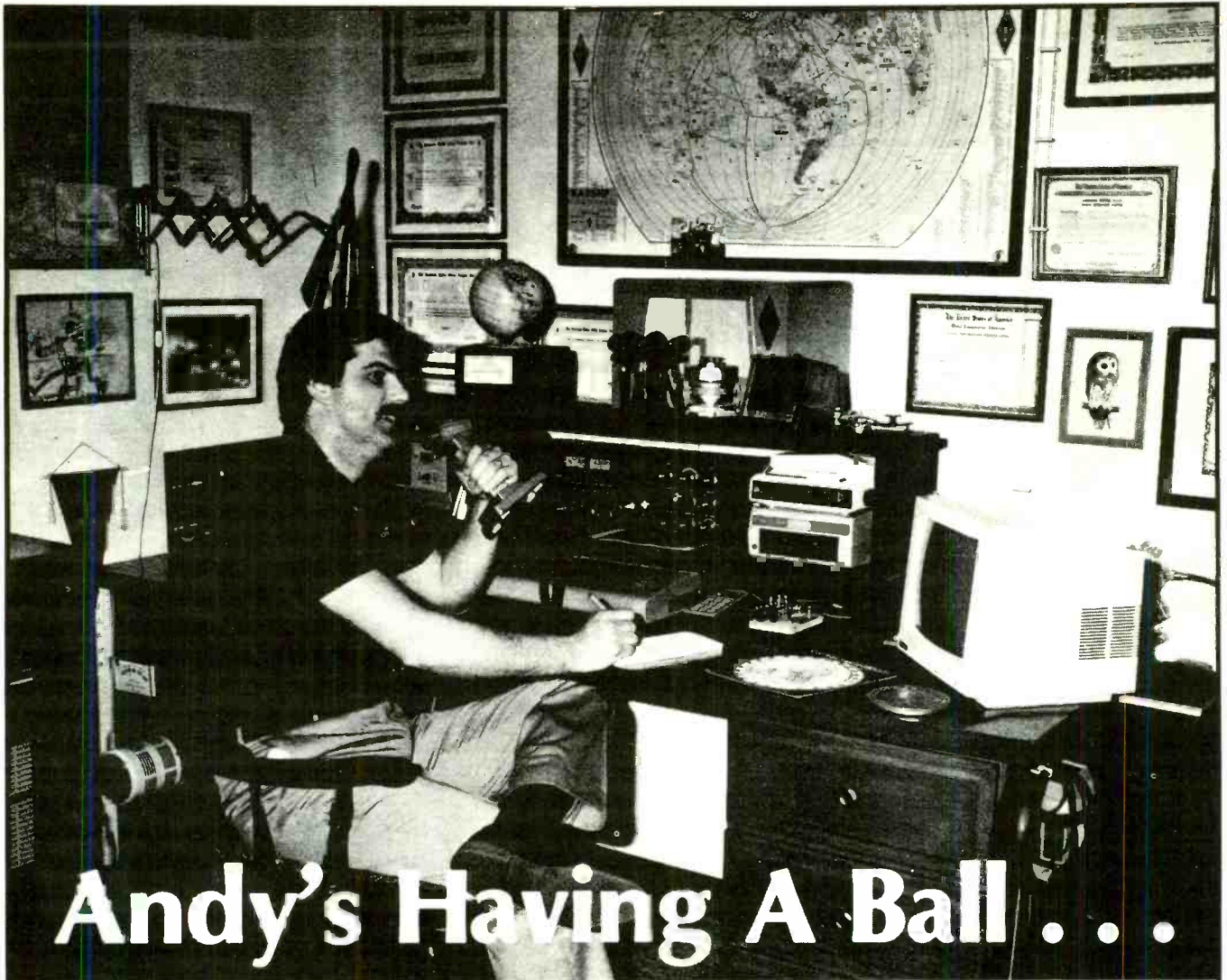

Andy's Having A Ball . . .

and you can too!

Andy is a Ham Radio operator and he's having the time of his life talking to new and old friends in this country and around the world.

You can do it too! Join Andy as he communicates with the world. Enjoy the many unique and exclusive amateur bands . . . the millions of frequencies that Hams are allowed to use. Choose the frequency and time of day that are just right to talk to anywhere you wish. Only Amateur Radio operators get this kind of freedom of choice. And if it's friends you're looking to meet and talk

with, Amateur Radio is the hobby for you. The world is waiting for you.

If you'd like to be part of the fun . . . if you'd like to feel the excitement . . . we can help you. We've got all the information you'll need to get your Ham license. Let us help you join more than a million other Hams around the world and here at home. Who are we? We're the American Radio Relay League, a non-profit representative organization of Amateur Radio operators.

For information on becoming a Ham operator
circle number 110 on the reader service card or write to:

AMERICAN RADIO RELAY LEAGUE

Dept CQ, 225 Main Street
Newington, Conn. 06111.

A Sampling of Winter 1988 English-Language International Shortwave Broadcasts

By Gerry L. Dexter

Time	Station/Country	Frequencies	Time	Station/Country	Frequencies
0000	Radio Exterior de Espana, Spain	9630	0200	Radiobras, Brazil	11745
	Radio Luxembourg	6090		Swiss Radio Int'l.	6135, 9725, 9885, 12035
	Radio Discovery, Dom. Rep.	15045		Radio Exterior Espana, Spain	9630
	All India Radio	9910, 11715, 11745, 15110		Radio Bucharest, Romania	5990, 6155, 9510, 9570, 11810, 11940
	Radio Portugal (30)	9680		Radio RSA, South Africa	6010, 9615, 11730
	Radio Havana Cuba	6080, 6140, 9740		Radio Havana Cuba	6080, 6140, 9525, 9740
	BBC	5975, 6175, 6195, 7325, 9515, 9590		Voice of Germany	5955, 6035, 7285, 9615, 9690
	WRNO	7365		Radio Warsaw, Poland	6095, 7145, 7270, 9575, 11815
	Radio Moscow	5915, 5940, 6000, 7115, 7215, 7310, 12050		Radio Moscow	5915, 5940, 6000, 7115, 9635, 12050
	Voice of Israel	9435, 9885, 11610		Radio Sweden Int'l. (30)	9695
	Radio Baghdad	11705		Voice of Free China	7445, 9680, 9765, 11740, 11745, 11860, 15345
	HCJB, Ecuador (30)	9870, 11755, 15115		HCJB, Ecuador	6205, 9870, 11775
	Voice of America	5995, 6130, 9455, 9775		Radio Cairo, Egypt	9475, 9675
	Vatican Radio (50)	6150, 9605, 11780		Radio Tiarana, Albania	9765
	Radio Berlin Int'l.	6080, 9730		Radio France Int'l. (15)	5950, 9715
	AFRTS, USA	6030, 9700, 11790, 15355		Radio Budapest, Hungary	9520, 9585, 9835
	Radio New Zealand	11780, 15150		Radio Kiev, Ukraine	7260, 9800, 11790, 11875, 13645
0100	Radio Canada Int'l.	5960, 9535, 9755, 11940		Radio Netherlands (30)	6020, 6165, 9590, 11730
	RAI, Italy	9575, 11800		Radio New Zealand	11780, 15150
	RAE, Argentina	9690, 11710	0300	Radio Portugal	9705
	Radio Prague, Czechoslovakia	5930, 6015, 6155, 7345, 9740, 11990		Radio Prague, Czechoslovakia	5930, 6015, 6055, 7345, 9540, 9630, 9740, 11990
	Voice of Germany	6040, 6085, 6145, 9505, 9545, 9565		Voice of Germany	5965, 6010, 6045, 9545, 9565
	KVOH, California	9495		Radio Moscow	5915, 5940, 6000, 7115, 9635, 12050
	Radio Moscow	5915, 5940, 6000, 7115, 7215, 7310, 7440, 12050		Voice of Greece (40)	7430, 9395, 9420
	Voice of Israel	9435, 9855, 11610		HRVC, Honduras	4820
	Voice of Greece (30)	7430, 9395, 9420		Voice of Free China	5955, 7445, 9680, 9765, 11745, 15345
	Radio Austria Int'l. (30)	9550		Radio France Int'l. (30)	6055, 9800
	All India Radio	7215, 9535, 9910, 11715		Voice of Turkey	9560
	Radio Budapest, Hungary	6025, 6110, 9520, 9585, 9835		Radio Belize	3285
	Radio Baghdad, Iraq	9705		Radio Budapest, Hungary	6025, 6110, 9520, 9585, 9835, 11990
	Radio Exterior Espana, Spain	9630		Radio Havana Cuba	6100, 6140, 9740, 11725
	WCSN Boston	7365		Radio Beijing, China	9645, 11660, 11970, 11980, 15445
	Radio New Zealand (45)	15150		TIFC, Costa Rica	5055
				Radio Warsaw, Poland	6095, 6135, 7145, 7270, 9525, 11815
				TWR Netherlands Antilles	9535
				Radio Austria Int'l. (30)	6150

Times are in UTC. Numbers in parentheses are starting times that many minutes past the hour.

Time	Station/Country	Frequencies	Time	Station/Country	Frequencies		
0400	Radio Camerouns (30)	4850	0900	Radio Canada Int'l. (30)	5960, 9755		
	Radio Bucharest, Romania	5990, 6155, 9510, 11810, 11940		Radio Afghanistan	4450, 15255, 17655		
	RAE, Argentina	9690, 11710		HCJB, Ecuador	6130		
	Radio Havana Cuba	5965, 6035, 6080, 6140, 9575, 9740		Radio Australia	6060, 9580, 11720		
	UAE Radio, UAE	9640, 11940, 15345		KTWR, Guam	11715		
	TWR Netherlands Antilles	9535		AFRTS, USA	6030, 9530, 9590, 15265		
	Radio Beijing, China	9645, 11980		Radio Singapore	5052, 11940		
	BBC	5975, 6175, 9510		1000	KNLS, Alaska	6085	
	TGNA, Guatemala	5955			Voice of Vietnam	9840, 12035	
	Voice of Israel	9435, 9815, 11585, 11960			NBC Papua New Guinea	4890	
	Radio Finland Int'l. (30)	11715, 11755			Radio Australia	6060, 9580, 11720	
	Radio Austria Int'l. (30)	9550			Radio Netherlands (30)	6020, 9650	
	Radio France Int'l. (15)	6055, 9800			TWR Monaco	9495	
	Swiss Radio Int'l.	6135, 9725, 9885, 12035			Radio Oman	9735, 11890	
	Voice of America	5995, 6130, 9455, 9775			SLBS Solomon Islands	5020, 9545	
Radio Berlin Int'l.	9560, 9620	1100	VOIRI, Iran (15)		11790		
0500	Radio Korea, S. Korea		6060, 9570		Radio Pyongyang, N. Korea	6576, 11735	
	Voice of Nigeria		7255		TWR Netherlands Antilles (10)	11815	
	Voice of Germany		5960, 6120, 6130, 9645, 9700		Radio France Int'l. (10)	6175, 9805, 11670, 11845, 15195, 15300, 15315, 15365, 17620	
	WRNO New Orleans		6185		Radio Bangladesh (30)	12030, 15525	
	Radio Moscow		6020, 7125, 7260, 9580		Voice of Vietnam	9755, 12035	
	Radio Dublin Int., Ireland		6930 (or 6950)		Radio New Zealand	6100, 9600	
	Radio Netherlands (30)		6165, 9715	Radio Singapore	5052, 11940		
	Vatican Radio		6185, 9645	Radio Japan	5990, 12035		
	Radio Havana Cuba		6090, 6100, 6140, 9740, 11725	Radio Pakistan	15605		
	0600		Voice of Nicaragua	6015, 6100	Radio Tirana, Albania (30)	9480, 11855, 15185	
			Radio Havana Cuba	9525	Radio Australia	5995, 9580	
			WYFR, Florida	7355, 9852	Radio Thailand	9655, 11905	
			ELWA, Liberia	4760	Radio Beijing	9535, 15280	
			Radio Cook Islands	11760	BBC	9510, 11775	
		ABC Perth, Australia	9610	1200	Radio Canada Int'l.	9625, 11855, 17820	
SIBS, Solomon Islands		5020, 9545	Radio Pyongyang, N. Korea		9600, 9715, 9977		
0700		HCJB, Ecuador	6205, 9870		Radio Ulan Bator, Mongolia	9615, 12015	
		Radio Netherlands (30)	9630		Radio Bangladesh (30)	15525	
		Radio New Zealand	9600, 11780		Radio Beijing	9535, 11650, 13650	
		Radio Havana Cuba	9525		HCJB, Ecuador	11740, 15115, 17890	
		Radio Japan	11705		VOPK Kampuchea	9695, 11938	
		Voice of Free China	5985		Radio Finland	11945, 15400	
		0800	TWR Monaco		7165	Radio Tashkent, Uzbekistan	7325, 9600, 9715, 11785, 15460
			KNLS Alaska		6095	Radio Australia	6060, 9580, 9770
	Radio Australia		9580		Radio Austria Int'l.	15320	
	BRT Belgium		9880		1300	All India Radio (30)	9545, 11810, 15335
	WCSN Boston		9465			Radio Korea, S. Korea	9750, 15575
	Radio Austria Int'l. (30)		6000			WRNO New Orleans	9715
	FEBC Philippines (30)		11850			Radio Canada Int'l.	11955, 15440
	0900		Radio Canada Int'l. (30)	5960, 9755		HCJB, Ecuador	11740, 15115, 17890
			Radio Afghanistan	4450, 15255, 17655		0900	Radio Canada Int'l. (30)
HCJB, Ecuador			6130	Radio Afghanistan			4450, 15255, 17655
Radio Australia			6060, 9580, 11720	Radio Australia			6060, 9580, 11720
KTWR, Guam			11715	Radio Australia			6060, 9580, 11720
AFRTS, USA			6030, 9530, 9590, 15265	Radio Australia			6060, 9580, 11720
Radio Singapore			5052, 11940	Radio Australia			6060, 9580, 11720
1000			KNLS, Alaska	6085			Radio Australia
		Voice of Vietnam	9840, 12035	Radio Australia			6060, 9580, 11720
		NBC Papua New Guinea	4890	Radio Australia			6060, 9580, 11720
		Radio Australia	6060, 9580, 11720	Radio Australia			6060, 9580, 11720
		Radio Netherlands (30)	6020, 9650	Radio Australia	6060, 9580, 11720		
		TWR Monaco	9495	Radio Australia	6060, 9580, 11720		
		Radio Oman	9735, 11890	Radio Australia	6060, 9580, 11720		
		SLBS Solomon Islands	5020, 9545	Radio Australia	6060, 9580, 11720		
	1100	VOIRI, Iran (15)	11790	Radio Australia	6060, 9580, 11720		
		Radio Pyongyang, N. Korea	6576, 11735	Radio Australia	6060, 9580, 11720		
		TWR Netherlands Antilles (10)	11815	Radio Australia	6060, 9580, 11720		
		Radio France Int'l. (10)	6175, 9805, 11670, 11845, 15195, 15300, 15315, 15365, 17620	Radio Australia	6060, 9580, 11720		
		Radio Bangladesh (30)	12030, 15525	Radio Australia	6060, 9580, 11720		
		Voice of Vietnam	9755, 12035	Radio Australia	6060, 9580, 11720		
		Radio New Zealand	6100, 9600	Radio Australia	6060, 9580, 11720		
Radio Singapore		5052, 11940	Radio Australia	6060, 9580, 11720			
Radio Japan		5990, 12035	Radio Australia	6060, 9580, 11720			
Radio Pakistan		15605	Radio Australia	6060, 9580, 11720			
Radio Tirana, Albania (30)		9480, 11855, 15185	Radio Australia	6060, 9580, 11720			
Radio Australia		5995, 9580	Radio Australia	6060, 9580, 11720			
Radio Thailand		9655, 11905	Radio Australia	6060, 9580, 11720			
Radio Beijing		9535, 15280	Radio Australia	6060, 9580, 11720			
BBC		9510, 11775	Radio Australia	6060, 9580, 11720			

COMMUNICATIONS

Time	Station/Country	Frequencies
	Radio Norway Int'l. (Sun)	9590, 15310, 17775
	BRT Belgium	15590
	Radio Finland Int'l.	11945, 15400
	TWR Netherlands Antilles	11815
	Radio Pyongyang, N. Korea	9325, 9345
1400	FEBC Philippines	11850
	Radio Norway (Sun)	15310
	Radio Sweden	11785, 15345
	Radio Netherlands (30)	15560
	TWR Netherlands Antilles	11815
	Radio Finland	15400
	Radio Japan	5950
	AFRTS USA	6125, 9700, 11890, 15330, 15430
	Radio Canada Int'l.	11955, 15440
1500	Radio Pyongyang, N. Korea	7290, 9325, 9940, 9977
	Radio Veritas, Philippines	9770, 15215
	KVOH California	17775
	WRNO New Orleans	11965

Time	Station/Country	Frequencies
	Voice of Greece (40)	11645, 15630, 17565
	Voice of Indonesia	11790, 15150
	HCJB, Ecuador	11740, 15115, 17890
	Radio Australia	9580
	FEBA, Seychelles	15325
1600	UAE Radio	9640, 11955, 15320, 17865
	Radio France Int'l.	11705, 17620, 17795
	Radio Budapest, Hungary	9835
	Radio Pakistan	15605
	WYFR Florida	9535, 11875
	Voice of America	15410, 15445, 15580, 17785, 17800, 17870
	BSKSA, Saudi Arabia	9705, 9720
	Voice of Vietnam	10040, 12020, 15010
	Voice of Nigeria	15120
	BRT Belgium (30)	17595
1700	WRNO New Orleans	15420
	Radio Norway Int'l. (Sun)	11850, 15310
	Radio Yugoslavia	5980, 6100, 7240, 11735
	Voice of Israel	9460, 11585, 13750
	WHRI Indiana	15105
	BBC	9410, 12095, 15070, 15420
1800	Radiobras, Brazil	15265
	Radio Canada Int'l.	15260, 17820
	All India Radio	11620, 11935
	Radio Netherlands (30)	17605
	WINB, Pennsylvania	15400
	Radio Kuwait	11675
	Voice of Nigeria	11770
1900	VOIRI, Iran (30)	9022, 11930
	TWR Monaco	11635
	Radio Norway (Sun)	9590, 11850, 15310
	HCJB, Ecuador	11740, 15270, 17790
	Radio Afghanistan	9530, 9635
	Radio Canada Int'l.	15260, 17820
	Radio Japan	11705
	Radio Algiers	9640, 15160, 17745
	Radio Kuwait	11675
	Voice of Nigeria	11770
	Voice of Greece (20)	9395, 9425
2000	Radio Discovery, Dom. Rep.	15045
	KVOH California	17775



"The extra \$36 is for the call to Micronesia to get the part."









Time	Station/Country	Frequencies	
2000	Radio Baghdad	9875	
	Radio Sofia, Bulgaria (30)	6070, 9700, 11750	
	Radio Budapest, Hungary	9835	
	Radio Netherlands (30)	9715, 11740	
	Swiss Radio Int'l.	12035	
	Radio Damascus, Syria (05)	9950, 12085, 15020	
	Radio Havana Cuba (10)	17845, (50) 15300, 17750	
	2100	Radio Canada Int'l.	11835, 151550, 17820
		RAE, Argentina	11710
		WRNO New Orleans	11705
Voice of Israel (30)		9435, 11610, 13725	
Radio Sofia, Bulgaria		9700, 11720	
BRT Belgium		5910, 9675	
Radio Australia		15395	
All India Radio		5965, 6125	
Radio Yugoslavia (15)		6100, 7240, 9620	
2200		Radio Canada Int'l.	5960, 9755
	Radio Korea, S. Korea (30)	15575	
	Radio Vilnius, Latvian SSR	7260, 9640, 11790, 11875, 13645	
	Voice of Free China	5985, 9955, 15370, 15440, 17845	
	Voice of Turkey	9560	
	Vatican Radio	9615, 11830	
	Radio Berlin Int'l.	6125, 6165, 11750	
	Radio Jamahiriya, Libya	7245	
	WHRI Indiana	9770	
	Radio Sofia, Bulgaria (30)	6070, 11720	
BBC	6120, 6175, 9590, 9915		
Radio Moscow	7190, 9530, 9720, 9760, 9860, 9880, 11750, 11770, 11850, 12030, 12050, 12060, 13600, 15420		
2300	Radio Canada Int'l. (30)	5960, 9755	
	Radio Moscow	7115, 7310, 12050, 13665, 15425	
	Voice of Israel	9435, 9855, 11610	
	Radio Sweden	9695, 11705	
	Radio Sofia, Bulgaria	9700, 11720	
	Voice of Greece (35)	9395, 11645	
	BRT Belgium (30)	9790	
	Radio Japan	11800	
	Radio Mediterranean, Malta	6110	
	Radio Berlin Int'l.	6080, 9730	
Radio Korea, S. Korea	15575		
Radio Kiev, Ukranian SSR (30)	7260, 9640, 9800, 11790, 11875, 13645, 13775		

QUALITY PARTS * DISCOUNT PRICES * FAST SHIPPING!

ALL ELECTRONICS CORP.

ALL ELECTRONICS CORP.

SEND FOR FREE 1987 CATALOG... 48 PAGES!

<h3>SWITCHING POWER SUPPLY</h3>  <p>Compact, well regulated switching power supply designed to power Texas Instruments computer equipment. INPUT: 14-25 Vac @ 1 amp OUTPUT: +12 Vdc @ 350 ma +5 Vdc @ 1.2 amp -5 Vdc @ 200 ma. SIZE: 4 3/4" square. CAT# PS-30 \$3.50 each</p>	<h3>BLACKLIGHT ASSEMBLY</h3>  <p>Complete, functioning assembly includes ballast, on/off switch, power cord, sockets and F4T5-BL blacklight. Mounted on a 7 1/8" X 3 1/8" metal plate. Use for special effects lighting or erasing EPROMS. CAT# BLTA \$10.00 each</p>	<h3>MINI PUSH BUTTON</h3>  <p>S.P.S.T. momentary Push to make. CAT# MPB-1 35c each - 10 for \$3.25</p>	
<h3>THIRD TAIL LIGHT</h3>  <p>Sleek high-tech lamp assembly. Could be used as a third auto tail light, emergency warning light, or special effects lamp. Red reflective lens is 2 3/4" X 5 1/2" is mounted on a 4" high pedestal with up/down swivel adjustment. Includes 12 V replaceable bulb. CAT# TLB \$3.95 each</p>	<h3>VIC 20 MOTHERBOARD</h3>  <p>26 IC's including 6520A and 6560. Not guaranteed but great for replacement parts or experimentation. CAT# VIC-20 \$15.00 each</p>	<h3>NICKEL-CAD CHARGER / TESTER</h3>  <p>Will charge most nickel-cad batteries even button & N. CAT# UNCC-N \$15.00 each</p>	
<h3>XENON FLASH TUBE</h3>  <p>3/4" X 1 1/8" dia. CAT# FLT-1 2 for \$1.00</p>	<h3>LED'S</h3>  <p>Jumbo T 1-3/4 (5mm) RED CAT# LED-1 10 for \$1.50 GREEN CAT# LED-2 10 for \$2.00 YELLOW CAT# LED-3 10 for \$2.00 TWO PIECE HOLDERS FOR ABOVE LED'S CAT# HLED 10 for 65c 100 for \$5.00</p>	<h3>10 AMP SOLID STATE RELAY</h3>  <p>Control: 3-32 Vdc Load: 10 amps, 120 Vac Size: 2 1/2" X 3 3/4" X 7 8" CAT# SSRLY-10A \$9.50 each - 10 for \$85.00</p>	
<p>MAIL ORDERS TO: ALL ELECTRONICS P.O. BOX 567 VAN NUYS, CA 91408</p>	<p>TELEX 5101010163 (ALL ELECTRONIC) CUSTOMERS OUTSIDE OF THE U.S.A. SEND \$1.50 POSTAGE FOR CATALOG</p>	<p>TOLL FREE 800-826-5432 INFO: (818) 904-0524 FAX: (818) 781-2653</p>	<p>QUANTITIES LIMITED MINIMUM ORDER \$10.00 CALIF. ADD SALES TAX U.S.A. \$3.00 SHIPPING NO C.O.D.</p>

CIRCLE 5 ON FREE INFORMATION CARD
CALL FOR FREE CATALOG

ALL SALES SUBJECT TO THE TERMS OF OUR 90 DAY LIMITED WARRANTY. FREE COPY UPON REQUEST.

TEXT TO SPEECH BOARD!

PC/XT COMPATIBLE. MAKE YOUR COMPUTER TALK!

A VERY POWERFUL AND AMAZING SPEECH CARD. USES THE NEW GENERAL INSTRUMENTS SPO256-AL2 SPEECH CHIP AND THE CTS256A-AL2 TEXT TO SPEECH CONVERTER.

THIS BOARD USES ONE SLOT ON THE MOTHERBOARD AND REQUIRES A COM SERIAL PORT. BOARD MAY ALSO BE USED IN A STAND ALONE ENVIRONMENT WITH ALMOST ANY COMPUTER THAT HAS A RS232 SERIAL PORT. FEATURES ON BOARD AUDIO AMP OR MAY BE USED WITH EXTERNAL AMPS.

DEMONSTRATION SOFTWARE AND A LIBRARY BUILDING PROGRAM ARE INCLUDED ON A 5 1/4" INCH PC/XT DISKETTE. FULL DOCUMENTATION AND SCHEMATICS ARE ALSO INCLUDED.



NEW! PRICE CUT! **\$69.95** ASSEMBLED & TESTED

NEW! IC TESTER! \$149.00

SIMILAR TO BELOW EPROM PROGRAMMER. PLUGS IN TO YOUR PC OR XT. TESTS ALMOST ALL 14, 16, AND 20 PIN 74XX SERIES. INCLUDES STANDARD POWER, "S" AND "LS" DEVICES. ALSO TESTS CD4000 SERIES CMOS. SOFTWARE INCLUDED CAN EVEN DETERMINE PART NUMBERS OF MOST UNMARKED AND HOUSE NUMBERED DEVICES WITH SIMPLE MOD. THIS UNIT CAN ALSO TEST 6.4K AND 256K DRAMS! WITH MANUAL AND SOFTWARE: \$149. PERFECT FOR SCHOOLS.

PC/XT EPROM PROGRAMMER \$169



ASK ABOUT OUR NEW PAL PROGRAMMER!

* LATEST DESIGN * PROGRAMS UP TO 4 DEVICES AT ONE TIME * FEATURES EASY TO USE MENU DRIVEN SOFTWARE THAT RUNS UNDER PC OR MS-DOS. * USES AN INTELLIGENT PROGRAMMING ALGORITHM FOR SUPER FAST (8X) EPROM BURNING. * THIS PLUG-IN BOARD ATTACHES TO AN EXTERNAL MINI CHASSIS CONTAINING 4 TEXTTOOL Z.I.F. SOCKETS. * NO PERSONALITY MODULES REQUIRED * AUTOMATIC VPP SELECTION: 12.5V, 21V, OR 25V. * EPROM DATA CAN ALSO BE LOADED FROM OR SAVED TO A DISKETTE. * PROGRAMMING SOFTWARE SUPPORTS: 2716, 2732, 2732A, 2764, 2764A, 27128, 27128A, 27256, 27256A, 27512, AND 27512A. * ASSEMBLED AND TESTED, BURNED. IN WITH MANUAL. \$169 WITH SOFTWARE.

JUST RECEIVED. SAME AS ABOVE PROGRAMMER, BUT PROGRAMS 8 UNITS AT ONE TIME - \$299.

Digital Research Computers

P.O. BOX 381450 • DUNCANVILLE, TX 75138 • (214) 225-2309

TERMS: Add \$3.00 postage. We pay balance. Orders under \$15 add 75c handling. No C.O.D. We accept Visa and MasterCard. Texas Res. add 6-1/4% Tax. Foreign orders (except Canada) add 20% P & H. Orders over \$50 add 85c for insurance.

CIRCLE 50 ON FREE INFORMATION CARD

Computer spreadsheets for technical calculations and Car compact disc player considerations

By Curt Phillips

No doubt you have heard about how well computer spreadsheet programs also calculate budgets, balance checkbooks and perform a variety of mathematical tasks. What you may not have considered is how useful computer spreadsheets can be for performing technical and engineering calculations. Because spreadsheets are generally marketed as "financial management programs," their capability for doing technical calculations has been given little exposure.

Actually, most spreadsheet programs work better for technical calculations than some programmable calculators that are often used. Being able to see all the data and constants on the screen at once helps the user to better understand the calculations. Furthermore, the full-size paper you can print the calculations on is easier to work with than a small paper tape.

Although many electronics calculations require only the four basic functions of addition, subtraction, multiplication and division, most spreadsheets support a full range of complex mathematical functions such as sine, cosine, arc-tangent and the other trigonometric functions, as well as logarithms, natural logs, absolute value, exponents and square roots. Remember that even when square roots are not intrinsically supported, raising a number exponentially to the 1/2 power is the same as taking the square root.

It doesn't take a complex formula to show you the advantages of using a spreadsheet to make calculations. Let's say you are working on an electronics project and need a resistance of a certain value. A search through your parts box yields no resistor with the needed value, and no combination that will add to the needed value by connecting them in series.

The formula for resistors in parallel:

$$R_T = \frac{1}{1/R_1 + 1/R_2 + 1/R_3 \dots}$$

requires no complex math, only division

A	B	C	D	E	F	G	H
1	R Value	1/value	Total >>	322.58			
2	1	1000	0.001				
3	2	1000	0.001				
4	3	1000	0.001				
5	4	10000	0.0001				
6	5	0	0				
7	6	0	0				
8	7	0	0				
9	8	0	0				
10	9	0	0				
11	10	0	0				
12	11	0	0				
13	12	0	0				
14	13	0	0				
15	14	0	0				
16	15	0	0				
17							
18		0.0031					
19							
20							
10-Dec-87 04:14 PM							NUM

Fig. 1. An example of using a spreadsheet to calculate values for resistors in parallel. This one is limited to 15 resistors but can be readily expanded to any number needed.

and addition. But it is tedious enough that you might not want to punch the calculator buttons repeatedly to compute the different possibilities through trial and error. When the formula is entered into a spreadsheet, however, it becomes easy to calculate many combinations of resistors in parallel (also capacitors in series).

I set up this spreadsheet to handle up to 15 resistors in parallel, but I could easily expand it to handle any number needed. In column A of Fig. 1, I placed a label for the resistor number to keep track of what value goes where. Column B is where the individual resistances are entered. Column C merely computes the inverse of the number in Column B.

At this point, cells in Column B with a value of zero can cause a problem. Some spreadsheets allow you to set division by zero to equal zero instead of giving you an error message or some indication of infinity. Other spreadsheets allow for an IF..THEN..ELSE function. With this you can enter the formula so that if the value of X in column B is greater than zero, it will calculate 1/X. Otherwise, it will display zero (@IF(B3> 0,1/B3,0) in the Lotus 1-2-3 formula format).

At cell C18, the sum of all the inverses

is calculated and at cell E2, the inverse of this total (C18) is taken (with the same precautions against division by zero). Cell D2 serves as a label for E2.

With this you can easily calculate the equivalent resistance of many combinations of resistors in parallel. Once the formula is entered correctly in the spreadsheet, all subsequent calculations will automatically be correct. Although you could calculate this simple formula repeatedly with a calculator, all the key punching required increases the possibility of mistakes. The probability that you would get tired of doing the calculations and quit is even higher.

Another example is shown using the formula:

$$f = \frac{10^6}{2\pi\sqrt{LC}}$$

Although this formula, where f = frequency in kHz, L = inductance in microhenrys, C = capacitance in picofarads, and $\pi = 3.14$, is more complex, it still does not require use of advanced math functions. This formula calculates the resonant frequency of a series circuit.

Here (Fig. 2) inductance L in microhenrys (μ H) is entered in cell B4 and capacitance C in picofarads (pF) is entered

B1: (,0) @IF(B4*B5>0,(10^6)/(2*3.14159*((B4*B5)^0.5)),0) READY						
	A	B	C	D	E	F
1	Frequency >>	12,031				
2						
3						
4	L in uH	35				
5	C in pF	5				
6						
7						
8						
9						
10						
11						
12						
13						
14						
15						
16						
17						
18						
19						
20						
10-Dec-87 04:22 PM				NUM		

Fig. 2. In this example, the spreadsheet is set up to calculate resonant frequency "f" for given values of capacitance "C" and inductance "L."

in cell B5. The cells in column A immediately to the left are used for labeling. The calculation is done in cell B1, where the formula is entered as $(10/92*3.14*((B4*B5)^0.5))$. The Lotus 1-2-3 IF statement is used to test B4*B5 for greater than zero to prevent division by zero. Again, the square root can be expressed by the 0.5 exponent, which is what I used in this example.

This spreadsheet is not only useful for practical calculations of circuit resonance, but as a teaching tool to easily illustrate the effect of changes in capacitance and inductance on resonant circuits.

Spreadsheet programs are available for almost all brands of computers, and even the less-expensive spreadsheet programs are useful for these types of calculations (graphics are not needed). So the next time you have some electronic calculations to do, give a spreadsheet a try.

Cars and Compact Disc Players

Compact disc players have made substantial inroads in home audio systems and are now being pushed for the automobile. Both as original equipment and in the after market, CD players are now

readily available in car-stereo configurations. Before you rush out and spend the extra money for a car CD player, however, you should consider several reasons why compact disc players might not be the best choice for use in automobiles.

First, consider the advantages of the compact disc and how they interact with the automotive environment. Compact discs offer a greater dynamic range than other forms of recordings and the noiselessness of the quiet passages is especially striking. However, the noiseless quiet passages are difficult to appreciate in a car where wind noise, engine noise and other sounds are mixed in.

The car's level of background noise also affects the usefulness of the wide dynamic range. Recording with a wide dynamic range may compel the listener to constantly adjust the volume; if it is turned loud enough for the soft passages to be audible over the background noise, the loud passages will shatter the windows (or the eardrums, whichever comes first). Similarly, if the loud passages are set at a tolerable volume level, the soft passages will be lost in road noise. This situation is worse with sports cars and not as annoying with luxury cars, but all cars exhibit these characteristics to some

extent. For many years, I have purposely compressed the dynamic range on tapes I record for use in my (sports) car, to overcome just these problems.

The cost of compact discs must also be considered. The cassette tapes I use at present are copies of albums that are kept safely at home. At \$10 to \$20 per CD, I won't buy two copies of each album, and I dislike the idea that my only copy of an album will be subjected to the extreme temperatures and other rigors of use in an automobile. Although CDs are certainly more rugged than LPs, I concur with the growing belief that they are not as indestructible as was first advertised. Compact disc players have error-correction and interpolation circuitry, but there's a limit to what the miracles of electronics can do when discs are severely damaged.

The possibility of theft must also be considered . . . and not just theft of the CD player. The considerable investment in the CDs themselves is at risk. Several years ago, my car was broken into and the thieves took my ham-radio transceiver (evidently thinking it was a CB rig) and 25 tapes in a case. My in-dash radio/tape deck was evidently more trouble than they had time for. My insurance covered loss of the radio but didn't pay a penny for the stolen tapes.

Because I had recorded almost all of the tapes, the pure monetary loss was limited and I had the means to replicate the collection (though the labor was enormous). Even if the cost of replacing stolen CDs is unimportant to you, sooner or later, certain CDs will be irreplaceable. Over time, production of some CDs will be discontinued, and you may have to choose between having your only copy at risk in the car or not listening to it in your car.

These are several reasons why I don't consider a car CD player to be a good choice for me; perhaps some of them will apply to you as well.

Your comments and ideas for this column are welcomed. You can contact me at P.O. Box 678, Garner, NC or by computer on Delphi (CURTPHIL) or The Source (BDK887). **ME**

Clone compatibility; making car signs; computer "mice"

By Ted Needleman

A question that I'm frequently asked is whether a PC compatible, or clone, is as good as a "true blue" IBM. If you already know the answer, and the reasons for it, just skip ahead a bit. But for those of you who don't, the answer today is often "Yes," but always with at least one reservation. This reservation is that as close to 100 percent compatibility as some clones are, *nothing* except another IBM is completely compatible. And even IBMs are not necessarily 100 percent compatible when comparing different IBM models.

Comparing compatibles to an IBM model is a complex subject that can be broken down into many categories. It would require a book to do justice to it. In this brief space, however, comparisons can be briefly considered in two areas: 1) software and hardware compatibility; 2) parts quality.

The major concern in the first group is with the model's BIOS (basic input/output system). This is coded information contained in Read Only Memory (ROM) on the system's motherboard. Its data tells the computer how to read the rest of the operating system from a disk when the computer is powered on, as well as performing self-test diagnostics. It also has much of the control codes on dealing with how disk drives, printers, video screen and keyboard are handled. Since IBM copyrighted this code and holds it close to its vest, supported by a battery of lawyers who are on the lookout for copyright infringement, a different BIOS must be used by compatible makers that gets around the copyright while being as compatible as possible. If the substitute BIOS isn't *very* compatible, you'll have problems running certain MS-DOS applications programs that go directly to BIOS routines rather than through the operating system to attain greater speed. Graphics-oriented programs are notorious for this. Happily, there are ways around the copyright that were found right from the start. Compaq, for example, was fully compatible with IBM's PC

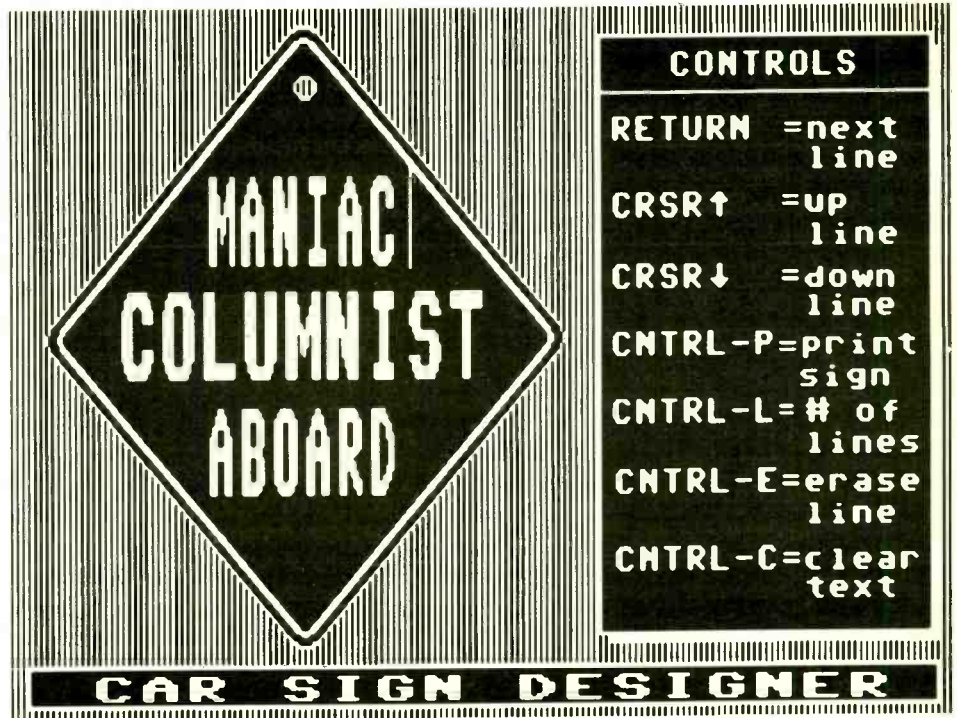

Example of a sign printout using Zebra Systems' "Car Sign Designer."

at the outset. Other "majors" have done the same.

The more serious BIOS challenge for today's buyer is with computer brands that do not carry a major company's name. They're generally sold by mail and feature remarkably low prices.

Today, two companies, Phoenix Technologies and Award Software, provide the BIOS for the majority of compatibles on the market. The BIOS from either company is good (though Phoenix's seems to be held in slightly higher regard by some). Since they're the major makers of BIOS's proven to be compatible with MS-DOS software, I have greater confidence when buying a "no-name" compatible or assembling one from mail-order sources if it comes with a BIOS from one of them. This assures me that the system will run most, if not all, software written for the IBM. Other BIOS brands may do the same...or may not. Check it all out with the supplier before you buy.

Sometimes you can get one of the cited BIOS ROMs substituted.

In addition to software compatibility concerns, hardware compatibility is another consideration. For example, some Tandy computer models use shorter-length full-size expansion boards than the standard IBM size. As a consequence, most of the clone boards sold at low prices won't fit into these machines, forcing you to pay much more when you expand your system (as everyone eventually does).

Other factors are not critical, but can affect compatibility. Disk format (5.25 or 3.5 inch) is a matter of choice. Most major software suppliers include both sizes in their packages now, but software from many smaller companies is only available in the 5.25-inch format. The pc bus format is evolving, too. While IBM's new Micro Channel bus will become a standard, it won't happen for another year or two. Its new VGA graphics will

become a standard a lot sooner. Therefore, when upgrading, you might try and buy a graphics display board that is either compatible or can be upgraded for use with higher-resolution VGA monitors.

Comparing an IBM computer's quality with that of a compatible is a wide-ranging proposition. One has to determine which brand of drives are used and which ones are better, for example. What size (power output) power supply is employed, are the ones used in "no-name" computers UL improved, ad infinitum. IBM in the past has used various brand drives, so it's difficult even here to make a judgment. The same holds true for unsocketed ICs. IBM has done it both ways. For me, I'd always want sockets so that it's easy to change parts.

One can go on and on here. The upshot now for prospective buyers of standard PC/XT/AT compatible computers is that IBM no longer makes them in their original form. So unless you're interested in a PS/2-series model, comparing them directly might be considered moot. Nevertheless, these models are still very much alive and kicking as compatibles. And it's an enormous market.

Should you buy a compatible? I believe so. There are a large number of systems, from companies big and small, which offer a better price/performance than Big Blue ever did. And while there is a saying that "Nobody ever got fired for buying IBM," I know several people who boosted their careers by purchasing three compatible computers for the price of two "true-blues."

To Less Serious Matters

While the greatest amount (in dollars) of software sold these days is for "serious" applications, such as word processing, spreadsheets, and the like, there is still a large market for entertainment software. After all, "All work and no play..." One such piece of software is Car Sign Designer from Zebra Systems. This program, available for the IBM, Apple II and IIGS, and C-64 and C-128, lets you make your own yellow diamond-shaped car signs. You know the ones. They bear

such messages as "BABY ON BOARD," "WIFE IN TRUNK," and other such witticisms.

If you've always wanted to express your own sentiments, such as "TAKE A LONG DRIVE OFF A SHORT PIER," now is your chance. For under \$30, you get two yellow sign holders, a package of yellow fan-fold pin-feed paper and the program disk with which to do it.

I received the IBM version. After copying it to my hard disk, and running an INSTALL program to specify my display adapter and printer, I proceeded to start making signs. The program comes with its own simple editor, and both the sign in progress and the editing keys are shown on the display (see screen dump). The CTRL-L command determines the number of lines on your sign (from one to four) and more or less centers everything. When the sign is printed (with CTRL-P) you fold the paper along the edges and slide it into the yellow plastic holder.

Extra sign holders, in packages of six, are available from Zebra. The signs come out with the letters a bit jagged, and not all printers are supported, so check with Zebra to make sure your configuration will work with the software. It's not the most serious piece of software I've reviewed in the last couple of months, but it is fun and very easy to use.

A Mouse-Eating Cat?

Until I started using an Apple Macintosh, I couldn't figure out what all the "mouse-mania" was about. After all, much of what I do is word processing, and while I'm not the world's greatest typist, anything that requires taking my hands off the keyboard is only going to slow me down even further. Then I started using PageMaker and MacWrite on the Macintosh. I discovered that pull-down menus, changing fonts, and selecting portions of text with the mouse quickly becomes addictive, and now all three of my PCs also sport little rodents.

Two of these are mechanical (Microsoft and Torrington), and the third is optical (Mouse Systems). Each has its pluses and minuses, but all require some

"Made in U.S.A."



We've been supplying quality crystals since 1965 — long before the flood of cheap imports.

We're still supplying quality crystals with

- Quick Turnaround
- Low Price
- High Quality

TO SOLVE CRYSTAL PROBLEMS, GET THIS CATALOG



JAN CRYSTALS

P.O. Box 06017

Ft. Myers, FL 33906

(813) 936-2397

CALL 1-800-237-3063
FREE (Except Florida)



CIRCLE 44 ON FREE INFORMATION CARD

A Career Start in 21st Century Electronics

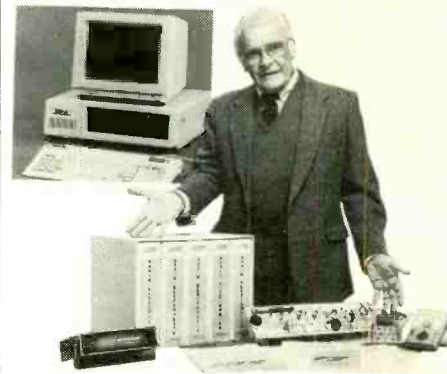

Since 1905, National Technical Schools has helped over 300,000 people just like you learn at their own pace and build successful careers. Enter the boom in electronics through home study courses in Microcomputer Technology & Servicing, TV & Radio Servicing, Video Technology, Industrial Controls (Micro-processing), Robotics or Basic Electronics.

To begin a new career or to sharpen your current skills, call 1-800-B-BETTER or write us today for complete details: NTS, Dept. ME-410, 456 West M.L. King Jr. Blvd., Los Angeles CA 90037.

Accredited by National Home Study Council
CIRCLE 45 ON FREE INFORMATION CARD

PC CAPERS...

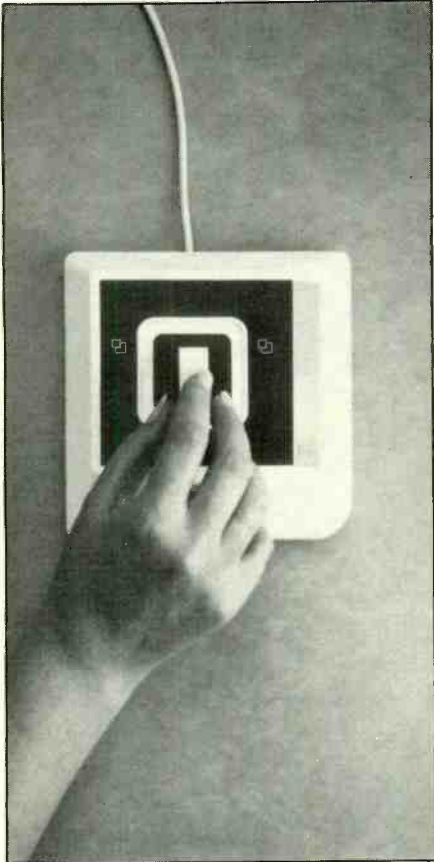

Felix for Mac Plus.



Felix for the IBM PC.

amount of clear desk space for "moving and shlepping." Substituting a joy-stick or trackball for these non-game applications never met with success. Last week, however, what may ultimately be the mouse's replacement showed up. It's called Felix.

I received both the IBM and Macintosh versions from Lightgate, but have only had the chance to experiment with the Mac Felix so far. Felix is a small box about the size of a floppy disk and approximately $\frac{3}{4}$ inch high. It has a small handle that slides about in a square area of about 1.25 inches on a side. On top of this handle is a button. The Mac version has two small membrane switches on the base to either side of the "slide area" (more about this in a while). It works with the original 128K Mac, the 512K

Mac and the Mac Plus. Versions for the SE and Mac II will be out soon. Felix plugs into the mouse port on the Mac, and into a Comm port on the IBM. The Mac version takes its power from the mouse port, while the IBM version includes a small "wall-plug" power supply which plugs into the serial computer's DB-25 connector.

Setting up the Mac version took about 45 seconds. First I unplugged the mouse, plugged Felix in, booted the Mac and selected the Control Panel from the Finder. After clicking on the tablet pointing mode, I "taught" Felix the screen size by running the pointer around the video screen's perimeter. That's all there is to setting up the system!

Felix is an interesting device. The handle is held with your fingers like a pencil.

A very small displacement of the handle translates into a much larger one on the screen. For those of us who are used to sweeping movements with a mouse, this takes a little getting used to. Once mastered (about 10-15 minutes), though, the fingers exercise a great deal of control.

The device operates electromechanically. Inside the case is an array of LEDs and detectors. The sliding handle operates a gate through which the beams shine as the handle is moved. There is little to go wrong with this design. Additionally, both versions of Felix have a precision mode, where full travel of the handle is limited to movement of the cursor over only a portion of the screen. The switch to precision mode is accomplished by pressing the membrane switch on the Mac version, and a scheme called "Hot-Spots" on the IBM version. Here, moving the handle to the lower right corner of travel and clicking the handle button serves to put Felix into precision mode. By using combinations of the CTRL, ALT and SHIFT keys, various macros can be assigned to three of the corner "Hot-Spots."

Felix is a cleverly designed device that overcomes many of the limitations of conventional mice. Whether the "cat" can catch up with the mouse, much less devour it, remains to be seen. At a list price of \$199 for the PC version and \$149 for the Mac version, it is considerably more expensive than a mouse. Its precision mode, however, will be very attractive to those of you who work with CAD or paint programs, while the "Hot-Spots" can make working with spreadsheets and word processors much simpler and efficient. **ME**

Names and Addresses

Zebra Systems, Inc.
78-06 Jamaica Ave.
Woodhaven, NY 11421
(718) 296-2385

Lightgate
6300 Telegraph Ave.
Oakland, CA 94608
(415) 653-8500

MASTER THE NEW ELECTRONICS WITH MCGRAW-HILL'S

Contemporary Electronics Series

The fast, easy and low cost way to meet the challenges of today's electronic innovations. A unique learning series that's as innovative as the circuitry it explains, as fascinating as the experiments you build and explore.

From digital logic to the latest 32-bit microprocessor, the McGraw-Hill Contemporary Electronics Series puts you into the electronic picture one easy step at a time. Fifteen unique Concept Modules, sent to you one every 4-6 weeks, give you a handle on subjects like optoelectronics, robotics, integrated circuits, lasers, fiber optics and more.

Each Concept Module goes right to the heart of the matter. You waste no time on extraneous material or outdated history. It's a fast, efficient, and lively learning experience... a non-traditional approach to the most modern of subject matter.

Unique Interactive Instruction

With each module, you receive a McGraw-Hill Action Audio Cassette. Each tape is a dynamic discussion that drives home the key facts about the subject. Your learning

With your first module, you get this solderless breadboarding system. You'll use it throughout the series to build electronic circuits and bring concepts to life.

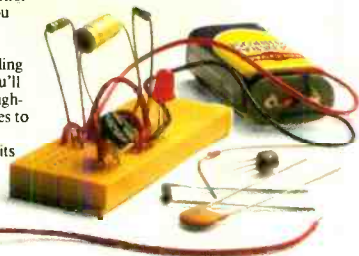

experience is reinforced through interaction with vividly illustrated text, audio cassettes, and actual electronic experiments. Indexed binders preserve backup material, notes, and tapes for convenient referral.

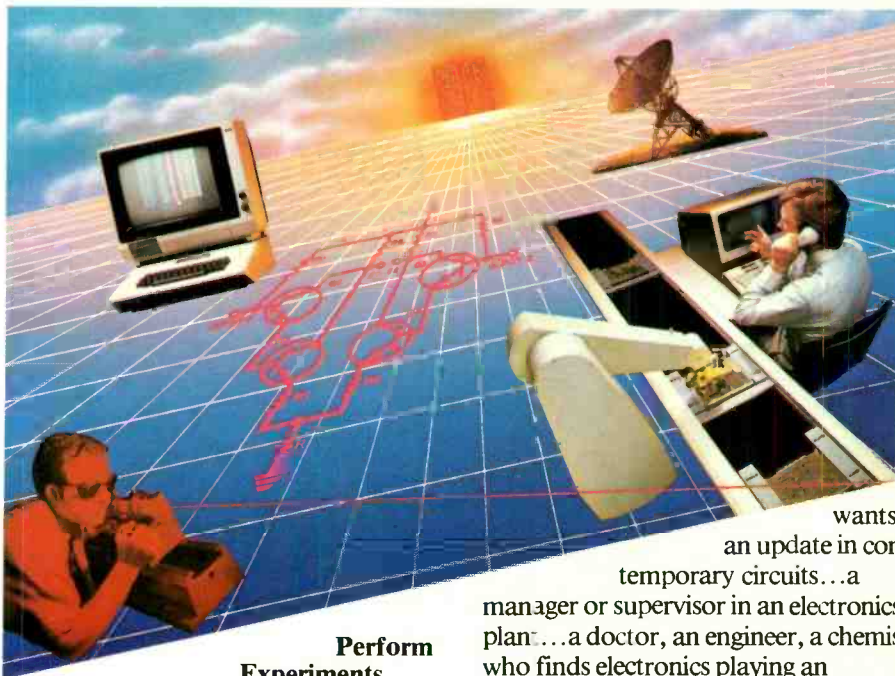

Perform Experiments in Contemporary Electronics

Throughout your series, laboratory experiments reinforce every significant point. This essential experience... dynamic, hands-on demonstrations of theory in practice... will help you master principles that apply all the way up to tomorrow's latest VLSI (Very Large Scale Integrated) circuitry.

In your very first module, you'll use integrated circuits to build a digital oscillator, verifying its operation with a light emitting diode (LED). You'll learn to identify passive and active components, understand concepts common to all electronic circuits.

For Anyone Interested in Electronics

The Contemporary Electronics Series is designed for anyone from hobbyist to professional. It's for you if you're looking for new fields of interest... if you're a teacher who

wants an update in contemporary circuits... a manager or supervisor in an electronics plant... a doctor, an engineer, a chemist who finds electronics playing an increasingly important role in your work. It's even for electronics engineers or technicians who feel their training needs freshening up. It's the quickest, most convenient, probably least expensive way to do it. And the only one that gives you hands-on experience.



15-Day No-Risk Trial

To order your first module without risk, send the card today. Examine it for 15 days under the terms of the order form and see how the Contemporary Electronics Series gets you into today's electronics. If card has been used, write us for ordering information.



McGraw-Hill
Continuing Education Center
3939 Wisconsin Ave.
Washington, D.C. 20016

GOfer—A High-Speed Text Searcher

By Art Salsberg

Microlytics, Inc. (E. Rochester, NY) established itself as a winning software company in the auxiliary word-processing field with its Word Finder thesaurus program, followed by a hardware spelling checker developed in conjunction with Xerox, PC Type Right. Now it has introduced a text searcher that can be added on to popular word processors and other programs—GOfer.

Fast text-retrieval software is the latest type of utility that appeals to computer users. The \$79.95 GOfer pop-up program is one of this new breed. It's designed for use with IBM PC/compatible computers and PS/2 machines, working with PC/MS-DOS 2.0 and higher. It comes on a 5¼-inch disk and is also available on a 3¼-inch disk.

GOfer takes up 79K of RAM when it's memory resident (it can be loaded from DOS without being RAM resident, too), and is not copy-protected. A clearly written and satisfactorily illustrated 78-page manual accompanies the program.

Using GOfer

GOfer installs easy enough with the aid of menus for the user to choose a variety of options. One of the setup options requires you to select programs you want GOfer to work with; about 30 programs are listed, including ASCII (editor), Lotus 1-2-3, PFS-Write, Sidekick, WordPerfect, Xywrite, WordStar, and dBase III, among them. At least one has to be selected, while the maximum number that can be chosen is ten. Buffer size and files choices can be changed from its preset sizes to adjust RAM memory size to be used if available memory is limited.

Read-from (source) and Write-to (target) programs are selected, with the most popularly used one chosen as the default. This might be your word-processor, for example.

Activating GOfer while within an applications program is accomplished by pressing the traditional hot keys, in this case Alt-G. (Another command key can be chosen if there's any conflict with a

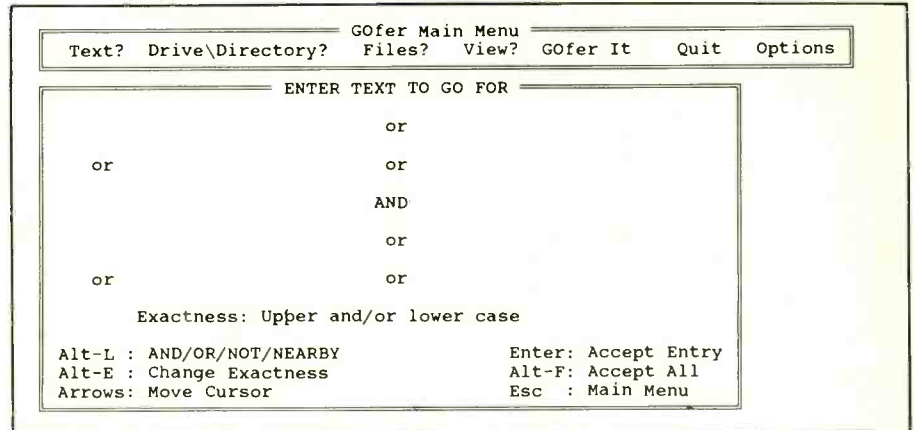

GOfer's Export Menu.

different program.) Pressing these keys places two windows on the screen while you're in the application program: the Main Menu, which is a horizontal line-up of major choices such as DriveDirectory?, and a Text Entry Window (see illustration). Pressing ESC at any time activates the Main Menu.

One normally starts by typing out text-search needs in "Enter Text To Go For." Pressing the Return key moves the cursor along its way. Up to 20 characters can be typed in each field. The eight fields presented are divided in half by a logical relationship, starting with AND. Pressing Alt-L changes the relationship be-

tween the upper and lower groups to OR, NOT or NEARBY. Choosing the latter brings up a small window to let you choose just how close they can be. An EXACTNESS selection fine tunes the search even more by allowing greater deviations, such as upper and/or lower case and misspelled words.

This done, you choose the drive and directory by either entering what's highlighted or typing in what you want. You can choose a directory tree, too, in the event you're not sure what the name is. All files in the chosen directory can be listed and the user simply navigates with the cursor-movement keys to the one(s)

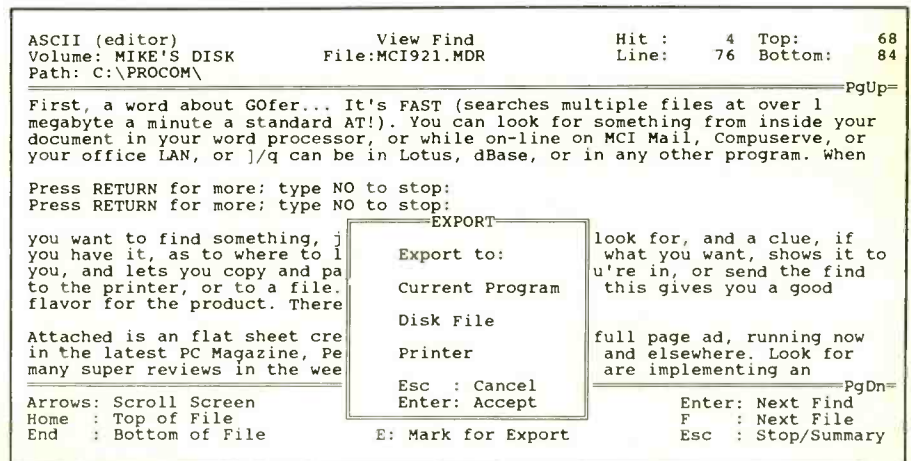

The program's Text Entry Window.

he wants, selecting it by pressing the space bar, which highlights it. Pressing Return confirms this and brings up an Output window.

Here you have a choice of viewing each find on the screen, writing to a disk file, printing or just plain browsing through the retrieved text. By pressing the key, E, while viewing or browsing, a small window pops up in the middle of the screen that's titled EXPORT. This gives you an opportunity to select the beginning and end of the retrieved text for transfer of the information to a destination you choose, such as the application program you're working in.

Selecting "Options" from the Main Menu provides the user with operating flexibility such as creating a second file that's compressed up to 50 percent, decompress, copy, delete, rename, changing the configuration, varying colors, etc.

Comments

GOfer worked admirably. It operates speedily in practice, while being spec'd at search rates through multiple files at up to 16K bytes per second on a PC-AT computer. There's no time wasted in compiling an index, as some other text-retrieval programs require, so the search starts immediately.

An indexed program, however, can have the ability to do the actual search faster once the index is compiled, though. This would be better if one had enormous files that don't change much. For most purposes, however, GOfer fits the bill very well.

Twenty characters and eight fields might seem limiting to some, but I found that I didn't need that much descriptive space at all. I like GOfer's compatibility with so many programs, which also includes communications programs. WordStar 3.x or 4.0 users will particularly welcome GOfer since they do not incorporate windows. Now, at least, there's some type of shot at quickly checking out text in another file while working within the word processor.

In all, GOfer is a useful utility to add, along with other handy ones. **ME**

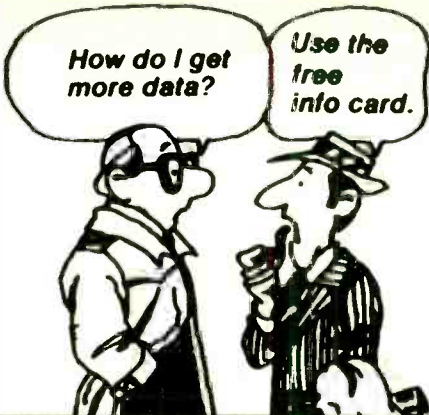

Free Product Information

Readers can obtain free information on products advertised by certain companies, as well as for some editorially mentioned products. Simply circle the appropriate number printed below an advertisement onto the Modern Electronics "Free Information Service" card bound into this issue. After filling in your name and address, just mail the postpaid card. Your request will be forwarded directly to the advertiser with a mailing label prepared by our reader-service department to ensure speedy response.

MCM Electronics

Quality is not an idle term at MCM! Every incoming shipment is checked and re-checked by our QC Department to see to it that you never receive a defective part.

Service is something you can always count on. Our experienced Sales Representatives and Electronic Technicians are standing by to take your orders and answer your questions quickly and courteously.

Selection helps us stand heads above the competition with nearly 10,000 in-stock items (including many hard-to-find products) that can be shipped to you immediately.

Discover the MCM difference! Order your copy of MCM's new Catalog today. It's a decision you'll never regret!

For your FREE copy, call TOLL-FREE! 1-800-543-4330
In Ohio, call 1-800-762-4315
In Alaska or Hawaii, call 1-800-858-1849

MCM ELECTRONICS
 358 E. CONGRESS PARK DR.
 CLEVELAND, OH 44115
 A PREMIER Company

SOURCE NO. ME-33



CIRCLE 38 ON FREE INFORMATION CARD

MODERN ELECTRONICS MART

Classified Commercial Rates: \$1 per word, 15-word minimum (\$15.00) prepaid. (Word count includes name and address; ZIP code and abbreviation each count as one word; P.O. Box number and telephone number count as two words each.) Indicate free category heading (Computers, Communications, Electronics, Video or Miscellaneous). A special heading is available for a \$6 surcharge. First word only is set boldface caps at no charge. Add 20% for additional boldface words.

Non-Commerical Rates: FREE to subscribers, as space permits; maximum 15 words. A recent *Modern Electronics* mailing label must accompany ad.

Mart Display Rates: 1" x 1 col., \$120; 2" x 1 col., \$230. Prepayment discount 5% for 6 issues; 10% for 12 issues prepaid at once.

(All advertisers with P.O. Box addresses must supply permanent address and telephone number. Copy is subject to publisher approval.)

Mailing Information: Copy must be received by the publisher by the 25th of the third month preceding the cover date. Send Advertising material with check or money order to: Modern Electronics, Classified Department, 76 N. Broadway, Hicksville, NY 11801.

PICKS UP A WHISPER 50 FEET AWAY!

The model WAT-50 miniature FM transmitter uses a 4-stage circuit NOT to be confused with a simple wireless microphone. Simply snap the unit on top of a 9V battery and you can hear every sound in an entire house up to 1 mile away! Use with any FM radio. Tunes to any frequency from 70mhz - 130mhz. Easy to assemble kit includes all parts and instructions. Only 29.98 tax incl.

The **WIRELESS TELEPHONE TRANSMITTER** model WTT-20 is only about the size of a dime, yet transmits both sides of a telephone conversation to any FM radio with crystal clarity. Completely automatic. Uses power from the telephone line itself - never needs a battery! Up to 1/4 mile range. Tunes from 70mhz - 130mhz. Easy to assemble kit includes all parts and instructions. Only \$29.98 tax incl.

Call or send **MO, VISA, MC** for immediate delivery. Single kit orders include **\$1.50 S&H. FREE SHIPPING** on orders of 2 or more. All orders shipped by U.S. Mail. COD add \$4.00. Personal checks allow 21 days.

DECO INDUSTRIES
BOX 607, BEDFORD HILLS, NY 10507
914-232-3878

CIRCLE 4 ON FREE INFORMATION CARD

REMOTE CONTROL KEYCHAIN

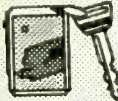

Complete w/min-i-transmitter and +5 vdc RF receiver Fully assembled including parts to build your own auto alarm

\$19.95 Check, Visa or M/C 30 days return

VISITECT INC. (415) 872-0128
PO BOX 5442, SO. SAN FRAN., CA 94080

VIDEO

CABLE TV We carry a full line including units for Tocom and Pioneer. Tocom tuners, technically correct, recordable, auto sensing. Units for Video Tape Copyguard from \$59.95. Deluxe Electronics, 1432 Heim, Orange, CA 92665 (714) 998-6866.

COPYGUARD CORRECTOR RESTORES RENTAL MOVIES. Connects between VCRs. Satisfaction Guaranteed. \$59.95 plus \$4 handling. 1-800-338-8751.

CABLE DESCRAMBLERS - secret manual. Build your own. Instructions, schematics, suppliers list for SSAVI, Gated Sync, Sine-wave. (HBO, Showtime, Cinemax, UHF, adult.) \$8.95, \$1.00 postage. **CABLETRONICS**, Box 30502ME, Bethesda, MD 20814.

Pay TV and Satellite Descrambling. Schematics, theory, bypasses for all major systems. \$14.95. **Experiments With Videocipher.** Cloning, musketeering. \$14.95. **Cable TV.** System design, security \$12.95. **MDS/MMDS Handbook.** Microwave hacking. \$9.95. **Build Satellite Systems Under \$600.** \$12.95. Any 3/\$27 of above. **Z-Trap.** Eliminates SSAVI flashing. \$14.95. **Z-Bag.** Bogus address generator for those studying addressable systems \$19.95. Both **Z-Trap** and **Z-Bag** \$29.95. **Scrambling News.** Monthly. Terrific. \$24.95/yr. Sample \$5 (refundable). Catalog #1. **Shojiki Electronics Corp.**, 1327P Niagara St., Niagara Falls, NY 14303. COD's 716-284-2163.

UNIQUE Video/film supplies! **FREE** catalog. Superior Pix, 323f S. Franklin Bldg., Suite 473, Chicago, IL 60606.

MICRO MART

508 Central Ave.
Westfield, N.J. 07090
(201) 654-6008

TTL SERIES	74367	60	74LS164	45	4012	25
7400	25	74396	85	4013	25	
7401	25	74393	100	74LS173	45	4015
7402	25	75324	20	74LS174	30	4016
7403	25	75452	55	74LS191	45	4019
7404	25	75454	55	74LS192	60	4022
7405	25	75454	55	74LS194	60	4023
7406	25	75454	55	74LS195	60	4024
7407	25	75454	55	74LS221	55	4025
7408	25	75454	55	74LS240	65	4035
7409	25	75454	55	74LS241	60	4040
7410	25	75454	55	74LS242	60	4041
7411	25	74LS500	20	74LS244	85	4042
7412	25	74LS501	20	74LS245	70	4046
7413	25	74LS502	20	74LS247	190	4047
7414	25	74LS503	20	74LS251	40	4049
7415	25	74LS504	20	74LS252	40	4050
7416	25	74LS505	20	74LS257	35	4051
7417	25	74LS506	20	74LS258	40	4052
7418	25	74LS507	20	74LS259	40	4053
7419	25	74LS510	20	74LS260	40	4056
7420	25	74LS511	20	74LS262	40	4058
7421	25	74LS512	20	74LS264	40	4059
7422	25	74LS513	25	74LS273	45	4070
7423	25	74LS514	35	74LS290	75	4071
7424	25	74LS515	20	74LS293	75	4072
7425	25	74LS520	20	74LS525	75	4073
7426	25	74LS521	20	74LS528	60	4076
7427	25	74LS522	20	74LS529	35	4077
7428	25	74LS526	20	74LS536	75	4078
7429	25	74LS527	20	74LS535	75	4081
7430	25	74LS528	20	74LS536	75	4082
7431	25	74LS529	50	74LS367	40	4085
7432	25	74LS300	20	74LS368	35	4086
7433	25	74LS301	20	74LS373	65	4093
7434	25	74LS302	20	74LS375	65	4163
7435	25	74LS303	20	74LS376	75	4164
7436	25	74LS304	20	74LS377	75	4165
7437	25	74LS305	20	74LS378	75	4166
7438	25	74LS306	20	74LS379	75	4167
7439	25	74LS307	20	74LS380	75	4168
7440	25	74LS308	20	74LS381	75	4169
7441	25	74LS309	20	74LS382	75	4170
7442	25	74LS310	20	74LS383	75	4171
7443	25	74LS311	20	74LS384	75	4172
7444	25	74LS312	20	74LS385	75	4173
7445	25	74LS313	20	74LS386	75	4174
7446	25	74LS314	20	74LS387	75	4175
7447	25	74LS315	20	74LS388	75	4176
7448	25	74LS316	20	74LS389	75	4177
7449	25	74LS317	20	74LS390	75	4178
7450	25	74LS318	20	74LS391	75	4179
7451	25	74LS319	20	74LS392	75	4180
7452	25	74LS320	20	74LS393	75	4181
7453	25	74LS321	20	74LS394	75	4182
7454	25	74LS322	20	74LS395	75	4183
7455	25	74LS323	20	74LS396	75	4184
7456	25	74LS324	20	74LS397	75	4185
7457	25	74LS325	20	74LS398	75	4186
7458	25	74LS326	20	74LS399	75	4187
7459	25	74LS327	20	74LS400	75	4188
7460	25	74LS328	20	74LS401	75	4189
7461	25	74LS329	20	74LS402	75	4190
7462	25	74LS330	20	74LS403	75	4191
7463	25	74LS331	20	74LS404	75	4192
7464	25	74LS332	20	74LS405	75	4193
7465	25	74LS333	20	74LS406	75	4194
7466	25	74LS334	20	74LS407	75	4195
7467	25	74LS335	20	74LS408	75	4196
7468	25	74LS336	20	74LS409	75	4197
7469	25	74LS337	20	74LS410	75	4198
7470	25	74LS338	20	74LS411	75	4199
7471	25	74LS339	20	74LS412	75	4200
7472	25	74LS340	20	74LS413	75	4201
7473	25	74LS341	20	74LS414	75	4202
7474	25	74LS342	20	74LS415	75	4203
7475	25	74LS343	20	74LS416	75	4204
7476	25	74LS344	20	74LS417	75	4205
7477	25	74LS345	20	74LS418	75	4206
7478	25	74LS346	20	74LS419	75	4207
7479	25	74LS347	20	74LS420	75	4208
7480	25	74LS348	20	74LS421	75	4209
7481	25	74LS349	20	74LS422	75	4210
7482	25	74LS350	20	74LS423	75	4211
7483	25	74LS351	20	74LS424	75	4212
7484	25	74LS352	20	74LS425	75	4213
7485	25	74LS353	20	74LS426	75	4214
7486	25	74LS354	20	74LS427	75	4215
7487	25	74LS355	20	74LS428	75	4216
7488	25	74LS356	20	74LS429	75	4217
7489	25	74LS357	20	74LS430	75	4218
7490	25	74LS358	20	74LS431	75	4219
7491	25	74LS359	20	74LS432	75	4220
7492	25	74LS360	20	74LS433	75	4221
7493	25	74LS361	20	74LS434	75	4222
7494	25	74LS362	20	74LS435	75	4223
7495	25	74LS363	20	74LS436	75	4224
7496	25	74LS364	20	74LS437	75	4225
7497	25	74LS365	20	74LS438	75	4226
7498	25	74LS366	20	74LS439	75	4227
7499	25	74LS367	20	74LS440	75	4228
7500	25	74LS368	20	74LS441	75	4229
7501	25	74LS369	20	74LS442	75	4230
7502	25	74LS370	20	74LS443	75	4231
7503	25	74LS371	20	74LS444	75	4232
7504	25	74LS372	20	74LS445	75	4233
7505	25	74LS373	20	74LS446	75	4234
7506	25	74LS374	20	74LS447	75	4235
7507	25	74LS375	20	74LS448	75	4236
7508	25	74LS376	20	74LS449	75	4237
7509	25	74LS377	20	74LS450	75	4238
7510	25	74LS378	20	74LS451	75	4239
7511	25	74LS379	20	74LS452	75	4240
7512	25	74LS380	20	74LS453	75	4241
7513	25	74LS381	20	74LS454	75	4242
7514	25	74LS382	20	74LS455	75	4243
7515	25	74LS383	20	74LS456	75	4244
7516	25	74LS384	20	74LS457	75	4245
7517	25	74LS385	20	74LS458	75	4246
7518	25	74LS386	20	74LS459	75	4247
7519	25	74LS387	20	74LS460	75	4248
7520	25	74LS388	20	74LS461	75	4249
7521	25	74LS389	20	74LS462	75	4250
7522	25	74LS390	20	74LS463	75	4251
7523	25	74LS391	20	74LS464	75	4252
7524	25	74LS392	20	74LS465	75	4253
7525	25	74LS393	20	74LS466	75	4254
7526	25	74LS394	20	74LS467	75	4255
7527	25	74LS395	20	74LS468	75	4256
7528	25	74LS396	20	74LS469	75	4257
7529	25	74LS397	20	74LS470	75	4258
7530	25	74LS398	20	74LS471	75	4259
7531	25	74LS399	20	74LS472	75	4260
7532	25	74LS400	20	74LS473	75	4261
7533	25	74LS401	20	74LS474	75	4262
7534	25	74LS402	20	74LS475	75	4263
7535	25	74LS403	20	74LS476	75	4264
7536	25	74LS404	20	74LS477	75	4265
7537	25	74LS405	20	74LS478	75	4266
7538	25	74LS406	20	74LS479	75	4267
7539	25	74LS407	20	74LS480	75	4268
7540	25	74LS408	20	74LS481	75	4269
7541	25	74LS409	20	74LS482	75	4270
7542	25	74LS410	20	74LS483	75	4271
7543	25	74LS411	20	74LS484	75	4272
7544	25	74LS412	20	74LS485	75	4273
7545	25	74LS413	20	74LS486	75	4274
7546	25	74LS414	20	74LS487	75	4275
7547	25	74LS415	20	74LS488	75	4276
7548	25	74LS416	20	74LS489	75	4277
7549	25	74LS417	20	74LS490	75	4278
7550	25	74LS418	20	74LS491	75	4279
7551	25	74LS419	20	74LS492	75</	

VISA
NATIONAL SEMICONDUCTOR • PANASONIC
OK MACHINE • EWC, INC. • INTERSIL • AD
EAC, INC. • J. W. MILLER • AAVID ENGINEER
E. F. JOHNSON • ATLANTIC SEMICONDUCTOR

256K (262,144 x 1) DRAM 150NS \$5.70/1; \$39.95/9
Factory Firsts

JONES • DIAMOND TOOL • UNGAR • ES • CW INDUSTRIES • AMDEK • G.E. UGAR • YAGEO • J. W. MILLER • REX CHEMICALS • ARIES • LUXCO

INTEGRATED CIRCUITS

Part No.	Price	Part No.	Price
7400 TTL		4000 CMOS	
7400N	1.50	74LS00	1.50
7401N	1.50	74LS01	1.50
7402N	1.50	74LS02	1.50
7403N	1.50	74LS03	1.50
7404N	1.50	74LS04	1.50
7405N	1.50	74LS05	1.50
7406N	1.50	74LS06	1.50
7407N	1.50	74LS07	1.50
7408N	1.50	74LS08	1.50
7409N	1.50	74LS09	1.50
7410N	1.50	74LS10	1.50
7411N	1.50	74LS11	1.50
7412N	1.50	74LS12	1.50
7413N	1.50	74LS13	1.50
7414N	1.50	74LS14	1.50
7415N	1.50	74LS15	1.50
7416N	1.50	74LS16	1.50
7417N	1.50	74LS17	1.50
7418N	1.50	74LS18	1.50
7419N	1.50	74LS19	1.50
7420N	1.50	74LS20	1.50
7421N	1.50	74LS21	1.50
7422N	1.50	74LS22	1.50
7423N	1.50	74LS23	1.50
7424N	1.50	74LS24	1.50
7425N	1.50	74LS25	1.50
7426N	1.50	74LS26	1.50
7427N	1.50	74LS27	1.50
7428N	1.50	74LS28	1.50
7429N	1.50	74LS29	1.50
7430N	1.50	74LS30	1.50
7431N	1.50	74LS31	1.50
7432N	1.50	74LS32	1.50
7433N	1.50	74LS33	1.50
7434N	1.50	74LS34	1.50
7435N	1.50	74LS35	1.50
7436N	1.50	74LS36	1.50
7437N	1.50	74LS37	1.50
7438N	1.50	74LS38	1.50
7439N	1.50	74LS39	1.50
7440N	1.50	74LS40	1.50
7441N	1.50	74LS41	1.50
7442N	1.50	74LS42	1.50
7443N	1.50	74LS43	1.50
7444N	1.50	74LS44	1.50
7445N	1.50	74LS45	1.50
7446N	1.50	74LS46	1.50
7447N	1.50	74LS47	1.50
7448N	1.50	74LS48	1.50
7449N	1.50	74LS49	1.50
7450N	1.50	74LS50	1.50
7451N	1.50	74LS51	1.50
7452N	1.50	74LS52	1.50
7453N	1.50	74LS53	1.50
7454N	1.50	74LS54	1.50
7455N	1.50	74LS55	1.50
7456N	1.50	74LS56	1.50
7457N	1.50	74LS57	1.50
7458N	1.50	74LS58	1.50
7459N	1.50	74LS59	1.50
7460N	1.50	74LS60	1.50
7461N	1.50	74LS61	1.50
7462N	1.50	74LS62	1.50
7463N	1.50	74LS63	1.50
7464N	1.50	74LS64	1.50
7465N	1.50	74LS65	1.50
7466N	1.50	74LS66	1.50
7467N	1.50	74LS67	1.50
7468N	1.50	74LS68	1.50
7469N	1.50	74LS69	1.50
7470N	1.50	74LS70	1.50
7471N	1.50	74LS71	1.50
7472N	1.50	74LS72	1.50
7473N	1.50	74LS73	1.50
7474N	1.50	74LS74	1.50
7475N	1.50	74LS75	1.50
7476N	1.50	74LS76	1.50
7477N	1.50	74LS77	1.50
7478N	1.50	74LS78	1.50
7479N	1.50	74LS79	1.50
7480N	1.50	74LS80	1.50
7481N	1.50	74LS81	1.50
7482N	1.50	74LS82	1.50
7483N	1.50	74LS83	1.50
7484N	1.50	74LS84	1.50
7485N	1.50	74LS85	1.50
7486N	1.50	74LS86	1.50
7487N	1.50	74LS87	1.50
7488N	1.50	74LS88	1.50
7489N	1.50	74LS89	1.50
7490N	1.50	74LS90	1.50
7491N	1.50	74LS91	1.50
7492N	1.50	74LS92	1.50
7493N	1.50	74LS93	1.50
7494N	1.50	74LS94	1.50
7495N	1.50	74LS95	1.50
7496N	1.50	74LS96	1.50
7497N	1.50	74LS97	1.50
7498N	1.50	74LS98	1.50
7499N	1.50	74LS99	1.50
7500N	1.50	74LS100	1.50

T.T.C. SOCKETS

SOLDER TAIL DIP SOCKETS
• Low profile
• Your choice: TIN OR GOLD
• Tin plated solder tail
• Gold plated solder tail
• Memory
• Micro

5% Carbon Film Resistors

Available in 1/4, 1/2, 1W
• Working Voltage
• Max. Working Voltage
• Rated Ambient Temp.
• Operating Temp. Range
• Dimension "L"
• Dimension "D"
• Dimension "W"
• How to Order: Take any standard value in 1, 5, 10, 15, 20, 25, 30, 33, 36, 39, 43, 47, 51, 56, 62, 68, 75, 82, 91, 100, 110, 120, 130, 150, 160, 180, 200, 220, 240, 270, 300, 330, 360, 390, 430, 470, 510, 560, 620, 680, 750, 820, 910, 1000, 1100, 1200, 1300, 1500, 1600, 1800, 2000, 2200, 2400, 2700, 3000, 3300, 3600, 3900, 4300, 4700, 5100, 5600, 6200, 6800, 7500, 8200, 9100, 10000, 11000, 12000, 13000, 15000, 16000, 18000, 20000, 22000, 24000, 27000, 30000, 33000, 36000, 39000, 43000, 47000, 51000, 56000, 62000, 68000, 75000, 82000, 91000, 100000, 110000, 120000, 130000, 150000, 160000, 180000, 200000, 220000, 240000, 270000, 300000, 330000, 360000, 390000, 430000, 470000, 510000, 560000, 620000, 680000, 750000, 820000, 910000, 1000000, 1100000, 1200000, 1300000, 1500000, 1600000, 1800000, 2000000, 2200000, 2400000, 2700000, 3000000, 3300000, 3600000, 3900000, 4300000, 4700000, 5100000, 5600000, 6200000, 6800000, 7500000, 8200000, 9100000, 10000000, 11000000, 12000000, 13000000, 15000000, 16000000, 18000000, 20000000, 22000000, 24000000, 27000000, 30000000, 33000000, 36000000, 39000000, 43000000, 47000000, 51000000, 56000000, 62000000, 68000000, 75000000, 82000000, 91000000, 100000000, 110000000, 120000000, 130000000, 150000000, 160000000, 180000000, 200000000, 220000000, 240000000, 270000000, 300000000, 330000000, 360000000, 390000000, 430000000, 470000000, 510000000, 560000000, 620000000, 680000000, 750000000, 820000000, 910000000, 1000000000, 1100000000, 1200000000, 1300000000, 1500000000, 1600000000, 1800000000, 2000000000, 2200000000, 2400000000, 2700000000, 3000000000, 3300000000, 3600000000, 3900000000, 4300000000, 4700000000, 5100000000, 5600000000, 6200000000, 6800000000, 7500000000, 8200000000, 9100000000, 10000000000, 11000000000, 12000000000, 13000000000, 15000000000, 16000000000, 18000000000, 20000000000, 22000000000, 24000000000, 27000000000, 30000000000, 33000000000, 36000000000, 39000000000, 43000000000, 47000000000, 51000000000, 56000000000, 62000000000, 68000000000, 75000000000, 82000000000, 91000000000, 100000000000, 110000000000, 120000000000, 130000000000, 150000000000, 160000000000, 180000000000, 200000000000, 220000000000, 240000000000, 270000000000, 300000000000, 330000000000, 360000000000, 390000000000, 430000000000, 470000000000, 510000000000, 560000000000, 620000000000, 680000000000, 750000000000, 820000000000, 910000000000, 1000000000000, 1100000000000, 1200000000000, 1300000000000, 1500000000000, 1600000000000, 1800000000000, 2000000000000, 2200000000000, 2400000000000, 2700000000000, 3000000000000, 3300000000000, 3600000000000, 3900000000000, 4300000000000, 4700000000000, 5100000000000, 5600000000000, 6200000000000, 6800000000000, 7500000000000, 8200000000000, 9100000000000, 10000000000000, 11000000000000, 12000000000000, 13000000000000, 15000000000000, 16000000000000, 18000000000000, 20000000000000, 22000000000000, 24000000000000, 27000000000000, 30000000000000, 33000000000000, 36000000000000, 39000000000000, 43000000000000, 47000000000000, 51000000000000, 56000000000000, 62000000000000, 68000000000000, 75000000000000, 82000000000000, 91000000000000, 100000000000000, 110000000000000, 120000000000000, 130000000000000, 150000000000000, 160000000000000, 180000000000000, 200000000000000, 220000000000000, 240000000000000, 270000000000000, 300000000000000, 330000000000000, 360000000000000, 390000000000000, 430000000000000, 470000000000000, 510000000000000, 560000000000000, 620000000000000, 680000000000000, 750000000000000, 820000000000000, 910000000000000, 1000000000000000, 1100000000000000, 1200000000000000, 1300000000000000, 1500000000000000, 1600000000000000, 1800000000000000, 2000000000000000, 2200000000000000, 2400000000000000, 2700000000000000, 3000000000000000, 3300000000000000, 3600000000000000, 3900000000000000, 4300000000000000, 4700000000000000, 5100000000000000, 5600000000000000, 6200000000000000, 6800000000000000, 7500000000000000, 8200000000000000, 9100000000000000, 10000000000000000, 11000000000000000, 12000000000000000, 13000000000000000, 15000000000000000, 16000000000000000, 18000000000000000, 20000000000000000, 22000000000000000, 24000000000000000, 27000000000000000, 30000000000000000, 33000000000000000, 36000000000000000, 39000000000000000, 43000000000000000, 47000000000000000, 51000000000000000, 56000000000000000, 62000000000000000, 68000000000000000, 75000000000000000, 82000000000000000, 91000000000000000, 100000000000000000, 110000000000000000, 120000000000000000, 130000000000000000, 150000000000000000, 160000000000000000, 180000000000000000, 200000000000000000, 220000000000000000, 240000000000000000, 270000000000000000, 300000000000000000, 330000000000000000, 360000000000000000, 390000000000000000, 430000000000000000, 470000000000000000, 510000000000000000, 560000000000000000, 620000000000000000, 680000000000000000, 750000000000000000, 820000000000000000, 910000000000000000, 1000000000000000000, 1100000000000000000, 1200000000000000000, 1300000000000000000, 1500000000000000000, 1600000000000000000, 1800000000000000000, 2000000000000000000, 2200000000000000000, 2400000000000000000, 2700000000000000000, 3000000000000000000, 3300000000000000000, 3600000000000000000, 3900000000000000000, 4300000000000000000, 4700000000000000000, 5100000000000000000, 5600000000000000000, 6200000000000000000, 6800000000000000000, 7500000000000000000, 8200000000000000000, 9100000000000000000, 10000000000000000000, 11000000000000000000, 12000000000000000000, 13000000000000000000, 15000000000000000000, 16000000000000000000, 18000000000000000000, 20000000000000000000, 22000000000000000000, 24000000000000000000, 27000000000000000000, 30000000000000000000, 33000000000000000000, 36000000000000000000, 39000000000000000000, 43000000000000000000, 47000000000000000000, 51000000000000000000, 56000000000000000000, 62000000000000000000, 68000000000000000000, 75000000000000000000, 82000000000000000000, 91000000000000000000, 100000000000000000000, 110000000000000000000, 120000000000000000000, 130000000000000000000, 150000000000000000000, 160000000000000000000, 180000000000000000000, 200000000000000000000, 220000000000000000000, 240000000000000000000, 270000000000000000000, 300000000000000000000, 330000000000000000000, 360000000000000000000, 390000000000000000000, 430000000000000000000, 470000000000000000000, 510000000000000000000, 560000000000000000000, 620000000000000000000, 680000000000000000000, 750000000000000000000, 820000000000000000000, 910000000000000000000, 1000000000000000000000, 1100000000000000000000, 1200000000000000000000, 1300000000000000000000, 1500000000000000000000, 1600000000000000000000, 1800000000000000000000, 2000000000000000000000, 2200000000000000000000, 2400000000000000000000, 2700000000000000000000, 3000000000000000000000, 3300000000000000000000, 3600000000000000000000, 3900000000000000000000, 4300000000000000000000, 4700000000000000000000, 5100000000000000000000, 5600000000000000000000, 6200000000000000000000, 6800000000000000000000, 7500000000000000000000, 8200000000000000000000, 9100000000000000000000, 10000000000000000000000, 11000000000000000000000, 12000000000000000000000, 13000000000000000000000, 15000000000000000000000, 16000000000000000000000, 18000000000000000000000, 20000000000000000000000, 22000000000000000000000, 24000000000000000000000, 27000000000000000000000, 30000000000000000000000,

CABLE T.V. CONVERTERS WHY PAY A HIGH MONTHLY FEE?

All Jerrold, Oak, Hamlin, Zenith, Scientific Atlanta, Magnavox and all specialized cable equipment available for shipment within 24 hours. For fast service MC/VISA or C.O.D. telephone orders accepted (312) 638-5320 60 Day Warranty (Quantity Discounts) 8 A.M. to 5 P.M. Monday through Friday Central Time. Stamp Envelope (60¢ postage) for FREE Catalog.

Midwest Electronics Inc.
5143 W. Diversey • Chicago, IL 60639
No Illinois Orders Accepted

DISTRIBUTORS WANTED

- Phone recorder control
- Automatically records phone conversations when receiver is lifted.
- Interfaces your phone to any tape recorder.
- Meets all FCC requirements.
- Guaranteed to work.



Send \$29.95 plus \$3 shipping and handling (VISA, MASTERCARD, COD) to:

ELECTRONIC DEVICES
4900 87th Ave. N., Pinellas Park, FL 33565
Dealer inquiries welcome

CONSOLIDATED ELECTRONICS

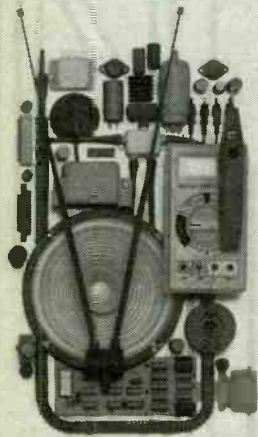

CONSUMER & INDUSTRIAL ELECTRONICS CATALOG • 17TH EDITION
\$3.00

GET THE ULTIMATE ELECTRONICS CATALOG.

Order your 260 page catalogue packed with over 10,000 money saving electronic parts and equipment. Send \$3.00 check or money order, or call 1-800-543-3568 today and use your Mastercard or Visa.
Consolidated Electronics, Incorporated
705 Watervliet Ave., Dayton, Ohio 45420-2599

NAME _____
ADDRESS _____
CITY _____
STATE _____ ZIP _____

CIRCLE 6 ON FREE INFORMATION CARD

SINGERS! REMOVE VOCALS FROM RECORDS AND CDs!



SING WITH THE WORLD'S BEST BANDS!

An Unlimited supply of Backgrounds from standard stereo records! Record with your voice or perform live with the backgrounds. Used in Professional Performance yet connects easily to a home component stereo. This unique product is manufactured and sold Exclusively by LT Sound • Not sold through dealers. Call or write for a Free Brochure and Demo Record.

LT Sound, Dept. ME-3, 7980 LT Parkway
Lithonia, GA 30058 (404) 482-4724
Manufactured and Sold Exclusively by LT Sound
24 HOUR PHONE DEMO LINE: (404) 482-2485

NO WAITING FOR COMPLETE, LOW PRICED, CHIP COMPONENT KITS

CC-1 Capacitor Kit contains 365 pieces, 5 ea. of every 10% value from 1pf to 33µf. CR-1 Resistor Kit contains 1540 pieces: 10 ea. of every 5% value from 10Ω to 10 megΩ. Sizes are 0805 and 1206. Each kit is ONLY \$49.95 and available for Immediate One Day Delivery!

Order by toll-free phone, FAX, or mail. We accept VISA, MC, AMEX, COD orders, or company P.O.'s with approved credit. Call for free detailed brochure.



COMMUNICATIONS SPECIALISTS, INC.
426 West Tall Avenue • Orange, CA 92665-4296
Local (714) 998-3021 • FAX: (714) 974-3420
Entire U.S.A. 1-800-854-0547

CIRCLE 12 ON FREE INFORMATION CARD

SATELLITE DESCRAMBLING, VIDEO-CYPHER II - Schematics, video and audio, DES, Cloning, Muskateering, Eprom codes. \$12.95, \$1.00 postage. CABLETRONICS, Box 30502ME, Bethesda, MD 20814.

CABLE TV Secrets - the outlaw publication the Cable Companies tried to Ban. HBO, Movie Channel, Showtime, Descramblers, Converters, etc. Suppliers list included. \$8.95. Cable Facts, Box 711-ME, Pataskala, OH 43062.

PROJECTION TV . . . Convert your TV to project 7 Foot picture . . . Results comparable to \$2,500 projectors . . . Total cost less than \$30.00 . . . PLANS AND 8" LENS \$21.95 . . . Illustrated information FREE. Macrocoma-MG, Washington Crossing, Pennsylvania 18977. Credit card orders 24 HRS. (215) 736-3979.

ELECTRONICS

INTRODUCTORY OFFER: Standard resin core solder 1 pound roll \$4.99. Product listing and price sheet free with order or by request. NUTTER RIDGE PURVEYORS, Star Route Province Road, Strafford, NH 03884.

LABORATORY Equipment, Electronic Test Equipment, Components, Unusual Items.— Industrial and Government Surplus and priced Cheap! Send 50¢ for catalog to: Lehman, R.D.#1, Box 580, Wrightsville, PA 17368.

(EP)ROM emulator-programmers. Free info sheet. SOLICON, 8825 El Matador Dr., Gilroy, CA 95020.

SUPERCONDUCTORS National Bureau of Standards research publication shows you how to make superconducting ceramics. Basically, "kitchen table physics". \$14.95. CABLETRONICS, Box 30502ME, Bethesda, MD 20814.

VOICE DISGUISERS! FM Bugs! Telephone Transmitters! Phone Snoops! More! Catalog \$1.00 (Refundable). XANDI ELECTRONICS, Box 25647, "T", Tempe, AZ 85282.

SAVE \$\$\$\$ on quality electronic components including IC's, TRANSISTORS, CAPACITORS, RESISTORS, PLASMA DISPLAYS, CONNECTORS, CABLE, HARDWARE, etc. Also, computer accessories and interesting KITS. Send \$1 for catalog (applies toward purchase). Orders shipped within 24 hours. CRC ELECTRONICS, 13547 S.E. 27th Pl., Bellevue, WA 98005. (206) 747-9636.

LINEAR PARTS—Transistors: MRF454 \$15, MRF455 \$12, MRF477 \$11, MRF492 \$16.75, MRF421 \$22.50, SRF2072 \$13, SRF3662 \$25, 3800 \$18.75, 2SC2290 \$19.75, 2SC2879 \$25. Tubes: 6KD6 \$10.50, 6LQ6 \$9.75, 6LF6 \$9.75, 8950 \$16.75. Best Prices on Palomar Road Noise Mics, Ranger AR3300. New 16 page Catalog listing radio/amplifier tricks—Channel Modification, PLL-Sliders, Peaking for Range, Hard-to-Find Linear Parts—Mail \$1.00 to: RFPC, Box 700, San Marcos, CA 92069. For Same Day Parts Shipment, Call (619) 744-0728.

\$\$\$\$\$ SUPER SAVINGS \$\$\$\$\$

on electronic parts, components, supplies and computer accessories. Free 40-page catalog for self-addressed and stamped envelope. Get on our mailing list. BCD ELECTRO, P.O. Box 830119, Richardson, TX 75083 or call (214) 343-1770.

LASERS and OPTICAL COMPONENTS. Write for free catalogue. M.J. Neal Co., 6672 Mallard Court, Orient, OH 43146. 614-877-3719.

SURVEILLANCE, Electronics, Debugging. Latest High Tech Equipment - Kits. Catalog \$2.00. TECHNOLOGY SERVICES, 829 Ginette Street, Gretna, LA 70056.

FIBER OPTIC CABLE .100" DIA. 10FT-8.50 100FT-69.95 JSDIST POB 361 PARCHMENT, MI 49004.

INEXPENSIVE car alarm! Easy to build, install. Complete plans \$2.00. Computerize, 4730 Auburn Rd., #142, Salem, OR 97301.

COMMUNICATIONS

DETECTIVES, Experimenters. Exciting New Plans. Hard to find MICRO and RESTRICTED Devices. Large Catalog \$5.00 Refundable on 1st Order. WILSON, P.O. BOX 5264, Augusta, Georgia 30906.

POLICE, Fire Scanning Radios. Bearcat ReGENCY Fanon. Harvey Park Radio, Box 19224ME, Denver, CO 80219.

TRANSISTORS-TUBES: MRF421 \$24.00, MRF454 \$14.50, MRF455-MRF477 \$11.75, MRF492 \$16.00, SRF2072 \$12.75, SRF3800 \$17.50, 2SC2290 \$16.75, 2SC2879 \$22.00, 6LF6, 6LQ6, 6JS6 8950, etc-call. New **RANGER AR3500** All Mode 10 Meter Transceiver \$319. Quantity Discounts! Best Prices on Hard-to-Find Parts, Antennas, Mics, Power Supplies, & Equipment! Catalog \$1.00 (refundable), or free with order. **RFPC**, Box 700, San Marcos, CA 92069. For information or Same Day Shipment—Call (619) 744-0728. VISA/MC/C.O.D.

SECRET CB PUBLICATIONS (modifications, schematics, etc.). **KITS, FM, PARTS, ACCESSORIES, BOOKS.** Catalog \$1.00 (refundable). Selman Enterprises, P.O. Box 8189, Corpus Christi, Texas 78412. 512/853-2935.

"STOP" POLICE/FIRE SCANNERS. SHORTWAVE.CB RADIOS.ANTENNAS. ACCESSORIES, MORE! BUY/SELL/TRADE! 1988 28-PAGE Catalog \$1.00. STAMP For Used List! **GALAXY**, Box 1202, Akron, OH 44309. (216) 376-2402.

COMMUNICATIONS PLANS, BOOKS, KITS! AM/FM broadcasting (licensed/unlicensed), 1750 Meter transceivers, ham/CB amplifiers, surveillance bugs, more! **FREE** catalog, **PAN-COM**, Box 130-ME2, Paradise, CA 95967.

COMPUTERS

TI-99/4A Software/Hardware bargains. Hard to find items. Huge selection. Fast Service. Free Catalog. **TYNAMIC**, Box 690, Hicksville, NY 11801.

COMMODORE CHIPS, Distributor, Factory Fresh. Low prices. For eg., 6510/6526-\$9.95, 6581-\$12.85, PLA/82S100-\$12.50, all 901 ROMS-\$10.95 and many others. Just released new C128 ROMS, AN UPDATE MUST, \$39.95 plus postage . . . "THE COMMODORE DIAGNOSTICIAN", a new inexpensive way to diagnose faulty chips. This aid is a double sided laminated display diagnosing 88 variations and what chip to look for. Over 4,000 sold. \$6.95 plus \$1.00 postage/handling . . . HD Power Supply for C-64, \$27.95 plus postage . . . **COMMODORE COMPUTER REPAIR AVAILABLE** at low prices (eg. C64-\$39.95 parts/labor) . . . Send for complete catalog . . . VISA/MC . . . **Kasara Micro Inc.**, 31 Murray Hill Drive, Spring Valley, N.Y. 10977. 1-800-248-2983 (Nationwide) or 914-356-3131.

HACKER'S Handbook, \$12.95, \$1 postage. **Computer Underground**, \$14.95, \$1 postage. **CABLETRONICS**, BOX 30502ME, BETHESDA, MD 20814.

Educational Engineering Software, CompDes_Circuit Design, CompMath_Math tutor, CompView_Digital Signal Analysis. \$49 each, (614)491-0832, **Bsoft Software**, 444 Colton Road, Columbus, Ohio 43207.

DISK box for 140 5 1/4" disks with lock \$14.95. 2 for \$27.00 ppd. Greeno Supply, Box 20891, New York, NY 10023.

BASIC Computers, 10 lesson correspondence course, \$39.50. Certificate. Details free. **AMERICAN TECHNICAL INSTITUTE**, Box 201, Cedar Mountain, NC 28718.

INVENTORS

INVENTORS! Have idea for product or invention, don't know what to do? Call AIM we present ideas to manufacturers - Toll Free 1-800-225-5800.

INVENTORS

INVENTORS! Can you profit from your idea? Call **AMERICAN INVENTORS CORPORATION** for free information. Over a decade of service, 1-800-338-5656. In Massachusetts or Canada call (413) 568-3753.

DO IT YOURSELF

REPAIR YOUR OWN TV . . . ITS EASY. Write Research, Rt. 3, Box 601B, Colville, WA 99114.

CABLE EQUIPMENT

CABLE TV DECODERS AND CONVERTERS get your free catalog or order toll free 1-800-624-1150. Information Call (402)-554-0417. **M.D. Electronics Inc.**, 5078 So. 108th Ste#115, Omaha, Nebraska 68137

SUBSCRIBER NEEDS

NEED scope schematics and manuals: Precision ES550 and Eico 227. **Robert Dalka**, P.O. Box 990, Camdenton, MO 65020.

WANTED: Hammarlund SP600 SuperPro Receiver. Price and condition. **J. Browning**, 6442 Cathay Cir., Buena Park, CA 90620.

WANTED: Persons or organizations restoring pinball machines (mechanical types like Bally's Hi/Lo Ace) and sell parts. **D. Hartman**, 2 Gillis Rd., Portsmouth, VA 23702.

MISCELLANEOUS

SATELLITE and cable equipment schematics, service manuals, booklets, diagrams, information packages, construction material, covers, converters, receivers, decoders. Catalog \$3.00. **Ponderosa Company**, 3624 Citadel Drive North #289M, Colorado Springs, Colorado 80909.

INTRODUCING 101 New and Improved Screwdriving Bits! Free details. Write: **Shockey's**, Dept. 457, 5841 Longford, Dayton, OH 45424. (513) 236-2983.

ASIAN LADIES want correspondence for friendship, marriage, **SUNSHINE INTERNATIONAL**, Dept. TW, Box 260, North Hollywood, CA 91603.

Free Product Information

Readers can obtain free information on products advertised by certain companies, as well as for some editorially mentioned products. Simply circle the appropriate number printed below an advertisement onto the Modern Electronics "Free Information Service" card bound into this issue. After filling in your name and address, just mail the postpaid card. Your request will be forwarded directly to the advertiser with a mailing label prepared by our reader-service department to ensure speedy response.

ATTENTION! ELECTRONICS TECHNICIANS

EARN YOUR
**B.S.E.E.
DEGREE**
THROUGH HOME STUDY

Our New and Highly Effective Advanced-Placement Program for experienced Electronic Technicians grants credit for previous Schooling and Professional Experience, and can greatly reduce the time required to complete Program and reach graduation. No residence schooling required for qualified Electronic Technicians. Through this Special Program you can pull all of the loose ends of your electronics background together and earn your B.S.E.E. Degree. Upgrade your status and pay to the Engineering Level. Advance Rapidly! Many finish in 12 months or less. Students and graduates in all 50 States and throughout the World. Established Over 40 Years! Write for free Descriptive Literature.

COOK'S INSTITUTE OF ELECTRONICS ENGINEERING

CI 4251 CYPRESS DRIVE
JACKSON, MISSISSIPPI 39212

CIRCLE 9 ON FREE INFORMATION CARD

SUBSCRIBER SERVICE CHANGE OF ADDRESS	ATTACH LABEL HERE	PLEASE PRINT
	NEW ADDRESS HERE	
Planning to move? Please let us know six weeks in advance so you won't miss a single issue of MODERN ELECTRONICS	NAME _____	STATE _____
Attach old label and print new address in space provided. Also include your mailing label whenever you write concerning your subscription to insure prompt service on your inquiry	ADDRESS _____	CITY _____
Modern Electronics 76 N. Broadway, Hicksville, NY 11801		DATE _____
		ZIP _____

CIRCLE 10 ON FREE INFORMATION CARD

ADVERTISERS' INDEX

RS#		Page #
41	ARRL	17
2	AMC Sales	39
5	All Electronics	75
46	C&S Sales	67
11	CTM	58
89	Cable Distributors	69
98	Cleveland Institute of Elec.	Cov. III
-	Command Productions	58
151	Communications Elec.	9
7	Communications Specialists, Inc.	88
112,113	Competitive Computer	6, 7
6	Consolidated Electronics	88
9	Cook's Institute	89
42	Daetron	68
4	Deco Industries	86
76	Digi-Key Corp.	87
50	Digital Research	75
-	Electronic Devices	88
-	Grantham College of Engineering	59
44	Jan Crystals	79
47	Jensen Tools	52
49	Kelvin Electronics	45
-	LT Sound	88
38	MCM Electronics	85
-	McGraw Hill Continuing Educ.	83
3	Micromart	86
-	Midwest Electronics	88
39	Movie Time	39
48	NRG Electronics	45
-	NRI Schools	10, 13
45	National Technical Schools	79
8	OptoElectronics	Cov. II
-	Pacific Cable Co., Inc.	3
43	Radio Shack	5
-	TV Scope	58
-	Visitect Inc.	86

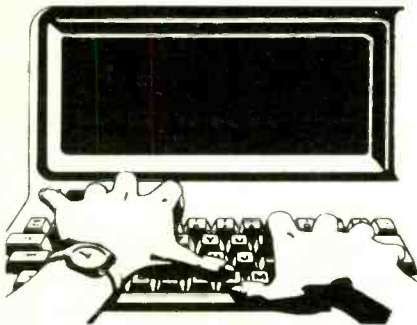

Free Product Information

Readers can obtain free information on products advertised by the above companies, as well as for some editorially mentioned products. Simply circle the appropriate number printed below an advertisement onto the Modern Electronics "Free Information Service" card bound into this issue. After filling in your name and address, just mail the postpaid card. Your request will be forwarded directly to the advertiser with a mailing label prepared by our reader-service department to ensure speedy response.

Surface Mount (from page 53)

Step 1 in the repair process is to remove most of the solder on the IC connections. (*Caution:* Prior to doing repair work, make sure that your soldering iron is properly grounded and that your electrostatic-discharge control wrist strap is properly connected.) Using a soldering iron and desoldering braid, slowly remove the solder from connections on all sides of the IC, as illustrated.

Next, using a fine-pointed hobby knife and a cone-tip soldering iron, gently free each IC connection from the circuit card. Once all connections have been freed, the IC can be removed.

When replacing the surface-mount IC, first align the IC's leads with the printed-circuit card traces. Holding the IC in place with your finger, solder a lead at each corner of the device to the board's pads. This will hold the IC in place until all connections are soldered. **ME**

Transistor Tester (from page 57)

bottom of the board. Peel the protective paper from the other side of the tape and mount the board assembly in the enclosure flush with one end of the box. Then mount the battery to the other end of the box with the other piece of foam tape.

Place the front panel on the box and secure it in place with the four screws that were provided.

Using the In-Circuit Transistor Tester is almost self-explanatory. You simply determine the base, emitter and collector leads of the transistor to be tested, clip the test-lead connectors to them accordingly and press the PRESS TO TEST pushbutton while observing the LEDs. If the transistor is good, either the NPN or the PNP LED will light, simultaneously identifying the type of transistor under test and verifying that it is good. If both LEDs or neither LED lights, the transistor is almost certainly bad, regardless of type, and should be replaced. **ME**

Mixing Frequencies (from page 33)

to intermediate frequencies and even individually checked there with a frequency counter.

The examination revealed one of the unsung marvels of the superhet: the intermediate frequencies maintain proper relative amplitude and phase relationships and thereby mimic the shape of the signal at the antenna very nicely. This test yielded the photo shown in Fig. 9, confirming the result shown in Fig. 8. A considerable improvement was realized when the amplitude of the sideband was reduced to half that of the carrier, shown in Fig. 10.

Further reducing the sideband for a 1:3 amplitude ratio gave additional improvement, but the modulation envelope never actually became sinusoidal, and the percentage of modulation decreased even more. Perhaps

at near 0-percent modulation a sinusoidal variation in the envelope may almost be there.

This single sideband information may be of use to someone who is attempting to modify a conventional receiver. However, the secret to whatever success SSB operation enjoys is in an additional heterodyning step that is not found in, for example, the AM broadcast-band receiver. There is simply no way to recreate a good modulation envelope by linearly mixing carrier and one sideband. Acceptable audio more likely comes from generating a proper carrier and heterodyning it with the output from the final intermediate-frequency range. By filtering out all audio frequencies, only the difference frequency remains, and that is the audio. **ME**

EXPAND YOUR CAREER HORIZONS...



The CIE Microprocessor Trainer helps you to learn how circuits with microprocessors function in computers.

START WITH CIE.

Microprocessor Technology. Satellite Communications. Robotics. Wherever you want to go in electronics... start first with CIE.

Why CIE? Because we're the leader in teaching electronics through independent study. Consider this. We teach over 25,000 students from all over the United States and in over 70 foreign countries. And we've been doing it for over 50 years, helping thousands of men and women get started in electronics careers.

We offer flexible training to meet your needs. You can start at the beginner level or, if you already know something about electronics, you may want to start at a higher level. But wherever you start, you can go as far as you like. You can even earn your Associate in Applied Science Degree in Electronics.

Let us get you started today. Just call toll-free 1-800-321-2155 (in Ohio, 1-800-362-2105) or mail in

CIRCLE 98 ON FREE INFORMATION CARD

the handy reply coupon or card below to:
Cleveland Institute of Electronics,
1776 East 17th Street, Cleveland, Ohio 44114

CIE

World Headquarters

Cleveland Institute of Electronics, Inc.
1776 East 17th Street • Cleveland, Ohio 44114

AMO-100

Please send your independent study catalog.
For your convenience, CIE will try to have a representative contact you — there is no obligation.

Print Name _____

Address _____ Apt. _____

City _____ State _____ Zip _____

Age _____ Area Code/Phone No. _____

Check box for G.I. Bill Bulletin or Educational Benefits

Veteran Active Duty **MAIL TODAY!**

Just call toll-free 1-800-321-2155 (in Ohio, 1-800-362-2105)



Yaesu has serious listeners for the serious listener.

Yaesu's serious about giving you better ways to tune in the world around you.

And whether it's for local action or worldwide DX, you'll find our VHF/UHF and HF receivers are the superior match for all your listening needs.

The FRG-9600. A premium VHF/UHF scanning communications receiver. The 9600 is no typical scanner. And it's easy to see why.

You won't miss any local action with continuous coverage from 60 to 905 MHz.

You have more operating modes to listen in on: upper or lower sideband, CW, AM wide or narrow, and FM wide or narrow.

You can even watch television programs by plugging in a video monitor into the optional video output.

Scan in steps of 5, 10, 12½, 25 and 100 KHz. Store any frequency and

CIRCLE 1 ON READER SERVICE CARD

related operating mode into any of the 99 memories. Scan the memories. Or in between them. Or simply "dial up" any frequency with the frequency entry pad.

Plus there's more, including a 24-hour clock, multiplexed output, fluorescent readout, signal strength graph, and an AC power adapter.

The FRG-8800 HF communications receiver. A better way to listen to the world. If you want a complete communications package, the FRG-8800 is just right for you.

You get continuous worldwide coverage from 150 KHz to 30 MHz. And local coverage from 118 to 174 MHz with an optional VHF converter.

Listen in on any mode: upper and lower sideband, CW, AM wide or narrow, and FM.

Store frequencies and operating modes into any of the twelve channels for instant recall.

Scan the airwaves with a number of programmable scanning functions.

Plus you get keyboard frequency entry. An LCD display for easy readout. A SINPO signal graph. Computer interface capability for advanced listening functions. Two 24 hour clocks. Recording functions. And much more to make your listening station complete.

Listen in. When you want more from your VHF/UHF or HF receivers, just look to Yaesu. We take your listening seriously.

YAESU

Yaesu USA

17210 Edwards Road, Cerritos, CA 90701
(213) 404-2700

Yaesu Cincinnati Service Center

9070 Gold Park Drive, Hamilton, OH 45011
(513) 874-3100



Dealer inquiries invited.

Prices and specifications subject to change without notice.
FRG-9600 SSB coverage: 60 to 460 MHz.