

ICD 08559

FEBRUARY 1986 \$1.95

CANADA \$2.50

MODERN ELECTRONICS™

THE MAGAZINE FOR ELECTRONICS & COMPUTER ENTHUSIASTS

HEATH/ZENITH'S NEW ROBOT: A 16-Bit CPU-Based Learning System

● How to Use Radio Shack's Color Computer as a Powerful Test Lab

● Design Guide to Temperature Sensors

● Design Guide to Video Players

● Design Guide to Your Monitor

- It "Talks"
- It "Walks"
- It "Sees"
- It "Hears"
- It Picks Things Up



Bulk Rate
 Permit No. 79
 U.S. Postage Paid
 Gordonsville, VA 22942

Plus: • Experimenting with Radio-Control Systems • Don Lancaster's "Hardware Hacker" • Computer Speedup Boards • Shortwave Communications • "Spelling Checker" Review • Latest Electronics & Computer News . . . and more!

ICOM 25-1000MHz Plus!

IC-R7000



ICOM's commercial quality scanning receiver...Top quality at a gem of a price.

ICOM introduces the IC-R7000 advanced technology 25-2000MHz* continuous coverage communications receiver. With 99 owner programmable memories, the IC-R7000 covers low band, aircraft, marine, business, FM broadcast, amateur radio, emergency services, government and television bands.

Keyboard Entry. For simplified operation and quick

tuning, the IC-R7000 features direct keyboard entry. Precise frequencies can be selected by pushing the digit keys in sequence of the frequency or by turning the main tuning knob.

99 Memories. The IC-R7000 has 99 memories available to store your favorite frequencies, including the operating mode. Memory channels may be called up by simply pressing the Memory switch, then rotating the memory channel knob, or by direct keyboard entry.

Scanning. A sophisticated scanning system provides instant access to most used frequencies. By depressing the Auto-M switch, the

IC-R7000 automatically memorizes frequencies in use while the unit is in the scan mode. This allows you to recall frequencies that were in use.

Other Outstanding Features:

- FM wide/FM narrow/AM/upper and lower SSB modes
- Six tuning speeds: 0.1, 1.0, 5, 10, 12.5 or 25KHz
- Dual color fluorescent display with memory channel readout and dimmer switch
- Compact Size: 4-3/8"H x 11 1/4"W x 10 7/8"D
- Dial lock, noise blanker, combined S-meter and center meter

- Optional RC-12 infrared remote controller
- Optional voice synthesizer. When recording, the voice synthesizer automatically announces the scanned signal frequency.

*Specifications guaranteed from 25-1000MHz and 1260-1300MHz. No coverage from 1000-1025MHz. No additional module required for coverage to approximately 2.0GHz.

See the IC-R7000 receiver at your local authorized ICOM dealer. Also available is the IC-R71A 0.1-30MHz general coverage receiver.

ALL THIS AT A PRICE YOU'LL APPRECIATE.

CIRCLE 115 ON READER SERVICE CARD



First in Communications

Which Way To YOUR Future?

Are you at a crossroads in your career? Have you really thought about it? Are you *planning* for your future, or perhaps refusing to face the subject? Which way will you go — down the same old road? Or are you ready for something else?

In electronics you can't stand still. If you are not moving ahead, then you're falling behind. At the crossroads of your career, various choices are available — and, yes, *decisions* have to be made.

Which road will you take — one that doesn't go where you want to be, or one that leads to hard work *but also* to the better life? Ah, decisions, decisions!

Career decisions are so important that you need all the *input* you can get before locking-in on one of them. Grantham College of Engineering offers you *one* source of input which may help you in making that decision. It's our free catalog.

Ask for our free catalog and you may be surprised to learn how it is easily possible to earn a B.S. degree in electronics without attending traditional classes. Since you are already in electronics (you are, aren't you?), you can complete your B.S. degree work with Grantham while studying at home or at any convenient place.

But don't expect to earn that degree without hard work. Any degree that's worth your effort can't be had without giving effort to the task. And of course it is what you learn in the process, as much as the degree itself, that makes you stand out above the crowd — that places you in an enviable position, prestige-wise and financially.

Grantham College of Engineering
10570 Humbolt Street
Los Alamitos, California, 90720

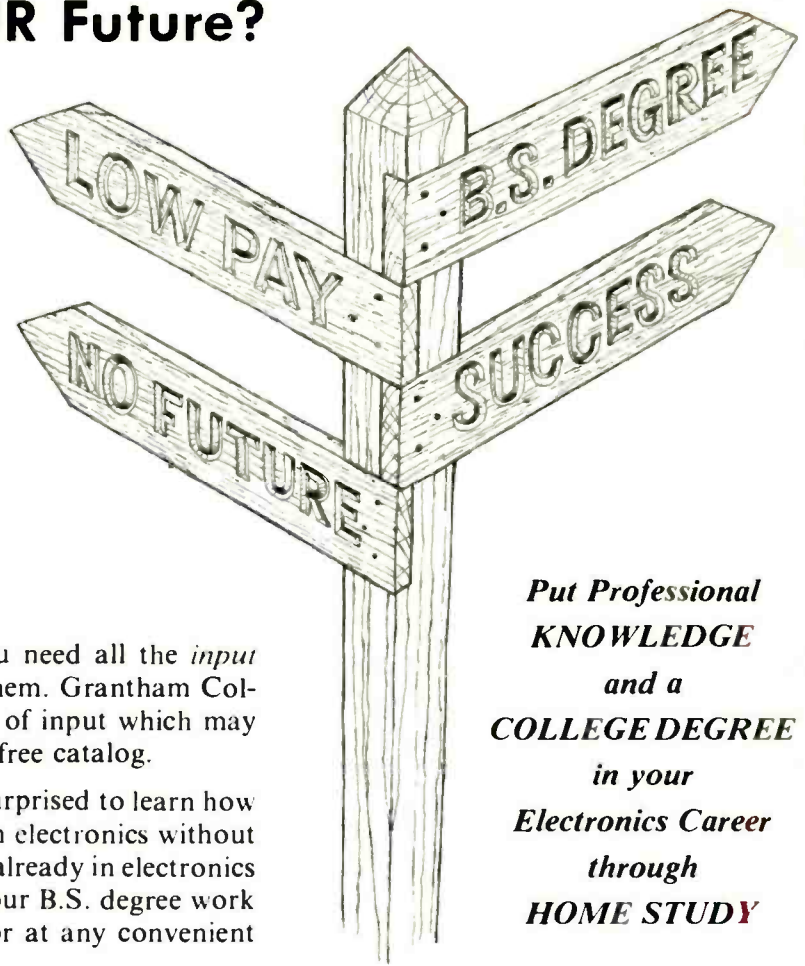

**Put Professional
KNOWLEDGE
and a
COLLEGE DEGREE
in your
Electronics Career
through
HOME STUDY**

Grantham offers this program, complete but without laboratory, to electronics technicians whose objectives are to upgrade their level of technical employment.

Recognition and Quality Assurance

Grantham College of Engineering is accredited by the Accrediting Commission of the National Home Study Council, as a degree-granting institution.

All lessons and other study materials, as well as communications between the college and students, are in the English language. However, we have students in many foreign countries; about 80% of our students live in the United States of America.

**This booklet
FREE!**

This free booklet explains the Grantham B.S. Degree Program, offered by independent study to those who work in electronics.

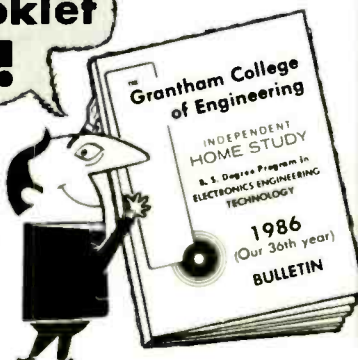

for
**FREE
Booklet
CLIP
COUPON**
and mail in
envelope or
paste on
postal
card.

Grantham College of Engineering M 02-86
10570 Humbolt Street, Los Alamitos, CA 90720

Please mail me your free catalog which explains your B.S. Degree independent-study program.

Name _____ Age _____

Address _____

City _____ State _____ Zip _____

FEATURES

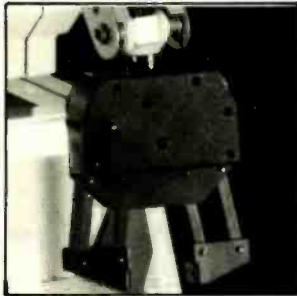

38

- 16 Build a CoCo Testlab, Part 1**
How to use a Radio Shack Color Computer as a test bench instrument. *By Jim Barbarello & Jack Boyle*
- 26 Testing CD Players**
Examines the new standards for specifying Compact Disc player performance. *By Len Feldman*
- 37 An Automatic Phone Disconnecter**
Project silences telephone when lights are turned off. *By Victoria di Zerega*
- 38 Introducing Hero 2000—**
Heath/Zenith's new robot.
By Alexander W. Burawa
- 50 Fine-Tune Your Color TV Receiver/Monitor**
BASIC program converts Commodore 64 into a color TV signal generator. *By Rich Torpey*
- 55 Using an LM-335 Temperature Sensor**
A readily available, low-cost IC for electronic thermometry. *By Joseph J. Carr*
- 62 The Ocean Box**
A low-cost, build-it-yourself wave-sound generator. *By J. Daniel Gifford*

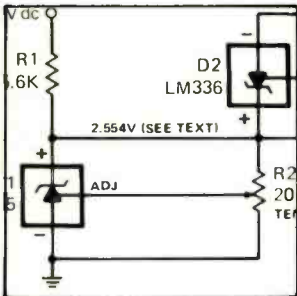

55

PRODUCT EVALUATIONS

- 14 Zenith's Model SB2777P Deluxe Color TV Receiver/Monitor Console.**
By Stan Prentiss

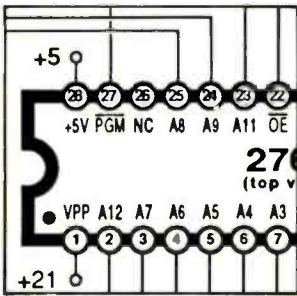

79

COLUMNS

- 72 Electronics Notebook**
A Multi-Purpose Radio-Control System.
By Forrest M. Mims III
- 79 Hardware Hacker**
Author answers readers' questions.
By Don Lancaster
- 84 PC Papers**
Apricot's Computers and Speed-Up Boards
By Eric Grevstad
- 89 Communications**
SW Listings Update.
By Glenn Hauser
- 92 Software Focus**
Spelling Counts. *By Art Salsberg*

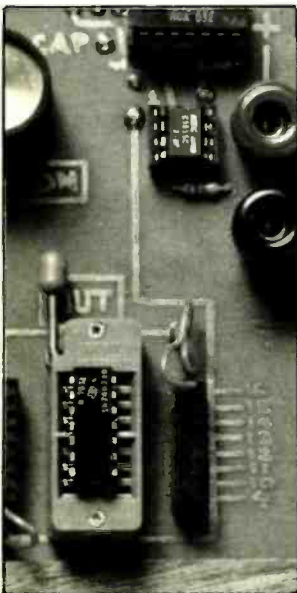

16

DEPARTMENTS

- 4 Editorial**
By Art Salsberg
- 4 Letters**
- 6 Modern Electronics News**
- 12 New Products**
- 71 Books & Literature**
- 104 Advertisers Index**

EDITORIAL STAFF

- Art Salsberg**
Editor-in-Chief
- Alexander W. Burawa**
Managing Editor
- Dorothy Kehrwierd**
Production Manager
- Elizabeth Ryan**
Art Director
- Barbara Scully**
Artist
- Pat Le Blanc**
Richard Kishanuk
Phototypographers
- Hal Keith**
Illustrator
- Bruce Morgan**
Photographer
- Leonard Feldman, Eric Grevstad, Glenn Hauser, Don Lancaster, Forrest Mims III, Stan Prentiss, Charles Rubenstein**
Contributing Editors

BUSINESS STAFF

- Richard A. Ross**
Publisher
- Art Salsberg**
Associate Publisher
- Dorothy Kehrwierd**
General Manager
- Arlene Caggiano**
Accounting
- Cheryl Chomicki**
Subscriber Services

SALES OFFICES

- Modern Electronics**
76 North Broadway
Hicksville, NY 11801
(516) 681-2922
- Midwest Advertising Representative
Market/Media Associates
1150 Wilmette Ave.
Wilmette, IL 60091
(312) 251-2541
Ted Rickard
Kevin Sullivan
- Western Advertising Representative
JE Publishers Representatives
6855 Santa Monica Blvd., Suite 200
Los Angeles, CA 90038
(213) 467-2266
Jay Eisenberg, Director
San Francisco: (415) 864-3252
Denver: (303) 595-4331

Offices: 76 North Broadway, Hicksville, NY 11801. Telephone: (516) 681-2922. Modern Electronics (ISSN 0748-9889) is published monthly by Modern Electronics, Inc. Application to mail at second class rates pending at Hicksville, NY and other points. Subscription prices (payable in US Dollars only): Domestic - one year \$16.97, two years \$31.00, three years \$45.00; Canada/Mexico - one year \$19.00, two years \$35.00, three years \$51.00; Foreign - one year \$21.00, two years \$39.00, three years \$57.00. Foreign Air Mail - one year \$74.00, two years \$145.00, three years \$216.00.

Entire contents copyright 1986 by Modern Electronics, Inc. Modern Electronics or Modern Electronics, Inc. assumes no responsibility for unsolicited manuscripts. Allow six weeks for delivery of first issue and for change of address. Printed in the United States of America. Postmaster: Please send change of address notice to Modern Electronics, Inc., 76 North Broadway, Hicksville, NY 11801.

Radio Shack Parts Place™

OVER 1000 ITEMS IN STOCK AT OUR STORE NEAR YOU!

(1) Plug-In PC Boards (4)

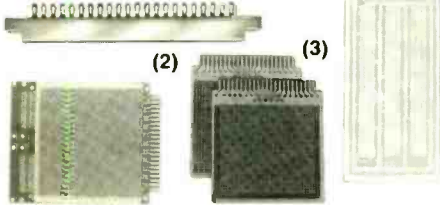

- (1) 44-Position Card-Edge Socket. Accepts plug-in PC boards below. #276-1551 2.99
- (2) Plug-In Board With RS-232 Ports. Ideal for computer projects! Predrilled to accept two PC-type RS-232 connectors (such as RS #276-1521). 4¹/₁₆ x 5¹/₁₆" Two buses. 1020 holes in DIP pattern. #276-187 3.99
- (3) Multi-Purpose Plug-In Board. 4¹/₂ x 4" with 1¹/₁₆" grids. #276-152 2.99
- Three-Voltage Source Board. Three-bus version of Fig. 3. #276-154 2.99
- (4) Jumbo Two-Bus Board. 4¹/₂ x 9¹/₁₆". Accepts up to 24 16-pin DIP sockets with plenty of room for discrete components. Two buses. #276-190 5.95
- Jumbo IC/Discrete Board. Like Fig. 4 but accepts up to 40 16-pin DIPs. Single bus. #276-191 5.95

New "Hot-Line" Service

Radio Shack Can Replace Almost Any IC or Semiconductor



More Than 200,000 Substitutions

No Minimum Order ■ No Postage Charge

If the IC or semiconductor you need is not part of our regular stock, our store manager will check our new in-store substitution guide and special-order a replacement from our warehouse. Your order will be sent ASAP to your Radio Shack store. We also offer this convenient service on selected tubes, crystals, phono cartridges and styli.

Improve Your Project!

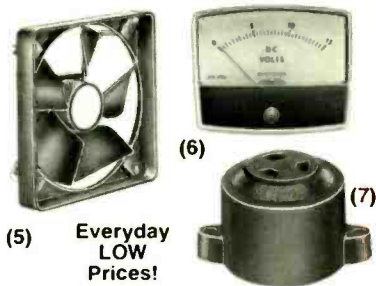

- (5) Everyday LOW Prices!
- (5) 120 VAC Cooling Fan. Ideal for computers, hi-fi, Ham equipment. Up to 65 CFM. 11 watts. 4¹/₁₆ x 4¹/₁₆ x 2¹/₂". #273-241 15.95
- (6) Panel Voltmeter. 0-15 VDC. Perfect for monitoring car electrical system or a power supply. 2³/₄ x 2¹/₄ x 1¹/₄". #270-1754 7.95
- (7) Two-Tone Piezo Buzzer. 100 dB minimum sound pressure level! 8-16 VDC. 2³/₈" mounting hole centers. #273-070 8.95

Join the Resistance



(8) 15-Turn PC-Mount Potentiometers. 3/4-watt. 10% tolerance. For critical fine-control and trimming.

Ohms	Cat. No.	Only
1000	271-342	1.49
10k	271-343	1.49
20k	271-340	1.49

(9) 50 Metal-Film Resistors. 1% tolerance. 1/4-watt. Assortment includes 12 popular values ranging from 10 ohms to one megohm. #271-309 Pkg. of 50, 2.49

Semiconductor Reference And Substitution Guide

New 1986 Edition

Complete data on Radio Shack ICs, SCRs, LEDs, diodes and optos. Plus "sub" listings for over 80,000 semi types. Over 270 pages. #276-4009 3.99



Low-Cost "Insurance"



- (10) Heavy-Duty Metal Oxide Varistor. Diverts power-line voltage "spikes". #276-568 1.69
- (11) Gas Discharge Tube. #270-811 2.49
- (12) Thermal Fuses. Used in coffee-makers and other heating devices. Rated 240 VAC, 10 amps.

Breaks Circuit at	Cat. No.	Each
139° C	270-1320	79
226° C	270-1321	79

Ready-to-Mount LEDs



- (13) Two-Color. Provides red and green output. A great mode or status indicator. Mounts in a 3/8" dia. hole. #276-025 1.49
- (14) Snap-Ins. Red output. Mount instantly in 5/16" holes. #276-018 Pkg. of 2/1.79

Enclosure and PC Board



Big value in a small, rugged plastic enclosure. 1³/₁₆ x 3⁷/₁₆ x 2⁵/₁₆". Includes PC board with 483 DIP-spaced holes, two labels, hardware, snap-in rubber feet. #270-291 2.99

64K Dynamic RAM

only **3⁹⁵** Each Super Quality



4164. Popular standard memory chip with 150 ns access. Low-power design. Now's the time to upgrade your computer! #276-2506

Capacitor Assortments

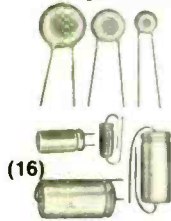

- (15) 100 Disc Capacitors. Includes NPOs, Hi-Qs, N-750s, Mylar and ceramic types. Popular values, up to 1000 WVDC. #272-801 1.98
- (16) 20 Electrolytic Capacitors. Minis and subminis. Popular values and sizes, up to 50 WVDC. #272-802 1.98

Switch Super-Values



- (17) Lighted SPST Toggle. For 12 VDC use only, rated 5 amps. Mounts in 7/16" dia. hole. #275-680 2.59
- (18) Flatted Lever Switches. Rated 6 amps at 125 VAC. SPDT. #275-635 2.39
DPDT. #275-636 2.69
DPDT Momentary. With spring return to center "off" position. #275-637 2.89

A BONANZA OF SPECIAL-PURCHASE BARGAINS!

DC Hobby Motors

1²⁹
Pkg. of 2

Just right for model-making, solar power and robotics experiments, or rainy day fun for the kids! Require 1.5 to 3 VDC. Approx. 1³/₄" long x 7/8" diameter. #273-205



Prewired TV RF Modulator

only **4⁹⁵**

Ideal for use with computers, satellite receivers, ATV, even custom datacom systems and experiments (see 9/85 issue of Modern Electronics, page 53). #277-1015



Prewired Clock Module

4⁹⁵

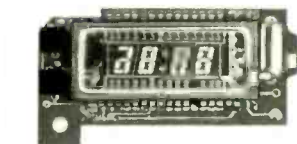

MA3003D-2. Fluorescent display with 1/4"-high digits is easy to read, night or day. Perfect for vehicles or your own custom application—requires 12 VDC. 1³/₈ x 2¹/₈ x 1¹/₂". With data. #277-1021

Computer Keyboard

only **5⁹⁵**



Very high-quality full-stroke matrix-output board with standard "QWERTY" layout plus cursor arrows, word processing and numbered functions—total of 75 keys. Originally produced for a computer system. 21-position ribbon cable connector. #277-1020

Over 1000 items in stock: Binding posts, Books, Breadboards, Buzzers, Capacitors, Chokes, Clips, Connectors, Fuses, Hardware, ICs, Jacks, Knobs, Lamps, Multitesters, PC Boards, Plugs, Rectifiers, Relays, Resistors, Switches, Tools, Transformers, Transistors, Wire, Zener Diodes, and more!

Radio Shack®

A DIVISION OF TANDY CORPORATION

Prices apply at participating Radio Shack stores and dealers

Passing Fancies

"Revolutions" in the electronics/computer field often pass us by on their way to oblivion. During their short stay as the hottest items in the marketplace, one might think that they're eternal.

For example, remember the digital watch? It entered our consumer minds around 1972, starting life as a \$2,000 Pulsar wrist watch. It was the most tantalizing new product in town. Direct-reading numbers, a blinking colon that seemed to have a life of its own, etc.

In one year the price dropped to around \$400, in non-precious-metal casing, of course. Enough of the public grabbed up the bargain to push sales deep into six-figure sales units. At that point, author Bill Green produced a digital wristwatch kit for around \$80, which a horde of readers assembled from construction plans. A true bargain!

Since then, prices plummeted, capped by masochistic Texas Instruments' \$20 digital timepiece in 1977 that knocked out many competitors. Then Hong Kong got into the act, producing them at such a low price (you can buy 'em now in HK for \$2!! retail; \$4-\$8 in the States), that the glint in buyers' eyes for ownership largely disappeared. No status wearing one now.

So what comes to the fore? Analog watches with electronic quartz-controlled circuits. Digital watches are now relegated to the back burner of ones with chips that do a zillion things, like tinkle tunes, feature games on its face, double as calculators, and other "high-tech" innovations incorporated into them. They still sell in fair numbers, but they're day has evidently passed.

The Visicalc spreadsheet program that spurred sales of personal computers (especially Apple II's) is only a memory now. So are video games for most of us. And so are Beta VCRs, though Sony won't admit it. They can't embrace VHS, its more successful competitor, but the company has jumped past it to 8-mm camcorders, which promise to be the next winner in the video cassette field. And who's rushing out to buy one of those marvelous audio turntables with dynamically balanced tone arms that can track an LP record when the machine is turned upside down? (or any turntable, for that matter, now that CD players are here)

Among the latest marvels to reach my desk, literally, is a new telephone system, AT&T's "Merlin." It's neat, moderately priced, and has some very nice standard

features for the money (conference call, transfer call, message, an intercom, traveling red indicator that latches onto an extension line with a yellow-green indicator when the call is for you). But its mouth-piece transducer is not very sensitive so the user has to practically kiss it in order for the other party to hear you well. And you better not punch the keypads too fast because it can't keep up with normal fast keypad dialing. Oh well, what does AT&T know about phones anyway.

Can you guess which products will soon face a similar fate, overtaken by a new evolution? How about 8-bit computers? Or 16-bit computers, for that matter. How long will computerized voices spew out guidance to automobile drivers? These devices just started entering cars, but driving a friend's, it soon began to irritate me. My family tired of talking clocks and calculators long ago, as an example. How about you and yours?



LETTERS

Switching Subscriptions

• I have been notified by *PC* magazine that *Computers & Electronics* is no longer published and they have arranged to take over the balance of my subscription. *PC* magazine is not what I want; *Modern Electronics* is! My subscription had 29 issues to run.

Can you apply the balance due from *Computers & Electronics* to *Modern Electronics*?

Robert M. Strong
Monroeville, PA 15146

Sorry, can't do. Too many issues to go, with attendant high costs. You can cancel PC and subscribe to Modern Electronics with the refund, however, and have bucks left over.—Ed

Schematics/Parts List Difference

• "Discover the Hidden World of FM Broadcastings" (*Modern Electronics*

Dec. 1985) has part-schematic differences. Part C10 of the schematic calls for a .1 μ f, but the parts list shows a .0047 μ f; R7 on the schematic shows a 470K resistor, but the parts list calls for 100,000 ohms. Which are correct? I wish to build the unit.

Fred Nazar K4HCL
Clearwater, FL

Correct values are: C10 = 0.1 μ F, R7 = 100K.—Ed.

B.I.C./Garrard Parts

• I have been hearing about inquiries from owners of B.I.C. turntables, as well as other B.I.C. audio equipment going back as far as the Garrard days, who say that they are having a difficult time locating service and parts, and heard that B.I.C. has gone out of business. South Street Service Company, 202 South St., Oyster Bay, NY 11771, has taken over all

of the service and parts for B.I.C. equipment. The owner, Adam Ruthkowski (former national service manager at B.I.C.) says that virtually all parts are still available through his company. In fact, they have re-manufactured many parts that previously were not available, such as grilles for speakers, turntable motors, head shells, etc.

Arthur M. Gasman
Port Washington, NY

Don, Where Are You?

• I just received my December 1985 issue. Where is Don Lancaster's column ["Hardware Hacker"]? I hope, I pray, that Don will be back next month.

Alan P. Wilson
Salem, IL

Don missed his print deadline, unfortunately. He's back in January issue.—Ed.

NEW HAND-HELD CALCULATORS. Computers are glamorous, but workhorse calculators are still going strong. Now, however, the new calculator breed is moving into computer technology strongly. For example, Sharp Electronics now has a scientific handheld calculator, Model EL-5520 (\$135), that features a RAM card system and serial interface.

An interchangeable RAM card for data storage or quick program changes comes in 4K-byte format, with up to 16K cards also available. Meanwhile, a built-in serial interface allows the calculator to communicate with higher-level "computers," as well as Sharp's four-color printer plotter. The calculator also performs 90 BASIC programming functions. Its display is a 16-digit LCD. Competitor Casio, in turn, has a new \$100 scientific calculator, Model FX7000G, that can display numeric equations as graphs at the touch of a keypad on a 2.17" x 1.5" LCD (96 x 64 dots).

TANDY HAPPENINGS. Tandy Corp./Radio Shack has bought the assets of American Home Video Corp., which includes 207 "Video Concept" stores and nine distribution centers. Tandy will operate the stores, located in major shopping malls in 29 states, with an expanded product line. . . Tandy's largess was illustrated recently with 13 new grants to educators, ranging from support for instructing diabetics at day camps to reducing time that teachers spend in meetings instead of in classrooms, among other projects. The company also announced formation of the Council on Microelectronics Technology, an association with select universities and educators engaged in new, innovative uses of technology.

CLOSED-DOOR PARTS SALES OPENED A CRACK. As too many service technicians and electronics hobbyists have learned, the so-called OEM parts distributors won't sell to them. They're mostly interested in orders of thousands of parts at one time. MILO Associates, Inc., however, has announced a refreshing policy of servicing the smaller-quantity buyer. The Indianapolis distributor, which has a large commercial electronics customer base, doesn't even have a minimum-quantity order requirement, and says they will work for their orders, even if the buyer doesn't know the manufacturer's part numbers. Lucky local buyers.

COMPUTER HAPPENINGS. The computer world is still rattling and rolling. IBM surprised everyone by advertising its thought-to-be-dead PCjr at remarkably low prices, as well as direct-mailing of promo discounting prices of software for it. There are reportedly hundreds of thousands of jr's in the warehouses, so with IBM no longer manufacturing it, it's an apparent dump. Nonetheless, the price (and the machine) is right.... There are plenty of excess inventory deals around the country. A recent deal for \$25-million of "excess" Toshiba-built personal computers was made by Advanced Computer Products, Inc., a Santa Ana, California-based dealer. The machines are configured as IBM XT's and PC's, according to a company spokesman. A PC-type with 256K and a single 360K floppy disk drive will retail for \$750....CBS Inc. has discontinued producing computer software for consumers, forming a new unit to develop and market software for the school, college and medical markets.

VIDEO CASSETTE PROGRAM NEWS. Some interesting programs on videotape have been announced recently that extend beyond the typical motion picture releases. Eastman Kodak, for instance, has established the KODAK Video Exchange, a videotape series on photographic how-to and travel subjects that can be rented via mail. Available in VHS, Beta and 8-mm formats, there are 22 Exploring Photography tapes to choose from, 15 Exploring America, and 6 Exploring the World titles. Initial membership in the Exchange, which entitles a member to two videocassettes and a mini tripod, is \$29.95. A viewer member can keep the cassettes for as long as desired. Charges are \$6.95 with return of a KODAK Exchange cassette or \$19.95 with no return cassette. For more information, call 1-800-237-8400 or write KODAK Video Exchange, 343 State St., Rochester, NY 14650.

For football viewing jocks and jockettes, TCS announced formation of a new video division, premiering "Great Moments in Penn State Football (three volumes), that lets fans relive the past ten years of memorable football history with the powerhouse team, as well as "Get Up and Cheer," an instructional video cassette on cheerleading. Available in both VHS and Beta.

THE WORLD IN STEREO DX. That's what Alabama's NDXE Global Radio Station promises to do with a 100-kW high-frequency stereo radio transmitter and a 100-ft. rotatable log-periodic antenna. Broadcasts, which are scheduled to start July 1986 for shortwave reception beamed to the Americas, Europe and the Pacific, will concentrate on "mass-market" fare: live concerts, sporting events, worldwide phone-in shows, news, and recorded music. Of course, the FCC through the ITU (the governing authority on world-wide frequency allocation) must be in the act. At the beginning, the 34-year-old Alabaman launching this program plans to experiment with different approved frequencies, but says the station will probably wind up in the 49-meter band. But who's got stereo shortwave receivers? Use of Leonard Kahn's high-frequency stereo system will work fine, says Norman. Besides, the upcoming new generation of shortwave receivers will be allwave stereo. Meanwhile, let us see who gets NDXE's QSL card first, acknowledging reception of its program Norman promises that it will be in 3-D, another first.

AT&T IN TELERECORDING VENTURE. AT&T and CompuSonics Corp. announced they've entered into a one-year agreement to jointly promote CompuSonic's digitally transmitted and received music and AT&T's ACCUNET® Switched 56 Service for use together. The CompuSonic system, Telerecording, enables a consumer to phone in a music record purchase to a record dealer, pay for the album with a credit card and download the album over the phone line to a 5¼" floppy disk.

ONE-MEGABIT ROM. Manufacturer Oki Semiconductor is selling in OEM quantities a 1-megabit CMOS ROM that can store a whole operating system. Designated MSM531000, the new ROM is organized into 131,072 eight-bit words, allowing it to interface easily with most microprocessors. It requires an active operating current of only 15 mA and a standby current of 100 microamps, operating from a single 5-V source. It's packaged in a 28-pin plastic DIP. Hot dawg!

ME

NEW!

Satellite Communications Training from NRI!



Move into commercial satellite communications and home satellite TV with NRI's latest training breakthrough!

Explore Every Aspect of Satellite Transmission and Reception As You Assemble, Install, and Train With the Complete TVRO System Included in Your Course

Back in 1964, great excitement surrounded the launching of Syncom 2, the true forerunner of today's satellites. But not even the most hopeful of scientists believed that in less than 25 years, communications satellites would have such a tremendous impact on the professional and personal lives of millions of people around the globe.

Today, thanks to the rapid development of satellite technology, a call to Paris is as clear and as easy to make as a call to your next door neighbor . . . executives from multi-national corporations and even small businesses use video conferencing to "meet" without leaving their offices . . . simultaneously a billion people witness a single event (a soccer game, an inauguration, a benefit rock concert) . . . global weather maps transmitted from satellites allow meteorologists to forecast weather trends weeks

in advance . . . and scientists now explore and investigate the mysteries of outer space without leaving their labs.

And, not surprisingly, these amazing applications of satellite technology have opened up exciting new opportunities for the technician trained to install, maintain, troubleshoot and repair satellite communications equipment.

Home Satellite TV Is Just at the Start of Its Explosive Future

You've seen them in suburban backyards and alongside country farmhouses. Home satellite TV systems are springing up all across the country.

Already there are over a million TVRO (Television Receive-Only) systems in place in the U.S. alone, and experts predict that by 1990, a remarkable 60% of U.S. homes will have a satellite dish. Contributing to the field's phenomenal growth are the support of the FCC and Congress, steady improvement in product quality, the development of smaller dishes, and a growing consumer enthusiasm for satellite TV.

New Jobs, New Careers for the Trained Technician

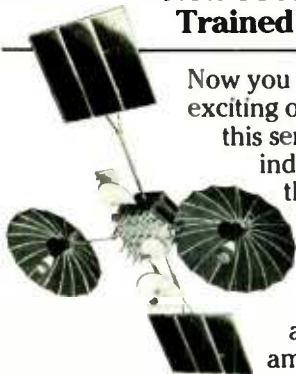

Now you can take advantage of the exciting opportunities opening up in this service- and support-intensive industry. NRI's new breakthrough training prepares you to fill the increasing need for technicians to install, adjust, and repair earth station equipment, such as dishes, antennas, receivers, and amplifiers.

As an NRI-trained technician, you can concentrate your efforts on consumer-oriented TVRO equipment. Or you can use your NRI training to build a career servicing larger commercial or military equipment used both to transmit and receive voice, data, and video signals. You'll also find opportunities in sales and system consulting, a role some expect to increase tenfold within the next five years on both the corporate and consumer levels.

NRI Brings Satellite Technology Down to Earth

Only NRI has the resources and the skills necessary to transform today's most sophisticated technology into understandable, step-by-step training.

NRI's new course in Satellite Communications gets you in on the ground floor of this booming technology. You are thoroughly trained in the necessary basic electronics, fundamental communications principles, and television transmission and operation.

Using the remarkable NRI Discovery Lab[®], you demonstrate first-hand many important points covered in your lessons. You perform critical tests and measurements with your digital multimeter. And, using your NRI Antenna Applications and Design Lab, you assemble and test various types of antennas and matching sections.

Then you concentrate on both commercial and consumer satellite earth station equipment, putting theory to practice as you assemble and install the 5' parabolic dish antenna system included in your course.

Your Home Satellite TV System Brings Theory to Life!

The Wilson TVRO system included in your course comes complete with 5' parabolic dish antenna system, low-noise amplifier (LNA), down converter, receiver, low-loss coaxial cable, and even a permanent polar mount.

By training with an actual TVRO system, you'll come to understand the function and operation of a satellite earth station—knowledge that you can apply to both consumer and commercial equipment. And once you have completed your TVRO system, you'll have access to the best television entertainment available—direct from the satellite to your home.

At-Home Training the Uniquely Successful NRI Way

It's hands-on training, at home . . . designed around the latest state-of-the-art electronic equipment you work with as part of your training. You start from scratch and "discover by doing" all the way up to the level of a fully qualified professional. You conduct key experiments . . . perform vital tests . . . install your own system . . . and you do it at the pace that suits you best.



But, most important to your success, you don't do it alone. Built into your NRI training is the enormous experience of our development specialists and instructors, whose long-proven training skills and personal guidance come to you on a one-to-one basis. They are always available for consultation and help.

Make Your Move Into the Future Today! Send for Your FREE NRI Catalog

Only NRI can train you at home for an exciting and rewarding career as a satellite communications technician. The knowledge and know-how you gain from your NRI training provide you with the soundest possible foundation for further growth with the industry. But now is the time to act. Return the post-paid card to us today. You will receive your 100-page catalog free. It's filled with all the details you'll want to know about our training methods and materials and our more than 70 years of successful

innovation in at-home, hands-on career training—the kind of experience that enables NRI to provide the most effective training possible to prepare you for today's, and tomorrow's, high-tech opportunities. (If the card is missing, write to us at the address below.)



NRI SCHOOL OF ELECTRONICS

McGraw-Hill Continuing Education Center
3939 Wisconsin Avenue, NW
Washington, DC 20016

We'll give you tomorrow.



For more information on products described, please circle the appropriate number on the Free Information Card bound into this issue or write to the manufacturer.

Laptop Portable Computer

Tandy's new Model 600 portable computer is an upward extension of its Model 100/200 laptop family. It is built around the low-power 16-bit 80C88 microprocessor and is supplied with 32K of user RAM, which is expandable to 224K that is usable in one contiguous memory bank. The computer comes with a built-in 3.5" floppy disk drive with 360K capacity, a full-size keyboard with special function keys, and an adjustable flip-up 80-character by 16-line liquid-crystal display (LCD) panel that has a matte finish to reduce glare.



Resident in ROM is Microsoft's Works software, which consists of five full-featured applications programs. The software makes use of key words that are displayed at the bottom of each screen. The built-in applications packages include: file-management, database, word-processing, spreadsheet, calendar and telecommunications software. An on-board rechargeable nickel-cadmium battery is said to provide approximately 11 hours of power on full charge. Recharging is accomplished with an ac adapter, supplied with the computer. \$1599.

CIRCLE 16 ON FREE INFORMATION CARD

Two-Channel Scope Waveform Storage Device

Sybex's new Model 602 Scope Memory is an add-on accessory that converts analog and digital oscilloscopes into dual-channel digital storage instruments. It easily connects to any standard 2-channel scope to provide an economical alternative to users who cannot justify the expense of purchasing a whole new instrument. The accessory functions as a conventional dual-channel storage scope or



in a comparison mode that permits storing and comparing new waveforms on one channel against a "standard" stored on the other channel.

Storage of both analog and digital signals is accomplished in a single sweep, into 2K of RAM in each of the accessory's two channels. (A front-panel LED comes on to indicate when memory is full.) The Model 602 features 18 selectable sample times with a 1.4-MHz maximum sampling rate. Each input is selectable in eight ranges. Resolution is 8 bits + 1 LSB. All input and output connectors are standard BNC type. \$895.

CIRCLE 17 ON FREE INFORMATION CARD

Mac Add-On Hard Disk

A 10M hard-disk subsystem for the Apple Macintosh has been announced by Paradise Systems, Inc. It comes with utility software that includes the system software package, the latest version of the Apple Finder operating system, a disk caching utility that speeds file access, and a backup and restore utility that permits a file to span more than one disk. The soft-

ware starts up the hard-disk system, reformats the disk drive and controls the automatic print buffer, which can hold up to 400K.

Installation is via a cable that plugs into the serial modem or printer port (when the latter is used, a printer can be connected to the serial port on the MAC-10). With this arrangement, the Mac's external floppy-disk drive port remains available for use with a second floppy drive. System software automatically detects to which serial port the MAC-10 is connected.



MAC-10 can be used with either 128K or 512K Macs. Its seek time is specified at 85 ms average, and data transfer rate is 10M bit per second. \$999.

CIRCLE 18 ON FREE INFORMATION CARD

Video Effects Titler

A microprocessor-based, stand-alone Video Effects Titler (VET for short) is a new video accessory from



MFJ Enterprises for both home video enthusiasts and professionals. With it, you can superimpose 30 pages of color titles over a camera im-

age, or add titles over existing video footage during editing. Titles can be easily composed and edited with the VET's typewriter-style keyboard.

Each of the 30 pages will display eight lines of 16 upper-and lower-case characters. Each character can be any one of 15 colors. Up to 30 pages of titles can be stored in the VET's memory and retained there even after the unit has been turned off or the plug has been pulled from the power source. A unique feature is the VET's expandability. An exterior port similar to the cartridge slot connectors used on home computers permits you to expand the system via such add-ons as a character font (style), special-effects, and popular computer-interface cartridges now under development. \$599.95.

CIRCLE 19 ON FREE INFORMATION CARD

TV & VCR Stereo Amplifier

New from Rhoades National Corp. (Columbia, TN) is the Model TA-450 Tele-Amp, which connects any TV receiver, VCR or satellite TV receiver to a pair of speaker systems to provide stereo sound reproduction. Tele-Amp accepts up to three mono or stereo inputs and has a Stereo-Plex circuit that synthesizes stereo from mono sources. It also has a head-



phone jack, EXQ noise reduction and loudness boost, and balance and volume controls.

Technical specifications for the amplifier include: 5 watts output into 8 ohms at 1.0% THD; 20-Hz to 20-kHz ± 3 dB frequency response; and 200-mV input sensitivity for 5-watt output. \$129.

CIRCLE 22 ON FREE INFORMATION CARD

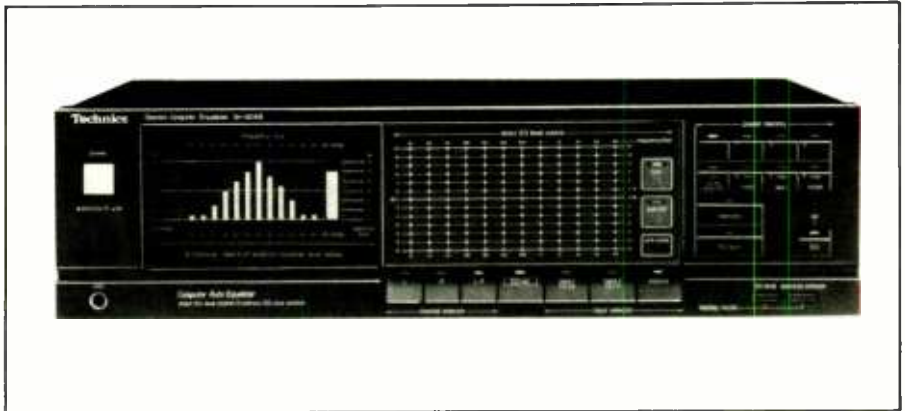

"Direct-Draw" Equalizer

Technics' Model SH-8066 stereo graphic equalizer has a "Direct Touch" control panel that does away with traditional slider controls. A user touches a flat-sheet panel to "draw" the desired curve. The 12-band equalizer also features a memory bank that stores eight preset curves, three preset at the factory and five of your own. "EQ Plus" and Automatic Equalizer functions help create the optimum curve while automatically adjusting for the sound system and room acoustics.

The Direct Touch panel offers equalization at any of 156 points with 2-dB/step ± 12 dB of boost and cut at each center frequency. A blue

fluorescent spectrum analyzer display shows the settings. A microphone supplied with the equalizer and a built-in pink-noise generator, activated by pressing an Auto EQ switch, let the SH-8066's computer automatically adjust equalization for a flat sound system response. The automatic procedure takes about 50 seconds to complete, after which the response is displayed as a bargraph of the dynamic music level.

A switch on the front panel of the equalizer lets you dub tapes from one deck to another and monitor either deck or the signal source. There is also an EQ Record switch for creating specially equalized music tapes for personal and car stereos. \$450.

CIRCLE 20 ON FREE INFORMATION CARD

Programmable Scanner

Uniden's new Bearcat 800XLT scanning monitor receiver is a tabletop unit that's microprocessor controlled. Featuring full programmability via its numeric keypads, the 800-XLT features full frequency coverage that includes the 800-MHz cellular telephone band, as well as public safety (police, fire, etc.), federal government, aircraft and military reception capability. It scans at a rate of 15 channels per second and handles 40 channels at a time. There's also a scan-delay provision that can add a three-second delay on any channel to prevent missed transmissions. Other controls include separate SQUELCH



and VOLUME controls, and SCAN, SEARCH, PRIORITY and HOLD functions. Channels and frequencies appear in a large LED numeric display at the top of the receiver's panel, while a large loudspeaker is built into the scanner's front panel. \$499.95.

CIRCLE 21 ON FREE INFORMATION CARD

(Continued on page 98)

Zenith's Deluxe 27" Color TV Receiver/Monitor Console

Modular in design and using RCA's Coty-29 picture tube, the new Zenith Model SB2777P 27" TV receiver/monitor console has a top-of-the-line Z-tech (Z-2) chassis. Much of its potential is due to a luminance/chrominance-separating comb filter (Zenith calls it PRP), found only in the company's best sets in which maximum bandwidth, picture/CRT compensation and top-performing tuners contribute to the quality of performance of the final product. It uses custom LSI (large-scale integration) chips and 27" short-neck 110° picture tube.

Perfectly complementing the console receiver is a compact, highly effective wireless remote-control transmitter. Not only does this little jewel control virtually all receiver/monitor functions, it can also control the functions of selected Zenith videocassette recorders.

Since this is a top-of-the-line console TV receiver/monitor, you can expect to pay a premium price for it, of course. Manufacturer's suggested retail price for the Model SB2777P is a hefty \$1399.95.

General Description

Besides its special 52% light-emissive, full-square picture tube and modularized LSI chassis, this set offers automatic CRT gun tracking and quartz-accurate 178-channel vhf/uhf/CATV direct-access electronic channel tuning. An advanced color sentry controls the picture with the help of a dynamic tint stabilizer, contrast regulator and color threshold.



Multichannel BTSC/dbx sound and second audio program (SAP) decoders add at least 12 kHz of broadband stereophonic (and monophonic) sound to the pleasure of viewing contrasty, richly colored pictures. The built-in 5-watt channel stereo audio amplifier is rated at 2% THD or less from 100 Hz to 10 kHz (0.6% between 1 and 3 kHz). Each amplifier channel drives an 8" woofer and a 2.5" tweeter.

First class all the way, tuned-channel numbers and time appear on-screen. Channels can be randomly accessed via either a touch-sensitive (capacitive) mem-

brane keypad on the console itself or via the included microprocessor-controlled SC6500 Space Commander the remote controller. (There's also a 12-hour parental-discretion lockout feature that can be switched in for any desired channels). Using the TV/stereo control, you get a programmable on-screen menu in large yellow letters from which you can choose SAP, stereo or mono sound—all selectable with the touch of a button on the remote-controller.

With the sophisticated remote controller that comes with this set, virtually all the controls on the set itself are

Full 4-MHz luminance bandpass appears at video detector and CRT.

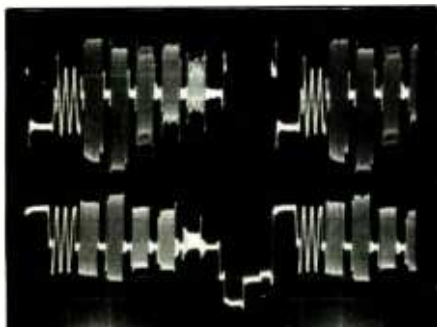

Chroma in the form of color bar test signal reveals system's full response.

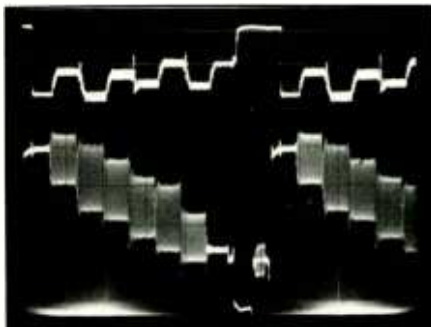

Color and luminance signal-to-noise ratios are satisfactory at 40 and 41 dB.



Zenith Model SB2777P TV Receiver/Monitor Laboratory Analysis

Tuner/system sensitivity	
vhf channels 3/10	-5.5/-6.0 dBW
uhf channels 15/60	0/+3 dBW
Age swing (before distortion; -5.5 to +55 dB)	60.5 dB
Dc restoration	83%
Chroma/luminance S/N through r-f measured at CRT	40/41 dB
CRT color temperature	7800° K
Convergence	99.8%
Maximum center vertical resolution	446 lines
Maximum horizontal resolution at CRT inputs (r-f source)	4.2 MHz
Maximum horizontal resolution via video input/output amplifiers at -3 dB)	3.5 MHz
Horizontal overscan	14%
Barrelling/pincushioning/flagwaving	slight pincushioning left side
Stereo/mono frequency response at -4 dB	100 Hz to 12 kHz
Sine-wave S/N at 5 kHz (through r-f/baseband)	40/65 dB
THD (measured at 1 kHz)	0.6%
Dynamic stereo channel (L and R) separation using stereo generator	38 dB
Dynamic range at 1 kHz before distortion	41.6 dB
Voltage regulation (dc) 100 V to 130 V	
LV (12 V)	11.9 V
(200 V)	204 V
HV (30 kV)	29.5 kV
Power consumption	108 W

Test Equipment: Tektronix Models 71.5 and 71.12 spectrum analyzers and Model C-5C camera; Hameg Model HM605 oscilloscope; B&K-Precision Models 1260 NTSC and 3020 function generators and Model 2007 stereo generator; Data Precision Models 195, 245, 1350 and 1750 multimeters; Sadelco Model FS-3D VU field-strength meter; Sencore Model VA48 (modified) video analyst; Gossen Luna-Pro light meter; and Polaroid 667 film.

tons for ENTER/RECALL, ANTENNA (switcher), up/down CHANNEL and VOLUME and favorite-channel flashback for the receiver functions. It also has TV/VCR, MUTE (TV or tape), PAUSE and the usual RECORD video, speed search and STOP functions common to modern wireless VCRs. You get all this in a compact package that weighs just 5 ounces, including battery.

This set is a member of Zenith's System 3 "Smart Set" line. As such, its cabinet has front-firing speakers and is available in French Provincial styling in pecan finish over woodgrain veneers and hardwood solids, complete with brass hardware that suggests key locks. The cabinet itself is on easy rolling casters and measures 48½" W x 32¼" H x 19¼" D, plus 2½" for the tube cap protector.

Test Results

Luminance and chroma video waveforms were excellent. The multiburst test is the primary means of determining high-frequency response up to 4.2 MHz (the limit any broadcast station radiates). A swept multiburst signal or a selection of several frequencies will pinpoint signal-to-noise (S/N) ratios. At the same time, color bars and their respective amplitudes and symmetries, plus chroma vectors, handily illustrate the dynamic condition of the color circuits.

In our lab tests, there were no disappointments in the color tests. The only exception was autocolour, which is usually the case. Autocolour is nominally "rank" in any system that doesn't use the vertical color (interval) test signal and selected sync as constant references. To maintain fleshtones under changing conditions. Zenith and most other TV manufacturers invariably compress oranges and reds. It is for this reason that we usually advise you to tune your own color and luminance if possible. Otherwise, you're begging for obvious distortions, including poor shading in adjacent color scenes.

Once correctly tuned, most color receivers will maintain proper phase rela-

"secondary" in nature. Hence, they're normally hidden from view inside a small push-to-open drawer at the top-right of the cabinet. Here, you'll find the channel-selection keypad; BALANCE, BASS and TREBLE controls for stereo sound; and normal TV or CATV wide-ranging auto-

Well-shaped vector confirms good color-circuit design. Engaging autocolour introduces distortion, (not in later models).

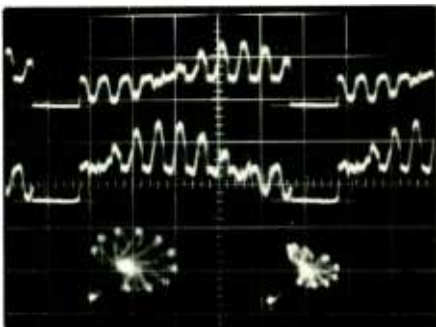

matic fine tuning (afc or aft) action. Also on the control panel is a STEREO/SAP indicator that lights to indicate when the 15,734-Hz stereo pilot carrier is detected.

The handy remote controller has the usual 10-button, direct-access channel-selection keypad. It also has separate but-

Composite waveforms illustrate both frequency range and total harmonic distortion (THD) of audio section.



(Continued on page 98)

Build a CoCo Testlab

How to use a Radio Shack Color Computer to test ICs, transistors, diodes and capacitors

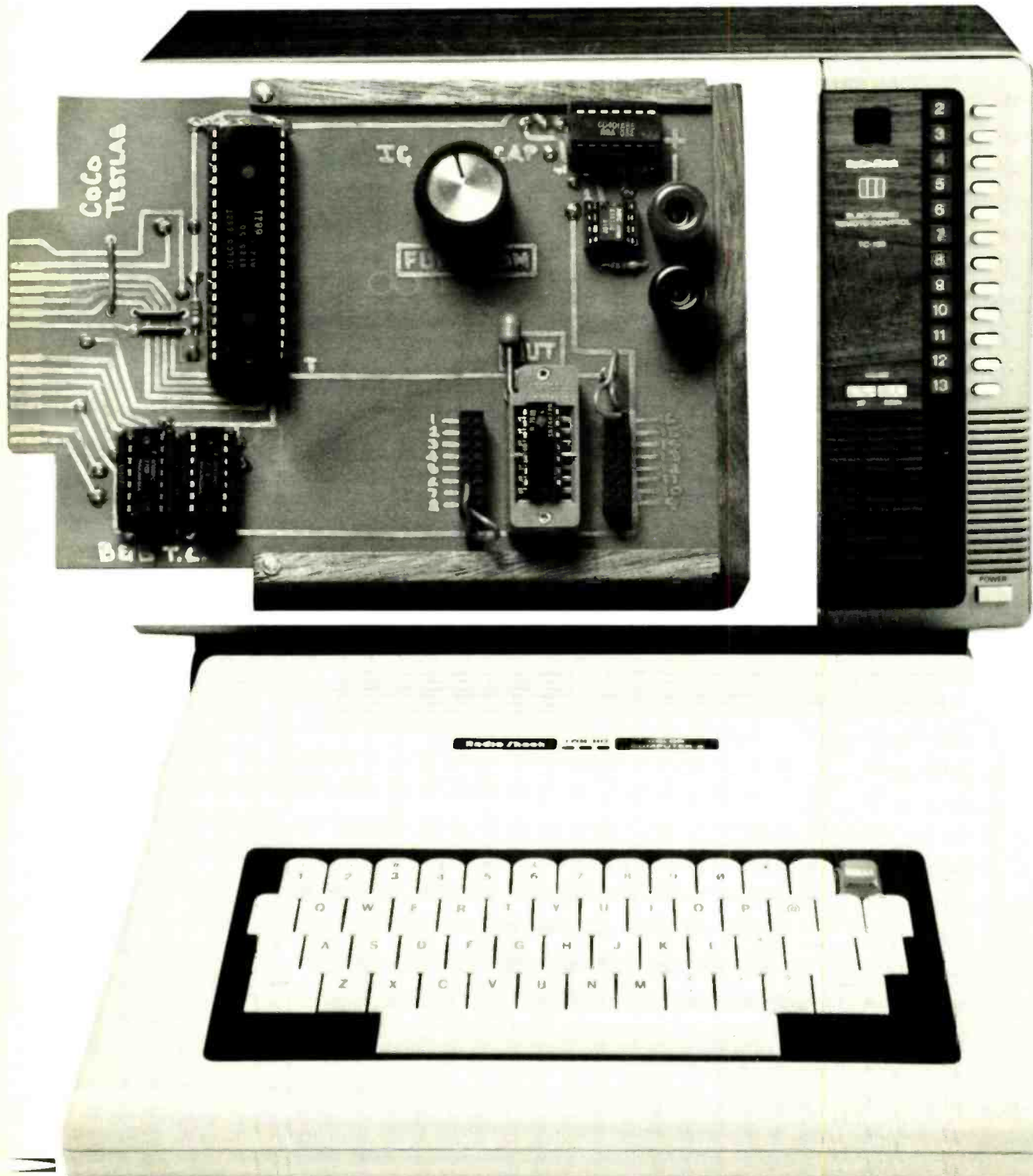

By Jim Barbarello & Jack Boyle

Your Radio Shack Color Computer can be much more than a word processor, games, player, etc. Given the right hardware and software, your CoCo can be used as a quick and accurate IC/transistor/diode and capacitor tester. The CoCo Testlab described here can test 14- and 16-pin TTL and CMOS ICs, npn/pnp silicon and germanium transistors, silicon and germanium diodes, and capacitors with values ranging from 4 pF to 40 μ F. (There is also a version of the Testlab for the Commodore 64 computer—see Parts List for details.)

Testlab is a hardware/software system. It consists of a build-it-yourself plug-in board (the hardware) and BASIC programs (the software) you key in from the computer's keyboard or load in from a cassette deck. The board plugs into the CoCo's cartridge slot and, thus, eliminates the need to modify the computer itself.

About the Circuit

The complete schematic diagram of the CoCo Testlab is shown in Fig. 1. The address the computer will use to communicate with the Testlab is defined by IC2 and IC3. The 6821 peripheral interface adapter (PIA) used for IC1 is the device commonly used for input/output (I/O) interfacing of 6800-series microprocessors.

There are 16 input lines on IC1, all of which connect to zero-insertion-force (ZIF) socket SO1. (A ZIF socket is recommended to eliminate the possibility of damage during insertion and removal of ICs being tested.) Only 13 of these lines go directly to SO1; the remaining three are routed to pins 9, 10 and 11 of SO1

(Continued on page 22)

Fig. 1. This is the complete schematic diagram of the CoCo Testlab. The circuit is designed to plug into the computer's cartridge port.

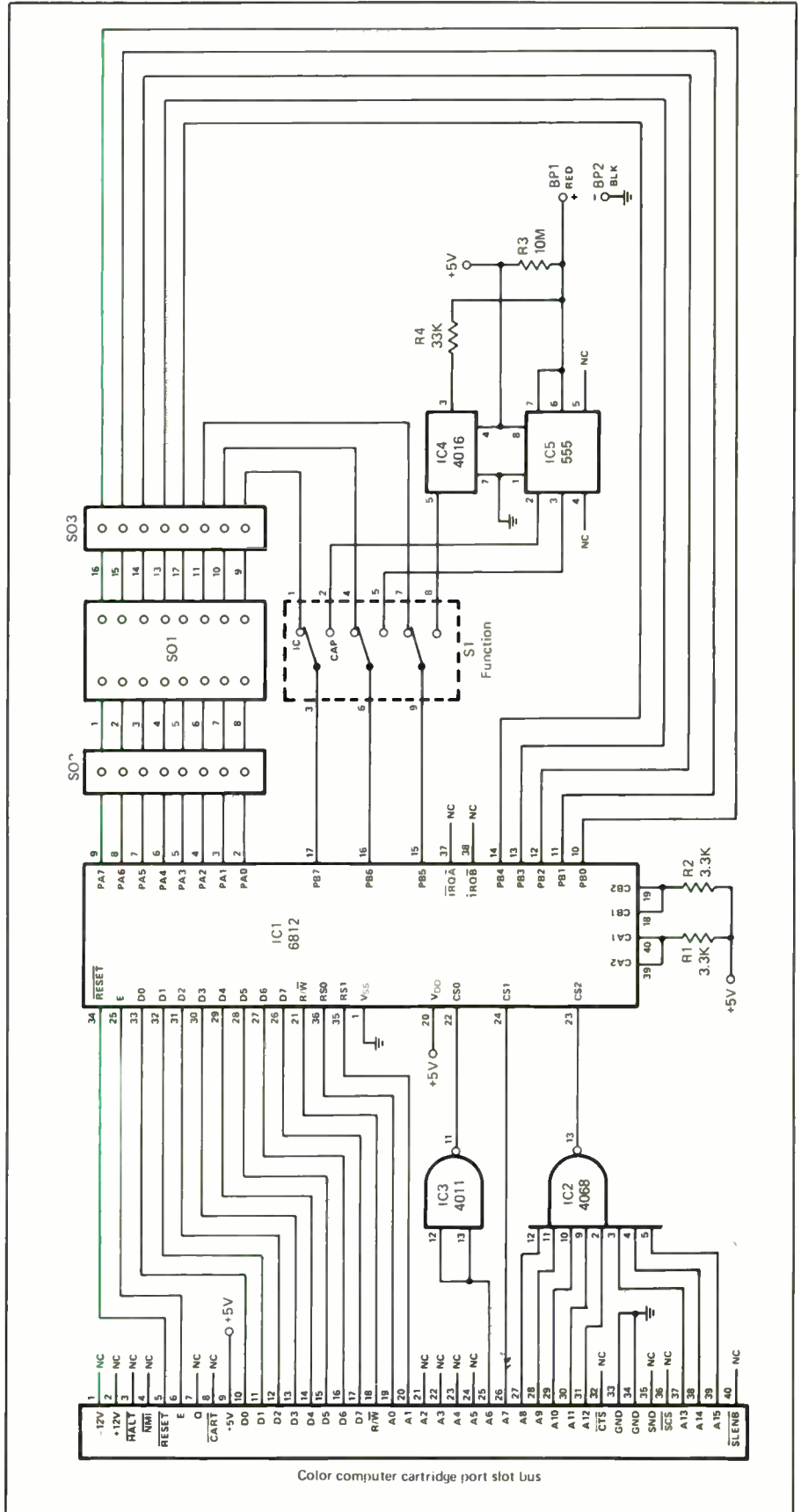

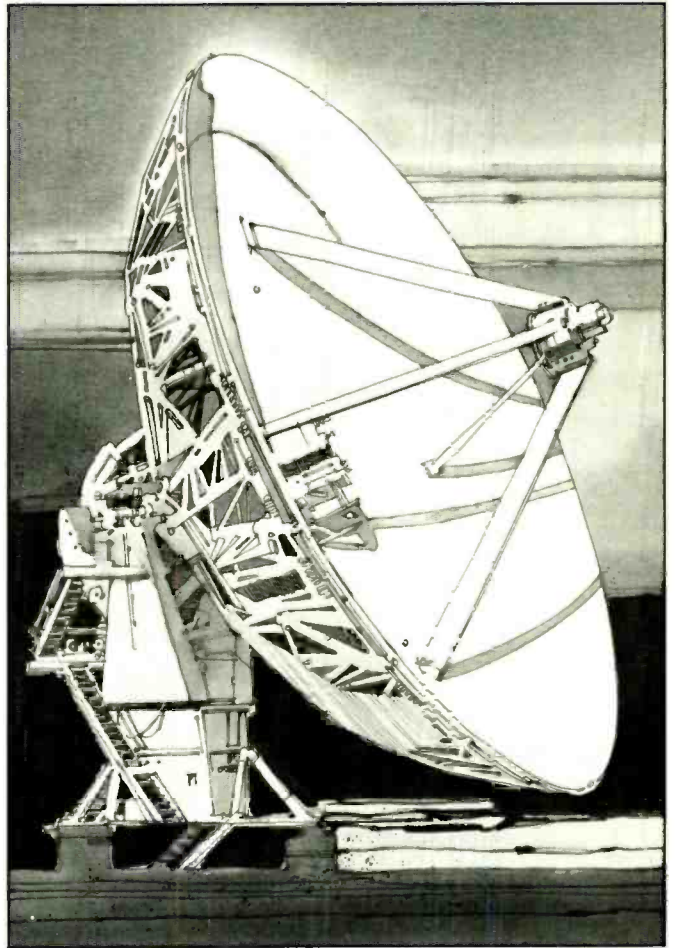
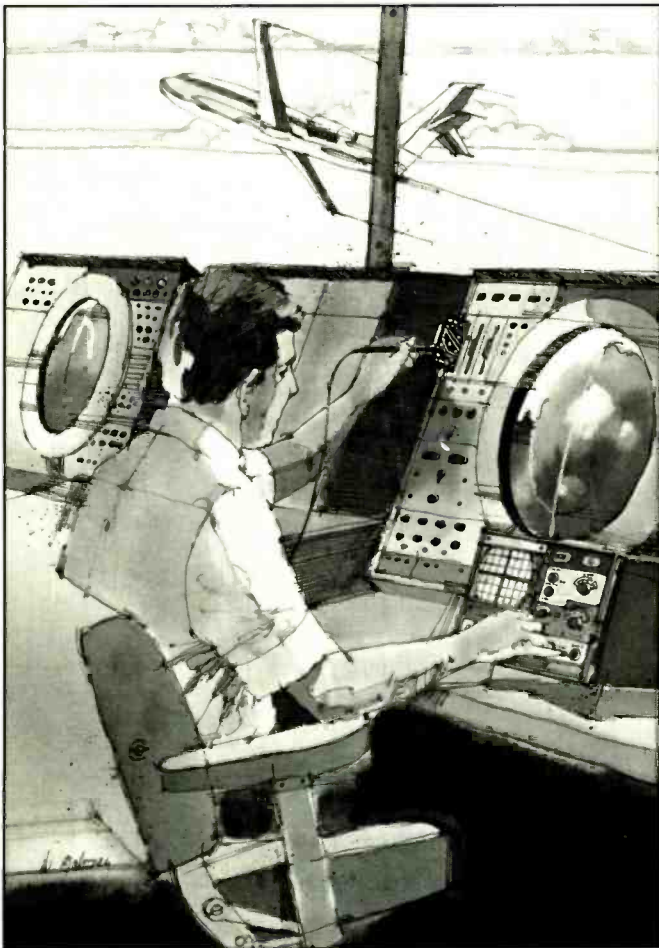
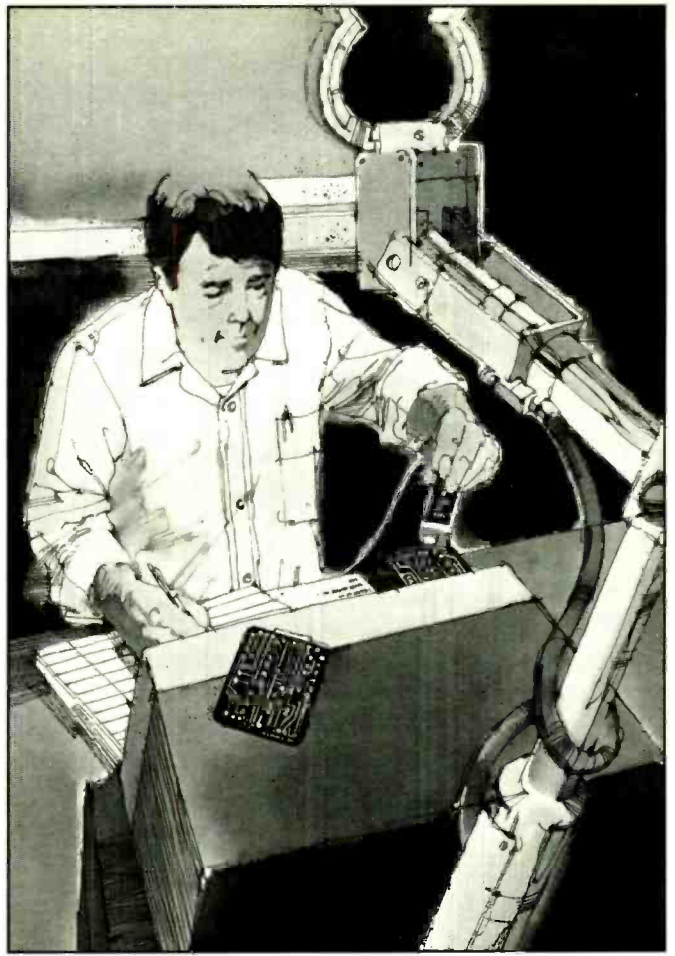

CIE MAKES THE WORLD OF ELECTRONICS YOURS.

Today's world is the world of electronics. To be part of it, you need the right kind of training, the kind you get from Cleveland Institute of Electronics, the kind that can take you to a fast growing career in business, aerospace, medicine, science, government, communications, and more.

Specialized training.

You learn best from a specialist, and that's CIE. We're the leader in teaching electronics through independent study, we teach only electronics and we've been doing it for over 50 years. You can put that experience to work for you just like more than 25,000 CIE students are currently doing all around the world.

Practical training.

You learn best with practical training, so CIE's Auto-Programmed® lessons are designed to take you step-by-step, principle-by-principle. You also get valuable hands-on experience at every stage with sophisticated electronics tools CIE-designed for teaching. Our 4K RAM Microprocessor Training Laboratory, for example, trains you to work with a broad range of computers in a way that working with a single, stock computer simply can't.

Personalized training.

You learn best with flexible training, so we let you choose from a broad range of courses. You start

with what you know, a little or a lot, and you go wherever you want, as far as you want. With CIE, you can even earn your Associate in Applied Science Degree in Electronics Engineering Technology. Of course, you set your own pace, and, if you ever have questions or problems, our instructors are only a toll-free phone call away.

The first step is yours.

To find out more, mail in the coupon below. Or, if you prefer, call toll-free 1-800-321-2155 (in Ohio, 1-800-362-2105). We'll send you a copy of CIE's school catalog and a complete package of enrollment information. For your convenience, we'll try to have a representative contact you to answer your questions. CIRCLE NO. 171 ON FREE INFORMATION CARD

CIE Cleveland Institute of Electronics
1776 East 17th St., Cleveland, Ohio 44114

YES! I want to get started. Send me my CIE school catalog including details about the Associate Degree program.

Print Name _____

Address _____ Apt. _____

City _____ State _____ Zip _____

Age _____ Area Code/Phone No. _____ / _____

Check box for G.I. Bulletin on Educational Benefits

Veteran Active Duty **MAIL TODAY!**

OR CALL TOLL FREE

1-800-321-2155

(In Ohio, 1-800-362-2105)

MO-50

PARTS LIST

Semiconductors

IC1—6821 peripheral interface adapter (PIA)

IC2—4068 CMOS 8-input NAND gate

IC3—4011 CMOS quad 2-input NAND gate

IC4—4016 CMOS quad analog switch

IC5—555 timer

Resistors (1/4-watt, 10% tolerance)

R1,R2—2200 ohms

R3—10 megohms

R4—33,000 ohms

Miscellaneous

BP1,BP2—5-way binding post

S1—3-pole, 4-position nonshorting rotary switch

SO1—16-pin zero-insertion-force (ZIF) IC socket

SO2,SO3—8-contact female header with contacts on 0.1" centers

Printed-circuit board (see text); sockets for ICs; control knob for S1; wire; solder; etc.

NOTE: The following are available from B&B Technical Consulting Inc., RD #1, Box 241 H, Tennent Rd., Manalapan, NJ 07726: complete kit of parts (includes BASIC tester programs on cassette tape), No. ME-1, for \$69.95; pc board, No. ME-2, for \$29.95; software cassette, No. ME-3, for \$9.95. New Jersey residents, please add sales tax. Send SASE for information on Commodore 64 version of Testlab.

through switch *S1*, which is used to select between the Testlab's IC and capacitor test functions.

With *S1* set to CAP switched line PB7 is used to trigger *IC5*. Line PB6 senses *IC5*'s output status. Switched line PB5 controls analog switch *IC4*, which either disconnects *R4* or places it in parallel with *R3*.

A capacitor to be tested connects between binding posts *BP1* and *BP2*, with the + lead going to *BP1* for polarized capacitors. To make a measurement, the software signals *IC1* to make PB7 and PB5 output lines and PB6 an input line. It also initially sets PB7 and PB5 to a logic-1 or high state, momentarily brings PB7 low to trigger *IC5*, and then starts sensing the level on PB6.

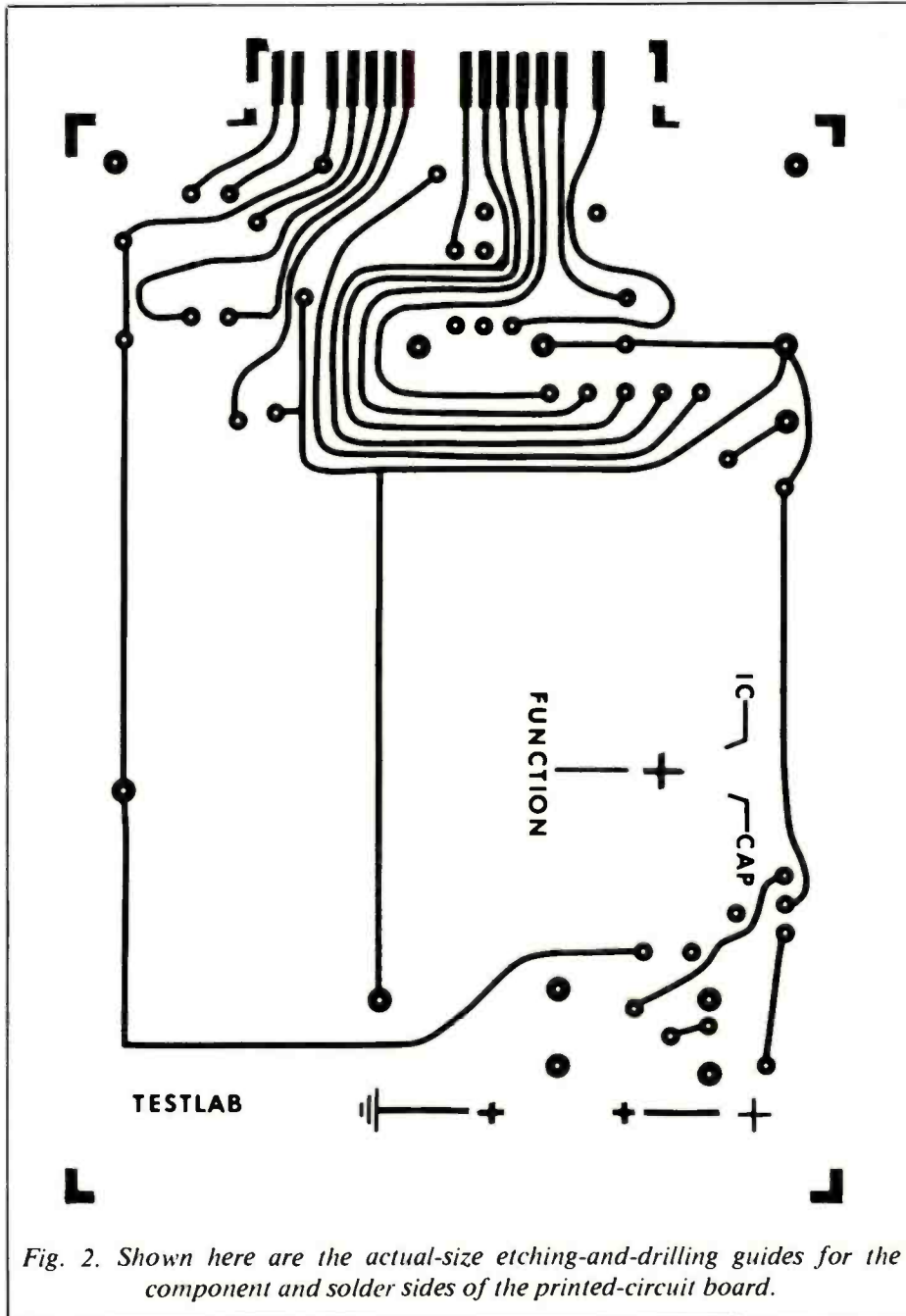
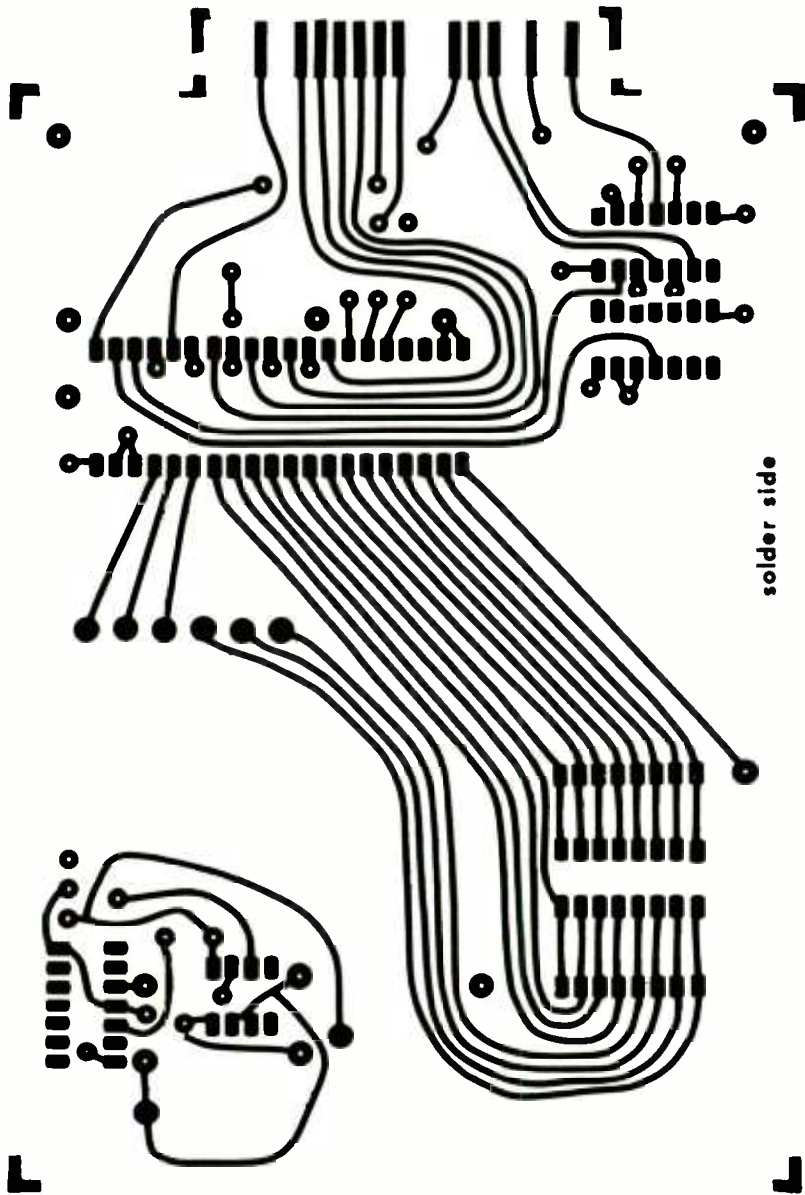

Fig. 2. Shown here are the actual-size etching-and-drilling guides for the component and solder sides of the printed-circuit board.

Integrated circuit *IC5* is a standard 555 timer IC operated in the one-shot mode. Its timing cycle is the product of the resistance value (in megohms) between V+ and pins 6 and 7 and the capacitance value (in microfarads) between V- and pins 6 and 7.

With PB5 high, analog switch *IC4* is on, connecting *R4* in parallel with

R3, for an effective resistance of 33,000 ohms (high range). Output pin 3 of *IC5* remains high until the timing cycle finishes, allowing the software to continuously sample PB6, looking for a low level and keeping count of how many samples have been taken. If a low level is found before a minimum sample



+ 5-volt and ground buses. To insure proper logic level sensing, all ICs to be tested are powered by the same 5-volt source.

Construction

For this project, you must fabricate your own printed-circuit board. This is the most difficult part of construction, since the double-sided board requires that you carefully register the component and solder sides.

Once you fabricate your pc board with the aid of the actual-size etching-and-drilling guides in Fig. 2, refer to the parts-placement diagram in Fig. 3 to locate all "feedthrough" holes (identified by the letter "F"). On a commercial board, these holes would be "plated-through" with metal. However, since this is a home-fabricated board, you must substitute short lengths of bare wires for the plating.

Ideally, the wire for the feedthroughs should be about the same diameter as that used for 1/4-watt resistor leads. However, it is more convenient to use solid—not stranded—hookup wire. Start by stripping 3" of insulation from a length of wire. Feed the bare wire through one feedthrough hole from either side of the board and solder to the pads on both sides of the board. Allow the solder to cool undisturbed until firmly set. Then clip the wire as close as possible to both soldered pads. Repeat this procedure with all F-labeled holes.

Next, install the three wire jumpers, identified with the letter "J" in Fig. 3. (Use insulated hookup wire for the jumpers.) Then install the resistors in their respective locations. Strip 1/4" of insulation from both ends of a red- and a black-insulated solid wire, both 2 1/4" long, and install them in the locations indicated.

Note in Fig. 3 the locations where there are asterisks, indicating that you must solder the connections to the pads on both sides of the board.

Use of sockets is highly recom-

number, due to stray capacitance in the circuit, the capacitor value is too low for the selected resistance. The software then makes PB5 low, turning off IC4 and changing the resistance to 10 megohms (low range). The timing cycle is then retriggered. This provides an autorange function for the full range of measurement.

If the sample count exceeds 65535, the capacitor's value is too large to measure and the software notifies you of this fact. When a valid count has been determined, the software converts that count into a capacitance value.

Power for the CoCo Testlab's circuit is provided by the computer's

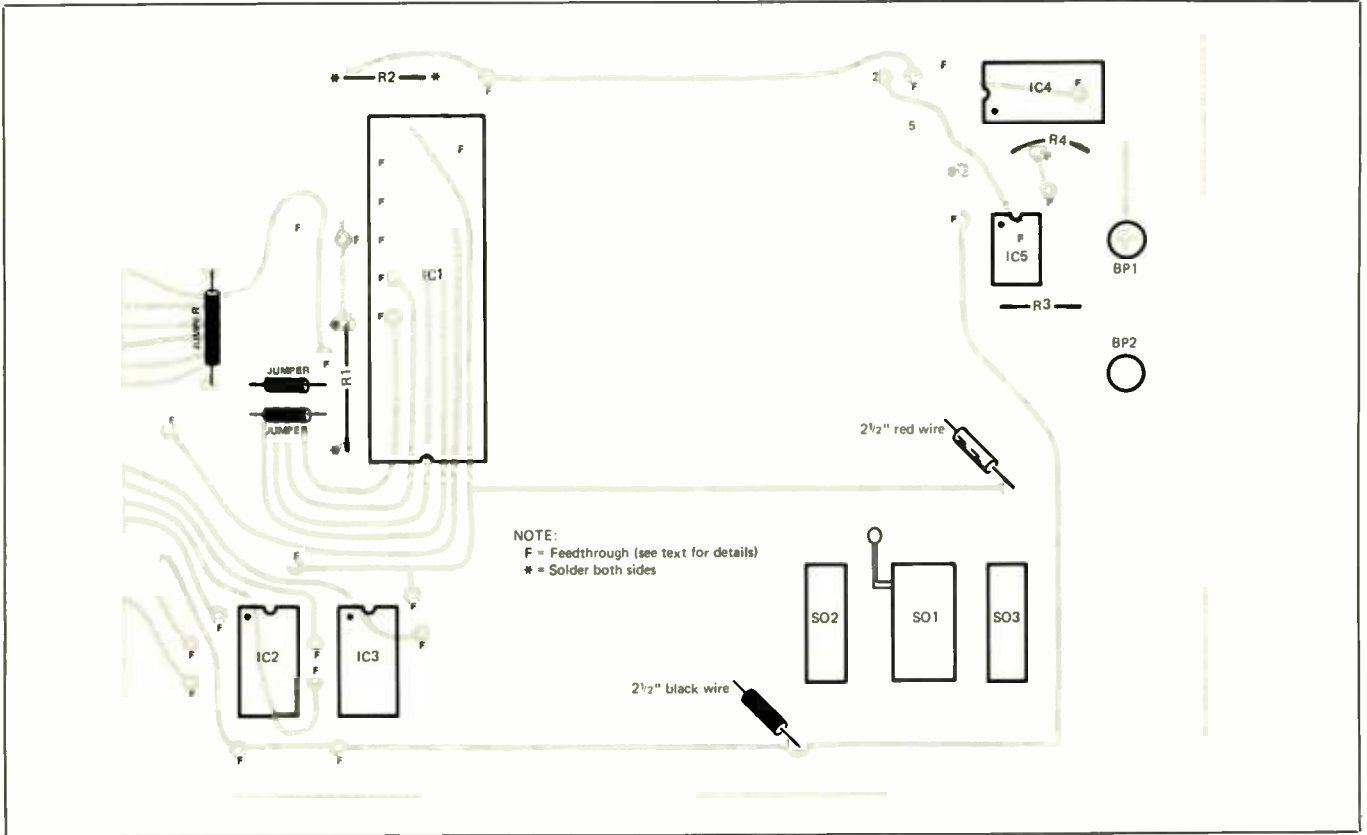

Fig. 3. This drawing shows installation information for the pc board. Note that certain wires and components must be soldered to the pads on both sides of the board.

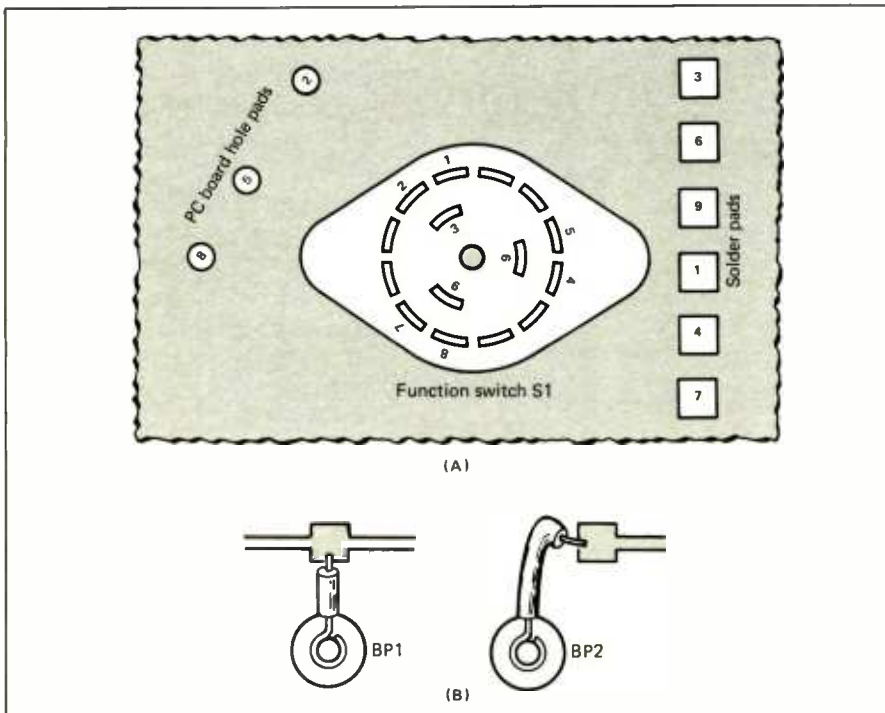

Fig. 4. These two drawings show the wiring details for the binding posts and function switch.

mended for all ICs in this project. Install them, ZIF socket *SO1*, and 8-contact sockets *SO2* and *SO3* on the component side of the board and solder their pins to the pads on the solder side. When you're finished, carefully inspect the connections to make sure that there are no solder bridges, especially between the closely spaced IC socket pads. Do not install the ICs in their sockets just yet.

Install *BP1*, *BP2* and *S1* in their respective locations on the board, fully tightening the hardware on the binding posts but making the hardware on the switch only finger tight. Then referring to the detail drawing in Fig. 4(A), orient *S1* as shown and tighten its mounting nut.

Prepare two 2" and nine 2½" lengths of hookup wire by stripping ¼" of insulation from one end and ⅛" of insulation from the other end. Connect and solder the ¼" end of the 2" wires to the solder posts on *BP1*

and BP2 and tack solder the other ends to the appropriate pads on the board. Similarly, connect and solder the 1/4" ends of the remaining nine wires to the lugs on S1, and tack solder the other ends to the appropriate pads on the board. Note that the wire going to hole 2 on the board must be soldered to both the component- and solder-side pads.

You may wish to make a small support for the Testlab to keep it level when plugged into the CoCo's cartridge slot. A block of wood measuring 1 1/2" high by 4" wide will do nicely. For convenience, you might want to permanently attach the board to the circuit card. Alternatively, drill a hole in the corners of the board at the end opposite the plug-in fingers and mount a 1" spacer in both locations.

Place a control knob on the shaft of S1. Then, referring back to Fig. 3, install the ICs in their respective locations. Make sure you index them in their sockets as shown.

Initial Checkout

Plug the Testlab into the cartridge slot of your computer and then turn on the power. If the normal sign-on message does not appear on the screen, there is a good chance that you did not make all necessary solder connections or/and that one or more of the ICs is not properly installed. If you encounter any difficulties, power down the computer, unplug the Testlab, and make any necessary corrections.

Caution: Never plug the Testlab

into or remove it from your computer's cartridge slot with power turned on. The cartridge port lines are connected directly to the CPU lines without safety buffering. Shorting pins together during insertion or removal could apply undesired voltages to and damage the CPU.

When you obtain the normal sign-on message, you are just about ready to use the Testlab for any of the purposes for which it was designed.

Coming Next Month

This completes Part I of this article. In next month's concluding installment, we will discuss now to use the Testlab to test ICs, transistors, diodes and capacitors. **ME**

MODERN ELECTRONICS

Now you can reach out every month and learn about the latest innovations in consumer electronics and personal computers—what's new, how products and circuits work, and what leading authorities think of them.

- *Stereo *Video *Home & Car Electronics
- *Test Instruments *Circuitry & Devices *Servicing
- *Personal Computers *Communications *Construction Projects

In every issue, authors lucidly explain how exciting, new electronics ideas are applied . . . issue forthright buying counsel . . . present complete plans to build electronic devices to enhance products, even unique ones that are not yet being sold in the marketplace.

Just fill out the coupon and mail with your check, money order, or credit card information (Visa or MasterCard) to enter your subscription. Do it today to ensure earliest delivery!

MODERN ELECTRONICS 76 North Broadway, Hicksville, NY 11801

Please send me Modern Electronics for 2 Years 1 Year

Name _____ 3 Years (36 issues) . . \$45.00 |
 Street _____ 2 Years (24 issues) . . \$31.00 |
 City _____ 1 Year (12 issues) . . \$16.97 |
 State _____ Zip _____

Charge My Order To: Payment Enclosed \$ _____

MasterCard

VISA

My account number is:

--	--	--	--	--	--	--	--	--	--	--	--	--	--	--	--	--	--	--	--



MODERN ELECTRONICS

76 N. Broadway, Hicksville, NY 11801

FREE INFORMATION SERVICE

For further information on products, dealers, or literature in this issue, circle the appropriate numbers below. Be sure to include your name and address before mailing.

1	2	3	4	5	6	7	8	9	10	11	12
13	14	15	16	17	18	19	20	21	22	23	24
25	26	27	28	29	30	31	32	33	34	35	36
37	38	39	40	41	42	43	44	45	46	47	48
49	50	51	52	53	54	55	56	57	58	59	60
61	62	63	64	65	66	67	68	69	70	71	72
73	74	75	76	77	78	79	80	81	82	83	84
85	86	87	88	89	90	91	92	93	94	95	96
97	98	99	100	101	102	103	104	105	106	107	108
109	110	111	112	113	114	115	116	117	118	119	120
121	122	123	124	125	126	127	128	129	130	131	132
133	134	135	136	137	138	139	140	141	142	143	144
145	146	147	148	149	150	151	152	153	154	155	156
157	158	159	160	161	162	163	164	165	166	167	168
169	170	171	172	173	174	175	176	177	178	179	180

Insert issue date here _____
 (month) (year)
 (must be completed to process)

Name _____

Company Name _____

Address _____

City _____ State _____ Zip _____

Phone _____

Testing CD Players

New standards for specifying Compact Disc player performance are examined.

By Len Feldman

When CD players were first introduced three years ago, some of the advertisements accompanying their introduction implied that sonic utopia had arrived: the sound was "perfect" and it was "forever." Since then, we've learned that (a) the sound is still not quite "perfect," (b) some CD players deliver more "perfect" sound than others and, (c) there's more to judging a CD player than just listening to sound quality.

All this suggests that CD players qualify as products to be tested and evaluated in a test lab setting, just as do amplifiers, tuners, tape decks and other audio components. But what parameters to test and how to test them meaningfully has been a subject of debate since the new CD format was introduced. Now, the EIAJ (Electronic Industries Association of Japan) has come up with two Standards for testing CD players. The first, identified as Standard Number CP-307, describes the tests to be performed and how the results are to be spelled out so that consumers can compare products on a fair and equitable basis. The second, Standard CP-308, specifies a test disc that will contain all of the required test signals needed for the tests spelled out in CP-307. Most of those test signals are available today, if not on a single disc, certainly from several Test Discs that have been around for some time.

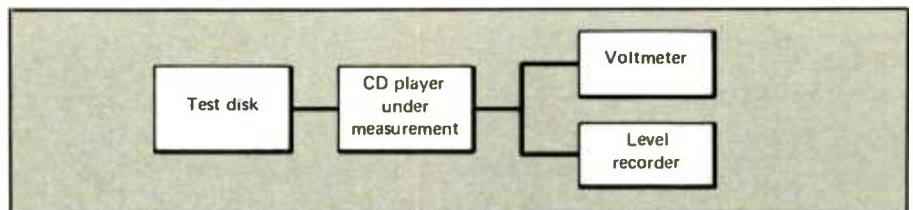

Fig. 1. Test setup for measuring response of a CD player.

A few of the test discs that have been used for evaluating CD players up to now include:

- Philips "Test Sample 3"—Catalog #410-055-2 (Test Signals)
- Philips "Test Sample 4A"—Catalog #410-056-2 (Music Tests)
- Sony "Test CD Type 1"—Catalog #YEDS-2 (Test Signals)
- Sony "Test CD Type 3"—Catalog #YEDS-7 (Test Signals)
- Technics "Test Disc 1"—Catalog #SH-CD001 (Test Signals)
- Denon "Digital Audio Check CD"—Catalog #33C39-7441 (Music + Signals)

What The EIAJ Wants Tested

Table I lists the 13 tests that the EIAJ Standard calls for. I'll discuss the usefulness of these tests presently, as well as the need for perhaps additional tests that were not included in the newly issued standard. Let's examine the listed tests, one by one, so that you will be in a better position to judge manufacturers' CD player performance claims as a prelude to choosing a machine for purchase.

Frequency Response: *A typical measurement for a CD player might read: "Frequency Response: 20 Hz to 20 kHz, ± 1 dB"*

This measurement is not unlike the frequency response specification offered for all audio components. It can be measured either by using some 17 spot frequencies (from 4 Hz to 20 kHz) or by using a sweep-frequency generator and a chart level recorder to plot a smooth, continuous frequency response curve. In the latter case, the sweep extends from 16 Hz to 20 kHz. In reporting the results, a tolerance must, of course, be stated. Thus, a typical example of a published specification might be: "Frequency Response: 4 Hz to 20 kHz, ± 0.5 dB." Figure 1 illustrates the test setup for this measurement.

Signal-to-Noise Ratio: *A typical measurement for a CD player might read: "Signal-to-Noise Ratio: 96 dB"*

This specification is referred to the "0-dB" or maximum recording level of a 1-kHz signal available on the test disc. The output level of such a test signal is compared with the output level reading when playing a special band of the test disc on which "infinite zero" recording has been made. (In terms of digital encoding, that's represented by a series of samples, each of which consist of 16 "binary zeros.") As usual, the S/N is expressed in decibels, or dB. The

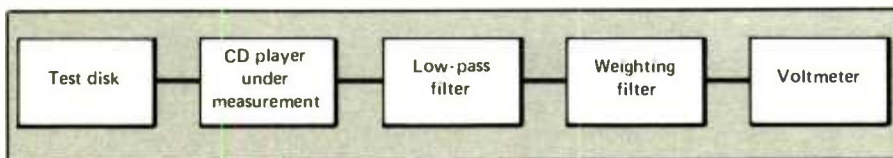

Fig. 2. Test setup for measuring signal-to-noise ratio of a CD player.

standard calls for insertion of an A-weighting filter when making this measurement. This filter tends to de-emphasize the low- and high-frequency noise components, while giving full weight to the mid-frequencies to which human ears are most sensitive. In general, the use of such a weighting filter yields "better" or higher S/N numbers than would otherwise be the case, but so long as all manufacturers measure signal-to-noise the same way, the use of the network is probably justified. In the case of the EIAJ Standard, a low-pass filter (having a cut-off frequency at 20 kHz) is also to be used, so that any noise components above 20 kHz (and, therefore, above human audibility) are excluded from the overall measurement. A block diagram of the test setup is shown in Fig. 2.

Dynamic Range: A typical measurement for a CD player might read: "Dynamic Range: 98 dB"

This specification has probably puzzled anyone who has read a specification sheet for a CD player. Often, dynamic range is listed just below (or just above) the signal-to-noise specification. Sometimes the two numbers are the same; in other cases they differ by a few dB. Now the EIAJ has introduced a standard definition of dynamic range, at least as far as it applies to CD players. To measure this "spec" you simply play a 1-kHz test signal that has been recorded at a -60-dB level compared

with the maximum or 0-dB level. Next, you measure the total harmonic distortion (THD), again interposing a weighting filter and a 20-kHz low-pass filter. You simply convert that distortion reading in percent to decibels and add the dB number to 60 dB (since you were already at -60 dB below maximum possible recording level) to obtain the dynamic range of the CD player.

To give an example, suppose the THD reading you get while playing the 1-kHz tone at -60 dB is 1.5%. That percentage is equivalent to -36.5 dB. Adding 36.5 dB to 60 dB, you arrive at a Dynamic Range "spec" for the player of 96.5 dB. As you can see, this result may or may not be equal to the signal-to-noise ratio reading obtained earlier, using a completely different procedure. If you think about it, though, you can see that the EIAJ method of computing dynamic range is meaningful and does give you an idea of how far apart the loudest and softest recorded sound can be without burying the softest sound in distortion.

Figure 3 shows the required test setup. The voltage amplifier illustrated in the diagram may be necessary to raise the overall level of the signals so that the distortion meter is able to read the total harmonic distortion (THD) of such a low-level signal. If such an amplifier is used, care must be taken to prevent it from introducing its own distortion.

Total Harmonic Distortion: A typical measurement for a CD player might read: "Total Harmonic Distortion: Less than 0.005% at 1 kHz"

For published specifications, this test uses signals recorded at the maximum or 0-dB recording level. Admittedly, that provides the lowest THD figures (distortion *increases* with decreasing signal levels in a digital recording system since, at lower levels, there are fewer digital "bits" with which to accurately define each digital sample level), but again, it's a matter of comparing "apples to apples." If everyone tests for and reports THD the same way, meaningful comparisons can be made by consumers. In making the THD measurement, once again, components outside the audio band are not included since the 20-kHz filter is inserted in the measurement path.

An interesting sidelight must be mentioned here. Initially, the frequencies that were to be used to measure THD were the usual ones, spaced an octave apart, using 1 kHz as a starting point, and choosing higher and lower frequencies up to 20 kHz and down to 4 Hz. A committee of the EIA (the U.S.-based Electronic Industries Association) pointed out that if these frequencies are used, under some circumstances the number of generated digital "codes" will be limited, or too low. This occurs if the ratio of the sampling frequency (44,100 Hz) to the frequency of the test signal is an integer or whole number.

Accordingly, for purposes of THD measurement, other frequencies were chosen and will be present on the test disc. For example, 997 Hz is used instead of 1 kHz; 499 Hz instead

Fig. 3. Test setup for measuring dynamic range of a CD player.

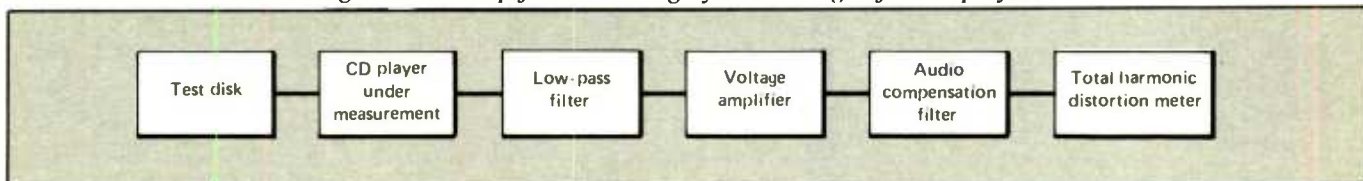

of 500 Hz; 19,997 Hz instead of 20 kHz, etc. The test setup for THD measurements is similar to that used for Dynamic Range measurements (Fig. 3) except that the weighting filter (referred to as the Audio Compensation filter in the diagram) and voltage amplifier are omitted. A manufacturer may report THD at one or more frequencies, and the THD is given in percent, with the frequency or frequencies of measurement specified as well.

Channel Separation: *A typical measurement for a CD player might read: "Separation: Better than 80 dB at 1 kHz" or "Separation: Better than 75 dB from 20 Hz to 20 kHz"*

Although the stereo channel separation provided by the CD medium is far higher than that of any analog audio component, the EIAJ Standard saw fit to include it in their list of required measurements. Only five test frequencies are provided for making this measurement (125 Hz, 1 kHz, 4 kHz, 10 kHz and 16 kHz), but these are available first as L-only signals (for measuring "R" channel output) and then as R-only signals for measuring the output at the opposite channel. Again, a low-pass filter is employed in the setup to eliminate any spurious, out-of-band signals from the measurement.

As you can see in Fig. 4, a spectrum analyzer is also called for. That's because the Standard considers only leakage of the *fundamental* frequency to be significant. In other words, if a 1-kHz signal is on the left channel, and the right channel has outputs of small amounts of 2 kHz, 3 kHz, etc., in addition to leakage of the 1 kHz, only the 1-kHz component is to be considered in calculating the ratio of signals. Separation is to be reported in dB and, if no frequency is listed, the separation may be assumed to have been measured at 1 kHz.

De-emphasis Error: *A typical measurement for a CD player might read: "Deemphasis error: No more than +0/-1.0 dB at 10 kHz"*

Table 1—New CD Player Tests

Measurement	Frequencies Used (Hz)	Equipment Used	Signal Level
Frequency Response	4,8,16,32,63,125 250,500,1K,2K,4K,8K 10K,12.5K,16K,18K,20K or 16 to 20K sweep	Ac Voltmeter	0 dB
Signal/Noise Ratio	1K	Low-pass filter A-weighting network Ac Voltmeter	0 dB & -inf.
Dynamic Range	1K	Distortion Meter A-weighting network Low-pass filter (Voltage Amplifier)	-60 dB
Harmonic Distortion	32,63,125,250,500 1K,2K,4K,8K,10K,12.5K 16K,18K,20K (See Text)	Low-pass filter Distortion meter	0 dB
Separation	125,1K,4K,10K,16K	Low-pass filter Spectrum analyzer Ac Voltmeter	0 dB
De-emphasis Error	125,1K,4K,10K,16K	Voltmeter	-20 dB
Wow-and-Flutter	3.15K	W & F Meter	0 dB
IM Distortion	60 + 7K (4:1)	Low-pass filter IM Distortion Meter Spectrum Analyzer	0 dB
Phase Difference	20K	Phase Meter or Dual-trace 'scope	0 dB
Level Difference Between Channels	1K	Voltmeter	0 dB
Output Voltage	1K	Voltmeter	0 dB
Pitch Error	20K	Frequency Counter	0 dB
Access Time	—	Stopwatch	0 dB

The CD format includes an optional preemphasis (during recording)/deemphasis (during playback) arrangement which recording companies may use if they wish. If a disc has been recorded with preemphasis (for still further improvement of signal-to-noise ratio), the player will sense that fact and will switch in the appropriate deemphasis.

The inaccuracy of that de-emphasis network can, of course, degrade the nearly perfectly flat frequency response of the player. Therefore, to measure this parameter, five test frequencies are recorded on the test disc at a -20 dB level, with preemphasis turned on. If output levels for any of the test frequencies deviates from 0

dB during playback, that deviation is reported as the deemphasis error, in dB. If the frequency at which the error was measured is not mentioned, it is understood to be 10 kHz.

Wow-and-Flutter: *A typical measurement for a CD player might read: "Wow-and-flutter: Below Measurable Threshold" or "Wow-and-flutter: ±0.001% Weighted peak or less"*

Most manufacturers of CD players, if they list this specification at all, usually state that it is "Below measurable limits." Indeed, wow-and-flutter in a CD player is really a function of the accuracy and stability of the digital "clock," which times the release of the digital sample codes

Heathkit®



Robotics technology comes to life in building HERO® 1 and teaching it movement, speech and object manipulation.



Hams! Get the latest in amateur radio technology including high-speed Packet Radio Communication.



Powerful new IBM-PC compatible Heathkit computers are yours to build easily and save with, or to buy assembled.



Build from our full line of precision test instruments and see how they can increase your troubleshooting effectiveness.



New Digital Rain Gauge records rainfall accurately and reads out inside your home in 100ths of an inch.

Your guide to everything that's new in electronics, computers and technical education. Over 400 items. Discover fascinating kits to build, enjoy and learn with, as well as assembled high tech products for home, business and hobby.

Get our famous High Tech Catalog

FREE

Heathkit®

Heath
Company

Heath Company
Dept. 079-384
Benton Harbor, Michigan 49022

MAIL COUPON TODAY and receive the latest issue of the Heathkit Catalog free of charge

Name _____

Address _____

City _____ State _____

CL-783BR2 Zip _____

CIRCLE 52 ON FREE INFORMATION CARD

A subsidiary of Zenith Electronics Corporation

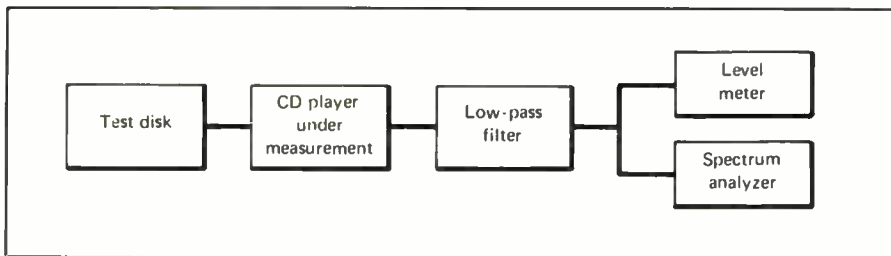

Fig. 4. Test setup for measuring channel separation in a CD player.

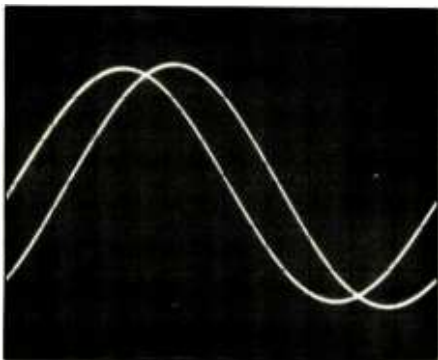

Fig. 5. Dual-trace scope photo shows time displacement (phase error) between 20-kHz test signals reproduced at left- and right-channel outputs of a typical CD player that uses a single D/A converter. Time delay amounts to more than 11 microseconds.

from the buffer into which they are fed from the laser pickup. Despite this fact, the EIAJ saw fit to include a measurement of wow-and-flutter. The measurement, if it can be made at all, is to be reported as the weighted peak value of wow-and-flutter. The standard does permit a manufacturer to state that wow-and-flutter is "Below Measurable Limits" if the measurement results turn out to be $\pm 0.001\%$ weighted peak or less.

Intermodulation Distortion: A typical measurement for a CD player might read: "SMPTE-Intermodulation Distortion: 0.01% or less" or "CCIF-IM: 0.005% or less"

This measurement is completely analogous to the SMPTE-IM measurement standardized long ago for audio amplifiers. The usual test frequencies of 60 Hz and 7 kHz, in a

ratio of 4:1, are to be available on the standard test disc, with the composite level of this signal corresponding to maximum (0-dB) recording level. Again, a low-pass filter and a spectrum analyzer are included in the test setup, as in Fig. 4.

The IM distortion is reported as a percentage and if no frequencies are stated, it is understood to mean SMPTE-IM (60 Hz + 7 kHz). Although not required, the standard suggests that in order to check IM at high frequencies, the tester or manufacturer may want to use a so-called CCIF test signal provided on the standard test disc. That signal consists of equal amplitudes of 11-kHz and 12-kHz signals. Such signals, when mixed together, may produce discrete amounts of difference signal (1 kHz), which is then reported as the CCIF-IM distortion.

Phase Difference Between Channels: To date, no manufacturers have been reporting this parameter, but in the future a typical measurement for a CD player having a single digital-to-analog converter might read: "Phase Difference Between Channels: 82 degrees or less"

Audio purists have made much of the fact that time-delay errors occur in CD players within a given stereo channel. When steep analog filters are used, phase error or time delays are introduced for high frequencies compared with low-frequency output. Little has been said about the phase or time-delay error that exists between channels. If a single digital-to-analog (D/A) converter is used in a CD player, it will switch back and

forth between left-channel and right-channel digital codes as it translates them back into analog signal levels. Even if all other circuits in the player introduce no phase shifts (or equal phase shifts between channels), the phase error between channels will still be around 11.3 microseconds. On the other hand, if separate D/A converters are used for each channel's audio recovery, this fixed phase error may not be present.

While you may not regard an 11.3-microsecond phase error as significant, it does represent quite a large angular displacement at high frequencies. This phase difference between channels can easily be measured using a dual-trace oscilloscope, as shown in Fig. 5. In this illustration, a 20-kHz test signal (recorded on both channels) was observed on a dual-trace scope and, sure enough, with the scope's horizontal sweep rate set for 10 microseconds per division, the two traces show up almost precisely 11.3 microseconds apart.

The EIAJ standard wants the phase error between channels to be reported in degrees. In the case of this 20-kHz signal, a time delay of 11.3 microseconds works out to be an angular error of just over 81 degrees. If 20-kHz signals are used, the frequency need not be stated by the manufacturer or tester.

Level Difference Between Channels: To date, few if any manufacturers have listed this specification. In the future, a typical measurement for a CD player might read: "Level difference between channels: 0.5 dB or less"

Any difference in output levels between channels on a CD player is more than likely caused by differences in gain of the analog stages that follow the D/A conversion process. These differences are easily measured by simply reproducing a test signal that's recorded at equal amplitude on both channels of the test disc. The observed level difference is simply reported in dB.

Table II—EIAJ CP-308 CD Test Disc Contents

Track No.	Channel(s)	Frequencies (Hz)	Level	Playing Time (Min.:Sec.)	Used To Measure
1	L,R	1K	0 dB	3:08	Reference Level Access Time Level Difference Output Voltage
2	L	1K,125,4K, 10K,16K	0 dB	4:58 (total)*	Separation
3	R	1K,125,4K, 10K,16K	0 dB	4:58 (total)*	Separation
4	—	—	— Inf.	2:58	Signal/Noise Ratio
5	L,R	1K	-60 dB	2:58	Dynamic Range
6	L,R	4,8,16,32**	0 dB	3:58 (total)*	Frequency Response Harmonic Distortion Difference Between Channels
7	L,R	63,125,250, 500**	0 dB	3:58 (total)*	Same as Track 6
8	L,R	1K,2K,4K, 8K**	0 dB	3:58 (total)*	Same as Track 6
9	L,R	10K,12.5K, 16K,18K**	0 dB	3:58 (total)*	Same as Track 6
10	L,R	20K**	0 dB	1:58	Same as Track 6 & Pitch Error Phase Difference
11	L,R	5 to 22.05K (Sweep)	0 dB	1:08	Frequency Response
12	L,R	1K,125,4K, 10K,16K	-20 dB	4:58 (total)*	De-emphasis Error
13	L,R	60 + 7K, 11K + 12K	0 dB	5:58 (total)***	SMPTE-IM & CCIF-IM
14	L,R	1K	0, -1, -3 -6, -10, -20 -60, -70, -80 -90 dB	9:58 (total)*	Level Linearity
15	L,R	3.15K	0 dB	3:08	Wow-and-Flutter
16	L,R	317	0 dB	0:58	Access Time

*Each of the frequencies shown lasts for approximately 1 minute.
 **Nominal frequencies are listed. For actual frequencies, refer to text.
 ***Each pair of IM test frequencies lasts for approximately 3 minutes.

Output Voltage: Typically, the output voltage of most CD players (with level controls, if available, set to maximum) is 2.0 volts rms.

This specification, though not a qualitative one, is nevertheless useful since it tells the prospective user what input level must be handled by the amplifier, preamplifier or receiver to which the outputs of the CD player are to be connected. The output volt-

age, accompanied by a "±" tolerance, is simply stated in volts.

Pitch Error: No manufacturers have been reporting this parameter to date. In the future, a published specification might read: "Pitch Error: +0.002%, -0%"

An error in the "clock frequency" of a CD player can result in an error of reproduced musical pitch. This may not be as unlikely to happen as it

seems. In fact, at least one player that has appeared on the market actually boasts a pitch-adjustment control much like the ones found on some turntables. The EIAJ Standard suggests measuring a 20-kHz recorded signal by means of a frequency counter. The pitch error, if any, would be calculated in percentage using the formula: $[(F_1 - F_0)/F_0] \times 100\%$. F_0 is the actual recorder frequency, F_1 is the reading obtained with the frequency counter.

Access Time: Typical measurements of access time for a CD player might be reported as follows: "Access Time: 2.5 seconds (long access); 1.5 seconds (short access)"

This last specification called for in the EIAJ Standard is the only one that deals with the mechanical performance of a CD player. There are two types of access-time reporting. The first, called "Short Access Time" is the time that elapses after a pushbutton or control is depressed in the middle of play or during ready-to-play state until the CD player actually starts to play the first adjacent piece of music. "Long Access Time" is the time it takes after a control is activated while playing back (or being ready to play) music located on the innermost track of a CD until it starts to play back music located on an outermost track of the disc. Both types of measurement are made using a stopwatch and are given in seconds and tenths of a second.

Conclusion

As cited earlier, all of the signals needed to perform tests in accordance with the new EIAJ Standard are available from earlier-released CD test discs. To perform all of the tests, though, I found that I needed to hop back and forth among some five test discs that I own. Obviously, having all of the required signals on a single test disc, preferably arranged

(Continued on page 97)

An Automatic Phone Disconnecter

Silences telephone when lights are turned off

By Victoria di Zerega

Since I work odd hours, I sleep when most others are active. As a result, I've been disconnecting the phone so that I won't be awakened. Unfortunately, I often forget to reconnect it and miss phone calls.

To preserve my sleep time and to avoid an alternative of simply leaving the receiver off the hook, I designed an electronic circuit that disconnects the phone when my lights are turned off, while simulating a phone that's ringing to a caller instead of a busy signal. I have it connected to the kitchen and bedroom lights. If either or both lights are on, the phone is on. There is also an "override" feature that allows the phone to remain on all the time if I'm expecting a call.

How It Works

The heart of the unit is a 2-input AND gate. The AND gate produces a high output only when both inputs are high, of course. The photocells used for on-off control have a resistance of about 3 Megohms in the dark, decreasing to about 100 ohms or so when light strikes them.

In operation, when either light is on, the resistance of that photocell decreases and pulls the AND gate's input low. Any low input to the AND gate results in the output going low. When the output is low, there is no voltage across the relay coil and the relay is in its normally closed position. Thus, the phone is on. When both lights are off, both inputs to the AND gate are pulled high and its out-

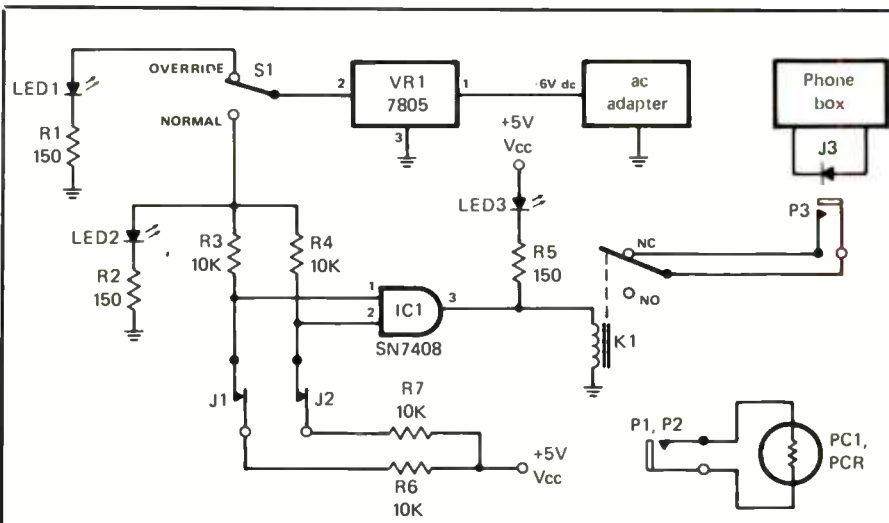

PARTS LIST

- | | |
|--|---|
| IC1—7408 quad 2-input AND gate | R1, R2, R5—150-ohm, ½-watt 10% tolerance resistor |
| J1 thru J3—2-conductor miniature closed-circuit phone jack | R3, R4, R6, R7—10,000-ohm, ½-watt, 10% tolerance resistor |
| K1—5-volt, 72-mA relay (Radio Shack No. 275-243 or similar) | S1—Spdt slide or toggle switch |
| LED1 thru LED3—Jumbo light-emitting diode (one each red, yellow and green) | VR1—7805 5-volt regulator |
| P1 thru P3—Miniature 2-conductor, closed-circuit phone jack | Misc.—ac adapter (see text); suitable enclosure; perforated board and solder posts; IC socket; speaker wire (for photocell and phone lines; machine hardware; hookup wire; solder; etc. |
| PC1, PC2—Cadmium-sulfide photocell (Radio Shack No. 276-116 or similar) | |

Complete schematic diagram of the automatic telephone disconnecter circuit.

put is high. Now there is voltage across the relay coil. Consequently, the relay pulls in, opening the phone circuit. Resistors *R3* and *R4* are pull-up resistors that keep the inputs to the AND gate high when the lights are off and improve reliability.

Using closed-circuit jacks for the sensor lines enable the unit to work properly when only one sensor is

used. Resistors *R6* and *R7* keep the AND gate inputs high when there is no sensor line plugged in to that input. A closed-circuit jack is also used on the phone terminal box so the phone will operate normally when the entire unit is disconnected.

(Continued on page 104)

Introducing Hero 2000 — A New Heath/Zenith Robot

This comprehensive learning system for robotics and automation features a versatile 8088-CPU-based robot in assembled or kit form that's complemented by class-room and self-study courses



By Alexander W. Burawa

Start with an 8088-based computer with healthy servings of user RAM and an operating system and BASIC ROM. Add a swing-out expansion card cage, a cassette port for low-cost mass storage, and the ability to accommodate an optional on-board 5.25-inch floppy disk drive. Put the whole thing on wheels; equip it with an arm/gripper mechanism; give it the ability to "see," "hear" and speak; and throw in a bunch of slave microprocessors. Take the design further by adding a radio-linked program/control console, and you have Heath/Zenith's new Hero 2000 robot trainer.

There's still more. Since Hero 2000 is basically an educational tool, Heath/Zenith offers three optional courses to go with the hardware to serve as a complete theory/lab training program in robotics.

As you might expect, this robot is expensive—but considerably less than you might imagine in terms current education costs. For the factory assembled Zenith version, the cost is \$4500, while for the kit Heath version, the cost is \$3000. These prices include a Hero 2000 robot with arm/gripper mechanism and radio remote console. The kit form is also available "stripped-down" without arm/gripper for \$2500.

A Mobile Computer

Hero 2000 isn't merely a redesign of Heath's pioneering Hero 1 robot. It's actually an entirely new product from the ground up.

Hero 2000 begins life as an almost complete stand-alone microcomputer that needs only a terminal and perhaps a disk drive (it comes equipped to use low-cost cassette mass

Hero 2000 shown with its software, tutorial materials and optional disk drive in left side of torso.

storage). The abilities to move about on its self-contained wheel-driven chassis and to lift and manipulate small objects are the things that make Hero 2000 into a "robot."

Built around a fast (5-MHz) 16-bit 8088 microprocessor, the computer has the same capabilities as IBM PC and PC-compatible computers. In addition to being faster than Hero 1's 8-bit 6808 processor, Hero 2000's 8088 can address a magnitude more memory. Thus, it can handle sophisticated nonrobotics software as well as strictly robotics functions. This makes Hero 2000 as almost much a practical stand-alone computer as it is a robot.

Whereas Hero 1 relied upon a single microprocessor to control all operations, Hero 2000's central 8088 CPU has under its command a small army of subprocessors that handle specialized tasks. These "local" processors free the 8088 CPU of having to directly and continuously control the various elements that make up the robot. This gives the system "multitasking" capability. It's also the primary reason why Hero 2000 is so much more advanced than Hero 1—without making it cost 10 times Hero 1's price. (Increased processor speed isn't evidenced by any great increase in the speed at which Hero 2000 performs assigned tasks. Rather, it's in the robot's ability to perform several operations simultaneously.)

Backing up the 8088 CPU are the means for storing information to be processed and to communicate and interact with the outside world. Resident memory consists of 24K of RAM and 64K of ROM. Inside the ROM are the operating system and a BASIC interpreter (enhanced with more than 20 special commands), as well as direct text-to-speech conversion, six demonstration routines, and diagnostic, service and adjustment routines. RAM can be expanded to 576K via three optional memory cards, ROM to 96K with more socket-pluggable ICs.

Also included are the various input/output ports. Among these are two RS-232C DCE serial ports and a 300-baud cassette port. Communication through the latter is via 2400- and 1200-Hz tones. Other ports are for keypad/display and remote terminal communication; motor control; sound, light and temperature sensing; vocalizing; etc. interfacing. Most of these are controlled by slave 8-bit microprocessors (8042s) via instructions from the 8088 CPU. The system is designed to accommodate 11 such slave processors.

A bus-oriented open architecture makes it easy to expand the computer's capabilities with memory, I/O, accessory and experimenter's solderless breadboarding cards. There are 12 slots in the swing-out card-cage/bus arrangement. Currently available are RAM, experimenter and disk-drive controller cards.

Local user interface with the computer is accomplished via a top-mounted hexadecimal keypad and a 7-segment display. The keypad provides access to stored routines and functions and permits programming the robot in machine language.

Users who already own a personal computer can use it to program and control of the robot. For robotics operations, however, this would be unwieldy, due to the required umbilical cable. Much more flexible is the radio-linked master controller.

Master Controller

R-f linked to the computer, the robot's master controller is a powerful 8088-based, 16-bit processing device that runs a specially enhanced version of BASIC for controlling the robot's 11 slave processors.

Built into the master controller are an elastomeric typewriter-style keyboard with pendant controls and a 2-line by 40-character LCD window. An RS-232C port is built in to permit interfacing with peripherals. Operating frequency is in the 75-MHz band,

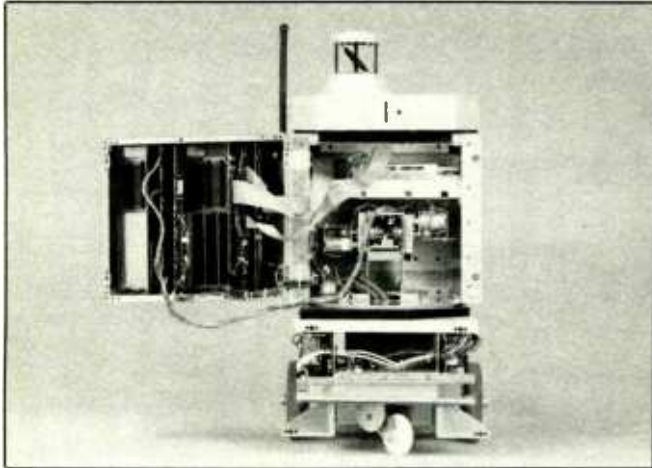

This interior view of the robot shows its card cage/bus assembly swung open. The white wheel shown at the bottom is for steering as Hero 2000 moves about.

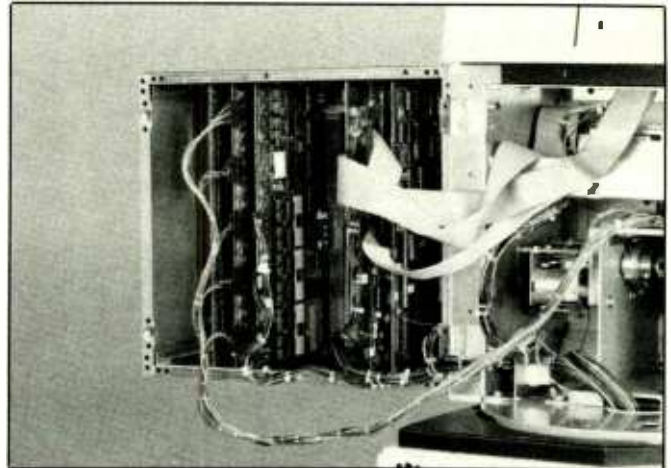

Card cage has five of its 12 slots occupied. More memory, I/O, an optional disk-drive controller, experimenter breadboard and other boards plug into remaining slots.

and minimum range is 100 feet line-of-sight.

Full-duplex operation is featured between master controller and computer/robot, at 110-baud transfer rate. Terminal, link and remote modes of communication are offered by the system, with a transmit rate of 33 characters per second.

Housed inside a sleek, sturdy plastic enclosure, the master controller measures 16"W x 6.375"D x 2.5"H and weighs a hefty 3.2 pounds, including its rechargeable nickel-cadmium battery. Obviously, this isn't a convenient pendant-type carry-around device like with Hero I. Most users will find it more convenient to operate it from a desktop or laptop.

Eyes, Ears and Voice

On-board are a number of devices through which Hero 2000 senses and interacts with its environment:

- There are two ultrasonic sonar transducers that detect objects and obstructions within a radius of 10.6 feet. One transducer on the head of the robot scans a full 360 degrees. The other is mounted on the front of the robot's base, where it always points directly ahead. This arrangement allows Hero 2000 to place itself with respect to objects in its environment. This 8042 slave-processor-con-

trolled system uses 24 bearings at 15-degree intervals.

- A light sensor scans 360 degrees, detecting and quantifying ambient light levels over the visible spectrum. It has a resolution of 255 levels and uses 24 bearings at 15-degree intervals.

- A sound sensor detects ambient sound within the range of normal human hearing. It has 255 levels of resolution.

- A temperature sensor measures ambient temperatures from +60 to +90 degrees F.

- A final sensor reads relative battery-voltage condition.

Hero 2000's "voice" is based on a 263A synthesizer system that produces human-like speech, music and special effects. Its direct text-to-speech conversion feature lets you type what you want to hear vocalized, in plain English on the keyboard of the remote console. The console then transmits the instructions to the robot. The synthesizer chip then generates up to 64 phonemes for the robot to voice.

The synthesizer chip provides 16 rate and amplitude levels and four full octaves of musical sound. In addition to speech, it provides sound-effects capability. There are four duration settings, 16 speech rates, 4096 instantaneous inflection levels

(32 in the transitioned mode at eight rates), 16 amplitude levels, and eight articulation rates. There are four full octaves for music. A vocal tract filter provides more than 250 settings.

Robot Functions

These include all the mechanical functions of Hero 2000, among which are its ability to move from one location to another, move arm and gripper, and anything else that contributes to its "robotics" capabilities.

Hero 2000 has eight closed-loop servomotors that power its drive system, torso and arm/gripper assembly. Each motor is controlled by a separate slave processor, under command of the 8088 main processor.

Each of the robot's two driven wheels has its own powerful motor. They can develop a pulling force of up to 26 pounds in both the forward and reverse directions. Eight speeds, from a snail-like 3.8 to a zippy 16 inches per second, are available in either direction, and the robot can turn on its own diameter.

Pulse-width modulation, speed regulation, position seeking and tracking, and self-initialization are featured in the motor-drive system. Hero 2000's base-mounted controller board can accommodate up to

(Continued on page 46)

From McGraw-Hill . . . the professionals' publisher

ELECTRONICS ENGINEERS' HANDBOOK, 2/e
by D. G. Fink & D. Christiansen
209/812 Pub. Pr., \$83.50 Club Pr., \$63.95

COMPUTER ARCHITECTURE, 3/e
by C. C. Foster & T. Iberall
583278-X Pub. Pr., \$38.95 Club Pr., \$29.25

THE ENCYCLOPEDIA OF ELECTRONIC CIRCUITS
by R. Graf
583265-8 Pub. Pr., \$50.00 Club Pr., \$39.95

GATE ARRAYS: DESIGN TECHNIQUES & APPLICATIONS
by J. Read
512/868 Pub. Pr., \$35.00 Club Pr., \$24.75

PHASE-LOCKED LOOPS
by R. G. Best, PHD
050/503 Pub. Pr., \$37.50 Club Pr., \$28.25

INTEGRATED CIRCUITS APPLICATIONS
by A. H. Seidman
582860-X Pub. Pr., \$47.95 Club Pr., \$33.95

OPTICAL COMMUNICATION SYSTEMS
by J. Gowar
582926-6 Pub. Pr., \$44.95 Club Pr., \$32.50

MICROWAVE SEMICONDUCTOR CIRCUIT DESIGN
by W. A. Davis
583044-2 Pub. Pr., \$47.50 Club Pr., \$35.50

HANDBOOK OF MICROCOMPUTER BASED INSTRUMENTATION & CONTROLS
by J. D. Lenk
582866-9 Pub. Pr., \$22.95 Club Pr., \$18.95

ELECTRONIC COMMUNICATIONS SYSTEMS
by W. D. Stanley
582834-0 Pub. Pr., \$32.95 Club Pr., \$22.50

MANUAL OF SATELLITE COMMUNICATIONS
by E. Fthenakis
225/94X Pub. Pr., \$44.50 Club Pr., \$31.95

MICROPROCESSOR AND MICROCOMPUTER DATA DIGEST
by W. H. Buchsbaum
582835-9 Pub. Pr., \$29.95 Club Pr., \$22.50

HANDBOOK OF TRANSFORMER APPLICATIONS
by W. M. Flanagan
212/902 Pub. Pr., \$49.50 Club Pr., \$36.75

ENCYCLOPEDIA OF COMPUTER SCIENCE AND ENGINEERING
by A. Ralston & E. Reilly
582794-8 Pub. Pr., \$87.50 Club Pr., \$49.95

STANDARD HANDBOOK FOR ELECTRICAL ENGINEERS, 11/e
by D. G. Fink & H. W. Beaty
209/74X Pub. Pr., \$85.00 Club Pr., \$65.50

ELECTRONICS ENGINEERING FOR PROFESSIONAL ENGINEERS' EXAMS
by C. R. Hafer
254/303 Pub. Pr., \$32.50 Club Pr., \$25.50

MODERN ELECTRONIC CIRCUITS REFERENCE MANUAL
by J. Markus
404/461 Pub. Pr., \$79.50 Club Pr., \$57.95

ANTENNA THEORY: Analysis and Design
by C. A. Balanis
582493-0 Pub. Pr., \$41.95 Club Pr., \$29.95

ENGINEERING MATHEMATICS HANDBOOK, 2/e
by J. J. Tuma
654/298 Pub. Pr., \$41.50 Club Pr., \$31.00



Join the **ELECTRONICS AND CONTROL ENGINEERS' BOOK CLUB®**

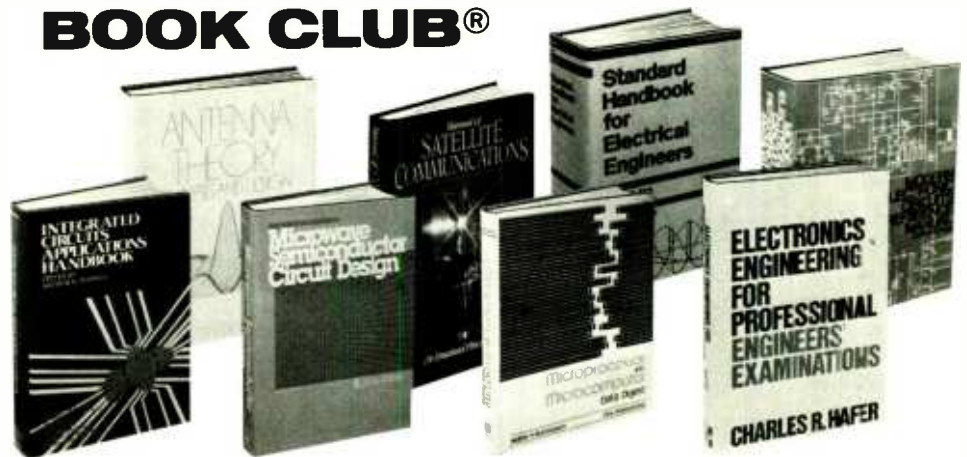

Get the competitive edge with the *newest* and the *best* information in your field . . . with books from all the leading publishers

New members! Any one of these great professional books for only **\$2.89** as a premium with your first selection! values up to **\$87.50**

Why YOU should join now!

- **BEST AND NEWEST BOOKS IN YOUR FIELD**—Books are selected from a wide range of publishers by expert editors and consultants to give you continuing access to the best and latest books in your field.
- **BIG SAVINGS**—Build your library and save money too! Savings ranging up to 30% or more off publishers' list prices— usually 20% to 25%.

BONUS BOOKS—You will immediately begin to participate in our Bonus Book Plan that allows you savings up to 70% off the publishers' prices of many professional and general interest books!

- **CONVENIENCE**—12-14 times a year (about once every 3-4 weeks) you receive the Club Bulletin FREE. It fully describes the Main Selection and alternate selections. A dated Reply Card is included. If you want the Main Selection, you simply do nothing—it will be shipped automatically. If you want an alternate selection—or no book at all—you simply indicate it on the Reply Card and return it by the date specified. You will have at least 10 days to decide. If, because of late delivery of the Bulletin you receive a Main Selection you do not want, you may return it for credit at the Club's expense.

As a Club member you agree only to the purchase of three books (including your first selection) during your first year of membership. Membership may be discontinued by either you or the Club at any time after you have purchased the first selection plus two additional books.



MAIL THIS COUPON TODAY

McGraw-Hill Book Clubs
Electronics and Control Engineers' Book Club®
P.O. Box 582
Highstown, NJ 08520-9959

Please enroll me as a member and send me the two books indicated, billing me for the \$2.89 premium and my first selection at the discounted member's price, plus local tax, shipping and handling charges. I agree to purchase a minimum of two additional books during my first year of membership as outlined under the Club plan described in this ad. A shipping and handling charge is added to all shipments.

Write Code No. of the \$2.89 selection here

Write Code No. of First Selection here

Signature _____

Name _____

Address/Apt. _____

City/State/Zip _____

This order subject to acceptance by McGraw-Hill. All prices subject to change without notice. Offer good only to new members. **E33786**

GIANT PRINTER SALE!!

List \$399.00

10" Printer

S A L E \$ 159⁰⁰ S A L E

10" Comstar 10X — This Bi-directional Tractor/Friction Printer prints standard sheet 8½"x11" paper and continuous forms or labels. High resolution bit image graphics, underlining, horizontal tab setting, true lower descenders, with super scripts and subscripts, prints standard pica, compressed, expanded, block graphics, etc. Fantastic value. (Centronics parallel interface.)

List \$399.00. Sale \$159.00.

1 Year Warranty
120-140 CPS
Premium Quality

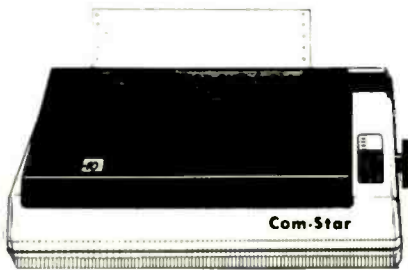

List \$599.00

15½" Printer

S A L E \$ 229⁰⁰ S A L E

15½" Comstar 15X — Has all the features of the 10" Comstar 10X plus a wider 15½" carriage and more powerful electronics to handle large ledger business forms! (Better than FX-100). The 15½" Comstar 15X also prints on standard size paper and continuous forms and labels. Fantastic value. (Centronics parallel interface.)

List \$599.00. Sale \$229.00.

List \$499.00

10" Printer

S A L E \$ 179⁰⁰ S A L E

10" Comstar 160+ High Speed — This Bi-directional Tractor/Friction Printer combines the above features of the 10" Comstar 10X with speed (150-170 cps) and durability. Plus you get a 2K buffer, 96 user definable characters, super density bit image graphics, and square print pins for clearer, more legible print (near letter quality). This is the best value for a rugged dependable printer. (Centronics parallel interface.)

List \$499.00. Sale \$179.00.

1 Year Warranty
150-170 CPS
High Speed

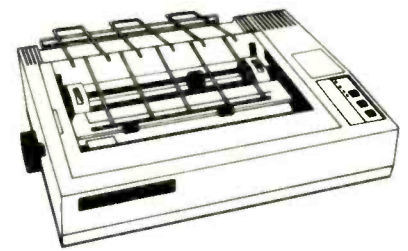

List \$699.00

15½" Printer

S A L E \$ 259⁰⁰ S A L E

15½" Comstar 160+ High Speed — This Bi-directional Tractor/Friction Printer has all the features of the 10" Comstar 160+ High Speed plus a wider 15½" carriage and the heavy duty electronics required for today's business loads. You can use large ledger business forms as well as standard sheets and continuous forms and labels. This is the best wide carriage printer in the U.S.A. (Centronics parallel interface.)

List \$699.00. Sale \$259.00.

List \$599.00

10" Printer

S A L E \$ 229⁰⁰ S A L E

10" Comstar 2000 — The ultimate printer has arrived! This Bi-directional Tractor/Friction Printer gives you all the features of the Comstar 160 plus higher speed (165-185 cps), 256 downloadable characters, proportional setting, external dark printing mode and a *lifetime printhead warranty. PLUS ...

Lifetime warranty*
165-185 CPS
High Speed & Letter Quality

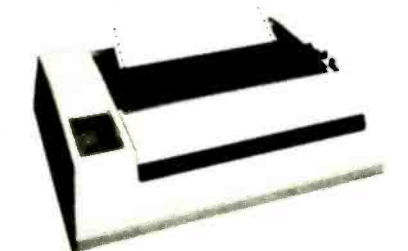

List \$599.00

10" Printer

S A L E \$ 229⁰⁰ S A L E

With the flip of a switch you can go into the letter quality mode which makes all your printing look like it came off a typewriter. Turn in term papers, do articles or just print programs. Have the best of letter quality and speed in one package. Fantastic printer (Centronics parallel interface.)

List \$599.00. Sale \$229.00.

• 15 Day Free Trial — 1 Year Immediate Replacement Warranty Parallel Interfaces

Commodore-64, VIC 20 — \$39.00

Atari — \$59.00

Apple II, II+, IIe — \$59.00

Add \$10.00 (\$14.50 for 15½" Printers) for shipping, handling and insurance. Illinois residents please add 6% tax. Add \$20.00 for CANADA, PUERTO RICO, HAWAII, ALASKA, APO-FPO orders. Canadian orders must be in U.S. dollars. WE DO NOT EXPORT TO OTHER COUNTRIES, EXCEPT CANADA.

Enclose Cashiers Check, Money Order or Personal Check. Allow 14 days for delivery, 2 to 7 days for phone orders. 1 day express mail!

VISA — MASTER CARD — C.O.D. No C.O.D. to Canada, APO-FPO.

COMPUTER DIRECT

We Love Our Customers

22292 N. Pepper Rd., Barrington, Ill. 60010

312/382-5050 to order

240K Apple® Compatible Computer System

NEW

SALE

Aplus 3000 computer system includes 192K RAM, 48K ROM (32K Microsoft Basic plus 16K ROM Emulator), 160K Laser 5 1/4" Disk Drive (Runs Apple II Software), Magic Window Wordprocessor, MagiCalc spreadsheet, Magic Memory Database. All for only \$399.00

Complete System

\$399.00

• 15 Day Free Trial

"Aplus 3000" System



Runs Apple II software

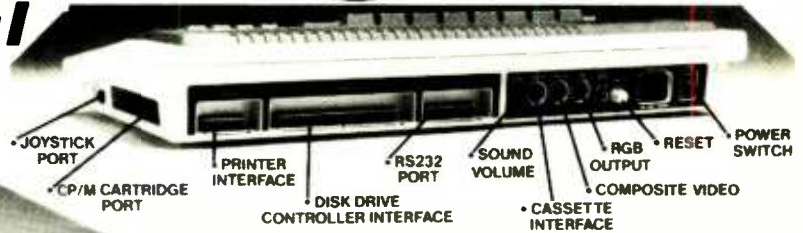

Double Immediate Replacement Warranty

If any of the Aplus 3000 computer system equipment fails due to faulty workmanship or material within 180 days of purchase we will REPLACE it immediately with no service charge!!

- Over 10,000 existing Apple® programs
- Centronics printer interface included
- 240K (192K RAM, 48K ROM)
- ArtSci's Magic Window II, Magic Memory, and MagiCalc Included
- 160K Laser 5 1/4" Disk Drive (Runs Apple II software)
- RGB (80 columns in color) and composite included

SPECIFICATIONS

A plus 3000 is a complete, self-contained computer based on the popular 6502A microprocessor and can tap into the tremendous software library of Apple II. Features include 192K Bytes RAM, 32KB Enhanced Microsoft BASIC, 80 column text, 560H X 192V color graphic display, 81 key sculptured keyboard and high efficiency switching power supply. Also included as standard are Centronics bus printer interface, Cassette interface, 4 channel sound generator, and 5 1/4" Apple Compatible Disk Drive.

- **TEXT**
 - 40 columns X 24 rows or 80 columns X 24 rows software selectable.
 - 5 X 7 characters in 7 X 8 matrix.
 - Upper and lower case characters.
 - One of Eight colors for characters/graphics and background, Red, Green, Blue, Cyan, Magenta, Yellow, Black and White.
 - Character set with normal, inverse and flashing capabilities.
- **GRAPHICS**
 - 280H X 192V 6 colors — Black, White, Violet, Green, Blue, Orange.
 - 280H X 192V 8 colors bit image — Black, White, Red, Green, Blue, Cyan, Magenta, Yellow.
 - 560H X 192V 6 colors — Black, White, Violet, Green, Blue, Orange. (High resolution color monitor required)

More Features than Apple® for less than Commodore®

Features	Aplus 3000	Apple Iie	Commodore C-128
RAM	192K	64K	128K
Runs Apple II Software	Yes	Yes	No
Function Keys	24	None	16
4 Voice, 6 Octave Sound	Yes	No	Yes
Composite Video	Yes	Yes	Yes
Disk Drive	included	Extra Cost	Extra Cost
Numeric Keypad	included	Extra Cost	Included
Video Cable	included	Extra Cost	Extra Cost
RGB Color Card	included	Extra Cost	Included
80 Column Card	included	Extra Cost	Included
Centronics Printer Interface	included	Extra Cost	Extra Cost
Drive Controller	included	Extra Cost	Included
\$150 Wordprocessor (Magic Window)	included	Extra Cost	Extra Cost
\$150 Spreadsheet (MagiCalc)	included	Extra Cost	Extra Cost
\$60 Database prg. (Magic Memory)	included	Extra Cost	Extra Cost
Your Cost	\$399.00	\$1745.00	\$1117.90

ACCESSORIES

	LIST	SALE
2nd Disk Drive	\$299.95	\$149.95
2 professional analog joysticks	\$ 39.95	\$ 24.95
Z-80 cort. allows CP/M use	\$ 99.95	\$ 59.95
RS232 adaptor	\$ 99.95	\$ 59.95
R/F Modulator (TV hookup)	\$ 29.95	\$ 19.95
RGB cable (RGB Monitor hookup)	\$ 24.95	\$ 19.95
Centronics cable (for Centronics printer)	\$ 34.95	\$ 24.95
Technical reference manual	\$ 29.95	\$ 19.95
Comstar 10x 120-140 CPS dot matrix printer	\$399.00	\$179.00
80 columns Hi-Res Amber Monitor	\$199.00	\$ 89.95
80 column Hi-Res RGB Monitor	\$399.00	\$259.00

Super Apple Compatible Disk Drive Sale \$149.95. Quieter, Cooler, Better Disk Drives for your Apple II plus, Iie, Iic (specify when ordering). List \$299.95. Sale \$149.95.

15 Day Free Trial — If it doesn't meet your expectations within 15 days of receipt, just send it back to us UPS prepaid and we will refund your purchase price!!

Add \$25.00 for shipping and handling!!

Enclose Cashiers Check, Money Order or Personal Check. Allow 14 days for delivery. 2 to 7 days for phone orders. 1 day express mail! We accept Visa and MasterCard. We ship C.O.D. to continental U.S. addresses only. Add \$10 more if C.O.D.

COMPUTER DIRECT

We Love Our Customers

22292 N. Pepper Rd., Barrington, Ill. 60010

312/382-5050 to order

APPLE and COMMODORE are registered trademarks of Apple Computer Inc. and Commodore Business Machines, Inc., respectively



Two views of the robot's head section. Shown in the photo at the left is the hex keypad and a data/address indicator panel. Details of the status panel and top-mounted ultra-

sonic sonar assembly are shown in the right photo. Just visible at the bottom of both photos is the arm assembly's shoulder at the point where it joins the torso.

five channels, though only three are currently used.

Five axes of motion fully articulate the robot's arm, with a sixth axis for the gripper. The arm can manipulate a variety of objects with human-like dexterity and is capable of lifting a pound in any orientation. It can travel over a 135-degree arc and has 180 degrees of motion at the elbow. Additionally, the wrist can revolve a full 360 degrees lock to lock and can bend 270 degrees. A patented software-controlled sense-of-touch capability can adjust gripping force and determine object size. Maximum closing force is 3.75 lbs, and maximum jaw opening is 4.375". There are 10 increments of jaw spacing, nine increments of closing force and seven increments of opening force. All are controlled from the remote console or by software.

One final robotic operation Hero 2000 can perform is to rotate its torso on its base, independent of its wheel-driven turning capability. The torso can rotate from -165 to +180 degrees. (Under computer control, Hero 2000 can be moving in one direction while be facing in another direction, or it can be standing stationary while it sweeps back and forth as it checks out its environment.)

All together, Hero 2000 measures

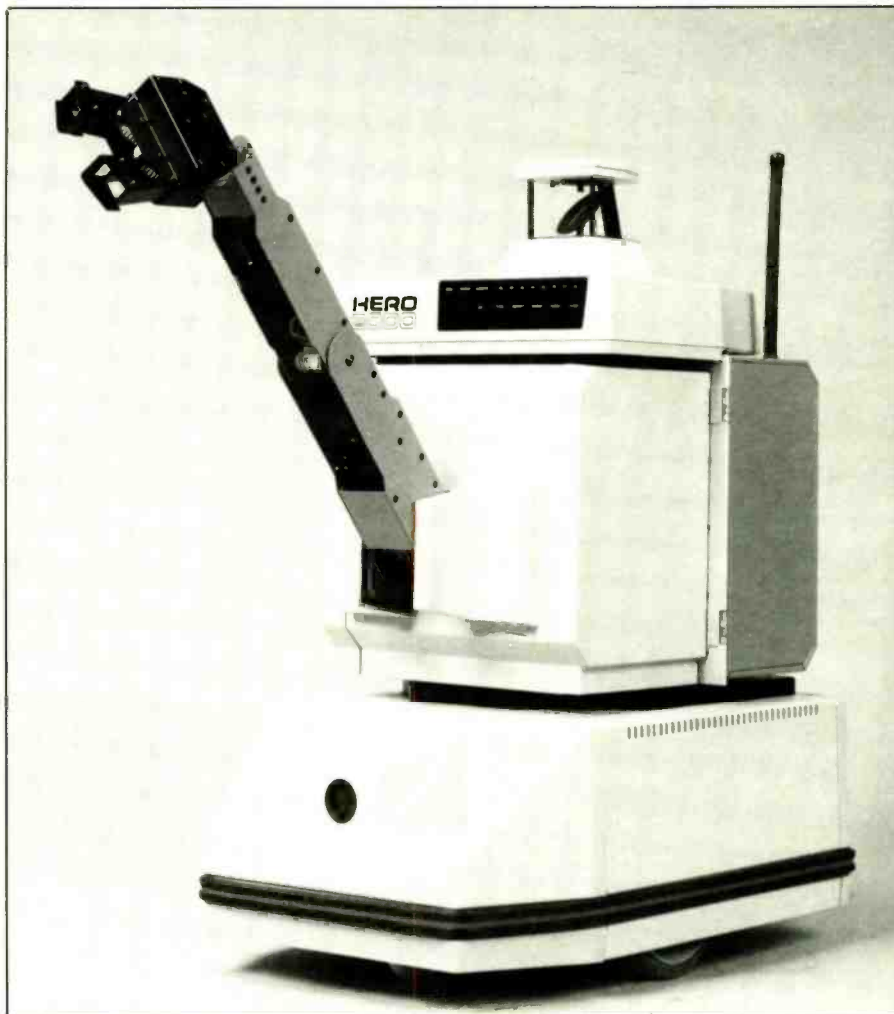

Hero 2000 poses with arm raised at the shoulder, elbow straight, wrist turned and flexed downward, and gripper jaws wide open. The disk just below the protective cover on the head section constantly rotates as Hero sonar scans its environment.



The radio-linked, 8080-based master controller has a typewriter-style keyboard, pendant controls and a 2-line LCD display panel. It has a 100-foot range.

32.4"H × 22.5"W × 16.5"D. Its 78-lb. weight includes battery and arm/gripper assembly.

Powering System

Power for Hero 2000's complex electronic and mechanical elements is obtained from an on-board 12-volt, 24-ampere-hour gelled-electrolyte battery. This battery provides 4 hours of normal operation and 6 hours of electronics-only operation and charges at a 7-ampere maximum rate. From this battery are derived: +5, +24, +12 and +5 volts (sleep). Maximum currents are 10 amperes for the main +5 volts and 1 ampere for all other lines.

Battery condition is constantly monitored by the computer to keep Hero 2000 running. A warning system alerts you when the battery reaches a low level of charge, and an internal battery sensor displays percent of power remaining. The sleep mode powers down all systems, except memory and the on-board real-time clock, to extend battery life for up to six days. (The sleep mode can be programmed to occur at desired intervals.)

Charge and full-charge detectors

and sleep control are polled by the computer. Whenever the computer detects a preset lower limit in any of these areas, an audible/visible warning is given. You must then connect Hero 2000 to its recharger. More conveniently, you can equip Hero 2000 with an optional auto-docking system that lets the robot seek out and automatically dock with its recharger.

The advanced docking-type recharger supplied with Hero 2000 plugs into a 105-to-135-volt (or 210-to-270-volt) ac line. It delivers a minimum of 19.2 volts at up to 7 amperes to Hero 2000 during the recharging cycle.

In design, this recharger is unusual. No power appears at its output terminals until no less than three conditions are satisfied, including detection of physical contact with the robot and a voltage fed back from the Hero 2000's internal battery is sensed. These measures make it safe to use the recharger in just about any environment.

An Educational Tool

Like its Hero 1 predecessor, Hero 2000 is an educational tool, rather than an industrial machine. Its pri-

mary function is to provide students with practical training and experience in design and control of mechanical elements and to serve as a testbed for professional practitioners of robotics and automation. Thus, the tutorial material in the form of looseleaf-bound "courseware" complements the robot.

Three different courses are currently available: *Intelligent Machines*, *Electronics For Automation* and *Hero 2000 Programming and Interfacing*. The first two are available in class-room and self-study formats, the last in self-study format only. All three courses include a cassette tape of "experiment" programs for use with Hero 2000.

If past experience with Heath/Zenith robotics courseware is any guide, other courses to supplement those already in the catalog should soon be available, supporting the basic investment one must make for Hero 2000.

Different Configurations

Under the Zenith name, Hero 2000 is factory assembled and comes with articulated arm/gripper assembly, r-f remote console and recharger. The Heath version robot is available only in kit form in a number of configuration options. At its lowest level, Hero 2000 comes without arm and remote console but does include docking recharger. To this you can later add the arm and console, extra memory and the disk drive. Of course, you can purchase the full Zenith configuration in kit form in one shot, thereby saving quite a bit over what you would have to pay if you were to later buy these items. Piecemeal purchases, on the other hand, will be attractive if your budget won't permit a one-shot purchase.

At the present time, Hero 2000 is available as a "mobile" robot. Buyers who require only pick-and-place automation (which accounts for the majority of industrial robotics applications) and therefore have no need for roll-about mobility might want to wait a bit before buying. Plans are in the works to make only the computer/arm-control system available at some future date.

Fine-Tune Your Color TV/Video Monitor

Simple BASIC program converts a Commodore-64 computer into a sophisticated color TV signal generator

By Rich Torpey

Having made a sizeable investment in a super-duper, high-tech TV receiver/monitor, you want to maximize its performance. Ordinarily, to be able to do this, you need a signal generator. However, if you own a Commodore 64 home computer, you can make it simulate such an instrument at no extra cost. All you need is the simple program shown in this article and your computer.

The program is written to run as-is in the Commodore 64 computer. If you have an Apple, Atari or other computer and the BASIC programming language, it should be relatively easy to modify the program as needed.

Using the program and computer to conduct color video tests is simplicity itself. It's no more difficult to use than an ordinary color-bar/cross-hatch generator. In fact, once you connect your computer to the TV set's antenna terminals and load and run the program, on-screen prompts make it easier to use than a dedicated generator.

The Program

Your first step is to load in BASIC and key in the program, using the listing shown here. Take your time as you do this, and carefully check each line as it's entered. When you're fin-



Fig. 1. The opening screen of the program displays the Options Menu, which offers seven choices.

ished keying in the program, save it on tape or disk under an easy-to-remember filename (for example, VID-TEST). Do this whether or not you feel there are any errors in it. It's easier to edit an incorrectly entered program than to rekey it from scratch.

Load the program back into memory and run it. The screen of your computer monitor should now display the "Options Menu" (Fig. 1). If you experience any operating difficulties with the program, LIST it and carefully check the appropriate line or lines for errors in keying. The program is liberally peppered with REM (remarks) statements that tell you what's going on at each stage. This makes it easy for you to "debug" the program in the event that it isn't operating properly.

Throughout the remainder of this article, little reference will be made to

the program itself. Instead, as each test is discussed, a simple reference in italics inside brackets will inform you of the option to select.

Color Picture Theory

If you're not familiar with the basics of the color TV picture, here's a brief review. Simply put, a color image is made up of separate monochrome (single-color) red, green and blue images. Each single-color image on its own resembles the image you would see on the screen of a black-and-white TV receiver or monitor. To obtain the rainbow of colors you see in the typical TV picture, the red, green, and blue images are combined on the screen. Individual colors are obtained by combining specific intensities of the red, green and blue colors.

The first step in evaluating a color monitor or receiver is to *turn off the color*. You might think this is an odd way to do things, but it's almost impossible to obtain a good color picture without first making a good black-and-white picture. The "gray-scale" signal is very useful for balancing the red, green and blue (usually abbreviated RGB) levels.

Gray-Scale Adjustments

As its name implies, the gray-scale consists of a series of steps in luminance (brightness level) from black to white, as shown in Fig. 2. The object of this test is to make the colors

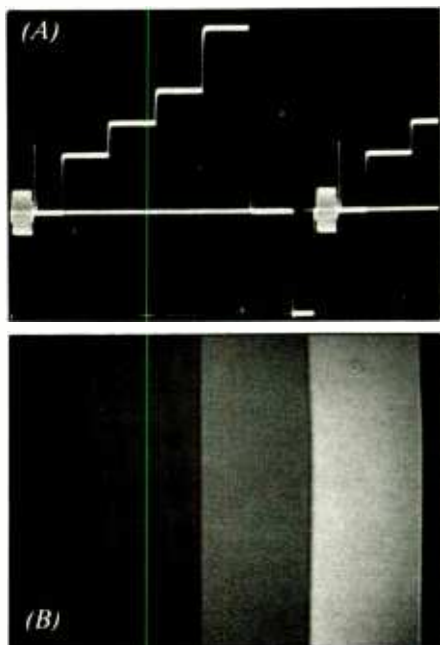

Fig. 2. The C-64's gray-scale signal displayed on an oscilloscope (A) and on a TV screen (B).

track at different levels of brightness. If you've ever noticed off-color areas in a color picture, chances are it's because at low brightness one color is a bit stronger than the other two.

TV service people usually throw the "setup" switch in the receiver or monitor to adjust color levels. This may be fine for low-light areas (such as shadows), but it doesn't check the overall picture. Using gray-scale [2] *Gray Scale*], you can examine the darkest gray bar for any hint of color tint. If any is detected, adjust the red, green and blue screen or bias controls to remove any hint of color from the dark bar.

(The human eye tends to get used to slight color shifts and edits them out. Therefore, it helps to occasionally look away from the screen when making gray-scale adjustments, to "recalibrate" your eyes. Alternatively, you can hold a clean white sheet of paper near the screen to serve as a reference.)

Once you've taken care of the dark bar, examine the brightest bar. If you

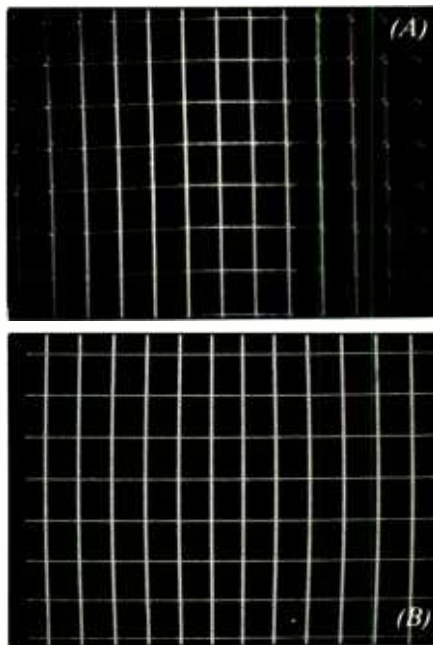

Fig. 3. Crosshatch pattern for convergence adjustments. (A) shows mis-convergence, (B) perfect convergence.

note any hint of coloration, use the drive or gain controls to eliminate it.

Purity Adjustments

With color receivers and monitors, there's another thing to consider: When three images are combined into one, they must all be properly registered (converged). Lack of proper convergence can make even a super-high-resolution picture appear to be low in resolution.

Most color TV receivers and monitors have three-gun picture tubes. The first step in conversion, therefore, is to make sure that the beams from the individual guns strike only the respective phosphor dots or stripes on the inside face of the CRT, without exciting either of the other two color phosphors. This is called "purity." To check purity, you examine a field of a single color. You should see no trace of color contamination; if you do, correct the purity.

Use the service manual supplied with your receiver or monitor—if

you're fortunate to have one—to determine the procedure to follow for making purity adjustments [3] *Purity (Red Field)*]. Consulting the manual also helps you to determine in which areas there are dangerous voltages present inside your set.

Convergence Adjustments

Crosshatch and dots are the patterns typically used in making convergence adjustments [1] *Convergence Patterns*]. If your set isn't properly converged, this pattern will reveal individual color lines or dots in various screen areas, as shown in Fig. 3(A).

Working with the convergence controls inside your set and observing the displayed pattern, your objective is to merge the pattern into pure white lines or dots in all areas of the screen, as shown in Fig. 3(B).

Conrac, a leading manufacturer of monitors for broadcasting, recommends the following guide:

- Degauss (demagnetize) the picture tube to prevent stray magnetism from affecting the picture.
- Adjust purity. (With consumer receivers with limited adjustment capability, you may have to live with what you get.)
- Adjust the red and green for proper convergence. Then converge the blue pattern into the red and green. (Some better monitors and projection TV receivers permit you to turn off individual guns for purposes of alignment. If your receiver or monitor doesn't have this capability, you must adjust all three colors at the same time.)

A couple of things you might keep in mind: If you notice misconvergence in the picture after moving or bumping your set, check the magnets *before* jumping right in with the controls. If your set has separate "static" and "dynamic" convergence controls, use the static group to converge the center and the dynamic group to converge the periphery of the screen.



WHAT'S NEW?

Blimey, mates! You'll be amazed at the great new products & values we have for you!

NEW

STEREO



You Can Get Stereo Satellite TV At An UNHEARD-OF Price! **ONLY \$199**

State of the art circuitry and advanced technical standards give you stereo satellite reception with maximum performance. This 70 MHz single conversion receiver features SAW IF Filter, Auto TV Thru-Mode on Standby/Power Off, and Base-Band Output for Descramblers. Cat D-6332

ROCKDALE STEREO SATELLITE RECEIVER

Move Your Dish Without Leaving the House!



\$249 Cat D-6335

SATELLITE POSITIONER & ACTUATOR

Raining? don't get soaked just because you need to move your satellite dish. With this Actuator (a motor-controlled arm that attaches to dish & mount) and Positioner (the remote control unit that sits under your receiver or TV), you can position your dish in total comfort. This unit is designed to suit most dishes. Install it yourself and save!

COMPLETE SATELLITE TV SYSTEMS FROM DICK SMITH!
BUY THE SYSTEM AND SAVE

ROCKDALE STEREO SYSTEM

Includes Stereo Receiver, 6' Dish, Low Noise Amplifier, Down Converter, Feed Horn, Cable - Everything you need!

Save \$186

\$799.00

AUSTRALIS 1 SYSTEM

Includes Receiver Kit, 6' Dish, Low Noise Amplifier, Down Converter, Feed Horn, Cable - Everything you need!

Save \$186

\$699.00

See Your Favorite Show Wherever You Go!

only **\$79.95**

INCLUDES 12V PLUG & AC ADAPTOR

Imagine - a miniature TV that operates from a 12V supply but draws very little current! Use the cigarette lighter plug in vehicles or the AC adaptor in the house (both are included!) The 5" B & W screen offers great definition so now you can see your favorite shows everywhere - in your car, truck, boat or van!

5" B & W TELEVISION



Cat Y-6000

Or Build Your Own Receiver & SAVE A FORTUNE!

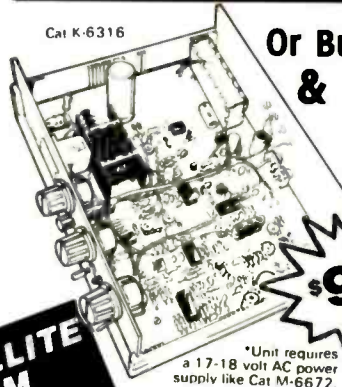

Cat K-6316

The performance rivals commercial receivers costing hundreds of dollars more. The ease of assembly &... field proven circuitry is fantastic. The quality... better than expensive commercial units.

Richard Maddox, author of *Troubleshooting & Repairing Satellite TV Systems*

You can put this kit together in just hours! Why wait any longer to enjoy the world of satellite television?

ONLY \$99.95 PLUS \$4 SHIPPING

AUSTRALIS 1 SATELLITE RECEIVER KIT

AS FEATURED IN DEC & JAN RADIO ELECTRONICS



Troubleshooting & Repairing Satellite TV Systems by Richard Maddox

This is a comprehensive guide for both home TVRD owners & professional service technicians. It covers installation, testing, servicing, alignment, & information not available in other handbooks.

Cat B-1845

VHF/UHF MASTHEAD AMP

This high gain amp (VHF 25 dB, UHF 20dB) boosts TV & signals even in fringe areas. Its high input capability resists overload on strong signals, while a built-in FM trap cuts interference. Includes UL-listed AC adaptor. Cat L-4200

NEW \$24.95

IN-LINE VHF AMP

This 10dB video amp has a bandwidth of 50-450 MHz & output capability of 30 dBmV. Noise figure is 4 dB & impedance is 75 ohms.



Cat L-4201

NEW \$8.95



DIP METER

Cat Q-1335

Frequency Range: 1.5-250 MHz in 6 plug-in coils
Modulation: Approximately 2 KHz sine wave
Crystal Oscillator: 1-15 MHz
Power Supply: 9V DC
Semiconductors: 2 transistors & 1 diode

\$59.95

NEW \$399

Cat Q-1240

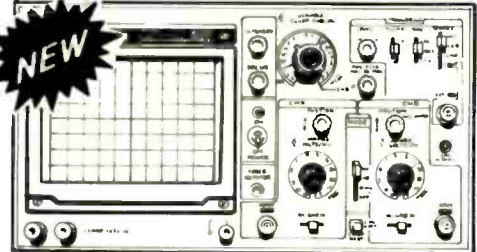

As always, Dick Smith brings you more for less! Our new model dual-trace 20 MHz oscilloscope is packed with features. The high brightness CRT assures easy readability, and a specially designed circuit for component testing allows you to determine component status in or out the circuit board! Other features include: wide bandwidth & high sensitivity, very low power consumption, high sensitivity X-Y mode, 2 axis (intensity modulation) panel electrical trace rotator, & regulated power supply circuit for accuracy. And the best feature of all: our new low price!

20 MHz DUAL-TRACE OSCILLOSCOPE

NEW A Whole New Range of "OK" BRAND WIRE WRAP TOOLS Call for Special Catalog!

NEW Hand-Held Convenience!

\$69 Cat Q-1220

A hand-held oscillator the size of a digital multimeter! 23 ranges of sine & square waves (switchable) between 20 Hz & 1.5kHz, plus a x100 range; 46 settings in all. Many other features: 600 ohms output.

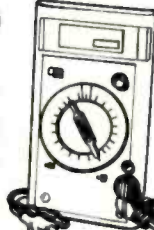

RC OSCILLATOR

NEW Your Board Missing a Track? No Worries! Get CIRCUIT-FIX KIT

Make circuit repairs & changes fast & simple! Kit includes spring-loaded clamp & guide, collet knife & blade, 154 asst. copper donuts, 32 sq. in. of foil, & instructions.
Copper Foil Donut Refill Cat H-5902 \$4.00
1 oz. Adhesive Copper Foil Cat H-5903 \$4.00

NEW Make Your Own PCB'S Directly from Magazine Art!

\$34.95 All necessary materials are in this kit 5"x6" steel print frame, film & processing pack, yellow filter, 4 oz etch resist, 16 oz. developer, blank copper boards, dry concentrated etch and 1:1 resist patterns & tapes, instructions.

PHOTO-ETCH PRINTED CIRCUIT KIT

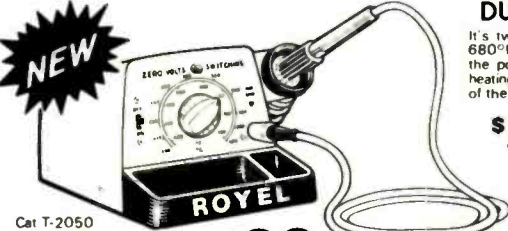

Cat T-2050

\$99

The ideal professional iron! It's ultra-light weight, so you can use it comfortably for long periods. Superior design ensures that the temperature at the top will be precisely the one selected. This is a lasting iron for the production line or workshop.

PROFESSIONAL SOLDERING STATION

DUO-TEMP SOLDERING IRON

It's two tools in one! Its normal tip idling temperature of 680°F is ideal for delicate printed circuits. Press a button and the power is doubled! The push-button also allows faster heating or "pulsing" to match heat output to the heat absorption of the task at hand!

\$22.95

Cat T-1830



FROM ROYEL

Learn About Integrated Circuits with Dick Smith's

FUNWAY INTO ELECTRONICS 3

Volume 3

Dick Smith's FUNWAY INTO ELECTRONICS series is packed with projects designed to teach electronics while entertaining inquiring minds & busy hands. Volume 3 is for those who have worked their way through volumes 1 & 2 for the advanced hobbyist. It contains 10 fascinating projects based on integrated circuits. We also offer matching kits (like the two below) to make building these projects even easier!

\$6.95

Cat B-2610

Learn Components in Funway V.1 Cat B-2600 \$4.95
Learn Soldering in Funway V.2 Cat B-2605 \$6.95

Cat K-3439



Digital FREQUENCY COUNTER KIT \$89.95

Featured in December MODERN ELECTRONICS

Superb design uses latest IC technology. Low component count makes it very reliable and easy to build. Measures frequency to 500 MHz (with optional prescaler) and period both with a 7 digit resolution. Supplied with the exclusive Dick Smith simplified step-by-step instructions and a quality pre-punched and silk screened front panel and case.

Compare with Ready-made Units!

\$44.95

Cat K-6312

Directivity >23db
Insertion Loss >0.3db
Frea. Response usable over c.n. range (narrow band) 400-520 MHz
Max Power 100 watts

UHF SWR POWER METER KIT

As seen in QST Oct '85

MINI AMP KIT *

\$14.95

Cat K-2667

Want an amplifier for your walkie stereo or radio? Don't be tied to phones; use this project and I steer in comfort! Or you can build this into a mini PA Amplifier.

★ Requires FUNWAY book, Volume 3 (Cat B-2610) for complete construction details.

Featured in March RADIO ELECTRONICS

MINI SYNTH KIT *

\$19.95

Cat K-2669

It's a real beauty, this one: a real live musical synthesiser - and it's live because it uses YOU as the note generator! you get an amazing range of control over the sound.

★ Requires FUNWAY book, Volume 3 (Cat B-2610) for complete construction details.

Featured in February RADIO ELECTRONICS

PRESCALER KIT Cat K-3432

Increase the range of your K-3439 Frequency Counter to a more professional range of operation: 10-500MHz

\$22.50

KITS

Cat K-3252

MOSFET AMP KIT

PROFESSIONAL SERIES

Cat K-3516

POWER OUTPUT	One Channel	Both Channels
8 ohms	184 W RMS	160W RMS
8 ohms	104W RMS	95W RMS

HARMONIC DISTORTION
Less than 0.2% for all powers up to 100 W into 8 ohm loads
Less than 0.3% for all powers up to 180 W into 4 ohm loads

Complete kit includes Case & Front Panel \$299

DESIGNER BOARDS

Now designing is so simple! No soldering, no mess - and each board comes with a pad of layout paper!

Cat P-4614	3" x 2.4" x 3"	\$4.95
Cat P-4615	7" x 2.7" x 3"	\$9.95
Cat P-4616	8" x 6" x 8"	\$19.95
Cat P-4617	8" x 9.75" x 8"	\$29.95

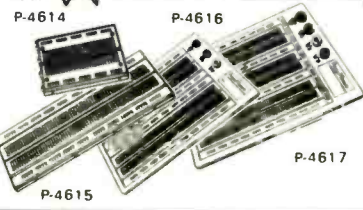

Protect your 2nd most valuable investment with the

Dick Smith Deluxe Car Alarm

Door & ignition alarms are no longer enough to save your car from professional thieves! Get the features of costly commercial alarms in this easy-to-build, inexpensive kit!

- 2 delayed & 6 instant outputs
- 10 sec. delayed entry & exit times
- Aux. battery provision • Siren output
- Flashing dash lamp, internal key-operated on/off, etc.

\$59.95

NEW RE-CHARGEABLE BATTERIES

Now Available! 2 New Sizes of "No-Leak" GEL CELLS

6V @ 1-2 Ah **\$6.95** Cat S-3310

12V @ 9 Ah **\$34.95** Cat S-3325

12V 1.2 Ah **\$7.95** Cat S-3315

12V 3 Ah **\$13.95** Cat S-3320

Ask about our GELL CELL CHARGERS!

Please state charger required when ordering.

LISA KEYBOARD CLOSEOUT- You Reap the Benefit!

Cat J-0055

Apple's loss is your gain: QWERTY keyboard with numeric keypad & more! There's no warranty, but at this price you can afford 3 or 4 spares!

were \$19.95

\$9.95

POWER SUPPLIES

3-6-9-12 VDC @ 1 amp

\$14.95

Cat M-9530

Invaluable around the home or workshop. It will give a maximum of 1 amp a 3.6.9 and 12 volts DC. Simply plugs into 117 VAC power socket-DC connections. Ideal for use with alarm systems, intercoms, etc.

HEAVY-DUTY SOLID-STATE 13.8V/5A Peak

\$19.95

Cat M-9545

Regulated DC Power Supply, 13.8 VDC, 3/ Cont. For home, lab service bench, CB stereo and auto radios, this is an extremely versatile unit. You'll wonder how you managed without it! Input is 117VAC@50Hz 100W, and the output is fully regulated low ripple up to 5 amps surge. The unit is fuse and double-short circuit protected with on/off switch and pilot light.

CONNECT WITH SAVINGS

'D' TYPE COMPUTER CONNECTORS



PLUGS (SOLDER TAIL)

9 Pin	were \$1.25	Cat P-2684	79¢
15 Pin	were \$1.60	Cat P-2687	89¢
25 Pin	were \$1.95	Cat P-2690	\$1.15

SOCKETS (SOLDER TAIL)

9 Pin	were \$1.75	Cat P-2685	89¢
15 Pin	were \$2.20	Cat P-2688	\$1.00
25 Pin	were \$2.60	Cat P-2691	\$1.45

BACKSHELLS

For P-2684, P-2685	were 90¢	Cat P-2686	63¢
For P-2687, P-2688	were \$1.00	Cat P-2689	65¢
For P-2690, P-2691	were \$1.25	Cat P-2692	65¢

NOW OPEN IN L.A.

CALL WRITE, OR VISIT OUR RETAIL CENTERS!

STORES AT:
BERKELEY: 2474 Shattuck Ave. (415)486-0755
REDWOOD CITY: 393 Convention Way (415)368-8844
SAN JOSE: 4950 Stevens Creek Blvd (408)241-2266
WESTWOOD: 1830 Westwood Blvd. (213)474-0626
HEAD OFFICE: 390 Convention Way, Redwood City, CA 94063

ORDERS ONLY: CALL TOLL FREE 1-800-332-5373 (Mon-Fri, 6am-6pm PACIFIC TIME)
IN CALIFORNIA: 1-415-368-1066

WHERE THE ELECTRONIC ENTHUSIAST IS # 1!

DICK SMITH ELECTRONICS

INCORPORATED IN THE STATE OF CALIFORNIA

MAIL ORDERS

P.O. Box 8021 Redwood City CA 94063

14 DAY MONEY-BACK GUARANTEE

SHIPPING & HANDLING:

We ship UPS Ground, unless otherwise requested. Add 5% of order total (\$5.00 minimum) for shipping (20% outside the U.S.A. - \$4.00 minimum). There is an additional \$1.00 handling fee. California residents please add sales tax.



132 pages of products & data! Includes Bonus! Coupons worth \$2 redeemable with your first order. Send only \$1 for postage & handling.

FREE CATALOG

NAME _____ ADDRESS _____ CITY _____ STATE _____ ZIP _____

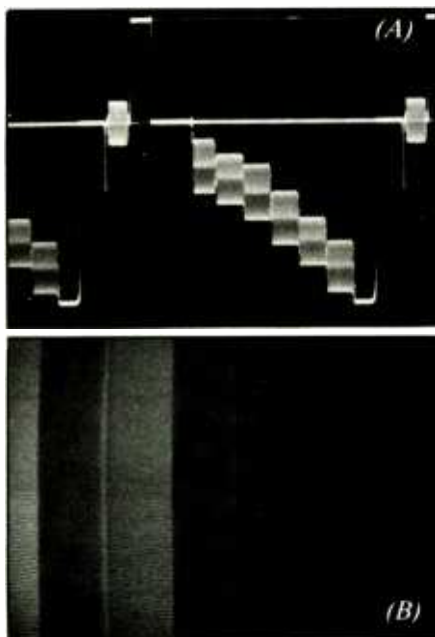

Fig. 4. Color-bar signal on oscilloscope (A) and TV screens (B).

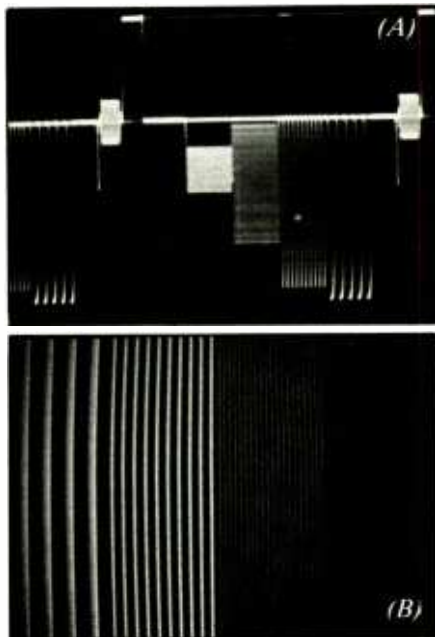

Fig. 5. The multiburst signal on oscilloscope (A) and TV screens (B).

Color bars generated by the C-64 are less saturated (a bit more on the pastel side) than those obtained from standard color-bar generators (Fig. 4). However, you can still adjust your set with them. The colors shouldn't be so intense that they bleed or smear, and you should be able to clearly see the difference between cyan (sky-blue) and green bars and between the magenta and red bars when adjusting tint or hue.

As a final check, examine the flesh-tones in a network program—not the commercials! When color color is adjusted to a *natural* level and color correction has been properly made, flesh-tones displayed in the picture should be close to the coloration of your hand. (Note: If you compare your hand's coloration against flesh-tones on the screens of most home sets, your hand will appear to be washed out, because home viewers tend to crank up the color. There is

Having made the necessary grayscale, purity and convergence adjustments, you should be able to obtain an excellent black-and-white picture.

It's now time to add color. To make the proper color adjustments, you use the color-bar function [4) *Color Bars*] of the C-64's program.

(Continued on page 99)

```

1 POKE 52,48;POKE 56,48;CLR:REM RESERVE MEMORY FOR CHARACTERS
2 REM VIDEO TEST PATTERNS
3 REM RICH TORPEY
10 PRINT "■"
11 PRINT CHR$(147)
15 PRINT "VIDEO TEST SIGNALS"
20 PRINT "  1) CONVERGENCE PATTERNS"
40 PRINT "  2) GRAY SCALE "
50 PRINT "  3) PURITY ( RED FIELD )"
60 PRINT "  4) COLOR BARS "
70 PRINT "  5) MULTIBURST"
75 PRINT "  6) WINDOW"
77 PRINT "  7) AUDIO TEST TONE ON/OFF"
78 PRINT "  B) END"
80 PRINT " WHEN YOU ARE FINISHED WITH A PATTERN HIT ANY KEY"
90 INPUT "WHICH PATTERN WOULD YOU LIKE?:"P
95 ON TP GOSUB 100,200,300,400,500,600, 700,2000
96 GOTO 10
99 REM LINES 100-200 USE CUSTOM CHARACTERS TO MAKE THIN LINES
100 PRINT CHR$(147)
103 FOR I = 12288 TO 12799 : POKE I,0 : NEXT I
104 POKE 53272,(PEEK(53272)AND240)+12
105 FOR T = 12448 TO 12455 : POKE T,0 : NEXT T
110 FOR U = 12456 TO 12462 : POKE U,128 : NEXT U
111 POKE 12463,170
115 FOR V = 12464 TO 12470 : POKE V,0 : NEXT V
116 POKE 12471,170
117 POKE 53281,0 : POKE 53280,0
120 FOR W = 12472 TO 12479 : POKE W,128 : NEXT W
125 FOR I = 1 TO 8
130 PRINT "UUUUUUUUUUUUUUUUUUUUUUUUUUUUUUUUUUUUUUUUUUUUUUUU"
131 PRINT "TWTTTWTTTWTTTWTTTWTTTWTTTWTTTWTTTWTTTWTT"
132 PRINT "TWTTTWTTTWTTTWTTTWTTTWTTTWTTTWTTTWTTTWTT"
133 NEXT I
180 AS=""
185 GET AS:IF AS="" THEN GOTO 185
189 POKE 53272,21
190 RETURN
199 REM USE "SPACE" CHARACTER COLORED SHADES OF GRAY + WHITE FOR GRAYSCALE
200 PRINT CHR$(147);POKE 53280,0;POKE 53281,0
210 FOR I = 1 TO 24
220 PRINT "■ ■ ■ ■ ■ ■ ■ ■ ■ ■ ■ ■ ■ ■ ■ ■ ■ ■ ■ ■ ■ ■ ■ ■"
250 AS=""
240 GET AS : IF AS="" THEN GOTO 240
250 RETURN
299 REM COLOR BACKGOUND AND BORDER FOR PURITY
300 POKE 53280,2
310 POKE 53281,2
315 PRINT CHR$(147)
320 AS=""
330 GET AS: IF AS="" THEN GOTO 330
340 RETURN
399 REM COLOR "SPACE" CHARACTER TO MAKE COLOR BARS
400 PRINT CHR$(147)
401 POKE 53280,0;POKE 53281,0
410 FOR I= 1 TO 25
420 PRINT "■ ■ ■ ■ ■ ■ ■ ■ ■ ■ ■ ■ ■ ■ ■ ■ ■ ■ ■ ■"
430 NEXT I
439 AS=""
440 GET AS:IF AS="" THEN GOTO 440
490 RETURN
499 REM USE CUSTOM CHARACTERS FOR MULTIBURST .5 , 1.0 , 2.0 , 4.0 MHZ NOT FLAT
500 PRINT CHR$(147)
510 FOR T = 12448 TO 12455:POKE T,255:NEXT
515 FOR U=12456TO12463:POKEU,0:NEXT
520 FOR V=12464TO12471:POKEV,240:NEXT
525 FOR W=12472TO12479:POKEW,204:NEXT
530 FOR X=12480TO12487:POKEX,170:NEXT
531 FOR S = 12544 TO 12551:POKE S,0:NEXT:REM SPACE
532 POKE53272,(PEEK(53272)AND240)+12
535 FOR I = 1 TO 25
540 PRINT "TUTUTUTUUUUUUUUUUUUUUUUUUUUUUUUUUUUUUUUUUUUUUUUUUUUUUUU"
543 NEXT I
545 AS=""
550 GET AS:IF AS="" THEN GOTO 550
559 POKE 53272,21
560 RETURN
599 REM WINDOW NEXT
600 PRINT CHR$(147);POKE 53280,0;POKE53281,0
610 FOR I = 1 TO 7:PRINT:NEXT I
620 FOR I = 1 TO 10
630 PRINT "■ ■ ■ ■ ■ ■ ■ ■ ■ ■ ■ ■ ■ ■ ■ ■ ■ ■ ■ ■ ■ ■ ■ ■"
640 FOR I = 1 TO 7 :PRINT:NEXT I
650 AS=""
660 GET AS: IF AS="" THEN GOTO 660
670 RETURN
699 REM NOW TONE TOGGLE
700 FOR I = 54272 TO 54296:POKE I,0:NEXT
703 IF FLAG = 1 GOTO 790
704 FLAG = 1
710 POKE 54296,31 :REM VOLUME
720 POKE 54294,125:REM LOW PASS FILTER
730 POKE 54277,200:POKE 54278,200
740 POKE 54276,17:REM SAWTOOTH START
750 POKE 54273,37:POKE 54272,162
755 RETURN
790 POKE 54276,16: REM SAWTOOTH OFF
794 FLAG = 0
796 RETURN
1000 GOTO 10
2000 END
READY.

```

Using An LM-335 Voltage-Mode Temperature Sensor

This readily-available, low-cost device is a "natural" for electronic thermometry experimenters.

By Joseph J. Carr

Electronic thermometers are a long-time favorite of project builders. They are generally easy to build, and provide a really useful application. Unfortunately, many of the temperature sensors used in such projects are not readily available, so you're stuck with buying special parts for premium prices. An appealing exception is the National Semiconductor LM-335Z voltage-mode temperature sensor. The LM-335Z is available from Digi-Key, Jameco and other mail-order sources for less than \$2 each.

The LM-335 shown schematically in Fig. 1 is a three-terminal voltage-mode temperature sensor. It operates in a manner similar to a zener diode, hence the zener symbol. It has a very low dynamic impedance (1 ohm or less), and its voltage drop is proportional to the absolute temperature of the device in degrees Kelvin ($^{\circ}\text{K}$). The positive (+) and negative (-) terminals are used for both power supply and output signal. A third terminal, shown coming out the body of the diode symbol, is for adjustment and calibration. In essence, the LM-335 is a special zener diode in which breakdown voltage is directly proportional to temperature, with a transfer function of approximately 10 millivolts per degree Kelvin (10 mV/ $^{\circ}\text{K}$).

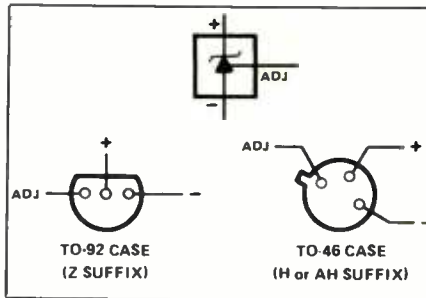

Fig. 1. The schematic symbol for IC temperature sensor resembles a zener diode with an "adjust" terminal. Sensors are available in both TO-92 plastic and TO-46 metal packages.

The LM-335, and its wider range cousins the LM-135 and LM-235 devices, operates with a bias current set by the designer. This current is not supercritical, but it must be within the range 0.4 to 5 milliamperes. We can use 1 mA to make resistor selection arithmetic easier.

Accuracy of the device is more

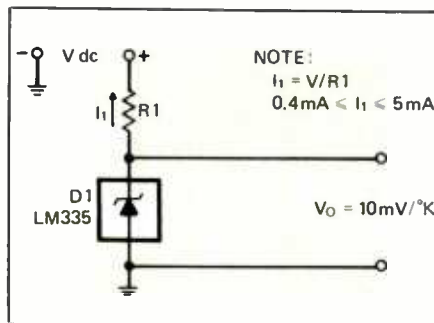

Fig. 2. This is the simplest method of using the LM-335.

than sufficient for most applications. The LM-135 version offers uncalibrated errors of 0.5° to 1°C , while the less costly LM-335 offers errors of about 3°C . Of course, clever design can reduce these errors if they are out of tolerance for some particular application.

One difference between the three devices is operating temperature range:

Device Type	Temperature Range (Centigrade)
LM-135	- 55 to + 150
LM-235	- 40 to + 125
LM-335	- 10 to + 100

Two package configurations are used for the LM-135 through LM-335 family. As shown in Fig. 1, these are the small plastic TO-92 case with a "Z" suffix (for example, LM-335Z) and the small metal can TO-46 transistor package with an "H" or "AH" suffix (for example, LM-335H or LM-335AH). The "Z" versions are the ones usually available from mail-order sources.

Shown in Fig. 2 is the simplest method of using the LM-335. Series resistor $R1$ limits the current through $D1$ to around 1 milliampere. A value of 4700 ohms for $R1$ is appropriate for +5-volt power supplies. This value can be scaled upwards for higher values of dc potential according to Ohm's law ($R = E/I$), or you can use the "standard" $I = 0.001$ ampere.

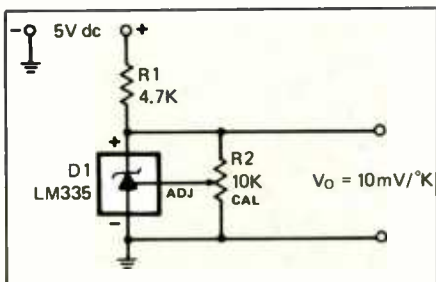

Fig. 3. Potentiometer R2 is added to the simplest circuit's adjust terminal to permit temperature calibration.

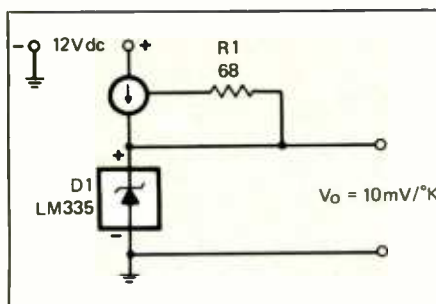

Fig. 4. An adjustable current source (circle with arrow) is used to bias the LM-355 for precision calibration.

For example, when the power source is +12 volts dc, the value of the resistor in series with the LM-335 is: $R(\text{ohms}) = (V+) \times 1000 = (12 \text{ Volts}) \times 1000 = 12,000 \text{ ohms}$.

The output of the Fig. 2 circuit is taken across the LM-335. This voltage has an approximate value of 10 mV/°K. Degrees Kelvin is the same as degrees centigrade, except that the zero point is absolute zero (close to -273 °C, rather than the freezing point of water). Using simple arithmetic, you can calculate how much voltage to expect at any given centigrade temperature. For example, suppose you want to know the output

voltage at 78 °C. The first thing you must do is convert the temperature to degrees Kelvin, simply by adding 273 to the centigrade temperature: $^{\circ}\text{K} = ^{\circ}\text{C} + 273 = 78^{\circ}\text{C} + 273 = 351^{\circ}\text{K}$.

Next, convert the temperature to the equivalent voltage: $E = (10 \text{ mV}) / ^{\circ}\text{K} \times 351^{\circ}\text{K} = (10 \text{ mV})(351) = 3510 \text{ mV} = 3.51 \text{ volts}$.

Enter Calibration

One problem with the Fig. 2 circuit is that it is not calibrated. While this circuit works well in applications where a high degree of precision is not needed, you might want to consider the Figure 3 circuit when greater precision is called for. This circuit permits single-point calibration of the temperature, using a potentiometer in parallel with the zener. Note that the "adjust" terminal of the LM-335 is now being used.

Calibration is relatively simple. All you need to know are the output voltage, which you can measure with a dc voltmeter, and the temperature in the area in which the LM-335 is being used. In some less-than-critical cases, you can measure the air temperature with a regular glass mercury thermometer. Wait long enough after turning on the equipment for both the mercury thermometer and the LM-335 to come to stabilize. Then adjust R2 for the correct output voltage. For example, if the room temperature is 25 °C (298 °K), output voltage will be 2.98 volts. In this case, you would adjust the R2 for a 2.98-volt reading.

Another approach is to use an ice/water solution as the calibrating source. The freezing point of water is

0° C, which is the temperature at which ice and water coexist in equilibrium. A mercury thermometer will show the actual temperature of the solution. Adjust R2 for an output of 2.73 volts (0° C = 273 °K).

Another connection scheme for the LM-335 is shown in Fig. 4. In this circuit a National Semiconductor LM-334 three-terminal adjustable-current source is used to bias the LM-335. Again, the output voltage will be 10 mV/°K.

Remote temperature sensing using LM-335 is shown in Fig. 5. In this circuit, the LM-335 is connected by a shielded two-conductor cable to the rest of the circuit. A ¼-inch stereo phone plug and jack or a two-circuit miniature 3.5-mm set (Radio Shack No. 274-249A or equivalent) serves as the interface. A cable length of several meters is possible.

Whenever the sensor is operated directly into its load, there may be a potential problem or two, especially if the load impedance changes wildly. To preclude this, use a buffer amplifier, as shown in Fig. 6. Here, we use an operational amplifier as an isolator/buffer between the sensor and its load. Gain of the amplifier in Fig. 6 is unity, but a higher gain could be used if desired.

The noninverting (+) input of the operational amplifier is connected across the LM-335. Bias for the LM-335 is from 12,000-ohm resistor R1, which is in keeping with our rule given earlier for $V+ = 12 \text{ volts}$. Since there is no voltage gain in this circuit, the output voltage is the same 10 mV/°K as previously.

A circuit like that in Fig. 6 might prove useful in monitoring remote temperatures. Either place the op amp in the receive end of Fig. 5, or locate it with the sensor. If the op amp is located with the sensor, a four-wire line is needed ($V-$, $V+$, ground and temperature). The advantage here is that line losses are overcome by the greater output of the op amp. The LM-335 is a rugged device, however,

Fig. 5. This is the arrangement to use for remote temperature sensing.

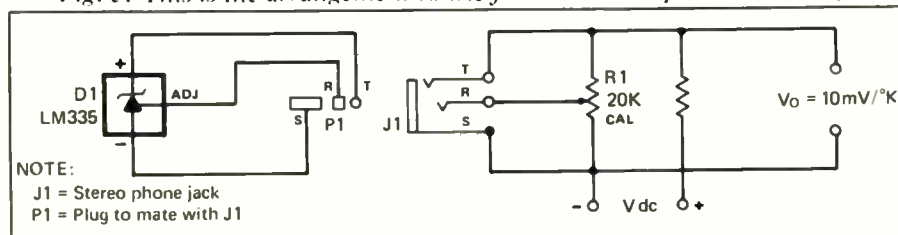

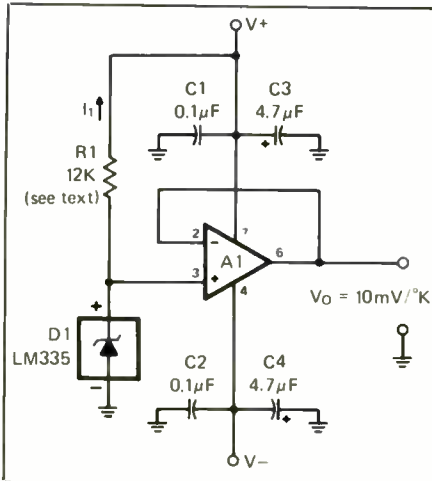

Fig. 6. Adding operational amplifier to LM-355 circuit provides isolation buffering and selectable gain.

and in many cases such measures would not be needed.

Temperature Scale Conversions

Though the Kelvin scale is used extensively in scientific calculations, it isn't popular in most "practical" situations. Most readers will want to make temperature measurements in either degrees centigrade or degrees Fahrenheit. Let's discuss the circuits that will automatically give °F and °C readings.

If the sensor's output is being fed into a microcomputer, it might be prudent to use the simplest circuit available, which is to measure in degrees Kelvin and let the computer do the converting. Here are the formulas that will be used: $^{\circ}\text{C} = ^{\circ}\text{K} - 273$ and $^{\circ}\text{F} = (1.8 \times ^{\circ}\text{C}) + 32$.

Before you jump right in, however, you must make the computer think it is seeing the correct kind of data. The analog-to-digital (A/D) converter will usually feed into the computer a binary number between 00000000 and 11111111, scaled to represent a temperature value. Assume an 8-bit A/D converter and a 0° to 100°C temperature range. The input to the A/D converter will be 2.73 to 3.73 volts.

If the A/D converter is able to provide offset measurements, you can set the maximum range for 1 volt and then offset it to 2.73 volts. In that unlikely case, 00000000 would represent 0°C, and 11111111 would represent 100°C. More likely, you will use a 5-volt unipolar input A/D converter to measure the narrow range of 2.73 to 3.73 volts and suffer a resolution loss. But this loss will usually be less than the nonlinearity of the transducer/sensor. Therefore, the

voltage represented by a change of one least-significant bit (LSB) in the A/D output data word would be approximately 20 mV and would represent 2° K. If all you need to measure is within 2°, you can use this system. Otherwise, some form of offset measurement is needed.

Figure 7 shows a scheme for converting the degrees Kelvin output of LM-335 sensor D1 into degrees centigrade. Since °C are the same as °K, no change of slope in the output factor is needed—the output is 10 mV/°C and circuit gain is unity.

The basic Fig. 7 circuit is an inverting dc amplifier based on a common operational amplifier like the 741. Gain is set by $R3/(R1 + R2)$. The noninverting (+) input of the dc differential amplifier receives both the temperature signal and a dc offset bias. Potentiometer R6 is used to set the voltage at point "A" to +1.83 volts (use a 2½-digit or more digital voltmeter). The result is that the output of A1 will be 2.73 volts less than it would have been were the offset not placed in the circuit, with the result that the output is scaled in °C.

Figure 8 is a circuit that converts °K to °F. To be able to make this conversion, you need two types of de-

Fig. 7. This circuit converts the °K output from LM-355 sensor D1 into °C.

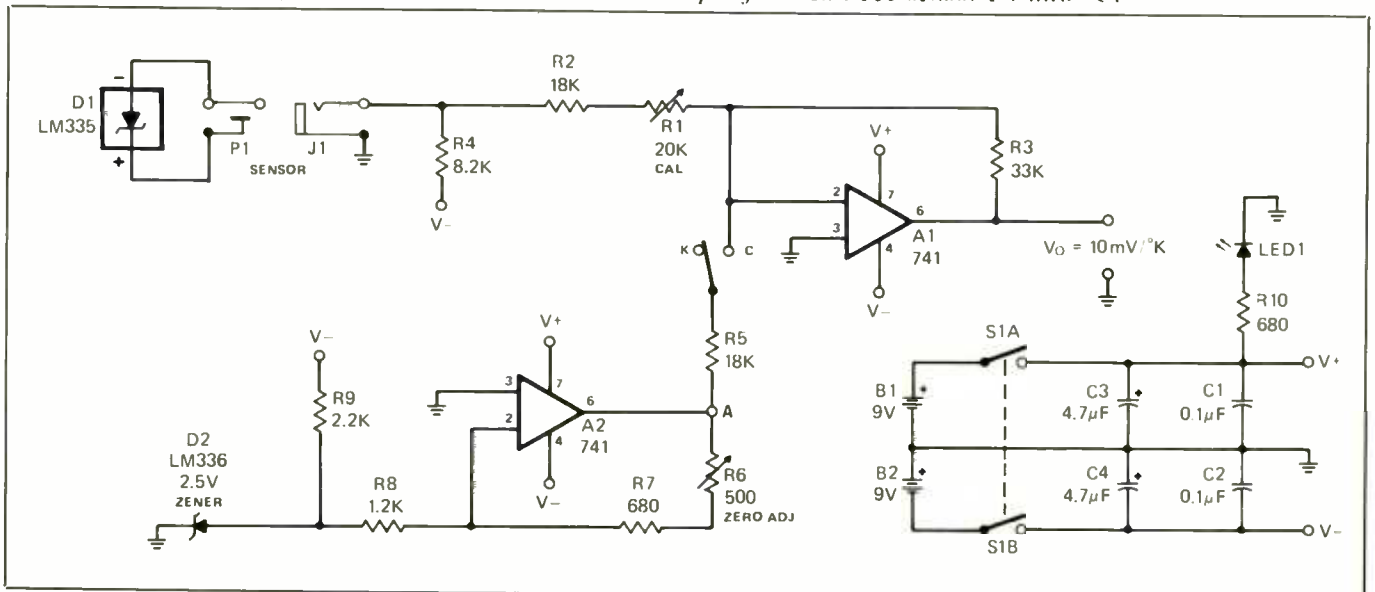

Direct-Reading °C and °F Sensors

Reader Carl Lodstrom (Applications Engineer at Dow-Key Microwave Corp.) passes on the following information about National Semiconductor's LM34 and LM35 series of IC temperature sensors that give *direct* readings in degrees Fahrenheit and centigrade, respectively. To paraphrase the applications note, the LM34 and LM35 have an advantage over linear temperature sensors calibrated in degrees Kelvin because you are not required to subtract a large constant voltage from their outputs to obtain convenient Fahrenheit or centigrade scaling. Also, no external calibration or trimming is required to ensure accuracy. Hence, use of an LM34 or LM35 series sensor eliminates the need for special circuitry and, thus, simplifies thermometer design.

Like the LM-355 described in the main text, the LM34/35 series are three-terminal devices and are available in TO-92 plastic and TO-46 metal-can packages. Of course, since the LM34

Fig. A. Pin identification for the LM34 and LM35 IC sensors.

and LM35 have no adjust terminals, their pinout differs from that of the LM-355 (Fig. A). Another difference is the schematic symbol, which is simply a box for the LM34/35 series (Fig. B).



TO-46 CASE
(H or AH SUFFIX)

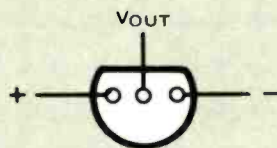

TO-92 CASE
(Z SUFFIX)

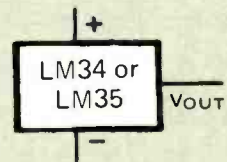

Fig. B. This is the schematic symbol for the LM34/35 series.

Depending on the sensor chosen, the output will be either $+10 \text{ mV}/^\circ\text{C}$ or $+10 \text{ mV}/^\circ\text{F}$. Measuring ranges are from -50° to $+300^\circ$ in Fahrenheit and from -55° to $+150^\circ$ centigrade. Guaranteed accuracy is 1.0° F at $+77^\circ \text{ F}$ or 0.5° C at $+25^\circ \text{ C}$.

The LM34/35 series of IC temperature sensors would be ideal for the project builder, except for the fact that they are not readily available from the usual mail-order parts suppliers. If you want just one or two, you may have a difficult time finding them outside of OEM distributor outlets, which normally sell in minimum-quantity lots.

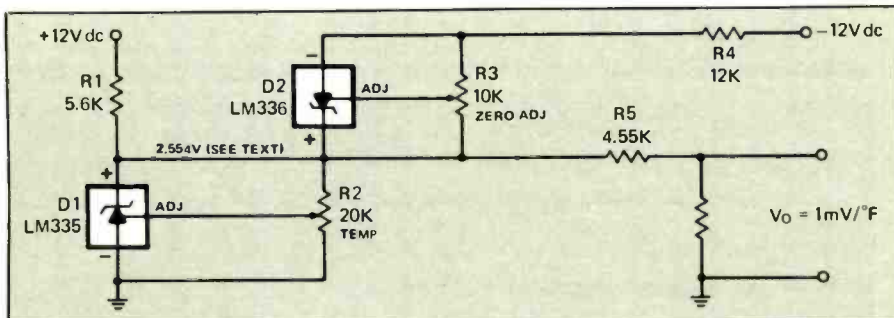

Fig. 8. Converting $^\circ\text{K}$ to $^\circ\text{F}$, using two types of degrees, different magnitudes.

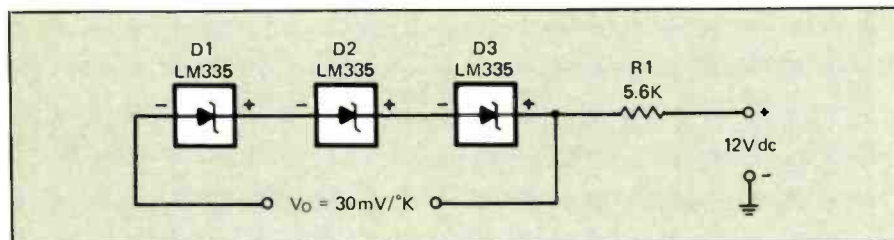

Fig. 9. Several LM-355 sensors make an average-temperature thermometer.

grees that are offset from each other (like Kelvin and centigrade, they have different zero references), and different magnitudes. Thus, the conversion circuit must offer both an offset and a change of slope. The off-

set is provided by potentiometer $R3$, which is used to set the 0°C point output level. Potentiometer $R2$ is used to set a calibration point at some higher temperature (for example, 25°C , or a room temperature of 77°F).

Calibration of the two points is performed in a manner similar to that detailed above. The zero point is set using a water/ice solution (adjust $R5$). The higher point is probably best set at room temperature. In both cases, the actual temperature could be measured with an ordinary mercury thermometer.

Measuring Average Temperature

There are times when it may be better to measure the average temperature in a small area, instead of taking a single temperature measurement for a large volume of space. One example might be in the temperature controller for a room where the average temperature is a more realistic indicator of the room's need for additional heat. Figure 9 shows the method for using several LM-335Z sensors for making an average-temperature electronic thermometer. The series-connected sensors form an output that is approximately $30 \text{ mV}/^\circ\text{K}$ for the



What do you want from a Ham magazine? News. Entertainment. Interviews. Projects. Reviews. Information. Great Reading.

Is that all?

Well, how about a WAZ Award Program, a Five Band WAZ Program, the two greatest World Wide DX Contests in the world, a DX Awards Program, two 160 Meter DX Contests, a USA-CA County Awards Program, a DX Hall of Fame. Twelve of the greatest achievement and operating programs in the Amateur Radio world. All from CQ.

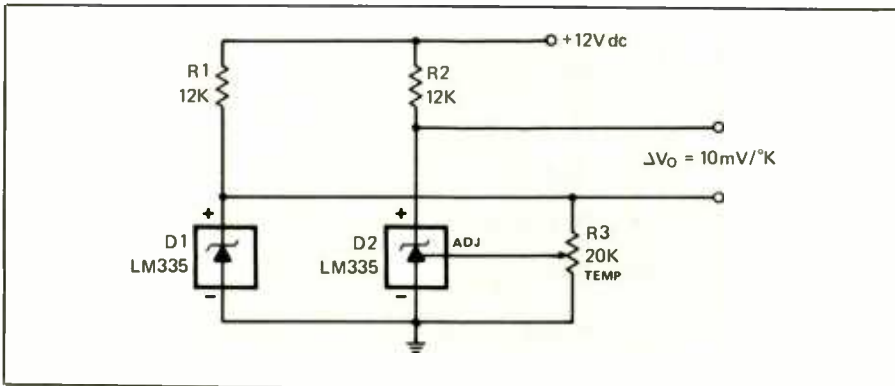

Fig. 10. A method of making a differential thermometer with ungrounded output.

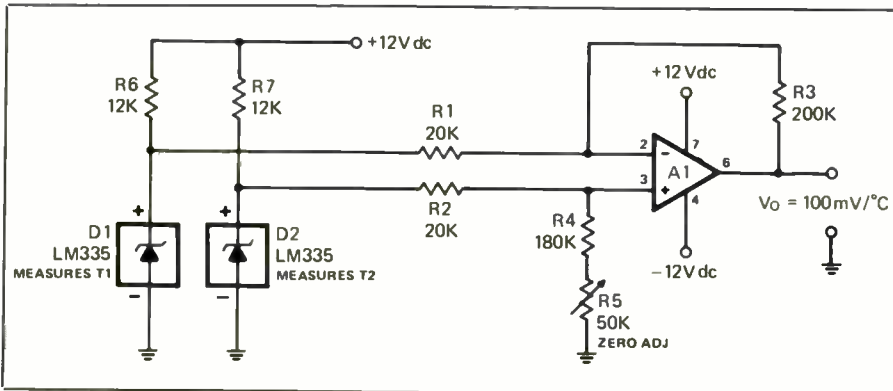

Fig. 11. Ground-referenced circuit does not require floating display devices.

average temperature. "Average" temperature here is the space average, not time average. The latter measurement would be made with a single sensor and an electronic integrator circuit to time-average the output signal.

Differential Thermometers

Figures 10 and 11 illustrate two methods for making a differential thermometer. These circuits produce an output that is proportional to the difference between two temperatures. The Fig. 10 circuit uses two LM335Zs in a bridge arrangement. The floating output voltage is taken between two ungrounded points. If the output is applied to the floating inputs of a voltmeter or similar display device, it will give a reading of the difference between the temperatures sensed by D1 and D2.

A ground-reference version of the Fig. 10 circuit is shown in Fig. 11.

This circuit has a simple dc differential amplifier added to its output. Since the unbalanced output is referenced to ground, you aren't constrained to using floating display devices.

One application of the differential thermometer is in measuring the difference between indoor and outdoor temperatures. Another is in environmental computer control circuits where the source selected for heating a home depends upon the relative difference between room temperature and hot water source temperature. If the solar-heated hot water source is not up to snuff, the "augmented" fossil-fuel heater would be turned on.

In Conclusion

The LM-335Z temperature sensor is easy to use, and provides relatively good accuracy in electronic thermometry at low cost. What's more, it's readily available to experimenters. **ME**

The Radio Amateur's Journal
76 N. Broadway, Hicksville, NY 11801

Please send me CQ for Life 3 Years 2 Years 1 Year
 New Renewal Start with _____ issue

Name _____ Call _____
Street _____ State _____ Zip _____

Charge My Order To: MasterCard VISA
Payment Enclosed \$ _____
3 Years (36 issues) \$48.00
2 Years (24 issues) 33.00
1 Year (12 issues) 18.00
My account number is _____





The Ocean Box

A low-cost wave-sound generator

By J. Daniel Gifford

If you've ever spent the night near the ocean or a fast-flowing river, you're aware of the powerfully soothing sound the water can make—in fact, you probably slept better than you do at home!

Ocean waves and running water, along with wind and falling rain, are natural sources of what is called *white noise*, a sound composed of all the frequencies that the ear can hear. Fans and heating/air conditioning blowers are artificial sources of white noise. Because of its broadband nature, white noise (whether natural or artificial) tends to mask out other sounds, even at comparatively low levels. This masking effect has been shown by numerous studies to contribute to deeper, more restful sleep.

White noise can also be used to mask out sounds in high-noise environments such as apartment buildings, dormitories, and offices to eliminate distractions and contribute to better concentration. Again, this masking effect occurs at fairly low levels of white noise volume.

There are a number of devices on the market that generate white noise, from simple and inexpensive fan-in-a-box units to complex and pricey electronic white noise generators. The latter can be set to resemble the sounds of surf, wind, rain, waterfalls, etc., but cost \$150 to \$200.

The Ocean Box presented here is a white noise generator that, too, can be set to resemble a full range of natural sounds. Although it lacks some

of the more sophisticated features of its commercial big brothers, it is otherwise comparable to them, and certainly comes out ahead when you consider that it can be built for about \$35.

The Circuit

The Ocean Box circuit is meant to be built into a small bookshelf speaker—Radio Shack's Minimus-3 (catalog No. 40-913) is ideal, although other, and perhaps cheaper types can be found at surplus stores and stereo dealers. The prototype's speaker/case was taken from an inoperative, inexpensive stereo system.

The speaker used does not have to be a multiple-element type; a single 4" to 7" one will perform very well, particularly if it has a central "whizzer cone." (Most commercial generators use only a 3" to 4" speaker.) The speaker chosen should be housed in an attractive enclosure since it is meant to sit out in plain view on a bookshelf or table.

The heart of the actual circuit (Fig. 1) is a digital white noise generator chip, National Semi's MM5837, which requires no external components for operation. An internally clocked shift register generates the sound, and only three of the IC's eight pins are actually used: V_{SS} (pin 4), Ground (pin 1), and Output (pin 3). Pins 5 through 8 are not used, while pin 2 is sometimes used to provide a second supply voltage for particular applications.

The output of the 5837 is sent to an n-channel MOSFET, in this case an IRFD123. Actually, any n-channel enhancement-mode MOSFET can be used here; this rather exotic unit is specified because of its convenient DIP mounting. Moreover, it's widely available.

The MOSFET is used as a voltage-controlled resistor: the current that passes from its drain to its source is controlled by the voltage level at its gate. At zero volt, the resistance will be very high (several megohms); at



Ocean Box is a wave-sound generator that sits unobtrusively on a shelf or table. It masks out unwanted sounds.

about 0.75 V and above, the MOSFET will exhibit its minimum resistance of about 3 ohms. (Other MOSFETs may exhibit minimum resistances of 10 to 200 ohms.) Output from the transistor's source is routed to a conventional LM386 amplifier circuit, which provides about 400 milliwatts into an 8-ohm load, more than enough for this purpose.

The voltage that controls the MOSFET is produced by a 555 timer-based envelope generator. (A CMOS 7555 was used in the prototype; either it or the conventional bipolar 555 may be used.) The envelope shape, which is controlled by four potentiometers, determines the shape of the amplifier's output amplitude and, thus, the shape of the sound the Ocean Box produces.

The first two pots control the tim-

er's on and off periods, and do so independently—changing one setting has no effect on the other. The time that the timer is on (that is, its output is high) is controlled by $R5$, the 2.2-Meg pot labeled "Wave." It controls the apparent length of the wave crashing on the beach. The other pot, $R6$, is a 5-Megohm unit labeled "Period"; it determines the time between waves.

If the timer's output was directly connected to the MOSFET, the sound would turn on and off sharply, sounding rather like a slow-motion steam train—not a particularly soothing sound. Therefore, the timer's output is used to charge and discharge a large capacitor ($C6$) through two more pots. $R8$ is a 1-M pot that controls charging of the capacitor; $R7$ is a 5-Meg unit that controls the

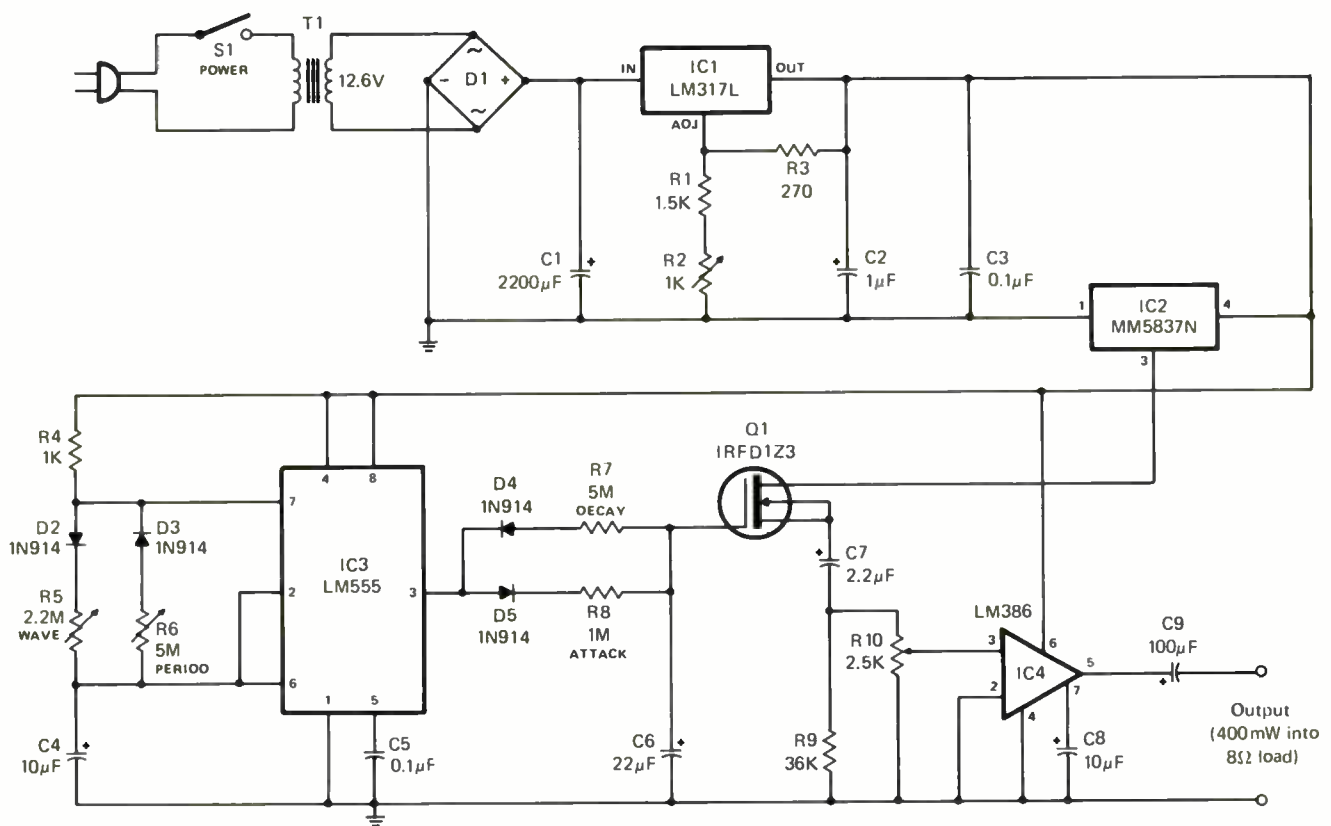

PARTS LIST

Semiconductors

D1—50-volt, 1-ampere bridge rectifier
 D2 thru D5—1N914 or 1N4148 diode
 IC1—LM317L adjustable regulator in TO-92 case (see text)
 IC2—MM5837 digital noise generator
 IC3—555 timer
 IC4—LM386 audio amplifier
 Q1—IRFD123 n-channel MOSFET (Radio Shack No. 276-2073 or similar)

Capacitors

C1—2200- μ F, 25-volt electrolytic
 C2—1- μ F, 16-volt tantalum
 C3, C5—0.1- μ F Mylar
 C4—10- μ F, 16-volt tantalum

C6—22- μ F, 16-volt tantalum
 C7—2.2- μ F, 16-volt tantalum
 C8—10- μ F, 16-volt electrolytic
 C9—100- μ F, 16-volt electrolytic

Resistors (1/4-watt, 10% tolerance)

R1—1500 ohms
 R3—270 ohms
 R4—1000 ohms
 R9—36,000 ohms
 R2—1000-ohm Cermet trimmer potentiometer
 R5—2.2-megohm potentiometer
 R6, R7—5-megohm potentiometer
 R8—1-megohm potentiometer

R10—2500-ohm potentiometer with spst switch (S1 below)

Miscellaneous

S1—Spst switch (part of R10)
 T1—12.6-volt, 120-mA power transformer (Radio Shack No. 273-1360 or similar)
 Small bookshelf speaker (see text); perforated board; experimenter's pc board (Radio Shack No. 276-170); sockets for ICs; ac line cord with plug; strain relief; 3/4" control knobs with indicator line (4); 1" control knob; double-faced foam tape; hookup wire; solder; etc.

Fig. 1. This is the complete schematic diagram of the Ocean Box; Q1 can be any n-channel MOSFET.

discharging of the capacitor. Like the Wave and Period controls, the "Attack" (or charging) and "Decay" (or discharging) controls operate independently. With the capacitor connected to the MOSFET's gate, the envelope and, hence, the output sound will rise and fall at a rate determined

by Wave and Period, and with a rising slope determined by Attack and a falling slope set by Decay. By adjusting these four pots, almost any imaginable white noise sound can be achieved: from the sigh of wind to the harsh crash of storm breakers to the long, slow roll of summer waves to

the irregular patter of rain. All of these sound patterns exhibit white noise's soothing masking effect.

The only real shortcoming of the Ocean Box against its commercial counterparts is preset sound patterns; that is, from Surf to Wind to Rain with the flick of a switch. Most

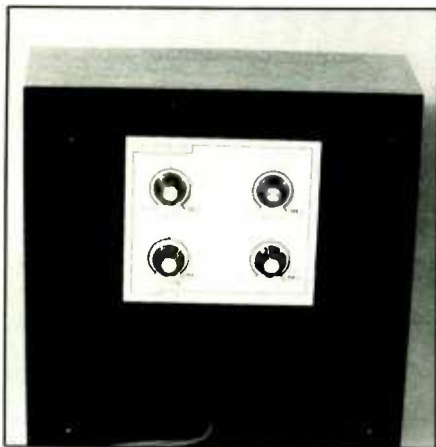

Fig. 2. This is a rear view of the project prototype, showing label placement and controls.

commercial units have such a switch, with one or two fine-tuning controls to allow the user to adjust the preset sound to his liking. As this omission halves the Ocean Box's cost and building complexity, as well as allowing an increase in overall sound range, it's a small loss.

In the prototype, the on-off/volume control is the only control on the front of the speaker. The four shaping controls are mounted on the back of the speaker housing (Fig. 2), where they will not detract from the unit's appearance. This arrangement is best suited for "set and forget" use. However, if you want to change the sound frequently, it may be better to mount the controls on the side or front of the speaker, perhaps behind a hinged panel.

There are two other adjustments that can be made to the sound of the Ocean Box, both dealing with the MM5837 itself. This IC has two voltage supply inputs, pin 4, V_{SS} , which should have a voltage of 14-16 volts, and pin 2, V_{GG} , which requires a voltage of about 27 volts. In practice, the voltage V_{SS} can be varied widely, and V_{GG} is not needed at all.

Varying V_{SS} has a strong effect on the quality of the base white noise sound that the MM5837 produces. At the highest supply level of 15 to 16

volts, the sound has a high, whispery quality; as the voltage is lowered, the sound becomes deeper and hollower until, at about 8 volts, it breaks into a series of rattles. The limit in this circuit is 12 volts, because that's the maximum that the LM386 can take. However, this is not much of a problem, as at the higher voltages the MM5837 can produce an annoying clicking sound. The best sound quality (at least to the author's ear) is produced between about 9 and 11 volts.

To enable the voltage to be adjusted, the Ocean Box is powered by a variable supply built around an LM317L adjustable voltage regulator IC. (The LM317L is a TO-92-cased light-duty version of the TO-220 LM317T, used because the circuit only draws about 60 mA. The more common and more expensive TO-220 version may be used in the LM317L's place.) The circuit's supply level can be adjusted by means of the 1K Cermet trimpot R2 from about 8.2 volts to about 12.5 volts. It will be up to you to adjust the sound to your liking before you reassemble the speaker.

Another control for the MM5837's sound is the addition of a high-pass filter like that formed by C7 and R9 to its output. The addition of these components gives a smoother, more pleasing sound, but were, of course, chosen to suit the author's ear. You may wish to experiment with their values before final assembly by first constructing the MM5837 and amplifier on a solderless breadboard. The range of suitable values for the two components is about 0.1-4.7 μF and 30 to 220K.

As a final note on the circuit, the LM386 has been left in its lowest-gain configuration, since it receives a strong signal from the MOSFET. If you want a slightly more powerful output, add a 10 μF capacitor between pins 1 and 8, with the positive terminal to pin 8; for even higher gain, add a resistor with a value up to 1.2K in series with the cap.

Construction

Since the Ocean Box is meant to be housed in a speaker cabinet, no cases for the circuit boards are necessary.

Fig. 3. Main circuit board is built on universal experimenter's pc board. Note how MOSFET and MM5837 share a common socket. Cables at left go to control pots; pot at right is volume control. Heavy wires at top right are speaker leads.

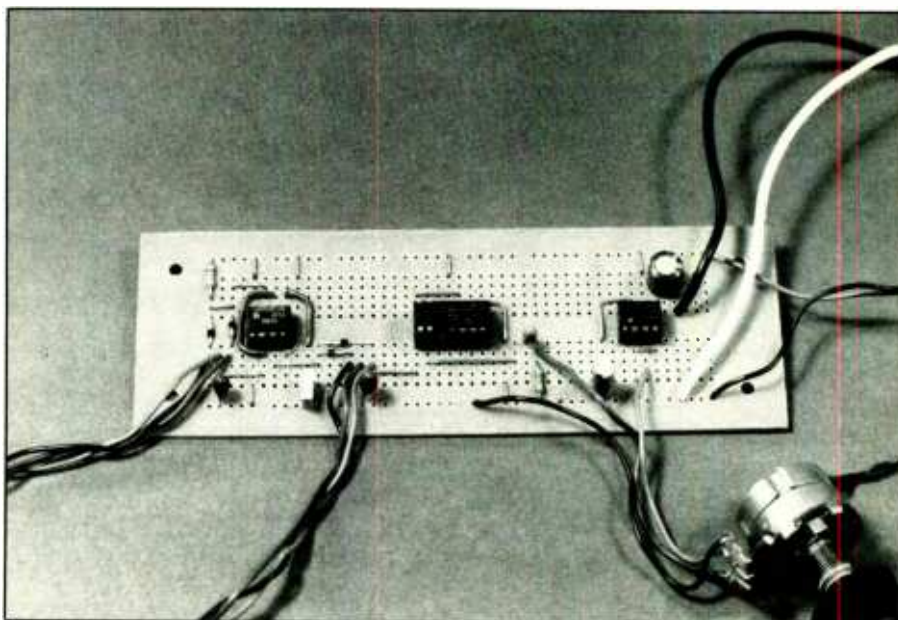

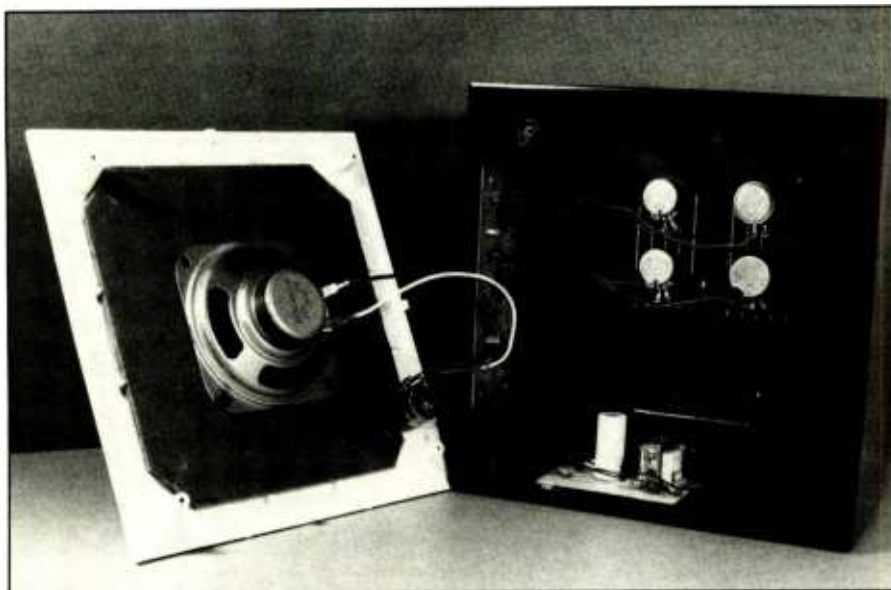

Fig. 4. Internal layout of prototype. Note mounting of pots and circuit boards.

The only thing to watch out for is thick walls on the speaker cabinet, which would interfere with the mounting of the four control pots. If

the speaker enclosure you use has thick walls, the pots will either have to be mounted in a section of thinner material in a cutout or be long-shaft

types mounted on a strip behind the wall material.

The prototype was assembled on two circuit boards, one containing the power supply components and the other containing the rest of the circuitry. Ordinary perfboard was used for the power supply, but an experimenter's universal PC board was used for the main circuit. Although ordinary perfboard or a custom PC board could be used, the experimenter's board is available at very low cost from a number of sources (including Radio Shack) and greatly facilitates construction. Note in Fig. 3 that sockets are used for all of the ICs and the MOSFET, with the transistor and the MM5837 sharing a common 14-pin socket. Use care in wiring the five pots to the board, making certain that the cabling is both neat and long enough to mount everything properly (see Fig. 4). The circuit boards must be securely mounted; in the prototype, this was done with double-faced foam tape.

Using the label of Fig. 5 will give the Ocean Box a finished appearance. It can be cut from the page, but a better solution is to make several photocopies on a good plain-paper copies. The best label should be kept for final use, and a spoiled copy used for layout. This "layout" copy should be lightly glued to the speaker housing and all of the appropriate drilling done, then removed and the good label applied.

If the surface the label is to be mounted on is smooth, the label can be directly applied to the surface with rubber cement. If the surface is rough or broken by openings, as is the prototype's, the label should be glued to a thin sheet of cardboard before being cut out. Any 1/4" knobs with indicator lines can be used with the four control pots. The on-off/volume knob on the front should be an attractive type that goes with the speak-

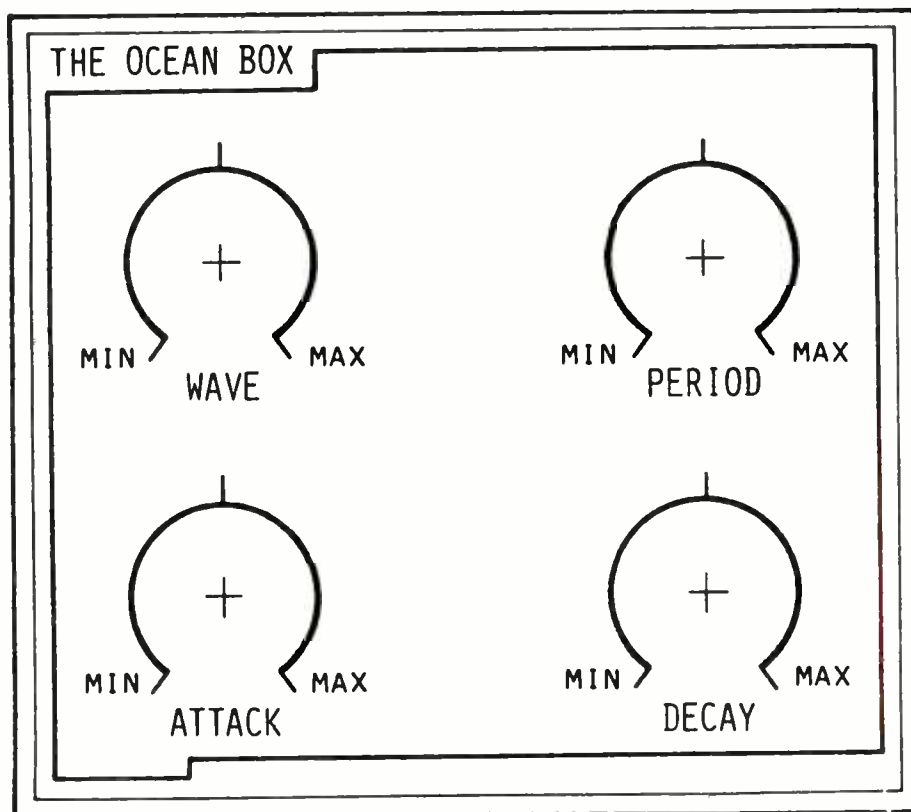

Fig. 5. Full-size layout of Ocean Box's control panel. For best results, photocopy this illustration (see text for details).

Continued on page 104

Encyclopedia of Electronics. (TAB Professional & Reference Books. Hard cover. 983 pages. \$60.00.)

As its title implies, this is a truly massive volume, both in terms of size and scope. The encyclopedia covers just about every topic in electronics, starting with "A Battery" and ending with "Zone of Silence." It has all its information listed in logical, alphabetical order. All topic entries are in capsule form, many accompanied by a schematic, drawing or photo.

There are more than 3000 key topics, all cross-referenced and indexed for easy look-up. To keep everything on an even keel, the index tells you not only on what pages relevant information on a given topic appears, but the pages on which allied illustrations and/or tables appear.

Created by an editorial board of 20 leading electronics experts, and edited by Stan Gibilisco, this work represents a fine one-volume source of detailed information for the whole breadth of electronics. Its succinct, information-packed presentations and easy subject locatability should make it among the most heavily used books in one's library.

Landmobile and Marine Radio Technical Handbook by Edward M. Noll. (Howard W. Sams & Co., Inc. Soft cover. 576 pages. \$24.95.)

A complete atlas of the commercial

two-way radio field, this book covers landmobile, marine and personal radio services in full technical detail. More than just a simple quick-reference guide, this book is basically theory-oriented. It provides technical discussions of two-way radio circuits used in modern mobile communications equipment. It also provides maintenance and installation data for service personnel and discusses the types of test equipment generally used in mobile radio servicing.

Coverage is very comprehensive. Among the topics discussed are: two-way radio services and frequency bands; transmission characteristics and modulation; solid-state theory for radio communications; digital and microprocessor electronics; antenna systems; repeater stations and cellular radio; radar equipment and satellite communications; and much more.

A no-nonsense text style and liberal use of photos, schematics and drawings make this book an ideal study guide for those who wish to obtain FCC certification in commercial mobile communications. In fact, the book closes with an "FCC Licensing, Operating Practices and Examination Requirements" chapter that serves as an excellent guide in this area. If there is a weakness, it's in the shallow coverage of cellular telephones.

Forrest Mims's Computer Projects by Forrest M. Mims III. (Osborne/McGraw-Hill. Soft cover. 249 pages. \$14.95.)

If you're interest is *computing*, rather than using a computer as an "appliance," this book is for you. It shows you how to really take charge of your computer's abilities with programs you enter at the keyboard and, in some cases, hardware to attach to your computer to make it do what you want it to do. It does this with a number of software and hardware "projects," each of which is designed to exercise your grey-matter.

The projects are built around programs written in Microsoft BASIC. Program examples given in the text are in the versions of BASIC for the IBM PCjr and Radio Shack Color Computer, but they can be adapted for use on other computers that use Microsoft BASIC. Whatever hardware is required for a project connects to your computer via joystick ports.

Projects covered in this book are quite varied and were selected to demonstrate the computer's capabilities. A brief sampling include: a computer storage oscilloscope; computerized security alarms; analog sensors for computers; analog computer techniques for digital computers; computer-aided drafting; creating custom characters with an X-Y plotter; experimenting with computer art, etc.

NEW LITERATURE

Satellite TV Booklet. A 16-page booklet from Luxor North America Corp. answers 78 most-frequently asked questions about satellite television. It is organized into seven sections under the headings: Getting Started, The Channels, The Birds, Satellite TV programming, The Dish, Satellite TV Receivers, and Tuning In. Simple diagrams and captions visually portray basic operation of a home satellite TV system, location of the Clarke satellite belt and a typical satellite footprint. For a free copy of "Everything You Need to Know About Satellite TV," write to: Luxor North America Corp., 600 108 Ave., N.E., Bellevue, WA 98004.

Hard-to-Find Items Catalog. Contact East is offering a free one-year subscription to its new tool and instrument catalog. The catalog lists more than 5000 hard-to-find items for assembling, in-

stalling, testing and repairing electronic equipment. Products include precision hand tools, tool kits, test instruments, soldering supplies and static-control devices. For a free copy, write to: Contact East, P.O. Box 786, N. Andover, MA 01845.

Parts & Equipment Catalog. Jameco's 80-page, 1986 catalog lists more than 3800 electronic parts, accessories and products useful to engineers, technicians and experimenters. Product lines include everything from linear and digital ICs to diodes and transistors to resistors and capacitors. Many pages are dedicated to Apple, IBM, Commodore and Tandy TRS-80 computer peripherals and accessories. New in this edition (and very handy to have if you are a circuit designer or experimenter) are eight pages of IC pin-out data. Among other items listed are: optoelectronic devices, test instruments,

power supplies, connectors, IC sockets, cables, prototyping materials and tools. For a copy of the catalog, send \$1 to: Jameco Electronics, 1355ME Shoreway Rd., Belmont, CA 94002.

Electronic Products Catalog. The latest Heath catalog describes in full detail more than 400 audio, video, automotive and marine, communications, test instrument, computer hardware and software and home electronic products, many of them in kit form. New additions include: a keyless doorlock kit; a digital rain gauge; an antenna noise bridge, vlf converter, active SWL antenna and Touch Tone decoder for communications; and a radiation monitor, RS-232 breakout box, digital LC bridge and 25-MHz dual-trace oscilloscope in the test equipment area. For a free copy, write to: Heath Co., St. Joseph, MI 49085.

A Multi-Function Radio-Control System

By Forrest M. Mims III

Remote control is a field which offers many interesting opportunities for the electronics experimenter. For example, I've used various remote-control methods to control the volume of a TV set, the joystick inputs of a computer, a miniature guided rocket, and air-borne motor-driven cameras suspended from kites and balloons.

In this column, I will describe an easily assembled, single-channel radio-control system with many on/off control applications. First, here's a case study that illustrates the versatility of such a system.

Radio-Controlled Telephone Bell

Recently, my brother Keith called to tell me he was scheduled to give an important speech to officials at the head office of the company for which he works. The subject of his speech was telephone etiquette, and Keith had devised a clever way to catch the attention of his audience. During a key part of the speech, he planned to trigger the bell of a telephone placed on the podium. He would then answer the phone and simulate a conversation with the non-existent caller.

After explaining his plan, Keith asked if I could design for him an infrared or radio remote-control unit to trigger the bell in the phone. An infrared system would be very compact and easy to conceal. But it might be difficult to guarantee line-of-sight to the receiver. A radio system would be bigger, but it would work without direct line-of-sight. Both methods would be susceptible to possible noise that might cause the bell to be triggered without a signal from Keith. The principal noise source that might affect the infrared receiver would be artificial lights, particularly fluorescents. Noise sources that might trigger a radio receiver include electromagnetic disturbances transmitted by nearby electric motors, light switches and lightning. Interference from CB and other radio-frequency transmitters might also cause false triggering.

Our discussion about the relative mer-

its and demerits of infrared and radio remote-control systems quickly became moot when Keith asked if I could assemble a working system during a brief visit he planned to make to my office. Visions of a sophisticated, noise-immune, remote-control system vanished from my mind as I asked Keith to stop by a Radio Shack store on the way to my office and buy the cheapest radio-controlled toy car in stock.

Keith arrived with a radio-controlled, 1/6 scale U.S. Army jeep purchased for the sale price of \$9.88. I immediately switched on my oscilloscope and began studying the operation of the jeep's non-crystal-controlled receiver and control system. The telephone Keith planned to use during his speech was an antique model with a nonfunctioning bell. Therefore, we decided to use an ordinary 2 1/2-inch doorbell from a hardware store (Eagle Electric Manufacturing Co. No. 292).

Most of the receivers in the R/C toy cars I've disassembled use driver transistors to switch the car's motors off and on. The doorbell we planned to use, however, consumed much more current than the drive motor of a toy car. Fortunately, the receiver in the Radio Shack jeep incorporated an output relay. This greatly simplified assembly of Keith's system since the relay could directly control the bell.

Within two hours or so, I managed to install the receiver from the toy jeep inside a plastic cabinet. The bell was mounted on the outside of the cabinet, and the batteries for both the receiver (9 volts) and the bell (6 volts) were installed inside the cabinet. The pocket-size transmitter reliably triggered the bell each time its button was pressed. Unfortunately, so did the CB rig in my pickup. Even though the toy receiver was far from being noise immune, Keith managed to use the remote-controlled bell quite successfully. He reduced the chance for an unwanted ring by switching on the concealed receiver just before his speech.

Practical R/C Systems

The Federal Communications Commission regulates radio-control transmitters.

Prior to 1983, users of R/C transmitters whose output power exceeded 100 milliwatts were required to secure a license from the FCC. The license requirement was eliminated in 1983 as part of the Reagan administration's program to reduce federal regulations.

Today, anyone can operate an R/C transmitter that has been tuned and certified by an FCC licensed second-class radio operator. The transmitter must operate at one of the frequencies authorized by the FCC, and its output power must not exceed 4 watts.

Some day I plan to design an ultra-miniature, crystal-controlled R/C transmitter having an output power of less than 100 milliwatts. Until then, I'll continue to use commercial R/C equipment, which is relatively inexpensive, readily available and easy to use.

Types of R/C Systems

Most commercial R/C systems are intended for use by model car, boat and plane enthusiasts. These systems range from inexpensive single-channel units to those having seven or more channels.

Most commercial systems use "digital-proportional" modulation. This is not a true digital modulation method wherein control signals are transmitted as sequences of binary words. Instead, control signals are embedded as one or more variable-duration pulses, one for each channel, within a constant interval period called the frame. The duration of the individual pulses within the frame determines the position of the servos connected to the receiver's output. The signal from the receiver of this kind of R/C system is not suited for directly driving a relay. However, a relatively simple decoder circuit can be designed to accomplish this function.

A second kind of commercial system uses pulse-proportional modulation. Here, the transmitter sends a series of pulses to the receiver at a rate of about 6 Hz. The receiver is connected to an electromagnetic actuator with a movable arm that flips back and forth each time a pulse is received. Varying the pulse parameters

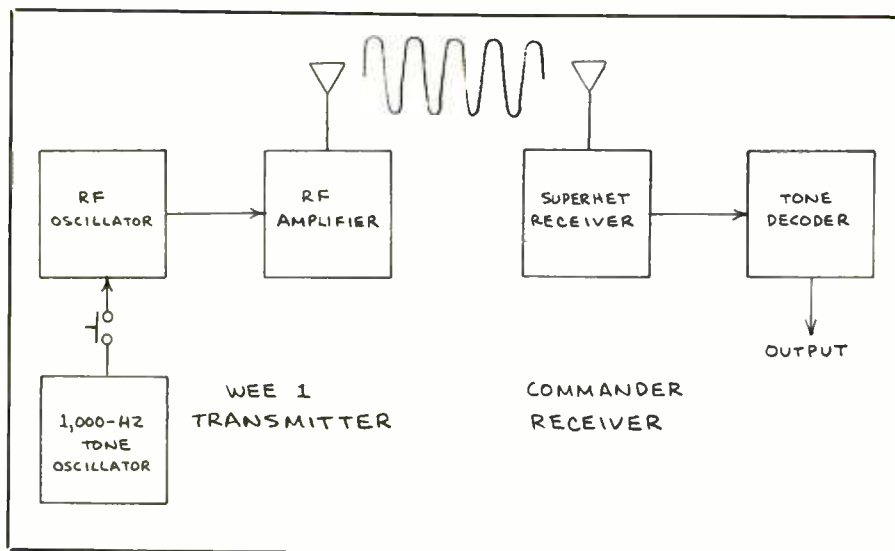

Fig. 1. Block diagram of Wee 1 and Commander radio-control system.

varies the average position of the actuator's arm. Pulse-proportional modulation is used in very simply R/C installations for model planes in which only the average position of the rudder is controlled. This kind of R/C system will directly drive a relay, but the relay will chatter instead of being either on or off.

A third kind of commercial R/C system, which is rarely used to control models, uses a simple on/off method of control which is well suited for driving a relay. When a switch on the transmitter is pressed, a tone is transmitted. The receiver decodes the tone and actuates a relay, motor or other electromechanical device. This kind of system is ideal for single-channel applications such as actuating a camera, pager, intrusion alarm or bell.

Commercial R/C Systems

For experimenters with a small budget or those who need a "quick-and-dirty" R/C system, a single-channel unit salvaged from a toy R/C car will suffice in some applications. Often, the major drawback of such systems is limited range (a few hundred feet) and susceptibility to noise and interference from signals on nearby frequencies. Interference usually occurs when the receiver's operating frequency is not crystal controlled.

A good time to look for salvageable

single-channel R/C toy cars is during the first few months after Christmas. Unsold systems are sometimes available on sale for as little as \$10 and returned systems, particularly defective ones, are available for even less.

Some relatively low-cost toy cars use the same digital-proportional modulation method of more sophisticated systems. The receivers of such systems are usually crystal controlled. These systems enable multi-channel operation. If you want to control more than one device with a single transmitter, you might want to consider such a system.

Radio Shack sells for \$16.95 a transmitter and receiver pair designed specifically for controlling toy cars (catalog No. 277-1012). The transmitter is crystal controlled, but the receiver is an inductively tuned unit. This system uses tone modulation to permit the receiver to control a left/right steering motor and a forward/reverse drive motor.

I discussed this R/C system in detail in "The Electronics Scientist" column in the January 1984 issue of *Computers & Electronics* (pp. 96-103). This column, which you should be able to find at most libraries, includes several circuits for modifying both transmitter and receiver to make them suitable for controlling devices other than motors of toy cars.

A disadvantage of R/C systems designed to control toy cars is their susceptibility to interference and electrical noise. If your budget permits, you can achieve better results by purchasing an R/C system designed specifically for controlling more sophisticated model planes and boats. One system with which I have experimented extensively is the Aero Sport Two. This 2-channel R/C system operates in the 72-MHz R/C band and is therefore unaffected by signals in the 27-MHz CB and R/C bands. The receiver is enclosed in a plastic housing, weighs about two ounces and measures $1\frac{1}{16}$ " \times $1\frac{3}{16}$ " \times $\frac{1}{4}$ ". A complete system is available for \$54.99 plus postage and handling from Hobby Shack (18480 Bandilier Circle, Fountain Valley, CA 92708). It includes a transmitter, receiver, two servos and a battery box for four AA cells.

The Aero Sport Two is a true digital-proportional system and is, therefore, designed to operate servos, rather than relays. I have designed a simple circuit that enables the Aero Sport Two receiver to drive an optoisolator. For details, see the "Experimenter's Corner" column in the January 1983 issue of *Computers & Electronics* (pp. 28, 33, 104-107).

A Multi-Function Single-Channel R/C System

The preceding commercial R/C systems each have important advantages and disadvantages. Without modification, however, none is well suited for the simple task of single-channel, go/no-go (on/off) control. Ace R/C, Inc. (Box 511, Higginsville, MO 64037), a manufacturer and supplier of R/C equipment since 1953, sells a single-channel transmitter/receiver pair ideally suited for general purpose, go/no-go remote control applications. The transmitter, called the Wee 1, has an output of nearly 500 milliwatts. The Wee 1 measures only $5\frac{1}{8}$ " \times $2\frac{1}{4}$ " \times $2\frac{1}{16}$ " and is available as a kit (11K16 at \$19.95) or factory assembled (11K17 at \$29.29).

Two versions of Ace's Commander superheterodyne receiver are designed specifically for use with the Wee 1. One is designed for a 2.4-volt nickel-cadmium

power supply (12K12) and the other for a 3-volt supply (12K13). Each is available assembled but without an enclosure for \$26.50. Weight is less than an ounce, and size is $1\frac{1}{16}'' \times 1\frac{1}{4}'' \times \frac{1}{16}''$.

Figure 1 is a block diagram that illustrates operation of the Wee I transmitter and Commander receiver. In operation, the transmitter's crystal-controlled oscillator generates an r-f carrier signal that is amplified and coupled to a 52" telescopic antenna. The transmitter includes a normally-off 1000-Hz multivibrator coupled to the r-f oscillator through a buffer transistor. When the switch that supplies power to this tone oscillator is closed, the carrier is modulated by the 1-kHz tone.

The receiver incorporates a crystal-controlled superhet circuit and a tone decoder. When the receiver detects a carrier signal having the proper r-f and tone frequencies, it supplies an output current capable of directly driving a small relay, optoisolator or external circuit.

Any of five FCC-authorized frequencies can be selected for this transmitter/receiver pair. The frequencies are 26.995, 27.045, 27.095, 27.145 and 27.195 MHz. Selecting a frequency requires some planning, particularly if others may be using R/C systems within half a mile or so of your location. Interference from CB radios might also cause problems. The 40-channel CB band extends from 26.965 to 27.405 MHz and encompasses all five frequencies at which the Wee I transmitter is available. The 27.145-MHz R/C frequency is close to CB channel 14 (27.125 MHz), a frequency used in many older 100-mW toy transceivers. The 27.195-MHz R/C frequency is even closer to CB channel 19 (27.185 MHz), the popular trucker's channel. Therefore, you may reduce potential interference problems by selecting one of the three other frequencies.

Incidentally, the frequency of the crystal in a superhet receiver does *not* match the frequency of the crystal in the transmitter whose signal the receiver is intended to receive. The receiver crystal is always ground for a frequency 455 kHz lower than that of the transmitter's crystal. Thus the crystal of a superhet receiver designed to detect the signal from a trans-

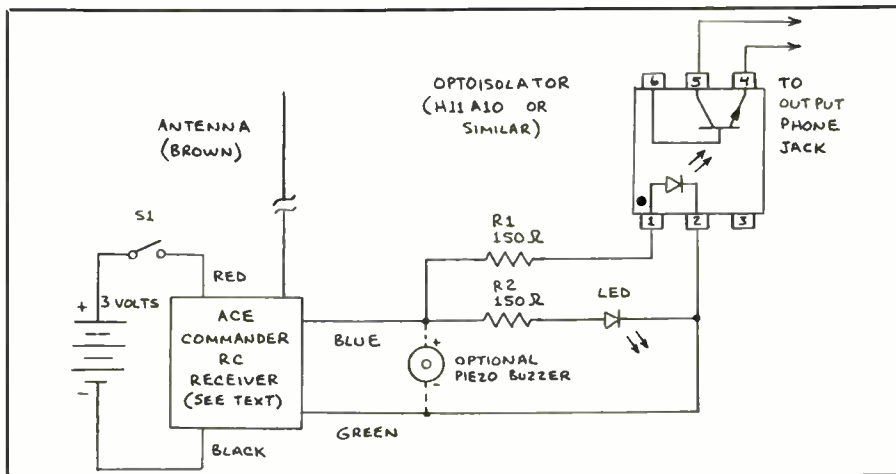

Fig. 2. A Multi-function radio/control receiver with optoisolator output.

mitter operating at a frequency of 27.145 MHz will have a frequency of 26.690 MHz ($27.145 - 0.455 = 26.690$).

Figure 2 shows how Ace's Citizenship receiver can be connected to an optoisolator which, in turn, can drive an external circuit or a relay. Resistor *R1* limits current to the infrared-emitting diode in the optoisolator. Resistor *R2* limits current to a red indicator LED that shows when the receiver has received a signal.

A General Electric H11A10 GaAs diode/npn phototransistor optoisolator was used in the prototype circuit I assembled. However, any similar optoisolator should also work.

Figure 3 shows how the receiver and the external optoisolator circuit can be installed in a compact plastic enclosure that measures only $4'' \times 2'' \times \frac{1}{16}''$ (Radio Shack No. 270-220). By installing the optoisolator and *R1* on a perforated board,

Fig. 3. Internal layout of a general-purpose radio-control receiver system.

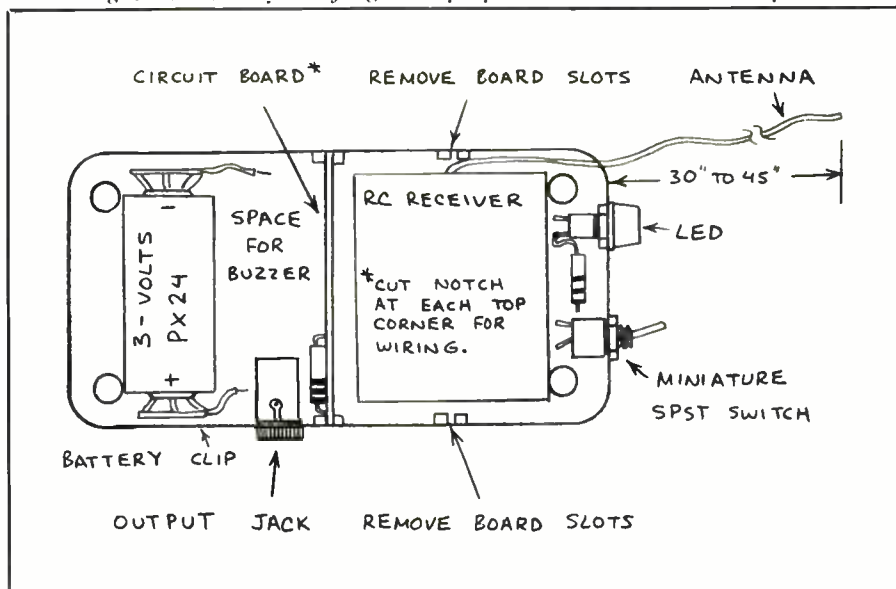

space is made available for later installation of additional components.

Using the Single-Channel R/C System

Before connecting the battery to the system, be sure to carefully check the wiring to make sure there are no errors. Also, make sure none of the exposed pc connections on the receiver board touch the phone jack or other exposed terminals. Each time the power switch is closed, the indicator LED will flash to indicate the receiver is functioning.

There are many practical applications for this single-channel R/C system. The simplest is to install a piezo-buzzer (Radio Shack No. 273-065 or similar) inside the receiver's case and use the system as a pager. There's ample space for the buzzer between the optoisolator and the 3-volt battery (see Fig. 3). Connect the positive terminal of the buzzer to the receiver's blue lead and the negative terminal to the receiver's green lead.

I installed a piezo-buzzer in the prototype unit for this purpose. However, I connected its leads to the circuit by means of a miniature connector so the buzzer can be easily removed when not needed.

The output transistor inside the optoisolator will drive many circuits directly. It will also function as a low-current switch for activating a camera such as Kodak's disk camera. Figure 4 shows how the receiver can drive an external relay. This permits the system to control devices that exceed the switching capability of the optoisolator alone.

To test the immunity of the system in Figs. 1 through 3 to interference from CB units, I tried keying the 40-channel rig in my pickup at the frequencies near that at which the R/C system operates while whistling into the microphone. Even though the receiver was only a few feet away, in no case did false triggering occur. Incidentally, the FCC prohibits using a CB station to whistle for entertainment purposes, but transmit audio tones that last no longer than 15 seconds for the purpose of making contact.

Though the receiver is apparently immune to r-f interference, it is susceptible to electromagnetic-pulse phenomena. For example, a nearby lightning bolt will trigger from one to several quick flashes of the indicator LED. The receiver LED will also flash when an electric space heater switches on and off. Fortunately, this occurs only when the receiver antenna is

Fig. 4. A relay interface for a general purpose radio-control system.

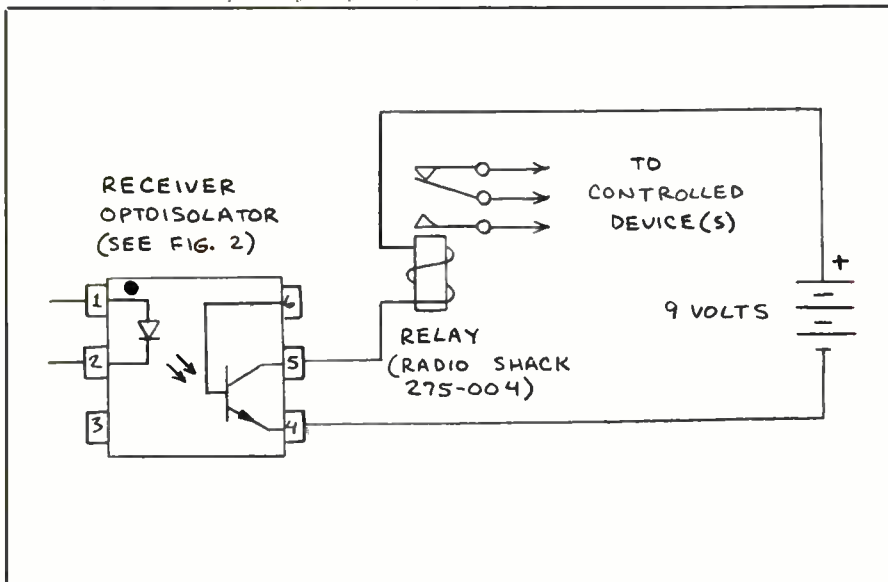

AMAZING SCIENTIFIC and ELECTRONIC DEVICES

LASER DEVICES

- LC5 BURNING CUTTING CO2 LASER \$20.00
- RUB3 RUBY LASER RAY PISTOL 20.00
- LRG3 IR LASER RIFLE/PISTOL 10.00
- LGU3 VISIBLE RED LASER RIFLE 10.00
- LBT1 LIGHT BEAM COMMUNICATOR 10.00
- LHC2 BEGINNER simulated VISIBLE LASER 5.00

SCIENTIFIC & ELECT

- TCL3 SOLID STATE TESLA COIL 35KV 7.00
- BTC3 250 THOUSAND VOLT TESLA COIL 10.00
- BTC5 1.5 MILLION VOLT TESLA COIL 15.00
- GRA1 GRAVITY GENERATOR 10.00
- IOG3 ION RAY FORCE FIELD GUN 10.00
- PTG1 PLASMA TORNADO GENERATOR 10.00

ULTRASONIC ACCOUSTICAL

- PPF1 PHASOR PAIN FIELD GENERATOR 15.00
- PSP3 PHASOR SHOCK WAVE PISTOL 8.00
- IPG5 POCKET PAIN FIELD GENERATOR 8.00
- RAT2 RAT AND PEST ELIMINATOR 7.00
- HT9 HIGH FREQ LISTENING DEVICE 8.00

SECURITY & PROTECTION

- BLS1 BLASTER WAND 10.00
- PPG1 PHASOR PROPERTY GUARD 15.00
- MFT1 MINI VOICE XMTR 2-3 MILE 7.00
- INF1 INFINITY TRANSMITTER 15.00
- STG1 STUN AND PARALYZING GUN 7.00
- SD5 SEE-IN-DARK NIGHT EYE 10.00

WE STOCK ALL PARTS NECESSARY FOR CONSTRUCTION OF THE ABOVE PROJECTS

• CATALOG CONTAINING HUNDREDS MORE OF ALL NEW AMAZING and FASCINATING PLANS EASY TO BUILD KITS AND ASSEMBLED ITEMS \$1.00 CATALOG INCLUDED FREE WITH ANY OF THE ABOVE PROJECT PLANS. SEND CASH, CHECK, MO, VISA, MC TO:

INFORMATION UNLIMITED

P O BOX 716, DEPT. ME3, AMHERST, NH 03031

CIRCLE 62 ON FREE INFORMATION CARD



DESCRAMBLER PARTS

We stock the exact parts and PC Board for Radio Electronic's February Article on building your own Cable TV Descrambler

#701 PARTS PACKAGE \$29.95

Includes all the original resistors, capacitors, diodes, transistors, integrated circuits, coils and IF transformers (BKAN-K552AXX).

#702 PC BOARD \$12.95

Original etched & drilled silk-screened PC Board used in the article.

#704 AC ADAPTOR \$12.95

(14 volts DC @ 285MA)

Both #701 & #702 \$39.00

FREE!! Reprint of Radio Electronics Article on Building Your Own Cable TV Descrambler with any purchase.

Add \$4.00 Postage & Handling

TOLL FREE

1-800-227 8529 (Orders Only)

1-617-339-5372 (Information)

J & W ELECTRONICS, INC.

P.O. Box 800A
Mansfield, MA 02048

CIRCLE 30 ON FREE INFORMATION CARD

within a few feet of the heater. If these sources of false triggering pose a problem, you can connect a timer circuit to the optoisolator that will trigger an output relay only when the received signal exceeds a preset interval. See *Engineer's Mini-Notebook: 555 Timer IC Applications*, published by Radio Shack, 1984, for timer IC design tips.

Caution: Because of the possibility of interference, *never* use an R/C system to control any circuit or system under circumstances that might endanger life or property. For example, an R/C system should never be used to control a life support system. Also, when using an R/C

system, you must abide by the radio service rules and regulations of the FCC. For detailed information about these regulations, write the Federal Communications Commission, Gettysburg, PA 17326.

Going Further

The catalogs available from ACR R/C Hobby Shack and other R/C dealers include abundant information about radio control. Fred Marks has written two of the best books available on the subject. They are *Getting the Most from Radio Control Systems* and *Basics of Radio Control Modeling*, both published by

Kalmbach Publishing Co. (1027 North Seventh St., Milwaukee, WI 53233). They are usually available from hobby shops that specialize in R/C models.

For detailed information on remotely-controlled photography using Kodak's disk camera, see my "Experimenter's Corner" columns in the Nov. and Dec. 1982 and Jan. 1983 issues of *Computers & Electronics*. These three columns describe in great detail the operation of the disk camera and how to modify its shutter switch for remote actuation. Also described are various methods of triggering a disk camera, including a one-shot timer, interval timer, various light triggers and, of course, radio control. The third article describes how to make aerial photographs by flying an R/C disk camera from a kite or helium-filled balloon.

Old Business

In the May 1985 installment of this column, I described an experimental security alarm system in which resistors are connected across ordinary magnet switches. This permits the alarm's controller to determine which sensor has been penetrated. In this column I observed that "I don't know if this method is an original idea, but it works quite well." In response, Sherwood M. Kidder, President of Northern Instruments, sent this interesting letter:

"I really had a surprise when I recently purchased a copy of *Modern Electronics* and saw your article on the security alarm system, because it is quite similar to the one I developed in 1979. My system does provide for some of the shortcomings⁵ that you describe. The resistive link and comparator were described in a patent application, #49807, June 1, 1979 . . . In your article you questioned the originality of the system and I just wanted to let you know that a similar system has been developed."

Incidentally, you can find a detailed explanation of how to design a simple computer-controlled intrusion alarm system based on the resistive burglar alarm concept in *Forrest Mims's Computer Projects*, Osborne/McGraw-Hill, 1985, pp. 227-242. **ME**



CIRCLE 92 ON FREE INFORMATION CARD

Now available to everyone!

Computer Publishing Society
a unit of the Computer System presents

Subscribe now—and become an official member! A subscription to **Computel** brings all of these exciting entitlements for the duration of the membership:

ONE YEAR SUBSCRIPTION: \$14.00
CANADIAN: \$18.00 FOREIGN: \$24.00
(SAMPLE COPY: \$1.00) (BACK ISSUE: \$2.00)

THE ONE YOU'VE ALL BEEN WAITING FOR

Computel
PUBLISHED MONTHLY

- The membership Plus Certificate through honorable looking invitation worth framing, created by the Computer Club to signify membership in the Computer System!
- Hundreds of VHS/LSAI and beta, moderate priced electronic gift items available for your own personal use or for use with the Computer Information Distribution Plan—available for purchase for your own business!
- Group discounts when buying computer systems, supplies, and components with the other members of the Society, from major retailers and factory shut-downs that we are constantly working as they arise!
- The complete price on computer hardware and software purchased through the Society at worldwide outlets!
- A comparison of the computer systems and equipment on the market BEFORE you make an investment through Computel's advisory panel of members whose dedication in your behalf will assist you on where to buy and where to get help!
- A multi-national magazine bulletin board for students, teachers, management personnel, Computer Clubbers, Phone Phreaks and anyone interested in current and future developments in Computers, Electronics, and Communications, making the hobby and the profession in a spontaneous display of equality you want to meet!
- FREE advertising in Computel for members who wish to trade or sell their equipment, leave messages or just want to find out who's going on with other members—we send publish almost anything you submit to us!

INFORMATION NEVER BEFORE PUBLISHED FOR THE PUBLIC!

Learn the secrets of computing!

COMPUTEL—the complete SOURCE for everyone! You can now do the things you've only heard about, right in the privacy of your own home. Indispensable reference for phreaks and hackers. Learn how to get all kinds of computer programs FREE! Get the inside story of big business systems—their quirks and flaws—and remain up to date with vital occurrences within the computer industry. Computel is a publication designed for everyone who has an interest in computers, computer systems, containing a wealth of hard-to-find information that you just won't find elsewhere! Subscribe now, and join the thousands already participating!

You will be in control of your computer with the only publication of its kind written for the user. Discover the secrets and learn the variables of modern computer command control concepts. Experiment with computer and telephone systems, analyze them, learn how they work, what they do . . . and how to get them on work for you! Everything that you heard about is published in Computel and you won't be satisfied until you hear it! VHS, Cassettes, 3.5, 5.25, and 8.0 inch floppy systems are studied. Computers and telephones are the focus! This publication is an absolute must for everyone interested in the Computer System! **ME**

CRUNCH!

THE CAPTAIN IS BACK...with an all new program for everyone!

•Check •Money Order •Postage •Cash	
The History of Computing	\$ 14.95
The History of the Telephone	\$ 16.95
The Phone Phreaks' Guide to Computers	\$ 19.95
Telephone Engineering Course	\$ 24.95
Computer Repair—Do it Yourself and SAVE!	\$ 24.95

ALL 5 REPORTS PLUS A SUBSCRIPTION TO COMPUTEL: \$ 69.00.

Computer Publishing Society

6354 Van Nuys Blvd., 161-CG / Van Nuys, CA 91401-2696

Don't miss out • Subscribe now!

CIRCLE 91 ON FREE INFORMATION CARD

Reworking video games, EPROMs and EPROM burning, more laser printer info, technical literature

By Don Lancaster

We'll start with our usual reminder that this is your column, and you can pick up technical help by using the phone number shown in the "Need Help?" box. Best calling times are 8 AM to 5 PM—*Mountain Standard Time*.

I also have lots of free stuff available for you, including book and product lists, a *Laserwriter* demo pack, printer glossaries, some shaft encoder software, and bunches of other neat stuff. Just call or write to get in on the fun.

Onward and upward . . .

Can Surplus Video Game Boards be Adapted for Home Use?

Well, yes and no. I get an astounding number of helpline calls from people who found some old commercial video game boards and would I please show them a simple way to convert the RGB (red-green-blue) game video output to NTSC (*Never The Same Color*) broadcast television format, preferably via vhf channel 3 or 4. To which I reply: "Uh, why do you suppose the video-game people went to all that RGB trouble in the first place?" The answer, of course, is that they needed images that were much better than the usual broadcast quality. The bottom line is that most video games output far too much information far too fast to do anything but produce a hopeless smear on a stock TV set. Things get even worse if you try vhf entry via the tuner.

For the best possible image, the video-game people use three separate channels for the red, blue, and green color information. Any other color is produced by suitably blending these three colors in various combinations. The red, blue, and green channels are kept separate all the way from the computer memory through to the individual guns on the CRT display.

Some video games will further complicate things by using more dots per scan line and more lines per field than does

broadcast TV. Others may scan the display *sideways* to give a picture that is taller than it is wide. Unusual scanning and formats will cause all sorts of problems on a stock color TV set.

We saw how to get from split sync to composite video and back again in the September 1985 *Hardware Hacker*. Simple circuits like these work well for most personal computer video needs. Something much more elaborate may be required for video-game use. *Motorola* makes a special RGB-to-NTSC converter chip called the *TDA1133*. You might like to check this device out. Sample circuits appear on their data sheet and in their companion ap notes.

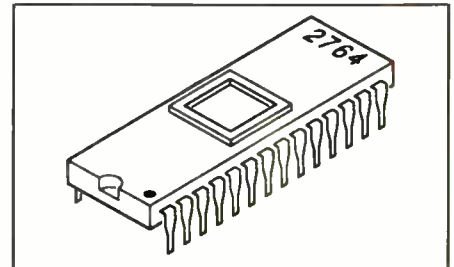

Fig. 1. A typical EPROM.

The best solution for home use of a commercial video game is to actually use an RGB monitor and make direct connections. This method will bypass the response limits of NTSC encoding and de-

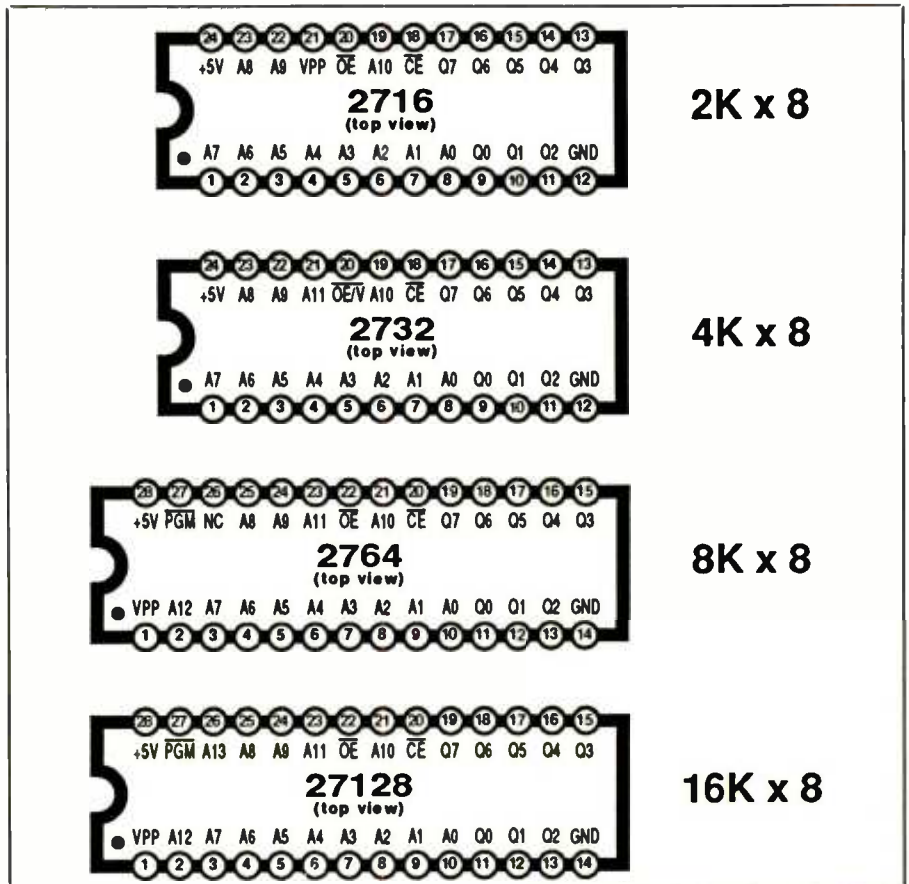

Fig. 2. Here are the pinouts for the four most popular EPROMs.

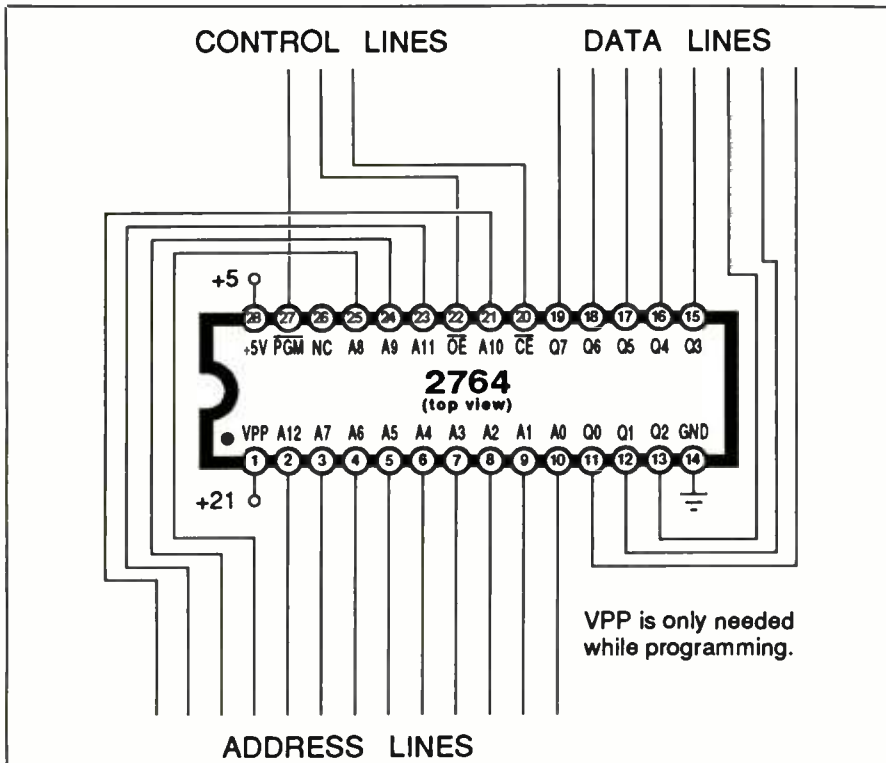

Fig. 3. How to connect a 2764 EPROM.

rial port commands that would not fit inside the original chip.

Figure 1 shows a typical EPROM. The most popular and most used EPROMs are the 2716, 2732, 2764 and 27128. These are available from *Intersil* and *Hitachi*, among others. For sources, use the ads you'll find right here in *Modern Electronics*. The pinouts for these popular chips appear in Fig. 2.

As you can see, the EPROM package has a glass window on top. To erase the EPROM, you direct very strong *short wavelength* ultraviolet light through the window. You can do this with a commercial EPROM eraser or simply by leaving the EPROM out in the sun for a week.

How does an EPROM work?

To understand how *any* memory works, separate all the pins into four groups. These groups are the *power* lines, the *address* lines, the *data* lines, and the *control* lines. Figure 3 gives details for the 2764, which seems to be the most popular EPROM in use today.

The *organization* of an EPROM is decided by the total number of bits available and by how many bits are grabbable at one time when a word is accessed. In the case of the 2764, the "64" stands for 64K, which means that there are a total of 65,536 bits available. All of the storage bits are grouped into 8-bit words. So, the 2764 is organized as 8K × 8, meaning that there are 8192 separate words of 8 bits each. You read or write only one whole word at any instant.

There are only two supply lines needed to read the EPROM, namely +5 Vdc and ground. The +5 volts must be well regulated and thoroughly bypassed. The current drawn by an EPROM will depend on its size and its operating mode, but something around 100 milliamperes is more or less typical. EPROMs using CMOS technology draw much less current, particularly in their standby mode.

A second power supply voltage is needed only while the EPROM is being programmed. This voltage very much depends on both the EPROM manufacturer and the type number, although typical

coding. RGB monitors are readily available and are not all that expensive these days. Chances are you will be *very* disappointed if you try to use a stock color TV receiver instead.

What is an EPROM?

An EPROM is a very popular type of computer memory that you can program yourself. The name stands for *Erasable and Programmable Read-Only Memory*. Once programmed, the EPROM will remember what you taught it. An EPROM is a *nonvolatile* memory, which means that you do not have to keep the power applied to keep the memory alive.

EPROMs are now very large, very cheap, and extremely easy to use. Most personal computers, printers and peripherals use EPROMs for firmware.

Hardware hackers quickly learn to love

EPROMs, since they let you rearrange the scenery to suit yourself. More importantly, even the largest EPROMs are now so cheap that many hackers are now putting two or three times the features into their computers or peripherals than they originally had.

As an example, we saw in the November '85 *Hardware Hacker* how to put a double-size EPROM into the monitor of an Apple IIe. This lets you have both the "old" monitor that is essential to run most older Apple software, plus a "new" monitor that lets you pick up features that include the mini-assembler, interrupts, and such.

Apple just doubled the size of the EPROM in the IIc and now calls it the 3.5 ROM. This expanded memory interfaces with their new 3.5-inch diskettes, has an *Appletalk* interface and a few self-test routines, and also picks up some of the se-

To **STANDBY**, connect the *chip select* (20) to +5 vdc. This will disable and power down the chip.

To **READ**, connect *program* (27) and *VPP* (1) to +5 vdc. Connect the *chip select* (20) and the *output enable* (22) to ground.

To **PROGRAM**, connect the *output enable* (22) and *program* to +5vdc. Connect *chip select* (20) to ground. Next, apply +21 vdc to *VPP* (1). Select the address and input the data. Then bring the *program* (27) line to ground for exactly 50 milliseconds to burn the word you have selected.

Fig. 4. Using the control lines.

values will be +12.5, +21 or +24 volts dc. It is extremely important to use the right programming voltage for your particular EPROM! Fail to do so and you will either lose data or "fry" the chip. Note that an "A" suffix EPROM usually is a low-voltage, nonstandard device.

Data is put into the EPROM once during programming. Since we have 8 bits per word, we'll need eight *data lines*, or one data line for each bit. During actual use, data is *read*, or output, from these data lines to the microcomputer peripheral controlling the EPROM.

The particular word to be programmed or to be read is chosen by a set of *address lines*. Because there are 8192 words in an 8K x 8 EPROM such as the 2764, we need 13 address lines. This happens because the 13th power of two is 8192. These 13 address lines are usually numbered from *A0* through *A12*.

To select a certain address, a binary pattern is put onto the address lines. For instance, to find word decimal 1659, a binary pattern of 0 0110 0111 1011 has to be placed on the EPROM address lines.

Because there are more address lines in a typical microcomputer than there are in a typical EPROM, the high-order address lines on the computer are separately de-

coded to decide when to activate the EPROM.

As an example, the 2764 used for the top half of the Apple IIe monitor sits at the top of the Apple address space from hex \$E000 to hex \$FFFF. Of the 16 Apple address lines, the top three go to an address decoder that activates the EPROM, while the bottom 13 lines go directly to the EPROM.

Finally, we have the three control lines—*chip-enable* (20), the *output-enable* (22) and the *program* (27) lines. These three lines decide what the EPROM will do at any time.

The various combinations of control lines are shown in Fig. 4. To read the EPROM, hold the *chip-enable* and the *output enable* at ground and connect *program* and *Vpp* (1) to +5 volts dc.

To put the EPROM in a standby mode, connect the *chip-enable* to +5 volts dc. This puts the EPROM in a power-down

mode that does not care in what state the other control pins are.

To program the EPROM, first connect the *output-enable* (22) and *program* (27) to +5 V dc. Ground the *chip-enable* (20). Apply the proper programming voltage to *Vpp* (1), which will typically be +21 V dc—*be sure and check*.

Continuing, select an address and input the desired bit pattern on the data lines. To blast the word into the EPROM, bring the *program* (27) pin to ground for exactly 50 milliseconds and then return this pin to +V dc.

Some newer EPROMs have a shorter programming time and some have "intelligent" programming algorithms that let you match the programming pulse width to what is needed. Be sure to consult the individual EPROM data sheets to determine exactly what is called for.

Today's EPROM's are so large that there is no way you could possibly pro-

NAMES AND NUMBERS

Bishop Graphics
5384 Sterling Drive
Westlake, CA 91359
(818) 991-2600

Burr-Brown
Box 11400
Tucson, AZ 85734
(602) 746-1111

Desktop Publishing
Box 5425
Redwood, CA 94063
(415) 364-0108

E-Tech Services
Box 2061
Everett, WA 98203
(206) 872-9004

Hitachi
1800 Bering Drive
San Jose, CA 95112
(408) 292-6404

Hughes Solid State
500 Superior Avenue
Newport, CA 92663
(714) 759-2942

Intel Corporation
3065 Bowers Avenue
Santa Clara, CA 95051
(408) 987-8080

Maxim
510 N. Pastoria
Sunnyvale, CA 94086
(408) 737-7600

Micro Power Systems
3100 Alfred Street
Santa Clara, CA 95054
(408) 727-5350

Mitsubishi Electronics
777 North Pastoria
Sunnyvale, CA 94086
(408) 730-5900

Motorola
Box 20912
Phoenix, AZ 85036
(602) 244-6900

NOAA/NGSDC
325 Broadway
Boulder, CO 80303
(303) 497-3000

Personal Publishing
245 South Parkside
Itaska, IL 60143
(312) 250-8900

Romulus Microcontrol
Box 8669
Rockville, MD 20856
(301) 540-8863

SAMS
4300 West 62nd Street
Indianapolis, IN 46206
(800) 428-SAMS

Silkconix
2201 Laurelwood Road
Santa Clara, CA 95054
(408) 998-8000

Teledyne Semiconductor
1300 Terra Bella Avenue
Mountain View, CA 94039
(415) 968-9241

Texas Instruments
Box 5012
Dallas, TX 75265
(214) 995-3821

Plan To Move? Let Us Know.

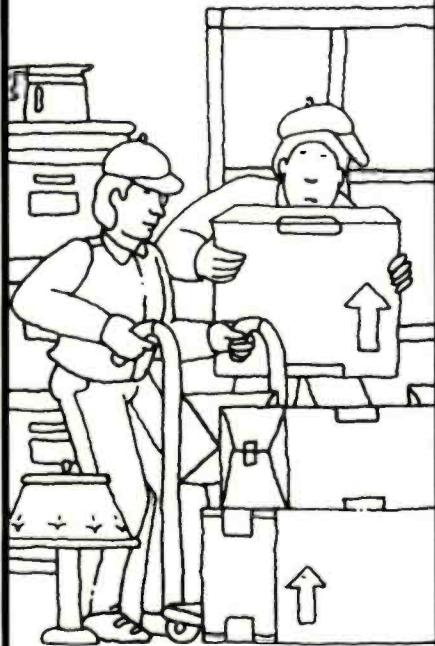

ATTACH LABEL HERE

PLEASE PRINT

NEW ADDRESS HERE

NAME

ADDRESS

CITY

DATE

STATE

ZIP

SUBSCRIBER SERVICE

CHANGE OF ADDRESS

Planning to move? Please let us know six weeks in advance so you won't miss a single issue of MODERN ELECTRONICS

Attach old label and print new address in space provided. Also include your mailing label whenever you write concerning your subscription to insure prompt service on your inquiry

Modern Electronics
76 N. Broadway,
Hicksville, NY 11801

HARDWARE HACKER...

gram one by hand, one byte at a time, without making a fatal error. So, our obvious next question is . . .

How do I Program an EPROM?

There are two reliable ways of programming an EPROM. You can use a service that does this for you, or else you buy your own EPROM programmer and eraser and do the chip burning yourself.

My favorite EPROM programming service is *E-Tech Services*, which charges something like \$14.50 to program a 2764. You usually submit your EPROM code ready to read on an Apple-compatible diskette. An east-coast source for EPROM programming is *Romulus Microcontrol*, but I have not personally checked these people out.

Most local computer clubs either own an EPROM programmer and eraser outright or will have a member who does custom programming for others.

For the many hackers who require only an occasional EPROM to be burned, these programming services are far and away the best way to go. Note that you would have to burn two dozen or more chips to pay for your own EPROM burner and eraser.

On the other hand, your own local EPROM burning service could be a very profitable venture.

You'll find there are two styles of EPROM burners. There's the industrial "stand-alone" type that typically costs \$1000 or more, and the "plug-in" style that fits a slot on an Apple or other personal computer and is often priced anywhere from \$50 to \$250.

What should you look for in an EPROM burner? I would *always* choose the plug-in type because it costs much less and has all of the disk, printer, and communications resources of the controlling computer available to it. I would also make sure the burner could program at least a 27128, and preferably could handle a 27256 or even a 27512.

If the programmer can also handle

EPROM-like devices such as PALs, PLAs, FPLAs and so forth, so much the better. Prices of these new devices are dropping dramatically and have exciting hacker potential.

Should you be stuck with an older EPROM burner that can handle only a 2732, I have some plans available for simple adaptors that let you work up to a 2764 or even a 27128 on it. Write or call for your no-charge copies. And, if you want more info on microcomputer memory in general, check out volume one of my *Micro Cookbook* (SAMS #21828).

Where Can I Find out More About Laser Printers?

Laser printers are fast becoming *the* opportunity of the decade. And, if you think what is here now is rather impressive, the stuff just around the corner is downright scary—spooky even.

To show you where things sit right now, the original of this entire column was written, "drawn," and typeset using plain old *Applewriter* on an Apple IIe. That includes *all* of the text, *all* of the drawings in final form, *all* of the pictorial symbols, and all the detail work such as the initial cap, the end logo, and even that title "racing stripe." For examples of what I generated with a laser printer, see Fig. 1 through 4 (including captions) and the "Names and Addresses" and "Need Help?" boxes.

The big question is how can you tap this opportunity goldmine?

As with any other field, specialty magazines are your first and foremost way of getting current and useful technical information.

There are two brand-new laser printing specialty magazines. One is *Desktop Publishing*, the other is *Personal Publishing*.

As a reminder, I also have a free laser printer demo pack waiting for you if you call or write. Don't pass this one up.

Any New Tech Literature?

Great heaping mountains of it came in

this month. Let's start at the top of the big pile before it collapses . . .

From *Texas Instruments*, volume II of the *TTL Data Book*, along with a *MOS Memory Data Book*, and a separate *Supplement to the MOS Memory Data Book*. These are all first-rate data manuals from a major source. You'll find lots more on those EPROMs in these two MOS memory books.

From *Silconix*, a *Mospower Data Book*, and a hard bound book titled *Mospower Applications*. While this later jewel has a \$25 list price, it is a cut above usual application-note collections. There's lots of info here on power field-effect transistors, switching-mode power supplies, telephone circuits, and more.

From *Maxim* comes an exciting data book on lots of new linear integrated circuits. This one is called *CMOS Data Ac-*

quisition Products. Maxim is both a second source of *Intersil* products as well as the innovator of some really wild linear integrated circuits. One of these forms a complete line-operated power supply using nothing but a 4-pin mini-DIP package, two capacitors and two resistors.

From *Bishop Graphics*, comes *Circuit Drafting and Technical Manual*. Besides all your usual tape and dot stuff, this dude has lots of hints on printed-circuit layout, electronic schematics, mil standards, and so on.

And, somewhat near the bottom of the barrel, a host of "second tier" data books. These include the *Data Acquisition IC Handbook* from *Teledyne* and a full-line catalog from *Micro Power Systems*. There's a *CMOS Databook* from *Hughes*; a *Data Book Supplement* from *Burr Brown* on A/D converters and op

amps, and a pair of books from *Mitsubishi* on very large high-power semiconductors—*Power Module Data Book* and *Power Module Application Book*. All of these are usually free on written request or a phone call.

Finally, remember that the way to end up working hard is to also play hard. For \$3.00 from *NOAA*, get a copy of *Thermal Springs List for the United States*. **ME**

NEED HELP?

Phone or write your *Hardware Hacker* questions directly to:

Don Lancaster
SYNERGETICS
Box 809
Thatcher, AZ, 85552
(602) 428-4073



"An enthralling inside look

...[at] what makes this amazing high-tech industry tick. Highly recommended."
—*Modern Electronics*

"The entire book is a joy to read. Best of all, it is a first-person account by a bonafide pioneer."
—*Creative Computing*

"Full of fascinating stories and adventures."
—Jeff Hecht, author of *Beam Weapons*

"An engaging, fast-paced tour." —*Kirkus Reviews*

Siliconconnections

Coming of Age in the Electronic Era

By FORREST M. MIMS, III

Illus. with photos / \$16.95 at bookstores,
or order direct from Dept. PL.,
1221 Ave. of the Americas, New York 10020.

McGRAW-HILL

CIRCLE 94 ON FREE INFORMATION CARD

Say You Saw It In *Modern Electronics*

QUALITY ETCHED PC BOARDS IN LESS THAN 5 MINUTES.



Convenient economical, high quality production of 12" x 12" panels is obtained using Kepro's Bench-Top Spray Etcher, only \$765. Kepro—the one stop source for all your Prototype and Short Run PCB needs.

kepro

Kepro Circuit Systems, Inc.

Write for full line catalog or call
1-800-325-3878 • 1-314-343-1630 (Missouri)

630 Axminister Drive • Fenton, MO 63026-2992

CIRCLE 32 ON FREE INFORMATION CARD

February 1986 / MODERN ELECTRONICS / 83

Apricot's Computers and Speedup Boards

By Eric Grevstad

I love innovative, elegant designs and I love raw hot-rod speed; I spend a lot of time trying to reconcile the two with a third factor, my gnawing need for miserly economy. With this month's products, I've succeeded.

For stylish design, the Apricot F2 is an MS-DOS machine that looks like modern art and is priced like a K-Mart special. For performance, I've been cruising around the A&W and pulling up next to AT owners at stoplights to test four speedup boards, add-ons that replace the PC's model Intel 8088 to give extra power at much less than an AT's cost.

The British Invasion

What's the best buy in IBM-compatible computing? I'd pick the Tandy 1000, with the Leading Eagle Model D as a possible rival. The best buy in MS-DOS computing, however, is Britain's Apricot F1—an 8086-based unit with 512K memory, 720K of floppy disk storage, parallel and serial ports, monochrome and color monitor interfaces, and GEM Desktop, GEM Write, GEM Paint, and communications software, all for \$995. It's a remarkable value, but you must be individualist enough to appreciate it. Apricots aren't PC-compatible, and that 720K of disk space consists not of two 5.25" drives but one 3.5" microfloppy.

Before you go off in search of clones, let me say that the F1's only software disadvantage is that its programs aren't available by cheap mail-order as 5.25" ones are. If you stick to store dealers, you'll find hundreds of Apricot titles, led by the Lotus, Microsoft, Ashton-Tate, and Software Publishing (PFS) libraries. And the hard-shelled disks are a pleasure to use—fast, quiet, and roomy enough to make you wish IBM would hurry up and change to them as everyone expects will happen someday.

In most ways, the Apricot is a pleasure. I tested the F2 (\$1,495), which has a second disk drive for 1.4 megabytes of mass storage; the F10 (\$1,995) has one micro-



Apricot F2 features 8086 CPU, 512K of RAM, two 720K floppy-disk drives serial and parallel ports, color and monochrome interfaces and GEM software.

floppy and a 10-megabyte hard disk. Any one of the three, used with Apricot's sharp 10" tilt-and-swivel color monitor (\$495), is the best-looking computer a desk could want, combining high-tech sex appeal with an amazingly trim 8" by 17" system footprint.

WordStar seemed a little sluggish, but the Apricot was a perky performer with my test copies of dBase II and 1-2-3. It's not truly a 512K machine, since it loads both its BIOS (basic input/output system) and MS-DOS into RAM, but the 408K left over should be adequate.

Only beginners, as I said in the November issue, will want to sacrifice another 226K for graphics drivers and the easy but uninspiring GEM Desktop, though GEM Paint is an enjoyable doodler and GEM Write a simple mouse-driven editor. (As that issue hit the stands, predicting "No one will call GEM Desktop innovative or original," Apple forced Digital Research to modify its icon "look." Apricot says it will bundle the revised GEMware.)

What's bad about the Apricot? Well, while I grew to like the cordless mouse (it resembles a *Star Trek* gadget, sitting on your desk while you twiddle its top like an arcade trackball), I hate infrared keyboards—a dumb gimmick for PCjr and a dumb gimmick here, with a synthesized "signal received" keyclick (even if you are using a fiber-optic connector) that drives you mad.

The keyboard has appealing features, such as a battery-powered time/date clock and calculator usable within a program, and a good typing response. But its design is nothing like IBM's; while Apricot-version programs can take advantage of its function-key layout and special keys, I can't forgive the tiny Control key where Alt belongs and Caps Lock where Control ought to be. It makes WordStar even worse than it was already.

If the F1, F2 and F10 had a BIOS ROM chip and a socket for a PC-style keyboard, I'd be ecstatic. As is, the British trio are finely engineered, attractive al-

ternative for those willing to be a little offbeat in return for a bargain.

Scoop: The Next Apricot

Apricot is working to overcome Yanks' objections. For this column's Election Day deadline, a company official graciously leaked word a month before release of the Xen (pronounced Zen), a system using an 80286 CPU running at 7.5 MHz with no wait states. Besides claiming 60-percent more speed than IBM's bulky PC AT, the Xen has a trim profile (its power supply sits on the floor) and combines one or two 720K micro-floppies with a 20-MB hard disk and optional tape backup.

That means Apricot is still betting on 3.5" drives (though an external 5.25" unit will be available), but there are optimistic signs: the Xen will come with Microsoft Windows and have an AT- instead of Apricot-style keyboard. Hinted a spokesperson, "I think that shows the direction in which we'll be heading." If that's true—if the Xen adds more mainstream compatibility to the family tradition of sleek designs and low prices—Apricot might become my favorite computer company.

Blazing Boards

Apricot and other firms, in fact, reflect an irony: while we all owe IBM thanks for setting defacto standards, there's almost never a compelling reason to buy IBM products (unless you're hamstrung by corporate dictates). If you want AT performance, for example, you can buy several machines that are cheaper, faster, or both. Better yet, if you don't need Xenix support or weird 1.2-megabyte floppy disks, you can save thousands of dollars by accelerating your existing PC or XT.

Speedup boards, the new CPUs that do this, fall into two categories. Some simply plug into an expansion slot, requiring special software to switch between your old 8088 and another, faster computer. Others, harder to install but transparent once installed, involve pulling the 8088 and running a cable between its socket and the board with the new processor.

Testing two of each, I found the pairs divided another way: some boards double your PC's speed, while some more than quadruple it.

Taking the four permutations one at a time, the plug-in, double-speed board is the category pioneer, Orchid Technology's PCTurbo 186 (\$945 with 256K). Once you've plugged in the PCTurbo and reclosed your IBM's case, you can use your old CPU and memory as if nothing had changed—until you load the speedup software by typing TURBO, booting the board's 8-MHz 80186, switching to its own memory, and leaving the 8088 to handle input/output chores.

Orchid's is no longer the fastest board available, but it's still very quick—scrolling text in a flash, cutting a Lotus 1-2-3 recalculation in half (see table). Its software supplies wonderful disk caching and system-customizing options (up to four RAM disks apiece for the PC and PCTurbo!). Unfortunately, it balked at some copy-protected programs, refusing to run Symphony, Framework, and dBase III from floppies, though an Orchid technician told me hard disk installations are less timing-sensitive. If that fails, there's always the GOPC command to return processing to the 8088.

Another "slow" speedup is Quadram's

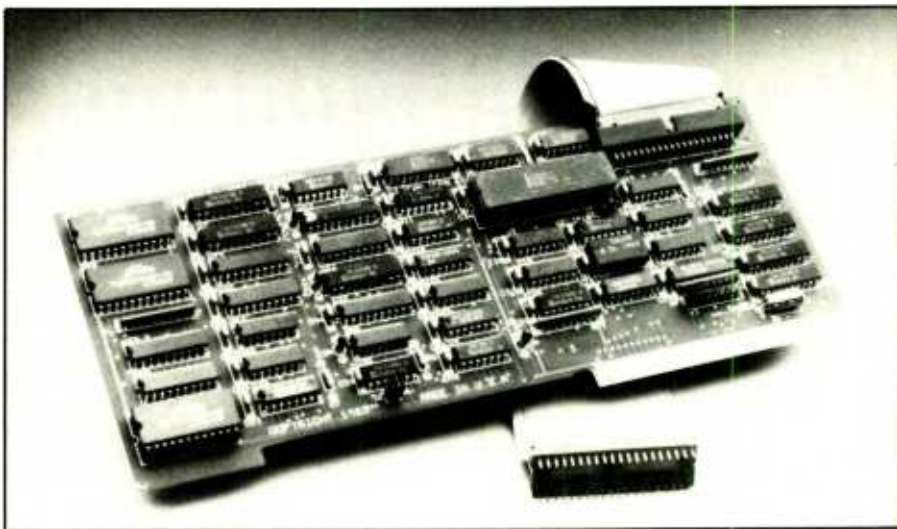

Quadram Corp.'s 8086 Quadprint board (above) merely doubles a PC's speed. Applied Reasoning Corp.'s 80286 PC-elevA Tor board (below) quadruples it.

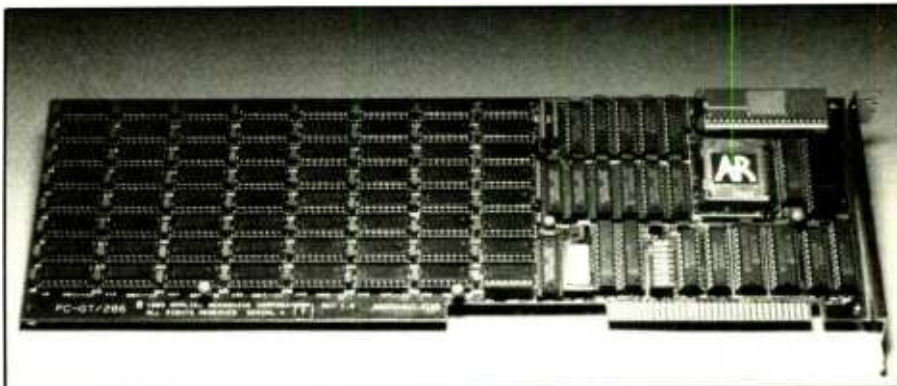

PC Speedup Board Benchmarks

	Norton		WordStar	Lotus 1-2-3	GEM Draw
	SI	Type			
IBM PC	1.0	34.54	1:58.75	6.42	8.33
IBM AT	5.7	39.68	43.48	2.27	2.79
Quadram QuadSprint	2.0	28.78	51.78	3.87	4.62
Orchid PCturbo 186	3.5	9.55	1:01.49	3.02	4.23
ARC PC-elevATor	9.2	7.23	26.02	1.59	2.05
STD PC286	9.2	24.79	26.72	1.40	1.77

Notes: All boards tested with a two-disk, 320K IBM PC with color monitor; all tests except Norton average of multiple times in seconds. Norton SI (Norton Utilities System Information) performance index relative to PC. Type: DOS Type command to scroll a long text file on screen. WordStar: Search and replace with Esc key pressed for maximum off-screen spreadsheet. GEM Draw: Time to redraw zoomed or full-sized image of graphics picture.

QuadSprint, a simpler board with an 8086 chip connected by cable to the 8088 socket. Despite a faster 10-MHz clock rate, it proved somewhat slower than the Orchid in use as well as installation (though, if you don't panic during the lobotomy procedure of prying out the 8088, it's a matter of 10 minutes' work compared to five).

On the other hand, the QuadSprint is the most economical speedup (\$645). It uses your PC's existing memory instead of obsoleting your investment. It's almost as fast as the Pcturbo, and a big improvement on the plain PC. And it ran every program I tried.

So much for the double-speed boards; what about the quadruple-speeders?

Both pack the power of an AT-beating 8-MHz 80286 (and offer terrifying 10-MHz models); neither ran my protected Framework and dBase III disks. Neither seemed 100-percent debugged. But both left me cackling maniacally, scorching through search-and-replaces with a PC that seemed to hover an inch above the desk.

If you like Orchid's approach, you'll like Applied Reasoning Corp.'s PC-elevATor (\$1,495 with 512K, \$1,695 with 1 MB). Like the Pcturbo, it plugs in easily and leaves your 8088 system alone until you run an UP program or go back DOWN. A 330-byte program, LEVEL, helpfully says "You are upstairs" or "You are downstairs," as if you couldn't

tell from text scrolling at warp speed or screens redrawing with a sort of violent shimmer.

By contrast, Seattle Telecom & Data's PC286 board evicts your 8088, uses only its own memory, and costs more (\$2,695, though that includes the 80287 math chip that's a \$400 option from ARC). But it's a gorgeous hunk of board, bristling with heat-sink fins and slots for expansion boards of its own, memory upgrade wafers (\$600 per 512K) for up to 1.5 megabytes on top of the standard 640K.

Active as soon as your turn on your computer, it ran Symphony (unlike the PC-elevATor) and displayed smoother screen handling—sluggish screen handling, in fact, waiting on the PC's slow BIOS and handling BASIC at half the unmodified speed. With applications and number-crunching benchmarks, the PC286 was similarly tremendous.

Of the two, I'd pick the PC-elevATor for its moderate cost and dual-mode operation, which not only gives a fallback position (if a program fails, you can run it on the 8088) but lets ARC add improvements by updating its BIOS software. If you can only afford one-tenth instead of one-quarter the price of an AT, or don't need to move mountains of spreadsheet or do computer-aided design work, the QuadSprint is a likable, low-cost helper.

Order Back Issues of



THE MAGAZINE FOR ELECTRONICS & COMPUTER ENTHUSIASTS

BACK ISSUE ORDER FORM

Please send me the following issues of *Modern Electronics* @ \$2.50 each:

Month(s) & Year(s): _____

Number ordered @ \$2.50 each: _____ Total Payment Enclosed: _____
(Check or M.O. only.)

NAME: _____

COMPANY (Optional): _____

STREET ADDRESS: _____

CITY: _____ STATE: _____ ZIP: _____

Names and Addresses

Apricot Inc.
47173 Benicia St.
Fremont, CA 94538
415-659-8500

Orchid Technology Inc.
47790 Westinghouse Dr.
Fremont, CA 04539
415-490-8586

Quadram Corp.
4355 International Blvd.
Norcross, GA 30093
404-923-6666

Applied Reasoning Corp.
765 Concord Ave.
Cambridge, MA 02138
617-492-0700

Seattle Telecom & Data Inc.
2637 151 Place N.E.
Redmond, WA 98052
206-883-8440

By Glenn Hauser

You can't miss "The National Radio of Texas," KCBI, if you're driving along U.S. 380 east of Denton, west of Prosper. In a pasture next to the road is a small metal building next to two strange-looking antennas. They are home-made corner reflectors, consisting of a relatively short and stocky vertical radiating element sticking up from the ground (the feed lines are buried) at the apex of a right-angled network of reflecting wires extending much higher. The one aimed northeast was in use, while the duplicate toward the southeast was ready to fire up as soon as management was prepared with funding and programming for an evening service to Latin America. We shouldn't say "fire up," since all that r-f energy has proved capable of setting the grass afire by heating stray pieces of metal on the ground, fusing the dirt around it red-hot. Most shortwave stations use entirely different antenna designs, curtain arrays, rhombics or log-periodics.

We knew it was KCBI since their signal was blasting into our car short wave radio. There were no gates, keep-out signs, and no identification expect for a van with station insignia, so we dropped in for a visit. Although identified with Dallas, dozens of miles away, KCBI programming tapes recorded in Dallas are played right here, a few feet from the converted mediumwave 50-kilowatt transmitter. Most are on cassette, but there's a reel machine for Radio Earth on Sunday afternoons. The live "Today in Dallas" call-in at noon (CT) Mon.-Fri. is relayed directly off their 89.3-MHz FM station, and the newscasts which follows comes via the FM subcarrier.

Chief Engineer Dave Briggs is quite proud of his equipment, especially his innovative harmonic trap design. Refining the harmonic suppression was a major reason for the long delay in getting on the air a year ago. There is room for more antennas; one will serve Mexico in cooperation with HCJB's station in McAllen, Texas, KVMV, which was reported some time ago to be interested in shortwave;

and Briggs hopes to put up a high-power antenna eventually for other clients on this land which is leased from him.

We appreciate the cordial reception transmitter engineer Tom Buxton gave us. He's also responsible for continuity, switching announcements and tapes. Several times he had to hustle to recycle the transmitter, which suddenly dropped off the air, so there were still some bugs in it. Although KCBI has stuck to frequencies in the 25-meter band, the equipment is capable of operating on all bands from 6 through 21 MHz.

The "coming" station is still NDXE, Opelika, Alabama. Al Quaglieri has interviewed Dickson Norman about his plans and problems. He blames the healthy Voice of America budget for a shortage of transmitter production at U.S. manufacturers Continental and Harris, and was hoping instead to get one delivered early in 1986 from France's Thomson-CSF. NDXE was still only a cleared piece of land with some site improvements, but no towers or antennas either. Norman has a 25-year plan to "conquer the world" by "superwave" radio with a power upgrade to 500 kW, a digital stereo satellite feed to cable systems, and the mass-manufacture of a \$50 all-wave synchronous-sideband stereo receiver. The antenna will be a steerable log-periodic vee, unique, he claims, among North American broadcasters. Also planned is a backscatter ionospheric measurement system, to enable pin-pointing antenna position for maximum target area coverage (a technique already used to great advantage by Radio Moscow). Furthermore, Norman plans to use a Kahn Universal AM Stereo Generator, for concert-hall fidelity with no platform motion.

A spring 1986 airdate is now the earliest possible; a tentative schedule has been put together for bands to be used, but not yet specific frequencies: 1400-1800 UTC to Europe on 17 and 21 MHz, to North America on 15; 1800-2300 to North America on 15; 2300-0900 to South America on 9 and 11; 0000-0300 to Europe on 9 and 11; 0900-1200 to the Pacific on 6 MHz.

FCC Threatens Pirates. The Federal Communications Commission monitoring station in Grand Island, Nebraska, has issued a notice that it has busted several pirate broadcasters, and has located many others near the following cities, which will meet the same fate if they don't voluntarily quit: Richmond, Charlottesville and Staunton, Virginia; Youngstown, Ohio; Miami and Orlando, Florida; Minneapolis, Minnesota; Washington, DC; Louisville, Kentucky; Waterbury, Connecticut; Newark, Delaware; Grand Rapids and Lansing, Michigan; San Francisco, California; Arkansas City, Kansas; Fort Smith, Arkansas.

Ham Nets. If you know exactly where and when to tune, you can eavesdrop or participate, as the case may be, in discussions which may coincide with your special interests. Check an hour earlier or later in case there's been confusion due to standard vs. daylight time. A World Peace Net, for the exchange of ideas and information about peace movements in different countries, meets Saturdays at 2355 UTC on 14250. The Halo Missionary Net, among people who are involved in missionary broadcasting, occurs Sundays at 1930 on 21390.

Project 137.5 Would you like to do some radio sleuthing and help solve a mystery? If you tune to 137.5 MHz and monitor for several days you will probably hear several satellites passing in rather closely spaced groups every 12 hours. In eastern U.S., the times have been running around 0000 and 1200 UTC; the times of satellite passes are, of course, different in other parts of the world. There seems to be a maverick satellite operating on this frequency that has been most difficult to identify. To make matters worse, it appears that the downlink transmitter is being turned on and off at unexpected times. Who put the satellite up and what is its purpose? The International Satellite Society would really love to know. Report forms and project explanation sheets are available for a SASE to ISS, Project 137.5, Box 670, Oxford, OH 45056, according to Victor G. Blackwell, Director.

DX Listening Digest is a new publica-

tion which attempts to put together all the significant DX news of the month, primarily but not limited to shortwave broadcast, drawn from a wide variety of published and broadcast sources. And half of each issue is devoted to *Enjoying Radio*, edited by David Newkirk, a unique forum bridging the gap between ham and SWL, technician and novice, equipment and philosophy. Samples are \$1, subscriptions \$17, from Glenn Hauser, Box 490756, Fort Lauderdale, FL 33349.

Now our summary of shortwave station news from around the world:

Listening Reports

Abu Dhabi. The new 500-kW transmitters of Voice of the UAF are currently registered tentatively: 5960 21-22, 6155 20-22, 6185 20-21, 7145 16-20, 7215 16-20, 7225 03-07, 9595 16-18, 9630 18-20, 9640 11-13, 9655 18-20, 11715 12-14, 11815 14-16, 11860 14-16, 11890 12-16, 11915 16-18, 15115 12-16, 15230 12-14, 15275 12-14, 15330 12-14, 17820 10-12 (via Bob Padula, Australian DX News)

Alaska. The tentative winter schedule for KNLS, Anchor Point: 0630-0930 in English due west on 6035, 0930-1200 6025, 1200-1300 6030, 1330-1500 6145; 1500-2030 in English and Russian due north on 7355 (via Harold Sellers, DX Ontario)

Australia. Keith Glover, whose warm and friendly voice many long-time shortwave listeners consider synonymous with Australia, retired on Oct. 26. Radio Australia won't be the same without him, and we wish him the very best.

Austria. Radio Austria International's schedule through March for the Western Hemisphere: to South America, 22-02 on 11660, 22-24 on 9760; eastern South America 00-02 on 9760; Central America 02-04 on 9580, 11660; North America 01-05 on 6000; western North America 05-07 on 6155; eastern North America 12-13 on 15320. Programs are in German, Spanish and English.

Bhutan. Two Indian DXers visiting Radio NYAB, Sudipto Ghose and Prodyut Banerjee, report in Asian DX Review that we may not have to wait until the end of 1987 for the installation of an Indian 50 kW transmitter. An interim 5 kW shortwave transmitter was to go on the air by the end of 1985; it will later become the standby. Frequencies vary widely; nominally 7040 and 3395, but on one occasion actually on 6788 and 3320 instead.

Cameroon. The National Radio, Yaounde, has escaped heavy interference on 9745 kHz by moving far out of band to 9355, well heard for several hours before sign-off at 2400, including news in English at 2100, and classical music on Sundays after 2300.

Costa Rica. A new high-powered shortwave station was imminent at presstime, Radio Lira Internacional, part of Adventist World Radio. Christian Zettl visited the existing MW station on 1540 kHz in Alajuela; he learned that the initial shortwave schedule would be 09-13 and 22-03 on the 49 and 25 meter bands, partly in English.

Chile. A fellow DX listener has volunteered his service to provide QSLs for two Chilean stations which would otherwise not reply. Send reception reports for Radio Nacional and Radio Agricultura directly to Carlos Toledo Verdugo, Casilla 166, San Fernando, VI Region, Chile, enclosing 2 IRCs or \$1 for return postage (via Don Moore).

El Salvador. It is definitely the location of the Nicaraguan clandestine Radio Monimbo. In DX South Florida, Bob Wilkner reports that long-range direction-finding (presumably FCC) has put it at 13-29 North, 89-44 West, on the coast near La Libertad, not far from the Guatemalan border. The frequency is slightly below 6230 kHz.

Guam. Although opposed by ham radio interests, KTWR has been granted permission to use the 7-MHz band, just like any other Pacific broadcaster, even though it's under U.S. jurisdiction. The tentative D85 schedule shows 7105 at 0445-1200, 7115 at 1145-1400, 7165 at 1045-1315, and 7200 at 1145-1430 (via Bob Padula, ADXN).

Guatemala. The mystery generic music "Nat King Cole" station, testing for months on 9960, has turned into Radio Caiman, another Cuban clandestine. The initial schedule was for an hour to a sesquihour at 7 am and 8 pm Cuban time, except Sundays 9 am and 7 pm. During the winter, that converts to 1200, 0100, 1400 and 0000 UTC. The frequency is announced, but never the station's schedule, sponsor or location. However, documents from the Cuban American National Foundation have been quoted, and Bob Wilkner of DX South Florida got the FCC to triangulate it to a point in Guatemala. Besides the usual anti-communist news and commentary, there's a "Hit Parade," announced in Spanish by a woman who gives English names and titles without accent. "Caiman" means alligator.

Israel. Though Israel Radio's winter schedule was not available at presstime, it should resemble the fall schedule. English was at 0500-0515 on 9009, 9435, 9815, 11655;

1100-1130 on 17630, 15560, 15425, 11605; 1800-1815 on 13720, 11585, 9920; 2000-2030 on 11655, 11605, 9435, 7410; 2230-2300 on 12025, 11655, 11605, 9435, 7410; 0000-0030 and 0100-0125 on 9815, 9435, 7410; and 0200-0225 on 9435, 7410, 5900.

Korea, North. Current registrations show not only the usual Pyongyang site for external services, but also 100 kW at Kanggye on 5955 and 6100, 24 hours, and 100 to 400 kW at Kujang (Bob Padula, ADXN).

Liberia. Though the host for a Voice of America relay, and a missionary station, ELWA, this country lacks its own external broadcasting service. The head of state, Doctor (formerly Sergeant) Samuel Doe, decreed a novel way to fund it—employers and government services, public corporations and the private sector were to contribute 50% of their August salaries towards the project, while citizens and residents in rural areas were to contribute \$10 per hut. So reported ELWA, via FBIS and Robert Horvitz in Review of International Broadcasting.

Libya. Horvitz also heard Radio Jamahiriyyah announce a new listener-participation program, "A Chat Worldwide," inviting people to send in tapes introducing themselves, and their hobbies, suggestions, greeting friends, dedicating songs. Cassettes should be sent to the African Service of Radio Jamahiriyyah, P.O. Box 333, Tripoli, Socialist Peoples Libyan Arab Jamahiriyyah. The broadcast is somewhere around 1900 on 15450.

Mexico. While ham radio provides a valuable communications service following natural disasters, such as the September earthquakes, it's not necessarily the only means, as media publicity would lead you to believe. We found that Radio Mexico Internacional survived the quakes and immediately went into full coverage of the disaster, including "we're OK" messages to relatives abroad, on 9705, 11770 and 15430 kHz up to 24 hours a day. And XEWW was doing it, too, on 6165 and 9515. Earthquake-conscious KGEI, San Francisco, also handled personal messages in the other direction on 9615.

A few weeks later in Oklahoma, we found the strongest Mexican on 120 meters was not Radio Huayacocotla, 2390 kHz, but Radio Juvenil, Piedras Negras, 2480—a second harmonic, but loud and clear during darkness. The correct callsign is XEVM.

New Zealand. Here's the current (summer) schedule for Radio New Zealand: 1725-2005 on 11780 and 15150; 2255-0045 and 0355-0630 (Saturdays also 0045-0355) on 17705, 15150; 0855-1115 on 9600 and 11780 (via Don Cook, DX Australia).

CABLE-TV

**WE'LL MATCH OR BEAT ANYONE'S
ADVERTISED RETAIL OR WHOLESALE PRICES!**

BONANZA!

Oman. A new site on the southern coast near Yemen has been registered, at Thumrait with two 100-kW transmitters: 5955 at 20-24, 7120 at 04-06, 9510 at 04-08 & 18-20, 9605 at 16-20, 11715 at 14-18, 11820 at 06-16, and 15130 at 08-14 (Bob Padula, ADXN).

Saudi Arabia. Following up our November item about jamming, Lamont Jensen points out that the seven 2-megawatt and three 1-megawatt Continental transmitters installed in the Kingdom since 1976 are all composed of two separate transmitters run through a combining network. They are separable, so the regular program could be carried at half-power (still a hefty signal) freeing up an equal number of 1-megawatt and 500-kilowatt transmitters for jamming, needing only a proper antenna.

South Africa. For those who would like to hear how the South African government reports events in this troubled country, here is the current tentative schedule for broadcasts in English: 0300-0426 on 9585, 7270, 5980, 4990 and 3230; 0630-0730 on 11900, 9585, 7270, 5980; 1100-1156 on 17780, 15220, 11900; 1300-1556 on 17780, 15220, 7270; 2100-2156 on 11900, 9585, 7270; and 0200-0256 on 9615, 6010, 5980. Only the last is intended for North America. Also try the SABC domestic service on 4835 around 0400.

U.S.A. "World of Radio" is now scheduled on WRNO: UTC Sats. 0400-0430 on 6185, UTC Suns. 0030-0100 on 7355, and Suns. 1400-1430 on 9715. Those who listen every week will be kept well-informed on radio developments, especially shortwave.

With enough receiver sensitivity, and a sufficiently low noise level, any location in the U.S. is likely to have a selection of "regular" harmonics audible from mediumwave broadcast stations in the region during darkness, and often peaking around sunrise and sunset. In Oklahoma in October, we were treated to these, in addition to the Mexican: KCRX, 2860, Roswell NM; KZNC, 2680, Hot Springs AR; KZIA, 3160, Albuquerque NM; KNEI, 2980, Brady TX; KWSH, 2520, Wewoka OK.

Yugoslavia. Aside from the 500-kilowatt transmitters being installed at Bijeljina, there are new 10-kW registrations for Zagreb on 6150 and 7160 at 0430-0600, 1400-1430, 1800-2200 and certain days also at 1430-1800 (Bob Padula, ADXN).

ME



Please mention you saw it in Modern Electronics when purchasing advertised products.

ITEM	SINGLE UNIT PRICE	DEALER 10-UNIT PRICE
RCA 36 CHANNEL CONVERTER (CH. 3 OUTPUT ONLY)	29.95	18.00 ea.
PIONEER WIRELESS CONVERTER (OUR BEST BUY)	88.95	72.00 ea.
LCC-58 WIRELESS CONVERTER	92.95	76.00 ea.
JERROLD 450 WIRELESS CONVERTER (CH. 3 OUTPUT ONLY)	105.95	90.00 ea.
SB ADD-ON UNIT	109.95	58.00 ea.
BRAND NEW — TRIMODE UNIT FOR JERROLD	<i>Call for specifics</i>	
MINICODE (N-12)	109.95	58.00 ea.
MINICODE (N-12) VARISYNC	119.95	62.00 ea.
MINICODE VARISYNC W/AUTO ON-OFF	179.95	115.00 ea.
M-35 B (CH. 3 OUTPUT ONLY)	139.95	70.00 ea.
M-35 B W/AUTO ON-OFF (CALL FOR AVAILABILITY)	199.95	125.00 ea.
MLD-1200-3 (CALL IF CH. 2 OUTPUT)	109.95	58.00 ea.
INTERFERENCE FILTERS — CH. 3	24.95	14.00 ea.
JERROLD 400 OR 450 REMOTE CONTROLLER	29.95	18.00 ea.
ZENITH SSAVI CABLE READY (DEALER PRICE BASED ON 5 UNITS)	225.00	185.00 ea.
SPECIFY CHANNEL 2 or 3 OUTPUT <i>Other products available — Please Call</i>		

Quantity	Item	Output Channel	Price Each	TOTAL PRICE
			SUBTOTAL	
			Shipping Add	\$3.00 per unit
			COD & Credit Cards — Add 5%	
			TOTAL	

California Penal Code #593-D forbids us from shipping any cable descrambling unit to anyone residing in the state of California. Prices subject to change without notice.

PLEASE PRINT

Name _____
 Address _____ City _____
 State _____ Zip _____ Phone Number (____) _____
 Cashier's Check Money Order COD Visa Mastercard
 Acct # _____ Exp. Date _____
 Signature _____

FOR OUR RECORDS:

DECLARATION OF AUTHORIZED USE — I, the undersigned, do hereby declare under penalty of perjury that all products purchased, now and in the future, will only be used on cable TV systems with proper authorization from local officials or cable company officials in accordance with all applicable federal and state laws.

Date: _____ Signed: _____

Pacific Cable Company, Inc.

7325 1/2 RESEDA BLVD., DEPT. M • RESEDA, CA 91335
 (818) 716-5914 • No Collect Calls • (818) 716-5140

IMPORTANT: WHEN CALLING FOR INFORMATION
 Please have the make and model # of the equipment used in your area. Thank You

Spelling Counts

By Art Salsberg

Some years ago, I complained to my son's English teacher about the grade he gave him on an essay test. It was an *A!*. I did think that the paper he wrote was thoughtful, nicely organized, and written well. But there were so many spelling errors, none noted by the teacher, that I was compelled to criticize his grading and teaching methods.

"Spelling doesn't count," he said. "Everyone eventually learns how to spell correctly. It's like one day he no longer wets his pants, with or without guidance."

Regrettably, this is untrue, which is why so many young people nowadays are poor spellers. Which is one reason why computer spelling checkers are so popular. Other reasons are that everyone makes typing mistakes and proofreading one's own work is a grueling job.

Much of my personal experience with computer spelling checkers is with WordStar's overlay option, SpellStar. I found it to be an interesting wordsmith aid, but its limited number of dictionary words—about 20,000—is bothersome. As a result, the program pegs too many words as being questionable, requiring me to spend much time keying in an "Ignore" code letter. Nor do I like to spend time adding many common words to the dictionary, except for tech terms.

There are better "spellers" around now, I know. The one I'm writing about is proof of that—*Webster's New World Spelling Checker*. It's based on the popular *Webster's New World Dictionary* and *Webster's New World Misspeller's Dictionary*.

Webster's New World Spelling Checker by Simon & Schuster Computer Software Division./For IBM PC/XT/AT/jr with 128K min. memory and Apple IIc/IIe/Plus with 64K min. memory and 80-column capability./Single DSDD disk./\$59.95, IBM; \$49.95, Apple.

I examined this spelling checker with a feeling of great optimism because it was claimed that it checks over 110,000 words. (Small paperback dictionaries

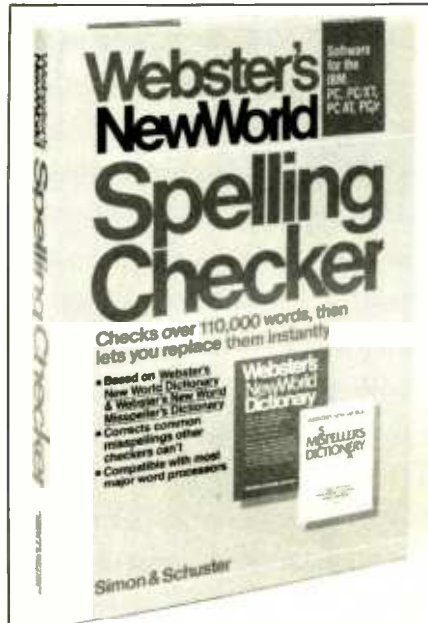

start at about 40,000 words, which is considered to be a bare minimum number, while the better paperbacks contain upwards of 70,000 words.)

Following very clear instructions in the accompanying manual, which includes fine screen displays, I toured the demonstration part of the disk. The interactive demo was excellent and the program was easy to handle.

A bevy of operating options are given in the program's "Main Configuration Menu." The spelling checker is compatible with a host of word processors. For IBM, the choice given includes Bank Street Writer, Perfect Writer, pfs:Write, Textra, Volkswriter, WordStar and XyWrite, among them, as well as an ASCII text file. For Apple computers, there is Apple Writer II, Bank Street Writer, PIE:Writer, and others, as well as ASCII text files. Additionally, if your word processor does not appear on the list, there are detailed instructions on how to perform a custom installation.

Among other configuration settings are selecting the scan level and choosing to create a special auxiliary dictionary on the document disk. (An 1100-word auxiliary dictionary that can be expanded to

2000 is on the program disk.) There's a choice of four scan levels. These are the strategies that the program uses to provide suggestions on alternative words to replace the ones being questioned. With "manual," there are no alternatives issued. "Quick Scan" searches in the alphabetical vicinity of questionable words (400 to 600 words). "Automatic Scan" (500 to 2000 words) provides a Quick Scan first, then, if no alternatives are found, searches further on the basis of your past recorded history of making spelling mistakes. If you typically make a lot of spelling mistakes or typing errors, or use a lot of difficult words, then the "Full Scan" (2000 to 3000 words) might be your best choice. This mode searches for transposition errors usually caused by typing mistakes as well as phonetic substitution. (Pressing F5 on an IBM PC when in the Automatic Scan mode will also put you into Full Scan.)

The display is broken up into five sections or windows. Across the top is information on what's being worked on: which file and disk drive are being used, and what part of the program is active, such as previewing, a selected scan level, or the configuration menu. A large window below is for listing of words that have questionable spelling according to the software utility. The user is given an opportunity to toggle the Return or Enter key to indicate if the word is OK or if it is both OK and should be added to an auxiliary dictionary. "Preview" can be bypassed if one wishes to do so, moving directly into correcting or okaying these words as they're shown used in the word processor's text. But I feel that going through the words listed substantially reduces time expended in the next step.

This space is also called the "Context" window when it's used in the subsequent step to display nine lines of text that incorporate one or more words that might be incorrectly spelled. The current questionable word is highlighted, jumping to the next questionable word automatically when the previous one is acted upon. A small window below it, the "Prompt" window, displays the current word highlighted within the nine lines of copy.

```

Webster's New World Spelling Checker          b:spell          Previewing
-----
? incompatible          ? pfs              ? xt
? continuously          ? spellster        ? xywrite
? dsdd                  ? spellster.
? iic                   ? textra
? iie                   ? vhs
? jr                    ? volkswriter
? 1100-word             ? wordprocessor
? occurrence            ? wordsmith
? pcs                   ? wordstar

Select words using the arrow keys.

Previewing Instructions:

Press Enter to change the symbol in front of any of the
above words. The symbols tell Webster's the following:
- This word is ok. Don't stop during the edit scan.
+ This word is ok. Add it to the auxiliary dictionary.
? This word is NOT ok. Stop during editing, as usual.
Press Esc when you are ready to edit your document.

```

Screen dump of Webster's during Previewing lists all questionable words found.

```

SpellStar - Spelling Check Operation      (Checking B:SPELL

SpellStar is now checking your document for misspelled words.

Number of words in document.....: 1353
Number of different words.....: 541
Number of words in main dictionary: 20863
Number of words in supplement.....:
Number of dictionary words checked: 13611
Number of misspelled words.....: 72
Total number of misspellings.....:

PC XT IBM IIC IIE PCS PFS VHS DEMO DSDD OK'D WETS ASCII HITCH ONE'S PROOF
SINON SON'S SWAPS HIGHLY KEYING NICELY TEXTRA TOGGLE CHECKER GRADING
OKAYING OPTIONS PREVIEW SPELLER SWAPPED XYWRITE BYPASSED CHECKERS DIGESTED
GRUELING SALSBERG SCHUSTER SPELLERS SURNAMES SWAPPING UPGRADED CORRECTLY
PROGRAM'S SPELLER'S SPELLINGS TYPICALLY WEBSTER'S WORDSMITH BOTHERSOME
CORRECTING EVENTUALLY PAPERBACKS PREVIEWING PROCESSORS STRATEGIES
WORDSTAR'S COMPATIBLES HIGHLIGHTED HYPHENATION INCORRECTLY INTERACTIVE
PROCESSOR'S VOLKSWRITER ADDITIONALLY CONTINUOUSLY CONTRACTIONS
"Space" = continue. "C" = continuous listing. "L" = stop/start list.

```

SpellStar's listing of questionable words is shown for the same manuscript used with Webster's. Note that many common words are questioned. This is due to the small number of words in the main dictionary of the SpellStar program.

A window at the right of the screen, the "Selection" window, lists words that the program thinks you really meant to type, including alternate spellings, words that are incorrectly run together, improper hyphenation, abbreviations and contractions, and words run together, such as "the the." More often than not, the first word on the list is the one you typed incorrectly; spelled right, of course. There are times when no words are listed, indicating that there's nothing in the dictionary that it might resemble. For example, "vhs"

would not bring up a selection of words with alternate spelling. (Should you use this abbreviation a lot, it should be added to the program's auxiliary dictionary so that it would not come up again as a questionable word.

The final window at the bottom is the "Command" window, which simplifies the already easy-to-use commands required. The IBM PC version makes fine use of functions keys, with eight of them employed for fast action. In the Apple version, it's almost always a control key-

letter combination that must be used. Moreover, there's disk swapping required with an Apple program because the dictionary and the program parts have to be separate. With only one drive, the document has to be swapped, too, making three swaps necessary. With an IBM PC or true compatible having dual drives, no swaps are needed; single-drive IBM PCs require dictionary and program swaps, an unlikely occurrence since so few people have only one drive on this machine. DOS 1.1 or higher can be used with IBM, while Apple requires DOS 3.3.

I used the IBM PC version for testing purposes. The manual implies that the speller's Preview feature is available only with this machine or compatibles, not with an Apple. The preview feature is a distinct plus, I believe, so I utilized this feature to its fullest.

Using The Speller

The program worked without a hitch time and time again, with very few words questioned because they weren't in the dictionary (aside from some technical words or some surnames or company names and the like). There's only one precaution: the Enter or Return key is used only to replace words during editing, except for decision toggling on the Preview words questioned. Other keys are used for all other functions.

After "reading" the document, the speller indicates the total number of words it digested, then proceeds to scan the dictionaries for alternatives (I kept the program on Automatic Scan), displaying letters of the alphabet in proper order as it completes each one. The number of questionable words totaled up is continuously upgraded at the same time.

Since I chose the "Preview" option, a list of questionable words were displayed on a spelling-check run with a particular manuscript I had. The 1065 total words it indicated required 120 seconds to display all the questionable words; 23 of them. In this group, I quickly okayed 13 names of people and streets and three highly technical terms, leaving me with seven questionable words.

SOFTWARE FOCUS...

```

Webster's New World Spelling Checker      b:spell      Automatic scan
-----
always a control key-letter combination that must be used.
Moreover, there's disk swapping required with an Apple program
because the dictionary and the program parts have to be separate.
With only one drive, the document has to be swapped, too, making
three swaps necessary. With an IBM PC or true compatible having
dual drives, no swaps are needed; single-drive IBM PCs require
dictionary and program swaps, an unlikely occurrence since so few
people have only one drive on this machine. DOS 1.1 or higher can
be used with IBM, while Apple requires DOS 3.3.

Word in question:  compatible                Possible spellings:
                                                    compatible
                                                    compatibles
                                                    compatibly

Replacng & Editing      Dictionary Reference
>/<>  Select              <F5>  Set scan level
<Enter>  Replace          <F6>  Suggest spelling
<F1>    Replace to end  <F7>  Look up word
<Esc>   No replacement  (PgUp to A, PgDn to Z)
</>    Edit word        <F8>  Add the word
<Ins>/<Del> Insert/Delete <F9>  Whoops!
<F2>   Erase word       <F10> Quit spell check
    
```

An incorrectly spelled word is displayed by Webster's in a nine-line context window, with possible spellings listed in a right-corner window. Moving a horizontal bar with an arrow key to the correctly spelled word and pressing Return twice replaces the questionable word in the display and automatically corrects spelling on the document disk.

```

Webster's New World Spelling Checker      b:spell      Automatic scan
-----
computer spelling checkers are so popular. Other reasons are
that everyone makes typing mistakes and proofreading one's own
work is a grueling job.
Much of my personal experience with computer spelling
checkers is with WordStar's overlay option, SpellStar. I found
it to be an interesting wordsmith aid, but its limited number of
dictionary words--about 20,000--is bothersome. As a result,
the program pegs too many words as being questionable, requiring
me to spend much time keying in an "Ignore" code letter. Nor do

Word in question:  WordStar                Possible spellings:
                                                    Words tar
                                                    Word star
                                                    Words
                                                    Worst
                                                    Wards
                                                    Word
                                                    Worlds
                                                    Worsts
                                                    Ward
                                                    Wars

Replacng & Editing      Dictionary Reference
>/<>  Select              <F5>  Set scan level
<Enter>  Replace          <F6>  Suggest spelling
<F1>    Replace to end  <F7>  Look up word
<Esc>   No replacement  (PgUp to A, PgDn to Z)
</>    Edit word        <F8>  Add the word
<Ins>/<Del> Insert/Delete <F9>  Whoops!
<F2>   Erase word       <F10> Quit spell check
    
```

In its editing mode, Webster displays "WordStar." The highlight bar was left in its start position and the Return key was pressed twice, allowing the word to remain as is.

Comparing the foregoing with SpellStar, the WordStar overlay indicated I had 1059 total words and also noted that there were 547 different ones (which Webster's doesn't reveal as a point of information). To load, read, sort and scan took 80 seconds, or 45 seconds less than Webster's. However, it indicated that 78

words were questionable in contrast to Webster's 23 words. Furthermore, its preview listing run words horizontally in 80-column fashion, which is more difficult to read than Webster's vertical list of words, nine per column.

At this point in the copy you're reading, ending with the word "column,"

above, I put Webster's spelling check and SpellStar through their paces again. Here are the results:

	Word Count	? Words	Time
Webster's	1406	20	140 sec.
SpellStar	1353	72	120 sec.

Going quickly through the Preview list, only four words among the 20 questionable ones listed by Webster's were spelled incorrectly. They were marked for editing. Most of the rest were apparent trade names or abbreviations. Note that one hyphenated word "1100-word," was a compound modifier preceding a noun, so it was correct even though questioned. Also, IBM does not use a period at the end of "jr" though the speller rightly questioned this. I added three words to the auxiliary dictionary: PCs, vhs, and WordStar. (Being that the name "Salsberg" had been added previously, it was not questioned.)

I stumbled for a moment when I saw "pcs" listed, but then realized that it was the plural of PC (personal computer). The Preview words are not capitalized, which would have aided me here, but this is a minor shortcoming of the program. More important is the fact no word was listed as being questionable that one would not expect to find. This is the result of a fairly full dictionary that's actually more than 114,000 words versus SpellStar's built-in 20,863 words.

Moving into the Context stage took the computer 20 seconds, which included adding three words to the auxiliary dictionary. After this, it takes less than five seconds of machine time to edit and replace each word. A neat method is used to accomplish this.

The word in question is highlighted in the nine-line context text, while a list of selected alternatives is displayed at screen-right. To select any of the suggested words, one simply moves a down-arrow to the chosen word and presses the Return key. Doing this automatically substitutes this word for the one questioned. The screen requests that you confirm this by pressing Return once again. Should a word not be found in the dictionary, you can try again with a Full

scan, though it's unlikely that it was missed. Alternatively, you can edit the word, shown by itself in a window below the Context space.

When the spelling check is completed, an uncorrected copy is also saved automatically (a .bak file). The whole process doesn't consume more time that one would spend proofreading by eye, while also automatically inserting corrections and helping you make a decision by offering you dictionary alternatives. The Webster speller can also be used as a conventional dictionary.

Conclusions

I'm very favorably impressed with *Webster's Spelling Checker*. It's got it all together, including being able to be placed on a hard disk where speed will be enhanced. If there's any shortcoming here, it would be the absence of capital letters in the Preview list, as cited earlier.

Though I haven't tried the Apple version, I'm sure it's slower than the IBM one since it uses overlays and there's disk swapping needed even with two disk drives. Also, the Preview feature seems to be absent and function keys aren't available on Apple computers.

For an IBM PC or compatible, though, this is a super program that's sure to help most anyone who does a lot of computer text work. It's powerful, does its job fast enough to live with, is very easy to use and is highly compatible with many word-processing programs. By "powerful," I mean more than just a large dictionary. It catches those missing periods at the end of abbreviations, such as Dr. for doctor, contraction errors such as dont for don't, words run together in error, and so on. No wonder that I developed a high sense of confidence in *Webster's Spelling Checker*, which has a wonderful low price of \$59.95, too. **ME**

Testing CD Players (from page 34)

in the order that they are called for, would make things a lot simpler. Table II shows what signals are called for by the EIAJ in their accompanying Test Disc Standard, and which of these signals are used for which of the tests I have discussed.

The EIAJ Standard is not truly perfect, just as CD players aren't. Many of the differences between CD players have nothing to do with their electrical performance. For example, the ability of a given player to track a disc accurately—even if the disc has minor scratches or built-in dropouts caused during manufacture of the disc—varies considerably among current CD players. So, too, does the ability to maintain good laser-pickup tracking in the presence of outside vibration and shock. Many listeners find that they can hear differences between players that use analog filters and those that use digital filters and a decoding process known as oversampling.

The use of a low-pass filter in so many of the measurements (especially THD) tends to eliminate any effects caused by out-of-band distortion components or "beats" which may, in turn, cause audible effects within the audio pass band. Many purists will feel that the use of such filters in the measurement process will tend to make many CD players look better on "spec sheets" than they actually *sound*.

For all of this, the EIAJ has done a commendable job in putting together this standard. It's a good start toward specifying CD player performance in a meaningful manner. And if it does fall short of doing the complete job, there's nothing to prevent the more dedicated manufacturer (or for that matter, the more dedicated product tester and critic) from going *beyond* the requirements of the standard and reporting additional performance characteristics that are deemed to be important. **ME**

NEW FROM DON LANCASTER

HANDS-ON BOOKS

CMOS Cookbook	14.50
TTL Cookbook	12.50
TV Typewriter Cookbook	12.50
Active Filter Cookbook	14.50
Micro Cookbook vol I	15.50
Micro Cookbook vol II	15.50
Enhancing your Apple vol I	15.50
Enhancing your Apple vol II	15.50
All About Applewriter	12.50
Applewriter Cookbook	19.50
Apple Assembly Cookbook	21.50
Incredible Secret Money Machine	7.50

UNLOCKED SOFTWARE

Absolute Reset IIe & IIc	19.50
Applewriter Toolkit (Dos 3.3e)	39.50
Applewriter Toolkit (ProDOS)	39.50
Both Applewriter Toolkits	59.50
Applewriter/Laserwriter Utilities	39.50
Laserwriter Demo Pack	FREE
Appleworks Disassembly Script	49.50
Enhance vol I Companion Disk	19.50
Enhance vol II Companion Disk	19.50
Assembly CB Companion Disk	19.50
Applewriter CB Companion Disk	19.50
Classic Cell Animation Demo	12.50

FREE VOICE HELPLINE VISA/MC

SYNERGETICS

Box 809-ME
Thatcher, AZ 85552
(602) 428-4073

CIRCLE 93 ON FREE INFORMATION CARD

Be an FCC LICENSED ELECTRONIC TECHNICIAN!



Learn at home in spare time. No previous experience needed.

No costly School. No commuting to class. The Original Home-Study course that prepares you for the FCC Radiotelephone license exam in your spare time! An FCC Government license is your "ticket" to thousands of exciting jobs in Communications, Radio & TV, Mobile two-way, Microwave, Computers, Radar, Aerospace and more. You don't need a college degree to qualify, but you do need an FCC License. **No need to quit your job or go to school!** You learn how to pass the FCC License exam at home at your own pace with this easy-to-understand, proven course. It's easy, fast and low cost! **GUARANTEED PASS**—You get your FCC License or money refunded. Write for free details. Soon you could be on your way to being one of the highest workers in the electronics field. **Send for FREE facts now. MAIL COUPON TODAY!**

COMMAND PRODUCTIONS

FCC LICENSE TRAINING, Dept. 20
P.O. Box 2223, San Francisco, CA 94128

Rush FREE facts on how I can get my FCC License in spare time. No obligation. No salesman will call.

NAME _____
ADDRESS _____
CITY _____ STATE _____ ZIP _____

PRODUCT EVALUATIONS...

Zenith's Deluxe 27" Color TV (from page 15)

tionships between burst and chroma, unless the broadcast medium wittingly or unwittingly distorts. When this occurs, anything can happen to fleshtones and hues. In all fairness, though, such vector distortion will be corrected in a -03 retrofit version of a new Zenith chroma IC scheduled for production before this analysis appears in print.

We excited the carrier to produce adequate sine-wave demodulated stereo at the left and right audio amplifier outputs. Entering stereo signals into one of the baseband ports on the rear of the set produced a 38-dB stereo separation figure.

Any attempt to go through the tuner and remainder of the system, however, gave erroneous results. This was due to dbx noise-reducing compression and expansion in the stereo decoder. On the other hand, the -4-dB fall-off at 12 kHz was obvious from the combined THD and peak-detected sound response waveforms.

As indicated in the accompanying table of test results, voltage regulation and vhf

tuner gain are a little on the loose side; convergence was an excellent 99.8%.

User Comments

This new Zenith TV receiver/monitor is certainly a handsome console with good to superior overall performance and plenty of bells and whistles.

Its large-screen picture is superlative, excelling in resolution, contrast, color depth and so on. Better than any Zenith we've examined, you can walk right up to this 27-incher's screen and still see all the images clearly without a sense of graininess, even with the sharpness control wide open.

The video and audio inputs and outputs available make it easy to add peripheral equipment, such as a VCR, satellite TV receiver, stereo component system, or a computer (40-column use only, of course).

Audio capability is not supreme, as one might expect. But it's par for better TV sets, and should prove very satisfying in

its stereo mode for most people. Hi-fi aficionados can always plug in their better component systems.

The accompanying remote control is a beauty since it incorporates so many functions in a very small, light (5 oz. with battery) package. Don't misplace it, however, since it is awkward to work controls manually without it.

In sum, there are very few deficiencies evident with the Zenith model SB2777P, and these are relatively minor. Add in the widespread availability of parts and service that a company as huge as Zenith provides throughout the country, and the set is a blue-ribbon winner.

As to its seemingly high price, which is discounted in many areas, it is a lot of bucks. But it buys you a color system that displays a truly fine color picture, decent sound, a nice piece of furniture, the conveniences of a full-function remote control, and built-in flexibility provisions for broadcast stereo and external audio and video additions.—Stan Prentiss. **ME**

CIRCLE 54 ON FREE INFORMATION CARD

NEW PRODUCTS... (from page 13)

FFT Analyzer Peripheral

The Spectrum Analyzer Peripheral from Rapid Systems turns IBM, Apple and Commodore computers into Fast Fourier Transform (FFT) analyzers at moderate cost. It features a variable order of FFT in sizes ranging from 16 to 1024. Sample frequency choices range from 100 Hz to 500 kHz, and peak-to-peak voltage choices range from 1.6 to 320 volts. Speed is 30 seconds for a 256-point FFT on the IBM PC, longer on Apple and Commodore computers, depending on transform size. Also featured are: selectable time window, rectangular or Hanning; baseband or Venier band operation, with user's analog antialiasing filters; voltage and power spectrum computation; power spectrum averaging; and one-keystroke printer operation for hard copies of spectrum data. All post processing capabilities of the com-



puter are available to store and retrieve spectral analyses from disk, allowing you to analyze and process the information and to compute and do word processing.

The Spectrum Analyzer Peripheral

also provides you with all the capabilities of a 4-channel digital oscilloscope with 2-MHz sampling rate, 500-kHz analog bandwidth, and diode protection on all inputs. The graphics display is color enhanced, using 138 x 288 pixels for data display (up to four traces) and four lines of text for initial (default) values of the scope's parameters. \$648 for IBM PC and XT and Apple II and IIe; \$548 for Commodore 64 and SX-64.

CIRCLE 56 ON FREE INFORMATION CARD

Project Design Forms

AF Publishing Co. is offering a set of Project Design Forms that simplify the task of putting ideas and designs for circuits, projects, etc. down on paper. There are six forms: Block Diagram, Schematic, PC Board Layout, Construction Details, Parts List and Wire List. Each is available in 50-sheet, 8 1/2" x 11" pads, each

printed on a different color paper for easy reference.

Grids on the layout forms simplify sketching and layout of circuits, drawing front and rear panels, etc. An area at the bottom of each form is reserved for documentation. \$14 for a complete set of all six pads (order No. CS-10). Address: AF Publishing Co., Special Products Div., P.O. Box 524, South Hadley, MA 01075.

Probe-Type DMM

A.W. Sperry's new Model DM-6590 "Electro-Probe" is a compact digital multimeter in a probe-style housing. Designed for measuring ac and dc



voltages and resistances, it has full-scale ranges of from 2 to 500 volts ac and dc and from 2 ohms to 2 megohms resistance. Its compact $6\frac{1}{8}$ "L \times $1\frac{1}{8}$ "W \times $\frac{3}{4}$ "D dimensions and built-on probe tip make it ideal for use in tight, hard-to-reach areas.

Features of the DMM include: autoranging on all functions; a $3\frac{1}{2}$ -digit liquid-crystal display (LCD) that

indicates both value measured and function selected; an audible continuity buzzer; a DATA HOLD button; and 200 hours of continuous operation from a fresh battery. Supplied with the DMM are a test lead, a detachable insulated alligator clip, two batteries, a carrying case and operating instructions.

CIRCLE 57 ON FREE INFORMATION CARD

Color TV/Video Monitor (from page 54)

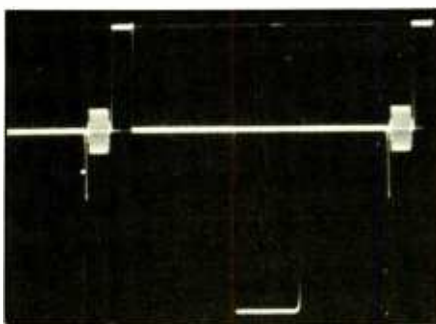

Fig. 6. Scope waveform display of the window signal.

nothing wrong with this, as long as you keep in mind that this is an unnatural condition when making color adjustments.)

In Closing

Some optional test signals for technicians are "multiburst" and "window" (Figs. 5 and 6, respectively).

The C-64's multiburst [5] *Multiburst* is a bit disappointing because of its sharp high-frequency roll-off. However, it's still useful for comparison purposes if you make note of its response instead of expecting a flat signal. Response is adequate for the C-64's 40-character-per-line display,

but if you tried to display 80 characters per line or a picture with very fine detail, you would note blurring in the picture.

Window [6] *Window* is displayed on a TV set as a white square in the center of the screen. This is very useful for checking frequency response. Look for a sharp leading edge (indicates good high-frequency response), a flat-topped waveform displayed on an oscilloscope's CRT, and even brightness of the window on the set's screen (indicates good low-frequency response).

A final note: When you view a black-and-white picture, examine it carefully. Are the shadows a good gray or black, without a hint of color in them? Are the bright whites really white? Examine especially carefully the credits. Are the letters solid black on white (or vice-versa), or do their edges betray coloration? You can tell a lot about *color* picture quality from viewing a black-and-white picture. And when everything is done correctly, you'll be surprised at just how good a TV receiver or monitor can look with just a bit of effort. **ME**

LEARN TV/VCR REPAIR



Now you can train at home in spare time for a money-making career as a TV/VCR Repair Specialist. No need to quit your job or school. We show you how to troubleshoot and repair videocassette recorders and TV sets, how to handle house calls and shop repairs for almost any make of television or VCR. You learn about TV receivers, tuners and antennas, x-ray emission, the characteristics of sound, how electrical impulses are converted into a TV picture, and much, much more. Tools are included with your course so you can get "hands-on" practice as you follow the lessons step by step. Send for free facts about opportunities in TV/VCR Repair and find out how you can start making money in this great career.

Experts show you what to do, how to do it...guide you every step of the way!

Everything is explained in easy-to-understand language with plenty of drawings, photos and diagrams. But if there is ever anything in your lessons you don't understand, you can write or phone your instructor and you can count on getting an authoritative answer. Send for free facts and color brochure. No cost. No obligation. No salesman will visit you. MAIL COUPON TODAY!

ICS SCHOOL OF TV VCR REPAIR, Dept. DL016
(SINCE 1951) Scranton, Pennsylvania 18515

Please send me free facts on how I can learn TV/VCR Repair at home in my spare time. No salesman will visit.

Name _____ Age _____

Address _____

City/State/Zip _____

Phone () _____

MODERN ELECTRONICS MART

Classified Commercial Rates: 90¢ per word, 15-word minimum (\$13.50) prepaid. (Word count includes name and address, ZIP code and abbreviation each count as one word; P.O. Box number and telephone number count as two words each.) Indicate free category heading. A special heading is available for a \$6 surcharge. *First word only is set boldface caps at no charge. Add 20% for additional boldface words.*

Mart Display Rates: 1" x 1 col., \$120; 2" x 1 col., \$230; 3" x 1 col., \$330. Prepayment discount 5% for 6 issues; 10% for 12 issues prepaid at once.

(All advertisers with PO Box addresses must supply permanent address and telephone number. Copy is subject to publisher approval.)

Mailing Information: Copy must be received by the publisher by the 20th of the third month preceding the cover date. Send Advertising material with check or money order to: Modern Electronics, Classified Department, 76 North Broadway, Hicksville, NY 11801.

COMPUTERS

RENT PUBLIC DOMAIN SOFTWARE, IT'S NOT COPYRIGHTED, no fees to pay, Copy hundreds of useful business, utility and game programs from our rental libraries onto your own computer at home! National Public Domain Library, 1533 Avohill, Vista, CA 92083. (619) 941-0925. Recording—(619) 727-1015.

APPLE II+, He Teac ½ height disk drive "The Best" \$105.00; Z-80 CP/M card \$30.00; 80 column card for II+ \$55.00. **IBM XT** compatible motherboard with 640K RAM and BIOS ROM \$205.00; color card \$80.00; Disk I/O card \$100.00; all 1 year guaranteed and postpaid. RGB Company, 1321 Oro St., El Cajon, CA 92021.

COMMUNICATIONS PLANS, BOOKS, KITS! AM/FM broadcasting (licensed/unlicensed), 1750 Meter transceivers, ham/CB amplifiers, surveillance bugs, more! FREE catalog. PAN-COM, Box 130-M2, Paradise, CA 95969.

CABLE Converters, Radar Detectors, Police Scanners, Send \$1.00 for catalog. G.L.C.I., 1717 4-Mile Rd. NE, Grand Rapids, MI 49505.

TI-99/4A Software/Hardware bargains. Hard to find items. Huge selection. Fast Service. Free Catalog. Tynamic, Box 690, Hicksville, NY 11801.

TI-99/4A Discount Softwares: FREE Catalog from Microbiz Hawaii, POB 1108 Pearl City, HI 96782.

PC-4 SOFTWARE \$10. PC-4 Schematic \$5. TOY, 217 South Pennsylvania Ave., Fremont, Ohio 43420.

COMMODORE-64: Refund if our "C" Module isn't easiest, cheapest, versatilest input device sensing/measuring/massaging temperature, light, RCL, more! Rush \$19.42 (\$18 for TS/ZX) to KALTEK, Adjuntas, PR 00601-0971ME. Info? SASE!

ELECTRONICS

USED ELECTRONICS and TEST EQUIPMENT Commercial, military. Low prices. **FREE LIST.** Andrew R. Sabol, RD-2, Waterville, NY 13480.

LINEAR PARTS, TUBES, TRANSISTORS—MRF454 \$16, MRF455 \$12, MRF477 \$11, MRF492 \$18. Catalog. RFPC, Box 700, San Marcos, CA 92069. (619) 744-0728.

UHF pre-amp kit 25 db gain \$13.50 ppd. **FREE MAIL ORDER FLYER. RETAIL STORE.** Network Sales, 90 Turner Elk Grove, IL 60007.

RECONDITIONED Test Equipment. \$1.25 for catalog Walter's, 2697 Nickel, San Pablo, CA 94806, (415) 724-0587.

RESISTORS - any value/quantity, ¼ watt @ \$.01, ½ watt @ \$.015 (\$1.00 minimum). Quantity discounts, 1,000+. Send wattage(s), value(s), quantity(s), and remittance - T.O.R.C.C.C. Electronics, Box 47148, Chicago, Illinois 60647; (312) 342-9171.

CIRCUIT BOARDS, Guaranteed lowest quotes and Free twelve hour prototypes. Single and Double sided boards. Small through large production quantities. Send specifications - T.O.R.C.C.C. Electronics, Box 47148, Chicago, Illinois 60647, (312) 342-9171.

LIGHT chasers, color organs, rope lights. Assembled, kits. Design Specialty, P.O. Box 1995, Huntington Beach, CA 92647.

LOGIC Probe. TTL/CMOS selectable. Response time 5ns. LED indicators. \$35.50 plus \$2.00 S/H. Logic Pulser. Pulses multifamily digital circuits. Repetition rate 0.5pps/400pps. Pulse width 10 micro seconds typical. \$40.50 plus \$2.00 S/H. Both for \$70.00 plus \$2.00 S/H. S.C. residences add 5% tax. Fully Guaranteed. M.F. Enterprises, 105 Creekside Road, Greer, SC 29651.

DIGITAL KLOCK KIT plays 1-of-12 melodies each quarter hour. Displays time, date, and other features. Send \$2.25 for complete assembly plans and pricing to **KERBER KLOCK KO.**, 36117 Hillcrest, Eastlake, Ohio 44094.

ELECTRONIC CATALOG. Over 4,500 items. Parts & components. Everything needed by the hobbyist or technician. \$2.00 postage & handling (U.S. Only), refundable with first \$15.00 order. T&M Electronics, Dept. M, 472 East Main St., Patchogue, NY 11772. (516) 289-2520.

AUTOMOTIVE radio replacement parts. Delco, Ford, Chrysler, Panasonic, etc. Laran Electronics, 3768 Boston Rd., Bronx, NY 10469 (212) 881-9600; NY State: 800-446-4430; National: 800-223-8314.

COUNTERMEASURES

BUGGED? Wiretapped? Find out fast. **COUNTERMEASURES** equipment catalog \$1. Capri Electronics, Route 1Z, Canon, GA 30520.

INVENTORS

INVENTORS! Can you profit from your idea? Call **AMERICAN INVENTORS CORPORATION** for free information. Over a decade of service. 1-800-338-5656. In Massachusetts call (413) 568-3753.

REPAIR YOUR OWN TV

NEW . . . REPAIR YOUR OWN TV EASY. Write, Research Rt. 3, Box 601BW, Colville, WA 99114.

VIDEO

SATELLITE RECEIVER KIT - Complete with PCB, Chassis, all Components and parts, with Downconverter completely assembled and tested. 24 channel tunable video and audio. Breakthrough proven straight forward design, requires no special tools. **ONLY \$180.00 TECHKIT, 1111 W. El Camino Real, Suites 109-141, Sunnyvale, CA 94087. VISA-MASTERCARD. Money back guarantee.**

DEALERS wanted: Channel 2, 3, and 4 notch filters. Money back guarantee. Send \$15.00 for sample and quantity price list. Specify channel(s). **GARY KURTZ, P.O. Box 291394, Davie, FL 33329.**

CABLE TV Converters/Descramblers. Guaranteed lowest prices in U.S. Jerrold, Hamlin, Zenith—Many others! Lowest Dealer Prices! Orders shipped within 24 hours! Complete illustrated catalog, \$2.00. Pacific Cable Co., Inc., 7325 ½ Reseda Blvd., Dept 508, Reseda, CA 91335. 818/716-5914.

CABLE TV CONVERTERS! Why pay an outrageous monthly fee? All Jerrold Products including new Jerrold Tri-Mode or Bi-State, SB-3, Hamlin, M-35-B, Oak VN-12, Zenith, and more. "New volt-guard surge protector." Dealers wanted. (Quantity Discounts). Send self addressed stamped envelope. (60¢ postage) or call for information, (312) 637-4408 Midwest Electronics. (C.O.D. orders accepted). 5143 W. Diversey, Chicago, Illinois 60639. **NO ILLINOIS ORDERS ACCEPTED.**

BUILD Your Own Satellite TV Receiving System And Save! Instruction manuals, schematics, circuit boards, parts kits! Send stamped envelope for complete product listing: **XANDI, Box 25647, Dept. 30K, Tempe, AZ 85282.**

CABLE AND SUBSCRIPTION TV secret manual. Build your own **descramblers, converters.** Instructions, schematics for line wave inboard/outboard gated sync SSAVI (HBO, Showtime, Cinemax, UHF, etc.). Send \$8.95 to **Cabletronix, Box 30502ME, Bethesda, MD 20814.**

TOKO IF transformers and coils used in video circuits. Transformer **BKAN K555ZAXX \$1.80, E520-HN - 300000023 \$1.00, 144LY-120k \$1.00.** Spec sheets with order. Add \$1.00 P&H. CP Electronics, PO Box 9056, Midland, Texas 79708.

SCIENTIFIC ATLANTA CABLE SYSTEMS! New CM-04 descrambler for series 8500, 8530, 8520 boxes. Receive all the pay channels your cable system has to offer. This is not a kit. Price \$125.00. Send \$2.00 for information and order form to: **ADVANCED TECHNOLOGY SYSTEMS, Box 316, Auburn, Mass. 01501 (617) 832-2339.**

Approximate Settings For Basic Sound Patterns

SOUND PATTERN	WAVE	PERIOD	CONTROL SETTINGS*		VOLUME
			ATTACK	DECAY	
Surf	40%	45%	50%	70%	Low-Moderate
Heavy Surf	30%	30%	35%	60%	Moderate-High
Wind	50%	25%	70%	85%	Low
Waterfall	75%	5%	100%	100%	Moderate-High

*0% minimum setting of pot; 50% center of pot travel; 100% maximum setting of pot

er. It does not need an indicator line or panel markings.

Use

The Ocean Box is meant to sit unobtrusively on a shelf or table in the room you wish to be most tranquil in. At first, set all four of the control pots to the center of their travel, then adjust each in turn until you reach a desired sound pattern. Adjustments, particularly this initial process, should be made slowly. Change only one control at a time, and let each change run through a few cycles before making further adjustments.

To make first-time adjustments easier, Table 1 gives rough settings of the four controls that will produce the basic range of white noise sounds. Instead of calibrations on the knobs, only rough percentages of pot travel (from minimum to maximum) are given. The most pleasing final form of these sounds is entirely subjective. Feel free to experiment with the settings to produce other sounds.

Once you've found a soothing sound pattern, set the volume control at a comfortable level and relax, free to sleep, study, work or read uninterrupted by sounds from the next room, office, or apartment.

Automatic Phone Disconnecter (from page 37)

Switch *S1* is the "Override" switch. In the "Override" position, V_{CC} is removed from the AND gate, turning it off. Light-emitting diodes *LED1* is the "Override" indicator and *LED2* is for "Normal" operation. *LED3* is used to indicate that the unit is functioning properly. When it is on, the phone is on, and vice-versa. Using different colored LEDs makes it easy to tell at a glance what the status of the unit is. (Also, I like lots of colored lights!) Any "ac adaptor" rated at greater than 6 volts and 125 mA can be used for the power supply. A 7805 regulator is mounted inside the case to provide a regulated 5-volt source.

Construction is simple and parts are widely available.

All jacks, LEDs and the switch are mounted on the case. The 7805 regulator uses a piece of 1/8" aluminum as a heat sink. I used 0.1" perf board to mount the parts. Any "speaker wire" or zip cord can be used for the phone and sensor lines. I simply soldered the sensors to the wire and wrapped the leads and the photocell with electrical insulating tape.

Pin numbers to the IC and the regulator are shown in the schematic. Don't overlook V_{CC} (pin 14) and Ground (pin 7) on the 7408! Also, note that the pin numbers on ICs are the top view, counterclockwise starting from the upper left. I ran a piece of #18 bus bar for V_{CC} and ground.

Since installing this system, my sleep time has never been sounder.

ADVERTISERS' INDEX

RS#		Page #
55	All Electronics Corp.	101
-	Command Productions	97
171	Cleveland Institute of Elec.	18, 21
31	Communications Electronics	5
91	Computel	78
59, 60	Computer Direct	44, 45
177	Dick Smith Electronics	52, 53
103	Digi-Key Corp.	103
-	Electronics Book Club	43
-	Grantham College of Engrg.	1
52	Heath Co.	31
115	ICOM, America	Cov. 1V
-	ICS	99
81	Information Unlimited	77
30	J&W Electronics	77
32	Kepron Circuit Systems	83
85	MCM Electronics	33
-	McGee Radio	102
94	McGraw-Hill	83
-	McGraw-Hill Book Club	43
61	Micro-Mart	102
-	NR1 Schools	8, 11
33	Radio Shack	3
170	Ramsey Electronics	Cov. 111
93	Synergetics	97
139	Trio-Kenwood	Cov. 11
-	Unity Electronics	102
92	Wolf	78

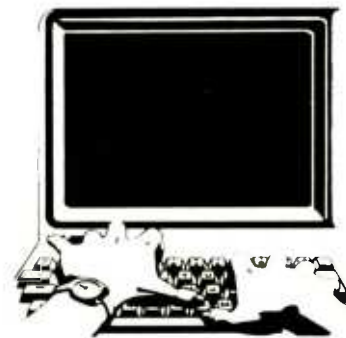

Free Product Information

Readers can obtain free information on products advertised by the above companies, as well as for some editorially mentioned products. Simply circle the appropriate number printed below an advertisement onto the Modern Electronics "Free Information Service" card bound into this issue. After filling in your name and address, just mail the postpaid card. Your request will be forwarded directly to the advertiser with a mailing label prepared by our reader-service department to ensure speedy response.



\$30.00 OFF

Save \$30 on the RAMSEY 20MHz Dual Trace Oscilloscope

Unsurpassed quality at an unbeatable price, the Ramsey oscilloscope compares to others costing hundreds more. Features include a component testing circuit for resistor, capacitor, digital circuit and diode testing • TV video sync filter • wide bandwidth & high sensitivity • internal graticule • front panel trace rotator • Z axis • high sensitivity x-y mode • regulated power supply • built-in calibrator • rock solid triggering

Was \$399.95 NOW ONLY **\$369.95** high quality hook on probes included



NEW RAMSEY 1200 VOM MULTITESTER

Check transistors, diodes and LEDs with this professional quality meter. Other features include: decibel scale • 20K volt metering system • 3 1/2" mirrored scale • polarity switch • 20 measuring ranges • safety probes • high impact plastic case

\$19.95 test leads and battery included



NEW RAMSEY D-4100 COMPACT DIGITAL MULTITESTER

Compact sized reliability and accuracy. This LCD digital multitester easily fits in your pocket, you can take it anywhere. It features full overload protection • 3 1/2 digit LCD readout • recessed input jacks • safety probes • diode check function • 2000 hours battery life

\$22.95 test leads and battery included

NEW 35 MHz DUAL TRACE OSCILLOSCOPE



A heavy duty and accurate scope for service as well as production use. Features include • wide frequency bandwidth • optimal sensitivity • extremely bright display • delayed triggering sweep • hold off • ALT trigger • single sweep • TV sync • 5X magnification • XY or XYZ operation • HF/LF noise reduction

3500 Dual Trace Oscilloscope **\$499.95** includes 2 high quality probes

ALL OSCILLOSCOPES INCLUDE 2 PROBES

NEW 15 MHz DUAL TRACE PORTABLE OSCILLOSCOPE



Ideal for field/bench applications, this scope can display up to 15 MHz signals. Internal battery pack allows up to 2 hours operation on a single charge. Features include • built-in battery charger • 5X horizontal magnification • high brightness CRT • front panel trace rotator • Internal rechargeable battery pack

2500 Portable Oscilloscope **\$449.95** includes 2 high quality probes

MINI KITS—EASY TO ASSEMBLE, FUN TO USE BEGINNERS & PROS WILL HAVE A GREAT TIME WITH THESE KITS

FM MINI MIKE

A super high performance FM wireless mike kit! Transmits a stable signal up to 300 yards with exceptional audio quality by means of its built in electret mike. Kit includes case, mike, on-off switch, antenna, battery and super instructions. This is the finest unit available.

FM-3 Kit **\$14.95**
FM-3 Wired and Tested **19.95**

Color Organ

See music come alive! 3 different lights flicker with music. One light each for high, mid-range and lows. Each individually adjustable and drives up to 300 W, runs on 110VAC.

Complete kit, ML-1 **\$8.95**

Video Modulator Kit
Converts any TV to video monitor. Super stable, tunable, over ch 4-6. Runs on 5-15V acceps stid video signal. Best unit on the market! Complete kit. VD-1 **\$7.95**



Super Sleuth

A super sensitive amplifier which will pick up a pin drop at 15 feet! Great for monitoring baby's room or as general purpose amplifier. Full 2W rms output, runs on 6 to 15 volts, uses 8-45 ohm speaker. Complete kit, BN-9 **\$5.95**

Led Blinky Kit

A great attention getter which alternately flashes 2 jumbo LEDs. Use for name badges, buttons, warning panel lights, anything! Runs on 3 to 15 volts. Complete kit, BL-1 **\$2.95**

CPO-1
Runs on 3-12 Vdc 1 watt out, 1 KHz good for CPO, Alarm, Audio Oscillator. Complete kit **\$2.95**

FM Wireless Mike Kit

Transmits up to 300' to any FM broadcast radio, uses any type of mike. Runs on 3 to 9V. Type FM-2 has added sensitive mike preamp stage.

FM-1 Kit **\$3.95** FM-2 Kit **\$4.95**

Whisper Light Kit

An interesting kit, small mike picks up sounds and converts them to light! The louder the sound, the brighter the light! Includes mike, controls up to 300 W, runs on 110 VAC.

Complete kit, WL-1 **\$6.95**

Tone Decoder

A complete tone decoder on a single PC board. Features 400-5000 Hz adjustable range via 20 turn pot, voltage regulation, 567 IC. Useful for touch-tone burst detection, FSK, etc. Can also be used as a stable tone encoder. Runs on 5 to 12 volts. Complete kit, TD-1 **\$5.95**



Siren Kit

Produces upward and downward wail characteristic of a police siren. 5 W peak audio output, runs on 3-15 volts, uses 3-45 ohm speaker. Complete kit, SM-3 **\$2.95**

Mad Blaster Kit

Produces LOUD ear shattering and attention getting siren like sound. Can supply up to 15 watts of obnoxious audio. Runs on 6-15 VDC.

Complete kit, MB-1 **\$4.95**

50 Hz Time Base
Runs on 5-15 VDC. Low Current 125mA 1 min. max. accuracy FB 7 Kit **\$5.50**
1B 7 Assy **\$9.95**

Universal Timer Kit

Provides the basic parts and PC board required to provide a source of precision timing and pulse generation. Uses 555 timer IC and includes a range of parts for most timing needs.

UT-5 Kit **\$5.95**

30 Watt 2 mtr PWR AMP

Simple Class C power amp features 81 mtr power gain. 1 W in for 8 out, 2 W in for 15 out, 4 W in for 30 out. Max output of 35 W. Incredible value, complete with all parts, less case and T-R relay.

PA-1, 30 W pwr amp kit **\$22.95**
TR-1, RF sensed T-R relay kit **6.95**

Power Supply Kit

Complete triple regulated power supply provides variable 6 to 18 volts at 200 ma and -5 at 1 Amp. Excellent load regulation, good filtering and small size. Less transformers, requires 6 3V (A 1 A and 24 VCT. Complete kit, PS-3LT **\$6.95**

- ### ACCESSORIES FOR RAMSEY COUNTERS
- Telescopic whp antenna—BNC plug **\$ 8.95**
 - High impedance probe, light loading **16.95**
 - Low pass probe, audio use **16.95**
 - Direct probe, general purpose use **13.95**
 - Tilt bail, for CT-70, 90, 125 **3.95**

PHONE ORDERS CALL **716-586-3950**

TELEX 466735 RAMSEY CI



RAMSEY ELECTRONICS, INC.
2575 Baird Rd.
Penfield, N.Y. 14626

KENWOOD

...pacesetter in Amateur radio

Scan the World



R-2000

All-mode receiver.

- Covers 150 kHz—30 MHz in 30 bands.
- All mode: USB, LSB, CW, AM, FM.
- Digital VFO's. 50-Hz, 500-Hz or 5-kHz steps. F. LOCK switch.
- Ten memories store frequency, band, and mode data. Each memory may be tuned as a VFO.
- Lithium batt. memory back-up.
- Memory scan.
- Programmable band scan.
- Fluorescent tube digital display of frequency (100 Hz resolution) or time.
- Dual 24-hour quartz clocks, with timer.
- Three built-in IF filters with NARROW/WIDE selector switch. (CW filter optional.)
- Squelch circuit, all mode, built-in.
- Noise blanker built-in.
- Large front mounted speaker.
- RF step attenuator. (0-10-20-30 dB.)
- AGC switch. (Slow-Fast.)
- "S" meter, with SINPO scale.
- High and low impedance antenna terminals.
- 100/120/220/240 VAC operation.
- RECORD output jack.
- Timer REMOTE output (not for AC power).
- Muting terminals.

Specifications and prices subject to change without notice or obligation.



R-1000

High performance receiver • 200 kHz-30 MHz in 30 bands • AM, CW, SSB • 3 IF filters • noise blanker • RF attenuator • S-meter • 120-240 VAC • muting terminals • built-in speaker • digital display/clock/timer



R-600

General coverage receiver • 150 kHz-30 MHz in 30 bands • AM, CW, SSB • IF filters • noise blanker • RF attenuator • S-meter with SINPO scale • front mounted speaker • 3 antenna inputs • 100-240 VAC operation • record jack • muting terminals • digital display

Optional accessories:

- VC-10 VHF converter for R-2000 covers 118-174 MHz
- YG-455C 500 Hz CW filter for R-2000
- HS-4 Headphones
- HS-5 Deluxe headphones
- HS-6 Lightweight headphones
- HS-7 Micro headphones
- DCK-1 DC cable kit for 13.8 VDC operation
- AL-2 Lightning and static arrester
- Service manuals are available for all receivers and most accessories.

Additional information on Kenwood all-band receivers is available from authorized dealers.

KENWOOD

TRIO-KENWOOD COMMUNICATIONS

1111 West Walnut Street
Compton, California 90220

CIRCLE 139 ON READER SERVICE CARD