

ICD 08559

MODERN ELECTRONICS™

JULY 1985 \$1.95

CANADA \$2.50

THE MAGAZINE FOR ELECTRONICS & COMPUTER ENTHUSIASTS

TREASURE-HUNTER'S GUIDE TO METAL DETECTORS

BUILD A PORTABLE GAS-LEAK INDICATOR ... IT CAN SAVE YOUR LIFE!

A Dual-Pulse Generator for Digital Bench Work

Laptop Portable Computers: The Hottest Carry-Alongs



On-the-go computing with a laptop portable (p. 28)

For Boating Enthusiasts: Marine Radio Communications

Don Lancaster Answers: "How Long Will a Battery Last?"



New CD player boasts fastest access time (p. 12)

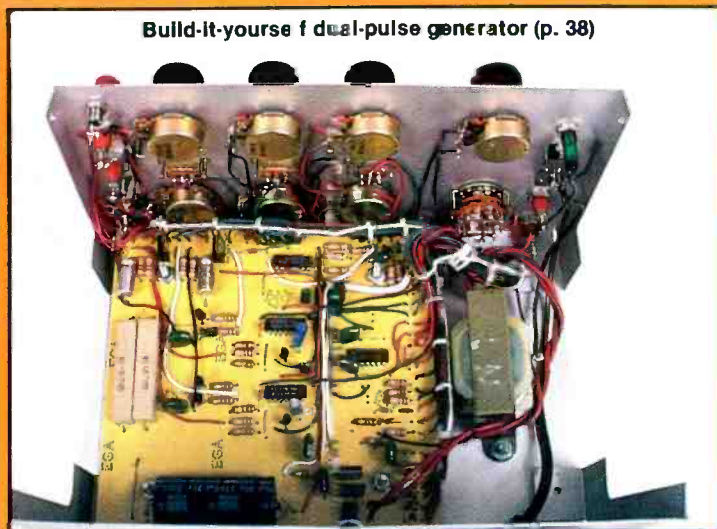

Build-it-yourself dual-pulse generator (p. 38)



Plus—*Equipment Tests*: Sony's New Third-Generation CD Player • Samsung's Entry-Level VHS VCR • A Low-Cost PC Printer Spooler • *Columns*: Forrest Mims' "Electronics Notebook" • *Electronic Gadgets* • *Shortwave Communications* • *Software Focus* • *Departments*: Latest Products & News . . . and more.

You've got everything to lose by not listening to a Uniden® Bearcat® Scanner.



BC210XL

You think it'll never happen to you. But don't count on it. Because crime isn't something you can control.

But there is a way you can be warned. With a Uniden® Bearcat® 210XL Scanner Radio. It lets you listen in on up-to-the-minute police reports, so you're always aware of what's happening, and where it's happening. That way, if a crime wave hits your neighborhood, you'll know about it when

the police do. Not when it's too late.

A Uniden® Bearcat® 210XL is no guarantee against crime. Just a way to know when to take precautions against it. Think for a moment of all that's at stake. Then take a moment and call 1-800-S-C-A-N-N-E-R to find your nearest Uniden® Bearcat® Scanner dealer.

Uniden Corporation of America, 6345 Castleway Court, Indianapolis, IN 46250.

uniden®
Bearcat®

CIRCLE 39 ON FREE INFORMATION CARD

UNIDEN

Commercial Communications
Marine Communications
Personal Communications
Satellite Technology
Telecommunications

 Uniden® Bearcat® Scanners are approved for use in neighborhood crime prevention programs.

©1984 UNIDEN CORPORATION OF AMERICA

MAKE MORE MONEY



TRAIN FOR ELECTRONICS

You say you're *already* trained in electronics but that you're *not* making enough money??? Well then, maybe you don't have an accredited bachelor's degree to prove that your education is *up to snuff!* Check out the Grantham Independent-Study B. S. Degree Program. It could make a *dollars and sense difference* in your electronics career.

Grantham offers this program, complete but without laboratory, to electronics technicians whose objectives are to upgrade their level of technical employment. Since the field of electronics is so enormous, opportunity for advancement is always present. Promotions and natural turnover make desirable positions available to the man who is ready to *move up*.

Grantham College of Engineering
10570 Humbolt Street
Los Alamitos, California, 90720

This booklet FREE!

This free booklet explains the Grantham B.S. Degree Program, offered by independent study to those who work in electronics.

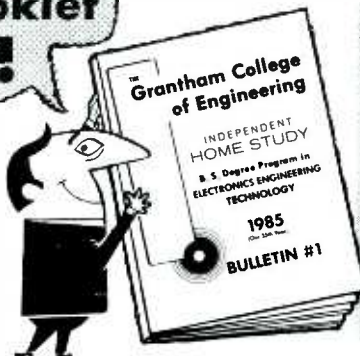

for **FREE Booklet CLIP COUPON** and mail in envelope or paste on postal card.

Do You REALLY Want to Make More Money?

Yes it does take *work* and a few sacrifices to climb up the electronics ladder to where the bigger money is. But, if that's where you want to be, then that's what you must do — *work* harder at learning and getting the right credentials, even if it takes a few sacrifices. A *B. S. degree* and the knowledge that rightly goes along with it can give you powerful ladder-climbing equipment in your search for *success in electronics*.

The accredited Grantham non-traditional B.S. Degree Program is intended for mature, fully-employed workers who want to upgrade their electronics careers.

Put Professional Knowledge and a COLLEGE DEGREE in your Electronics Career through Independent Home Study

Study materials, carefully written by the Grantham College staff for independent study at home, are supplied by the College. Your technical questions related to these materials and the lesson tests are promptly answered by the Grantham home-study teaching staff.

Recognition and Quality Assurance

Grantham College of Engineering is accredited by the Accrediting Commission of the National Home Study Council, as a degree-granting institution.

All lessons and other study materials, as well as communications between the college and students, are in the English language. However, we have students in many foreign countries; about 80% of our students live in the United States of America.

Grantham College of Engineering M-785
 10570 Humbolt Street, Los Alamitos, CA 90720

Please mail me your free catalog which explains your B.S. Degree independent-study program.

Name _____ Age _____

Address _____

City _____ State _____ Zip _____

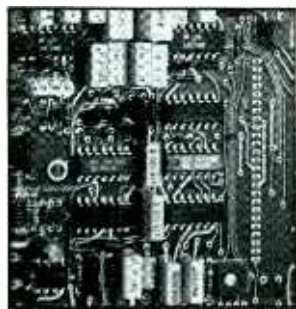

22



34

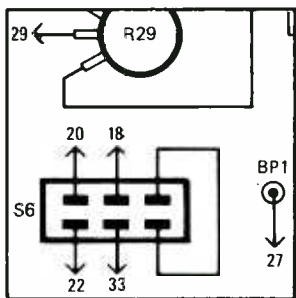

38



60

FEATURES

- 22 **Metal Detecting For Fun & Profit, Part 1**
All about modern detectors. *By Gerald S. Pattee*
- 28 **Portable Computers '85: One Lap Ahead, Part 1**
A critical look at laptop computers.
By Eric Grevstad
- 34 **Small-Boat Radio Communications**
Guide to marine radio. *By Ed Noll*
- 38 **Low-Frequency Dual-Pulse Generator**
Project offers digital-circuit experimenters a source of reliable clock pulses. *By Duane M. Perkins*
- 54 **Portable Gas Detector . . . It Can Save Your Life!**
Low-cost project features bargraph indication of toxic gas concentrations. *By Larry D. Gray*
- 56 **Oscilloscope User's Guide, Part 2**
Conclusion. *By Vaughn D. Martin*
- 60 **The Teleguard, Part 2**
Phone accessory project conclusion.
By Anthony J. Caristi

PRODUCT EVALUATIONS

- 12 **Sony Model CDP-302**
Third-generation CD player. *By Len Feldman*
- 15 **Samsung Model VT-210T**
Entry-level VHS VCR. *By Stan Prentiss*
- 17 **Stewart Instruments "PC Spooler"**
Low-cost computer printer buffer.
By Fred Blechman

DEPARTMENTS

- 4 **Editorial**
A \$40-Billion Lifestyle. *By Art Salsberg*
- 4 **Letters**
- 5 **Modern Electronics News**
- 6 **New Products**
- 51 **Free Information Service**
- 62 **Electronics Notebook**
A Multi-Function Two-Transistor Oscillator.
By Forrest M. Mims III
- 68 **Hardware Hacker**
Discusses "How long will a battery last?" and other tidbits. *By Don Lancaster*
- 75 **Software Focus**
Newstar's "Newword."
By Eric Grevstad
- 76 **Electronic Gadgets**
"Talking" home products. *By Eric Grevstad*
- 78 **Communications**
By Glenn Hauser
- 81 **Books and Literature**
- 88 **Modern Electronics Mart**
- 92 **Advertisers Index**

EDITORIAL STAFF

- Art Salsberg**
Editor-in-Chief
- Alexander W. Burawa**
Managing Editor
- Dorothy Kehrwyder**
Production Manager
- Elizabeth Ryan**
Art Director
- Barbara Scully**
Artist
- Pat Le Blanc**
- Richard Kishanuk**
Phototypographers
- Hal Keith**
Illustrator
- Larry Mulvehill**
Photographer
- Leonard Feldman, Glenn Hauser, Don Lancaster, Forrest Mims III, Stan Prentiss, Charles Rubenstein**
Contributing Editors

BUSINESS STAFF

- Richard A. Ross**
Publisher
- Art Salsberg**
Associate Publisher
- Dorothy Kehrwyder**
General Manager
- Anthony C. Sparacino**
Newsstand Sales Director
- Arlene Caggiano**
Accounting
- Cheryl Chomicki**
Subscriber Services

SALES OFFICES

- Modern Electronics**
76 North Broadway
Hicksville, NY 11801
(516) 681-2922
- Eastern Advertising Representative
Paul McGinnis Company
60 East 42nd Street
New York, NY 10017
(212) 490-1021
- Midwest Advertising Representative
Market/Media Associates
435 Locust Road
Wilmette, IL 60091
(312) 251-2541
Ted Rickard
- Western Advertising Representative
JE Publishers Representatives
6855 Santa Monica Blvd., Suite 200
Los Angeles, CA 90038
(213) 467-2266
Jay Eisenberg, Director
San Francisco: (415) 864-3252
Denver: (303) 595-4331

Offices: 76 North Broadway, Hicksville, NY 11801. Telephone: (516) 681-2922. Modern Electronics (ISSN 0748-9889) is published monthly by Modern Electronics, Inc. Application to mail at second class rates pending at Hicksville, NY and other points. Subscription prices (payable in US Dollars only): Domestic - one year \$16.97, two years \$31.00, three years \$45.00; Canada/Mexico - one year \$19.00, two years \$35.00, three years \$51.00; Foreign - one year \$21.00, two years \$39.00, three years \$57.00. Foreign Air Mail - one year \$74.00, two years \$145.00, three years \$216.00. Entire contents copyright 1985 by Modern Electronics, Inc. Modern Electronics or Modern Electronics, Inc. assumes no responsibility for unsolicited manuscripts. Allow six weeks for delivery of first issue and for change of address. Printed in the United States of America. Postmaster: Please send change of address notice to Modern Electronics, Inc., 76 North Broadway, Hicksville, NY 11801.

MUST LIQUIDATE At Far Below Dealer Cost! TOTAL Personal Computer System

FACTORY REFURBISHED!

GET ALL THIS AT ONE LOW PRICE!

64K Computer • 16 Hue Color, 5" Monitor • Disk Drive • Printer • Two Software Packages: "Easy Script" word processing and "The Manager" data base program!

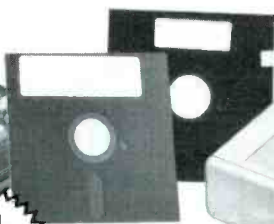

Carries easily as a suitcase! Plugs into 115V outlet.

FULL FACTORY WARRANTY!

803 Printer

Sorry, we're not permitted to PRINT the famous brand-name. BUT, we CAN "tell all" if you call us TOLL FREE: 1-800-328-0609!

THE COMPUTER.

For business, education and home use! Thousands of programs are available.

Snap-on computer! 64K RAM, 20K ROM. Full-size typewriter keyboard. Upper and lower case letters, numerals, symbols, reverse characters. 2 cursor control keys, 4 function keys, programmable to 8. Music synthesizer with 3 independent voices, each with 9 octave range. Input/output ports accommodate . . . user, serial, ROM cartridge, joysticks, external monitor, phone modem.

Built-in disk drive! Intelligent high speed unit with 5 1/4" floppy disk recorder. 170K formatted data storage; 35 tracks. 16K ROM. Uses single sided, single density disk. Serial interface. Second serial port to chain second drive or printer.

Built-in color monitor! Displays 40 columns x 25 lines of text on 5" screen. High resolution. 320 x 200 pixels. 16 background, character colors.

Built-in ROM cartridge port! Insert ROM program cartridge. Multitude of subjects available in stores across the nation!

THE PRINTER.

Graphics quality 6 x 7 dot matrix printer. An ideal "fit" for this system . . . and included in the astonishingly low package price below!

Print method: Bi-directional impact dot matrix.

Character matrix: 6 x 7 dot matrix.

Characters: Upper and lower case letters, numerals and symbols. All PET graphic characters.

Graphics: 7 vertical dots — maximum 480 columns. Dot addressable.

Character codes: CBM ASCII code.

Print speed: 60 characters per second.

Maximum columns: 80 columns.

Character spacing: 10 characters per inch.

Line feed spacing: 6 lines per inch in character mode or 8 lines per inch selectable. 9 lines per inch in graphics mode.

Line feed speed: 5 lines per second in character mode. 7.5 lines per second in graphics mode.

Paper feed: friction feed. (Tractor feed optional.)

Paper width: 4.5" to 8.5" width. Up to 10" with optional tractor feed.

Multiple copies: Original plus maximum of two copies.

Dimensions: 13"W x 8"D x 3 1/4"H. Wt.: 6 1/2 lbs. Power: 120V AC, 60 Hz.

THE SOFTWARE.

"Easy Script" One of the most powerful word processors at any price! Cut re-typing, create documents from standard paragraphs, do personalized letters, see and change a document before it is printed. Instruction manual has extensive training section that simplifies use . . . even for someone who has never used a computer or word processor before!

"The Manager" A sophisticated database manager for business or home use. Business uses: accounts payable/receivable, inventory, appointments, task manager. Home uses: mailing lists, home inventory, recipes, collection organizer, investment tracking, checkbook balancing. School uses: research article index, gradebook.

TOTAL Personal Computer System Now Available At FAR BELOW dealer cost!

TOTAL PACKAGE PRICE \$488

Item H-507-64011-02
Shipping, handling: \$24.00

Other popular brands of computer peripherals available at liquidation prices. For information, Call TOLL FREE: 1-800-328-0609.

Compatible with Commodore Computer Systems (Not included in package price.)

JOYSTICKS (Set of 2)

Give you the fun of playing a wide selection of games.

Mfr. List: \$59.90 pr.

\$18 pr.

Liquidation Price
Item H-507-63622-01 Ship, handling: \$6.00 pr.

64 MODEM

Access new worlds of information with your computer.

Mfr. List: \$109.95

\$44

Liquidation Price
Item H-507-63646-00 Ship, handling: \$4.00



Credit card members can order by phone. 24 hours a day, 7 days a week.

Toll-Free: 1-800-328-0609



Your check is welcome! No delays when you pay by check!

C.O.M.B. CO.®

Authorized Liquidator

14615 28TH AVENUE NORTH
MINNEAPOLIS, MINNESOTA 55441-3357

SEND ME THE ITEMS I HAVE LISTED BELOW

Price subject to change after 60 days. Sales outside continental U.S. are subject to special conditions. Please call or write to inquire.

Item No.	How Many	Item	Ship/Handl.	Price

C.O.M.B. CO.®

Item H-507

14615 28th Ave. N. / Minneapolis, MN 55441-3357

Send the items indicated at left. (Minnesota residents add 6% sales tax. Please allow 3-4 weeks for delivery. Sorry, no C.O.D.)

My check or money orders is enclosed. (No delays in processing orders paid by check, thanks to TeleCheck.)

Charge: MasterCard® VISA Am. Ex. Diners Club

Acct. No. _____ Exp. _____

PLEASE PRINT CLEARLY

Name _____

Address _____

City _____

State _____ ZIP _____

Phone _____

Sign here _____

A \$40-Billion Lifestyle

True high-tech living may not have arrived yet, but we're surely heading there when you consider that the consumer electronics industry contributes more than \$40-billion to our economy, not to mention almost 1½-million full-time jobs. This information was garnered by an Arthur D. Little, Inc. study made for EIA's Consumer Electronics Group, based on 1983 information on 27 electronic products that were combined into 12 categories.

Leading the pack on total dollar value of business generated is color TVs, with nearly \$15-billion, followed by home computers with \$7.14-billion. Both also led in number of full-time jobs supported. All these figures relate to total economic impact in the U.S., of course, and take into account retail value added and other indirect economic influences.

The study also revealed what we all know: much of what's produced is from foreign sources. For example, *all* video-cassette recorders sold in the home U. S. market were imported from the Far East. Hitachi makes RCA-brand machines, Matsushita does the same for GE, Sony for Zenith (in 1983), Sanyo for Sears, and so on. Of the 14.4-million color TV units produced for 1983 inventory, 3.82 million were imported fully or in part from another country. Most computers, how-

ever, were made in the U.S., though many components were sourced from abroad. Corded telephones, too, are heavily imported, with almost 40% made overseas. And so it goes, with the U.S. fast turning into a sales, distribution and servicing nation in the consumer electronics area.

Interestingly, there are a lot of jobs created even when products are manufactured abroad. Often, overseas companies also set up manufacturing facilities in the U.S. as their sales increase. Additionally, there are byproducts such as video carts that spring up as ancillary equipment made in the U.S.

So importing is not all bad. It's not all good, either, naturally, as manufacturing facilities continue to disappear along with the technically skilled job opportunities they offer us. Survival of the fittest, it's called. We made our own bed in many ways. Licensing of technology at giveaway prices; little reinvestment in more efficient production methods; poor quality control; low productivity; high labor costs; and other factors.

There is a lot of pressure being applied to leading manufacturing countries who export to the U.S. but limit imports from us. Just to give you some idea of the obstacles that face American manufacturers, plants here have to be inspected and

pass certification requirements by the Japanese Ministry of International Trade and Industry before U.S. products can be marketed in Japan. Japanese inspectors, in fact, fly in to the U.S. for this purpose. Obviously, this adds to delays and increased costs. Now, Japan is granting Specific Foreign Inspection Bodies in the U.S. to inspect, register and certify American facilities. Nonetheless, high tariffs, language barriers, and complex bureaucratic measures are still major hurdles that face American exporters.

No one predicts that consumer electronics manufacturing will have a resurgence in the U.S. But who knows? See Apple Computer's Macintosh production facilities, for example. Built from scratch and using the most modern automated facilities available, it spits out a completed computer in less time that it takes to make a typical telephone call.

Whatever the source of manufacture, however, the American public continues to luxuriate in more and more consumer electronics products, with sales, distribution and service jobs growing by leaps and bounds to make it happen.



LETTERS

April Fool's In July

•We were amazed to see the article on "In Situ" Solar Cell Process in your April 1985 issue. Our engineers have been working on a similar project for the past two (2) years and have perfected it. Several omissions in your article may cause minor headaches for readers attempting this project.

First, the white sand must come from the White Sands area in Southeast New Mexico. Beach sand contains too much salt and potassium compounds, but New Mexico sand contains trace amounts of Indium Lithide necessary for ion doping.

Second, after assembly, unit must be baked with the mentioned chemical at 525 degrees F for 3½ hours plus a half hour

per 2000 ft. elevation, with 120 Vdc across the screen and pan, with the screen positive. This will ensure even polarized distribution of the hypolithium disilicate ion implantation. A diode in series with the panel must be installed, as darkness will generate a reverse current flow, discharging the storage batteries.

D. C. Short
Icudahack, VA

(The sand in Thatcher, Arizona is even better, we've been told.—Ed.)

A Reset Fan

•Please send me program 1 and the source code for KREBF spell. Since I recently purchased an Apple IIe computer, I've

been looking for a way to reset into the monitor from a protected program. Your article in the February and March 1985 issues was what I needed.

Wally Lee
Montreal, Canada

Author's Correction

•There were a few errors made in transcribing my manuscript, "Using Voltage Comparators" (May 1985 issue): Page 37, Fig. 5, the unlabeled resistor connected to V+ should be labeled "33K" and the unlabeled resistor to ground should be labeled "68K." Thanks.

Robert Witte
Greensboro, NC

VCR TAPE SHORTAGE? Industry people predict a serious shortage of blank videotape by fall due to higher sales than ever and manufacturers' reluctance to increase production because price cuts have been so severe that there's not much money to be made. Whether this comes true or not, it's likely that prices will rise, so stock up now.

Sales of blank cassettes are expected to double that of 1984, reaching 122-million units. Home VCR machine sales increased 77% in first-quarter '85, adding to threatened blank-tape problem.

NEW TOP-TEN COMPUTER CHAIN. Heathkit Electronic Centers' name change to Heath/Zenith Computers & Electronics and plans for remodeling its 70-store chain to emphasize popular computers and accessories will put the company among the top ten computer chains in the U.S. in store numbers and volume. Owned and operated by Veritechnology Electronics Corp., a subsidiary of Zenith Electronics Corp., as is Heath, the centers will continue to carry traditional Heathkit electronic products and its educational learning centers.

LIQUID-CRYSTAL SHUTTER PRINTER. Casio uses LCD shutter in new printer to control the way light strikes a photoconductor, making the print head fully electronic. Boasts speed that's 200 times faster than convention LCD's 240 dots per inch resolution, and operating noise below 50 dB. Interface options are Centronics-type and RS232C serial.

COMPUTER SERVICING. Commodore Business Machines reorganized and expanded its customer service capability recently, creating a national network of regional service centers. There are 650 locations now, with plans to almost double the number, including 160 locations to be handled by RCA. A toll-free Customer Support line is now active, too, to answer questions (not line: 800-247-9000.)

Howard W. Sams now publishes "Computerfacts" service data to cover repair information for popular microcomputers and peripherals. They're available from local electronic parts distributors.

CD USERS. From West Germany comes a flat-diaphragm speaker that uses honeycombed ceramic material. The company, Mac Audio, claims that this enables the speaker to vibrate axially without material deformation and ensuing sound distortion from 50 to 6500 Hz. The novel development was prompted by the great increase in dynamic range produced by digital compact discs.

SILICON VALLEY RANKS #1. It's no surprise to learn that Silicon Valley leads all other areas in number of electronics companies. An industry group study (American Electronics Association) reveals that this area has 331 such businesses, with neighbors Santa Clara and San Jose next in line with 316 and 296, respectively, followed by California's San Diego (253) and Mountain View (208). New York City ranks next with 190, followed by Minneapolis, MN (155); Palo Alto, CA (146); Dallas, TX (142); Irvine, CA (124) and Portland, OR the same.

For more information on products described, please circle the appropriate number on the Free Information Card bound into this issue or write to the manufacturer.

High-Performance Communications Receiver

The Model FRG-8800 is a deluxe hf communications receiver from Yaesu Electronics for tuning the 150-kHz to 29.99-MHz band. Direct frequency entry is provided through a front-panel keypad, which also controls scanning functions and storage/recall of channels programmed into memory, all under control of an 8-bit microprocessor. A large green LCD window displays tuned frequency, operating mode, and signal-strength information on a SINPO/S-meter bargraph. The general-coverage receiver offers selectable agc, all-mode squelch, two 24-hour clocks, and recording capability, including timer switching.

A facility is built in for easily interfacing the receiver with a personal computer for expanded operating control. Pushbuttons on the front panel are provided for selecting operating mode (AM, LSB, USB, CW and FM); narrow/wide bandwidth; agc on/off; noise blanker on/off; and fast and slow frequency scanning. A large manual tuning (rotary) control is also provided.



Options available include the Model FRV-8800 vhf frequency converter that nests inside the receiver and is tuned by the front-panel controls to add the 118-to-173.999-MHz band, an FM-Wide unit, an active antenna, and an antenna tuner that covers 150 kHz to 30 MHz. \$599.

CIRCLE NO. 112 ON FREE INFORMATION CARD

Cordless Headphone System

Nady's new cordless stereo headphone system allows you to listen to music through a high-fidelity headphone, without the restriction of the usual cable umbilical. The system works with any audio source and has a range of about 35 feet in a 360°

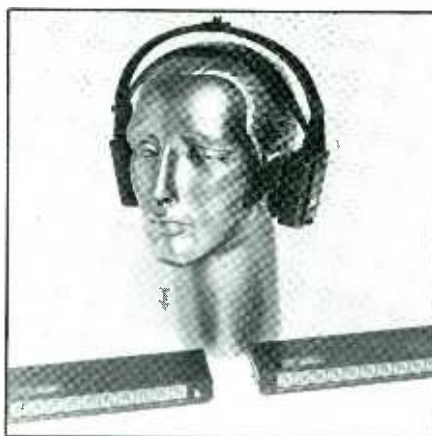

zone. The system consists of a Model IRT-200 infrared transmitter and a Model IRH-210 infrared stereo headphone/receiver. (Special transmitters that provide more coverage in

larger or oddly-shaped rooms are also available. They are series-linked in a master/slave arrangement.)

The headphone/receiver has a rated frequency range of from 50 to 15,000 Hz at less than 1% distortion. Headphone/receiver power is supplied by a 9-volt battery, while transmitter power is obtained from the ac line. The transmitter plugs into any audio output source and radiates an audio-modulated IR signal, which is picked up by an IR sensor on the headphones and thereafter demodulated by the receiver. Any number of receiver/headphones can be used in an area.

CIRCLE NO. 113 ON FREE INFORMATION CARD

Test Clip For Closely Stacked Boards

New from AP Products is an innovative test clip that fits between closely stacked printed-circuit boards to greatly simplify testing of integrated circuits. Called the "Low Profile

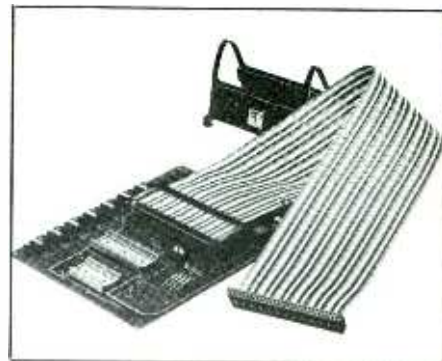

Logical Connection™ System," it eliminates the need for 'extender boards and umbilical-type connectors required by standard test clips. Height is just 0.33" which allows for testing of ICs on boards that are spaced as little as 0.5" apart.

An 18" flat ribbon cable allows for a faster and easier connection to test equipment than does umbilical hookup. Installation of the clip is simple. An application tool allows the test

clip to flex open and fit securely on the IC. The tool can then be removed, the IC tested, and the tool used again to disconnect the clip. The standard end termination is a female socket connector. However, a custom end termination for nonstandard needs can be ordered.

CIRCLE NO. 107 ON FREE INFORMATION CARD

Remote Radar Detector

SuperFox II from Fox Marketing is a new superheterodyne remote radar detector with a dielectric focusing lens to pick up radar signals at long range, including the new pulsed K-band radar.

The radar detector offers such convenience features as preset sensitivity and an LED range display. In the preset mode, sensitivity is at its maximum. By using the squelch control, you can manually adjust sensitivity for local conditions. The LED display changes from green to yellow to red as relative strength of the radar signal increases. The display is recessed to protect against washout in bright light and is faced with a polarizing filter. Backing up the LED display is an audible alarm that grows in intensity as the source of radar signals becomes stronger.

The control module mounts under the dashboard, while the waterproof, corrosion-resistant receiver mounts behind your car's front grille. \$299.95.

CIRCLE NO. 106 ON FREE INFORMATION CARD

300/1200-Baud Modem

Anchor Automation's new Signalman Express 300/1200-baud direct-connect modem, with a standard RS-232 data interface, has a host of features not generally found in its price class, \$439. Its operating modes are automatic ANSW/ORIG selection, microprocessor-controlled dialing, answer, autodial from memory, and automatic speed-mode selection.



The automatic dial feature is coupled with its telephone number storage system, which holds up to 10 numbers of 48 characters each. Additionally, the modem has an audio line monitor speaker with volume control, analog loopback self-test, and eight mode-configuration switches. Also provided are tone and pulse dialing, dial-tone selection and busy detect. There are eight indicator lamps. The modem measures 9" x 6" x 1 1/2".

CIRCLE NO. 105 ON FREE INFORMATION CARD

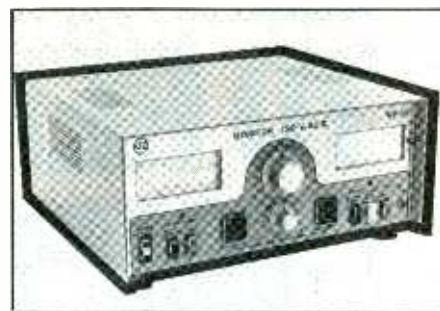

Variable Isolated Ac Power Source

VIZ's new Model WP-30 isolated power source offers an ac output that is fully variable from 0 to approximately 150 volts at 60 Hz, with continuous 0-to-5-ampere output current to a maximum of 650 VA. Maximum output current can be preselected by the user. Thereafter, if a load should attempt to draw more current than what the unit is set for, a built-in latching relays opens the circuit and reduces output voltage and current to zero.

Among the power source's features are: two parallel three-prong ac receptacles to accommodate more than one load; a power-line leakage tester that measures ac leakage in electrical equipment; and separate 3 1/2" analog pointer-type meters for monitoring output voltage and current. Rated meter accuracy is ±2% of reading. The unit measures 14"W x 12 1/2"D x 6"H and weighs 25 lb. \$399.

CIRCLE NO. 104 ON FREE INFORMATION CARD

Hi-Fi/Multi-Channel TV Videocassette Recorder

Built-in multichannel television sound terminals and VHS Hi-Fi stereo sound record/playback are just two of the highlights of Sharp Electronics' new Model VC-5F7U videocassette recorder. Among the VCR's other features are a 14-day,

(Continued on page 67) ▶

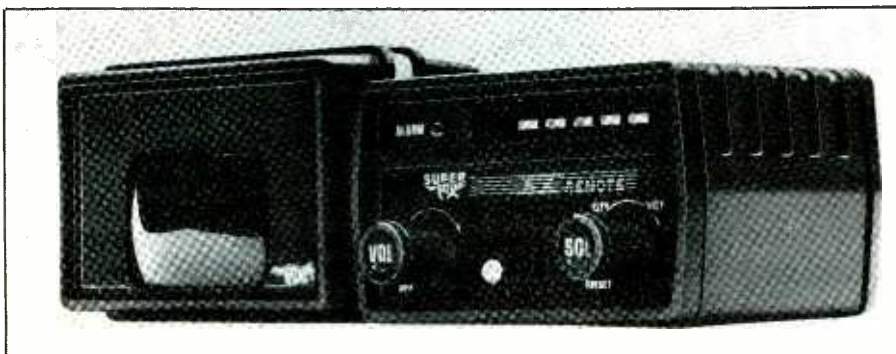

NRI Trains You At Home—As You Build

GET THE KNOW-HOW TO REPAIR EVERY COMPUTER ON THIS PAGE... AND MORE.

IBM is a Registered Trademark of International Business Machine Corporation.
Epson is a Registered Trademark of Epson America, Inc.
Apple and the Apple logo are Registered Trademarks of Apple Computer, Inc.
Compaq is a Registered Trademark of COMPAQ Computer Corporation.
© 1984 AT&T Technologies, Inc.



Your Own IBM-Compatible Computer

Learn the Basics the NRI Way—and Earn Good Money Troubleshooting Any Brand of Computer

The biggest growth in jobs between now and 1995, according to Department of Labor estimates, will occur in the computer service and repair business, where demand for trained technicians will actually *double*.

You can cash in on this opportunity—either as a full-time corporate technician or an independent service-person—once you've learned all the basics of computers the NRI way. NRI's practical combination of "reason-why" theory and "hands-on" building skills starts you with the fundamentals of electronics, then guides you through advanced electronic circuitry and on into computer electronics. You also learn to program in BASIC and machine language, the essential languages for troubleshooting and repair.

You Build—and Keep—a Sanyo MBC-550-2

The vital core of your training is the step-by-step building of the 16-bit Sanyo MBC-550-2 computer. Once you've mastered the details of this state-of-the-art machine, you'll be qualified to service and repair virtually every major brand of computer, plus many popular peripheral and accessory devices.

With NRI training, you learn at your own convenience, in your own home. You set the pace—without classroom pressures, rigid night-school schedules, or wasted time. You build the Sanyo MBC-550-2 from the keyboard

up, with your own personal NRI instructor and the complete NRI technical staff ready to answer your questions or give you guidance and special help whenever you need it.

Learn MS/DOS Operating System

Praised by critics as the "most intriguing" of all the IBM-PC compatible computers, the new Sanyo uses the same 8088 microprocessor as the IBM-PC and features the MS/DOS operating system. As a result, you'll have a choice of thousands of off-the-shelf software programs to run on your completed Sanyo.

Your NRI course includes installation and troubleshooting of the "intelligent" keyboard, power supply, and disk drive, plus you'll check out the 8088 microprocessor functions, using machine language. You'll also prepare the interfaces for future peripherals such as printers and joysticks.



Your NRI course includes the Sanyo MBC-550-2 Computer with 128K RAM, monitor, disk drive, and "intelligent" keyboard; the NRI Discovery Lab®, teaching circuit design and operations; a Digital Multimeter; Bundled Spread Sheet and Word Processing Software worth \$1500 at retail—and more.

100-Page Free Catalog Tells More

Send the postage-paid reply card today for NRI's big 100-page color catalog on NRI's electronics training, which gives you all the facts about NRI courses in Micro-computers, Robotics, Data Communications, TV/Video/Audio Servicing, and other growing high-tech career fields. If the reply card is missing, write to the address below.

NRI SCHOOLS

McGraw-Hill Continuing
Education Center
3939 Wisconsin Avenue, NW
Washington, DC 20016



We'll Give You Tomorrow.

Audio

Third-Generation CD Player: Sony's Model CDP-302

It's interesting to observe the different design tacks that manufacturers have taken with their Compact Disc players. Even co-developers of the basic system, such as Sony of Japan and Philips of Holland (Magnavox-brand in the U.S.), use different approaches.

For example, Philips, right from the start, employed a four-times-oversampling technique and a 14-bit digital-to-analog converter to provide the equivalent of 16-bit resolution. Along with digital filtering prior to D/A conversion, this allowed Philips to remove out-of-band sampling components and other conversion artifacts without introducing severe phase shift at high frequencies.

In contrast, Sony used steep, analog multi-pole filters at the output of the D/A converters. Sony maintained that this approach was better able to suppress residual noise at the player's output, even if it did introduce severe phase shift at the upper end of the audible spectrum.

With the introduction of Sony's CDP-320, the subject of our review, and other so-called "third-generation" models, Sony appears to have approached this design difference with a "best of both worlds" solution.

The new CD player incorporates what Sony calls its "Ultralinear D/A converter." This chip includes a true 16-bit D/A converter with two-to-one oversampling and new digital filters that are said to deliver a high degree of noise rejection. Furthermore, the model incorporates a new Linear Motor Tracking Mechanism that is claimed to provide the fastest track access time in the industry, as well as a new miniaturized laser pickup and a VLSI chip to handle all primary digital functions. Beyond this are many convenience features, such as a wireless remote control, that will be examined later on.

This 17"W x 3 1/4"H x 13"D player weighs less than 15 pounds. Its suggested retail price is \$550.

Description

Considering the relatively low cost of the CDP-302, the unit is loaded with features

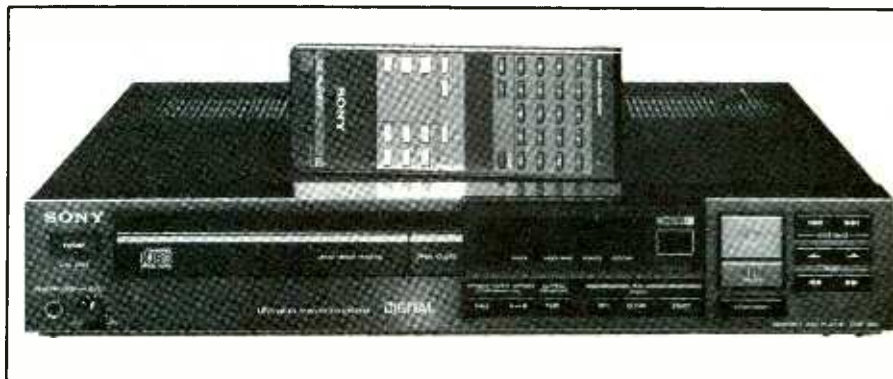

that just a year ago would have been found only on CD players costing twice as much. Aside from the inclusion of a full-function hand-held wireless remote control, the CDP-302 has a host of features. It is able to seek music by track or index number, while random access by track and index number is also possible, as is sequential programming by track or index number (in any random order) for up to 16 selections. Programs can be repeated, as can an entire disc, a given track, or any preselected continuous music segment.

The front-loading drawer of the CDP-302 is flanked by a power switch, headphone jack and headphones level control on the left and an open/close button on the right. The display area to the right of the drawer shows track number being played and elapsed playing time of that track or total remaining play time for the entire disc, depending upon the setting of a touch-switch.

If a given disc is divided into index numbers as well as tracks, these will also be displayed as they are played through. "Disc" is displayed when a disc is moving within the drawer, while "Scan" illuminates as the player's fast-moving pickup is searching for the point on the disc that you have programmed.

Sony might just as well have omitted that last indication, since, with its new linear-pickup motor and low-mass miniaturized laser pickup assembly, locating a desired point on a disc occurs so rapidly that you barely have time to look from the front panel or the remote-control keypad

before the desired point on the disc is reached and music begins to play.

The new Linear Motor Tracking Mechanism bypasses the use of worm and reduction gears in transferring its torque to the laser-beam pickup. Accordingly, the pickup moves at an astounding speed of 50,000 tracks/second, providing 1/2 to 1 second access time, the fastest to date. This was achieved while increasing track accuracy of the pickup through use of a feedback system controlled by a velocity sensor that permits the pickup to slow down when it approaches the desired track to ensure precise selection.

Moreover, error-detection technology has been enhanced with the machine's new Unilinear Converter System, which now employs only a single master clock for all signal-processing and control circuits. Additionally, a new high-speed D/A converter operates with a high-res digital filter that is said to have a band-pass ripple of merely ± 0.01 dB.

Incidentally, while random access programming cannot be done from the remote control, that hand-held unit does permit you to quickly get to any track by pressing only one or two buttons of its calculator-like 23-key pad.

Below the display area are the repeat programming buttons and the touch buttons required for random programming of selections. "Pause" and "Play" buttons are located to the right of the display area, while further to the right are the "Forward" and "Backward" advance buttons used to move the pickup

ahead or back, track by track; index advance and retard buttons; and a pair of manual search buttons. Sound can be monitored while pressing the manual buttons, even though the pickup is moving along the surface of the disc at several times its normal speed.

The rear panel of the CDP-302 is equipped with a pair of stereo output jacks, a sub-code output connector, an auxiliary ac socket, and a special pair of terminals labeled "Remote Out" and "Remote In." These remote jacks have nothing to do with the supplied wireless remote control unit. Rather, they are intended for connection to similar terminals on other Sony audio components, such as its Model TC-W7R cassette deck. When such connections are made, a different, optional Model RM-S410 remote system controller allows control of several components from that special single hand-held remote unit. The sub-code output is a future-use feature that is expected to be able to enable discs with digitally encoded graphics as well as audio to

be played on a TV set or monitor when adding a special accessory.

Laboratory Measurements

Frequency response for the CDP-302 was so uniform that there would be no point in publishing a graph to depict its response characteristics. All you would see would be a ruler-flat straight line superimposed on the "0 dB" calibrated line of such a graph. In fact, deviation from absolute flat response never exceeded 0.1 dB between the measurement extremes of 20 Hz and 20,000 Hz.

Harmonic distortion of a 1-kHz signal, reproduced from our special Philips test disc, measured under 0.003% at 0-dB (maximum) recorded level, increasing to a still negligible 0.033% at a -24-dB recorded level. Even more remarkable was the fact that at 20 kHz, where most CD players exhibit considerably higher orders of distortion, harmonic distortion was still well below 0.01% for maximum recorded level signals.

To give you an idea of the kind of clean signal that is produced by the CDP-302, we ran a spectrum analysis of the output of the machine while a 20-kHz signal at maximum recorded level was being played. The frequency of the spectrum analyzer was swept from 0 Hz to 100 kHz, linearly.

As you can see in Fig. 1, the only significant signal to appear in the photo is the desired 20-kHz output (the tall spike to the left of center in the photo). Normally, when we use an analyzer in this manner with other CD players, we nearly always run into spurious signals at super-audible frequencies which show up as additional "spikes" in the photo, to the right of the desired signal. Of course, these ultra-high frequencies themselves cannot be heard, but they can interact with other frequencies present (such as the 44.1-kHz sampling frequency) to create "beats" which do show up as audible frequencies.

The absence of such spurious "beats" is consistent with our ultra-low intermodulation distortion (IM) readings, which were only 0.002% at maximum recording level for the standard SMPTE-IM test tones, and 0.0023% for the equal-amplitude, twin-tone IM measurement known as IHF-IM. In this last-named measurement, 19-kHz and 20-kHz tones are simultaneously reproduced by the player from a special test disc, and the output signal is scanned by a spectrum analyzer to see if any 1-kHz difference-beat signals are present.

Unweighted signal-to-noise ratio for the CDP-302 was a very high 95.5 dB, increasing to an even higher 101.3 dB when an A-weighting network was employed. Output was linear to within 0.5 dB from maximum recording level to -80 dB below maximum level. Channel separation exceeded 90 dB at mid-frequencies and remained in excess of 85 dB even at the high-frequency end of the spectrum.

Reproduction of a 1-kHz square wave by the CDP-302 is shown in the scope photo of Fig. 2. There is none of the usual "ringing" present at the leading edge of the top of the waveform that is normally seen with players employing steep, multi-

Illustrated are internal details of Sony's drive/laser pickup system.

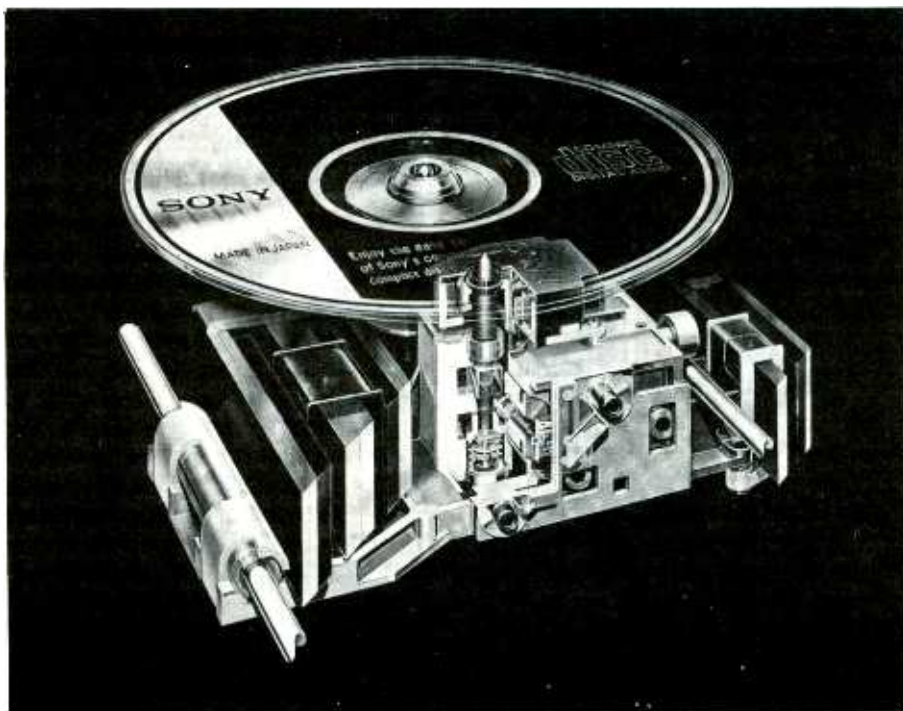

PRODUCT EVALUATIONS . . .

Sony's Model CDP-302 continued . . .

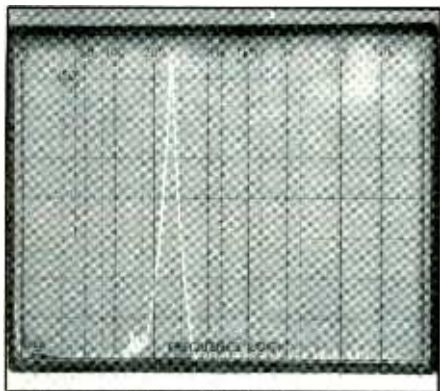

Fig. 1. IM distortion/spurious response components (20-kHz test tone).

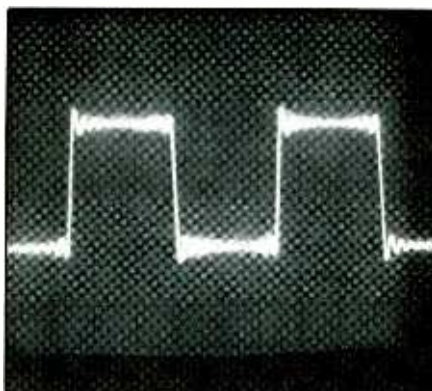

Fig. 2. CDP-302 gave almost perfect square-wave reproduction at 1 kHz.

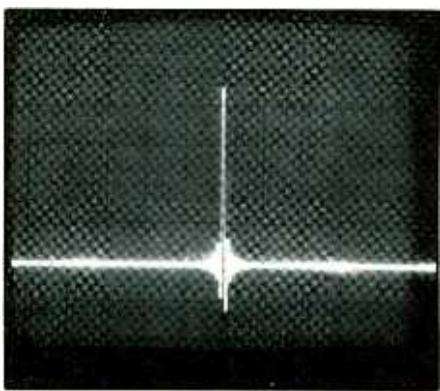

Fig. 3. CDP-302 unit's pulse signal reproduction is typical of players with digital filters, oversampling.

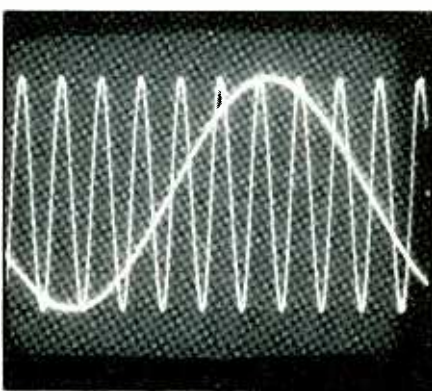

Fig. 4. No measurable phase shift occurred between 200-Hz and 2-kHz signals as reproduced by Sony's player.

pole analog output filters. Furthermore, what ripple there is along the top and bottom of the waveform is so symmetrical that it cannot be attributed to phase shift. Rather, this slight ripple merely means that higher-order harmonics of the square wave are not present to produce the "ideal" square wave shape. This is to be expected, since everything above 20 kHz is supposed to be filtered out by the digital filter arrangement employed in this player. In any case, the waveshape shown in Fig. 2 is the closest thing to a true square wave that we have ever seen reproduced by any CD player.

Figure 3 provides further confirmation of the excellent filter characteristics of

this player. It shows the output from the player when a single unit pulse signal was played on our test disc. Finally, in Fig. 4, you can see the excellent phase characteristics of this player, as a 200-Hz signal is reproduced from the left output while a 2000-Hz signal is reproduced from the right channel of the test disc. If there is no phase shift over that range of frequencies, both signals should cross the zero-axis in the positive-going direction at the same time and that's exactly the case here!

Use & Listening Tests

When you first load a CD disc into this machine, the display tells you the disc's

total number of tracks and total playing time. This is nice. Selecting a track from this staging point, however, points up the utility of a numeric keyboard for this purpose, which is absent. Thus, you must advance the track numbers one by one instead of punching in the specific ones. Up to 16 programs can be locked in for quick selection, of course, once you step to the ones you want "memorized."

The foregoing shortcoming aside, which doubtlessly would add significantly to the model's price, Sony's new CDP-302's performance reflected a host of important advances—it operated beautifully.

"Defective" tracks on our error-correction/tracking disc were played all the way through without even a mute or a mistracking. This means that the player easily corrected for missing information that extended over a length of more than 900 micrometers. Furthermore, the player was about as impervious to external shock as any we've ever seen. For example, we tapped the player's top and sides, but that lightweight laser pickup never lost its place.

Playing a wide selection of CD discs, the CDP-302 produced sound quality every bit as good as its superb measurements indicated it should. Some of our earliest CDs—those which we had been convinced were badly recorded—actually took on an acceptable musicality and better overall tonal balance when played on this machine.

Particularly impressive in light of the model's top tracking ability is its fantastic track-access speed. You get what you want in a blinding flash!

So kudos to Sony for this fine new CD player at a modest price. It is truly a "third-generation" machine. For about \$50 more, you can get the same workings with Sony's CDP-520ES CD player, sold only by electronic specialty stores. The extra bucks gets you slightly tighter-tolerance components on the analog amp board, gold plating on connectors, and a three-year warranty vs. the CDP-302's one-year one.—Len Feldman

CIRCLE 90 ON FREE INFORMATION CARD

Entry-Level VHS VCR: Samsung's Model VT-210T

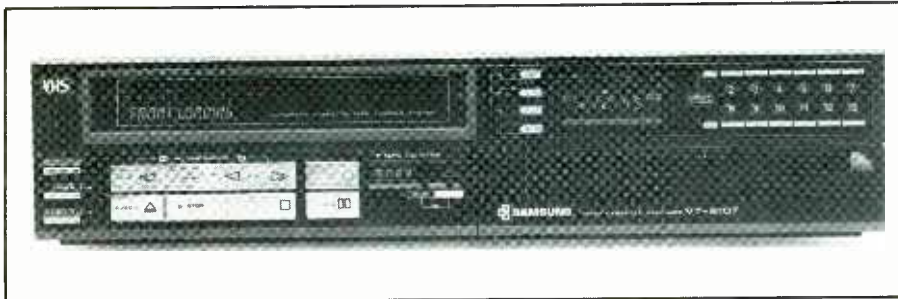

With the addition of videocassette recorders to its popular TV receiver line, Samsung Electronics America, Inc. is a video equipment power to be reckoned with. As many of you know, its products are pegged at the low price end, with the bottom of its line often serving as a price leader for retailers around the country. Examined here is Samsung's least expensive VCR, its "entry-level" model VT-210T, a front-loading VHS VCR that will likely be touted in local retail advertisements at a low price point.

The two-head, machine features three record/playback speeds; one-event, one-week programmable timer; automatic tape rewind; an 82-channel electronic tuner with 12 preset stations; and a six-key wired remote control.

Measuring about 17" W × 4" H × 15"D, the VCR is an attractive-looking slim-line-type machine. Suggested retail price is \$399.95; which could well be brought in below \$300 in some discount operations if past is prelude.

Description

The mainly metal cabinet with plastic front is finished in black. The usual array of controls are on the front panel: Play, Rewind, Fast Forward, Stop, Eject, Record, Pause/Still, as well as Power, Timer, and Video/TV, the latter enabling the user to record one program while watching another. Clock/date function settings are hidden behind a front-panel plastic door. Record Speed selection and Tracking controls are located here, too.

Also on the front panel are a 4-digit mechanical timer, numeric time display (in

white), a Dew indicator that lights should moisture be excessive, speed selection indicators, tape counter Reset and Memory buttons, and 12 channel pushbuttons. In addition there are camera inputs for video, audio and pause. There are light indicators for the following controls when they are activated: Power, TV, Play/Stop/Record/Pause controls, and TV channels.

A plastic door at the flat top of the case

covers TV channel-tuning controls and an afc on/off switch. The 17-ft.-corded remote control plugs into the back of the VCR. Vhf and uhf inputs and outputs are fixed here, too, as well as baseband audio and video outputs for those with TV/monitors, just plain monitors, or other VCRs.

Its vhf/uhf tuner, which doesn't cover cable-channel frequencies among its 12 fixed selections, is voltage tuned—not phase-locked loop. (This does not mean that you can't play or record cable channels, of course. You can! What you cannot do, though, is record a cable channel while watching *another* cable channel.)

Performance Tests

If you go by luminance and red-field signal-to-noise lab-tested numbers of 41 and 45 dB, respectively, then you have a winner here. But if you look at a maximum video bandpass of 2 MHz or less, then

Samsung Model VT-210T Videocassette Recorder Laboratory Analysis

Tuner/system sensitivity	
vhf channels 3/10	-3/-5 dBmV
uhf channels 15/60	0/+8 dBmV
Ac operating range	100-130 V
AC power drain	
In record	23.9 W
In playback	21.6 W
Tape times	
Play (on time)	5 sec.
Stop (off time)	3 sec.
Record (on time)	3 sec.
Signal-to-noise ratio (S/N)	
luminance (SP/LP, SLP)	41/40 dB
chroma (SP/LP, SLP)	45/43 dB
Horizontal resolution (at baseband and r-f)	≤ 2 MHz
Audio response (at baseband)	
SP/SLP	10/4 kHz
Wow and flutter, average/peak (NAB at 3 kHz)	
SP	0.09%/0.025%
LP	0.11%/0.13%
SLP	0.25%/0.315%
Carrier-to-noise (C/N)	
Video	27 dB
Audio	15 dB

Test Equipment: Tektronix Models 7L5 and 7L12 spectrum analyzers; Hameg Model HM605 oscilloscope; Sadelco Model FS-3D VU field-strength meter; Data Precision Models 945 and 1350 multimeters; B&K-Precision Models 1250 NTSC generator, 1035 wow-and-flutter meter, and 3020 sweep function generator; Sencore VA48 video analyst (modified).

PRODUCT EVALUATIONS . . .

Samsung's Model VT-210T continued . . .

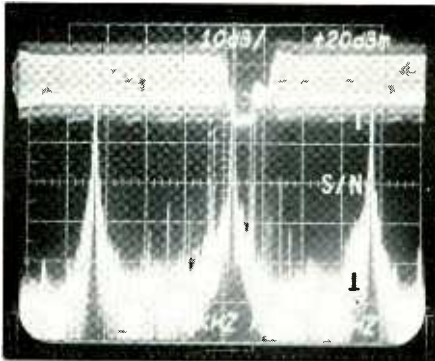

VT-210T's measured redfield S/N was exceptionally high at 45 dB, but there was some evidence of top raster jitter.

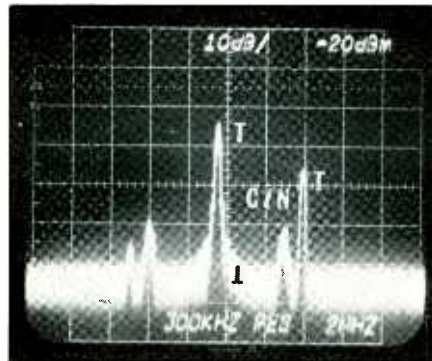

Scope photo shows the audio and video carriers—only the audio carrier is partially removed to the left side.

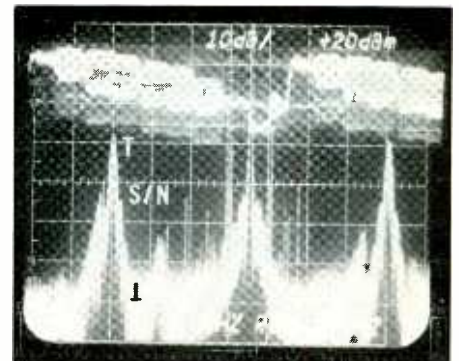

Response with NTSC color-bar signal was fair, and S/N measured 41 dB, but there was some background jitter.

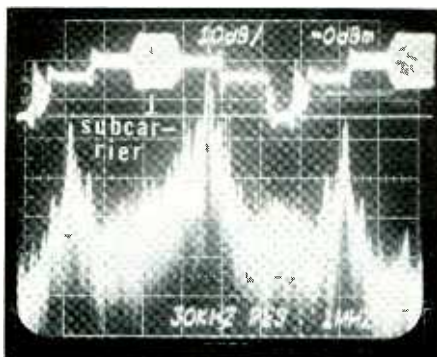

With swept chroma, both 3- and 4-MHz chroma I-Q frequencies are down and 3.58-MHz subcarrier is accentuated.

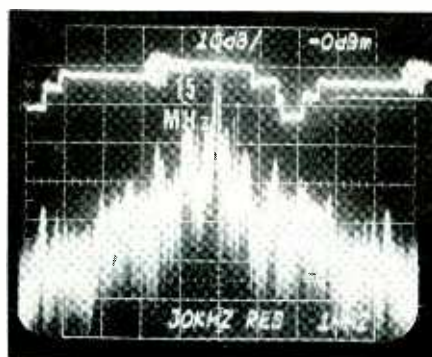

As revealed in these traces, the VT-210T's high-frequency luminance response does not exceed about 2 MHz.



Grayscale staircase response, as indicated by the top trace in this photo, was reasonably linear in the VT-210T.

there could be some concern. Usable audio was a bit more than 10 kHz in SP (standard speed) at one extreme to 4 kHz in SLP mode, its slowest speed. The latter is no great shakes, of course, but not uncommon among modestly priced VCRs.

Gray-scale (staircase) linearity is acceptable, and while the 3.58-MHz color subcarrier is obviously emphasized, reproduced colors are reasonable despite considerable lack of chroma amplitude at both 3 and 4 MHz on either side. As you can see in the swept chroma waveform pictured in this review, the spectrum analyzer display clearly shows the chroma peaking on either side of reference. Both video and audio carrier-to-noise (C/N) figures of 27 dB and 15 dB are reasonable,

although only the audio carrier is well-suppressed (as in vestigial sideband) on the left in our scope photo.

Considering that all these instrument-generated photos were taken in the audio-video baseband mode, with the exception of the final carrier display, you should be aware that there's deterioration in the signal image when going through r-f channels 3 and 4, since the equipment's modulator and the receiver's tuner intermediate frequency amplifiers (i-fs) and video detector contribute additional noise and even some further nonlinearities. Therefore, we'd suggest, if possible, playing this recorder through baseband processors for better results.

Most of the command controls work

reasonably well, although both in FF and Pause/Still you're likely to see some slightly out-of-sync noise lines in each. This, however, is relatively normal for two-head record/playback VCRs. Tuner sensitivities are good, except for channel 60, which is a bit low, and uhf tuning setup isn't too difficult if you rotate the variable resistor tuning wheels carefully. The wired remote control is operated smartly, and you may use the recorder on either baseband or r-f outputs, regardless of baseband or r-f inputs. So, any input will operate all outputs all the time.

The Samsung model tested had modest power drain, amounting to only 23.95 Wrms in Record mode and 21.6 Wrms in playback, both at 120 Vac. The unit oper-

ated efficiently between 100 and 130 Vac, indicating adequate voltage regulation.

Comments

There are a number of basic shortcomings that might be cited for this bottom-of-the line VCR from a company whose products are not known for deluxe features even with one of its top models. Price vs. performance is the name of Samsung's game. Nonetheless, we missed an activity light for Reverse and Fast Forward. Since the screen blanks with these functions, unless you're nose-to-nose with the tape counter, one wonders if either function is really working.

Picture Search, you say? Yes, there is such a function on the Samsung VT-210T VCR. But it operates only on its slowest speed, SLP, which we'll soon delve into.

The use of an electronically displayed counter instead of a mechanical counter is another feature that would be helpful to have. Its operation could be seen from a distance, which would at least take the onus off not having light indicators for Reverse and Fast Forward. Cable-channel renters, too, might miss not be-

ing able to set up some of the channel presets for their reception if their service provides many channels.

The one-event/one-week programmable timer is not in keeping with the extended abilities of most current VCRs. However, it will serve very well for virtually everyone, since very few people really record, in absentia, a host of programs over a period of many weeks.

Main controls—Play, Reverse, etc.—are sure chintzy-looking. They appear to be elongated aluminum pieces with coarse lines across each one. There's evidently a microswitch behind them to activate the electro-mechanical components, but the touch and consequent bar movement is not first class.

But don't be so quick to condemn, one might say. After all, this machine has a desirable front-load at what promises to be a mighty fine low price. So let's look at what the TV screen reveals when the new model is in operation.

Its fastest, and therefore best performing, speed displays an adequate picture and decent sound at a normal viewing distance. Moving in close, you'll see the deficiencies that a 2-MHz maximum

bandwidth capability combined with other shortcomings produces. But though not pinpoint sharp, a forgiving eye won't be bothered at a reasonable distance.

Slow-speed recording/playback is another story, though. On this VCR it is really a waste of effort, the results are that poor. Everything on screen sort of "swims" when in this mode. So even if this mode has the additional feature, picture search, it's a useless frill.

So what do we have here? The lowest-priced VCR in Samsung's new line can serve nicely for watching rented video movies and recording TV programs at its highest speed and playing them back. Its included wired remote control adds a desirable convenience for many people. Beyond this, your prime consideration would be price, price, price. It could well be the lowest in your market area, saving you much bucks and providing you with satisfactory videocassette performance at its highest speed. Alternatively, Samsung announced 4-head models that one might want to also consider.—*Stan Prentiss*

CIRCLE 91 ON FREE INFORMATION CARD

Computers

Stewart Instruments' "PC Spooler" Printer Buffer

The "PC Spooler" printer buffer from Stewart Instruments, Garden Grove, CA, is a handy outboard hardware device that plugs in between your personal computer and printer. Like other printer buffers, it accepts data (up to its memory capacity) from the computer, feeding it to your printer at the much-slower rate that it necessarily handles. This frees your computer for other activity while the printer is still chugging away. The unit is transparent to the user, not requiring additional software modification.

The device comes assembled with either 16K (\$99) or 64K (\$139) of internal memory, with the necessary cables and connectors already installed. It is contained in a small, brown plastic box that measures 4¼"W × 4"D × 1¼"H". Two push-switches and a red LED protrude through the top of the unit, and a brushed aluminum bezel is marked with the switch and LED functions.

Power is provided by a 120-Vac 60-Hz wall-plug transformer and 6-ft. power cord and plug, which is supplied. A short

ribbon cable, extending from the back of the unit, terminates in a female Centronics-type 36-pin connector. Another 2-ft-long ribbon cable terminates in a male Centronics-type 36-pin connector.

Test Results

After making appropriate plug-in connections, just send your computer's output to the printer in the normal way. The LED on the PC Spooler blinks as data comes in and is stored in its memory. If

PRODUCT EVALUATIONS . . .

"PC Spooler" continued . . .

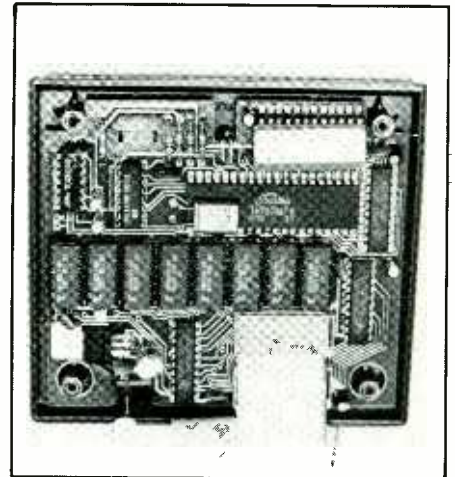

This photo shows an interior view of the PC Spooler with full 64K of RAM.

the printer is on, it will start operating as the PC Spooler accumulates data. If you wish to stop printing, press the right-hand switch to stop printing, and press it again to resume without losing a single character. To clear memory entirely, press the left-hand switch.

I tested the PC Spooler with two computers and two printers. In the first trial, I printed a double-spaced text file of 7633 bytes using the PC Spooler, a TRS-80 Model III and a Star Delta-10 printer. The computer was free in 33 seconds, while the printer continued for another 1½ minutes. Although the Delta-10 is rated at 160 characters per second, the actual thput (accounting for line feeds and time to accept data from the PC Spooler) amounted to about 64 characters per second. Obviously, the larger the printing task (and the slower the printer) the greater the advantage of using a printer buffer like the PC Spooler.

For comparison, I then printed a 10,881-byte-long program listing. It took only 13 seconds for the PC Spooler to accept all the data and free the computer; that's about 837 characters per second. The same printer required 187 seconds to print the entire listing, a thput of only about 58 characters per second. The sig-

nificance of this is that it took more than 14 times longer for the printer than the Spooler! Even on this relatively short task, almost three minutes of free computer time became available.

Next I used the PC Spooler with a Sanyo MBC-555 microcomputer and a relatively slow CP-80 Type 1 printer. I printed a 9552-byte listing. The PC Spooler freed the computer in 52 seconds, so the transfer rate was about 184 characters per second. The printer, which began printing while the Spooler was accepting data, took 240 seconds, for a thput of about 40 characters a second. The computer was therefore available for use about three minutes sooner that it would have been without the Spooler.

How It Works

Figure 1 illustrates a block diagram of the unit. In addition to eight memory chips, there are seven other ICs, plus a crystal, voltage regulator and various other discrete components. All components and chips are mounted on a single, two-sided printed-circuit board.

Input data is presented to the input interface, and a negative data strobe is generated by the computer. The Spooler re-

turns a busy signal. After input data has been loaded into PC Spooler's memory, Spooler generates a negative-going acknowledge signal, then removes the busy signal from the input interface so that it's ready for the next input data.

Two independently controlled memory pointers are maintained by the microcontroller, one for storing input data, the other for retrieving output data. If the output pointer overruns the input pointer, then the PC Spooler memory has become empty, and output to the printer is suspended. If the input pointer overruns the output pointer, then the PC Spooler memory has filled completely, and further input data is inhibited by sending a busy signal back to the computer.

Printing can be temporarily suspended by a single pressing of the STOP/RESUME PRINTING pushbutton. Data will continue to be loaded from the input until either done or the PC Spooler memory is full. Printing can be toggled back on by once again pressing the STOP/RESUME PRINTING pushbutton switch.

Printing can be permanently suspended by pressing the CLEAR MEMORY pushbutton, which erases the PC Spooler's mem-

(Continued on page 92) ▶

EXPAND YOUR CAREER HORIZONS...



The CIE Microprocessor Trainer helps you to learn how circuits with microprocessors function in computers.

START WITH CIE.

Microprocessor Technology. Satellite Communications. Robotics. Wherever you want to go in electronics ... start first with CIE.

Why CIE? Because we're the leader in teaching electronics through independent study. Consider this. We teach over 25,000 students from all over the United States and in over 70 foreign countries. And we've been doing it for over 50 years, helping thousands of men and women get started in electronics careers.

We offer flexible training to meet your needs. You can start at the beginner level or, if you already know something about electronics, you may want to start at a higher level. But wherever you start, you can go as far as you like. You can even earn your Associate in Applied Science Degree in Electronics.

Let us get you started today. Just call toll-free **1-800-361-2155** (in Ohio, 1-800-362-2105) or mail in

the handy reply coupon or card below to:
Cleveland Institute of Electronics,
1776 East 17th Street, Cleveland, Ohio 44114.



Cleveland Institute of Electronics
1776 East 17th St., Cleveland, Ohio 44114

MO-36

Please send your free independent study catalog. For your convenience, CIE will try to have a representative contact you — there is no obligation.

Print Name _____

Address _____ Apt. _____

City _____ State _____ Zip _____

Age _____ Area Code/Phone No. _____

Check box for G.I. Bill bulletin on Educational Benefits

Veteran Active Duty

MAIL TODAY!

CIRCLE 5 ON FREE INFORMATION CARD

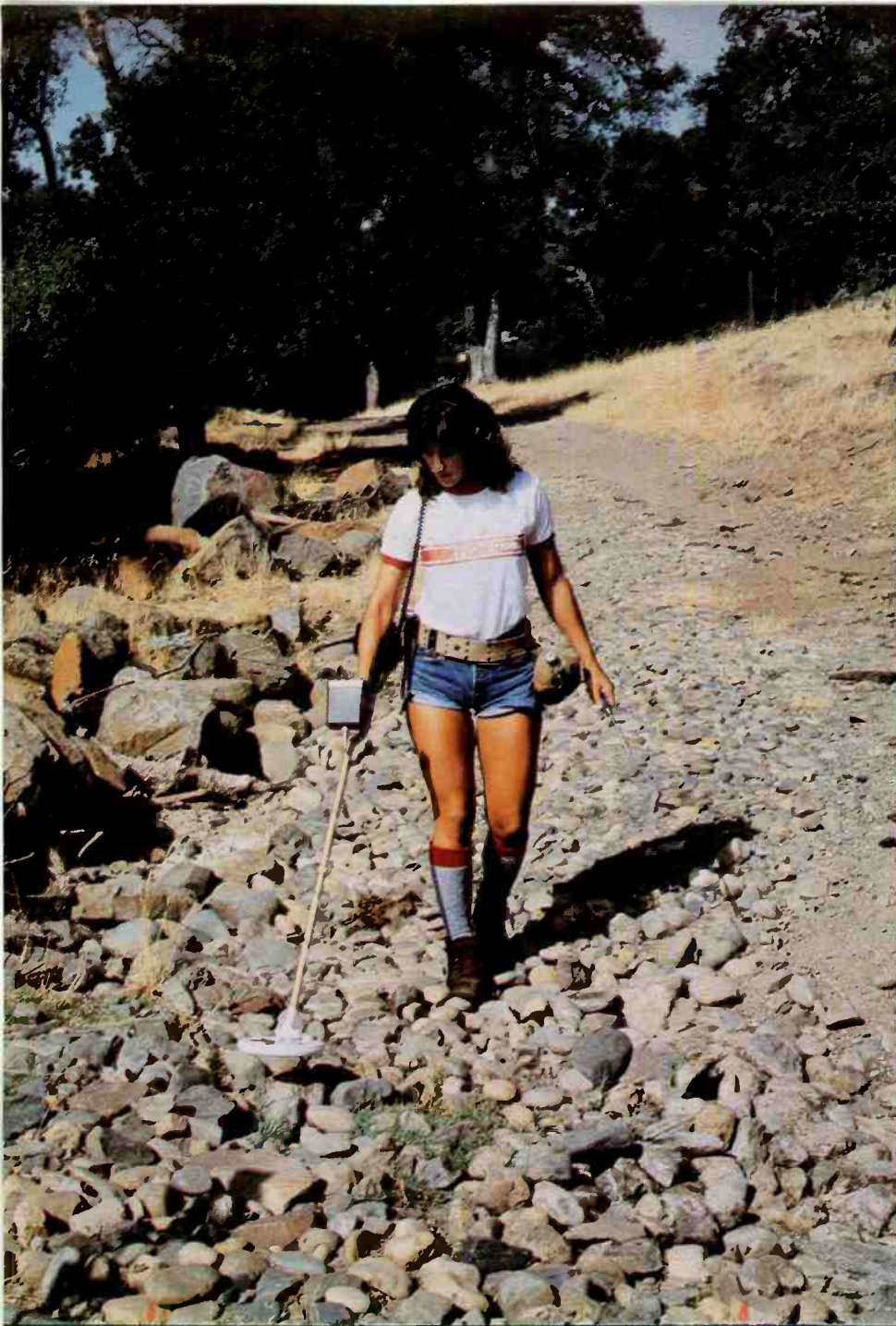

By Gerald S. Pattee

Portable metal detectors have been used by the "public" for more than a quarter-century now to locate buried metallic objects such as rings, coins, and other "treasure." On land and beneath the sea, they have been key tools of the trade for many treasure hunters, with thousands of mapped locations pinpointed as likely areas to find buried and sunken treasure.

Basically, a metal detector is only an audio oscillator whose resonant circuit is changed when a metallic material is encountered. The change is registered by an audio sound or a meter's movement. A large "search" coil held in a horizontal plane is passed over a suspected treasure-trove area, while searching for such an inductive interaction.

From a base of a simple oscillator design, advanced electronics technology has been applied to modern metal-detectors to make them substantially easier to set up and to allow them to distinguish between various objects, from ferrous to nonferrous matter. For example, meter scales are often calibrated in items—nickel, iron, copper penny, etc.—rather than in conductivity, which the material actually represents. Many of today's detectors can also indicate how deep the object is buried, and distinctive changes in audio pitch indicators enable a treasure hunter to "hear" a description of a detected object before even looking at a meter for confirmation.

Here are details on what makes the metal-detector tick and the features to consider when comparison shopping to buy one.

Different Approaches

There are a number of different approaches a designer or manufacturer can take to produce a working metal

Metal Detecting For Fun & Profit

(Part 1)

How modern metal detectors work and tips on treasure hunting and purchasing

detector. Each has its own set of advantages and disadvantages.

•Perhaps the simplest design approach is that of the *BFO* (beat-frequency oscillator) type of metal detector. This type of detector employs two oscillators, a mixer, an amplifier and a speaker and meter, either of which or both can be switched in by the user. (Some very inexpensive metal detectors omit the meter and provide audible indication only.) The block diagram of the BFO system is shown in Fig. 1.

In the BFO system, one oscillator generates a fixed-frequency signal, while the other oscillator's frequency is allowed to vary. Part of the variable oscillator's frequency-determining network is an inductive loop that serves as the system's pickup coil. When a metallic object is placed within the loop's field, it changes the inductive reactance of the coil and shifts the frequency of the variable oscillator. (Initially, both oscillators are tuned to each other so that their frequencies are almost identical.)

The output signals from the two oscillators are fed into a mixer, where they are heterodyned (beat together) and the difference-frequency signal is filtered and fed to an amplifier stage that, in turn, drives a speaker and/or meter. When the variable oscillator is initially tuned to the fixed oscillator, away from any metal, a beat frequency signal that sounds like "motorboating" will be heard. Thereafter, any metal or conductive material that passes into the pickup coil's field will cause a shift in the coil's inductive reactance, changing the frequency of the variable oscillator, which results in a change in the pitch of the sound coming from the speaker. The greater the change in the coil's inductive reactance, the higher will be the pitch of the sound.

•*Transmitter/receiver* (TR), or balanced-induction, systems operate on the principle of a balanced condition within the pickup loop. This sys-

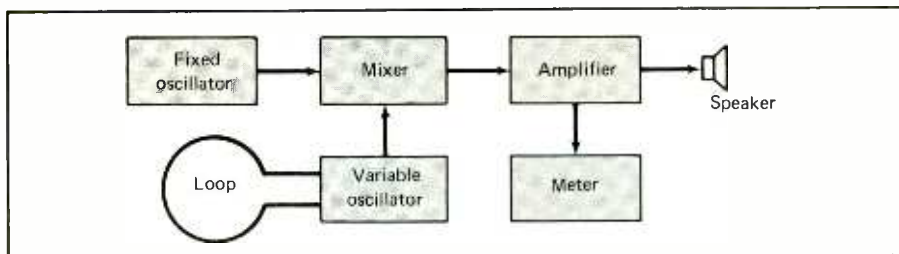

Fig. 1. Beat-frequency oscillator is approach commonly used in simplest metal-detector designs. It uses one fixed and one variable oscillators.

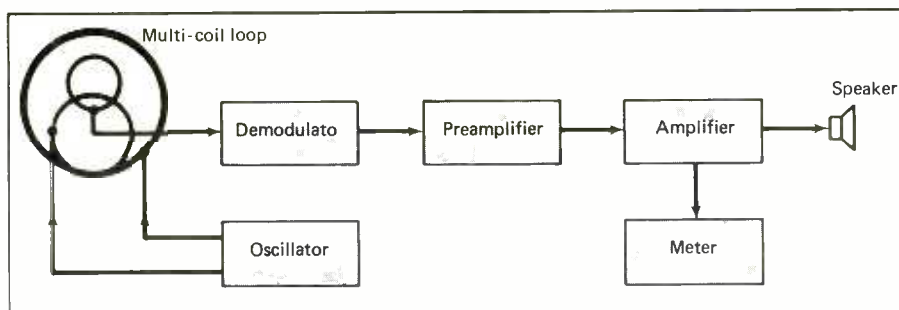

Fig. 2. Balanced-induction (also known as transmitter/receiver) design represents a step upward in level of metal detector circuit sophistication.

tem (Fig. 2) employs one modulated r-f oscillator, a multi-coil loop, and demodulator, preamplifier and amplifier circuits. Detection indication in this system (indeed, all systems) is either audible through a speaker or visual on a meter or both.

In the TR system, the oscillator operates at approximately 100 kHz. The loop consists of two exciter coils and one pickup coil, with the last positioned and tuned at the factory during assembly for a null (minimum-signal) state.

The signal from the pickup coil first goes to the demodulator, which extracts the audio information from the modulated signal. The resulting low-level signal is then boosted by the preamplifier and amplifier for delivery to the speaker and/or meter.

Passing a metal or mineral object into the field of the loop distorts the electromagnetic field generated by the exciter coils, causing more or less signal to be induced into the pickup coil. The degree of distortion directly controls the pitch of the sound and

how far the meter's pointer swings.

•*TR discriminating detectors* normally function in the same manner as the balanced-induction metal detector just described. The discriminator function is accomplished by summing phase-shifted signals.

A reference signal that is in-phase with the signal sent to the loop is compared with the signal received from the loop. Comparison is accomplished by shifting the reference phase in the same direction a nonmagnetic mineral (a copper coin, for example) would cause the phase of the received signal to shift. Addition of signals of the same phase causes a signal to be passed through the amplifying system and on to the speaker/meter system. Magnetic minerals, on the other hand, cause such a drastic shift that addition to the shifted reference signal cannot be accomplished. As a result, magnetic mineral signals are automatically eliminated.

•*Ground-canceling* (GC) metal detectors have the ability to reject or nullify false signals caused by varia-

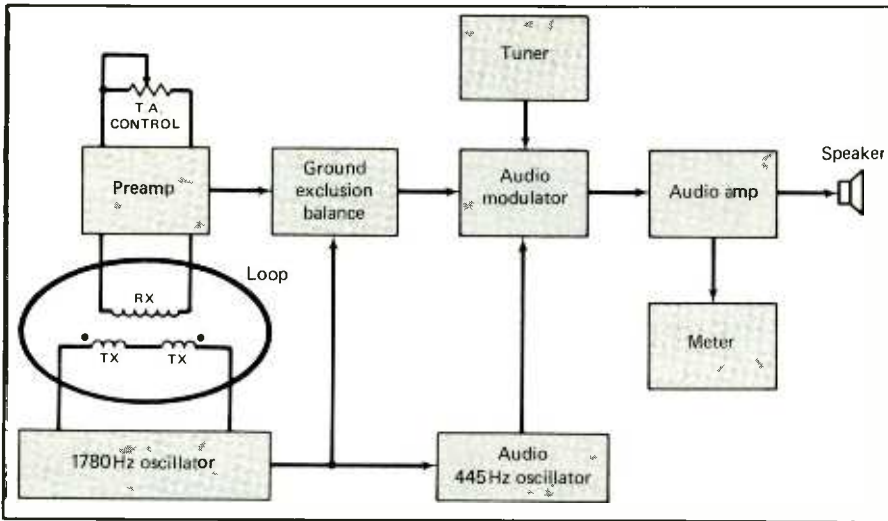

Fig. 3. Ground-canceling metal detectors consist of nine elements, including the loop; they reject false signals caused by variations in magnetic soil.

tions in magnetic soil. They generally consist of the eight basic elements shown in Fig. 3.

As with the previous two systems, the GC system's loop is nulled at time of assembly for minimum signal output. With no target in the loop's field, the output from the GC circuit is a steady dc voltage that is proportional to the amount of signal coming out of the loops. The tuner is adjusted so that audio modulation produces either a tone or no tone, depending on the user's preference.

If material coming into the loop's field shares the same time relation-

ship with the oscillator and GC circuit, there is no change in ground balance output and the detector is in a state of balance. However, if loop output either leads or lags oscillator output, GC circuit output will change proportionally and the increased output from the audio modulator will be passed through the audio amplifier to produce a detectable change in speaker output and/or meter pointer deflection.

By proportionally adjusting the tuner and GC control, the detector can be returned to the balanced state to neutralize any variations in the sig-

nal induced by soil conditions. When the system is in-balance, a ground-canceling detector will respond equally to ferrous and nonferrous metals, with little or no loss in signal.

Primitive by today's standards, some of the detector designs described above are still in use—only they have been improved upon over the years to the point where they are hardly recognizable as such. Old or new, however, it is results that count, and many modern designs are more than adequate in this respect. Looking at the latest crop of sophisticated metal detectors, it is obvious that the big "in" system for the 1980s and perhaps on into the 1990s is the motion detector.

Motion Versus Nonmotion

Regardless of the electronic design of the circuitry, all metal detectors fall into one of either of two basic categories—motion and nonmotion. Each category can be subdivided according to the physical and electronic configurations of each detector.

With a motion detector, if you hold the sensing coil (loop) stationary a few inches above a metal target, you will obtain neither a sound from the speaker nor a reading on the meter. However, as you move the loop back and forth or up and down, the

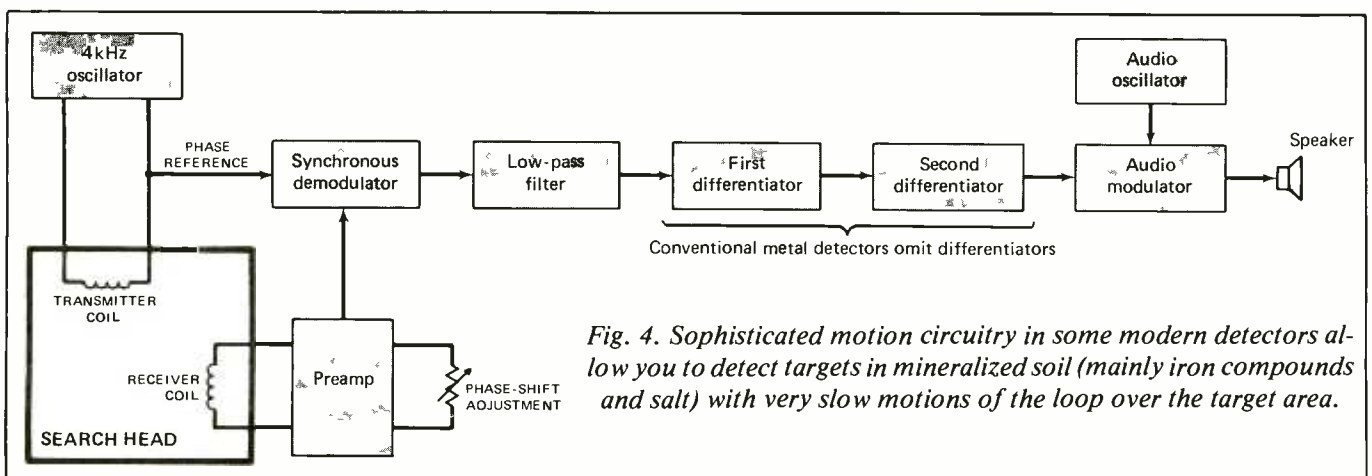
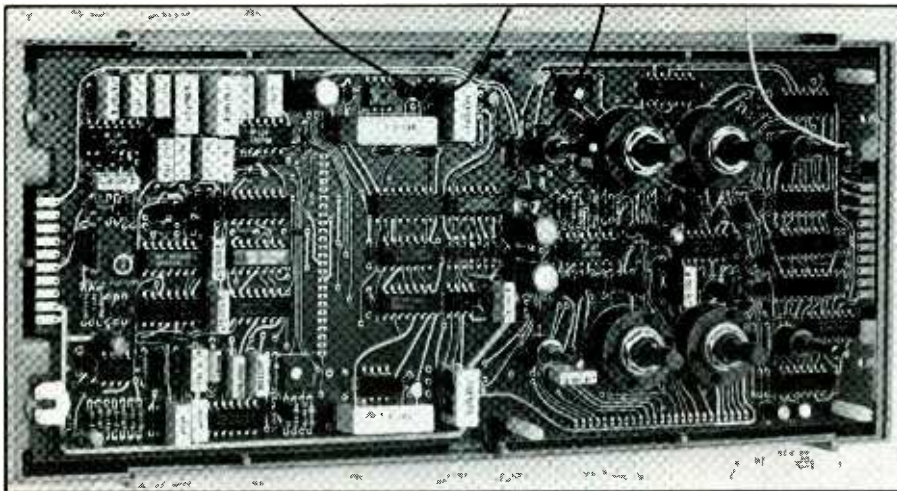
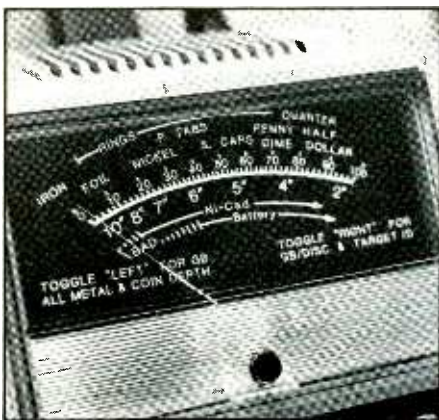

Fig. 4. Sophisticated motion circuitry in some modern detectors allows you to detect targets in mineralized soil (mainly iron compounds and salt) with very slow motions of the loop over the target area.



A look inside Teknetics' Model 8500B will give you some idea of the level of sophistication achieved in modern identification-type metal detectors.



Meter-type visual indicators on metal detectors have been and still are traditional pointer types (left). Teknetics' top-of-the-line Model 9000, however, uses a unique liquid-crystal display window (right) instead.

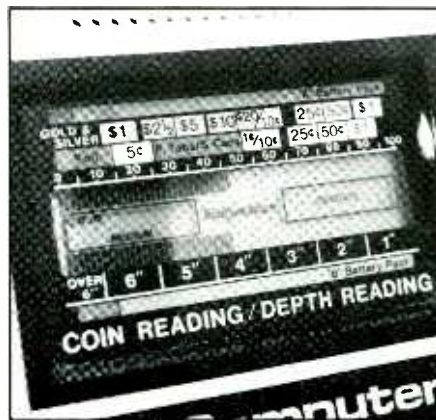

ics' top-of-the-line Model 9000, however, uses a unique liquid-crystal display window (right) instead.

speaker will emit a sound and/or the meter's pointer will swing up- and down-scale. The response will be abrupt as the loop is swept toward and away from the metal target.

With a nonmotion, or manual, detector, you must first adjust the tuner for a low-frequency (or low-volume) sound from the speaker and then move the loop into position over the target. At this point, even if you hold the coil stationary, the detector will immediately begin to respond as you pass the loop over or near the buried object. Slowly moving the loop away from the target causes the sound to

gradually fade, until it is back to where it was when you completed tuning the detector.

In operation, all types of metal detectors radiate an electrical field, which actually does the detecting. However, with a nonmotion detector, it is the operator who is responsible for maintaining the field, by manually adjusting the controls for a balanced condition away from any metal or conductive material.

A motion detector constantly searches for electronic balance. If it is not in motion, it sits at electronic "idle." Moving the detector creates

Historical Background

What started out as an experiment in the Los Angeles garage of research engineer Dr. Gerhard Fisher in the late 1920s has opened up an entirely new way of finding buried metal objects. Dr. Fisher's interest in metal-detection equipment was sparked by errors aircraft pilots discovered in their direction-finding gear when flying over areas of highly conductive mineralized ground. He correctly concluded that a portable electronic device for finding buried metal and ore deposits could be developed.

In 1931, Dr. Fisher was granted his first metal-detector patent. His equipment was ungainly—two wood boxes containing some simple copper coils and a few vacuum tubes. However, from this humble beginning was born the metal detector that has spawned a whole new industry.

Little serious interest was expressed in metal-detection equipment in the years between 1931 and early in the 1940s. Shortly into World War II, the U.S. Army began using metal detectors ("mine sweepers" in the popular press) to locate buried land mines. It was not until the appearance of practical transistors in the 1950s that it became possible to build truly portable, lightweight metal detectors. Starting with these simple, basic designs, metal-detecting equipment has since evolved into truly sophisticated electronic instruments that can cost as much as \$500 and more.

an imbalance, when in the presence of a metal object, that becomes stronger than the detector's ability to keep itself in balance and triggers the alerting system. Stopping movement allows the detector to rebalance itself and discontinue the alert.

A major problem with most nonmotion metal detectors is that you must continually readjust them to maintain a balanced state. Also, portable nonmotion metal detectors are subject to drift as battery voltage drops, temperature and humidity changes, etc. Needless to say, users of early detection equipment had their

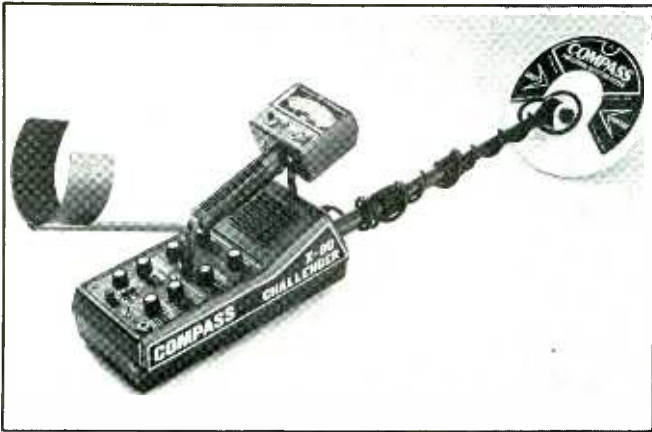

Compass' Model X-80 Challenger metal detector features a three-section telescoping stem that collapses to smallest size in industry and fatigue-reducing arm rest.

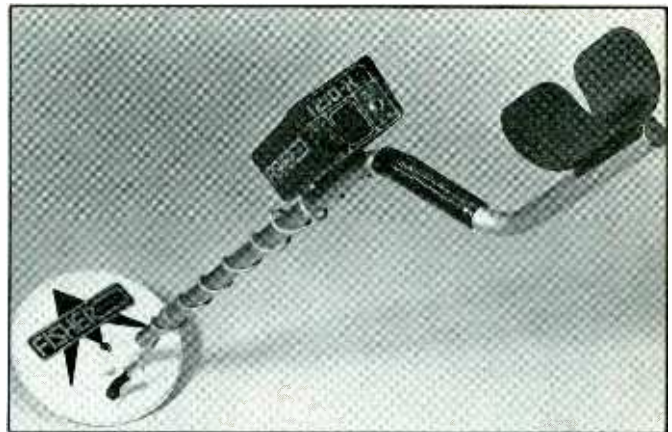

Like other models in the line, the Fisher auto-tune/ground-reject Model 1210X features slow-motion VLF discrimination circuitry in an economy priced package.

hands full just keeping everything running the way it should.

Although it was not the first company to introduce a motion-type metal detector, Fisher Research Laboratory has recently patented a model that typifies modern design. With introduction of its X Series detector, Fisher has achieved a design that automatically rejects ground mineralization and metallic trash but detects buried targets. It also eliminates the need to rapidly "whip" the search coil back and forth.

A unique type of "motion circuitry" is used in the Fisher detectors (Fig. 4). It allows the user to detect targets in mineralized soil (primarily iron compounds and salt) with very slow motions of the search head over the target area.

The search head consists of a transmit and receive coil arrangement in a co-planar induction null balanced configuration. The transmit coil is energized at very-low frequencies to cause eddy-currents in metallic targets. The resulting imbalances and phase signatures of the various metallic and/or conductive objects are detected by the receive coil, which generates a signal that is then amplified and synchronously demodulated and low-pass filtered. The demodu-

lated signal is then passed through a double differentiator circuit that controls audio responses over the center line of the target.

Concurrent with the detection of target signals, the circuitry also senses the phase and amplitude of background (soil) signals and automatically nulls them out, leaving only the target information. Critical circuit paths that are subject to dc drift are then ac-coupled to provide stable drift-free operation.

Identification Detectors

How does an identification-type metal detector know what it is looking at and separate a dime from a quarter or a ring from an aluminum pulltab? The answer is that it really does not know. All the detector understands is that the object in question has the relative size, shape and conductivity of an object similar to what it is indicating.

As its name implies, a metal detector simply detects metal—or at least objects that have electrically conductive properties. It does not care if the object is worth a fortune or just two cents. To a metal detector, there are only two types of metals. One is ferrous metal, which contains iron,

and the other is nonferrous metal, which contains no iron.

Nonferrous metals are better conductors than ferrous metals. If a metal detector simply had to distinguish between high- and low-conductivity metals, a simple go/no-go indicator would suffice. However, most metallic objects nowadays are alloys in which are combined different metals. For example, gold rings are alloys; a 10K gold ring is made up of so many parts of gold, so many parts of copper, etc. Each alloy has its own conductivity, which can be anywhere between very low to very high. (Only a slight variation in the mixture of metals produces a new alloy.) Every type of metal and alloy, therefore, has its own conductivity "signature."

Thanks to some very fancy electronics, the visual-identification detector identifies the signatures, rather than the items themselves. Unfortunately, some signatures are so close to others, it takes an expert user to interpret exactly what his metal detector has found. The difficulty here is that metals are limited to a narrow range of property parameters—size, shape and conductivity. With so few parameters to evaluate, some doubt is to be expected in a detector's electronic analysis.

Even so, it is common to find that detector meter scale graduations are identified with such legends as nails, nickels, pulltabs, coins, etc. Each designation and its location on the meter scale is based upon the expected degree of conductivity for the item.

At the low (left) end of the scale is the low-conductivity ferrous group, consisting of iron, nails, nickel, etc. Moving up-scale, you will find such medium-conductivity alloy legends as rings, pulltabs, etc. At the top (right) end is the high-conductivity group for alloys that have no or only a minuscule amount of iron in them, such as silver coins.

In addition to the items scale, another very useful feature included on some identification-type meters is a numbered scale with closely spaced graduations. The items scale may be useful for determining what has been detected according to a particular grouping. However, due to the uncertainty of the rough reading, it will not let you actually pinpoint what your detector has located. To be able to do this, you need the finer-graduated number scale. Once you become familiar with your metal detector, you can use the numbers to zero in on the identity of the item.

Using both scales, the meter's pointer might tell you that a dime has been located, but the numbers will help you determine whether it is a silver or a clad (alloy) dime. It might even tell you that you have located a different object altogether, one that is similar in shape and conductivity to a dime but is not in fact a dime.

A final scale frequently included on metal-detector meters gives an indication of the approximate depth of a target buried under the surface of the area under investigation. This scale is usually calibrated in inches from as little as 1" to as much as 6" or more, depending on the make and model of detector. Pointer deflection is a function of the strength of the detection signal delivered to the audio

amplifier and passed on to the meter. An object buried closer to the surface will generate a stronger signal than the same object buried deeper and, therefore, causes a greater meter pointer deflection. Hence, the depth scale is calibrated with maximum detecting depth as its left index and minimum depth at its right index.

Other Improvements

Metal detectors made in the early days of solid-state electronics were skimpy affairs. They employed relatively unsophisticated (by today's standards) circuitry housed inside a box that was only slightly larger than a package of king-size cigarettes. The box was mounted to one end of a stem, the search coil to the other end. The detector might have weighed just a couple of pounds.

In contrast, the case that houses the modern metal detector's electronics is, on the average, much larger because it now contains much more sophisticated circuitry. Whereas an early metal detector might have had only a few transistors and support components, the modern detector generally contains a multitude of components, including more integrated circuits that there were transistors in the early models. (One modern detector, the Teknetics Model 9000 Coincomputer, has four dozen ICs and a dozen transistors, plus more than 250 resistors, capacitors, diodes and controls—all on three compact, densely packed printed-circuit boards.) This level of sophistication requires a lot of real estate, which accounts for the much larger boxes. The result of all this, of course, was an increase in product weight.

Stem design, too, has evolved. Fixed-length stems have given way to tubular metal constructions that can be extended or collapsed to suit the needs of almost any height user.

A metal detector is usually used for hours at a time. Hence, weight becomes a critical consideration. Three

to six pounds might not seem like very much, but the *manner* in which this weight is normally carried can lead to rapid user fatigue. With the detector held in the customary manner (similar to the way you would hold a walking cane), all its weight is concentrated on the wrist and, to a lesser degree, the forearm in a manner that places unaccustomed tension on the muscles of both. Because the search head must be maintained in the proper attitude, wrist motion is restricted and wrist and forearm muscle cramping rapidly sets in.

To combat this problem, manufacturers offer two alternatives. One is removal of the heavy electronics package from the stem and hanging it from a neck strap or waist belt. The other is a modification of the basic stem that makes it into a crutch-like device with a cup-like rest that fits around the forearm and transfers most of the muscle action from the wrist to the more powerful forearm. Either or both options are available for most modern metal detectors, or you can obtain a detector specifically designed to be one or the other.

Coming Next Month

So far, we have traced the metal detector through its various stages of evolution, starting when it was little more than a simple curiosity and ending with its present level of sophistication. Our focus has been on the different approaches the various manufacturers take in designing the electronic wonders that now grace dealer shelves. Many of these are so advanced that they do everything except dig up what you find.

Next month, in the concluding part of this article, we will zero in on what you should look for when planning to buy a metal detector. To this end, you will find a detailed table that lists current manufacturers of metal detectors, the various models available, prices and salient feature. **ME**

Portable Computers '85: One Lap Ahead

(Part 1)

A critical look at laptop computers

By Eric Grevstad

Briefcase or laptop portable computers can be very useful to many people—from traveling businesspeople to note-taking students. Poorer screen legibility notwithstanding when compared to desktop video display monitors, their compact size and battery power supplies make them attractive alternatives to not having a computer for on-the-move work where ac power is often not available.

Writers who travel are especially attracted to portable computers. One of *Modern Electronics*' contributors, for example, finishes a day's work on a portable while flying to and from trade shows. He downloads his outpourings to his office computer, where he finalizes editing on a better screen display. From warehouse inventory takers to executives who extract information from their headquarters' bigger computers, portable computers are proving to be invaluable tools for some people.

It's in this area, too, that the technological pace of computers seems to be hottest. Today's portables are blurring yesterday's models. There are 8-bit machines for under \$1000 and 16-bit machines for over \$2000. Furthermore, the \$999 note-takers are growing power to match the larger, folding-display portables, while both groups will be challenged by hybrid machines—laptops as easy to use as a Model 100 and run the same software as an IBM PC/XT.

Let's examine this relatively new

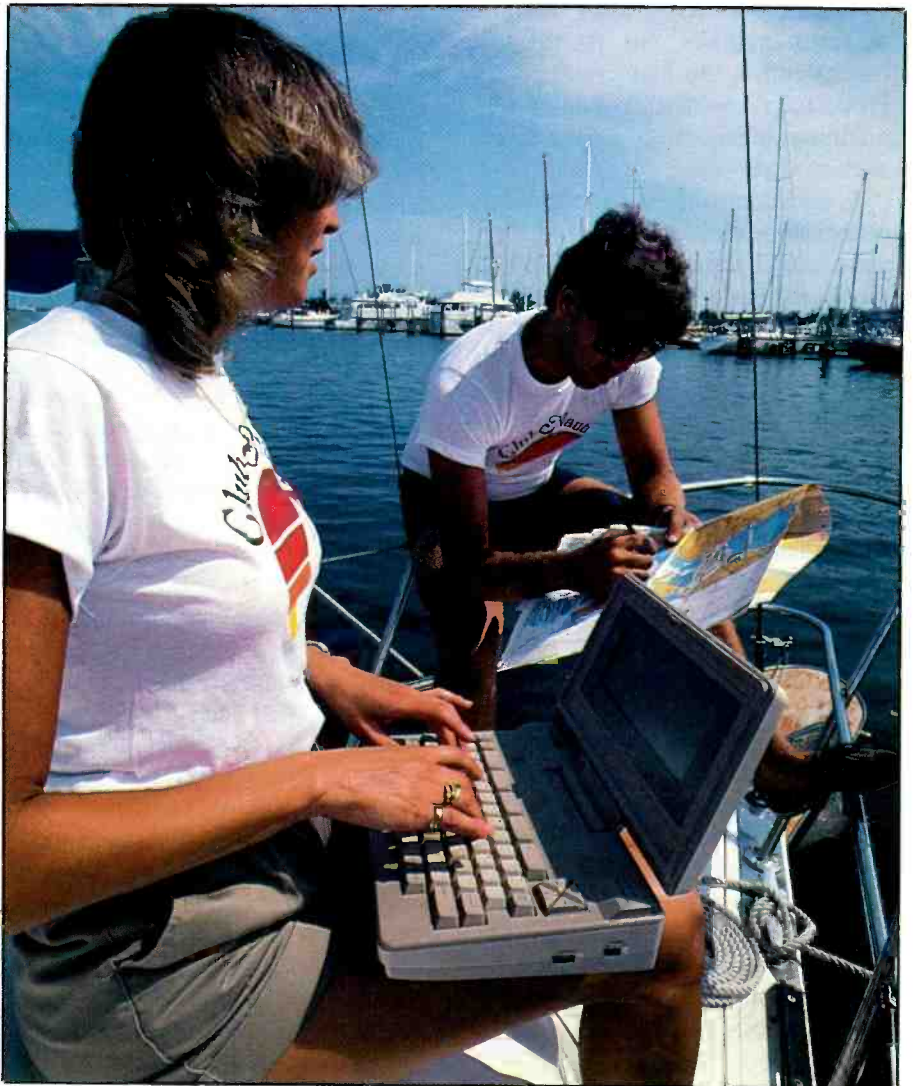

breed of computer to see where it may fit into the scheme of things.

A Short History

The first true portable, back when the word referred to the Kaypro- or

Compaq-style suitcases now called transportables, was the Epson HX-20. The four-pound package carried a lot, by September 1982's standards—16K RAM, a microcassette drive for mass storage, and an

... In The Beginning

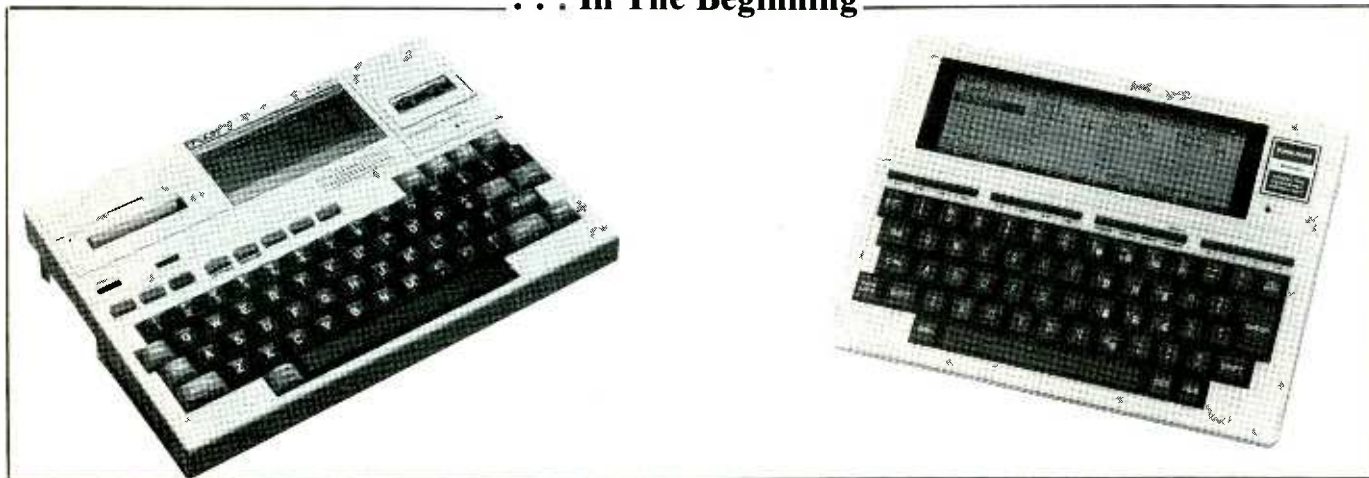

Laptops first appeared in late 1982 when Epson introduced its HX-20 "notebook" computer (left); it failed to take the market by storm. Six months later, Radio Shack's Model

100 (right) made laptops attractive to a considerable number of buyers by offering expandable RAM, a much larger display, a built-in modem, and software in ROM.

adding-machine printer—but had little software and only a four-line, 20-column liquid-crystal display. Instead of seeing the HX-20 conquer the market, Epson saw its trademarked phrase, "notebook computer," become generic.

In April 1983, Tandy/Radio Shack set the first landmark. Its Model 100 notebook-size portable came with 8K of memory, expandable to 32K, a quadrupled (eight-line, 40-column) LCD, and a built-in 300-baud modem. Better still, it came with ready-to-run ROM software, selected by an easy screen menu: a terminal program, text editor, address and appointment keepers, and genuine Microsoft BASIC. Except for mass storage (a cassette tape recorder), it had everything most buyers could want for \$799.

So popular was the Model 100 that Tandy soon lost exclusive rights to the design, made by Japan's Kyocera Electronics. On the heels of its success, NEC imported the Kyocera-made PC-8201A. It did not have an onboard modem, but featured up to 64K RAM, effected by switching between two 32K banks that shared the ROM programs. By 1984, Olivetti had some dealers selling another Ky-

ocera version, the M10, which was a Model 100 with a tiltable screen. However, the 100's shortcomings soon became evident. With no operating system per se, it lacked third-party software compared to the CP/M and MS-DOS libraries (most users stuck to Microsoft's ROMware). The screen hardly held a paragraph, and the memory filled quickly enough to require tiresome cassette file-swapping.

Moreover, beyond reporters taking notes and travelers wiring memos to the home office, the Kyocera trio lacked the spreadsheet and database power to endear the computers to many businesspeople.

There was the Grid Compass, of course, which since 1982 has been the delight of the portable market. It featured a 16-bit Intel 8086 CPU and 8087 math coprocessor to outperform the IBM PC, 256K of RAM and 384K of bubble-memory storage, an exotic 25 × 80 electroluminescent display that shined brighter than desktop CRTs, and some MS-DOS software in addition to its own integrated programs. But the Grid debuted at \$8150, and has remained largely the property of cost-no-object buyers like the CIA (which appreciates its

magnesium shielding to guard against emitted-radiation eavesdroppers), though its price has been reduced to about \$4250.

The Ultimate 100

The second landmark portable didn't appear until May 1984, though it didn't earn praise for any hardware innovations. True, its flip-up 16 × 80 screen was the largest LCD to date, and it used the 80C86, the low-power CMOS version of the Grid's 16-bit chip. But its MS-DOS compatibility was mostly a matter of waiting for publishers to format software for its \$795 external drive.

However, the Hewlett-Packard HP-110's appeal lay in two features: elephantine memory and Lotus 1-2-3 in ROM. The only thing bigger than the 9 lb. micro's 272K of RAM, which serves, Model 100-style, as battery-backed file storage, is its colossal 384K ROM—holding MS-DOS 2.11, a text editor, a terminal program, HP's Personal Applications Manager program menu, and Lotus Development Corp.'s best-selling spreadsheet, graphics, and database integrated package.

Now the number-crunchers could

at last work at home or on the road and share their 1-2-3 files with PCs at the office. The magic numbers were enough to revitalize the portable industry, despite Hewlett-Packard's steep price—\$2995 for what is, in effect, the ultimate Model 100, rather than a disk-based, full-screened computer. That came with the third landmark machine, which appeared in September 1984.

The Future, Seen Faintly

The Data General/One has almost no software in ROM, no friendly menu to shield users from MS-DOS, and a modest 128K RAM in its base (\$2895) configuration. What it does have is a built-in 3½" microfloppy drive—holding 720K, twice the data of a PC's 5¼" disk—and the first 25-line, 80-column LCD screen. Except for the different disk format, it's fully IBM compatible. And with an external 5¼" floppy disk (\$795), it runs desktop programs off the shelf.

DG undercut its own portability by charging \$178 for a battery pack and recharger, but the /One can run eight to 10 hours away from an ac outlet with it. This isn't as long as the Model 100's and HP-110's 20 hours per charge, but better than the Grid's one hour. The minicomputer maker did its homework before introducing the portable: there were 70 MS-DOS programs available on 3½" disks when the /One left the factory.

The /One's biggest problem, in fact, is that its 25×80-character (256×400-pixel) display teeters on the cutting edge of LCD technology. To simplify the addressing and refreshing circuitry (the hardware that turns individual pixels on and off and redraws the display, CRT-fashion, to show a continuous image), the screen is treated as four smaller, adjacent screens running separately. Even so, the industry's largest LCD is also one of its dimmest—fine under ideal



Grid Compass has 25 × 80 electroluminescent display brighter than CRTs.

lighting conditions, but no substitute for the real thing.

More Technology

LCD screens, in fact, remain the biggest hurdle in portable technology. It's the one factor preventing laptops

from being real PCs instead of peripherals. Since it takes little current to realign liquid crystals, stirring their cigar-shaped molecules from perpendicular to parallel to a glass faceplate, LCDs are well suited for battery power. However, since they reflect light instead of emitting it,

Data General/One has 25 × 80 LCD display and bundled software in ROM.

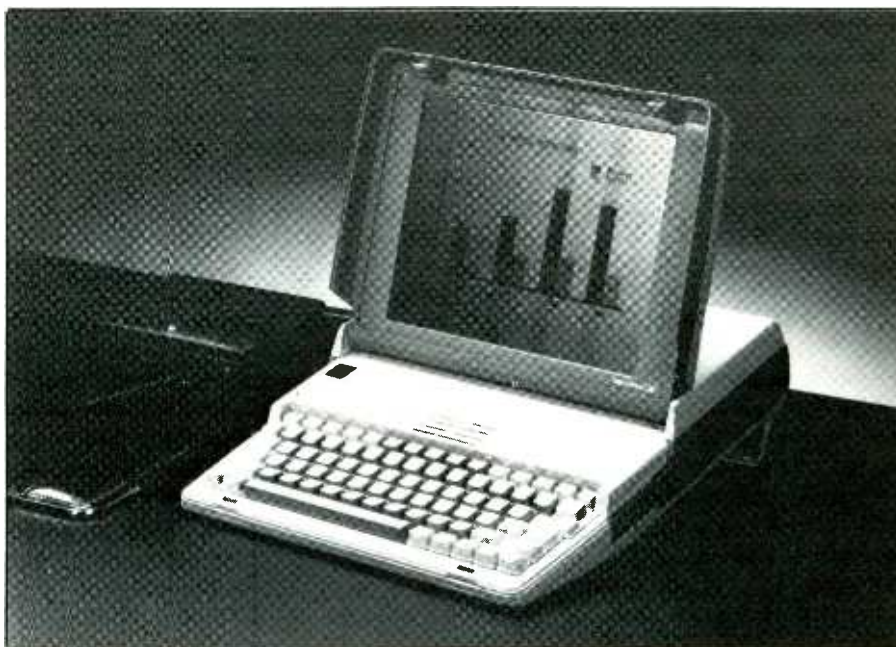

they're hard to read unless under a spotlight. Unfortunately, LCDs have only a fifth to a tenth of the CRT monitor's contrast, and that only within a roughly 30° viewing angle.

The costly Grid Compass uses an electroluminescent display (ELD), in which current stimulates a layer of phosphorescent chemicals whose glow appears through holes (pixels) in the front panel. Such displays are brighter and have more contrast than even CRT monitors. Equally important, they need comparatively little current—only 13 watts in the Grid.

But they require high voltages (up to 200 volts), sophisticated x- and y-address drivers, and expensive manufacturing techniques to spread the perfectly smooth chemical layer, which is only a few thousand angstroms thick. Prices are coming down, though. Grid now sells the base Compass for a thrifty \$4250, but ELDs still don't seem likely to take over the portable market just yet.

Gas plasma displays (GPDs) promise a simpler way. They use similar technology to ELDs, but with neon gas (or a neon/argon mixture) replacing the phosphor. They draw more current than ELDs, but at low-

er voltages, and their circuitry is simpler (ac plasma displays need no CRT-style refreshing, staying lit until current drops below a minimum level). On the other hand, they're bulkier and heavier. The front glass must be strong enough to keep the outer atmosphere away from the low-pressure neon.

Interestingly, Grid Systems Corp. announced a machine that might replace its ELD-screened, bubble-memoried Compass as the portable buyer's favorite fantasy: the Grid-Case. It promises 100-percent IBM-PC compatibility, right down to ports for an external RGB monitor and IBM keyboard or numeric keypad. There's also a 720K microfloppy drive, up to 512K RAM plus space for 512K of ROM-chip software, and a bright 25-line, 80-column gas plasma display. Except for a price in the \$6000 range (thought a 128K, LCD-screened model will be half that), the GridCase looks like what everyone's been expecting: total desktop functionality and compatibility in a 10-lb., battery-powered package.

Another interest-generator in GPDs is due to a corporation that makes a \$3000 desktop display: IBM.

Gossip about Big Blue's "Clamshell" has predicted everything from a high-tech GPD to a DG/One clone; all that's known for sure at this writing is that IBM has ordered two-million 3½" disk drives, but maybe they're for a compact successor to the desktop PC.

Except for uncertainty over screens, portable design is moving right along. This ranges from interest in new lithium batteries to replace today's lead-acids and NiCds to the apparent emergence of two winners in the mass-storage standards race.

The first looks like the 3½" microfloppy disk. Its drive's resistance to being bashed around in car trunks isn't proven, but the plastic-shelled disk has come a long way since its early appearances in Hewlett-Packard desktops and Apple's Macintosh. A Microsoft-proposed standard specifies double-sided disks, 80 tracks per side, and nine sectors per track, putting 720K into your shirt pocket. It's been adopted by the DG/One, its near-twin, the Texas Instruments Pro-Lite (more compatible with TI's Professional than the IBM PC, and aimed more at vertical markets than general sales) and Britain's Apricot

Portable Computers—Eleven Leading Contenders

Model	Base Price	Wt. (lbs)	CPU	RAM (Base-Max.)	ROM	LCD Screen	300-baud modem?	Onboard storage (d)	Bundled software (e)
Tandy 100 (a)	\$ 399	4	80C85	8-32K	32-64K (c)	8 × 40	yes	RAM	BA, wp, com, desk
Commodore LCD (b)	600	5	65C102	32K	96K	16 × 80	yes	?	BA, wp, ss, db, com, desk
Epson Geneva/PX-8	995	5	Z80	64-184K	32-96K (c)	8 × 80	opt.	RAM, mcs	CP/M, BA, wp, ss, desk
Tandy 200	999	5	80C85	24-72K	72-104K (c)	16 × 40	yes	RAM	BA, wp, ss, com, desk
NEC PC-8401A Starlet	999	5	Z80	64-96K	96K	16 × 80	yes	RAM	CP/M, wp, ss, db, com
Sharp PC-5000	1695	10	8088	128-256K	192K	8 × 80	opt.	128K bub	MS-DOS, BA, wp, ss, com, desk
Kaypro 2000 (b)	1995	11	8088	256-768K	?	25 × 80	?	720K 3½"	MS-DOS, ?
Morrow Pivot	1995	10	80C86	256-640K	32K	16 × 80	yes	360K (2) 5¼"	MS-DOS, wp, com, desk
Data General/One	2895	9	80C88	128-512K	34K	25 × 80	opt.	720K 3½"	MS-DOS, wp, com
Hewlett-Packard 110	2995	9	80C86	272K	384K	16 × 80	yes	RAM	MS-DOS, wp, ss, db, gfx, com
Grid Compass	4250	10	8086	256-512K	none	25 × 80 ELD	300/ 1200	384K bub	none

Notes

- (a) See text for comparison of Tandy 100, NEC PC-8201A, and Olivetti M10.
- (b) Not in production at presstime. Entry based on pre-release information.
- (c) Sockets for one (Tandy) or two (Epson) additional 32K ROMs.
- (d) mcs = microcassette; bub = bubble memory cartridge.
- (e) BA = BASIC, wp = word processing, ss = spreadsheet, db = database, gfx = graphics, com = communications, desk = schedule, calendar, calculator, appointment or address book, etc.



Morrow's "Pivot" 16-bit computer has a backlit LCD screen.

computers. With the IBM expected soon, *de facto* standardization should be no problem.

Simple, cheap disks seem to be replacing bubble memory, which observers once thought promising for portable applications. Bubble cartridges can be seen in the Grid and in Sharp's slow-selling PC-5000, whose 8 x 80 screen and marginal MS-DOS compatibility have offset its competitive price (\$1995 with 128K RAM and a built-in 80-column thermal printer). Sharp's cartridges hold 128K, but hate rough handling and extreme temperatures—and cost a hefty \$269 each.

The other winner alluded to earlier in the mass-storage derby is good old silicon. With its CMOS chips able to retain files with just a bit of battery power, the Model 100 got people used to the volatile idea of using RAM for storage. The HP-110 followed the desktop trend of setting aside some RAM as a lightning-fast electronic disk drive, formatted and treated as a regular disk by the computer's disk operating system.

The latest news from the chip works concerns high-speed ROMs that read so quickly that software can run directly from ROM instead of first being transferred to RAM. These should appear soon, letting a model with just 32K of RAM run desktop-sized programs like Microsoft's Word. The whole 32K would be free for file storage.

Coming Next Month

This concludes Part 1 of our two-part article on laptop computers. In next month's concluding installment, we'll discuss the new laptops for 1985 and tell you about big disks and back-lighting. We'll also include hands-on impressions of the laptops that are already on the market and pass on some information about Kaypro and Zenith machines about to debut. **ME**



DON'T LET THE ELECTRONICS REVOLUTION PASS YOU BY!

SUBSCRIBE TO



Now you can reach out every month and learn about the latest innovations in consumer electronics and personal computers—what's new, how products and circuits work, and what leading authorities think of them.

- *Stereo *Video *Home & Car Electronics
- *Test Instruments *Circuitry & Devices *Servicing
- *Personal Computers *Communications *Construction Projects

In every issue, authors lucidly explain how exciting, new electronics ideas are applied . . . issue forthright buying counsel . . . present complete plans to build electronic devices to enhance products, even unique ones that are not yet being sold in the marketplace.

Just fill out the coupon and mail with your check, money order, or credit card information (Visa or MasterCard) to enter your subscription. Do it today to ensure earliest delivery!

MODERN ELECTRONICS 76 North Broadway, Hicksville, NY 11801

Please send me Modern Electronics for 2 Years 1 Year

Name _____
 Street _____
 City _____
 State _____ Zip _____

Charge My Order To: Payment Enclosed \$ _____ 2 Years (24 issues) \$22.97

MasterCard My account number is: 1 Year (12 issues) \$12.97

VISA  _____



PINCOM INTERNATIONAL, INC.

12603 CRENSHAW BOULEVARD • HAWTHORNE, CALIFORNIA 90250 • (213) 679-9999

MARK IV — 15 STEP LED POWER LEVEL INDICATOR KIT

This new stereo indicator kit consists of 36 4-color LED's (15 per channel) to indicate the sound level output of your amplifier from -36dB to +3dB. Comes with a well designed silk screen printed plastic panel and has a selector switch to allow floating or gradual output indicating. Power supply is 6-12VDC with THG on board input sensitivity controls. This unit can work with any amplifier from 1W to 200W. Kit includes 70 pcs driver transistors, 38 pcs matched 4-color LED's, all electronic components, PC board and front panel.

MARK IV KIT \$31.50

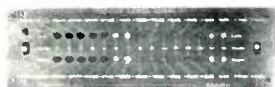

20 STEPS BAR/DOT AUDIO LEVEL DISPLAY KIT

This new designed audio level display unit is using a new integrated circuit from National Semiconductor to drive 20 pieces of color LED's (green, yellow and red) on each channel. It provides two types of display methods for selection "bar" or "dot". The display range is from -57dB to 0dB. Kit is good for any amplifier from 2 watts to 200 watts! Power supply requires 12VAC or DC. So it is great for cars as well! Kit comes with printed circuit board, all LED's, electronic components, switches, and silk screen printed professional front panel.

MODEL TY-45 \$38.50

0-15 VOLT 2AMP REGULATED POWER SUPPLY KIT

This is a professional power supply kit. Output voltage adjustable from 0-15VDC. Output current also can be limited to two range sections such as 200mA and 2A. An elaborated protection system also designed to give out a beeping sound and a flashing LED warning will appear when output was over loaded or short circuited. High stability and reliability resulting from employing a high quality voltage regulator IC. The front panel of the power supply is well designed with output terminals, on/off switch, voltage adjusting control, jumbo size meter for reading both AMPS and VOLTS.



Also with a volt/amp switch as well as current limit select switch. Kit comes with refined metal case, silver color with sand brushed front panel, all electronic parts, pc board, 3" jumbo size meter, transformer, circuit diagram and instructions.

TR-100 KIT \$59.50

TA-1000 KIT \$51.95

Power Transformer \$24.00 ea.

100W CLASS A POWER AMP KIT

Dynamic Bias Class "A" circuit design makes this unit unique in its class. Crystal clear, 100 watts power output will satisfy the most picky fans. A perfect combination with the TA-1020 low TIM stereo pre-amp.

Specifications • Output power 100W RMS into 8Ω, 125W RMS into 4Ω • Frequency response 10Hz-100KHz • THD less than 0.01% • S/N ratio better than 80dB • Input sensitivity 1V max • Power supply ±40V at 5A.

LOW TIM DC STEREO PRE-AMP KIT TA-2800

Incorporates brand-new DC design that gives a frequency response from 0-130KHz ±0.5dB. Added features like tone defeat and loudness control let you tailor your own frequency supplies to eliminate power fluctuations!

Specifications: • THD-TIM less than .005% • Frequency response DC to 130KHz ±0.5dB • RIAA deviation ±0.2dB • S/N ratio better than 70dB • Sensitivity: Phone 2mV 47kΩ, Aux 100mV 100kΩ • Output level 1.3V Max output 15V • Tone controls: Bass ±10dB @ 50Hz, Treble ±10dB @ 15KHz • Power supply ±24VDC @ 0.5A. Kit comes with regulated power supply. A you need is a 48VCT transformer @ 0.5A.

Only \$44.50 Transformer \$4.50 ea.



80W + 80W STEREO AMPLIFIER KIT PRE-AMP — TONE CONTROLS — POWER AMP

TA-800 is an 80 watts + 80 watts stereo. The Low T.I.M. preamplifier employs a low distortion linear I.C. (LM4558) and three negative type tone controls for High, Medium and Low frequency control. The rear power amplifier uses newly developed high frequency darlington hybrid type transistors (AN7337/AN7338) in a push-pull circuit. There is also on board speaker protector to generate a delay time between the speakers and the amplifier. Large aluminum heat sink, which is mounted on pc board, requires no external hook-up wires. The kit comes with instructions, all electronic parts, predrilled pc board, and heat sinks. Power transformer not included. Easy to build, guaranteed to work.

TA-800 KIT \$65.00

Transformer (52VCT 4A) \$22.50

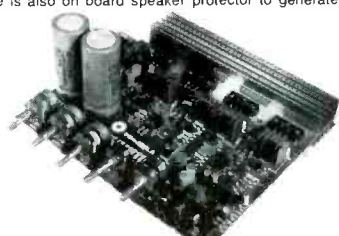

DISCO LIGHT ORGAN KIT



The TY-23B Color Light Organ is designed for use at home, party, disco or commercial advertisement purpose. It gives you the moving light effect coordinated with the frequency of the music changes. When music or an audio signal input is fed into this unit, it will be divided into High, Medium and Low frequency by means of an electronic equalizer circuit to drive three groups of light bulbs. Each group of lights has an independent sensitivity control.

Besides working as a Color Light Organ, the TY-23B also can be used in "Light Chaser" mode to perform light effects for signs as follows: (1) Switch on one after the other. (2) Flashes all together. (3) Switch off one after the other. Flashing rate can be controlled. The output power of this unit is 3000 watts (110V) which is 30 100 watt color spot lights or 600 5 watt light bulbs. Build one of these color organs today and enjoy watching your music. Great for school projects! All electronic parts, metal case, predrilled pc board and instructions come with kit.

TY-23B DISCO LIGHT ORGAN KIT \$64.50

TY-41 INFRA-RED REMOTE SWITCH KIT

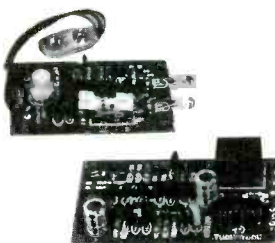

This infra-red remote control switch kit is suitable for many kinds of electrical and electronic applications, such as light controller, garage door opener, TV on/off, alarm system and many others. It does not use any antenna to transmit the signal, but it transmits an invisible light signal so the receiver can pick it up as far as 30 ft. away. Kit comes with all electronic components, pc board, relay and the infra-red LED.

TY-41 INFRA-RED SWITCH KIT \$23.50

DIGITAL PANEL METER KIT



3 1/2 Digit Multi-Use Panel Meter. The TY-43 digital panel meter kit using the IC 7107 A/D converter from Intersil is a principal component which direct drives a 16mm high 3 1/2 digit LED display. The unit needs very few external components and is extremely easy to assemble and adjust. You can produce various kinds of voltage, current and resistance measuring meters, by adding a limited number of components, you can even change it into a thermic meter, frequency counter and capacitor meter. (Application Circuit diagrams enclosed with kit).

Input sensitivity is DC ±19.9mV full scale
Input impedance is 10¹² ohms
Operating source is 5 - 6VDC @ 150MA
Overall size: 1 1/2" x 4"

TY-43 DIGITAL PANEL METER KIT \$31.50



★ SPECIAL ★ Excellent Price! Model 001-0034 \$29.50 per Kit Transformer \$10.50 ea.

TA-322 30 WATTS TOTAL 15W + 15W STEREO AMP KIT

This is a solid state all transistor circuitry with on board stereo pre-amp for most microphone or phone input. Power output employs a heavy duty Power Hybrid IC. Four built on board controls for, volume, balance, treble and bass. Power supply requires 48VCT 2.5A transformer. THD of less than 0.1% between 100Hz-10KHz at full power (15 Watts ± 15 Watts loaded into 8Ω).

60W + 60W O.T.L. AMP

Stereo pre-amp + tone control + power amp. All in one unit, fully assembled! Compact in size: 7"x4"x2 1/2". Can be fitted into most cabinets. Power transistors using 2SC1667 X 4 to give a max output of 60W + 60W (8Ω) • Frequency response: 20Hz-85KHz (-1dB) • Total harmonic distortion: 0.02% (1KHz) • Signal/Noise Ratio: 88 dB (open loop) • Tone control: 100 Hz ± 16 dB 10 KHz ± 14dB • Dynamic range: 60 dB • Power Supply: 48V-70V 5 Amp • Filter Capacitor: 4700µF 75V or better.

MODEL: SA-4520

Part #370-0350 \$39.95 ea.
1 Transformer Part #670-0230 . . . \$22.50 ea.
2 Filter Capacitor 4700µF 70V \$6.50 ea.

MAGNETIC HEAD EQUALIZER

• Standard RIAA curve for all kinds of magnetic heads • 3 stages crossover circuit for best results • Output voltage guaranteed to be stable without any oscillation • Power Supply: 24 V.D.C



MODEL: MA-142 Part #370-370 \$6.95 ea.

STEREO MIC. AND ECHO MIXER FOR STEREO AMPLIFIER SYSTEM

The circuitry employs all integrated circuits, BBD type echo circuit, echo time can be adjusted (max. 30 Msec.) Also with a microphone preamp on the board. Fully assembled.



MODEL: MX205 Part #370-0360 \$29.95 ea.

0-30VDC POWER SUPPLY KIT



This kit includes a high efficiency regulating circuitry. By using the IC 723 and darlington power transistor to provide a stable and ripple free DC voltage from 0 - 30 volts at 3 amps or 0 - 15 volts at 5 amps (depends on the power transformer used, not included with kit). Overload and short circuit protection also featured on this kit. Easy to build! Guaranteed to work! All electronic parts, pc board, heat sink for power transistor, instructions included.

TR-355 POWER SUPPLY KIT \$14.50
24VCT Transformer (for 0-30V) \$10.50

LOW T.I.M. TRANSISTORS 100W + 100W



• Employs Hitachi low noise IC for pre-amp • Max. output 16 V P-P (non distortion) • With hi-low filter, and tone defeat circuit • Rear power amp with short circuit protection • Giant heat sink for maximum results • Tone controls ±14dB • All components (except pots for volume, and tone controls) are pre-assembled, the quality is guaranteed. • Power supply DC ±35V-50V

MODEL: SA802C Part #370-0340 \$85.00

POWER TRANSFORMER (68V-80V CT 6 AMP) Part #670-0220 \$24.50

SEND ONE DOLLAR FOR OUR DETAIL CATALOG

Inside California
Outside Calif. (Incl. Mexico & Canada)
Overseas

Shipping & Handling Charges

Under \$50.00 Over \$50.00

Purchase	Charge
10%	5%
15%	10%
25%	20%

Minimum Order \$10.00/Calif. Residents add 6.5% Sales Tax. Phone Orders Accepted on VISA or MC ONLY. NO C.O.D.'s. Prices subject to change without notice.

CIRCLE NO. 175 ON FREE INFORMATION CARD



STORE HOURS
MON-FRI-10-7
SAT-10-6

Small-Boat Radio Communications

A guide to marine radio receivers, frequencies and applications

By Ed Noll, W3FQJ

Two-way radio has become essential for the many small pleasure and commercial boats that ply busy inland and coastal waters. On small boats that carry more than six passengers for hire and on many small commercial craft a marine radio is compulsory. Similar conditions apply for small boats that travel the Great Lakes. In fact, a radio is a reassuring and practical installation to have on board even the smallest of boats.

Distress, safety and rescue communications is the most important application for a marine radio. Marine airwaves are also kept busy with a variety of other communications, including navigation, movement and management of commercial boats, voice connections among private shore and ship stations and ship-to-shore radiotelephone services.

Modern marine radios are compact, lightweight and mount where there is little room to spare. Much of the credit for this goes to the micro-computer chip, which provides miracles in versatility and convenience of operation. Thanks to miniaturization, even hand-held marine radio models are available.

Where The Action Is

There is a concentration of small-boat radio activity on the 156-to-158-MHz vhf/FM band. If you live near



Raytheon's Model 1285 typifies sophisticated modern SSB marine radios.

the coast, you can listen to the chit-chat with your scanner. Second in marine activity is the medium-wave 2-to-3-MHz band, which uses upper-sideband modulation and can be tuned-in with a general-coverage SW receiver with sideband capabilities.

On the vhf marine band, reliable communicating range is 20 miles under ordinary conditions and considerably more under good propagation conditions. If your boating takes you farther out from shore, a medium-wave (MW) sideband radio is advisable. Keep in mind, however, that the FCC permits an MW installation only if a vhf radio is also aboard. With MW, you can expect reliable communication up to about 150 miles during daylight hours and farther at night. Most radios designed

for operation on the 2-to-3-MHz MW band can also be operated on several of the higher-frequency marine bands, extending the range of operation to thousands of miles for open-sea travel (see Table 1).

Vhf/FM Marine Band

There are approximately 50 channels allocated in the 156-to-162-MHz spectrum for marine radio use. Channel numbers and frequencies are given in Table 2. Messages that can be handled and channel numbers allocated are as follows:

- *Distress, safety and calling*—Channel 16 (156.8 MHz) is used in an emergency and to get the attention of another station. Distress frequencies are also designated as calling fre-

Table 1
Marine Bands (MHz)

156 to 162
2 to 3
4.1 to 4.45
6.2 to 6.5
8.2 to 8.8
12.3 to 13.2
16.0 to 17.4
22.0 to 22.7

quencies to insure that a maximum number of stations will be listening at a given time. This compulsory channel on all vhf marine radios is monitored extensively. Thus, if you have a distress situation it is likely that your call will be heard immediately. The success of this arrangement depends on cooperation of all users to maintain a listening watch on this frequency and, at the same time, keep it clear of all unnecessary communications. For the shore-bound listener, this is a good frequency to monitor, because of the frequent calls made on it.

• *Intership safety*—This second compulsory channel on a marine radio is used for ship-to-ship safety and search-and-rescue messages with ships and aircraft of the Coast Guard. Channel number for this service is 6 (156.3 MHz).

• *Coast Guard Liaison*—This channel is used to talk to the Coast Guard. However, contact must first be made with the Coast Guard over Channel 16. Channel number is 22 (exact frequency is given in Table 2). Note that for all channels shown in the table, ship transmit and receive frequencies are given. Transmit and receive frequencies are usually the same, but there are exceptions.

• *Noncommercial Working*—These are the channels to be used for recreational boats. Messages must be about the needs of the vessel—not idle chatter. Typical uses include fishing reports and rendezvous, scheduling, repairs, and berthing in-

formation. Channels are 9, 68, 69, 70, 71, 72 and 78. Use Channels 70 and 72 only for ship-to-ship.

• *Commercial Working*—These channels are for working vessels only and are restricted to messages about business or needs of the vessel. Channels are 7, 8, 9, 10, 11, 18, 19, 67, 79,

80 and 88. Use Channels 8, 67 and 88 only for ship-to-ship messages.

• *Public Correspondence*—These channels are used to contact the marine operator to make radiophone contacts through the telephone system. They permit you to make contact with the marine operator at a

Table 2. Vhf Marine Channels

Type of Traffic	Channel	Frequencies (MHz)		
		Transmit	Receive	
Distress, safety, calling	16	156.800	156.800	
	6	156.300	156.300	
	22	157.100	157.100	
	Noncommercial	9	156.450	156.450
		68	156.425	156.425
		69	156.475	156.475
		70	156.525	156.525
		71	156.575	156.575
		72	156.625	156.625
		78	156.925	156.925
Commercial	7	156.350	156.350	
	8	156.400	156.400	
	9	156.450	156.450	
	10	156.500	156.500	
	11	156.550	156.550	
	18	156.900	156.900	
	19	156.950	156.950	
	67	156.375	156.375	
	79	156.975	156.975	
	80	157.025	157.025	
	88	157.425	157.425	
Public correspondence	24	157.200	161.800	
	25	157.250	161.850	
	26	157.300	161.900	
	27	157.350	161.950	
	28	157.400	162.000	
	84	157.225	161.825	
	85	157.275	161.875	
	86	157.325	161.925	
	87	157.375	161.975	
	88	157.425	162.025	
Port operation	5	156.250	156.250	
	12	156.600	156.600	
	14	156.650	156.650	
	20	156.800	156.800	
	65	156.275	156.275	
	66	156.325	156.325	
	73	156.675	156.675	
	74	156.725	156.725	
Navigation	13	156.650	156.650	
State control	17	156.850	156.850	
Weather: WX1			162.550	
	WX2		162.400	
	WX3		162.475	

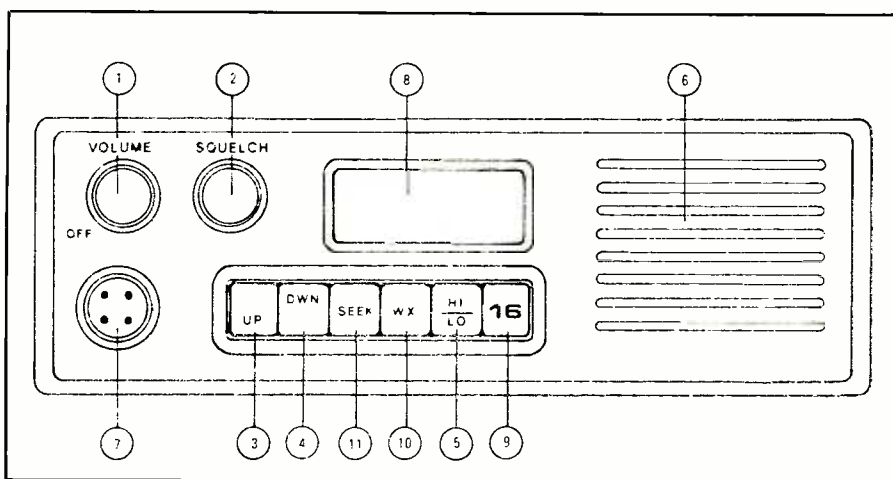

Fig. 1. Vhf/FM marine radio's front panel; numbers are explained in text.

public coast station. You can then make and receive calls from telephones on the shore. Except for distress calls, public coast stations usually charge for this service. Channels for this service are 24, 25, 26, 27, 28, 84, 85, 86, 87 and 88.

- **Port Operations**—These radio channels are used to direct the movement of ships in or near ports, locks and waterways. Messages must pertain to the operational handling, movement and safety of ships. Channels are 5, 12, 14, 20, 65, 66, 73 and 74. Use Channel 20 only for ship-to-coast messages.

- **Navigational**—Channel 13 is referred to as the bridge-to-bridge channel and is also the main working channel at most locks and bridges. Messages must be kept short and pertain to navigation, such as the passing or meeting other vessels. Maximum output power on Channel 13 must not exceed 1 watt.

- **State Control**—Channel 17 is allocated for communications among ships and coast stations operated by state and local governments. Messages must relate to state regulations and control of boating activities.

- **Weather**—On channels WX-1, WX-2 and WX-3, you can pick up weather broadcasts from the National Oceanic and Atmospheric Admin-

istration (NOAA). These are receive-only channels.

Single-Sideband Marine Bands

Vhf marine radio is intended mainly for harbor and coastal communications within about 20 miles of coast stations. For longer-distance communications, there are a number of marine channels allocated between 2 and 30 MHz (see Table 1). The medium-wave 2-to-3-MHz band is widely used by small boats. At one time, this band was used exclusively for close-in communications and was extremely congested but has since been alleviated with the establishment of a vhf marine channel. Furthermore, use of a 2-to-3-MHz band when in harbors, ports, lakes and rivers is prohibited for intership communication. The band is used mainly for making contact when beyond the vhf range of a coast station you wish to contact. Of course, the band may also be used for distress communications. In fact, all ship radiotelephone stations that operate on this band must also be capable of operating on the 2182-kHz international distress and calling frequency. In addition, the radio must be capable of working on at least two other frequencies in the band.

Many frequencies on this band are

available for coastal ship-to-shore service. Intership safety frequencies are 2082.5 and 2638 kHz. There are also similar frequencies for use about the Great Lakes, Gulf of Mexico, and the southern Pacific Coast area. Bands accommodate a number of public correspondence coastal stations, and arrangements can be made for making high-seas telephone calls. Even longer-distance communications can be made on the hf marine bands. On these high-frequency bands, there is a considerable amount of code (CW) activity.

Citizens Band radios can be installed aboard a boat and are permitted to operate on any of the 40 available CB channels. They can be used for conducting personal or business communications over shortwave. You can tune in to the coastal activities with a CB radio or a general-coverage shortwave receive. Traditionally, Channel 9 (27.065 MHz) is used for emergency communication.

Selected Coast Guard shore stations monitor CB Channel 9, though on a secondary basis, since both the Coast Guard and the FCC emphasize that CB radio service is not a substitute for the marine distress system and its vhf/FM 156.8- and MW2181-kHz frequencies. CB does, however, provide an alternative when a boat is not equipped for these bands, provided appropriate shore stations monitor on this band.

Landmobile radios are found on some coastal, inland-water and lake boats. Such are assigned frequencies that permit communications with landmobile service base and mobile stations ashore. Many coastal businesses involve both land and water activities.

FM Marine Radios

On the vhf/FM marine-radio band, maximum permissible output power is 25 watts. A good relatively high antenna will help you pick up boating communications despite the modest



Fig. 2. Hand-held marine radios, such as the Ray Jeff model shown in this photo, offer multichannel vhf/FM communications in a convenient carry-along package.

output power. At most coastal locations, you can use a directional antenna with your scanner to improve received signal levels.

Not too many years ago, a typical marine radio was available with limited channel capability but could be expanded to include coverage of many individual. Each additional channel was an extra-cost option, which could be very costly if you wanted full coverage of all channels. Fortunately, the modern frequency synthesizer and microprocessor have changed all that. Now a small radio with 63-channel capability and 25-watt output can weight only 3.5

lbs., measure a mere 8½" × 7" × 2½" and be priced within the means of most boaters.

Are the new breed of frequency-synthesized, microprocessor-controlled radios easy to operate? You bet they are, as a glance at the drawing of a typical radio shown in Fig. 1 reveals. The control complement consists of a combination VOLUME control/power switch (1), SQUELCH control (2) and a series of six push-buttons. To select a channel, you use the UP (3) or DWN (4) button. Momentarily pressing and releasing the UP causes the radio to tune to the next channel in the upward direction, while doing the same with the DWN button causes the radio to go to the next channel in the downward direction. Maintaining pressure on either button will cause the channel selector to continuously increment or decrement until the key is released when the desired channel number appears in the display (8).

The HI/LO button (5) lets you select between 25 watts of output power or the 1-watt required for close-in harbor operation. Pressing the 16 button (9) switches the radio to emergency Channel 16. Pressing the WX button (10) permits monitoring of any of the four weather channels, the specific

one selected with the UP and/or DWN button when in this mode.

Marine-band scanning is selected by pressing the SEEK button (11). Touching this button once causes the entire band to be scanned at a rate of three channels per second. When an active channel is detected, the scan function pauses for two full seconds. If you wish to continue listening on this channel, you simply touch the SEEK button a second time to freeze the scan function; otherwise, the radio will simply continue scanning.

Antenna system performance with this type of radio is quite good, because of the shortness of the vhf antenna compared with the antenna required for the much lower medium-wave frequencies. Mounted in-the-clear on a boat, the antenna performs efficiently. Of course, good grounding of the radio is required to keep down noise level. Tie metallic surfaces together with a good ground.

Hand-held radios (Fig. 2) have become increasingly popular because of their usefulness in harbors and marinas. With them, you can stand out in the open on a boat and have a good look at activities as you com-

(Continued on page 86) ▶

Fig. 3. Some radios have a LED display to indicate heading of incoming signal.

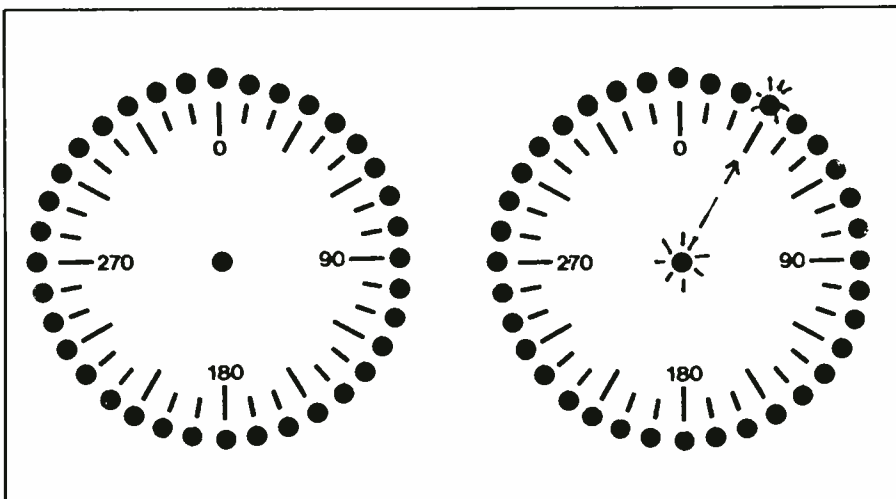

Low-Frequency Dual-Pulse Generator

Offers digital-circuit experimenters a source of reliable clock pulses to 10 kHz

By Duane M. Perkins

If you intend to do serious experimenting with digital circuits, you will soon discover that you need a source of reliable clock pulses. You can, of course, buy an expensive pulse generator to meet your needs. However, for less than \$100 you can build the Dual-Pulse Generator described here, using only readily available parts.

Each of the two pulse outputs is independently adjustable in phase, pulse width and amplitude. Though both are driven by the same oscillator, which provides for clocking a circuit that requires a two-phase clock, one output can be set up to provide a frequency that is a subharmonic of the other.

Circuit Description

Though the pulse generator provides two independently controllable outputs, it has a single oscillator from which the pulses are derived, as shown in Fig. 1. Therefore, the frequency of the pulses is established by the relaxation oscillator designed around unijunction transistor *Q1*. In addition to providing four frequency ranges for the internal oscillator, the generator's RANGE switch (*S2*) has a position for a 60-Hz pulse, derived from the ac line at the center tap of the power supply transformer (see Fig. 3), plus an input at *BP4* for an external signal source.

There are four internal oscillator frequency ranges. These are 1 to 10

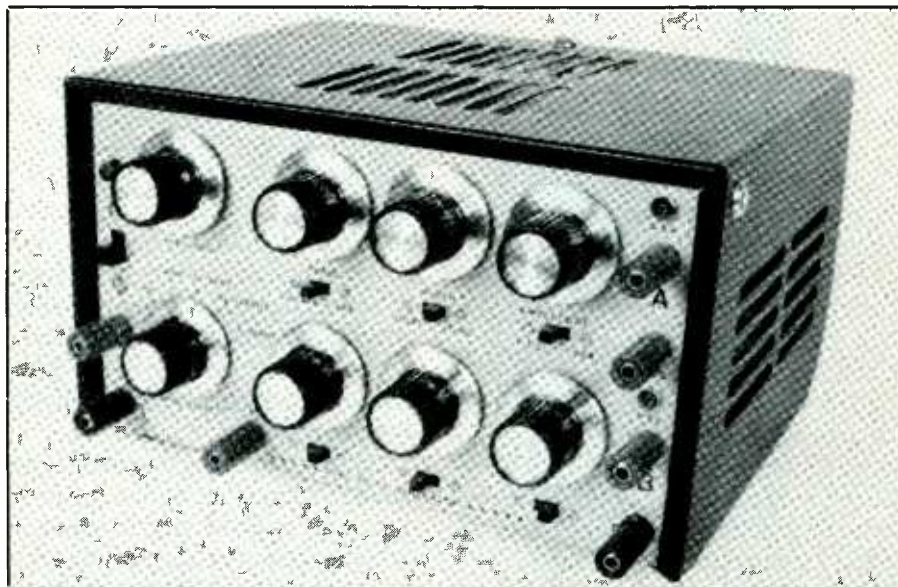

Hz, 10 to 100 Hz, 100 to 1000 Hz and 1 to 10 kHz. These limits are only approximate. Exact range limits will depend on the intrinsic standoff ratio of the UJT used for *Q1*.

Because the pulse generator contains a $\div 2$ circuit, its output will be half the frequency of the oscillator. The 60-Hz output is generated from the 120-Hz pulses taken from the center tap of the power transformer.

Any waveform with an amplitude between 0.5 and more than 9 volts can be applied to the EXTERNAL INPUT at *BP4*. Output pulse frequency will be half the input frequency and can go as high as 15 kHz. For maximum phase control range, a sawtooth dc waveform with a peak amplitude of about 9 volts works best. However an ac sine wave will permit

some degree of control. A square wave or pulse input will drive the pulse generator but will not permit phase control.

Referring to Fig. 1, the TRIGGER OUTPUT at *BP3* is taken from the base-2 (*B2*) terminal of *Q1*, after being amplified by *Q2* to a peak amplitude of about 5 volts. This amplitude is sufficient to assure positive triggering of an oscilloscope. Trigger frequency will be twice that of the output pulses from the generator circuits. PHASE control *R15* in Fig. 2 sets the amount of delay between the trigger pulse and the following output pulse. This delay permits events just prior to the output pulse to be viewed on an oscilloscope's screen.

Both pulse generator circuits are identical. Hence, when you refer to

Fig. 2, you will note two sets of component numbers and IC and transistor lead designations. Numbers in parentheses refer to components and connections for generator B, while those not in parentheses refer to generator A. Resistors *R13* and *R14* are common to both generators and are not repeated.

An input signal to the noninverting input of *IC3A* (taken from the output of the Fig. 1 circuit) is converted to pulses with fast rise and fall times by the LM339 voltage comparator. The reference voltage for *IC4A* is taken from the wiper of PHASE control *R15*, which determines the timing of the output pulse relative to the input signal cycle.

The pulse that appears at the comparator's output is used to clock ÷ 2 flip-flop *IC4A*. The symmetrically square pulse at the output of *IC4A* then goes to SQUARE/VARIABLE switch *S3*, which directs it to the output amplifier made up of *Q3* and *Q4*.

With *S3* set to SQUARE, the output of *IC4A* goes directly to the input of output amplifier *Q3/Q4*. Setting *S3* to VARIABLE diverts the output from *IC4A* to the trigger input of *IC5A* at pin 6. Before arriving at *IC5A*, however, the square pulses from *IC4A* are differentiated by the RC value of the network composed of *C11* and *R17*. From the output of *IC5A* at pin 5, the signal is routed to *S3*'s VARIABLE contacts and then on to the input of the *Q3/Q4* output amplifier.

The brief negative-going pulses are fed to the trigger input of *IC5A* to generate positive output pulses whose duration is determined by the RC value of the timing network connected to the discharge (pin 2) and threshold (pin 1) terminals of *IC5A*. Potentiometer *R19* provides a means for setting the timer's pulse duration, while SHORT/LONG switch *S4* selects the range by switching in either *C12* for a short-duration or *C13* for a long-duration pulse.

Because output amplifier *Q3/Q4* uses complementary transistors in a

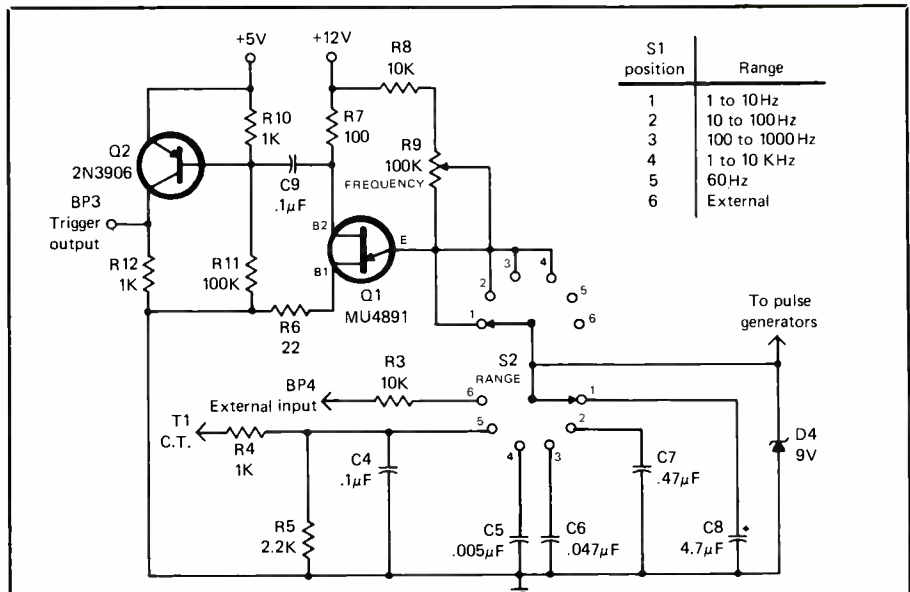

Fig. 1. Generator uses this single oscillator for both pulse channels.

PARTS LIST

Semiconductors

D1,D4—9-volt zener diode (1N4739 or similar)
 D2,D3—1N914 switching diode
 LED1,LED2—Light-emitting diode
 IC1—7812 12-volt regulator
 IC2—7805 5-volt regulator
 IC3—LM339 voltage comparator
 IC4—4013 flip-flop
 IC5,IC7—556 dual timer
 IC6,IC8—LM317 voltage regulator
 Q1—MU4891 unijunction transistor
 Q2,Q3,Q5,Q6,Q8—2N3906 transistor
 Q4,Q7—2N3904 transistor
 RECT1—VM08 or similar 50-PIV bridge rectifier

Capacitors

C1—3300- μ F, 35-volt electrolytic
 C2,C3—0.22- μ F disc
 C4,C9,C10,C17,C18,C19,C26,C27,C28—0.1- μ F disc
 C5,C13,C22—0.005- μ F disc
 C6—0.046- μ F disc
 C7—0.47- μ F tantalum
 C8,C16,C25—4.7- μ F, 35-volt electrolytic
 C11,C20—0.001- μ F disc
 C12,C21—1- μ F tantalum
 C14,C23—0.1- μ F disc
 C15,C24—22- μ F, 35-volt electrolytic

Resistors (1/2-watt, 10% tolerance)

R1,R5—2200 ohms
 R2,R4,R10,R12,R18,R28,R32,R42—1000 ohms
 R3,R8,R16,R17,R26,R30,R31,R40—10,000 ohms

R6—22 ohms

R7—100 ohms

R11,R13,R14,R27,R41—100,000 ohms

R20,R21,R34,R35—470 ohms

R23,R24,R37,R38—15,000 ohms

R25,R39—100 ohms, 2 watts

R9—100,000-ohm linear-taper potentiometer

R15,R19,R29,R33—1-megohm, linear-taper potentiometer

R22,R36—5000-ohm, linear-taper potentiometer

Miscellaneous

BP1 thru BP7—Five-way binding posts (five red, four black)

I1—Panel-mount neon lamp assembly with current-limiting resistor

S1—Spst slide or toggle switch

S2—6pdt nonshorting rotary switch

S3,S5,S6,S8—Spdt miniature slide or toggle switch

S4,S7—Dpdt miniature slide or toggle switch

T1—12.6-volt, 1.2-ampere, center-tapped power transformer

Printed-circuit board; 14-pin DIP IC sockets (4); metal cabinet (see text); four-lug (none grounded) terminal strip; panel clips for LEDs (2); pointer-type control knobs (8); line cord with plug; plastic strain relief or rubber grommet; plastic cable ties or lacing cord; lettering kit or tape labeler; aerosol clear lacquer; stranded hookup wire; machine hardware; solder; etc.

totem-pole configuration, one transistor will be saturated while the other is cut off. Hence, the output is alternately switched between ground and the supply voltage. This enables the amplifier to sink or source a large current with equal ease and results in very fast rise and fall times.

Since the output amplifier is an inverter, it is the intervals between pulses from the timer that become positive output pulses. The pulse width control, *R19*, has the direct effect of varying the interval between output pulses, which directly varies pulse width. This becomes apparent if the control is set for a certain pulse width and the frequency is then changed. Pulse width varies with frequency, but the interval between pulses remains fixed.

By varying the supply voltage to the output amplifier, the amplitude of the output pulses is also varied. Adjustable voltage regulator *IC6* permits a range of from 1.2 to 12 volts. Alternatively, amplitude switch *S5* can be set to TTL to supply the output amplifier from the fixed 5-volt supply. This arrangement maintains a constant output impedance regardless of amplitude. Resistor *R25* prevents damage to the transistors in the event that the output is short-circuited to ground or a positive supply voltage. Since output impedance at the collectors is very low, output impedance at the output terminals is essentially equal to the 100-ohm resistance.

The voltage-sensing circuit connected to the output consists of voltage comparator *IC3B* with a 5-volt reference and missing-pulse detector *IC5B* and *Q5* with a timing cycle of about 0.5 second. If the amplitude of the output signal exceeds 5 volts, the pulse will be inverted by the comparator. The negative-going pulse causes *Q5* to conduct, discharging timing capacitor *C16*, and trigger the timing circuit to begin a 0.5-second positive output pulse that causes *LED1* to turn on. The timing cycle

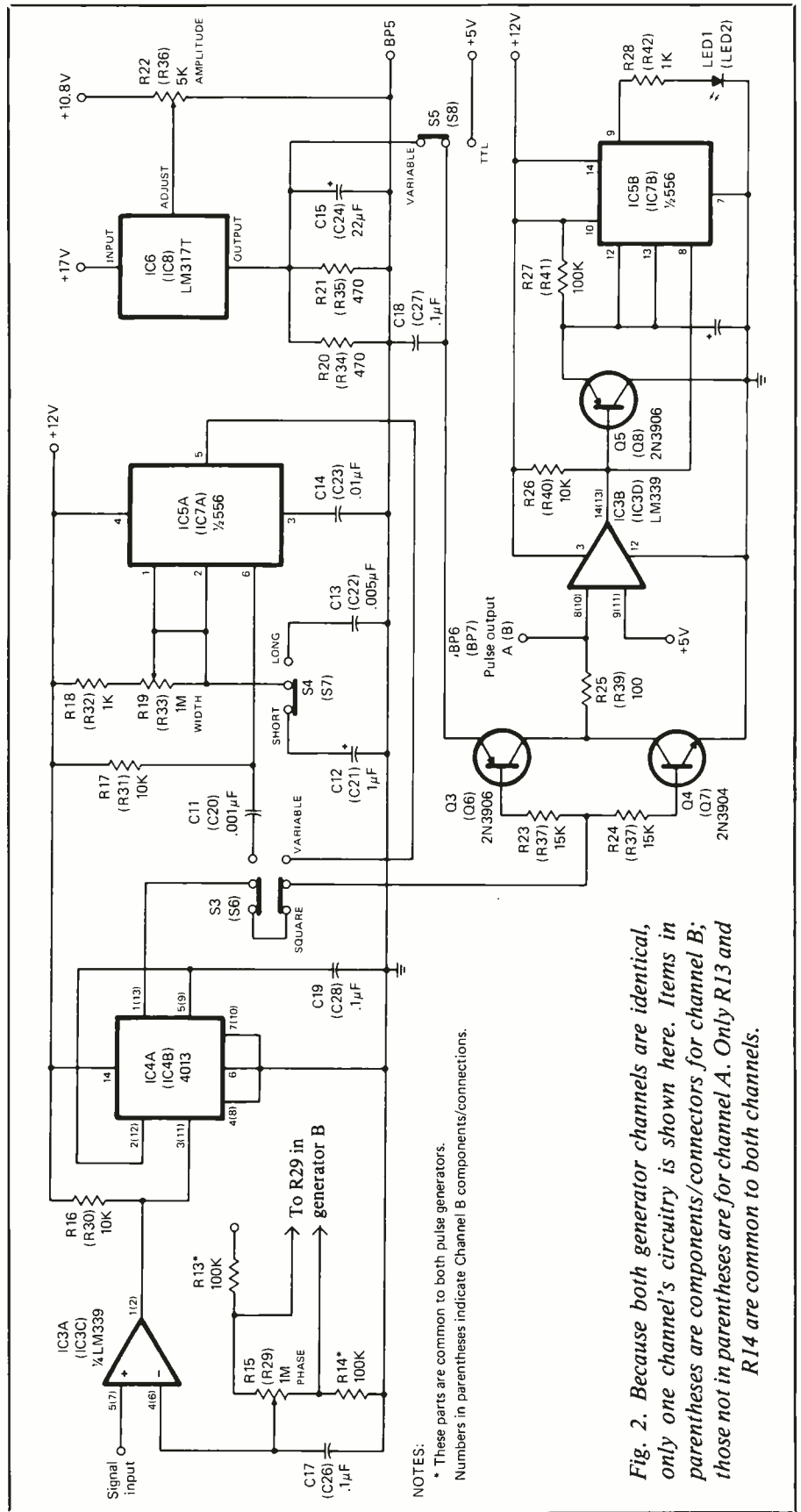
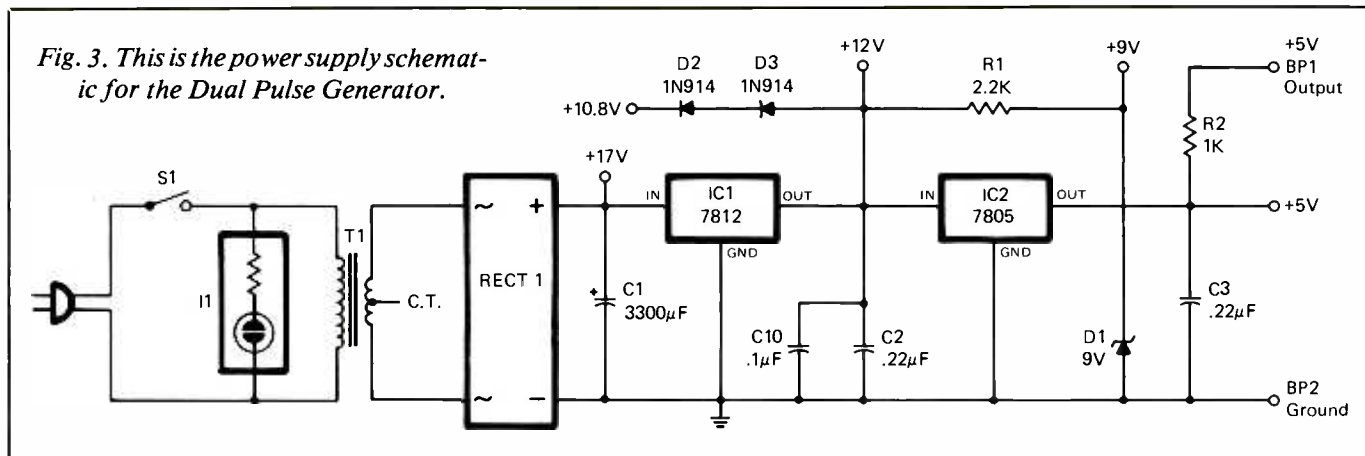

Fig. 2. Because both generator channels are identical, only one channel's circuitry is shown here. Items in parentheses are components/connectors for channel B; those not in parentheses are for channel A. Only *R13* and *R14* are common to both channels.

Fig. 3. This is the power supply schematic for the Dual Pulse Generator.



will be continually retriggered as long as output pulse amplitude exceeds 5 volts, and *LED1* will glow continuously if the frequency exceeds about 1 to 2 Hz, depending on pulse width. At lower frequencies, *LED1* will turn on and off in time with the pulses.

The power supply, shown in Fig. 3, is a straightforward circuit consisting of bridge rectifier *RECT1* across the 12.6-volt secondary of *T1* and fixed 12- and 5-volt regulators *IC1* and *IC2*. Zener diode *D1* provides the 9-volt low-current supply for the phase control circuits. Silicon diodes *D2* and *D3* in series drop the 12-volt supply to 10.8 volts to limit maximum supply voltage to the output amplifiers to 12 volts. (The output of the LM317 regulators is 1.2 volts above the voltage at the ADJ terminals of *IC6* and *IC8*).

Construction

Due to the relatively complex nature of the circuitry and the need for low-impedance ground and positive-voltage supply buses, a printed-circuit board is almost mandatory for this project. You can fabricate your own pc board, using the actual-size etching-and-drilling guide in Fig. 4 and wire it according to the accompanying components-placement diagram.

Wire the pc board exactly as shown in Fig. 4. Take care to orient the com-

ponents as shown so that electrolytic capacitors, diodes and LEDs are properly polarized and the bridge rectifier, ICs and transistors have their pins go into the proper holes in the board. Incidentally, it is an excellent idea to use sockets for all dual in-line package (DIP) ICs and reserve installation of these ICs for last, after voltage checks have been made.

When making connections to the pc board, use heat and solder judiciously. Use only enough to assure good electrical and mechanical connections. Take particular care to avoid creating solder bridges between the closely spaced pads between IC pins and transistor leads.

Note in Fig. 4 that, because of the large number of wires that interconnect the board with the components on the front panel, all but two of the connection pads are arranged along two edges of the pc board. This makes it possible to neatly bundle the wires into a cable, using plastic cable ties or lacing cord. It also makes it easy to flip up the board assembly for circuit tracing should this become necessary. To this latter end, it is recommended that you use stranded hookup wire throughout project assembly.

Your next task is to machine the metal cabinet in which the pulse generator is to be housed. The cabinet will have to be fairly large in order to accommodate the large pc board and

power transformer and all the various controls, switches, indicators and binding posts on the front panel, along with their identifying legends. The author chose Radio Shack's Cat. No. 270-270 cabinet for his prototype. This cabinet measures 9¼ "W × 6¾ "D" × 5½ "H and easily accommodates all components, as shown in the photos.

In his prototype, the author used miniature slide-type switches for *S1* and *S3* through *S8*, which require three holes each for mounting (two round for securing it to the panel with machine screws and one rectangular for the toggles). If you wish to simplify the machining operation, you can substitute miniature toggle switches, which require a single round hole. Bear in mind, however, that toggle switches normally operate exactly opposite the manner in which slide-type switches operate. That is, if you flip a horizontally mounted toggle-type switch to the left, the *right* contacts will close. Therefore, you will have to either reverse the front-panel legends for these switches or wire the switches backward from the directions shown in Fig. 5.

If you use slide-type switches, you will have to drill and cut a total of 46 holes in the cabinet, one in the rear wall for the line cord, six in the bottom for mounting the pc board and power transformer, and the remain-

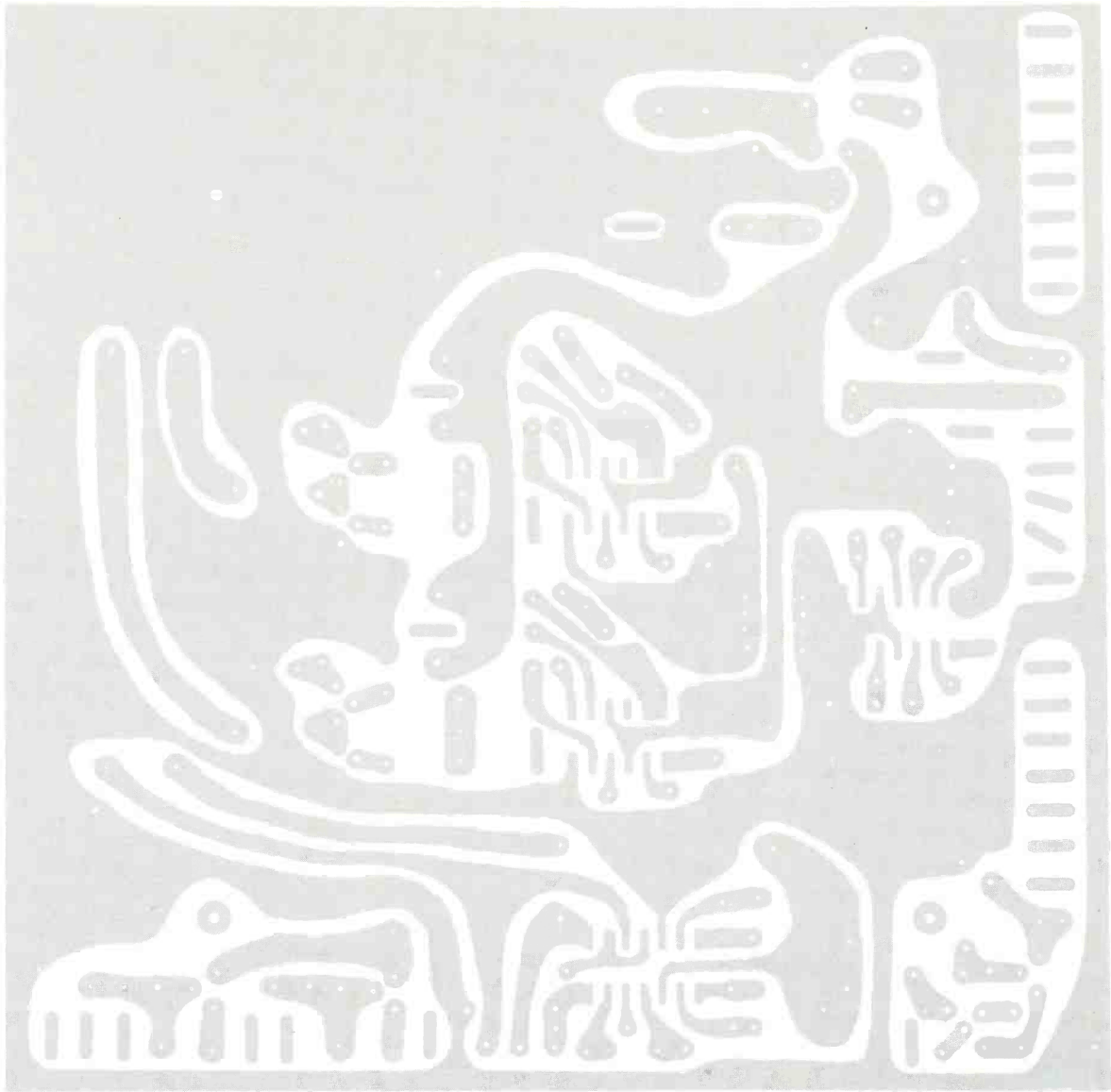

Fig. 4. Above is the actual-size etching-and-drilling guide; opposite page is components-placement diagram.

der in the front panel for the switches, controls, indicators and binding posts. By substituting toggle-type switches, you can reduce the number of holes to 33 (one for mounting the terminal strip for *R13* and *R14*), all of them round, though of different diameters.

After machining the cabinet and deburring all holes, test fit the switches, controls, indicators and binding posts on the front panel. The only component that must be se-

curely mounted at this time is RANGE switch *S2*, since you will have to place its pointer knob on its shaft and rotate it through each position to mark off the range locations on the panel. This done, remove the components and set them aside.

Carefully label the front panel with the appropriate legends, using a dry-transfer lettering kit or a tape labeler. If you use a lettering kit, spray two or more *light* coats of clear lacquer over the entire surface of the

front panel to protect the lettering. Allow each coat to dry before applying the next. Do *not* try to get by with only one or two heavy coats; if you do, the lettering will almost certainly lift and dissolve.

When the final coat of lacquer has completely dried, mount the front-panel controls in their respective locations, with *LED1* and *LED2* set into panel clips. Place the knobs on the shafts of the potentiometers and *S2* and check that they point straight up

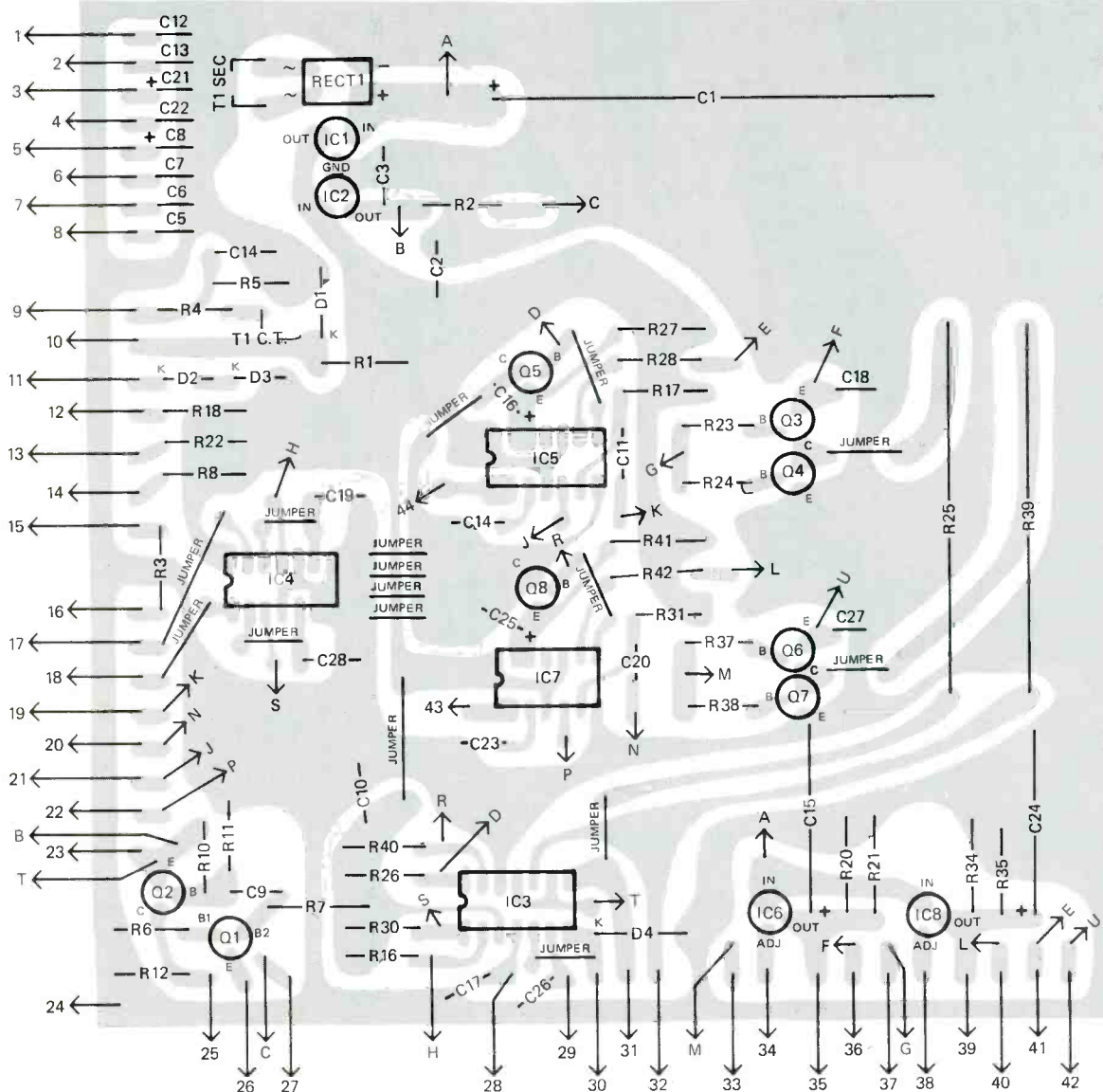

When installing polarized components, make certain you properly index their leads and pins as shown here.

at mid-rotation for the pots and properly index to the marked locations on the panel for S2. Then mount the power transformer to the floor of the cabinet with machine screws, lockwashers and nuts.

Next, split apart the conductors at the free end of the line cord for a distance of about 8" and cut off 5" from one conductor. Trim 1/4" of insulation from each conductor, tightly twist together the fine wire conductors in each and lightly tin with

solder. Pass the free end of the cord through the hole in the rear wall of the cabinet and secure it in place with a plastic strain relief, about 4" from the split point. Alternatively, line the hole with a rubber grommet, pass through the cord, and knot it about 4" from the split point, thereby eliminating the need for a strain relief.

Front-panel wiring in Fig. 5 is keyed to the components-placement diagram in Fig. 4. That is, numbered points in both figures mate with each

other. Note in Fig. 4 that there are also several lettered points. These do not connect to similar points on the front panel but to the same lettered points on the circuit board itself. In essence, they are long jumpers but are treated as part of the cable wiring.

Study Figs. 4 and 5 before actually wiring the board to the front panel. Once you are satisfied you know what goes where, place the circuit board on the floor of the cabinet with one row of pads facing toward the

OPEN

Video to Video Cable Set

Own a video cassette? Want to dub tapes? You must have one of these amazing cable sets. Doesn't matter what type...VHS, Beta, Umatic...Phillips... this suits any to any! Comes with 2 metres audio/video cable with phono adaptors to suit UHF (PL259), BNC, 6.5mm, 5 pin DIN and 8 pin DIN. Every video enthusiast should have one!

HUGE SAVINGS **\$9.95**

DICK SMITH'S FUNWAY INTO ELECTRONICS GIFT PACK

Contains the famous introductory Funway into Electronics Vol. 1 which starts off from the very basics of electronics and shows you how to make 20 different projects, including Transistor Tester, Beer Powered Radio, Light/Dark Indicator, Electronic Siren, Radio Receivers, Music Maker and many more. Book and all components included.

ONLY \$24.95

Cat K-2605



NO SOLDERING REQUIRED

"PROTECT YOUR CAR" CAR ALARM

Sophisticated yet simple. Uses a triggering technique which will sense a voltage drop anywhere in the electrical system, making it less prone to false alarms.

\$34.95 Cat L-5090

HIGH TECH - EASY TO INSTALL



CURRENT SENSING



Cat K-3439 **\$89.95**

KIT 500MHz DIGITAL FREQUENCY COUNTER

Uses latest IC technology, especially designed for ease of construction and reliability.

- Includes high quality instrument case
- 7 segment display
- 3 frequency ranges, 0-10MHz, 0-50 MHz, 10-500MHz (with optional pre-sealer)
- high accuracy.

PRE-SEALER Cat K-3432

\$22.50

GAMMA FOR APPLE IIIC COMPUTERS

- Media Standard 5.25" single sided floppy diskette
- Tracks/Diskette 40
- Sectors/Track 16
- Bytes/Sector 16
- Disk Rotation Speed: 300 rpm
- Track to track access time less than 12msec
- Track Density 48 tpi
- Capacity 160K bytes

LIST PRICE **\$199**
\$129 ONLY

- Low cost
- Precise band positioner
- Track 00 sensor positioner
- notes readable noise
- Reliable data read/write time
- 12 msec track to track access
- 160K bytes storage capacity

APPLE is a registered trademark of Apple Computer, Inc. GAMMA is a registered trademark of Video Technology Ltd.



Cat X-7505

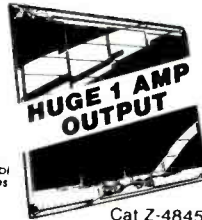

HUGE 1 AMP OUTPUT

HIGH OUTPUT SOLAR PANEL \$149

Cat Z-4845

Calling all boat owners, amateur operators, technicians and anyone else who's ever had to keep a 12V battery charged in an out-of-the-way place.

- 2 x 10V @ 500mA (20V @ 500mA or 10V @ 1A)
- Diode Protected

EVERYTHING FOR THE ELECTRONICS ENTHUSIAST

CIRCLE NO. 173 ON FREE INFO CARD



132 PAGES PACKED WITH ELECTRONIC GOODIES AT INCREDIBLY LOW PRICES!

THAT'S THE 1985 DICK SMITH ELECTRONICS CATALOG



NEW SWISS MADE 1GHz Frequency Counter

We have been fortunate enough to make this exclusive direct buy. Compare the price of this state-of-the-art unit with older models.
Cat Q-1315 **\$249⁰⁰**

At last! 'No leak' Rechargeable BATTERIES 12V 3Ah Gel Cell

**OFFER EXPIRES
END JUNE**

Designed especially for 'trickle charge' circuits such as burglar alarms and emergency supplies. Sealed to prevent leaks and mess.

- Cat S-3315 12V 1.2Ah \$7.95 ea
10 up \$6.95 ea WILL BE \$9.95
- Cat S-3320 12V 3Ah \$13.95 ea
10 up \$12.95 ea WILL BE \$17.95

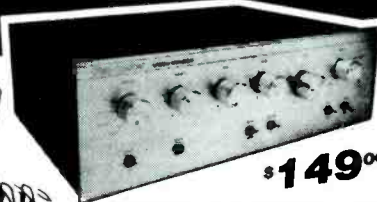

PLAYMASTER MOSFET AMPLIFIER KIT

\$149⁰⁰

Build this handsome Mosfet Integrated Stereo Amplifier yourself and impress your friends. Just look at these features for such a low price:

- LED indicated input • loudness control • muting control
- integral speaker protection • full speaker switching facility
- stereo/mono switching • tape monitor switch • FULL 45 watts per channel output • frequency response 30Hz-20kHz
- Cat K-3515 Full instruction supplied with kit

IDC CONNECTORS

NO SOLDER 'D' TYPE 25 pin 'D' Plug

Cat P-2693 \$5.49 ea
10 up \$4.80 ea

25 way 'D' Socket

Cat P-2694 \$5.95 ea
10 up \$5.50 ea

36 way Centronics Connectors

57.30360 Plug
Solder tail w/cover
Cat P-2680 \$2.95 ea
10 up \$2.50 ea

57.40360 Socket

Solder tail
Cat P-2681 \$5.95 ea
10 up \$5.50 ea

50 Watt Amp Module

Ideal for home stereo systems. An economical solution for those who want to update their old system without a huge outlay of money. • Input sensitivity is 500mV • Supplied with exclusive instruction booklet • rugged fiberglass PCB • easy assembly. Heatsink bracket is supplied but heatsink itself is extra.
Cat K-3440 **\$14⁹⁵**

100 Watt Amp Module

• 100 watts RMS, 5kHz at 100dB signal to noise ratio. • the ultimate in simplicity; even the power transistors mount on the PCB. • PCB heatsink bracket is supplied • Hason-board fuse protection • input sensitivity: 1V • Use with K-3468 power supply. Ideal for the home constructor or technician who wants to 'roll his own' amplifier system for the home or professional use.
Cat K-3442 **\$19⁹⁵**

IDC COMPUTER CABLE

We buy this cable by the mile direct from the manufacturer to get the lowest possible price so check our prices before you buy.

Type	Cat No.	Price
26 way	W-2750	46¢/ft
34 way	W-2752	60¢/ft
40 way	W-2754	72¢/ft
50 way	W-2756	89¢/ft

AMAZING
VALUE



AMAZINGLY LOW PRICE! CAN'T READ OUR AD?

\$6⁵⁰

\$2 off for any customer who has difficulty reading this ad.

2 1/2" double glass lens, stamp/coin viewer - excellent for inspecting hair-line cracks in PCB's.
Cat Y-0500



Cat H-2505

Normally \$9.95
\$4.95 if you buy
by the end of
June
VALUE!

INSTRUMENT CASE

A superb case for all 'instrument' type projects, and many other besides. Case splits apart for ease of working, comes complete with 4 moulded feet and assembly screws. Amazingly versatile allowing for various PCB mounting positions. Front & rear panel are moulded plastic for ease of working (they can be replaced with aluminium panel if required). Size approx. 8" x 6 1/2" x 2 1/2". Cat H-2505



19" RACK MOUNTING CASE

Professional quality black instrument case fits standard 19" racks, overall they're 16.75" x 9.8" x 5.5"

Cat H-2481 **\$29.95**
10 up \$26.95 ea

QUALITY NI-CAD Rechargeable Batteries

From \$1.49 ea
(10 up price of AA)

Ni-Cads work out much cheaper in the long run, especially if you buy them from Dick Smith Electronics.

Type	Cat No.	Price each
AA	S-3300	1.99
AAA	S-3305	1.95
C	S-3301	2.95
D	S-3003	2.95



**OPENING
SPECIAL**

DICK SMITH ELECTRONICS

INCORPORATED IN THE STATE OF CALIFORNIA

MAIL ORDER CENTER AND SHOWROOM:

390 Convention Way, Redwood City CA 94063
PO Box 2249, Redwood City CA 94063
Telephone: (415) 368 8844
Order Hotline: (415) 368 1066
California residents add 6 1/2%
HANDLING - ALL ORDERS \$1.00
PLUS SHIPPING
INSIDE USA 5% OF ORDER TOTAL
(MIN \$1.50)
OUTSIDE USA 10% OF ORDER TOTAL (MIN \$3.00)

**OFFER EXPIRES
END JUNE**

**MAIL THIS COUPON TODAY WITH \$2 & \$1 PACKAGING
AND WE'LL SEND YOU A CATALOG AS SOON AS THEY
ARE PRINTED IN JUNE \$2 COUPON IN CATALOG REDEEMS YOUR COST
WITH YOUR FIRST ORDER**

Name _____ Address _____
City _____ State _____ Zip _____ ME 2

OVER 60 STORES IN 3 COUNTRIES

Applications

Different families of digital integrated circuits have different input voltage requirements. As a rule, though, the input voltage should not exceed the circuit's positive supply voltage nor go below the circuit's reference ground. However, the nearer the input voltage's excursion comes to the circuit's positive supply and ground, the more reliable will the IC change state when it should.

TTL devices, for example, operate with a positive supply of +5 volts \pm 0.5 volt. When driving a TTL device with the pulse generator presented here, output amplitude switch *S5* (*S8*) should be set to TTL to assure that the maximum allowable voltage will not be exceeded.

The input of a TTL device is a current source. When the input voltage is low (logical 0), the pulse generator must sink enough current to pull the voltage below 0.8 volt. A regular TTL device requires a current of 1.6 mA per input. Low-power and low-power Schottky devices require considerably less current.

Since the pulse generator's output resistance is 100 ohms, the maximum current it can sink without exceeding the 0.8-volt limit is 8 mA. Accordingly, it can drive four regular TTL inputs, or

any combination of inputs that requires less than 8 mA.

When the input voltage of a TTL device is high (logical 1), there is very little current and the output of the pulse generator will be nearly 5 volts. It is not possible to obtain more drive by increasing the voltage. This would cause the supply voltage of the TTL circuit to be exceeded, and damage the IC.

The CMOS family can be operated with a wide range of supply voltages, from a minimum of about 3 to a maximum of 16 volts. Split supplies are often used so that V_{ss} is below ground level. When driving CMOS with a split supply, the pulse generator's ground should be connected to V_{ss} , rather than the ground of the circuit.

When driving CMOS, the output voltage should be adjusted to a level that is well above the mid-point between V_{ss} and V_{dd} , but sufficiently below V_{dd} to assure that the input voltage does not exceed V_{dd} . A voltage of 80% to 90% of the difference between V_{ss} and V_{dd} will assure positive operation.

The voltage level of the output pulse can be set by using a dc voltmeter. Simply obtain a square output and measure

the voltage. The peak voltage will be twice the measured voltage. When pulse width is varied, peak voltage will remain the same even though there will be a change in average voltage.

CMOS inputs require very little current. Therefore, any reasonable number of CMOS inputs can be driven without concern for the power required.

The +5-volt output can be used to calibrate a voltmeter or dc scope. This output has a 1000-ohm series resistor (*R2*) to prevent short-circuit damage. It is *not* intended for use as a power supply for other circuits.

An ac or dc scope can be voltage calibrated by setting the output pulse amplitude to 5 volts. Rotate the AMPLITUDE control to the point where the LEDs turn on. Peak voltage will be 5 volts, regardless of pulse width. If there is no load on the output, the TTL amplitude will also be 5 volts.

One of the two outputs can be adjusted to a frequency that is a submultiple of the other. Rotate the WIDTH control counterclockwise until the timer locks in on the submultiple desired, then continue counterclockwise rotation slightly to obtain the desired pulse width.

front panel and the other row facing the power transformer.

Make the stranded wires that connect the board to the front panel 3" to 4" longer than really necessary to allow the board to be removed from the cabinet should troubleshooting ever be needed. Make the wire jumpers only as long as needed to route them through the cable harness.

As you proceed with wiring, make sure to isolate the common ground from the cabinet. If you do not and connect the generator to the negative supply of a circuit being driven, you may create a short circuit.

Once wiring is complete, mount the circuit board on 1/2" spacers to the floor of the cabinet. Then gather the wires together into a bundle and secure it every 1 1/2" or so with plastic

Pc board and T1 go on floor of enclosure, everything else on front panel.

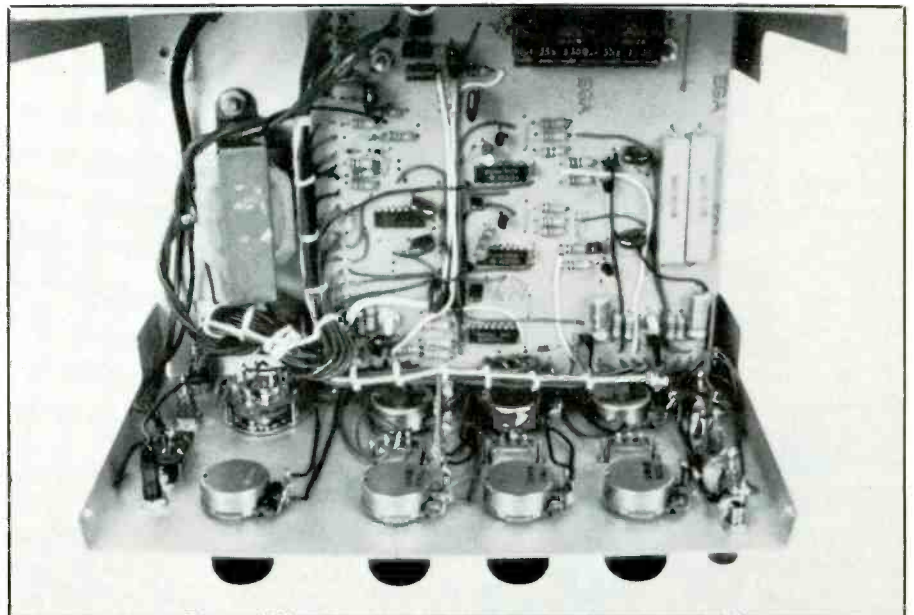

A Great Gift Idea
DON'T LET THE ELECTRONICS
REVOLUTION PASS YOU
OR A FRIEND BY!
SUBSCRIBE TO



Now you can reach out every month and learn about the latest innovations in consumer electronics and personal computers—what's new, how products and circuits work, and what leading authorities think of them.

***Stereo *Video *Home & Car Electronics**
***Test Instruments *Circuitry & Devices *Servicing**
***Personal Computers *Communications *Construction Projects**

In every issue, authors lucidly explain how exciting, new electronics ideas are applied . . . issue forthright buying counsel . . . present complete plans to build electronic devices to enhance products, even unique ones that are not yet being sold in the marketplace.

Feature articles, tutorials, and construction projects are the hallmarks of MODERN ELECTRONICS, the new monthly magazine for electronics and computer enthusiasts. Covering the entire spectrum of these fields, you'll gather insights in every important area to help you make buying decisions for work and play purposes . . . improve performance of your present equipment . . . increase your electronics competence . . . and add to your practical and intellectual knowledge of electronics and computers.

To be sure you get this valuable information delivered to you regularly, and share the experiences of our writers and editors—Forrest Mims, Len Feldman, Stan Prentiss, Charles Rubenstein, Glenn Hauser, and many others—you can subscribe to MODERN ELECTRONICS today. As a Charter Subscriber, you'll save 45% off the newsstand price when you buy a one-year subscription for only \$12.97. Or save 51% when you subscribe for two years at \$22.97.

Just fill out the coupon and mail with your check, money order, or credit card information (Visa or MasterCard) to enter your Charter Subscription. Do it today to ensure earliest delivery!

MODERN ELECTRONICS 76 North Broadway, Hicksville, NY 11801

Please send me Modern Electronics for 2 Years 1 Year

Name _____
 Street _____
 City _____
 State _____ Zip _____

2 Years (24 issues).....\$22.97□

1 Year (12 issues).....\$12.97□

Charge My Order To: Payment Enclosed \$ _____

MasterCard



VISA

My account number is:

--	--	--	--	--	--	--	--	--	--	--	--	--	--	--	--	--	--	--	--



PACKED WITH
MORE THAN
5,000 QUALITY
ELECTRONIC
PARTS AND
ACCESSORIES!

Look inside our new 132 page catalog, which offers over 300 new items. You'll find a full line of test equipment, computer accessories, speakers, CATV equipment, television parts and many more, along with the largest selection of original Japanese semiconductors in the country. All of them at unbelievably low prices.

CALL TODAY FOR YOUR
FREE COPY OF CATALOG #10!



MCM ELECTRONICS
 858 E. Congress Park Drive
 Centerville, Ohio 45459
 513-434-0031

CALL TOLL FREE
1-800-543-4330

(IN OHIO CALL 1-800-762-4315)
 (IN HAWAII OR ALASKA 1-800-858-1849)

SOURCE NO. ME-5

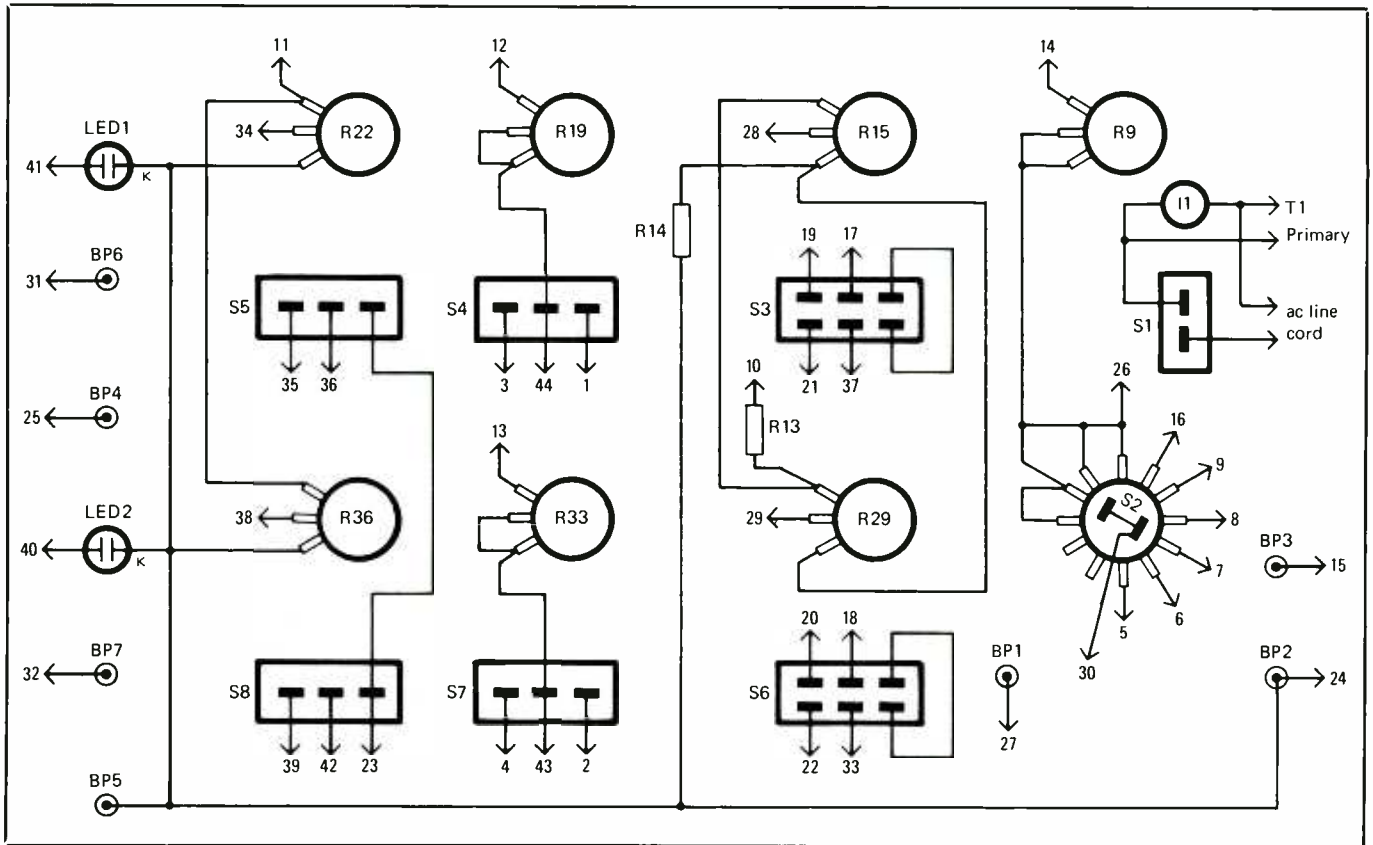

Fig. 5. Details for wiring front-panel-mounted components into rest of generator's circuitry.

cable ties (or lace with cord) to form a neat cable harness.

Checkout

With IC3, IC4, IC5 and IC7 still not installed on the board, plug the generator's line cord into an ac outlet and flip the POWER switch to on. The neon lamp should light. Now, referring to Figs. 3 and 2, measure the voltage at the points indicated in the power supply and at the supply pins of IC sockets. When you are satisfied that all is okay, turn off the power and unplug the line cord. Wait a minute or so for the capacitors to discharge. Then install the DIP ICs in their respective sockets, taking care to properly orient them and practicing safe handling procedures for CMOS IC2.

Plug the line cord back into the ac outlet and flip the POWER switch to on. Set the RANGE switch to any of

the generator's internal oscillator ranges and use an oscilloscope to check for the presence of a sawtooth waveform at the emitter of Q1.

Next, check each pulse generator as follows:

Set the PHASE controls to about the middle of their ranges. Using the scope, check the outputs of the comparators in IC3. All should be delivering positive dc pulses. Rotate the PHASE controls while observing on the screen that the widths of the pulses vary as you do this.

A square-wave pulse should be observed at the outputs of IC4 at pins 1 and 13. Set S3 (S6) to SQUARE and S5 (S8) to TTL. The output pulses at A and B OUTPUT terminals BP5 and BP7 should be square and have an amplitude of 5 volts. (This part of checkout will be easier to perform with a two-channel scope that can simultaneously display the outputs

from generators A and B.) Set S5 (S8) to VARIABLE and rotate AMPLITUDE control R22 (R36). Observe that the amplitude of the displayed pulses varies between 1.2 and 12 volts and that LED1 (LED2) lights when the control is rotated past the 5-volt position. If this does not occur, measure the supply voltage at the output of IC6 (IC8) as the control is rotated.

Check for output pulses from both generators with all four frequency ranges and over the full range of the FREQUENCY control. Set the RANGE switch to LINE and check for 60-Hz output pulses. It may be necessary to rotate the PHASE control to a point below mid-position to obtain an output pulse. Set the RANGE switch to EXTERNAL and apply an appropriate signal to EXTERNAL input BP4.

(Continued on page 85)

HACKERS

Hacknet™ is a unique network of computer users -- scientists, businessmen, educators, and lots of kids -- dedicated to computer intrusion, war games, and software piracy.

Hacknet publishes *Hack!*® -- the national newsletter of computer use and abuse. *Hack!* includes tips on breaking into computer systems, information on recent legislation governing unauthorized system access, reviews of hardware and software security devices on the market, articles on famous computer crimes, and our most important feature -- the Bit Swap -- a bulletin board for readers to exchange information on computer access.

Hacknet also publishes the **Access Directory**® -- The most unique tool ever for the serious computer programmer or hacker. This directory lists hundreds of access numbers for major computer systems nationwide. Some systems welcome you with open arms; others defy you to get in. Only with Access can you find these systems.

Membership in the Hacknet brings you a subscription to *Hack!*, a copy of the current edition of the Access Directory, and future updates and notices of importance to hackers. You can also choose to be included in the forthcoming National Hacker Directory.

If you aren't a hacker, you're not getting even one-hundredth of the possible power (*and fun!*) out of your computer. And if you are a hacker, Hacknet information on security and legislation can be crucial to knowing your legal limits.

One year membership in the Hacknet is \$14.95. The Access Directory is available separately for \$9.95 plus \$2.00 shipping and handling.

There are 87,000,000 computers in the United States. Is *one* really enough for you?

HACKNET

24 Evans Rd., Suite 401
Marblehead, MA 01945

Portable Gas Detector ... It Can Save Your Life!

Easy-to-build project gives bargraph indication of concentrations of toxic gases and organic solvents

By Larry D. Gray

Have you ever thought you smelled gas and wished you had a way to check out your suspicion? Do you need to efficiently check the carburetor air-to-fuel mixture in your car but cannot justify spending the big bucks for a professional analyzer? Well, with the Portable Gas Detector described here, you can do both—and the project will cost you only about \$35 to build. To top it all off, you can use the Detector as an alcohol breath analyzer.

About the Circuit

At the heart of the gas detector's circuit is a Figaro 812 solid-state gas-sensor device (GS1 in Fig. 1). The sensor uses n-type SnO₂, the resistance of which decreases with an increase in concentration of gas. The 812 has a high sensitivity to toxic gases and organic solvents. Hence, GS1 can sense very small concentrations of carbon monoxide and alcohol. Although it is not as sensitive to hydrocarbon products, like natural gas, it still gives good results.

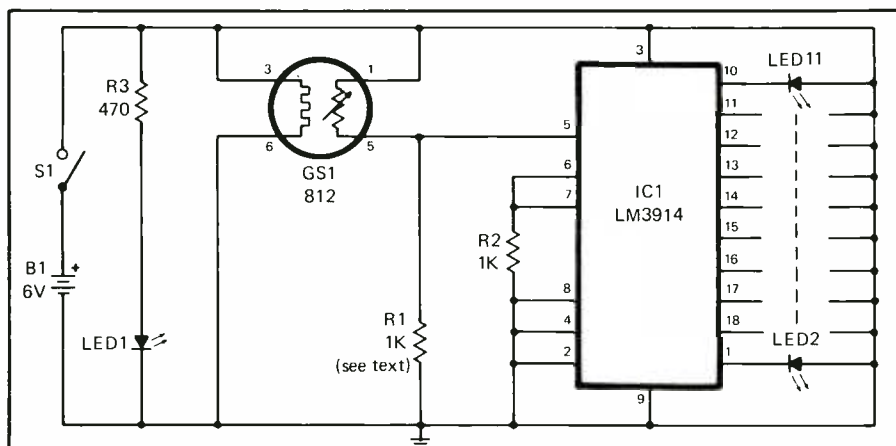

PARTS LIST

- B1—Four 1.5-volt AA cells in series (see text)
- GS1—Figaro 812 gas sensor
- IC1—LM3914 dot/bargraph display driver
- LED1—Green 3-mm light emitting diode
- LED2 thru LED11—Red 3-mm light-emitting diode
- R1, R2—1000-ohm, ¼-watt, 10% tolerance resistor
- R3—470-ohm, ¼-watt, 10% tolerance resistor
- S1—Spst toggle or slide switch

Misc.—4 7/8" × 2 1/2" × 1 1/4" plastic box; pc board or perforated board and solder posts; four-cell AA battery holder; chassis-mount seven-pin miniature tube socket; machine hardware; hookup wire; solder; etc.

Note: The following are available from QDI Inc., P.O. Box 205, West Union, OH 45693: Figaro 812 gas sensor for \$14.95; etched and drilled pc board for \$6.95; complete kit of all board-mounted parts, including GS1, tube socket and pc board but not plastic case, for \$29.95. Please include \$3.00 for postage and handling.

Fig. 1. Circuitry for Gas Detector is very simple. Most of the work is done by gas sensor GS1; IC1 and LED2 through LED11 form the display.

Since *GSI* does all the work in this circuit, the only other items needed are the components that make up the eye-catching bargraph light-emitting diode display. Consequently, the circuit is quite simple. The LM3914 voltage comparator used for *IC1* is all that is needed to sequentially drive the display consisting of *LED2* through *LED11*.

Contained inside the LM3914 are 10 comparators. The first comparator is referenced 0.12 volt above ground. Each successive comparator is then referenced another 0.12 volt above the previous one. With this arrangement, an input of 1.2 volts is required for a full-scale display indication in which all 10 LEDs that make up the bargraph display are lit. Current through the display is controlled by *R2*. The 1000-ohm value specified for this resistor limits the current through the 10 LEDs to 10 mA.

Gas sensor *GSI* and resistor *R1* form a voltage divider that limits the maximum voltage delivered to *IC1* to 1.2 volts. When the sensor is exposed to air, its resistance is relatively high (about 50,000 ohms), and very little voltage (0.08 volt) is applied to the LM3914. As a combustible or toxic gas passes over the sensitive surface of *GSI*, sensor resistance drops, increasing the voltage dropped across *R1*. In turn, this causes *IC1* to light one or more display LEDs, the number being lit increasing as the voltage increases. The more combustible or toxic the gas, the lower the resistance of *GSI* and the greater the number of LEDs that light.

To avoid confusion, a green LED is used for *LED1* to indicate when power is on. Resistor *R3* serves as a current limiter for this LED.

Power for the circuit is supplied by *B1*, which consists of four AA cells in series. While any type of AA cell can be used to power the project, alkaline cells are recommended if you expect to obtain reasonably long operating life, since *GSI*'s heater draws consid-

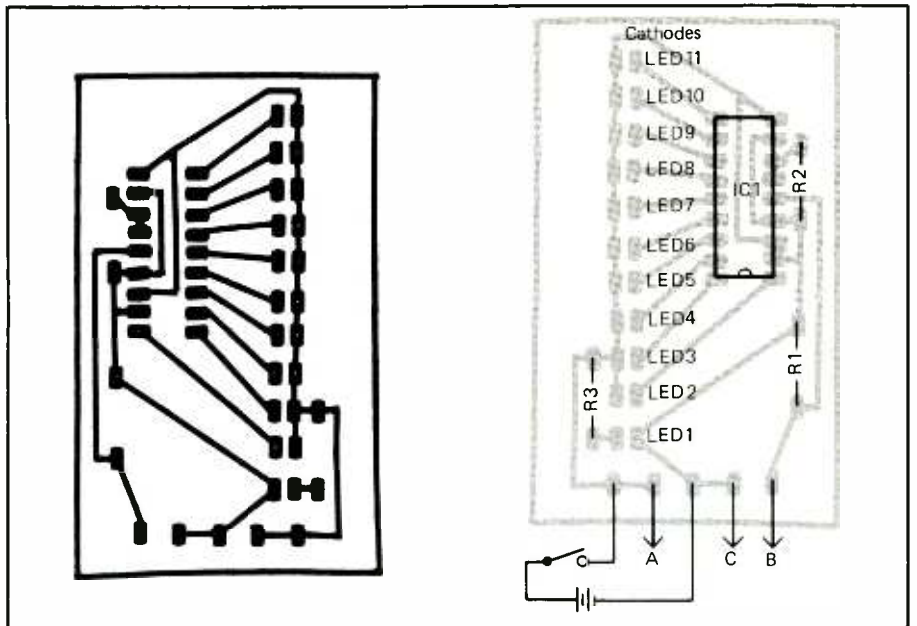

Fig. 2. Actual-size etching-and-drilling guide is at left; components-placement diagram at right gives complete board assembly details.

erable current, though the rest of the circuit draws very little.

Construction

Owing to the simplicity of the circuit, you can use either a printed-circuit board or a perforated board and solder posts for assembly. If you decide to fabricate your own pc board, use the actual-size etching-and-drilling guide shown in Fig. 2. Whether you choose pc or perforated board construction, the components-placement guide, also in Fig. 2, should be used. It is not necessary (or advisable) to install *IC1* in a socket.

Gas sensor *GSI* plugs into a seven-pin miniature tube socket and, therefore, presents no problems with regard to indexing during installation. Wiring details for this socket are shown in Fig. 3.

Once the circuit has been assembled, it can be temporarily connected to the battery supply and tested before final assembly. Before proceeding to testing, however, machine the plastic box in which the project is to be housed to accommodate the bat-

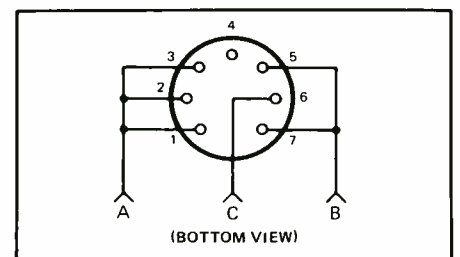

Fig. 3. Wire the gas sensor's socket as shown here; match the lettered points to the same points in Fig. 2.

tery holder on the floor of the box, the gas sensor (in its socket) to the top end, and the circuit board and power switch to the cover. Note that the circuit board mounts to the lid with no hardware. Instead, a single column of 11 holes into which the domes of the LEDs plug is sufficient to hold the assembly in place. Of course, the holes should be just large enough to provide a snug—not force—fit. If you wish, however, you can apply a small drop of clear plastic cement to

(Continued on page 87) ◆

Oscilloscope User's Guide

Part 2 (Conclusion)

A close-up look at the high-performance general-purpose oscilloscope and how to use it for making tests and measurements

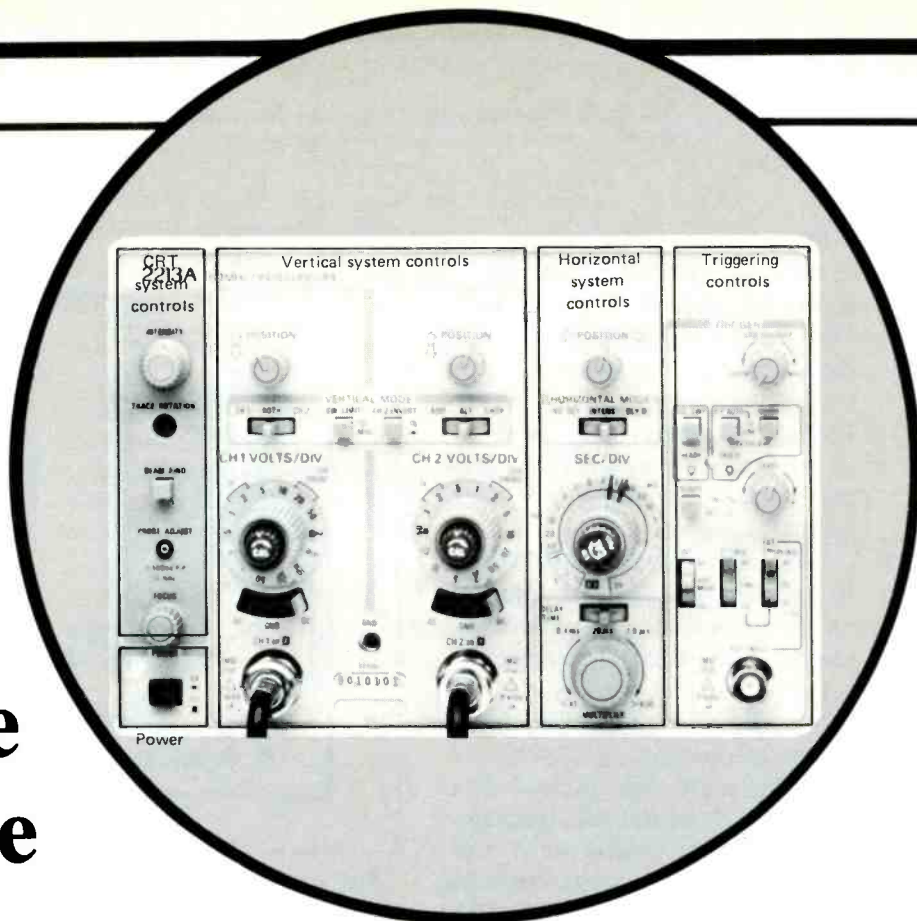

By Vaughn D. Martin

Last month, in Part 1 of this article, we introduced you to the high-performance, general-purpose oscilloscope and began telling you how to use it to make various types of measurements. In this concluding part, we continue with our discussion of how to use the scope in time-saving ways.

Differential Measurements

The ADD vertical mode and the channel 2 INVERT button on the 2200 Series scopes let you make differential measurements. Often differential measurements eliminate undesirable components from a signal being mea-

sured (Fig. 8). If you have a signal that is very similar to the unwanted noise, the setup is simple: Feed the signal with the spurious information into channel 1; feed the signal that is like unwanted components into channel 2; set both input coupling switches to DC (use AC if the dc components of the signal are too large); and select the alternate vertical mode by moving the VERTICAL MODE switches to BOTH and ALT.

Now set the VOLTS/DIV switches so that the two signals are about equal in amplitude. Then set the right-hand VERTICAL MODE switch to ADD and press the INVERT button so that the common-mode signals have opposite polarities.

If you use the channel 2 VOLTS/DIV

switch and CAL control for maximum cancellation of the common signal, the signal that remains will contain only the desired part of the channel 1 input signal. The two common-mode signals will have canceled out, leaving only the difference signal.

Using The Z Axis

The scope's CRT has three axes: horizontal (X), vertical (Y), and intensity of the electron beam (Z). The input for the Z axis is usually located on the rear of the instrument. This input lets you modulate the intensity of the displayed signal on the screen, using an external signal. The Z-axis input will usually accept a signal of up to 30 volts peak-to-peak over a usable fre-

quency range of dc to 5 MHz. Positive voltages decrease and negative voltages increase brightness, with 5 volts causing a noticeable change in intensity.

The Z-axis input is an advantage to users who have their instruments set up for a long series of tests. One example is the testing of high fidelity equipment (Fig. 9).

Using TV Triggering

The composite-video waveform consists of two fields, each of which contains 262 lines. Many oscilloscopes offer TV triggering to simplify viewing of video signals. Usually, however, the oscilloscope will trigger only on fields at some sweep speeds and lines at others. The 2200 Series scopes trigger on either lines or fields at any sweep speed.

To view TV fields with a 2200 Series scope, use the TV FIELD mode, which allows the scope to trigger at the field rate of the composite-video signal on either field. Since the trigger system cannot recognize the difference between the two fields, it will trigger alternately on the two and produce a confusing display if you look at one line at a time. To prevent this, add more holdoff time with the variable holdoff control or by switching the vertical operating mode to display both channels. This makes total holdoff time for one channel greater than one field period. Then position the unused vertical channel off-screen to avoid confusion.

It is important to select the trigger slope that corresponds with the edge of the waveform where the sync pulses are located. Selecting a negative slope for pulses at the bottom of the waveform allows you to see as many sync pulses as possible.

When you want to observe the TV line portion of the composite video signal, use the NORM trigger mode and trigger on the horizontal synchronization pulses for a stable display. It is usually best to select the blanking level of the sync waveform

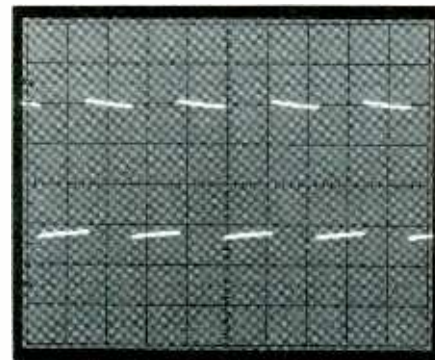
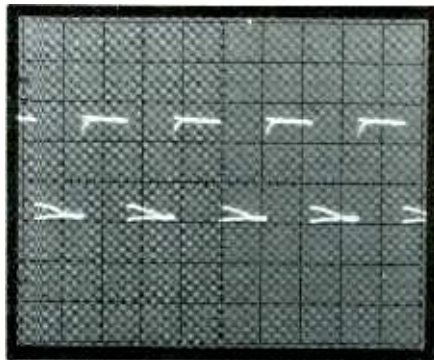

Fig. 8. Differential measurements allow removal of unwanted information from a signal any time there is a signal closely resembling the unwanted components. Once common-mode component is fed to channel 2 and inverted, signals can be added with ADD vertical mode (result shown in photo at right).

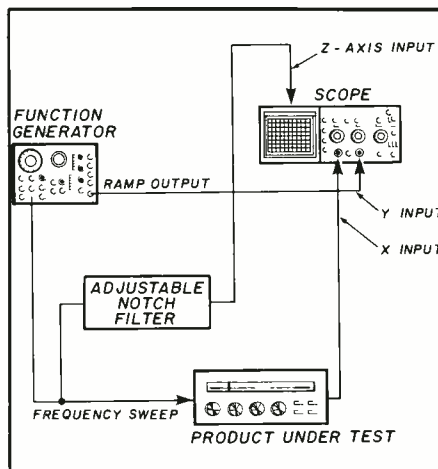

Fig. 9. This setup illustrates how a scope's Z axis, along with a sweep function generator and notch filter, can be used to test hi-fi equipment.

so that the vertical field rate will not cause double triggering.

Delayed Sweep Measurements

Delayed sweep is a technique that adds a precise amount of time between the trigger point and the beginning of a scope sweep. Delayed sweep is often used as a convenient way to make a measurement (the risetime measurement is a good example). To make a risetime measurement without delayed sweep, triggering must be on the edge that occurs prior the desired transition. With delayed sweep, you can trigger anywhere

along the displayed waveform and use the delay time control to start the sweep exactly where you want.

Sometimes delayed sweep is the only way to make a measurement. Suppose the part of the waveform you want to measure is so far from the only available trigger point that it will not show on the screen. The problem can be solved with delayed sweep by triggering where you have to and using delay out to where you want the sweep to start.

The delayed sweep feature you will probably use most often is intensified sweep, which lets you use the delayed sweep as a positionable magnifier. You trigger in the usual way and then use the scope's intensified horizontal mode. The on-screen signal will now have a brighter zone after the delay time. Run the delay time (and intensified zone) out to the part of the signal that interests you. Then switch to delayed mode and increase sweep speed to magnify the selected waveform portion so that you can examine it in detail.

Single-Timebase Scopes

Very few single-timebase scopes offer delayed sweep measurement. Those that do may have measurement capabilities similar to those of the Tektronix Model 2213, which has three possible horizontal operating

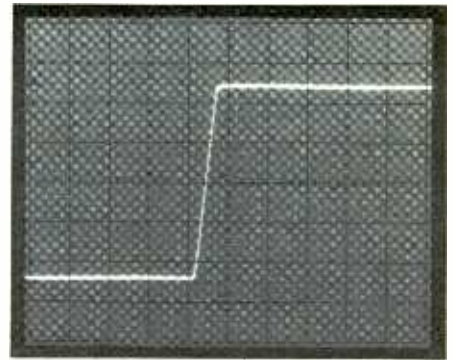
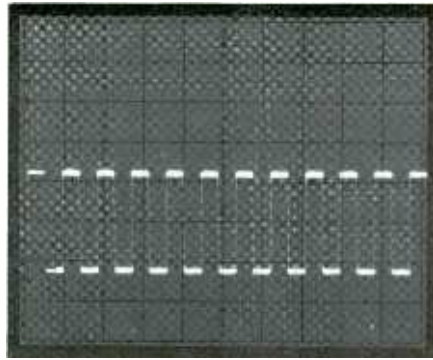
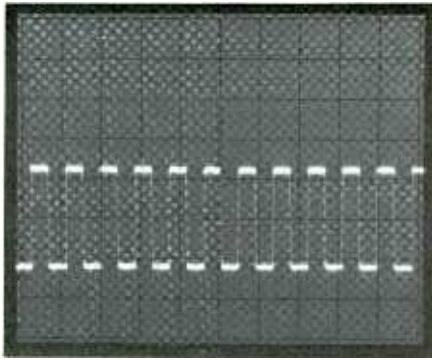

Fig. 10. Delayed sweep adds precise amount of time between trigger point (left) and beginning of sweep (center). By adjusting controls to display one transition of input waveform (right), you can obtain risetime measurement.

modes, labeled on the front panel NO DLY, INTENS and DLY'D.

When you set the HORIZONTAL MODE switch to NO DLY (no delay), only the scope's normal sweep functions. When you choose INTENS (intensified sweep), normal sweep will be displayed with an intensified trace after a delay time. The amount of delay is determined by both the DELAY TIME switch position. You can use 0.5 s, 10 s, or 0.2 ms and the DELAY TIME MULTIPLIER control, which lets you use from 1 to 20 times the switch setting. The DLY'D (delayed) position makes the sweep start after the selected delay. After selecting this position, move the SEC/DIV switch to obtain a faster sweep speed to examine the waveform in greater detail.

This list of horizontal modes should begin to give you an idea of how useful are these delayed sweep features. Start by making the risetime measurement described below. (Note that when making risetime measurements, you must take the risetime of the measuring instrument into account, as in Fig. 10.)

Dual-Timebase Scopes

Delayed sweep is normally found in dual-timebase scopes like the Model 2215, which have two totally separate horizontal sweep generators. In dual-timebase instruments, one sweep is triggered in the normal fashion while

the start of the second sweep is delayed. To avoid confusion, we will call the delaying sweep the A sweep and the delayed sweep the B sweep. The length of time between the starts of the A and B sweeps is called the delay time.

Dual-timebase scopes offer all the measurement capabilities of single-timebase instruments, plus convenient comparisons of signals at two different sweep speeds; jitter-free triggering of delayed sweeps; and timing measurement accuracy of 1.5%. Most of this increase in measurement performance is possible because you can separately control the two sweep speeds and use them in three horizontal operating modes. In the Model 2215, these modes are A sweep only, B sweep only, and A intensified by B, as well as B delayed. The HORIZONTAL MODE switch controls the operating mode, and two SEC/DIV switches, concentrically mounted on the Model 2215, control the sweep speeds (Fig. 11).

When you use the ALT (alternate) position of the HORIZONTAL MODE switch, the scope displays the A sweep intensified by the B sweep and the B sweep delayed. As you set faster sweeps with the B SEC/DIV switch, you will see the intensified zone on the A trace diminish in size and the B sweep expanded by the new speed setting. As you move the B DELAY TIME POSITION control to change where the B sweep starts, the intensified

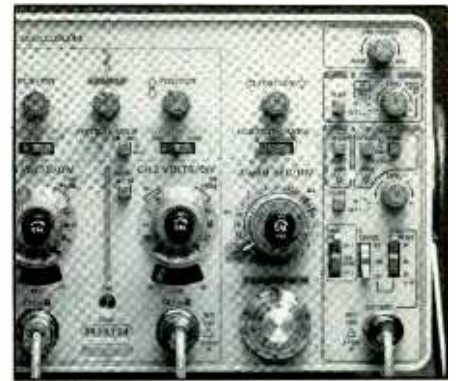

Fig. 11. Close-up of Tektronix's Model 2215 scope shows HORIZONTAL MODE and two concentrically mounted SEC/DIV switches used for controlling sweep speed.

zone will move across the trace and the B waveform will change.

This sounds more complicated than it really is. As you use the scope, you will find that the procedure, in fact, is very easy. You will always see exactly where the B sweep starts; and you can see the size of the intensified zone to judge which B sweep speed you need to make the measurement you want.

Measurement At Two Sweep Speeds

Examining a signal with two different sweep speeds simplifies making complicated timing measurements.

The A sweep gives a large slice of time on the signal to examine; the intensified zone shows where the B sweep is positioned; and the faster B sweep speeds magnify the smaller portions of the signal in great detail. You will find this capability useful in many measurement applications (Fig. 12).

Because you can use the scope to show A and B sweeps in channels 1 and 2, four traces can be displayed. To prevent overlapping traces, however, most dual-timebase scopes offer an additional position control, like ALT SWP SEP (alternate sweep separation) position on the Model 2215. With this and the two VERTICAL POSITION controls, all four traces can be placed on-screen without confusion.

Separate B Trigger

Jitter can prevent you from making an accurate measurement any time you want to examine a signal that is not perfectly periodic. With two timebases and delayed sweep, you can overcome this with the separate trigger available for the B sweep. Trigger the A sweep as usual and move the intensified zone out to the portion of the waveform you want to measure. Then set up for a triggered B sweep, instead of letting the B sweep simply run after the delay time.

On a Model 2215, the B TRIGGER LEVEL control does double duty. In its fully clockwise position, it selects the run-after-delay mode. In any other position, it is a trigger level control for the B trigger. The B TRIGGER SLOPE control lets you choose positive or negative transitions for the B trigger. These two controls let you set the scope to trigger a stable B sweep even when the A sweep has jitter.

Increased Timing Measurement Accuracy

In addition to letting you examine signals at two different sweep speeds and a jitter-free B sweep, a dual-timebase scope lets you get increased time

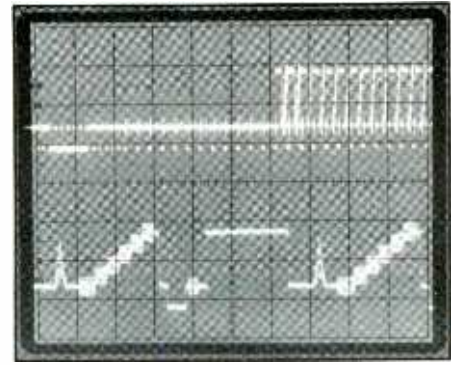
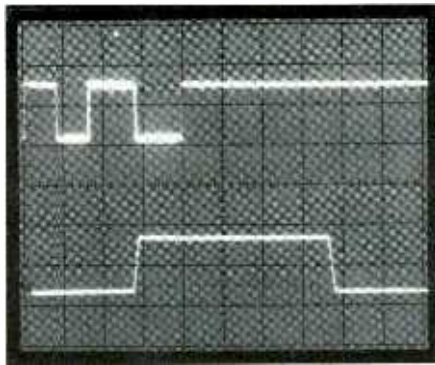

Fig. 12. Alternate delayed-sweep measurements are fast and accurate. One use (left photo) is examination of timing in a digital circuit. Another (right photo) shows one field of a composite video signal (upper waveform), where the intensified field is the lines magnified by the faster B sweep.

measurement accuracy. Note that the B DELAY TIME POSITION control is a measuring indicator as well as a positioning device. The numbers in the window at the top of the dial are calibrated for the major divisions of the graticule, while the numbers around the perimeter divide each major division into hundredths.

To make timing measurements accurate to about 1.5% with the B DELAY TIME POSITION control, do the following: 1) use the B runs-after-delay mode; 2) place the intensified zone (or use the B sweep waveform) where the timing measurement begins and note the B DELAY TIME POSITION dial setting; 3) dial back to where the measurement ends and note the reading there; 4) subtract the

first reading from the second and multiply by the A sweep SEC/DIV setting. You will find an example of this accurate—and easy—timing measurement in Fig. 12.

In Conclusion

Making an investment of several hundred to more than one thousand dollars to buy a high-performance general-purpose oscilloscope implies a commitment to better electronic testing and servicing. Naturally, this extends to learning how to use the instrument to its utmost capability to reap all of the benefits it has to offer. So be sure to set aside the time needed to fully acquaint yourself with your new scope. **ME**

SUBSCRIBER SERVICE

CHANGE OF ADDRESS

Planning to move? Please let us know six weeks in advance so you won't miss a single issue of Modern Electronics.

Attach old label and print new address in space provided. Also include your mailing label whenever you write concerning your subscription to ensure prompt service on your inquiry.

Modern Electronics
76 N. Broadway
Hicksville, NY 11801

ATTACH LABEL HERE

NEW ADDRESS HERE

PLEASE PRINT

NAME _____

ADDRESS _____

CITY _____ STATE _____

DATE _____ ZIP _____

The Teleguard

Part 2 (Conclusion)

Phone accessory automatically calls a preprogrammed telephone number when your burglar/fire alarm sensor is tripped

By Anthony J. Caristi

Last month, we described what this useful accessory does, how it does it, constructing the project and initial checkout. In this part, we tell you how to set up the project and how to connect it into your security/fire-alarm system.

Setup and Use

Plug Teleguard's line cord into an ac receptacle and its other cord into the telephone line from the phone company, and switch *S2* to SET-UP. *OUTPULSING LED1* should now light, indicating that Teleguard has established connection to the telephone system. Dial the emergency number you have selected, using Teleguard's keypad. As you do this, *LED1* will flash in accordance with the digits being dialed. When *LED1* stops flashing, switch *S2* to NORMAL to put the system into its "guard" mode.

System operation can be checked by simulating an emergency condition. You do this by activating the external protective circuit (Fig. 4). Before you wire the premises to be monitored with switches and/or sensors, you can simulate the emergency condition simply by using a length of hookup wire to short terminal A to terminal C on *TS1*. This simulates the closing of a normally-open protective circuit (Fig. 4A). If everything is okay, *OUTPULSING LED1* should pulse on and off in accordance with



Interior view of the assembled Teleguard project shows neat layout.

the programmed telephone number. When outpulsing ceases, you can lift the receiver of the telephone that is on the same line as Teleguard and hear the special tone that denotes existence of an emergency condition. (Be sure to alert the party being called, should he answer the telephone, that this is only a test.)

Having verified that the system works with normally-open protective devices, it is a good idea to also verify operation with normally-closed devices. Again, you can do this locally simply by jumpering from terminal A

to terminal C of *TS1* with one wire and from terminal A to terminal B with a second wire. (This arrangement is detailed in the normally-closed diagram in Fig. 4.) To trip the circuit, simply disconnect wire from terminal B.

Once you know Teleguard is operating as it should, you can proceed to wire the premises to be protected with appropriate sensors and run conductors from the sensors to the project. Although Fig. 4 does not it, you can mix normally-open and normally-closed sensors in your system. To do

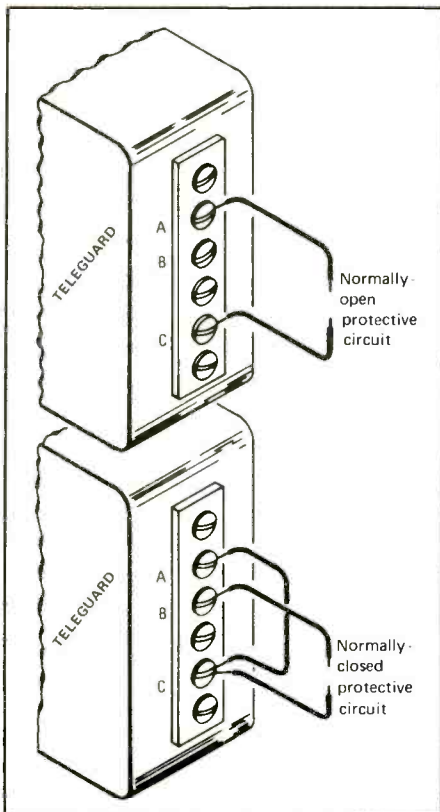

Fig. 4. Teleguard can accommodate both normally-open and normally-closed sensors, depending on how protective circuit is connected.

this, simply replace the wire jumper between terminals A and C of *TSI* with two separate wires and run these to opposite ends of the series string of normally-close sensors.

Should you wish to change the telephone number stored in Teleguard's memory at any time, simply do the following: (1) set *SI* to SET-UP; (2) dial in the new number with the project's keypad after *LED1* extinguishes; and (3) when outpulsing ceases, set *SI* to NORMAL. You can do this any number of times.

If for any reason you wish to deactivate Teleguard, simply disconnect its modular plug from the telephone line but leave its ac line cord plugged into the ac receptacle. This way, the telephone number programmed into

Teleguard's memory will not be lost and the project will be ready to be instantly returned to service.

In Closing

With Teleguard at your service, you can have a secure feeling whenever you leave your home or business unattended. With the proper sensors, Teleguard can alert you (or anyone you designate) if an intruder attempts to break into your home or business, a fire starts, water floods a basement, or any other condition that can be indicated by opening or closing a circuit.

In a future article, we will discuss several types of solid-state sensors you can build at low cost for use with Teleguard. These will monitor such conditions as temperature and pressure and detect the presence of fluids. They will enhance operation of Teleguard and provide state-of-the-art protection. **ME**

FUN & EDUCATIONAL ELECTRONIC KITS

ROBOT KITS

PEPPY

(Sound/Touch Sensor)

- Power source: 2 ea. AA batteries (not included) **MV-916 \$24.95**
- Color: pink

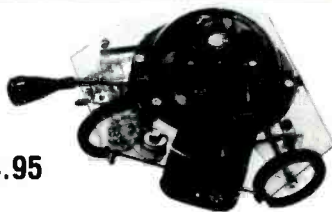

PIPER-MOUSE

- Movement: 3 wheels driven by 2 DC motors
- Control: Supersonic sound sensor including condenser microphone & PC board
- Power source: 2 ea. AAA batteries & 1 ea. 9V battery (not incl.)
- Color: blue

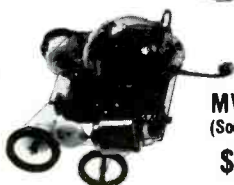

MV-915
(Sound Sensor)
\$44.95

MEMOCON-CRAWLER

- Movement: 3 wheels driven by 2 DC motors
- Control: Memory/electronics circuit (through the keyboard)
- Element: 4-bit static RAM
- Modes: Right, left, forward, pause, buzzer, beam (LED)
- 256 steps (no repeat steps) approx. 0.7-0.3 sec/1 step
- Power source: 2 ea. AA batteries, 1 ea. 9V battery (not incl.)
- Color: black



MV-918 (Programmable Memory) \$74.95

PHONE:
(305) 884-8686

MORNING DISTRIBUTING CO.
P.O. BOX 717, HIALEAH, FLA. 33011

HOBBY KITS®

EXPERIMENT — LEARN ELECTRONICS
BUILD AND DESIGN YOUR OWN AM, FM, CW, OR
SSB RECEIVERS, TRANSMITTERS AND, ETC.
WITH OUR MINI-LINEAR CIRCUIT KITS.
All Kits Come Complete With Etched and Drilled Circuit Boards
and All Parts Needed To Function As Described.

AFA-1 AUDIO AMP LM-380 1-2 Watts 4-16 OHM Output	\$ 4.95
AFP-1 AUDIO PREAMP Dual Audio Preamp—For Mike Etc.	\$ 3.95
BMD-1 BAL. MIX LM 1496 Mixer—S.B. Modulator Tuned Output	\$ 9.95
DET-1 AM DET Am Envelope Detector With AGC Output	\$ 3.95
DET-2 FM DET LM 3065 FM Detector (455 KHZ or 4-11 MHZ)	\$ 7.95
DET-3 SSB DET LM 1496 SSB Detector (Needs OSC-1 or OSC-4)	\$ 9.95
DET-4 DETECTOR CW/SSB Using a dual age FET transistor	\$ 4.95
IFA-1 IF AMP CA 3028 30 DB Gain. Optional AGC (455 KHZ or 9-11 MHZ)	\$ 6.95
FLS-9 SSB FILTER 9 MHZ/2. 1KHZ BW with USB XAL for OSC-1	\$49.95
IFA-2 IF AMP CA 3028 30 DB Gain 1-100 MHZ. Optional AGC	\$ 6.95
MBA-1 FREQ. MULT. Tuned Output Buffer-Mult.-Amplifier to 250 MHZ	\$ 5.95
OSC-1 CRYSTAL OSC 100 KHZ—20 MHZ Not Tuned	\$ 3.95
OSC-2 CRYSTAL OSC Ov. 18-200 MHZ Tuned Output	\$ 4.95
PSV-1 POWER SUPPLY LM 723 With Pass Transistor, 3 amps max.	\$ 7.95
PLL-2 TONE DETECTOR LM 567 PLL Tone Detector	\$ 5.95
RF/MIX-1 RF-AMP/MIXER CA 3028—Tuned RF AMP/Mixer 1-100 MHZ	\$ 7.95
RF/MIX-2 RF-AMP/MIXER 3N204 Tuned RF AMP/Mixer 1-250 MHZ	\$ 7.95
VCO-3 VARIABLE HI STAB. OSC. Varactor Tuned. 400 to 600 KHZ Output	\$ 7.95
VCO-4 VARIABLE HI STAB OSC. Varactor Tuned. 3 to 20 MHZ Output	\$ 7.95

Other Robot Kits Are Available
Send For Free Brochure
Send \$2.50 For Shipping & Handling

A Multi-Function Two-Transistor Oscillator

By Forrest M. Mims III

Some integrated circuits, particularly the 741 operational amplifier and the 555 timer, have for many years been considered standard devices by engineers and experimenters alike. Because these and other ICs are so exceptionally versatile, it's easy to overlook simple circuits made from discrete components that are equally versatile and sometimes simpler.

One of the best examples of a highly versatile non-integrated circuit is the two-transistor oscillator shown in Fig. 1. This circuit is designed to function as a code-practice oscillator when connected to a telegraph key, speaker and battery. However, it has numerous other applications, some of which have greatly influenced my career as an electronics experimenter. While this circuit may not affect anyone else's career, perhaps it will lead experimenters to reconsider the value of discrete transistors in their circuits.

Back to Basics

For some 20 years, Radio Shack stores have sold an assembled version of the code-practice oscillator circuit in Fig. 1 for a few dollars (catalog number 20-1155). During my senior year at Texas A&M University in 1966, I used one of those circuits to supply pulses to some of the first commercially available infrared-emitting diodes. I used those pulsed infrared emitters as optical sources for miniature travel aids for the blind and in light-wave communications experiments.

Later in 1966, I used the basic circuit in Fig. 1 to drive a silicon solar cell. The cell emitted pulses of infrared which were detected by a second, identical solar cell nearby. I also used a miniaturized version of the circuit to drive an infrared-emitting telemetry transmitter which I launched in small rockets. A light-sensitive cadmium-sulfide photocell varied the pulse rate of the infrared transmitter, thus providing an indication of the rocket's roll rate. In 1968, I modified the circuit slightly so that it would cause a small incandescent lamp to emit brilliant flashes of light. I

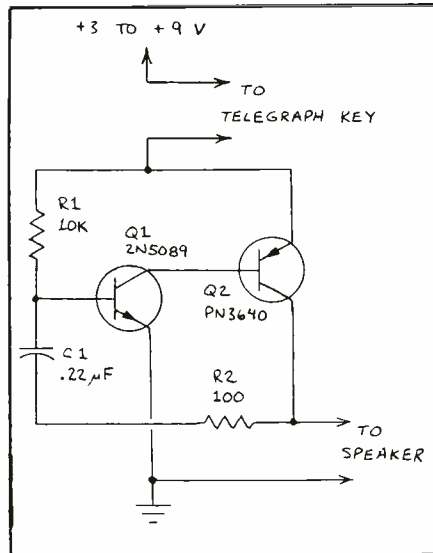

Fig. 1. Schematic diagram of a CPO Radio Shack has sold for 20 years.

built a series of miniature flashers to assist in the recovery of dozens of night-launched model rockets that carried an experimental guidance system.

These experiments with the basic circuit in Fig. 1 had consequences more far ranging than I could ever have imagined. The rocket light flasher became the subject of my first magazine article and led directly to my decision to become an electronics writer. Ed Roberts helped with some of those night launchings. In 1969, Ed and I joined with two friends to form MITS, Inc. Though our first product was a model rocket light flasher, MITS is best remembered for the Altair 8800, the first personal computer.

Designing travel aids for the blind, a project which still occupies a good deal of my time, led to a series of articles and books about light-emitting diodes and lasers. The experiments in transmitting infrared pulses between two identical solar cells led to similar work with LEDs. In 1973, after I used a pair of identical LEDs to transmit audio in both directions through both the air and an optical fiber, I submitted an invention disclosure to Bell Labs. After agreeing to pay for the suggestion if they used it, Bell Labs rejected it as being impractical. Five years

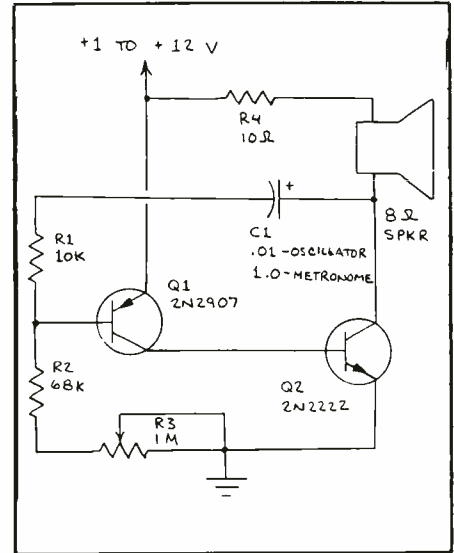

Fig. 2. Shown here is the schematic of a simple oscillator/metronome.

later, however, Bell Labs announced it had developed an optical telephone that incorporated the core of my suggestion. Since *Business Week* said the new phone would "dramatically alter the basic nature of the phone network" (December 4, 1978), I spent several months asking Bell Labs to pay for the use of the suggestion. They refused, I sued, and they eventually settled out of court.

Recently I learned that after more than 20 years Radio Shack plans to discontinue the code practice oscillator circuit in Fig. 1. For sentimental reasons, I'm sorry to see the end of that product. On the other hand, the basic circuit can be assembled in a minute or so on a plastic breadboard. Recently I've experimented with an assortment of applications for the circuit and many of them are covered below. First, let's review the circuit's operation. Referring to Fig. 1, when the key is closed *C1* begins to charge through *R1*, *R2* and the speaker. Both *Q1* and *Q2* are initially off. Eventually, the charge on *C1* becomes high enough to switch *Q1* on, which then switches *Q2* on.

When *Q2* is on, the speaker is connected directly across the power supply through *Q2*'s emitter-collector junction. Meanwhile, *C1* discharges to ground

through the base-emitter junction of *Q1*. When the charge on *C1* falls below that necessary to keep *Q1* switched on, *Q1* switches off; *Q2* then switches off, and current is no longer supplied to the speaker. The charge-discharge cycle repeats, resulting in audible pulsations from the speaker. If the charging time is made brief by making *C1* small, the speaker will emit a high-pitched tone.

Introducing the Circuits

Note that *Q2* in Fig. 1 is a pnp transistor. For applications like light flashers, where low-switching impedance is desired (for maximum current), it's best to use an npn transistor switch, since its on resistance is less than that of a pnp transistor. The basic circuit can be modified for this purpose by rearranging it to be a mirror image of the circuit in Fig. 1. This version of the basic circuit is used in each of the circuits that follow. It can produce fast rising and falling current pulses having a peak amplitude greater than 1 ampere. And it will oscillate when the power supply voltage is only about 0.7 volt.

Each circuit given below specifies a 2N2907 for the pnp transistor and a 2N2222 for the npn transistor. However, many different pnp and npn transistors can be substituted for these. For best results, use silicon transistors designated for switching applications. You may wish to use a power transistor for the npn unit in applications that switch lots of current (e.g. driving incandescent lamps).

To monitor the operation of the circuits, break the connection between *Q2*'s emitter and ground and insert a small resistor in the gap. Connect an oscilloscope across this resistor to monitor the pulsed output from the circuit. If this monitoring resistor has a value of 1 ohm, it will have very little influence on the circuit's operation. If a circuit fails to operate, disconnect the power while looking for the problem. Otherwise, *Q2* may stay turned on and both it and any device with which it is in series may be damaged or destroyed by the excess heat generated.

Incidentally, the very fast rise and fall times of the basic circuit can produce in-

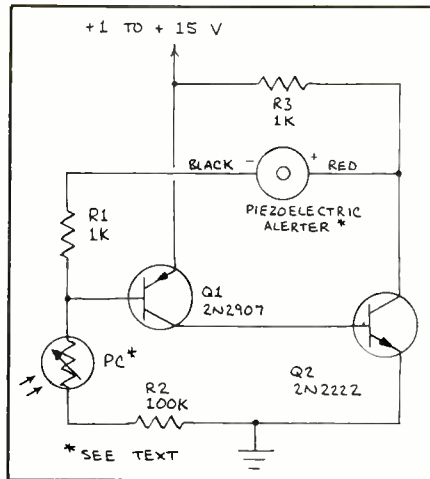

Fig. 3. This light-dependent oscillator uses a piezoelectric alerter.

terference on a nearby radio. Be sure to keep this in mind while testing the circuit.

Audio Oscillator Circuits

Figure 2 shows a mirror image of the circuit in Fig. 1 configured as an audio oscillator. Potentiometer *R3* controls the circuit's oscillation frequency. When *C1* is 0.01 microfarad, the circuit generates a tone. The tone slows to a series of distinct clicks or pocks when *C1* is increased to 1 microfarad. Resistor *R4* limits current through the speaker and thereby reduces the volume of the sound from the speaker. The volume can be increased by increasing power supply voltage. Resistor *R1* controls the time *Q2* remains on during each cycle. When the pulse duration is brief (*R1*'s value is reduced), speaker volume is reduced.

Figure 3 is an audio oscillator whose frequency is determined by the intensity of light that strikes a cadmium-sulfide photocell (Radio Shack 276-116 or similar). When the light level is increased, resistance of the photocell falls, thus increasing the frequency of oscillation.

A unique feature of the Fig. 3 circuit is the substitution of a piezoelectric alerter (Radio Shack 273-064 or similar) for *C1* in Fig. 2. The inherent capacitance of the alerter permits the circuit to oscillate. At the same time, the alerter emits an audio

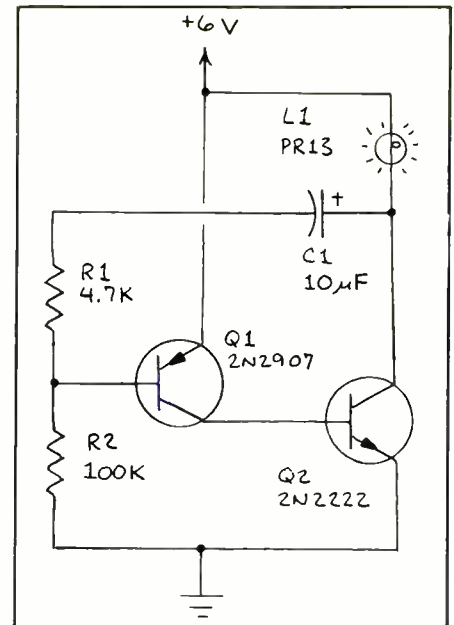

Fig. 4. An incandescent-lamp flasher.

tone, thereby eliminating the need for a separate speaker as in Fig. 2.

Lamp and LED Flashers

Figure 4 is the circuit for an incandescent lamp flasher similar to one I have often used to track and recover night-launched model rockets. This circuit generates from one to two flashes per second. The rate can be altered by changing the value of *C1* or *R2*. Use care when first operating the circuit or when altering its flash rate. If the lamp stays on continually without flashing, the heat generated by the heavy current flow will quickly overheat and possibly damage or destroy *Q2*. If *Q2* becomes warm, substitute a suitable heat-sinked npn power transistor.

Figure 5 is an LED flasher circuit. With the values shown and when the power supply provides 9 volts, the circuit delivers a 1-millisecond pulse twice each second. The pulse has an amplitude of 600 milliamperes. I have used this circuit to drive an ultra-bright Stanley H2K red LED. The resulting flashes are too bright to observe at close range. (See the April "Electronics Notebook" for more information about the remarkable H2K.)

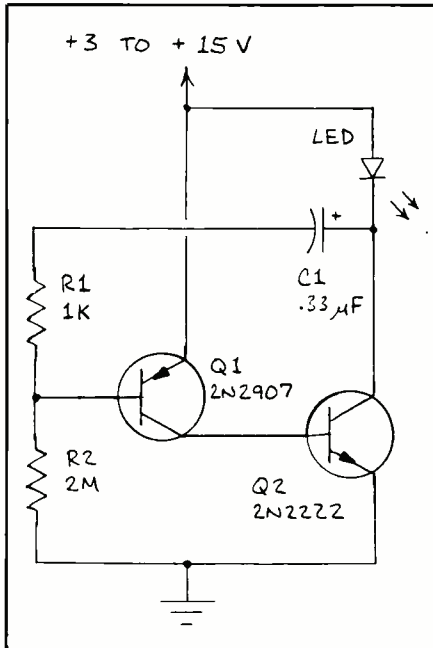

Fig. 5. A simple LED flasher circuit.

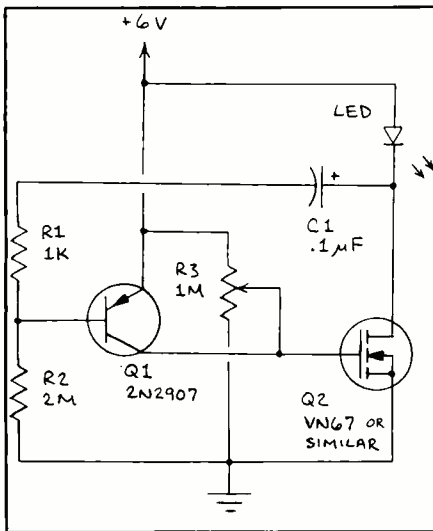

Fig. 6. A power-MOSFET flasher.

Figure 6 is a variation of the circuit in Fig. 5 in which the Q2 npn transistor has been replaced by a power MOSFET. Though I used a VN67, any n-channel MOSFET should work. With the values shown, the circuit delivers a 1 millisecond pulse to the LED every 80 milliseconds (a

flash rate of about 12.5 Hz). Peak current through the LED is 500 milliamperes, and the pulses are very square.

For the circuit in Fig. 6 to oscillate, potentiometer R3 must be properly adjusted. After the desired operating mode is achieved, the resistance between the rotor and the two stationary terminals can be measured and a pair of fixed resistors substituted for the pot.

I have used the circuit in Fig. 6 to drive both near-infrared and red LEDs. For very high pulse current through the LED, use a low on-resistance MOSFET (under 1 ohm). If you can't find a low on-resistance MOSFET, two or more standard power MOSFETs can be connected in parallel to reduce the resistance of the current path through the LED. Be sure to avoid driving the LED above the current level for which it is rated; otherwise, it will be degraded or even destroyed.

Figure 7 shows a pair of two-flash-per-second flasher circuits that are activated by the presence or absence of light at phototransistor Q3. In Fig. 7A, the flasher

circuit is disabled when Q3 is dark. Light at the active surface of Q3 switches on this transistor and permits the flasher circuit to function.

The circuit in Fig. 7B can be used as a warning flasher that operates only at night. The circuit is disabled when light switches Q3 on, thereby clamping Q2's base to the positive supply. When Q1 is dark, the flasher operates normally. The circuit consumes only about 1 microampere when Q3 is illuminated and the supply provides 5 volts. When the supply provides 12 volts, standby current drain increases to about 4 microamperes.

Incidentally, the dark-activated function can be accomplished by means of a cadmium-sulfide (CdS) photocell instead of a phototransistor. One way is to remove Q3 and connect a cadmium-sulfide photocell between the positive supply and Q1's base. Alternatively, connect the CdS photocell across C1. There is no reason why the light/dark activation methods described here cannot be used with any of the other circuits in this column. For in-

Fig. 7. Light-activated (A) and dark-activated (B) flasher circuits.

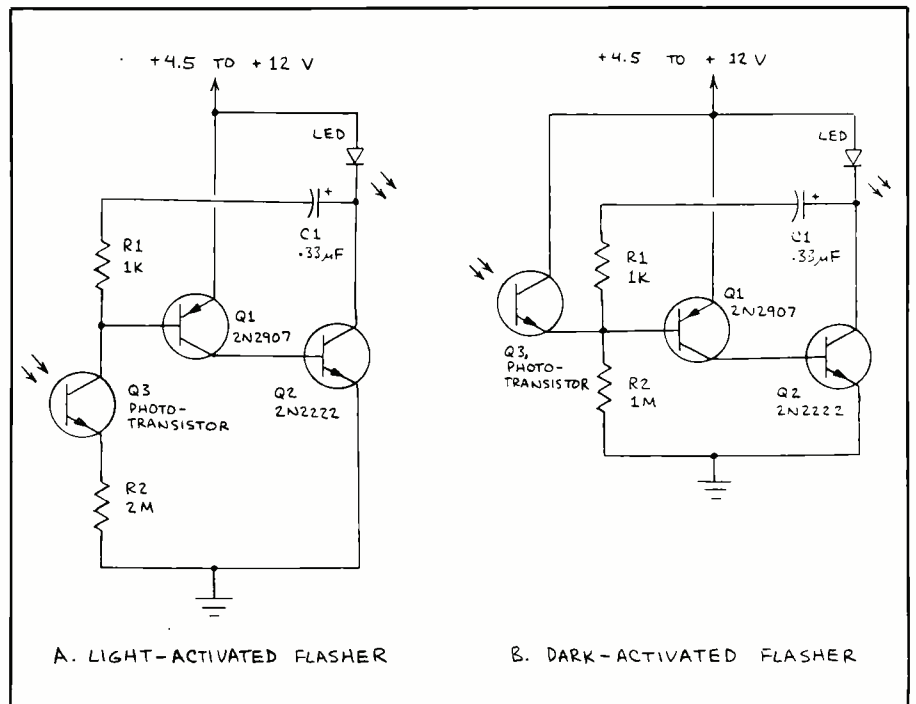

SEND FOR THIS
FREE CATALOG NOW



SAVE MONEY
HIGH QUALITY
FAST DELIVERY

We are utilizing the latest equipment and technology to maintain our quality at reasonable prices.

JAN
CRYSTALS
Since 1958

- General Communication
- Industry
- Marine VHF
- Scanners
- Amateur Bands
- CB Standard
- CB Special
- Microprocessor

Call or Write
JAN CRYSTALS
P.O. Box 06017
Fort Myers
FL 33906-6017
(813) 936-2397



CIRCLE 89 ON FREE INFORMATION CARD

Here's
one reason why
you may be missing
some vital communications
on your scanner.



More and more professional communications systems these days include low power portables. Your scanner simply can't hear them without help. A professional Antenna Specialists brand monitor antenna solves the problem, effectively and permanently. Mobile or base, you can finally hear it all.

12 models available, all frequencies 25-512 MHz. Illustrated: Model MONR1 mobile VHF/UHF and Model MONR31 tri-band base antennas.

Professional monitor antennas by...

the antenna specialists co.
a member of The Allen Group Inc.



12435 Euclid Avenue, Cleveland, OH 44106
Canada: A. C. Simmonds & Sons, Ltd.

CIRCLE NO. 176 ON FREE INFORMATION CARD

Over 75,000 active amateurs in over 125 countries throughout the world read and enjoy a different kind of ham magazine every month. They read CQ.

It's more than just a magazine. It's an institution.

SUBSCRIBE TODAY!



The Radio Amateur's Journal
78 N. Broadway, Hicksville, NY 11801



Please send me CQ for Life 3 Years 2 Years 1 Year
 New Renewal Start with _____ issue

Name _____ Call _____
Street _____
City _____ State _____ Zip _____

Charge My Order To: Payment Enclosed \$ _____
MasterCard My account number is _____
3 Years (36 issues) \$42.00
2 Years (24 issues) 29.00
1 Year (12 issues) 16.00

VISA

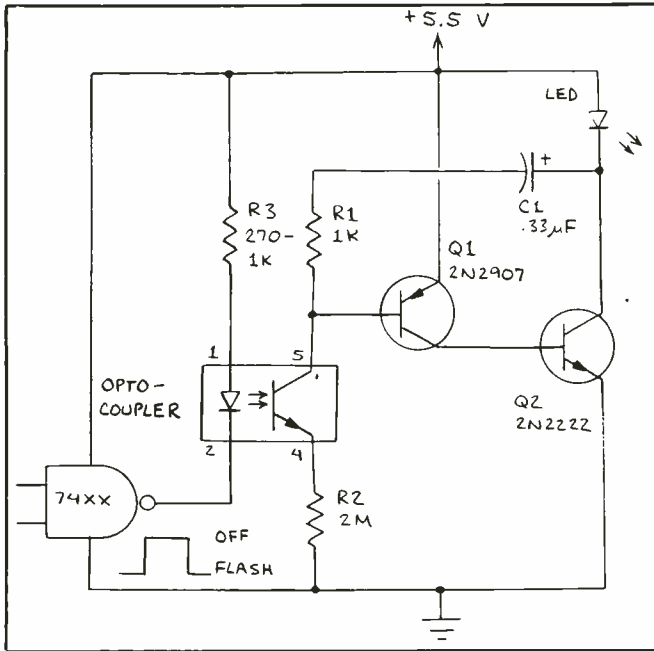

Fig. 8. Schematic diagram of a TTL gated LED flasher.

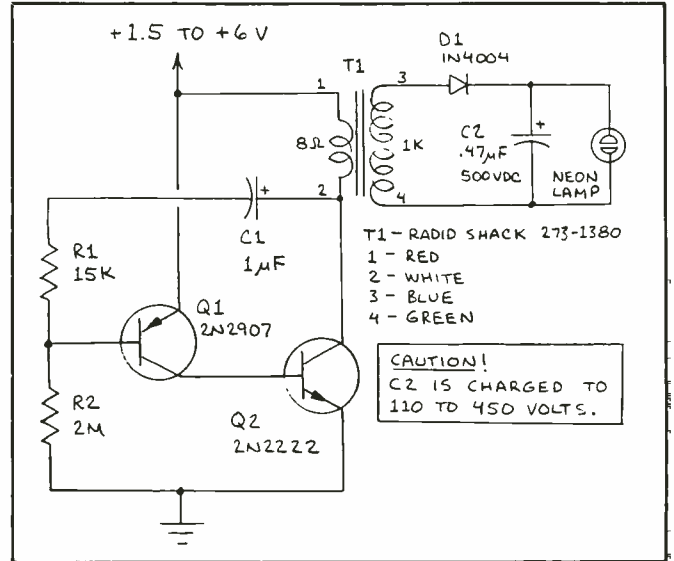

Fig. 9. Schematic diagram of a dc-to-dc converter.

stance, a phototransistor or photocell can be used to make a light- or dark-activated tone generator.

Figure 8 shows one way to control the basic flasher circuit by means of an external logic signal. The LED in an opto-coupler is connected to the output of a TTL logic gate. When gate output is low, the LED receives current and illuminates the phototransistor in the optoisolator. This permits the flasher circuit to function. When the output of the logic gate is high, the LED is extinguished, the phototransistor is dark, and the flasher circuit does not operate. The basic technique shown here can be applied to the other circuits in this column.

Dc-to-Dc Upconverter

A dc-to-dc upconverter can be made by replacing the LED of the previous circuits with the 8-ohm winding of an 8:1000-ohm miniature output transformer. For each current pulse through the winding, a high-voltage pulse is induced in the secondary winding. This voltage can be rectified and stored in a capacitor or used to

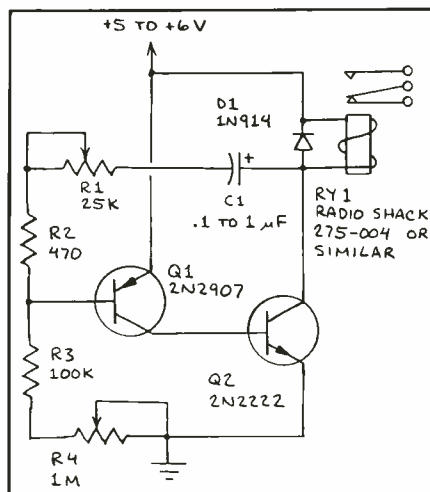

Fig. 10. Two transistors make an ultra-simple relay controller circuit.

drive low-impedance loads, such as a piezoelectric bimorph tactile stimulator.

Figure 9 shows how this kind of circuit can flash a neon lamp. Though I used a Radio Shack No. 273-1380 output transformer, other transformers with a similar turns ratio should also work. Diode *D1*

rectifies the high-voltage pulses from *T1* and *C2* accumulates the voltage. Capacitor *C2* discharges through the neon lamp when the charge stored in it reaches the lamp's firing voltage. The charge/discharge cycle then repeats.

The circuit in Fig. 9 can produce surprisingly high output voltages at relatively low current drains. Here are the results I measured for the prototype circuit:

Supply Voltage	Current Drain (mA)	Output Voltage
1.5	0.6	110
3.0	1.6	320
4.5	2.2	450
6.0	2.6	450

Note how the output from the circuit saturates when the supply voltage exceeds 4.5 volts. Be sure *C2* is rated for the expected voltage level.

Relay Controller

Adding a relay permits the basic oscillator circuit to supply a continuous stream of current pulses to a high-power device. Figure 10 shows an experimental circuit

NEW PRODUCTS...

(from page 7)

that does just that. Note that the supply should range from 5 to 6 volts for consistent results. Potentiometer *R1* and capacitor *C1* control both the time interval the relay is closed per pulse and the rate at which the pulses are applied. Potentiometer *R2* controls only the pulse rate. Switching cycles of a few seconds can be achieved by careful adjustment of the various components.

Pulse Generator

Since the oscillator circuit produces fast rising and falling pulses, it is well-suited as a pulse generator. Figure 11 shows how a pulse generator can be implemented by inserting a 50-ohm resistor between *Q2*'s emitter and ground. Here is a summary of the operation of the circuit with the values shown in Fig. 11 when the supply was 12.5 volts:

C1 Value (μ F)	Pulse Duration (μ s)	Maximum Rate
0.001	5	1500
0.010	22	225
0.100	200	23

The amplitude of the output pulse ranges from 10 volts ($C1 = 0.001 \mu\text{F}$) to 11 volts ($C1 = 0.1 \mu\text{F}$). The rise time for all values of *C1* is a very fast 10 nanoseconds (measured at 10% to 90% points).

Going Further

The circuits shown here merely illustrate the wide range of applications for the basic two-transistor oscillator shown in Fig. 1. Here are some other applications you might want to explore:

- Continuity tester
- Burglar alarm
- Low-power radio-frequency transmitter
- Pulse-amplitude modulator
- Pulse-duration modulator
- Monostable multivibrator
- Sound-effects generator
- Infrared tone transmitter/beacon

Finally, though to my knowledge the basic oscillator circuit isn't available in integrated form, you can easily assemble



five-event timer; a double-azimuth four-video-head system for noiseless still and fine field advance; automatic program search system (APSS) video search at $7 \times$ normal speed; and a 20-minute memory backup system. The front-loading VCR also offers an all-electronic four-digit tape counter with memory and comes with a 14-function wireless remote-control system. \$995.95.

CIRCLE NO. 103 ON FREE INFORMATION CARD

Telephone Line Controller

Teltone's Model T-130 Telephone Access Unit provides in and out access for computers and other devices with an asynchronous RS-232 port. It goes beyond being just a modem or autodialer. With the T-130 and applications software, a computer can automatically dial telephone numbers,

(Continued on page 82)

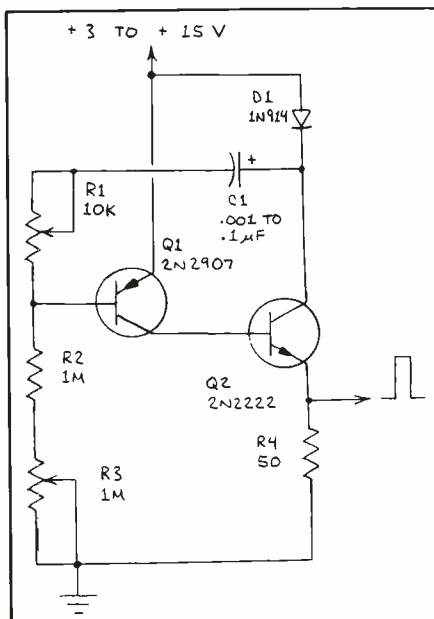

Fig. 11. Adjustable pulse generator.

its components on a 14-pin dual in-line header. Some of the companies that advertise in this magazine sell such headers, along with plastic covers. **ME**

JAM IT!

Even the Very Best Radar Detector Can't Protect You from the Newest Radar.

NEW MODEL J4H1 RADAR JAMMER

THE ULTIMATE IN RADAR PROTECTION

Radar Jammer: Compact under-dash unit causes speed radar guns to read out a percentage of your true speed, or whatever speed you dial in. Or, new "SCRAMBLE" mode will prevent radar from obtaining any reading. Activated by Whistler, Escort, or other detector. Best defense against instant on radar. Operates on both X and K bands. **WARNING:** This device is not legal for use against police radar, and is not FCC approved.

Transmitters: The heart of the jammer is the microwave oscillator (transmitter). In the past, these were very expensive, and limited to only about 100 milliwatts of power. We now have our own *Low Cost, High Power* Transmitters up to 300 milliwatts or more. Please call for prices.

Radar Detectors: We highly recommend using a remote detector that is mounted so that nothing is readily visible to either the police, or thieves. (A dash mount detector is an invitation to thieves and an irritation to police!) We agree with Motor Trend and Autoweek that WHISTLER SPECTRUM is the best detector available, and we know of *no other remote detector* that is even in the same LEAGUE as the SPECTRUM REMOTE. *Order the best for yourself now.* (Our detectors are already modified for direct connection to the jammer.)

ORDER TODAY—MONEY BACK GUARANTEE

<input type="checkbox"/> Complete Literature & Plans Pkg.	\$ 14.95
<input type="checkbox"/> Set of Circuit Boards	40.00
<input type="checkbox"/> X and K-band Microwave Oscillators (Transmitters)	Call
<input type="checkbox"/> Whistler Spectrum (modified for use with Jammer)	259.00
<input type="checkbox"/> Whistler Spectrum Remote (modified)	259.00
<input type="checkbox"/> Modify your Spectrum for use w/ Jammer	55.00

CALL or send the following information:

• Items Ordered • Name • Shipping Address
• Payment: Check, Money Order, VISA or MC (include card number, expiration date, and signature)

SEND TO: Oregon Microwave Inc., 9513 S.W. Barber Blvd., #1096
Portland, OR 97219 ORDER LINE: (503) 626-6704
*Formerly Philips Instrument Design Co.

CIRCLE 55 ON FREE INFORMATION CARD

Battery life, ET watching, secret Apple manuals, EPROM burner power supply, opening the Mac

By Don Lancaster

This month's column seems to involve lots of books and manuals, mostly since a bunch of really good ones showed up here in the past few weeks. Some old, some new, all great. Starting with the obvious, there's my very latest and brand new book, *Enhancing Your Apple II*, Volume II (SAMS #22425).

As usual, this is your column, so write or call me (between 8:00 A.M. and 5:00 P.M. weekdays Mountain Standard Time is best) per the box at the end. You will often get better results by calling rather than writing. Once again, all the names and numbers of manufacturers and suppliers mentioned here appear in the large box.

On to this month's really great stuff . . .

How Long will a Battery Last?

The reason you haven't found quick and simple answers to battery-life questions is that there aren't any quick and simple answers. However, far and away the best set of battery technical manuals I've ever seen appear in the four-volume *Eveready Battery Engineering Data* library (\$5 each). Volume I is on Mercury and Silver Oxide batteries; Volume II is mostly on Alkaline batteries; Volume III covers good old Carbon-Zinc; and Volume IV is on rechargeable Nickel-Cadmium batteries. While the whole library is valuable, chances are you will find Volumes II and III most useful.

These manuals completely cover everything *Eveready* makes, but you will have to look elsewhere for info on lead-acid and lithium batteries.

Before going further, a quick review is in order. There are two basic types of batteries. Primary batteries are normally not supposed to be recharged. You use them once and, when they're exhausted, chuck them. Secondary batteries are rechargeable and may be used over and over again. A plain old, el-cheapo flashlight battery is a primary battery using carbon-zinc chemistry. If the battery is marked "heavy duty," it uses a variation of carbon-zinc chemistry that involves zinc chloride. If the battery is marked "alkaline," it uses

BATTERY TYPE	EVEREADY	Load in Milliamperes			
		0.8	8.0	80	800
"AA" Standard	#1015	1100	97	4	---
"AA" Heavy Duty	#1215	1350	120	9	---
"AA" Alkaline	#E91	2000	190	16	20
"C" Standard	#935	2400	240	12	---
"C" Heavy Duty	#1235	3650	352	28	---
"C" Alkaline	#E93	5600	560	49	60
"D" Standard	#950	5600	560	21	60
"D" Heavy Duty	#1250	7020	702	68	107
"D" Alkaline	#E95	11500	1200	108	240
"9V" Standard	#216	481	18	---	---
"9V" Heavy Duty	#1222	500	20	---	---
"9V" Alkaline	#522	5500	53	4	---
"Camera"	#189	75	3	---	---
		Hours	Hours	Hours	Minutes

Table gives rough estimates of life for various types and sizes of batteries for different load conditions. Times given in rightmost column are in minutes!

manganese dioxide chemistry. There also are primary lithium batteries that use, of all things, lithium chemistry.

The most common secondary batteries are lead-acid ones, such as are used in cars and motorcycles, and NiCd ones using nickel-cadmium chemistry and are used to power electric toothbrushes, carving knives, portable tools, and so on.

To grossly oversimplify, a heavy-duty primary battery offers twice the life at twice the cost of a plain one. An alkaline battery offers four times the life at four times the cost of a plain one. And lithium very reliably offers 10 times the life at 20 times the cost.

We'll note in passing that, while everyone calls them "batteries," most are really single cells. A flashlight usually has *one* battery in it that consists of two to five cells. A 12-volt car battery has six 2.0-volt cells in it. But a 9-volt transistor battery really *is* a battery, since it has six individual 1.5-volt cells inside it.

Much more on all this in the manuals.

Anyway, Table 1 shows an estimate of primary battery life for various currents that I worked up. I'd like to call these "ball park" figures, but they are not nearly that precise. Let's call them "county" figures instead, since they will get you within a ten-mile bicycle ride of what you really want to know.

Why such variation? First, battery quality varies dramatically. Fresh batteries are much better than ones that have lain around a warehouse or wherever for years. Name-brand batteries are almost always much better than house-brand batteries, since the latter sometimes get swept out of a Hong Kong alley.

Secondly, the nature of the load has lots to do with battery life. Batteries that are run two hours per day will generally last much longer than batteries run continuously until they die. Some batteries have their chemistry further optimized for continuous low current, for occasion-

The "secret" Apple manuals

Table 2

IIC Technical Reference Manual #A2L4030

Two volume set essential for intelligent IIC use and operation. \$50. Available from any Apple dealer, but only after you start kicking and screaming and throwing a temper tantrum.

IIE Technical Reference Manual #A2L2005

The same treatment given to the IIE in a single volume. \$30 from any Apple dealer.

Inside Macintosh and Supplement

Two enormous notebooks with all of the inside secrets of the Mac. \$100. The supplement contains a dozen utility disks and an upgrade service. \$100 extra. Available only from Macintosh Support, 10460 Bandy Drive, M/S 3-G, Cupertino CA, 95014.

These are the "secret" manuals you absolutely need if you hope to do anything worthwhile on a newer Apple computers. Text tells you how you might get them.

al high current, or for a mix of the two. Cell polarization affects performance at very low currents, while internal impedance and self-heating affects high-current ratings.

Thirdly, just what is a "dead" battery? As most batteries age, their output voltage drops. At some point, whatever the battery is connected to will either quit outright, distort badly, not put out useful power or not provide enough light. Yet these same batteries could possibly still be used for a long time in some other use.

The chart assumes a battery is "dead" when its output drops to 67% of its initial

voltage. Thus, 1.5-volt cells are "dead" when they drop below 1.0-volt, while 9-volt transistor batteries are "dead" when their terminal voltage drops below 6.0 volts. This "deadness" criteria lies in the middle of the published curves.

Be sure to note that the rightmost column of Table 1 is in *minutes*, rather than hours! As a general rule, the life of all primary cells drops dramatically when you try to get more than 200 milliamperes out of them, unless they are optimized for high current service.

While we are on the subject, *Polaroid* has some interesting 6-volt batteries you

might like to play with. These are very flat, very compact, offer very high power, and as with everything made by Polaroid, very expensive.

Their #606166 designers kit will get you started. It includes a pair of lithium batteries, a pair of ordinary ones, and a special and very thin battery holder. Cost is around \$25. After playing with these, I wasn't very impressed, but maybe you will be by them.

How can I start ET watching?

The proper name of this activity is called SETI, short for *Search for Extra-Terrestrial Intelligence*. Surprisingly, there are a large number of amateur radio astronomers that are doing lots of very interesting, very impressive, and very legitimate research these days. All this on their own, without grants or federal help.

The center of amateur SETI activities seems to be a group called the *Society of Amateur Radio Astronomers*, which is headed by one Jeffrey M. Lichtman. Jeffrey has self-published several very interesting books. One is *Microwave Radio Astronomy, An Amateur Introduction*, a second is *Solar Amateur Radio Astronomy*, and a final nuts-and-bolts one is the *Amateur Radio Astronomers Circuit Cookbook*. Cost is around \$35 total for all three.

It's interesting to note the similarity between many radio astronomy circuits and those things that *Modern Electronics* readers are already doing, such as legal access of satellite broadcasts. Much of the same circuitry can be adapted or used directly, and the larger market for the satellite stuff has driven the costs way down. Antenna mounts and tracking mechanisms, of course, scream robotics.

Another thing you can do is visit the free museum at the VLA (very large array) radio astronomy facility outside Magdalena, New Mexico. Visitors are most definitely welcome, but play down the ET watching if you expect to get behind the scenes and be treated seriously. And, while you are in the neighborhood, drop in on us here at Synergetics. The VLA is only a half day's drive away.

Where do I get those secret Apple manuals?

They weren't supposed to be secret. ▀

HARDWARE HACKER...

Only a monumental communications foulup made them that way. You see, there is a "secret" manual for the IIe called, of all things, the *IIe Technical Reference Manual*. There is a similar "top-secret" manual pair for the IIc called the *IIc Reference Manuals*. And there is a humongous pair of "Q-level" security binders and dozens of support diskettes called *Inside Macintosh* and the *Macintosh Software Supplement*.

It is categorically impossible to do *anything* useful on *any* newer Apple machine without these manuals. Their pricing is not at all out of line with their contents. In fact, they are worth far more than the asking price. (For details, see Table 2.)

Here's how to get the manuals. First, politely but firmly go to a large Apple dealer with the exact part numbers and try to buy them. If the dealer turns a deaf ear, you might try to sweeten the pot with a bigger order; try to group at least three, or preferably five, orders for the same manual at once. Do this with some friends or through your local school or club.

Note that borrowing one of these manuals will not work, since no one in their right mind would ever let one out of their sight for more than a few moments, if at all. Note also that the IIe and IIc manuals are normally ordered through dealers, while the Macintosh stuff must be ordered directly from the address shown.

If all else fails, you may just have to bite your time. Rumor has it that the *McGraw-Hill Bookstore* is one mail-order source that normally stocks and quickly ships the IIe and IIc manuals. There is another rumor that *Addison Wesley* will shortly republish the manuals as a stock bookstore item.

Go for it.

I need an EPROM burner power supply

Most EPROMs need a special programming voltage of +12, +21 or +24 volts to do the blasting during the programming process. More often than not, all you have is a +5-volt supply to work with. What is a you do?

The simplest way is to build your own switching dc-to-dc converter. While that sounds awful, all it takes these days is a \$2.80 mini-DIP integrated circuit, a plain

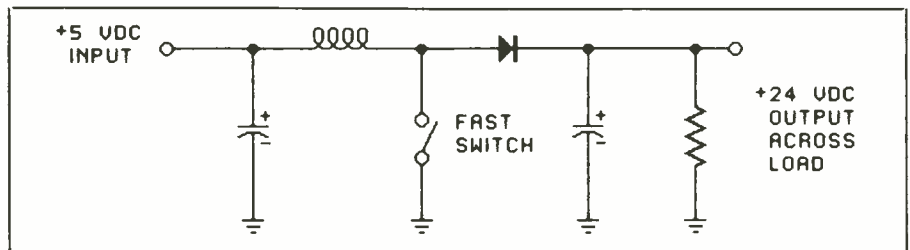

Fig. 1. Illustrated is general idea of switch-mode step-up converter.

old coil, and a few other stock parts. Total cost is well under \$5.

The general idea of a switch-mode dc-to-dc step-up converter is shown in Fig. 1. Say you leave the switch open. The input voltage will appear at the output, minus a small diode drop. Thus, the *minimum* possible output voltage you can get roughly equals the supply voltage, and this circuit works to step-up only.

Now, suppose you rapidly flip the switch on and off. When the switch is closed, current through the inductor will increase. When the switch is opened, current through the inductor must go somewhere else, like through the diode and into the load. The greater the percentage of time the switch is closed, the higher the output voltage.

All you need to get this to work is some way of sensing the output voltage and comparing it against a reference voltage. The error signal you get is then used to

vary the duty cycle, or the off/on time of the switch. Fortunately, all the fancy stuff is available ready to use in a *Motrola MC34063* chip.

This circuit is very similar to a neat "free energy" machine called a *hydraulic ram*. The inductor acts as a large downhill pipe. The diode acts as a check valve and small diameter uphill pipe. The switch acts as a dump valve, except that you "close" the switch to dump water.

You first open the valve, dumping water. The mass of the water running down the pipe gets going good. Then you close the valve. All that mass of water running down the pipe wants to keep going in the worst sort of way, so the downhill water will force some water past the check valve and into the small uphill pipe.

By letting lots of water at fairly low pressure go downhill, you can force a little water uphill at very high pressure. Repeatedly opening and closing the valve ra-

Fig. 2. This is the complete circuit for the selectable burn switch-mode voltage step-up converter. It is built around a *Motrola MC34063* switching regulator.

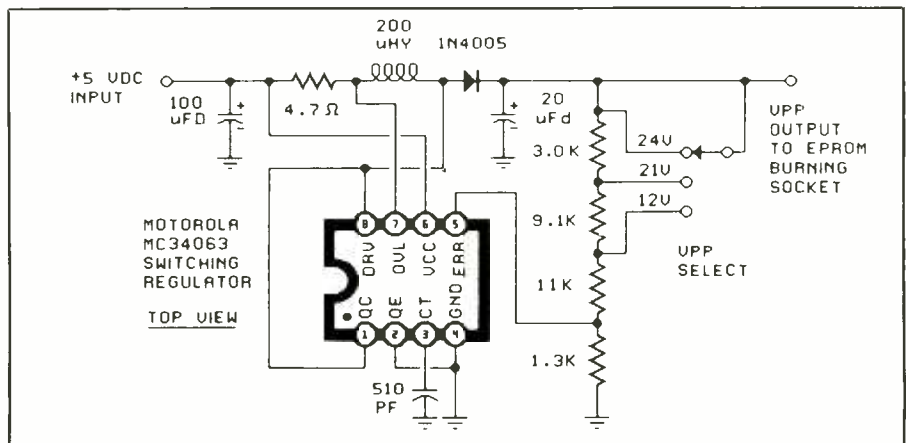

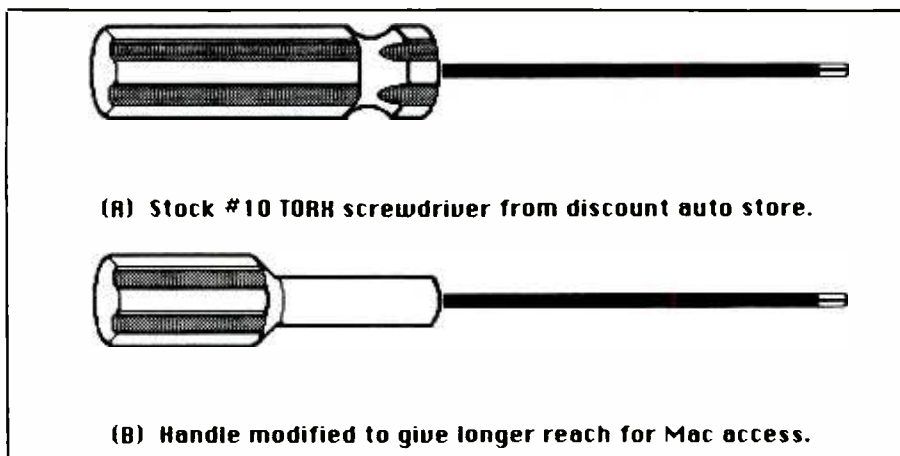

Fig. 3. Drawings show a stock Torx driver (top) and the same driver after modification to permit easy access to the recessed screws in the MacIntosh computer.

pidly, continuously pumps water uphill, with no energy input except gravity.

Figure 2 shows us the complete circuit. Jumpers or a switch select your choice of 12-, 21-, or 24-volt output. Be sure to use

the correct value for your particular EPROM or you will either blow up the chip or else get a weak or missing blast.

The coil can be just about any old r-f choke, as long as it has a dc current rating

of 100 mils or so. There is nothing critical about any of the parts. One warning, though. If you ever break the resistive divider feedback loop from the output, output voltage will try to go very high, with nasty results all around. Be careful!

This same chip can be used in other circuits to step down or step up, with either positive or negative output polarity. An extra pass transistor can also be added for higher currents.

Switching mode power supplies have gotten so simple and cheap that it is often unthinkable to do things the inefficient, high iron "old" way.

How do I open the case on a MacIntosh?

There are four screws with funny heads on them that hold the MacIntosh case together. These are #10 TORX screwheads. This is the same screw used on many cars for such things as mounting lights and trim. Unfortunately, a stock #10 TORX screwdriver will not reach two of the screws, since its shaft is an inch too short.

You can buy an *Xcellite* #XTD-10 Torx screwdriver from *Jensen Tools*, *Techni-Tool*, or most any larger electronics distributor. This one will work fine, but there is a sneakier and easier way.

Go to your local discount auto parts store and buy the cheapest #10 Torx driver you can find. Usually there will be only two sizes available. You want the smaller of these. Then grind, cut, file, melt, stomp, or otherwise molest the handle down to the shape shown in Fig. 3. The cut-down part of the handle should be 7/16" or less in diameter, and you need about 1 1/2" removed. The modified driver should now reach all MacIntosh case screws, including the two buried screws.

By the way, if you are a hacker-type, and if you can latch onto one of the old 128K boards that get removed during a Fat-Mac upgrade, it's a fairly simple matter to add your own reworked monitor and keyboard. This lets you pick up a Mac-like machine for next to nothing.

Fortunately, the Mac will cold boot on either the external or internal drive. Thus, you can use an external add-on drive as your only drive.

Unfortunately, you have to know an insider or else get real lucky to do this.

Names and Numbers		
Addison-Wesley Publishing General Books Division Reading, MA 01867 (617) 994-3700	MacIntosh Support 10460 Bandlely (M/S 3-G) Cupertino, CA 95014 (408) 973-4897	Society of Amateur Radio Astronomers Jeffrey M. Lichtman 440 Winside Lane Coram, NY 11727 (516) 331-1524
Bodine Electric 2500 West Bradley Place Chicago, IL 60618 (312) 478-4515	McGraw-Hill Bookstore 1226 Sixth Avenue New York, NY 10020 (212) 512-4100	Synergetics Box 809 Thatcher, AZ 85552 (602) 428-4073
Dr. Dobbs Journal 2426 Embarcadero Way Palo Alto, CA 94303 (415) 424-0600	Modern Electronics 76 North Broadway Hicksville, NY 11801 (516) 681-2922	Techni-Tool 5 Apollo Road Plymouth Meeting, PA 19462 (215) 825-4990
Eveready 270 Park Avenue New York, NY 10017 (212) 551-4377	Motorola Box 20912 Phoenix, AZ 85018 (602) 244-6900	Torx Camcar Box 607 Rochester, IN 46975 (219) 223-3131
Garland Publishing 136 Madison Avenue New York, NY 10016 (212) 686-7492	Polaroid 748 Memorial Drive Cambridge, MA 02139 (617) 577-2000	VLA Radio Astronomy Site Visitor Center Magdalena, NM 87825 (505) 772-4011
Jensen Tools 1230 South Priest Road Tempe, AZ 85281 (602) 968-6241	Howard W. Sams 4300 West 62 Street Indianapolis, IN 46206 (800) 428-SAMS	

HARDWARE HACKER...

Apple pays dealers a \$300 bounty for the return of the old boards. Some Apple developers got upgrade kits without having to send the old board in. For some strange reason, these old boards seem to have a street value of \$301.00.

It is also feasible to upgrade a 128K Mac to a 512K Fat Mac by yourself, buying RAMs from mailorder outlets. You must be willing to do the usual cutting, soldering, chopping and channelling. You also will void warranty if you try this. Full details appear in *Dr. Dobbs Journal*, January 1985, pages 4 and 18 through 23. The newest 128K boards are far easier to modify than the earlier ones. Details on both versions appear in the same issue.

I need a good book on motors for robotics

How about a great book instead, costing—are you ready for this?—only \$3.50? It is called the *Small Gearmotor Handbook*, and *Bodine* publishes it. It's been around for a long time, but things in the

motor world don't exactly happen in the fast lane. Very readable, very solid, and very heavy on fundamentals.

*Where do I find a magazine on . . . computers and dentistry
computers and the handicapped
computers and war gaming
computers and genealogy
computers and tinaja questing
computers and robotics
computers and . . .*

It sure would be nice if there was some listing of *all* the computer magazines, particularly the smaller, regional, specialty, self-published, or obscure ones. Often these smaller journals are where the real action is, particularly in some special interest field.

I've just found a real gem of a directory. And somehow it got up to its seventh year and its *eleventh* edition without anyone knowing it even existed.

It's called *Microcomputer Periodicals*:

An Annotated Directory. It is written by George Shirinian and published by Garland Publishing. There are over a thousand microcomputer publications listed. Most are in the U.S., but some are international. Most listings are annotated, explaining what the publication is about, how much it costs and includes a critical review summary.

Other sections of the directory give you a by-subject cross reference listing, along with names of earlier publications that changed names or folded. Very nice. Also most useful. See you next month.

NEED HELP?

Phone or write your hardware hacker questions and comments directly to

Don Lancaster
Synergetics
Box 809
Thatcher, AZ 85552
(602) 428-4073

LISTEN UP!

Here's what you've been looking for—an all new hard-hitting monthly magazine which gives a unique insider's view of what's really going on in the world of communications. POP' COMM is your primary source of information—bigger and better than any communications magazine, with exciting coverage of scanners, shortwave broadcast & utility stations, spy stations, pirate and clandestine broadcasters, RTTY monitoring, survivalist communications systems, FCC news, wiretapping and bugging, voice scrambling/unscrambling, surveillance/undercover communications, satellite & cable TV, sophisticated telephones, & more: What you've been looking for all along! Take advantage of substantial savings over the newsstand price by subscribing now. Don't miss out on even one single issue of POPULAR COMMUNICATIONS—order your subscription now.



**Twelve
Issues
\$14**

SUBSCRIBE NOW & SAVE!

POPULAR COMMUNICATIONS 76 N. Broadway, Hicksville, NY 11801

Yes! The NEW POPULAR COMMUNICATIONS is just the magazine I've been looking for. Start sending it to me now! I understand that I may cancel at any time for any reason, and receive a full refund on my unused subscription.

Paid by: Check Money Order MasterCard Visa
My account number is

--	--	--	--

Name _____
Street _____
City _____ State _____ Zip _____

- 1 Year (12 issues) \$14.00
Newsstand price \$23.40
- 2 Years (24 issues) \$25.00
Newsstand price \$46.80
- 3 Years (36 issues) \$36.00
Newsstand price \$70.20

Canada/Mexico — one year \$15.00 two years \$28.00 three years \$40.00
Foreign — one year \$25.00 two years \$45.00 three years \$65.00
Foreign Add. Mail — one year \$71.00 two years \$139.00 three years \$207.00

Between Two WordStars: Newword 2.14

By Eric Grevstad

Newword (Ver. 2.14) by Newstar Software, Inc. For PC-DOS or MS-DOS computers, \$249; for CP/M-80 computers, \$100.

Since it first lumbered onto CP/M systems in 1979, MicroPro's WordStar has set the standard for word-processing software (although it's unheard-of for a six-year-old program to stay an industry benchmark).

If legends die hard, programs don't become legends without merit. Once you pay WordStar's steep price (\$395 for the IBM-PC version), spend days to learn the essentials, a lifetime of discovering additional commands, and waiting for frequent disk access, you've got more versatile editing and formatting power than most, if not all, other word-processing programs. MicroPro's new 16-bit WordStar 2000 (\$495) only disappointed its fans: WS2000 adds gee-whiz features, but its commands are almost as complex while being completely different, thereby discouraging upgrades.

Fortunately, there's a compromise: a word processor that both 8- and 16-bit WordStar buffs already know how to use, that makes valuable improvements on the original (including the mail-merge and spelling functions that cost extra in WordStar Professional), and that costs less. It's Newword, an unabashed WordStar clone from Newstar Software, and the IBM (and compatible) version is \$249. Moreover, if you have a CP/M-80 system, Newword is just \$100.

Instant Recognition, Extra Features

The non-copy-protected Newword starts with virtually the same opening menu as its progenitor: D to open a WordStar-compatible document, N for a non-document ASCII file, and so on. A disadvantage is that you can't run a DOS program from within 16-bit Newword.

Once writing, there's a nearly identical screen display, with a status line showing the current filename and cursor position,

a ruler line of margins and tabs, and an optional menu of editing commands. The status line adds a nice feature, which is a "fullness gauge" of eight hyphens, changing to equal signs as your text fills available memory.

The gauge reflects one of Newword's main advantages. If your system has enough room, it keeps the entire program and your entire file in RAM, eliminating disk access when you request a command or scroll down a page in your document. Racing against WordStar 3.31 with the same 3,000-word article, Newword loaded the file in 5.3 seconds instead of 10.3, then scrolled to the end in 2.7 seconds instead of 13.9.

Only after the gauge is full (in my 256K system, 40 double-spaced pages) will Newword start swapping portions of your document from disk. This allows, Newstar claims, files up to four million characters long. (Past that, you'll have to chain-print separate files).

With a few exceptions, Newword's commands match WordStar's. !T (Control-T) to delete a word, !B to align a paragraph after insertion or deletion has mused up its margins. Both programs show text as it will be printed with justified or ragged-right margins and visible page breaks; Newword can also show underlining and boldface on monochrome monitors.

Some commands, while identical, have been improved: !QF (find) puts the cursor at the beginning of the desired word or phrase instead of the end, and !KS (save and continue) returns the cursor to its previous location instead of to the top of the file (replacing !KS!QP in WordStar).

Two new commands are invaluable: !U, besides aborting a command or print run, undeletes the most recently cut text (restoring accidental deletions, or relocating a block if you've moved the cursor). And !KN toggles the familiar block commands into a column mode, in which !KB and !KK (beginning and end) mark the top-left and bottom-right corners of a column to be moved, copied, or cut just as full-width blocks are.

When it can work entirely in RAM, WordStar wins some benchmark races. Its single-page scrolling is faster than

Newword's, and it found (with !QF) a distant phrase in 3.1 seconds compared to 10.3. On the other hand, Newword deleted a paragraph in half WordStar's time, and took 46 seconds instead of 1:01.3 for a global search-and-replace test.

Printing, Spelling, Customizing

Like WordStar, Newword uses a battery of dot commands imbedded in text (.po 8, .lh 16) to specify margins, line height, headers and footers, forced page breaks, and so on. When printing, you can use your installed defaults or answer menu prompts for the number of copies, whether to pause for single-sheet paper feed, which printer driver to use (there are over 20, ranging from Diablos and Epsos to Hewlett-Packard's LaserJet), etc.

Newword's mail-merge commands include not only the usual form letter addressing, but conditional if-else commands that merge and insert depending on various criteria (you can insert a paragraph about the Red Sox in letters to Boston, or one about valued prime customers if the data shows income over \$50,000, and so on). Its spelling checker is Oasis Systems' excellent The Word Plus. It packs a 45,000-word dictionary and utilities that let you make anagrams to cheating at crossword puzzles.

Other utilities supplied with Newword let you customize the program to within an inch of its life, not only specifying margins or printers, but assigning up to 40 commands to the PC's function keys. The detailed documentation will bring joy to hackers' hearts. There's a 27-page listing of subroutines and patches, showing how to change defaults you didn't know Newword had.

Newword lacks the bells and whistles of some of the latest WP programs, though. If you need instant reformatting, multiple documents in windows, and unimaginably detailed printout control, and mouse controllers, perhaps you'll prefer Microsoft Word. But if you don't need such features, or are already familiar with WordStar and wish it had the edges smoothed, Newword is a first-rate performer at a bargain price. **ME**

Appliances That Talk To You

By Eric Grevstad

As gimmicks go, speech synthesis is a mixed blessing. On one hand, my usually silent apartment is now full of friendly voices—a pleasant female tone murmurs in my ear that it's time to get up, and a cheery fellow booms "Have a nice day" in my bathroom. On the other hand, there are two things of which most of us don't like to be reminded: "You're wasting time" and "You're gaining weight." This month's products do exactly that.

The voices come from Innovations (110 Painters Mill Road, Owings Mills, MD 21117, 800-638-6170 or 301-363-4304), a mail-order firm whose catalog combines watches, radar detectors, and portable TVs with the usual lineup of cordless phones, pulse monitors, and sheep's wool mattress pads (these seem to show up in every catalog I've read). There are also two items that deserve to be reviewed together, possibly under the heading "The sublime and the ridiculous": a talking watch and a talking bathroom scale.

Thanking Your Wrist

The Satoki Talking Watch (\$59.95) may be one of the neatest high-tech toys you can wear, but it looks slightly tacky: a somewhat bulky black plastic case, an unappealing rubbery strap, and a front crystal that seems prone to faint scratches (though maybe my review model had been knocked about by previous users). It's not water-resistant, either; so you'll have to be careful when washing your hands, swimming and showering.

Its LCD display shows the hours, minutes, and seconds, with an A or P for A.M. or P.M. The day of the week isn't spelled out clearly—a marker highlights one letter in the line (SMTWTFS). Otherwise the Satoki's quite readable.

Pressing the lower left button shows the calendar (month and date), the second of the watch's four modes: if you don't press it again to go to the alarm or



Satoki's Talking Watch backs up the usual alphanumeric display with selectable vocal announcement of time.

timer modes, the time display returns after three seconds.

Unlike most digital watches today, the Satoki has no light for night reading. It's not needed, however. In the dark, or anytime you want to show off, press the top-right button and the watch *tells* you the time—a beep, followed by "It's 11:49 A.M." (or whatever). My first two days with the watch, I instinctively answered, "Thank you."

The Satoki's speech chip and dime-sized speaker give it a female voice (a little picture of a woman's head is the LCD symbol for voice-alarm mode), loud enough to wake light sleepers or alert the next table in a quiet restaurant. It's not Meryl Streep or Jane Pauley, but it's not too tinny or Donald Duckish either. "P.M." sounds like "P.A.," "three" is "tree" and "5:59" is close to "5:55" (perhaps it should say "niner" as Air Force pilots do), the the voice is surprisingly understandable.

And when you merge the voice with more traditional functions, the fun really begins. Like other watches, the Satoki can beep twice every hour and once every half-hour; if you really want to get thrown out of theatres or churches, a verbal announcement can echo the chime.

A beep and "It's 4:14 A.M." can precede the regular alarm, turned off by pressing any button except the top right. Press that one and you've activated a snooze alarm that sounds every five minutes: "It's 7:19 A.M. Please hurry up." The intonation, with the emphasis on "Please," is just about perfect.

Finally, the Satoki has not a count-down but a count-up timer. It beeps and, if you like, announces "One minute passed," "Two minutes passed," and so on through three, four, five, 10, 20, 30, 40, 50, and 60 minutes. It's not precise enough to use as a stopwatch, but it might save you money when making long-distance calls.

All in all, the Satoki performs well at a reasonable price. It rates an A as a watch for the blind, about a B+ as one for sighted gadget lovers. I couldn't stand the half-hourly announcements, but I found the snooze alarm almost pleasant.

Your Weight and Fortune

The other conversation piece in Innovations' catalog is the Weight Talker bathroom scale, a Hong Kong import that combines recorded messages with five on-board memories for different family members' last weighings. Not only will the Weight Talker's baritone tell you, "Your weight is 175 pounds," it'll chide, "You have gained six pounds."

The unit's a bit too heavy to slide around with your foot (I like to kick a scale under the sink when not using it), and it takes some skill at standing on one foot and pushing buttons with your toes. First thing in the morning, I'm usually not dexterous enough.

When you push its "on" button, the scale asks you to "Enter your memory number." You push one of five addi-

tional buttons, telling the scale who you are. (Something to memorize in large families; Dad's #1, Mom's #2, Kathy's #3, and so on). Next, it's "Please step on the scale." After a pause, Weight Talker gives the result, followed (if your weight's changed since last time) by "You have gained" or "You have lost" such-and-such. Finally, it says, "Have a nice day," and turns itself off.

Rear-mounted switches let you adjust the volume, change "Have a nice day" to "Goodbye," turn off the memory feature, or hear your weight in kilograms instead of pounds (which also disables the memory feature). A sixth user button, marked "Guest," supplies memoryless measurement for visitors.

The scale measures in increments of one pound or half a kilogram, announcing "Overload" at 287 pounds (130.5 kg). When its seven AA batteries need replacing, it declares "My battery is low." If you kick the "on" button accidentally or enter a memory number without stepping on the scale, the unit repeats its last prompt, then skips to "Have a nice day" and shutoff.

Weight Talker usually told my weight within a few seconds, but it occasionally took up to two minutes (which is too long to stand around naked). Too, even at its quietest setting it's more than loud enough for a small tiled bathroom. At louder volumes, you'll share your weight with everyone in the house.

A \$119.95 bathroom scale might sound outrageously expensive, even for gadgeteers. However, if you check out prices of voiceless digital bathroom scales, you'll discover that it's really a moderate price tag. But as Edgar Watson Howe said, "A really busy person never knows how much he weighs."

Be a Capacitor

Finally, there's possibly the simplest gadget this column will ever review (though I've been looking at those clocks that run from electrodes poked into raw pota-

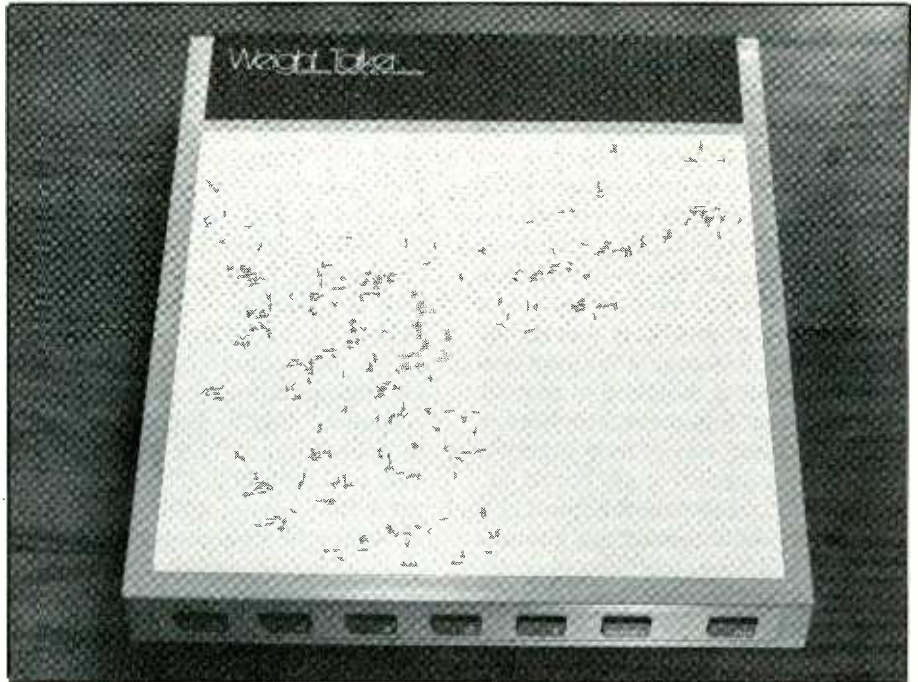

Weight Talker's talking scale can be programmed for five family members. It chides you if you have put on a few pounds since your last weigh-in.

toes). The Westek Touchtronic switch converts any incandescent lamp to three-way operation, using a one-way bulb (up to 200 watts) and controlled by simply touching the base or any other metal part of the lamp.

Several lamp companies offer the switch in their products; an adapter to convert existing lamps is distributed by a Pennsylvania antique dealership, Objects of Value (P.O. Box 192, Wynnewood, PA 19096, 215-896-6883).

The adapter (\$23.95 including shipping) screws into your lamp's bulb socket, raising the bulb about two inches, and has a signal wire that clips to the shade harp. Once it's installed, each time you touch the lamp you act as a capacitor, upsetting the balance of an automatic gain control (agc) circuit and advancing a flip-flop—from no light, to a 10 percent, to 50 percent, to full brightness. (If the outlet into which the lamp is plugged is controlled by a wall switch, that switch

will cycle through the four states.)

The adapter works like a charm, though the brochure scrupulously details possible hangups (a few people have non-conductive skin; cordless telephones without ground insulator plugs may overpower the switch; etc.).

I'm not sure how often you'd actually use the 10- and 50-percent steps, despite Westek's promised 62- and 30-percent respective energy savings. My 100-watt bulbs tended to hum (according to Westek, few bulbs' filaments are mounted firmly enough to resist vibrating in time with the switch's 200-kHz master clock.)

But the adapter can make table lamps more convenient, impress your guests (especially if you run a wire to a house plant and touch that), and let you ease out of darkness and into light. I put it in my bedside lamp while I had the flu and kept getting up at 3:00 A.M.; it sure beat fumbling for the switch, only to be hit with a traumatic full 100 watts. **ME**

International Shortwave Programs

By Glenn Hauser

How to bring the marvels of shortwave listening to more Americans? If they won't take the initiative to find out about it and buy a shortwave receiver, why not put shortwave on cable? Exactly this is happening on a few scattered cable TV systems that also offer audio services on the FM band. Cox Cable in Oklahoma City, for instance, has reserved several channels at the low end of the band to relay a variety of shortwave stations, including BBC, Moscow, WWV, and even AFRTS, which is forbidden to rebroadcast on the air! Subscriber John Norfolk noted, however, lots of technical problems and unreliability as this started up.

A franchise bidder in California, Cable Co-op of Greater Santa Cruz, promises to carry six different shortwave channels, and somehow "automatically search for and tune into only those signals which are clearly received . . . ensuring that listeners will always enjoy clear, interference-free audio." Thanks to Paul Johnson for pointing this out.

Shortwave promoters have taken advantage of local-access TV programming in some locations, notably New Brunswick, and International News Watch in Grand Rapids, Michigan. We'd like to hear about any other developments like these readers come across.

Publicizing shortwave is usually one of the topics discussed at ANARCON—the annual convention of the Association of North American Radio Clubs. This year's event, which is open to anyone interested, whether club member or not, takes place July 19-21 at the Red Carpet Convention Complex in Milwaukee, WI. Among the shortwave notables who will be present is guest speaker Clayton Howard, recently retired from HCJB. For more information, send two stamps to ANARCON '85, P.O. Box 24, Cambridge, WI 53523.

Now, country by country, let's get updated on major shortwave developments (all times are UTC).

Abu Dhabi. Voice of the UAE began testing this spring on the following schedule, via Charles Foxx: 0200-0400 on

17815, 0400-0600 on 15330, 0600-1000 on 15490, 1000-1300 on 17820, 1300-1600 on 11715, 1600-2100 on 9595, but changes were likely.

Alaska. KNLS, Anchor Point, is scheduled this summer on 11850 in English at 0700-0930, beamed due west from the Kenai Peninsula. Those in the opposite direction, such as New England, should be getting a significant fraction of the 100-kW signal.

Argentina. RAE has changed its English schedule again to daily hours at: 1800 on 15345, 0100 and 0400 on 9690 and 11710, and a final repeat (when we've been hearing it best) at 1200 on 15345.

Austria. ORF's English to North America is now at 1230 (Sunday 1200)-1300 on 15320; 0130-0200 on 6000 and 9635; 0330 (Sunday 0300)-0400 on 5945 and 6000; 0430-0500 on 6000 and 9635. If you can't listen every day, at least try Saturday, Sunday and Monday.

Bhutan. Our dream of being able to hear Radio NYAB is getting a bit closer, with news from Prodyut Banerjee in India that among the items in an aid package promised by his government to Bhutan is a 60-kW shortwave transmitter!

Colombia. The station in our April column on 5941 has another name, La Voz de Marandua, which, according to a letter received by Jerry Berg in Massachusetts, means "messenger of the jungle" in a native language. In April, David Crawford and Robert Wilkner in Florida heard what was apparently a clandestine station for Colombia, Radio Maquisaria, La Voz de las Fuerzas Armadas Revolucionarias, between 2112 and 2150 on 10543.9 kHz.

Cuba. For a spell of about an hour at local noon on Good Friday, which was probably coincidental and accidental, the Cuban classical music network CMBF, Radio Musical Nacional, normally limited to low-power frequencies around 950 kHz, appeared on several channels generally carrying Radio Rebelde—720, 690, 680, 650, 640 and 630 kHz, giving South Florida AM listeners an all-too-brief taste of the classics. Or could this be a portent of things to come? We can't think of there being a nicer possible retaliation against Radio Marti.

Earth. Somewhere on the planet there

must be a good home for Radio Earth; the station pulled out of the Dominican Republic after March 24 due to poor reception made worse by Radio Clarin's inability to change frequencies. After several weeks off the air, Radio Earth hoped to resume operations via a better-heard station. Its future plans are to be revealed at ANARCON.

Ecuador. HCJB planned these topics for its Friday "Passport" specials: June 15, a call for peace in Palestine; June 22, 1985 Faith America Foundation Conference in Washington, DC; June 29, questions and answers on Ecuador. Listen at 1905 on 17790, 15295; UTC Sat. 0105 on 15155, 9745; 0535 on 6095, 9745, 11910; 1005 on 6130, 11925. Life in Ecuador is the topic of a call-in program June 21 at 0430 on 6095, 9745, and from 0500 on 11910; June 22 at 0700 on 6130, 6205, 9745, 9870, 11925. After your international access code, call 593-2-241-560.

Egypt. Radio Cairo's sesquihour in English to North America is at 0200 on 9475 and 9675. Some of the programs, valid at least through June (UTC days): Mon. 0235 Life in Egypt; Tue. 0250 Cultural Life in Egypt, 0300 Between Egypt and America; Wed. 0235 Tourism in Egypt, 0250 Mohammad the Prophet of Islam; Thu. 0205 This Week's Weather Report, 0235 Modern Egyptian History; Fri. 0205 Arab Poetry, 0235 Pharaonic Egypt, 0300 Famous Egyptian Singers; Sun. 0235 Stamp Collectors Club (via Mike Manderscheid, SPEEDX).

Guam. Adventist World Radio is proceeding with plans to set up a 100-kW shortwave station here to serve Asia. Fund raising is underway, and transmitter and antenna have been purchased. Among its first frequencies may be 12025. The unrelated existing Guam shortwave station, another missionary, KTWR, has received FCC permission for a new curtain antenna to serve Australia and New Zealand. It should be under construction already and lead to increased English-language programming also audible in North America.

Guatemala. A new contra station in the making was the most likely explanation of weeks of powerful music-only tests starting in March on 9920 kHz around

1300-1500 and 2200, and on 7360 or 7400 at 0000-0200. FCC direction-finding puts it in Guatemala City or, less likely, Belize. The Voice of America is also setting up relays here, but as far as we know, on mediumwave only. Cuban clandestine La Voz del CID has also been promising new facilities, and has already been located in Guatemala, among other countries.

Hong Kong. Its years may be numbered as a British Crown Colony, but BBC is continuing its plan to set up a shortwave relay here, with two 300-kW transmitters to begin service in 1987 at the earliest. BBC must calculate that 10 years of service, before an uncertain future when China takes over in 1997, will be worth the \$11-million cost. However, China is currently very receptive to foreign broadcasts from Western stations, and might allow it to continue relaying BBC.

Japan. Among the revisions in Radio Japan's schedule: a one-hour General Service at 2300 on 17755, pushing the one-hour Regional Service another 15 minutes later, to start at 0015, on 11710; and also its repeat to start at 0200 on 21640, 21610, 17825 and 15195. But listeners in eastern North America have better luck with the Gabon relay at 1500 on 21550. Weekly program previews go out UTC Tues. at 0045 and 0230; also frequently on World of Radio (noted later).

Liechtenstein. Radio Liechtensein, Vaduz, was to start testing a 10-kilowatt transmitter in April at 0730-0930 on 7205. Unfortunately, this is somewhat questionable since it appeared April 1 in Play-DX, Italy.

Mexico. Hurry up to hear Huaya if you haven't already. That *campesino* station on 2390 kHz, Radio Huayacocotla, only used the 120-meter band because it couldn't get a mediumwave authorization. Most local listeners lack shortwave radios, so they tune to an image on 1480 instead! But now a permit for 1390 kHz has been issued, and the station planned to move there this summer, if not already. The schedule is Mon.-Sat. 1200-1500 and 2100-0100 UTC. Thanks to Christian Zettl in Mexico, who among others has also noted temporary reactivation from several more-or-less dormant Mexican shortwave stations—XEWV on 15176/

16150, 9515, 6165; XEQQ on 9680.3; ZEQQ on 9555; and XEEP on 6185. The government prodded them to do so if they wanted to keep their licenses.

Micronesia. Plans exist to set up a 25-kW shortwave transmitter to serve all four Federated States, which presently only have low-power mediumwave on each island; per Andy Sennitt.

New Caledonia. The French-government controlled station in Noumea on 11710 and 7170 kHz continued to be the only shortwave outlet despite the recent growth of separatism. However, Jean-Yves Camus in Paris reports in DSWCI Shortwave News that the Kanak Socialist National Liberation Front (FLNKS) is planning its own station as soon as funds can be raised.

Nicaragua [non] Contra station Radio Quince de Setiembre has recently started using more "inband" frequencies, in addition to some in the middle of the 5-MHz range—4950, 5980, 7195, as well as out-of-band 6280. Besides afternoon and evening transmissions, they operate at 1200-1400 and past 0600.

Norway. This should be the best time of the year for reception from Radio Norway in North America, thanks to the midnight sun. Sunday-only English half hours are scheduled as follows: 1300, 1400, 1900 and 2000 all on 15305; Mon. 0000 on 9580, 0400 on 9645; all subject to change (via Kraig W. Krist).

Paraguay. A hot frequency recently has been 5350 kHz, LSB, used in the early evening to feed sports and other programming from Radio Comuneros and Emisoras Paraguay for relay by stations in the hinterlands and abroad.

Raoul Island. Bob Rankin in Kansas has heard station ZME-3 on 9950 USB at 0615-0630 in contact with Wellington on 8080. Where in the world is this? If you don't know, a browse through an Atlas should prove more enlightening than my telling you!

Saipan. "Super-rock" KYOI has been on the air several years, with a slick American sound beamed to Japan. It has made a dent in the Japanese market, and is in the black, thanks to several major American advertising accounts. Yet the station is now for sale, asking price \$2

million. The reason? Reportedly, it seems KYOI has not been able to get any publicity in the Japanese media; no advertising will be accepted, not even schedules in newspapers.

Sharing the small island is KFBS, which as a missionary station, faces no such problems. Maybe they'd like another transmitter? They already have three, currently tentatively scheduled as follows: 6040, 1400-1600, 9510 1230-1300, 9520 1300-1600, 9525 1600-1800, 9600 1200-1400, 9620 1400-1600, 9685 0900-1200, 9735 1600-2000, 11735 2100-2300 11745 0900-1100, 11835 1600-1700, 11935 1700-1730, 15125 1000-1230 & 2200-2400, 15415 0000-0100, 17840 0100-0300, 17875 0000-0300 (all according to *Australian DX News*).

Suriname [non] Radio Free Suriname, via La Voz del CID, mentioned last month, has been retimed an hour earlier to 1930 on 11680, 9940.

Switzerland. Swiss Radio International has expanded "Dateline" to six days a week, but "Swiss Shortwave Merry-go-Round" remains on Saturdays by contracting into a weekly 10-minute slot. "Great Saturday Grapevine" moves to Sundays twice a month (presumably with a name change), leaving only two or three Sundays a month for longer feature programs. Broadcasts have also been retimed so they start at the top of the hour rather than on the quarter-hour: At 0200 on 12035, 11925, 9885, 9725, 6135; 0400 on 15305, 12035, 9725, 6135. Red Cross Broadcasting Service is also rescheduled to include a broadcast to North America twice a month on UTC Tuesday and Friday at 0340-0357 on the 0400 frequencies above, July 2, 5, 30; August 2, 27, 30.

Syria. Keeping up with Damascus' English frequencies is difficult, but at latest check 17840 was in use at 1200; 12085 and 15435 at 2005.

Tristan da Cunha. Those seeking ZOE, the rarest of shortwave broadcast stations, will be interested in a note Miss Laurian Rogers sent in reply to an inquiry from Bob Wilkner in Florida: the transmitter of 3290 kHz is still 40 watts, with no plans to increase it; it never operates later than 2205 GMT, and is scheduled

COMMUNICATIONS...

Mon.-Fri. 1600-1700; Mon./Wed./Fri. 1945-2200; Sun. 1000-1200. It relies heavily on BBC transcriptions.

Turkey. One of the best signals into North America, especially the east, from the Middle East, is Voice of Turkey on 9560 kHz. A service in Turkish at 0000-0400 contains lots of beautiful music, and is flanked by English broadcasts at 2300 and 0400. The first half hour of each daily broadcast consists of News, and Letter from Turkey. Features following are: Sat., DX Corner; Sun., Turkish Panorama; Mon. & Wed., Music; Tue., Turks and Turkish Music; Thu., From Anatolia; Fri., Step by Step Turkey. There could be revisions July 1. A good frequency for Turkish programs during the day is 15220.

United Kingdom. BBC World Service has started a weekly "Computer World" program. Listen on Mondays at 1615 on 9515, 15260; 2315 on 11750, 9915, 9590, 7325, 6175, etc.; GMT Tue. 0145 on most

of the same; and 0730 on 9510. "Waveguide," which has simple technical advice and frequency information on "how to hear us better," is now scheduled: Tues. 1115 on 11775, 6195, 5965; 2100 on 15260, 15070; Wed. 0430 on 9510, 6175; Thurs. 0130.

Universe. This rather large entity has its own timezone, and for one magic minute, June 30 at 2359 UTC, you can witness the harmony of the spheres being restored, with a 61-second minute! Count 'em on WWV, 2.5, 5, 10, 15 or 20 MHz.

USA. Now it's the *Christian Science Monitor* that's planning on entering the shortwave broadcasting field. Plans were not firm at presstime, but several 250-kW transmitters might be located in Maine, a Carolina, or Puerto Rico. It would take a minimum of two years to bring off. Although this might be more commercial than religious, we could expect the journalistic core of the station to match the high level of the newspaper, and the

weekly public radio program *Monitoradio* it has already been producing for some time.

KCBI, Dallas, and WMLK, Pennsylvania, still were not ready to begin regular service in April. NDXE in Alabama seems to have been somewhat exaggerated in its publicity; never mind the June start mentioned last month; that was put off until fall, with little actual progress in construction. In fact, the application was put up for sale, but there would be little advantage for anyone to buy it.

The next new U.S. shortwave station actually going on the air may well be George Otis' KVOH, Simi Valley, California. Antennas have been going up, and the transmitter being built in Tampa. July 4 is the target date. A proposed schedule is: 1600-2200 on 17775 or 17830; 2200-2400 on 15120; 0000-0300 on 11970, 0400-0600 on 9755, 0600-0800 on 6005.

Meanwhile, all current and planned U.S. shortwave operations have been hustling to forecast their expected frequency requirements for the next five years, so the International Telecommunications Union can begin in August a test run of its new computer program to assign times and frequencies. If this works out, it might well solidify into locked-in reality. So stations are likely to overestimate their needs, just in case.

As part of its gigabuck expansion program, Voice of America is to install three new transmitters at Greenville, NC site B for testing, each a different make. Dozens of the approved model will then be ordered, a multi-million dollar deal. This was discovered by Kent Sidel on a visit to the site.

Keep informed on the latest shortwave news by monitoring our weekly program *World of Radio*, via WRNO, New Orleans: UTC Sats. 0430 on 6185, UTC Suns. 0130 on 7355, and 1300 on 9715 (possibly changing to another 31-meter channel like 9852.5 or to a 25-meter channel, such as 11965).

Uzbekistan. Radio Tashkent's summer schedule is somewhat different than expected: 1200-1230 and 1330-1400 on 15115, 11785, 9715, 9650, 7340. Unfortunately, these frequencies face considerable interference from HCJB, WRNO, and RCI. **ME**

AMAZING

SCIENTIFIC and ELECTRONIC

DEVICES

- LASER DEVICES**
- LC5 BURNING CUTTING CO2 LASER \$15.00
- RUB3 RUBY LASER RAY PISTOL 15.00
- LRG3 IR LASER RIFLE/PISTOL 10.00
- LGU3 VISIBLE RED LASER RIFLE 10.00
- LHP/LLD LASER LIGHT XMTR/RCVR SYS 10.00
- LHC2 BEGINNER SIMULATED VISIBLE LASER 5.00
- SCIENTIFIC & ELECT**
- TCL3 SOLID STATE TESLA COIL 35KV 7.00
- BTC3 250 THOUSAND VOLT TESLA COIL 10.00
- BTC5 1.5 MILLION VOLT TESLA COIL 15.00
- HVM3 125 THOUSAND VOLT DC SUPPLY 10.00
- IOG3 ION RAY FORCE FIELD GUN 10.00
- PTG1 PLASMA FIELD GENERATOR 8.00
- ULTRASONIC ACCOUSTICAL**
- PPF1 PHASOR PAIN FIELD GENERATOR 15.00
- PSP3 PHASOR SHOCK WAVE PISTOL 8.00
- IPG5 POCKET PAIN FIELD GENERATOR 8.00
- RAT2 RAT AND PEST ELIMINATOR 7.00
- HT9 HIGH FREQ LISTENING DEVICE 8.00
- SECURITY & PROTECTION**
- BLS1 BLASTER WAND 10.00
- PPG1 PHASOR PROPERTY GUARD 15.00
- MFT1 MINI VOICE XMTR 2-3 MILE 7.00
- INF1 INFINITY TRANSMITTER 15.00
- VWPMS TELEPHONE XMTR 8.00
- SD5 SEE-IN-DARK NIGHT EYE 10.00

WE STOCK ALL PARTS NECESSARY FOR CONSTRUCTION OF THE ABOVE PROJECTS

- CATALOG CONTAINING HUNDREDS MORE OF ALL NEW AMAZING and FASCINATING PLANS EASY TO BUILD KITS AND ASSEMBLED ITEMS \$1.00 CATALOG INCLUDED FREE WITH ANY OF THE ABOVE PROJECT PLANS. SEND CASH, CHECK, MO, VISA, MC TO:

INFORMATION UNLIMITED
P.O. BOX 716, DEPT. ME7, AMHERST, NH 03031

Need A Storage Scope?

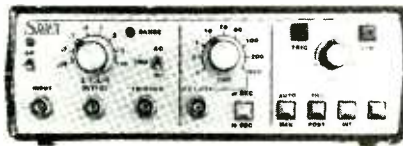

The Model 601 Scope Memory converts your oscilloscope into a storage scope. With the Scope Memory you can capture & display transients, pulses and low frequency signals. Stores both analog & digital signals in a single sweep.

Features include a 1.4 MHz sample rate, 2K memory, pre and post trigger capabilities.

Price \$515 Plus Shipping

SIBEX INC.

2340 State Road 580 • Suite 241
Clearwater, Florida 33515
(813) 797-9589

CIRCLE 93 ON FREE INFORMATION CARD

The latest technical books and literature in the electronics and computer field.

39 One-Evening Electronic Projects by Robert J. Traister. (Tab Books Inc.; 170 pages. Soft cover, \$9.65; hard cover, \$14.95.)

Here's a construction project book directed to electronics hobbyists with all levels of experience. The book is divided into four chapters, with the final one devoted to 39 electronic projects. Prior chapters cover electronic component basics, test and alignment instruments, and a host of guidelines on building electronic projects. The remaining two-thirds of the text provides electronic building information with appropriate schematics and parts lists. Among the projects presented are: self-powered field-strength meter, 25-watt dummy load, audio signal tracer, NiCd battery charger, code practice oscillator, miniature 10-meter transmitter, booster amplifier, and similar small projects. These are indeed one-evening projects. As such they are not sophisticated circuits, of course. However, many are useful electronic gadgets and they're quite inexpensive. Each project provides some nice step-by-step information to help move the novice along.

Understanding Solid State Electronics by William E. Hafford & Eugene W. McWhorter. (Texas Instruments; soft cover; 286 pages; \$14.95.)

This makes the tenth book in a TI Learning Center series on basic electronics. Following the tradition of earlier volumes, it does a creditable job of tutoring the neophyte in the fundamentals of solid-state electronics—without resorting to heavy mathematics and complicated theories. The text is logically organized, with each succeeding chapter building on the last, in easy-to-understand language. Each chapter begins with a list of key words to be discussed (definitions are summarized in a glossary) and concludes with a series of review questions, the answers for which follow the index.

Starting with what electricity does in every electrical system, the book explains how diodes, transistors and

other solid-state devices work, and how they are used in circuits and systems. In 13 chapters, it explains complex concepts like electricity, semiconductor theory, how circuits make decisions, and more. Along the way, integrated circuits are introduced and explained, with coverage including analog, digital, MOS and large-scale devices. With its profuse use of informative drawings (mostly in two colors) and photos, the material in this book is almost certain to provide the necessary tutoring for anyone with a reasonable level of reading comprehension.

The TRS-80 Color Computer 2 User's Guide by Brewer, Brownstein & Sharpe. (Macmillan Publishing Co.; soft cover; 124 pages; \$5.95.)

As its name implies, this book is meant to serve as a guide to using the popular Radio Shack Color Computer 2. It can, in fact, be used instead of the user's manual supplied with the computer, since it repeats much of the instructions and directions it details. Among the topics covered are set-up and operation of the basic computer, expanding the computer with add-ons (peripherals) to make it into a full-blown system, and a review of the best software to use with the CoCo. The text, written in a very readable conversational style, assumes zero knowledge about the CoCo and computing, though it will not put off the knowledgeable reader. Nice photographs and line drawings clarify the text.

In limited pages, this book manages to impart quite a bit of useful information about the CoCo and computing in general. Partitioned into eight basic chapters, the book leads off with setting up the CoCo, checking it out, adding peripherals, and using plug-in program cartridges and cassette-tape and floppy-disk programs. It then discusses the innards that make the computer work. Later chapters deal in detail with peripherals, software, communications, com-

puter clubs, publications devoted specifically to the CoCo, and routine maintenance and repairs. A comprehensive glossary closes the book.

NEW LITERATURE

Technical Electronics Supplies Catalog. Contact East is offering a free 76-page 1985 Electronic Tool and Test Instrument Catalog that lists and describes more than 5000 technical products for assembling, testing and repairing electronic circuits and equipment. Products are featured with four-color photographs, and include precision hand tools, test instruments, tool kits, soldering supplies, a wide selection of telecommunications tools and instruments, and a full range of static-protection items. For a copy, write: Contact East, 7 Cypress Dr., P.O. Box 160ME, Burlington, MA 01803.

Test Equipment Catalog. A 20-page short-form catalog in which are listed and described more than 50 test instruments is available from VIZ Test Equipment. Included in the listings are digital and analog meters, isolated ac power sources, signal generators, dc power supplies, and universal counters. The multi-color catalog introduces such new instruments as power supplies, isolated ac power sources, and digital frequency counters. Technical specifications listed include voltage and current ranges, meter display accuracy, measuring range, and resolution. The catalog also gives comprehensive information about VIZ's product applications. For a free copy, contact: VIZ Test Equipment, 335 E. Price St., Philadelphia, PA 19144.

Pc Tools & Accessories Catalog. A 10-page, full-color catalog that features a complete line of pc-board assembly and IC component-handling tools is now available from OK Industries Inc. The catalog gives complete descriptions and specifications for an array of pc boards and accessories, including lead bender/cutters and DIP sockets. Also included are useful production aids, such as a 40-tray component holder, pc card guides, brackets and binding posts. For a free copy of PC Board Assembly Tools and Accessories catalog, contact: OK Industries, Customer Service, 3455 Conner St., Bronx, NY 10575.

NEW PRODUCTS...

(from page 67)

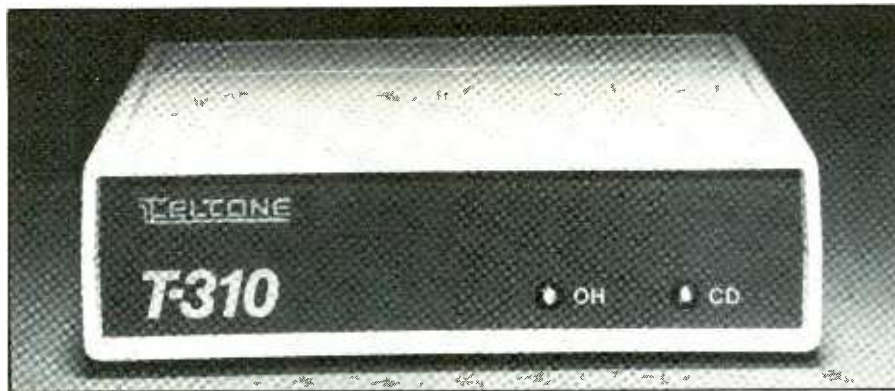

observe the status of calls, deliver taped or synthesized messages, receive Touch-Tone (DTMF) responses, convert Touch-Tone input into ASCII and dial another number.

The FCC-approved device for direct connection to the telephone line also includes an audio port that permits non-FCC-approved devices, such as speech synthesizers and tape players, to be coupled to the phone line to give computers the ability to provide "human" voice or computer-generated responses to Touch-Tone input. The T-130 uses modular phone connectors and is powered by a low-voltage wall transformer. \$365; \$21 for optional battery-back-up for user settings in memory.

CIRCLE NO. 102 ON FREE INFORMATION CARD

Electronic "Bug" Detector

If you are concerned that your home, office or car may be electronically bugged, Capri Electronics' new Model TD-17 transmitter detector may give you peace of mind. A wide frequency response (1 MHz to 1 GHz) allows the TD-17 to detect virtually all r-f bugging transmitters commonly used for surveillance.

When used to sweep an area, the TD-17 warns of the presence of a nearby r-f transmitter when an RF ALERT LED lights. A flashing RANGE LED and audio tone give an indication of distance to the bug. Then, using a SENSITIVITY control in conjunc-



tion with the two LEDs, you can zero in on locations of hidden bugs.

The hand-held TD-17 weighs less than 7 oz. and is housed inside a high-impact plastic case. It comes with battery, antenna and instruction manual. \$200.

CIRCLE NO. 101 ON FREE INFORMATION CARD

Outdoor Telephone Jack

AT&T's weatherproof outdoor telephone jack lets do-it-yourselfers install a telephone equipped with a modular jack on a porch, patio, deck, or anywhere outside the home,

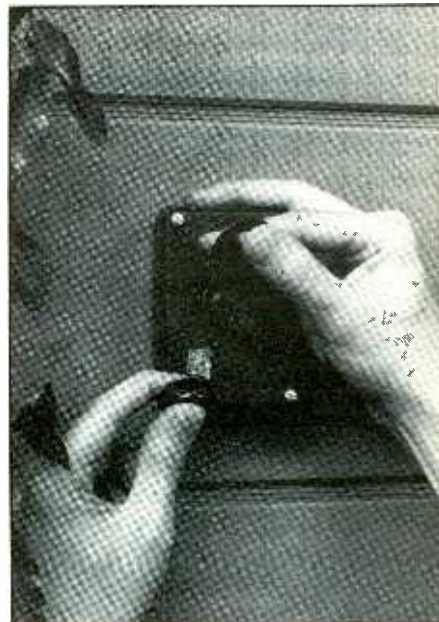

without having to worry about damage due to weather. The new outdoor jack comes with all the parts needed for installation. It is equipped with a protective cover to keep out the elements, plus a modular plug protector to insure a durable and secure telephone connection in any outdoor location. Availability is from any dealer that sells AT&T products. \$8.85.

CIRCLE NO. 109 ON FREE INFORMATION CARD

4 1/2-Digit DMM

Theall's Model KT5005 digital multimeter offers a 4 1/2-digit LCD display and full voltage, current and resistance measuring capabilities in a compact hand-held instrument. The DMM can resolve 100 μ V on the 200-mV range and provides accuracy of 0.05% on all dc ranges up to 200 volts. The 1000-volt dc range provides a resolution of 1 volt dc, with an accuracy of 0.1%. Six resistance ranges cover from 200 ohms to 20 megohms full-scale, with resolution of 100 milliohms on the 200-ohm range and an accuracy of 0.2%. Additionally, the DMM has five ac voltage ranges, six each dc and ac current

Dual-Pulse Generator

(from page 50)

Rotate the PHASE control to a position that results in an output pulse.

Return the RANGE switch to the LINE position and rotate the PHASE controls as necessary to obtain output pulses. Set *S3 (S6)* to VARIABLE and *S4 (S7)* to SHORT. Slowly rotate WIDTH control *R19 (R33)* counterclockwise from its fully clockwise position. Observe that the pulse, which will be almost equal to the period of the fully clockwise position, becomes shorter as the control is rotated counterclockwise.

Set the RANGE switch to its highest range and the FREQUENCY control to about the middle of its rotation. Set *S3 (S6)* to SQUARE and observe the square pulse output. Set *S3 (S6)* to VARIABLE and *S4 (S7)* to LONG. Rotate WIDTH control *R19 (R33)* fully clockwise and then slowly counterclockwise. As you do this, the pulse width will become narrower and continue to narrow until it suddenly becomes wide again and drops to half the original frequency. Further counterclockwise rotation will cause the pulse to narrow again until the frequency drops to a third of the original, and so on.

Feed the TRIGGER pulse output at *BP3* into the scope. You should observe a very narrow positive pulse with an amplitude of 5 volts. Because this pulse is very brief, it may be difficult to observe on the CRT screen. If your scope has a triggered-sweep capability, use this pulse to trigger the sweep while observing one of the output pulses. Note that the PHASE control varies the position of the pulse on the CRT screen.

For details on how to use the Dual Pulse Generator, refer to the "Applications" box.

In Closing

From the foregoing, it should be obvious that this is no ordinary "experimenter's" instrument. With its two independently adjustable generators, it offers a flexibility not usually expected in an instrument that costs as little as this one does to build. **ME**

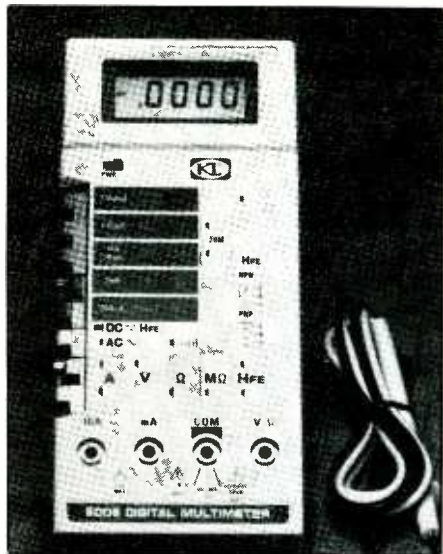

ranges, and a diode and transistor h_{fe} test capability. The meter also features auto-polarity, overload and low-battery indicators; side-mounted range/function selector switches; built-in tilt stand; test leads; and carrying case. Rated battery life is 150 hours. \$99.95.

CIRCLE NO. 111 ON FREE INFORMATION CARD

Direct-Burial Cables

A new line of direct-burial actuator cables for satellite earth station and communications applications has been announced by Nema Electronics International. Each type of cable provides the proper cabling for both motor power and sensor/control lines in a single polyethylene jacket

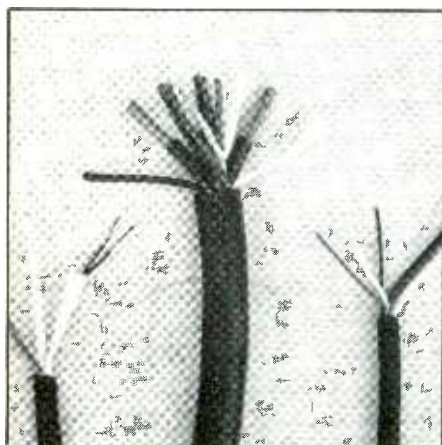

that is suitable for direct burial. Model ST-1 consists of two 16-gauge and two 22-gauge conductors, while Model ST-2 contains two 12-gauge conductors and three 22-gauge conductors. Both also have foil shields and drain wires. Nema also offers a line of five satellite control cables that contain motor, sensor, polarator and coaxial signal lines.

CIRCLE NO. 110 ON FREE INFORMATION CARD

Water Detector

The WaterBug 100 from Winland Electronics is a water-detection device for consumer applications. It was designed for easy use in boats, laundry rooms, basements, computer areas, sump pumps, or any other area where the presence of water

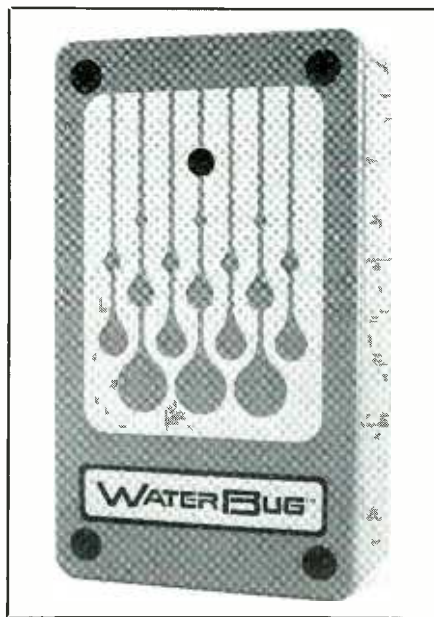

could cause damage or present a hazard. The device requires no installation; you simply lay it flat, directly on the area to be monitored. Then, when water bridges the contacts on the back of the WaterBug, the circuit triggers and sounds an alarm. \$19.95. Address: Winland Electronics, Inc., 418 S. Second St., P.O. Box 473, Mankato, MN 56001.

municate. The control panel is very simple, and operation is even easier than with nonportable radios. This tiny radio can communicate on 78 US and International marine channels, and can receive four weather channels. Typical users are small-boat owners, and even larger-boat owners find them convenient to use as a back-up for larger radios. It is a dream for the sailboat enthusiast because it operates from a rechargeable nickel-cadmium battery. Regular output power is 3 watts, and there is a 1-watt setting for close-in operation. Channel selection is via a knurled thumbwheel digital selector, and a NORM/CH16/WX switch permits a choice of normal operation, immediate operation on emergency Channel 16, or reception of weather broadcasts. A LED indicates proper transmit operation.

More elaborate and costly vhf marine radios provide additional communicating convenience. This may be in the form of a 10- to 20-position keypad and a programmable memory bank that permits you to key in a specific scanning order for as many stations as you wish to monitor. You can also establish a scanning priority to have a desired station override any scanning routine, time share between priority stations and emergency Channel 16, etc.

It is possible to include a direction finder with your marine radio. One such system consists of a center LED surrounded by 36 LEDs arranged in a circle (Fig. 3). When its associated directional antenna is positioned properly on the boat, a line between the center LED and the appropriate LED on the circle indicates the heading of the boat. The antenna does not rotate; instead, directivity is controlled electronically.

When the direction finder is first turned on, the LEDs in the circle flash on and off sequentially, giving the appearance of clockwise rotation. When a signal is received, rotation stops and the single LED that remains on indicates the direction from which the signal originates.

SSB Marine Radio

A single-sideband (SSB) radio for the mf and hf marine bands is usually not as small and compact or as simple to tune as a vhf radio. Maximum output power is 150 watts PEP or higher. The greater power is needed to cover greater distance and to compensate for the relatively poor efficiency of its antenna system (compared to a vhf installation).

Available antenna space for SSB operations is limited, especially on a small boat. Typical antenna length may fall between 12 and 16 feet as a function of available space. These antennas are very short electrically, compared to the operating frequencies of the sideband radios; so good

grounding is extremely important and an antenna coupler is a necessity. The coupler can be built into the radio or mounted externally to it. On larger boats, the coupler is sometimes mounted at the antenna and is automatically tuned when changing radio operating frequency of the radio is changed.

A small SSB marine radio may operate on 32 channels, including eight channels each on the 2-, 4-, 6-, and 8-MHz marine bands. A simple switch arrangement permits choice of channel. This does not mean the radio cannot operate on other channels (all channels can be programmed into memory). A qualified technician can set up the radio to accommodate frequency changes for the 32 switch positions. A larger SSB radio can permit operation on any frequency on any of the bands. A liquid-crystal display (LCD) is usually provided to indicate the transmit frequency. This type of radio would be fully frequency synthesized and employ microprocessor control with a 16-key programming keypad. A typical example of such a radio is the Raytheon Model 1285 shown in the lead photo. Some units include a receiver tunable between 100 kHz and 30 MHz.

Modulation modes are selectable to provide standard reduced carrier, SSB with partial carrier, and SSB with full carrier. The last is often useful when a Coast Guard station is trying to take a fix on boat location. Immediate switching to the 2182-kHz emergency frequency is essential for all models. Many models have a sea-watch automatic scanning capability that permits up to 10 selected channels to be monitored for calls.

In Closing

There is interesting radio listening in the coastal areas and from further out to sea. If you dwell too far inland to pick it up, make plans to take your scanner to your shore vacation spot this summer. Be listening! **ME**

CABLE TV CONVERTER REPAIR

- ALL MAKES
- ALL MODELS
- 7 DAY TURNAROUND
- FLAT RATE PRICING BY MODEL

CALL FOR INFORMATION

“THE CONVERTER SHOP”

794 Franklin Lakes Ave
Franklin Lakes, NJ 07417
Tel (201) 848-8229

LED1 and LED11 to hold the assembly in place.

Testing and Use

When power is first applied to the circuit by closing S1, GS1's heater element begins to warm up the sensitive surface. This display will initially light, sometimes to full scale, and then fall back to zero as the sensor stabilizes. This indicates that the sensor is ready to use. If during warm-up LED2 or LED3 remain on, this is an indication that the battery is getting weak and should be replaced.

Testing can be accomplished with a gas-type cigarette lighter. Simply press the gas-release button (do not rotate the spark wheel) and allow the escaping gas to come into contact with the gas sensor. If the battery is fresh and you have properly wired

the circuit, the LEDs should give a full-scale reading.

Having satisfied yourself that the Gas Detector is operating as it should, turn off the power and proceed to final assembly. Mount the battery holder on the floor of the plastic box with machine hardware. Do the same for the gas sensor's socket on the top of the box. Then carefully align the 11 LEDs with the holes in the box's lid and gently press home. Place a 1" length of plastic electrical tape over the exposed lugs of the gas sensor's socket to insulate it from the rest of the circuitry. Fit the lid onto the box and secure it in place with the supplied screws. Finally, plug GS1 into its socket. If you wish, you can label the LEDs and put the legend "Gas Detector" onto the lid with a dry-transfer lettering kit and follow up with two or three light

coats of clear lacquer to protect the lettering from scratches.

There are a couple of improvements you might want to incorporate into your Gas Detector. An obvious one is to replace the standard AA cells with rechargeable NiCd cells. If you do this, it is a good idea to also install an appropriate accessory jack to obviate the need to remove the cells for recharging.

Detector sensitivity can be increased by substituting a larger value resistor for that specified for R1 in the Parts List. This will cause the voltage dropped across R1 to be greater for a given concentration of gas. If you wish to have both the standard and the increased sensitivities, you can install a switch that will allow you to choose between the 1000-ohm and larger-value resistors as circumstances dictate.

ME

MICRO
MART

508 Central Ave.
Westfield, N.J. 07090
(201) 654-6008

UHF-TV PREAMP
(As featured in Radio Electronics March/ May articles, 1982)

This inexpensive antenna mounted pre-amp can add more than 25 dB of gain to your system. Lots of satisfied customers and repeat orders for this high quality kit which includes all component parts, PC Board, Case, Power Supply and Balun \$34.50 Assembled Version \$57.50

CG11S FOR RADIO ELECT. KIT FOR PROJECT...
10K0 .5% 1K 2.2% 1/2W (12UM) & 1/2W (10UM)
COMPLETE SET (BULK) 4 COILS..... 8.50
HC1330-PRIME (MOTOR)..... 21.00
BFQ-85 TRANSISTOR..... 1.50
DISC CAPS. (POLY)..... 201.00
74123-PRIME (MOTOR)..... 71.00
470UF 75V RADIAL..... 3.10
470UF 10V RADIAL..... 4.10
2N3904..... 1071.00
1N914..... 4071.00
5K1 DIP MIC A..... 21.00
5.1V ZENER DIODE..... 51.00
VOLTAGE REGULATOR (PRIME TO 220V) .80% .70%
7824, 7905, 7912-1K OR MATCH..... 371.00
VOLTAGE REGULATOR (SPECIAL UNMARKED) TO 220V
MAY INCLUDE POSITIVE/NEG. & ADJUST 15/1.00
78L08 VOLTAGE REGULATOR (DIODE)..... 201.00
PN2222A (PLASTIC)..... 201.00
2N5309..... 2071.00
555 TIMERS-PRIME (TTL)..... 471.00
74123 OR AMPHINET DIP HI REL. PIGTAIL..... 471.00
JUMBO RED LED'S-DIFFUSED LENS, PRIME (TTL)
NO COSMETIC REJECTS, ALL 100%..... 1571.00
100/56.00 1,000/857.50
LED MOUNTING CLIPS/RINGS..... 1571.00
8 PIN IC SOCKETS..... 1571.00
28 PIN IC SOCKETS..... 1571.00
TEXAS INST./8944A KEYBOARD INC./DATA FOR
PIMS MADE WHEN EACH KEY DEPRESSED... 4.95
CLOCK MODULE-CRYSTAL CONTROLLED, GREEN
DISPLA/72VDC (PRIME SET SWITCHES)/DATA-4.95
DIP SWITCH-12 POSITION..... 271.00
DIP SWITCH-8 POSITION..... 471.00
DIP SWITCH-3 POSITION..... 1071.00
ROTARY SWITCH-3 POSITION, 3A 125V 371.00
GIANT ALPHA NUMERIC RELAY 1 1/2"x2 1/4"
2X3 1/2" TOTAL RED LED MATRIX w/DATA-4.95
11 LED BAR GRAPH DISPLA/2 3/4" LONG, RECT
LED'S (SPECIFY RED, ORN, AMB)/DATA... 2.69
TAPPED TRANSFORMER (2A) 7.5, 9, 15, 18V @ 9.95
WALL PLUG TRANSFORMER 24V 520MA... 2.95
TRANSFORMER (6.3V @ 2A)..... 131.20
5,600UF 25V (COMP GRADE) 5/8" x 1 1/2" 371.00

FREE

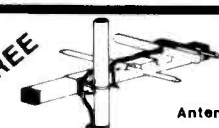

Antenna

FREE THE ANTENNA WITH EVERY PURCHASE OF ANY OF THE FOLLOWING PROFESSIONAL INSTALLATION KITS

48445- FREE ANTENNA + 65 FEET OF FRENCH SHIELDED COAXIAL CABLE, 2 FT COAXIAL CABLE PATCH CORD WITH FT CONNECTORS, 2 FT 500 OHM TWIN LEAD, 2 PCS INSTALLER'S NYLON WALL FEED THRU'S, 2 PCS NYLON CABLE TIES, 500 TO 75 OHM BALUN, 500 OHM TERMINAL FT CONNECTOR, 1/4 BOLT AND ALL MOUNTING HARDWARE \$9.95 + \$3.25 SHIPPING

44124- FREE ANTENNA/WALL CEILING MOUNT FOR SIMPER EASY INDOOR INSTALLATION, 25 FT FRENCH SHIELDED COAXIAL CABLE, ALL PATCH CORDS, TIE-RALUN CONNECTORS, ETC (SAME AS ABOVE) + SPECIAL WALL/CEILING MOUNTING HARDWARE \$8.95 + \$3.25 SHIPPING

48446- FREE ANTENNA/SPECIALTY DESIGNED POLE/HARDWARE FOR EXTRA EASY INDOOR USE + 24 FT PREMIUM SHIELDED COAXIAL CABLE, ALL CORDS, TIES/RALUN/CONNECTORS, ETC (SAME AS ABOVE) \$9.95 + \$3.25 SHIPPING

47UF 50V RADIAL (NICHICON)..... 2071.00
47UF 25V RADIAL (NICHICON)..... 1071.00
1UF 50V MONOLITHICS..... 2011.00
.22UF 50V MONOLITHICS..... 201.00
POTS-1 MEG, LINEAR TAPER EACH..... 511.00
MOTION DETECTOR BOARDS-#2 EACH..... 710.00
MOTION DETECTOR IC'S 550LW22521/82, 70 #10 BLACK, PLASTIC PROJECT BOX FOR ABOVE 1.95
EXTENSIVE CONSTRUCTION ARTICLE FOR DET.#1
1,000 PC RESISTOR ASS'T 130 VALUES 1/2W-#3
ZENER DIODES-20V 1/4W..... 3071.00
ZENER DIODES-15V 1/4W GLASS..... 3071.00
1N4007'S..... 2071.00
ZENITH IV REPLACEMENT IS SPECIAL \$4 EACH
221-42, 221-43, 221-45, 221-4B, 221-69,
221-76, 221-87, 221-9A, 221-10A, 221-105,
221-106
25C1172BITOSHIBA-HORIZ. OUTPUT..... 1.95
CHIP CAPS-SET OF 4,2 EACH 2.7K,3.3K+1.00
MINIATURE GEAR MOTOR(AURORA)..... 271.00
AMMETER/10-15 A.C. AMPERES..... 4.95
RF CHOKES-1/8" DIA, 9, 2uH, 12UM, 22UM 1071.00

MICRO-CONTROLLER BOARD (Kit/\$119.50)

Terms: MICRO-MART accepts Visa, MC and telephone COD's. Minimum order \$10.00 Shipping—U.S. orders, \$2.00 Canada and other countries \$3.50 (includes ins.) Shipping rate adjusted where applicable. NJ residents add 6% sales tax.

MICRO-MART • 508 CENTRAL AVE., WESTFIELD, NJ 07090 • (201) 654-6008

Computer problems? DON'T BLAME THE SOFTWARE!

Isolators prevent:

Pat. # 4,259,705



- CPU/printer/disk interaction
- Lightning or spike damage
- AC power line disturbances
- RFI-EMI interference

Commercial Grade Isolators

ISO-1 3 Isolated Sockets \$ 81.95

ISO-2 2 Isolated Socket Banks, 6 Sockets \$ 81.95

Industrial Grade Isolators

ISO-3 3 Double Isolated Sockets \$122.95

ISO-11 2 Double Isolated Banks, 6 Sockets \$122.95

Laboratory Grade Isolators

ISO-17 4 Quad Isolated Sockets \$213.95

ISO-18 2 Quad Isolated Banks, 6 Sockets \$180.95

Circuit Breaker, any model (Add-CB) Add \$ 11.00

Remote Switch, any model (Add-RS) Add \$ 20.00

ESP Electronic Specialists, Inc.

171 S. Main St., Box 389, Natick, Mass. 01760 (617) 655-1532

Toll Free Order Desk 1-800-225-4876
MasterCard, VISA, American Express

CIRCLE 12 ON FREE INFORMATION CARD

CIRCLE 53 ON FREE INFORMATION CARD

July 1985 / MODERN ELECTRONICS / 87

www.americanradiohistory.com

MODERN ELECTRONICS MART

Classified Commercial Rates: 90¢ per word, 15-word minimum (\$13.50) prepaid. (Word count includes name and address, ZIP code and abbreviation each count as one word; P.O. Box number and telephone number count as two words each.) Indicate free category heading. A special heading is available for a \$6 surcharge. *First word only is set boldface caps at no charge.* Add 20% for additional boldface words.

Mart Display Rates: 1" x 1 col., \$120; 2" x 1 col., \$230; 3" x 1 col., \$330. Prepayment discount 5% for 6 issues; 10% for 12 issues prepaid at once. (All advertisers with PO Box addresses must supply permanent address and telephone number. Copy is subject to publisher approval.)

Mailing Information: Copy must be received by the publisher by the 20th of the third month preceding the cover date. Send Advertising material with check or money order to: Modern Electronics, Classified Department, 76 North Broadway, Hicksville, NY 11801.

VIDEO

DESCRAMBLE CABLE and over the air programs. Details \$1, Plans \$9.95, Kits \$100.70. Minute Kits, Dept. D, Box 531, Westchester Sq. Sta., Bronx, NY 10461.

SCIENTIFIC ATLANTA CABLE SYSTEMS. New CM-04 descrambler for 8500 series boxes. Receive ALL pay channels. Send \$2.00. Advanced Technology Systems, Box 316, Auburn, MA 01501 (617) 832-2339.

ZENITH SSAVI MANUAL. Original manual used by technicians. Theory of scrambling, schematics, parts list, repair. For UHF and cable. For speedy delivery send \$15.00 cash or money order. **BAY STATE ELECTRONICS**, PO Box 263, Accord, MA 02018.

PROTECT your VCR from harmful power surges. Write: UP-TYME Computer Supplies, Dept. ME75, Box 95357, Atlanta, Georgia 30347.

CABLE and SUBSCRIPTION TV secret manual. Build your own descramblers, converters—HBO, Showtime, Movie Channel, UHF. Latest theory, schematics, instructions, suppliers list. Send \$8.95 to **CABLETRONICS**, Box 30502ME, Bethesda, MD 20814.

Canadian Pay TV and Satellite Descrambler Manual. All systems described. Schematics and construction details included. New chapter. Reception of pay channels via inexpensive dish and probe type microwave antennas in America and Canada. 58 pages. \$12.95. Complete product catalogue \$2 (refundable). Shojiki Electronics Corp., 1327 Niagara St., Niagara Falls, NY 14303. C.O.D.'s call 1-800-882-9200.

SATELLITE EQUIPMENT AT DISCOUNT PRICES. ALL MAJOR BRANDS AVAILABLE. SEND FOR FREE PRICE LIST. GALAXY SATELLITE SYSTEMS, PO BOX 970499, MIAMI, FL 33197.

Cable Converters to Scramblers. Lowest Price. Dealer inquiries accepted. Quantity discounts. **FREE CATALOG.** P G Video Corp., 210 Fifth Ave., N.Y., NY 10010.

SATELLITE TELEVISION, Everyones Guide. \$2.50 Money-back guarantee. SAT/FLORIDA, 2910 SE 19 Avenue, Gainesville, FL 32601.

HOME Satellite Handbook has everything you need to know about Satellite Television. \$10.00, SV Box 422, Seaford, New York 11783.

Order Form

Please print in block letters.

MODERN ELECTRONICS 76 North Broadway, Hicksville, NY 11801

Name _____
 Street _____
 City _____
 State _____ Zip _____

1	2	3	4	5
6	7	8	9	10
11	12	13	14	15
16	17	18	19	20
21	22	23	24	25

SATELLITE TV Receiver Breakthrough! Build your own system and save! Instruction manuals, schematics, circuit boards! Send stamped envelope: XANDI, Box 25647, Dept. 30C, Tempe, AZ 85282.

COMPUTERS

APPLE OWNERS: Hard-sided carrying cases for Macintosh \$100, Macintosh and external drive \$130, and IIC \$100. Send check or money order, or MC/Visa accepted. Justin Case Manufacturing Corp., 334 Main Street, Port Washington, NY 11050 (or telephone 516-883-2299).

ABSOLUTE IIe/IIC RESET To the "old" monitor ROM. Don Lancaster puts you back in total control. Capture routines, source code, detailed instructions, bonus book, \$19.95. **SYNERGETICS**, Box 809-ME, Thatcher, AZ 85552. VISA/MC. (602) 428-4073.

CONTROL your world with your computer! Control up to 48 devices easily. Complete plans, schematics, programs \$9.95. SASE for more information. B&W Electronics, 3621 Lowden, Kalamazoo, MI 49008

CB RADIO MODIFICATIONS! Increase channels, range, privacy. Conversion hardware, books, plans, kits, repairs. Catalog \$2. CBCI, Box 31500ME, Phoenix, AZ 85046.

PROTECT your computer and modem from harmful power surges. Write: UP-TYME Computer Supplies, Dept. MEC75, Box 95357, Atlanta, Georgia 30347.

TI-99/4A Software/Hardware bargains. Hard to find items. Huge selection. Fast Service. Free Catalog. **TYNAMIC**, Box 690, Hicksville, NY 11801.

ELECTRONICS

"BIONIC" EARS. HEAR LEAVES FALL FROM QUARTER MILE. AUTOMATIC LEVEL CONTROL FM WIRELESS MICROPHONE. COMPLETE INFORMATIONAL PLANS PACKAGE. BOARD, MOST PARTS FROM RADIO SHACK. \$7.95 PLUS \$1.50 SHIPPING. DIRIJO CORP., BOX 212, LOWELL, NC 28098.

Picture Flyer lists quality electronic surplus at low prices. Since 1970. Send for the last 3 issues. Star-Tronics, Box 683, McMinnville, OR 97128.

FREE PARTS FLYER! EVERYTHING FOR THE EXPERIMENTER. MARKE-TECH, 6831 TOTEM BEACH ROAD, MARYSVILLE, WA 98270.

ELECTRONIC CATALOG. Over 4,500 items. Parts & components. Everything needed by the hobbyist or technician. \$2.00 postage & handling (U.S. Only), refundable with first \$15.00 order. T&M Electronics, Dept. M, 472 East Main St., Patchogue, NY 11772. (516) 289-2520.

ELECTRONIC HOBBYIST: You can become a part of our information network, share your ideas, and have access to unique and fascinating projects. Send \$1.00 and be a part of the network today. T&K Specialty, 6888 Kent Dr., Baker, LA 70714.

GUARANTEED quality surplus components for less! Free flyer. Electronix Ltd, 3214 South Norton, Sioux Falls, South Dakota 57105.

WE HAVE QUALITY PARTS, DISCOUNT PRICES AND FAST SHIPPING!

TRANSFORMERS

120 volt primaries

5.6 VOLTS @ 750 MA \$3.00
 6 VOLTS @ 150 MA \$1.25
 12 VCT @ 200 MA \$2.00
 18 V. @ 650 MA \$3.50
 18 VOLTS @ 1 AMP \$4.50
 24 VOLTS @ 250 MA \$2.50
 24 VCT @ 1 AMP \$4.50

LINE CORDS

TWO WIRE
 6' 18ga TWO WIRE
 3 FOR \$1.00

THREE WIRE
 8 FOOT 18ga THREE WIRE
 \$2.00 EACH

MIKE CONNECTOR

5 CONDUCTOR IN-LINE PLUG AND CHASSIS MOUNT JACK TWIST LOCK STYLE. SAME AS SWITCHCRAFT 12CL5M. \$2.50 PER SET

7 CONDUCTOR RIBBON CABLE

SPECTRA STRIP RED MARKER STRIP 28 GA STRANDED WIRE. \$5.00 PER ROLL (100 FT.)

REVERBERATION UNIT

ACCUTRONICS COIL SPRING TYPE UNITS. USED IN ELECTRONIC ORGANS TO PROVIDE ACOUSTIC DELAY SOUND EFFECTS. INPUT IMPEDANCE 8 OHMS. OUTPUT IMPEDANCE 2250 OHMS. 4 1/2" x 16 1/2" x 1 1/4" \$7.50 EACH

WALL TRANSFORMER

ALL ARE 115 VAC PLUG IN

4 VDC @ 70 MA \$2.00
 6 VAC @ 500 MA \$3.50
 6VDC @ 750 MA \$6.50
 9VDC @ 500 MA \$5.00
 9 VAC @ 1 AMP \$3.00
 12.5 VAC @ 265 MA \$2.50
 17 VAC @ 500 MA \$4.00
 24 VAC @ 250 MA \$3.00

MULTI-SWITCHES

3 STATION NON-INTERLOCKING
 3 - 2PDT SWITCHES. EACH OPERATES INDEPENDENTLY.
 1 1/4" BETWEEN MOUNTING CENTERS.
 \$1.75 EACH

METER

THIS 2-1/4" SQUARE METER MEASURES 0-15 VDC. \$4.50 EACH

2K 10 TURN MULTI-TURN POT

SPECTROL #MOD 534-7161 \$5.00 EACH

SOUND AND VIDEO MODULATOR FOR T.I. COMPUTER

T.I. # UMI381-1. DESIGNED FOR USE WITH T.I. COMPUTERS. CAN BE USED WITH VIDEO SOURCES. BUILT-IN A/B SWITCH CHANNEL 3 OR 4 SELECTION SWITCH. OPERATES ON 12 VDC. HOOK UP DIAGRAM INCLUDED. \$10.00 EACH

SPRING LEVER TERMINALS

TWO COLOR CODED TERMINALS ON A STURDY 2 3/4" x 3 3/4" BAKELITE PLATE. GREAT FOR SPEAKER ENCLOSURES OR POWER SUPPLIES. \$1.00 EACH 10 FOR \$9.00

5 STATION INTERLOCKING

MADE BY ALPS 3 - 2PDT AND 2 - 6PDT SWITCHES ON FULLY INTERLOCKING ASSEMBLY. 3/4" BETWEEN MOUNTING CENTERS. \$2.50 EACH

SUB-MINIATURE D TYPE CONNECTOR

SOLDER TYPE SUB-MINIATURE CONNECTORS USED FOR COMPUTER HOOK UPS

DB-15 PLUG \$2.75
 DB-15 SOCKET \$4.00
 DB-15 HOOD \$1.50
 DB-25 PLUG \$2.75
 DB-25 SOCKET \$3.50
 DB-25 HOOD \$1.25

ROTARY SWITCH

1 POLE 6 POSITION 1 1/4" DIA x 1 1/2" HIGH 75¢ EACH 10 for \$6.00

48 KEY ASSEMBLY FOR T.I. COMPUTER

NEW TEXAS INSTRUMENTS KEYBOARD. UNENCODED. 48 S.P.S.T. MECHANICAL SWITCHES. TERMINATES TO 15 PIN CONNECTOR. SOLID METAL FRAME 4" x 9". \$6.50 EACH 2 FOR \$11.00

TI SWITCHING POWER SUPPLY

T1 # 1053214-2 COMPACT, WELL-REGULATED SWITCHING POWER SUPPLY DESIGNED TO POWER TEXAS INSTRUMENTS COMPUTER EQUIPMENT.

INPUT: 14VAC-25 VAC AT 1A
 OUTPUT: +12VDC AT 350MA
 +5VDC AT 1.2A
 -5VDC AT 200MA

SIZE: 4 3/4" x 4 1/4" x 1 1/4" \$5.00 EACH

"PARALLEL" PRINTER CONNECTOR

SOLDER STYLE 36 PIN MALE USED ON "PARALLEL" DATA CABLES. \$5.50 EACH

PUSHBUTTON POWER SWITCH

DOUBLE POLE POWER SWITCH PUSH-ON. PUSH-OFF. \$1.00 EACH

EDGE CONNECTORS

ALL ARE .156" SPACING

10 PIN EDGE CONNECTOR
 TRW #50-10-A-20 \$2.00 EACH

120V INDICATOR

NEON INDICATOR. RATED 120 V 1/3 W. MOUNTS IN 5/16" HOLE. RED LENS. 75¢ EACH 10 FOR \$7.00 100 FOR \$65.00

I.D.C. MALE

SAME AS ABOVE. WILL PRESS FIT ON STANDARD RIBBON CABLE. \$5.00 EACH

SWITCHES MINI-PUSH BUTTON

S.P.S.T. MOMENTARY NORMALLY OPEN 1/4" BUSHING

35¢ EACH
 10 FOR \$3.25
 100 FOR \$30.00

SPECIFY COLOR:
 RED, BLACK, WHITE, YELLOW.

22/44 TIN

P.C. STYLE. NO MOUNTING EARS. \$1.50 EACH 10 FOR \$14.00

22/44 GOLD
 P.C. STYLE \$2.00 EACH 10 FOR \$18.00

28/56 GOLD
 28/56 GOLD PLATED CONTACTS 156 CONTACT SPACING. \$2.50 EACH 10 FOR \$22.00

GEL CELL BATTERY

12 VDC @ 2.6 AMP HOUR 5 5/8" x 2 1/4" x 3 3/4" \$25.00 EACH

FREE! ➔ **SEND FOR** ➔ **FREE!**

NEW 1985 48 PAGE CATALOG

13.8 VOLT REGULATED POWER SUPPLY

THESE ARE SOLID STATE FULLY REGULATED 13.8 VDC POWER SUPPLIES. ALL FEATURE 100% SOLID STATE CONSTRUCTION, FUSE PROTECTION, L.E.D. POWER INDICATOR.

2 AMP CONSTANT, 4 AMP SURGE. UL LISTED \$18.00 EACH

RELAYS SOLID STATE RELAY

HEINEMANN ELECTRIC #101-5A-140-5 AMP CONTROL: 3-32VDC LOAD: 140VAC 5 AMPS SIZE: 2" X 1 1/4" X 1/4" HIGH \$5.00 EACH 10 FOR \$45.00

COMPUTER GRADE CAPACITORS

2,000 mfd. 200 VDC 1 3/4" DIA. x 5" HIGH \$2.00

3,600 mfd. 40 VDC 1 3/8" DIA. x 3 3/4" HIGH \$1.00

6,400 mfd. 60 VDC 1 3/8" DIA. x 4 1/4" HIGH \$2.50

31,000 mfd. 15 VDC 1 3/4" DIA. x 4" HIGH \$2.50

72,000 mfd. 15 VDC 2" DIA. x 4 3/8" HIGH \$3.50

185,000 mfd. 6 VDC 2 1/2" DIA. x 4 1/2" HIGH \$1.50

CLAMPS TO FIT CAPACITORS 50¢ ea.

SLIDE POTS

100K linear taper 2" LONG 1 5/8" TRAVEL 75¢ EACH

500K linear taper 2 7/8" LONG 1 3/4" TRAVEL 75¢ EACH

DUAL 100K audio taper 3 1/2" LONG 1 1/2" TRAVEL \$1.50 EACH

L.E.D.'S STANDARD JUMBO DIFFUSED

RED 10 FOR \$1.50
 GREEN 10 FOR \$2.00
 YELLOW 10 FOR \$2.00

FLASHER LED 5 VOLT OPERATION RED JUMBO SIZE \$1.00 EACH

BI POLAR LED 2 FOR \$1.70

LED HOLDERS TWO PIECE HOLDER FOR JUMBO LED 10 FOR 65¢ 200 FOR \$10.00

CLEAR CLIPLITE HOLDER MAKE LED A FANCY INDICATOR. CLEAR. 4 FOR \$1.00

DC CONVERTER

DESIGNED TO PROVIDE A STEADY ±5 VDC @ 240 MA FROM A BATTERY SUPPLY OF 3.5 TO 6.25 V

2 1/16" x 1 1/16" x 1 1/16" HIGH \$1.50 EACH

IN4148 SPECIAL

45" SPACING P.C. LEADS 1000 FOR \$10.00 10,000 FOR \$385.00

MINIATURE 6 VDC RELAY

SUPER SMALL SPDT RELAY. GOLD COBALT CONTACTS. RATED 1 AMP AT 30 VDC. HIGHLY SENSITIVE. TTL DIRECT DRIVE POSSIBLE. OPERATES FROM 4.3 TO 6 V. COIL RES. 220 OHM.

1 3/16" x 1 3/32" x 7/16" AROMAT # RSD-6V \$1.50 EACH 10 FOR \$13.50

MINIATURE TOGGLE SWITCHES

ALL ARE RATED 5 AMPS @ 125 VAC

S.P.D.T. (on-on)
 P.C. STYLE. NON-THREADED BUSHING 75¢ EACH 10 FOR \$7.00

S.P.D.T. (on-on)
 SOLDER LUG TERMINALS \$1.00 EACH 10 FOR \$9.00 100 FOR \$80.00

S.P.D.T. (on-off-on)
 SOLDER LUG TERMINALS \$1.00 EACH 10 FOR \$9.00 100 FOR \$80.00

S.P.D.T. (on-on)
 P.C. LUGS THREADED BUSHING \$1.00 EACH 10 FOR \$9.00 100 FOR \$80.00

P.D.P.T. (on-on)
 SOLDER LUG TERMINALS \$2.00 EACH 10 FOR \$19.00 100 FOR \$180.00

CRYSTALS

CASE STYLE HC33/U 2 MHZ COLORBURST 3579.545 KC \$3.50 EACH \$1.00 EACH

METAL OXIDE VARISTOR
 POPULAR GE # 130LA10A VARISTOR. 5/8" DIAMETER. \$1.25 EACH

TRANSISTORS

2N706 4 FOR \$1.00
 2N2222A 3 FOR \$1.00
 PN2222 4 FOR \$1.00
 2N2904 3 FOR \$1.00
 2N2905 3 FOR \$1.00
 2N2907 3 FOR \$1.00

KEY ASSEMBLY 5 KEY

CONTAINS 5 SINGLE-POLE NORMALLY OPEN SWITCHES MEASURES 3 3/4" LONG \$1.00 EACH

6 KEY
 CONTAINS 6 SINGLE-POLE NORMALLY OPEN SWITCHES. MEASURES 4 1/4" LONG \$1.25 EACH

13 VDC RELAY

CONTACT: S.P.N.C. 10 AMP @ 120 VAC ENERGIZE COIL TO OPEN CONTACT COIL: 13 VDC 650 OHMS SPECIAL PRICE \$1.00 EACH

4 PDT RELAY
 14 pin style 3 amp contacts 24 volt d.c. or 120 volt a.c. coil Used but fully tested \$1.70 EACH specify coil voltage LARGE QUANTITIES AVAILABLE SOCKETS FOR RELAY 50¢ each

8" P.A. SPEAKERS

C. T. S. MODEL 8B3079 \$5.00 EACH 8 OHMS COIL. 3.0 OZ FERRITE MAGNET CASE OF TYPICAL RESPONSE RANGE: 8 SPEAKERS 100 - 10,000 HZ. \$32.00 POWER RATING 15 WATTS MAX. DRILLED TO MOUNT LINE MATCHING TRANSFORMERS.

3 1/2" SPEAKER
 8 OHM IMPEDANCE. FULL RANGE SPEAKER. 8 OZ MAGNET. 4" DIAGONAL MOUNTING CENTERS. \$2.50 EACH 10 FOR \$20.00

SOLID STATE BUZZER
 STAR #SMB-06L. 6 VDC. TTL COMPATIBLE. \$1.00 EACH 10 FOR \$9.00

TOLL FREE ORDERS ONLY
 1-800-826-5432 (ORDER ONLY)
 (IN CALIFORNIA: 1-800-258-6666)
 ALASKA, HAWAII, OR INFORMATION (213) 380-8000

ALL ELECTRONICS CORP.

905 S. VERMONT AVE. P.O. BOX 20406 LOS ANGELES, CA 90006

6228 SEPULVEDA BLVD. VAN NUYS, CA 91411

QUANTITIES LIMITED MINIMUM ORDER \$10.00 USA: \$3.00 SHIPPING FOREIGN ORDERS: INCLUDE SUFFICIENT SHIPPING CALIF. RES. ADD 6 1/2% NO C.O.D.!



CIRCLE 56 ON FREE INFORMATION CARD

SPEAKER CATALOG

1001 bargains in electronics. Save up to 50% call toll free 1-800-346-2433 for ordering only. Order by VISA/MC/AMX. No COD's. Missouri, Alaska, Hawaii call 1-816-842-5092, or write McGee Radio, 1901 McGee St., K.C., MO 64108. Postage for catalog \$1.00.

Quality Microwave TV Antennas

Multi-Channel 1.9 to 2.7 GHz
40dB Gain True Parabolic 20 Inch Dish
Complete System \$84.95 (Shipping incl.)
Dealerships, Qty. Pricing, Replacement Parts

Philips-Tech Electronics
P.O. Box 34772 • Phoenix, AZ 85067
(602) 947-7700 (\$3.00 Credit all phone orders!)

LIFETIME WARRANTY MasterCard • Visa • COD's

PANASONIC ZENITH GE SYLVANIA QUASAR MAGNAVOX RCA SHARP HITACHI PHILCO SANYO SONY SAMSUNG SAMPO MGA TOSHIBA GOLDSTAR EXACT ORIGINAL PARTS FOR TV AND VCR. CALL NOW 800-874-1765 NY ONLY 800-874-1764.

KITS! Sound effects generator, capacitance meter, C64 drum machine, stereo scratch filter, and more. Semi-assembled and tested. Free literature. GRAYCO, 1024 Lancer, San Jose, CA 95129.

Automotive radio replacement parts. Delco, Ford Chrysler, Panasonic, etc. Laran Electronics, 3768 Boston Rd., Bronx, NY 10469 (212) 881-9600; NY State: 800-446-4430; National: 800-223-8314.

REVERBERATION FOR ORGANS

Solid state with controls for reverberation and room size.
EVERY ORGAN SHOULD OWN ONE. Send for free flyer—
DEVTRONIX ORGANS, INC.
6101 WAREHOUSE WAY
SACRAMENTO, CALIFORNIA 95826

7 MILLION TUBES FREE CATALOG

Includes all Current, Obsolete, Antique, Hard-To-Find Receiving, Broadcast, Industrial, Radio/TV types. **LOWEST PRICES**, Major Brands, In Stock.

UNIFY Electronics Dept. ME
P.O. Box 213, Elizabeth, NJ 07206

COMMUNICATIONS

COMMUNICATIONS plans, kits, books. 1750 Meter transceivers, AM/FM broadcast transmitters, ham/CB amplifiers, surveillance bugs, much more! Catalog \$1.00. PANCOM, Box 130-ME2, Paradise, CA 95969.

MacPAINT™ SCHEMATICS PACKAGE

—A complete library of all 74HC00 series CMOS integrated circuits in two sizes, along with bunches of other electronic symbols and schematic drawing aides. \$23.50. SYNERGETICS, Box 809-ME, Thatcher, AZ 85552. VISA/MC. (602) 428-4073.

POLICE Descramblers for Scanners, telephone devices, etc. Free Catalog. Krystal Kits, P.O. BOX 445, Bentonville, Ark. 72712.

MISCELLANEOUS

MacPAINT™ PRINTED CIRCUIT LAYOUT PACKAGE Kiss tape and dots goodbye forever. Faster, much more accurate, cheaper, far more fun. New Don Lancaster package gives you professional results every time. Diskette and bonus book, only \$23.50. SYNERGETICS, Box 809-ME, Thatcher, AZ 85552. VISA/MC. (602) 428-4073.

ENTERTAINING? Advertising? Dazzle 'em with light displays activated by our reasonably priced professional quality **Color Organ** and **Light Chaser** controllers. **Design Specialty**, Box 1995, Huntington Beach, CA 92647.

LEARN TELEVISION BASICS. Perfusely illustrated text teaches television basics, including color and special circuits, in easy to understand language. Includes construction projects too. \$6.50 postpaid by Aptron Laboratories, Inc. P.O. Box 323, Bloomington, IN 47402.

CASES: Carrying, Shipping, Special-purpose. Stock . . . Custom. For more information, contact Justin Case Manufacturing Corp., 334 Main Street, Port Washington, NY 11050.

Telephone privacy! Eliminates unwanted ringing. Know who's calling before you answer. Simple details \$3.00. A.C.T., Suite 193, 2442 NW Market, Seattle, WA 98107.

CORRESPONDENCE to Asia for lasting relationship. Free Information. **AAWS-ME**, Box 2777; Orcutt, CA 93455-0777 Tel. No. 805-937-5230.

MODERN ELECTRONICS
76 N. Broadway, Hicksville, NY 11801

FREE INFORMATION SERVICE

For further information on products, dealers, or literature in this issue, circle the appropriate numbers below. Be sure to include your name and address before mailing.

1	2	3	4	5	6	7	8	9	10	11	12
13	14	15	16	17	18	19	20	21	22	23	24
25	26	27	28	29	30	31	32	33	34	35	36
37	38	39	40	41	42	43	44	45	46	47	48
49	50	51	52	53	54	55	56	57	58	59	60
61	62	63	64	65	66	67	68	69	70	71	72
73	74	75	76	77	78	79	80	81	82	83	84
85	86	87	88	89	90	91	92	93	94	95	96
97	98	99	100	101	102	103	104	105	106	107	108
109	110	111	112	113	114	115	116	117	118	119	120
121	122	123	124	125	126	127	128	129	130	131	132
133	134	135	136	137	138	139	140	141	142	143	144
145	146	147	148	149	150	151	152	153	154	155	156
157	158	159	160	161	162	163	164	165	166	167	168
169	170	171	172	173	174	175	176	177	178	179	180

Insert issue date here _____
(month) (year)
(must be completed to process)

Name _____
Company Name _____
Address _____
City _____ State _____ Zip _____

SUBSCRIBER SERVICE

CHANGE OF ADDRESS

MODERN ELECTRONICS
76 N. Broadway, Hicksville, NY 11801

Planning to move? Please let us know six weeks in advance so you won't miss a single issue of MODERN ELECTRONICS. Attach old label and print new address in space provided. Also include your mailing label whenever you write concerning your subscription to ensure prompt service on your inquiry.

ATTACH LABEL HERE

NAME _____
ADDRESS _____
CITY _____ STATE _____
DATE _____ ZIP _____

PLEASE PRINT

NATIONAL SEMICONDUCTOR • PANASONIC QUALITY - Name brand products from nationally recognized manufacturers. SERVICE - Computerized order processing and inventory control. E.F. JOHNSON • ATLANTIC SEMICONDUCTOR SAVINGS - Volume Discounts • OEM Quantity Pricing • Toll Free 800 Number

DIODES • DIAMOND TOOL • UNGAR AR • CV INDUSTRIES • AMDEK • G.E. RINGAR • VALGEO • J.W. MILLER • ALKO GC CHEMICALS • ARIES • PLESSEY

INTEGRATED CIRCUITS

Table listing various integrated circuits including Linear, Memory, and Micro categories with part numbers and prices.

1% METAL FILM RESISTORS

Table listing 1% metal film resistors with standard resistance values and power ratings.

IC SOCKETS

Table listing IC sockets for various integrated circuits, including single base and low profile types.

PANASONIC ELECTROLYTIC KIT

Panasonic electrolytic kit advertisement featuring Panasonic LS Series capacitors and a price of \$39.95.

DISC CAPACITORS

Table listing disc capacitors with various capacitance values and physical dimensions.

TANTALUM CAPACITORS

Table listing tantalum capacitors with various capacitance values and physical dimensions.

Memory

Table listing memory components including RAM and ROM parts.

5% Carbon Film Resistors

Table listing 5% carbon film resistors with various resistance values and power ratings.

WIRE WRAP DIP SOCKETS

Table listing wire wrap DIP sockets for various integrated circuits.

PANASONIC V-SERIES

Panasonic V-Series electrolytic capacitors advertisement with technical specifications and pricing.

170 METALLIZED POLYESTER CAPACITORS

Table listing 170 metallized polyester capacitors with various capacitance values.

PANASONIC TANTALUM KIT

Panasonic tantalum kit advertisement including a list of 180 tantalum capacitors.

Micro

Table listing micro components including various microprocessors and controllers.

WIRE WRAP DIP SOCKETS

Table listing wire wrap DIP sockets for various integrated circuits.

EDGEBOARD CONNECTORS

Table listing edgeboard connectors for various board configurations.

EDGEBOARD CONNECTORS

Table listing edgeboard connectors for various board configurations.

AMP Champ Connectors

Table listing AMP Champ connectors for various applications.

AMP Champ Connectors

Table listing AMP Champ connectors for various applications.

416 200 nsec 15,354 P I Item

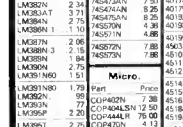

1 AMP SILICON RECTIFIERS

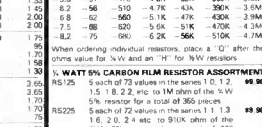

3 AMP SILICON RECTIFIERS



ELECTRONIC HARDWARE KIT

Electronic hardware kit advertisement listing various electronic components and their prices.

LATCH TYPE CONNECTORS

Table listing latch type connectors with various configurations and prices.

LATCH TYPE CONNECTORS

Table listing latch type connectors with various configurations and prices.

416 200 nsec 15,354 P I Item

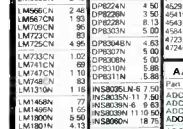

1 AMP SILICON RECTIFIERS

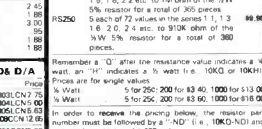

3 AMP SILICON RECTIFIERS



ELECTRONIC HARDWARE KIT

Electronic hardware kit advertisement listing various electronic components and their prices.

LATCH TYPE CONNECTORS

Table listing latch type connectors with various configurations and prices.

LATCH TYPE CONNECTORS

Table listing latch type connectors with various configurations and prices.

416 200 nsec 15,354 P I Item



1 AMP SILICON RECTIFIERS

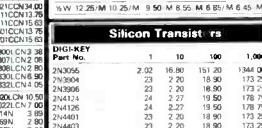

3 AMP SILICON RECTIFIERS

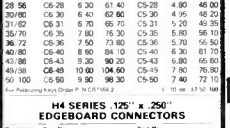

ELECTRONIC HARDWARE KIT

Electronic hardware kit advertisement listing various electronic components and their prices.

LATCH TYPE CONNECTORS

Table listing latch type connectors with various configurations and prices.

LATCH TYPE CONNECTORS

Table listing latch type connectors with various configurations and prices.

416 200 nsec 15,354 P I Item



1 AMP SILICON RECTIFIERS

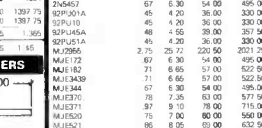

3 AMP SILICON RECTIFIERS

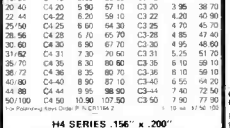

ELECTRONIC HARDWARE KIT

Electronic hardware kit advertisement listing various electronic components and their prices.

LATCH TYPE CONNECTORS

Table listing latch type connectors with various configurations and prices.

LATCH TYPE CONNECTORS

Table listing latch type connectors with various configurations and prices.

416 200 nsec 15,354 P I Item

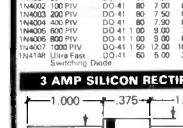

1 AMP SILICON RECTIFIERS



3 AMP SILICON RECTIFIERS



ELECTRONIC HARDWARE KIT

Electronic hardware kit advertisement listing various electronic components and their prices.

LATCH TYPE CONNECTORS

Table listing latch type connectors with various configurations and prices.

LATCH TYPE CONNECTORS

Table listing latch type connectors with various configurations and prices.

416 200 nsec 15,354 P I Item

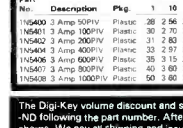

1 AMP SILICON RECTIFIERS

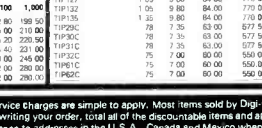

3 AMP SILICON RECTIFIERS



ELECTRONIC HARDWARE KIT

Electronic hardware kit advertisement listing various electronic components and their prices.

LATCH TYPE CONNECTORS

Table listing latch type connectors with various configurations and prices.

LATCH TYPE CONNECTORS

Table listing latch type connectors with various configurations and prices.

The Digi-Key volume discount and service charges are simple to apply. Most items sold by Digi-Key may be combined for a volume discount. Items that are not discountable are identified by the suffix N/D following the part number. After printing your invoice, total all the discountable items and apply the volume discount. To the subtotal, add the non-discountable items. Then add the service charges. We pay our shipping and invoice charges to addresses in the U.S.A., Canada and Mexico and when cash or money order accompanies order. Digi-Key only ships orders within the continental U.S., Alaska, Hawaii, Canada and Mexico.

WHEN ORDERING BY PHONE, CALL 1-800-344-4539 (AK, 218-681-6674). BY MAIL SEND YOUR ORDER TO DIGI KEY, P.O. BOX 677, Thief River Falls, MN 56701. You may pay by check, money order, Master Charge, VISA or C.O.D. DIGI-KEY GUARANTEE: Any parts or products purchased from Digi-Key that prove to be defective will be replaced or returned at no charge within 90 days from receipt with a copy of your invoice. *PRICES SUBJECT TO CHANGE WITHOUT NOTICE.

CIRCLE 57 ON FREE INFORMATION CARD

July 1985 / 1000'S / MODERN ELECTRONICS / 91

PRODUCT EVALUATIONS . . .

“PC Spooler” (from page 18)

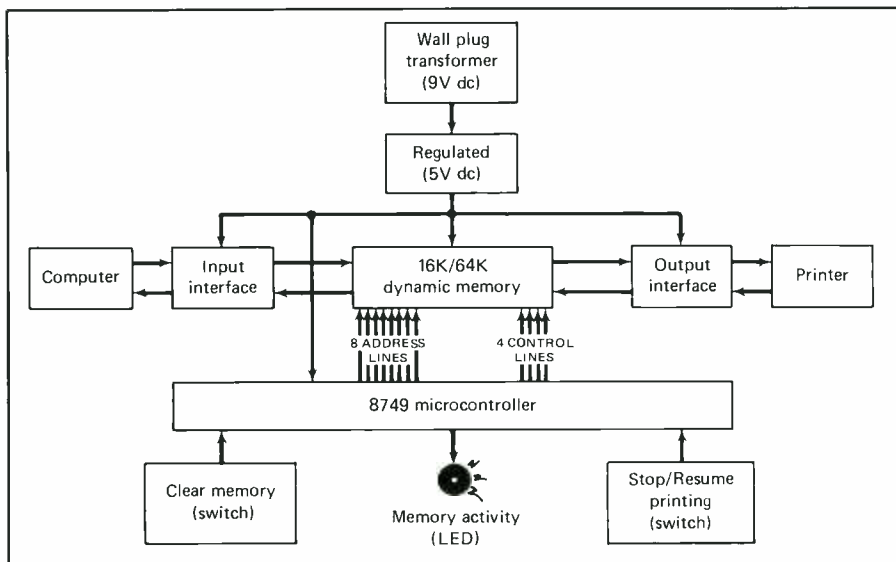

Functional block diagram of PC Spooler shows all input and output lines.

ory. Printing will start with the next data sent to the PC Spooler by the computer.

Each time input data is written to memory, the MEMORY ACTIVITY LED is illuminated, indicating communication between the computer and the PC Spooler.

Output data is presented to the printer through the output interface. The printer-busy line is tested. If disabled, a negative data strobe is generated by the PC Spooler, and busy is again checked. When clear, the next data in memory is transmitted to the printer.

Conclusions

The PC Spooler performed flawlessly. It's dumb, of course, in the sense that it doesn't have some of the programmable features of more costly "intelligent" printer buffers, such as choosing number of copies desired, formatting and graphic dump commands, memory-remaining readout, and so on. Nonetheless, it does its work well at a very low cost.

The unit is limited to use with parallel-interface printers, of course, which wipes out you RS-232 serial-interface printer owners. Nor does it offer great memory storage capacity or expandability in that direction. Just as waiting for a computer's output to complete its feed to a printer before being able to peck away at the computer's keyboard becomes an irritant after a while, even of only a few minutes, so does limited buffer memory become bothersome if you regularly work on large manuscripts.

Accordingly, the PC Spooler isn't for a novelist's use. But if you typically work with a more limited number of pages that have to be printed, don't care much about fancy graphics and other niceties, then this unit is most useful and about as low in price as you can get at \$99. If you've got the extra \$40, though, the 64K version would be more desirable because you'll surely grow into it quickly.

—Fred Blechman

CIRCLE 94 ON FREE INFORMATION CARD

ADVERTISERS' INDEX

RS#	Page #
56	All Electronics Corp. 89
176	Antenna Specialists Co. 65
54	B & K Precision Cov. III
5	Cleveland Institute of Elec. 21
-	C.O.M.B. Co., Inc. 3
-	Converter Shop 86
-	Devtronix Organs Inc. 90
173	Dick Smith Electronics 46, 47
57	Digi-Key Corp. 91
53	Electronic Specialists 87
-	Grantham College of Engrg. I
95	Hacknet 53
23	Information Unlimited 80
89	Jan Crystals 65
85	MCM Electronics 49
-	McGee Radio 90
12	Micro-Mart 87
38	Morning Distributing Co. 61
-	NRI Schools 8, 11
55	Oregon Microwave Inc. 67
-	Phillips-Tech Electronics 90
175	Pinecom International 33
93	Sibex Inc. 80
-	Tektronix, Inc. Cov. IV
39	Uniden Bearcat Cov. II



Free Product Information

Readers can obtain free information on products advertised by the above companies, as well as for some editorially mentioned products. Simply circle the appropriate number printed below an advertisement onto the Modern Electronics "Free Information Service" card bound into this issue. After filling in your name and address, just mail the postpaid card. Your request will be forwarded directly to the advertiser with a mailing label prepared by our reader-service department to ensure speedy response.

New from B&K-PRECISION, for telephone service, test and repair

COMPLETE TELEPHONE PRODUCT ANALYZER. A total self-contained system for diagnostic testing, servicing and calibration of corded and cordless telephones, answering machines and automatic dialers. Performs every test you'll ever need to test and repair any phone product including verification of pulse and touch-tone numbers, measurement of frequency error and modulation deviation. **MODEL 1050 \$1695**



MODEL 1050 \$1695

CORDLESS TELEPHONE TESTER. Provides full servicing and calibration capability for base and portable phone units. All rf test and measurement functions. Replaces expensive FM generators and modulation monitors, yet performs all tests required for cordless phone system analysis and repair, including full frequency testing and alignment. Generates all prior and recently approved frequencies. **MODEL 1047 \$895**



MODEL 1047 \$895



MODEL 1045 \$395

TELEPHONE PRODUCT TESTER. For in-store consumer or service use. Tests handset cord, phone line cord, dial/reset functions, voice and dial number levels, ring function and voice quality of corded and cordless phones, answering machines and automatic dialers. **MODEL 1045 \$395**



MODEL 1042 \$19.95

TELEPHONE LINE ANALYZER. Quickly identifies a problem as external or in the phone itself. Tests for condition of external phone line, phone line cord, ring and line voltage levels and polarity. Easy to use, no batteries or external power needed. **MODEL 1042 \$19.95**

These test instruments cover every possible level of service required for telephone products. They are equally useful for training. The instruction manuals provided offer a comprehensive course of training for service personnel and students. Call your nearest B&K-PRECISION distributor for off-the-shelf-delivery or additional information—or contact B&K-PRECISION.

B&K-PRECISION DYNASCAN CORPORATION

6460 West Cortland Street • Chicago, Illinois 60635 • 312 889-9087

International Sales: 6460 W. Cortland St. Chicago, IL 60635

Canadian Sales: Atlas Electronics, Ontario

South and Central American Sales: Empire Exporters, Plainview, NY 11803

CIRCLE 54 ON FREE INFORMATION CARD

Now! Tek quality and expert advice are just a free phone call away!

The industry standard in CRT performance.

Crisp, easy-to-read, bright CRT; 14kV accelerating potential, provides high writing rate and small spot size. Full size 8x10 cm display for measurement accuracy.

Display controls are flexible and easy to use.

Separate intensity controls reduce blooming in alternate sweep mode. Focus tracking minimizes control adjustment and BEAM FIND eliminates confusion.

Vertical system provides measurement assurance.

Flat transient response and high accuracy ensures true reproduction of your signals. Fast risetime and high bandwidth is well suited for a variety of measurement.

Perform delayed sweep measurements accurately and easily.

Both sweeps can be displayed alternately making differential measurements easy and accurate (1%). An interlocking SEC/DIV control simplifies set-up.

Stable hands-off triggering.

P-P AUTO detects signal peaks, then sets the trigger level for you. Display asynchronous signals using VERT MODE triggering. Independent TV field and line selection.

Front panel laid out by function for ease of use.

Color coding aids the user in operation. Functions and modes are placed logically. All nomenclature is clearly labeled, and protected behind a scratchless Lexan surface.

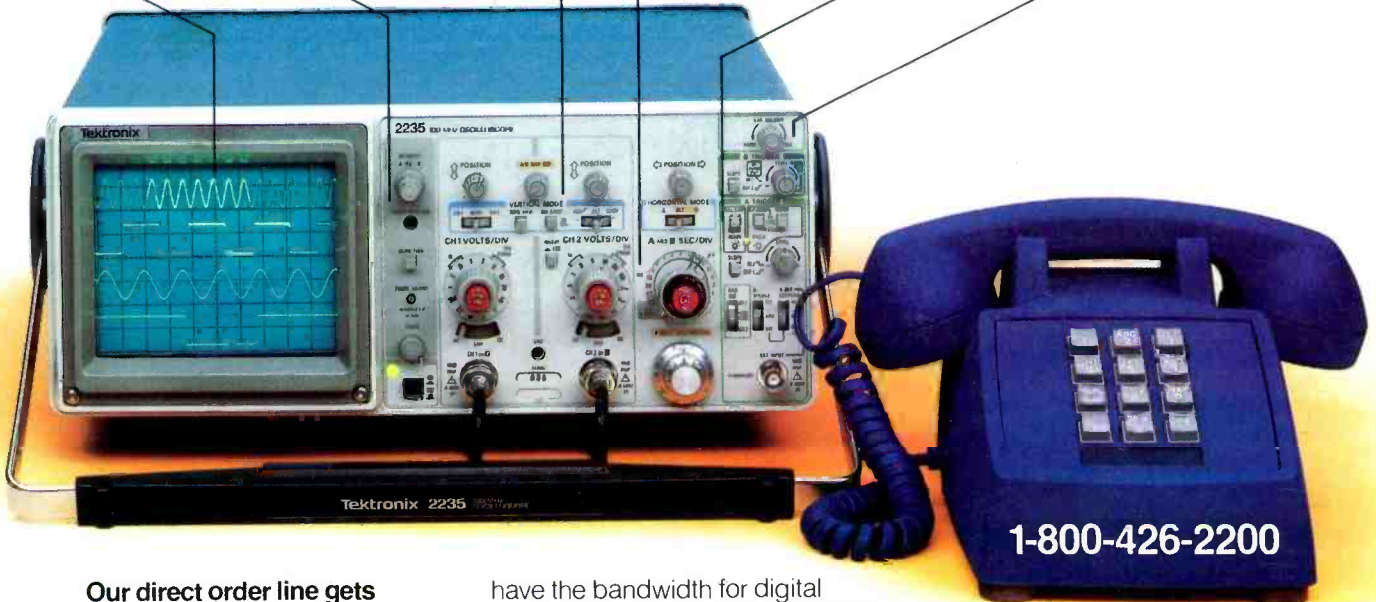

Our direct order line gets you the industry's leading price/performance portables... and fast answers from experts!

The 60 MHz single time base delay 2213A, the 60 MHz dual time base 2215A and the 100 MHz dual time base 2235 offer unprecedented reliability and affordability, plus the industry's first 3-year warranty* on labor and parts, CRT included.

The cost: just \$1275 for the 2213A, \$1525 for the 2215A, \$1750 for the 2235.† Even at these low prices, there's no scrimping on performance. You

have the bandwidth for digital and analog circuits. The sensitivity for low signal measurements. The sweep speeds for fast logic families. And delayed sweep for fast, accurate timing measurements. All scopes are UL Listed and CSA approved.

You can order, or obtain literature, through the Tek National Marketing Center. Technical personnel, expert in scope applications, will answer your questions and expedite delivery. Direct orders include comprehensive 3-year warranty*, operator's

manual, two 10X probes, 15-day return policy and worldwide service backup.

Order toll free: 1-800-426-2200, Ask for Rick.

In Oregon, call collect: (503) 627-9000. Or write Tektronix, Inc. P.O. Box 1700 Beaverton, OR 97075

1-800-426-2200

Tektronix
COMMITTED TO EXCELLENCE