

ICD 08559

MODERN ELECTRONICS™

DECEMBER 1984 \$1.95
CANADIAN & FOREIGN \$2.50

THE MAGAZINE FOR ELECTRONICS & COMPUTER ENTHUSIASTS

- **First Look:
Sony's Car CD Player**
- **ME Tests Coleco's
"Born-Again"
ADAM Computer**



The First Car CD Player (p. 14)

- **RGB Monitors—The Video Kings**
- **New Instant-RPM Tach Project**
- **How IC's Work**
- **Hyping Cassette Tapes for Car Stereo**

- **TV Satellite—The "Quiet Video Revolution"**
- **Squeeze the Best from Multimeters**

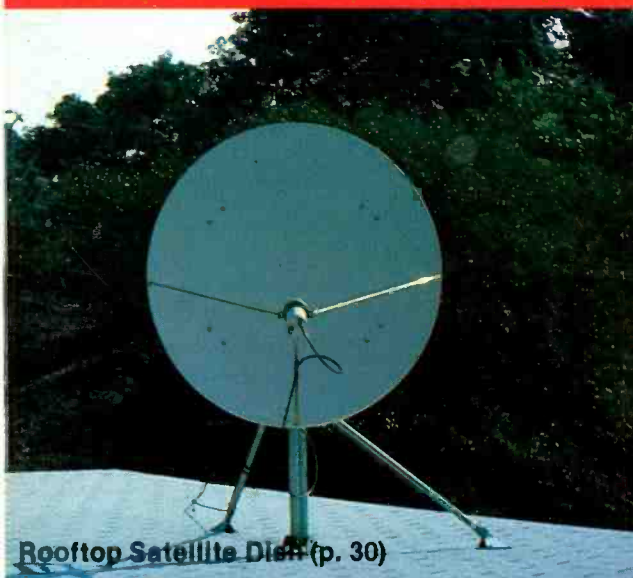

Rooftop Satellite Dish (p. 30)

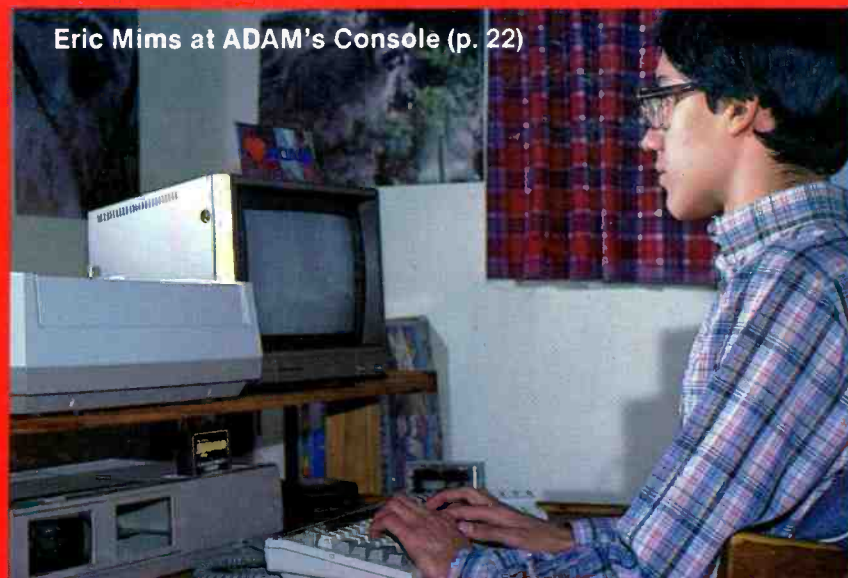

Eric Mims at ADAM's Console (p. 22)

Plus: ● Testing Mitsubishi's New VCR with Built-In Stereo TV Decoder ● Forrest Mims' "Electronics Notebook" ● New Amateur Radio Exam Procedures ● Latest News in the Electronics/Computer Field





The DX 1000 makes tuning in London as easy as dialing a phone.

Direct access keyboard tuning brings a new level of simplicity to shortwave radio. With the Uniden® Bearcat® DX 1000, dialing in the BBC in London is as easy as dialing a telephone. And you can switch from the BBC to Peruvian Huayno music from Radio Andina instantly. Without bandswitching.

Featuring the innovative micro-processor digital technology made famous by Uniden® Bearcat® scanner radios, the DX 1000 covers 10 kHz to 30 MHz continuously, with PLL synthesized accuracy. But as easy as it is to tune, it has all the features even the most sophisticated "DXer" could want. 10 memory channels let you store favorite stations for instant recall—or for faster "band-scanning" during key openings. The digital display measures frequencies to

1 kHz, or at the touch of a button, doubles as a two time zone, 24-hour digital quartz clock. A built-in timer wakes you to your favorite shortwave station. Or, it can be programmed to activate peripheral equipment like a tape recorder to record up to five different broadcasts—any frequency, any mode—while you are asleep or at work.

The DX 1000 also includes independent selectivity selection to help you separate high-powered stations on adjacent frequencies. Plus a noise blanking system that stops Russian pulse radar interference.

There's never been an easier way to hear what the world

has to say. With the Uniden® Bearcat® DX 1000 shortwave radio, you have direct access to the world.

For the name of your nearest retailer dial toll-free ... 1-800-SCANNER.



Frequency Range: 10 kHz to 30 MHz continuously. **Tuning:** Direct keyboard entry, selectable 3 or 24 kHz per revolution knob tuning, or manual step tuning in selectable 1-99 kHz steps. **Sensitivity:** 1.0 μ V AM, 0.5 μ V CW/SSB/FM, 1.6-30 MHz. **Image and IF Rejection:** 70 dB or more. **Memory:** 10 frequency capacity. **Frequency Stability:** Better than 100 Hz after warm-up. **Modes:** AM/LSB/USB/CW/FM. **AGC:** Selectable Fast/Slow release times. **Filter Bandwidths:** 2.7 kHz, 6 kHz and 12 kHz. **Filter Selection Independent of Mode.**

uniden®
Bearcat®

Uniden® Corporation of America,
Personal Communications Division
6345 Castleway Court,
Indianapolis, IN 46250

CIRCLE 28 ON FREE INFORMATION CARD



MAKE MORE MONEY



TRAIN FOR ELECTRONICS

You say you're *already* trained in electronics but that you're *not* making enough money??? Well then, maybe you don't have an accredited bachelor's degree to prove that your education is *up to snuff!* Check out the Grantham Independent-Study B. S. Degree Program. It could make a *dollars and sense difference* in your electronics career.

Grantham offers this program, complete but without laboratory, to electronics technicians whose objectives are to upgrade their level of technical employment. Since the field of electronics is so enormous, opportunity for advancement is always present. Promotions and natural turnover make desirable positions available to the man who is ready to *move up*.

Grantham College of Engineering
10570 Humbolt Street
Los Alamitos, California, 90720

This booklet FREE!

This free booklet explains the Grantham B.S. Degree Program, offered by independent study to those who work in electronics.

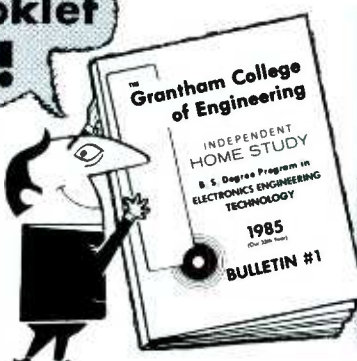

for **FREE Booklet CLIP COUPON** and mail in envelope or paste on postal card.

Do You REALLY Want to Make More Money?

Yes it does take *work* and a few sacrifices to climb up the electronics ladder to where the bigger money is. But, if that's where you want to be, then that's what you must do — *work* harder at learning and getting the right credentials, even if it takes a few sacrifices. A *B. S. degree* and the knowledge that rightly goes along with it can give you powerful ladder-climbing equipment in your search for *success in electronics*.

The accredited Grantham non-traditional B.S. Degree Program is intended for mature, fully-employed workers who want to upgrade their electronics careers.

Put Professional Knowledge and a COLLEGE DEGREE in your Electronics Career through Independent Home Study

Study materials, carefully written by the Grantham College staff for independent study at home, are supplied by the College. Your technical questions related to these materials and the lesson tests are promptly answered by the Grantham home-study teaching staff.

Recognition and Quality Assurance

Grantham College of Engineering is accredited by the Accrediting Commission of the National Home Study Council, as a degree-granting institution.

All lessons and other study materials, as well as communications between the college and students, are in the English language. However, we have students in many foreign countries; about 80% of our students live in the United States of America.

Grantham College of Engineering M-12-84
10570 Humbolt Street, Los Alamitos, CA 90720

Please mail me your free catalog which explains your B.S. Degree independent-study program.

Name _____ Age _____

Address _____

City _____ State _____ Zip _____

FREQUENCY COUNTERS

6 MODELS • RANGES TO 1.3 GHz

CERTIFIED CALIBRATION • METAL CASES • LSI CIRCUITRY WITH NO CUSTOM IC'S • AC/DC OR BATTERY OPERATION • PRECISION TIME BASES • EXCLUSIVE LED BAR GRAPH SIGNAL STRENGTH INDICATOR ON MODELS 8010-S & 8013-S
MADE IN USA

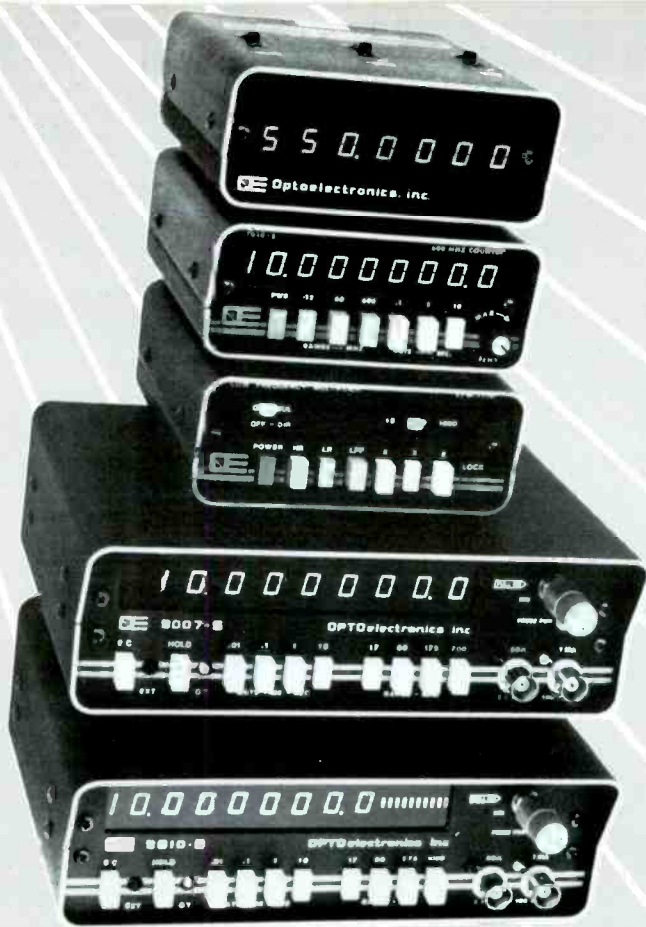

PRICE LIST

MODEL	PRICE	NI-CAD BATTERY OPTION	TIME BASE OPTIONS	
			#TCXO-80 ±0.1 PPM	#OCXO-80 ±0.05 PPM
#K-7000-AC	\$150.	\$25.	N/A	N/A
#7010-S/600 MHz	\$235.	\$25.	\$75.	N/A
#7010-S/1 GHz	\$310.	\$25.	\$75.	N/A
#8007-S	\$350.	\$60.	\$75.	\$125.
#8010-S	\$435.	\$60.	\$75.	\$125.
#8013-S	\$499.	\$60.	\$75.	\$125.

MODEL	RANGE (FROM 10 Hz)	TIME BASE		AVERAGE SENSITIVITY		GATE TIMES	MAX RESOLUTION					SENSITIVITY CONTROL	EXT CLOCK INPUT / OUTPUT	METAL CASE	PROBE POWER JACK
		FREQ	STAB-DESIGN	BELOW 500 MHz	ABOVE 500 MHz		12 MHz	17 MHz	60 MHz	175 MHz	MAX FREQ				
K-7000-AC	550 MHz	5.24288	±4 PPM-RTXO	15 mV -24 DBM	N/A	(2) .1, 1 SEC	10 Hz		100 Hz			No	No	Yes	No
7010-S	1 GHz	10.0 MHz	±1 PPM-TCXO	10 mV	20 mV	(3) .1, 1, 10 SEC	.1 Hz	1 Hz		10 Hz		Yes	No	Yes	No
8007-S	600 MHz		*±0.1 PPM-TCXO	-27 DBM	-21 DBM										
8010-S	700 MHz	10.0 MHz	±1 PPM-TCXO	10 mV	20 mV	(4) .01, .1, 1, 10 SEC	.1 Hz	1 Hz		10 Hz		Yes	Yes	Yes	Yes
8010-S	1 GHz		*±0.1 PPM-TCXO	-27 DBM	-21 DBM										
8013-S	1.3 GHz		*±0.05 PPM-OCXO												

*AVAILABLE OPTION

ACCESSORIES

- LFM-1110** Measure audio frequencies faster with increased resolution. Multiplies low frequency signals by 10, 100 or 1000. Built in low-pass filtering and signal amplification. (Pictured 3rd from top) **\$150.**
- AP-8015-A** 1-1300 MHz preamplifier for reading extremely low level signals. Compact aluminum enclosure can be coupled directly to BNC input connector on counter. Supplied with AC adapter, can also be powered from accessory power output on 80XX-S series front panels. 25 dB gain to 1 GHz, 10 dB gain at 1.3 GHz **\$195.**
- TA-100** RF pick-up antenna, telescope-swivel elbo **\$12.**

- P-100** Direct 50 Ohm probe **\$18.**
- P-101** Low-pass probe. Attenuates RF frequencies **\$20.**
- P-102** Hi-Z probe. General usage, 2X attenuation **\$20.**
- CC-70** Carry case, small, for K-7000AC, 7010-S **\$10.**
- CC-80** Carry case, large for 80XX-S series **\$12.**

CALL FACTORY TOLL FREE
1-800-327-5912
FROM FLORIDA (305) 771-2050/1
TELEX 514849



OPTOelectronics inc.

5821 N.E. 14th Avenue Ft. Lauderdale, Florida 33334
CIRCLE 46 ON FREE INFORMATION CARD

To US and Canada Add 5% to max of \$10. per order for shipping/handling
Foreign orders add 15%



EDITORIAL STAFF

Art Salsberg
Editor-in-Chief

Alexander W. Burawa
Managing Editor

Dorothy Kehrwierd
Production Manager

Elizabeth Ryan
Art Director

Pat Le Blanc
Richard Kishanuk
Phototypographers

Hal Keith
Illustrator

Larry Mulvehill
Photographer

Leonard Feldman
Glenn Hauser
Forrest Mims III
Stan Prentiss
Charles Rubenstein
Contributing Editors

BUSINESS STAFF

Richard A. Ross
Publisher

Art Salsberg
Associate Publisher

Dorothy Kehrwierd
General Manager

Anthony C. Sparacino
Newsstand Sales Director

Arlene Caggiano
Accounting

Cheryl Chomicki
Subscriber Services

SALES OFFICES

Modern Electronics
76 North Broadway
Hicksville, NY 11801
(516) 681-2976

Eastern Advertising Representative
Paul McGinnis Company

690 Broadway
Massapequa, NY 11758
(516) 541-5666
Ian Ross

Midwest Advertising Representative
Market/Media Associates

435 Locust Road
Wilmette, IL 60091
(312) 251-2541
Ted Rickard

Western Advertising Representative
JE Publishers Representatives

6855 Santa Monica Blvd., Suite 200
Los Angeles, CA 90038
(213) 467-2266

Jay Eisenberg, Director
San Francisco: (415) 864-3252
Denver: (303) 595-4331

Offices: 76 North Broadway, Hicksville, NY 11801. Telephone: (516) 681-2976. Modern Electronics (ISSN 0748-9889) is published monthly by Modern Electronics, Inc. Application to mail at second class rates pending at Hicksville, NY and other points. Subscription prices (payable in US Dollars only): Domestic - one year \$16.97, two years \$31.00, three years \$45.00; Canada/Mexico - one year \$19.00, two years \$35.00, three years \$51.00; Foreign - one year \$21.00, two years \$39.00, three years \$57.00. Foreign Air Mail - one year \$74.00, two years \$145.00, three years \$216.00.

Entire contents copyright 1984 by Modern Electronics, Inc. Modern Electronics or Modern Electronics, Inc. assumes no responsibility for unsolicited manuscripts. Allow six weeks for delivery of first issue and for change of address. Printed in the United States of America.

Postmaster: Please send change of address notice to Modern Electronics, Inc., 76 North Broadway, Hicksville, NY 11801.

MODERN ELECTRONICS

THE MAGAZINE FOR ELECTRONICS & COMPUTER ENTHUSIASTS

DECEMBER 1984

VOLUME 1, NUMBER 3

FEATURES

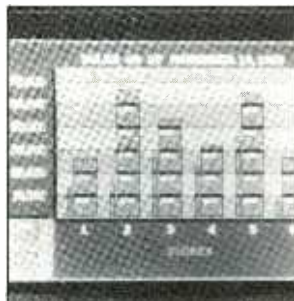

22 Coleco's Adam: The "Born-Again" Computer

Here's what this exciting family computer is like in its 1984/1985 second life.

By Charles Rubenstein

30 Satellite TV—The "Quiet" Video Revolution

The geosynchronous satellite picture and a view of the future of TV. *By Stan Prentiss*

38 Tape Dubbing For Car Stereo

How to optimize home-dubbed tapes for the car stereo environment. *By Norman Eisenberg*

44 Color Video Monitors For Personal Computers

Getting a handle on what they are, what they do, and defining your needs. *By Fred Blechman*

50 Using & Misusing Multimeters

A host of tips on getting the most service out of a multimeter. *By Gary McClellan*

58 How To Get Started in Electronics, Part II

A focus on integrated circuits and how to use them. *By Forrest M. Mims III*

63 A Bargraph Tachometer For Any Automobile

Plans for making the easiest-reading display of engine rotational speed. *By Steve Pence*

70 A Santa Switch

Footswitch project turns on/off tree lights, reduces electricity cost. *By Rich Vettel*

44

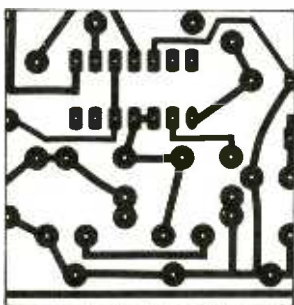

63

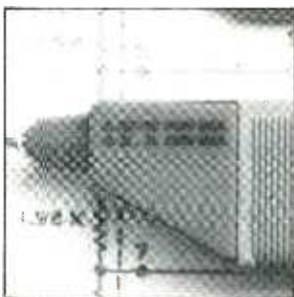

50



30

PRODUCT EVALUATIONS

14 Sony CDX-R7 Car CD Player

A Compact Disc player for your car. *By Len Feldman*

17 Mitsubishi HS-400UR

A hi-fi VCR with built-in TV stereo decoder. *By Stan Prentiss*

DEPARTMENTS

4 Editorial

5 Modern Electronics News

12 New Products

72 Electronics Notebook

Cassette recorder analog data logger
By Forrest M. Mims III

78 Communications

FCC goes "public" with ham radio tests.
By Gordon West

92 Advertisers Index

Buffalo Bill

William Cody, known as "Buffalo Bill," was quite a showman. A talented man in his own right, he embellished his accomplishments with the ready assistance of newsmen and authors who puffed up his claimed experiences, spreading the misleading information. Gullible readers believed it all, of course, and historical distortions remain to this day.

Interestingly, a similar chain of events has occurred in the personal computer field, with a string of ongoing books and magazines carrying the torch of historical inaccuracies forward. Examples include the origins of the first modestly priced, powerful small computer, "Altair," and even how its name was chosen.

For the record, Altair was not the first small computer. It was, however, the first successfully marketed one to individuals (as compared to corporate sales) owing to a variety of positive attributes—very-attractive cost (the microprocessor alone was selling for the price of the whole computer that included it), powerful CPU, an

open bus that invited adding other devices, and publicity in the form of an article in a high-circulation magazine directed to electronics enthusiasts.

The latter is where I came into the picture. As the publication's editorial director, I initiated a search for such a computer, which took about a year from its inception to locate and to publish plans for building it.

Actually, the idea came to mind during the 1973-1974 holiday season when I was reading a manuscript submitted by Don Lancaster. It detailed plans for building an under-\$40 ASCII keyboard and encoder that the author suggested be used with a computer, among other devices. The article was published in an April 1974 issue. At the same time, a major article on Intel's powerful 8080 CPU in *Electronics* magazine focused our search further.

This culminated in hastening the development of MITS's computer, Altair, through my relayed offer to make it a January 1975 front-cover story if the edi-

torial deadline could be met. It was, including the attractive enclosure that I insisted it have, and history was made! The computer's name was suggested by a staff editor, John McVeigh (now an FCC lawyer), at a get-together with *ME's* managing editor, Al Burawa, and Les Solomon, technical editor.

Examining this chain of events, it is clear that the progenitor of the small computer was Don Lancaster with his keyboard/encoder and TV typewriter developments. So I'm especially pleased to advise our readers that this innovative figure, who also initiated a bevy of "Cookbook" technical texts that others copied, will be a regular author in *Modern Electronics*, writing a column and articles that will start next month.

What a happy tenth anniversary for the Altair computer!

Art Salsberg

LETTERS

Likes Article Mix

• The magazine looks great, with easy-to-read type style and nice mix of interesting articles. I am glad to see that Popular Electronics is alive and well under the new banner. Also, it was good to see that Al Burawa came aboard as Managing Editor. I am subscribing promptly so as not to miss an issue.

Adolph A. Mangieri
New Kensington, PA

Fuelish Errors

• In my "Fuel Miser" article (October 1984), I'd like to correct some errors. On the schematic diagram, pin 2 of *ICI* should go directly to pin 6 of *ICI*, not to the common line as shown; and the *CR5* symbol should have the jogged bar of a zener diode. In the text on page 74, instructions should read: For gas systems, connect the jumper between points A and C. For oil systems, connect the jumper between Pins B and C.

Anthony Caristi
Waldwick, NJ

Missed the Picture

• I enjoyed your interview with H. Edward Roberts, the developer of the Altair computer. But how come you didn't print his picture?

I. Green
Brooklyn, NY

Missed the deadline. But h-e-r-e-'s Ed!
—Ed.



PHOTO BY LOU RUTLEDGE

The Short of It

• I was a charter subscriber to "Popular Electronics" from when they started way back in OCT. 1954 and up till they stopped printing it. I was sorry to see it stop because it was well written and had a goodly variety of articles.

So here last week in the "Short Waves" column by Glenn Hauser of the *Greenburg Tribune* paper I was pleased to read that a new magazine (MODERN ELECTRONICS) was going to start publication (1st issue, OCT. 1984) and that among other articles, they would continue the SW listings by Glenn Hauser.

I would like to subscribe as a charter member to it and am enclosing a check in the amount of \$12.97.

J. Machala, TV-Radio Service
Donora, PA

Pleased to have you as a reader. Mr. Hauser's SW listing will be published when seasonal reception changes are made by broadcasters.—Ed.

Radio Shack Parts Place

Quantity Discounts!

No Minimum Order!

First Quality!

Ceramic Disc Capacitors

- Hi-Q Design
- Moistureproof
- 50 WVDC Minimum



pF	Cat. No.	Pkg. of 2	µF	Cat. No.	Pkg. of 2
4.7	272-120	.39	.001	272-126	.39
47	272-121	.39	.005	272-130	.39
100	272-123	.39	.01	272-131	.39
220	272-124	.39	.05	272-134	.49
470	272-125	.39	1	272-135	.49

Tantalum Capacitors

- 20% Tolerance
- IC PCB Spacing



µF	WVDC	Cat. No.	Each
0.1	35	272-1432	.49
0.47	35	272-1433	.49
1.0	35	272-1434	.49
2.2	35	272-1435	.59
10	16	272-1436	.69
22	16	272-1437	.79

Monolithic Ceramic Caps

Epoxy Dipped ■ 50 WVDC

Value	Temperature Coefficient	Cat. No.	Each
10 pF	NPO	272-151	.69
100 pF	NPO	272-152	.69
470 pF	NPO	272-153	.69
1000 pF	Z5U	272-154	.69
4700 pF	Z5U	272-155	.69
.01 µF	Z5U	272-156	.69
.047 µF	Z5U	272-157	.69
1 µF	Z5U	272-158	.79

1/4-Watt, 5% Resistors

Pkg. of 5 **39¢**



Ohms	Cat. No.	Ohms	Cat. No.
10	271-1301	10k	271-1335
100	271-1311	15k	271-1337
150	271-1312	22k	271-1339
220	271-1313	27k	271-1340
270	271-1314	33k	271-1341
330	271-1315	47k	271-1342
470	271-1317	68k	271-1345
1k	271-1321	100k	271-1347
1.8k	271-1324	220k	271-1350
2.2k	271-1325	470k	271-1354
3.3k	271-1328	1 meg	271-1356
4.7k	271-1330	10 meg	271-1365
6.8k	271-1333		

Power Transformers

120 VAC Primaries

Type	Volts	Current	Cat. No.	Each
PC Mini	12.0 CT	120 mA	273-1360	2.49
Miniature	6.3	300 mA	273-1384	2.59
Miniature	12.6	300 mA	273-1385	2.79
Miniature	25.2	300 mA	273-1386	3.49
Miniature	12.6 CT	450 mA	273-1365	3.59
Miniature	25.2 CT	450 mA	273-1366	3.99
Standard	6.3	1.2 A	273-1351	3.99
Standard	12.6 CT	1.2 A	273-1352	4.99
Standard	25.2	1.2 A	273-1353	5.99
Heavy-Duty	12.6 CT	3.0 A	273-1511	5.99
Heavy-Duty	25.2 CT	2.0 A	273-1512	6.29
Heavy-Duty	18.0 CT	2.0 A	273-1515	6.99

CT = Center Tap

Computer/Game Connectors

Type	Positions	Cat. No.	Each
Solder Sub-D Male Hood for Above	9	276-1537	1.99
Solder Sub-D Female Hood for Above	9	276-1538	2.49
Solder Sub-D Male Hood for Above	9	276-1539	1.99
Solder Sub-D Male Hood for Above	15	276-1527	2.49
Solder Sub-D Female Hood for Above	15	276-1528	3.49
Solder Sub-D Male Hood for Above	15	276-1529	1.99
Solder Sub-D Male Hood for Above	25	276-1547	2.99
Solder Sub-D Female Hood for Above	25	276-1548	3.99
Solder Sub-D Male Hood for Above	25	276-1549	1.99
Solderless Sub-D Male	25	276-1559	4.99
Solderless Sub-D Fem.	25	276-1565	4.99
Printer Connector	36	276-1534	6.99
Cable Socket	34	276-1525	3.19
Disk Drive Connector	34	276-1564	4.95
Card Edge Socket	44	276-1551	2.99
D-Sub Dustcap (Set)	25	276-1546	2/39¢
5-Ft. Ribbon Cable	25	278-772	3.59
25-Ft. Ribbon Cable	25	278-773	16.95

Hi-Fi Electret Mike Elements

PC Board-Mount. Omnidirectional. 2-10 VDC with very low current drain, 1 milliamp max. 20 to 15 kHz \pm 4 dB. 6.6 mm high. 270-090 99¢

Omnidirectional. Great for projects, upgrading old mikes. Clean 30 to 15,000 Hz response. 4-10 VDC. 7/16 x 3/8" dia. With leads. 270-092 ... 2.69

Xenon Strobe Tube

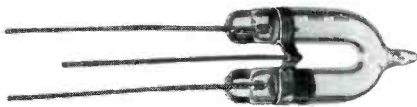

For replacement or photo and "light-show" projects. Trigger: 4 kV. Anode: 200 V min. 100,000-flash life. 272-1145 2.99

SPST DIP Switches

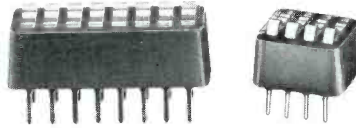

For digital or low-current applications. Mount in DIP sockets or on PC boards.

8-Position. Fits 16-pin DIP socket. 275-1301 1.99
4-Position. Fits 8-pin DIP socket. 275-1304 1.49

Dynamic Transistor Checker



battery. 22-025

Cut 20%

Reg. 14.95 **11.95**

Tests In or Out Of Circuit

Indicates relative current gain, "opens" and "shorts". Makes it easy to match transistors. Features a front panel socket plus hook-clip leads for in-circuit tests. Output jack for external meter or scope. 2 3/4 x 4 3/8 x 1 9/16". With instructions. Requires "AA" battery. Sale 11.95

Dictionary of Electronic Terms

NEW!

Defines over 1200 modern day electronic terms with concise, understandable descriptions. Large, easy-to-read typeface. Over 100 illustrations. Special up-front section contains over 200 common abbreviations, acronyms and electronic symbols. 96 pages. 62-1391 2.79



Timer IC Mini Notebook

By Forrest Mims III

An excellent reference and hobby book covering the versatile 555 and 556 ICs. By one of America's most popular technical authors. Large schematic diagrams. 32 pages. 276-5010 99¢



Communications ICs

Type	Cat. No.	Each
XR 2206 AFSK Generator	276-2336	5.95
XR 2211 AFSK Decoder	276-2337	5.95
MC1330 Video Detector	276-1757	1.99
MC1350 IF Amplifier	276-1758	1.99
MC1358/CA3065 FM Detector	276-1759	1.79

Voice Synthesizer IC

SPO256-AL2. MOS LSI. Uses a program stored in its built-in ROM to synthesize any English word. Requires low-cost support components and host computer. Easy to interface. Requires 3.12 MHz clock crystal (available through Radio Shack). 5 VDC, single supply. 28-pin DIP with detailed data. 276-1784 12.95

Melody Synthesizer IC

AY-3-1350. NMOS. Ideal for door bells and musical funboxes. Programmed with Yankee Doodle, Brahms' Lullaby, Blue Danube, Star Wars—28 favorites in all. Requires extra parts. 28-pin DIP with data. 276-1782 5.99

27-Range, 30,000 Ohms Per Volt Multitester



\$10 Off!

Reg. 34.95 **24.95**

Features single-knob function switch, color-coded 4" mirrored scale, polarity-reverse switch. DC Volts: 0 to 1000, 8 ranges.

AC Volts: 0 to 1000, 5 ranges. DC Current: 0 to 10 amps, 5 ranges. Resistance: 0 to 10 megohms, 4 ranges, (10 ohms center scale). dB: -10 to +62, 5 ranges. Accuracy: \pm 4% AC, \pm 3% DC. 6 1/4 x 4 1/2 x 1 3/4". Fused and overload protected. Requires one "AA" and one 9V battery. 22-203 Sale 24.95

A DIVISION OF TANDY CORPORATION

Radio Shack®

OVER 8800 LOCATIONS WORLDWIDE

Prices apply at participating Radio Shack stores and dealers

THE MILLION-RUBLE MOVIE. An 11-ft. dish antenna atop a Columbia University building picks up Soviet domestic TV broadcasts every day. It tracks signals from four "Molniya" satellites that beam "Programma I" across the U.S.S.R., providing up to 15 hours of reception daily. Video quality is said to be much better than local U.S. reception since the U.S.S.R. employs a modified SECAM video system with 625 horizontal lines as compared to the U.S.'s NTSC system of 525 lines. There are other differences: Russian TV signals are circularly polarized, whereas American signals are linear; Russian bandwidth is 50 MHz, while U.S.'s is 36 MHz; sound is part of the video signal, while here it's on an FM sub-carrier attached to the video AM carrier frequency. Furthermore, unlike American domestic satellites, Russia's aren't geostationary, so Columbia U's ground station has to continuously track them.

COMPUTERIZED SCRABBLE®. A computer version of this popular board game for the Commodore-64 computer, from Epyx Computer Software, eliminates the need for a human opponent. It features a playing vocabulary of more than 12,000 words, four skill levels, and can also accommodate up to three human players on its on-screen board. Keeps score, automatically, too.

PORTABLE CD PLAYER. Sony Corp. pulls a "Walkman" with a new portable Compact Disc digital-audio player. The Model D-5 measures slightly more than the disk itself, 5" x 5- $\frac{1}{4}$ ", and weighs only 1 lb. 5 oz. It can be plugged into home stereo systems as well as being used with headphones. \$299.95.

TOP ENGINEER EMPLOYERS. Soon-to-be-graduated engineering students, responding to a study that sought their views on what company is the best place to work, placed IBM Corp. in first place with 32.2% yea's. Hewlett-Packard ranked second in the 1983 poll by Deutsch Shea, with 17.3%, followed by General Electric (16.9%), Texas Instruments (12.3%), Hughes (11.5%), Bell Laboratories (10.6%), and Digital (10.6%), all representing the double-digit favorites.

BLIND-HAM AID. A new antenna rotator, the HAM-SP from Telex/Hy-Gain, is designed to assist visually impaired amateur radio operators. Its control unit's functions are marked in both Braille and conventional lettering, while the model also emits a high-frequency tone to indicate rotor action.

FASTER THAN A SPEEDING New Strobe lights from Eastman Kodak's Spin Physics Div. are said to pulse four times faster than similiar devices--2,000 timer per second. It can be used to measure the spin rate of a bullet in flight, as well as for a host of industrial motion studies.

VOICE MAIL. A new software product that provides "voice mail" has been announced by Texas Instruments. Called EtherVoiceTM, it works in conjunction with other TI electronic mail modules, sending voice messages to any number of users on its network using one's voice rather than a computer keyboard. \$150.

We are the Pro's in the Proto-board® business...



- Three binding posts for external power.
- Global UBS-100 socket unconditionally guaranteed for life.
- Heavy unbreakable plastic panel with slip-proof rubber feet.
- Design and prototype custom circuits without soldering.

Global's newest Proto-board 10 solderless breadboard system follows our long established reputation of quality Proto-boards. For use in a wide variety of electronic circuit design and custom circuit applications, the Proto-board 10 accepts up to eight 14-pin IC's and all other types of electronic components with lead sizes from 20 to 26 gauge. This Proto-board has been designed to take 22 gauge hook-up wire for interconnecting circuits. A jumper kit, WK-1, containing 22 gauge wire is also available.

Global Specialties is the Pro in the Proto-board business. We became the leader by understanding your breadboarding needs and producing products which precisely fill those needs. And we'll continue to make the industry's most complete line of solderless breadboarding equipment in our own factory in the United States under stringent design, manufacturing and quality control standards.

See your local electronics distributor, or call our toll-free...

Product Availability Line:
1-800-243-6077.

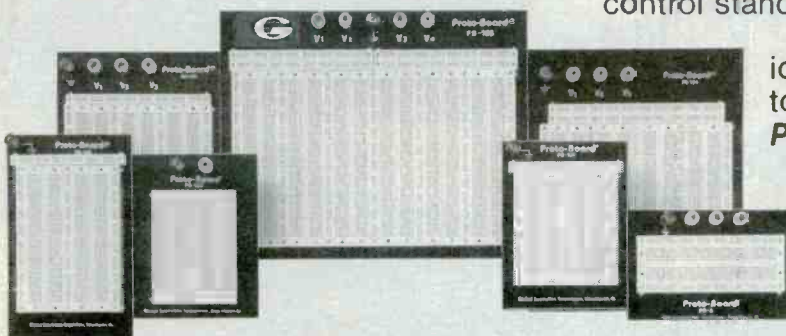

GLOBAL SPECIALTIES An Interplex Electronics Company
70 Fulton Terrace, New Haven, CT 06512-1819
(203) 624-3103, TWX: 710-465-1227
Other Offices: San Francisco (415) 648-0611, TWX: 910-372-7992
Europe: Phone Safron-Walden, England 0799-21682, TLX: 817477

COMPUTERS ARE CREATING JOBS FOR NRI-TRAINED PEOPLE.



IF YOU'RE SERIOUS ABOUT MAKING MONEY IN MICRO-COMPUTERS, NRI IS SERIOUS ABOUT SHOWING YOU HOW.

The U.S. Department of Labor projects job openings for qualified computer technicians will soon double. International Resource Development, Inc., estimates a 600% increase in these jobs in a decade. And most of these will be new jobs, created by the expanding role of computers.

NEVER HAS THERE BEEN A FASTER-GROWING FIELD OF TECHNOLOGY.

Many people are afraid of losing their jobs to computers, but thousands of jobs will be created for those who are prepared to meet the challenge.

With NRI training, you'll be prepared. You can have a profitable, exciting future as an expert who can handle the operational, programming and technical aspects of all kinds of microcomputers and micro-processors.

LEARN IN YOUR SPARE TIME.

NRI trains you in your own home, at your convenience...no classroom schedule to meet, no need to quit your job. As a class of one with complete course materials and the backing of a staff of professional electronics instructors, you'll get extraordinary hands-on training on the latest model in the most popular line of microcomputers: the new TRS-80™ Model 4, with disk drive for greater memory capacity. The TRS-80 Model 4 complete with advanced features

TRS-80 is a trademark of the Radio Shack division of Tandy Corp.



Your NRI course will include the new TRS-80 Model 4 with Disk Drive, the Gemini 10X dot-matrix printer... plus a professional LCD multimeter, NRI Discovery Lab and hundreds of demonstrations and experiments. It's all yours to keep.

that are built right in...features that are offered as options on other microcomputers. Designed to perform diverse personal and business functions and to accept the most software, the TRS-80 is a great computer to learn on. And it's yours to keep,

LEARN HOW TO USE, PROGRAM AND SERVICE STATE-OF-THE-ART MICROCOMPUTERS.

Through your carefully designed NRI course, you'll get a wealth of practical experience. You'll build circuits...from the simplest to the most advanced...with your NRI Discovery Lab.® You'll use a professional 4-function LCD digital multimeter for analysis and troubleshooting.

With NRI training you'll explore your computer's registers, memory and input-output ports. You'll even write programs to control the circuits you've designed and built. You'll perform hundreds of challenging experiments, always backed by a full-time faculty ready to help you personally.

When your NRI training is complete, you'll be a computer technician, ready for your first job — servicing, testing or programming all types of microcomputers — in a rewarding and challenging new career.

GET NRI'S FREE CATALOG TODAY.

Send the postpaid card today for your FREE 100-page catalog. It's a valuable guide to opportunities and training in the high-tech revolution.

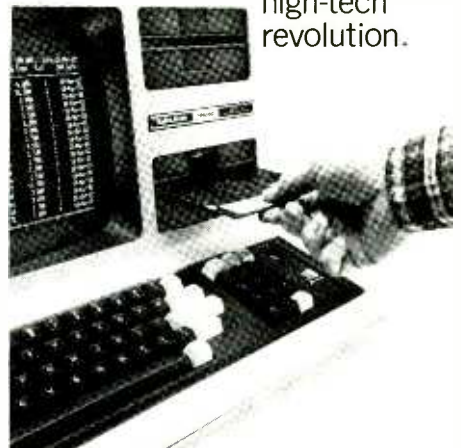

For greater computer memory capacity, a double density disk drive is included.

You'll see how easily you become part of the growing high-tech world of microcomputers.

If the card has been removed, please write to us today.

NRI SCHOOLS

McGraw-Hill Continuing Education Center

3939 Wisconsin Avenue, N.W.
Washington, D.C. 20016

We'll give you tomorrow.



For more information on products described, please circle the appropriate number on the Free Information Card bound into this issue or write to the manufacturer.

Makes Pocket Stereos Into Home Music Systems

A new music system concept from Bose Corp. transforms any pocket stereo into a complete high-quality home music system. Called the Bose Model RM-1 RoomMate, it features two full-range speakers, an active equalization network, distortion-limiting circuitry, and a dual-channel power amplifier, all fitted into two 9" x 6" x 6" enclosures. Used in conjunction with a personal stereo AM/FM/tape or tape-only player, the RoomMate is claimed to provide room-filling high-fidelity sound.

Use of Bose 4½" full-range speakers, combined with electronic equalization, is said to allow the RoomMate system to deliver music with an unexpected amount of presence and clarity, especially in the low-frequency band where the response of pocket stereos is typically limited. The system is separated into a master unit—which contains one of the speakers, the amplifier, and the active equalization network—and a slave unit that contains the other speaker. \$260.

CIRCLE NO. 102 ON FREE INFORMATION CARD

Lap-Size Personal Computer

A 9-lb., notebook-size computer recently introduced by Hewlett-Packard offers the power and capabilities of a desktop micro in a portable package. Called The Portable, the new computer features a flip-up LCD screen, full-size typewriter-style keyboard, preprogrammed software in ROM, and 656K of memory (384K of ROM and 272K of

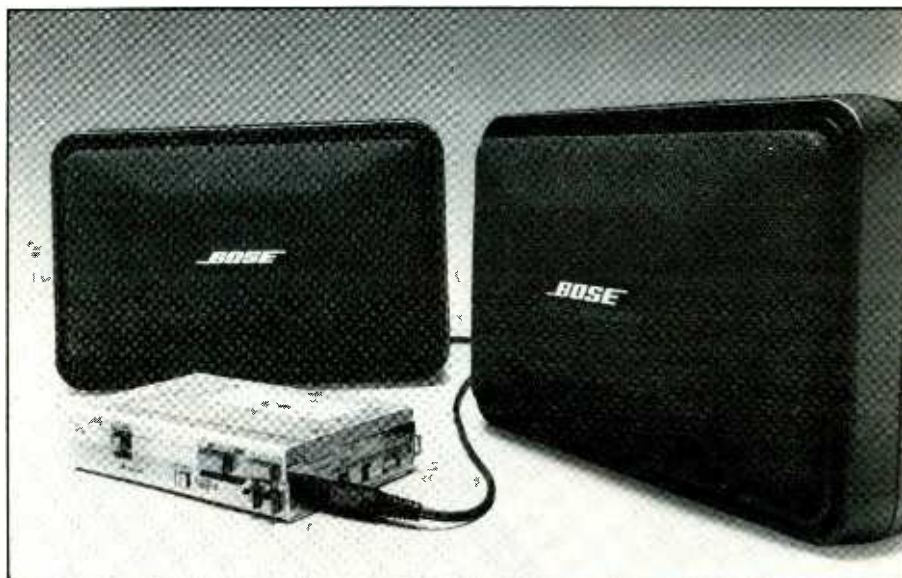

RAM). The Portable is designed to run MS-DOS software and to share data with other personal computers.

The Portable can be used as a stand-alone computer, with part of its large, continuously powered RAM acting as a RAM disk; as a remote terminal with its built-in modem; or as a data-sharing companion to other desktop computers. It also functions as the central element of a complete computing system, with a battery-powered, 710K microfloppy 3½" drive and HP's ThinkJet printer. Software built into The Portable include Personal Applications Manager that shields the user from having to learn MS-DOS; MemoMaker

word processor; Lotus 1-2-3; and a terminal emulator. Continuous powering of the RAM system, even when the display is off, makes it possible to save programs and data at all times and allows the user to work while traveling without a disk drive. Display format is 80 x 16 lines of text or 480 x 128 pixels in the graphics mode. The Portable measures only 13" x 10" x 3". \$2995.

CIRCLE NO. 104 ON FREE INFORMATION CARD

General-Purpose Oscilloscope

Offering a 20-MHz bandwidth, two input channels, and a single time base, the Model SS-5702 oscilloscope from Iwatsu Instruments features just about everything needed in a general-purpose test and servicing instrument. The compact, lightweight scope (it measures 16"D x 10"W x 6.4"H and weighs only 14.4 lbs.) is designed to be equally at home on the servicebench and in the field. Built-on are a carrying handle and fold-away tilt stand. The scope's display is a 6" rectangular CRT with internal graticle for parallax-free viewing. In addition to providing variable sweep

length and 2-channel X-Y operation, the Model SS-5702 includes a TV-V trigger mode for TV and video troubleshooting and servicing.

Frequency response is rated at from dc to 20 MHz (-3 dB), with rise time of 17.5 ns. Vertical deflection factor is 5 mV to 10 V/division, while horizontal deflection factor is 0.5 μ s to 0.2 s/division, both at $\pm 4\%$ accuracy. External intensity modulation is accomplished with up to 3-volt peak-to-peak signals, with a frequency range of from dc to 1 MHz. \$535.

CIRCLE NO. 105 ON FREE INFORMATION CARD



An assortment of accessories are available optionally. Among these are a stand that turns the tool into a miniature drill press for precise drilling and grinding operations. Other options include a grinding accessories kit, cut-off wheels, drilling bits, grinding wheels, end mills, slot cutters, brass brushes, and grinding points. Transformers are available for operating the drill on 117 or 220 volts ac power. \$17.95.

CIRCLE NO. 106 ON FREE INFORMATION CARD

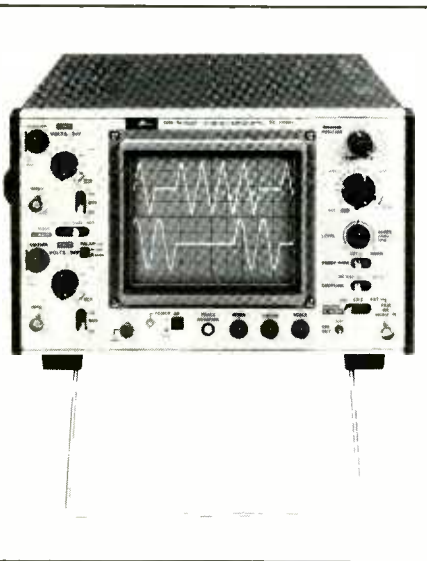

Precision Mini-Drill

An electric mini-drill that's said to be ideal for precision work at the electronics workbench is available from OK Industries as the Model EDG-01. It can be used with an assortment of bits, grinders, mandrels, and other accessories for prototype work, revising and redesigning printed-circuit boards, solder removal, grinding, and polishing. Shank sizes up to 0.126" in diameter can be accommodated by the drill's chuck. Measuring only 4 7/8" long, this is an almost ideal tool to use in confined areas.

Car FM Signal Booster

Antenna Specialists' new Model ASC-100 FM auto Stereo X-Pander is designed to boost FM broadcast signals by up to 13 dB to virtually eliminate weak station fading and "picket fencing" often encountered in suburban and rural areas. The device is claimed to compensate electronically for the inadequate perfor-

(Continued on page 82)



Audio

Testing The First Car CD Player: Sony's CDX-R7

When Philips and Sony first demonstrated their laser-optical Compact Disc players in this country nearly three years ago, they predicted that Compact Discs would be used in moving automobiles. Many of us thought that a car, bouncing along on a highway or on a pothole-filled city street, would be an impossibly hostile environment for the laser-beam pickup. Though not in contact with the disc it is reading, tracking accuracies measured in microns would be difficult to maintain.

Barely a few months later, while I was on a tour of the Philips and Polygram Record Company facilities in Eindhoven, Netherlands, and Hannover, West Germany, our transportation was provided by a minibus. On the front dashboard of that bus was a standard Philips CD player (Magnavox, in the U.S.), resting on a bit of foam padding, and modified only to the extent of having its power supply altered so that it could operate from a 12-volt car battery. Only a severe road bump caused the player to mis-track. Clearly car CD players *were* possible and practical.

Now, Sony Corporation, a co-developer of the CD format, has made car CD players available in the U.S. The one we tested in the lab and on the road is its Model CDX-R7. It not only plays CDs, but also includes a complete AM/FM stereo tuner and preamp-control section. Perhaps the most amazing thing about this product is that it can fit in a standard DIN-size opening found in European-made cars.

Design changes in the laser-optical pickup and in large scale integrated circuitry (LSI) were needed to make a car CD player practical, according to Sony. To meet this need, Sony developed LSI for all primary functions of the new car CD player product. As for a smaller, yet stable and reliable



laser optical system, Sony also developed a miniaturized laser optic mechanism which, they tell us, will be applicable not only to car CD players, but will someday be found in "Walkman"-type CD products as well! The miniaturization was made possible, in part, by housing much of the tuner circuitry in a separate, flat container that has no controls and can be mounted at some distance from the main section of the unit. The two parts are interconnected by means of a multi-conductor cable and a pair of stereo audio cables.

Multi-Purpose Front-Panel Controls

The front panel of the Sony CDX-R7 is no larger than that of any in-dash care stereo front panel. Along its top is a slot into which the Compact Disc to be played is inserted. When you insert a disc part way, the mechanism takes over and draws it into the machine, placing it in position for play. Push the eject button at the far right and the disc comes out partially, but if you fail to remove it the rest of the way within 15 seconds, the disc is drawn back inside and is held in a pause mode. This neat arrangement

protects the disc from dust. If you then fail to release the pause within 15 minutes, the player's power is turned off completely.

The left end of the front panel houses the more usual controls that you would expect to find on any car stereo front-end component: concentric volume, fader and balance controls, bass and treble tone controls. A display switch beneath the left end of the disc slot determines what indications will be visible in the display area nearby. When playing CDs, touching this switch alters the display from showing time of day (clock function) to displaying the track number of the disc being played. Unlike home CD players, this unit does not tell you time played within a given track. When using the built-in AM/FM tuner, the same display alternates between showing time of day and frequency of tuned-to stations.

A local/distance switch and an FM mono/stereo switch along the lower edge of the panel are used only when listening to the tuner. Remaining controls and switches located beneath the display area, however, serve different purposes, depending upon whether you are listening to a disc or to the tuner. The button la-

beled MEMORY/RESET used to store preset station frequencies in the tuner mode, returns the pickup to the beginning of a disc for replay of the first track when listening to CDs.

The fast-forward/rewind switch used to scan quickly through the music on a disc (at 10 times normal speed, and at an amplitude that is reduced by about 12 dB) serves as a manual tuning rocker switch in the tuner mode. A second rocker switch allows you to advance to the next (or previous) track of a CD (just as in Sony's home CD players) but becomes a scanning control in the tuner mode. It pauses for four seconds as each station is locked in, allowing you to decide whether to stay on that station or to continue scanning. A PLAY/PAUSE button at the far right of the front panel performs the same function during CD play as that control does on home CD players. Remaining controls on the front panel relate exclusively to tuner operation. They include an AM/FM band selector switch, a tuner on/off switch, and six numbered preset buttons. Since there are secondary buttons labeled FM1, FM2, and AM that work in conjunction with the presets, it is possible to "memorize" a total of 18 favorite stations (12 FM and 6 AM).

A One-Chip LSI

The silicon-gate CMOS LSI developed for digital signal processing of Compact Disc signals combines the functions previously performed by as many as three separate ICs. The chip, designated as CX23035, performs nine separate functions. They include bit-clock generation, using a phase-lock loop circuit; data decoding; detection protection and insertion of frame synchronizing signals; detection and correction of serious data errors; interpolation by "mean

value" or previous value holding; decoding and error correction of sub-code signals; constant linear velocity (CLV) servo/spindle motor control; tracking counter with 8 bits and Central Processing Unit (CPU) interface via a serial buss. The IC itself is configured as an 80-pin flat package, with a maximum power dissipation of 500 milliwatts. It may be safely stored at any temperature from -55°C to $+150^{\circ}\text{C}$, and operated at any temperature from -20°C to $+75^{\circ}\text{C}$. The ability to operate over such a wide temperature range was, of course, essential for any device intended for use in the hostile and extreme environment of an automobile.

Smaller Laser-Optic Pickup

Pictured here is the new Laser Optic assembly developed for this player

and, to its left, a typical laser pickup assembly used in home-type CD players. The latter occupies nearly three times the cubic volume of the newly designed pickup.

Operation of the new pickup is somewhat similar to earlier, physically larger optical systems used in CD players. An emitted laser beam produced by a laser diode passes through a grating plate and a collimator lens, after which it is deflected 90 degrees by a 45-degree mirror and focused by means of another lens to the reflecting surface of the CD. Between the grating plate and the first lens in a Polarization Beam Splitter that incorporates dielectric membranes which act as a sort of prism, directing the laser beam from the diode onward to the 45-degree mirror and the reflected beam from the surface of the disc to a photodiode. The chief dif-

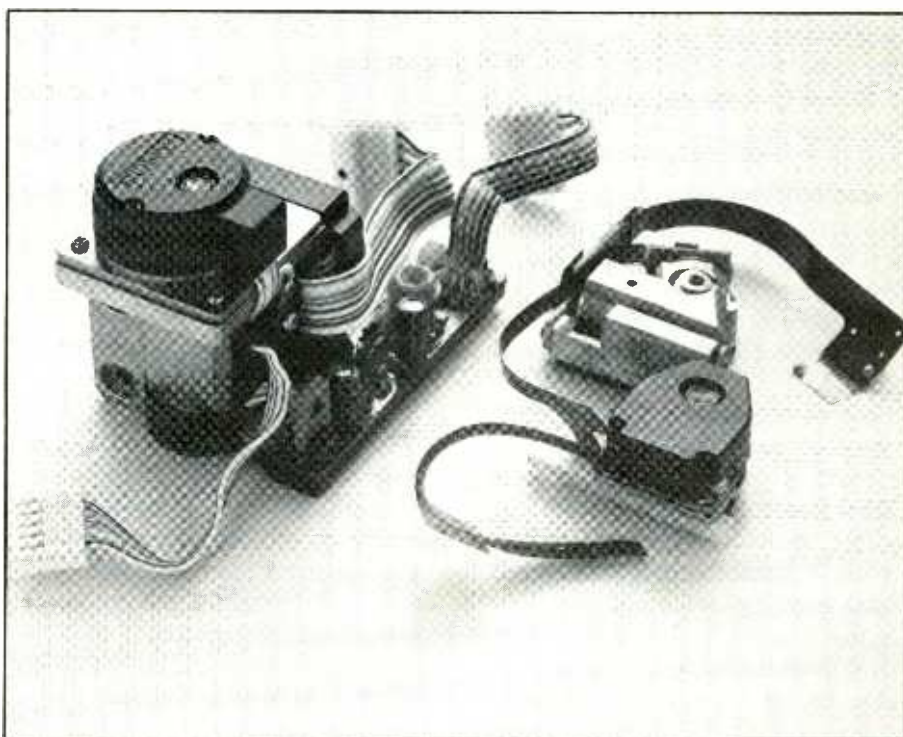

The new laser-optical pickup used in the car CD player (right) is barely one-third the size of standard CD pickups used in home-type players (left).

PRODUCT EVALUATIONS . . .

Testing The First Car CD Player: Sony's CDX-R7

ference between this optical pickup and earlier, larger ones used in CD players is that the pickup has, in a sense, been folded back on itself. The miniaturization was accomplished without sacrificing any of the elements needed for accurate and stable servo tracking and focusing of the laser beam onto the precise "track" of the CD and at the precise depth required for accurate reading of the digital information imbedded below its surface.

Performance Measurements

We measured the performance of the CDX-R7 unit both as an AM/FM stereo tuner and as a full-function car CD player. For the latter tests, we used special digitally generated test-signals discs supplied by Philips and Sony. Harmonic distortion for a mid-frequency signal, at 0-dB recorded level, was only 0.005%, while IM distortion was even lower, measuring an insignificant 0.002% at the same recorded level.

Signal-to-noise ratio, with respect to maximum recorded level, was nearly 92 dB, while separation between left and right channel signals was more than 80 dB. Output linearity was accurate to within 0.2 dB from maximum recording level down to -80.0 dB below that level.

One of our special test records contains built-in defects designed to simulate scratches (of varying widths), and dust particles (of varying diameters) superimposed upon indented musical selections. By noting where, in the music, a machine mistracks, it is possible to accurately estimate tracking ability and error correction capability of the given player. Only a few home-type CD players are able to get through this obstacle course with no evidence of mistracking. The Sony CDX-R7 did so without any difficulty. That means that it

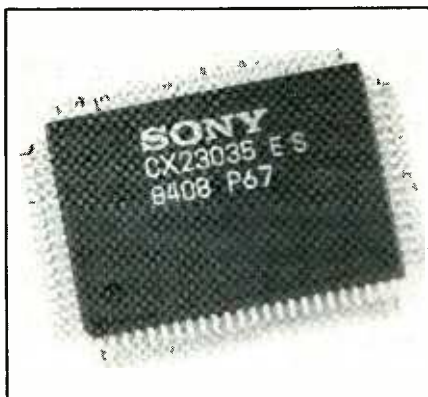

CDX-R7's 40-pin LSI chip.

could "overlook" missing digital code of at least 900 microns in length. We subjected the machine to a fair amount of vibration and shock, induced by tapping it less than gently on its top and sides, and still the pickup continued to track those microscopic pits beneath the surface the Compact Disc without ever mistracking.

As for the FM tuner section of this combination unit, its usable sensitivity measured a very low 10 dBf (0.9 microvolt into 75-ohm antenna impedance) in mono, 13.0 dBf (2.5 microvolts) for stereo. 50-dB of quieting was obtained with only 14 dBf (2.8 microvolts) in mono, and with less than 30 dBf (17.4 microvolts) is stereo, making this one of the most sensitive FM car tuners we have tested.

Harmonic distortion in mono measured 0.15%, while in the stereo reception mode it increased very slightly to 0.18%. Signal-to-noise ratio for strong FM signals was 72 dB for mono, 70 dB for stereo. Stereo separation measured nearly 40 dB at mid-frequencies, and almost as high (38 dB) at higher-frequency extremes. Tuner output level was just over 1.0 volt, enough to drive most car-stereo power amplifiers, which

would of course have to be used with this system. Frequency response was virtually flat from 30 Hz to 10 kHz, and exhibited a slight dip of around -2.5 dB at 15 kHz, the top FM transmitted audio frequency.

In-Use Tests

While we did not install the DCX-R7 player in our car, we did place it atop the dashboard and, with the aid of a cable that could draw power from the cigarette lighter, we powered up the unit and took it and a few of our favorite CDs for a spin. Along well-paved highways there was not the slightest glitch or mistracking. Only when we searched out and ran through really severe potholes or over major bumps were we able to get the unit to mute, momentarily, as it mistracked. Once past the road defect, music returned almost immediately, and nine times out of ten the pickup was still where it should have been. On one occasion, it had moved enough to begin playing another track. Bear in mind that we were deliberately trying to get the unit to mistrack. Given fair driving conditions, you can therefore expect no more mistracking problems than you would get with ordinary car stereo cassette players; and that means no mistracking whatsoever.

When you stop to think of the size of those microscopic pits beneath the surface if a CD (there are more than ten *billion* of them on a disc), it is nothing short of amazing that a player of this type works as well as it does inside a moving vehicle. If you have become a devotee of CDs at home, there's no longer any reason not to extend your CD listening to the highway. For the quality and performance demonstrated by the Sony CDX-R7 unit, its \$700 suggested retail price does not seem like too high a price to pay.—Len Feldman

CIRCLE 24 ON FREE INFORMATION CARD

Video

Hi-Fi VCR Has TV Stereo Decoder: Mitsubishi's New Model HS-400UR

Having already established a solid reputation as a leader in the manufacture of high-quality projection-TV receivers, Mitsubishi has recently branched out to become a maker of videocassette recorders. The company's new Model HS-400UR VCR is one of the new hi-fi VHS-format machines that have for the past year or so been receiving so much attention in the media. Aside from following the "hi-fi" trend, the new VCR also claims a legitimate first in videocassette recorders. Without extra tuners, taps, or add-ons, the three-motor, two-head HS-400UR accepts multichannel stereo TV sound directly from an ordinary TV antenna.

All the Model HS-400UR needs to provide stereo sound is a composite sound/video broadcast signal. This may not sound like a very attractive feature if you're not living in one of the large cities (like New York, Chicago, or Los Angeles) where FCC-approved stereo TV broadcasts are occasionally being test aired. But keep in mind that stereo TV broadcasting is soon to sweep the country, which will make the Model HS-400UR's built-in stereo decoder a definite plus. (See "Stereo Is Coming! Stereo Is Coming!" box elsewhere in this report for more details.)

General Description

Mitsubishi's Model HS-400UR hi-fi VCR, priced at \$950, delivers everything claimed of it and more. Housed inside a dark enclosure that measures 16 $\frac{1}{2}$ "W x 15 $\frac{3}{8}$ "D x 4"H and weighs 21 lbs. is a front-loading transport, user-programmable tuner/timer, and all recording and playback electronics. The transport accepts standard VHS videocassettes and offers legends that light up when specific functions are selected.

Operation of the transport mechanism is via logic-controlled soft-



Mitsubishi's front-loading VHS Hi-Fi videocassette recorder is the only one on the market that directly receives stereo TV broadcasts.

touch pushbuttons. Included in the transport control lineup are the usual REW(ind), PLAY, FF (fast-forward), REC(ord), STOP, and PAUSE buttons. Built into the PLAY, REC and PAUSE buttons are indicators that light up when any of these functions is activated. Recording, of course, is activated simply by pressing just the REC button. These controls are arranged in two levels just below the cassette compartment. To the immediate left of the cluster are the VIDEO/TV switch and DEW lamp, while to the right are the AUDIO LEVEL meters (actually yellow bargraph displays), separate L and R slide-type recording level controls, STEREO and SAP (separate audio program) indicators, and a MANUAL/FIXED REC(ord) LEVEL switch.

Behind a dark plastic window in the upper-right quadrant of the front panel of the VCR are the 7-segment displays that indicate tuned CHANNEL and COUNTER/TIMER functions. To the left of the display windows are COUNTER/TIMER, RESET, and MEMORY switches, while to the right is a large rocker-type touch switch for scanning through the channels in the upward and downward directions.

Infrequently used controls are hidden behind a drop-down panel that occupies the lower-right quadrant of the front panel. Included here are a programming button; clock/timer-set buttons; TRACKING control; HEADPHONE VOLUME control (the HEADPHONE jack is located at the extreme right-bottom of the front panel); SP/LP/EP tape-speed selector switch; SAP switch; L+R audio switch; AUDIO ONLY switch; VIDEO/AUDIO switch; and NORMAL/STEREO recording switch.

The cassette loading slot occupies almost the entire upper-left quadrant of the VCR's front panel. A spring-loaded door behind the slot protects the transport mechanism and head drum assembly from airborne contaminants. Videocassettes are power loaded into and ejected from the VCR. The cassette EJECT switch and VCR POWER switch are located to the immediate left of the cassette loading slot. To the right is the infrared remote-control receiver's pickup.

Controls for programming channels into the tuner memory bank are located behind a panel on the top of the VCR's enclosure. On the rear panel are located a SHARPNESS con-

PRODUCT EVALUATIONS . . .

Hi-Fi VCR Has TV Stereo Decoder: Mitsubishi's New Model HS-400UR

trol, video input and output jacks, and two sets of audio input and output jacks. Also included here are a switched accessory ac outlet rated to handle 2.5 amperes and coaxial and 300-ohm twin-lead connectors for vhf and uhf inputs and outputs.

The tuner is cable-ready and can tune any of 105 vhf/uhf/CATV channels of which any 16 can be pre-programmed into memory for instant access with the system's remote-control transmitter. Teamed with the tuner is a user-programmable 14-day, 4-event timer for unattended recording off the air.

Operated in the video mode, the HS-400UR VCR offers the usual viewing capabilities, including normal-speed, picture-search, and slow-motion (at half speed) modes.

Keep in mind that this is either a standard video (albeit with stereo multichannel record/playback capabilities) or a wide-range high-fidelity stereo recorder. Consequently, different controls must be operated to select either of the two functions.

Internally, the VCR's circuitry consists mainly of ICs, with a sprinkling of discrete transistors and lots of resistors, capacitors, and wiring cables to various connectors. The connectors simplify servicing of the VCR, should this become necessary. They allow for more convenient troubleshooting than usual and easy replacement of circuit board assemblies. Test points and adjustment potentiometers are clearly labeled.

Test Results

Using brand new Polaroid "super-color" videocassettes, I ran a full series of laboratory tests on the rather unique Mitsubishi Model HS-400UR videocassette recorder. Though I was able to perform video and chroma/luminance tests, using

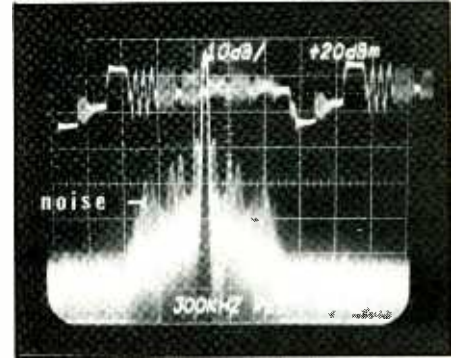
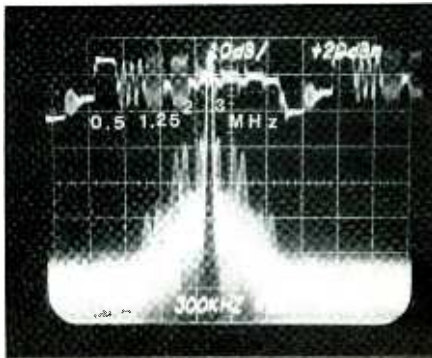

Fig. 1. Multiburst determines high- and low-frequency horizontal resolution.

the usual lineup of bench instruments, I wasn't able to check on-the-air performance, simply because there are no stereo-TV broadcasts in my reception area.

I was able to overcome the handicap of not having stereo-TV broad-

casts with the aid of two spectrum analyzers, a very good multifunction NTSC generator, a gated-rainbow generator with variable r-f output, a sine/square/triangle sweep-function generator, an rms-calibrated variable power supply, and several digital

(Continued on page 86) ▶

Mitsubishi Model HS-400UR Videocassette Recorder

Ac operating range	< 100 to > 130 V ac
Power drain (record/play) at 117 V ac	37/36.42 W
Play (on time)	5 seconds
Stop (off time)	3 seconds
Fast-forward time	4 min. 5 sec.
Rewind time	4 min. 15 sec.
Luminance/chroma S/N	42/42 dB (SP & EP)
Horizontal resolution at baseband	2.5 to 3 MHz SP; 2 MHz EP
Horizontal resolution through r-f modulator & TV receiver	2.5 to 3 MHz
Audio response at baseband (-3/-6-dB points)	10/12 kHz
Stereo/Channel separation best	30 dB at 8 kHz
worst	24 dB at 16 kHz
Wow/flutter (NAB at 3 kHz)	0.06%/0.065% SP; 0.1%/0.11% EP
T60 tape playback times	60/180 min. (SP/EP)

Test equipment: Tektronix Models 7L5 and 7L12 spectrum analyzers; Hameg Model HM605 oscilloscope; Sadelco Model FS-3D VU field-strength meter; Data Precision Models 245 and 945 multimeters; B&K-Precision Model 1260 NTSC colorbar/multiburst and Model 3020 sweep function generators and Model 1035 wow/flutter meter; Sencore Model VA 48 (modified) video analyst and Model PR57 ac Powerite; RCA Model VGM2023S TV monitor; Tektronix Model C-5C oscilloscope camera.

EXPAND YOUR CAREER HORIZONS...



The CIE Microprocessor Trainer helps you to learn how circuits with microprocessors function in computers.

START WITH CIE.

Microprocessor Technology. Satellite Communications. Robotics. Wherever you want to go in electronics ... start first with CIE.

Why CIE? Because we're the leader in teaching electronics through independent study. Consider this. We teach over 25,000 students from all over the United States and in over 70 foreign countries. And we've been doing it for over 50 years, helping thousands of men and women get started in electronics careers.

We offer flexible training to meet your needs. You can start at the beginner level or, if you already know something about electronics, you may want to start at a higher level. But wherever you start, you can go as far as you like. You can even earn your Associate in Applied Science Degree in Electronics.

CIRCLE 36 ON FREE INFORMATION CARD

Let us get you started today. Just call toll-free 1-800-321-2155 (in Ohio, 1-800-362-2105) or mail in the handy coupon.



Cleveland Institute of Electronics
1776 East 17th St., Cleveland, Ohio 44114

YES ... I want to get started! Send me my FREE CIE school catalog ... including details about the Associate Degree program ... plus my FREE package of home study information.

Print Name _____

Address _____ Apt. _____

City _____ State _____ Zip _____

Age _____ Area Code/Phone No. _____

Check box for G.I. Bill bulletin on Education Benefits

Veteran Active Duty

MAIL TODAY!

MO-24

1984



1985

The "Born-Again" Computer: Coleco's ADAM

A fresh look at the exciting family-computer system that aroused great expectations last year, only to fall prey to production flaws that marred its debut. Here's what ADAM is like in its 1984/1985 second life.

~ Retrospective ~

After a year of trials and tribulations, Coleco says that its ADAM Family Computer System is ready! As any newspaper reader knows, it wasn't ready last year, when only 95,000 out of an anticipated 500,000 models reached its retail dealers. In Coleco's apparent zeal to make it in time for the big Christmas season, poor quality control was all too evident, operating manuals were poorly prepared, and a host of "bugs" were not discovered until the system was on the home-computer market.

All this bedeviled the introduction of a moderately priced home computer system that twirled in the publicity spotlight like no other computer before it ever had. The press corps

had lavished uncontrolled praise for the concept of a whole computer system that included a letter-quality printer for around \$600 or so. When a series of problems cropped up, however, the press people apparently felt betrayed, and their enthusiastic support turned into vicious attacks.

Licking its corporate wounds, Coleco forged ahead with ADAM in 1984. It corrected its manufacturing and inspection deficiencies, says Coleco, as it doubled its warranty period from three months to six months. Furthermore, a network of ADAM Service Centers by Honeywell Information Systems has been established across the country in the event that the unimaginable should happen.

Additionally, Coleco has set up a consumer hotline with a no-charge phone number to answer any questions one may pose concerning the ADAM computer.

So let us dissect ADAM again, the 1984/1985 one. The one that has been prepped for the upcoming Christmas season, a year late. Its promise is still there. But has it been fulfilled? To answer this, we enlisted the services of two respected computer authorities who have had considerable experience with the "old" ADAM. One expert, Charles Rubenstein, looks at the latest ADAM anew, while another, Forrest Mims, will illustrate hands-on work with the system next month.—Art Salsberg



The 1984/1985 ADAM
By Charles Rubenstein

The ADAM Family Computer System is unlike other home computers in its class. You don't have to mix and match different options to make it a real computer system, which is often a fitful experience in the discount stores where such "lower-priced" computers are generally sold. The entire ADAM system is thoughtfully packaged for you in a large, colorful, rectangular container. Its suggested retail price is now \$750.

The system consists of the main computer console with a digital tape drive (and space for a second drive), a game cartridge slot, and a built-in word-processing program; a de-

tached keyboard; a letter-quality printer; game controllers with numeric keypads; and a pair of digital "data pack" tape programs (the BASIC language and a super game, "Buck Rogers/The Planet of Zoom"); plus appropriate operating manuals. Completing this are all the necessary cables and a TV/game switch box, as well as a preformatted blank tape pack (C-250 tape cassette). The only addition needed is a color TV receiver, which most people own. Or add a video monitor for sharper display of text, if you wish.

Setting up the 1984 version of Coleco's ADAM color computer system

gave me a feeling of *deja vu*. Yes, indeed, it was only a year ago that I examined a pre-production version of Coleco's revolutionary offering. Now before me was the late-1984 production unit, with the bugs said to be worked out and real printed operating manuals. What follows, then, is a review that treats ADAM as a new computing machine.

Inside ADAM

ADAM's memory console is housed in an attractive, hard-plastic shell with a different appearance than other computers. The basic unit has a

“Each peripheral has its own computer chip.”

front-loading digital-tape-cassette door at the left-most side, with room for an optional second tape drive to its right. At the top-front, toward the right side is a ColecoVision game slot that accommodates ROM packs. To its left is the computer's RESET switch and at the slot's right is a separate reset for the cartridge. Appropriate input and output connectors are situated around the bottom portion of the console, including a front-bottom receptacle for the detachable keyboard.

Resting inside its main unit is ADAM's heart. It consists of the still-ever-popular Z80A microprocessor that addresses 64K bytes of user memory, and an extra 16K of RAM for video memory.

The foregoing is rounded out by an operating system in 8K of ROM, and four MC6801 computer-on-a-chip devices, each with 2K ROM and 128 bytes RAM. The microprocessors perform a variety of tasks, including controlling access to the printer, keyboard, and tape drive, and one functions as a master network controller



ADAM comes with a true typewriter-style keyboard with full-travel keys. The detachable keyboard can be located anywhere, limited only by its tether cable.

in support of the CPU. A heat-sinked Texas Instruments 9228 video processor chip and a Singetics SN76489 sound controller chip handle video and audio processing.

Topping this off is ADAM's 24K-byte word-processing ROM, the built-in SmartWriter that is automatically set to be used at the press of a key (ESCAPE/WP) after the computer is turned on.

As much as the heart of any computer is its central processor unit, its brain is composed of a conglomeration of programs and callable sub-routines termed its operating system. These programs take up memory space much as does an application program being run by the computer. So whenever a new device is added to a computer, this program's space increases to include routines needed for the new peripheral.

ADAM breaks with this traditional approach in favor of multiprocessing and networking of its ports. To do this, each peripheral device has its own self-contained Motorola MC6801 “computer,” as cited earlier. These are connected into a serial bus, half-duplex, bidirectional “AdamNet” that's accessed at high speed: 62,500 bits per second.

Each of these peripheral “computers” incorporate a custom 2K-byte



The main console easily stows under the monitor shelf on a typical computer desk as shown here. Program tapes load and unload via a flip-out cassette door.

“ . . . a solid keyboard that's easy to become accustomed to.”

ROM operating system, relieving the main operating system from the chore (and time) to control another device, such as a floppy disk drive or a modem that's added. As a result, higher operating speed is attained.

Digital Tape Drive

“Tape, you say?” Yes, indeed, but not standard audio cassette tape. The neat tape drives employed in ADAM are *digital* drives that accept *digital* tape packs. Each tape contains 300 ft. of tape that's 0.15" wide. The tape is formatted, too, and has a capacity of 256K bytes on two tracks (128 blocks on each track).

The computer-controlled drives move the tape at high speeds, with a data transfer rate of 1.4K bytes per second. Normal tape speed is 20" per second, while fast-forward and rewind moves along quite briskly at 80" per second. In contrast, an audio cassette's standard speed is at 1 1/8" per second. Floppy disks have a much faster transfer rate than ADAM's tape drives, of course, with 3 1/4" to 250K bytes per second not being un-

common. Nonetheless, compared to audio tape, the ADAM system is a substantial improvement.

Controlled by its own MC6801 computer chip, as are all ADAM peripherals, the networked drive can be accessed during normal game play, thus speeding the interactive quality of a game. ADAM loads new programming and video screens at the rate of one per 16 seconds (about 16K bytes) *while* one is playing a game on the video screen.

A further advantage of the ADAM's networking scheme is that if you have two tape drives, a cassette in either drive is sensed and that drive is booted when the system is reset.

ADAM's Keyboard

Any computer's keyboard is a hard-working peripheral. Moreover, if one's fingers don't take kindly to its feel, it will impair computing work. In both cases, ADAM's keyboard will surprise you. It is decidedly not in the toy-like category.

This is in fact a solid keyboard that is easy to become accustomed to. Its

keys offer a solid, yet silky touch. There's sufficient tactile feedback to let you know you struck a key, too.

Coleco followed the dictates of the personal computer market today in choosing a detachable keyboard, enabling users to position it for their comfort. It has 75 ASCII-coded keys, scanned every 5 to 8 milliseconds. There are 54 “regular” keys, 5 X-Y cluster cursor controls, 6 user-defined ones, and 10 special-function keys.

The six user-defined “smart” keys are used extensively in the word-processing mode to call subroutines and for direct action. The cursor keys are useable in game-playing as well as in word processing for instant cursor-controlled editing.

The barely 3-lb. separate keyboard measures 15" x 7" x 1.5" to 2.5" (a 12-degree slope), and is attached to the memory console by a 2-ft. coiled 6-wire AdamNet cable. The coil enables the keyboard to be placed up to 5-ft. away from the console and be used comfortably on one's lap.

To prove that the keyboard is indeed part of a networked system, its

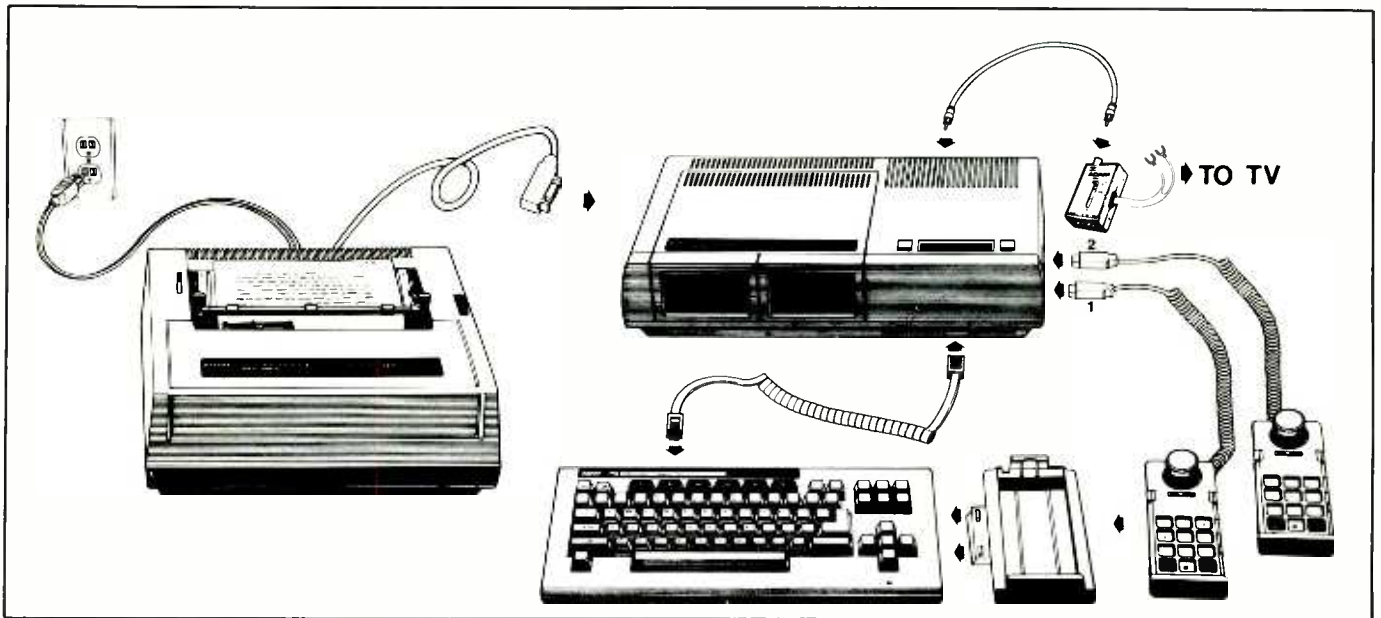

Illustrated in this drawing are the hardware components of the Coleco ADAM Family Computer. Clockwise from top are the main console with vhf TV/computer switch; two numeric keypad/joystick controllers, detachable keyboard, and letter-quality printer/power supply system.

“The printer incorporates the computer’s power supply.”

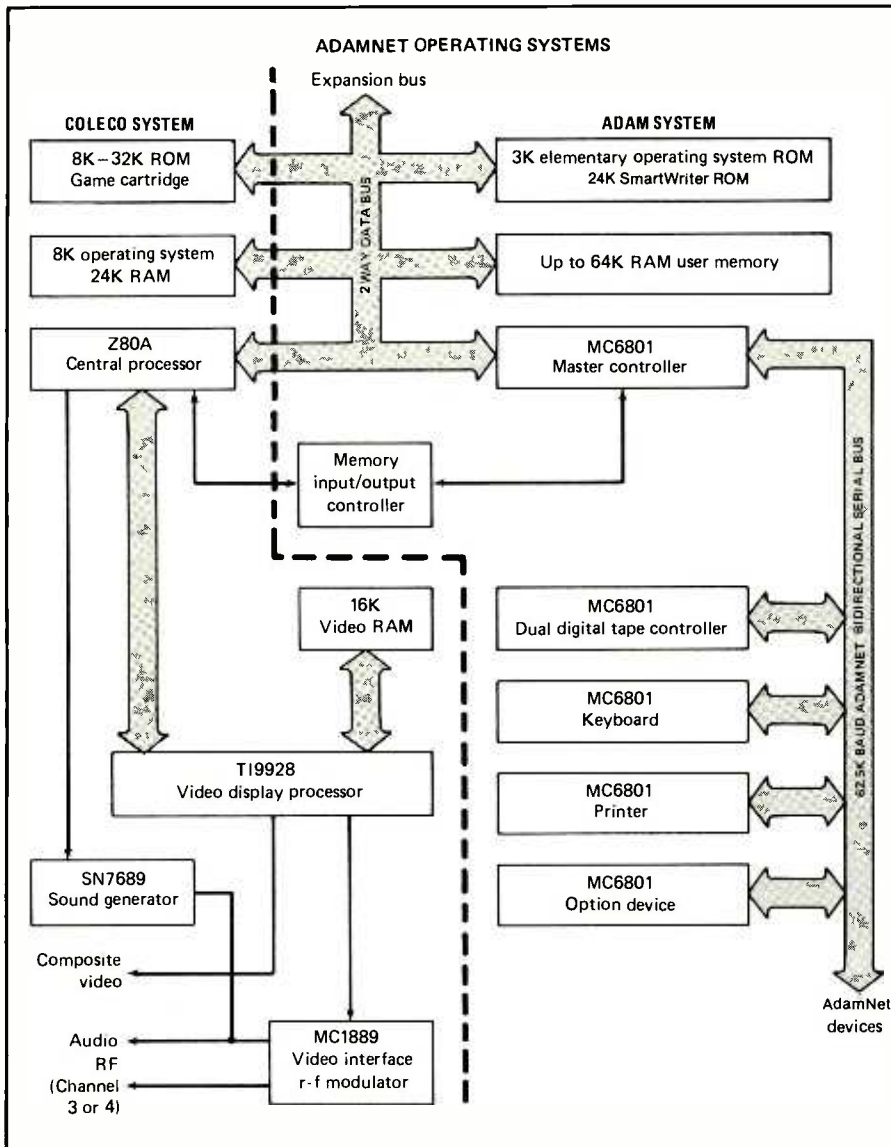

Block diagram of ADAM illustrates how ADAM add-on module (right of dotted line) retrofits to ColecoVision games player to make a complete computer.

ADAM’s 14-lb. printer, which measures 15" × 13.5" × 6", uses a simple, rugged, solenoid-hammer design to hit a daisy-wheel’s selected character petal. Type style can be changed easily by substituting another daisywheel. Much ado has been made about the loud machine-gun sound it makes while printing. In my opinion, however, it’s not too bad as formed-character printers go. It’s even preferable to the high-pitched whine of some high-speed dot-matrix printers now on the market. Noise can be damped a smidgen by the addition of foam-rubber acoustic isolators to the bottom of the printer (supplied with the machine).

The printer chugs along at 10 characters per second, which is very slow compared to dot-matrix printers, but not bad in the low-cost letter-quality printer arena. What you get on paper is typewriting print that’s indistinguishable from that of a moderately priced electric typewriter, which is neat. Though different type faces can be used, the printer’s 10 characters-per-inch pitch cannot be changed.

In addition to its print function, the printer, oddly, incorporates the computer’s power supply. This provides for +12-volt and ±5-volt logic power through an internal regulated power supply located at the rear of the printer enclosure, as well as for the printer’s +12-volt needs. This makes the case-top directly above the supply warm to the touch when it’s operating, adding about 10 degrees to its “cold” temperature. (Another hot spot is at the top-center of the memory console, where the video processor circuit is located below it. Temperature rise here is about 5 degrees.) Not so terrible.

More disconcerting, however, is that the whole system’s on-off power switch is located at the printer’s rear panel; in the center, no less. Therefore, to turn the computer system on or off, one must reach blindly behind the printer and grope for a large slide switch. Equally bothersome is an

cable connection can be transferred into the AdamNet port on the left side of the console and “fool” ADAM into thinking it has no keyboard, but rather is in communication with a new peripheral device. Replacing the keyboard into its normal port results in an automatic reset as ADAM’s controller senses a new device coming into the network.

A Letter-Quality Printer

What really ignited the enthusiasm of most people for the ADAM Family

Computer was the inclusion of a letter-quality printer as part of the modestly priced system. Its glitter is a bit masked one year later, owing to the introduction of a few daisywheel printers in the \$400 selling-price range as well as virtually letter-quality dot-matrix printers whose prices dip below \$500. Nonetheless, this factor is still very important when one considers the overall price of an ADAM system, which in discount-store catalogs is around \$700 for the entire system.

“ADAM’s word-processing program is ensconced in ROM.”

ever-present low hum that emanates from the power supply.

The printer handles single-sheet paper up to 9½" wide. One can put in fan-fold paper, though an optional tractor-assembly unit should be purchased if this is to be used regularly.

Paper cannot be loaded and adjusted with the greatest of ease. The platen is a bit sticky, even when advancing paper forcefully with the printer’s side knob. But it’s certainly manageable.

Like other low-cost letter-quality printers, there’s an every-so-slight daisywheel tilt on printing of some letters. But one really has to examine this very closely to detect it. The overall print quality is good.

In actual speed tests, a 10.7 cps average was attained by the printer. Speed dwindled to about 7.9 cps with mixed alphanumerics, however, while number-only characters were printed at almost 12 cps.

Built-in Word Processing

ADAM’s word-processing program is part and parcel of the computer, ensconced in ROM as part of its circuit. Thus, a user need not load an application program to set up ADAM as a word-processor system.

When ADAM is turned on, it is immediately ready for use as a functioning *electric* typewriter for short notes or whatever. Pressing the keyboard’s ESCAPE/WP key converts the computer into an *electronic* word-processing machine. Now you can move text around, insert words, erase, do automatic search or replace of words buried in the text, change the screen’s background color, print superscripts and subscripts, highlight text, modify on/off error and key-click sounds, automatic page numbering, and other ordinary functions of a word processor such as automatic word wrap.

ADAM’s built-in SmartWriter is a minimum-power word processor. This is sufficient for most people’s needs, I admit, and is in fact prob-

ably more desirable than, say, the complex WordStar, for the majority of ADAM-class users. (WordStar’s software and manual alone approaches the cost for the entire ADAM computer system.) The most evident omission is the absence of flush-right-margin formatting. But let’s face it, even thousand-dollar IBM Selectric typewriters don’t have this feature either.

When SmartWriter is selected, appearing on the video screen are vertical and horizontal scales that indicate the screen cursor’s relative position on the “page” for margin markers and tab stops. A simulated platen roller is located near the bottom of the screen where the line one is typing appears, giving one the feeling of using a typewriter. Up to eight lines of type are scrolled above it in the manner of typewriter paper. Under the platen are six Smart Key labels, which correspond to the keys lined up at the top of the keyboard, each of which has a Roman numeral. The Smart Key labels on the screen change, depending on what’s originally selected. For example, if you press Smart Key II, Screen Options, a new set of options appear on the screen’s labels. Select one of these and another set of options give you more choices. Therefore, if you chose Color Select from among the options, the labels would change to present you with choices of color, any of which are activated by simply pressing the appropriate single Smart Key on the keyboard.

As a result, many people will be able to use the word-processing system without even glancing at the instruction booklet. It’s all common sense if you can read.

The only real complaint I have is that the BACK SPACE key resets the LOCK, and that unlike most shift locks, ADAM locks the number keys as well as the alpha keys.

Up to 36 large letters or numbers are displayed on the video screen, so what you see is not what you get when

it’s printed out (standard 8½" × 11" paper typically uses 80 characters maximum for a full line). This is commonplace with lower-cost computers since most people will be using limited-resolution TV sets for display, which cannot deliver sufficiently sharp text when alphanumerics are halved in size. However, there is a horizontal scroll provision in ADAM called the “Moving Window Format” that handles 80 characters to a line. Only 36 characters can be seen at a time, though. When using this format, ADAM automatically moves existing line copy to the left so that the extra characters can be seen while typing. This is mostly useful when you want to be sure that columns are lined up properly. Typing is displayed at the top of the screen while using the Moving Window instead of on the roller positioned near the screen’s bottom when in the Standard Format.

In sum, SmartWriter is an easy-to-use word processor that is inviting to work with, even though it lacks many bells and whistles. Several PRINT, EDIT, MARGIN, and other functions are all a Smart Key away.

Odds & Ends

Unlike standard joystick controllers, the Coleco version has a diode-matrix-encoded Touchtone number keypad. The recessed-membrane keypad can be placed into a “holster” on the right side of the keyboard for use as a convenient number pad. The controller’s joystick appears to be ruggedly constructed, and has slide-mounted speed-fire buttons. The controller has more uses than merely controlling action games. It can also be employed to control the cursor and text scrolling when in its word-processing mode.

A plastic flap at the back of ADAM’s memory console contains a 60-conductor edge card Expansion Module Interface port for future additions to the basic ADAM comput-

er. There's also a separate phono-type socket for a color video monitor and a seven-pin DIN socket for auxiliary video that includes composite video (pin 3) and audio output (pin 1). Pin 4 is used as a ground.

The ColecoVision slot accommodates ColecoVision ROM cartridges. The cartridges do indeed work in the ADAM, converting it into a ColecoVision game player. In fact, one can save some money, about \$100, by using the game machine in conjunction with a computer module to create one's own ADAM.

It was interesting to observe the differences between a ROM-cartridge and a data-cassette video game. The data-tape version of Buck Rogers, for example, was a 144K enhanced version of the ROM-cartridge's Buck Roger's game. Both had nice sound effects. The ADAM sound system uses three programmable tone generators and a white-noise generator, by the way.

Software

Since the Adam awakes ready for word processing rather than for BASIC programming, a digital data pack containing SmartBASIC, an APPLEsoft BASIC clone, is supplied with the system. I suspect that few Adam owners will ever discover SmartBASIC lacks some of the niceties of other of other BASICs. CHAIN, MERGE, RENUM(ber), REPEAT and RESET are missing, for instance, and PR#1/PR#0 toggles are needed to print from BASIC. Nonetheless, this BASIC version is very useful.

ADAM's graphics comes in several SmartBASIC-controlled modes. There is the standard default TEXT mode, where 24 lines of 36 characters are used to list and create your BASIC programs. Next up the scale is SmartBASIC's "GR" mode, "low-resolution" graphics that splits the screen into a 40 x 40 "graph paper" with 4 text lines at the bottom of the

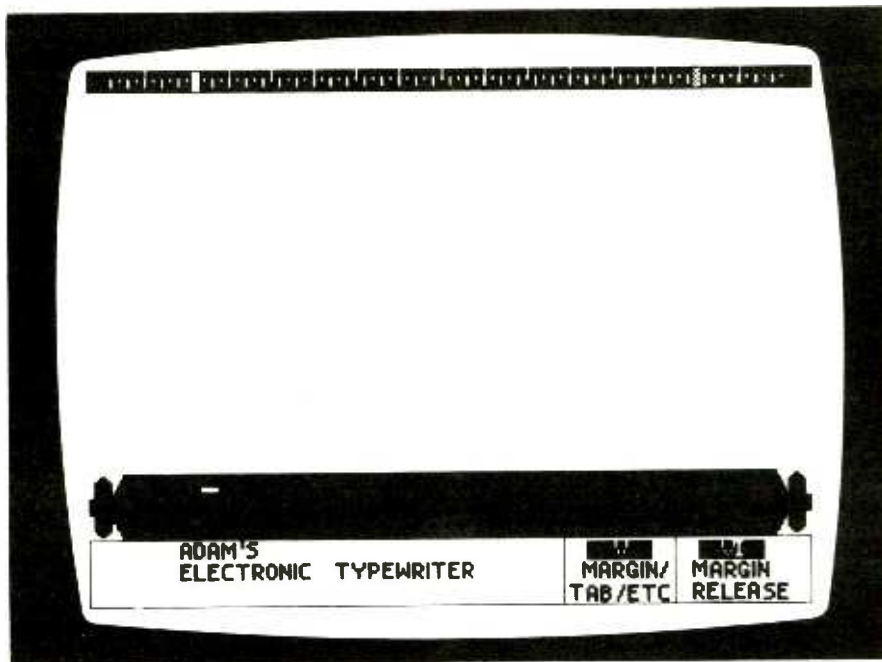

On turn-on, ADAM goes into its typewriter mode and gives a display as shown. Selecting the SmartWriter word processor changes screen display, retaining graphic representation of the platen but offering a more extensive list of options.

page and, finally, two types of HiRes graphics. First there is the "HGR" mode, which splits the screen into 256 x 159 pixels plus 4 lines of text, and then the "HGR2" mode, which is 256 x 192 pixels (nearly 50,000 points) of pure graphics.

Even in LoRes, the screen is capable of displaying 16 different colors. The memory needed to store a screen naturally depends on the resolution needed. However, with 16 Kbytes reserved for video RAM, ADAM has plenty of room for background displays and the sprites (32 of them) weaving their way around them.

There are no demo programs provided that utilize these roughly Applesoft-compatible SmartBASIC commands. But the nice SmartBASIC manual supplied is rather complete in its explanations, and each command is accompanied by a short example. Regrettable, though, is the lack of information on how to copy programs using dual drives, how to accomplish sprite manipulation and

animation, or even how to invoke those nifty sounds and musical interludes that the games use.

Even more surprising is the absence of a BREAK key to "unhang" you when all else fails, and no information at all on the additional *built-in* characters available (mathematical symbols, musical notes, inverse video, card symbols, and funny characters). What a shame. And yet, after seeing the Super Game Pack in action and an optional SmartLOGO data pack, I am convinced that there's some awesome graphics power available in the machine.

There is a bundle of software that Coleco has made available for use with ADAM. Outstanding among them is Smart Logo (\$79), which is accompanied by a high-quality manual that emulates the good documentation-in-a-binder used with professional software. Also available are CP/M 2.2 and Assembler (\$79),

(Continued on page 81) ▶



Take your family beyond computers



Enter the fascinating world of the home robot

HERO JR is a friendly, dynamic home companion robot. He'll wake you in the morning, guard your home at night, and entertain throughout the day with small talk, songs, and games.

Buy HERO JR assembled, ready to roll out of the box. Or, build him from a simple "We Won't Let You Fail" kit. Either way, you don't need to know anything about robots. His built-in personality is fully pre-programmed. A flip of the switch turns him into your personal robot. Let him move on his own or direct him with a wireless remote control.

Slip in a new cartridge for more pre-programmed phrases, games and actions. And, with his RS-232 interface, optional HERO JR BASIC and a personal computer, you can write your own programs.

There's a lot to learn...and even more to enjoy! So, for less than the cost of a home computer, introduce your family to the wonders of robotic living.

See HERO JR at Heathkit Electronics Centers* in major cities across the U.S. and Canada. Consult your telephone white pages for the store nearest you.

OR SEND TODAY FOR MORE INFORMATION!



Mail this coupon today. Get your...

FREE Heath Catalog.

Full color, full information on HERO JR plus over 500 other fascinating electronic kits.

Mail to: HEATH COMPANY
Dept. 079-238
Benton Harbor, MI 49022

Name _____

Address _____

City _____

State _____ Zip _____ RO-118

Heath®/Zenith®

Heath

Company

*Units of Veritechnology Electronics Corporation.

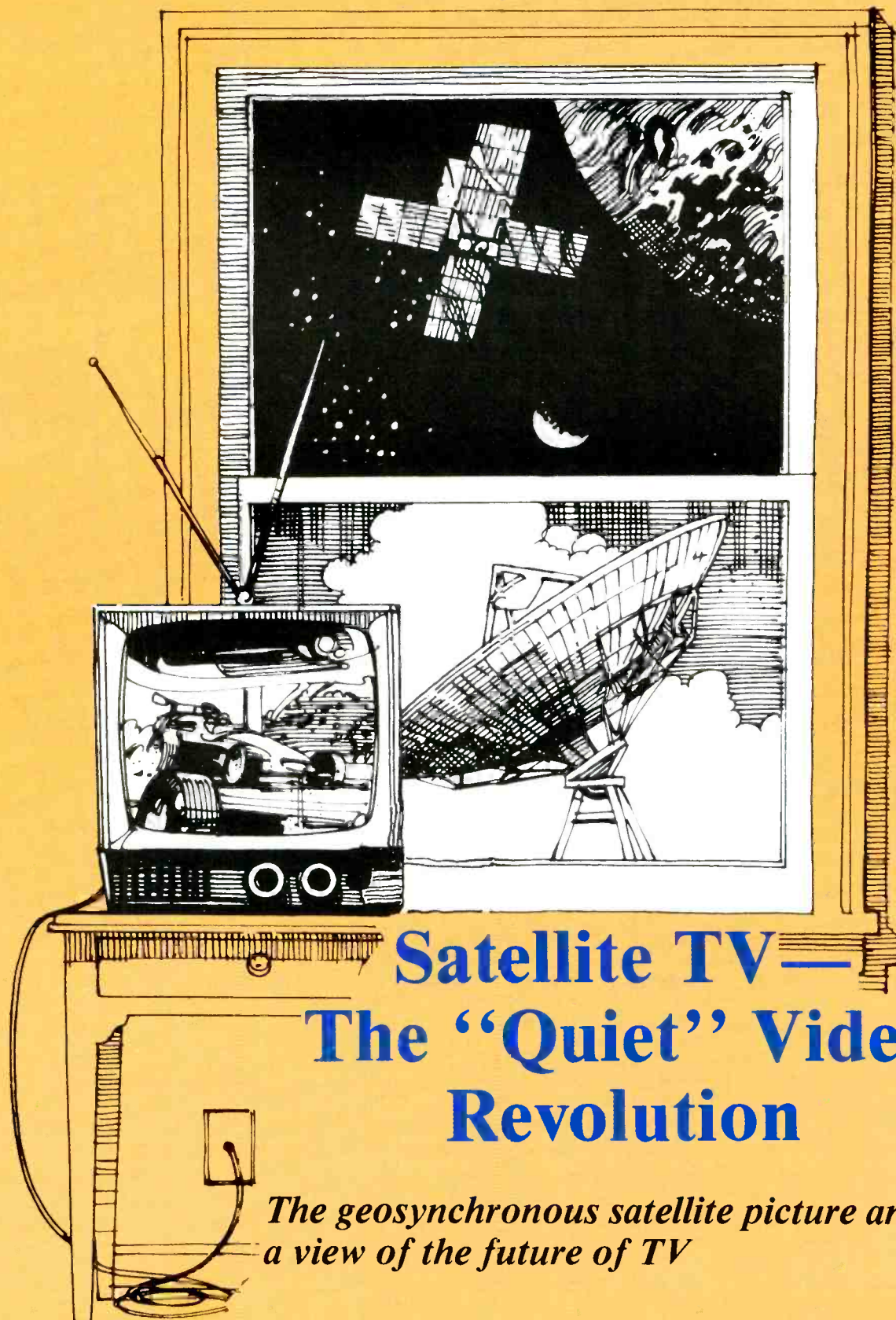

Satellite TV— The “Quiet” Video Revolution

*The geosynchronous satellite picture and
a view of the future of TV*

By Stan Prentiss

Commercial carriers and cable services are doing quite well delivering telephone, data-link, teleconferencing, and video/audio signals throughout the continental U.S. (CONUS), Hawaii, Puerto Rico, and the Virgin Islands. But direct satellite-to-home service is still facing a series of bumpy ups and downs on its way to becoming financially established.

Cost effective and electronically proven C-band transmissions on 4 and 6 gigahertz (GHz) aren't normally bothered by atmospheric and precipitation. They operate at lower transponder (satellite frequency translation and amplification) power, even though commercial service requires 15-to-30-ft. receptors, and usually 10-to-12-ft. receptors are required for home reception—although some 8-footers can operate in exceptional signal locations using better-quality low-noise amplifiers and converters.

Most C-band TV receive-only (TVRO) earth stations can usually squeeze by with 120° K (Kelvin) low-noise amplifiers (LNAs), low-noise down-converters (LNCs), or block down-converters. There are, of course, differences between these units. LNAs offer only the usual 50 dB of amplification, while LNCs furnish amplification and a single down-conversion to 70 MHz. LNCs, on the other hand, provide both amplification and initial down-conversion from 0.950 to 1.450 GHz so that connected TV receivers can tune any transponder (channel) of a selected satellite as long as they are of the same horizontal or vertical polarity. If an orthogonal input feed is used, however, either polarity channel can be selected at will.

Depending on age and utility, satellites nominally have between 10 and 24 channels. Some new ones are now being proposed for 36 channels, while others are hybrids that operate on both the C band at 4/6 GHz and



In this photo is shown a number of the latest antennas for receiving satellite TV broadcasts. The manufacturer, Prodelin, is one of the leading suppliers of user-erectable satellite TV receiving antennas to the growing marketplace.

the Ku band at 12/14 GHz simultaneously. At present, there is nothing in the way of commercial or home-type "birds" working the highest transmission ranges. But with the advent of high-powered direct-broadcast service (DBS) in 1986 or 1987, the uplink will increase to some 17 GHz. The downlink will occupy 12.2 to 12.7 GHz. There will also be a huge addition of power, and coverage will basically be CONUS-only. Many of these proposed satellites will operate at 200 watts per channel.

USCI Pioneers & Survives

Reputedly in debt to the tune of more than \$40-million, United Satellite Communications, Inc. (originally founded by Prudential Life Insurance, General Instrument Corp., and others) will hopefully soon have other partners with a few more millions and extra help to keep the venture solvent. Before press time, lots of rumors were flying around, none of them backed by anything concrete.

Having commenced operation on November 15, 1983, USCI now

serves Chicago, Champaign and Peoria in Illinois, all of Indiana, Cincinnati, Dayton, Louisville, Philadelphia, Harrisburg, and Richmond via Canada's ANIK 2 "Little Eskimo" satellite. Meanwhile, plans are moving forward to transfer over to GTE's GSTAR 2 satellite, scheduled for launch in early 1985.

Brainchild of personable Engineering Director Bill Rowse, and supported by modern video/audio consoles and racks of TV monitors, plus Ampex and Marconi 1" tape equipment, the five-channel uplink begins operations on 70 MHz. It up-converts to 14 to 14.5 GHz and drives a single 9.8-meter antenna with 2.2-kW klystrons. Channels in use are numbered 21, 45, 70, 82, and 94—all delivered at 15 watts per transponder from a west longitude position over the equator at 105° WL. This position is expected to coincide with GSTAR 2's projected slot. This is done so that previously installed 2.5-to-4-ft. antennas and their LNB down-converters will not have to be reoriented, even though a slight 26° feed rotation might increase signal

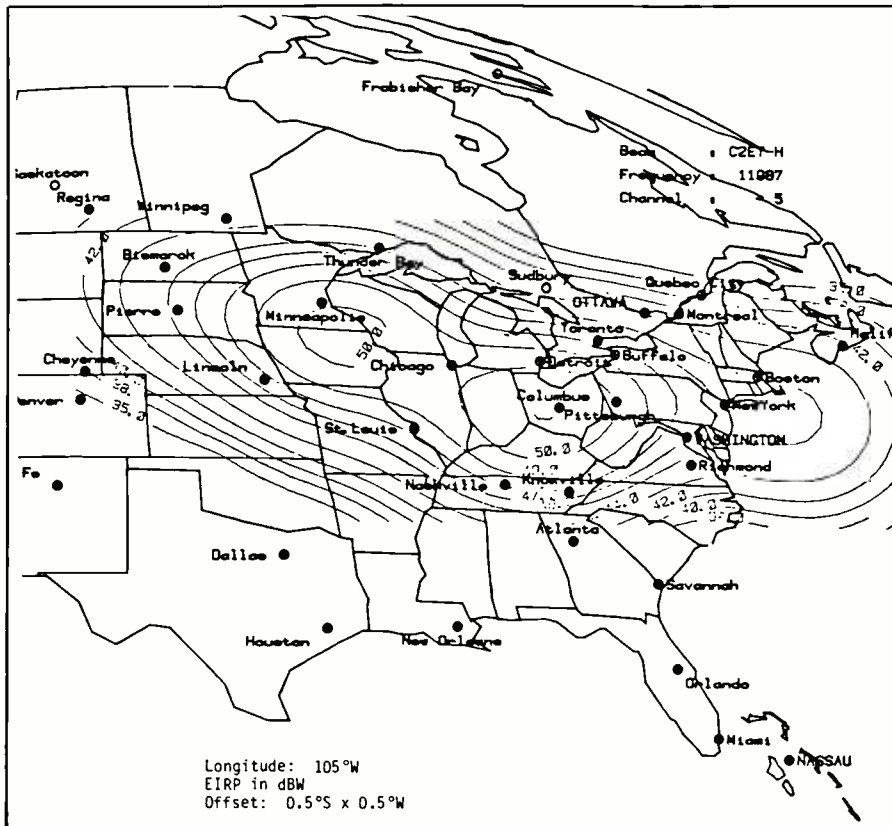

Fig. 1. This map shows the reception-area "footprint" of Canada's ANIK satellite, which is stationed in geosynchronous orbit at 105° west longitude. The contours are marked as EIRP in dBW as they span the North American continent.

strength by 1 to 2 dB in certain better-reception locations.

Upon changeover, clear video/audio signals previously emanating from ANIK C2 are scheduled for scrambling via Linkabit or other comparable system. A 72-dB dynamic-range Dolby system will be added for sound processing and noise quieting. An additional five 20-watt transponders will be acquired for coverage of the western U.S. This means that between 52% and 80% of the entire coast-to-coast United States population is expected to be able to receive service, retaining the same 50 dBW EIRP (effective isotropic radiated power) as before.

Originating in Northvale, NJ, the uplink and subsequent 11.7-to-12.2-GHz downlink are said to suffer little from sun outage and should have signal availability of better than 99%. Signal loss might be observed during

very heavy rainfall, which normally occurs during the summer.

A "footprint" of ANIK's present coverage at 105° WL is shown in Fig. 1. Observe how much of the U.S. is covered by this relatively low-powered satellite. Contours are marked as EIRP in dBW as they span the North American continent.

STC Almost Operational

With USCI's obvious head start, Satellite Television Corp., now owned by COMSAT, is preparing to enter the CONUS race via Satellite Business System's SBS 4, launched August 29 from the NASA Space Shuttle. Originally, STC and its satellite builder, RCA Astro Electronics, contracted to deploy only high-powered "birds" in 1986. But initial competition from USCI forced the interim SBS decision, even though STC still targets 1986 for its 200-watt DBS

service. Two satellites instead of three, however, are to cover CONUS *without* spares in space or ground reserve, thereby simultaneously cutting costs and extending coverage.

At the same time, COMSAT has also been looking for a financial partner to share the service and help with the considerable expense. All of this follows COMSAT's recent sale to IBM, divesting itself of Satellite Business Systems (SBS). This move permits the corporation to once again devote its prime attention to U.S. and international commercial satellites, for which it was granted a Congressional Charter in 1962, followed by company formation in February 1963.

When STC finally becomes operational on SBS 5 in 1985, installers will have very simplified rooftop-mount 0.75-to-0.9-meter (1.46-to-2.95-ft.) aluminum or fiberglass parabolic antennas and 0.950-to-1.450-GHz LNC down-converters at 223° K temperatures. Claimed efficiencies will also be greater than 68%. Roofmounts are to be secured with lag bolts, and there is to be a special field-strength type of satellite test locator temporarily LNC-connected for rapid identification of SBS 4, and, subsequently, STC 1 and 2.

If SBS requests, and the FCC approves, a temporary 110° location emerges for SBS 4. This is the same permanent slot assigned to the high-powered "birds." This would ensure no further antenna-pointing correction and only 11.7-to-12.2- and 12.2-to-12.7-GHz bandswitching. Announced antenna suppliers are ANCOM and Toshiba, subscriber toll is to be \$400 to \$425, and the one-time installation fee is to be \$100 to \$150. Finally, the monthly charge is to be \$15 to \$20.

Direct Broadcast Systems

Here, too, casualty figures are already rolling in on "high-power" DBS, with the recent withdrawals of RCA, Western Union, and CBS from the expensive multimillion-dol-

"Casualties rolling in on high-power DBS."

lar venture. This leaves STC, United States Satellite Broadcasting Co., Inc. (USSBI), and Dominion Video Satellite, Inc. as survivors of round one. Another seven companies are waiting in the wings for round two and FCC approval or disapproval this fall. Two others, Direct Broadcast Satellite Corp. and Graphic Scan, will learn their fate as well, perhaps by the time this is in print.

To cut costs and compete effectively with each other, most applicants are proposing a two-satellite system to cover the CONUS. Among the seven, six would like to do the job with split (half) U.S. signals. However, Hughes wants to offer *full* CONUS spread with 32 channels, using two 16-channel satellites. But the usual 53 to 54 EIRPs may well be cut to 47 to 48 dBW. This would require

larger antennas than those usually projected for the higher-powered 200-watt systems. Under this full-signal proposal, Hughes would deliver 100 watts per transponder to come within the 1600-watt (1.6-kW) limitation of current traveling-wave tubes, or TWTs, and space power supplies.

In the 50-watt-per-channel category, National Exchange and Satellite Development Trust are proposing two satellites, each 16 channels and each half-CONUS. In the 200-watt-per-channel group, Space Communications Services would like six channels plus spot beams; Satellite Syndicated Systems wants six channels but no spot beams; and the National Christian Network and Advanced Communications would be happy with two regular satellites and six transponders each.

Of those applicants fully approved and in firm contract with a satellite supplier, Dominion Video Satellite will have two co-located Hughes translator "radiators" at 118.8° WL. Each is to have six channels in the downlink range of 12.29690 to 12.61766 GHz, left-hand circular polarization (LHCP), an assigned bandwidth of 24 MHz, and a total of 18 antenna beams. Required operational date is December 4, 1988.

United States Satellite Broadcasting is in contract with RCA Astro Electronics for construction of a pair of six-channel DBS satellites to be located at 100.8° and 147.8° WL. Each is to use identical downlink frequencies between 12.23858 and 12.64682 GHz. USSB 1 and USSB 2 are to provide six LHCP channels apiece and three antenna beams per transpond-

Prodelin



Part of the giant M/A-COM group, with annual net sales of more than \$637-million, Prodelin is a member of the Cable Home Group, which manufactures antenna reflectors. All reflectors are of compression-molded fiberglass, and they range in size from 0.75 to 3.7 meters in diameter. In addition, Prodelin manufactures universal and T-bar mounts, advanced feeds, and state-of-the-art satellite receivers.

Claiming to have one of the most

modern engineering facilities around, Prodelin has recently completed a multimillion-dollar design and antenna-mount plant near Newton, NC and should have a brand new \$7-million pressing plant on-line in nearby Catawba by the end of the year. This plant will have three presses, will be three stories high, and will have another story in the ground. This is in addition to the already operational plant now working at capacity in Indiana. Like

other reliable manufacturers of home TVRO and cable satellite receivers, Prodelin is selling all the equipment its plants can produce.

Staffed by engineering imports and local North Carolinians, the Newton plant is located in the foothills of the Appalachian Mountains (the Smokies). The engineering portion shares some of its 40 acres with an outdoor antenna range measuring 1400 feet between its elevated transmit and receive towers.

At the present time, all Prodelin receivers accept low-noise block down-converter frequencies between 950 and 1450 MHz. This enables connected TV receivers to tune any of a particular satellite's channels of one or the same polarity. Orthogonal (dual-polarity) models are also obtainable, and it is understood that multiple-feed antennas will be available in the future.

Prodelin designers state that metal meshes embedded in the fiberglass will permit reception of Ku-band signals on C-band antennas with the proper feeds. At the moment, Prodelin is a major supplier of Ku-band antennas to satellite-to-home broadcaster United Satellite Communications, Inc., known throughout the industry by its USCI initials.

U.S. Domestic Satellite System (DOMSAT)*

Satellite Name	Location °WL	Band (GHz)	When Launched
SATCOM V	143	4/6	Oct. 1982
SATCOM I-R & II	139	4/6	Apr. 1983
			Mar. 1976
GALAXY I	134	4/6	June 1983
SATCOM III-R	131	4/6	Nov. 1981
COMSTAR	127	4/6	Feb. 1981
SPACENET I	120	4/6	May 1984
		12/14	
WESTAR V	122.5	4/6	June 1982
SBS I	100	12/14	Nov. 1980
WESTAR IV	99	4/6	Feb. 1982
SBS II	97	12/14	Oct. 1981
TELSTAR 301	96	6/6	July 1983
SBS III	95	12/14	Nov. 1982
WESTSTAR III	91	4/6	Aug. 1979
COMSTAR III	87	4/6	Sept. 1978
SATCOM IV	84	4/6	Jan. 1982
WESTAR II	79	4/6	June 1974
COMSTAR D1 & D2	76	4/6	July 1976
			Sept. 1976
GALAXY	74	4/6	Sept. 1983
SATCOM II-R	72	4/6	Sept. 1983
WESTAR	retired (8/83)	4/6	Apr. 1974
SATCOM I	retired (5/84)	4/6	Dec. 1975
GSTAR A2	105	12/14	Aug. 1984

*In orbit as of August 1984

SATCOM - RCA American Communications, Inc.
 WESTAR - Western Union Telegraph Company
 SBS - Satellite Business Systems
 GALAXY - Hughes Communications, Inc.
 COMSTAR - owned - Comsat General Corporation
 operated - American Telephone and Telegraph Company
 TELSTAR - American Telephone and Telegraph Company
 SPACENET - GTE Spacenet Corporation

This table lists the current status of the U.S. domestic satellite systems launched to date, by location in WL and service band. Note that two have been retired.

er. Assigned bandwidths of 24 MHz and antenna power of 22.1 dBW and maximum antenna gains of 32.9 dBi (isotropic) for east and west CONUS have also been approved.

Originally, Satellite Television Corp. was approved as a four-satellite package for individual positions, serving approximately one time zone each with three channels. However, with vastly improved efficiency and technology, STC now claims that two satellites can serve twice the ground area as the four originally proposed, bringing it into line with all other DBS-approved applicants.

STC also requested tracking, telemetry, and command assignments in reserve guardbands at either end of the receive/transmit 12.2-to-12.7- and 17.3-to-17.8-GHz DBS frequency allocation, asking for a 1-MHz channel spacing for telemetry and 2-MHz spacing for command, with two telemetry channels per satellite. Consequently, the FCC approved four frequency assignments of 12.2045 to 12.2075 GHz at a bandwidth of 1 MHz and one 2-MHz assignment at 17.3070 GHz.

The satellites were originally to be co-located at 101° WL, using LHCP

downlinks of 12.29690 to 12.41354 GHz for STC 1 and 12.32606 to 12.44270 GHz for STC 2. But STC has now requested 110° for both. Assigned bandwidths are 24 MHz, along with three antenna beams at a power of 21.8 dBW and maximum antenna gain of 35.2 dBi for all of the CONUS area.

Fixed Satellite Service

This service constitutes the same 500-MHz bandwidth as does DBS and occupies adjacent geosynchronous (orbiting with the same period as the Earth's rotation) positions above the equator. However, it operates in two distinctly different frequency regions. The ku-band uplinks are at 14.017 to 14.483 GHz and downlinks are at 11.717 to 12.183 GHz, while the C-band uplinks are at 5.945 to 6.405 GHz and downlinks are at 3.720 to 4.180 GHz.

Until recently, Satellite Business Systems was the only Ku-band occupant. But GTE has launched SPACENET I (that serves Landmark Communications, Entertainment Financial, Bonneville Satellite, Spanish International, Southern Baptist, etc.), and SPACENET II, scheduled for November launch, will be devoted largely to GTE's Sprint telephone service.

In January 1985, the GSTAR A2 satellite is slated to fly aboard Europe's Ariane (as did others) from Kourou, French Guiana.

The SPACENETS are hybrid satellites. They operate simultaneously in the Ku and C bands. GSTAR, on the other hand, will have 16 transponders for the Ku band, of which 10 are already assigned to USCI.

Other Fixed Satellite majors include: Western Union with 23 WESTARS scheduled up to the year 2000; RCA and its 17 SATCOMS (one a launch failure); COMSAT General scheduled for seven satellites; AT&T launching four TELSTARS and four AURORA ALASCOMS; SBS's 1 through 9 series; Hughes' GALAXY group and others

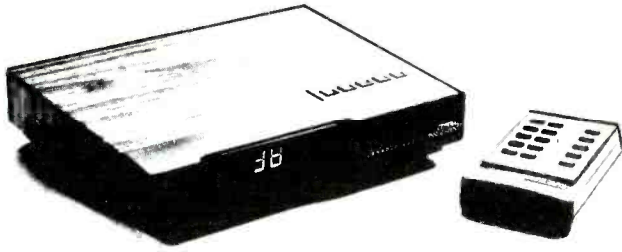

CABLE-TV PRICE SLASH!

ITEM	OUTPUT CHANNEL <i>(Circle the one used on your system)</i>		REG.	NOW	QTY.	PRICE
	CH. 2	CH. 3				
LCC-58 400 MHz CONVERTER	CH. 2	CH. 3	109.00	90.00
(10 or more)	CH. 2	CH. 3	82.00	75.00
JERROLD 450 CONVERTER (66 CH.)	CH. 2	CH. 3	134.00	105.00
(10 or more)	CH. 2	CH. 3	110.00	90.00
EAGLE COMTRONICS 400 MHz CONVERTER ...	CH. 2	CH. 3	109.00	90.00
(10 or more)	CH. 2	CH. 3	82.00	75.00
SB ADD-ON UNIT	CH. 2	CH. 3	129.00	99.00
(10 or more)	CH. 2	CH. 3	79.00	58.00
BRAND NEW SB TRIMODE COMPLETE UNIT	CH. 2	CH. 3	Please call for price quotes and details.	
SB TRIMODE CONVERSION KIT	CH. 2	CH. 3	Please call for price quotes and details.	
MINICODE (N-12)	CH. 2	CH. 3	109.00	89.00
(10 or more)	CH. 2	CH. 3	79.00	56.00
MINICODE (N-12) VARISYNC	CH. 2	CH. 3	119.00	99.00
(10 or more)	CH. 2	CH. 3	86.00	62.00
C-1000 ADD-ON (COMPATIBLE—ALL ZENITH SYSTEMS)	CH. 2	CH. 3	260.00	225.00
(5 or more)	CH. 2	CH. 3	220.00	185.00
MLD-1200-3	CH. 3 ONLY		129.00	99.00
(10 or more)	CH. 3 ONLY		85.00	58.00

IMPORTANT: WHEN CALLING FOR INFORMATION —
Please have ready the make and model # of the equipment used in your area.
Thank You

Name _____ Sub-Total

Street _____ Shipping

City/State/Zip _____ TOTAL

Phone Number Area Code _____ Number _____

Sale of De-scramblers may be prohibited in some states. If in doubt, check with local authorities. No Ohio orders accepted.

MUST BE SIGNED AND RETURNED WITH YOUR ORDER

I understand that the purchase of these cable T.V. products does not authorize their use on any cable T.V. system. I agree to obtain the proper authorization from local officials or cable company officials in my area.

Signed _____

Add \$2.00 per unit shipping or call for specifics. Payment is accepted by money order or Cashier's check only. COD's & credit cards are not accepted as our low prices prohibit their use.

Transamerican Cable Distributors

449 BROADWAY AVE. • BEDFORD, OHIO 44146 • (818) 956-5839

Please—No Collect Calls

“Two-thirds of U.S. TV stations get programs via satellite.”

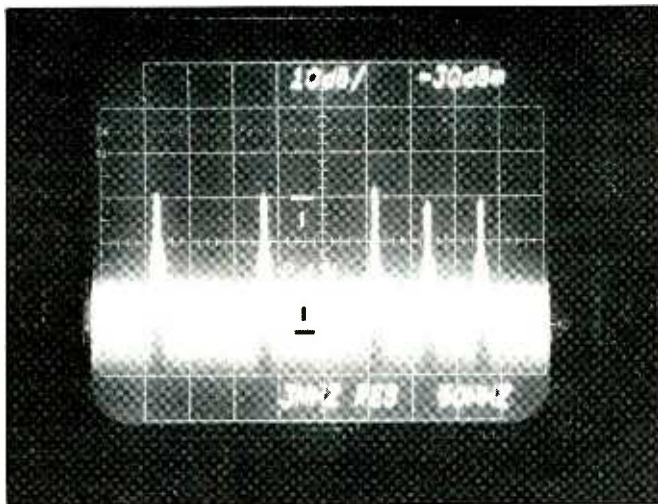

Fig. 2. This photo of a spectrum analyzer display illustrates the fine-quality ANIK C2 transponder signals as seen through USCI's low-noise block converter at 1.2 GHz.

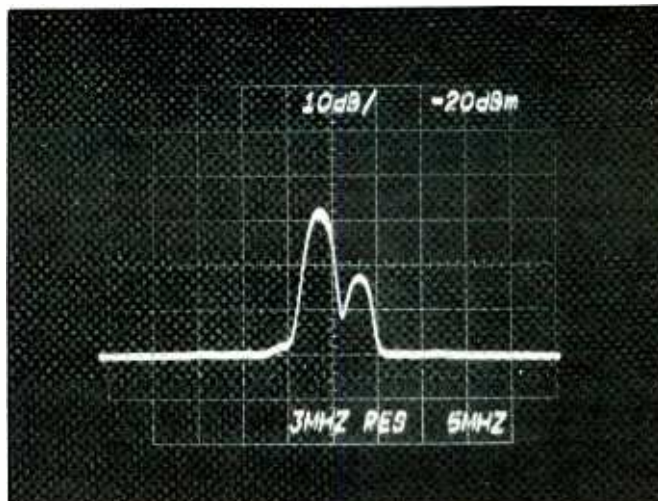

Fig. 3. This is a photo of a 60-to-66-MHz remodulated transponder and analyzer-filtered signal into the TV receiver. Though not symmetrical, it does the required job.

totaling nine satellites; GTE's GSTAR and SPACENET with eight satellites; the ASC 1 through 5 series; USSI with USAT 1 through 5; and others pending applications. There is a total of 124 satellites of the FSS group in position, ready for launch, under construction, or with applications pending. With patience and care, you can count them yourself, using the reasonably up-to-date U.S. Domestic Satellite (DOMSAT) Summary Table supplied by the Federal Communications Commission (FCC).

Of course, some of the satellites still orbiting in space, such as WESTAR I and SATCOM I, have been retired from service, the first in 1983 and the second this year. More will enter retirement shortly, since their design lives extend over a period of between seven and 10 years. With advanced engineering and experience, however, orbit life can be considerably extended, especially when the NASA Shuttle goes into the pick-up-and-repair business, the task depending on individual satellite importance and worth.

C-Band—Still King

With C-band downlink at a "mere" 4 GHz, even 5- and 6-watt transpond-

ers can reach most 10-to-12-ft. antennas without nature's problems. They are, however, subject to occasional interference from microwaves, which are extensively used for point-to-point ground communication. Nevertheless, virtually all ongoing commercial operations may well include video, telephone, teleconferencing, data traffic, major network service, cable, remote transceive activities at sea and in the oil fields, and others over old reliable C band.

According to National Cable Television Association's estimates, C-band activity is very stimulated. NCTA estimates that most of the 5865 U.S. cable systems and their 8579 head ends are receiving satellite service via 8000 dishes measuring between 4.5 and 7 meters in diameter. As for the networks, ABC has scheduled C-band service for the Pacific and Mountain time zones, and NBC will try Ku-band service via SBS with rather large receiving antennas and probably 20-dB carrier-to-noise (C/N) ratios to avoid most outages.

All in all, it is estimated that two-thirds of the 896 commercial U.S. TV stations and virtually all public-radio TV stations receive programming via satellites, bringing the total to more than 1000. Antennas for this service

measure between 4.5 and 15 meters in diameter, depending on CONUS or territorial station locations.

You might think that with such bustling space activity all geosynchronous parking slots would be quickly filled. But the \$50-to-\$100-million per equipment launch is a large sum, and satellites typically have short operating lives. In addition, there are now limited orbital positions set aside for Fixed C-and Ku-band Satellite Service and for DBS.

Parking Slots

The 1983 Regional Administrative Radio Conference in Geneva assigned eight orbital positions for U.S. DBS between 61.7° and 175° WL with 32 channels each for main service areas, 24-MHz passbands, and 10° service area separations. However, as many as eight satellites are permitted to be clustered together in a service area if they are spaced no closer than 0.4° apart.

Ku-band service can have almost 40 slots, C-band service another 40 parking positions with 2° spacing when this revised regulation takes effect by or before 1990. So there is little room for a sky full of "birds" at 22.3 km above *terra firma*—or so it would appear.

Channel Master



Owned by the largest TV antenna manufacturer in the U.S. (and perhaps the world), this earth-station satellite dish and electronics maker has just moved from Oxford into the huge former Sylvania TV manufacturing plant in Smithfield, NC. The single-story building contains 700,000 square feet of floor space and is said to be the "largest industrial plant ever sold in North Carolina."

Television receive-only (TVRO) operations are expected to occupy about 350,000 square feet of the plant. The remainder of the space is to be absorbed by TV antenna and allied electronics operations now in transit from Ellenville, NY, where Channel Master has been involved in cable and radio/TV antenna fabrication for many years. Upon completion of this move, all U.S. Channel Master activities will be con-

solidated under one roof. Receiver electronics manufacturing, however, will continue in Taiwan.

For home use, Channel Master manufactures TVRO parabolas with diameters of 2 meters and 8, 10, and 12 feet. Commercial models measuring 3.7, 4.5, and 5 meters are also available. The 8- and 10-foot antennas are formed from sheet molded composition (SMC) material, while the 2-meter and 12-footers are produced by resin transfer molding (RTM). The remainder are "hand-layup" types of fabric and resin.

The SMC process produces more accurate parabolas, where smaller dishes require better accuracies. Commercial and CATV products are called "micro-beam" and include SMATV distribution systems.

Just about now, Channel Master will be introducing new receivers and satellite microprocessor (SATSCAN) units with such features as programmable satellite locators, full-featured infrared remote controllers, and other improvements. General Manager Dave Waddington estimates that the industry has shipped 400,000 TVRO units this past year at average values ranging from \$1600 to \$1700. He also estimates a growth rate for the TVRO products industry at 20% per year.

Depending on dish size LNA, receiver and/or SATSCAN, the prices for Channel Master systems range from \$1500 to \$4000.

A good many of the geosynchronous sites have already been filed, as the FCC chart shows, and additional assignments are pending probable approval with each passing month. So it would be hasty to jump to premature conclusions. There are, indeed, considerable restraints on available space, and the U.S. satellite industry must abide by international commission rules.

Looking Into Space

As a limited exercise and a sample of what is to come in satellite antennas,

let us look at the spectrum-analyzer display from ANIK C2's 11.7-to-12.2-GHz downlink, the receive antenna, and its low-noise block converter at a bandwidth of 22 MHz (Fig. 2). To be able to make this measurement, the analyzer must be connected through an auxiliary 10-dB buffered LNB outlet and a 75-to-50-ohm impedance match is required, resulting in a 1-dB cable loss. Add these figures up, and you have an initial loss of 17 dB.

There is antenna gain and a probable 50-dB LNB signal amplification, indicating an incoming satellite

signal of about -100 dB. A look at the Anik C2 footprint reveals that Washington, DC has an EIRP of 48, which is not bad at all in terms of dBW. EIRP is obtained from the equation: $EIRP = P_{antenna} + G_{transmitter} - L_{power}$. $P_{antenna}$ is usually specified at 15 W, and L_{power} is usually -1. Therefore, $G_{transmitter} = 48 - 15 - (-1) = 34$.

Next, it would be nice to know true carrier-to-noise ratio. Additional math reveals: C/N (apparent) from

(Continued on page 81) ▶

Tape Dubbing For Car Stereo

How to optimize home-dubbed tapes for the car stereo environment

By Norman Eisenberg

With a car stereo cassette-tape system installed, you're ready to experience one of its big advantages—hearing the terrific sounds of your record library, dubbed to tape, while driving. You might think that all you have to do to copy your discs onto tape with your home cassette deck is simply a matter of putting the record on your turntable, popping a blank cassette into your deck, and pressing the record button. Though this carefree approach might work, there's a lot about stereo sound in a moving vehicle that requires some special attention if you want to get the most from your home dubbing efforts.

Consider The Environment

Perhaps the most important factor to consider is the vast difference in noise

levels between those normally encountered in a home listening environment and those in a moving vehicle. A really quiet domestic environment might have an ambient (prevailing) noise level of about 35 dB (decibels). You can't expect to get this degree of quiet in any vehicle, not even the plushest, best-insulated luxury car with the windows rolled up, no heating or air conditioning on, the wipers turned off, and your vehicle maintaining an optimum cruising speed. In fact, the car's ambient noise level is almost certain to be greater than in a home environment if the same vehicle is standing still.

Of course, depending on the vehicle's design, traffic conditions, and the nature of the road, the interior ambient noise level (or "noise floor" as it's sometimes called) of a vehicle can be anywhere between 35 and 75 dB with the windows rolled up. Turning on the vehicle's heater or air conditioner adds about 10 dB to the fig-

ure. And rolling down the windows while driving at a constant speed in light to moderate traffic adds another 15 dB to the noise figure.

Whatever a given ambient noise level at the moment, expect it to increase whenever you accelerate, blow the vehicle's horn, or shift through the gears (with a manual transmission, of course).

The music reproduced by your car stereo system, then, must ride over the car's noise level of you wish to hear it with some reasonable clarity. Since every additional 3 dB of sound level involves a doubling of amplifier power (wattage), you can begin to understand why some of today's car stereo power ratings rival those of home music systems.

The 1 or 2 watts of power supplied by the old car radio could, of course, provide sound, but it is very limited in dynamic range, as well as frequency response. The attempt by manufacturers to give the driving public

Normal hookup in the tape-monitor loop of a stereo receiver or integrated amplifier does not permit adjustments, since the signal to the cassette recorder comes before the tone controls. With this setup, you have to settle for what you can get.

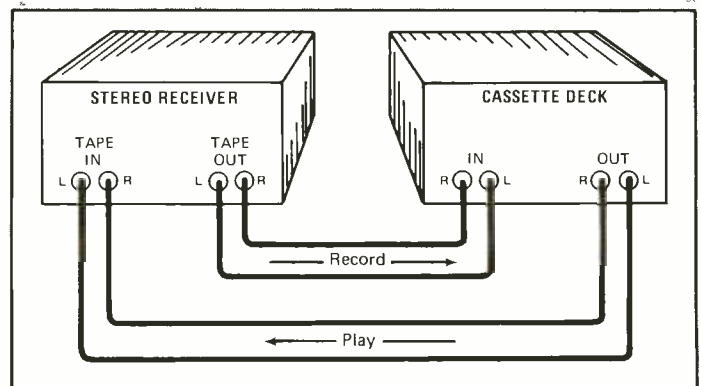

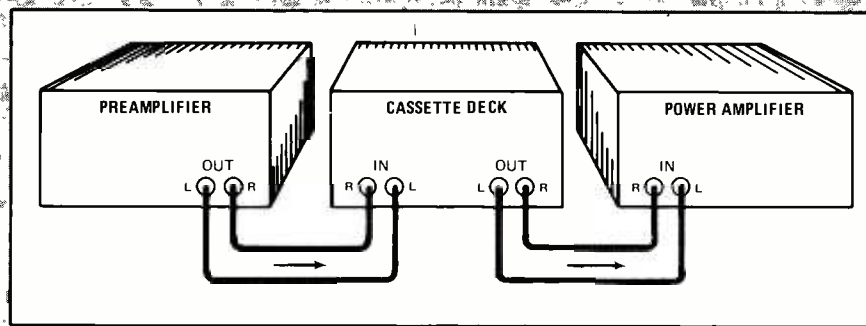

In systems that have separate preamplifier outputs and power amplifier inputs, full adjustment is possible when the recorder is connected as shown here. Here, the signal into the recorder comes after the tone controls.

something far better than the traditional car radio provides, not to mention the relatively modest efficiency of the better car speaker systems currently being sold, explains the greater power-output capability of today's car stereo sound systems. It also influences what you record at home to play through your car stereo tape player. It means that you must use somewhat higher recording levels than you might otherwise consider when recording for playing through your home stereo system.

Recording Procedure

Higher recording levels means a little more than simply allowing your home cassette deck's meters or displays to hit higher marks. You want sound that's sufficiently loud to hear in the noisy vehicle environment. In addition, you want what you hear to be as clear and as distortion-free as possible. In recording terms, this means getting the softest passages in a given musical selection to ride just above the vehicle's noise floor. At the other extreme, you want the loudest passages to remain below the tape deck's own tape-saturation, clipping, and distortion ceiling.

For optimum playback in a car stereo system, you'll have to exercise more care when recording than you would for making a tape for playback through only your home cassette deck. To begin with, the better a

given cassette deck, especially in terms of headroom and distortion, the better the chance of obtaining satisfying results when recording tapes for use in vehicles. Also of importance is the choice of tape type.

Assuming your home cassette deck has controls (or pushbuttons) for allowing you to optimize bias and equalization, high-bias cassette tapes are preferred over standard low-bias ferric-oxide tapes. If you use metal-particle tape, you can expect up to 8 dB greater headroom in the highs and perhaps 2 or 3 dB more headroom in the midrange in a good-quality cassette deck. Interestingly, many TV commercials are made to sound louder than the normal programs because the midrange has been slightly boosted during recording, not because someone in the studio has boosted the overall signal level. This trick actually makes the audio louder while keeping within the legal modulation limits of the broadcast signal.

You can do essentially what the sound engineers do for TV commercials for your tapes, though you'll have to arrive at the desired results by trial and error. Begin by making the best tape you possibly can, writing down the level settings used and the minimum and maximum swings of the signal meters or displays. Most instructions for recording on tape tell you to keep the recording level indicators below the 0-dB mark. This is a

good general rule to follow when recording for playback in a home listening room, but the 0-dB mark is not sacrosanct. Occasional excursions beyond the 0-dB mark, into the +dB range, are permitted for brief loud passages. With a good-quality recorder and good grade of tape, such occasional violations will likely produce no audible distortion on playback when recording your on-the-road tapes.

Play the tape in your car, listening for passages that sound too weak or too loud. Then go back with the same tape and rerecord the same selection, this time adjusting recording levels accordingly. Write down the new recording levels used. You may have to repeat this procedure several times before arriving at the optimum recording levels.

If you're recording a series of short selections, you may have to go through this procedure for each selection, unless you can hit on an average for the whole group that produces results that satisfy your listening tastes. This procedure may involve a lot of work, but it's worth the effort if you end up with the best-sounding home-recorded tapes you can find anywhere.

Other Considerations

There's no problem in playing back a high-bias or metal tape in a car stereo system that lacks a tape selector switch. Bias is an important consideration only in the recording process—not on playback. So, if you have a metal tape, feel free to play it in any car stereo cassette player.

With regard to equalization, you have only two variations: 120 μ s (microsecond) that applies to all low-noise ferric-oxide tapes, and 70 μ s that is used for all other types of tape, including metal. Most recent-vintage car cassette players feature a switch that permits you to select the equalization required for different tape formulations. But even if your player

Some receivers and integrated amplifiers offer pre-amplifier output and power amplifier input jacks that give almost as much adjustment latitude as is possible in separate-component stereo sound systems. That is, the system's tone controls can be used to tailor the sound while dubbing.

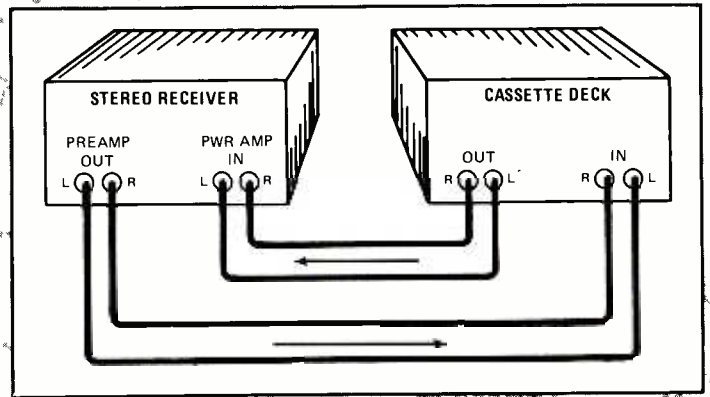

doesn't, you can approximate the 70- μ s equalization by cutting back on the treble control during playback.

Cassette size, in terms of playing time, also has a bearing on results obtained. Avoid using a C-120 (120-minute) cassette. The long playing time of these cassettes is obtained with thinner tape that lacks the capabilities and durability of the thicker tape used in C-90 and C-60 cassettes. It also places more of a strain on the motors and transports of both your home and car tape decks.

If you use C-120 cassettes, you run the risk of a number of mechanical problems. Among these are speed irregularities, jamming of the tape, and tape snarling. From a practical point of view, then, the best size cassette to use in your car tape player is the shortest length required for accommodating a given program. Better decks will do fine with C-90 cassettes, but you'll probably be even better off with C-60 cassettes.

One of the things you'll have to take into account when recording for playback in a car cassette deck is program selection timing. You'll have to time your dubbing to avoid an unpleasant break in the music at the point where the tape runs out in one direction and reverses itself. You really have to plan your program carefully, noting timings of individual selections or movements, the lat-

ter when dubbing a long symphony or concerto. Also, choose some appropriate selection to go with the main piece you're dubbing, just in case you have to fill a portion of the tape. Long stretches of blank tape running in your car stereo can be annoying and distracting.

All the rules you've heard or read about cleaning your tape deck apply with greater emphasis for car tape players. Tape heads should be cleaned after eight to 10 hours of use. Cotton-tipped swabs, dipped in isopropyl alcohol will do nicely. If you cannot gain access to the heads, you can use any of the brand-name cassette tape cleaners on the market.

Degaussing need not be performed as often as you do head cleaning. A good interval to observe is to degauss after every 30 to 50 hours of play. A handheld electrical degausser is the recommended tool, but a degaussing cassette can serve as well in decks where the heads are inaccessible.

Bending The Rules

Some rules you may have read or heard regarding tape dubbing at home can be bent a little when rolling your own for playback in a car. For example, you may have heard that

(Continued on page 92)

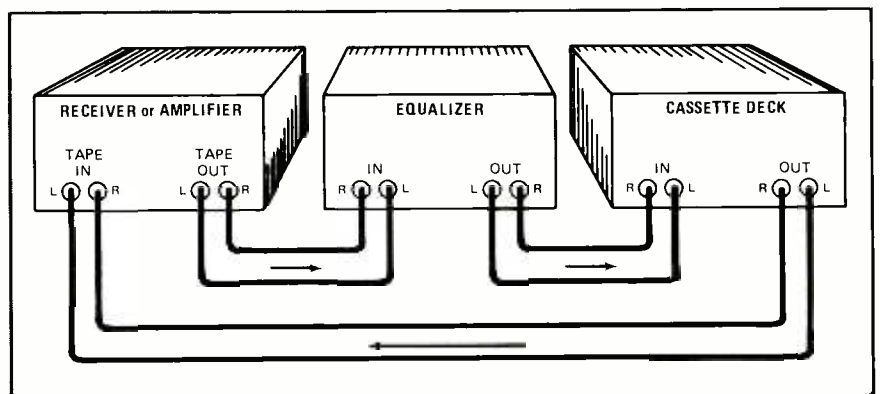

Graphic equalizer permits widest possible tonal adjustments while dubbing when connected so that signal paths are as shown.

A Great Gift Idea

**DON'T LET THE ELECTRONICS
REVOLUTION PASS YOU
OR A FRIEND BY!**

SUBSCRIBE TO



Now you can reach out every month and learn about the latest innovations in consumer electronics and personal computers—what's new, how products and circuits work, and what leading authorities think of them.

- *Stereo *Video *Home & Car Electronics
- *Test Instruments *Circuitry & Devices *Servicing
- *Personal Computers *Communications *Construction Projects

In every issue, authors lucidly explain how exciting, new electronics ideas are applied . . . issue forthright buying counsel . . . present complete plans to build electronic devices to enhance products, even unique ones that are not yet being sold in the marketplace.

Feature articles, tutorials, and construction projects are the hallmarks of MODERN ELECTRONICS, the new monthly magazine for electronics and computer enthusiasts. Covering the entire spectrum of these fields, you'll gather insights in every important area to help you make buying decisions for work and play purposes . . . improve performance of your present equipment . . . increase your electronics competence . . . and add to your practical and intellectual knowledge of electronics and computers.

To be sure you get this valuable information delivered to you regularly, and share the experiences of our writers and editors—Forrest Mims, Len Feldman, Stan Prentiss, Charles Rubenstein, Glenn Hauser, and many others—you can subscribe to MODERN ELECTRONICS today. As a Charter Subscriber, you'll save 45% off the newsstand price when you buy a one-year subscription for only \$12.97. Or save 51% when you subscribe for two years at \$22.97.

Acting now you won't miss any of our exciting upcoming features, such as Comparing Color TV Sets, Circuit Designing from Scratch series, Automotive Security Alarms, Correcting Apple IIe Monitor Flaws, Adjustable Power-Supply Designs, Computer Peripheral Switching, and much more.

Just fill out the coupon and mail with your check, money order, or credit card information (Visa or MasterCard) to enter your Charter Subscription. Do it today to ensure earliest delivery!

MODERN ELECTRONICS 76 North Broadway, Hicksville, NY 11801

Please send me Modern Electronics for 2 Years 1 Year

Name _____
 Street _____
 City _____
 State _____ Zip _____

2 Years (24 issues) \$22.97
 1 Year (12 issues) \$12.97

Charge My Order To: Payment Enclosed \$ _____

MasterCard

VISA



My account number is:

--	--	--	--	--	--	--	--	--	--	--	--	--	--	--	--	--	--	--	--

TECHNICIANS!

**We Have What You Need At
The Prices You Want!**

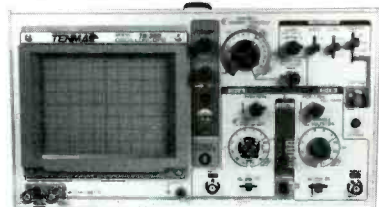

TENMA
20MHz DUAL TRACE
OSCILLOSCOPE

\$389.95

Backed By Our 2 Year Warranty
High Quality 10:1 Probes Included

#72-320



TENMA
DIGITAL
MULTIMETER
HFE TEST
0.5" LCD display
DC input impedance
10MΩ

\$39.80

#72-050

AGC FUSES
STANDARD
1 1/4x1/4

25A 4A
5A 5A
7.5A 6A
1A 7A
1.5A 8A
2A 10A
2.5A 15A
3A 20A
(100-up pcs.)
(NO MIXED QTYs.)

3.5¢
each

36 PIN PARALLEL
CONNECTOR



\$3.95
#83-310

PANASONIC 2-4 HOUR
VIDEO HEAD REPLACES
PANASONIC PART #VEH-0070



#32-160
\$39.95

JAPANESE SEMICONDUCTORS

• A768 .38	• D900 2.85
• C1826 .34	• D1341 1.92
• C2027 1.69	• BUY69A 2.85
• C2810 .48	(min. 10 pcs.)
• 4164-150NS 4.60	(min. 9 pcs.)

**We have the Largest
Selection of Original
Japanese Semiconductors
in the Country!**

We Also Have... a full line of: test equipment, computer accessories, telephone accessories, speakers, television parts, flybacks, yokes, switches, fuses, lamps, capacitors, resistors, cartridges, styli, wire, CATV equipment, and many more. **Over 4,500 items AT THE LOWEST PRICES AROUND!**

- Terms:**
- \$10 minimum order. \$1.00 charge for orders under \$10.
 - \$20 minimum charge card order.
 - Orders shipped UPS C.O.D.
 - Most orders shipped within 24 hours.
 - Sales office open 8:30am to 6:00pm. Saturdays 10:00am to 3pm, EST.



**CALL TOLL FREE
1-800-543-4330**

(in Ohio, 1-800-762-4315)

mcm THE ONLY
ELECTRONICS
PARTS COMPANY
YOU'LL EVER
NEED

858 East Congress Park Drive
Centerville, Ohio 45459
513-434-0031

**CALL OR WRITE TODAY
FOR YOUR FREE 128 PAGE
CATALOG! OVER 4500 ITEMS!**



PRICES SUBJECT TO CHANGE WITHOUT NOTICE

SOURCE NO. ME-1

CIRCLE 67 ON FREE INFORMATION CARD



The Amdek Color 600 hi-res RGB monitor.

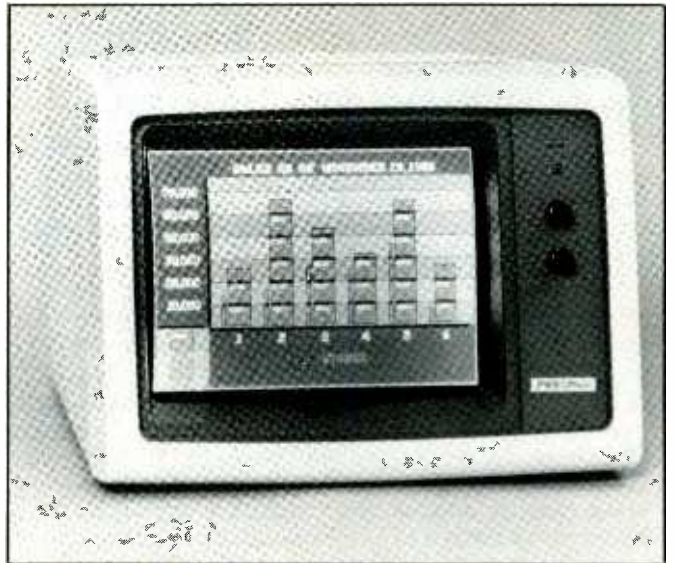

Princeton Graphics' Model HX-12 hi-res RGB color monitor offers outstanding resolution on its 12" screen.

Color Video Monitors For Personal Computers

*Getting a handle on what they are, what they do,
and defining your needs*

By Fred Blechman

If you own a late-model micro-computer that generates high-resolution color graphics, you'll find that you need a high-quality color video monitor to be able to view what it can display. Until recently, you could use a high-resolution com-

posite-video color monitor for this. Beginning a few years ago, however, a new trend was established, making your choice of video monitors more restrictive. New microcomputers coming into the marketplace are frequently supplied with video output connectors designed to feed only *RGB* video monitors.

The upshot of this is that buyers and users of these newer RGB-only computers are faced with another

confusing factor to consider. So let's cut through the mystery that appears to surround the subject of color video monitors. To set the foundation of our discussion, we'll lead off with an explanation of the differences that exist between the prevailing composite-video and RGB monitors and discuss the different "standards" that pertain to RGB monitors. We'll finish up with some comments on different manufacturers' offerings in RGB

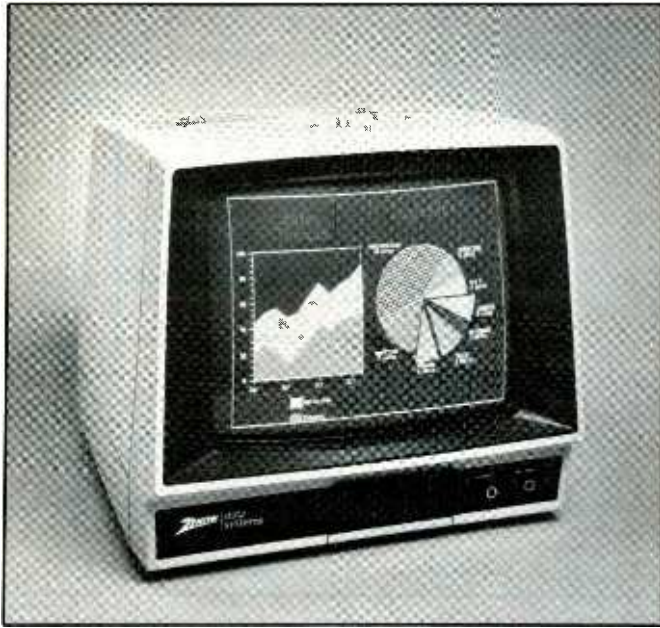

The Sakta 13" hi-res RGB color monitor.

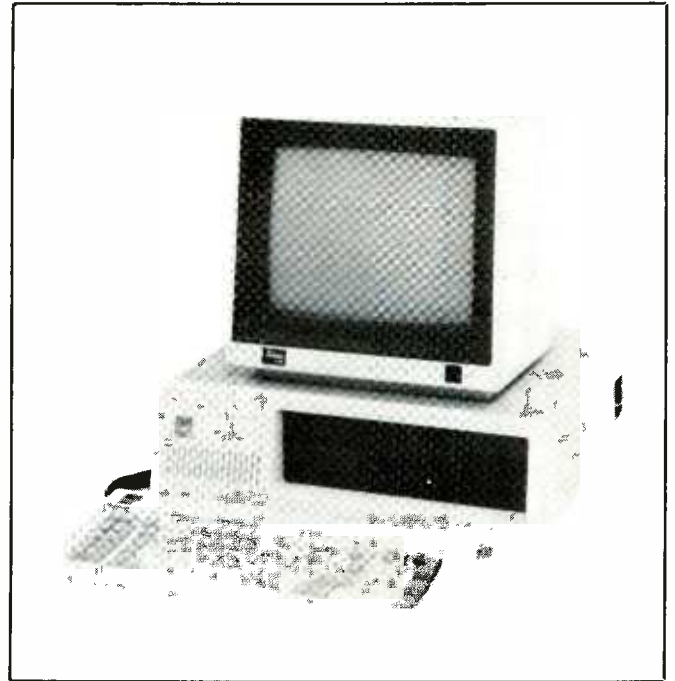

Zenith's Model ZVM-133 RGB color monitor permits sync polarity programming and has a green-screen-only switch.

monitors, based on "eyeball" tests and include information about other such monitors that we didn't have the opportunity to examine.

Before we start, however, here's a caveat: Beware of claims made by manufacturers. Unless a claim is based on an actual standard that's fully spelled out and adopted industrywide, a manufacturer is free to (and often does) make his own interpretation. Claims like "medium," "high," "ultra-high," and "super-high" with regard to resolution are not based on a standard, and, hence, are open to interpretation.

Composite Monitors

As you probably already know, color video monitors are available in various designs. Among the most prevalent are composite-video, RGB TTL (digital), and RGB analog. Let's deal with composite-video monitors first.

The term "composite" is derived from the makeup of the standard broadcast television signal as it's sent out over the airwaves in the U.S. This

signal is a composite of all the video, color, audio, and synchronization "sync" signals required to provide picture and sound in a TV receiver. The composite signal is usually referred to as the NTSC (National Television Systems Committee) standard. This composite signal is generally available through a phono jack located on the rear of computers and labeled MONITOR.

A composite monitor is designed to accept this signal, separate it into its component parts, amplify the video and audio portions, display the picture on the screen of the CRT, and feed sound to a (usually built-in) loudspeaker. In essence, a composite video monitor is a TV receiver minus antenna input and tuner. The composite monitors that offer true high-resolution (or better) displays are, of course, superior in performance, particularly picture quality, to the typical TV receivers.

The process of combining signals and then separating them into their component parts introduces distortion. This distortion, plus the various

undesired side effects of harmonics, beat frequencies, and oscillator instability, combine to cause "crawlies" or interference patterns that appear in the displayed picture.

Though a composite monitor will produce a far better picture than can be obtained by connecting a computer to a TV receiver through its antenna input via an r-f modulator, the result still leaves much to be desired in terms of picture quality, particularly with reference to alphanumeric text-intensive screens.

You might ask why, then, have composite monitors become so popular? The obvious answer is that they represent a step up from less-than-adequate TV receiver displays. But that's not the only reason for their popularity. More importantly in today's heavy word-processing applications world, an absolute necessity exists for a monitor that can handle the more than 40-character lines and more than 320 graphics dots ("pixels") required per line that represent the limits for a standard TV receiver. Another telling factor is that the typi-

“RGB monitors make possible the cleanest displays.”

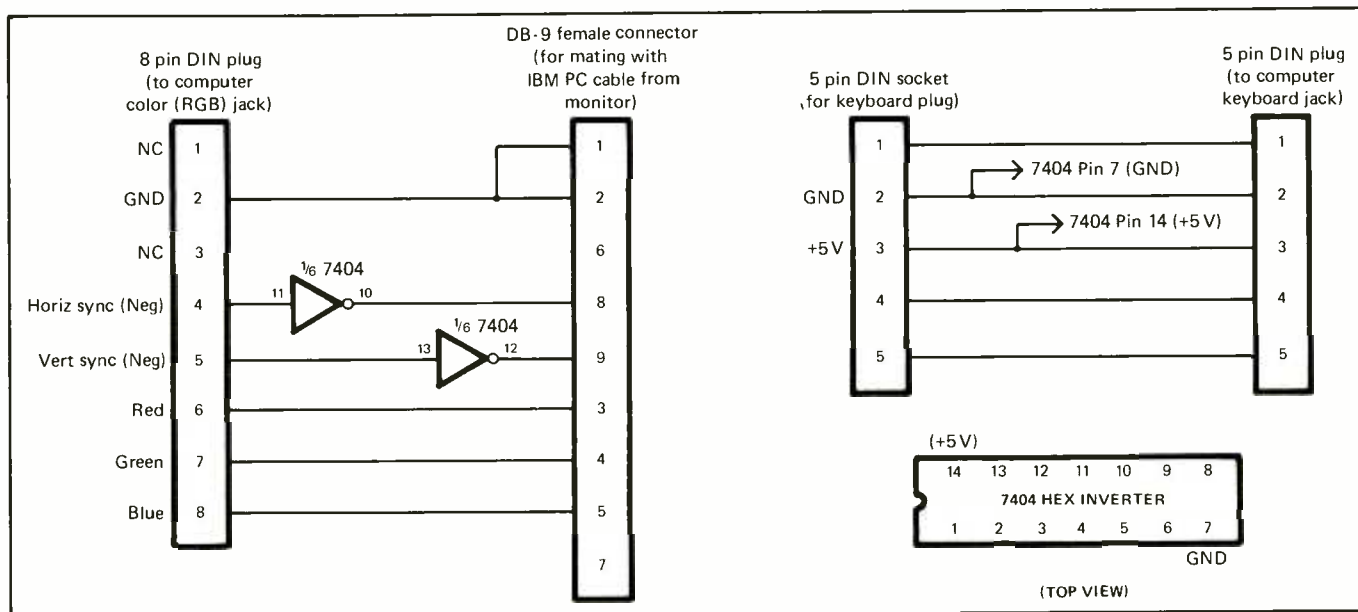

Sync inverter “fix” for Sanyo MBC 550/555 series and other Japanese computers that use negative sync pulses involves use of a hex inverter and simple wiring of cables and connectors as shown here.

cal composite monitor costs only about half of what you would have to pay for the *average* RGB monitor. Cost often being the determining factor in computing systems not bought for wholly business purposes, it’s not surprising that many people choose a composite monitor where a choice exists between it and the RGB.

RGB Color Monitors

To meet the high and ultra-high resolution needs of today’s more sophisticated microcomputers, RGB monitors—long used in industry—make possible the cleanest displays. The RGB appellation stands for the red, green, and blue chroma “channels” used to excite the phosphor dots (or stripes) in the color CRT. Varying amounts of each of these colors, whether in TV reception or in displaying color computer screens, can create any color in the rainbow. In the RGB monitor, instead of having to go through various forms of electronic manipulation to provide a composite signal, each of the three primary colors is processed in its purest form by its own separate channel.

As previously cited, there are basically two different types of RGB monitors—*analog* and *digital*. The latter is usually referred to as *TTL*. The analog variety is rarely found in the microcomputer world and is mentioned here only to inform you that it does exist.

RGB *TTL* monitors process 0- to 5-volt digital signals. But the *manner* in which any given monitor does so can take either of two forms, which reveals another area in which a standard is sorely needed. Some RGB monitors process only negative-going signals, others only positive-going signals, and still others either polarity signals. Synchronization can be positive or negative. It’s sometimes carried on the green signal, in which case it’s called “composite sync.” Usually, the horizontal and vertical sync pulses are separate.

Most RGB *TTL* monitors provide an “intensity” input that permits the use of 16 colors instead of the usual eight for which most microcomputers are set up. But if you have a computer that issues an intensity signal, you are able to access the second battery of eight colors if you wish to.

In addition to the profusion of possible RGB signal combinations and polarities, there is also very little standardization relating to input connectors on the monitors or output connectors on the computer with which they are used.

Picture Resolution

Color monitors, by their very nature, are not capable of producing as sharp a display as a good monochrome monitor can. The difference has to do with the way the phosphor coating is laid down on the inside surface of the CRT’s screen. A monochrome screen is composed of a continuous coating of phosphor made up of microscopically small particles, each of which is capable of glowing when struck by high-speed electrons from the CRT’s electron gun. A color screen, on the other hand, is composed of tiny depositions of individual red, green, and blue areas that are generally laid down in a dot-triad arrangement.

Each triad arrangement is composed of one red, green, and blue dot. The distance between the dots is called “dot pitch” and is normally expressed

in millimeters. Obviously, the smaller the dot-pitch distance, the higher the resolution capability of the screen, assuming the monitor's "bandpass" is also relatively high.

Manufacturers' specifications are sometimes exaggerated and frequently incomplete. Even though bandpass is usually quoted (the higher the number the better), the dot-pitch specification (the lower the better) may be the limiting factor in the monitor's resolution capability. That is, a given monitor's picture tube might have a very small dot pitch, but if its bandpass (in megahertz or MHz) isn't up to snuff, the advantage of a super tube is wasted.

Since the very popular IBM Personal Computer (IBM PC) offers a high-resolution screen composed of 640 dots horizontally by 200 dots vertically, most manufacturers claim this as the resolution for their monitor—even if the displayed images are fuzzy. Because sharpness (another way of expressing resolution) is a visual perception that is difficult to define, manufacturers sometimes make claims based on what they think customers want to hear and not on actual performance.

Display quality really being in the eye of the beholder, the stiffest test to which a monitor can be subjected is to compare it side by side with another monitor for which the same or similar claims are made. Of course, both monitors should be displaying the *same* picture at the time of the comparison. This way you'll be able to judge the veracity of the claims, not just take the manufacturers' word for it. By making side-by-side comparisons, you'll find that most monitors provide a readable, though not necessarily a sharp, picture. The difference is revealed mostly in displays of alphanumeric text material, rather than in picture graphics.

Sync Inverter

Since most RGB monitors support the IBM PC "standard" RGB signal (positive separate sync), they won't

Test Results

The best way to conduct tests on video monitors is not with sophisticated test equipment, but with your own eyes. After all, the quality of the displayed image is all that really matters. Consequently, the following comments on four popular models of RGB TTL video monitors are based on side-by-side "eyeball" comparisons, rather than on the results obtained with meters, spectrum analyzers, and such.

Dynax FORTIS FC10

Manufacturer: Dynax Inc.
5698 Bandini Blvd.
Bell, CA 90201
(213-260-7121)

Price: \$599

Bandpass: not specified

Dot pitch: 0.43 mm

Comments: This 13" monitor provided readable, but not sharp, text definition at 80 characters per line. Color was good, but it was not possible to center the screen. A green-only switch is provided for users who wish to use it for text display. Adjustable front legs permit the screen to be tilted. Only separate positive sync is supported. A shielded cable for use with an IBM PC is provided.

Princeton Graphics Model HX-12

Manufacturer: Princeton Graphic Systems
1101-I State Road
Princeton, NJ 08540
(609-683-1660)

Price: \$695

Bandpass: 15 MHz

Dot pitch: 0.31 mm

Comments: The 12" monitor provided the sharpest display of those tested. It centered easily. Princeton claims outstanding resolution, and examination confirmed the claim. The HX-12 requires separate positive sync input. A shielded cable for use with the IBM PC is included.

Sakata Model SC-200

Manufacturer: Sakata USA Corp.
651 Bonnie Lane
Elk Grove Village
IL 60007
(312-593-3211)

Price: \$649

Bandpass: Not specified

Dot pitch: 0.39 mm

Comments: The appearance of alphanumeric text on the 13" screen of this monitor was excellent (about the same as on the Taxan Model 420), and centering was very broad and smooth. Especially good contrast was provided by a black-faced picture tube. However, proper yellow was not obtainable, which appeared an orange/brown in the display. All others of the remaining seven colors, including black, were fine. Since there are normally no external color controls on an RGB monitor, this situation was not correctable. This monitor accepts only separate positive sync signals. It is not supplied with a cable to the computer.

Taxan Model 420

Manufacturer: Taxan Corp.
18005 Cortney Ct.
City of Industry,
CA 91748
(818-810-1291)

Price: \$595

Bandpass: 18 MHz

Dot pitch: 0.38 mm

Comments: This was the only monitor tested that, using a three-position switch and two connectors on the back, permitted almost any configuration of RGB TTL signal to be displayed. It has a nonflare 11" CRT. Horizontal positioning of the display was excellent. Text was very easy to read, though, naturally, not as crisp as on a good monochrome monitor. A cable is provided for use with the IBM PC.

work "as-is" with some computers. A typical case in point is the Sanyo MBC 550/555 series and other Japanese microcomputers that use separate *negative* sync pulses. Some RGB monitors (for example, the Taxan Model 420) have an external switch that can be set to allow them to accommodate either positive or negative sync pulses, while yet others allow sync polarity to be selected with internal switches or jumpers.

If the RGB monitor you want (or have) requires positive sync pulses and your computer outputs only negative sync pulses, you can obtain the proper polarity for interfacing the two with a sync inverter adapter. The "SanSync" inverter shown in the drawing was designed by David Vereeke specifically for Sanyo MBC 550 series computers. It's typical of the genre. This adapter gets its power from the computer itself, taken from the keyboard connector.

If you have a Sanyo MBC 550 or 555 computer and need an RGB inverter, you can build one yourself—if you can find the required connectors—or buy it already assembled from A-OK Computers (816 Easely St., Suite 615, Silver Spring, MD 20910; telephone: 301-585-5105) for \$37.95 plus \$1.20 for postage and handling.

What To Look For

When shopping for an RGB monitor, make sure it will handle the signal output configuration of your computer. As pointed out, the major variation to be on the lookout for is in the polarity (positive or negative) and method of delivery (composite or separate) of the sync pulses.

Bear in mind that the higher the quality of the monitor, the more you're likely to spend for it. Look for a model with a bandpass of no less than 12 MHz and a dot pitch of no greater than 0.39 mm. Although a narrower bandpass and wider dot pitch will still give you a readable display, text characters will be more tiresome to read. If your only interest

is in displaying graphics, however, you may find "looser" specifications perfectly adequate.

The Marketplace

During preparation of my latest book, I had the opportunity to test a number of popular RGB TTL video monitors. The results of my side-by-side "eyeball" comparisons are summarized in the "Test Results" box

elsewhere in this article, along with particulars for each model.

To make this article as meaningful as possible (and to satisfy my own professional curiosity), I also studied the literature from manufacturers whose RGB monitors enjoy a relatively high degree of popularity in the personal computer products marketplace but weren't subjected to tests. The results of my studies are presented in the "Without Comment" box.

Without Comment

The following listing is of models of RGB TTL video monitors that were *not* examined during preparation of this article. It is presented here to give you a broader idea of what's available in the marketplace. The listing is not complete. Rather, it is representative of the marketplace. All information is taken directly from manufacturers' literature and stands without comment.

Amdex Color 600

Manufacturer: Amdex Corp.
2201 Lively Blvd.
Elk Grive Village
IL 60007
(312-364-1180)

Price: \$650

Bandpass: not specified

Dot pitch: not specified

General: A switchable color matrix allows this monitor to display the full 16 IBM or Apple colors. A "text" switch on the front panel changes text color from white to green. Built in are an audio amplifier, speaker, and headphone jack.

Bright Up Model CC1411

Manufacturer: Bright Up Industries Co., Ltd.
7158 Industrial Park Blvd.
Mentor, OH 44060
(216-951-0144)

Price: \$574

Bandpass: not specified

Dot pitch: 0.39 mm

General: This monitor has a 14" screen. It also has an internal adjustment for positive and negative sync and comes with an attached cable for the IBM PC.

Comrex Model CR-6800

Manufacturer: Comrex Int'l. Inc.
3701 Skypark Dr.
Suite 120
Torrance, CA 90505
(213-373-0280)

Price: not specified

Bandpass: 22 MHz

Dot pitch: 0.32 mm

General: This 14" monitor offers switchable sync polarity. No mention is made of a cable to the computer.

Zenith Model ZVM-133

Manufacturer: Zenith Data Systems
1000 Milwaukee Ave.
Glenview, IL 60025
(312-391-8949)

Price: \$559

Bandpass: 20 MHz

Dot pitch: 0.41 mm

General: This 13" monitor has negative sync available by using the proper pins on its DB-25 input connector (a unique approach) and a green-screen-only switch. No mention is made of a cable to the computer.

Computer problems? DON'T BLAME THE SOFTWARE!

Isolators prevent:

Pat. # 4,259,705

- CPU/printer/disk interaction
- Lightning or spike damage
- AC power line disturbances
- RFI-EMI interference



Commercial Grade Isolators

- ISO-1 3 Isolated Sockets \$ 81.95
ISO-2 2 Isolated Socket Banks, 6 Sockets \$ 81.95

Industrial Grade Isolators

- ISO-3 3 Double Isolated Sockets \$122.95
ISO-11 2 Double Isolated Banks, 6 Sockets \$122.95

Laboratory Grade Isolators

- ISO-17 4 Quad Isolated Sockets \$213.95
ISO-18 2 Quad Isolated Banks, 6 Sockets \$180.95

- Circuit Breaker, any model (Add-CB) Add \$ 11.00
Remote Switch, any model (Add-RS) Add \$ 20.00

ESP Electronic Specialists, Inc.

171 S. Main St., Box 389, Natick, Mass. 01760 (617) 655-1532

Toll Free Order Desk 1-800-225-4876
MasterCard, VISA, American Express

CIRCLE 76 ON FREE INFORMATION CARD

MICROWAVE TV ANTENNA SYSTEMS

Freq. 2.1 to 2.7 GHz . 34 db Gain +

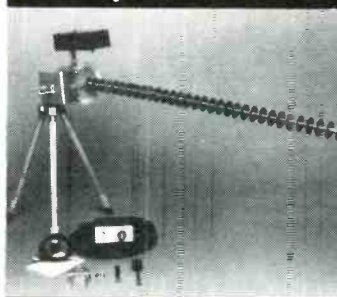

LIFETIME LIMITED WARRANTY
PARTS & LABOR

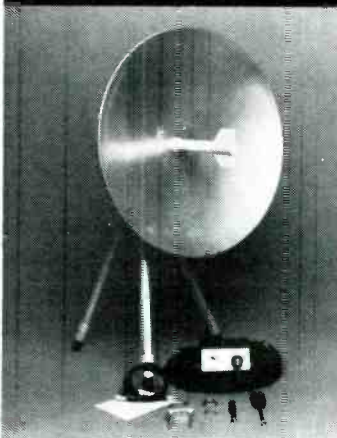

COMPLETE SYSTEMS:

- (as Pictured)
Commercial 40" Rod Style \$99.95
Parabolic 20" Dish Style \$79.95
COMPONENTS
Down Converters (either style) \$34.95
Power Supplies \$24.95 (12V to 16V. DC+)
Data Info (Plans) \$ 9.95

CALL OR WRITE FOR
KITS, PARTS, OR MORE
INFORMATION

Shipping & Handling Add \$5.00
We Repair Most Types Down
Converters & Power Supplies

Phillips-Tech Electronics

P.O. Box 34772
Phoenix, AZ 85087
(602) 967-8972

Special Quantity Pricing
Dealers Wanted



CIRCLE 53 ON FREE INFORMATION CARD

Learn micro-processing with the new MICRO-PROFESSOR 1P



Students, engineers or technicians—
upgrade your micro-processing skills
with the new Micro-Professor 1P.

The MPF-1P features:

- extensive software support
- more built-in memory
- improved keyboard
- larger display

Three tutorial guides help cover all
capabilities. The ideal training tool!
MPF-1P will deliver you into the growing
world of micro-processing. Invest now!

Plus—FREE GIFT Only \$179.95
Add \$5.00 for ship & hdg

Check this box for FREE
Z-80 Microprocessor
Programming and
Interfacing textbook when
you order within 7 days.
\$12.95 value.

ETRONIX

Dept. RE194
14803 N.E. 40th
Redmond, WA 98052

For immediate action call TOLL FREE:
1-800-426-1044

Full money back guarantee.



CIRCLE 66 ON FREE INFORMATION CARD

KNAPCO

MOV'S V130-LA-10A
SPIKE ELIMINATORS
10/\$9.90 \$1.29
HEAVY DUTY SOLID-STATE RELAY \$6.95
3 CONDUCTOR EQUIPMENT CORDS \$2.69
115 V. BLOCK FANS \$2.95
MOTOROLA CRT DISPLAY MONITORS \$49.95

Tri-Color LEDs Red/Green Yellow A.C. 69¢
AN INNOVATIVE 20 MHz OSCILLOSCOPE THAT EMPHASIZES OPERABILITY
\$535 SPECIAL \$495.
ANALOG OSCILLOSCOPE

"AUTO LIGHT-OFF"
AUTO LIGHT OFF UNIT
ADJUSTABLE DELAY
2/12V 10 AMP
RELAY TRIGGERED CIRCUITS
SOLD SEARS \$39.95 \$3.95
SGL WABER Linegard
SONALERTS #SC628 \$3.95
PROJECT CASE \$9.95

POWER SUPPLIES
CONDOR POWER SUPPLIES \$34.50
CONDOR #CS-6.0VPP \$39.95
Power One POWER SUPPLY \$39.95

POWER INVERTER
12V. to 115V. Tripp Lite 450 Watt \$89.95
PV400
S1 POWER SUPPLY \$1
NEW \$29.95
4 WATT AMPLIFIER \$99¢

Voltage Regulator
Boards Just hook up to transformer \$1.29
ADJUSTABLE BOARDS 4.5V. to 18V.DC \$1.95
RFI FILTERS \$1.99
SHIELDED RS-232 SERIAL CABLES \$9.95

Piezo Elements 100/20. 39¢
TRANSFORMERS \$4.95
Jumbo LEDs 100/\$5.00
Specialty Chips \$2.25

SEND FOR FREE CATALOG
or call us at (813) 392-0406

add 10% for shipping and handling min. shipping charge \$2.50
H.J. Knapp of Florida, Inc.
4750 96th St. N. St. Petersburg, Florida 33708



CIRCLE 43 ON FREE INFORMATION CARD

Using & Misusing Multimeters

Here are a host of tips on getting the most service out of a multimeter

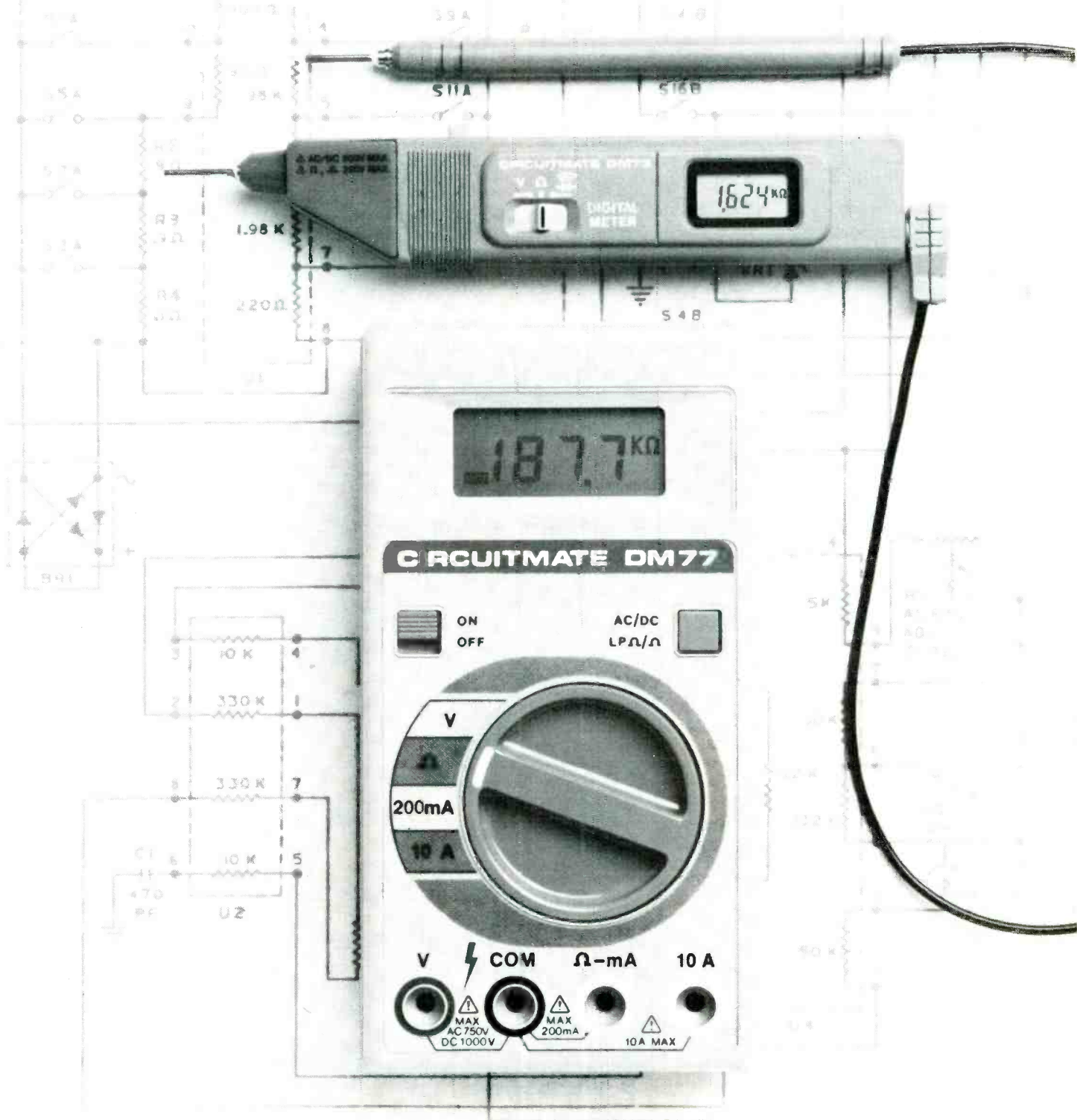

By Gary McClellan*

A multimeter is probably the most useful electronic test instrument one can own. Use it properly, take good care of it, and it'll give you many years of circuit troubleshooting and other measurement applications. If you don't, however, you may get some unpleasant surprises, ranging from incorrect voltage and resistance readings to an inoperative tester; maybe even an electrical shock. To avoid these problems, it clearly pays to take some time to learn more about your multimeter. Here are some guidelines.

1. Whether you're an old pro or just unwrapped your first multimeter, read the operator's manual that accompanies the instrument as carefully as possible. Besides the basic how-to-use-it information it contains, you may discover a bonus or two. For example, one manual for a multimeter I use shows you how to build a simple transistor tester accessory for it. Others I've read discuss testing a variety of components, and describe the use of helpful accessories such as high-voltage probes, r-f probes, and so on.

In addition to digesting the basics presented in a manufacturer's manual, it's a good idea to write useful information inside the front cover of the booklet that can help you with insurance in the event of a theft or if you lose the instrument. This should include the model number, serial number, purchase date and price.

2. Building upon what's in the manual, you should understand just what the multimeter's capabilities are. Not understanding this is the most common reason why users misuse their instruments. For example, if you tried to measure a 20-kHz ac signal on your meter, but didn't realize the manual indicated a 400-Hz ac re-

sponse, your reading will be *wrong!* Doing this without thinking, you'll believe that there's a defect in the circuit, wasting troubleshooting time.

So the rule is: Know the limitations of your multimeter. Don't overload voltage and current ranges by applying too much voltage and current to the instrument. If you think you might exceed the DMM's ratings, use a high-voltage probe for the voltage ranges and an external high-current shunt for the current ranges. And never under any circumstances apply voltage to the ohms ranges! Though today's multimeters will withstand momentary overloads, there are limits to how much abuse they can withstand without damage, particularly the lower-priced models that have less extensive overload protection.

Here's an embarrassing story about what can happen if one ignores the operating limits of a meter. Some years ago I was troubleshooting a microwave oven with a new digital multimeter (DMM) having a 2000-volt dc range. So I figured the DMM would handle 2000 volts dc, naturally, and certainly the 1200 volts I expected from the oven. I connected the DMM to the oven's power supply, plugged in the ac cord, and pressed "cook." The oven hummed and, accompanied by a sharp cracking sound, the DMM expired permanently. What happened? A shorted rectifier inside the oven applied something like 1500 volts ac to the DMM! Had I read the manual I would have learned that the DMM couldn't handle over 1500 volts dc. Actually, it was exposed to about 4200 volts, peak-to-peak! The moral of this story is that when in any doubt whatsoever, expect more than the DMM can handle. Had I been careful and connected a high-voltage probe to the DMM, I'd have saved a \$150 instrument from damage.

3. "Use your multimeter properly" is an obvious rule. But it's one that's often ignored, especially when you are pressed for time. The idea, of

course, is simple: Measure ac volts on ACV ranges, ac current on ACA ranges, dc volts on DVC ranges, dc current on DCA ranges, ohms on the Ohms ranges, and so on. This is plain common sense, but in practice it is easy to push the wrong button or plug the leads into the wrong jacks. The rotary range/function selector switch featured on some meters does a lot to make this operation exceptionally "goof proof," but no instrument is completely safe in this respect.

In practice, this rule is easy to remember if you get into the habit of setting the function and range switches *before* making any measurements. If you aren't sure of how large the measurement might be, set the range switch to the highest range and switch to lower ranges as necessary until you get a usable reading. Then connect the ground clip and make the measurement with the probe.

Two common abuses to multimeters are accidentally measuring volts on the Ohms ranges and applying volts to the current ranges. With the Beckman Industrial HD100 DMM, the ohms ranges will withstand up to 600 volts DC or RMS AC without harm; this is exceptional protection for a DMM! Typically, modern multimeters can withstand 250 volts or less for very short periods of time, though some extend this range to 600 volts. Apply voltages above the extremes for an extended time period and you'll likely overheat protective resistors and diodes. As for applying voltages to current ranges, on most DMMs a fuse will blow, protecting expensive high-current resistors. However, voltage overloads may cause precision resistors to change value or damage an expensive IC chip if full meter protection is not incorporated into the instrument. As a result, expensive repairs or recalibration would be required!

4. You should always maintain equipment properly, of course. For example, if you don't replace test

*Beckman Industrial Corp., Brea, CA

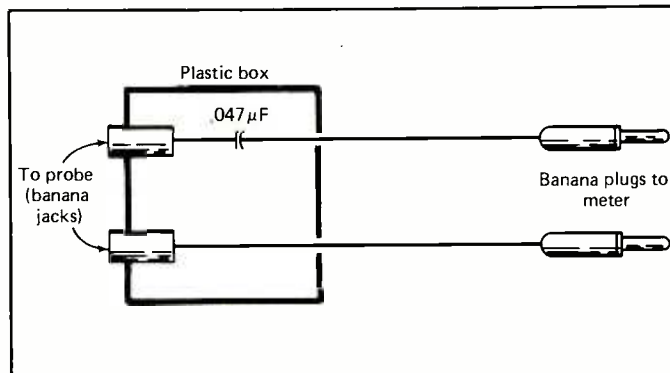
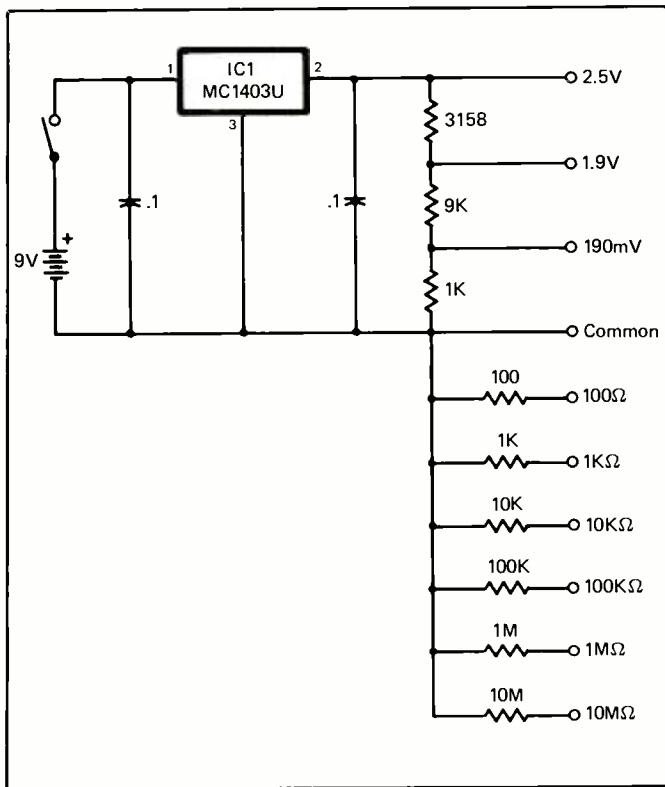

Fig. 2. To eliminate any possibility of dc component from affecting an ac reading, it is a good idea to place a blocking capacitor (0.047 μ F at 1600 volts) between the test leads and the input jacks of the multimeter. House the capacitor inside a plastic box to eliminate electrical shock hazards.

Fig. 1. Shown in this schematic diagram is a calibrator you can build to periodically check the condition of your multimeter's resistance and dc-voltage ranges. For best results, use only 1% or better tolerance resistors.

leads that have insulation you will expose yourself to the possibility of an electrical shock. Don't discover defects the hard way.

Always check your test leads before using them. Look for cracks in wire insulation, especially where the wire enters probe and connector bodies. Replace broken connectors and probes immediately.

Keep your multimeter's case free of dirt and dust. If the case breaks, replace it promptly. A carrying case should be used for additional protection in any event. This will extend the life of the instrument, particularly if it gets rough handling.

If you goof and seriously overload your meter, check it to make certain it wasn't damaged by the overload. Check the overloaded range by measuring a few known voltages, currents, or resistances, and comparing the results. If different, repairs may be required. Note that faulty meters may seem to work properly, but

could actually be out of calibration. Should the meter indeed be damaged, tag it as such so that someone else in a service shop, school, or even at home won't use it unsuspectingly.

It is a good idea to have your multimeter calibrated periodically, even if it has not been overloaded. Generally, most quality DMMs used for professional work should be recalibrated yearly by the factory or an instrument service company that specializes in such work. When used in applications where accuracy is particularly critical, it may be necessary to recalibrate every six months.

You might want to build the simple calibrator (shown in Fig. 1) to check your meter periodically. With it you can check the key dc ranges and all Ohms ranges. For best results, obtain combinations of 1% precision resistors to match the values shown. Then measure the voltages and resistances with your calibrated multimeter and write them down for reference. Lat-

er, if there's any doubt about your instrument's accuracy, compare the values. If there is much difference, have the meter recalibrated.

Finally, if your multimeter is ac powered, check the condition of the cord once in a while and replace it if damaged. Or if your instrument is battery powered, replace the battery promptly whenever the Low Battery indicator is displayed. I never experience such an indication, however, because I replace the batteries in all my instruments yearly, even if they are still good. You might want to do the same, as this reduces the chances of a battery expiring just when you need the instrument the most.

5. The first step in making any type of high-voltage measurement is to make sure that you have the right equipment to do the job. For voltages above 1000 volts dc or 750 volts ac, you should consider using a high-voltage probe with your multimeter. This probe attenuates the voltage by

100, making it easy to make measurements and protecting the DMM from overloads at the same time. A suitable one can be obtained at low cost from your electronics distributor or the DMM's manufacturer.

Be sure to use the right high-voltage probe with your multimeter, of course. These probes are designed to match standard input resistances, which may vary according to the model you have. Connect a probe designed for another input resistance, like one of those old 11-megohm VTVM probes, and a DMM will give you the wrong reading!

When making a high-voltage reading, always connect the ground clip to the circuit *first*. Then set the DMM down so that you aren't holding it before you touch the probe tip to the circuit. It's a good idea, too, to place one hand behind your back when applying the probe. One can never be too careful.

With some high-voltage circuits, where the voltages are lethal, such as in microwave ovens, it is wise to modify the procedure a bit. Always turn off the power, then connect the ground clip and clip the probe to the circuit point. Stand back, then power the device and note the reading. When through, shut off the power before removing the probe.

6. You may be surprised to know that ac voltage and current measurements are often the toughest to make accurately with a typical multimeter. There are two major reasons for this: Waveshape and signal frequency.

The waveshape of an ac signal being measured is most critical, especially with less-expensive multimeters. DMMs are calibrated at the factory using a low-distortion sine wave. Therefore, for best accuracy, you must be measuring the same type of signal. In real life, however, this may not happen, so errors will creep into your ac measurements. How much error depends upon how distorted your signal is and the type of ac converter circuit in your meter. Most

low-cost multimeters use an "average-responding" rectifier. This circuit may be as simple as a diode and two resistors or as fancy as an op amp and a few diodes. In practice, this simple circuitry is highly sensitive to waveshape and will give you consistently wrong readings from a distorted signal.

A better way to measure ac signals is with a True RMS (TRMS) multimeter. Circuits without these instruments use sophisticated averaging circuitry, usually contained inside a custom IC chip, and measure distorted waveforms with far greater accuracy than simpler average-responding circuits. Typical uses for a TRMS

Digital Vs. Analog Meters

Years ago, the VOM (volt-ohm-milliammeter) and the VTVM (vacuum-tube voltmeter) were the only choices one had when buying a multimeter. The VOM was popular, owing to its battery-powered portability, while the bulkier VTVM was chosen for its special measuring attributes where portability was not a consideration. Both use meter movements with "pointers" that move across calibrated scales. Both are analog-type meters, of course.

The electronic VTVM features higher input resistance than the VOM, thereby exhibiting less loading effect when taking measurements in a "live" circuit. Its lower input capacitance enables it to measure ac voltage at a higher frequency than the VOM can, too. Moreover, a more sensitive measuring capability, owed to its amplifier stages, makes measuring low voltages or resistances more accurate. On the other hand, a VOM is more stable, doesn't require warmup, and can measure current and decibels.

These differences evaporated, however, when solid-state VOMs were introduced a number of years ago. They combined the best attributes of both earlier instruments, while eliminating the need for tubes to warm up. VTVMs quickly disappeared from the market, not surprisingly, being replaced by electronic models, while VOMs still

linger on in the form of very-small, low-cost instruments.

Currently, digital multimeters (DMMs) are the most popular voltage and resistance test instruments. They earned this position for some very clear reasons. Firstly, scales don't have to be interpreted, as with analog instruments. Therefore, there's usually no eye strain or cerebral strain at all in reading a measurement value, since it's right there in familiar numeric form. Accurate readings are further enhanced due to the fact that there is no parallax error occurring from viewing a scale pointer at one angle or another. Little skill is needed, therefore, to use a DMM. Supporting this further, many DMMs have automatic range, overranging, and polarity features.

Surprisingly, there isn't much in the way of tradeoffs. It's sometimes charged that a DMM's LCD display is difficult to read in dim light, which is true. But, then, so are meter scales. DMMs cannot function well in the face of rapidly changing values, but most users do not use a multimeter for this purpose. The same is true of measuring decibels, which DMMs cannot do. Relative cost of a DMM is higher than that of a VOM, but you get what you pay for. However, if you don't need very-high resolution, there are modestly priced DMMs available with better than 1% accuracy.

meter would be for servicing SCR motor speed controllers in industry, audio signals in the broadcast studio, and so on. Naturally, the TRMS circuit costs more, so the meter's overall price is higher. To users who need greater overall performance for their multimeters, the higher cost is certainly acceptable.

Probably the best approach when measuring ac signals where the waveform is unknown is to check it out first with an oscilloscope to get a rough reading (typical accuracy 3% to 5%). Then switch to the multimeter for a precise reading if the waveform looks like a clean sine wave.

Square waves can be measured with your multimeter if the frequency is low: a 5-volt square wave will read about half, or 2.5 volts, on most DMMs. This may be helpful if you are working on a digital circuit, and an oscilloscope isn't handy. Don't exceed the frequency limits, or the readings will be no good.

Also, the frequency of the ac signal being measured is important. Multimeters are very frequency-limited, and if you try to measure a signal above or below its limits you reading will be incorrect! To complicate things further, the frequency response will be different on the meter's other ac ranges, with the lowest ac range having the widest response. Thus, if you are measuring a signal on the lowest ac-volts range, and it is near the frequency limit, switching ranges will probably give different readings!

State-of-the-art DMMs often have frequency ranges of 45 Hz to 10 kHz on the lowest voltage range, while other designs or cheaper models may be restricted to 40 Hz or so. Check the frequency response limits in your operator's manual and be sure to stay well within them.

Did you know that audio signals are tough to measure on a digital multimeter, owing to its slow response time? To get maximum accuracy for digital readout, the cir-

cuitry is designed to make readings very slowly, at perhaps 1 to 2 readings a second. If your signal changes amplitudes more often than that, the DMM will make partial readings and display “garbage.” Remember that your ac ranges give the best accuracy when measuring steady-state signals.

If you find it necessary to measure wide-amplitude-changing ac signals, such as audio and transducer outputs, it is usually better to use an oscilloscope or analog voltmeter. The same is true if you must measure signals whose frequencies exceed the range of the DMM. I keep a 10 MHz

What Is A Half-Decade?

Numeric displays for digital multimeters are typically specified as having 3½- or 4½-decade capacity. Since each decade represents a power of 10, or another digit moving from right to left, you might think that a 3½-decade display can provide a maximum count of 4999 and a 4½-digit display a count of 49999. Though this could be the case when dealing with displays containing a half-decade, it almost never is for test instruments. In the case of the DMM (and many frequency/period counters), the half-decade in the display counts to only 1!

If a decade counts to only 1, why do manufacturers call it a *half-decade*? Isn't this misleading and a violation of the truth-in-advertising law? Technically speaking, it is misleading—but only if you don't understand what is implied by the term “half-decade.” It's not a violation of the law, either, because the half-decade does more than just count to 1. It's also used to indicate polarity for dc voltages and currents.

To obtain the polarity-indicator function, the center horizontal segment of the display is turned on and off selectively to indicate negative and positive values, respectively. (Most DMMs with LED-type displays indicate only negative polarity with the minus sign. If the minus sign isn't present in the display, the

value being read is implied to be positive. Many LCD-type displays indicate both negative and positive values with minus and plus signs, respectively.) Since a single decade display does double duty as both a numeric and a polarity indicator, manufacturers early on adopted the convention of calling it a half-decade display. Interestingly, until a few years ago, a display that counted to only 1 with no polarity indication built into the system was referred to as a ¼-decade display.

In the early days of numeric-indicating digital test instruments, any decade that counted to only 1 used the 1 as an “overflow” indicator. Today's 1-count display/driver schemes are considerably more sophisticated. When a 1 comes up in the display in the half-decade position, it's a true 1 and not just an arbitrary overflow (sometimes called an “overrange”) indicator.

Built-in logic circuitry holds the 1 in the display until the value being measured exceeds the capacity of the display. At this point, the display either blanks out and is replaced by some indication that means the range limit has been exceeded, or the number in the display remains unchanged, with a separate indicator activated to inform the user that the display range has been exceeded.

wide-band analog voltmeter handy for these occasional measurements.

Another lesser-known problem with measuring ac signals is when a dc voltage is present. For example, the output from a power supply rectifier may contain many volts of dc plus some ac ripple. With some DMMs, particularly early models, both voltages will be read at once. This can be quite a surprise if you were to measure power supply ripple and get a reading greater than the supply voltage! If you have this problem, the cure is to connect a 0.047- μ F, 1600-volt dc blocking capacitor in series with the input, as shown in Fig. 2. Note that if your work is confined to solid-state applications, you can probably get by with a 200-volt dc capacitor.

And finally, don't forget that ac measurements are especially susceptible to hum and noise pickup. If you are measuring low-level signals in a high-impedance circuit, simply touching the hot lead or moving it around may affect the reading. The cure is to use a shielded cable with appropriate connectors for these measurements.

7. Let's move on to dc voltage and current measurements. These measurements are among the simplest and most troublefree you can make, yet there are pitfalls to avoid. Consider the following:

Like ac measurements, the voltage or current you are measuring must be steady. If it changes your DMM readings will "bounce around" and cause confusion. After all, it is hard to trust a multimeter that keeps giving different readings! The solution is to use an oscilloscope or analog voltmeter, accepting a loss of accuracy.

Any ac or noise components on the dc signal will cause errors, as they combine with the desired signal and are therefore also measured. Some multimeters are better than others at rejecting these signals. If you need greater rejection of annoying ac or noise components, look for a meter

with higher Common Mode Rejection Ratio (CMRR) and Normal Mode Rejection Ratio (NMRR) specifications.

8. In a pinch, the measurement of noisy signals can be improved two ways. First, try connecting a 0.1- μ F polyester capacitor across the input jacks. Or if your meter is ac/battery powered, switch to battery operation. Sometimes the absence of line-induced noise does the trick, allowing greater accuracy.

9. Ohms measurements can be affected by three different factors:

Voltage appearing on the circuit being checked for resistance is a problem, naturally. This is especially true with circuit capacitors, which set up a current flow in the circuit that adds or subtracts from the current source in the multimeter. As a result, you get the wrong reading. A tipoff of a "live" circuit is when you get an overrange indication (circuit is powered) or a changing reading (voltage being bled off by the meter).

Solid-state devices can conduct current and, thus, throw off your readings. Most modern multimeters have "low-power" ohms provisions, which applies roughly 0.5-volt maximum to the circuit. Consequently, those widely used silicon devices won't turn on, thereby giving you a more accurate picture of the circuit's resistances. Of course, if you have an older multimeter that doesn't have low-power ohms, or if you work with germanium devices, it will be necessary to unsolder parts before making any measurements.

Often, the 20-megohm range of your multimeter will be sensitive to noise pickup. Touching the leads or moving them around may affect your reading quite a bit. This is caused by the high-impedance, hum-sensitive circuitry and low currents used on this range. If you have this problem, one way to reduce it is to use shielded leads. Another way is to connect a 0.1- μ F polyester capacitor across the test-lead input jacks.

10. Let's round up our discussion with some brief thoughts on DMM use. Did you know that DMMs generate r-f signals? How much signal and at what frequencies depends upon the make and model of the instrument. The signal is strongest on the leads when the instrument is set for the lowest dc voltage range.

I discovered this fact when I was working on a communications receiver. A broadband buzzing sound appeared in the speaker whenever the DMM was placed on the upturned chassis. Moreover, some DMMs can be influenced by strong signals from nearby transmitters. As a result, it pays to be wary of any readings made in this environment, as r-f pickup through the leads and case can throw off your readings. Many manufacturers today internally shield the DMM circuitry to reduce r-f pickup.

Digital circuitry using CMOS logic requires special care when being tested with a multimeter. Always ground one probe to the circuit before touching any inputs; that way any static charge carried by the instrument will not pass through any IC inputs, damaging parts. Also be careful when using the Ohms position to locate "stuck" lines, or lines shorted to power or ground by a bad IC. Removing the bad IC may cause the DMM to apply full voltage to an IC input, damaging the part. Admittedly, this situation is unlikely with modern instruments having low-power ohms ranges, but older multimeters may apply enough voltage and current to cause damage.

Some applications, such as receiver alignment, require an instrument that shows voltage trends clearly. A DMM won't do the job, as the display updates too slowly. Additionally, you must remember the last reading displayed before it changes. In this case, an analog type meter or an oscilloscope should be used. I use a high-quality FET multimeter for these applications, so analog meters aren't dead yet, are they? **ME**

How To Get Started In Electronics

Part II: Inside Integrated Circuits

By Forrest M. Mims III

The material for this article is extracted from the author's book *Getting Started In Electronics*, published by Radio Shack. Copyright 1983 by Forrest M. Mims III.

Electronic circuits can be made by simultaneously forming individual transistors, diodes and resistors on a small "chip" of silicon. The components are connected to one another with aluminum "wires" deposited on the surface of the chip. The result is an "integrated circuit." An integrated circuit, or IC, can contain as few as several to as many as hundreds of thousands of transistor. ICs have made possible affordable personal computers, video games, digital wristwatches, and many other very sophisticated products.

Some integrated circuits can be of extremely high circuit density to perform tremendously complex operations. For example, one kind of IC contains 262,144 transistors on a silicon chip only about 1/4" square! Imagine building a project in which only one of these ICs was needed, using just discrete transistors and resistors. The cost would be staggering, the size of the circuit enormous, and the finished project so heavy you couldn't carry it around. Your power requirements would be ridiculously high, too. Yet, the IC version is small and light enough to fit into the palm of your hand and can reasonably be powered by a battery.

Though not all ICs are as tremendously complex as the one cited above, you can readily see why the integrated circuit has become the backbone of modern electronics and can even be regarded as a fundamental building

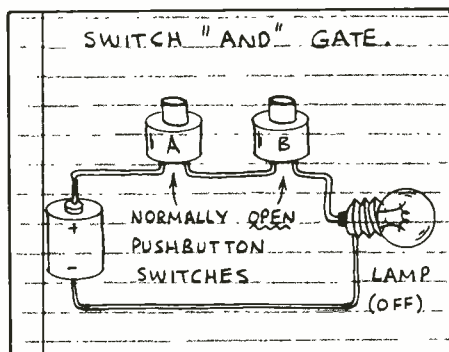

(A)

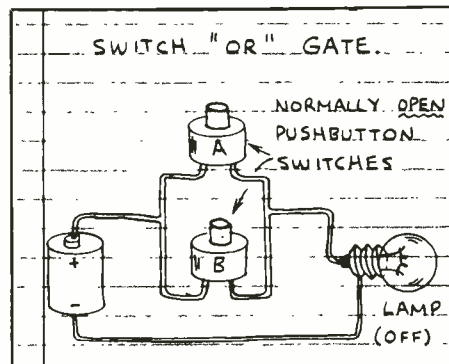

(B)

block for the electronics experimenter and hobbyist. In this concluding part of our serialization from Forrest Mims' book, *Getting Started In Electronics*, we'll introduce you to the fascinating world of ICs and take some of the mystery out of its use and operation.

IC Categories

Integrated circuits are grouped into two major categories. *Analog* (or linear) ICs produce, amplify, or respond to variable voltages. They include many kinds of amplifiers, timers, oscillators, and voltage regulators. *Digital* (or logic) ICs respond to or produce signals that have only two voltage levels. They include micro-

processors, memories, and many kinds of simpler chips.

Some ICs combine analog and digital functions on a single chip. For example, a digital chip might include a built-in analog voltage regulator section. And an analog timer chip might include an on-chip digital counter to give much longer time delays than are possible with the timer alone.

IC chips are supplied in many different types of packages. By far the most common are variations of the dual in-line package (or DIP), which is made from plastic (cheap) or ceramic (more robust). Most DIPs have 14 or 16 pins, but the pin count can range from 4 to 64.

Digital ICs

No matter how complicated they may ultimately be in terms of functions performed, all digital ICs are made from simple building blocks called *gates*. Gates are like electronically controlled switches. That is, they are either on or off.

The three simplest (mechanical—not IC) gates can be demonstrated with some pushbutton switches, a battery and a lamp. For example, in (A), an AND gate, the lamp glows only when switches A and B are closed. In OR-gate (b), the lamp glows whenever switch A or switch B or both are closed. Finally, in NOT-gate (C), the lamp is on continuously (note that the switch is a normally-closed type, unlike the normally-open type in the previous two circuits). Only when the switch is opened is the lamp off. In other words, the NOT gate reverses (inverts) the usual action of a switch.

In all three circuits, the switches

are the gates' inputs. The lead without switches in these circuits is the common or "ground" lead.

Diode Gates

It's often desirable to control a gate electrically, rather than mechanically. The simplest electrically controlled gate uses *pn*-junction diodes that are switched on (forward biased) or off (reverse biased) by an input signal of several volts (high or binary 1) or an input that is near or at ground (low or binary 0) potential.

In diode OR-gate circuit (D), when the input voltage at A or B is more positive than ground, it passes through the forward-biased diode(s)

and appears at the output. Otherwise, the output is at or near ground. Diode AND-gate circuit (E) requires that the input voltage at A and B be more positive than ground for current to flow from the battery through the resistor to the output. If either A or B is at or near ground, one or both diodes become forward biased and current flows away from the output.

The outputs do not reach a full 6 volts when high because the diodes require a forward voltage of 0.6 volt. This voltage is subtracted from the output voltage. (In electronics jargon, a silicon diode causes a "voltage drop" of 0.6 volt.)

Transistor Gates

The voltage drop of diode gates means amplification is required to connect together a series of such gates. While transistors could be used to provide the necessary amplification, they can also function directly as gates! In (F) are shown circuit diagrams for some of the simplest bipolar transistor gates. Alongside each is a truth table that explains basic operation. The Ls and Hs in the truth tables stand for logic 0 (low) and logic 1 (high), respectively. Together, these circuits form the resistor-transistor logic (RTL) family of digital ICs.

Note in the circuits on the right

that two new logic functions have been introduced. These are the NAND and NOR gates, which contain a built-in NOT function that provides outputs exactly the opposite of those provided by the AND and OR gates. That is, if the two inputs to the NAND gate are high, the gate's output will be low. Similarly, if either or both inputs to the NOR gate are high, its output will also be low.

All gates shown in (F) are called logic circuits because they make logical "decisions." Logic gates often have more than the two inputs shown. Additional inputs increase the decision-making power of a gate. They also increase the number of ways gates can be connected to one another to form advanced and complex digital-logic circuits.

The NOT gate, or inverter, is very important, since it can invert (reverse) the output from another gate. Strictly speaking, however, the inverter is not a decision-making circuit, as gates with two or more inputs are, because it has only one input.

A close relative to the inverter is the buffer, a noninverting circuit that isolates gates from other circuits or allows them to drive loads that draw greater than normal current.

Three-state (sometimes called "tri-state") inverters and buffers have outputs that can be electronically dis-

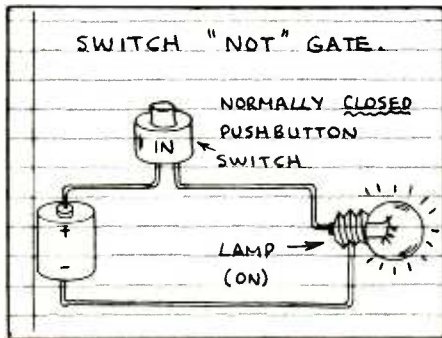

(C)

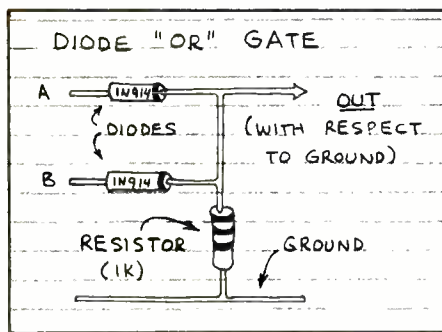

(D)

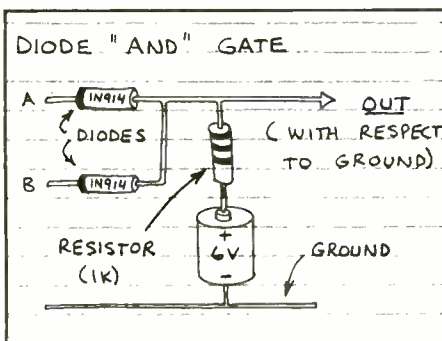

(E)

"AND" GATE			"NAND" GATE		
A	B	OUT	A	B	OUT
L	L	L	L	L	H
L	H	L	L	H	H
H	L	L	H	L	H
H	H	H	H	H	L

"OR" GATE			"NOR" GATE		
A	B	OUT	A	B	OUT
L	L	L	L	L	H
L	H	H	L	H	L
H	L	H	H	L	L
H	H	H	H	H	L

"EXCLUSIVE-OR" GATE			"EXCLUSIVE-NOR" GATE		
A	B	OUT	A	B	OUT
L	L	L	L	L	H
L	H	H	L	H	L
H	L	H	H	L	L
H	H	L	H	H	H

(F)

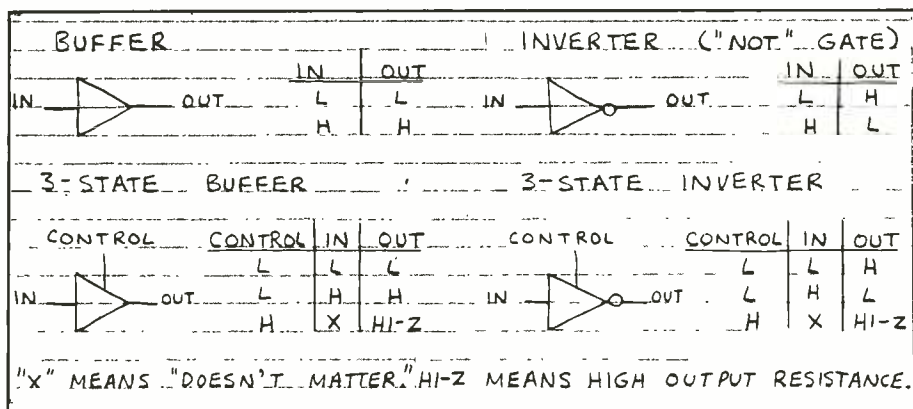

(G)

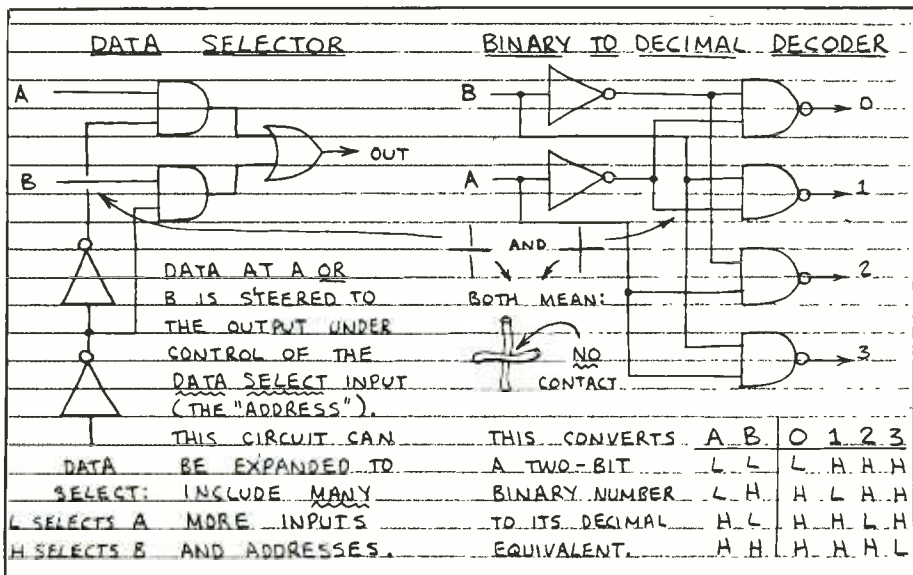

(H)

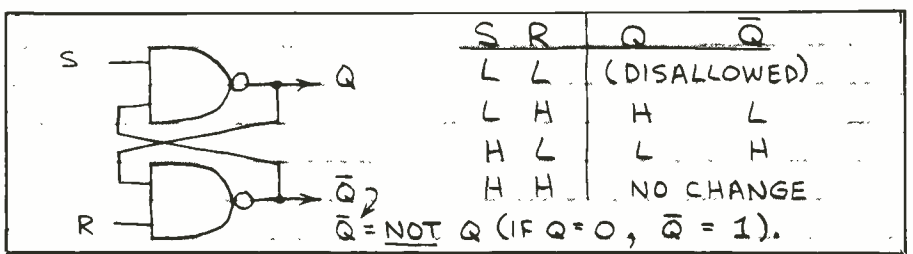

(I)

connected from the remainder of the circuit. The output is then neither high nor low. Instead, it "floats" and appears as a very high resistance. Standard and three-state buffers and inverters are summarized in (G).

Often, circuits made from gates exchange information in binary 1s and 0s that are encoded as high and low voltage levels. The information is usually sent over wires called *buses*. If the outputs of a number of gates are connected to the same bus, "traffic

jams" can occur. Using three-state gates can put an end to this problem by placing data from a gate on the bus only when a slot for it exists.

Gates can be used individually or connected together to form a logic circuit. Almost all logic circuits can be placed in one of two categories—combinational or sequential.

Combinational Logic

Combinational logic circuits respond to incoming data almost immediately

and without regard to earlier events. These circuits can be very simple or immensely complicated. Virtually any combinational circuit can be implemented with only NAND or NOR gates, or a combination of both. Two examples of combinational networks that use more than one kind of gate are illustrated in (H).

Sequential Logic

The output state of a sequential logic circuit is determined by the previous state of the input. In other words, bits of data move through sequential circuits step-by-step. Often, the data advances one step when a pulse is received from a "clock" (a circuit that emits a steady stream of pulses). The sequential logic building block is the common flip-flop.

Illustrated in (I) through (L) are five basic flip-flops. The basic RS (reset-set) flip-flop in (I) is also called a *latch*. Its Q and \bar{Q} (the latter is pronounced "not-Q") are always in opposite states. The clocked RS flip-flop in (J) ignores data at S and R until a clock (or *enable*) pulse arrives at the clock input. Then it changes states.

A D (data or delay) flip-flop, shown in (K), stores the current outputs between clock pulses. The JK flip-flop in (L) allows both inputs to be high, in which case, its outputs "toggle" or switch states with each clock pulse. The Q (or \bar{Q}) output is low (or high) for every *other* input pulse to the T (toggle) flip-flop in (M). Therefore, the input pulses are divided by two.

Two or more flip-flops can be connected in various ways to make up different types of counters. Some arrangements yield binary counters that count in the binary format of 0s and 1s. Others can count in the decimal format and can be arranged to reset to 0 after a count of 9 or 5 or 1 for digital clocks, frequency counters, meters, etc. There are, of course, many types of IC counters, most of which include special features, such as count up, count down, reset, etc.

It's interesting to note that combinational and sequential logic ele-

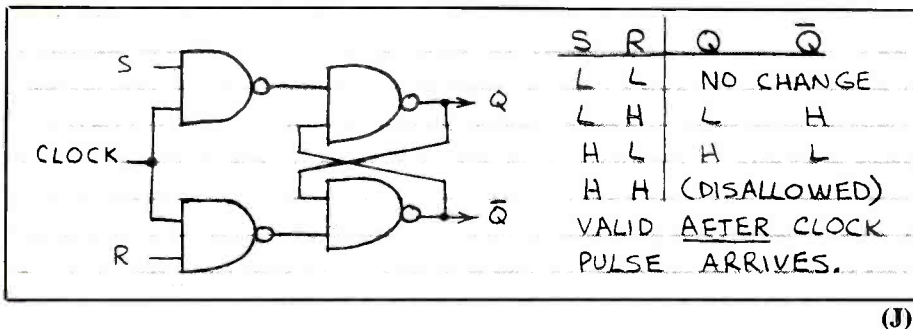

(J)

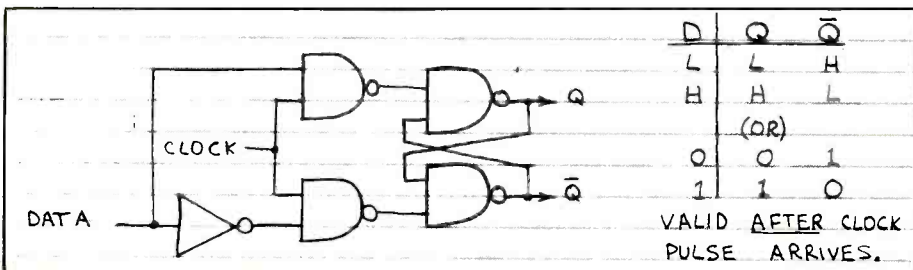

(K)

ical operations. Op-amps amplify the *difference* between voltages or signals (ac or dc) applied to their two inputs. The voltage applied to only one input will be amplified if the second input is grounded or maintained at some voltage level.

The op-amp has an inverting (-) and a noninverting (+) input. The polarity of a voltage applied to the inverting input is reversed at the output, while polarity at the noninverting input is the same as the output.

In some applications, the op-amp is used without feedback to provide maximum amplification (level). Usually, however, the gain is reduced to a more practical level by feeding back some of the output to the inverting input, as in circuit (P).

Without feedback resistor R_2 in the circuit, the output voltage will swing from full on to full off (or vice-versa) when the voltages applied to the inputs differ by only about 0.001 volt! This digital-like mode makes possible many useful applications.

When operated as a comparator, the op-amp can be used as a timer. All that's needed is an RC (resistor-capacitor) network like the R_1/C_1 combination shown in circuit (Q). In this circuit, C_1 gradually charges to +9 volts through R_1 . When the voltage on C_1 exceeds the *reference voltage* supplied to the noninverting input of

ments can be mixed to fill the needs of specific applications. A typical example of this is the decimal counting circuit, shown in (N), that counts to 9 and on the next pulse resets to 0 to repeat counting up. The 7490 is a common BCD (binary-coded decimal) counter whose four output lines at A, B, C and D are decoded by the 7448 to turn on and off specific bars in the LED numeric display as the numbers cycle from 0 to 9 and repeat.

Linear ICs

Input and output voltages of linear ICs can vary over a wide range. Often, the output voltage is proportional to the input voltage such that if the two were graphed, the result would be a straight line (linear).

A single bipolar or field-effect transistor can function as a digital or a linear circuit. In both cases, the transistor can invert the signal at its input, as illustrated in (O). In the digital side of this circuit, transistor Q_1 is used as a switch. When the input is near +V (high), Q_1 turns on and LED_1 lights. When the input is near ground (low), Q_2 turns off. This turns off LED_1 and allows LED_2 to come on. This portion of the circuit is a combined buffer and inverter.

In the linear side of circuit (O), Q_2 is an amplifier that operates over the

entire range from full off to full on. Resistors R_4 and R_5 form a voltage divider that applies a small voltage to Q_2 's base to keep the transistor slightly on even when no input is present. This allows Q_2 to operate in a linear mode. As input voltage rises, LED_3 brightens, LED_4 dims.

Op-Amps

Operational amplifiers (or "op-amps") are by far the most versatile of linear ICs. They're called "operational" amplifiers because they were originally designed to do mathemat-

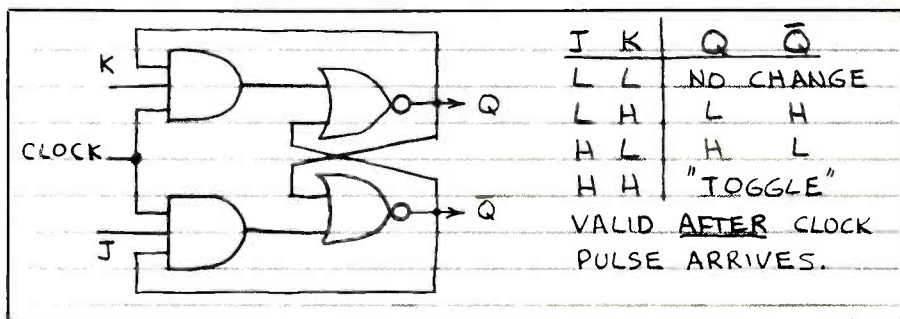

(L)

(M)

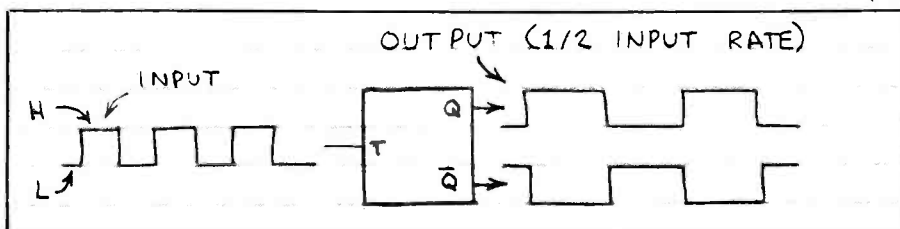

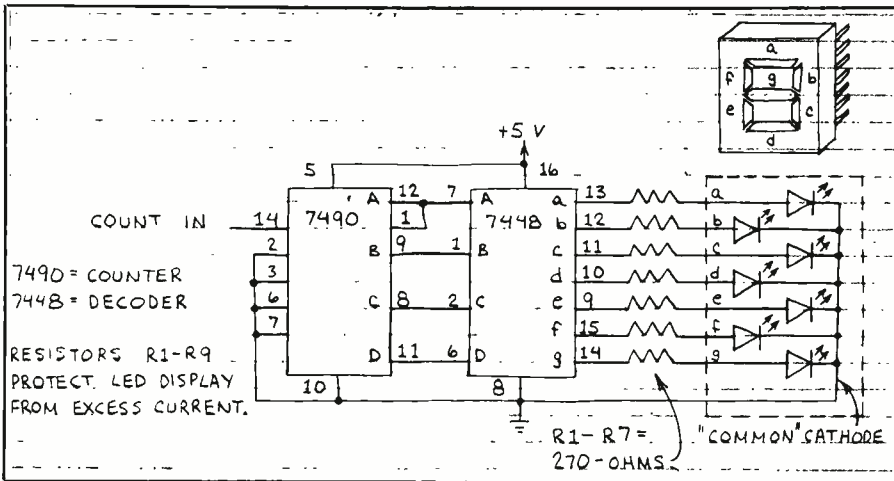

(N)

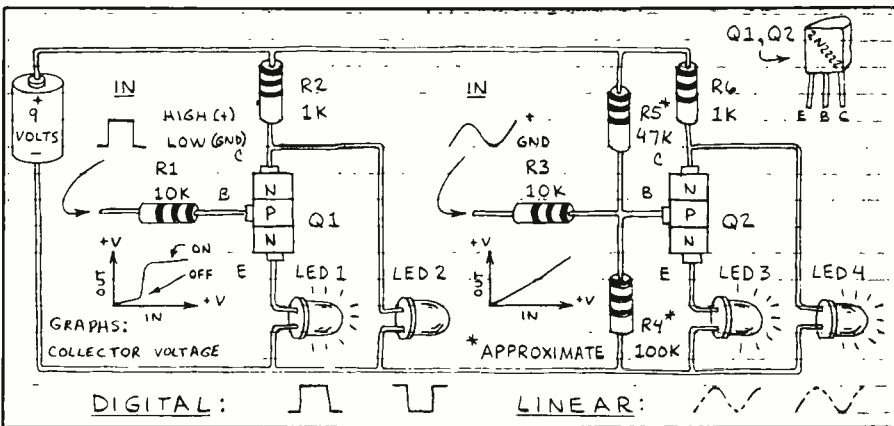

(O)

the op-amp, the output swings from high to low and the LED glows.

The time delay can be changed by altering the values of $R1$ and $C1$ or the setting of $R2$. To initiate a new cycle, $C1$ must first be discharged. (Use a normally-open pushbutton switch connected between the top of $C1$ and ground to do this.)

This simple timer circuit is the key ingredient of most IC timers. Most include an output flip-flop to give definite high or low output. Some include a binary counter that advances one count per delay period (or cycle). The timer is recycled each time the

count advances. A decoder at the counter output permits total delays ranging from days to a year or more to be selected.

Voltage Regulators

Voltage regulators convert a voltage applied to their inputs into a fixed or variable (usually lower) voltage. In most, a small fixed reference voltage (usually a volt or so) is applied to the noninverting input of an op-amp. The reference voltage (V_{ref}) is then amplified by the ratio of the feedback and input resistors. If one of the re-

sistors is a potentiometer, the output voltage (V_{out}) can be varied from V_{ref} to $+V$ (the supply voltage applied to the chip). Actual IC voltage regulators include extra transistors to provide V_{ref} and to allow the chip to drive loads that require more power than an op-amp alone can deliver.

Many types of fixed- and variable-output IC regulators are available. Most are installed in packages made of metal or having a metal tab to help radiate away excessive heat.

There are also many types of special-function linear ICs, many of which incorporate op-amps. Among these are audio amplifiers, phase-locked loops (PLLs), function generators, and telephone, radio, television, and computer communications devices. There are even many kinds that detect temperature, light, weight, and pressure!

In Parting

This concludes our serialization of Forrest Mims' book, *Getting Started In Electronics*. Though we've presented a lot of interesting information to get you started with a foundation in electronics, much more is covered in the book that's available at Radio Shack retail stores. **ME**

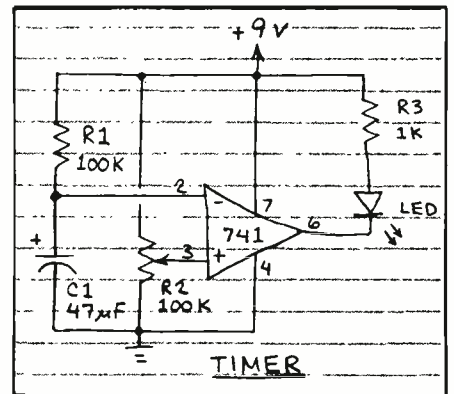

(P)

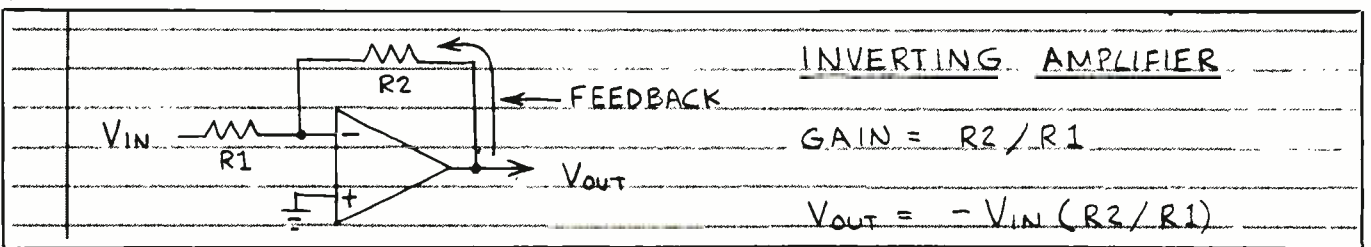

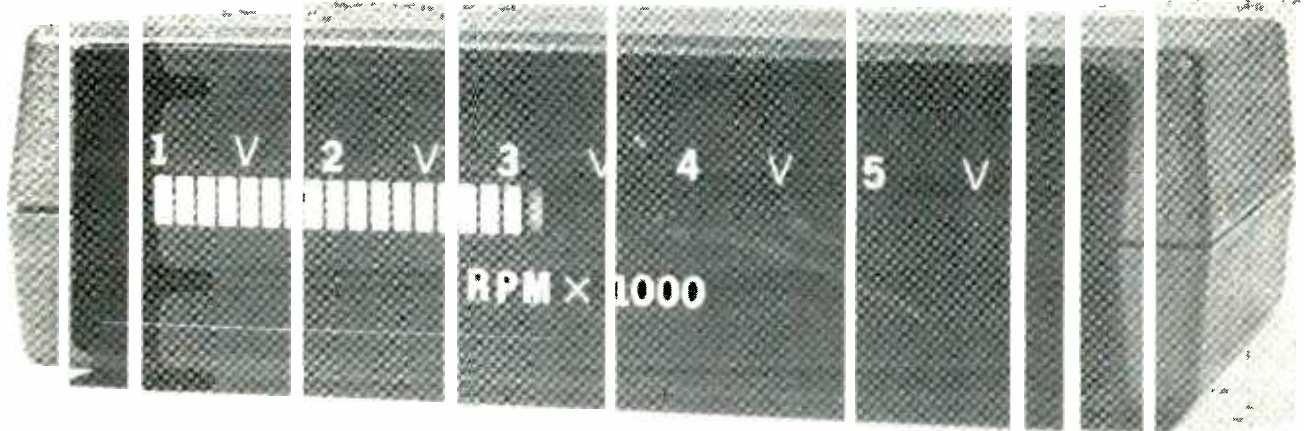

A Bargraph Tachometer For Any Automobile

Adding this 1½"-high all-electronic tach to a car's instrument panel gives a driver the easiest-reading display of engine rotation speed

By Steve Pence

Any automobile enthusiast worth his salt wants a tachometer to see his engine's revs as he shifts from gear to gear, squeezing the most from each one without wasting gas or harming the machine. The electronic tachometer described here is better than the traditional tachs because it uses a 40-segment

bargraph display that's easier to read than the traditional analog meter or digital numeric display types.

Since the bargraph tach is all-solid state, the instrument has an instantaneous display of revolutions per minute. Finally, its compact dimension, measuring only 1½" high, permits easy mounting on the steering column without blocking your view of the speedometer.

The bargraph tachometer can be

used with any 4-, 6-, or 8-cylinder engine. It can be set up to display a 0-to-8000-rpm standard range or an expanded-scale 1000-to-6000-rpm range.

Circuit Description

The full schematic of the electronic bargraph tachometer is shown in Fig. 1. This circuit can be driven either by the signal available from the points

“... has instantaneous display of revolutions per minute.”

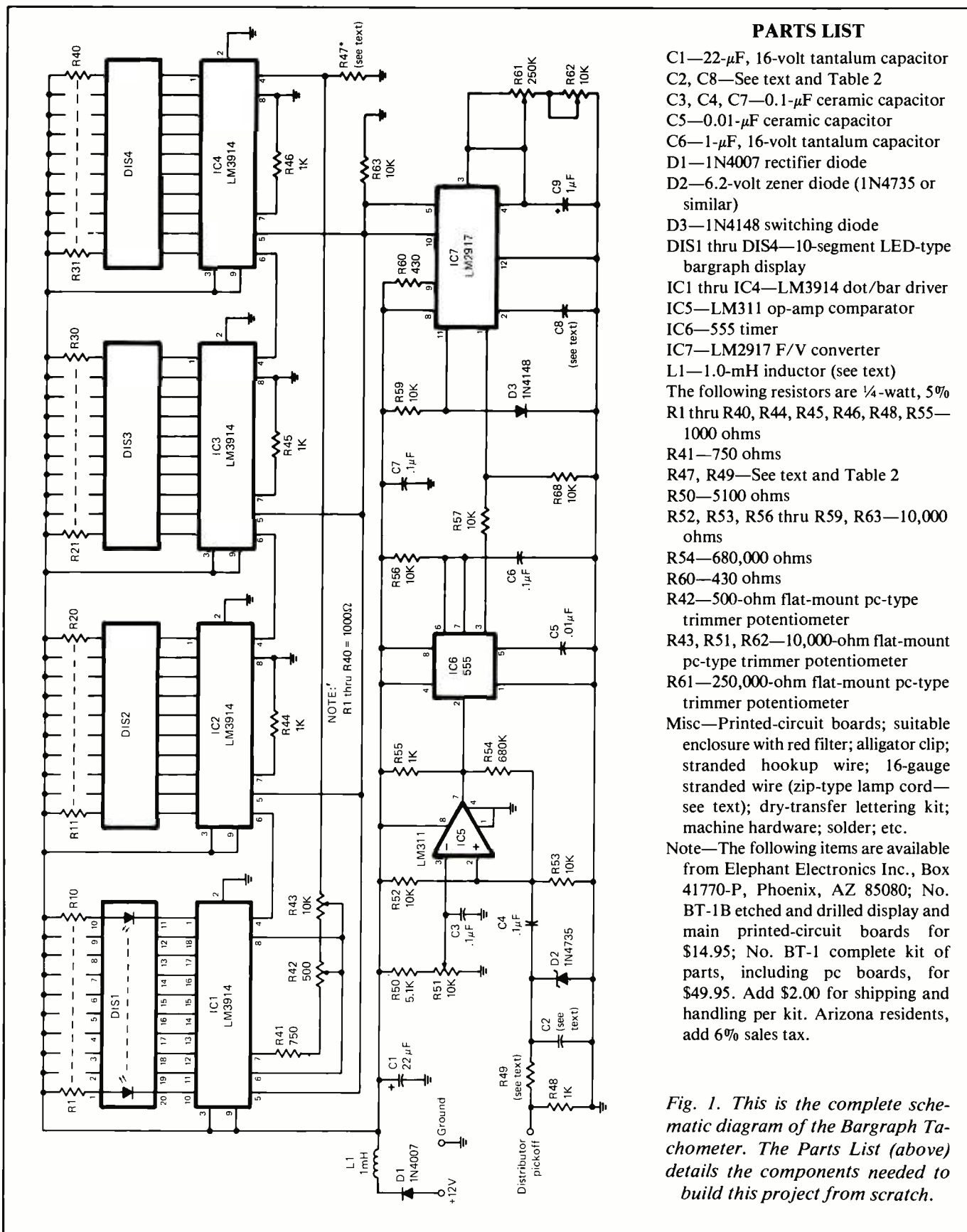

PARTS LIST

- C1—22- μ F, 16-volt tantalum capacitor
 - C2, C8—See text and Table 2
 - C3, C4, C7—0.1- μ F ceramic capacitor
 - C5—0.01- μ F ceramic capacitor
 - C6—1- μ F, 16-volt tantalum capacitor
 - D1—1N4007 rectifier diode
 - D2—6.2-volt zener diode (1N4735 or similar)
 - D3—1N4148 switching diode
 - DIS1 thru DIS4—10-segment LED-type bargraph display
 - IC1 thru IC4—LM3914 dot/bar driver
 - IC5—LM311 op-amp comparator
 - IC6—555 timer
 - IC7—LM2917 F/V converter
 - L1—1.0-mH inductor (see text)
- The following resistors are 1/4-watt, 5%
R1 thru R40, R44, R45, R46, R48, R55—1000 ohms
R41—750 ohms
R47, R49—See text and Table 2
R50—5100 ohms
R52, R53, R56 thru R59, R63—10,000 ohms
R54—680,000 ohms
R60—430 ohms
R42—500-ohm flat-mount pc-type trimmer potentiometer
R43, R51, R62—10,000-ohm flat-mount pc-type trimmer potentiometer
R61—250,000-ohm flat-mount pc-type trimmer potentiometer
Misc—Printed-circuit boards; suitable enclosure with red filter; alligator clip; stranded hookup wire; 16-gauge stranded wire (zip-type lamp cord—see text); dry-transfer lettering kit; machine hardware; solder; etc.
- Note—The following items are available from Elephant Electronics Inc., Box 41770-P, Phoenix, AZ 85080; No. BT-1B etched and drilled display and main printed-circuit boards for \$14.95; No. BT-1 complete kit of parts, including pc boards, for \$49.95. Add \$2.00 for shipping and handling per kit. Arizona residents, add 6% sales tax.

Fig. 1. This is the complete schematic diagram of the Bargraph Tachometer. The Parts List (above) details the components needed to build this project from scratch.

or the spark from the ignition coil. Either source will provide an accurate indication of engine speed in revolutions per minute (rpm).

The spark impulse signal is capacitively picked up with a simple clamp-on assembly attached to the wire that connects the ignition coil's high-voltage output to the distributor. Resistor *R48* terminates the pickoff wire and aids in reducing the ringing that is typical at this point. Nearly all of the remaining spurious noise is filtered out by *R49* and *C2*, leaving a relatively clean pulse to be coupled through *C4* into the noninverting (+) input of *IC5*.

Comparator *IC5*'s trip point is adjustable via *R51*. For proper circuit operation, *R51* must be set so that *IC5*'s output is normally high with no input but pulses low when an input signal is present. To make the very narrow pulse at *IC5*'s output useful (it's only a few hundred microseconds wide), it must be stretched to at least 1 millisecond in duration.

Pulse stretching is performed by 555 timer *IC6*, which is configured as a one-shot multivibrator. Pulse width is set by the values of *R56* and *C6*. The output pulse at pin 3 of *IC6* is then coupled to frequency-to-voltage (F/V) converter *IC7*.

As its name implies, *IC7* generates an output voltage that is proportional to the frequency of the input signal. The parameters of the converter are governed by the values of *C8*, *C9*, and *R61 + R62*. The conversion equation is: $V_{out} = V_{cc} \times C8 \times R61 + R62$. V_{cc} for LM2917 (*IC7*) is nominally 7.5 volts, which is regulated by a built-in zener diode.

The value of *C9* determines how much ripple is present in the output voltage, as well as how quickly the voltage can change. If *C9*'s value is too large, response time will be sluggish; if it's too small, there will be excessive ripple, and the display won't be stable.

Bargraph displays *DIS1* through *DIS4* are driven by *IC1* through *IC4*.

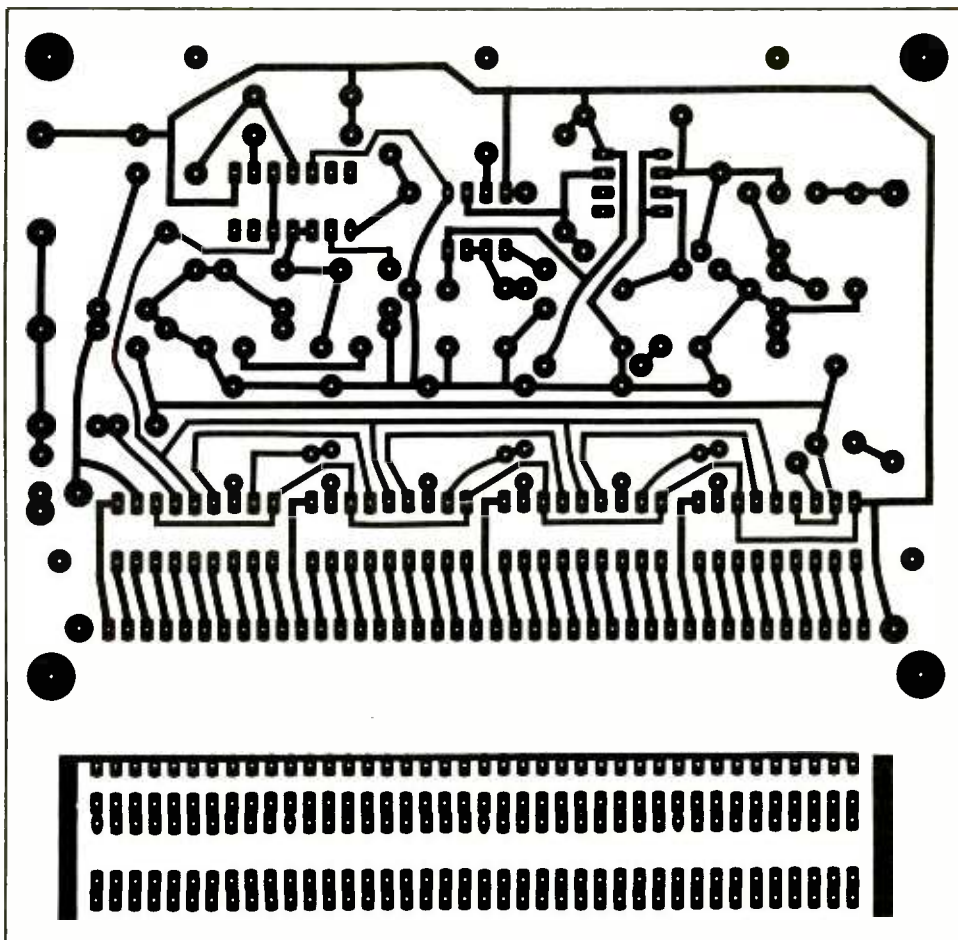

Fig. 2. These are the actual-size etching-and-drilling guides to use for fabricating your own printed-circuit boards. The guide at the top is for the main board; the guide at the bottom is the one to use for making the display board.

The LM3914 dot/bar drivers are cascaded and calibrated to display the voltage delivered from *IC7*'s output.

The LM3914 contains an internal precision voltage divider consisting of a series string of 10 1000-ohm resistors. The junction between each pair of resistors connects to the non-inverting input of its own respective built-in comparator. Since both ends of the divider chain are brought outside the IC, the devices can be "stacked" in series to provide greater display resolution.

Although each LM3914 IC has its own internal precision voltage reference, only the reference in *IC1* is actually used. A nominal 1.25 volts is developed across pins 7 and 8. Since

this voltage is constant, the current through the program resistor connected to these pins is also constant. The current drawn from pin 7 "programs" the amount of current available for the LEDs in the bargraph displays. This is approximately 10 times the current that the program resistor "sees."

The precision reference forces a constant current down through the parallel combination of the internal voltage dividers, *R43* and, finally, *R47*. The setting of *R43* determines what total voltage will be applied to the precision divider and, therefore, what each increment will represent. For example, if the potential across the 40,000-ohm precision divider is

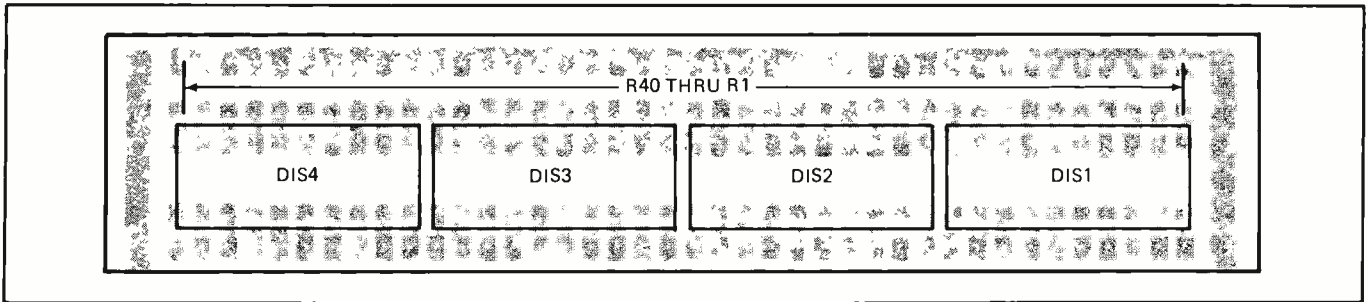

Fig. 3. Resistors R1 through R40 mount on the display board in an upright—not flat—position. Be absolutely certain that you properly orient the displays before soldering them.

set to 5.0 volts, each increment will be equal to 5 volts/40, or 0.125 volt.

Resistor R47 essentially extends the bottom of the precision voltage divider. This permits the point at which the first comparator trips to be set to some voltage other than one increment above ground. In the case of the prototype, the first LED turns on at 1 volt, representing 1000 rpm.

If you wish to customize your bargraph tachometer for your particular needs, the best way to go about it is to follow a design example. Such an example is given in the box elsewhere in this article.

Construction

Begin construction of your bargraph tachometer by fabricating your display and main printed-circuit boards, using the etching-and-drilling guides in Fig. 2. (If you prefer not to make your own boards, you can purchase ready-to-use boards from the source given in the Parts List.)

Start assembly by installing the 40 current-limiting resistors (R1 through R40) on the display board (Fig. 3). These resistors mount on-end—not flat against the board. After soldering their leads to the foil pads on the board, carefully trim away the excess lengths and save the longer of the two from each resistor. These leads will be used later to connect the display board to the main board. Discard the shorter leads.

Next, install and solder into place the four 10-segment displays. This

	Capacitive Takeoff			Points/Tach Takeoff			rpm range	R47 (Ohms)
	R49 (ohms)	C2 (μF)	C8 (μF)	R49 (ohms)	C2 (μF)	C8 (μF)		
4-cyl	1k	0.01	0.1	4.7k	0.22	0.1	0 to 8K	short
6-cyl	1k	0.01	0.047	4.7k	0.22	0.047	1K to 6K	665
8-cyl	1k	0.01	0.033	4.7k	0.22	0.033		

Table 1. Listed here are the resistor and capacitor values to use for R49, C2 and C8 for different engine designs, types of signal takeoff, and desired range.

done, temporarily set aside the display assembly and proceed to wiring the main board.

Using the components-placement guide in Fig. 4, install first the resistors and trimmer potentiometers on the main board, then the diodes, capacitors, and wire jumpers (indicated by the Js in Fig. 4). Now, referring to Table 1, determine what values you need for C2, C8, and R49 and whether you need a 665-ohm resistor or a wire jumper for R47. These values will be different for different numbers of cylinders in your vehicle, type of signal takeoff, and the rpm range you wish your tach to indicate. Once you determine the values needed, install and solder them in their respective locations. The last items to install on this board are the integrated circuits. Since this project is intended to be used in a motor vehicle, where it will be subjected to severe vibration, it's best to install the ICs directly on the board, without the use of sockets.

Be sure when you mount the polarized components (diodes, electrolytic capacitors, ICs, and displays) that

you observe orientations before soldering them into place.

You may find that some components, if purchased locally, may be too large to fit on the component side of the main pc board. If you encounter this problem, mount the high-profile components on the foil side of the board. Under no circumstances, however, should you mount any of the ICs on the foil side of the board.

Retrieve the display assembly and examine the foil side. You will note that on both ends of the board are long rectangular foil traces. These are deliberately designed into the board's layout to ease the task of securing the display board to the main board. To do this, you'll need a 6" or longer length of 16-gauge stranded wire. A convenient source of this wire is ordinary zip-type lamp cord.

Strip away about 5" of insulation from the 16-gauge wire. Then tightly twist the fine wires together and liberally tin the bundle with solder. Also, liberally pretin the long foil traces at each end of the display board.

Set the main board on a flat surface, its foil side up and the pins of

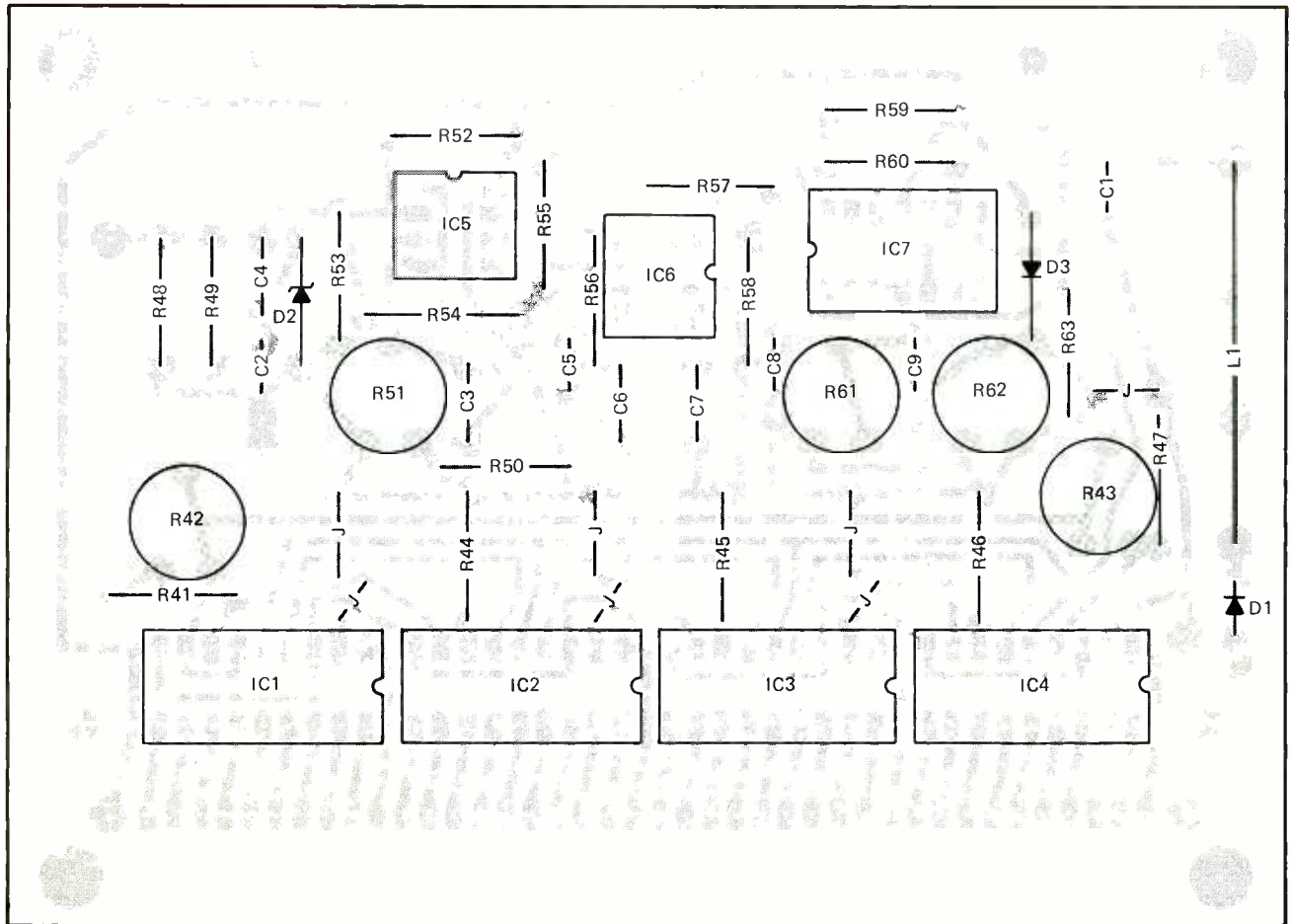

Fig. 4. This is the component-layout diagram for the main board. Before soldering any of the ICs or diodes into place make certain that they are properly oriented. Also, install wire jumpers at the locations indicated by the Js.

IC1 through IC4 farthest away from you. Temporarily set the display board, its foil side facing you, just past the long column of holes in the main board. You will note when you do this that there are two holes, located at the beginning and end of the column, that are much larger in diameter than the remainder of the holes. These are the holes through which you will pass the pretinned 16-gauge wires that will fasten the two boards together.

Remove and set aside the display board. Pass the free end of the 16-gauge wire through one of the larger holes from the *component* side of the board, adjust the length protruding from the foil pad to $\frac{3}{8}$ ", and solder the wire to the foil pad. Make sure that the wire is perpendicular to the

	input frequency in Hz	rpm indication	IC7 output voltage (1K-6K rpm range)	IC7 output voltage (0-8K rpm range)
4-cyl	60	1800	1.8	1.35
	200	6000	6	4.5
	266.66	8000	—	6
6-cyl	60	1200	1.2	0.9
	200	4000	4	3
	300	6000	6	4.5
	400	8000	—	6
8-cyl	60	900	0.9	0.675
	200	3000	3	2.25
	300	4500	4.5	3.375
	400	6000	6	4.5
	533.33	8000	—	6

Table 2. Use this table when calibrating the tachometer (see text).

plane of the board during soldering. Allow the connection to cool for about 10 seconds. Do *not* cut this wire from the component side of the board just yet.

Set the display board back on the main board and align the pretinned traces with the respective holes in the main board. Solder the 16-gauge wire to the appropriate trace. This completes mounting of one wire. Trim the 16-gauge wire flush with the component side of the main board. Then repeat the entire procedure for the other pretinned trace/large hole combination. Discard the remaining length of the 16-gauge wire. When you're finished with this operation, the display board should be perfectly aligned with the smaller holes and perpendicular to the main board.

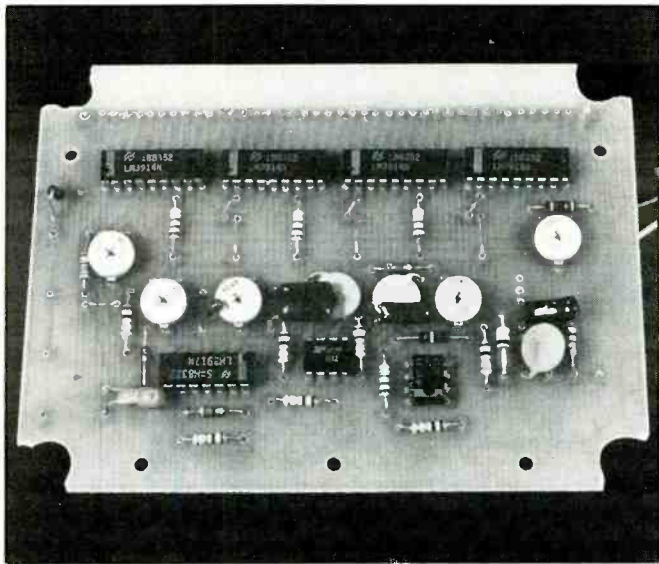

Fig. 5. This is the wired main circuit board. Note the locations and orientations of the diodes and ICs and the locations of the wire jumpers. Note also that the capacitors are folded flat against the board's surface.

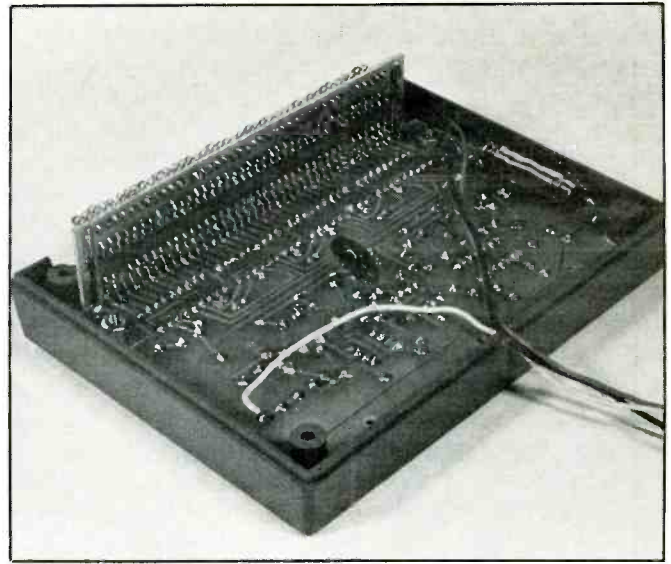

Fig. 6. Completely wired project sits snug inside a compact plastic enclosure. Only high-profile components mount on the foil side of the board, as shown. Power and signal leads exit the enclosure through a notch in the rear.

Locate the longer cut-off leads from *R1* through *R40* and, one at a time, install and solder them to the matching pads at the bottom of the display board and the line of holes between the two 16-gauge wires connected to the larger holes on the main board. When you're finished, the integrated assembly should appear exactly as it does in the photo in Fig. 6. Note in this photo the capacitor and choke mounted on the foil side of the main board and the connections for the power and tachometer pickoff leads. The lengths of the leads (they must be *stranded* hookup wires) will be determined by the requirements of your particular installation.

If you don't have access to or aren't planning to use the distributor points as the signal pickoff, you'll have to fabricate a capacitive pickoff. To do this, you'll need a short length of $\frac{3}{16}$ " thin-wall brass tubing (available from most hobby shops) and an alligator clip. With a jeweler's saw or a hacksaw fitted with a 32-tooth-per-inch blade, split a 2" length of the tubing down the middle. Then

use a fine-tooth flat file to remove any burrs and sharp edges.

With a round file, dish out the forward parts of the alligator clip's jaws to accommodate the tubing halves. Holding the two halves of the brass tubing together, clamp the alligator clip over them. Liberally solder the clip jaws to the tubing (see Fig. 7). Make these connections both electrically *and* mechanically secure. The

soldering job done, you should be able to use the alligator clip to open and close the tubing like a clamshell. This will allow you to clamp the assembly over the wire that goes from the ignition coil to the center of the distributor assembly.

If you use a standard enclosure like those sold by many electronics parts stores, it will have to be modified to accommodate this project. (If you

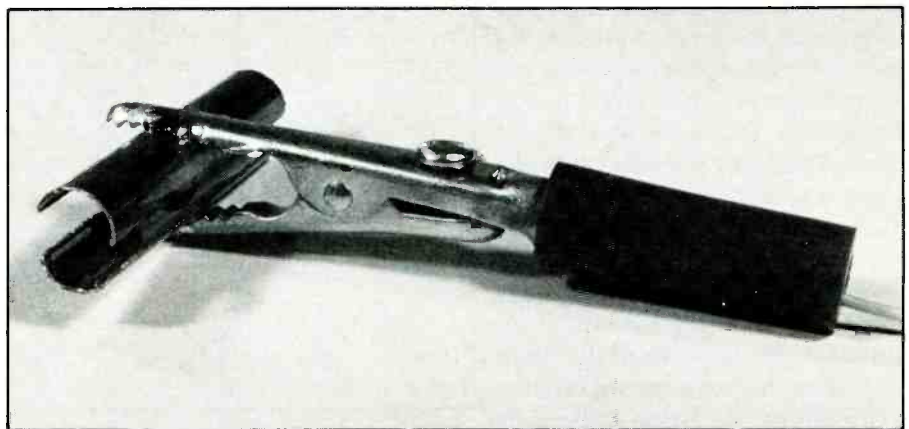

Fig. 7. Capacitive pickoff is easily fabricated with a length of brass tubing and an alligator clip. Be sure to make solder joints mechanically and electrically secure. Full details on fabricating the capacitive pickoff are given in the text.

Design Example

Perhaps the best way to understand how to go about customizing the bargraph tachometer for use in a particular vehicle is to step through the design process. Let's start by assuming that the engine whose revolutions per minute are to be monitored is a four-cycle, four-cylinder model and that the desired range to be displayed is 1000 to 6000 rpm. This means that the highest frequency signal fed to the tach will be 200 Hz (see Table).

From the LM2917's application notes, you know that the highest usable frequency is defined by the formula $F_{\max} = I2 / (C8 \times V_{cc})$, where $V_{cc} = 7.5$ volts. Therefore, $C8 = I2 / (F_{\max} \times V_{cc}) = 180 \mu A / (240 \text{ Hz} \times 7.5 \text{ V}) = 0.1 \mu F$. F_{\max} is set at 240 Hz instead of 200 Hz to provide a little headroom to compensate for component tolerances and prevent saturation of the LM2917.

The measurement span of the circuit is 5000 rpm (6000 - 1000), which yields 5000/40, or 125 rpm for each of the 40 segments in the bargraph display. Since the display starts at 1000 rpm, the top reading will actually be one increment below 6000 rpm, or 5875 rpm (6000 - 125).

Because the supply voltage for IC7 is limited to 7.5 volts by an internal zener diode, this IC's output will not go much higher than 6.0 volts. In this particular case, the output voltage can be set to give a 1:1 correspondence with engine speed. In other words, 5875 rpm will produce an output of 5.875 volts.

Having defined V_{out} , F_{\max} , and the value of C8, you must now determine what values to use for the R61 + R62 combination. Rearranging the above equation, you get $V_{out} = V_{cc} \times F_{in} \times C8 \times (R61 + R62)$. And from this you obtain $(R61 + R62) = V_{out} / (V_{cc} \times F_{in} \times C8)$. Plugging the known values into this equation, you get $(R61 + R62) = 5.875 \text{ V} / (7.5 \text{ V} \times 200 \times 0.1 \mu F) = 39,166$ ohms, a value well within the range of the values specified in the Parts List for the two trimmer potentiometers.

The next step is to set up the dot/bar driver chain. This involves choosing appropriate resistor values so that the proper voltages are applied to the precision voltage divider.

You already know what voltage must be applied to the top of the divider at pin 6 of IC4 (5.875 volts maximum). The bottom of the divider, at pin 4 of IC1, must be one voltage increment less than the lowest reading (1.0 - 0.125, or 0.875 volt). Setting the voltages at these levels allows the first comparator to change

	Two-Cycle			Four-Cycle		
	4-cyl	6-cyl	8-cyl	4-cyl	6-cyl	8-cyl
Sparks/rev.	4	6	8	2	3	4
Sparks/sec. @600 rpm	40	60	80	20	30	40
Sparks/sec. @6000 rpm	400	600	800	200	300	400
Camshaft speed to crankshaft speed	equal	equal	equal	half	half	half

state when the input signal is 1.0 volt, and the last comparator changes state at 5.875 volts.

Now that you know the voltages that will be applied across R43 and R47, you can calculate the values of these resistors if you also know the current that will be flowing through them. Current for the divider chain and calibrating resistors R43 and R47 is provided by the precision reference in IC4.

The precision reference puts out a constant current whose exact value depends on the setting of R42. If we assume that R42 is set to the center of its range, $I_{con} = [1.25 \text{ V} / (R41 + R42)] + 75 \mu A = (1.25 \text{ V} / 1000 \text{ ohms}) + 75 \mu A = 1.325 \text{ mA}$. Therefore, $R47 = V_{low} / I_{con} = 0.875 \text{ V} / 1.325 \text{ mA} = 660$ ohms. The nearest standard 1% tolerance value to this is 665 ohms.

Because R43 is in parallel with the 40,000-ohm precision divider chain, you must first determine what this total parallel resistance will be, using the formula $R_t = (V_{hi} - I_{con}) / 1.325 \text{ mA}$. Therefore, $R_t = 3773$ ohms. Since R_t can also be expressed as $1/R_t = 1/R43 + 1/R_{div}$, you can solve for R43 as follows: $1/R43 = 1/R_t - 1/R_{div} = 1/3773 - 1/40,000 = 3447$ ohms. If R43 is a 10,000-ohm potentiometer, its wiper will be near midpoint when set to this value.

The above basic procedure can be used to set up the tachometer to match your particular needs and desires.

purchase a kit from the supplier given in the Parts List, however, this will not be necessary.) First, use a jeweler's or coping saw to cut a 4 3/8" wide by 1 1/2" high rectangular opening in the front for the display window. Use a sharp utility or X-acto knife to finish off the cut edges. Then, to assure adequate clearance for the display board components and bezel, completely remove the six molded-in pc

board mounting studs located directly behind the window area.

Drill two No. 32 holes in the bottom half of the case to accommodate the forward support hardware. Use the main board as a template for marking the locations of these holes. Then use 6-32 x 1" machine hardware and 1/4" plastic spacers to mount the board.

Drill another No. 32 hole in the

center of the enclosure's rear where the two halves meet. This will be the hole through which the power and signal pickoff wires exit the case.

Calibration

The tachometer project is now ready to be calibrated. This is most easily accomplished with a signal generator

(Continued on page 85) 

A Santa Switch

Ornamental footswitch eliminates fumbling under tree to turn on or off and features a half-power position to reduce electricity cost

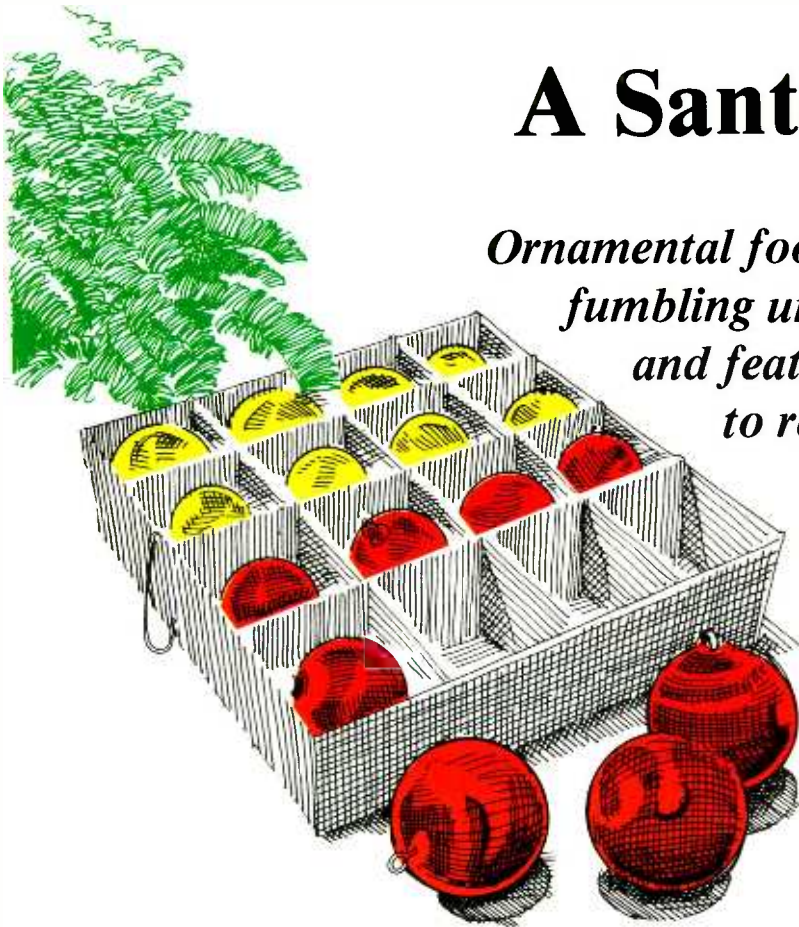

By Rich Vettel

If you're like many people who decorate a Christmas tree with lights, your ac extension cord is usually buried in awkward-to-reach location. Having gone through this scenario just once too often, I decided to put together a switch box that would eliminate the problem once and for all.

This project not only gives me the convenience of controlling my Christmas-tree lights with the tap of a foot, it also provides an attractive decoration for under the tree. As a bonus, my lights will last almost indefinitely on the half-power setting I've built into the project, while cut-

ting my utility costs. Best of all, I was able to build my Santa Switch in a single evening for less than \$10 in all new parts.

How It Works

Referring to the schematic diagram, master on/off switch *S2* contains a built-in neon lamp that just begs to become Santa's (or Rudolph the Red-Nosed Reindeer's or Frosty the Snowman's) nose. This being the case, with one tap of the foot, you can turn on and off the Christmas tree lights and the nose of the under-tree decoration.

The dimmer circuit consists of a rectifier diode (*DI*) in one leg of the ac line cord. With dimmer switch *S1* closed, the rectifier diode is out of the circuit, since the switch contacts of-

fer the path of least resistance to the flow of current from the ac line to the tree lights. Opening *S1* diverts current flow through *DI*. When this occurs, the 117-volt ac line power is converted to pulsating (half-wave) dc. With only one alternation of the ac line voltage available, only half the power is delivered to the tree lights.

As an added safety measure, 2-ampere fuse *FI* is included in the circuit. If a problem develops with any of the lights connected to the Santa Switch, the fuse will blow before a possible fire hazard develops.

Construction

The Santa Switch can be built inside almost any type of enclosure as long as the hazardous ac line voltage is completely isolated. I built mine inside a Bakelite box available in almost any electronics parts store. After machining the box to accommodate the switches, fuse, and extension cord, I covered it by gluing on red felt and gold piping, which I obtained from a fabric store. The Santa Claus face was salvaged from a Christmas stocking, but a cutout from a greeting card would do just as well. If you prefer, you can use a Frosty the Snowman, Rudolph the Red-Nosed Reindeer, or any other face or scene that suits your fancy.

Prepare the box by drilling the holes for *S1*, *S2*, and the fuse holder. (You can forego the chassis-mount fuse holder if you wish, using a clip-type fuse holder inside the box instead.) You also have to drill holes through which to bring the two pieces of an extension cord into the box.

Before mounting the components in the box, glue on the felt cover, using the gold piping to cover the seams. Then mount the switches and fuse holder in their respective holes.

Determine where along the length of the extension cord you want to install the Santa Switch and cut it at this point. Separate the conductors of the cut extension cord for a distance of 6", strip away $\frac{3}{8}$ " of insulation from each, twist together the fine wires of each, and tin with solder.

Pass the free ends of the extension cord through their respective holes in the box and tie a knot in each *inside* the box, leaving enough slack in the wires to make connections into the circuit without pulling the knots away from the holes. The knots are necessary to serve as strain reliefs.

Now, referring to the wiring diagram, interconnect all the parts as shown, and solder them into place. Use heavy-duty stranded hookup wire to interconnect between the two switches and between *S2* and the indicated lug on the fuse holder. Also, install *D1* directly across the lugs of *S1*. Make certain that all connections are mechanically secure before you solder them.

With all wiring completed, assemble the box and install the fuse in its holder.

Checking It Out

Plug a lamp (note: do NOT use this project with any electrical appliance other than an incandescent lamp) into the socket end of the extension cord coming from the Santa Switch. Then plug the other end of the extension cord into an ac outlet. If the neon lamp in *S2* doesn't light up, press this switch once. The neon lamp

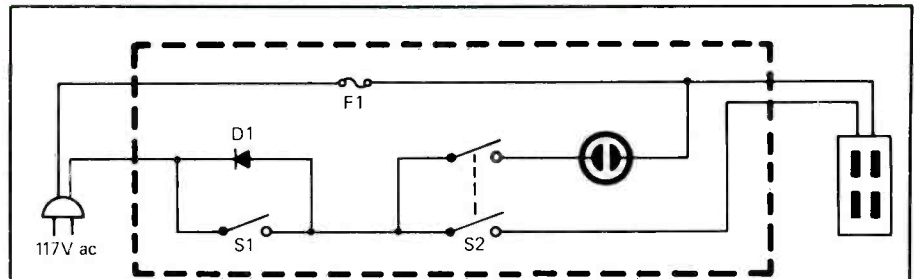

PARTS LIST

- D1—1N5402 rectifier diode
- F1—2-ampere fuse
- S1—Illuminated spdt push-push switch (Radio Shack No. 275-671 or similar)
- S2—Standard spst push-push switch

- Misc.— $6\frac{1}{4}$ " \times $3\frac{3}{4}$ " \times 2" Bakelite or plastic box (Radio Shack No. 270-627 or similar); chassis-mount or clip-type fuse holder for F1; extension cord (preferably green); 12" \times 9" red felt; 2-ft. gold piping; Santa, Frosty, or Rudolph decoration (see text); hookup wire; solder, glue, etc.

Complete schematic diagram and Parts List for the Santa Switch.

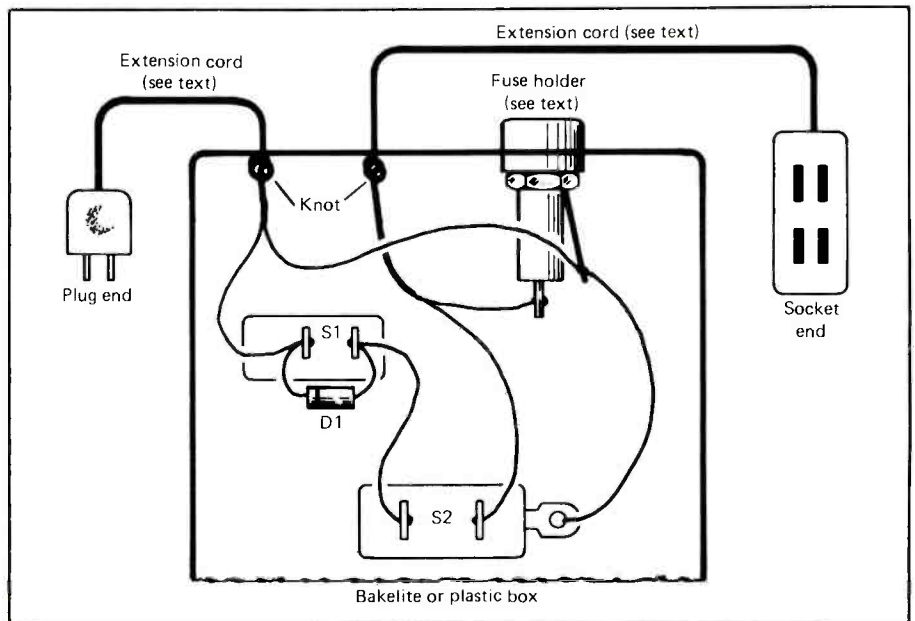

Santa Switch can be built inside any insulating enclosure.

and the plugged-in lamp should both light. Press *S1* once. The incandescent lamp should either dim or brighten. Press *S1* several times to confirm the bright/dim action. Finally, press *S2* once again to extinguish both lamps. If everything

works as described, the Santa Switch is ready to use.

You're now ready to enjoy your Santa Switch. This project could also make a nice Christmas gift that's certain to be appreciated by young and old alike.

ME

A Cassette Recorder Analog Data Logger

By Forrest M. Mims III

The portable cassette tape recorder was invented to provide a convenient means for both recording and playing back speech and music. Computer hobbyists in the mid 1970s found an entirely unexpected role for cassette recorders when they discovered they could be used to save computer program listings and data.

The cassette recorder can also be used to store non-speech or music analog data, such as light intensity, temperature, velocity, revolution rate and many other parameters. Recently, I've spent a good deal of time experimenting with these applications, this column being my first report on the subject.

It's surprisingly easy to store analog data on tape. All that's necessary is an appropriate sensor and a circuit that transforms the signal from the sensor into a variable audio-frequency signal. The variable-frequency signal can be connected directly to a cassette recorder's microphone jack, or it can be transformed into an audio frequency tone and transmitted to the recorder's microphone.

Several methods are available for extracting and decoding a signal that has been saved on a cassette tape. The simplest is to connect a digital frequency counter to a cassette recorder's phone jack. The signal can also be decoded by means of an oscilloscope or frequency-to-voltage (F/V) converter circuit. Figure 1 is a block diagram of a complete analog data storage and retrieval system that employs an F/V converter circuit.

A Typical Sensor Circuit

Figure 2 shows a typical sensor circuit that can be connected to the microphone jack of many cassette record-

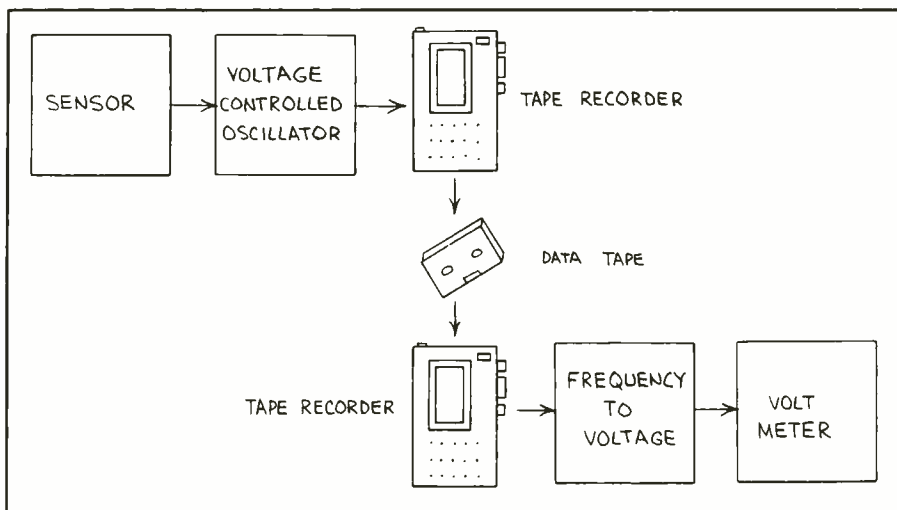

Fig. 1. An analog cassette-tape data storage and retrieval system.

ers. Though the circuit shown is designed as a light-sensitive oscillator, the cadmium-sulfide (CdS) photoresistor can be replaced by a temperature-sensing thermistor or other variable-resistance sensor.

In operation, the 555 timer IC oscillates at a frequency determined by the resistance of *PCI*. As the light level on *PCI*'s sensitive surface increases, the resistance of *PCI* decreases, thereby increasing the circuit's oscillation frequency. Capacitor *CI* has been selected to keep the maximum frequency within the frequency-response range of typical battery-powered cassette recorders.

The circuit in Fig. 2 is merely one of many suitable variable-frequency oscillators. For example, simple bipolar and unijunction transistor oscillators and various kinds of op-amp and timer integrated-circuit oscillators can also be used. In some cases, an oscillator circuit is not even necessary. For example, a magnet sensor switch connected in series with a resistor and a flashlight cell will generate a series of pulses when the sensor switch is placed near a rotating object

to which a small magnet has been affixed. This method can be used to transform to an audio tone the rotation of many kinds of objects including bicycle wheels, anemometers and engine shafts.

A Frequency-to-Voltage Converter

There are several basic circuits and chips that transform to a representative voltage a variable-frequency signal. I've experimented with a circuit that uses a 555 timer IC and several circuits using the 9400 and the LM331, two chips designed specifically as F/V converters. Though all these circuits work well, I prefer the LM331 integrated circuit.

Figure 3 shows a basic F/V converter designed around the LM331. Since the phone output of most cassette recorders has a very low impedance (typically 8 ohms), it's necessary to couple the output signal from the recorder to the F/V circuit with a small audio transformer.

In operation, one of the inputs of a comparator in the LM331 is biased at

a voltage determined by $R2$ and $R3$. The signal from the recorder is inductively coupled through $T1$ to capacitor $C1$ and from there to the second input of the comparator. When the amplitude of the incoming signal exceeds that of the reference voltage provided by $R2$ and $R3$, the output of the comparator changes state until the input signal level falls below the

comparator is the "multiplier" LM331. For switches, loses a current output filter a time constant of $R6$ discharges using the constant to charge source. Capacitor $C2$ is frequency-

LM331 output impedance allows for a particular input on you may an analog

digital meter. The pointer of an analog meter permits trends of a changing frequency to be easily observed, a capability not possible by watching the flickering digits of a digital meter. On the other hand, the digital readout of a DVM or DMM permits a more accurate measurement of output voltages.

Figure 4 is a graph that shows the linear response of the LM331 to a variable frequency ranging from 1 to 10 kHz. The graph was made by recording the voltage output from the

LM331 as the frequency of this signal applied to its input was altered. Here are the actual measurements used to plot the graph for a sine-wave signal:

Input Frequency (kHz)	Output (V)
1	1.35
2	1.67
3	2.48
4	3.22
5	3.98
6	4.76
7	5.53
8	6.25
9	6.95
10	7.13

These results were obtained when the circuit in Fig. 3 was powered by a 9-volt battery. When the circuit is powered by a supply delivering from 10 to 12 volts, the output voltages can be easily adjusted by means of $R5$ to be 1/100 the signal frequency. This is accomplished by applying a 5-kHz input signal and adjusting $R5$ for an output of 5 volts. The output will

then range from almost exactly 0.1 volt at 100 Hz to 10 volts at 10 kHz.

Incidentally, as you can see by referring to Fig. 4, when the incoming signal was a square wave, a non-

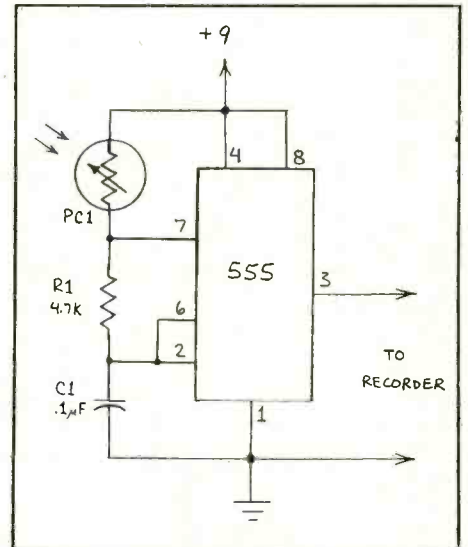

Fig. 2. A typical light-sensitive 555-timer oscillator circuit.

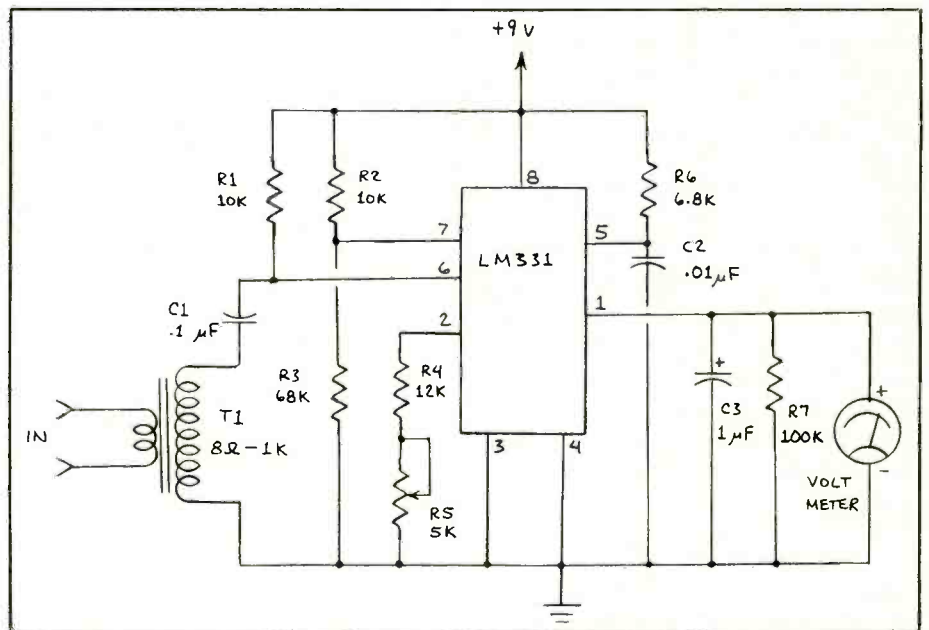

Fig. 3. A frequency-to-voltage (F/V) converter circuit built around the popular LM331 F/V integrated circuit.

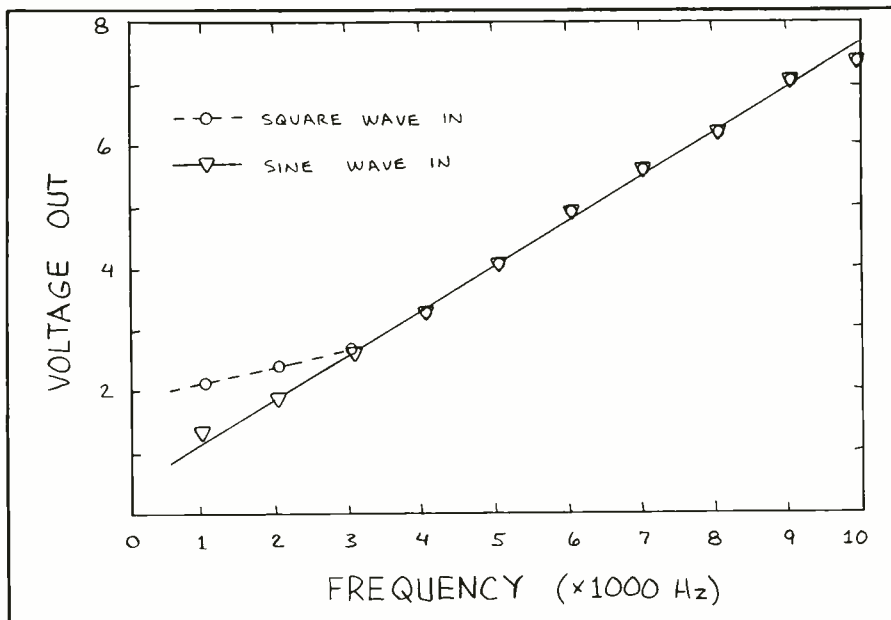

Fig. 4. This is the typical calibration curve for the LM331 F/V chip.

linear knee occurred when the signal frequency was 3 kHz. Other anomalies will occur if the amplitude of the incoming voltage is too high or low. In any case, the voltage of the input signal should range between -0.2 and the supply voltage.

Selecting a Recorder

One of my prized possessions is an Olympus L200 microcassette recorder. This tiny, voice-actuated machine weighs only 4.4 ounces and measures $4.2 \times 2.0 \times 0.5$ inches. Miniature recorders like the L200 are ideal for recording data from a shirt pocket. Unfortunately, however, microcassette recorders lack the frequency range of recorders that use standard cassettes.

For this column I spent a good deal of time testing the low-frequency response of the L200 and Radio Shack's Model CCR-82 computer cassette recorder. Over the frequency range between 100 and 1000 Hz, the

CCR-82 worked exceptionally well. The L200, however, has poor frequency response below about 400 Hz. Though an F/V circuit con-

nected to the L200 can be adjusted to decode frequencies below 400 Hz, this hampers the decoding of higher-frequency signals.

Figure 5 compares the performance of the CCR-82 and the L200 over the 100-to-1000-Hz range. As you can readily see, the performance of the CCR-82 is very linear over this entire frequency range, making this recorder an excellent choice for analog data recording applications. Unfortunately, the poor low-frequency response of the L200 causes a sharp knee in its response. When used to record higher-frequency signals, the L200 should work nearly as well as the CCR-82 since the L200 has a specified frequency response of 400 to 6000 Hz. Unfortunately, despite a series of tests, I was unable to obtain consistent results with the L200 at higher frequencies.

It's important to understand how to make graphs like the one in Fig. 5 if you wish to store analog data on cassette tape. Such graphs are essential

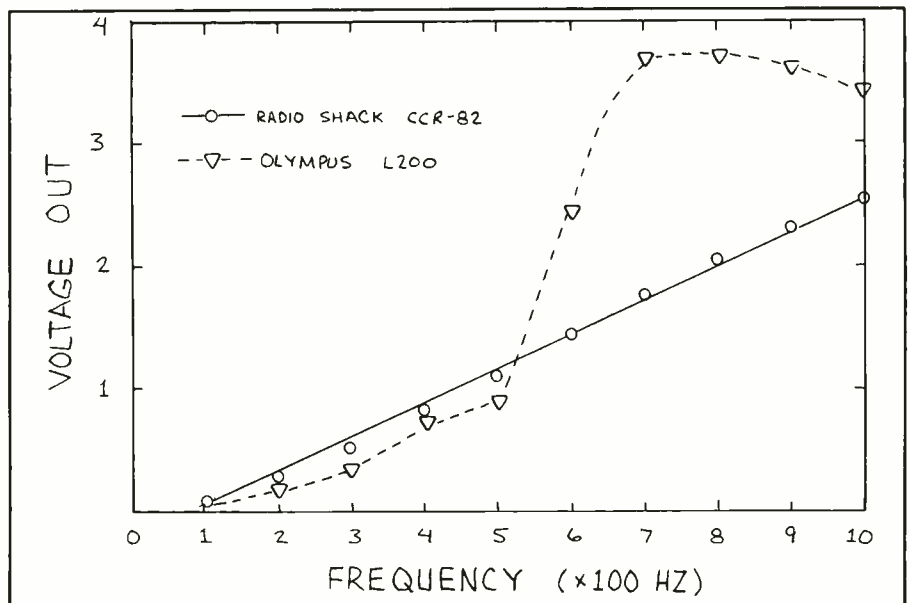

Fig. 5. This drawing is of the calibration curves obtained for two popular cassette recorders, the Radio Shack CCR-82 and Olympus L200.

for properly calibrating an analog data logging system.

First, it's necessary to store on tape a known sequence of audio-frequency tones spaced uniformly across the desired signal range. In the case of Fig. 5, I connected a signal generator directly to the microphone input of both the L200 and the CCR-82 and stored 10-second-long tone bursts at 100-Hz intervals between 10 Hz and 1000 Hz. I then connected the input of the F/V converter circuit in Fig. 3 to the output of each recorder and played back the tapes. While each tape was played, I recorded the voltage for each signal frequency indicated on a digital multimeter connected to the output of the F/V converter. Finally, I plotted the data from each tape on the graph in Fig. 5.

Graphs like the one in Fig. 5 are often called calibration curves. If the curve is in fact a straight line, as is the case with the CCR-81 in Fig. 5, the response of the system is linear and it's very easy to correlate an output voltage from the F/V converter with its respective signal frequency. On the other hand, a nonlinear response, such as the one given by the L200, limits the usefulness of an analog data recording system.

In any case, it's important to note that the readout procedure requires the recorder's volume control to be properly adjusted. During my tests, I found that the CCR-82 worked best when the volume control was set to just above the 3 point on its dial. The L200 worked best when the volume control was set to between 5 and 6. Other recorders may require very different settings.

Using the System

Before using the analog data recording system, it's necessary to adjust the sensor circuit so that the frequen-

cy of the signal it generates falls within the proper range. Likewise, it's necessary to make sure the F/V converter is properly adjusted.

If you plan to take down the decoded voltages by hand, it's important to make sure each data sample is recorded for at least five seconds. This will allow the DVM readout to settle long enough for you to record the reading. If you have access to a chart recorder, the samples can be much briefer since the pen will plot output as a continuous readout.

Many modifications can be made to a cassette recorder analog data logging system. The simplest is to change the input sensor circuit to permit the storage of various kinds of information. If your recorder is equipped with a REMOTE jack, you can turn on and off the drive motor by an external tim-

ing circuit. This will allow you to place up to 180 10-second data samples on a 30-minute tape. If the samples are recorded at intervals of one hour, this arrangement would allow you to take data for seven and a half days on a single tape.

Finally, if you have a personal computer you may be able to interface the LM331 F/V decoder to one of its joystick ports. For example, Radio Shack's Color Computer has voltage-dependent joystick ports that can be directly connected to the LM331 F/V converter so long as the output from the converter doesn't exceed 5 volts. Use caution when making connections to a computer's joystick ports, or you may damage the machine if you exceed the permissible voltage levels. You may also void the computer's warranty. **ME**

SOLVE FOR IMPEDANCE AND PHASE ANGLE. YOU HAVE 20 SECONDS.

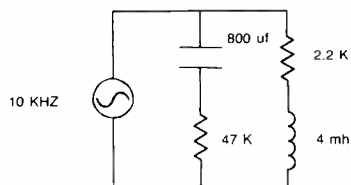

TIME'S UP!

If you were using MENTOR™ you'd be on problem #2.

Whether you use electronics in your vocation or you're just beginning to learn, MENTOR™ (for the Apple II family) is an invaluable tool.

PROFESSIONALS AND HOBBYISTS:

Save time in the design process. Often-used formulas are at your fingertips, for quick calculation of unknowns.

STUDENTS:

Grasp fundamental electronic principles more easily. Understand the inter-relationships of a circuit, by varying parameters and watching the related effect.

EDUCATORS:

MENTOR™ has been aiding in electronic instruction for over 4 years, in high schools, colleges, and universities, throughout the country.

System Requirements:

Apple II, II+, IIc, IIe, III
48K RAM, 1 disk drive

Korsmeyer
ELECTRONIC DESIGN, INC.

5701 Prescott Avenue
Lincoln, Nebraska 68506-5155

CIRCLE 65 ON FREE INFORMATION CARD

The FCC Goes "Public" With Amateur-Radio Tests

By Gordon West, WB6NOA

The Federal Communications Commission is now officially out of the ham-radio test-giving process. No longer will anyone wishing to become a licensed radio amateur or to upgrade a license go down to the local FCC field office to take a test. The test you take now will be from a fellow ham operator.

The FCC Notice of Proposed Rule Making NPR Docket 83-27 outlines a volunteer examiner program where local amateur radio operators will take over the responsibility of giving these tests. Public Law 97-259 amended the Communications Act of 1934 that allows the FCC to accept the voluntary services of licensed radio amateurs in preparing and administering the examinations for the amateur radio service.

No Secret Questions

The FCC has also published every single question with the exact wording that may be found on any amateur radio examination. Similar to FAA pilot exams, students will know precisely what is going to be asked on any upcoming test.

Questions will be multiple-choice types and will be taken from the following question pools:

Class License	Total Questions in Pool	Actual Questions on Exam
Novice	200	20 selected by a single volunteer examiner. Also, 5-wpm code sending and receiving test.
Technician	500	50 questions selected by FCC. No further code test.
General	*same as Technician	13-wpm code sending and receiving test
Advanced	500	50 questions selected by the FCC. *Code test same as General.
Extra	400	40 questions selected by FCC. 20 wpm code sending and receiving test.

**No further test if previous level was passed*



This installation shows a 350XL with a Kenwood tuner at right.

A novice license is the entry-level ticket that you might first want to pursue. The code is easily learned at 5 wpm in about 30 days. The written material can be digested by reading books, but it's much better to get involved with a ham-radio class. Many amateur radio clubs sponsor free ham radio novice classes. You can go to your local ham-radio store and look on its bulletin board for ham club class information.

The novice test is given to you by

your instructor. You'll first take the code test, both sending and receiving. Next you'll take the 20-question multiple-choice exam. The instructor will tell you how well you did.

He or she will send away for your call letters, which takes about three weeks. Your call letters will be sent to you directly to your home address from the FCC in Gettysburg, PA.

A novice license allows you worldwide code privileges on four amateur radio bands. You are *not* permitted to use voice with a novice license at the time of this writing; however, there appears to be a move to allow novice operators some voice privileges on the 220-MHz band next year. Until this happens, though, a novice licensee is restricted to Morse code transmissions only.

The technical/general class license is your next step up the amateur-radio ladder. The technician test should take approximately 60 to 90 days of book study if you have no background in electronics. Since all questions are published, there is no chance of getting any question that

you didn't know was coming. Several publishers will likely be publishing the multiple-choice-type answers to the questions.

Learning ham radio in a classroom situation is one of the best ways to get started. Not only will you learn how to pass the test, you'll also develop good operating procedures as taught by visiting ham-radio instructors.

The technician class license allows voice privileges on vhf frequencies above 50 MHz, and code on novice bands. If this is all that you're looking for, you won't need to increase your code speed beyond 5 wpm. Fur-

thermore, a technician-class license allows you to use of the 2-meter radio repeaters as well as taking advantage of the orbiting amateur-radio satellite. If you're into computers, radio teleprinter, slow-scan television, and talking with handie-talkie or mobile radios, the technician-class license with only a 50-question test may be just the thing for you.

However, if you want to talk to the "world," you will need to pass the general-class 13-wpm code test. This takes about the same amount of time as the technician written test, and you study both at the same time. An ideal

classroom situation would be tech theory for two hours and general class code for one hour. About three months of this and you are ready to pass your general-class 13-wpm sending and receiving code test.

Both the code test and the technician-class examination are administered by three amateur radio extra-class volunteer examiners. These volunteer examiners have been appointed by volunteer exam coordinators to give ham radio tests. All tests must be open to the public; no private tests are allowed.

Any local FCC field office can tell you who to contact for taking an amateur-radio examination. A list of volunteer exam coordinators who may be giving examinations in your area is published here to assist you. The American Radio Relay League, Newington, CT 06111, can also be contacted for information about volunteer examinations in your immediate vicinity.

The general-class license allows worldwide privileges on all amateur-radio bands. Recent band expansions give you more than enough elbow room to take full advantage of this coveted license. The general class license is "the biggie" that everyone should shoot for.

The advanced and the extra-class licenses give you more exclusive frequencies in addition to general-class frequencies. These higher-class licenses don't give you any new bands, they just give a little bit more elbow room to communicate.

Locating Ham Classes

Most amateur-radio clubs and many community colleges offer ham radio licensing courses. There is likely to be a ham radio store and a ham radio club in your area, too. If you can't find one, stop by the house of the fellow who lives down the street who has that huge tower. Chances are he

Amateur Radio Volunteer-Examiner Coordinators

Region 1. Connecticut, Maine, Massachusetts, New Hampshire, Rhode Island and Vermont:

The W5YI Report

P.O. Box 10101, Dallas, TX 75207

American Radio Relay League

Main Street, Newington, CT 06111

(Both W5YI and the ARRL cover ALL areas)

Region 2. New Jersey and New York:

Metroplex Amateur Communications Association

P.O. Box 237, Leonia, NJ 07605

The W5YI Report and ARRL

Region 3. Delaware, District of Columbia, Maryland and Pennsylvania:

Laurel Amateur Radio Club, Inc.

P.O. Box 3039, Laurel, MD 20708

Mountain Amateur Radio Club

P.O. Box 234, Cumberland, MD 21502

The W5YI Report and ARRL

Region 4. Alabama, Florida, Georgia, Kentucky, North Carolina, South Carolina, Tennessee and Virginia:

Western Carolina Amateur Radio Society VEC

P.O. Box 16189, Asheville, NC 28816

Central Alabama VEC

606 Tremont Street, Selma, AL 36701

The W5YI Report and ARRL

Region 5. Arkansas, Mississippi, New Mexico, Oklahoma and Texas:

Dallas Amateur Radio Club, Inc.

P.O. Box 173, Dallas, TX 75221

The W5YI Report and ARRL

Region 6. California:

Greater Los Angeles Amateur Radio Group
c/o Steven L. Shafit

21921 Lanark Street #201

Canoga Park, CA 91304

San Diego County Amateur Radio Council, Inc.

P.O. Box 82642, San Diego, CA 92138

The W5YI Report and ARRL

Region 7. Arizona, Idaho, Montana, Nevada, Oregon, Utah, Washington and Wyoming:

Boeing Employees Amateur Radio Society

P.O. Box 3707, Seattle, WA 98124

The W6YI Report and ARRL

Region 8. Michigan, Ohio and West Virginia:

Dayton Amateur Radio Association

P.O. Box 44, Dayton, OH 45401

The W5YI Report and ARRL

Region 9. Illinois, Indiana and Wisconsin:

DeVry Amateur Radio Society

3300 North Campbell Avenue

Chicago, IL 60618

The 5WYI Report and ARRL

Region 10. Colorado, Iowa, Kansas, Minnesota, Missouri, Nebraska, North Dakota and South Dakota:

The W5YI Report and ARRL

Region 11. Alaska:

Anchorage Amateur Radio Club

P.O. Box 101987

Anchorage, AL 99510-1987

Region 12. Caribbean Insular Areas:

Director, Military Affiliate Radio System

P.O. Box 7388, Cidra, Puerto Rico 00639

The W5YI Report and ARRL

Region 13. Pacific Insular Areas:

The W5YI Report and ARRL



Hams on the air.

will know of a ham club in your area, or he will be able to tell you where classes may be given.

The American Radio Relay League can also assist you in finding volunteer exam coordinators who will tell you about upcoming classes, tests, and courses. The ARRL also has an excellent information sheet about the amateur radio service.

If you are good at studying on your own, you might take advantage of the many ham radio home study courses that are available. Furthermore, there are many helpful self-study books available.

Conclusion

Since the amateur-radio test is given by local hams, chances are you won't encounter "stage fright" when you sit for the code test. You'll be in a re-

laxed atmosphere—possibly the same classroom where you have been receiving your original instruction. The new testing procedures will also eliminate that long drive to a distant FCC testing point.

A word of caution, though. Don't expect that any team of extra-class volunteer examiners will let someone pass if they really don't make the grade. Volunteer examiners are under close scrutiny by exam coordinators as well as the FCC. Any impropriety of exam test-giving could result in the extra-class operators losing their own license. Nonetheless, the general atmosphere is conducive to reducing the jitters when taking the test. So now it's easier than ever to get a coveted amateur-radio license, joining a large and respectful worldwide fraternity. **ME**

NEW!! 46 CHANNEL VHF TO UHF CATV/VCR CHANNEL CONVERTER
With Built In Amplifier and Fine Tuning

- Converts cable TV-Mid and Superband Channels to be received on your TV/VCR's Standard UHF channels
- Designed to enhance VCR units and cable modems
- Conversion line tuning control permits adjustment without special tools or screwdrivers
- Built in Amplifier for UHF gain of +5 to 8 db
- Channel conversion chart on top of unit
- Easy hookup and excellent performance

GMI Model 3640 Our Price **\$32.95 ea.**

EX PRECISION TELEPHONE LINE ANALYZER Model 1042

Fast and easy-to-use for quick line checks. No external power required. Isolates problem to telephone line or telephone. Tests wiring for do-it-yourself installation and line functions that affect telephone operation. Complete instructions incl.

\$16.95 ea.

POPULAR IC CHIPS

TYPE	DESCRIPTION	1 - 9	10 - UP
LM-380N	2 watt Audio Power Amp	\$1.49	\$1.49
LM-386N-3	Low Voltage Audio Amp	1.99	1.19
NE-564N	Digital Phase Locked Loop	3.50	2.85
LM-565N	Phase Locked Loop	1.49	.99
LM-733N	Video Amp	1.69	.98
MC-1330	Video Detector	2.29	1.69
MC-1349	Video II Amp	2.06	1.55
MC-1350	Video II Amp	1.75	1.19
MC-1352	Video II Amp AGC	2.69	2.09
MC-1358	Audio II Amp	1.75	1.64
MC-1374P	R.F. Modulator	3.19	2.99
MC-1458	Dual Comp. Op Amp	.88	.59
MC-1498N	Balanced Mod/Demodulator	1.79	1.34
LM-1889	Video Modulator	2.79	1.95

CLOSEOUT While They Last! TUSA CATV BLOCK CONVERTERS
CVU-1000 Deluxe Model Reg. \$29.95 ea. **\$24.95 Closeout**

WINEGARD 7-ELEMENT 75 OHM UHF YAGI ANTENNAS

OPTIONAL Winegard UHF Antenna Preamp 18db Gain NF: 1.8db **\$39.95 ea.**

12 db GAIN Specify Channel **\$8.95 ea.**
8 OR MORE **\$7.95 ea.**

SANYO UHF VARIATOR TUNERS 75 Ohm Input - 45 MHz Output For Channels 14 - 83

MODEL 1158-403A **\$16.95 EACH**

All units are brand new from Sanyo. Call for Quantity Price

Brand New Hitachi NICAD BATTERIES

Stop wasting money on one-life batteries. These Hitachi batteries can be recharged over and over again. All units are brand new - not surplus.

AA 2 for **\$3.69**
C 2 for **\$5.69**
D 2 for **\$5.69**

75 OHM CABLE CONNECTORS

F-59 Male connector for RG-59A cable. Comes complete with your choice (specify of 1/4" or 1/2" crimp-type ferrule). 100 for **\$10.50** 20c ea.

NEW!! Model SC-34 AB SWITCH ELIMINATOR SIGNAL COMBINER

with Switchable Chan. 3 or 4 insertion
Permits STV, MDS, Satellite or VCR signal insertion into existing MATV/CATV head ends • Permits remote control TV's to switch between all and premium record. Involving • Multi TV set operation allows channel change and TV on/off control. Installs in minutes on any set.

Note: To receive the cable frequencies you must subscribe to the local cable company.

\$99.95 EACH \$94.00 10 OR MORE

Wahl Soldering Irons

MODEL 7470 Temperature-Adjustable Micro Soldering Station Compact 500 to 700°F Perfect for micro circuits and fine mfg. Grounded tip. Comes with 3/16" B type tip, no wiring sponge & stand. 3 wire grounded power supply cord **\$39.95 ea.**

ISO-TIP Model 7700 "Quick Charge" Iso-Tip Cordless Soldering Iron

Recharges completely in 3-4 hours in its 1-1/2 hours for partially discharged battery. Cassio overcharge. Up to 125 electronic joints per charge. Kit contains cordless soldering iron, stand, 7545 tip, 7548 tip & instructions **\$29.95 ea.**

MODEL 7800 Iso-Tip "Hot" Cordless Soldering Iron Fastest recharging cordless soldering iron on the market. Same as above but recharges in ONE HOUR **\$39.95 ea.**

QUALITY POWER TRANSFORMERS

24V CT. 500 mA. **\$3.19 ea. 10 - 49 \$2.75 ea. 50 or more \$2.25 ea.** For Larger Quantities Call

COLORMAX 36 CHANNEL REMOTE CATV CONVERTER

Now you can change channels or fine-tune your TV set by remote control up to 20 ft. away. This unit receives channels 2-13 plus mid & superband cable channels then outputs them on Channel 3.

MODEL CM35-2P 2 pc. REMOTE CONTROL **\$69.95 ea. \$64.95 ea.**

GEN. INSTRUMENT LC558 58 CHAN. CATV CONVERTER

Features all the standard VHF, mid and Superband cable TV channels. Provides excellent reception on any channels that are not being serviced by your local cable company. Converts all cable channels to channel 3 for viewing on your regular TV set. Hand held wireless remote control allows remote channel change and TV on/off control. Installs in minutes on any set.

Note: To receive the cable frequencies you must subscribe to the local cable company.

\$99.95 EACH \$94.00 10 OR MORE

Phone-A-Tenna THE BRAND NEW WINEGARD Model BF-8808 Amplified FM radio signals an average of 18db (8 times). Improves reception and extends range to allow a greater selection of stations and reduces fading. Install in minutes under dash on radio antenna cable. Separate switch and indicator light. 12 VDC. REG. OUR PRICE \$36.25 ON SALE \$24.95

Here's the best quality, cost working phone antenna on the market. Simple installation. Mounts outdoors. Does not void telephone warranty. COMPLETE KIT includes antenna, 40' coaxial cable, adaptor and easy instructions. List Price \$62.25 **Special \$37.95**

ORDER NOW TOLL FREE 800-854-4655
OUTSIDE CALIFORNIA 714-635-5090
INSIDE CALIFORNIA 714-635-5090

R.F. ELECTRONICS
1086 C N. STATE COLLEGE BLVD., DEPT. R ANAHEIM, CALIFORNIA 92806

SURPLUS SYLVANIA VHF VARIATOR TUNERS

45 MHz output. Channels 2 through 13 as well as the mid-band channels. Hookup data included.

WHILE THEY LAST! \$13.95 ea.

OPEN TUES - FRI 10 - 6 SAT 10 - 5 CLOSED SUN & MON

SEND FOR FREE MAIL ORDER CARD

New Television Converter Book

VIDEO SCRAMBLING TECHNIQUES

CIRCUITS, THEORY, WAVEFORMS, Subscription TV Reference Manual

This information packed book details the methods used by subscription TV companies to scramble and descramble video signals. Covers the Sinewave, Gated Pulse, SSAVI system, and the methods used by most cable companies. Includes circuit schematics, theory, waveforms and trouble shooting hints. Only \$12.95 plus \$2.00 first class P & H. Information \$2.00, refundable. Foreign orders please remit in U.S. funds only.

ELEPHANT ELECTRONICS (Formerly Random Access)
Box 41770-G, Phoenix, AZ 85080

CIRCLE 54 ON FREE INFORMATION CARD

The "Born-Again" Computer: Coleco's ADAM *(from page 28)*

Smart Letters & Forms (\$29), Smart Filer (\$25), Address Book w/Auto Dialer (\$49), and Expertype (\$49). A bevy of entertainment and family-learning software is also on hand in data-tape form as well as in Coleco ROM cartridge style.

Hardware Expansion

Coleco is apparently moving along nicely with additional hardware for its ADAM, too. As cited earlier, an additional Digital Data Drive (\$200) can be installed right next to the resident one that comes with the basic computer. As dual-disk owners know, this makes backup of data easier.

There's even a 5¼" disk drive marketed by Coleco that works in conjunction with the Data Tape drives and the word processing ROM program. It's single sided, double density, storing up to 160K bytes. With a suggested retail price of only \$300 by the manufacturer, and given the nature of discounters, it's an attractive route to go.

Receiving and sending data over phone lines is easy enough with the ADAMLink direct-connect modem and software, a \$100 package. Operation is at 300 baud, of course. Thus, ADAM owners can reach out to information services such as Compu-Serve, bulletin boards, etc.

Memory is easily expanded beyond its resident 80K. A 64K-byte Memory Expander simply plugs right into ADAM's memory console, giving a user 144K of data storage, which for word-processing purposes is an added 32 pages of double-spaced pages of typewritten matter (\$200).

There's also an ADAM Universal Interface with both an RS232 serial port and a Centronics parallel port for only \$100. Consequently, peripherals made by other manufacturers can be added to ADAM.

Final Comments

The ADAM Family Computer System lives up to its specifications. Looking at it one year later, it meets

the promise it initially had as a moderately priced home computer system that hangs all together with simplicity and serves a whole family's computing wishes for nonbusiness purposes.

The glitches and other problems incurred with earlier models have clearly been worked out. There's even a bold label on the machine that warns users not to place a data pack on the printer, TV set, etc., which was a major cause of losing data by early ADAM buyers.

I still have some criticisms, as pointed out previously, such as the ever-present low hum coming from the printer, and some software and documentation limitations, natural-

ly. But overall, I'd have to say that the ADAM is more than an adequate computer system for general home use. The ROM and bundled software are excellent for first-time users, especially youngsters. For the latter, the Data Tape cassettes are preferred media since their casing is rugged, whereas floppy disks aren't.

Coleco's ADAM, therefore, should be keen competition to the other useful home computers on the market, such as Radio Shack's Color Computer 2, the Commodore 64, and Atari's 800XL. None of them are bundled as a whole plug-'em-in system or easily used with a letter-quality printer, so ADAM has a preeminence that can be claimed for it. **ME**

CIRCLE 20 ON FREE INFORMATION CARD

Satellite TV—

(from page 37)

the waveform is an average of 30 dB; C/N (correction) = 10 log bandwidth/resolution + 2.5 dB for the scope detector = -11.15 dB; and C/N (true) = 30 dB - 11.15 dB = 18.85. The last figure is very good.

You might also be interested in the video signal-to-noise ratio. A simplified equation will give you this: $S/N = C/N + 35$ dB = 53.85 dB, which is equal to studio quality.

For your receiver, you would probably also like to know the carrier-to-threshold ratio that exists before the introduction of black and white noise dots. The equation for this is: C/N (threshold) = 5 dB + 5 log $(0.5 \times 22 \text{ MHz} / 4.2 \text{ MHz}) = 7.28$ dB. The 22-MHz figure is bandwidth, and the 4.2-MHz figure is the maximum video frequency.

Note in the waveform that transponders 1 and 2 are about 31 dB in amplitude, transponders 4 and 5 are about 29 dB, and transponder 3 is 32 dB. This unevenness explains why

channels 82 and 94 in your receiving locality may be slightly weak.

What does all this have to do with your TV receiver? Well, when FM is detected and AM video is demodulated, your TV receiver "sees" a 6-dB-down 3-MHz-resolution response with the same 30-dB or more carrier-to-noise ratio as the satellite signal (Fig. 3). However, amplification has taken place in the satellite receiver so that your signal is now only 48 dB down (plus 6 dB), instead of -60 dB. This helps, since your TV receiver now has almost 2 mV (millivolts) of signal, which is plenty to put a very viewable picture on the receiver's CRT screen.

Parting Remarks

From the foregoing, it should be quite obvious that satellite TV operations have been going strong for some time now. It should be equally obvious that it will continue to gain strength in the very near future.

ME

NEW PRODUCTS ...

(from page 13)

mance typical of standard automobile antennas. It can be installed in minutes, without tools, and tucks away under the dashboard. The electronics is housed inside a small ($2\frac{1}{8}'' \times 2'' \times \frac{3}{8}''$) high-impact plastic case. The fuse-protected unit operates on any 12-volt, negative-ground power

source. It has a built-in LED that lights when the device is properly connected.

A deluxe version, designated the Model ASC-100 DX, provides the same performance as the standard version, except that it has an on/off switch for use in areas densely ser-

viced by FM stations. \$25, Model ASC-100; \$28, Model ASC-100 DX.

CIRCLE NO. 107 ON FREE INFORMATION CARD



High-Fashion Headphones

Yamaha Electronics is offering two stereo headphone models styled by the Porsche Design Group with the idea of combining excellent sound, high fashion, and human engineering. The new lightweight phones are designed for people who want both good sound and good looks. Both models curl up into palm-sized packages for easy portability.

These Natural Sound phones feature newly designed diaphragms in ball-type housings that sit on the ear and are held in place by a flexible band. The bands easily adjust to fit any size head and seal the diaphragms to the ears for optimum bass response and to provide superior fidelity. The low-end Model YHL-006 (\$40) comes with a vinyl carrying case, while the high-end Model YHL-003 (\$50) has a wider-range diaphragm for extended frequency response and comes with a leather carrying case. Both are supplied with mini plugs for portable use and phone plug adaptors for home use.

CIRCLE NO. 108 ON FREE INFORMATION CARD

ME

A QUALITY TRIPLE-REGULATED POWER SUPPLY AT A LOW, LOW PRICE!!

NOT A KIT!

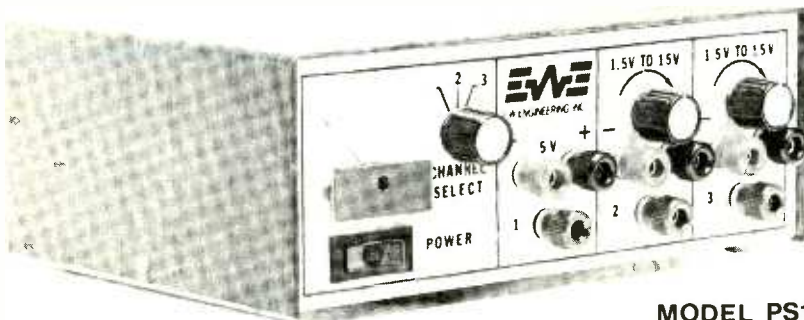

MODEL PS101
FULLY ASSEMBLED & TESTED!

\$ **119** ⁸⁸
FULL 1 YEAR
REPLACE-
MENT
WARRANTY

- Made In The United States -

This DC triple regulated variable power supply has all the features you could ask for plus a full 1 year guarantee. Fully adjustable from $1\frac{1}{2}$ VDC to 35 VDC! Three completely independent supplies that offer many advantages! They can be either a pos. supply or a neg. supply...they can also be stacked in series so that a 5V and two 15V supplies can total a 35 VDC supply or any combination of the three...(after one of the terminals is grounded to give it a reference)...for the first time you can now purchase this American made fully adjustable power supply at a price that is one-half of what you'd expect to pay!

SPECIFICATIONS

3 outputs:
Fixed 5 VDC $\pm 0.2V$
2 variable $\leq 1\frac{1}{2} V$ to $\geq 15 VDC$
Polarity - floating; can be used as pos. or neg.
Ripple less than 10mV at full load,
Regulation $\leq 1\%$ no load to full load,
Line Regulation $< 0.2\%$ 108 VAC to 135 VAC.
Current:
Fixed supply 1.0 amp max.
Variable supplies 0.5 amp max.

Protection built in, current limiting, with thermal shutdown.
Power: 108-135 VAC.
Dimensions: $8\frac{1}{4}'' \times 3\frac{1}{4}'' \times 7\frac{1}{4}''$ (WxD)
Wood grain finished metal case.
Weight: 4 lbs., 9 ozs.
Lighted on/off power switch, easy-to-read Voltmeter and large binding posts.
Warranty: one year full replacement warranty from date of purchase.

DISTRIBUTOR AND REPRESENTATIVE INQUIRIES INVITED

E.W.
E.W. ENGINEERING, INC.

VISA, MASTERCARD, AMEX TELEPHONE ORDERS ACCEPTED!
6 Herman Drive, E. Granby, CT 06026 □ 203/651-0285

CIRCLE 75 ON FREE INFORMATION CARD

A Bargraph Tachometer For Any Automobile *(from page 69)*

set for a frequency that represents the top end of the tach's measurement range. However, in a pinch, the 60-Hz signal from a 12.6-volt transformer can be used.

Connect a 12-volt dc power source to the appropriate power leads of the tachometer. With no signal applied to the tach's input, adjust the setting of *R51* until the voltage at pin 7 of *IC5* goes high. Set *R61* and *R62* to center of rotation. Then connect the signal lead from the tach to a square wave source with an output amplitude of 10 to 15 volts peak. Set the frequency of the signal generator to one of those listed in Table 2 that matches your vehicle's specifications. Adjust the setting of *R61* until you obtain the reading called out in Table 2. If necessary, use *R62* as a fine adjust.

Next, set up the display drivers. Set *R42* and *R43* to center of rotation. At this point, you have two choices. You can make the tach indicate a 0-to-8000-rpm range or expand the range to indicate from 1000 to 6000 rpm. Your choice will dictate how to calibrate the tach.

If you choose the 1000-to-6000-rpm range, measure the voltage across *R47* while adjusting the setting of *R42* for a reading of 0.875 volt. This sets the voltage at the lower end of the precision divider chain. Then connect the meter between the wiper of *R43* and ground and adjust the setting of *R43* for a reading of 5.875 volts. This sets the voltage at the top end of the voltage divider.

If you've decided to have your tachometer display a 0-to-8000-rpm range, only the voltage at the wiper of *R43* need to be set—to 6.000 volts.

With calibration complete, it's a good idea to lock the positions of all trimmer potentiometers (except *R51*) with plastic cement or nail polish.

Installation

You're now ready to install your tachometer in your vehicle. For powering the project, you'll have to con-

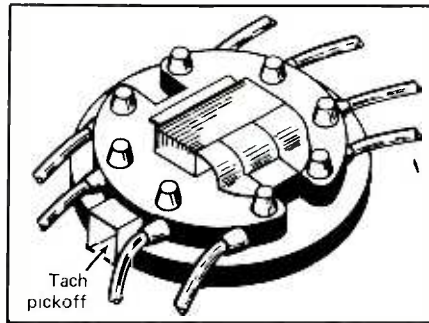

Fig. 8. Location of tach pickoff on the Delco high-energy ignition.

nect it to the vehicle's chassis (ground lead) and a source of +12 volts (hot lead) that is switched on and off with the ignition key. After connecting the wires to the appropriate points in your vehicle's electrical system, start the engine. At this point, there should be a stable reading of engine rpm at idle on the tach's display. If the reading isn't stable slowly adjust the setting of *R51* until the display settles down.

When *R51* is properly set, you should be able to rev the engine and observe a fast and smooth response in the display as engine speed increases. When you've completed this final calibration step, lock *R51* with plastic cement or nail polish.

Use a dry-transfer lettering kit (white) to label the filter that fits in front of the bargraph display with the appropriate legends. A typical example of how to label the filter is illustrated in the lead photo.

If your vehicle uses the Delco high-energy ignition system, there are no points or ignition coil from which to pick off a signal. However, this type of distributor does have a tach output (Fig. 8) that can be used in place of the ignition points.

The tachometer can be mounted just about anywhere within convenient viewing range when you're in the driver's seat. However, keep it out of direct sunlight or you may find it difficult to impossible to read the display. Under the dashboard or directly on the steering column are perhaps the best places to mount it.

Under-dash mounting can be accomplished in either of two ways. You can use two self-tapping sheet-metal screws to fasten the top half of the case to the bottom of the dashboard and then assemble the lower half of the box to the upper. Alternatively, you can assemble the box first and then anchor it to the underside of the dash with foam tape that has adhesive on both faces.

To mount the tach on the steering column, the best approach is to use a large hose clamp. First, cut two narrow slots, parallel to each other, through the bottom of the tach's case. Then thread the clamp through both slots and cover the exposed metal inside the case with electrical tape. Next, wrap a turn or two of nonskid rubber or plastic around the steering column. Finally fasten the tach, via the hose clamp, over the rubber or plastic, making the clamp moderately tight to prevent it from coming loose from road vibrations. **ME**

STATE OF THE ART KITS

TOUCH-TONE DECODER AND ENCODER KITS

HAL-567-12 TOUCH-TONE DECODER, SINGLE LINE IN 12 LINES OUT. COMES COMPLETE WITH P.C. BOARD AND ALL PARTS. NO SOCKETS CASE OR POWER SUPPLY. \$39.95

HAL-567-18 TOUCH-TONE DECODER, SINGLE LINE IN 18 LINES OUT. COMES COMPLETE WITH P.C. BOARD AND ALL PARTS PLUS SOCKETS NO CASE OR POWER SUPPLY. \$69.95

HAL-EC0-12 TOUCH-TONE ENCODER, 3 x 4 12 CHARACTER, USE FOR DIALING. COMPLETE WITH ALL ELECTRONIC PARTS. INCLUDES SPEAKER FOR AUDIO COUPLING AND I.E.D. FOR VISUAL INDICATION. CRYSTAL CONTROLLED SINGLE IC CHIP & ALUM CASE. \$29.95

HAL-EC0-18 TOUCH-TONE ENCODER, 4 x 4 16 CHARACTER USE FOR DIALING. COMPLETE WITH ALL ELECTRONIC PARTS. INCLUDES SPEAKER FOR AUDIO COUPLING AND I.E.D. FOR VISUAL INDICATION. CRYSTAL CONTROLLED, SINGLE IC CHIP & ALUM CASE. \$39.95

VARIOUS CLOCK KITS

HAL-5314 (Most Famous Clock Kit) 6 DIGIT ELECTRONIC CLOCK KIT, 12 OR 24 HOUR FORMAT. COMPLETE KIT LESS POWER SUPPLY ADAPTOR AND CASE. RUNS OFF ANY 12 VOLT A.C. SOURCE. REQUIRES 250 MA. \$12.95

HAL-5375 (Alarm Clock Kit) 6 DIGIT ELECTRONIC CLOCK KIT, 12 HOUR FORMAT. ONLY OPERATE ON 12 VOLTS A.C. OR D.C. HAS TIME BASE ONBOARD. COMES COMPLETE LESS POWER ADAPTOR AND CASE. \$18.95

HAL-79 SPECIAL (Student Class Kit) 8 DIGIT BASIC ELECTRONIC KIT, WITH OPTIONS AND PROVISIONS TO MAKE IT AN ALARM CLOCK AND A D.C. OPERATED CLOCK. COMPLETE LESS OPTIONS, POWER SUPPLY ADAPTOR AND CASE. \$7.95

OPTION #1 TO MAKE IT AN ALARM CLOCK \$2.95

OPTION #2 TO MAKE IT A D.C. 12V CLOCK \$4.95

CLOCK CASE ONLY WHEN BOUGHT WITH CLOCK KIT Reg. \$6.50 - ONLY \$4.50

12 VOLT A.C. ADAPTOR ONLY WHEN BOUGHT WITH CLOCK KIT Reg. \$4.95 - ONLY \$2.95

80 HZ TIME BASE CRYSTAL TIME BASE KIT USING MM5389 - COMPLETE \$4.95

HAL-EG-100 FUNCTION GENERATOR KIT, 1 HZ TO 100 KHZ IN FIVE BANDS. AMPLITUDE NAD OFFSET ADJUSTABLE. OUTPUT IMP. 500 OHMS. WAVE FORMS - SINE, SQUARE AND TRIANGULAR AND TTL. CLOCK IS TO 5V LEVEL, 200 NS RISE AND FALL TIME. COMPLETE KIT WITH CASE AND POWER SUPPLY AND ALL ELECTRONIC PARTS INCLUDING MANUAL. \$89.95

SHIPPING INFORMATION: ORDERS OVER \$25 WILL BE SHIPPED POST-PAID EXCEPT ON ITEMS WHERE ADDITIONAL CHARGES ARE REQUESTED. ON ORDERS LESS THAN \$25, PLEASE INCLUDE ADDITIONAL \$2.50 FOR HANDLING AND MAILING CHARGES. MICHIGAN RESIDENTS ADD 4% SALES TAX. SEND 20¢ STAMP OR SASE FOR FREE FLYER.

COMPLETE SETS OF P.C. BOARDS AVAILABLE FOR UNICORN ROBOT, PROJECT, HEART-A-MATIC, PROJECT, PLANO-MATIC, PROJECT, AND MANY, MANY OTHER KITS AVAILABLE.

HAL-TRONIX, INC. P.O. BOX 1101 SOUTHGATE, MICH. 48195 PHONE (313) 265-1782

HAL HAROLD C. NOWLAND W423H

CIRCLE 73 ON FREE INFORMATION CARD

PRODUCT EVALUATIONS . . .

Hi-Fi VCR Has TV Stereo Decoder: Mitsubishi's New Model HS-400UR (from page 18)

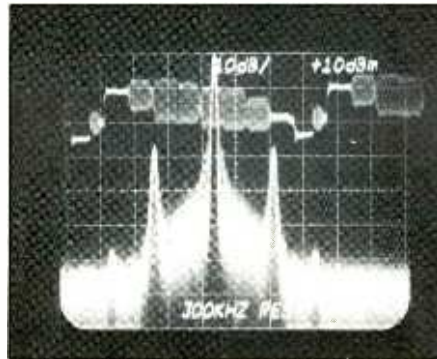
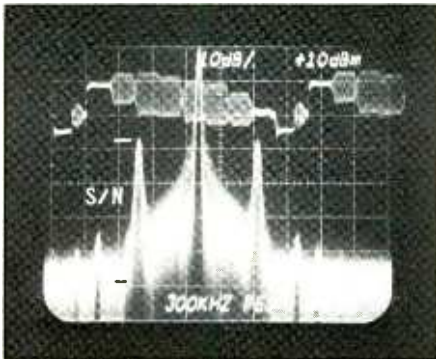

Fig. 2. Color bars are usually handled well in VCRs, as demonstrated here.

multimeters. Some of the results obtained with this setup were rather surprising. The test results are summarized in the table and shown graphically on the waveform photos.

To make the laboratory test results as meaningful as possible, I've included waveform photos for both the SP (standard-play) and EP (extended-play) speeds. Any slight differences between the photo pairs are easily explained by the difference in tape speed.

Using multiburst for checking maximum horizontal resolution, I obtained the waveforms shown in Fig. 1. A close examination of the two photos here will reveal that there's little difference between the first three bursts in Fig. 1A for the SP mode, amounting to no more than 3

dB. However, in the Fig. 1B photo for the EP mode, there's easily a 6-dB difference between the 0.5- and 2-MHz bursts, with a considerable increment of noise beyond 2 MHz.

You might think you see a 3-MHz resolution in the SP mode, but at more than 15 dB down, there isn't much with which to work. Noise in the EP mode, of course, makes any such extended frequency useless. In addition, there's some 3.58-MHz burst oscillation in the fifth bar, apparently characteristic of these recorders but invisible on-screen because of the foreshortened response.

In the color-bar representations shown in Fig. 2, all bars are fairly well regulated and situated approximately where they should be in terms of locations and amplitude and with

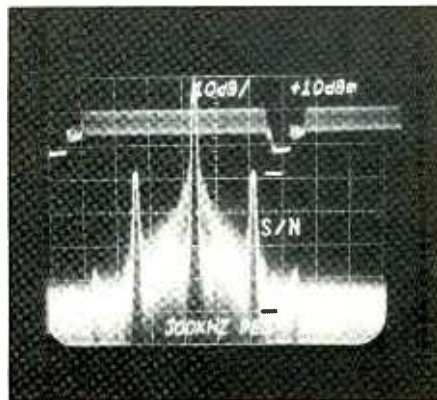
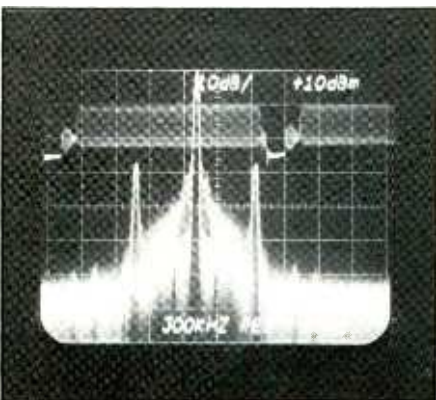

Fig. 3. Red field has the same characteristics as the color bars.

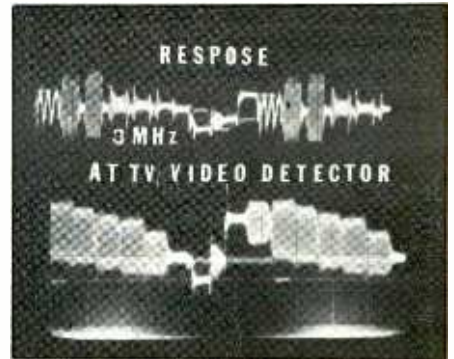

Fig. 4. Multiburst at the TV monitor's video detector reveals true 3-MHz response in the SP mode.

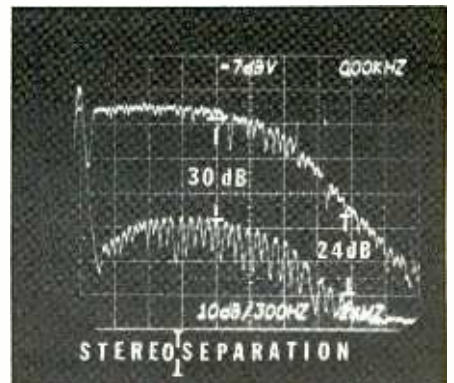

Fig. 5. This is the dual spectrum analysis of the VCR's audio frequency response and stereo separation.

hardly any noise. In effect, the colors aren't especially speed-sensitive, as illustrated in the two photos, although some of the secondary bars don't appear to be quite as solid.

A red field is used in Fig. 3 to evaluate color signal-to-noise ratio. Primary amplitudes, once again, are similar for SP and EP speeds.

Figure 4 is a photo of the SP-recorded signals reproduced by the video detector of an excellent TV monitor. Observe that the 1.25- and 2-MHz multibursts appear to be accentuated, although the color bars look much the same as before.

Finally, Fig. 5 is the audio dual

Stereo Is Coming! Stereo Is Coming!

Since its inception, broadcast TV programming has been restricted to a monophonic sound channel. Though the FM sound channel in the composite TV broadcast signal is theoretically capable of wide-range high-fidelity sound synonymous with that obtainable with standard FM radio broadcasts, the quality of the sound sent over the airwaves has traditionally been about equal to that obtainable with AM radio. This was—and, in the main, remains—the sound situation for TV programs. Now this situation is on the verge of major change, thanks to an FCC-approved scheme to put wide-response *stereo* audio on the broadcast TV signal.

FCC-approved Broadcast Television Systems Committee (BTSC)

stereo TV is being test aired in selected large urban areas across the U.S. at present. Unless you live in one of these areas and have a stereo decoder with built-in dbx expansion/compression system, you can't yet receive the benefits of stereo TV sound. However, it won't be too long before you can, if the broadcasters keep to schedule.

Broadcast TV stations throughout the country are slated to receive stereo excitors some time during the third or fourth quarter of 1985. When they do, those viewers who have the proper equipment will be able to immediately take advantage of high-fidelity stereo TV sound. At the present time, though, engineering modifications are continuing, and problems with TV transmitter and antenna (diplexer) installations

are presenting a formidable challenge to the four or five manufacturers who are resolutely tackling the problems.

As the major TV networks turn more to satellite-distributed programming, instead of conventional microwave and cable, you'll find a rich fare of stereo TV sound. In the meantime, look around for a new stereo amplifier and a pair of good speaker systems to make the union complete. Or purchase a good TV monitor with a built-in BTSC/dbx decoder and satisfactory speaker systems. You'll be glad you did! As you'll soon discover, baseband video/audio is the *only* way to go to obtain maximum picture resolution and satisfactory sound when using video recorders, videodiscs, and video displays.

peak-detected waveform. A 2-kHz/division scale was used here, with the test starting at about 200 Hz and working gradually out to 20 kHz, although the first frequency at the left is really 1 kHz. What you see here are the relative positions of the two channels as recorded from the function generator's linear output. It rises a little at the beginning, remains fairly linear to about 8 kHz, and drops off by some 4 dB at around 10 kHz. Roll-off is almost precipitous beyond the 12-kHz point.

Audio separation at 8 kHz is a generous 30 dB and at 16 kHz an equally generous 24 dB. Probably the best usable frequency response you can expect to obtain from this VCR would be out to about 13 kHz, which is more than sufficient to handle just about

anything in the way of audio that's likely to be transmitted in the stereo-TV signal.

Since we approached this as a *video* product, no attempt was made to evaluate the Model HS-400UR as a strictly audio product.

User Comment

In light of the fact that I received neither an operator's manual nor a service manual with the unit I tested, it took me a little time to figure out how to use the Model HS-400UR. Programming the desired channels into the tuner's memory bank was somewhat difficult at first but went easy enough once I figured out the sequence to use. The TUNER/EXT/EXT AUDIO switch threw me until I real-

ized that "EXT" meant baseband video/audio inputs.

The compact remote-control transmitter box duplicates the transport controls on the VCR itself. However, it lacks what I consider three essential functions: a TV/VCR switch, up/down channel scan buttons, and a means for controlling audio volume. Also, it can directly address only 16 channels, awkwardly I might add.

With the Model HS-400UR, Mitsubishi has a multichannel stereo/SAP videocassette recorder first. As such, I would say that in terms of design concept, Mitsubishi deserves an AAA rating. Translating the concept into an actual product is another matter altogether. In this area, I would give Mitsubishi a rating of a big 8 out of 10.—*Stan Prentiss* **ME**

CIRCLE 30 ON FREE INFORMATION CARD

AMAZING SCIENTIFIC and ELECTRONIC DEVICES

- PLANS**—All Parts Available In Stock
- LCS BURNING CUTTING CO2 LASER \$15.00
 - RUB3 RUBY LASER RAY PISTOL 15.00
 - BTC5 1.5 MILLION VOLT TESLA COIL 15.00
 - PTG1 PLASMA TORNADO GENERATOR 8.00
 - DISPI LIGHTNING AND ION LAMP 7.00
 - LRG3 SOLID STATE LASER RIFLE 10.00

- KITS**—Includes Plans and Parts
- LHC2K SIMULATED RED/GRN/YEL LIGHT LASER 34.50
 - BTC3K 250,000 VOLT TESLA COIL 139.50
 - IOG1K ION RAY GUN 109.50
 - PSP3K PHASOR SHOCK WAVE PISTOL 49.50
 - PPG1K PHASOR PROPERTY GUARD 175.00
 - INF1K INFINITY TRANSMITTER 134.50
 - MFT1K 2-3 MILE RANGE FM VOICE XMTR PC BOARD 49.50

- ASSEMBLED AND TESTED PRODUCTS**
- LGU30 RED 1MW PORTABLE He-Ne LASER 315.00
 - TCL30 SOLID STATE TESLA COIL 35KV 74.50
 - IPG50 POCKET PAIN FIELD GENERATOR 64.50
 - BLS10 BLASTER DEFENSE WEAPON 89.50
 - TAT20 AUTO TELEPHONE RECORDER 24.50
 - PPF10 PHASOR PAIN FIELD PORTABLE 249.50
 - SNP20 SECURITY PHONE LISTENER 99.50

• **CATALOG** CONTAINING DESCRIPTIONS OF ABOVE PLUS **HUNDREDS** MORE AVAILABLE FOR \$1.00 OR INCLUDED **FREE** WITH ALL ABOVE ORDERS. PLEASE INCLUDE \$3.00 PH ON ALL KITS AND PRODUCTS. PLANS ARE POSTAGE PAID. SEND CHECK, MO, VISA, MC TO

INFORMATION UNLIMITED
P.O. BOX 716, DEPT. ME10, AMHERST, NH 03031

CIRCLE 34 ON FREE INFORMATION CARD

SAVE BY BUILDING OUR RACK MOUNT STUDIO EQUIPMENT

QUADRAFUZZ — four separate frequency bands of distortion are mixed for the smoothest fuzz you've ever heard. no. 6720..... \$39.88

HYPERFLANGE/CHORUS — the cleanest, widest range, most versatile flanger anywhere at any price. no. 6750..... \$149.95

VOCODER — unmatched performance in a versatile, low cost rack package. no. 6710..... \$99.95

HOT SPRINGS — user's agree, short of studio plate systems, you won't find a better reverb at any price. no. 6740..... \$59.95

**ADD \$3 SHIPPING
FOR EACH KIT ORDERED**

Innovative, cost effective designs by Craig Anderton in easy to assemble kits from:

PAIA Electronics, Inc.

Direct mail orders and inquiries to: Dept. 11E
1020 W. Wilshire, Oklahoma City, OK 73116 • (405) 843-9626
Ask for your free catalog.

CHARGE TO VISA OR MC TOLL-FREE
1-800-654-8657 9AM to 5PM CST MON-FRI

CIRCLE 60 ON FREE INFORMATION CARD

MODERN ELECTRONICS MART

Classified Commercial Rates: 90¢ per word, 15-word minimum (\$13.50) prepaid. (Word count includes name and address.) *First word only is set boldface caps* at no charge. Add 20% for additional boldface words.

Mart Display Rates: 1" x 1 col., \$120; 2" x 1 col., \$230; 3" x 1 col., \$330. Prepayment discount 5% for 6 issues; 10% for 12 issues prepaid at once.

(All advertisers with PO Box addresses must supply permanent address and telephone number. Copy is subject to publisher approval.)

Mailing Information: Copy must be received by the publisher by the 20th of the third month preceding the cover date. Send Advertising material with check or money order to: Modern Electronics, Classified Department, 76 North Broadway, Hicksville, NY 11801.

Cable Converters to Scramblers. Lowest Price. COD shippers. Dealer inquiries accepted. Quantity discounts. Catalog \$1. P.G. Video Corp., PO Box 296, Latham, NY 12110 (518) 274-6593.

Cable TV Converters. All types. All systems. Zenith, Scientific-Atlanta, Terrold specials. \$2 catalog. United Electronic Supply, PO Box 1206, Elgin, IL 60121-0119 (312) 697-0600.

ELECTRONIC CATALOG. Over 4,500 items. Parts & components. Everything needed by the hobbyist or technician. \$2.00 postage & handling (United States Only), refundable with first \$15.00 order. T & M Electronics, 472 East Main St., Patchogue, NY 11772. (516) 289-2520.

CB RADIO MODIFICATIONS! Increase channels, range, privacy. Conversion hardware, books, plans, kits, repairs. Catalog \$2. CBCI, Box 31500ME, Phoenix, AZ 85046.

NEW... REPAIR ANY TV... EASY. Anyone can do it. Write, Research, Box 601BY, Colville, WA 99114.

APPLE OWNERS: Hard-sided carrying cases for Macintosh \$100, Macintosh and external drive \$130, and IIc \$100. Send check or money order, or MC/Visa accepted. Justin Case Manufacturing Corp., 334 Main Street, Port Washington, NY 11050 (or telephone 516-883-2299).

STAINED GLASS! Supplies, books, tools, patterns, etc. for moneymaking hobby. Whittemore, Box 2065KC, Hanover, MA 02339.

SCANNERS, ACCESSORIES - 2% ABOVE COST! Great Newsletter! Nationwide Frequency Printouts! Send Stamp for Membership Information! SPOTLIGHT-VIP, Box 3047, Greenville, NC 27836.

US\$8.00 including disk, thousand name brand programs for Apple, IBM-PC. Details Reliant, P.O. Box 33610, Sheungwan, Hongkong.

Biggest TI-99/4A selection. Newest exciting software and hardware bargains. Hard to get items. Send for free catalog. Fast Service. Tynamic, Box 690, Hicksville, N.Y. 11801.

Order Form Please print in block letters.

MODERN ELECTRONICS 76 North Broadway, Hicksville, NY 11801

Name _____
Street _____
City _____
State _____ Zip _____

1	2	3	4	5
6	7	8	9	10
11	12	13	14	15
16	17	18	19	20
21	22	23	24	25

WE HAVE QUALITY PARTS, DISCOUNT PRICES AND FAST SHIPPING!

TRANSFORMERS

120 volt primaries



5.6 VOLTS @ 750 MA	\$3.00
6 VOLTS @ 150 MA	\$1.25
12 VCT @ 200 MA	\$2.00
18 V @ 650 MA	\$3.50
18 VOLTS @ 1 AMP	\$4.50
24 VOLTS @ 250 MA	\$2.50
24 VCT @ 1 AMP	\$4.50
42 VCT @ 1.2 AMP	\$4.50

RS-232 EXTENSION



9 LINE CONNECTED LINES 1 THROUGH 8 & 20. DB25 MALE TO FEMALE. 10 FEET SHIELDED.

\$11.00 EACH

MIKE CONNECTOR



5 CONDUCTOR IN-LINE PLUG AND CHASSIS MOUNT JACK. TWIST LOCK STYLE. SAME AS SWITCHCRAFT 12CL5M.

\$2.50 PER SET

7 CONDUCTOR RIBBON CABLE



SPECTRA-STRIP RED MARKER STRIP. 28 GA STRANDED WIRE. \$5.00 PER ROLL (100 FT.)

REVERBERATION UNIT



ACCUTRONICS COIL SPRING TYPE UNITS. USED IN ELECTRONIC ORGANS TO PROVIDE ACOUSTIC DELAY SOUND EFFECTS. INPUT IMPEDANCE 8 OHMS, OUTPUT IMPEDANCE 2250 OHMS. 4 1/2" x 16 1/4" x 1 1/16".

\$7.50 EACH

WALL TRANSFORMER

ALL ARE 115 VAC PLUG IN



4 VDC @ 70 MA	\$2.00
6 VDC @ 100 MA	\$2.50
6 VDC @ 500 MA	\$5.00
9 VAC @ 1 AMP	\$3.00
15 VAC @ 300 MA	\$3.00
16.5 VAC @ 10 VA	\$3.50
17 VAC @ 500 MA	\$4.00

MULTI-SWITCHES

3 STATION NON-INTERLOCKING

3 2PDT SWITCHES EACH OPERATES INDEPENDENTLY.

1 3/4" BETWEEN MOUNTING CENTERS.

\$1.75 EACH

METER

0 - 15 V.D.C.

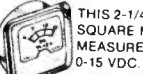

THIS 2-1/4" SQUARE METER MEASURES 0-15 VDC.

\$4.50 EACH

COMMUNICATION MICROPHONE



NEW C.B. STYLE MIKE WITH PUSH S.P.D.T. SWITCH.

\$5.00 EACH

SOUND AND VIDEO MODULATOR FOR T.I. COMPUTER



T.I. # UM1381-1. DESIGNED FOR USE WITH T.I. COMPUTERS. CAN BE USED WITH VIDEO SOURCES. BUILT-IN A/B SWITCH. CHANNEL 3 OR 4 SELECTION SWITCH. OPERATES ON 12 VDC. HOOK UP DIAGRAM INCLUDED.

\$10.00 EACH

SPRING LEVER TERMINALS

TWO COLOR CODED TERMINALS ON A STURDY 2 3/4" x 3 3/4" BAKELITE PLATE. GREAT FOR SPEAKER ENCLOSURES OR POWER SUPPLIES.



\$1.00 EACH 10 FOR \$9.00

5 STATION INTERLOCKING

MADE BY ALPS. 3 2PDT AND 2 6PDT SWITCHES ON FULLY INTERLOCKING ASSEMBLY. 3/4" BETWEEN MOUNTING CENTERS.

\$2.50 EACH

SUB-MINIATURE D TYPE CONNECTOR



SOLDER TYPE SUB-MINIATURE CONNECTORS USED FOR COMPUTER HOOK UPS.

DB 15 PLUG	\$2.75
DB 15 SOCKET	\$4.00
DB 15 HOOD	\$1.50
DB 25 PLUG	\$2.75
DB 25 SOCKET	\$3.50
DB 25 HOOD	\$1.25

PUSHBUTTON POWER SWITCH

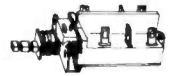

DOUBLE POLE POWER SWITCH. PUSH ON, PUSH-OFF.

\$1.00 EACH

2K 10 TURN MULTI-TURN POT



SPECTROL #MOD 534-7161

\$5.00 EACH

PHOTO-FLASH CAPACITORS

170 MFD 330 VOLT

1 1/8" x 7/8"

2 FOR \$1.50 10 FOR \$7.00

2 CHANNEL LIGHT ORGAN

EASILY HOOKS INTO STEREO SPEAKERS AND ALLOWS 110 VAC LIGHTS TO DANCE WITH MUSIC. TWO SEPARATE 110 VAC OUTPUTS FOR HIGH AND LOW FREQUENCY AUDIO SIGNALS. USE TWO ORGANS FOR STEREO.



\$6.50 PER UNIT

COLOR LIGHT STRING AVAILABLE \$1.75 EA

5 STATION NON-INTERLOCKING

SAME AS ABOVE. EXCEPT EACH SWITCH OPERATES INDEPENDENTLY.

\$2.50 EACH

"PARALLEL" PRINTER CONNECTOR



SOLDER STYLE 36 PIN MALE USED ON "PARALLEL" DATA CABLES.

\$5.50 EACH

SWITCHES

MINI-PUSH BUTTON

S.P.S.T. MOMENTARY NORMALLY OPEN 1/4" BUSHING.

35¢ EACH 10 FOR \$3.25 100 FOR \$30.00

SPECIFY COLOR: RED, BLACK, WHITE, GREEN, YELLOW.

EDGE CONNECTORS



ALL ARE 156" SPACING

750 MFD 330 VOLT

2" HIGH x 1 1/4" DIA

\$1.25 EACH 10 FOR \$11.00

10 PIN EDGE CONNECTOR

TRW #50-10-A-20

\$2.00 EACH

120V INDICATOR



NEON INDICATOR. RATED 120 V 1/3 W MOUNTS IN 5/16" HOLE - RED LENS.

75¢ EACH 100 FOR \$7.00 1000 FOR \$65.00

18/36 GOLD SOLDER EYELET

\$2.00 EACH

SOLID STATE RELAY



HEINEMANN ELECTRIC #101-5A-140 - 5 AMP CONTROL: 3-32VDC LOAD: 140VAC 5 AMPS SIZE: 2" X 1 1/2" X 3/4" HIGH

\$5.00 10 FOR \$45.00

22/44 TIN

P.C. STYLE, NO MOUNTING EARS

\$1.50 EACH 10 FOR \$14.00

22/44 GOLD

P.C. STYLE **\$2.00 EACH** 10 FOR \$18.00

28/56 GOLD

28/56 GOLD PLATED CONTACTS 156 CONTACT SPACING.

\$2.50 EACH 10 FOR \$22.00

FREE! FREE! FREE! SEND FOR NEW LARGER! 48 PAGE CATALOG FREE! FREE! FREE!

LINE CORDS

TWO WIRE 6' 18ga TWO WIRE 3 FOR \$1.00

THREE WIRE 18 INCH 18ga THREE WIRE 2 FOR \$1.00

8 FOOT 18ga THREE WIRE \$2.00 EACH

KEY ASSEMBLY

5 KEY \$1.00 EACH

CONTAINS 5 SINGLE-POLE NORMALLY OPEN SWITCHES MEASURES 3 3/4" LONG

6 KEY \$1.25 EACH

CONTAINS 6 SINGLE-POLE NORMALLY OPEN SWITCHES MEASURES 4 1/4" LONG

ROTARY SWITCH

1 POLE 6 POSITION

1 1/4" DIA x 1 1/2" HIGH

75¢ EACH 10 FOR \$6.00

COMPUTER GRADE CAPACITORS

2,000 mfd. 200 VDC 1 3/4" DIA - 5" HIGH	\$2.00
3,600 mfd. 40 VDC 1 3/8" DIA - 3 3/4" HIGH	\$1.00
6,400 mfd. 60 VDC 1 3/8" DIA - 4 1/4" HIGH	\$2.50
22,000 mfd. 40 VDC 2" DIA x 6" HIGH	\$3.00
31,000 mfd. 15 VDC 1 3/4" DIA - 4" HIGH	\$2.50
72,000 mfd. 15 VDC 2" DIA x 4 3/8" HIGH	\$3.50
185,000 mfd. 6 VDC 2 1/2" DIA - 4 1/2" HIGH	\$1.50

CLAMPS TO FIT CAPACITORS 50¢ EA.

SLIDE POTS

100K linear tape 2" LONG

1 5/8" TRAVEL 75¢ EACH

500K linear taper 2 7/8" LONG

1 3/4" TRAVEL 75¢ EACH

DUAL 100K audio taper 3 1/2" LONG

2 1/2" TRAVEL \$1.50 EACH

L.E.D.'S STANDARD JUMBO DIFFUSED

RED 10 FOR \$1.50

GREEN 10 FOR \$2.00

YELLOW 10 FOR \$2.00

FLASHER LED 5 VOLT OPERATION RED JUMBO SIZE \$1.00 EACH

BI POLAR LED 2 FOR \$1.70

LED HOLDERS TWO PIECE HOLDER FOR JUMBO LED 10 FOR 65¢ 200 FOR \$10.00

CLEAR CLIPLITE HOLDER MAKE LED A FANCY INDICATOR CLEAR. 4 FOR \$1.00

SOLDERING IRON STAND

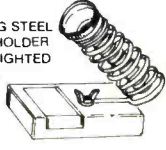

SPRING STEEL IRON HOLDER ON WEIGHTED BASE

\$5.00 EACH

BATTERY OPERATED SMOKE DETECTOR



BRK MODEL #79R UL APPROVED 9 VOLT BATTERY OPERATION FOR CEILING OR WALL MOUNT

\$8.00 EACH 2 FOR \$15.00

RELAYS

MINIATURE 6 VDC RELAY

SUPER SMALL SPDT RELAY. GOLD COBALT CONTACTS.

RATED 1 AMP AT 30 VDC. HIGHLY SENSITIVE. TTL DIRECT DRIVE POSSIBLE. OPERATES FROM 43 TO 6 V. COIL RES 220 OHM

1 3/16" x 13/32" x 7/16" AROMAT # RSD-6V

\$1.50 EACH 10 FOR \$13.50

MINIATURE TOGGLE SWITCHES

ALL ARE RATED 5 AMPS @ 125 VAC

S.P.D.T. (on-on) P.C. STYLE, NON-THREADED BUSHING 75¢ EACH 10 FOR \$7.00

S.P.D.T. (on-on) SOLDER LUG TERMINALS \$1.00 EACH 10 FOR \$9.00 100 FOR \$80.00

S.P.D.T. (on-off-on) SOLDER LUG TERMINALS \$1.00 EACH 10 FOR \$9.00 100 FOR \$80.00

S.P.D.T. (on-on) P.C. LUGS, THREADED BUSHING \$1.00 EACH 10 FOR \$9.00 100 FOR \$80.00

D.P.D.T. (on-on) SOLDER LUG TERMINALS \$2.00 EACH 10 FOR \$18.00 100 FOR \$180.00

CRYSTALS

CASE STYLE HC33/U

2 MHZ COLORBURST 3579.545 KC

\$3.50 EACH \$1.00 EACH

METAL OXIDE VARISTOR

G.E. # V82ZA12 50 VOLTS, NOMINAL D.C. VOLTAGE, 5/8" DIAMETER

2 FOR \$1.50

3 1/2" SPEAKER



8 OHM IMPEDANCE, FULL RANGE SPEAKER. 8 OZ MAGNET. 4 1/4" DIAGONAL MOUNTING CENTERS.

\$2.50 EACH 10 FOR \$20.00

TRANSISTORS

2N706	4 FOR \$1.00
2N2222A	3 FOR \$1.00
PN2222	4 FOR \$1.00
2N2904	3 FOR \$1.00
2N2905	3 FOR \$1.00
2N2907	3 FOR \$1.00

POWER SUPPLY W/ PRE-AMP

THIS SUPPLY WAS USED TO POWER AN 8 TRACK/CASSETTE UNIT. IT WILL SUPPLY APPROX 18 VDC AND INCLUDES A SMALL PRE-AMP TO BOOST SIGNAL LEVEL. RCA PLUGS FOR LINE IN/OUT

\$4.50 EACH

13 VDC RELAY

CONTACT S.P.N.C. 10 AMP @ 120 VAC ENERGIZE COIL TO OPEN CONTACT

COIL 13 VDC 650 OHMS

SPECIAL PRICE \$1.00 EACH

4 PDT RELAY

14 pin style

- 3 amp contacts
- 24 volt d.c. or 120 volt a.c. coil
- Used but fully tested

\$1.70 EACH

specify coil voltage

LARGE QUANTITIES AVAILABLE

SOCKETS FOR RELAY 50¢ each

TOLL FREE ORDERS ONLY 1-800-826-5432 (ORDER ONLY)

(IN CALIFORNIA: 1-800-258-6666)

ALASKA, HAWAII, OR INFORMATION (213) 380-8000

ALL ELECTRONICS CORP.

905 S. VERMONT AVE. P.O. BOX 20406 LOS ANGELES, CA 90006

6228 SEPULVEDA BLVD. VAN NUYS, CA 91411

QUANTITIES LIMITED MINIMUM ORDER \$10.00 USA. \$2.50 SHIPPING FOREIGN ORDERS: INCLUDE SUFFICIENT SHIPPING CALIF RES ADD 6 1/2% NO C.O.D.!

CABLE TV CONVERTERS

Eagle 2000-60 chn. wireless deluxe. \$109.95
 Jerrold 400 DRX-3-105. \$ 99.95
 Jerrold SB-3 'The Real Thing'. \$ 99.95
 Oak N-12. \$ 79.95
 Oak VN-12 Veri-Sync. \$ 89.95
 Zenith Cable Add-On. \$229.95

Others Available, Quantity Discounts

United Electronic Supply
 P.O. Box 1206
 Elgin, IL 60121
 312-697-0600



A SINGER'S DREAM!

REMOVES VOCALS FROM RECORDS!
 Now You can sing with the world's best bands! The Thompson Vocal Eliminator can remove most or virtually all of a lead vocal from a standard stereo record and leave the background!
 Write or call for a free brochure and demo record.

**LT Sound, Dept. ME, P.O. Box 338,
 Stone Mountain, GA 30086 (404) 493-1258**

VIEW 8 TRACES ON YOUR SINGLE OR DUAL TRACE SCOPE WITH THIS LOW COST DEVICE!!

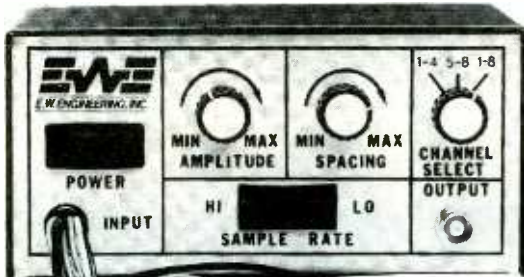

Now you no longer have to spend thousands on an expensive multi-trace oscilloscope - our single trace Hitachi scope combined with this module will allow you to view up to 8 simultaneously occurring analog or digital (or both) signals in their real time and amplitude relationship. The MPX 101 may be used on any oscilloscope, whether single, dual or multiple traces. Its low cost makes it a particular favorite for designers, testers, hobbyists and repairmen who want to compare and analyze displayed signals in a timing diagram format. The controls on the front panel of the metal case allow you to vary amplitude and spacing of the displayed signals.

**MODEL MPX101
 FULLY ASSEMBLED & TESTED!**



\$99.88

**NOT
 A
 KIT**

**FULL 1
 YEAR
 REPLACE-
 MENT
 WARRANTY**

- Made In The United States -

SPECIFICATIONS

Inputs: 8 signals plus ground via 9 input leads terminated with alligator clips
 Bandwidth: ± 1 dB to 5 MHz
 Impedance: 10.9 K
 Input Voltage: ± 5 V peak (diode clamped to ± 5 Volt supplies)
 Output: Staircase waveform summed with input signals, 0-800 mV full scale
 Step Amplitude: Variable 0 to 150 mV/step
 Signal Voltage: Variable 0 to

150 mV/step @ 5V Input
 Multiplex Rate: Switch selectable, 40 KHz or 4 KHz
 Impedance: 50 Ohms
 Power: 105-135 VAC @ 1 V a
 Dimensions: 6.25" x 3.25" x 4.75" (WxHxD)
 Operating Temperature: 0-40°C
 Weight: 1 lb. 10.5 oz.
 Warranty: one year full replacement warranty from date of purchase
 Lighted on/off power switch
 Wood grain finished metal case

DISTRIBUTOR AND REPRESENTATIVE INQUIRIES INVITED



VISA, MASTERCARD, AMEX TELEPHONE ORDERS ACCEPTED!
 6 Herman Drive, E. Granby, CT 06026 □ 203/651-0285

CIRCLE 21 ON FREE INFORMATION CARD

FREE catalog featuring scanner accessories, carrier/subcarrier detectors, voice scramblers, unusual kits. Capri Electronics, Route 1E, Canon, GA 30520, (404) 376-3712.

TRICKS of the burglar alarm trade: If you want to learn about burglar alarms, learn from an experienced installer. Free brochure: MENTOR, (Dept. R), 135-53 No. Blvd., Flushing, N.Y. 11354.

ORIENTAL WOMEN AND MEN seek intelligence, literate American and Canadian correspondence. Asian Exchange, Honokaa, HI 96727.

CORRESPONDENCE to Asia for lasting relationship. Free Information. AAWS-ME, Box 2777; Orcutt, CA 93455-0777 Tel. No. 805-937-5230.

NOTCH FILTERS for cable TV. Channels 2-6, 14-22, A-I. Send \$20 for sample and quantity price list. Specify channel. Money back guarantee. CATV, P.O. Box 17621, Ft. Lauderdale, Fla. 33318.

Cable TV converters and descramblers. Low prices. Quantity discounts. Send \$5 for informative catalog. R & M Distributors, P.O. Box 266-M, Boston, MA 02186. (617) 871-5838.

REVERBERATION FOR ORGANS

Solid state with controls for reverb-eration and room size.
EVERY ORGAN SHOULD OWN ONE.

Send for free flyer—

DEVTRONIX ORGANS, INC.
 6101 WAREHOUSE WAY
 SACRAMENTO, CALIFORNIA 95826



SUPER LONG PLAY TAPE RECORDERS

10 Hour Model — \$95.00*
 14 Hour Model — \$159.00*

Modified Panasonic Slimline, high quality, AC-DC Recorders provide 5 or 7 continuous hours of quality recording & playback on each side of cassette for a total of 10 or 14 hours depending on model. Built-in features include • Voice level control • Digital counter, etc. TDK DC 180 Cassette Furnished.

PHONE RECORDING ADAPTER
 Records calls automatically. All Solid state connects to your telephone jack and tape recorder. Starts recording when phone is lifted. Stops when you hang up. **\$24.50*** FCC APPROVED

VOX VOICE ACTIVATED CONTROL SWITCH
 Solid state. Self contained. Adjustable sensitivity. Voices or other sounds automatically activate and control recorder. Uses either recorder or remote mike. **\$24.95***

*Add for ship & hdg. Phone Adapter & Vox \$1.50 ea. Records \$4.00 ea. Cal. Res. add tax. Mail order VISA MIC, COD's OK. Money Back Guarantee. Qty. disc. avail. Dealer Inquiries invited. Free data.

AMC SALES INC. Dept. M9335 Lubec
 St., Box 928, Downey, CA
 (213) 90421 Phone
 869 8519

CIRCLE 31 ON FREE INFORMATION CARD

QUALITY - Name brand products from nationally recognized manufacturers. **SERVICE** - Computerized order processing and inventory control. **SAVINGS** - Volume Discounts • OEM Quantity Pricing • Toll Free 800 Number. **MAINTENANCE** - Computerized Inventory Control.

1% Metal Film Resistors

100 ppm/°C
100 ppm/°C

Part No.	Value	Price
LM2970	1.0	1.00
LM2971	1.5	1.00
LM2972	2.2	1.00
LM2973	3.3	1.00
LM2974	4.7	1.00
LM2975	6.8	1.00
LM2976	10	1.00
LM2977	15	1.00
LM2978	22	1.00
LM2979	33	1.00
LM2980	47	1.00
LM2981	68	1.00
LM2982	100	1.00
LM2983	150	1.00
LM2984	220	1.00
LM2985	330	1.00
LM2986	470	1.00
LM2987	680	1.00
LM2988	1000	1.00
LM2989	1500	1.00
LM2990	2200	1.00
LM2991	3300	1.00
LM2992	4700	1.00
LM2993	6800	1.00
LM2994	10000	1.00

PANASONIC ELECTROLYTIC CAPACITORS

NEW! 3500 Series
NEW! 3500 Series
NEW! 3500 Series

For Complete Specs on Physical Size and Electrical Characteristics, consult your FREE DIGI-KEY Catalog.

PANASONIC ISW Series Large Aluminum Electrolytic Capacitors

Part No.	Value	Price
P3500	1000	1.00
P3501	1500	1.00
P3502	2200	1.00
P3503	3300	1.00
P3504	4700	1.00
P3505	6800	1.00
P3506	10000	1.00
P3507	15000	1.00
P3508	22000	1.00
P3509	33000	1.00
P3510	47000	1.00
P3511	68000	1.00
P3512	100000	1.00
P3513	150000	1.00
P3514	220000	1.00
P3515	330000	1.00
P3516	470000	1.00
P3517	680000	1.00
P3518	1000000	1.00
P3519	1500000	1.00
P3520	2200000	1.00
P3521	3300000	1.00
P3522	4700000	1.00
P3523	6800000	1.00
P3524	10000000	1.00

5% Carbon Film Resistors

Part No.	Value	Price
LM3000	1.0	1.00
LM3001	1.5	1.00
LM3002	2.2	1.00
LM3003	3.3	1.00
LM3004	4.7	1.00
LM3005	6.8	1.00
LM3006	10	1.00
LM3007	15	1.00
LM3008	22	1.00
LM3009	33	1.00
LM3010	47	1.00
LM3011	68	1.00
LM3012	100	1.00
LM3013	150	1.00
LM3014	220	1.00
LM3015	330	1.00
LM3016	470	1.00
LM3017	680	1.00
LM3018	1000	1.00
LM3019	1500	1.00
LM3020	2200	1.00
LM3021	3300	1.00
LM3022	4700	1.00
LM3023	6800	1.00
LM3024	10000	1.00

WIRE WRAP DIP SOCKETS

Standard profile
Under mounting and packaging capabilities

For Complete Specs on Physical Size and Electrical Characteristics, consult your FREE DIGI-KEY Catalog.

PANASONIC V-SERIES Electrolytic Capacitors

Part No.	Value	Price
V1000	1000	1.00
V1001	1500	1.00
V1002	2200	1.00
V1003	3300	1.00
V1004	4700	1.00
V1005	6800	1.00
V1006	10000	1.00
V1007	15000	1.00
V1008	22000	1.00
V1009	33000	1.00
V1010	47000	1.00
V1011	68000	1.00
V1012	100000	1.00
V1013	150000	1.00
V1014	220000	1.00
V1015	330000	1.00
V1016	470000	1.00
V1017	680000	1.00
V1018	1000000	1.00
V1019	1500000	1.00
V1020	2200000	1.00
V1021	3300000	1.00
V1022	4700000	1.00
V1023	6800000	1.00
V1024	10000000	1.00

WATTY CARBON FILM RESISTOR ASSORTMENT

Part No.	Value	Price
LM3100	1.0	1.00
LM3101	1.5	1.00
LM3102	2.2	1.00
LM3103	3.3	1.00
LM3104	4.7	1.00
LM3105	6.8	1.00
LM3106	10	1.00
LM3107	15	1.00
LM3108	22	1.00
LM3109	33	1.00
LM3110	47	1.00
LM3111	68	1.00
LM3112	100	1.00
LM3113	150	1.00
LM3114	220	1.00
LM3115	330	1.00
LM3116	470	1.00
LM3117	680	1.00
LM3118	1000	1.00
LM3119	1500	1.00
LM3120	2200	1.00
LM3121	3300	1.00
LM3122	4700	1.00
LM3123	6800	1.00
LM3124	10000	1.00

PANASONIC ISW Series Large Aluminum Electrolytic Capacitors

NEW! 3500 Series
NEW! 3500 Series
NEW! 3500 Series

For Complete Specs on Physical Size and Electrical Characteristics, consult your FREE DIGI-KEY Catalog.

PANASONIC ISW Series Large Aluminum Electrolytic Capacitors

Part No.	Value	Price
P3500	1000	1.00
P3501	1500	1.00
P3502	2200	1.00
P3503	3300	1.00
P3504	4700	1.00
P3505	6800	1.00
P3506	10000	1.00
P3507	15000	1.00
P3508	22000	1.00
P3509	33000	1.00
P3510	47000	1.00
P3511	68000	1.00
P3512	100000	1.00
P3513	150000	1.00
P3514	220000	1.00
P3515	330000	1.00
P3516	470000	1.00
P3517	680000	1.00
P3518	1000000	1.00
P3519	1500000	1.00
P3520	2200000	1.00
P3521	3300000	1.00
P3522	4700000	1.00
P3523	6800000	1.00
P3524	10000000	1.00

SILICON TRANSISTORS

Part No.	Value	Price
LM3200	1.0	1.00
LM3201	1.5	1.00
LM3202	2.2	1.00
LM3203	3.3	1.00
LM3204	4.7	1.00
LM3205	6.8	1.00
LM3206	10	1.00
LM3207	15	1.00
LM3208	22	1.00
LM3209	33	1.00
LM3210	47	1.00
LM3211	68	1.00
LM3212	100	1.00
LM3213	150	1.00
LM3214	220	1.00
LM3215	330	1.00
LM3216	470	1.00
LM3217	680	1.00
LM3218	1000	1.00
LM3219	1500	1.00
LM3220	2200	1.00
LM3221	3300	1.00
LM3222	4700	1.00
LM3223	6800	1.00
LM3224	10000	1.00

PANASONIC V-SERIES Electrolytic Capacitors

NEW! 3500 Series
NEW! 3500 Series
NEW! 3500 Series

For Complete Specs on Physical Size and Electrical Characteristics, consult your FREE DIGI-KEY Catalog.

PANASONIC V-SERIES Electrolytic Capacitors

Part No.	Value	Price
V1000	1000	1.00
V1001	1500	1.00
V1002	2200	1.00
V1003	3300	1.00
V1004	4700	1.00
V1005	6800	1.00
V1006	10000	1.00
V1007	15000	1.00
V1008	22000	1.00
V1009	33000	1.00
V1010	47000	1.00
V1011	68000	1.00
V1012	100000	1.00
V1013	150000	1.00
V1014	220000	1.00
V1015	330000	1.00
V1016	470000	1.00
V1017	680000	1.00
V1018	1000000	1.00
V1019	1500000	1.00
V1020	2200000	1.00
V1021	3300000	1.00
V1022	4700000	1.00
V1023	6800000	1.00
V1024	10000000	1.00

SILICON RECTIFIERS

Part No.	Value	Price
LM3300	1.0	1.00
LM3301	1.5	1.00
LM3302	2.2	1.00
LM3303	3.3	1.00
LM3304	4.7	1.00
LM3305	6.8	1.00
LM3306	10	1.00
LM3307	15	1.00
LM3308	22	1.00
LM3309	33	1.00
LM3310	47	1.00
LM3311	68	1.00
LM3312	100	1.00
LM3313	150	1.00
LM3314	220	1.00
LM3315	330	1.00
LM3316	470	1.00
LM3317	680	1.00
LM3318	1000	1.00
LM3319	1500	1.00
LM3320	2200	1.00
LM3321	3300	1.00
LM3322	4700	1.00
LM3323	6800	1.00
LM3324	10000	1.00

PANASONIC ISW Series Large Aluminum Electrolytic Capacitors

NEW! 3500 Series
NEW! 3500 Series
NEW! 3500 Series

For Complete Specs on Physical Size and Electrical Characteristics, consult your FREE DIGI-KEY Catalog.

PANASONIC ISW Series Large Aluminum Electrolytic Capacitors

Part No.	Value	Price
P3500	1000	1.00
P3501	1500	1.00
P3502	2200	1.00
P3503	3300	1.00
P3504	4700	1.00
P3505	6800	1.00
P3506	10000	1.00
P3507	15000	1.00
P3508	22000	1.00
P3509	33000	1.00
P3510	47000	1.00
P3511	68000	1.00
P3512	100000	1.00
P3513	150000	1.00
P3514	220000	1.00
P3515	330000	1.00
P3516	470000	1.00
P3517	680000	1.00
P3518	1000000	1.00
P3519	1500000	1.00
P3520	2200000	1.00
P3521	3300000	1.00
P3522	4700000	1.00
P3523	6800000	1.00
P3524	10000000	1.00

3 AMP SILICON RECTIFIER

Part No.	Value	Price
LM3400	1.0	1.00
LM3401	1.5	1.00
LM3402	2.2	1.00
LM3403	3.3	1.00
LM3404	4.7	1.00
LM3405	6.8	1.00
LM3406	10	1.00
LM3407	15	1.00
LM3408	22	1.00
LM3409	33	1.00
LM3410	47	1.00
LM3411	68	1.00
LM3412	100	1.00
LM3413	150	1.00
LM3414	220	1.00
LM3415	330	1.00
LM3416	470	1.00
LM3417	680	1.00
LM3418	1000	1.00
LM3419	1500	1.00
LM3420	2200	1.00
LM3421	3300	1.00
LM3422	4700	1.00
LM3423	6800	1.00
LM3424	10000	1.00

PANASONIC ISW Series Large Aluminum Electrolytic Capacitors

NEW! 3500 Series
NEW! 3500 Series
NEW! 3500 Series

For Complete Specs on Physical Size and Electrical Characteristics, consult your FREE DIGI-KEY Catalog.

PANASONIC ISW Series Large Aluminum Electrolytic Capacitors

Part No.	Value	Price
P3500	1000	1.00
P3501	1500	1.00
P3502	2200	1.00
P3503	3300	1.00
P3504	4700	1.00
P3505	6800	1.00
P3506	10000	1.00
P3507	15000	1.00
P3508	22000	1.00
P3509	33000	1.00
P3510	47000	1.00
P3511	68000	1.00
P3512	100000	1.00
P3513	150000	1.00
P3514	220000	1.00
P3515	330000	1.00
P3516	470000	1.00
P3517	680000	1.00
P3518	1000000	1.00
P3519	1500000	1.00
P3520	2200000	1.00
P3521	3300000	1.00
P3522	4700000	1.00
P3523	6800000	1.00
P3524	10000000	1.00

SHIP-KEY - Ship your order to the address on the invoice. **SHIP-KEY** - Ship your order to the address on the invoice. **SHIP-KEY** - Ship your order to the address on the invoice.

SHIP-KEY - Ship your order to the address on the invoice. **SHIP-KEY** - Ship your order to the address on the invoice. **SHIP-KEY** - Ship your order to the address on the invoice.

Tape Dubbing For Car Stereo *(from page 40)*

you should never change tonal balance when dubbing, the idea being to put a signal onto the tape that's as close as possible to the source in terms of frequency balance. For most home setups, in fact, if you connect a tape deck into the system in the normal manner, via the tape-loop jacks of your receiver or amplifier, it's impossible to modify the tonal balance, since these jacks come before the tone controls. (If your car stereo system has its own graphic equalizer, there's no need to modify the tonal balance of the recording, because you can make any tonal adjustments required during playback with the equalizer.)

If your car stereo system doesn't have a graphic equalizer or if, for any number of reasons, you want to deliberately modify the tonal balance of a given source when dubbing, you can do so only by taking the signal being taped from some point in your home system *after* the tone controls. Alternatively, you can feed the signal through an equalizer patched into the system *before* it enters the input jacks of the recorder.

If your home system has a separate preamplifier and power amplifier, reconnect your home tape deck so that its inputs are fed from the outputs of the preamp. The deck's outputs should then be connected to the inputs of the power amp.

In a home system built around an integrated amplifier or receiver, you can manage this hookup only if the integrated unit has a circuit-interrupt feature. If it does, it will have two pairs of jacks on the back labeled PREAMP OUT and POWER AMP IN. Remove the jumpers that connect between these pairs of jacks and use the now-accessible points for connecting your cassette deck into the system as described above.

In the extreme case, where you have no access whatsoever to the pre-amp outputs and power amp inputs,

you can still modify tonal balance for dubbing. You simply disconnect the input cables to the cassette deck and install your equalizer between the free ends of these cables and the inputs of the deck. Actually, this is the best and most professional way of doing the job. Some equalizers have a switch that lets you choose between equalizing for tape feed and equalizing for general playback.

The decision to use an equalizer, and to what extent, for either recording or playback of car tapes can be made only after trial-and-error dubbing and listening. A great deal depends on your driving situation, your vehicle and its interior acoustics, the type of music to which you listen most, the source(s) being copied for playback in your vehicle, etc.

Another professional touch you can add to your home-made tapes is to provide smooth and noiseless transitions between selections. If you're taping a source in its entirety, the transitions will have been taken care of for you by the sound engineer at the recording studio. On the other hand, if you're making up your own program from several different sources, the way to get the quiet transition is simply to use the PAUSE control on the recording deck as soon as the last note of what you're copying has died away. The PAUSE control stops the recording and the tape but leaves the deck ready for instant start-up when you release it.

In Conclusion

The technique for dubbing to tape for playback in a car stereo system requires more patience than you would exercise when recording for home playback. To obtain optimized recordings, you'll have to do some things you wouldn't ordinarily dream of for home listening. But if done properly, the resulting tapes will give you a feeling of genuine satisfaction.

ME

ADVERTISERS' INDEX

AMC Sales Inc.	90
AP Products	Cov. IV
All Electronics Corp.	89
Cleveland Institute of Electronics	21
Devtronix Organs	90
Digi-Key Corp.	91
E.W. Engineering, Inc.	82, 90
Electronic Specialists	49
Elephant Electronics	80
Etronix	49
Global Specialties	7
Grantham College of Engineering	1
Haltronix, Inc.	85
Heath Co.	29
Information Unlimited	88
Knapp	49
Korsmeyer Electronic Design	77
LT Sound	90
MCM Electronics	43
NRI Schools	8, 11
OptoElectronics, Inc.	2
Paia Electronics	88
Phillips-Tech	49
Radio Shack	5
RF Electronics	80
Tektronix	Cov. III
Trans American	35
Uniden Bearcat	Cov. II
United Electronic Supply	90

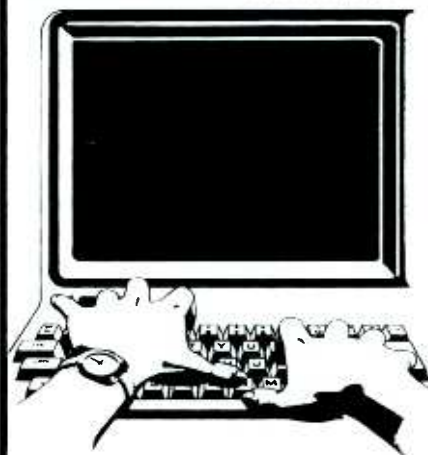

Free Product Information

Readers can obtain free information on products advertised by the above companies, as well as for some editorially mentioned products. Simply circle the appropriate number printed below an advertisement onto the Modern Electronics "Free Information Service" card bound into this issue. After filling in your name and address, just mail the postpaid card. Your request will be forwarded directly to the advertiser with a mailing label prepared by our reader-service department to ensure speedy response.

Now! Tek quality and expert advice are just a free phone call away!

100 MHz dual time base scope.

Easy-to-read CRT; bright, full-sized 8x10 cm; 14 kv accelerating potential complete with BEAM FIND; separate A/B dual intensity controls, FOCUS and TRACE ROTATION.

Wide range vertical sensitivity.

Choose from 2 mV/div (1x probe) to 50 V/div (10x probe); color-keyed for 1x and 10x probes; variable control increases scale factor by 2.5 to 1.

Two 100 MHz, high sensitivity channels.

3.5 ns risetime; dc to ≥ 100 MHz bandwidth from 5 V/div to 5 mV/div; extended sensitivity of 2 mV/div at ≥ 90 MHz.

A/B sweep selection.

Calibrated A sweeps from 50 ns/div to 0.5 s/div; B sweeps from 50 ns/div to 50 ms/div; variable control for up to 2.5 to 1 reduction and 10x magnification for sweeps to 5 ns/div.

Dual time base measurements.

Select either A or B sweeps, or both alternately with A intensified by B.

B trigger slope and level.

Use B trigger level to select B-triggered or run-after-delay modes; use B TRIGGER SLOPE to select transitions.

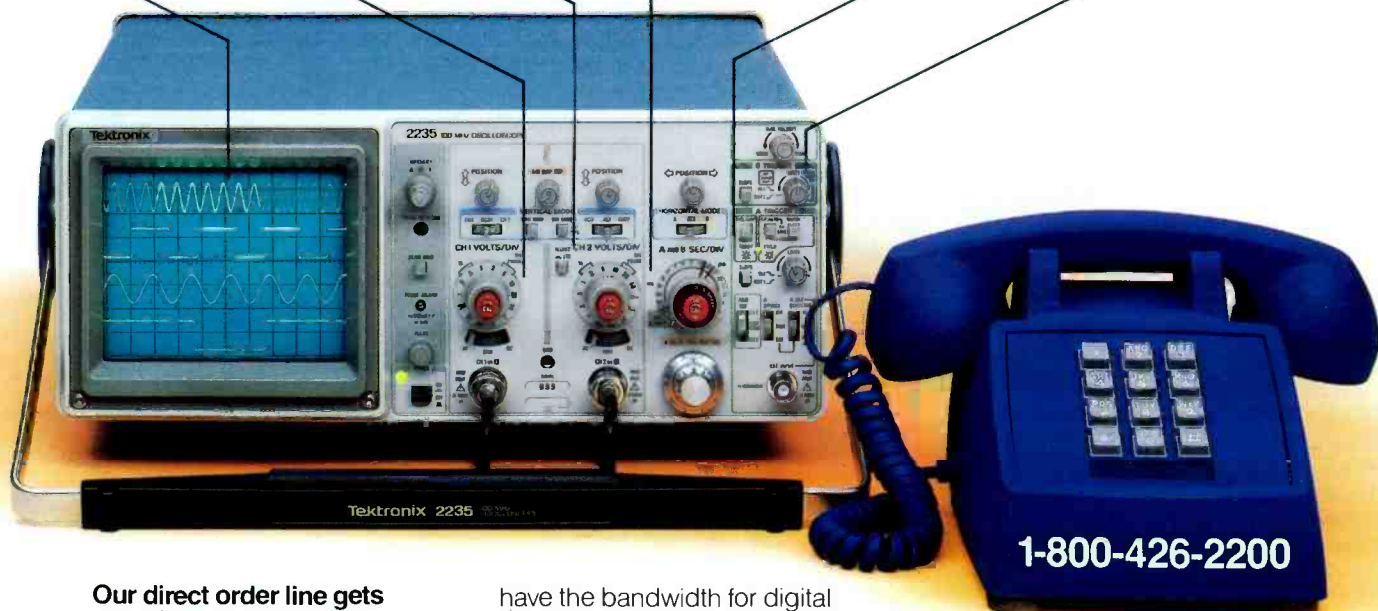

1-800-426-2200

Our direct order line gets you the industry's leading price/performance portables... and fast answers from experts!

The 60 MHz single time base delay 2213A, the 60 MHz dual time base 2215A and the 100 MHz dual time base 2235 offer unprecedented reliability and affordability, plus the industry's first 3-year warranty* on labor and parts, CRT included.

The cost: just \$1200 for the 2213A, \$1450 for the 2215A, \$1650 for the 2235.† Even at these low prices, there's no scrimping on performance. You

have the bandwidth for digital and analog circuits. The sensitivity for low signal measurements. The sweep speeds for fast logic families. And delayed sweep for fast, accurate timing measurements. All scopes are UL Listed and CSA approved.

You can order, or obtain literature, through the Tek National Marketing Center. Technical personnel, expert in scope applications, will answer your questions and expedite delivery. Direct orders include comprehensive 3-year warranty*, operator's

manual, two 10X probes, 15-day return policy and worldwide service backup.

Order toll free: 1-800-426-2200, Ask for Rick.

In Oregon, call collect (503) 627-9000. Or write Tektronix, Inc. P.O. Box 500, Delivery Station Y6-088 Beaverton, OR 97077

CIRCLE 25 ON FREE INFORMATION CARD

Tektronix
COMMITTED TO EXCELLENCE

LITTLE THINGS MEAN A LOT

Being the first company to make solderless breadboards isn't necessarily what makes us the best. It's all the little things you don't see, like our spring clip terminals, that make AP® PRODUCTS ACEBOARDS so big on reliability.

From our largest ACEBOARD with over 5000 tie points, to a single tie point block, our spring clip terminals give you nothing but good, solid contact on every connection. They accommodate a wide variety of leads and have the best electrical properties, because our spring clips are solid alloy, not plated nickel. We've even developed enough normal force to break through any oxides which could occur on solder plated leads. You've come to trust our test clips for the same reason.

Since one bad connection can ruin a whole circuit, we pay close attention to how well our spring clip terminals sit within the insulator cell areas. Spring clip edges are never exposed at the insertion window.

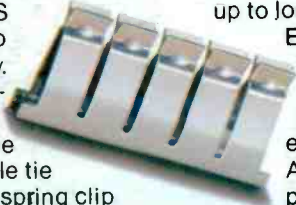

Leads won't buckle, clips won't oxidize, it all adds up to longer life.

Even from the outside there's more to an ACEBOARD than meets the eye. Our durable Acetal Copolymer plastic body is a good insulator with excellent dielectric properties.

And special manufacturing techniques in the insertion of the contacts into the plastic body insure that your Breadboard will always remain flat. No skimping or planned obsolescence here. Again, just good solid contact on every connection.

Turn our breadboard body over...and you'll discover another key to its reliability. The double-sided adhesive foam you'll

see there is more than a pressure sensitive mount. It also insulates to prevent shorts and seals the bottom of the individual spring clip cells.

If solder shavings from resistors or component leads drop into the cell, they can't spread into other cells to short them out.

Take a close look at our ACEBOARDS. AP PRODUCTS has the biggest and most complete line of

ACEBOARD sizes. It's also our commitment to you that if your ACEBOARD doesn't

work perfectly, bring it back to your AP PRODUCTS distributor. He'll replace it, no hassles.

To help you see for yourself what a big difference the little things make, we're offering you a 10% discount on the entire AP PRODUCTS ACEBOARD/Breadboard line.

Just fill out the coupon and present it to your AP PRODUCTS distributor.



For the name of the distributor nearest you, call TOLL FREE (800) 321-9668. (In Ohio, call collect: (216) 354-2101).



A P PRODUCTS INCORPORATED

9325 Progress Parkway, Box 540
Mentor, Ohio 44060, (216) 354-2101
TWX: 810-425-2250

In Canada, call Lenbrook Electronics • (416) 477-7722

CIRCLE 68 ON FREE INFORMATION CARD

This coupon is worth 10% off the purchase price of any size ACEBOARD or Breadboard product. Offer expires 12/31/84.

ME 12

Your Name _____

Address _____

City _____ State _____ Zip _____

Dealer Name _____

ACEBOARD # _____

Limit 5 ACEBOARDS or Breadboards per coupon. Offer valid only at participating AP PRODUCTS distributors.