

YOUR ONE-STOP SOURCE OF ELECTRONICS INFORMATION

ICD 08559

MODERN ELECTRONICS™

NOVEMBER 1984

\$1.95

THE MAGAZINE FOR ELECTRONICS & COMPUTER ENTHUSIASTS

- * **Circuit Design From Scratch** * **The New Camcorder Video Recorders** * **A Second Chance for IBM's PCjr Computer**
- * **Exciting Scanner Radio Frequencies You've Missed** * **Hooking Up Extension Speakers** * **Automotive Theft Protector**
- * **Voltage Spike And Hash Protection**
- * **Latest Electronic/Computer News**

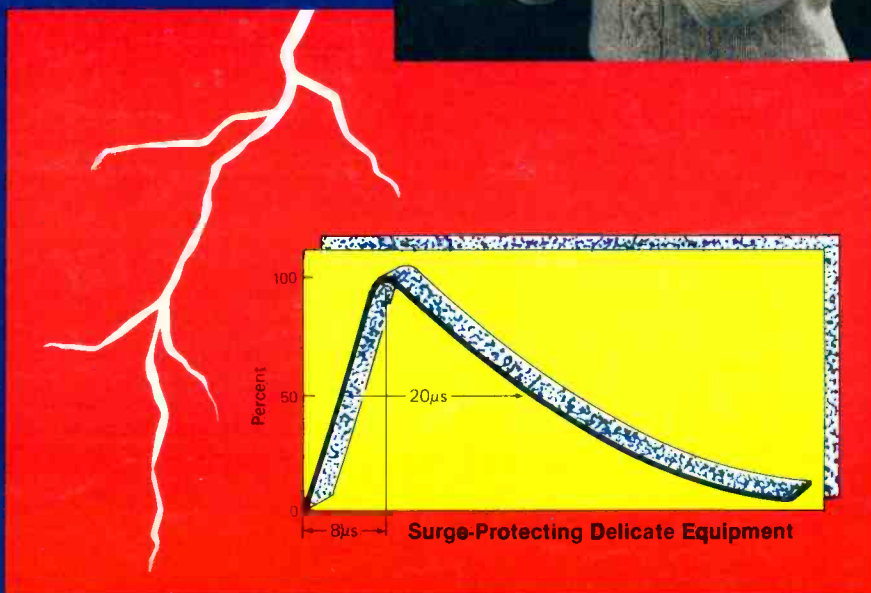
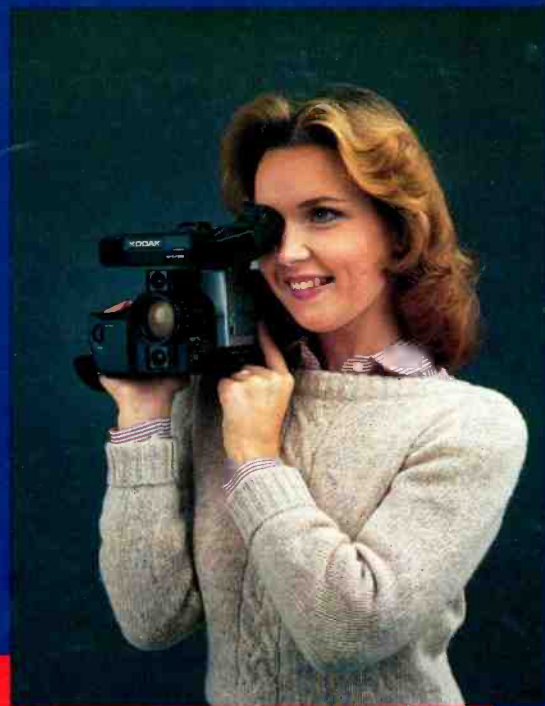

Plus: ● **Testing Pioneer's Stereo Receiver with Video-Computer Switching/Sanyo's Half-Size VCR/Light Pen for Apple Computers/Beckman's Hand-Held Digital Multimeter** ● **Technical Book Reviews** ● **Experimenting with Forrest Mims**

CRIME.

DETECTOR.

Like a smoke detector protects you from fire, a Uniden® Bearcat® Scanner Radio is a simple way to help protect you from neighborhood crime. Because if a crime wave hits, you'll be the first to know about it with up-to-the-minute police reports. And you'll be ready to take precautions against the kind of people who do their shopping at night.



REBATE.

Get up to \$50 back on Uniden® Bearcat® Scanners. To get the rebate on the Uniden® Bearcat® Scanner you've purchased, send: (1) original dated sales slip (non-returnable), (2) purchase confirmation cut from carton flap, and (3) this completed request to: Crime Detector Rebate, P.O. Box 50208, Indianapolis, Indiana 46256.

Please circle the scanner purchased:

- | | |
|--------------------------|------------------------|
| (1) BC-300/\$50 Rebate | (9) BC-200/\$10 Rebate |
| (2) BC-210XL/\$25 Rebate | (10) BC-180/\$5 Rebate |
| (3) BC-100/\$25 Rebate | (11) BC-155/\$5 Rebate |
| (4) BC-20/20/\$20 Rebate | (12) BC-151/\$5 Rebate |
| (5) BC-250/\$20 Rebate | (13) BC-5-6/\$5 Rebate |
| (6) BC-220/\$20 Rebate | (14) BC-5/\$5 Rebate |
| (7) BC-260/\$15 Rebate | (15) BC-15/\$5 Rebate |
| (8) BC-201/\$15 Rebate | |

First Initial Middle Initial Last Name

Address

City State Zip

Requests must be postmarked by December 8, 1984. Offer valid only on purchase made between October 1, 1984 and November 25, 1984. All requests must be postmarked by December 8, 1984. Limit of one Uniden® Bearcat® Scanner per household, and/or consumer, regardless of number of Uniden® Bearcat® Scanners purchased. This is a consumer rebate offer only. Resellers, companies and employees of Uniden®, their advertising agencies, distributors and retailers are not eligible. This official coupon must accompany all requests, and may not be reproduced. This offer may not be used in conjunction with any other rebate offer from Uniden® Bearcat®. Offer good only in U.S.A. Void where taxed or prohibited by law. Allow 6-8 weeks for delivery of check.



CIRCLE 26 ON FREE INFORMATION CARD



Uniden® provides major financial support to the Neighborhood Crime Prevention Coordinating Committee.
© 1984 Uniden Corporation of America

Where's Your **ELECTRONICS** Career Headed?

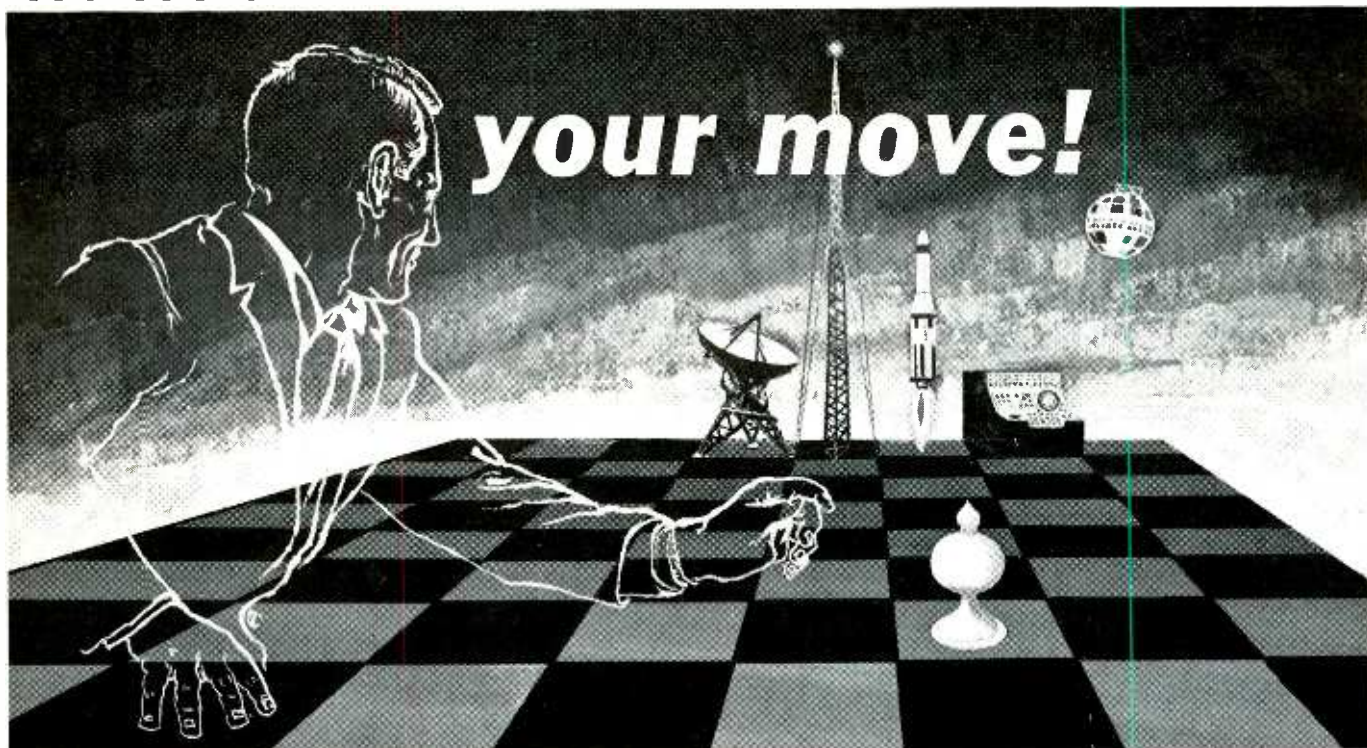

The Move You Make Today Can Shape Your Future

Yes it's your move. Whether on a chess board or in your career, you should plan each move carefully. In **electronics**, you can *move ahead* faster and further with a

B. S. DEGREE

Put professional knowledge and a COLLEGE DEGREE in your electronics career. Earn your degree through independent study at home, with Grantham College of Engineering. No commuting to class. Study at your own pace, while continuing your present job.

The accredited Grantham non-traditional degree program is intended for mature, fully employed workers who want to upgrade their careers . . . and who can successfully study electronics and supporting subjects through

INDEPENDENT STUDY, AT HOME

Free Details Available from:

Grantham College of Engineering
2500 South La Cienega Blvd.
P. O. Box 35499
Los Angeles, CA 90035

Independent Home Study Can Prepare You

Study materials, carefully written by the Grantham staff for independent study at home, are supplied by the College, and your technical questions related to those materials and the lesson tests are promptly answered by the Grantham teaching staff.

Recognition and Quality Assurance

Grantham College of Engineering is accredited by the Accrediting Commission of the National Home Study Council.

We are located at 2500 S. LaCienega Blvd., Los Angeles, California, but for faster response please use our mailing address: P. O. Box 35499, Los Angeles, CA 90035.

Grantham College of Engineering M-11-84
P. O. Box 35499, Los Angeles, CA 90035

Please mail me your free catalog which explains your B.S. Degree independent-study program.

Name _____ Age _____

Address _____

City _____ State _____ Zip _____

FREQUENCY COUNTERS

6 MODELS • RANGES TO 1.3 GHz

CERTIFIED CALIBRATION • METAL CASES • LSI CIRCUITRY
 WITH NO CUSTOM IC'S • AC/DC OR BATTERY
 OPERATION • PRECISION TIME BASES • EXCLUSIVE LED
 BAR GRAPH SIGNAL STRENGTH INDICATOR
 ON MODELS 8010-S & 8013-S
 MADE IN USA



PRICE LIST

MODEL	PRICE	NI-CAD BATTERY OPTION	TIME BASE OPTIONS	
			#TCXO-80 ±0.1 PPM	#OCXO-80 ±0.05 PPM
#K-7000-AC	\$150.	\$25.	N/A	N/A
#7010-S/600 MHz	\$235.	\$25.	\$75.	N/A
#7010-S/1 GHz	\$310.	\$25.	\$75.	N/A
#8007-S	\$350.	\$60.	\$75.	\$125.
#8010-S	\$435.	\$60.	\$75.	\$125.
#8013-S	\$499.	\$60.	\$75.	\$125.

MODEL	RANGE (FROM 10 Hz)	TIME BASE		AVERAGE SENSITIVITY		GATE TIMES	MAX RESOLUTION					SENSITIVITY CONTROL	EXT CLOCK INPUT/OUTPUT	METAL CASE	PROBE POWER JACK
		FREQ	STAB-DESIGN	BELOW 500 MHz	ABOVE 500 MHz		12 MHz	17 MHz	50 MHz	175 MHz	MAX FREQ				
K-7000-AC	550 MHz	5.24288	±1 PPM-RTXO	15 mV -24 DBM	N/A	(2) .1, 1 SEC					100 Hz	No	No	Yes	No
7010-S	1 GHz	10.0 MHz	±1 PPM-TCXO	10 mV -27 DBM	20 mV -21 DBM	(3) .1, 1, 10 SEC	.1 Hz	1 Hz		10 Hz	Yes	No	Yes	No	
8007-S	600 MHz		±0.1 PPM-TCXO												
8010-S	700 MHz	10.0 MHz	±1 PPM-TCXO	10 mV -27 DBM	20 mV -21 DBM	(4) .01, .1, 1, 10 SEC	.1 Hz	1 Hz		10 Hz	Yes	Yes	Yes	Yes	
8013-S	1 GHz		±0.1 PPM-TCXO ±0.05 PPM-OCXO												

*AVAILABLE OPTION

ACCESSORIES

- LFM-1110 Measure audio frequencies faster with increased resolution. Multiplies low frequency signals by 10, 100 or 1000. Built in low-pass filtering and signal amplification. (Pictured 3rd from top) \$150.
- AP-8015-A 1-1300 MHz preamplifier for reading extremely low level signals. Compact aluminum enclosure can be coupled directly to BNC input connector on counter. Supplied with AC adapter, can also be powered from accessory power output on 80XX-S series front panels. 25 dB gain to 1 GHz, 10 dB gain at 1.3 GHz \$195.
- TA-100 RF pick-up antenna, telescope-swivel elbo \$12.
- P-100 Direct 50 Ohm probe \$18.
- P-101 Low-pass probe. Attenuates RF frequencies \$20.
- P-102 Hi-Z probe. General usage, 2X attenuation \$20.
- CC-70 Carry case, small, for K-7000AC, 7010-S \$10.
- CC-80 Carry case, large for 80XX-S series \$12.

CALL FACTORY TOLL FREE
1-800-327-5912
 FROM FLORIDA (305) 771-2050/1
 TELEX 514849



OPTOelectronics inc.

5821 N.E. 14th Avenue Ft. Lauderdale, Florida 33334
 CIRCLE 46 ON FREE INFORMATION CARD

To US and Canada Add 5% to max of \$10. per order for shipping/handling
 Foreign orders add 15%



EDITORIAL STAFF

Art Salsberg
Editor-in-Chief
Alexander W. Burawa
Managing Editor
Dorothy Kehrwieler
Production Manager
Elizabeth Ryan
Art Director
Pat Le Blanc
Richard Kishanuk
Phototypographers
Hal Keith
Illustrator
Larry Mulvehill
Photographer
Leonard Feldman
Glenn Hauser
Forrest Mims III
Stan Prentiss
Charles Rubenstein
Contributing Editors

BUSINESS STAFF

Richard A. Ross
Publisher
Art Salsberg
Associate Publisher
Dorothy Kehrwieler
General Manager
Anthony C. Sparacino
Newsstand Sales Director
Arlene Caggiano
Accounting
Cheryl Chomicki
Subscriber Services

SALES OFFICES

Modern Electronics
76 North Broadway
Hicksville, NY 11801
(516) 681-2976

Eastern Advertising Representative
Paul McGinnis Company
690 Broadway
Massapequa, NY 11758
(516) 541-5666
Ian Ross

Midwest Advertising Representative
Market/Media Associates
435 Locust Road
Wilmette, IL 60091
(312) 251-2541
Ted Rickard

Western Advertising Representative
JE Publishers Representatives
6855 Santa Monica Blvd., Suite 200
Los Angeles, CA 90038
(213) 467-2266
Jay Eisenberg, Director
San Francisco: (415) 864-3252
Denver: (303) 595-4331

Offices: 76 North Broadway, Hicksville, NY 11801. Telephone: (516) 681-2976. Modern Electronics (ISSN 0748-9889) is published monthly by Modern Electronics, Inc. Application to mail at second class rates pending at Hicksville, NY and other points. Subscription prices (payable in US Dollars only): Domestic - one year \$16.97, two years \$31.00, three years \$45.00; Canada/Mexico - one year \$19.00, two years \$35.00, three years \$51.00; Foreign - one year \$21.00, two years \$39.00, three years \$57.00. Foreign Air Mail - one year \$74.00, two years \$145.00, three years \$216.00.

Entire contents copyright 1984 by Modern Electronics, Inc. Modern Electronics or Modern Electronics, Inc. assumes no responsibility for unsolicited manuscripts. Allow six weeks for delivery of first issue and for change of address. Printed in the United States of America. Postmaster: Please send change of address notice to Modern Electronics, Inc., 76 North Broadway, Hicksville, NY 11801.

MODERN ELECTRONICS

THE MAGAZINE FOR ELECTRONICS & COMPUTER ENTHUSIASTS

NOVEMBER 1984

VOLUME 1, NUMBER 2

FEATURES

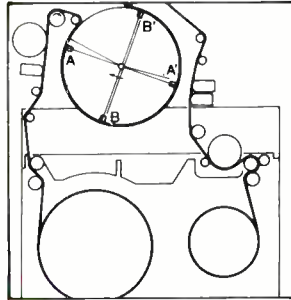

26

26 Camcorders—A Revolution in Home Movie Making

A new 8-mm video machine format competes with other VCRs. *By Len Feldman*

32 Is Your Scanner Being Wasted?

There's more to live radio-communication eavesdropping than police and fire conversations. *By Tom Kneitel*

34 A Second Chance For Junior

A fresh look at IBM's newly changed PCjr computer. *By John M. Woram*

44 Adding Extension Speakers to a Stereo System

Practical installation tips on enhancing stereo sound and providing audio in more locations. *By Norman Eisenberg*

50 Beyond Op-Amps

How to use special-purpose operational amplifiers. *By Joseph J. Carr*

57 Circuit Design From Scratch

A hands-on approach to creating your own circuits. *By Jules H. Gilder*

64 Surge Protection

Protection methods for computers and electronic equipment, including a make-your-own device. *By TJ Byers*

76 How to Short-Circuit Auto Thieves

Project features an "engine-stall" anti-theft device. *By Anthony J. Caristi*

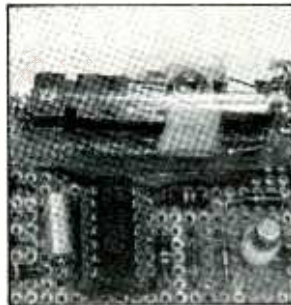

76

PRODUCT EVALUATIONS

14 Pioneer SX-V90 Stereo Receiver

A high-power FM stereo/AM receiver with a video control center. *By Len Feldman*

16 Sanyo VCR3 Mini-Size Tabletop VCR

Full featured, half-size videocassette recorder. *By Stan Prentiss*

19 Beckman HD110T Handheld Digital Multimeter

Beckman Industrial's professional, portable DMM. *By Al Burawa*

22 Tech-Sketch Apple Computer Light Pen

A new, modestly priced light pen with interface board and Micro Illustrator software expressly for Apple II's.



19



44

DEPARTMENTS

4 Editorial

By Art Salsberg

4 Letters

6 Modern Electronics News

12 New Products

49 Books and Literature

71 Electronics Notebook

Optical Fiber Sensors and Systems
By Forrest Mims III

92 Advertisers Index

The TV Tube

Computers may be front-line news, but that ubiquitous TV tube is there in video monitors and seemingly everywhere. Sight certainly titillates us, especially when a picture is displayed in color. And more so when the fare is entertaining.

Television broadcasts began delivering their signals to households in 1941, first in black-and-white, then later in color. Viewing TV programs captured the hearts and eyes of the U.S. populace like no other modern medium has done. As a result, more than 98 percent of our population has access to TV broadcasts from full-power transmitters or translators. I recall reading somewhere that the typical household operates a TV set for an average of 6½ hours per day. Now that's entertainment!

Television as we know it today was made possible by Vladimir Zworykin's development of an electronic TV transmitting "camera" for RCA.

I remember having lunch with him about a year before he passed away at the age of 92. A delightful man whose only obvious concession to age was a slight loss of hearing, he riveted my attention with lively discussions about his college days in France, where he often met with Madame Curie and other scientists.

The traditional TV broadcasting environment that he knew so well is changing. So is the method of delivery. Cable TV, in particular, has attracted a substantial percentage of viewers, and is still growing. Don't shed a tear for traditional TV broadcasters, though, since cable operators are compelled by FCC ruling to carry all over-the-air TV broadcasts in the area they serve. Cable Pay TV has achieved its success by offering many other program choices, of course, as well as ensuring that the receiving quality of broadcast TV channels aren't marred by atmos-

pheric noise or multipath transmission "ghosts." Cable TV won't take over the TV delivery-system world, though, since many people won't (or can't) pay for TV programs when they can get some over-the-air programs free. Moreover, the only really economical areas that cable can operate in are in the suburban areas, not rural or many urban sections of the country.

There are other TV delivery challengers moving in. The most important one now is satellite-TV transmissions. This TV field is already churning, with more than 80 channels spewing out in the 4-GHz C-band. Direct-broadcast satellite (DBS) transmissions are coming up, too, in the 12-GHz band. DBS in particular has the potential to produce pictures with much better quality than possible with TV broadcast or cable TV

(Continued on page 86)

LETTERS

Early Reactions

- Terrific! But then, it really wasn't a surprise. It's what I expected. It's exciting to see one of the most successful concepts in targeted publishing be reignited.

*Robert A. Hanson, Vice President
Grey-North Inc.
Chicago, IL 60654*

- Congratulations on your first issue! It looks very impressive and we are glad to be a part of it.

*Lawrence Jackel, President
Tab Books Inc.
Blue Ridge Summit, PA*

- Congratulations on the debut of *Modern Electronics*. Your magazine is filling a void that has existed in hobby electronics since the passing of *Popular Electronics*, and is doing so in a first-class way.

*Harry L. Helms,
Editor, Spectrum Books
Prentice-Hall, Inc.
Englewood Cliffs, NJ*

Low is Too Low

- Excellent premiere issue! However, the requested price correction in our advertisement on the Memotech MTX512 computer was supposed to be made for the DMX80 dot-matrix printer, not for the basic unit, which remains a low \$595.

*Richard Gavotski, V.P. Marketing
Memotech Corp.
Needham, MA*

Sorry, you're right. The tiny print at the bottom of the ad for the printer should have been changed from \$395 to \$299.—Ed.

Wants The Truth

- I read with considerable interest Mr. Perkins' article "The Versatile 555" (premiere issue, November 1984). Though the article was very interesting and informative, it would have been nice to have gotten more information on what goes on in the 555 timer, perhaps in the form of a truth table.

*R. L. Dormer
Philadelphia, PA*

Good point. Here it is below.—Ed.

TRUTH TABLE

Trig. Pin 2 note 1	Thresh. Pin 6 note 2	Reset Pin 4	Trig. Comp. Output	Thresh. Comp. Output	FF Output	Amp. Output Pin 3	Disch. Pin 7
High	High	High	Low	High	High	Low	Cond.
Low	No Effect	High	High	Doesn't Matter	Low	High	Cutoff
High	Low	High	Low	Low	No Change	No Change	No Change
As Above	As Above	Low	As Above	As Above	High	Low	Cond.

Note 1: relative to voltage at pin 5

Note 2: relative to one-half voltage at pin 5



Take your family beyond computers

Enter the fascinating world of the home robot

HERO JR is a friendly, dynamic home companion robot. He'll wake you in the morning, guard your home at night, and entertain throughout the day with small talk, songs, and games.

Buy HERO JR assembled, ready to roll out of the box. Or, build him from a simple "We Won't Let You Fail" kit. Either way, you don't need to know anything about robots. His built-in personality is fully pre-programmed. A flip of the switch turns him into your personal robot. Let him move on his own or direct him with a wireless remote control.

Slip in a new cartridge for more pre-programmed phrases, games and actions. And, with his RS-232 interface, optional HERO JR BASIC and a personal computer, you can write your own programs.

There's a lot to learn...and even more to enjoy! So, for less than the cost of a home computer, introduce your family to the wonders of robotic living.

See HERO JR at Heathkit Electronics Centers* in major cities across the U.S. and Canada. Consult your telephone white pages for the store nearest you.

OR SEND TODAY FOR MORE INFORMATION!



Mail this coupon today. Get your...

FREE Heath Catalog.

Full color, full information on HERO JR plus over 500 other fascinating electronic kits.

Mail to: HEATH COMPANY
Dept. 079-238
Benton Harbor, MI 49022

Name _____

Address _____

City _____

State _____ Zip _____

RO-118

Heath/Zenith
Heath
Company

CIRCLE 25 ON FREE INFORMATION CARD

*Units of Veritechnology Electronics Corporation.

NEW LOW-TECH COMPUTER. With "high tech" very much in favor as a catch word today, it's interesting to observe that a company is readying a low-tech computer package for Christmas. Called "Dynasty B.C.," the latter standing for "Before Computers," the \$19.95 product is actually a large abacus. Enclosed with it is a complete operating manual, down to maintenance (use furniture polish to maintain shine).

LOW-POWER TV. Some 200 LPTV construction permits have been issued by the FCC so far, two-thirds in Alaska. With more than 12,000 applications in hand, the FCC figures that about 4,000 LPTV licenses will be eventually issued. These stations can cover an area of 15 to 20 miles, so don't compete, with the big boys. LPTV Stations can use up to 10 watts transmitter power for VHF and 1 kilowatt for VHF. At present, the low-power very-local broadcasters reach approximately 2½-million viewers. How many times in their broadcasts, however, is unknown.

MACINTOSH SOFTWARE AUTHOR BOOST? If you want to do any serious software writing for the Macintosh computer, you better spring for Apple's more costly Lisa. No other way, which has deterred less-affluent authors. Rumor is that Apple will end the logjam with an assembler-debugger that'll let the writers create assembly programs for the Mac right on a Mac.

LIGHTWAVE TRANSMISSION SPEED RECORDS. In an AT&T Bell Laboratories experiment with new ultratransparent fiber, an unboosted signal was sent out at 420-million pulses per second over a record distance of 203 kilometers. In another experiment, an unboosted two-billion pulses per second signal traveled 130 km.

WHEN E.F. HUTTON TALKS... Huttonline, a personal online personal computer service from E.F. Hutton, provides clients with account data, investment information, electronic mail, and securities quotes from anywhere in the U.S. and many foreign countries. The 24-hours-per-day, seven days a week service cost \$17 per month for two hours of use, after which it's 12¢ per minute.

EE SALARIES RISE. The median 1984 salary of an electrical/electronic engineer is now \$44,500, according to a survey by the National Society of Professional Engineers. Highest paying area is New York City, which hit \$51,300, while Cleveland was lowest with \$41,696. Respondents in the communications area rang the bell with a median income of \$47,000 nationwide. Starting salary offers to 1984 grads with B.S. degrees ranged from an average low of \$24,204 to an average high of \$28,044, based on an American Electronics Association survey of 400 U.S. companies.

EARTH-STATION SHOW. A recent earth-station trade show (SPACE & STTI in Nashville, TN) drew about 10,000 attendees who visited 531 exhibits. There were about 300 satellite dishes set up outside the Opryland Hotel, where the meet was held. Block-down frequency converters, 500-1500 MHz, were heavily displayed. It's estimated that there will be 1-million installed TV earth terminals by April 1985.

COMPACT-DISC CHANGER. Record changers fell into disfavor many years ago, with single-play machines taking over. This left in its wake the remains of V-M, Webcor, BSR, Collaro, Garrard, and Dual changers, as Japanese single-play models took over from U.S., British, and German makes. Now Technics (Panasonic's audio-component arm) has reinvented the wheel with the introduction of a Compact-Disc changer, its Model SL-P15. The new \$1,500 changer can handle 51 CD discs, with expansion to 251 discs using an optional accessory. The company, which markets two other CD players (single-play types), offers a free Compact Disc starter kit to purchasers of one of its CD players that includes three Compact Discs, membership in a Compact Disc club, and a coupon for an additional free disc and a CD cleaning system. The \$85-value offer is good through 1984.

COMPUTER HERO. Apple Computer's co-founder, Steve Wozniak, was named 1984 Computer Hero by award-sponsor Gusdorf Corp., a computer furniture maker. The recipient was chosen from among dozens of nominees submitted by computer users groups across the country. Press releases credit Steve with building the first personal computer, which he actually didn't since Ed Roberts of MITS preceded him with his Altair 8800 computer. Nonetheless, Wozniak is indeed a computer hero.

FREE SOFTWARE PREVIEW. Visitors to the Boston Museum of Science will soon be able to sample computer software programs at no charge. A host of software companies are participating in this innovative program by donating software to the museum's hardware/software resource center.

FAT MAC. Apple Computer finally got its hands on 256K-bit chips for its Macintosh computer. Fat Mac will therefore be available, with 512K memory rather than its 128K model for \$3195, \$700 more than the original model. Japan is said to be the source for the 256K-bit RAM that will replace 64K-bit chips in its limited-space enclosure. The computer community has been gasping for the higher-memory chips, of course. After all, one can quadruple memory in the same physical space. With user RAM quickly eaten up by more sophisticated software, with additional help data, windows, graphics, integrated applications, and so on, higher-memory RAM is desperately needed in a Catch-22 situation between hardware and software makers. At the same time, note that Motorola Semiconductors has previewed its new MCM6257 256K-bit dynamic RAM (262,144 bits). The HMOS device uses a single +5 volt supply and has standard 16-pin dual-in-line packaging. Inputs and outputs are TTL compatible. Since sampling started in mid-1984, can full production be far behind?

HEDY LAMARR. A popular 1940's actress, Hedy Lamarr, participated in applying for a patent, "Secret Communications System," according to an article in IEEE Spectrum's September 1984 issue. Though gaining fame running nude in a film called Ecstasy under her Austrian name (Hedwig Kiesler), her secret past included collaboration on a method for guiding torpedoes to targets with a frequency-hopping scheme. This is a form of spread signal, though the technique today is different.

Learn robotics and you build this

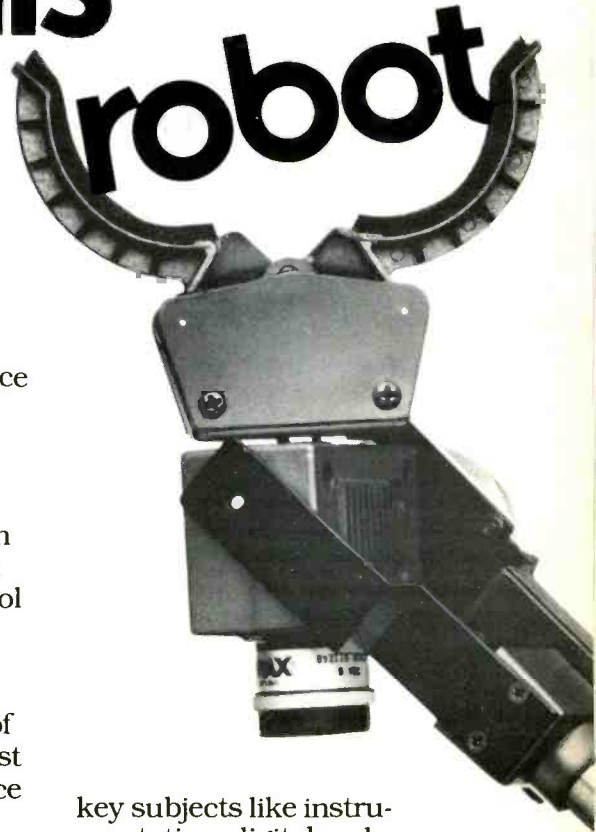

New NRI home training prepares you for a rewarding career in America's newest high-technology field.

The wave of the future is here. Already, advanced robotic systems are producing everything from precision electronic circuits to automobiles and giant locomotives. By 1990, over 100,000 "smart" robots will be in use.

Over 25,000 New Jobs

Keeping this robot army running calls for well-trained technicians . . . people who understand advanced systems and controls. By the end of the decade, conservative estimates call for more than 25,000 new technical jobs. These are the kind of careers that pay \$25,000 to \$35,000 a year right now. And as demand continues

to grow, salaries have no place to go but up!

Build Your Own Robot As You Train at Home

Now, you can train for an exciting, rewarding career in robotics and industrial control right at home in your spare time. NRI, with 70 years of experience in technology training, offers a new world of opportunity in one of the most fascinating growth fields since the computer.

You need no experience, no special education. NRI starts you at the beginning, takes you in easy-to-follow, bite-size lessons from basic electronics right on through

key subjects like instrumentation, digital and computer controls, servomotors and feedback systems, fluidics, lasers, and optoelectronics. And it's all reinforced with practical, hands-on experience to give you a priceless confidence as you build a programmable, mobile robot.

Program Arm and Body Movement, Even Speech

Designed especially for training, your robot duplicates all the key elements of industrial robotics. You learn to operate, program, service, and troubleshoot using the same techniques you'll use in the field. It's on-the-job training at home!

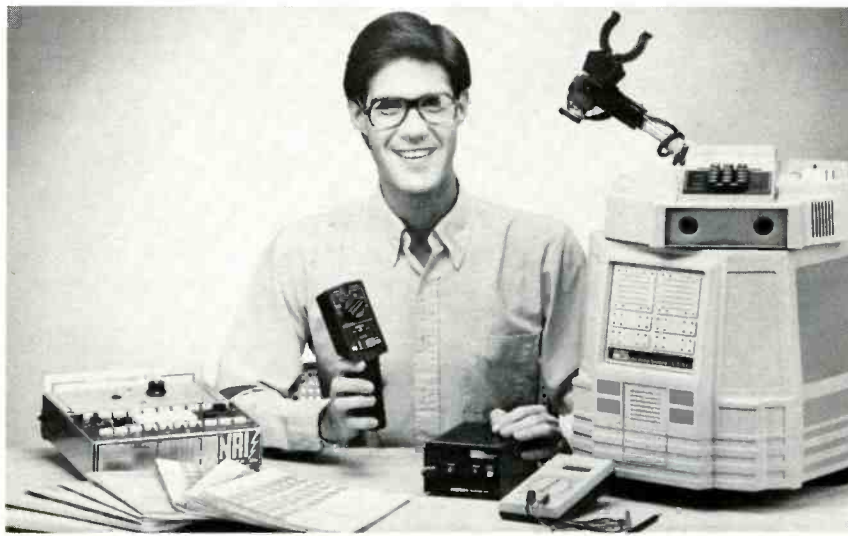

You get and keep Hero 1 robot with gripper arm and speech synthesizer, NRI Discovery Lab for electronic experimentation, professional multimeter with 3½-digit LCD readout, 51 fast-track training lessons.

industrial control as

Building this exciting robot will take you beyond the state of the art into the next generation of industrial robotics.

You'll learn how your completely self-powered robot interacts with its environment to sense light, sound, and motion. You program it to travel over a set course, avoid obstacles using its sonar ranging capability. Program in complex arm and body movements using its special teaching pendant. Build a wireless remote control device demonstrating independent robot control in hazardous environments. You'll even learn to synthesize speech using the top-mounted hexadecimal keyboard.

Training to Build a Career On

NRI training uniquely incorporates hands-on building experience to

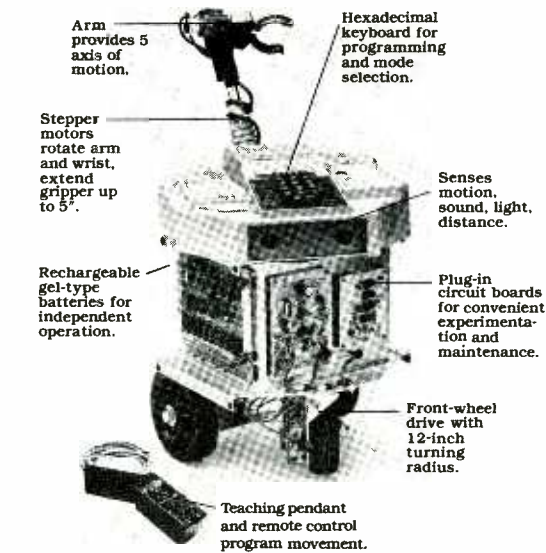

Your mobile robot duplicates functions of state-of-the-art industrial units.

reinforce your learning on a real-world basis. You get professional instruments, including a digital multimeter you'll use in experiments and demonstrations, use later in your work. And you get the exclusive NRI Discovery Lab[®], where you examine and prove out theory from basic electrical concepts to the most advanced solid-state digital electronics and microprocessor technology. Devised by an experienced team of engineers and educators, your

experiments, demonstrations, and equipment are carefully integrated with 51 clear and concise lessons to give you complete confidence as you progress. Step-by-step, NRI takes you from the beginning, through today, and into an amazing tomorrow.

Send for Free Catalog Now

Send for NRI's big free catalog describing Robotics and Industrial Control plus over a

dozen other high-technology courses. You'll see all the equipment you get in detail, get complete descriptions of every lesson, find out more about career opportunities for trained technicians. There's no cost or obligation, so send today. Your action today could mean your future tomorrow. If the card has been removed, please write us today.

NRI NRI SCHOOLS
McGraw-Hill
McGraw-Hill Continuing Education Center
3939 Wisconsin Ave.
Washington, DC 20016

WE'LL GIVE YOU TOMORROW.
CIRCLE 24 ON FREE INFORMATION CARD

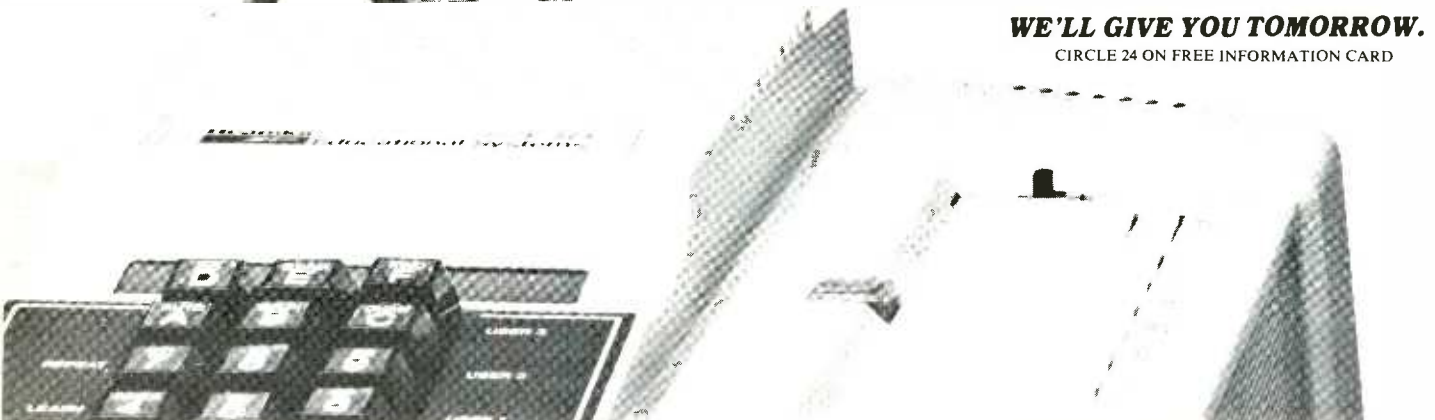

For more information on products described, please circle the appropriate number on the Free Information Card bound into this issue or write to the manufacturer.

Productivity-Oriented Personal Computer

Built-in software, preprogrammed into ROM, is the key feature of a new personal computer from Commodore. Called the Commodore Plus/4, the new color computer allows the small businessman or productivity-oriented home user to switch from word processing to spreadsheet to database management to graphics software at the touch of a function key. Also preprogrammed into the computer are a machine-language monitor with 12 commands and Enhanced BASIC with more than 75 commands, including 11 just for graphics.

Supplied with 64K of RAM (60K available for BASIC programming), the Plus/4 features a full-size typewriter-style keyboard and HELP, eight reprogrammable function, and four cursor-control keys. Each of the computer's 62 graphics characters is

directly available from the keyboard. Two built-in tone generators come as standard equipment.

The computer has a screen windowing capability. In the text mode, characters can be displayed in standard, reverse, or flashing video. The Plus/4 can display 128 colors consisting of 16 primary colors and eight luminance levels. It also offers high-resolution graphics plotting capability, with 320 × 200-pixel screen resolution. Displays can be split-screen text with high-resolution graphics.

CIRCLE NO. 104 ON FREE INFORMATION CARD

DMM Communicates Via Optional Interfaces

BBC-Metrawatt's Model M-2110 4¾-digit LCD multimeter offers a choice of three popular interfaces for communicating with computer systems. It can be ordered with factory-installed IEEE-488, RS-232C serial, or Centronics parallel interface. It is claimed that with no programming experience, users can quickly configure a data-acquisition system or simply output measurement data to a printer. (Programs for the Apple II,

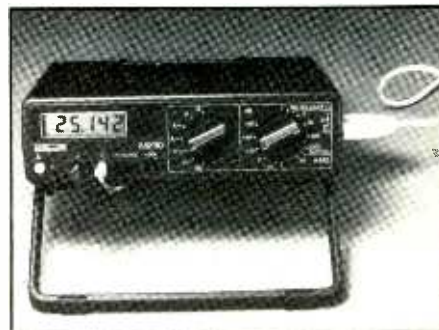

Hewlett-Packard, IBM, Commodore, and Epson computers are included in the manual.)

The DMM is also a high-performance stand-alone multimeter. Basic dc accuracy is rated at 0.05% + 1 digit. Functions include dc and true rms ac voltage and current, resistance, decibels, and capacitance. All functions and ranges are selected with two rotary switches.

A 30,000-count A/D converter is claimed to give the DMM a 5½-digit resolution in many applications. The Model M-2110 DMM is designed to meet the world's most stringent safety standards, including Germany's VDE guidelines. \$685.

CIRCLE NO. 110 ON FREE INFORMATION CARD

VHS Hi-Fi VCR

Great pictures and terrific sound can be yours with Sharp's new Model VC-489 VHS Hi-Fi video-cassette recorder. The audio section has an impressive list of specifications, including: flat frequency response from 20 to 20,000 Hz, less than 0.005% wow and flutter, greater than 80-dB dynamic range, less than 0.3% distortion figure, and a ±150-kHz modulation rate.

Video features are no less impressive. The VCR uses Sharp's V14 Plus double azimuth four-video-head system for special effects and high-quality picture playback and a 142-channel, cable-ready synthesized tuner. Standard video features include: a

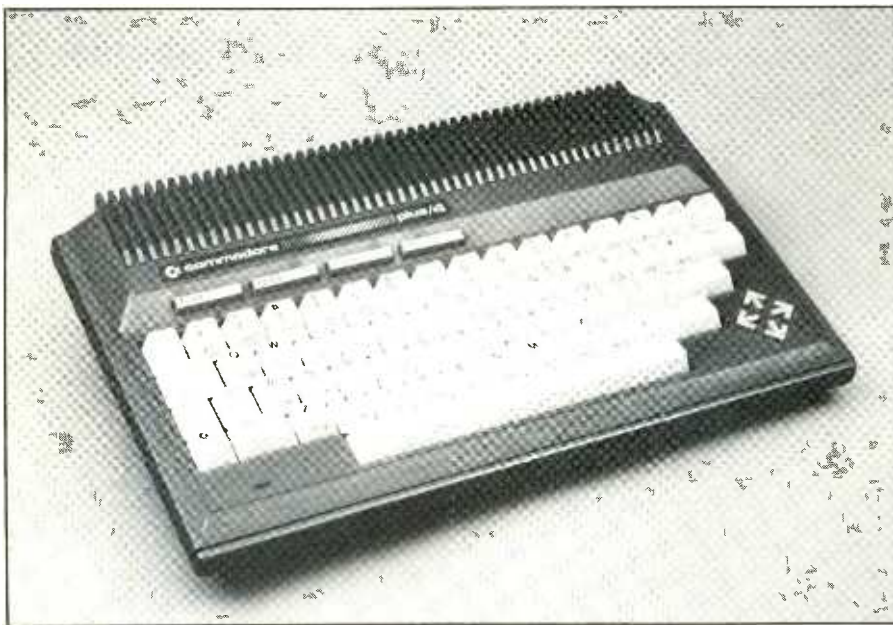

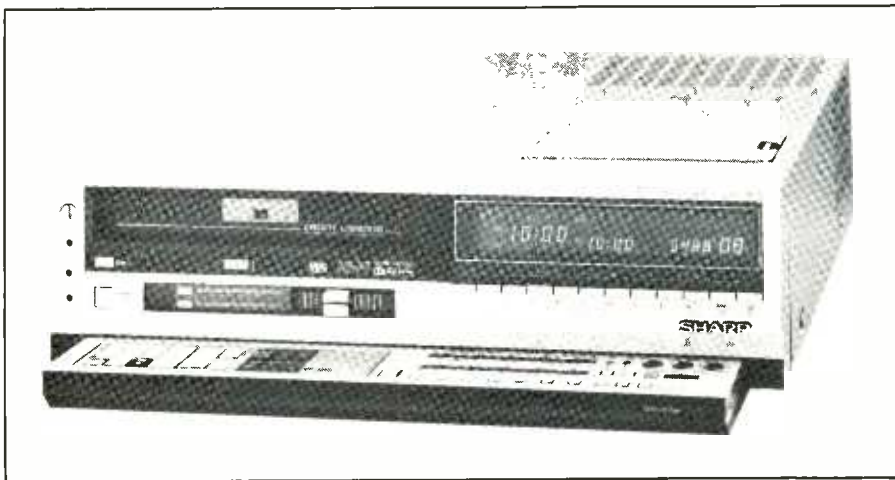

14-day, 8-event programmable timer with triple time display; a video search system that operates at 7× normal speed in SP/LP and 15× normal speed in EP; and detachable Sharpshooter infrared wireless remote-control unit.

Except for the main power switch, record-level controls, channel-selection buttons, and a front panel headphones level control, all controls are located in a drawer that glides into the bottom of the machine to conceal them from view. \$1399.95.

CIRCLE NO. 107 ON FREE INFORMATION CARD

Ambience/Surround Sound Decoder

If the music played through your hi-fi system doesn't sound lively enough, Phoenix Systems has just what you need to give it the needed sparkle in its

new Model P-250 delay-enhanced ambience/surround-sound decoder. The second-generation decoder is designed to extract ambience signals from stereo recordings and surround sound from encoded movies. It includes a new center-channel output, in addition to the conventional left, right, and surround outputs to provide four-channel reproduction.

When switched to the mono mode, a built-in stereo synthesizer is said to improve the sound of even low-fi mono sources. Delay time is adjustable over a 5-to-50-ms range to match room size and speaker system placement. Other controls include center volume, rear volume, and master volume. A separate pushbutton is provided for switching between surround sound and stereo. \$250 assembled; \$180 kit.

CIRCLE NO. 106 ON FREE INFORMATION CARD

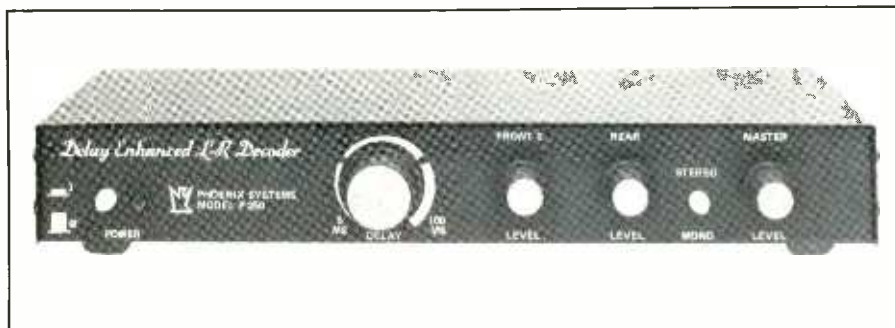

Real Percussion for Apple II's

If you're musically inclined and own an Apple II+ or IIe computer, you'll find Ensoniq's new Drum-Key program a welcome addition to your software library. The electronic music interface board and software package is designed to be used with stereo systems and electric instrument amplifiers. Drum-Key uses digital recordings of 28 actual drum and percussion instruments to create nearly lifelike sounds with your computer. It lets you compose, play, and record all manner of percussion patterns and riffs and allows you to play along with any of the 100 rhythm patterns and 26 songs built into the program. These patterns and songs can also be loaded from and saved on disk.

The 28 available sounds include kick bass, snare, four different tomtoms, a variety of cymbals, tambourine, and six sounds made by conventional drum synthesizers. Features include: real-time multi-track recording; single-step recording and editing; programmable pattern length; selectable time signature and meter; programmable tempo; programmable error correction; rhythm control; colorful graphic screen displays; programmable audio and video metronome; and sync output for use with external synthesizers or connection to multiple-drum machines, \$139. Address: PVI Div. of Ensoniq, 1 Great Valley Pkwy E., Malvern, PA 19355.

CIRCLE NO. 100 ON FREE INFORMATION CARD

Glass-Vibration Detector

A glass-vibration detector designed to be used in security systems is now available from Mouser Electronics. The Model ME106-GSS830 GlassGuard's design is said to eliminate the drawbacks of earlier me-

(Continued on page 80)

An Audio Receiver With Video In Mind: Pioneer's New Model SX-V90

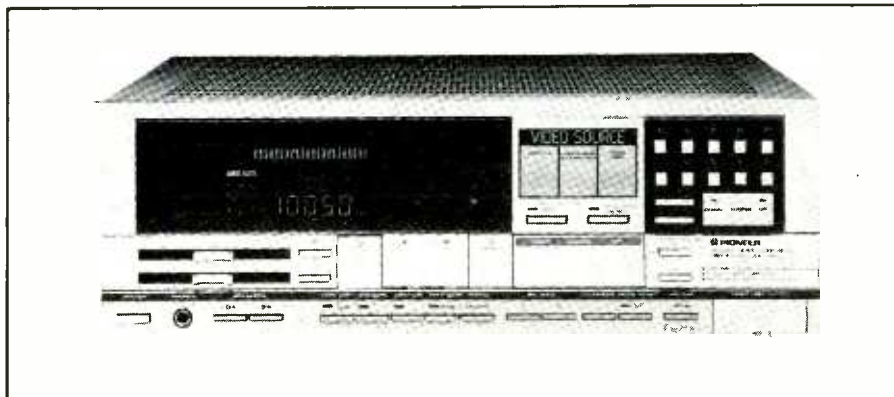

Hoping to hasten the coming integration of audio and video into a single entity, a few manufacturers have done more than just fantasized about the bright new future of home-entertainment electronics. They're already creating products to fill the needs of the home user. One company committed to the coming age of audio/video entertainment is Pioneer Electronics, which recently introduced an unusual stereo receiver. In addition to offering just about every imaginable feature of a classy high-powered AM/FM-stereo receiver, the new Model SX-V90 could well serve as the central control unit for such video components as a VCR, videodisc player, and personal computer

Recognizing that not all video program sources offer stereo sound channels or high signal-to-noise (S/N) ratios, Pioneer has built into the SX-V90 a Dynamic Noise Reduction (DNR) system for reducing tape noise, such as the hiss normally audible when playing back conventional VCR audio tracks. Another circuit incorporated into the SX-V90 simulates a stereo effect that enhances the sound track of normally monophonic video program sources.

While incorporating many switching and control features that will appeal to the video enthusiast, Pioneer hasn't overlooked the important "basics" of AM/FM tuner/amplifier design in this receiver. The

125-watt/channel amplifier section is built around Pioneer's nonswitching design in which a high-speed servo system automatically adjusts bias current to the power stages to suit input requirements. Because this design approach never permits the output stages to switch off entirely, the system delivers class-A performance with the efficiency of class-B design.

The Model SX-V90 receiver/control center measures $17\frac{3}{16}$ " \times $16\frac{1}{16}$ " \times $5\frac{1}{16}$ " and weighs 41.5 lbs. Its suggested retail price is \$799.95.

General Description

Quartz PLL synthesis in the AM/FM tuner section assures precise station tuning. A built-in memory system permits up to 10 AM and 10 FM stations to be preset and instantly recalled with the touch of a button. Tuning can also be accomplished by continuous scanning up and down the dial, with the tuner automatically locking onto only those signals whose level assures satisfactory reception. Alternatively, tuning can be done completely manually.

Along with presetting an FM station's frequency in this receiver, you can simultaneously preset its i-f bandwidth (wide or narrow) so that each time that station is recalled from memory, it will be tuned with the preset bandwidth. The microprocessor that controls the tuning system also

permits any of two volume levels to be preprogrammed for all program sources, and input sensitivity can even be preset to compensate for the different levels provided by the various program sources connected to the receiver. This way, you won't be constantly adjusting the volume control every time you switch from one program source to another or from a video sound source to a strictly audio program source.

The video facilities include three separate sets of inputs for video program sources, the ability to dub video tapes from one VCR to another while listening to any audio source, and the capability of operating a personal computer or playing a video game using the switching facilities of this versatile integrated receiver.

The receiver's many functions are accessed by light-touch buttons or, in the case of setting the tonal quality of the sound, horizontal slide-type controls. Located right on the front panel are a stereo headphones jack and two pushbuttons for selecting speakers A, speakers B or both. Large touchpads provide access to CD/AUX, AM, FM, and PHONO sources. (The last is supplemented by another switching arrangement that selects between moving-coil and moving-magnet phono cartridges.) Five smaller pushbuttons are provided for tape-to-tape dubbing; turning on/off a subsonic filter; connecting an accessory (equalizer, time-delay unit, decoder, etc.) in series with the audio signal path; selecting WIDE/NARROW FM i-f bandwidth; and selecting between moving-coil and moving-magnet phono cartridges.

A multipurpose display area occupies almost half of the upper portion of the front panel. Output power is displayed as an expanding green "spray" that increases in height as output power increases. Separate indicators are provided for the left and right channels. Volume settings are

made against a 22-increment calibrated scale, which is also used for indicating channel-balance settings.

The signal-strength "meter" is also in the form of a green illuminated display. The frequency of a tuned AM or FM station appears in a numeric display area, with accuracy on FM to two decimal places.

Other illuminated indicators tell you which preset volume level has been selected; whether loudness or audio muting functions are engaged; whether the tuning mode is manual or automatic; which speaker systems have been selected; and whether or not an FM broadcast signal is being received in stereo. To the far right of the display area are illuminated legends that indicate which of the video and audio program sources has been selected and which, if any, of the tape monitors is active. All in all, there's not much that can occur within this receiver that isn't denoted by one of the many elements of its elaborate display.

Located in the upper-right of the front panel are three large touch pads for selecting one of the *video* sources. Below these are smaller keys that turn on/off the DNR noise-reduction system and stereo-simulation circuit. A rocker-type button permits adjustment of volume level, while immediately to its right are located the two pushbuttons for setting the preset volume levels. Separate L and R touch buttons are provided for setting channel balance. Touching both buttons simultaneously automatically returns the balance setting to its electrical center. Rounding out the complement of strictly audio controls is a trio of pushbuttons for selecting LOUDNESS, MONO/STEREO mode, and MUTING.

In the upper-right corner of the front panel are located all the controls for the tuning options. AUTO/MANUAL and MEMORY switches are positioned to the left of a large rock-

er-type UP/DOWN tuning switch. Above these are the 10 small STATION CALL keys and indicators that are used to select previously memorized AM and/or FM stations.

An unusual, and useful, feature of this versatile receiver is a pair of VIDEO DISC OUTPUT jacks that can be accessed by removing a small cap on the lower-right corner of the front panel. These jacks enable you to copy both the audio and the video tracks of a videodisc into a videocassette tape. Copying can be performed even with the receiver's power turned off, because the jacks simply provide a convenient passive connection to the videodisc player.

On the rear panel of the SX-V90 are all the video and audio connectors for accommodating the various devices that can be used with the receiver, as well as sundry special-purpose switches.

Both composite-video and r-f type connectors are provided. If you own a TV monitor that can accommodate a composite-video input signal, you'd connect it to the 75-ohm output jack on the receiver. A full TV receiver, on the other hand, would connect via its antenna terminals to the terminals labeled TV(VHF) on the SX-V90. The same applies to the video inputs, each of which offers F-type r-f and composite-video source facilities.

There are also terminals for connecting 75- and 300-ohm FM and external AM antennas to the receiver. (An accessory AM loop antenna is supplied). A slide switch near the antenna terminals permits the increments of the frequency-synthesizing tuning system to be set for 9- or 10-kHz steps on AM and 50- or 100-kHz steps on FM. This not only lets you use the receiver in a foreign country, but it also lets you receive FM-stereo signals from those cable-TV companies that don't position their services at standard 100- or

200-kHz increments on the FM dial. Near the frequency-incrementing switch is a 50/75-microsecond deemphasis selector switch.

Output connectors are provided for two pairs of stereo speaker systems, and there are three ac convenience receptacles, one switched and two unswitched. Finally, there are preamplifier-output and power-amplifier-input jacks (externally linked together) and a jack to accommodate an AM-stereo decoder when it becomes available.

Laboratory Report

With strong FM signals, the FM tuner section had an exceptionally good S/N ratio, measuring 86 dB in mono and 82 dB in stereo. In the wideband i-f mode, distortion measured an extremely low 0.02% in mono and 0.05% in stereo for a mid-frequency modulating signal.

FM stereo separation was also superb. It measured nearly 60 dB at 1000 Hz and was still a very high 50 dB at 10 kHz. Of course, distortion and separation figures deteriorate somewhat if you have to switch to the narrow i-f bandwidth mode to eliminate adjacent-channel interference.

With respect to sensitivity to weak signals, the tuner required an input of only 10.8 dBf (1.9- μ V) at the 300-ohm antenna terminals to deliver a listenable signal in mono. A stereo signal of greater than 28 dBf (about 14 μ V) switched reception from mono to stereo.

Unlike the case with most all-in-one receivers, the AM tuner section in the SX-V90 provided remarkably flat response all the way out to about 5 kHz. If this doesn't sound so hot, you should know that most AM tuner sections in integrated receivers attenuate audio frequencies beginning as low as 2.5 kHz!

The power amplifier section of this receiver delivered a respectable 144

PRODUCT EVALUATIONS...

Pioneer's Model SX-V90 continued

watts/channel into 8-ohm loads before the onset of clipping. Dynamic headroom measured a modest 0.8 dB above the rated value of 125 watts/channel. The power amplifier's damping factor measured 45. CCIR IM (twin-tone) distortion was a low 0.038% at rated output, while IHF IM distortion measured almost as low, with a reading of 0.0513% for rated output.

Using the moving-magnet inputs, sensitivity measured 0.3 mV for a 1-watt output. For the moving-coil inputs, sensitivity increased to 0.02 mV. A 12-mV audio signal was required through the high-level inputs to produce a 1-watt output into 8-ohm loads. Phono overload for the moving-magnet inputs, using a 1000-Hz test tone, was 175 mV—well above the 150 mV claimed by Pioneer. For the moving-coil inputs, overload occurred at 15 mV.

Overall amplifier frequency response was flat within 1 dB from 11 Hz to 60 kHz and within 3 dB from 5 Hz to 100 kHz. These readings exactly match the figures claimed by Pioneer for the SX-V90. RIAA equalization was a bit off at both the high and the low ends of the frequency spectrum, deviating from the standard curve by a maximum of +0.2 dB at 50 Hz and +0.3 dB at 15 kHz.

The signal-to-noise ratio (S/N) through the moving-magnet phono inputs, referred to a 5-mV input sig-

nal and with the volume control set for a 1-watt reference output, measured a very respectable 82 dB. An identical S/N reading was obtained for the high-level inputs, this time referred to a 0.5-volt input signal. Switching to the moving-coil phono inputs, S/N measured 68 dB. All measurements were A weighted. Residual noise with the volume control at minimum was 89 dB below 1 watt output.

User Comment

If you're about to embark upon creating an audio/video home-entertainment center, you'd do well to investigate what the Pioneer Model SX-V90 has to offer. This one-step control center may be all that you'll ever need.

During our listening tests, we were very interested in the DNR system and stereo synthesizer circuit. Both delivered performance beyond our expectations. If you presently own a conventional (not "hi-fi") VCR, you already know how noisy the sound track from the video tape can be on playback and how flat it can sound in the absence of stereo. With DNR and stereo simulation, you'll be pleasantly surprised with how good these tapes can really sound.

The DNR system in this receiver is particularly effective in dealing with noise on the sound tracks of video tapes. In fact, some of our tapes that have no better than a 40-dB S/N ac-

tually sounded almost acceptable when processed with DNR.

The stereo synthesizer was even more interesting. Quite frankly, we expected it to be just another of those systems that simply introduces a series of nulls and peaks in the response of each channel to create a pseudostereo effect. We were surprised, then, that our measured response of each channel with the stereo simulator turned on was still perfectly flat. There were neither the peaks nor the valleys so characteristic of some stereo simulators. The simulator in the SX-V90 provided a pleasant, if only moderate, stereo effect.

As for sound quality, the SX-V90's performance is the equal of any strictly audio receiver on the market today. There's enough power to handle the wide dynamic range of the new digital audio program sources, with the ability to drive medium-efficiency speaker systems to adequate sound pressure levels.

The FM tuner section is quite sensitive, and stereo reception is clean and distortion-free. And as noted above, the AM tuner provides a much better than average response.

Given its great sound and its tremendous flexibility and versatility as an audio/video control center, one can hardly balk at the SX-V90's seemingly high price. Actually, the price is quite reasonable when all things are considered.—*Len Feldman*.

CIRCLE 71 ON FREE INFORMATION CARD

A Half-Size Tabletop VCR: Sanyo's New Model VCR3

Videocassette recorders have really come a long way in terms of performance, versatility, and ease of use since their introduction a number of years ago. The VCR you buy today is likely to be a much refined version of the early models, incorporating fea-

tures and functions not available in even top-of-the-line models back then. And you almost always get all this at a much lower price. Typifying the new design trends in the Beta arena is the Sanyo Model VCR3, a Beta II/III format recorder/player

with a front-loading tape mechanism, soft-touch transport controls, and very compact size (about half that of a standard VCR).

This VCR features a double-azimuth, three-head design for jitter-free special effects like freeze frame

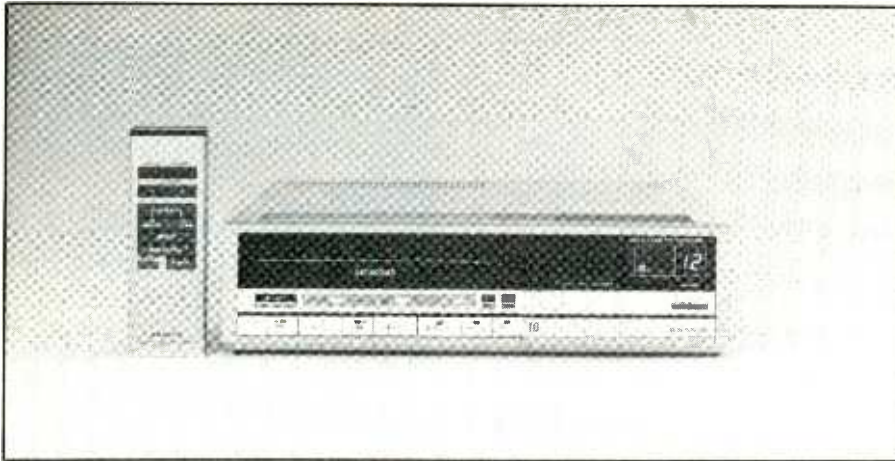

and 1/2-speed slow-motion playback, plus Betascan high-speed picture search in both Beta III and Beta II. In keeping with the "cable-ready" trend, the VCR3 has a user-programmable automatic fine tuning (aft) controlled tuner that can tune 105 vhf, uhf, and cable channels. The VCR can be user-programmed to record up to eight events over a 14-day period via its built-in timer.

For precise tape and record/play control, the VCR3 features a five-motor, quartz-locked transport. Other standard features include an electronic tape counter with memory rewind; a see-through cassette viewing window; adjustable tracking; a dew/humidity indicator; tuner memory system; and a fluorescent time/tape-counter display. A nine-button, 18-function infrared wireless remote control unit is also supplied as standard equipment.

Housed inside an attractive silver-finished enclosure with black plastic accents, the VCR3 measures a very compact 13 3/4" D × 12 1/8" W × 3 1/2" H, and weighs only 16 1/2 lbs. Suggested retail price is \$699.95.

General Description

As is the case with most VCRs nowadays, the front panel of the VCR3 is logically divided into three sections.

Occupying the upper-left quarter of the panel is the slot for loading and unloading tape cassettes. This slot is protected from environmental contaminants by a spring-loaded door that is pushed out of the way by the cassette during loading and automatically opens to deliver the cassette when the eject button is pressed.

The upper-right quarter of the front panel has two display windows. In one, fluorescent numeric indicators display time of day or tape consumption. In the other is displayed the number of the channel to which the VCR is current tuned.

Immediately below the cassette slot are the EJECT, VTR/TV and OPEN switches and a series of boxes with graphic legends that light up to inform the user of the operating status of the VCR. All the way over to the right and in line with the other switches and status indicators is a pair of touch-bar switches labeled TV CHANNEL, that are used for scanning through the TV channels in either the up or down direction.

On the bottom third of the front panel are arranged in a horizontal row the POWER switch and the various transport and record/play controls, all soft-touch. Built-in status lights come on to inform the user which of certain transport controls have been activated.

Pressing the OPEN button on the front panel causes a slanted triangular mini-panel to pop up at the front-top of the VCR. On this panel are contained the programming controls for setting the clock, selecting tape speed, storing selected channels in memory, turning on and off the timer, and the remote, recall, and all-clear buttons. Also on the mini-panel are dual tracking controls.

All 12 vhf channels are factory programmed into memory. In addition, any four uhf channels can be user-programmed into memory. This puts a total of 16 channels at your fingertip, all accessible via the VCR's front panel manual scanning buttons or from the buttons on the wireless remote-control unit.

Reflecting the compact size and coloring of the VCR3 itself, the infrared remote-control unit measures a compact 6" × 1 1/16" × 1 3/4" and is housed inside a silver and black case. Power is supplied by two AA cells. Nine pushbuttons are supplied for switching on and off the VCR's power, choosing between VCR and TV, scanning up and down the preprogrammed channels and operating the PLAY, REW(ind), FF (fast-forward), STOP, PAUSE/STILL, and RECORD functions. The PLAY and SLOW keys are raised and slanted forward for ease of use. Though the remote-control unit is very compact, it is easy to operate by small and large fingers.

Laboratory Results

To test the Sanyo Model VCR3 in our laboratory, we enlisted the aid of a 4.2-MHz RCA Model VGM2023S TV/monitor for both r-f and pure video or audio (baseband) signals. As color, multiburst, staircase, and red field patterns were generated and recorded, we began tuner sensitivity, average ac power checks, and final cabling verifications between the receiver's video detector and a high-

PRODUCT EVALUATIONS ...

Sanyo's New Model VCR3 continued

Laboratory Test Results

Tuner/system sensitivity:				
vhf channel 3				-5 dBmV
uhf channels 20 & 40				-1 dBmV
Ac operation range at 60 Hz				100-130 V ac
Average power consumption at 117 V ac:				
Record				35 W
Play				36 W
Start-up recording time				1.5 seconds
Stop recording time				instantaneous
Start-up play time				4 seconds
Maximum audio range				
(measured between 200 and 10,000 Hz)				-3 dB at 5.7 kHz
Play times (minutes):	L-250	L-500	L-750	L-850
Beta II	60	120	180	200
Beta III	90	180	270	300
Maximum luminance S/N				42 dB
Maximum chroma S/N				46 dB
Maximum audio S/N				40 dB
Luminance bandpass at:				
reference				2 MHz
baseband				3 MHz
Betascan: Beta II				7× normal
Beta III				9× normal
Wow/flutter: Beta II				0.085%/0.125%
Beta III				0.15%/0.25%

Measuring equipment: Tektronix Models 7L5 and 7L12 spectrum analyzers; Hameg Model HM and Telequipment Model D67A oscilloscopes; RCA Model VMG2023S TV/monitor; Sadelco Model FS-3D UV field-strength meter; Data Precision Models 1350 and 945 multimeters; B&K Precision Model 1260 NTSC color-bar/multiburst and Model 3020 sweep-function generators, and Model 1035 wow/flutter meter; Sencore Model VA48 video analyst and Model PR57 ac Powerite; Tektronix Model C-5C and Minolta Model XD-11 cameras.

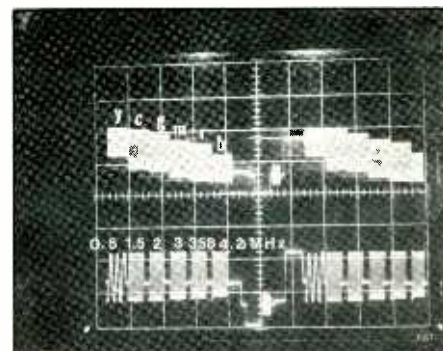

Fig. 1. Perfect color bars and multi-burst is an equipment processing goal—it is not a reality.



Fig. 2. This is the spectrum analyzer/oscilloscope display of multi-burst processing through the Sanyo VCR3 videocassette recorder.

sensitivity 60-MHz oscilloscope and 0.1-to-1800-MHz spectrum analyzer. This arrangement made it possible to determine precisely what, if any, difference there was in performance between baseband and r-f in the Beta II and Beta III modes.

The results obtained at our laboratory testbench are summarized in the table and waveform photos elsewhere in this report. In the photos, the oscilloscope waveforms of the various recordings have been superimposed on spectrum analyzer displays to give results in terms of both volts/division and time base, as well as amplitudes in decibels (dB) and

frequency. Most waveforms for this report were generated by a new B&K Precision Model 1260 NTSC multi-function generator designed as a broadcast standard.

For tuner sensitivity, if you would like to translate dBmV (75 ohms) to dBm (50 ohms), use the conversion factor $\text{dBmV (75 ohms)} = \text{dBm (50 ohms)} + 54.47 \text{ dB}$. For TV channel 3, the readout becomes $-5 \text{ dBm} = \text{dBm} + 54.47 \text{ dB}$, or $\text{dBm} = -59.47$.

The vhf and uhf tuner readings given in the table compare favorably with those obtained from a modern TV receiver. At 35 to 36 watts, average ac power drain is conservative for

VCRs. Transport stop and start time figures, on the other hand, are excellent, as were the general operation and flexibility of all controls on the VCR.

Audio response of the VCR3, down 3 dB at 5.7 kHz, is not exactly "hi-fi," but neither are you paying for this capability. Signal-to-noise ratio (S/N) for luminance and chroma are very good. Luminance bandpass at baseband is about average for a VCR, as are the wow and flutter figures.

In the waveform in Fig. 2, you will notice some overshoot switching transients among the multibursts, accentuated by r-f connections. Most

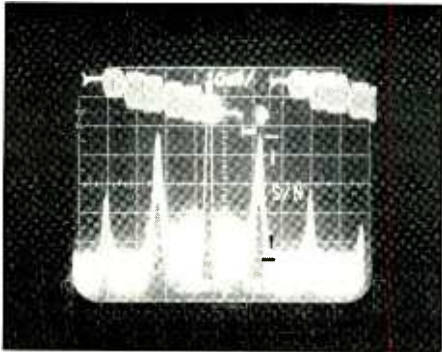

Fig. 3. Baseband-to-baseband processing means better S/N ratios and cleaner displayed pictures.

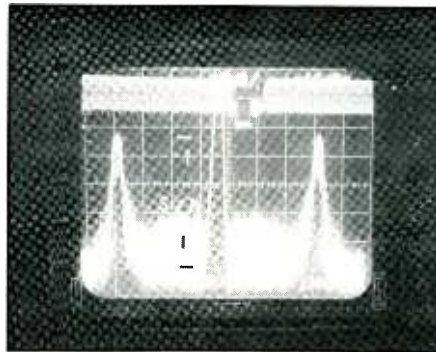

Fig. 4. This waveform display illustrates the excellent red-field 45-dB S/N ratio of the Sanyo VCR3.

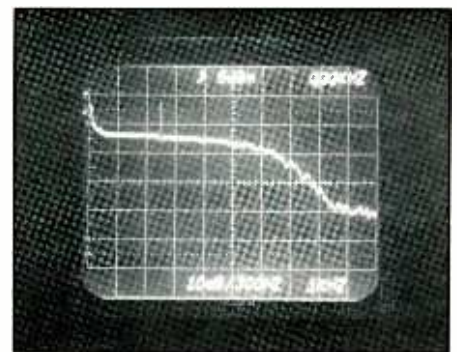

Fig. 5. This is the audio spectrum response of the VCR3 over a frequency range of from 200 Hz to 10 kHz.

of these occur *after* the 2-MHz period, however, and probably will not show up in the displayed pictures—unless there are lots of fast-changing, high-frequency scenes. This is normal for most VCRs.

The color-bar (Fig. 3) and red-field (Fig. 4) responses at baseband are self-explanatory. Compared with the standard in Fig. 1, the six color bars (yellow, cyan, green, magenta, red, and blue) and their relative amplitudes are processed extremely well, and the red field appears nicely without inclusion of spurious (spurs) frequencies. The glitch that appears in the waveform photo in Fig. 5 is man-made, the result of instrument bandswitching. Otherwise, the curve is fully representative of the VCR3's audio performance. Notice here that serious rolloff does not begin until just before the 7-kHz point on the scale. Also, the differences in re-

sponse are no more than 1 to 2 dB when switching from the Beta II to the Beta III mode, and vice-versa.

User Comment

Sanyo's Model VCR3 is a model of versatility for a videocassette recorder in its price range. Particularly noteworthy are the fast-response record, play, and stop actions of the transport. And the VCR's ultra-compact size, generally attractive appearance, and disappearing programming controls all make good aesthetic and practical sense for a table-top home videocassette recorder.

The slim infrared remote-control transmitter supplied with the VCR3 is quite appealing, once you get accustomed to handling its various control buttons. If the TV receiver with which you use the VCR3 also has remote-control capability, you will un-

doubtedly appreciate the VCR's remote-control transmitter even more.

Lest you get the idea that the VCR3 is a model of perfection, we would like to see some improvements made in future models. These include additional programmable channels, more first-touch control-key action, and quartz-accurate PLL (phase-locked loop) vhf/uhf/cable channel tuning.

Taking into account performance, operating flexibility, wireless remote-control transmitter, compact size, classy looks, and price, we rate the Sanyo Model VCR 3 a big 9 on a scale of 1 to 10. Prospective buyers should, of course, also take into account that the Beta System VCRs are had by less than 30% of VCR owners. So if you intend to trade or share video-taped material with friends, check out which format machine they own, Beta or VHS, since the cassettes are incompatible. —Stan Prentiss

CIRCLE 23 ON FREE INFORMATION CARD

Beckman's Handheld HD110T Digital Multimeter

Dependability is the key ingredient in the success of a professional service instrument. With respect to multimeters, the term "dependability" goes far beyond the usual dictionary definition. It encompasses such things as measuring accuracy, flexibility, reli-

able operation, ease of use, and—especially in an instrument designed for field servicing—ruggedness. Many modern multimeters fall short of the ideal in at least one of these areas. One that doesn't is the Model HD110T hand-held digital multime-

ter, part of Beckman Industrial's Heavy Duty Series.

A traditional multimeter in almost every sense of the word, the Model HD110T is designed to give fast, accurate measurements of ac and dc voltage, ac and dc current, and resis-

PRODUCT EVALUATIONS ...

Beckman's Handheld HD110T Digital Multimeter continued

tance. It goes beyond this by providing a diode-test function and, with an optional plug-in probe, a temperature-measuring function. (The "T" in the model number indicates that this DMM has a facility for accommodating a thermocouple-type temperature probe. A similar DMM, the Model HD110, lacks this facility.)

Designed especially for the field-service user (though it will be equally at home on a crowded testbench), the DMM measures 7"H × 3.9"W × 2"D and weighs 19 ozs., including battery. Suggested retail price of the Beckman Model HD110T digital multimeter is \$209.

General Description

Though the DMM resembles the usual field-service multimeter in size, shape, and general appearance, Beckman has chosen to depart from tradition by housing its instrument inside a rugged bright-yellow plastic case. If you frequently "lose" your meter on a cluttered testbench or in a crowded service kit, you'll really appreciate the eye-catching color of the Model HD110T.

This DMM is particularly easy to use, reminiscent of the days when all multimeters were passive "VOMs." All functions and ranges are selected with a single positive-detented 28-position rotary switch with a large, easy-to-grasp and -manipulate bar-type knob. This single switch does away with the popular, and often confusing, multiplicity of pushbutton and slide switches that often grace many DMMs currently on the market. It also eliminates the need for setting range and function in separate operations.

In addition to an OFF position that disables power to the instrument when not in use, the range/function switch offers five each ac and dc voltage, five each ac and dc current, and six resistance range positions. This



accounts for 27 of the 28 positions. The final position, located in the resistance cluster, is for testing the condition of junctions in diodes and transistors and is labeled with a diode symbol. Temperature measurements with the optional temperature probe are made with the range/function switch set to the T/200 μ dc position. The DMM is shipped from the factory set to display temperature in degrees Fahrenheit. It can be set to display in degrees Celsius by opening the case and repositioning a jumper on its printed circuit board.

The instrument comes equipped with professional-style probe assemblies. The probes come to fine, needle-like points for making measurements in even the most densely populated microcircuit assemblies. The very fine points also easily pierce the insulation of conductors (as well as the plastic masking on the copper traces of many printed circuit boards), obviating the need to make physical breaks in a circuit to make a measurement.

The probe bodies are grooved for

positive grip, and moded-on circular guards prevent fingers from touching the metal of the probes. Flex-type strain reliefs on both the probe handles and the hoods of the test cable banana plugs assure long life for the test cables.

The case of the Model HD110T is environmentally sealed, and the instrument is waterproof. To this end, the 9-volt battery that powers the DMM is not accessible through a door or a panel-covered compartment. Instead, when it comes time to replace the battery, you must remove the four screws that secure the back of the instrument in place, remove the panel, and remove the old and pop in the new battery. This may sound like a lot of work just to replace a battery, but bear in mind that with an LCD panel to display readings and low-power solid-state logic circuitry, there should be very few times this procedure must be performed. (A fresh battery provides an estimated 2000 hours, or about two years, of power for the instrument. When about 10% of the battery's useful life remains—about 200 hours—the decimal point in the display, which serves as a low-battery indicator, blinks to let you know that replacement time is coming up.) The job itself can be accomplished in less than five minutes.

Built into the back of the instrument case is a plastic tilt bail. The bail stows flat against the back of the case when the DMM is not in use and swings out to permit the Model HD110T to sit on a tabletop at a comfortable viewing angle. Additionally, the removable bail can be flipped over to serve as a carrying handle for the instrument.

The user's manual that comes with the Beckman Model HD110T digital multimeter is surprisingly complete and informative for a pocket-size booklet. In 60 pages, it manages to give full details on every aspect con-

nected with the instrument. Included are details on operation, technical specifications, general details, replacement parts, drawings of the instrument's internal structure, and full schematic diagram. It also offers a full rundown on the various optional accessories that can be used with the Model HD110T and other similar DMMs in the company's Heavy Duty Series. This manual is a worthy companion to the thoroughly professional Model HD110T DMM.

Functions And Ranges

Unless you do a lot of high-voltage TV servicing and must routinely make measurements in excess of 1500 volts dc, the Model HD110T should be all the meter you ever need in the field for measuring voltage, current, and resistance. In the dc volts mode, it has five ranges that go from 0 to 200 mV, 2 V, 20 V, 200 V, and 1500 V full-scale. Resolution on each range is 100 μ V, 1 mV, 10 mV, 0.1 V, and 1 V, respectively. Displayed accuracy is 0.25% of reading plus 1 digit on all dc voltage ranges.

The ac voltage ranges are the same as for dc, except that the highest range goes to 1000 V, instead of the 1500 V in the dc mode. Resolution is also identical with that in the dc mode. The meter has an ac voltage frequency range of from 45 Hz to 10 kHz. Displayed accuracy changes with frequency. Between 45 Hz and 2 kHz, it is 0.75% of reading plus 3 digits; between 2 kHz and 5 kHz, it is 1.5% of reading plus 5 digits; and between 5 kHz and 10 kHz, it is 2.5% of reading plus 9 digits.

In the current-measuring modes, there are six identical ranges for both ac and dc. These are 0 to 200 μ A, 2 mA, 20 mA, 200 mA, 2 A, and 10 A. The last range is not obtained directly with positioning of the range/function switch but, rather, by moving the "hot" test cable from the stan-

dard A (ampere) jack to the 10A jack on the front panel of the instrument. Resolution on both ac and dc current is identical, at 100 mA on the 200- μ A range, 1 μ A on the 2-mA range, 10 μ A on the 20-mA range, 100 μ A on the 200-mA range, and 10 mA on the 10-A range.

Accuracy, of course, in the current-measuring functions is different for the dc and ac modes. On dc, it is 0.75% of reading plus 1 digit for the first five ranges and 1.5% of reading plus 1 digit on the 10-A range. As is the case for ac voltage, accuracy changes with frequency of the ac current being measured. It is 1.5% of reading plus 3 digits on the first four ranges between 45 Hz and 5 kHz. Accuracy on the 2-A range is specified only between 45 Hz and 2 kHz and is the same as for the first four ranges. The 10-A range is a special case whose accuracy is specified at 2.0% of reading plus 3 digits over a frequency range of 45 Hz to 400 Hz, there being very few conditions where more than 2 amperes are at frequencies greater than 400 Hz.

Resistance can be measured in any of six ranges that offer full-scale readings of 200, 2k, 20k, 200k, 2M, and 20M ohms. Resolution on these ranges goes from 0.1 ohm on the lowest range to 10k ohms on the highest range, increasing linearly by one magnitude from lowest to highest range. Accuracy on the 200- to 2M-ohm ranges is rated at 0.5% of reading plus 1 digit and is 1.5% of reading plus 1 digit on the 20M-ohm range. Maximum test currents are specified at 2.5 mA, 250 μ A, 25 μ A, 2.5 μ A, 250 nA, and 25 nA from the lowest to the highest range.

In the diode-test function, test current is 2 mA \pm 20%. Resolution in this mode is 1 mV, while accuracy is rated at 0.25% of reading plus 2 digits. Overload protection is 600 volts dc or rms ac.

With the optional Model TP-255

temperature probe plugged in, the Model HD110T can measure from -20 to 1260 degrees Celsius or from -4 to 1999 degrees Fahrenheit (depending on location of the internal jumper). Resolution is 1 degree in either case, and accuracy is rated to be within \pm 4 degrees C or \pm 6 degrees F worst-case.

Input impedance is 22 megohms, all ranges, in the dc voltage function and 2.2 megohms, shunted by 75 pF, all ranges, in the ac voltage function. Normal-mode rejection is greater than 60 dB beyond 49 Hz and common-mode rejection is greater than 140 dB up to 1500 V dc in the dc voltage function.

The instrument has full built-in protection. It can accommodate up to 1500 V dc or peak ac on any dc voltage range, 1000 V rms ac (1500 V peak) or 250 V dc in the ac voltage function. Overcurrent protection is up to 20 amperes on the 10-ampere ac and dc current ranges and up to 600 V at 2 amperes (fused) on the 2-ampere range. Overload protection in the resistance function is 600 volts dc or ac on any range.

User Comment

What do you get in an instrument like the Beckman Model HD110T, which costs a bit more than the average digital multimeter on the market? If you know anything about Beckman, you know the name is synonymous with dependability, reliability, and service. If you have used a professional multimeter before, you know the feeling of confidence you can get with an HD110T. In every respect, this is a *professional* digital multimeter that is equal to just about any measuring task to which you might care to put it.

With the aid of a series of laboratory-grade precision resistors, a voltage-reference standard, and a calibrated constant-current source, I was

PRODUCT EVALUATIONS ...

able to verify the accuracy of this instrument. In every function, and on every range, it performed at least within specification. In some cases, the DMM considerably exceeded its published specifications. One area in which the instrument cannot be faulted, therefore, is in its ability to accurately measure voltages, currents, and resistances.

As for ease of use, I would rate the Model HD110T a big 9.8 on a scale of 1 to 10. The single range/function switch is a real time-saver when lots of measurements must be made in as

short a period of time as possible. I never had to double-check to make sure the instrument was set to the proper function and range once I set the switch, as I frequently must when working with two of the three DMMs I have on my testbench.

While I never actually went out into the "field" to perform tests with this instrument, I believe my testbench is a good substitute. Not only is it cluttered with parts, tools, and test instruments, all disorganized by the time I am at work for 20 minutes or so, I am one of those people who

consistently "loses" small items ("small" in this case being about as large as a toaster). I have been known to lose my grey-cased hand-held DMM as many as three times in an hour. This was not the scenario when it came to the Model HD110T, whose bright yellow case makes it virtually impossible to lose this instrument, short of literally hiding it behind a much larger item.

In sum, this instrument is rugged, easy to use, and accurate enough to do double duty on a service bench in a testing facility.—*Al Burawa*

CIRCLE 52 ON FREE INFORMATION CARD

Tech-Sketch's New Apple Light Pen

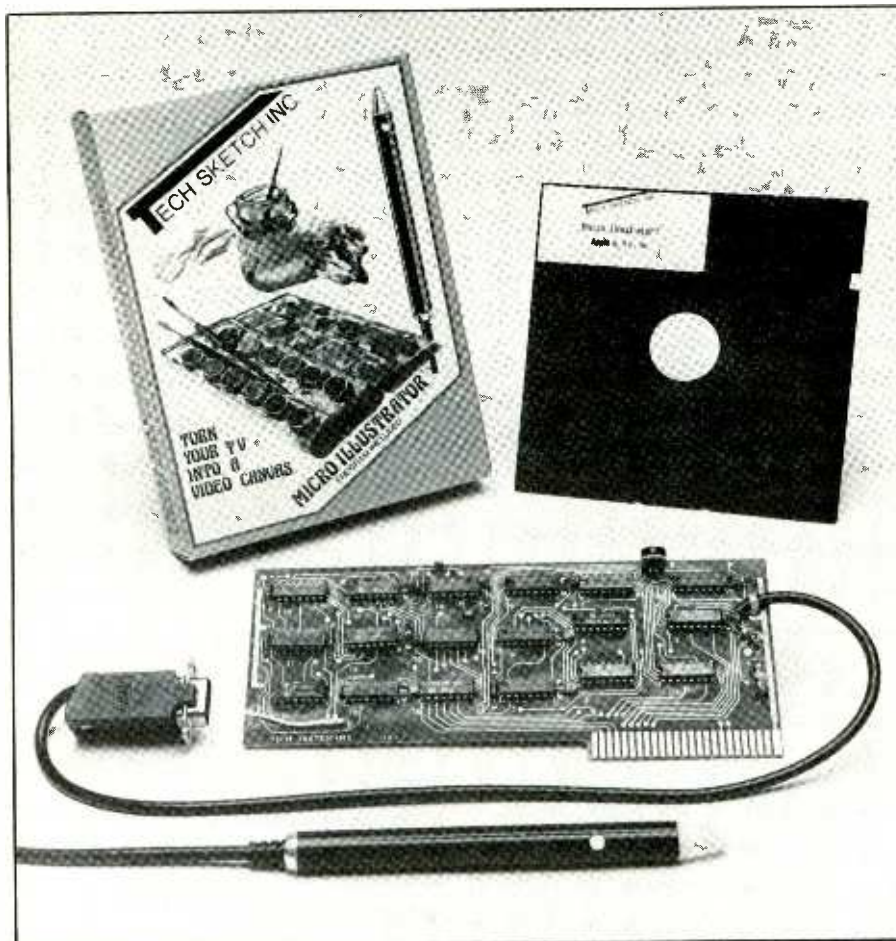

A light pen is a marvelous computer peripheral that pinpoints a location on a video display. This location is converted into X-Y coordinate information that may be used by a computer to switch from one program to another or even to create complex computer graphics.

This device has been available to microcomputer users for many years, but was not widely used for a variety of reasons. Chief among them was the relatively high cost of light-pen interfaces, followed by inadequate software to complement the electronics.

Now, a bevy of modestly priced (about \$60) light pens are available for a variety of personal computers that incorporate analog-to-digital converter ports, which includes Commodore and Atari computers. Apple computers, however, do not feature A/D converters. As a result, cost for implementation of a light pen for it have been rather high, usually starting at about \$250.

A new light pen for Apple II's came to our attention recently that

(Continued on page 82)

EXPAND YOUR CAREER HORIZONS...



The CIE Microprocessor Trainer helps you to learn how circuits with microprocessors function in computers.

START WITH CIE.

Microprocessor Technology. Satellite Communications. Robotics. Wherever you want to go in electronics ... start first with CIE.

Why CIE? Because we're the leader in teaching electronics through independent study. Consider this. We teach over 25,000 students from all over the United States and in over 70 foreign countries. And we've been doing it for over 50 years, helping thousands of men and women get started in electronics careers.

We offer flexible training to meet your needs. You can start at the beginner level or, if you already know something about electronics, you may want to start at a higher level. But wherever you start, you can go as far as you like. You can even earn your Associate in Applied Science Degree in Electronics.

CIRCLE 36 ON FREE INFORMATION CARD

Let us get you started today. Just call toll-free 1-800-321-2155 (in Ohio, 1-800-362-2105) or mail in the handy coupon.



Cleveland Institute of Electronics
1776 East 17th St., Cleveland, Ohio 44114

YES ... I want to get started! Send me my FREE CIE school catalog ... including details about the Associate Degree program ... plus my FREE package of home study information.

Print Name _____

Address _____ Apt. _____

City _____ State _____ Zip _____

Age _____ Area Code/Phone No. _____

Check box for G.I. Bill bulletin on Education Benefits

Veteran Active Duty

MAIL TODAY!

MO-20

Kodak's Kodavision 2000 Series of 8-mm video products consists of two models of camcorders and a tuner/timer with cradle for playing back camcorder-recorded tapes and for recording off the air and playing back through a TV receiver.



By Len Feldman

With the advent of consumer videocassette recorders and portable color cameras a few years ago, a revolution in home movie making has emerged. Anyone who has ever used a video color camera will readily tell you that making home movies on video tape hands

Camcorders— A Revolution In Home Movie Making

*A new 8-millimeter format moves
into competition with Beta and VHS*



“A revolution in home movie making has emerged.”

down beats using a conventional photographic-film 8-or 16-millimeter movie camera.

The major appeal of using the camera/VCR system is its ability to let you play back whatever action you record as soon as you've finished recording it. There's no wait for processing, nor are there attendant processing costs. If you use a video cam-

era with an electronic viewfinder, a standard feature with most better cameras nowadays, you don't even have to be near a TV receiver or monitor to check out the results. Playback through the camera's own viewfinder, albeit in black and white, is easily accomplished, since the viewfinder is really a tiny TV screen.

Another big plus for the taping of

home movies is the camera/VCR system's ability to erase and reuse tapes. If you don't like how "take one" came out, you can immediately repeat the scene without wasting tape. You just back up to the beginning of the scene (rewind the tape) you want to do over, start the action, and record it all over again.

There are, of course, some negatives to going the video camera/VCR route. As any user of even the lightest-weight video camera is likely to tell you, having to worry about a trailing cable and a fairly bulky portable VCR is a nuisance. If you park the VCR on the floor while shooting a scene, the cable leading to the handheld camera invariably becomes so short that you have to "cut" the scene at odd moments when the tether restricts your ability to follow the action. Lugging the VCR with a shoulder strap or a carrying case strapped to your waist quickly leads to shoulder and back aches.

The inconvenience of lugging around a portable VCR, no matter how light in weight, along with a camera and trailing cable, has prompted manufacturers to design a camera with the recording mechanism built into it. Such a "camcorder" is now a reality. It essentially puts to rest most of the gripes of the separate camera and VCR, but it also raises new issues with which the consumer must contend.

Setting The Stage

Once it was decided the camcorder (a contraction of *camera/recorder*) was the way to go for the home user to gain the benefits of video-tape movie making, the method of incorporating

General Electric's Uni-Cam Model 5080 is another example of the compact 8-mm variety of portable integrated video camera/recorders. Note the transport record/play buttons to the left of the tape compartment.





The photo above is a close-up view of the JVC Model GR-C1U video camcorder. To make the camcorder compact enough for one-hand operation (right), JVC uses a miniature version of the standard VHS videocassette (left above).



the recording mechanism into the camera had to be devised. This was no mean feat. A few years ago, the industry was in general agreement that to accomplish this without greatly increasing the weight of the system would require a completely new tape format. Because of their sizes, Beta and VHS videocassettes formats were generally ruled out.

A consensus was reached that the new tape width should be 8 millimeters (about $\frac{1}{3}$ " wide, instead of the $\frac{1}{2}$ " wide tape used by both of the existing home VCRs. After more than two years of effort, representatives of leading Japanese electronics companies decided upon a standardized 8-mm wide tape in a compact package not much larger than the familiar audio cassette. Furthermore, the new 8-mm cassette was to have a 90-minute record/play time, and its small size would readily lend itself to the design of a compact integrated camera/recorder.

While some people fear the introduction of a third system for video recording, over and above the already popular but incompatible Beta and VHS formats, some manufac-

urers feel that the 8-mm system has great merit. Cited are the facts that it's newer and involves more sophisticated technology, including the possibility of *digitally* recording the tracks for the stereo portion of a program. Other companies never involved in manufacturing either VHS or Beta machines are eager to enter the field with a totally new system.

Included among the supporters of the new 8-mm format are two companies that have made worldwide reputations in the world of photographic *film* technology. These are Kodak and Polaroid.

In January, at the Winter Consumer Electronics Show in Las Vegas, Kodak startled the industry by unveiling its first series of video products, called Kodavision 2000. The main components of that introduction were a pair of camcorders that use the 8-mm videotape cassettes, a special cradle into which the camcorders could be placed for tape playback, and a tuner/timer that can turn the whole system into a home video recorder capable of taping TV programs off the air.

Despite Kodak's enthusiasm for

the new 8-mm system (incidentally, it's being built for Kodak by a major Japanese electronics firm), many insiders feel that the introduction of this format is ill-timed. The opinion is that it will do nothing but confuse the consumer, who's already confused by the existence of the incompatible Beta and VHS home recording systems. It's felt that the 8-mm format simply clouds the issue even more by putting a *third* incompatible system into the marketplace.

It's obvious that Polaroid doesn't share this view. At the Summer Consumer Electronics Show in June of this year, Polaroid announced its camcorder, a compact package that weighs less than 4.5 lbs. The Polaroid camcorder features an f1.4 through-the-lens (TTL) optical viewfinder, a 6:1 power zoom lens with macro (close-up) capability, a back light switch for unusual backlighting conditions, and one-trigger operation.

The $\frac{1}{2}$ " Camp

Meanwhile, $\frac{1}{2}$ " video tape technology wasn't stagnating. More than a year ago, Sony (developer of the Beta

“Now there are four choices open to the home movie maker.”

format) introduced its BetaMovie, a video camera/recorder combination that handles *regular-size* Beta videocassettes. With all the extra mechanical parts required to move the tape and electronics to do the recording built into the camera housing, the camcorder still weighed no more than about 6 lbs., battery included.

The price of the original Model BMC-110K BetaMovie outfit was no more than the cost of a separate camera and VCR together. The BetaMovie camcorder was enthusiastically received by many video fans who had up to that point refrained from getting involved with video taping with a camera because of the complexity and inconvenience involved.

There were also critics, who felt that the first BetaMovie units lacked some of the special features found on separate cameras. For example, because it lacked an *electronic* viewfinder, normally supplied with better cameras, movies made with the original BetaMovie can't immediately be viewed. To view a recorded tape, you need a standard Beta videocassette recorder and a TV receiver.

Whatever its shortcomings, Beta-

Movie represents a magnificent technological achievement. To cram everything needed to capture pictures on tape—camera, tape transport, and recording electronics—into a small, portable package no larger than an ordinary video camera involved innovative adaptations of the basic Beta system. That the adaptations made it possible for BetaMovie to be fully compatible with the standard Beta System is remarkable.

One element of BetaMovie's technology is illustrated in Fig. 1. The video head drum in BetaMovie camcorders is much smaller in diameter than the assembly in standard Beta VCRs. To compensate for this and to assure full compatibility with the standard Beta format, the BetaMovie mechanism wraps the tape more fully around the head drum (300° as opposed to the 180° in standard Beta VCRs). By doing this, the length of each “pass” of the spinning video head in the BetaMovie system is identical to that in the standard Beta VCR system. Consequently, a tape recorded with a BetaMovie camcorder plays back perfectly in any standard Beta-format VCR.

More recently, a second-generation BetaMovie camcorder was announced by Sony. This new model also weighs slightly more than 6 lbs., but it has the added flexibility afforded by automatic focusing.

VHS Overtakes Beta—Again

Meanwhile, the people behind the VHS format weren't standing idly by, either. Their approach, however, was quite different from that taken by the Beta proponents. The large size of the basic VHS videocassette, being considerably larger than the standard Beta cassette, is of no great consequence when the tape is used in a standard VCR. But when you're talking about integrating recording and camera functions into a single compact unit, the difference in size of the videocassettes becomes *quite* important. Fortunately, JVC (developer of the VHS format) had already introduced the VHS-C videocassette. This compact cassette isn't much larger in length and width than a standard audio cassette, but it holds 20 minutes of standard 1/2" VHS video tape. And it's playable in *any* standard portable or table top VHS deck simply by popping it into a special adapter that simulates a standard-size VHS videocassette.

The VHS-C videocassette was the perfect tape package around which to build the first VHS-format camcorder. This is exactly what JVC has done for its Model GR-C1U “VideoMovie” camcorder.

As was the case with the BetaMovie units, JVC's VideoMovie employs a new 4-head sequential recording system that works with a smaller head drum. As shown in Fig. 2, the new arrangement is much more compact than the assembly used in standard VHS VCRs. Again, to assure compatibility with the standard VHS format, the VHS VideoMovie, like the BetaMovie, system wraps the tape more fully around the drum, 270° instead of the 180° for the standard VHS VCR. Additionally, the

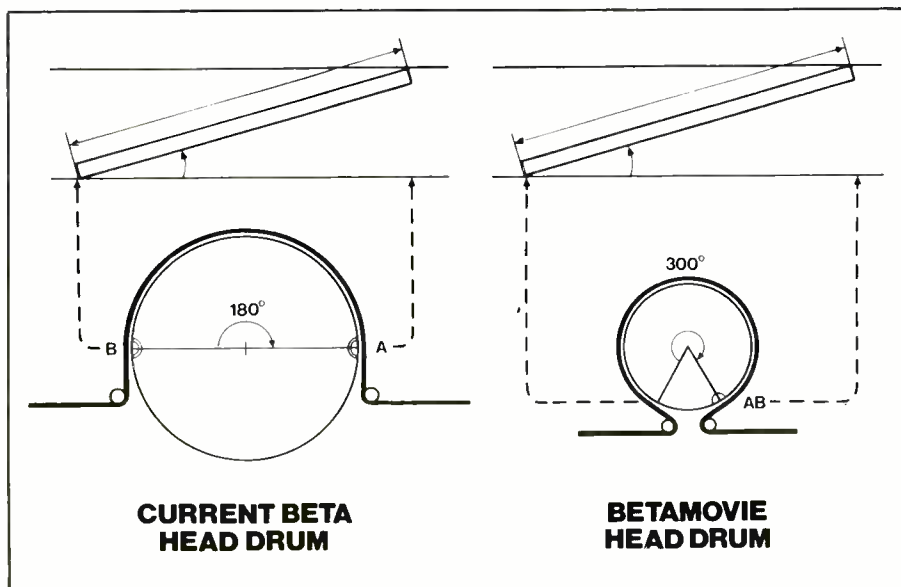

To maintain full compatibility with standard Beta VCRs, Sony's BetaMovie camcorder uses standard-size Beta videocassettes and more fully wraps the tape around the smaller head drum (right) than in the conventional VCR (left).

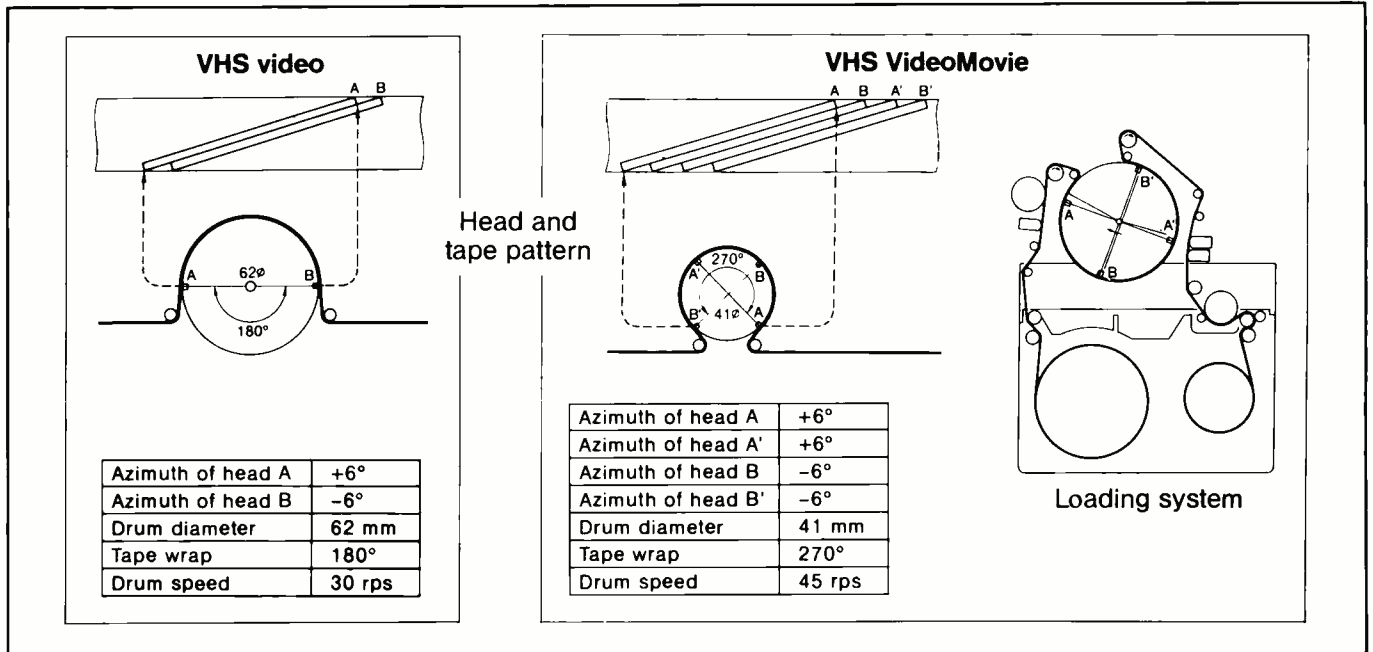

Though JVC chose to use a miniature version of the standard VHS-format videocassette in its VideoMovie camcorder, playback compatibility with a standard VCR is obtained in the same way as in the Sony BetaMovie—the tape is wrapped more fully around the scaled-down head drum, as shown at the right.

rotational speed of the drum in VideoMovie transports has been upped to 45 rps, as opposed to 30 rps.

In what has become an ongoing case of technological “leapfrogging,” JVC’s camcorder is equipped with an *electronic* viewfinder. This allows you to immediately play and review tapes on the viewfinder’s built-in monitor screen—without the need for a separate VCR and TV receiver or monitor. Furthermore, cables and output jacks are provided to permit the VideoMovie camcorder to connect directly to a TV receiver or monitor without the need for a separate VCR. So if your only reason for buying a camcorder is to make video movies, JVC’s VideoMovie doesn’t require you to buy a table-top or portable VCR.

Of course, if you already own (or plan to buy) a standard VHS VCR, you can exercise either or both of two options. You can buy a couple of standard-size cassette adapters to play back your VHS-C videocassettes in a standard deck, or you can dub from the VHS-C onto a standard VHS cassette. If you do the latter,

you’ll undoubtedly want to use the fastest-speed standard-play (SP) mode, which provides the same longitudinal tape speed as that used by the VideoMovie camcorder for best resolution or picture quality.

The Buy Decision

As matters now stand, you have not three, but *four* choices if you want to use a video camera for home movie making. (1) You can choose one of the new lightweight portable VCRs, perhaps one that’s part of a two-piece system that includes a tuner-timer that allows you to use the combination as a home VCR. (2) You can select a BetaMovie camcorder, perhaps your wisest choice if you already own a Beta home VCR. (3) You can purchase a standard VHS VideoMovie camcorder, which eliminates the need for having to also buy a separate standard VHS VCR if all you’re interested in is making home movies. (4) Finally, if you want to be a pioneer, you can select a new 8-mm camcorder from Kodak or Polaroid.

It’s much too early to hand down a verdict with regard to 8-mm video. Beyond Kodak and Polaroid, such major companies as GE and Fisher seem to be committed to the new format, though none has shipped a model at this writing. Meanwhile, in spite of the limitations cited above, BetaMovie has been gaining fairly wide acceptance, thanks to its simplicity of operation and the fine picture and sound quality it delivers. VHS VideoMovie is also making great strides and is being heavily promoted by such recent converts to the VHS format as RCA, Zenith and other well-known names in video.

For the moment at least, the 8-mm format offers little advantage over the two older systems. Whether or not its smaller cassette size and its potentially superior technical attributes will swing video movie makers over to it in time remains to be seen. Most people feel that it’s too much to hope for a single worldwide standard and that both Beta and VHS are too firmly entrenched to just go away and let 8-mm camcorders take over the marketplace.

ME

NEW!

uniden® Bearcat® Products

Communications Electronics,™ the world's largest distributor of radio scanners, is pleased to announce that *Bearcat* brand scanner radios have been acquired by Uniden Corporation of America. Because of this acquisition, Communications Electronics will now carry the complete line of Uniden *Bearcat* scanners, CB radios and Uniden *Bandit*™ radar detectors. To celebrate this acquisition, we have special pricing on the Uniden line of electronic products.

Bearcat® 300-E

List price \$549.95/CE price \$339.00
7-Band, 50 Channel • Service Search • No-crystal scanner • AM Aircraft and Public Service bands. • Priority Channel • AC/DC Bands: 32-50, 118-136 AM, 144-174, 421-512 MHz. The *Bearcat* 300 is the most advanced automatic scanning radio that has ever been offered to the public. The *Bearcat* 300 uses a bright green fluorescent digital display, so it's ideal for mobile applications. The *Bearcat* 300 now has these added features: Service Search, Display Intensity Control, Hold Search and Resume Search keys, Separate Band keys to permit lock-in/lock-out of any band for more efficient service search.

Bearcat® 20/20-E

List price \$449.95/CE price \$269.00
7-Band, 40 Channel • Crystalless • Searches AM Aircraft and Public Service bands • AC/DC Priority Channel • Direct Channel Access • Delay Frequency range 32-50, 118-136 AM, 144-174, 420-512 MHz. Find an easy chair. Turn on your *Bearcat* 20/20 and you're in an airplane cockpit. Listening to all the air-to-ground conversations. Maybe you'll pick up an exciting search and rescue mission on the Coast Guard Channel. In a flash, you're back on the ground listening as news crews report a fast breaking story. Or hearing police and fire calls in your own neighborhood, in plenty of time so you can take precautions. You can even hear ham radio transmission, business phone calls and government intelligence agencies. Without leaving your easy chair. Because you've got a *Bearcat* 20/20 right beside it.

The *Bearcat* 20/20 monitors 40 frequencies from 7 bands, including aircraft. A two-position switch, located on the front panel, allows monitoring of 20 channels at a time.

Bearcat® 210XL-E

List price \$349.95/CE price \$209.00
6-Band, 18 Channel • Crystalless • AC/DC Frequency range 32-50, 144-174, 421-512 MHz. The *Bearcat* 210XL scanning radio is the second generation scanner that replaces the popular *Bearcat* 210 and 211. It has almost twice the scanning capacity of the *Bearcat* 210 with 18 channels plus dual scanning speeds and a bright green fluorescent display. Automatic search finds new frequencies. Features scan delay, single antenna, patented track tuning and more.

Bearcat® 260-E

List price \$399.95/CE price \$249.00
8-Band, 16 Channel • Priority • AC/DC Frequency range 30-50, 138-174, 406-512 MHz. Keep up with police and fire calls, ham radio operators and other transmission while you're on the road with a *Bearcat* 260 scanner. Designed with police and fire department cooperation, its unique, practical shape and special two-position mounting bracket makes hump mounted or under dash installation possible in any vehicle. The *Bearcat* 260 is so ruggedly built for mobile use that it meets military standard 810c, curve y for vibration rating. Incorporated in its rugged, all metal case is a specially positioned speaker delivering 3 watts of crisp, clear audio.

NEW! Bearcat® 201-E

List price \$279.95/CE price \$179.00
9-Band, 16 Channel • Crystalless • AC only Priority • Scan Delay • One Key Weather Frequency range 30-50, 118-136 AM, 146-174, 420-512 MHz. The *Bearcat* 201 performs any scanning function you could possibly want. With push button ease, you can program up to 16 channels for automatic monitoring. Push another button and search for new frequencies. There are no crystals to limit what you want to hear.

NEW! Bearcat® 180-E

List price \$249.95/CE price \$149.00
8-Band, 16 Channel • Priority • AC only Frequency range: 30-50, 138-174, 406-512 MHz. Police and fire calls. Ham radio transmissions. Business and government undercover operations. You can hear it all on a *Bearcat* 180 scanner radio. Imagine the thrill of hearing a major news event unfold even before the news organizations can report it. And the security of knowing what's happening in your neighborhood by hearing police and fire calls in time to take precautions. There's nothing like scanning to keep you in-the-know, and no better way to get scanner radio performance at a value price than with the *Bearcat* 180.

Bearcat® 100-E

The first no-crystal programmable handheld scanner.
List price \$449.95/CE price \$234.00/SPECIAL!
8-Band, 16 Channel • Liquid Crystal Display Search • Limit • Hold • Lockout • AC/DC Frequency range: 30-50, 138-174, 406-512 MHz.

The world's first no-crystal handheld scanner has been compressed into a 3" x 7" x 1 1/4" case more scanning power than is found in many base or mobile scanners. The *Bearcat* 100 has a full 16 channels with frequency coverage that includes all public service bands (Low, High, UHF and "T" bands), the 2-Meter and 70 cm. Amateur bands, plus Military and Federal Government frequencies. It has chrome-plated keys for functions that are user controlled, such as lockout, manual and automatic scan. Even search is provided, both manual and automatic. Wow...what a scanner!

The *Bearcat* 100 produces audio power output of 300 milliwatts, is track-tuned and has selectivity of better than 50 dB down and sensitivity of 0.6 microvolts on VHF and 1.0 microvolts on UHF. Power consumption is kept extremely low by using a liquid crystal display and exclusive low power integrated circuits.

Included in our low CE price is a sturdy carrying case, earphone, battery charger/AC adapter, six AA ni-cad batteries and flexible antenna. The *Bearcat* 100 is in stock for quick shipment, so order your scanner today.

Bearcat® DX1000-E

List price \$649.95/CE price \$489.00
Frequency range 10 kHz to 30 MHz. The *Bearcat* DX1000 shortwave radio makes tuning in London as easy as dialing a phone. It features PLL synthesized accuracy, two time zone 24-hour digital quartz clock and a built-in timer to wake you to your favorite shortwave station. It can be programmed to activate peripheral equipment like a tape recorder to record up to five different broadcasts, any frequency, any mode, while you are asleep or at work. It will receive AM, LSB, USB, CW and FM broadcasts.

There's never been an easier way to hear what the world has to say. With the *Bearcat* DX1000 shortwave receiver, you now have direct access to the world.

Uniden® PC22-E

List price \$159.95/CE price \$99.00
The *Uniden* PC22 is a 40 channel AM remote mobile CB radio. It's the answer for today's smaller cars which don't always provide adequate space for mounting. Since all the controls are on the microphone, you can stash the "guts" in the trunk. The microphone has up/down channel selector, digital display, TX/RX indicator and external speaker jack. Dimensions: 5 3/4" W x 7 7/8" D x 1 1/2" H. 13.8 VDC, positive or negative ground.

QUANTITY DISCOUNTS AVAILABLE

Order two scanners at the same time and deduct 1%, for three scanners deduct 2%, four scanners deduct 3%, five scanners deduct 4% and six or more scanners purchased at the same time earns you a 5% discount off our super low single unit price.

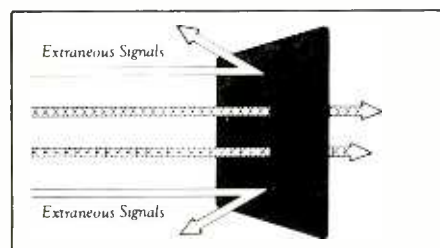

Both *Bandit*™ radar detectors feature E.D.I.T.™ the Electronic Data Interference Terminator that edits-out false alarm signals

Uniden® PC33-E

List price \$59.95/CE price \$44.00
The *Uniden* PC33 boasts a super-compact case and front-panel mike connector to fit comfortably in today's smaller cars. Controls: Power & Volume, Squelch; Switches: ANL. Other features of the PC33 include Graduated LED "S"/RF Meter, Digital channel indicator. Dimensions: 6" W x 6" D x 1 1/8" H. ±13.8 VDC.

Uniden® PC55-E

List price \$89.95/CE price \$59.00
The full featured *Uniden* PC55 front-panel mike connector makes installation easier when space is a factor. It has ANL, PA-CB, Channel 9 and RF Gain Switches. LED "S"/RF meter, TX lite, PA & external speaker jacks. Dimensions: 6" W x 6" D x 1 1/8" H. ±13.8 VDC.

Bandit™ Radar Detectors

Now that everyone else has taken their best shot at radar detection, the *Uniden* *Bandit*™ has done them one better...with E.D.I.T.™, the Electronic Data Interference Terminator that actually edits-out false alarm signals.

The *Bandit* 55, features a convenient brightness/dimmer control for comfortable day or night driving, plus a handy highway/city control for maximum flexibility wherever you drive. The *Bandit* 95 Remote, is a two-piece modular unit that lets you mount the long-range radar antenna behind the grill, out of view. The ultra-compact control unit can then be inconspicuously tucked under the dash or clipped to the visor. Order *Bandit* 55-E for \$119.00 each or the *Bandit* 95-E Remote for \$139.00 each.

OTHER RADIOS AND ACCESSORIES

- FB-E-E Frequency Directory for Eastern U.S.A. \$12.00
 - FB-W-E Frequency Directory for Western U.S.A. \$12.00
 - BC-WA-E *Bearcat* Weather Alert"..... \$35.00
 - A60-E Magnet mount mobile antenna \$35.00
 - A70-E Base station antenna \$35.00
- Add \$3.00 shipping for all accessories ordered at the same time. Add \$3.00 shipping per scanner antenna.

BUY WITH CONFIDENCE

To get the fastest delivery from CE of any product in this ad, send or phone your order directly to our Scanner Distribution Center.™ Michigan residents please add 4% sales tax or supply your tax I.D. number. Written purchase orders are accepted from approved government agencies and most well rated firms at a 10% surcharge for net 10 billing. All sales are subject to availability, acceptance and verification. All sales on accessories are final. Prices, terms and specifications are subject to change without notice. All prices are in U.S. dollars. Out of stock items will be placed on backorder automatically unless CE is instructed differently. A \$5.00 additional handling fee will be charged for all orders with a merchandise total under \$50.00. Shipments are F.O.B. Ann Arbor, Michigan. No COD's. Most products that we sell have a manufacturer's warranty. Free copies of warranties on these products are available prior to purchase by writing to CE. International orders are invited with a \$20.00 surcharge for special handling in addition to shipping charges. Non-certified checks require bank clearance.

Mail orders to: Communications Electronics,™ Box 1002, Ann Arbor, Michigan 48106 U.S.A. Add \$7.00 per scanner, radar detector or CB or \$12.00 per shortwave receiver for U.P.S. ground shipping and handling in the continental U.S.A. For Canada, Puerto Rico, Hawaii, Alaska, or APO/FPO delivery, shipping charges are three times continental U.S. rates. If you have a Visa or Master Card, you may call and place a credit card order. Order toll-free in the U.S. Dial 800-521-4414. In Canada, order toll-free by calling 800-221-3475. WUI Telex CE anytime, dial 671-0155. If you are outside the U.S. or in Michigan dial 313-973-8888. Order today.

Scanner Distribution Center™ and CE logos are trademarks of Communications Electronics.™ Ad # 070184-E † *Bearcat* is a registered trademark of Uniden Corporation. Copyright © 1984 Communications Electronics

Order Toll Free ... call 1-800-521-4414



Consumer Products Division

818 Phoenix □ Box 1002 □ Ann Arbor, Michigan 48106 U.S.A.
Call TOLL-FREE 800-521-4414 or outside U.S.A. 313-973-8888

CIRCLE 33 ON READER SERVICE CARD

Is Your Scanner Being Wasted?

*If You're Using It Only To Monitor Police & Fire,
You Are Missing Plenty!*

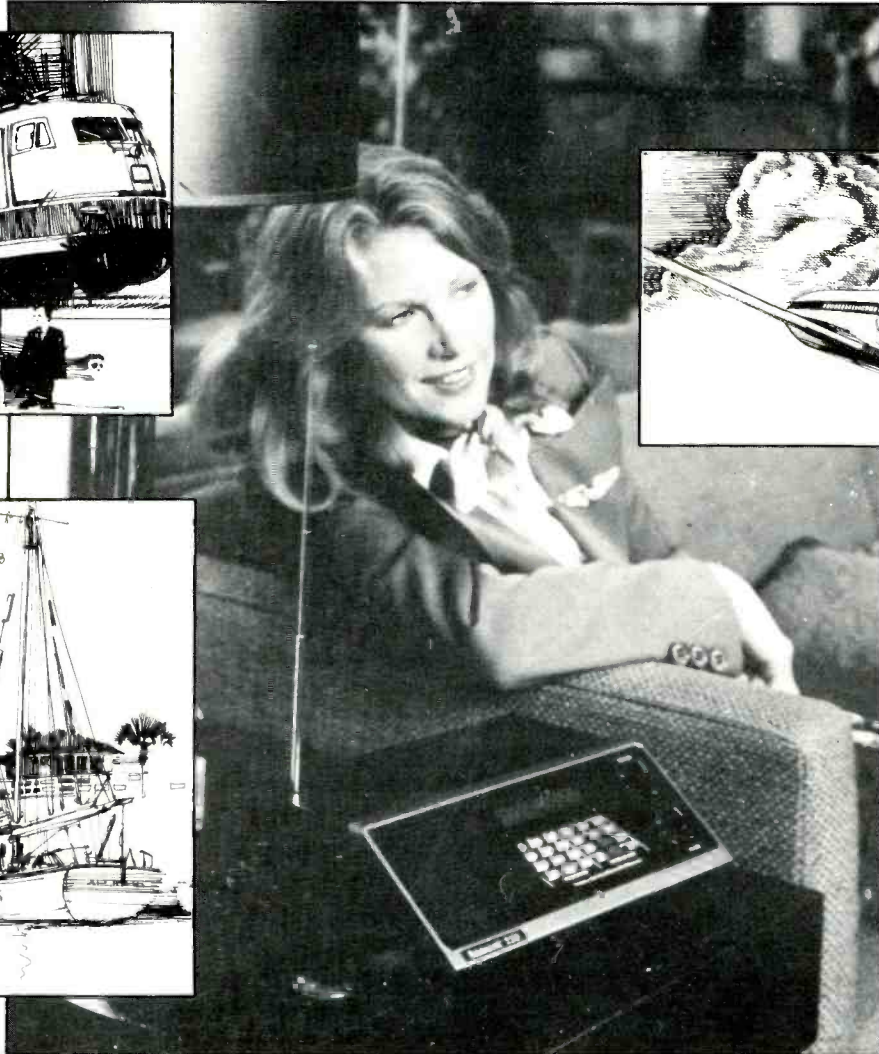
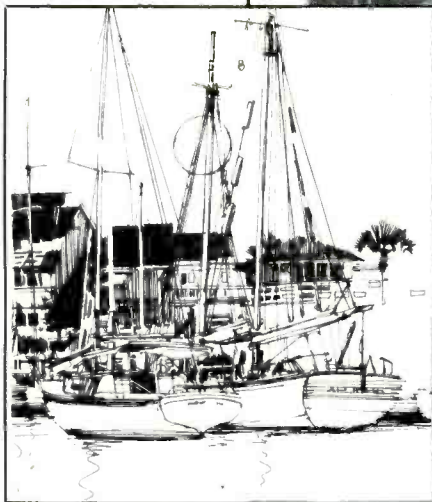
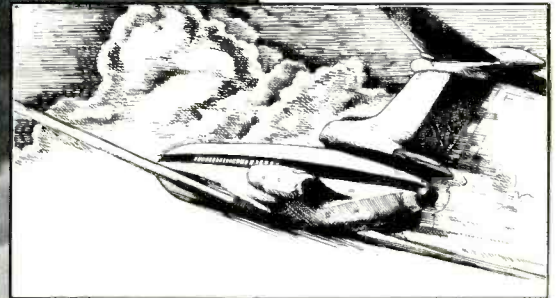
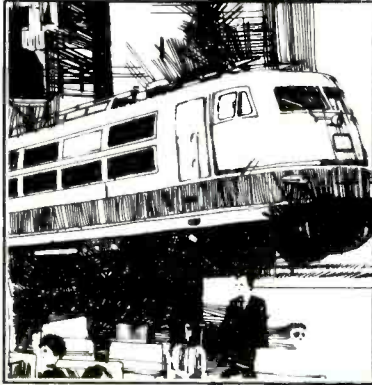

By Tom Kneitel, K2AES

Scanner radio receivers are perhaps one of the most underutilized electronic products around. It's not that people aren't buying them in large numbers, and it's not that those who own them don't use them. The problem is that people usually buy the scanners to hear their area police or fire department and

never take full advantage of all of the other things which might be tuned in.

Most modern scanners are designed to permit users to program in anywhere from 20 to 50 different frequencies, and all offer a "search-scan" feature that gives a scanner the ability to explore the public safety and aeronautical bands in order to ferret out previously unknown stations and frequencies. With such potentials available, it's not at all diffi-

cult to listen in on all sorts of interesting communications and hear what's really going on behind-the-scenes in your community or neighborhood, or even in other parts of the world!

What's On?

Did you know that more than half of the communications frequencies between 30 and 512 MHz are reserved for the exclusive use of stations oper-

ated by federal agencies? On a standard scanner, this is most evident by the fact that virtually all of the frequency space lying between 162 and 174 MHz is used by the military, the FCC, FBI, NASA, the National Park Service, Dept. of Agriculture, Dept. of Commerce, federal prisons, U.S. Marshals and dozens of others, including U.S. Customs.

Another exclusive government band lies between 406 and 420 MHz, although not all scanners cover this entire range of frequencies.

There are also some reserved federal frequencies in the so-called "low band." You might wish to check out the frequency bands shown below with your scanner in the "search" mode. The frequencies in this range have been popular with our military forces. When propagation conditions have been optimum, reception has been possible from overseas points such as Central America.

30.00 to 30.51 MHz
32.00 to 33.00 MHz
34.00 to 35.00 MHz
36.00 to 37.00 MHz
38.00 to 39.00 MHz
40.00 to 42.00 MHz
46.60 to 47.00 MHz

Your own local broadcasting stations use two-way communications for remote news pickups and for on-the-scene reports from the scenes of accidents and disasters such as major fires, train wrecks, or weather-related problems. These communications are generally very interesting and often contain lots of little details which never seem to make it through to the public in the actual broadcasts.

Look for these communications on 161.64, 161.67, 161.70, 161.73 and 161.76 MHz; also search out frequencies in the 450.05 to 450.925 and 455.05 to 455.925-MHz bands.

Newspapers also send out reporters who need to be in contact with their offices. Their observations from accident and crime scenes often can be quite pointed and intuitive, even though you might never see those thoughts in print. Newspaper

reporters communicate on 173.225, 173.275, 173.325, 173.375, 452.975 and 453.00 MHz.

Scanners that cover the vhf aeronautical band (118 to 136 MHz) in addition to the public service bands have a wonderful built-in extra that has never been sufficiently appreciated by many scanner owners. That extra is the ability to eavesdrop on what they're saying overhead in airliners and private aircraft.

One of my own favorite frequencies here is 123.45 MHz, which is (unofficially) used as a chit-chat channel between airline pilots. Private pilots sometimes pass the time of day with one another by chatting on 122.85 and 122.9 MHz.

Airline operations take place in the band 128.825 to 132.0 MHz, and conversations can be pretty far-out at times. While passengers may be familiar with certain airline terminology, one of the buzzwords seldom mentioned to the public is the infamous "writeup." A "writeup" is the airline term for a complaint the pilot has about his aircraft, and these are the frequencies where they radio in their writeups to ground stations.

The writeups can consist of anything as simple of "inoperative head" (the toilet doesn't work) or a foul taste to the drinking water to rather formidable-sounding complaints such as various warning lights flashing or the aircraft's radar suddenly breaking down. Though there are plenty of other things to hear on these frequencies, too, I must admit that the writeups are always the most interesting. I always picture the passengers blissfully watching a film and sipping their cocktails while, unbeknown to them, the pilot is up front reading off a litany of mechanical problems to the ground crew, often complaining bitterly that it is a repeat writeup for a problem that requires attention every week!

All At Sea

Very few areas of the nation aren't within receiving range of a coastline,

navigable waterway or lake. This means that there are communications of interest to be monitored on the marine band. This band is subdivided into more than 40 different frequencies, each with its own designated purpose. While some of these channels are a bit on the dullish side, others have been known to produce really interesting communications.

Frequency 156.8 MHz is a distress, safety and calling channel. That's the first place a vessel will appear on a scanner if it's got a problem. Sometimes these problems can be quite dramatic and frightening—fires, grounding, taking on water, etc. After initial contact is made on 156.8 MHz, the communications are often shifted to 157.1 MHz, where they continue.

Search and rescue operations can often be heard on 156.3 MHz, sometimes accompanied by communications in the aeronautical band on 123.1 MHz, and also in the public safety band on 155.16 MHz.

Ship-to-shore telephone calls take place on 10 channels lying between 161.8 and 162.025 MHz, although only 1 or 2 specific channels may be assigned for use in a given area. A scanner placed in the search mode with these frequencies programmed in as the search limits should readily determine the best listening opportunities in your own area.

And, speaking of telephone calls, don't overlook the mobile telephone channels lying between 152.03 and 152.21 MHz, 152.51 and 152.81 MHz, 454.025 and 454.65 MHz. These are *not* the channels used by the new cellular mobile telephones, they are the frequencies used by the mobile telephones that have been in operation for a number of years. Thus far, scanner manufacturers have not gone overboard in bringing out receivers which will be of much use in monitoring cellular telephones, part of the problem being that during any phone call the fre-

(Continued on page 87)



A Second Chance For Junior

Analyzing IBM's revitalized PCjr personal computer



By John M. Woram

It wasn't long ago that Big Blue—as IBM is so often called—startled the industry by introducing its 5150 series of computers. If the designation isn't immediately familiar to you, you're in good company. Even IBM itself seems to prefer calling them simply "PC." By now, almost everyone knows that, when capitalized, it stands for "IBM Personal Computer," though the "IBM" prefix is understood when the acronym PC is used.

The industrial giant apparently did its homework well, for in a few short years since its introduction, the series 51 . . . oops, I mean the PC, has become somewhat of a micro-standard. In fact, these days, if you own a Microsoft disk-operating-system (MS-DOS) machine that isn't PC-compatible, it's a handicap in the marketplace that better be made up for by some redeeming features.

About a year or so ago, the rumor mill had it that IBM was about to strike again by launching a scaled-down version of the PC that was code-named the "Peanut." This was supposed to be a popularly priced junior version for those who didn't need all the power of the PC itself. Based on the great popularity of the PC, the computing world could hardly wait for the new model. At last, a solid computer for the masses, people assumed.

Well, maybe not. In the first quarter of 1984, the Peanut—now officially dubbed the PCjr—began showing up on dealers' shelves. As of mid-summer, many of them were still sitting on those shelves. For if not quite still-born, Junior was nevertheless sickly. People took an instant dislike to its block-type "Chiclet"-style keys on the keyboard, which made touch-typing a chore. Equally distressing to prospective buyers was the perception that the Junior was deliberately crippled by its corporate parent. On top of the keyboard fiasco, the



Photos courtesy of IBM.

IBM might have liked this photo to be of a business environment in light of the major changes in the new PCjr's memory and keyboard. PCjr is still a great games player, but business and educational use are now its forte.

PCjr's image was damaged by a limited-capacity memory. The nitpickers then added the fact that it had only one built-in disk drive and all PC software wouldn't run on it.

To further complicate matters, neither IBM, their dealers or prospective customers seemed to have a clear idea of who the target customers were supposed to be. Was it for business applications? Was it for the general public? IBM indicated that it was for everyone at that time. But the business community was turned off by several factors. For one, Junior would not support IBM's own green-screen-type monochrome monitor; it had to be operated in conjunction with another type monochrome monitor, an RGB monitor, or a standard TV set. Furthermore, the manual that accompanied the machine was written in a style that seemed to appeal more to precocious sub-teenagers than to more mature customers. And then that wretched keyboard, among other deficiencies.

On the other side of the coin, the PCjr's comparatively high price also turned off the so-called mass market

and school purchases. The conclusion seemed to be that, despite superb color graphics and impressive musical capabilities, Junior was overpriced as a fun & games machine.

The Old & New

IBM's original PCjr had a lot going for it, though. One could start off with a lower-priced "entry" model that included 64K of RAM memory, built-in 64K ROM, two ROM cartridge slots, cassette-based data storage, built-in color graphics, built-in serial port, lightpen and dual joy stick input facilities, a complex sound generator, and the IBM-logo security blanket.

The foregoing was obviously not enough to attract too many buyers, though. But Junior can be taught a few new tricks, as IBM has proved.

Listening to the marketplace, IBM announced several important PCjr changes this past August, not the least of which is a spanking new keyboard, which we'll examine soon. Tipping its corporate hat to buyers of the earlier PCjr, IBM is giving them

"PCjr now comes with 128K of memory."

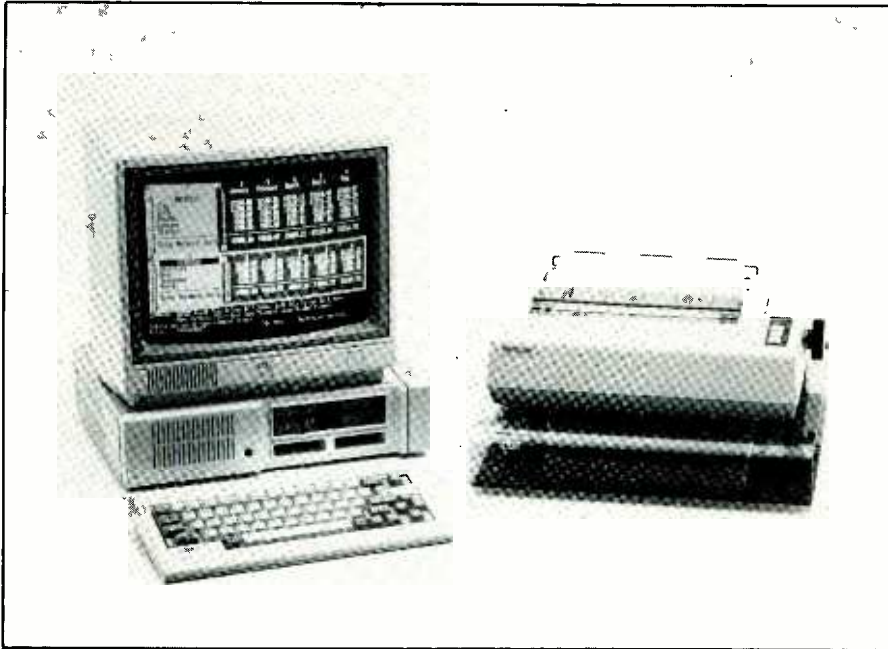

The new IBM PCjr is shown here with its redesigned true typewriter-style keyboard. Shown atop the main computer unit at the left is the optional IBM Color Display video monitor, while at the right is shown the optional IBM PC Graphics Printer (dot matrix), seated atop a smoked acrylic plastic stand.

new keyboards at no charge! The new-style keyboard is standard issue for all PCjrs now made.

In another move, IBM severed its marketing thrust to just plain kids. The PCjr is now presented as a small business computer. Underscoring this, IBM no longer makes an "entry-level" PCjr. The basic PCjr now comes with 128K of user memory instead of 64K, and has a double-sided disk-drive built in. In effect, IBM retained its "enhanced" model and did away with the intro system.

As another bonus, IBM has introduced a new, optional 128K add-on memory expansion module. Up to three of the new external modules may be fitted to the right-hand side of the PCjr, after removing a plate, giving it a total of 512K bytes of memory. Since Junior doesn't have enough punch to drive more than one of these all by itself, a supplementary power supply is also available.

Before the recent change, IBM had not drawn much attention to Junior's expansion capabilities, and it re-

mained for others to publicize this important point. In fact, Big Blue is still not making a second disk drive available. But now with the new keyboard, more memory, and a growing list of third-party peripherals (including additional disk drives) Junior seems to have been given another chance at making it. So perhaps this is a good time for an updated look, along with a review of several of Junior's key features, such as the new keyboard, cartridge system, memory, disk drives and, of course, price (which was reduced).

The Keyboard

The late, unlamented 62 Chiclets have been replaced by a *real* keyboard, with 62 full-sized sculpted keys with a nice fingertip feel to them. These represent a key-by-key replacement of the old board, with no changes in keystroke combinations for Control, Alternate and Function keys. For example, while the bigger PC has ten dedicated func-

tion keys on the left side of the keyboard, Junior has a single Function key (labelled Fn) in the upper right-hand corner. This is used in conjunction with the regular top-row numeric keys for Function key operation. Thus, two keystrokes (Fn, 2) take the place of the PC's single F2 key, and so on. Moreover, legends on the keys are right on their tops instead of above or below keys as in the "old" keyboard.

Direct keyboard entry of IBM's extended ASCII graphics characters must still be preceded by holding down the Alt key while pressing the Fn, letter-n keys. After doing so, hold down the Alt key again, while entering any three-digit extended ASCII code. When the Alt key is released, the appropriate graphics character appears on screen. Thus, pressing Alt-2,2,7 will display the Greek symbol π . This feature enables the user to enter lines such as PRINT " π " instead of the less-informative PRINT CHR\$(227). While in this mode, the Shift key must be held down in order to use the Insert, Delete and cursor movement keys. Otherwise these keys act as a partial numeric keypad, in an incomplete imitation of the PC's dedicated numeric keypad.

Aside from these limitations, the new keyboard is a big step in the right direction, and should go a long way towards making Junior a viable product. Like its predecessor model, the new keyboard uses an infrared optical link to the PCjr system, and this feature may be defeated by using a direct-connection cable.

Contrasting the new keyboard with that of the PC's, it takes up less space since it has only 62 keys vs the PC's 83. Missing is a numeric keypad. The QWERTY keyboard follows the standard key layout, whereas the PC's keyboard is flawed by a small "Enter" and "Control" key that causes operators to make typing mistakes. This problem is compounded further on the PC by extraneous keys separating the afore-

PCjr vs. PC

(Basic 64K-memory systems are no longer produced by IBM though some may still be for sale.)

	PC	PCjr, with IBM add-ons	PCjr, with third-party peripherals, as noted
—64K Base System, with no disk drives—			
64K PC	\$1265	\$ 599 64K PCjr	—
Color Card	244	0 not needed	—
Total	\$1509	\$ 599 [\$910]	—
—128K System with two disk drives—			
64K PC, with two drives	—	(2 drive PCjrs are still not available from IBM.)	\$ 999 128K PCjr, one drive
64K more memory	\$2240	—	\$ 795 Legacy II second drive
Color Card	100	—	0
Printer Card	244	—	0
Printer Card	75	—	99 IBM
Total	\$2659	—	\$1893 [\$766]
—256K System with one disk drive—			
256K PC, with one drive	—	\$ 999 128K PCjr	\$ 999 128K PCjr, one drive
Color Card	1995	325 128K exp.	395 128K Tecmar jr-Captain
Printer Card	244	0	0
Printer Card	75	99	99 IBM
Total	\$2314	\$1423 [\$891]	\$1493 [\$821 savings]
—512K System with one disk drive—			
256K as above	\$2314	\$1423 as above	\$1493 256K system above
64K exp. board	—	150 power supply	0
192K additional	265	325 128K exp.	395 128K Tecmar jr-Captain
Total	\$2879	\$2223 [\$656]	275 128K Tecmar jr-Cadet

Notes:

- The PCjr does not require an additional card to drive any type of monitor.
- For more than 256K, the PCjr memory expansion requires an additional power supply.
- The Tecmar jr-Captain includes separate AC power. The jr-Cadet is powered by the jr-Captain.
- Interface cables and monitor are not included above.

Comparisons between different configurations of IBM PCjr and PC computers.

mentioned keys from the QWERTY keys, a mistake not duplicated on the PCjr's keyboard.

The Cartridge System

Two ROM cartridge slots are supplied, each one of which can handle up to 32K bytes. Junior's Advanced BASIC language is supplied in a plug-in cartridge, and a variety of other programs are becoming available in this format. In fact, Lotus Development Corporation's extremely popular 1-2-3 software is now sold as a two-cartridge package for the PCjr.

Cartridge software should be appealing on at least two counts. First,

it's easy to use—just plug in and turn on. Second, it's difficult to impossible to make bootleg copies without doing a lot of heavy-duty assembly-language programming. Conceptually, you might be able to download a cartridge to a diskette, but the program will still refer to locations in the cartridge address area. So without the cartridge in place, it just won't work. That feature alone should be very attractive to some software writers, and add further support to Junior.

Memory

Although IBM itself is a late-comer in supplying additional memory, several other companies have been sell-

ing add-on modules to boost Junior all the way to 640K. For example, Tecmar's jr-Captain and jr-Cadet expansion modules may also be attached to the right side of the PCjr chassis, and will hold 64K to 512K of add-on memory.

Disk Drive

With IBM continuing to manufacture Juniors with no more than one disk drive, third-party suppliers are also filling this gap quite nicely, too. From Legacy Technologies, Ltd., the Legacy II module supplies a second disk drive, plus a controller that will handle both drives. A 10-Megabyte hard-disk is also available.

The Bottom Line

At its introduction earlier this year, the 64K Junior had a \$669 price tag. This has been cut to \$599 "list"—if you can find any. IBM stopped manufacturing them as previously cited. The 128K version with a single-diskette drive started out at \$1269, but is now only \$999 in its improved state. To either of these prices, add \$30 for a TV connector cable, or \$20 for an RGB cable.

Along with the growing supply of add-ons from other companies, the new prices make for some interesting PC/PCjr cost comparisons. The chart below lists the components required to assemble several representative systems, starting out at the bare bones entry level and progressing up to a 512K system. The bracketed figure is the amount saved by purchasing a PCjr instead of a PC. In each case, provision has been made to drive a color monitor. The systems are assembled from IBM hardware supplemented by the two third-party suppliers mentioned above.

Before rushing out to buy all the items listed under the PCjr column, a few words of caution. Some add-ons preclude the use of others. For example, the Legacy II disk drive is physically configured in such a way that the Tecmar add-on memory won't fit,

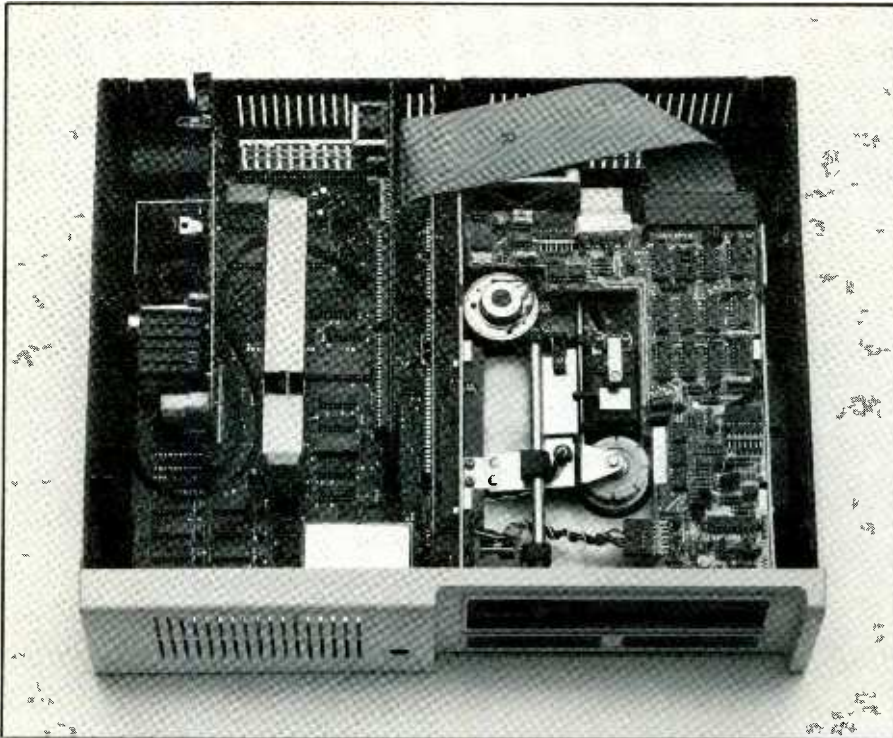

The left side of the PCjr's main unit contains the computer board with plug-in cards, the right side, the floppy-disk drive, below which are the cartridge slots.

and vice versa. By no small coincidence, the Legacy II has its own expansion slots designed to accommodate other (presumably, from Legacy) add-ons. In other words, if you're planning to add memory and a second disk drive, make sure the products are compatible with each other and with the PCjr before buying.

As an alternative to adding a second disk drive, you may decide to add sufficient memory to set up an "electronic disk"—that is, a special section of memory used to simulate an actual disk drive. Such an electronic disk runs a lot faster than the real thing, and may very well obviate the need for another mechanical disk drive. Of course, the electronic disk vanishes when power is turned off, so you'll have to write its contents to a real disk before hitting the Off switch. By the way, IBM's expansion module and Tecmar's jr-Captain both come with the software required to set up an electronic disk drive.

Since IBM is still not making disk drives a part of its own catalog, it

might seem that they are still trying to restrict Junior to a marketplace that is positioned well below the PC. On the other hand, the company continues to encourage others to support the product, and as can be seen from the comparisons cited, there's a lot of money to be saved by buying a Junior instead of a PC, and then shopping elsewhere for some of the hardware and peripherals.

Getting back to Junior, here are a few more points that may be made for or against choosing it instead of its big brother PC equivalent. First, a few of the positive features:

Cartridge BASIC

As noted earlier, some of Junior's BASIC comes in an easy-to-use plug-in cartridge, which adds several new keyboards to the language, such as NOISE, PLAY, PALETTE, PALETTE USING, and PCOPY. (The cartridge and BASIC manual costs \$75.) Briefly stated, NOISE offers various noise sources whose volume and duration

may also be specified; PLAY is used to compose three-part harmony; the PALETTE statements are used for enhanced color graphics, and PCOPY copies one screen page to another.

The new PLAY statement alone should be enough to keep you busy for hours. It may be followed by various parameters to specify such things as the note, octave, duration, legato, staccato, volume, tempo, rests, and so on. Furthermore, your tune may be placed in a "background buffer" so that it continues to play on while the rest of your program is being executed.

Color Graphics

Like the PC, the PCjr sets aside 16K for color graphics video memory. But that's about as far as the comparison goes. The PC uses a dedicated color board whose memory address begins at hexadecimal B8000. With no separate color board, the PCjr borrows 16K off the top of the available 64K or 128K of system memory. Although the beginning of this block is not actually found at address B8000, Junior is configured in such a way that references to this address will be diverted to wherever the video memory actually resides. This means that color graphics programs written on the PC will be compatible with the PCjr computer.

However, Junior is also able to offer a full 16 colors in medium resolution, or 4 colors in high resolution, by stealing even more (32K) of the system's memory. This is needed for the last two of the three new screen modes, which are listed here:

SCREEN 4 Medium-resolution,
4 colors

SCREEN 5 Medium-resolution,
16 colors

SCREEN 6 High-resolution,
4 colors

Before using SCREEN modes 5 and 6, a CLEAR,,,32768 statement must be used to set aside the required 32K

(Continued on page 86)

A Closer Look at Junior



The newly upgraded and price-reduced IBM PCjr is what the machine should have been in the first place. With its larger memory capacity, a "real" keyboard, and a realistic suggested selling price, the new Junior is now a machine to be reckoned with by other computer makers.

Although the keyboard weighs the same—25 ounces—it's a night-and-day comparison with the original one. The new keyboard can be directly used for serious typing purposes, whereas the earlier one could not. It has conventional size/shape keypads and has the feel that one expects for a machine in its price class. Key layout is the accepted QWERTY format (sorry, Dvorak key layout advocates), in traditional IBM "Selectric" form. The latter is not used for IBM's larger microcomputer models, to the delight of third-party keyboard makers such as Keytronic. Moreover, the large, inverted-L-shape "Enter" key is a welcome change from the other IBM PC's use of a too-small keypad key used for the same function.

With 62 keys compared to the PC's 83 keys, there's obviously more missing than just a numeric keypad. Junior requires the use of multiple keys to perform certain functions that are accomplished with separate keys on the PC. This makes for a smaller-size keyboard that takes up less space on a desk, though it's traded away somewhat by a slightly more burdensome operation. Function keys are lined up horizontally at the top of the keyboard in traditional style (again, this is violated with larger PCs, which position them at the left of the keyboard). They normally perform as numbers 0-9, but using a key there as a toggle, they turn into function keys F1-F10 for easy "List," "Run," "Load," etc., commands.

The separate keyboard can be made even more separate by using the Junior's infrared mode that eliminates the need for a direct connection to the main computer body. With obstacles blocking the signals and interference from other sources (such as a bevy of PCjr's used in a classroom), many people will find this feature to

be a mere frill. However, it's there for one to utilize, taking advantage of the keyboard's light weight to move it and to operate it on the user's lap. A Forrest Mims-type experimenter, though, will welcome this feature as a special opportunity to experiment with a variety of infrared-driven applications.

Key legends are now on top of the keys, where they belong, while programming audible key clicks for either on or (happily) off is retained.

Although the PCjr—previously a machine for all seasons, according to IBM's marketing people—is now implied to be less a computer for computer games than for adult work, it still defaults to 40-character-wide lines with double-size letters . . . the better to see on standard TV sets. For 80 columns, the user has to type "Width 80." No big deal, of course. But an adult/business-directed machine would have the 80 columns set as the default.

The PCjr's graphics and color quality are stunning. Unlike with other PC models, text and graphics are built-in features. There's a choice of seven screen modes, too, which are three more than PCs have. Furthermore, Junior's complex sound generator lends itself to better musical results than does the simple one-tone system of other PCs. In addition to graphics and color functions that are "extras" with other PC models, a built-in serial port and both NTSC and RGB color ports come with the smaller computer, as well as light pen and joystick ports, among others.

As good as the color is on the PCjr, I would still rather use a monochrome video monitor, which you can with the Junior, if its main application will be for word processing. But, then, I would say the same thing for any computer.

A video monitor (or small TV set) can be set comfortably atop the PCjr's main body, as shown in a

photograph in the article. For non-IBM monitors, however, you should check out the monitor in this location to be sure it doesn't produce interference that effects the computer's operation. Sometimes, extra shielding is required here.

Many prospective buyers will find the PCjr's open architecture inviting, since a growing number of third-party manufacturers are producing additional hardware because of it. A second, outboard disk drive, for example, is available (IBM doesn't offer one . . . yet) for users who wish to use the Junior for disk-intensive programs or to eliminate the tedium of the many floppy-disk exchanges that are necessary with a single drive. So if you're a heavy computer user, and intend to buy a PCjr, plan on a second double-sided, double-density floppy disk drive.

Two ROM cartridge slots are maintained in the PCjr. Probably originally intended mostly for game cartridges, it's likely that more and more business-oriented programs will be supplied in ROM-cartridge form. One of the most popular integrated-program pieces, Lotus 1-2-3, should be available by the time you read this, for example. Incidentally, it's important to note that inserting or removing a ROM cartridge automatically resets the computer. So if you do this when data is in memory, you'll blow away your work. Therefore, it's imperative to *save* your data before using a cartridge.

You'll find plenty of software available for use with the PCjr, though many of the more sophisticated, popular ones are not yet on board. The PCjr uses IBM's DOS 2.10, a more complex disk operating system than its popular DOS 1.10, which does not include graphics. The 2.10 version is shared by all of IBM's micros, so it's all in the family. To get PCjr BASIC, however, requires using a separate ROM cartridge, while the other PC models take it straight from the DOS disk. Since there are some differences in BIOS calls be-

tween the Junior and other PCs, not all software designed for the latter will work well with Junior. Enough will, though, to provide a tolerable degree of compatibility for people who already own IBM PC software. Check out what can and what cannot be used with the PCjr at your local authorized IBM dealer.

For a 128K-RAM PCjr, keep in mind that 16K is immediately needed for video, while 24K is needed for the disk operating system, leaving the user with only 88K of application RAM. Therefore, you'll likely need another 128K minimum of memory plugged into the Junior's side for some of the better business software.

The PCjr, which has been called a scaled-down PC, is quite compact, measuring 13.9" x 11.4" x 3.8" for its main body. Weight is only 8 1/4 lbs, though this is accomplished by having a separate 2.8 lb stepdown transformer for wall plug-in. It provides 17 volts to the Junior, but is limited in power for extensive external circuits. There's no problem getting inside the Junior. The top pops off easily by twisting a coin in the appropriate slots in the enclosure.

There's always a few little things about any computer that could irk a person, of course. The list is short for the PCjr. Among them are the following: Why does IBM insist on using nonstandard connectors? Couldn't Big Blue have included a parallel port, which is what most printers are set up to use without having to buy a serial interface board?

Where does the PCjr sit among competing brands now that IBM has corrected what everyone acknowledges to have been a mistaken design thrust with its earlier Junior? Wrong question for the limited space given here; it would take a book to provide this answer, which would require customizing the response finally to an individual's needs.

But not to avoid this natural query altogether, let's quickly contrast the PCjr with the Apple IIc, examined here last month: Both are compact

(Junior's footprint is about 20 square inches more than the IIc's). Both use bulky external transformers, the IIc's being bulkier and heavier. Both come with 128K RAM. The Junior's memory, though, can be greatly expanded. Junior's floppy disk holds more than twice as much data as the IIc's. Both have a reduced number of keypads compared to "standard" desktop computers. Both handle monochrome, composite video, and RGB video displays. Neither comes with a parallel port that would expand one's printer choices inexpensively.

Junior further provides a Look-No-Wires-Mom infrared keyboard and two ROM-cartridge slots. The IIc throws in a Dvorak-keyboard toggle switch, a second disk-drive controller for use with an outboard disk drive, an audio volume control, a headphone jack, and a TV-set modulator. Neither is completely compatible with software written for their other micro models, though Apple likely has an edge here in sheer software available, especially for games. The Apple IIc, using a CMOS microprocessor 6502 version, can be used for battery-powered portable applications with an optional LCD video display that's promised soon.

The Junior with a color monitor has about the same suggested retail price as the Apple IIc with a monochrome video monitor. The PCjr's keypads are somewhat superior to that of the IIc's. There will be more hardware add-ons for the PCjr than for the Apple IIc since the latter does not employ an open architecture.

In sum, the PCjr is now a neat personal computer at the high price end of low-end computers (or is it the low end of higher-priced, disk-based computers?). In comparing the PCjr to just one personal computer in its price range, you can see that there are many plusses and minuses, and that much depends on your intended applications and whether or not you own or have friends who own one of the brands contrasted here.

A Great Gift Idea

**DON'T LET THE ELECTRONICS REVOLUTION PASS YOU OR A FRIEND BY!
SUBSCRIBE TO**

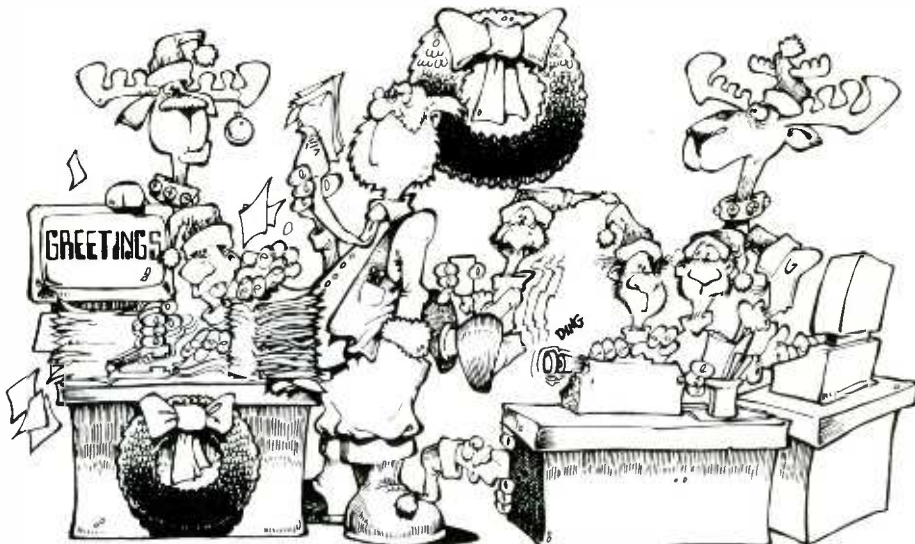

Now you can reach out every month and learn about the latest innovations in consumer electronics and personal computers—what's new, how products and circuits work, and what leading authorities think of them.

- *Stereo *Video *Home & Car Electronics
- *Test Instruments *Circuitry & Devices *Servicing
- *Personal Computers *Communications *Construction Projects

In every issue, authors lucidly explain how exciting, new electronics ideas are applied . . . issue forthright buying counsel . . . present complete plans to build electronic devices to enhance products, even unique ones that are not yet being sold in the marketplace.

Feature articles, tutorials, and construction projects are the hallmarks of MODERN ELECTRONICS, the new monthly magazine for electronics and computer enthusiasts. Covering the entire spectrum of these fields, you'll gather insights in every important area to help you make buying decisions for work and play purposes . . . improve performance of your present equipment . . . increase your electronics competence . . . and add to your practical and intellectual knowledge of electronics and computers.

To be sure you get this valuable information delivered to you regularly, and share the experiences of our writers and editors—Forrest Mims, Len Feldman, Stan Prentis, Charles Rubenstein, Glenn Hauser, and many others—you can subscribe to MODERN ELECTRONICS today. As a Charter Subscriber, you'll save 45% off the newsstand price when you buy a one-year subscription for only \$12.97. Or save 51% when you subscribe for two years at \$22.97.

Acting now you won't miss any of our exciting upcoming features, such as Comparing Color TV Sets, Tape Dubbing Methods for Car Stereo, Circuit Designing from Scratch series, Automotive Security Alarms, The TV Satellite Picture, Santa's Tree-Light Controller project, Computer Peripheral Switching, and much more.

Just fill out the coupon and mail with your check, money order, or credit card information (Visa or MasterCard) to enter your Charter Subscription. Do it today to ensure earliest delivery!

MODERN ELECTRONICS 76 North Broadway, Hicksville, NY 11801

Please send me Modern Electronics for 2 Years 1 Year

Name _____
Street _____
City _____
State _____ Zip _____

2 Years (24 issues) \$22.97

1 Year (12 issues) \$12.97

Charge My Order To: Payment Enclosed \$ _____

MasterCard

VISA



My account number is:

--	--	--	--	--	--	--	--	--	--	--	--	--	--	--	--	--	--	--	--

A Great Gift Idea

Send the following gift subscription to my friend at my expense.

Happy Holidays From: _____

Name _____
Street _____
City _____
State _____ Zip _____

2 Years (24 issues) \$22.97 1 Year (12 issues) \$12.97

Charge the above order to: Payment Enclosed \$ _____

MasterCard

VISA



My account number is:

--	--	--	--	--	--	--	--	--	--	--	--	--	--	--	--	--	--	--	--

Adding Extension Speakers To A Stereo System

Practical installation methods to obtain better sound reproduction and additional listening areas with extra speaker systems.

By Norman Eisenberg

Everyone knows that the normal complement of speaker systems for stereo reproduction is a pair—one for each channel. Furthermore, many stereo system owners have discovered that using additional (“extension”) speakers can prove to be both useful and enjoyable. There are, of course, two basic reasons for adding extra speaker systems to a stereo setup. One is to enhance the sound in the same room in which the main speakers are located. The other is to supply stereo sound to another room. The two aims aren’t mutually exclusive; you can do both—if you go about it properly.

Most of today’s stereo receivers and integrated amplifiers have provisions for connecting extra speaker systems and then selecting them or the main pair or both pairs with a front-panel switch. Owners’ manuals usually refer to this feature, but just as often provide little or no information on some important conditions involved when extra pairs of speaker systems are added. These considerations include speaker impedances, available power from the amplifier, relative volume, and the gauge and length of the cables used to interconnect speaker systems and amplifier or receiver with which they are used.

The Parameters

For most consumer-grade audio equipment, the standard amplifier output load is 8 ohms. This is the im-

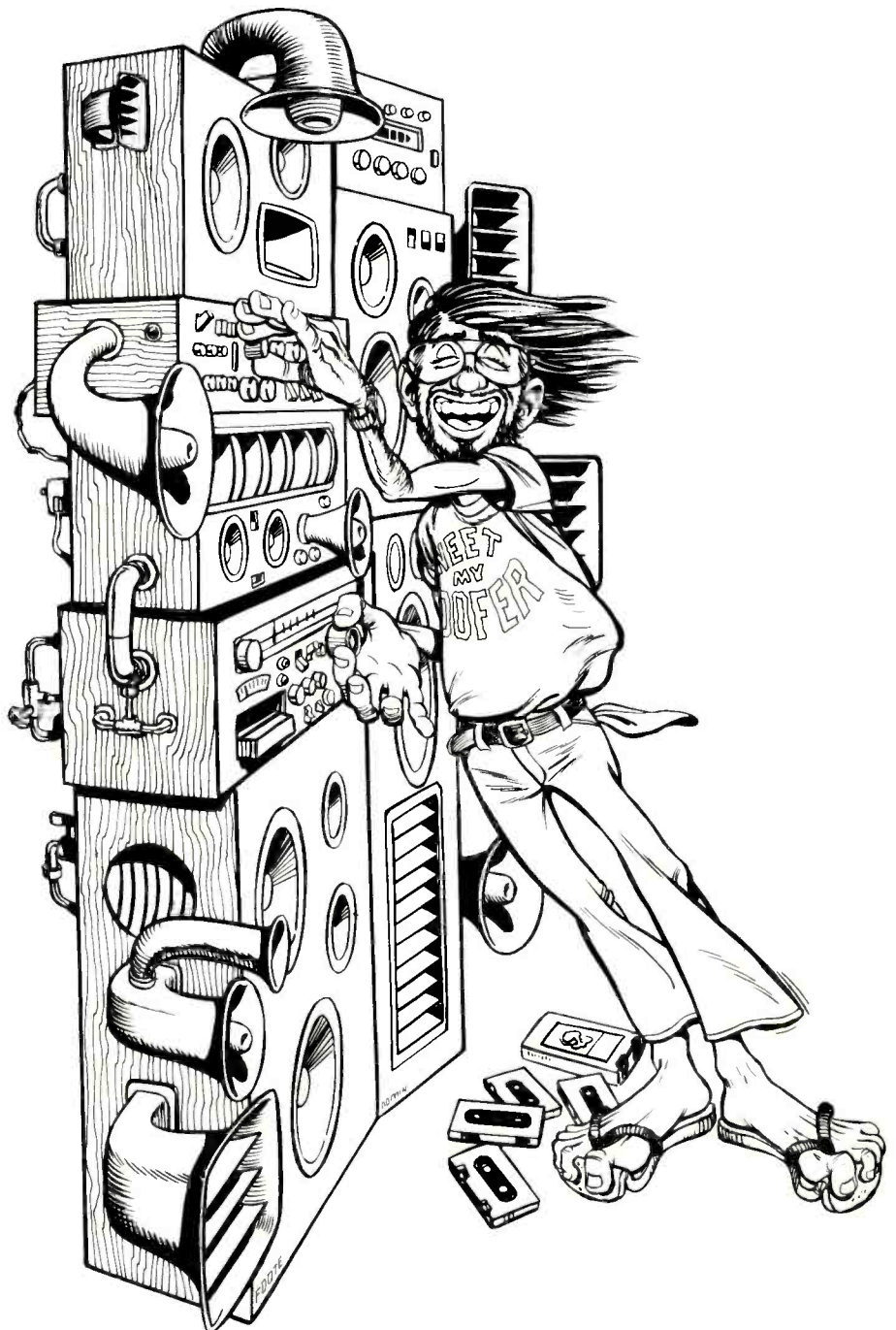

pedance for which the amplifier's output power is stated in the list of technical specifications. It also happens to be the nominal impedance of the vast majority of speaker systems.

Because they're constant-voltage devices, most receivers and amplifiers can supply more than their rated power into loads whose impedances are less than 8 ohms. How much power they can deliver, however, and with how much distortion and into how low impedance the load before the danger point is reached varies considerably from one amplifier to another. Unfortunately, even though this information is frequently of critical importance, rarely do manufacturers include it along with the other technical specifications.

With some professional-grade, heavy-duty amplifiers, you'll see a specification for 4-ohm loads. You might also see a statement to the effect it's safe for the impedance to go as low as 2 ohms. Supplementary information might even give you legitimate power data at these low-impedance speaker loads.

Most user's manuals for typical home stereo amplifiers and receivers are rather vague on this subject. The best I have come across in recent years promises 62.5 watts per channel into 8 ohms and 90 watts per channel into 4 ohms. This manual also cautions the user to connect only 8-ohm or greater speaker systems to the amplifier when using remote speakers. The cautionary note takes pains to specify that both remote *and* main speaker systems must have a minimum of 8-ohms impedance.

More typical, unfortunately, is the manual for many recent receivers and amplifiers that simply states remote speaker systems can be hooked up and selected with a front-panel switch. This is a very idealistic (and unrealistic) view. Things just aren't that simple. If you were to take a statement like this on face value, you could blithely blow your amplifier or speakers or both!

In the real world, very few—if any—things are perfect in design. Speak-

Estimating Total Impedance

The following equations can be used to determine *nominal* total impedances (Z_t), but don't assume you can blithely combine any number of speaker systems in series-parallel arrangements and hit the mark. In these equations, Z_1, Z_2, \dots, Z_n represent the nominal impedances of the individual speaker systems.

For any number of speaker systems:

$$Z_t = \frac{1}{\frac{1}{Z_1} + \frac{1}{Z_2} + \frac{1}{Z_3} + \dots + \frac{1}{Z_n}}$$

For two speaker systems in parallel:

$$Z_t = \frac{Z_1 \times Z_2}{Z_1 + Z_2}$$

For speaker systems in series:

$$Z_t = Z_1 + Z_2 + Z_3 + \dots + Z_n$$

Fig. 1. Equations for estimating the total speaker impedance presented to the outputs of an amplifier.

er systems, particularly, aren't. When a manufacturer specifies his speaker system to have an 8-ohm impedance, this is a *nominal* figure. The speaker system may, indeed, have an 8-ohm impedance—but only at selected frequencies. In fact, the impedance may quite readily drop to 7 or 6 ohms at certain frequencies. This would present no problems for the driving amplifier if only one pair (stereo) were connected to it, since even the most skimpily designed receiver can usually cope with a 4-ohm load. When you connect *two* such pairs of speaker systems in parallel to each of the receiver's outputs, the amplifier section could be in very real trouble. As for using three pairs of speaker systems, forget it!

Estimating Impedances

To estimate the total impedance presented to an amplifier (including the amplifier section of a receiver), note the equations in Fig. 1. Bear in mind that these equations represent "best-

case" approximations when it comes to speaker systems, since actual impedance when a speaker reproduces music will vary across the audio range, often dipping below the rated nominal value.

If your owner's manual isn't explicit on the safe lower limit of impedance you can apply to the outputs of your amplifier or receiver, try to get the information from the manufacturer. Failing this, play it safe and assume that no impedance of less than 4 ohms total should be used with the amplifier as-is.

Similarly, consider the power available to drive the combination of main and extension speaker systems. You can't assume, for example, that a receiver rated for, say, 80 watts per channel when driving one pair of speaker systems (one per channel) will obligingly pump out double that power so that each of two speaker systems on each channel will be getting 80 watts of power. Things just don't work that way. Except for the most rigorously designed, heavy-duty professional-grade amplifiers, chances are that there will be a drop of at least 3 dB for each added speaker system per channel. Hence, the 80 watts per channel delivered by the amplifier becomes more like 40 watts per channel with respect to each of two speaker systems connected to a given channel.

Keep in mind that the more speaker systems you try to run off the same output channel, the closer you come—in terms of reduced load impedance and increased demand on available power reserves—to the safe operating limit of a given amplifier or receiver. When that limit is reached or exceeded, the amplifier will shut itself down, if you're lucky, or self-destruct, perhaps taking the speaker system with it if no safeguards are built in.

While it's generally safe to make use of the extra speaker outputs on today's receivers and amplifiers, the watchword (unless you can get specific advice to the contrary from the manufacturer) is to use no more than

one extra pair of speaker systems. Like the main pair, the added pair should have an impedance of 8 ohms.

Going Beyond Two Pair

If you wish to use more than one extra pair of speaker systems, or if your equipment doesn't have a built-in speaker-pair selector, you'll need a separate switching setup. You can make your own speaker switch (see Fig. 2) or buy one already made up from most hi-fi equipment dealers.

Typical of the ready-made speaker-switching accessories on the market today are the Model 30-5006 that handles up to three pairs of stereo speaker systems and Model 30-5002 that handles up to five pairs, both from Audiotex. If you have a separate power amplifier, you can use Adcom's Model GFS-1 switcher (Fig. 3), which handles up to three speaker systems.

Beyond Switching

Using a speaker switching device will effectively handle impedance relationships, but it can't solve the power-drain problem. With regard to power, you must exercise some common sense. For instance, assume you're running three speaker systems from one side of an amplifier and the amplifier itself is rated to deliver 60 watts of power per channel. When all three speaker systems are being used simultaneously, each can get no more than 20 watts. This may be enough to drive the speaker systems adequately for your purposes, but don't expect to hear consistently loud and clear crescendos from all three, or even just one of the three.

With any switching arrangement in which several speaker systems are driven from the same amplifier, you have the additional problem of having to adjust the relative volumes from each speaker. For example, suppose you have set up the added speaker systems to provide a wider stereo spread in the same room in which your main speakers are located. Depending on program mate-

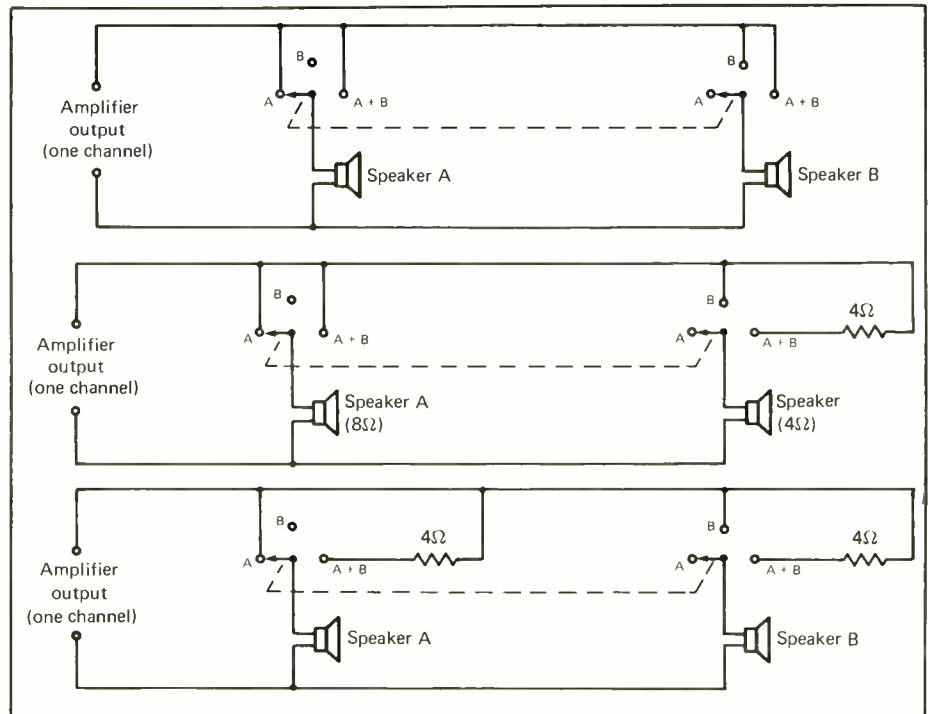

Fig. 2. You can build your own switching arrangement for selecting either or both speakers connected to the output of an amplifier—for 8-ohm-only systems (top), for mixed 8/4-ohm systems (center), and for 4-ohm-only systems (bottom).

rial, room acoustics, and the positions of all four speaker systems, it may be necessary to play one or even a pair of the speaker systems louder than the others. The volume control on your receiver or amplifier may be able to serve as a master level control, but it can't be used to adjust the volume of sound emanating from any *one* of the speaker systems.

The solution, of course, is to use an "L pad" (Fig. 4). This is a dual-sectioned volume control that maintains correct impedance match while adjusting the volume of an individual speaker system. L pads are sold by many hi-fi equipment dealers. When you buy one, get the best you can afford, and make sure its impedance is the same as that of the speaker system whose volume it will control. Wiring an L pad into your hi-fi setup is a simple enough procedure. Logically, it should be located fairly close to the speaker system it's to control.

An L pad, of course, can't increase the volume beyond the level set by the master volume control in the ampli-

fier. So it may take some juggling between the settings of the two controls before you can get the balance you want. Remember, too, that when you turn down the L pad to silence an extension speaker system, the control will still be taking power from the line. Hence, even though the one speaker system is muted, the other speakers in the system won't be getting full power.

Another Approach

The whole switching setup can be avoided if you're willing to use a fancier and costlier type of setup—an additional power amplifier for each pair of added speaker systems. The easiest, though most complex and costly, way to go is with a separate preamplifier and separate power amplifier for the main speaker systems. You can then use the preamp to drive whatever other individual power amp(s) you add to the setup.

If the added power amps have their own input level controls, so much the better. If they don't, you can still use



Fig. 3. If you prefer a ready-to-install speaker switching box, you can use the Adcom Model GFS-1 shown here or a similar product from another manufacturer.

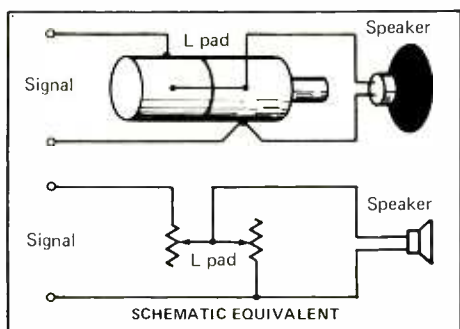

Fig. 4. To control the volume from extension speakers, you will need an L pad for each speaker you add.

L pads in the lines that go to the speaker systems connected to them.

Instead of using power amps for the extra speaker systems, you can use integrated amplifiers that *do* have volume controls. This choice offers redundancy that can prove to be a boon in terms of flexibility for elaborate extra speaker system arrangements.

Added amplifiers can be run from a receiver as well as from an integrated amplifier (see Fig. 5). An unused tape monitor jack, or the circuit-interrupt option, can be adapted for feeding signals from the main system into an added amplifier that's driving the extension speakers. The disadvantages of going this route include added equipment complexity and installation space, as well as cost. On the plus side is the fact that this

type of setup gives you full control over each speaker system, independently of the others and with optimum relationships of impedance, power, and damping for *all* the speaker systems.

Where They're Used

One of the most popular uses for extension speaker systems is in supplying stereo sound to one or more rooms other than the main listening room. If only one such "remote" setup is planned, the simple use of the existing speakers B outputs on your

receiver or amplifier will suffice. Of course, the cautions regarding speaker impedances explained above still apply, and you'll have to insert L pads in the lines feeding the remote speaker systems to be able to control the volume without having to use the control on the amplifier.

If your hi-fi equipment doesn't have provisions for connecting an extra pair of speaker systems to it, you'll have to use one of the switching arrangements described above.

When more than one remote setup is planned, a more elaborate switching arrangement is needed. Probably your best bet would be to buy a multiple-speaker switch after discussing your needs with your local audio equipment dealer. It would be better but more costly to introduce an additional amplifier into the system. Under no circumstances should you try to add several remote speaker systems directly to the outputs of a power amplifier by coming up with a series-parallel arrangement that *seems* to present the correct impedance on the basis of arithmetic computation. Many a well-intentioned hi-fi buff has done just this only to have caused very expensive damage to his hi-fi system.

Within the main listening room itself, there are two good reasons for

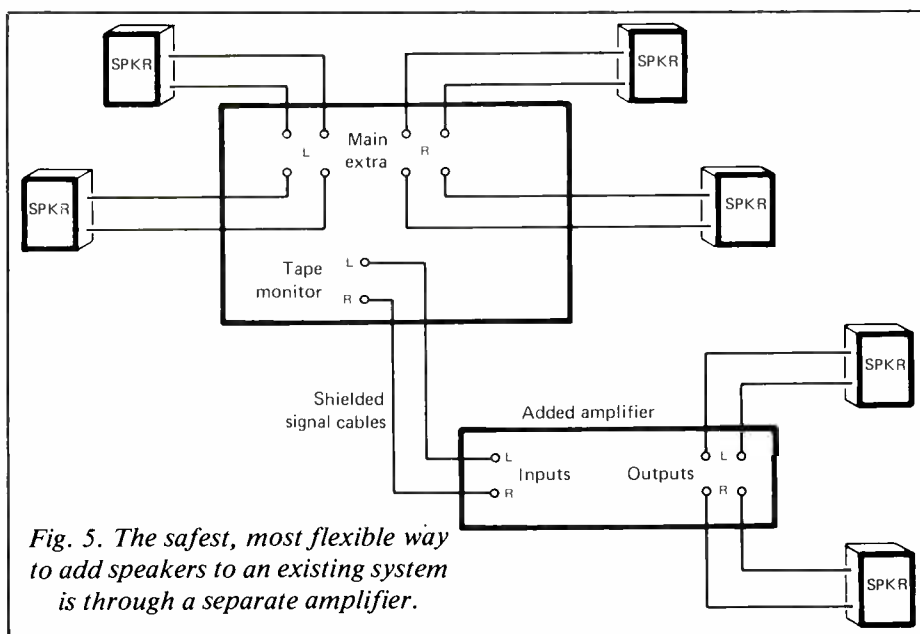

Fig. 5. The safest, most flexible way to add speakers to an existing system is through a separate amplifier.

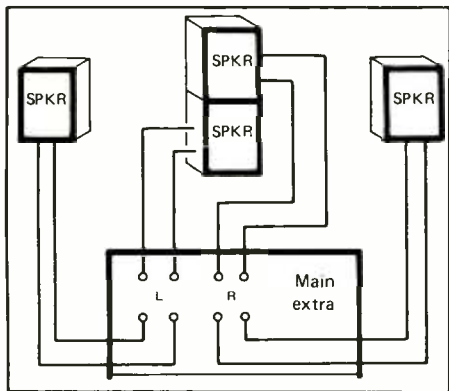

Fig. 6. To obtain center-channel fill, stack speakers systems as shown here.

using additional speaker systems. One is to enhance the stereo effect by using extension speaker systems as "flankers." Positioned along the side walls and flanking the two main speaker systems, the extension speakers can lend a dramatic highlight to large-scale musical works. They create a "big stage" effect that adds a rich ambience to the sound while washing out a lot of system response problems resulting from deficiencies in room acoustics.

Should center filling be the only application you plan for your extension speaker systems, you can probably achieve your goal by using the extra speaker outputs on your present equipment. You'll need L pads to obtain the kind of balance you want, of course. If you want flanking in your main listening room *and* remote listening in another room, you'll have to plan on using an accessory speaker switcher or get an additional driving amplifier.

A need for speaker flankers is indicated, in most instances, for installations in which the main speaker systems are relatively close together or are fairly directional in their dispersion pattern. At the opposite extreme is the situation where the main speaker systems are too far apart and don't provide a consistently solid center image or aural focus. What results from a situation like this is a "hole" in the middle of the stereo spread.

Fig. 7. In this wire-gauge table, the cable run range in feet is shown between the two lines.

Speaker Impedance in ohms	Cable Gauge for cable run in feet			
	0-30 ft.	31-40	41-70	71-100
4	18	16	14	12
8	18	16	14	14
16	20	18	16	14

The hole-in-the-middle problem can be effectively dealt with by using a center-fill speaker system that provides A-plus-B (left-plus-right) channel signal. Center filling makes the stereo presentation more substantial or solid by providing a "wall of sound" effect. Again, musical perception is improved, and many problems of otherwise poor room acoustics are solved.

The concept of a center-fill speaker that handles an A-plus-B (monophonic) signal suggests the use of just one speaker system to do the job. Don't become a victim of this logic! Hanging a single speaker system onto the outputs of a solid-state amplifier can be tricky at best and downright dangerous at worst. Because a common ground may be involved in the two channels in solid-state amplifiers, manufacturers do not recommend bridging the channels with a speaker system.

Ruling out a single speaker system, you can obtain a perfectly workable A-plus-B fill by using two speaker systems. Simply stack one atop the other and plant the pair in the same location in which you'd put a single speaker system (see Fig. 6). Each speaker system in the stacked pair gets its own left or right channel signal from the left and right outputs of the amplifier or receiver. But since the two signals are so closely coupled physically, they form an acoustic mix that is perceived as a monophonic source containing the signal in channel A plus that in channel B.

As with all the other varieties of added speaker system hookups, the center-fill arrangement can be driven directly from the extra speaker out-

puts on your present stereo equipment. Alternatively, the speaker systems can be driven by their own separate amplifier driven from the tape-monitor or preamp output on the main amplifier. Again, use L pads for controlling the volume of the added speaker systems.

A Final Consideration

When adding extension speaker systems, you must consider the thickness (gauge) of the cables delivering power to them from your amplifier. This is particularly important for installations where the add-on systems are far removed from the driving amplifier. Cables that aren't thick enough can reduce total power delivered to the speaker systems, resulting in a loss in listening volume.

In figuring the gauge to use for your cables, it's important that you take into account the *actual* cable lengths you'll be using. This is the actual length in feet, measured from the amplifier's output, routed along baseboards and doorways, and dressed around cabinets, etc., to the speaker systems. As a general rule of thumb, the longer the cable runs, the larger the thickness of cable needed.

Specific lengths of cable runs vary somewhat from one speaker manufacturer to another. The best advice is to follow the recommendations supplied with the speaker systems you purchase. If none are given, and you can't obtain them from the manufacturer, use the table in Fig. 7 to determine what you should use. This table errs slightly on the side of caution, but you won't go wrong by using a thicker (lower gauge number) cable than might nominally be required. **ME**

The latest technical books and literature in the electronics and computer field.

The Complete Book of Oscilloscopes by Stan Prentiss. (Tab Books Inc.; 230 pp.; \$11.50.)

This is a veritable course on oscilloscopes, both service and laboratory types. In addition to covering oscilloscope basics, the author presents applications information for a number of different scope types, including vectorscopes, spectrum analyzers, sampling scopes, and digital analyzers. Supplemented by good drawings and scope photos, this book can serve well to show readers how to use oscilloscopes as well as how to choose them for specific applications.

How to Buy an IBM PC or Compatible Computer by Danny Goodman. (PC World Books by Simon & Schuster, Inc.; 207 pp.; \$14.95.)

The author, in collaboration with the Editors of *PC World* magazine, presents practical considerations to weigh when buying an IBM PC or compatible. The non-technical book covers memory, floppy- and hard-disk drives, monitors, printers, modems, disk operating systems, programming languages, and applications programs, as well as supplies, computer room considerations, and maintenance plans. Written smoothly and adequately illustrated, the book's content covers only the tip of the iceberg, laying a foundation of what the PC system is all about, but neglecting to offer much in the way of the many alternative considerations available to a prospective buyer, both in hardware and software. Therefore, it's an excellent starter book, but one will certainly have to dig further to make judicious buying decisions.

How To Get Free Software by Alfred Glossbrenner. (St. Martin's Press; 436 pp.; \$14.95.)

This is a wonderful book for any microcomputer owner. The number

of free software programs revealed is breathtaking. Many of the "free" offerings are not really free since membership in a computer club or a subscription fee is required, but the costs are low enough considering charges for software to call it "free."

There is a lot of software enumerated that is obtainable on line, where one pays a fee to the telecommunications service company as well as telephone time. But many are well worth the small expense. The author obviously did a lot of investigating in order to compile this information. It's a worthy book for virtually any computerist, chock full of information that one would truly be hard pressed to gather.

20 Selected Solar Projects: Making Photovoltaics Work For You by TJ Byers. (Prentice-Hall, Inc.; hardcover; 173 pp.; \$11.95.)

This is a fine book for anyone who wishes to learn about applications of photovoltaics. In addition to step-by-step instructions on building photovoltaic projects, the principles of each circuit presented are discussed in detail. Construction projects include a Charge Controller, Ventilation Fan, Robot Controller, Fence Charger, Photophone, Solar Tracker, and Music Box, among others. These self-powered devices do away with the need to plug into ac voltage or to use fast-draining batteries that always need replacement. All the circuitry, pc foil patterns, parts lists, and theoretical background information you could want.

IC Voltage Regulator Sourcebook With Experiments by Vaughn Martin. (Tab Books Inc.; 245 pp.; \$11.50.)

Packed with in-depth information on IC voltage regulators and allied circuits, this book should appeal to serious experimenters as well as practicing technical people. It can serve admirably as a design reference book since the editorial approach is both tutorial and hands-on, with appro-

prate formulas and projects that one can build to verify theory presented. A wide variety of schematics, drawings, and tables support the text.

NEW LITERATURE

Parts & Equipment Brochure. A free six-page brochure from JDR Microdevices lists linear and digital devices, as well as a variety of computer accessories and peripherals. Address: JDR Microdevices, 1224 S. Bascom Ave., Dept. ME 11, San Jose, CA 95128.

LCD Modules. A new four-page brochure from C. Itoh Electronics describes features and technology of its family of alphanumeric and liquid-crystal display modules. The LCD's discussed range in size from 8 characters \times 1 line top 640 columns \times 200 rows. Address: C. Itoh Electronics Inc., Marketing Communications, Att: J. DeVita, 5301 Beethoven St., Los Angeles, CA 90066.

Microcomputer Protection. Electronic Specialists' new 40-page free catalog describes a variety of protective devices, including ac line conditioners, modem and phone-line surge suppressors and equipment isolators and filters. Write for Catalog 841. Address: Electronic Specialists, Inc., 171 South Main St., P.O. Box 389, Natick, MA 01760.

Capacitor-Performance Literature. Corning Electronics offers free literature on performance parameters for each capacitor in its lines of glass or multilayer ceramic capacitors. Typical characteristics are shown in graph form through 1 MHz to 2 GHz. Address: Corning Electronics, 3900 Electronics Drive, Raleigh, NC 27604.

Elapsed-Time Bulletin. A four-page bulletin from the Fredericks Company on its miniature, electrochemical elapsed-time indicators is available free. The products provide non-reversible direct-scale reading of actual elapsed operating time of electrical equipment. Address: The Fredericks Company, Huntingdon Valley, PA 19006. **ME**

Beyond Op-Amps

How to use special-purpose op-amps in practical and exotic circuits.

By Joseph J. Carr

The operational amplifier revolutionized analog computer design in what seems eons ago, but early models were not well-suited to general use in analog circuits owing to its bulk and high power drain. In the mid-sixties, when the μ A-709 integrated-circuit operational amplifier was developed, it became possible to use this wonderful invention for a wide range of applications.

Figure 1 shows the four basic forms of op-amp circuit: inverting follower (Fig. 1A), noninverting follower with gain (Fig. 1B), unity gain noninverting follower (Fig. 1C), and dc differential amplifier (Fig. 1D).

The inverting follower circuit shown in Figure 1A produces an output signal that is 180 degrees out of phase with the input signal—which is where it gets its name, “inverting” follower. The gain of the inverting follower is simple: $-R2/R1$, where the minus sign indicates the inversion. Thus, when a circuit like that in Fig. 1A has an input resistor ($R1$) of 10 kohms, and a feedback resistor ($R2$) of 100 kohms, the gain is $(-100\text{ k})/10\text{ k}$, or -10 . The input impedance of this circuit is equal to $R1$.

The noninverting follower with gain (Fig. 1B) provides no phase reversal between input and output. The input impedance of this circuit is very high, and is not related to the value of any resistors in the circuit. The gain of the circuit is $[(R2/R1) + 1]$, so in the example above, the gain where $R1 = 10\text{ kohm}$ and $R2 = 100\text{ kohm}$ will be 101.

The unity gain noninverting follower (Fig. 1C) is a special case of Fig. 1B in which the feedback resistor

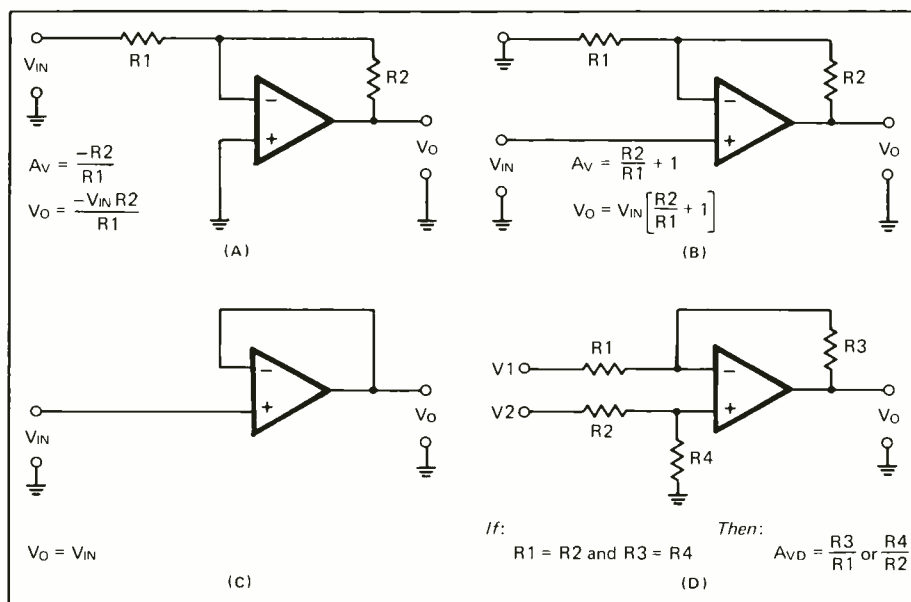

Fig. 1. Four basic op-amp circuits: (A) inverting follower, (B) noninverting follower, (C) unity-gain noninverting follower, and (D) differential amplifier.

is zero ohms: the output is connected directly to the inverting input. This circuit provides a voltage gain of one (“unity gain”). There are two main purposes for the unity gain noninverting follower: buffering and impedance transformation. “Buffering” means that the circuit provides isolation between input and output. Thus, variations in load will not affect the input circuit, an ideal situation where oscillators and other such sensitive circuits must drive unstable loads. Impedance transformation is high-to-low: a high input impedance reduces to a low output impedance. Since the voltage remains the same, and the impedance drops at the output, we can see that the unity gain noninverting amplifier provides a power gain greater than unity while providing a voltage gain of one.

Finally, we have the dc differential amplifier (Fig. 1D). This type of amplifier is used to provide a single-ended (that is, unbalanced) output from a differential (that is, balanced) input signal source. Output voltage V_o is proportional to the differential voltage (A_{vd}) and the difference between input voltages $V1$ and $V2$ ($V1 - V2$):

$$V_o = A_{vd} \times (V1 - V2).$$

The gain is calculated in much the same manner as for the inverting amplifier, and is equal to either $R3/R1$ or $R4/R2$, provided that $R1 = R2$ and $R3 = R4$ (these equalities are important).

The foregoing circuits are based on single op-amps. When we use two or more op-amps, however, even more complex circuits are possible. In the remainder of this article we will deal with IC versions of the Instrumenta-

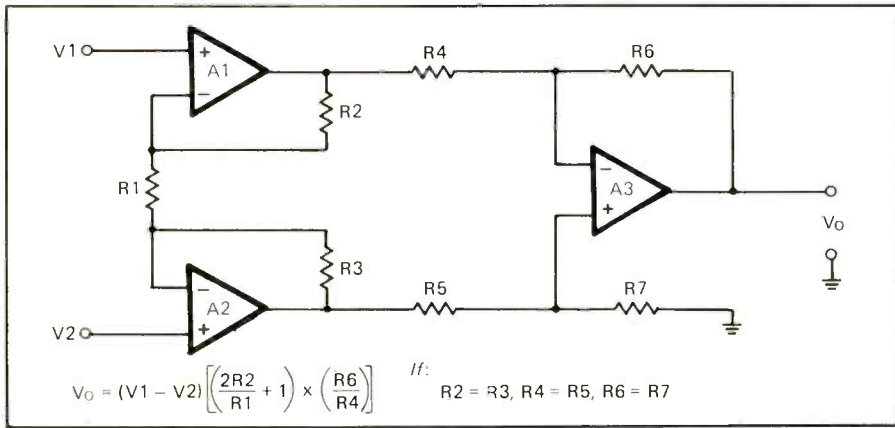

Fig. 2. The instrumentation amplifier provides an extremely high input impedance, high possible gain, and easy design. The gain equation is shown at bottom.

tion Amplifier (IA) circuit shown in Fig. 2. The IA provides an extremely high input impedance (similar to the noninverting follower circuits), a high possible gain, and easy design. The gain equation for this circuit is shown in Fig. 2.

The IA circuit shown in Fig. 2 consists of two sections: A1 - A2 and A3. Amplifier A3 forms a simple dc differential amplifier such as shown in Fig. 2, and obeys the same rules. The A1 - A2 amplifier is a differential-noninverting-input-with-differential-output stage. By cascading these two forms of amplifier we obtain the instrumentation amplifier.

In many cases, where variable or adjustable gain is required, we leave all resistors constant except R_1 . We must be careful, however, because R_1 appears in the denominator of the equation in Fig. 2. This location means that the gain can be very, very large when the resistance of R_1 drops close to zero. In some cases, the designer will place a small-value fixed resistor in series with a variable resistor (potentiometer) to adjust gain, but limit it to a maximum.

IC Operational Amplifiers

The operational amplifier truly revolutionized analog circuit design.

For a long time, the only additional advances were that op-amps became better and better (they became nearer the ideal op-amp of textbooks). While that was an exciting development, it was not a really new device. The big breakthrough came when the analog device designers made an integrated-circuit version of Fig. 2, the integrated-circuit instrumentation amplifier (ICIA).

Figure 3 illustrates one popular ICIA, Precision Monolithics, Inc.'s AMP-01 device. The AMP-01 is housed in an 18-pin dual-inline-pin (DIP) package (Fig. 3A).

The basic circuit for the AMP-01 is shown in Fig. 3B. Notice how simple the circuit is! There are few connections: differential inputs, dc power supply (V^- and V^+), output, ground and two gain-setting resistors. The voltage gain of this circuit is given by:

$$V_{vd} = 20 R_s / R_g$$

Suppose we want to make a differential voltage amplifier with a gain of $\times 1000$. We need to make a resistor ratio of $1000/20$, or $50:1$. Thus, if R_s is set to 100 kohms, and R_g is 2 kohms, we will have the required gain of 1000. The permissible gain range is 0.1 to 10,000.

The dc power supply voltages are up to ± 18 -volts dc. Notice in Fig. 3B

Fig. 3. Pin designations and basic circuit of Precision Monolithic's IC instrumentation amplifier.

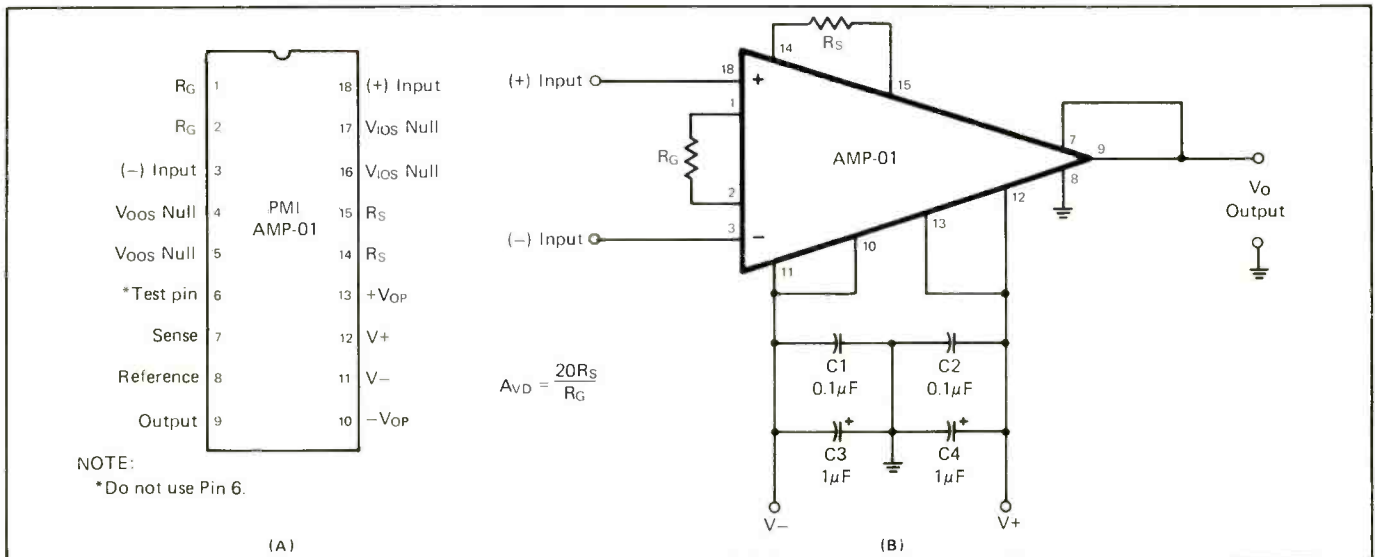

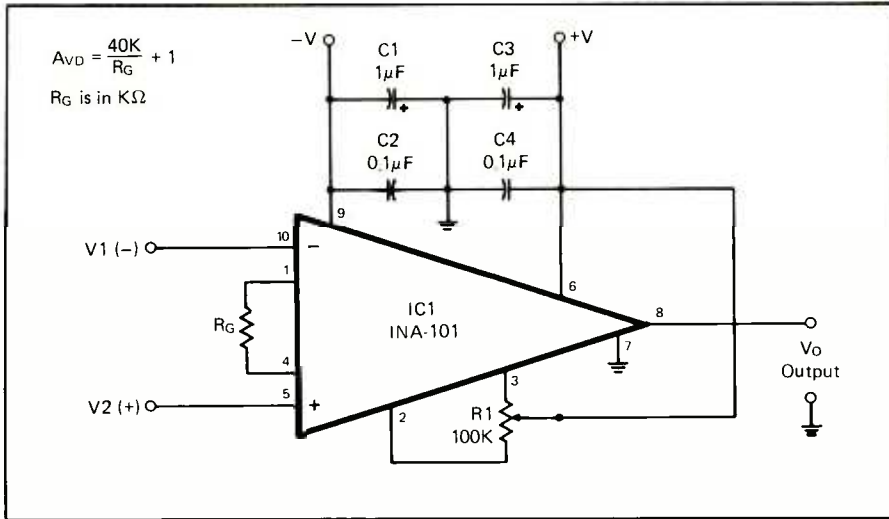

Fig. 4. Simplified Burr-Brown INA-101 ICIA circuit and its gain equation.

that the dc power supply lines are heavily bypassed. The 0.1-µF units are used to bypass high frequencies, while the 1-µF units are for low frequencies. The 0.1-µF units must be mounted as close as possible to the body of the amplifier.

The maximum operating frequency depends upon the gain. At a gain of 1, the maximum small-signal input frequency is 570 kHz, while at a gain of 1000 it reduces to 26 kHz.

The Burr-Brown INA-101 is another new ICIA device. This amplifier is similarly simple to connect. There are only dc power connections, differential input connections, offset

adjust connections, ground and an output. Gain of the circuit is set by:

$$A_{vd} = (4 \text{ k}/R_g) + 1$$

The INA-101 is basically a low-noise, low-input bias current integrated circuit version of the IA of Fig. 2. The resistors labeled R2 and R3 in Fig. 2 are 20 kohms, hence the "40k" term in Fig. 4.

Potentiometer R1 in Fig. 4 is used to null the offset voltages appearing at the output. An offset voltage is a voltage that exists on the output at a time when it should be zero (that is, when V1 = V2, so that V1 - V2 = 0). The offset voltage might be internal to the amplifier or a component

of the input signal. Dc offsets in signals are common, especially in biopotential amplifiers such as ECG and EEG used to measure electrical impulses from the heart and brain.

Still another ICIA is National Semiconductors' LM-363 device shown in Fig. 5; the miniDIP version is shown in Fig. 5A (an 8-pin metal can is also available), while a typical circuit is illustrated in Fig. 5B. The LM-363 device is a fixed-gain ICIA. There are three versions:

Designation	Gain
LM-363-10	10
LM-363-100	100
LM-363-500	500

The LM-363-xx is useful in places where one of the standard gains is required and there is minimal space available. Two examples spring to mind. We could use the LM-363-x as a transducer preamplifier, especially in noisy signal areas; the LM-363-x can be built onto (or into) the transducer to build up its signal before sending it to the main instrument or signal acquisition computer. The other example is in bioamplifiers. The biopotentials are typically very small, especially in lab animals. The LM-363-x can be mounted on the subject and a higher-level signal sent to the main instrument; a little exotic, but nonetheless useful.

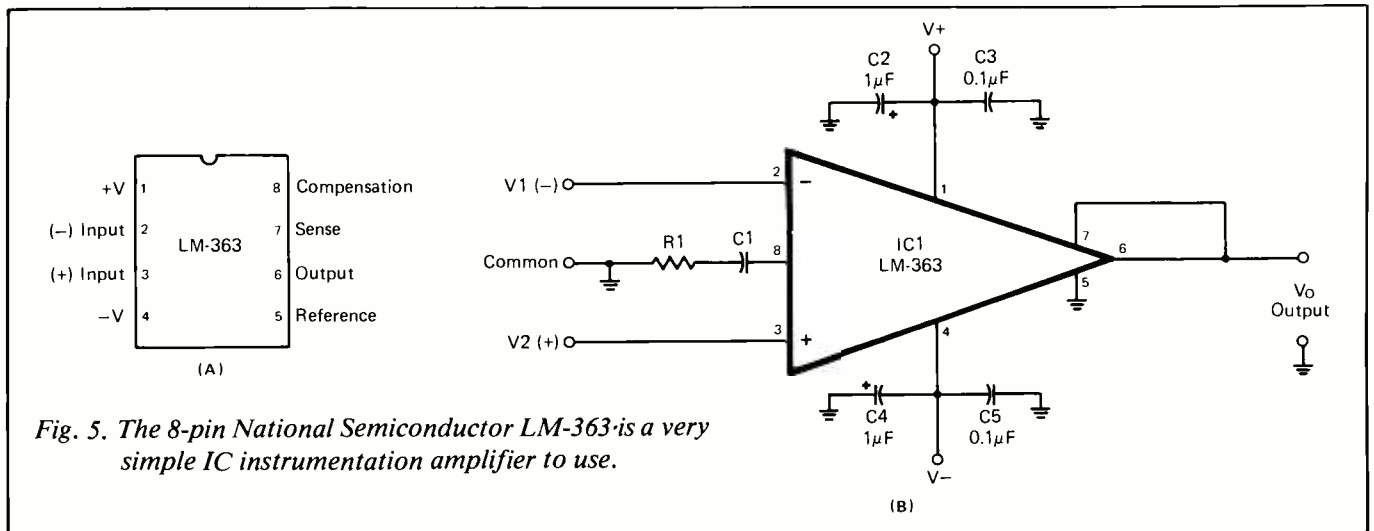

Fig. 5. The 8-pin National Semiconductor LM-363 is a very simple IC instrumentation amplifier to use.

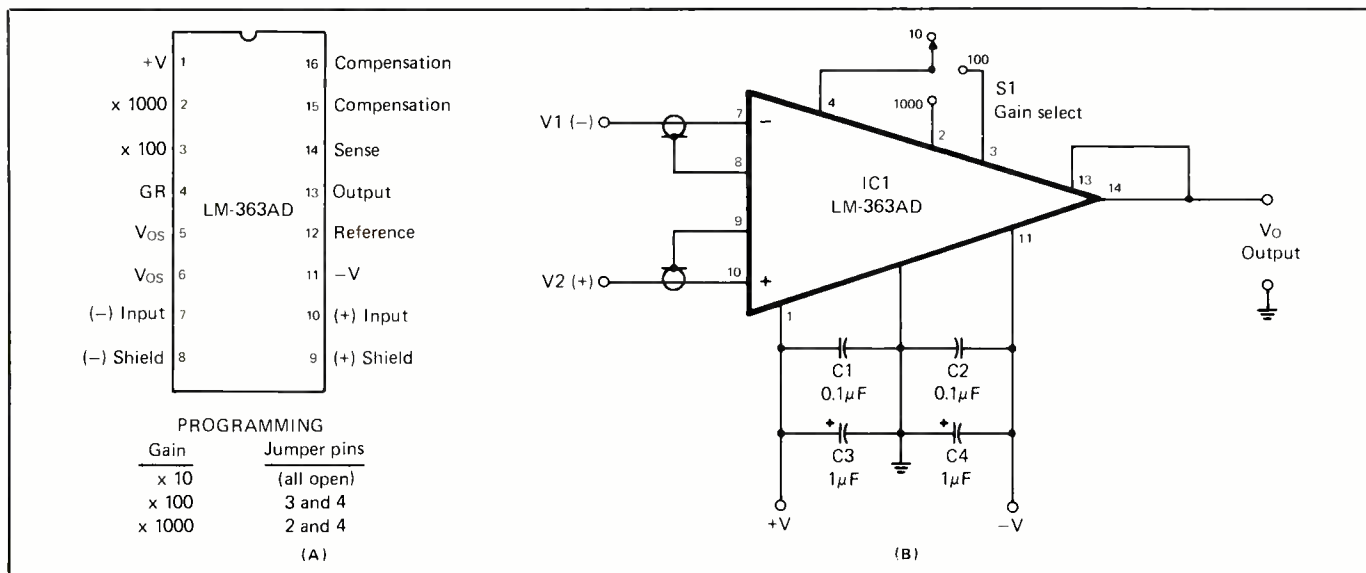

Fig. 6. The LM-363AD is a selectable-gain version of the National Semiconductor LM-363 ICIA.

A selectable-gain version of the LM-363 device is shown in Fig. 6; the 16-pin DIP package is shown in Fig. 6A, while a typical circuit is shown in Fig. 6B. The type number of this device is LM-363-AD, which distinguishes it from the LM-363-x devices. The gain can be $\times 10$, $\times 100$ or $\times 1000$, depending upon the programming of the gain-setting pins (2, 3 and 4). The programming protocol is as follows:

Gain Desired	Jumper Pins
$\times 10$	(All Open)
$\times 100$	3 & 4
$\times 1000$	2 & 4

Switch S1 in Fig. 6B is the GAIN SELECT switch. This switch should be mounted close to the IC device, but is quite flexible in mechanical form. The switch could also be made from a combination of CMOS electronic switches (for example, 4066).

The dc power supply terminals are treated in a manner similar to the other amplifiers. Again, the 0.1-μF capacitors need to be mounted as close as possible to the body of the LM-363-AD integrated circuit.

Pins 8 and 9 are guard shield outputs. These pins are a feature that makes the LM-363-AD more useful for many instrumentation problems

than other models. By outputting a signal sample back to the shield of the input lines, we can increase the common-mode rejection ratio. This feature is used a lot in bipotential amplifiers and in other applications where a low-level signal must pass through a strong interference (high-noise) environment.

The LM-363 devices will operate with dc supply voltages of ± 5 volts to ± 18 volts dc, with a common-mode rejection ratio (CMRR) of 130 dB. The 7 nV/[SQR(Hz)] noise figure makes the device useful for low-noise applications (a 0.5 nV model is available at premium cost).

Isolation Amplifiers

There are many applications for instrumentation amplifiers that present a danger to the user. In biomedical applications, for example, the issue is patient safety. There are numerous signal acquisition needs in biomedical instrumentation where the patient is at risk. Even the simple ECG machine, which measures and records the heart's electrical activity, was once implicated in patient safety problems. Another problem area in biomedical applications is catheterization instruments. There are several tests where physicians insert an elec-

trode or transducer into the body, and then measure the resulting signal: the intracardiac ECG places an electrode inside the heart by way of a blood vein; the cardiac output computer uses a signal from a thermistor inside a catheter placed in the heart (also through a vein), and simple electronic blood pressure monitors use a transducer that connects to an artery. In all of these cases we do not want the patient exposed to small differences of potential due to current leakage from the 60-Hz ac power lines. The solution is use of an isolation amplifier.

Another application is signal acquisition in high voltage circuits. We do not want to mix high-voltage sources with low-voltage electronics because we don't want the low-voltage circuits to blow out. Again, the solution is the isolation amplifier.

Figure 7 shows the basic symbol for the isolation amplifier. The break in the triangle used to represent any amplifier denotes that there is an extremely high impedance (typically 10^{12} ohms) between the inputs and output of the isolation amplifier.

Notice that there are two sets of dc power supply terminals. The V- and V+ terminals are the same as found on all ICIA or op-amp devices. These

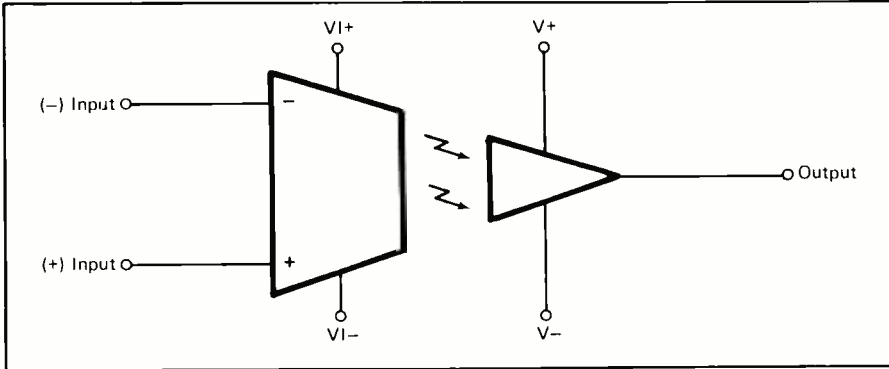

Fig. 7. Shown here is the basic symbol for the isolation operational amplifier.

dc power supply terminals are connected to the regular dc supply of the equipment where the device is used. Such a power supply derives its dc potentials from the ac power source by way of a 60-Hz transformer. The isolated dc power supply inputs (VI- and VI+) are used to power the input amplifier stages, and must be isolated from the main dc power supply of the equipment. The VI- and VI+ terminals are usually either battery powered or powered from a dc-to-dc converter that produces a dc output from the main power supply by using a high frequency (50- to 500-kHz) oscillator. The high-frequency "power supply" transformer does not pass 60-Hz signals well, so the isolation is maintained.

Figure 8 pictures the circuit of an isolation amplifier based on the Burr-Brown 3652 device. This isolation amplifier is not generally available to hobbyists, but would be used even in small "one-of-a-kind" professional labs.

The dc power for both the isolated and nonisolated sections of the 3652 is provided by the 722 dual dc-to-dc converter. This device produces two independent ± 15 V dc supplies that are each isolated from the 60-Hz ac power source and from each other. The 722 device is powered from a +12-V dc source that is derived from the ac power source. In some cases, the nonisolated section (which is connected to the output terminal) is powered from a bipolar dc power supply

that is derived from the 60-Hz ac source, such as a ± 12 VDC or ± 15 V dc supply. In no instance, however, should the isolated dc power supplies be derived from the ac power source.

There are two separate ground systems in this circuit, symbolized by the small triangle and the regular three-bar "chassis" ground symbol. The isolated ground is not connected to either the dc power supply ground/common, or the chassis ground. It is kept floating at all times, and becomes the signal common for the input signal source.

Circuit gain is approximately:

$$\text{GAIN} = \frac{1,000,000}{R1 + R2 + 115}$$

In most design cases, the issue is the unknown values of the gain setting resistors. We can rearrange the equation above to solve for (R1 + R2):

$$(R1 + R2) = \frac{1,000,000 - (115 \times \text{GAIN})}{\text{GAIN}}$$

Where: R1 and R2 are in ohms and GAIN is the voltage gain desired

Let's work an example. Suppose we need a differential voltage gain of

(Continued on page 87)

Fig. 8. This is the circuit of an isolation amplifier based on the Burr-Brown 3652 device.

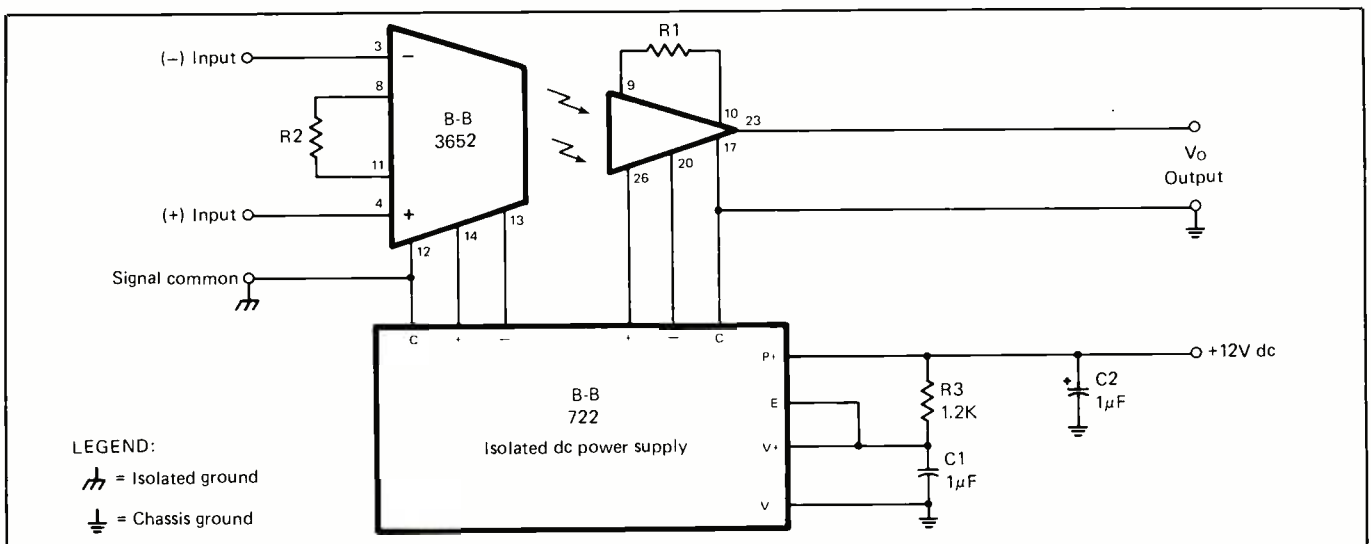

Circuit Design From Scratch

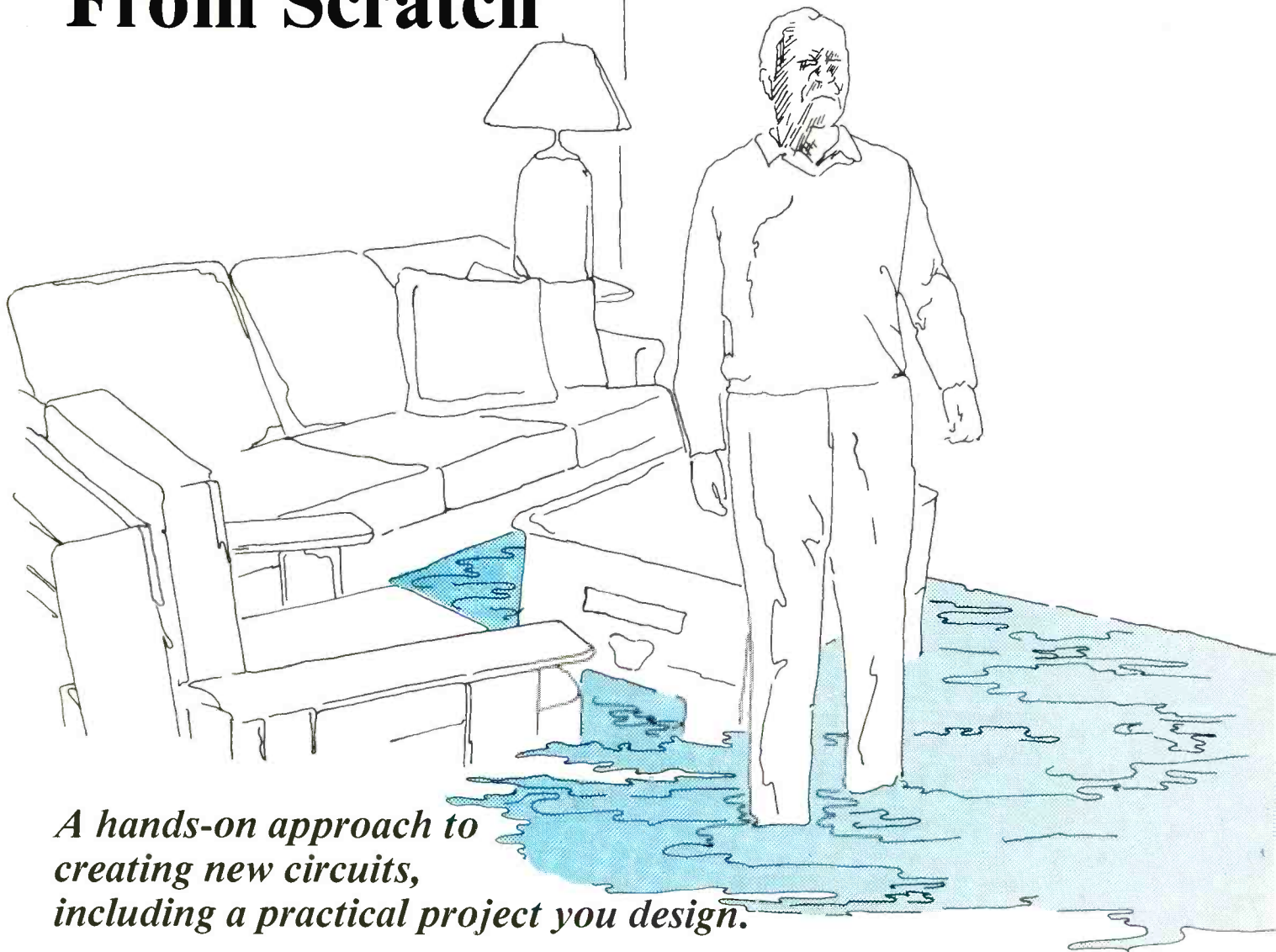

A hands-on approach to creating new circuits, including a practical project you design.

By Jules H. Gilder

As an electronics hobbyist, you've probably assembled a few kits, put together some projects that have appeared in magazines, and maybe even "designed" your own projects from ideas borrowed from magazines and books. But have you ever wondered just how you go about designing a circuit from scratch? Where do you begin? How

do you know what components to choose? How do you know how to interconnect the components?

If you've ever asked yourself these and similar questions, you're ready to take the big step. You can start with this article, which will show you how things are done, take you from the concept, through the intermediate design, and onto the final circuit-building stages.

The objective in designing a project comes from a specific need. Once you

know *what* you want a project to do, you can map out the circuits that will accomplish the objective. So, let's assume that you need a controller that will turn on and off a pump to remove the water resulting from minor flooding in your basement. This defines your need. Now you can proceed with the actual design stage.

Let's take the concept phase just a step further. Designing a controller to turn on a pump when the water reaches a certain level isn't difficult.

But having the pump continue operating when the water level drops below the high water level is another matter altogether. So, it would be wise to design into the controller the ability to turn on the pump when a certain high water level is reached and continue to operate until the water falls to some predetermined lower level. It should then turn off and remain off until the water once again rises to the high level. In addition, it would be nice if the two water levels at which the pump turns on and off could be easily adjusted.

Let's take things a step at a time:

(1) Define the Task.

Now that you know roughly what you want your project to do, you can flesh out things a little more. The first design step, then, is to define *exactly* what is to occur and in what sequence. To detect the water level electronically, you'll need some sort of sensor. For the time being, however, let's assume you have a device that will give an electrical signal when the required water level is reached.

Next, write down exactly what's going to happen when the pump is used. A handy way to do this is in tabular format, such as in Fig. 1. The first six entries define basic operation. In line 1, when no water is present or the water level is too low (no sensors covered with water), the pump should be off and the controller should keep it off. When water starts to rise and covers the low-water sensor, nothing should happen (line 2). Only when the water has risen to the high water mark and covers the second sensor (line 3) should the controller turn on the pump. Once the pump is on, it should remain on as long as both sensors are activated (line 4). As the pump drains the water and the level drops below the high-water mark (and sensor) but is still above the low-water mark, it should continue pumping (line 5). Finally, when the pump reduces the level of the water to below the low-water mark, the pump should turn off (line 6).

	(A) Low Sensor	(B) High Sensor is on	(C) Pump Turn or Keep On	(D) Pump Turn or Keep On
1.	Dry	Dry	No	No
2.	Wet	Dry	No	No
3.	Wet	Wet	No	Yes
4.	Wet	Wet	Yes	Yes
5.	Wet	Dry	Yes	Yes
6.	Dry	Dry	Yes	No
7.	Dry	Wet	No	Yes
8.	Dry	Wet	Yes	Yes

Fig. 1. Make up a list of your needs.

Lines 7 and 8 in Fig. 1 have been added as a safety measure that deals with the problem of a sensor failure. This feature tells the pump to turn on when rising water triggers the high-level sensor even if the low-level sensor fails and tells the system that conditions are dry.

Summarizing your needs in the tabular format shown in Fig. 1 completes the most important design phase. Knowing exactly what the circuit should do and when it should do it helps later on in determining if the circuit is working properly because it sets a standard against which to measure performance.

(2) Design Approach.

In addition to clarifying the function of the pump controller and summarizing its operation, Fig. 1 also helps you decide what approach should be taken for the design of the system. There are eight distinct conditions the controller circuit must meet. Looking at columns A and B and then at columns C and D you can readily see that in each case only one of two possible conditions can exist—wet or dry in columns A and B and yes or no in columns C and D. Since there are only two conditions with which the circuit must cope, you have a binary situation that suggests a *digital* approach to circuit design. On the other hand, if your definition of the task required continuous operation, such as generation of a voltage that varied in level with changing water level, an analog approach would have been more appropriate.

In digital circuits, only one of two conditions exist. Something is either on or off. To make the design rules universal, digital designers use easily recognizable symbols to define the on and off states. These symbols are the digits 1 and 0 for on and off, respectively. Hence, in Fig. 1, "wet" could be replaced by a 1 and "dry" by a 0. Rewriting the Fig. 1 table in binary yields the Fig. 2 table.

	(A) Low Sensor	(B) High Sensor is on	(C) Pump Turn or Keep On	(D) Pump Turn or Keep On
1.	0	0	0	0
2.	1	0	0	0
3.	1	1	0	1
4.	1	1	1	1
5.	1	0	1	1
6.	0	0	1	0
7.	0	1	0	1
8.	0	1	1	1

Fig. 2. Truth table of your needs list.

Rules of Logic. Before proceeding, it's important that you know something about digital logic and the digital elements that will perform the functions you wish to implement. So here's a short course on the subject.

Digital devices can perform several different types of operations called logical functions. The three most basic functions, upon which all the others are built, are known as the AND, OR, and NOT functions. Understanding the principles of each of these operations will give you a firm foundation upon which to develop your digital design skills.

Let's look at the simplest first—the NOT function. This is simply a device that takes a single input and outputs the opposite of it. The diagram for the digital logic element that performs this function is shown in Fig. 3. If you feed a 0 into the NOT element, the output would be 0, as shown, and vice-versa. Hence, the output is *not* the same as the input, and thus the name for this logic element. Another name for the NOT element is "inverter."

In examining the symbol for the NOT element in Fig. 3, you will note that there is a small circle at the apex

of the triangle. This circle is universally used in digital electronics to indicate a not or invert function. If there were no small circle at the apex of the triangle, the input and output would be identical and the device would be called a "Buffer." The purpose of the buffer is to isolate signals sent to it from other circuits.

In addition to assigning special symbols to each of the various logic operations, digital designers have devised a shorthand method of defining the logical operations that can be performed. As we did in Fig. 2, the summaries are in tabular format, using 1s and 0s to represent the two logic states. These summaries are called "truth tables." The NOT truth table is shown to the right in Fig. 3.

The next logic function we'll examine is the OR function, whose symbol is shown in Fig. 4, along with its truth table. An OR device must have two or more inputs and one output. When examining the symbol for the OR device (also known as the OR "gate"), note that there is no small circle at its output, indicating that no signal inversion takes place.

The rules of operation for the OR gate state that an output signal will occur if there is an input signal on any one or more input lines. Thus, examining the truth table for this device, if input A is 1 or input B is 1 or both inputs A and B are 1, the output (C) will also be 1. The only time there will be no output signal is when both input A and input B have no signal applied to them. (In Fig. 4 only two inputs are shown to the OR gate. Actually an OR gate can have any number of inputs, though there is a practical limit to the number you'll find in available IC gate packages. Additional inputs would be added to the truth table as columns between input 2 and output. The same rules apply in any case. More than two inputs can be given to any of the logic elements discussed here *except* for the inverter and the buffer elements.

The last of the basic logic operations is the AND function. The symbol for this gate and its truth table are

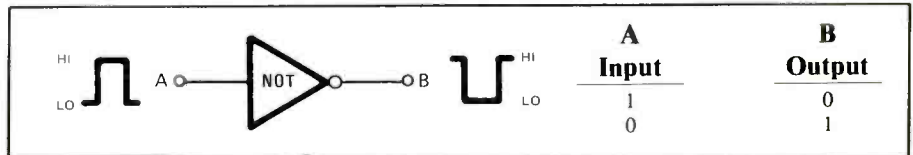

Fig. 3. The NOT gate is so named because its output is the opposite of its input. Hence, the NOT gate is also commonly referred to as an "inverter."

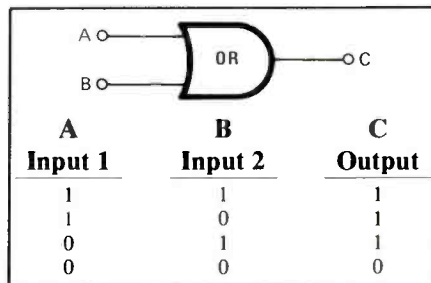

Fig. 4. The schematic/logic symbol and truth table for the OR gate.

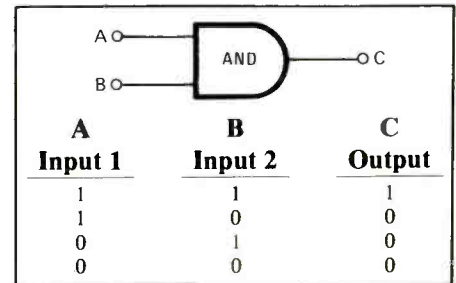

Fig. 5. The schematic/logic symbol and truth table for the AND gate.

shown in Fig. 5. Like the OR gate, the AND gate must have two or more inputs and one output. The rules for operation of the AND gate state that an output signal will occur only if there are signals on *all* input lines simultaneously. If any one or more input lines doesn't have a signal on it, there will be *no* output.

Now that you're familiar with the basic building blocks used in digital circuit design, you must take your knowledge one small step further. That is, you should also be aware that there are complementary devices to the OR and AND devices, known as the NOR and NAND functions. Technically, these are the NOT OR and NOT AND functions and, as you may already have surmised, are implemented by combining NOT gates (inverters) with the standard OR and AND gates. The symbols for these two types of gates are given in Fig. 6. Note in the truth

tables for each of these gates how the outputs differ from those in the truth tables in Fig. 4 and Fig. 5 with the same output conditions.

Reading A Truth Table. When you read a truth table, such as that for the NAND gate, you say that output C is equal to 1 when input A equals 1 and input B is not equal to 1, or when input A is not equal to 1 and input B is equal to 1, or when input A is not equal to 1 and input B is not equal to 1. This description of what's happening is awkward and doesn't lend itself to easy analysis or manipulation. To overcome this problem, English mathematician and logician George Boole in 1847 published a "Mathematical Analysis of Logic" pamphlet in which he stated a mathematical way of expressing the relationships between logical statements. Thus was born Boolean algebra.

In Boolean algebra, the AND func-

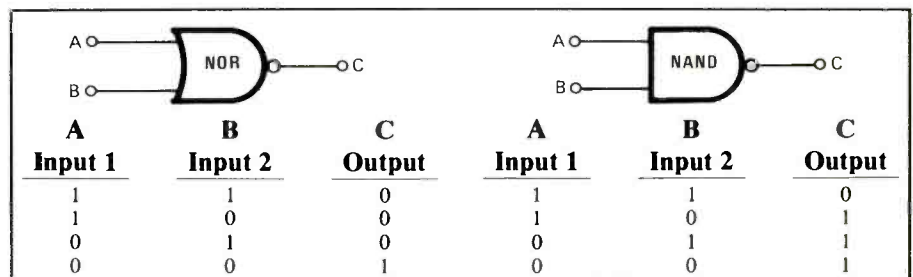

Fig. 6. Shown here are the schematic/logic symbol for the NOR (left) and NAND (right) gates, along with the truth tables that define their operation.

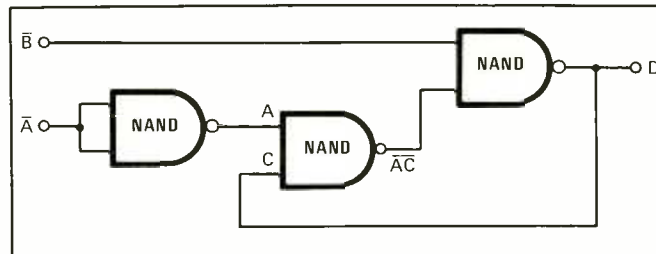
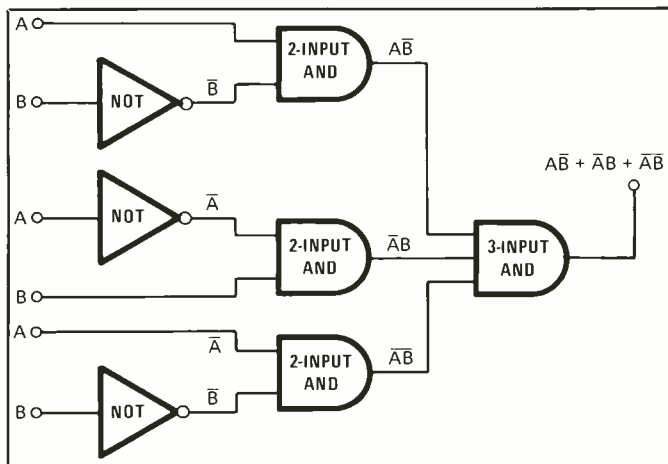

Fig. 8. The basic circuit of the water-pump controller has only three NAND gates.

Fig. 7. By using a combination of AND gates and inverters (NOT gates), you can construct a 2-input NAND gate, as shown here. Note the complexity of the circuit.

tion is represented by multiplication and the OR function by addition. The NOT function is represented by placing a bar over the variable that represents the input to the circuit. Thus, AB is read as A and B; $A + B$ is read as A or B; and \bar{A} is read as not-A, or the inverse of A.

Returning to the NAND truth table in Fig. 6, you begin writing the Boolean equation by first marking off only those rows that have a 1 in the output column, since all you're interested in are the conditions that generate an output. Now, working one row at a time, construct the equation. Since there are three rows that have a 1 in the output column, your equation will have three terms.

For the first term, C equals 1 if A equals 1 and B is not equal to 1:

$$C = A\bar{B}$$

This is only part of the equation. Note that C also equals 1 if the condition in the next row is true or the condition in the last row is true. Since $C = 1$ for row 2 or row 3, a plus sign will be used to connect the terms in your equation. The next term comes from row 3 in the truth table. Here, $C = 1$ if A is not equal to 1 and B is equal to 1. Similarly, for row 4, $C = 1$ if A is not equal to 1 and B is not equal to 1. Therefore, the equation becomes

$$C = A\bar{B} + \bar{A}B + \bar{A}\bar{B}$$

By writing the Boolean equation for your circuit, you have taken a major step in synthesizing digital circuits. From the above equation, you

can now use AND, OR, and NOT gates to construct the equivalent of a NAND gate, as shown in Fig. 7.

If you connect all As together and all Bs together in the Fig. 7 circuit and apply 1s and 0s to the circuit according to the truth table, you'll find that the output corresponds exactly with that in the truth table. Obviously, this is a rather complex, although functional, circuit. If you could simplify the equation so that it had fewer terms in it, your circuit would become simpler. Since you already know in advance that this function can be implemented with a NAND gate, you also know that your equation can be reduced to only one term.

To simplify your equation, you'll have to use some rules of Boolean algebra. The ones you'll be using are:

1. $X + XY = X + Y$
2. $XY = X + Y$
3. $X(Y + Z) = XY + XZ$
4. $X + X = 1$
5. $X + XY = X + Y$
6. $X + Y = XY$

Using these relationships, you can now simplify your equation, starting with:

$$C = A\bar{B} + \bar{A}B + \bar{A}\bar{B}$$

Using rule 3, you get

$$C = A\bar{B} + \bar{A}(B + \bar{B})$$

Then, from rule 4, you get:

$$C = A\bar{B} + \bar{A}$$

And from rule 1, you get:

$$C = \bar{A} + \bar{B}$$

Finally, from rule 2, you get:

$$C = A\bar{B}$$

From the foregoing, you can see that the original equation for a NAND gate that was composed of AND, OR and NOT gates has been reduced to an equation of one term, which represents the equation for a NAND gate. Similarly, the circuit in Fig. 7 reduces to the simplified NAND gate in Fig. 6.

(3) Developing An Equation

Now that you know how to convert a truth table into an equation, you can proceed to the next step in your circuit design—converting the truth table that defines operation of the pump controller into an equation. You do this in the same way as you did for the NAND truth table.

Referring back to Fig. 2, you can see that the output column (D) has five rows in which 1s appear. This means that your equation will initially have five terms in it and that you're probably going to want to simplify it later. Using the same technique as above, you write out the equation as

$$D = A\bar{B}\bar{C} + A\bar{B}C + A\bar{B}\bar{C} + \bar{A}\bar{B}\bar{C} + \bar{A}\bar{B}C$$

Next, using rule 3, you get

$$D = B(A\bar{C} + AC + \bar{A}\bar{C} + AC) + \bar{A}\bar{B}C$$

$$D = B[A(\bar{C} + C) + \bar{A}(\bar{C} + C)] + \bar{A}\bar{B}C$$

Now, using rule 4, you get

$$D = B(A + \bar{A}) + \bar{A}\bar{B}C$$

$$D = B + \bar{A}\bar{B}C$$

(4) Optimizing The Equation And Circuit

Although the last equation represents a considerable simplification of the

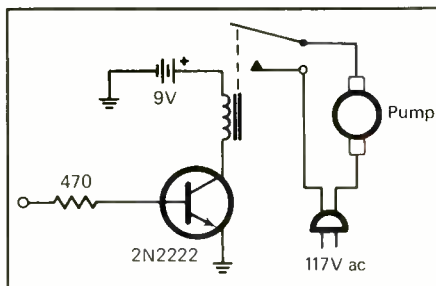

Fig. 9. Pump controller drive circuit.

original, implementation would require you to use a 3-input AND gate, an OR gate, and an inverter. Digital logic devices are typically sold with several gates per chip, and buying three chips to implement this function, while inexpensive, would be wasteful. Therefore, you should try to simplify your equation further.

To do this, you'll use rule 5, setting $X = B$ and $Y = AC$. By substituting these values in the equation, you get

$$D = B + A\bar{B}C = B + AC.$$

Using rule 6 and again setting $X = B$ and $Y = AC$, you get

$$D = \bar{B}AC.$$

Now you have only one term, and only two NAND gates and a NOT gate are needed if the inputs from the water sensors supply inverted signals. This is great, because 2-input NAND gates come packaged four to an integrated circuit. Plus, if the two inputs to a NAND gate are shorted together, the gate operates like an inverter (see lines 1 and 4 in the NAND gate truth table in Fig. 6). Hence, you can construct the controller from a single integrated circuit and still have one NAND gate left over. The basic circuit is shown in Fig. 8.

(5) Choosing An IC

Having decided on the design of the logic portion of the controller, you must now decide on what IC you're going to use to build the circuit. Unless you have specific reasons to do otherwise, I suggest you use a CMOS IC, because it requires very little power and is fairly insensitive to variations in supply voltage. (Any source that delivers up to +16 volts

dc can be used to power a circuit built around a CMOS digital IC.)

The ideal choice of a CMOS IC for your controller is the 4011 quad 2-input NAND gate. If you prefer, however, you can substitute a 7400 TTL device for the 4011, but if you do, make certain that the voltage delivered to it from the power supply doesn't exceed 5.25 volts.

Interfacing To The Pump

You've completed the difficult part of designing your controller. Now all that's left to do is interface the controller to the real world. The first thing you must do is connect the controller to your pump. But you can't do this directly, since the controller can't deliver enough power to directly drive the pump, nor can it handle the ac power that the pump requires. Instead, you're going to design an "interface" circuit to accomplish your goal. In this case, the interface circuit consists of a driving transistor that takes the low current output from the logic circuit and amplifies it to operate a relay. In turn, the relay delivers ac line power to the pump.

The design of the interface circuit hinges upon your selection of a relay. Since it's assumed that you want low-power operation to permit use of a battery or perhaps an ac adapter from a tape recorder, a 5-volt relay with a 72-mA coil current (see Parts List) neatly fills the bill. The contacts of the specified relay are rated to handle 125 volts ac at 3 amperes, which is sufficient to handle most pumps. If your pump draws more than 3 amperes, choose a relay whose contacts will handle the higher load.

Choosing a transistor is your next step. Since the controller is going to output a positive voltage level (logic 1) when the pump should turn on, you need a transistor that will turn on when a voltage is applied to its base. Npn transistors operate this way. Your choice of transistor isn't critical; virtually any npn silicon device will do. The only thing you have to be careful about is to make sure that the

maximum deliverable current from the transistor isn't lower than the current required to energize the relay's coil. Because the specified relay requires only 72 mA, a commonly available and low-cost 2N2222 transistor, with a maximum collector current rating of 800 mA, is a good choice here.

Since the relay's coil is an inductive device, on turn-on, it can generate a high-voltage spike that can damage the rest of the circuit. To obviate this possibility, you'll want to connect a diode across the coil. Again, your choice of diode isn't critical. In fact, just about any general-purpose rectifier diode will serve. A typical example is the 1N4148 diode specified in the Parts List.

Finally, a current-limiting resistor should be connected to the base of the transistor. Any resistor whose value is between 220 and 1000 ohms will do. A 470-ohm resistor is specified because that's what I had on hand when I built my circuit.

Once you have the relay connected to the controller and operating properly, you must connect it to the pump. You can do this by simply placing the switching contacts of the relay between the "hot" side of the ac power line and the pump, as shown in Fig. 9.

(7) The Water Sensor

You're now coming into the home stretch. There's just one more thing to do—design the water sensor—and the project will be complete.

There are lots of ways of determining when water reaches a certain level. Most of them rely on some sort of mechanical movement to turn on a switch. The preferable approach, however, is to use the simple, direct approach of electrical detection.

To detect the level of the water, you'll use two electrodes and take advantage of the fact that most of the water around isn't pure. Unless it's distilled, water almost always contains some impurities that convert it from a nonconductor to a modest conductor of electricity. When two probes (metal wires, bars, etc.) are

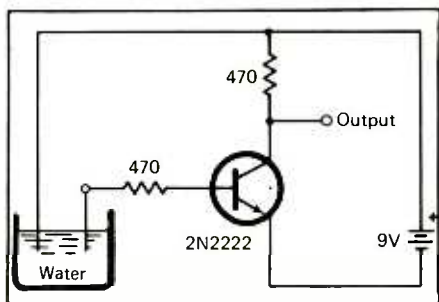

Fig. 10. Water sensor circuit.

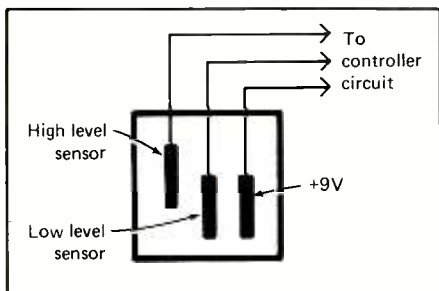

Fig. 11. Details of water sensor.

placed in water and a battery is connected to them, a current will flow through the water.

A sensor requires two probes. One goes to the positive (+) side of the circuit's power supply, the other to some device that can use a low current to produce a switching action. The switching device is a transistor. Once again, you can use a 2N2222 transistor, since by design it's a switching device.

The circuit for the sensor portion of the project is the same as for the relay driver in the interface circuit, except that the relay is replaced by a 470-ohm resistor (Fig. 10). The output is taken from the point where the resistor joins the collector lead of the transistor. Operation of this circuit is summarized in the truth table that accompanies the schematic in Fig. 10. Closer inspection will reveal that this truth table is identical to that for the NOT gate. Hence, the sensor circuit fulfills the inverted-output requirement for the controller's logic section.

Because your circuit is going to be detecting two water levels, it will need two identical sensors. The level adjustment is made by simply spacing

the sensor wires at different levels. Since both sensors are to connect to the same circuit, it isn't necessary to have two separate wires from the positive side of the power supply. One is sufficient. A convenient way to arrange the three probes is to fasten them to a piece of plastic (see Fig. 11), with the power lead and low-level sensor placed at the same level and the high-level sensor placed higher up.

(8) Putting It All Together

Now that you've designed all the bits and pieces, you must construct the circuit. A complete schematic of the entire controller is shown in Fig. 12. Shown are all sensors, the controller logic circuit, and pump interface. In fact, everything but the pump itself is shown. The reason for this is that, strictly speaking, the pump isn't part of the project. It's a device all its own, with its own ac power cord.

This being the case, all you need to use the controller with the pump is a convenient way to plug it in, which is provided by the chassis-mount ac receptacle, SO1.

Construction of the project is simple and straightforward. The very few components that make up the circuit obviate the need for a printed-circuit board (though you can use one of your own design if you wish). The whole system can be hand-wired in about a half hour on a piece of breadboard or a solderless socket.

The only thing you must be a bit cautious about during construction is the CMOS IC. This device can be permanently damaged by mishandling. But if you don't walk across a carpet on a dry day just before handling the IC, you should have no problems. If you want to avoid problems, you can use an IC socket and keep the IC aside until everything is wired and ready to go.

ME

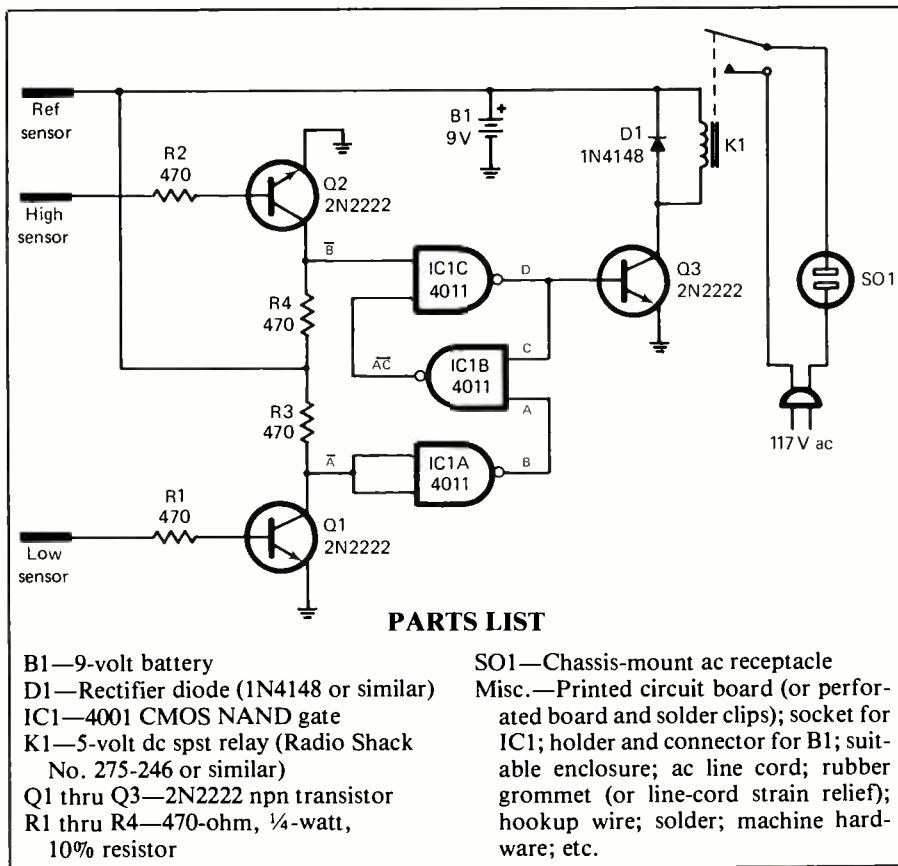

Fig. 12. This is the overall schematic diagram of the water-pump controller. The only element not shown is the pump itself, which plugs into socket SO1.

STOP DREAMING START BUILDING

HANDY MAKES IT EASY!

Build anything from computers to LED flashers... any project you want the fast, easy, fun way. Use HANDY solderless breadboards to build, test, modify and expand your ideas.

**SATISFACTION GUARANTEED
OR YOUR MONEY BACK!**

JUST LOOK AT THESE SOCKET FEATURES...

- Full contact labeling — simplifies component layouts
- New durable clip design assures reliable, low resistance, corrosion-free interconnections
- High temp plastic — no warping or melting...ever!
- Self-adhesive backing — mounts anywhere
- Big 9 14-pin IC capacity per socket
- Expands horizontally and vertically

HB-0100. 1 Buss Strip.
100 tie points. Compares
at \$3.00!
\$2²⁵

HB-1000. 1 Socket Strip.
640 tie points. 9 14-pin
IC capacity. Compares at
\$12.50!
\$9⁹⁵

HB-4714. 4 Socket Strips.
7 Buss Strips. 4 Binding
Posts. 3260 tie points.
36 14-pin IC capacity.
Compares at \$89.00!
\$63⁹⁵

HB-2312. 2 Socket Strips.
3 Buss Strips. 3 Binding
Posts. 1580 tie points.
18 14-pin IC capacity.
Compares at \$51.50!
\$31⁰⁰

HB-2112. 2 Socket Strips.
1 Buss Strip. 2 Binding
Posts. 1380 tie points.
18 14-pin IC capacity.
\$24⁹⁵

HB-1110. 1 Socket Strip.
1 Buss Strip. Ground plate.
740 tie points 9 14-pin
IC capacity. Compares at
\$15.50!
\$11⁹⁵

HB-1210. 1 Socket Strip.
2 Buss Strips. Ground plate.
840 tie points. 9 14-pin
IC capacity. Compares at
\$18.50!
\$13⁹⁵

HB-3514. 3 Socket Strips.
5 Buss Strips. 4 Binding
Posts. 2420 tie points.
27 14-pin IC capacity.
Compares at \$66.00!
\$47⁹⁵

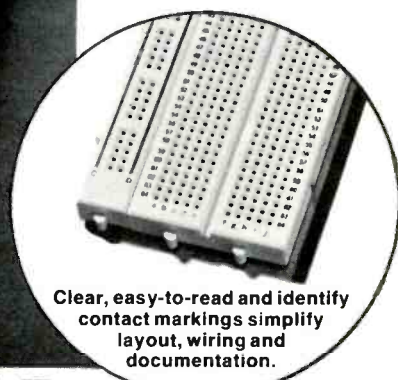
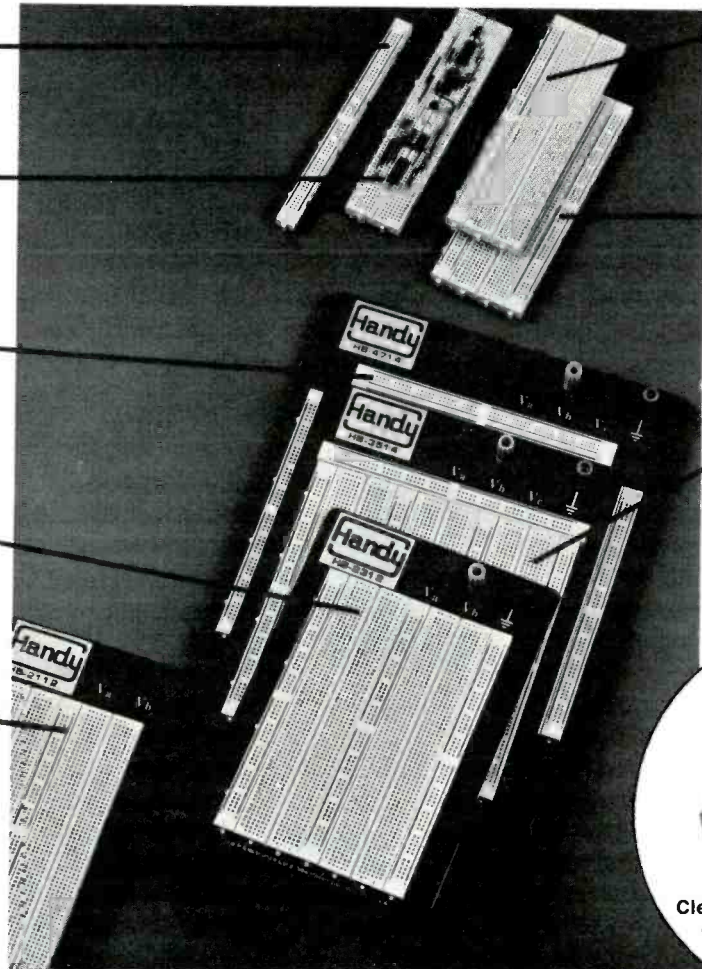

Clear, easy-to-read and identify
contact markings simplify
layout, wiring and
documentation.

FOR LESS!

Available at Selected Distributors throughout the USA and Canada
HANDY PRICES ARE UP TO 25% LESS THAN COMPETITORS!

**SEND FOR
FREE
Colorful
Brochure!**



a division of RSP Electronics Corp.

7 Business Park Drive • P.O. Box 699 • Branford, CT 06405

Telephone: (203) 488-6603

TWX: (910) 997-0648

CompuServe: 71346, 1070

Easy Link Mail Box: 62537580



ORDER TOLL FREE

1-800-34-HANDY
charge with VISA or
MasterCard. All items
off-the-shelf for
Immediate Shipment!

Mail Orders: Please add \$3 (Canada & Int'l add \$5) for shipping/handling.
Charge Cards: (Min. \$15). Please include Acct. No., Exp. Date and your signature.
Checks: drawn in U.S. Dollars on U.S. banks only. C.O.D.'s accepted.
Connecticut Residents: Add 7.5% Sales Tax.

CIRCLE 22 ON FREE INFORMATION CARD

November 1984 / MODERN ELECTRONICS / 63

Surge Protection

Protecting computers and electronic equipment from damaging effects of electrical spikes and surges

By TJ Byers

Snap, crackle and pop may be pleasant breakfast sounds to some people, but to an owner of a computer, amateur radio transceiver or other expensive electronic gear, they spell trouble. I am referring to the ever-present menace of lightning. Every year, damage done to computers alone by lightning runs into the millions of dollars. And whether you like it or not, your costly equipment could be next.

Protecting your system from the damaging effects of lightning, however, is not as big a chore as you may imagine. In this article I will show you how to do it for \$10 or less. But before we get started, let's take a look

at lightning and how it gets into a system in the first place.

Lightning Spikes

Destructive electrical energy enters your system through the only avenue available to it—your ac power cord. It is ironic that the very lifeline that feeds and sustains your computer and other equipment is also responsible for its demise. The electricity delivered to your home has probably traveled through hundreds of miles of wire and several substations before it reaches you. Herein lies the problem.

A typical lightning flash is composed of many short-duration feeler strikes. A single bolt may contain as many as a hundred individual discharges that, when viewed together,

appear as one—much like the scanned dots on a TV screen merge to form a picture.

When lightning strikes, it does so with a force of millions of volts. The rapid succession of feeler strikes produces huge amounts of radio-frequency radiation. In fact, the largest part of it falls below 8 MHz, and you can actually hear lightning (other than the thunder) by listening to an AM radio during a thunderstorm. The high-frequency radio waves are picked up by your radio's antenna and delivered to the speaker as an annoying crackling sound.

In a similar fashion, the sprawling utility grid picks up noise from lightning, when lightning strikes close to a power line, the wires act like a large antenna and absorb part of the radia-

An ideal location for surge-protection devices is inside a grounded ac power-distribution strip like this Archer 6-outlet model from Radio Shack or another manufacturer.

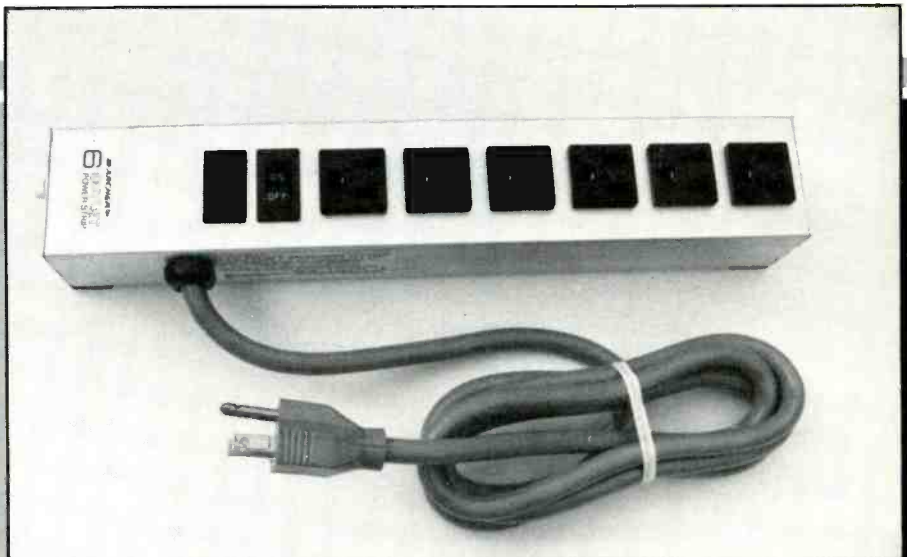

tion. Voltage spikes as high as 6000 volts can easily be injected into the power grid in this manner and be distributed throughout the network. It is not unusual for a lightning strike many miles away to affect you. The voltage spikes travel from the strike down the wires, into your home, and right into your computer.

Power-Line Disturbances

Power-line disturbances are generally divided into two types, *spikes* and *surges*. Although the terms are often used interchangeably, shorter-duration phenomena are usually considered spikes (10 to 500 μ s), whereas high-voltage disturbances lasting longer than 500 microseconds are looked upon as surges. Therefore, lightning-induced transients are classified as spikes.

But lightning is not the only source of electrical pollution found on your ac power line. Potentially harmful electrical disturbances come from all sorts of places, some of which are closer than you think.

Each time your air conditioner cycles, for instance, the compressor motor places a big high-voltage spike on the line. Likewise, refrigerators, heaters, and other heavy appliances that

draw large currents produce momentary power surges when turned on. And believe it or not, the worst offender may be innocently seated right beside your computer—your printer.

Power surges behave differently than spikes, and are normally brought about by the collapse of a magnetic field, such as the motor in your printer. The closer the load is to your computer, the greater its influence. That is why your printer, even though less powerful than, say, a refrigerator or fan, is more influential. And while these surges are not particularly harmful, they can play havoc with a computer system. Video displays come out jumbled, memory is lost or scrambled, and keyboard entries are meaningless.

Metal-Oxide Varistors

The way to solve these problems is to limit the amount of voltage allowed on the line. In other words, clip the spikes and surges. Fortunately, there is an easy and inexpensive way to do this that uses a device called a *metal-oxide varistor* (MOV).

Basically, the MOV is a voltage-dependent resistor that behaves somewhat like two back-to-back zener diodes. That is, it is a nonlinear de-

vice that has a specific breakdown voltage. The MOV is made of zinc oxide combined with small amounts of bismuth, cobalt, and manganese. The zinc oxide combines with the other elements to form an array of p-doped and n-doped semiconductor junctions. The junctions align themselves to form a disoriented array of series and parallel paths that the electrons will ultimately follow. The diversity of this microstructure is what causes its nonlinear semiconductor properties.

When a voltage that is lower than the threshold voltage of the MOV is applied across it, the MOV acts like a nonconducting open circuit. But if the applied voltage exceeds the MOV breakdown voltage, it begins to conduct, effectively clamping the input voltage to a safe level. In other words, the MOV safely absorbs the voltage transient and dissipates the energy as heat.

The physical dimensions of the MOV determine its electrical characteristics. MOVs are available in a wide range of operating voltages and currents, ranging from 5 to 3000 volts and peak currents up to 50,000 amps. Their response time is measured in mere nanoseconds (typically 35 ns). ▶

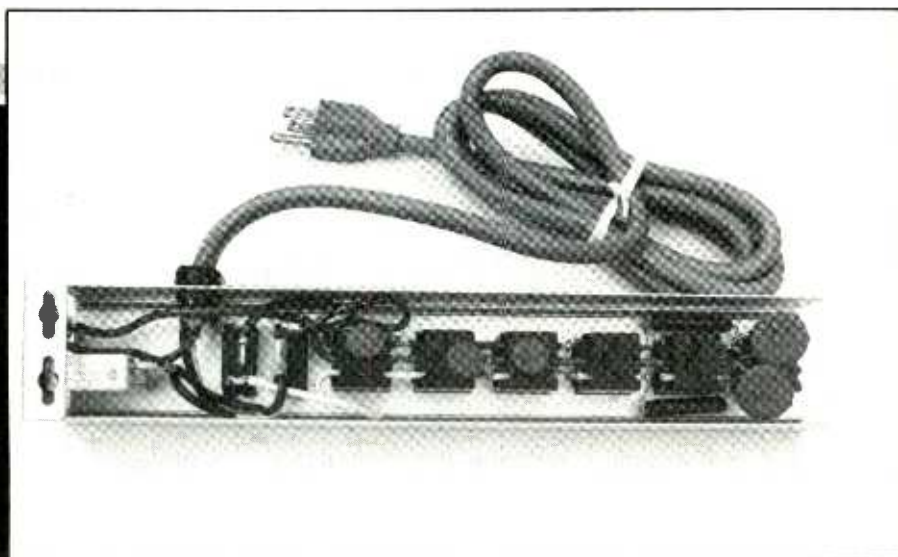

After wiring them into place, fold the MOV devices flat against the ac sockets as shown. The capacitors and r-f chokes wired across the end two sockets make up a noise filter.

As you may have guessed by now, MOVs lie at the heart of our surge protection devices. The amount of protection you need, however, depends upon your system. Therefore, I have devised three protection projects for you to choose from, each with varying degrees of protection.

Good Protection

The first of these devices is also the simplest, because there is nothing to build. It comes already assembled. This product, which is sold by a variety of companies under the name of *Voltage Spike Protector*, contains a single MOV device that is connected across the two prongs of the power line (Fig. 1). Any transient in excess of 130 volts is readily suppressed by the MOV and is prevented from entering your equipment.

To use the spike protector, simply plug the computer into the adapter and insert the adapter into the wall outlet. That's it.

Unfortunately, the Voltage Spike Protector does not protect against all forms of power surge. If the lightning strike is such that a voltage spike of equal proportions is induced into both wires, the MOV cannot sense it. This kind of power-line disturbance is termed *common-mode voltage*. As far as the MOV is concerned, the voltage between the two power legs is just fine, even though they may be riding on a power surge thousands of volts above ground!

Better Protection

To alleviate the foregoing problem, I constructed the second of the surge protectors. It contains three MOV devices. One is wired across the hot and neutral lines of the ac input, just like in the "good" version mentioned. To keep common-mode spikes from creeping into the system, though, two additional MOVs are added, each extending to ground from the power-line legs (Fig. 2). With this arrangement, the outlet

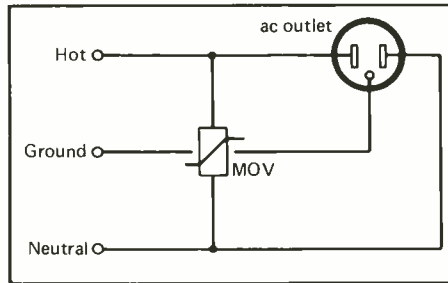

Fig. 1. Good protection is provided by any number of commercial products with MOV devices.

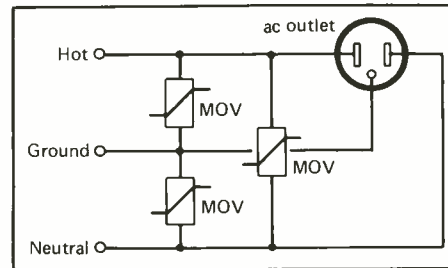

Fig. 2. Better protection is afforded when three MOV devices are wired across the prongs as shown.

voltage can never be more than 130 volts in any direction.

Duplicating the surge protector is relatively straightforward and something you can do in a matter of minutes. First, obtain a six-outlet expansion socket, such as Radio Shack's 61-2622, and remove the cardboard back. To do this you must unbolt the four screws located in each of the corners. These screws are actually coarsely-threaded rivets that can be backed out with a standard slot screwdriver in a turn or less.

With the cover removed, you are faced with six copper strips that are used to expand a two-outlet socket into six. If you have the misfortune, as I did, of having the metal strips tumble into your hands along with the cardboard back, do not panic. Simply shove them back into their respective slots with a firm thumb.

The next step is to solder the MOV devices in place. There is plenty of room inside the plastic cover to accommodate them; just be sure noth-

ing touches that could short something out. Using the photo as your guide, slip the MOVs into position and solder them in place. Remember, one MOV goes across the lines, another connects between the thin prong and ground (the stripe with the round inserts), and the third is soldered between the remaining prong and ground. It does not make any difference which direction you insert them, because MOVs are bidirectional devices.

Now replace the back. Remove the wall plate from the wall socket and fasten the surge protector in place using the long screw supplied with the adapter. Henceforward, when you plug your computer into this outlet, it will be protected from all forms of voltage surge.

Best Protection

But even this protection is not enough in some cases. Though your computer is protected from the lethal effects of voltage spikes, it is still susceptible to electrical noise. Noise can best be described as unwanted voltage excursions which fall within the limits of the MOV protector. In effect, it is small signals which ride atop the power-line voltage, but are not

Parts List

GOOD

- (1) Voltage Spike Protector

BETTER

- (1) 6-Outlet Plug
- (3) Metal-Oxide Varistor (see sidebar)

BEST

- (1) 6-Outlet Power Strip (Radio Shack 61-2619A)
- (3) Metal-Oxide Varistor (see sidebar)
- (2) 100- μ H r-f Choke (Radio Shack 273-102)
- (2) 0.047- μ F, 500 V disc Capacitor

particularly harmful to the system. What noise does to a computer, though, is scramble the data contained in the memory chips. Words come out misspelled and, in extreme cases, data is lost altogether.

To remove unwanted noises from an ac line, you need a filter . . . which brings us to our third design. In addition to being MOV protected, the last option incorporates a filter for the removal of noise from the power line. This is the kind of noise you are likely to experience from your printer.

The entire project is built inside a Radio Shack Power Strip (part number 61-2619A). This power strip has a single, heavy-duty cord that expands to six outlets housed in a sturdy metal case. As added features, the power strip comes equipped with a built-in 15-amp circuit breaker, and off/on switch, and power indicator lamp.

To modify the power strip, the aluminum housing must be split in half. This is accomplished by simply removing the eight screws that secure the two end plates. However, this is easier said than done. For whatever reason (I suspect safety), the retaining screws have recessed square-drive heads that require a special tool to turn them. After several false starts, I finally elected to file a groove in the screw heads and twist them out with an ordinary slot screwdriver. Once the screws were removed, I threw them away and replaced them with conventional Phillips-head screws. I strongly suggest you do the same.

With the end plates out of the way, the lower half of the metal case easily slides off, exposing the bottoms of the outlets. Begin the modification by removing a short strip of insulation from each of the three wires connecting the first four sockets together. An X-acto™ knife works best. Now solder the three MOVs to these wires, bridging one across the black and white wires, one cross the black and green, and one across the white and green. After soldering, bend the leads so the MOVs rest against the

back of the outlets, as illustrated .

Next, we will work on the link connecting the last two sockets, numbers 5 and 6 as you count from the breaker end. With a pair of wire cutters, completely remove the section of the black and white wires between sockets 4 and 5, leaving a small pigtail connected to the fourth socket. Strip the insulation from the pigtails. DO NOT cut the green wire!

This last operation divides the

power strip into two sections. Into the severed portion of the line will be inserted the filter. Before you can do that, though, you must remove a small piece of insulation from the three wires joining outlets 5 and 6, just like you did when installing the MOV devices.

Solder an r-f choke from the black pigtail of socket 4 to the freshly exposed black wire between 5 and 6. Then do the same for the white wires.

Lightning Bolts

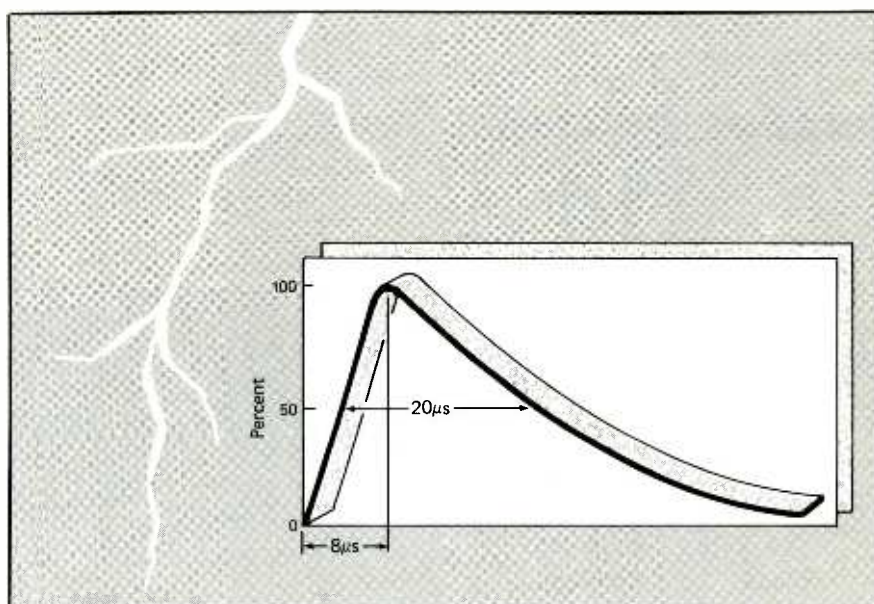

A typical lightning strike is characterized by more than one stroke per flash with peak currents of 20,000 amps or higher. The lightning bolt travels a crooked path to the ground. The path is created by the feeler current as it ionizes its way through the atmosphere, thereby producing the classic zig-zag pattern. Lightning-induced power-line spikes of up to 6000 volts have been recorded with rise times as short as 500 nanoseconds. In an effort to standardize a "typical" stroke, the

IEEE has proposed the above wave-shape. Based on both RFI (Radio-Frequency Interference) and EMI (ElectroMagnetic Interference) measurements, they developed the so-called 8/20 μ s-pulse theory. This representative pulse has an 8- μ s linear rise time to its crest, graduating to an exponential decline to zero. Pulse width, at the 50% points, is defined as 20 microseconds. The performance of all surge-protecting devices, including MOVs, is gauged according to this standard.

LISTEN UP!

Here's what you've been looking for — an all new hard-hitting monthly magazine which gives a unique insider's view of what's really going on in the world of communications. POP'COMM is your primary source of information — bigger and better than any communications magazine, with exciting coverage of scanners, shortwave broadcast & utility stations, spy stations, pirate and clandestine broadcasters, RTTY monitoring, survivalist communications systems, FCC news, wiretapping and bugging, scrambling/unscrambling, surveillance/undercover communications, satellite & cable TV, sophisticated telephones, & more. What you've been looking for all along! Take advantage of substantial savings over the newsstand price by subscribing now. Don't miss out on even one single issue of POPULAR COMMUNICATIONS — order your subscription now.

Twelve Issues
\$14

Name _____
Street _____
City _____ State _____ Zip _____

Paid by: Check Money Order MasterCard Visa
My account number is _____

- 1 Year (12 issues) \$14.00
Newsstand price \$23.40
- 2 Years (24 issues) \$25.00
Newsstand price \$46.80
- 3 Years (36 issues) \$36.00
Newsstand price \$70.20

POPULAR COMMUNICATIONS

76 N Broadway, Hicksville, NY 11801

Yes! The NEW POPULAR COMMUNICATIONS is just the magazine I've been looking for. Start sending it to me now! I understand that I may cancel at any time for any reason, and receive a full refund on my unused subscription.

Finally, connect a 0.047- μ F disc capacitor across the green and white leads, laying the capacitor out of the way after installation. Another 0.047- μ F capacitor connects across the black and green leads of the last two receptacles.

The power-line filter is unique in that the MOVs serve a dual purpose. First and foremost, they are guardians for spikes and surges on the line. Secondly, the stray capacitance of the MOV, which is about 0.1 μ F, supplies the input capacitance needed for the pi-section filter.

When using the power strip for a computer system, you should plug the printer and other peripherals into the first four outlets. The computer itself plugs into either of the last two sockets. If your system uses a buffer interface of any sort, plug it into one of the filtered outlets.

And there you have it, three different devices to protect your computer and electronic systems against the ravages of nature. It must be noted, however, that not a one of them is a lightning arrester, so in the rare event that lightning actually strikes your house, damage will result. But when used as intended for everyday power line abuses, they are very effective and cheap insurance.

There are, of course, a host of commercial isolators to prevent high-voltage spikes and power-line hash from damaging or causing your equipment to malfunction. These include high load capacity, high EMI and RFI attenuation, and other refinements. But whether you build or buy, it pays to protect your investment in computers, computer data, and electronic equipment with such protective devices. **ME**

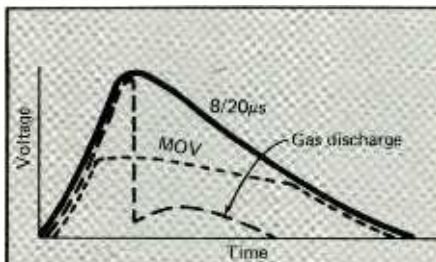

MOV Operation

The Metal Oxide Varistor (MOV) is the most popular of the surge-protection devices. Basically, the MOV is fabricated from a ceramic element composed of zinc oxide and several kinds of metal-oxide additives that have been sintered together at relatively high temperatures. The resulting structure produces a disoriented array of semiconductor junctions that behave like two back-to-back zener diodes. Suppression is achieved by clamping the input voltage to a threshold level and dissipating the surge energy as heat.

MOV Shortage

Recently, there has been a surge in the demand for MOV devices. As a result, there is currently a shortage of the devices on the market. At the time of this writing, Radio Shack was sold out of the item, though I was assured that it would be back in inventory by the time you read this article.

In the event you have problems locating enough MOVs for your particular project, you should know that they can be purchased from more than one source. I've had pretty good luck with Digi-Key (P.O. Box 677, Thief Falls, MN 56701) ordering their Panasonic line. Their part number is P7063 which retails for only \$1.21 in the current catalog. You might also obtain MOVs from your local parts distributor. Both RCA (SKMV130J) and Sylvania (ECG2V130) package the devices in their general-purpose replacement line.

Fiber-Optic Sensors

By Forrest M. Mims III

Most references to fiber optics these days relate to lightwave communications. Optical fibers, however, have many applications as sensors that are completely unrelated to communications. Moreover, unlike conventional electronic sensors, fiber-optic sensors can be made immune to electromagnetic interference and electrical shock hazards.

In this column I'll describe the most important kinds of optical-fiber sensors. Then I'll explain how to make several kinds of sensing systems based upon fiber optics.

Optical Fibers

Figure 1 shows how a light ray travels through the simplest kind of optical fiber. This fiber consists of a central core surrounded by a cladding. As long as the index of refraction of the core is *higher* than that of the cladding, the light ray will always be reflected away from the core-cladding interface and back into the fiber. Therefore the ray can travel through a bent or coiled fiber. Since there is a sharp difference in index of refraction between the core and cladding, the fiber illustrated in Fig. 1 is called a *step-index* fiber.

Over long distances, step-index fibers can introduce signal distortions that limit their usefulness in lightwave communications. This occurs when light rays take different paths through the fiber, thereby emerging from the opposite end of the fiber at different times.

Fibers intended specifically for communications often lack an abrupt core-cladding boundary. Instead, the core material gradually merges into the cladding material, thereby providing a gradual change in the index of refraction. This causes light to travel through the fiber as shown in the illustration in Fig. 2.

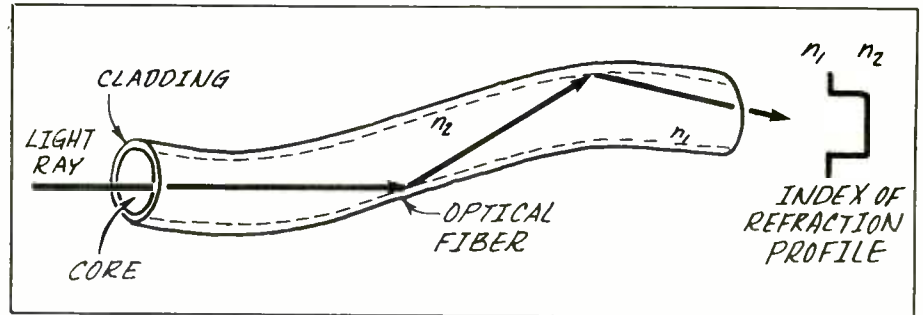

Fig. 1. How light travels through a step-index fiber.

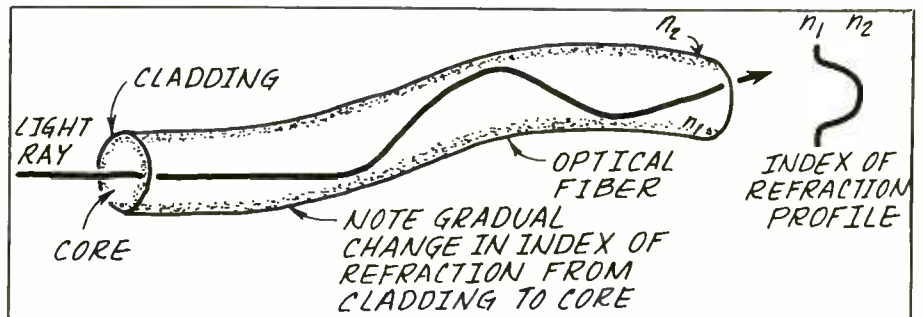

Fig. 2. How light travels through a graded-index fiber.

A fiber like the one in Fig. 2 is called a *graded-index* fiber. Since light near the cladding travels faster than light in the core, several rays injected simultaneously into one end of the fiber will arrive at the opposite end at the same time even if they follow different paths. Consequently, light travels through a graded-index fiber with considerably less distortion than light that travels through same length of a step-index fiber.

Both stepped-index and graded-index fibers can be used to make fiber sensors. Interestingly, some of the same factors that limit the usefulness of these fibers in communications make them ideally suited as sensors.

Fiber Optic Sensors

There are surprisingly many ways to make sensors that employ optical fibers. Most such sensors can be placed into either of two broad categories. The first and by far the largest category includes all applications where-

in optical fibers simply carry light to and from detectors and emitters. Since in these applications the fiber plays only a passive role, sensors in this category can be called *indirect-mode* fiber-optic sensors.

The second category includes those applications in which the light passing through a fiber is in some way altered by mechanical stress or some other force or influence upon the fiber. Since the fiber plays an active role in the sensing process, sensors in this category can be called *direct-mode* fiber-optic sensors.

If you've never before worked with fiber optics, these explanations probably seem more complicated than they really are. Actually, many kinds of fiber-optic sensors, particularly those in the indirect-mode category, are very easy to make.

Indirect-Mode Sensors

Figure 3 shows three basic kinds of indirect-mode fiber-optic sensors.

All are easily assembled and have many applications. They can each use low-cost plastic or glass fiber. Suitable light sources include light-emitting diodes (LEDs) and small incandescent lamps. If the light source is operated at a constant dc bias (i.e. unmodulated), the detector can be a low-cost cadmium-sulfide (CdS) photoresistor, solar cell, phototransistor or photodiode. If the light source is modulated, the response time of the cadmium-sulfide detector will be too slow to permit its effective use.

The in-line sensor in Fig. 3(a) is by far the simplest. In operation, a light source couples light into a fiber separated from a second fiber by a narrow gap. Normally, light crosses the gap and arrives at the detector. If, however, the end of the first fiber is moved, the light level at the detector will be reduced proportionally. If the end of the first fiber is caused to vibrate, the light arriving at the detector will be modulated at the frequency of the mechanical vibration.

In-line fiber-optic sensors can be used as vibration sensors, accelerometers, microphones and pressure sensors. They can also detect the presence of very small objects pass-

ing through the gap that separates the two fibers.

In some cases, only one fiber is required to make an in-line sensor. For example, the second fiber may be omitted if the free end of the first fiber is placed close to a light source or detector having a small emitting or detecting region.

The dual-fiber reflective sensor in Fig. 3(b) can be used to sense the presence or absence of objects. It can also detect the presence or absence of markings on paper or other material.

The dual-fiber sensor is particularly useful when there's a possibility of electrical shock. It's also very useful when the object to be detected is submerged in a liquid, perhaps one that's very hot and corrosive. Conventional electronic detectors require careful shielding, insulation and encapsulation before they can be used in harsh environments like these.

The Y-fiber reflective sensor in Fig. 3(c) is a modification of the sensor in Fig. 3(b). Here the two fibers have been spliced into a single fiber that carries the light to and from the target or object being detected.

All sensor systems in Fig. 3 can be made using bundles of fibers instead

of individual fibers. Bundles can carry more light, but their detection resolution is not nearly as good as that of a single fiber. When a bundle is divided into the Y configuration shown in Fig. 3(c), the result is called a *bifurcated* optical fiber cable.

Direct-Mode Sensors

Strange things can happen when an optical fiber is bent. If the bend has a large radius of curvature, the light will travel through the fiber relatively unaffected. But if very tiny bends, so-called *microbends*, are present, the light passing through a fiber may be attenuated. This may occur when some of the light passing through the core is coupled out of the core and into the cladding. Other phenomena may also take place.

Figure 4(a) shows a very simple arrangement for detecting pressure using an optical fiber. This is the principle behind the fiber optic guitar designed several years ago by Dynamic Systems, Inc. of McLean, VA. Instead of usual strings, six optical fibers are stretched over the bridge of this guitar. Light from an LED is passed through the fibers and de-

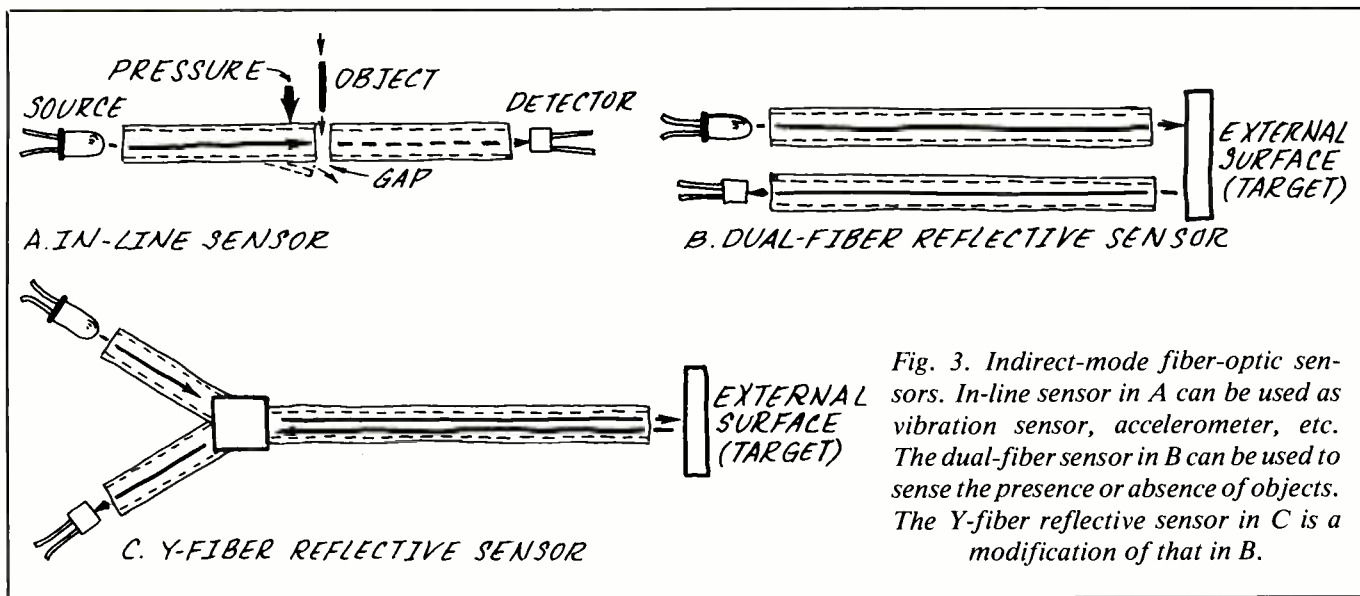

Fig. 3. Indirect-mode fiber-optic sensors. In-line sensor in A can be used as vibration sensor, accelerometer, etc. The dual-fiber sensor in B can be used to sense the presence or absence of objects. The Y-fiber reflective sensor in C is a modification of that in B.

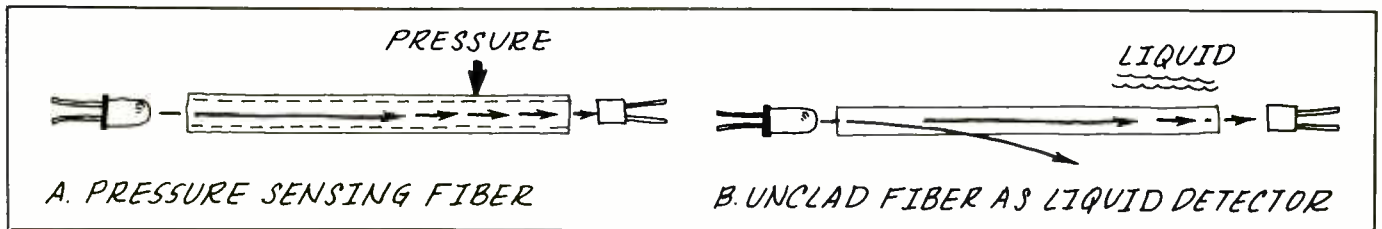

Fig. 4. Direct fiber-optic sensors for detecting pressure (A) and liquid (B).

ected by a photodetector. When the fibers are plucked or strummed, the intensity of the light passing through them is modulated. The resulting signal variations are amplified and transformed into sound by a conventional amplifier and speaker.

I have no idea how well the sound from a fiber-optic guitar compares with that from a conventional instrument. At least the fiber optic instrument has the potential of being shock-proof, an important advantage over standard electric guitars.

A more advanced pressure sensing application has been studied by the United States Navy. The fiber sensor consists of a coil of fiber immersed in water. Sound waves passing through the water distort the fiber, and the effect upon light passing through the fiber can be detected by a photodetector.

Figure 4(b) is an interesting sensor that uses an unclad fiber to detect the

presence of a liquid. Normally, the fiber transmits light directly to a detector. When the unclad fiber is surrounded by liquid, some of the light is coupled out of the fiber and into the liquid. This occurs because the index of refraction of a liquid is higher than that of air. A detector senses the reduction in light level that indicates the presence of the liquid.

Other direct-mode fiber-optic sensors are also in use. Among the most sophisticated is the fiber-optic gyroscope, a sophisticated sensor that employs a fiber coil as part of an interferometer that senses rotation. The fiber gyroscope may some day provide a compact, all solid-state substitute for traditional mechanical gyros.

Do-It-Yourself Sensors

You can make many kinds of inexpensive fiber-optic sensors from readily available components like

LEDs, phototransistors, photodiodes and cadmium-sulfide photoresistors. Black heat-shrinkable tubing is handy for securing fibers in place and blocking ambient light. You can find these components and supplies at most electronics parts suppliers.

Plastic optical fibers are available from some hobby and craft shops. Though these fibers aren't as transparent as glass or silica fibers, they are very inexpensive and can be cut with a hobby knife.

Glass and silica fibers are available in large quantities from more than a dozen manufacturers, but small quantities may be more difficult to find. Some mail-order and hobby electronics dealers stock plastic, glass and silica fibers.

Dolan-Jenner Industries, Inc. (PO Box 1020, Woburn, MA 01801) makes various kinds of fiber-optic sensors and a wide variety of glass and quartz (silica) multifiber (bun-

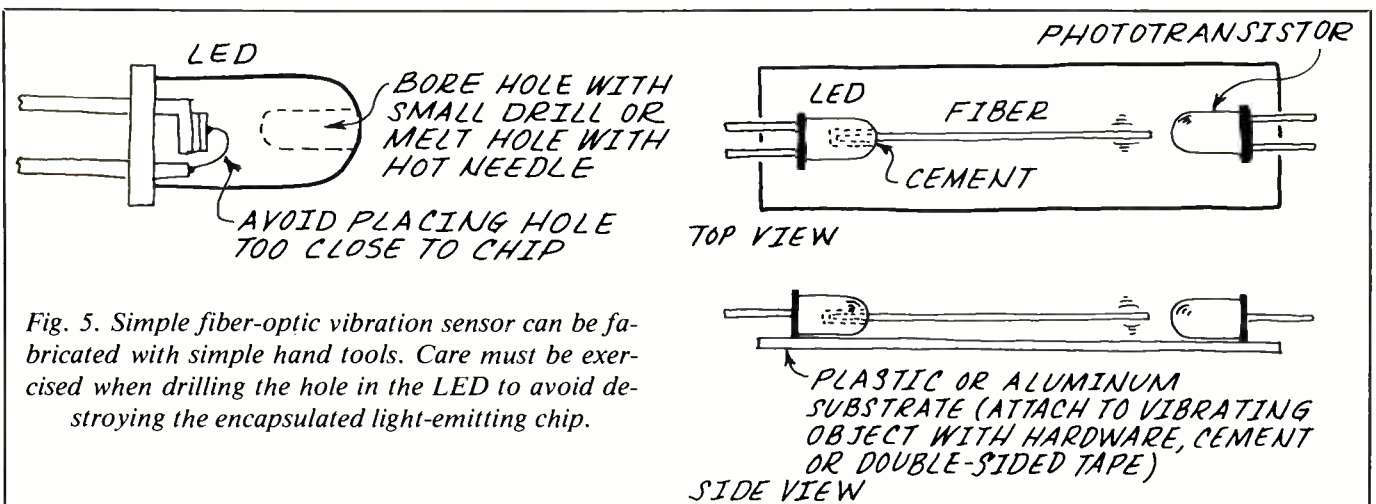

Fig. 5. Simple fiber-optic vibration sensor can be fabricated with simple hand tools. Care must be exercised when drilling the hole in the LED to avoid destroying the encapsulated light-emitting chip.

dle) light guides suitable for use with do-it-yourself sensors. The company has a minimum order of \$50, a requirement which shouldn't be hard to meet in light of the prices charged for its multifiber light guides. I've used a well-made Dolan-Jenner bifurcated light guide in various sensing roles for many years.

For some applications it's desirable to use one or two single fibers rather than a bundle. Keep in mind, however, that single fibers can be more difficult to work with than larger-diameter bundles. For example, silica fibers may have a diameter not much greater than that of a human hair.

Glass and silica fibers transmit the near infrared radiation emitted by GaAs:Si and AlGaAs LEDs far better than do plastic fibers. However, they are more difficult to prepare for use since their exposed ends must be perfectly flat for maximum light transmission.

One way to obtain flat ends is to cleave the fiber by lightly scoring it with a carbide tool while stretching it around a cylinder such as a plastic film container. If the tension is just right, the fiber will separate at the cleavage point and leave both exposed ends perfectly flat.

Learning to cleave glass and silica fibers requires experience. For more

information, see "The Forrest Mims Circuit Scrapbook" (McGraw-Hall, 1983, pp. 38-40).

CAUTION: Small bits of glass and silica fibers are like invisible, very sharp splinters. *Always* protect your eyes with clear goggles when cleaving such fibers. Pick up small bits of discarded fiber with a piece of masking tape to be sure no unpleasant surprises befall vulnerable elbows or bare feet.

A Fiber Optic Vibration Sensor

Figure 5 shows an ultra-simple fiber-optic vibration sensor. The key part of the sensor is a short length of plastic fiber cemented into a small hole bored into the top of an epoxy-encapsulated red LED.

Figure 6 shows one of the many possible transmitter-receiver circuits that can be used with the sensor in Fig. 5. In operation, light emerging from the fiber strikes the sensitive surface of phototransistor Q1. When the fiber is displaced, less light reaches Q1. Therefore, vibration of the fiber causes the signal from Q1 to be modulated at the frequency of vibration. The signal can be viewed on an oscilloscope or made audible by connecting an external/speaker amplifier to the output.

Many modifications to the sensor

in Fig. 5 are possible. For example, adding a fixed fiber to the phototransistor might provide much more vibration sensitivity, since the ends of the two fibers could be adjusted for any desired tolerance. This method might also increase the light level at the phototransistor, thereby providing a stronger signal.

The side of the fixed fiber can be cemented to a small machine nut. Very fine adjustments of the relative positions of the ends of the two fibers could then be made by rotating a screw inserted into the nut.

A Multipurpose Sensor

Dual-fiber reflective sensors like the one shown in Fig. 3(b) have many applications. They can detect objects as well as measure their reflectance and indicate if the object is moving, vibrating or stationary. They can also detect markings on paper and on other surfaces.

Figure 7 shows one of many ways to make a reflective fiber-optic sensor using a bifurcated light guide. I have used this setup along with the circuits in Fig. 6 to measure the reflectance of various surfaces in order to predict the detection range of miniature infrared travel aids for use by the blind.

Though the LED circuit in Fig. 6 is

Fig. 6. Transmitter and receiver circuits for the fiber-optic vibration sensor.

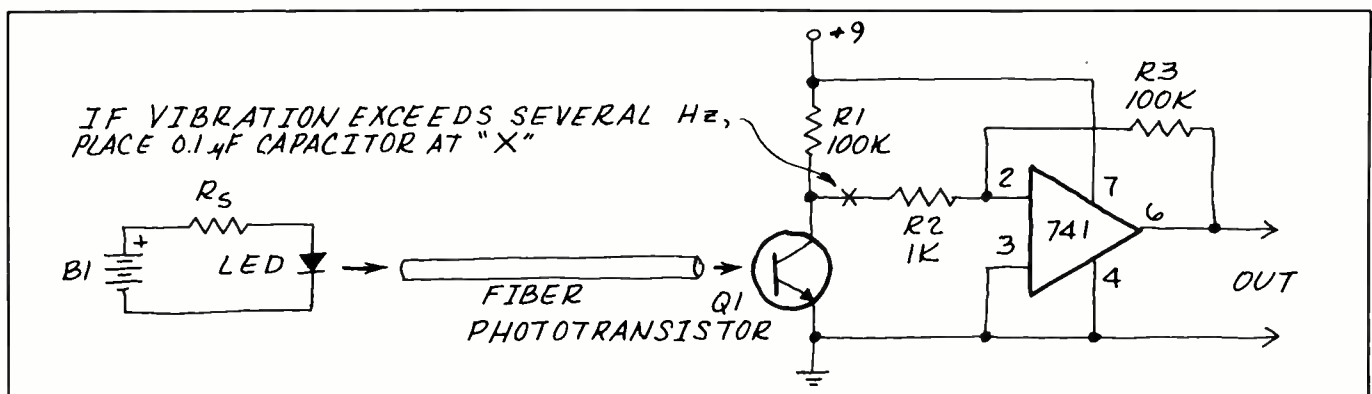

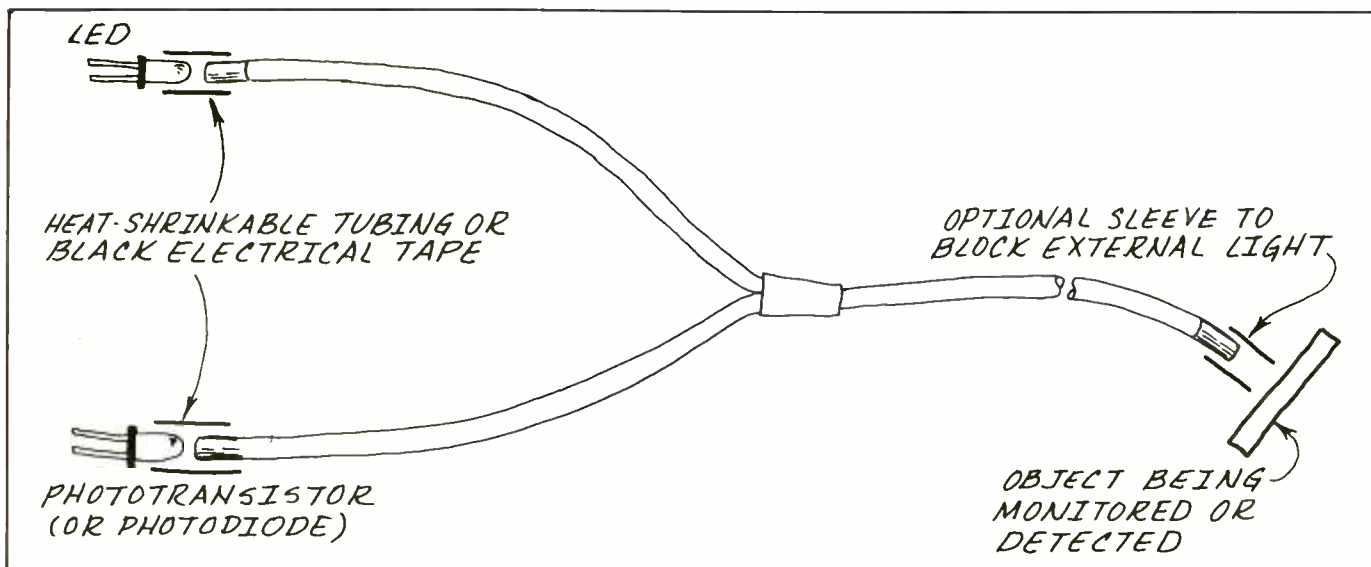

Fig. 7. This is an example of a multipurpose fiber-optic sensing system.

operated at a dc bias, it can also be operated in a pulsed mode to reduce interference from external light sources. This requires that the receiver's detector be capacitively coupled to its amplifier to eliminate the passage of dc signals.

Going Further

The field of sensing with fiber optics has grown rapidly over the past few years. Many technical papers on the subject have been published and many patents have been issued.

If you have access to a good library, you may want to find the December 1981 issue of *IEEE Spectrum*. It contains an excellent article on fiber-optic transducers by several Sperry Research Center engineers.

Some of the more interesting patents include Fiber Optic Transducers (US 4,408,829), Fiber Optic Musical Instruments (US 4,442,750), Fiber Optic Accelerometer (US 4,419,895), Fiber Optic Position Sensor (US 4,403,152) and Optical Fiber Tactile Sensor (US 4,405,197). Copies of United States patents are available for

a nominal fee from the U.S. Department of Commerce, Patent and Trademark Office, Washington, DC 20231.

Manufacturers of fiber-optic communications devices have published many fine booklets you may find helpful. You can find names of companies and their addresses in trade publications like *Laser Focus* and *Lasers And Applications*. Both magazines publish annual trade directories loaded with useful information.

Several books for the experimenter interested in fiber optics are also available. Waldo Boyd, for example, has written for The Blacksburg Group "Fiber Optics" (Sams, 1982), an excellent book of fiber optic communications experiments. "A Practical Introduction to Lightwave Communications" (Sams, 1982), a book I developed for an IEEE course by the same name, has circuits and information about fiber-optic communications that can be applied to fiber-optic sensors. Finally, "The Forrest Mims Circuit Scrapbook (McGraw-Hill, 1983) includes practical tips about working with fiber optics and building suitable transmitting and detecting circuits.

ME

STATE OF THE ART KITS

HAL 2304 MHZ AMATEUR DOWN CONVERTERS (FREQ. RANGE 1900/2500 MHZ)	
2304 MODEL #1 KIT BASIC UNIT WITH PRE-AMP LESS DIE-CAST CASE & FITTINGS	\$19.95
2304 MODEL #2 KIT BASIC UNIT WITH PRE-AMP WITH DIE-CAST CASE & FITTINGS	\$29.95
2304 MODEL #3 KIT BASIC WITH HI-GAIN PRE-AMP WITH DIE-CAST CASE & FITTINGS	\$39.95
POWER SUPPLY FOR THE ABOVE - COMPLETE WITH ALL PARTS LESS CASE	\$19.95
POWER SUPPLY CASE BLACK PLASTIC CASE - UNDRILLED	\$5.00
CONIFER PARACEPTOR ANTENNA PERFECT FOR THE 2304 MOD 2 & 3 - 6 DB OVER ANY DISH	\$49.95
HAL-PA-2: 1 QHZ 2 STAGE PRE-AMP DESIGNED FOR THE 2304 DOWN CONVERTER. MADE TO PIGGIE BACK ON THE 2304 BOARD. OFFERS 22 DB MORE GAIN. HAS IM- AGE REJECTION FILTER	(KIT) \$34.95
PRE-AMP TRANSISTOR EXCHANGE EXCHANGE TRANSISTOR IN 2304 WITH NEC 64535	\$5.00
SLOTTED ARRAY ANTENNA 16 DB GAIN USE WITH 2304 MOD 1 KIT, NO CASE REQUIRED	\$29.95
2100-2500 MHZ	
*AMR COMPLETE UNIT COMPLETE SYSTEM AS SHOWN. NOT A KIT. INCLUDES A PRE-ASSEMBLED PROBE DOWN CONVERTER. DISH. POWER SUP- PLY. CABLES AND CONNECTORS. TESTED UNIT. OFFERS 24 DB GAIN OR GREATER. BUY ONE AT \$99.95 BUY THREE OR MORE \$89.95 ea. *AMATEUR MICROWAVE RECEIVER	
EPRO 2000 PROGRAMMER EASY TO USE. NO COMPUTER NEEDED. FREE STANDING EPROM AND GAME CARTRIDGE PROGRAMMER. EASY TO USE. NOW MAKE ARCHIVAL COPIES FOR YOUR OWN RECORDS. THE EPRO 2000 CAN ALSO MAKE BACK-UP COPIES OF 2732 AND 2716 EPROMS. OR OF THEIR RESPECTIVE EQUIVALENTS. IN EPROMS OR ROMS. SAVE ON THOSE INDUSTRIAL SERVICE CALLS. EXTRA BLANK CARTRIDGES ARE AVAILABLE AT THE LOW COST OF \$6.50 EA OR \$6.00 IN LOTS OF 10 LESS EPROM	
PRE-AMPLIFIERS	
HAL PA 19 WIDE BAND - 2:200 MHZ - 19 DB - BUILT AND TESTED	\$9.95
HAL PA 14 WIDE BAND - 10 MHZ TO 1.4 GHZ - 12 DB - BUILT AND TESTED	\$12.95
SHIPPING INFORMATION: ORDERS OVER \$25 WILL BE SHIPPED POST-PAID EXCEPT ON ITEMS WHERE ADDITIONAL CHARGES ARE REQUESTED. ON ORDERS LESS THAN \$25 PLEASE INCLUDE ADDITIONAL \$2.50 FOR HANDLING AND MAILING CHARGES. MICHIGAN RESIDENTS ADD 4% SALES TAX. SEND 20¢ STAMP OR BASE FOR FREE FLYER.	
COMPLETE SETS OF P.C. BOARDS AVAILABLE FOR UNICORN ROBOT PROJECT HEART-A-MATIC PROJECT PIANO MATIC PROJECT AND MANY OTHER KITS AVAILABLE	
HAL-TRONIX, INC. P.O. BOX 1101 SOUTHGATE, MICH. 48195 PHONE (313) 285-1782	

CIRCLE 73 ON FREE INFORMATION CARD

How To Short-Circuit Auto Thieves

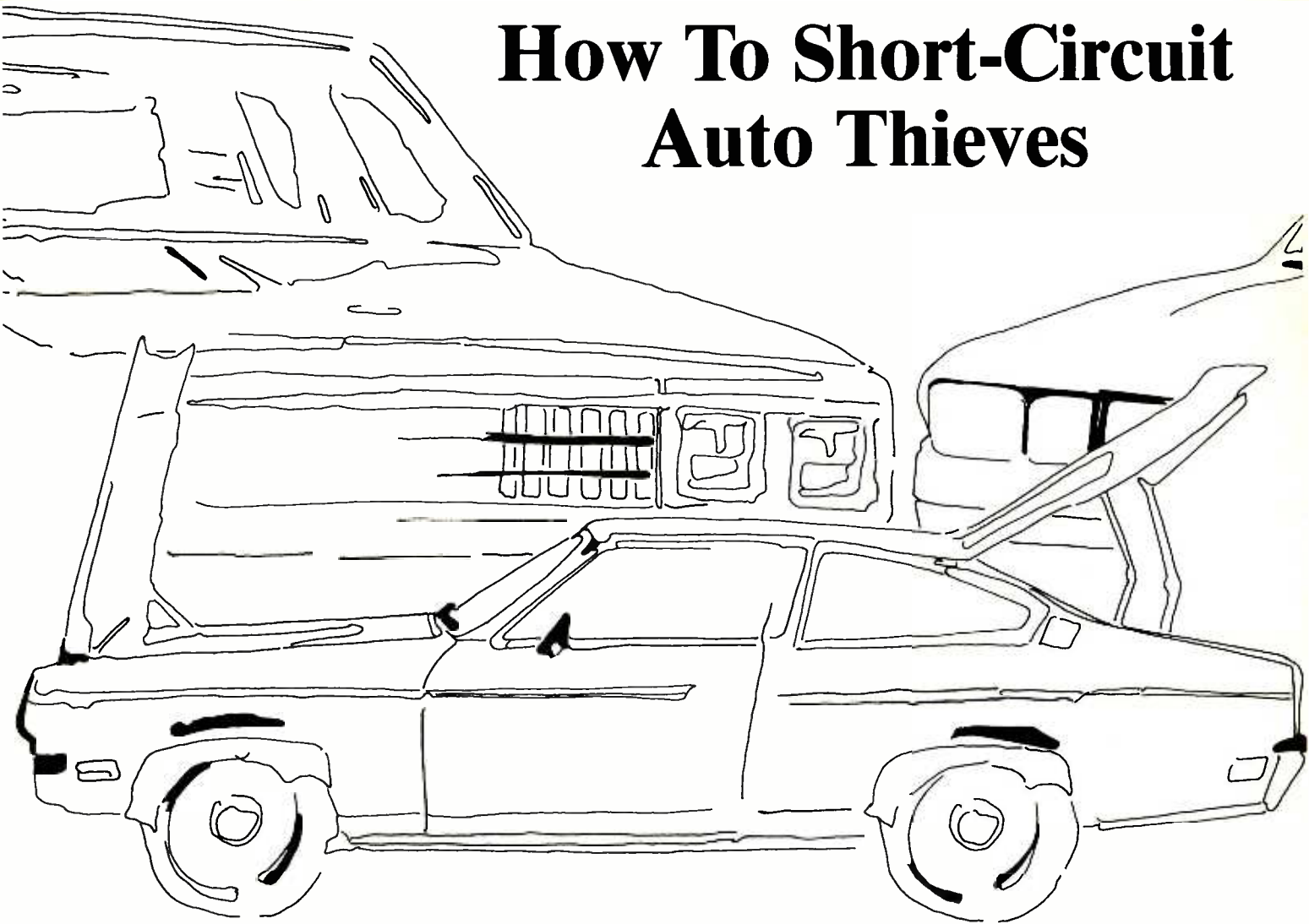

An "engine-stall" anti-theft device that you can install and forget with confidence that it will work

By Anthony J. Caristi

Installing an anti-theft device on your car or other vehicle makes good sense these days. But the best anti-theft device in the world is useless if your forget to turn it on.

The car anti-theft device presented here overcomes this problem. It sets itself automatically whenever the ignition is turned off! Also, it is inexpensive, reliable, and easy to build. And it works on all gasoline-operated

vehicles with commonplace negative-ground electrical systems.

The heart of this theft-deterrent device is an Amperite thermal time-delay relay whose contacts are connected to a vehicle's ignition circuit. These contacts are normally open. However, they automatically close after a delay of about five seconds when the car is started unless a hidden reset button is pressed. Without the latter action, the car will simulate engine trouble, stall in a few seconds, and not be able to be started again

with the ignition key. You can be sure that a would-be automobile thief won't bother staying around in order to fix it.

How It Works

The schematic diagram in Fig. 1 illustrates the logic portion of the circuit. Two NAND gates, *IC1A* and *IC1B*, are connected in a configuration called a bistable or latch circuit. This circuit has two stable states. In one, the logic level of the output ter-

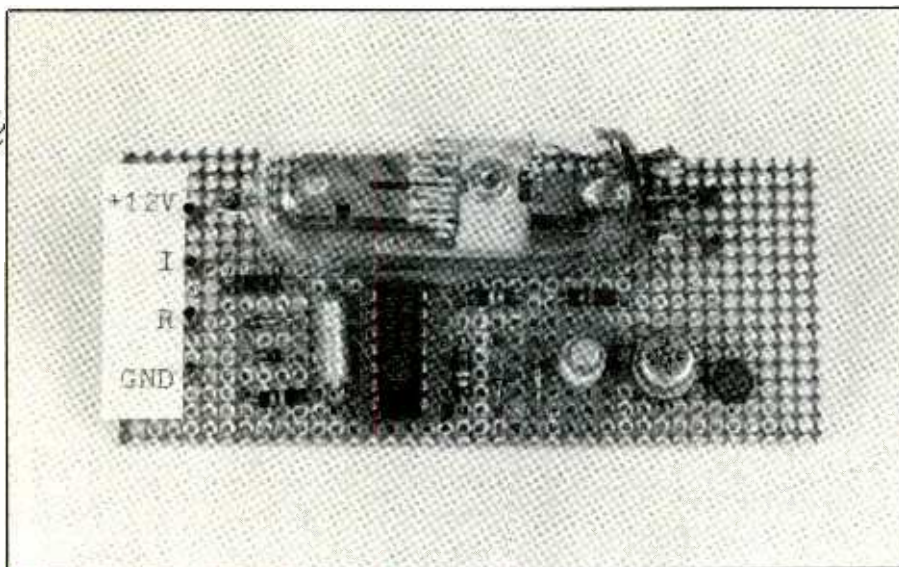

Author's prototype was assembled on a piece of perforated board. You can do the same, or you can make your own printed circuit board, using the etching-and-drilling guide that appears elsewhere in this article.

minal, pin 11 of the *IC1A*, is at zero- or 12-volt potential, depending upon the "set." When the circuit is in a reset mode, the logic level at pin 11 of *IC1A* is zero. *Q1* and *Q2*, connected in a Darlington configuration, are thus cut off since there is no base current in *Q1*. Thus, no current can flow through the heater coil of the thermal relay, and the contacts stay open.

When the vehicle is stopped and the ignition turned off, the logic level to the IGN terminal of the circuit is set to zero, since this terminal is connected to the ignition-key circuit. This causes the output of *IC1A* pin 11 to go to +12 volts and drives *Q1* with a base current of about 0.5 milliamperes. The LED then lights, indicating that the circuit is now armed. Hence, you can leave your vehicle without ever having to worry whether you set your anti-theft protection.

If a would-be thief decides to steal your car before you return, he (or she) will in some way energize your ignition system—either by hot wiring it or forcing your ignition keyswitch. Your car starts, but five seconds later stalls out since the heater of the time delay relay has been energized through the ignition circuit and *Q2*.

Of course, each time you return to your car, you must deactivate the circuit or you will face the same stall-out as a car thief would. This is accomplished by causing a momentary zero logic condition at the reset terminal of the circuit. The reset pulse forces the output of *IC1A* to go to zero volt, thus cutting off *Q1* and *Q2* and preventing the relay from operating.

Diodes *D1* through *D4* have been included in the circuit to protect *IC1* from possible voltage spikes that might come from the vehicle's electrical system.

Construction

The entire circuit can be placed on a small printed-circuit board measuring about 2" by 3½". Figure 2 is a full-size illustration of the foil layout as seen from the copper side of the board. Figure 3 illustrates the component layouts as viewed from the component side of the board.

It is recommended that an IC socket be used for *IC1* rather than soldering the chip directly into the board. In the event that service is ever required, it would be extremely difficult to remove the chip if it were soldered in

place. Be sure to follow the component layout exactly as shown for the IC, transistors, diodes and electrolytic capacitor. These components are polarized and the circuit will not work if any of these parts are placed in the circuit in the wrong direction. Pin 1 of *IC1* is identified by a small dot.

The time-delay relay may be mounted directly to the top of the board using a small amount of silicone glue or some other similar adhesive. This type of mounting is an excellent method for this component, which has a glass envelope. To make connections to the relay, you can solder wires directly to the pins if you clean them thoroughly before you start. It's best to use an acid flux here (though *never* for any other electronic components, where rosin-core must be used). It is suggested that you solder the wires to the relay before you mount it to the board, thoroughly washing off solder connections with alcohol to remove any excessive flux.

You have the option of mounting the LED on the board or at a remote location. The best installation for the module would be in the engine compartment, hidden from view. In that case you might want to run a pair of wires to the passenger compartment so that you can view the LED, which provides a visual indication of the set or reset status of the circuit.

Initial Checkout

It would be a good idea, of course, to check out your module before you install it in your vehicle. To do so you will need a 12-volt dc power source and a pair of jumper test leads. Connect the dc power source to the +12 volt and ground terminals of the module. Observe proper polarity! Connect a jumper lead between the IGN terminal and +12 volts. Momentarily jump the reset terminal to ground with the second jumper lead. The LED should now be off.

Now remove the jumper lead between the IGN terminal and +12 volts and connect it between the IGN ter-

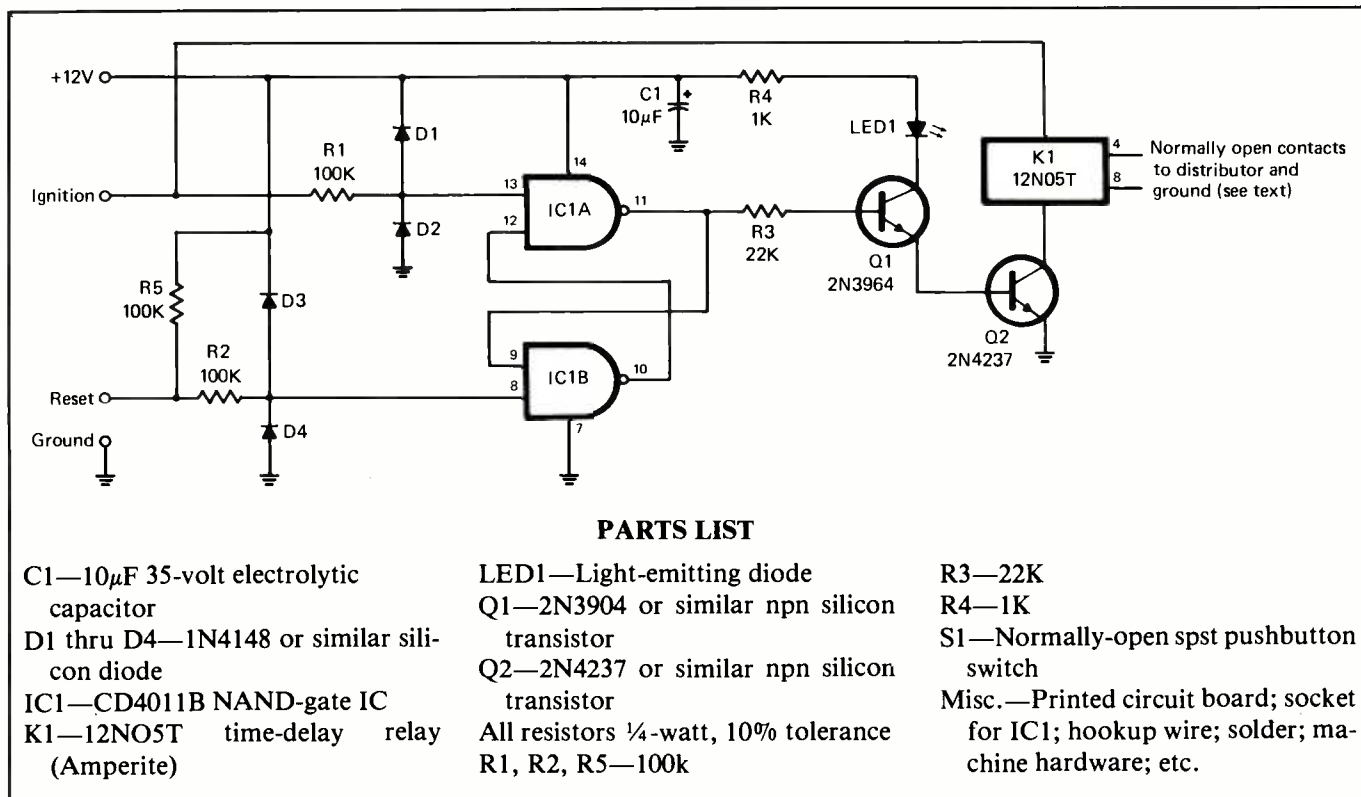

Fig. 1. The install-and-forget vehicle anti-theft module is very simple in design, as illustrated in this schematic.

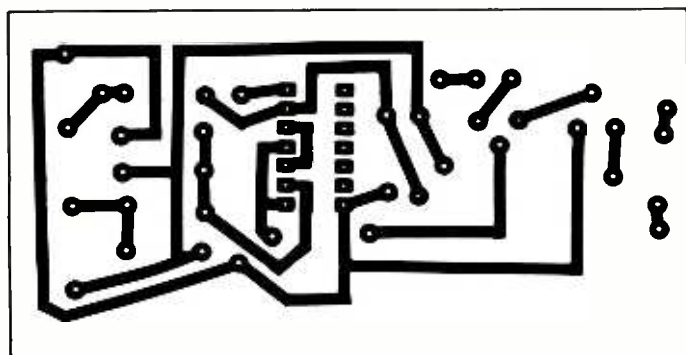

Fig. 2. This is the actual-size etching-and-drilling guide for homebrewing the pc board.

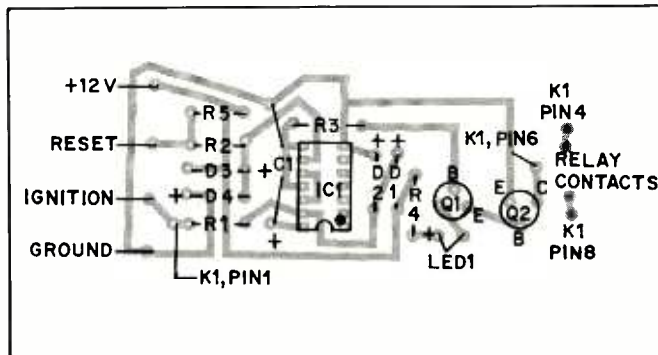

Fig. 3. After fabricating your pc board, use this drawing as a guide to component placement.

minimal and ground. The LED should light. Reconnect the jumper lead between IGN and +12 volts. The LED should remain lit. Now take the second jumper lead and momentarily connect the reset terminal to ground. The LED should be extinguished. This completes checkout of your module.

If your module does not work properly, disconnect the power source and recheck all the solder connections. Be sure there are no solder

bridges that might short one copper path to another. Check all components for location and proper orientation. You might want to substitute another chip for IC1, in case the chip you used is defective.

Installation

The theft-deterrent module is connected into your existing ignition sys-

tem as illustrated in Fig. 4. Since different manufacturers have slightly different ignition systems, follow only those instructions that apply to your vehicle.

The four connections located on one side of the module are the same for all vehicles, and should be made as follows:

The +12-volt terminal of the module should be connected to any hot lead of the vehicle that has +12 volts

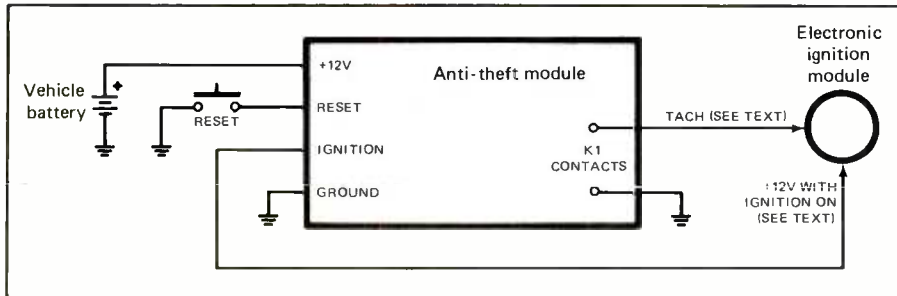

Fig. 4. How to install the anti-theft module in a vehicle.

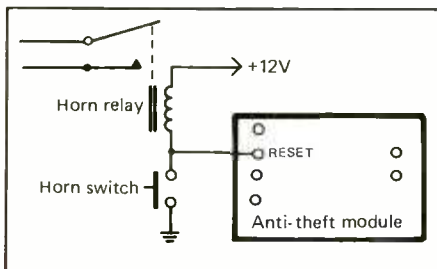

Fig. 5. The horn switch line is the simplest point in your vehicle to use for connecting the reset line.

on it at all times, engine running or not. The ground connection of the module can be made to any exposed metal part of the car body or chassis. The IGN terminal of the module is connected to the power lead that feeds the ignition system when you turn the ignition key to its ON position. This point is easily accessible at the electronic module or coil of your ignition system or at the key switch behind the dashboard. The connection point should have voltage only when the ignition key is turned on, and should be zero when the engine is turned off. If in doubt, use a voltmeter to be sure.

To install a reset switch, the reset terminal of the module can be wired to a hidden pushbutton switch in the passenger compartment. It's much easier, though, simply to use your horn relay instead (see Fig. 5). The only disadvantage to this is that you must briefly sound your horn each time you start your car.

On all cars, connect one side of the

relay contact to ground. On General Motors vehicles with electronic ignition, connect the remaining relay contact to the terminal of the distributor marked TACH. This is the left-hand terminal of the distributor, looking at the terminal side of the distributor.

On Chrysler vehicles you must determine which wire of two is the correct one to use. You can find out by briefly shorting one of the wires to ground while the engine is running. If the engine stops, you've just found the correct relay contact. If not that wire, it's the other.

On Ford Motor vehicles, the correct connection for the relay contact is the wire that runs between the coil and the distributor. This is also the contact for cars with ignition points.

If you drive an import, though, your best bet is to consult your dealer to determine how to connect the relay to its electrical system.

Final Checkout

When your installation is complete, check out the operation of the anti-theft module as follows: Start your car, then turn it off. The LED should be lit. Now start your car while the LED is still on. After a few seconds the engine should stall out. Press the reset button. The LED should be extinguished. Start your car. The engine should run normally.

Now that your vehicle is protected against theft and your forgetfulness, check with the insurance agent who handles your coverage. You may qualify for a reduced rate!

ME

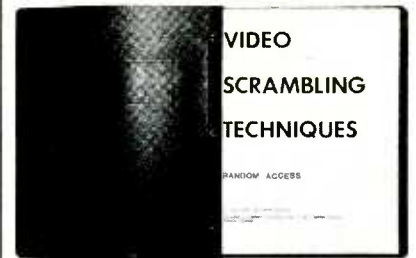

CIRCUITS, THEORY, WAVEFORMS, Subscription TV Reference Manual

This information packed book details the methods used by subscription TV companies to scramble and descramble video signals. Covers the Sinewave, Gated Pulse, SSAVI system, and the methods used by most cable companies. Includes circuit schematics, theory, waveforms and trouble shooting hints. Only \$12.95 plus \$2.00 first class P & H. Information \$2.00, refundable. Foreign orders please remit in U.S. funds only.

ELEPHANT ELECTRONICS

(Formerly Random Access)

Box 41770-G, Phoenix, AZ 85080

CIRCLE 54 ON FREE INFORMATION CARD

AMAZING SCIENTIFIC and ELECTRONIC DEVICES

- LASER DEVICES**
- LC5 BURNING CUTTING CO2 LASER \$15.00
 - RUB3 RUBY LASER RAY PISTOL 15.00
 - LRG3 IR LASER RIFLE/PISTOL 10.00
 - LGU3 VISIBLE RED LASER RIFLE 10.00
 - LHP/LLD LASER LIGHT XMTR/RCVR SYS 10.00
 - LHC2 BEGINNER simulated VISIBLE LASER 5.00

- SCIENTIFIC & ELECT**
- TCL3 SOLID STATE TESLA COIL 35KV 7.00
 - BTC3 250 THOUSAND VOLT TESLA COIL 10.00
 - BTC5 1.5 MILLION VOLT TESLA COIL 15.00
 - HVM3 125 THOUSAND VOLT DC SUPPLY 10.00
 - IOG3 ION RAY FORCE FIELD GUN 10.00
 - PTG1 PLASMA FIELD GENERATOR 8.00

- ULTRASONIC ACCOUSTICAL**
- PPF1 PHASOR PAIN FIELD GENERATOR 15.00
 - PSP3 PHASOR SHOCK WAVE PISTOL 8.00
 - IPG5 POCKET PAIN FIELD GENERATOR 8.00
 - RAT2 RAT AND PEST ELIMINATOR 7.00
 - HT9 HIGH FREQ LISTENING DEVICE 8.00

- SECURITY & PROTECTION**
- BL51 BLASTER WAND 10.00
 - PPG1 PHASOR PROPERTY GUARD 15.00
 - MFT1 MINI VOICE XMTR 2-3 MILE 7.00
 - INF1 INFINITY TRANSMITTER 15.00
 - VWPMS TELEPHONE XMTR 8.00
 - SDS SEE-IN-DARK NIGHT EYE 10.00

WE STOCK ALL PARTS NECESSARY FOR CONSTRUCTION OF THE ABOVE PROJECTS

• CATALOG CONTAINING HUNDREDS MORE OF ALL NEW AMAZING and FASCINATING PLANS EASY TO BUILD KITS AND ASSEMBLED ITEMS \$1.00 CATALOG INCLUDED FREE WITH ANY OF THE ABOVE PROJECT PLANS. SEND CASH, CHECK, MO, VISA, MC TO:

INFORMATION UNLIMITED
P.O. BOX 716, DEPT. ME11, AMHERST, NH 03031

CIRCLE 67 ON FREE INFORMATION CARD

NEW PRODUCTS . . .

(from page 13)



chanical-type detectors. At the first vibration sensed by the mechanically actuated detector, a normally-closed contact opens to transmit a pulsating signal at a pulse width of 1 to 3 mm/second. Sensitivity is user-adjustable for accurate detection with a wide range of glass thicknesses.

The sensor is claimed to be fully compatible with other mechanical-

type detectors. No power supply or control box is needed for it. The case that houses the sensor has a transparent lens for quick setting of sensitivity. A single GlassGuard is designed to protect more than 16 square feet of 0.31"-thick glass. The device measures 1.55" in diameter by 0.65" thick. It is rated to operate at 50 volts dc and 0.1 ampere maximum. Maximum contact resistance is 200 milliohms.

CIRCLE NO. 105 ON FREE INFORMATION CARD

Multipurpose Function Generator

A new multipurpose function generator for electronics laboratories and design centers has been introduced by Global Specialties. The Model 2005 generator provides sine, triangle, square, and pulse waveform outputs with variable amplitude,

symmetry, and offset. Specified frequency range is 0.05 Hz to beyond 5 MHz. A pair of pushbutton switches on the front panel permit signal level to be attenuated by 20, 40, or 60 dB in 20-dB steps. Additionally, output signal level can be varied over a 0-to-20-dB range.

Maximum output amplitude is 20 volts p-p open circuit, 10 volts p-p into 50 ohms. The output can be continuous, gated, or triggered by an external signal or by means of a manual switch on the front panel. When used as a sweep generator, an internal ramp with variable duration provides a recurring linear sweep over a frequency range of 1000:1 linear, 10,000:1 logarithmic. Dc offset is adjustable from -10 to +10 volts into open circuits, -5 to +5 volts into 50 ohms. All output waveforms can be adjusted to operational requirements

MICROWAVE TV ANTENNA SYSTEMS

Freq. 2.1 to 2.7 GHz . 34 db Gain +

COMPLETE SYSTEMS:
(as Pictured)

Commercial 40"
Rod Style \$99.95
Parabolic 20"
Dish Style \$79.95

COMPONENTS
Down Converters
(either style) \$34.95
Power Supplies \$24.95
(12V to 16V. DC+)

Data Info (Plans) \$ 9.95

CALL OR WRITE FOR
KITS, PARTS, OR MORE
INFORMATION

Shipping & Handling Add \$5.00
We Repair Most Types Down
Converters & Power Supplies

**Phillips-Tech
Electronics**

P.O. Box 34772
Phoenix, AZ 85067
(602) 967-8972

Special Quantity Pricing
Dealers Wanted



LIFETIME LIMITED WARRANTY
PARTS & LABOR

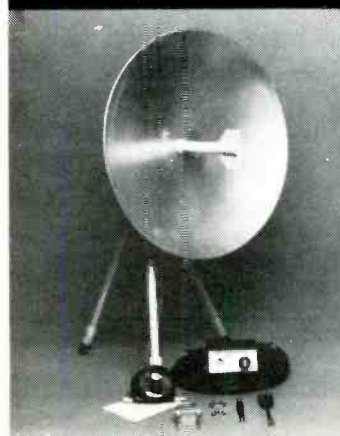

CIRCLE 53 ON FREE INFORMATION CARD

Computer problems? DON'T BLAME THE SOFTWARE!

Isolators prevent:

Pat. # 4,259,705

- CPU/printer/disk interaction
- Lightning or spike damage
- AC power line disturbances
- RFI-EMI interference



Commercial Grade Isolators

ISO-1 3 Isolated Sockets \$ 81.95
ISO-2 2 Isolated Socket Banks, 6 Sockets \$ 81.95

Industrial Grade Isolators

ISO-3 3 Double Isolated Sockets \$122.95
ISO-11 2 Double Isolated Banks, 6 Sockets \$122.95

Laboratory Grade Isolators

ISO-17 4 Quad Isolated Sockets \$213.95
ISO-18 2 Quad Isolated Banks, 6 Sockets \$180.95

Circuit Breaker, any model (Add-CB) Add \$ 11.00
Remote Switch, any model (Add-RS) Add \$ 20.00

ESP Electronic Specialists, Inc.

171 S. Main St., Box 389, Natick, Mass. 01760 (617) 655-1532

Toll Free Order Desk 1-800-225-4876
MasterCard, VISA, American Express

CIRCLE 76 ON FREE INFORMATION CARD

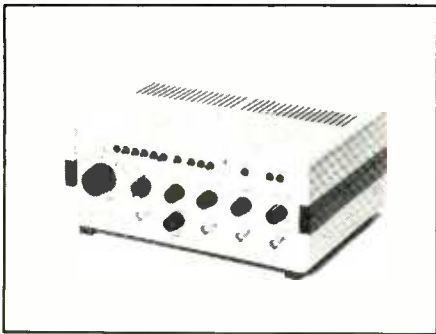

using the symmetry control (10% to 90%). The instrument can also be frequency modulated with an external signal using VCO IN as the FM input. \$650.

CIRCLE NO. 101 ON FREE INFORMATION CARD



Cordless Voltage Tracer

For quick circuit tracing, Triplet's new Model 915 "Quik-Chex" voltage tracer may be just what you need. The pocket-size, portable cordless tester can quickly trace voltage presence, ground faults, defective fuses, and identify hazardous electrical equipment. It's battery operated by two AAA cells and has a built-in solid-state high-gain amplifier and an indicator lamp that glows when its single blade-type probe is touched to a surface on which a voltage is present.

The voltage tracer operates from 6 to 240 volts ac or dc, with no indication if the blade is at ground potential. Poorly grounded wiring systems, equipment, or lines with induced voltage will cause the tracer's lamp to glow dimly. This feature is especially useful in farm environ-

ments that are prone to stray, or "tingle," voltages. The product is tested at 1500 volts and features an epoxy-embedded resistor that protects against moisture and arc-over to provide extra isolation for the user. \$19.00, including pocket case.

CIRCLE NO. 102 ON FREE INFORMATION CARD

A QUALITY TRIPLE-REGULATED POWER SUPPLY AT A LOW, LOW PRICE!!

NOT A KIT!



MODEL PS101
FULLY ASSEMBLED & TESTED!

\$ 119⁸⁸
FULL 1 YEAR
REPLACE-
MENT
WARRANTY
- Made In The United States -

This DC triple regulated variable power supply has all the features you could ask for plus a full 1 year guarantee. Fully adjustable from 1 1/2 VDC to 35 VDC! Three completely independent supplies that offer many advantages! They can be either a pos. supply or a neg. supply...they can also be stacked in series so that a 5V and two 15V supplies can total a 35 VDC supply or any combination of the three...(after one of the terminals is grounded to give it a reference)...for the first time you can now purchase this American made fully adjustable power supply at a price that is one-half of what you'd expect to pay!

SPECIFICATIONS

3 outputs:
Fixed 5 VDC \pm 0.2V
2 variable \leq 1 1/2 V to \geq 15 VDC
Polarity - floating; can be used as pos. or neg.
Ripple less than 10mV at full load,
Regulation \leq 1% no load to full load,
Line Regulation $<$ 0.2% 108 VAC to 135 VAC.
Current:
Fixed supply 1.0 amp max.
Variable supplies 0.5 amp max.

Protection built in, current limiting, with thermal shutdown.
Power: 108-135 VAC.
Dimensions: 8 1/4" x 3 3/4" x 7 1/4" (WxHxD)
Wood grain finished metal case.
Weight: 4 lbs., 9 ozs.
Lighted on/off power switch, easy-to-read Voltmeter and large binding posts.
Warranty: one year full replacement warranty from date of purchase.

DISTRIBUTOR AND REPRESENTATIVE INQUIRIES INVITED



VISA, MASTERCARD, AMEX TELEPHONE ORDERS ACCEPTED!
6 Herman Drive, E. Granby, CT 06026 □ 203/651-0285

CIRCLE 75 ON FREE INFORMATION CARD

November 1984 / MODERN ELECTRONICS / 81

PRODUCT EVALUATIONS ...

Tech-Sketch's New Apple Light Pen (from page 22)

has a more moderate price tag—\$149.95. Produced by Tech-Sketch, a company involved with mainframe computer light pens, the new peripheral includes an Apple II interface card and Island Graphics' Micro Illustrator graphics software.

General Description

The light pen itself is a 6" long, 1/2" diameter black, plastic device that looks and feels like an ordinary marking pen. Its tip is a 1/2" long white cone whose 3/16" opening houses a photodiode detector.

Unlike most light pens, which require the user to activate it by pressing computer keys, this pen has a plastic pushbutton switch right on its barrel to do the same job efficiently. At the rear of the pen is a 4-conductor, 3-ft-long cable that terminates in a DB-9 connector. Unlike the coiled cable used with many peripheral devices, it avoids the slight pullback of a coil that might interfere with one's drawing "creativity."

The plug-in interface card, which is essential hardware for using a light pen with an Apple II, simulates the joystick port of Commodore or Atari computers. Tech-Sketch uses an "AppleBus"-compatible circuit (which means Apple IIc users will not be able to use it) with 18 integrated circuits.

The card can go into any Bus connector, but it's suggested that slots 5 or 7 be used. This makes it easier to use a hook jumper that connects to the Apple's sync pulse through a resistor near the machine's game input/output socket. The card has a DB-9 joystick male plug on it for rear mounting on the Apple and for subsequent light pen plug-in. Once installed, there is no need to calibrate the boards since this is handled by using a software routine.

Once the interface card is installed and the pen plugged in, merely place the Micro Illustrator disk into the Ap-

ple drive and turn on the system. At this point the screen displays a user-friendly calibration procedure consisting of lining up the pen to, first, a vertical, and then a horizontal line to define the X and Y mid-range points. Then the speed at which the pen will be checked for an input is set. This corresponds to the speed at which the screen's cursor will follow or lag behind the actual position of the pen on the screen.

Using the Micro Illustrator package gives the user a complete artist's palette of colors for creative use when employing a color monitor or TV set. The distribution disk also has several picture files that allow you to see how creative the software authors were.

User Comments

Like most computerists, I often plunge into using a device before reading the manufacturer's instructions completely. I do this to check on the user-friendliness of the system. The consequence of this was that I did not observe the notation that the Tech-Sketch light pen could not be used with green-phosphor video monitors.

Trying to use it on an Apple II green-phosphor monitor, the keyboard's "bell" alerted me, indicating I was not on the alignment line. I had to plug the computer into a BMC color monitor before the program would allow me to continue. As a result, I could not display a previously created picture since the alignment procedure precedes the menu, and the menu requires that the light pen work.

Once the foregoing was done, I easily calibrated the pen and was rewarded by the standard Micro Illustrator Menu. Touching the pen to the screen, the cursor crosshairs followed the tip as it went up to the DRAW box. Pressing the pen's pushbutton while gliding the device across

the screen yields a high-resolution drawing.

To bring up the program's catalog, I pressed a keyboard key and then called up a prepared picture.

The color graphics were impressively beautiful. I then went back to the main menu and tried to replicate some of these graphics. I discovered, however, that working with a light pen could be a bit frustrating. Since the CRT screen is slightly curved, when the light pen head is seemingly correctly aligned, it's susceptible to not being precisely parallel to the screen, yet sensitive enough to detect the trace. This leads to slight shifts of the cursor, which causes extraneous points, line, etc.

Returning to the menu, I could select a variety of colors, brush strokes, and even geometric shapes to fashion my graphic masterpiece.

Conclusion

Unlike touch-tablets, joysticks, and mice, where the user operates a device while trying to coordinate movements on a separate video display, a light pen gives one an intimate "touch" that makes using it easy, much as a pen on paper.

The Tech-Sketch light pen uses an easy alignment and speed-control program that allows for rapid or slow cursor movement. The pen functions superbly in menu mode, though there are a few minor problems when in the drawing mode. The latter are common to all light pens, though, and are due to the sensitivity of the pen to off-perpendicular placement and hand movements, as well as the inability of the software to allow creation of new patterns on top of existing ones.

I like the pen for what it can do and for its more modest cost. The color software is practical, too, providing up to ten different brush strokes and ten drawing modes, and can erase mistakes and store up to 48 screens on a diskette—*Charles Rubenstein.*

CIRCLE 31 ON FREE INFORMATION CARD **ME**

It's Back!

THE AMATEUR RADIO VERTICAL ANTENNA HANDBOOK

CAPT. PAUL H. LEE, USN(RET), N6PL

Capt. Paul H. Lee's *Vertical Antenna Handbook* became a classic in its first printing. Out of print for several years, this Second Edition has been brought out in response to your demand and the needs of the service. Among the topics covered are vertical antenna theory, design, installation, and construction. Specific information is given on vertical arrays, feeding and matching, short verticals, ground effects, and multiband and single-band verticals, plus there is a section that answers many of the most commonly asked questions about vertical antennas for the amateur. The Second Edition features an addendum on antenna design for 160 meters, the band that finally is coming into its own.

Order your copy now.



CQ Publishing, Inc.
76 N. Broadway, Hicksville, NY 11801

Please rush me my copy of the 2nd Edition of *The Vertical Antenna Handbook*:

\$9.95 for the book plus \$2 for shipping & handling.

Name _____ Call _____
Address _____
City _____ State _____ Zip _____

MasterCard VISA

My account number is:



--	--	--	--	--	--	--	--

Over 75,000 active amateurs in over 125 countries throughout the world read and enjoy a different kind of ham magazine every month. They read CQ.

It's more than just a magazine. It's an institution.

SUBSCRIBE TODAY!



 The Radio Amateur's Journal
76 N. Broadway, Hicksville, NY 11801

Please send me CQ for Life 3 Years 2 Years 1 Year
 New Renewal Start with _____ issue

Name _____ Call _____
Street _____
City _____ State _____ Zip _____

Charge My Order To: Payment Enclosed \$ _____
3 Years (36 issues) \$42.00
2 Years (24 issues) 29.00
1 Year (12 issues) 16.00
MasterCard My account number is _____
VISA



--	--	--	--	--	--	--	--	--	--	--	--	--	--	--	--	--	--	--	--

A Second Chance For Junior *(from page 38)*

of memory. Programs using these screen modes will not run on the PC.

For programs requiring less than the default value of 16K, the CLEAR statement may also be used to free up some of this space. For example, the SCREEN 0, WIDTH 40 mode needs only 2K of memory.

Note that the PCjr allows one to use as much memory as available for graphics, whereas the PC and PCXT models are limited to 16K. Thus, smooth animation effects are achievable with the PCjr.

Now a few of the minuses . . .

Execution Time

Junior is quite a bit slower in operation than the PC. Both machines use the popular 8088 microprocessor, but the jr. doesn't use direct-memory access (DMA), so data transfer rate suffers. Depending on the nature of your work, this may or may not matter much. For example, a home-brew

EDITORIAL *(from page 4)*

transmissions. Microwave TV transmissions in the 2-gigahertz band is another new TV service authorized by the FCC. Called MMDS, for multichannel, multipoint distribution service, it can handle up to 30 transmission channels. This format is viewed by industry as the ultimate over-the-air pay TV system.

Topping the foregoing are improvements in home TV receivers, including better TV picture tubes (CRTs), comb filters for fuller luminance bandwidth, and so on. Stereo sound is another fillip to enhance overall "viewing" pleasure. And videocassette recorders make the TV field all the more exciting.

Modern Electronics will keep you in touch with the many aspects of television, you can be sure, while not neglecting other appealing areas of electronics and computers for work and for fun.



BASIC program to calculate elliptic integrals takes 56, 65, 78, and 94 seconds of Junior's time to crank out the first four columns in the table. The same chore needs only 32, 37, 44 and 52 seconds on the PC, which is an almost 2:1 improvement in execution time. This is perhaps a worst-case example; with most of the program time spent on internal calculations, the relatively long delay between each new screen display can become annoying. On a more screen-intensive type of program, the delays might be less obvious, or perhaps a lot less perceptible.

Word Processing

For the PC, IBM's monochrome green screen is one of the cleanest displays around. For word-processing applications it's a lot easier to stare at than any color monitors, and most, if not all, other monitors. But as noted earlier, the PCjr will not support this screen, and so it must be used with either a TV set or another monitor. Although color graphics on a good RGB monitor are really impressive, few color monitors come close to the good old IBM green screen for displaying text only. So if word processing takes up a good part of your computing day, this may be an important consideration. (Also remember that Junior's color graphics eats up 16K of available memory, so a 128K system is really only a 112K system.) Text clarity can be improved by using a monochrome monitor of course, though IBM's, with its longer persistence phosphor design, can't be employed with the PCjr.

Power Supply

As several third-party manufacturers—and now IBM, too—have shown us, the PCjr is readily expandable. However, Junior's own power supply doesn't have the strength to power much else beside the basic system. Therefore, many of the add-ons require, and of course come equipped, with their own separate power lines. And since the peripherals are all ex-

ternal devices, some fully-expanded Juniors take on the appearance of a micro-kluge; with add-ons tacked upon add-ons, the whole thing begins looking like a collection of second thoughts. Of course, this is strictly an aesthetic judgment and doesn't affect performance at all. The same thing can be said about Junior's fan, which makes it quite a bit noisier than the PC.

Conclusion

Now although the folks at Big Blue may be a trifle stuffy at times, no one's ever accused them of being stupid. Surely they know very well that if Junior is perceived to be a viable product, others will leap on the bandwagon and begin to produce all sorts of enticing add-ons. A small fortune will be spent advertising these products, and most of the ads will have a PCjr prominently displayed. And if all goes well, software companies should love the concept of cartridge software. With the IBM logo on a well-supported and suitably-priced computer, an even larger segment of the market may finally be persuaded to get involved with computers. If so, everyone profits, especially IBM.

There's little doubt that Junior's new power and attractive prices will cause some downscale defections among prospective PC buyers. And perhaps we shall see some defections from PC as well to one of Big Blue's hard-disk models.

Scarcely a week had passed since the Junior keyboard/memory announcements when IBM was back in the news with its new PC-AT model challenging the smaller-capacity PC-XT hard-disk model. This is available with 512K internal memory, a 20 Megabyte hard-disk drive, a high-density 1.2-Megabyte 5 1/4" (!) floppy disk system, eight expansion slots, and a new keyboard all its own. So could it be that old Blue itself is engineering the eventual demise of the PC in favor of the PCjr at one end of the market and the PC-AT at the other? We shall see.

ME

CIRCLE 29 ON FREE INFORMATION CARD

Beyond Op-Amps

(from page 56)

1,000. What combination of $R1$ and $R2$ will provide that gain figure?

If GAIN = 1000

$$(R1 + R2) = \frac{1,000,000 - (115 \times 1000)}{1000}$$

$$(R1 + R2) = \frac{1,000,000 - (115,000)}{1000}$$

$$(R1 + R2) = \frac{885,000}{1000}$$

$$(R1 + R2) = 885 \text{ ohms}$$

In this case, we need some combination of $R1$ and $R2$ that adds to 885 ohms. The value 440 ohms is "standard," and will result in only a tiny gain error if used.

Conclusion

The IC instrumentation amplifier and the isolation amplifier open new applications that the simple op-amp cannot match. Digital electronics fans should be aware that linear circuits are not dead. They live in more sophisticated manifestations than ever before.

ME

Is Your Scanner Being Wasted?

(from page 33)

quency may be shifted many times. Also, the range of the stations is limited to very localized coverage.

Of course, there is a wealth of activity on the older frequencies and they are a constant source of chatter. Much of this communication is of an almost embarrassingly personal nature, often funny.

On The Right Track

Frequently overlooked as a source of interesting scanner fare are the frequencies used by the railroads—America's forgotten transportation mode. These communications take place in the band that runs from 160.215 to 161.565 MHz, and to a limited extent in the uhf band on 452.325, 452.375, 452.425, 452.475, 452.775, 452.825, 452.90, 452.925,

452.95, and 452.975 MHz.

These frequencies contain communications of train dispatchers, yardmasters, and conversations between train crew members. There's something very gutsy and rugged about the people who work on the railroads; they offer a unique brand of chatter which sounds different than anything else you're liable to hear on a scanner. These frequencies are active in most areas of the nation. In urban areas you'll find the activities of the railway police to be pretty grisly as they wage a constant battle against

the vandals and vagrants who frequent track, yard and station areas.

You are invited to explore the many exciting areas you can access via a scanner. Actually, there are many more than are described here. A scanner puts you on the inside of what's going on, and gives you a glimpse of events you'd otherwise never have known about. The nicest part about it is that you can add these potentials to your scanner without giving up the ability to monitor the neighborhood police or fire departments you like to hear.

ME

VIEW 8 TRACES ON YOUR SINGLE OR DUAL TRACE SCOPE WITH THIS LOW COST DEVICE!!

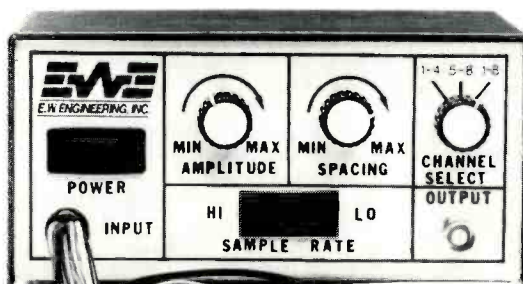

Now you no longer have to spend thousands on an expensive multi-trace oscilloscope - our single trace Hitachi scope combined with this module will allow you to view up to 8 simultaneously occurring analog or digital (or both) signals in their real time and amplitude relationship. The MPX 101 may be used on any oscilloscope, whether single, dual or multiple traces. Its low cost makes it a particular favorite for designers, testers, hobbyists and repairmen who want to compare and analyze displayed signals in a timing diagram format. The controls on the front panel of the metal case allow you to vary amplitude and spacing of the displayed signals.

**MODEL MPX101
FULLY ASSEMBLED & TESTED!**

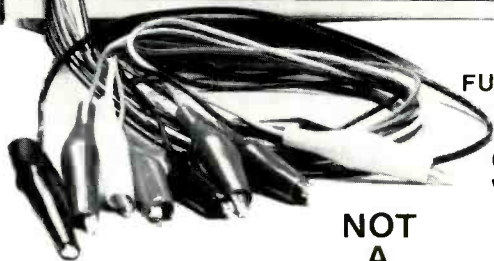

**NOT
A
KIT**

\$99⁸⁸
FULL 1
YEAR
REPLACE-
MENT
WARRANTY

- Made In The United States -

SPECIFICATIONS

Inputs: 8 signals plus ground via 9 input leads terminated with alligator clips
Bandwidth: ± 1 dB to 5 MHz
Impedance: 10.9 K
Input Voltage: ± 5 V peak (diode clamped to ± 5 Volt supplies)
Output: Staircase waveform summed with input signals, 0-800 mV full scale
Step Amplitude: Variable 0 to 150 mV/step
Signal Voltage: Variable 0 to

150 mV/step @ 5V Input
Multiplex Rate: Switch selectable, 40 KHz or 4 KHz
Impedance: 50 Ohms
Power: 105-135 VAC @ 1 V a
Dimensions: 6.25" x 3.25" x 4.75" (WxHxD)
Operating Temperature: 0-40°C
Weight: 1 lb. 10.5 oz.
Warranty: one year full replacement warranty from date of purchase
Lighted on/off power switch
Wood grain finished metal case

DISTRIBUTOR AND REPRESENTATIVE INQUIRIES INVITED

EWE
E.W. ENGINEERING, INC.

VISA, MASTERCARD, AMEX TELEPHONE ORDERS ACCEPTED!
6 Herman Drive, E. Granby, CT 06026 □ 203/651-0285

CIRCLE 21 ON FREE INFORMATION CARD

SAVE BY BUILDING OUR RACK MOUNT STUDIO EQUIPMENT

QUADRAFUZZ — four separate frequency bands of distortion are mixed for the smoothest fuzz you've ever heard. no. 6720..... \$39.88

HYPERFLANGE/CHORUS — the cleanest, widest range, most versatile flanger anywhere at any price. no. 6750..... \$149.95

VOCODER — unmatched performance in a versatile, low cost rack package. no. 6710..... \$99.95

HOT SPRINGS — user's agree, short of studio plate systems, you won't find a better reverb at any price. no. 6740..... \$59.95

**ADD \$3 SHIPPING
FOR EACH KIT ORDERED**

Innovative, cost effective designs by Craig Anderton in easy to assemble kits from:

PAIA Electronics, Inc.
Direct mail orders and inquiries to: Dept. 11E
1020 W. Wilshire, Oklahoma City, OK 73116 - (405)843-9626

Ask for your free catalog.

CHARGE TO VISA OR MC TOLL-FREE
1-800-654-8657 9AM to 5PM CST MON-FRI

CIRCLE 30 ON FREE INFORMATION CARD

GILFER SHORTWAVE "BEST SELLERS"

New 6th Edition

"Confidential Frequency List"



Now including RTTY frequencies. O. Perry Ferrell's ultimate utility listing. Detailing over 12,500 stations, by frequency. Every important AM, CW, FAX, RTTY and SSB station included.

\$13.95+\$1.00 UPS

DATONG Active Antennas

INDOOR — AD-270
3-meter dipole, low noise amp, 13' downlead, flat response from 200 kHz to over 30 MHz, 12 db gain, with cable, converter, hardware (specify lugs, RCA phone or PL-259 connector).

\$124.50+\$5.00 s&h

OUTDOOR — AD-370 with stainless steel whips; mounts to any flat surface; with converter and 26' cable. \$144.50+\$5.00 s&h

Basic or Modified Receivers: Yaesu, Japan Radio, NRD-515, ICOM R-71A, Bearcat, Sharp, Sony & Panasonic.

GILFER SHORTWAVE

International Radio Specialists

P.O. Box 239 Park Ridge, NJ 07656 U.S.A.

Phone (201) 391-7887

CIRCLE 72 ON FREE INFORMATION CARD

88 / MODERN ELECTRONICS / November 1984

MODERN ELECTRONICS MART

Classified Commercial Rates: 90¢ per word, 15-word minimum (\$13.50) prepaid. (Word count includes name and address.) *First word only is set boldface caps* at no charge. Add 20% for additional boldface words.

Mart Display Rates: 1" x 1 col., \$120; 2" x 1 col., \$230; 3" x 1 col., \$330. Prepayment discount 5% for 6 issues; 10% for 12 issues prepaid at once.

(All advertisers with PO Box addresses must supply permanent address and telephone number. Copy is subject to publisher approval.)

Mailing Information: Copy must be received by the publisher by the 20th of the third month preceding the cover date. Send Advertising material with check or money order to: Modern Electronics, Classified Department, 76 North Broadway, Hicksville, NY 11801.

Cable Converters to Scramblers. Lowest Price. COD shippers. Dealer inquiries accepted. Quantity discounts. Catalog \$1. P.F. Video Corp., PO Box 296, Latham, NY 12110 (518) 274-6593.

Cable TV Converters. All types. All systems. Zenith, Scientific-Atlanta, Terrold specials. \$2 catalog. United Electronic Supply, PO Box 1206, Elgin, IL 60121-0119 (312) 697-0600.

Giant Shortwave Listener's Catalog. Features shortwave receivers, antennas, accessories, radio-teletype equipment, books, and much more. FREE! Universal Shortwave Radio, 1280 Aida Drive, Reynoldsburg, OH 43068 (614) 866-4267.

APPLE OWNERS: Hard-sided carrying cases for Macintosh \$100, Macintosh and external drive \$130, and 11c \$100. Send check or money order, or MC/Visa accepted. Justin Case Manufacturing Corp., 334 Main Street, Port Washington, NY 11050 (or telephone 516-883-2299).

TS 1000, TS 2068, TI 99/4A, VIC 20 software: FREE CATALOG: Turn programs into profits: Midwest Software 9922 Harwich, Crestwood, MO 63126.

CB RADIO MODIFICATIONS! Increase channels, range, privacy. Conversion hardware, books, plans, kits, repairs. Catalog \$2. CBCI, Box 31500ME, Phoenix, AZ 85046.

Order Form

Please print in block letters.

MODERN ELECTRONICS 76 North Broadway, Hicksville, NY 11801

Name _____
Street _____
City _____
State _____ Zip _____

1	2	3	4	5
6	7	8	9	10
11	12	13	14	15
16	17	18	19	20
21	22	23	24	25
26	27	28	29	30
31	32	33	34	35

WE HAVE QUALITY PARTS, DISCOUNT PRICES AND FAST SHIPPING!

TRANSFORMERS

120 volt primaries



5.6 VOLTS @ 750 MA	\$3.00
6 VOLTS @ 150 MA	\$1.25
12 VCT @ 200 MA	\$2.00
18 V @ 650 MA	\$3.50
18 VOLTS @ 1 AMP	\$4.50
24 VOLTS @ 250 MA	\$2.50
24 VCT @ 1 AMP	\$4.50
42 VCT @ 1.2 AMP	\$4.50

RS-232 EXTENTION

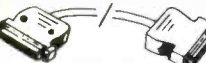

9 LINE CONNECTED. LINES 1 THROUGH 8 & 20. DB25 MALE TO FEMALE. 10 FEET SHIELDED. \$11.00 EACH

MIKE CONNECTOR



5 CONDUCTOR IN-LINE PLUG AND CHASSIS MOUNT JACK. TWIST LOCK STYLE. SAME AS SWITCHCRAFT 12CL5M. \$2.50 PER SET

7 CONDUCTOR RIBBON CABLE



SPECTRA-STRIP RED MARKER STRIP. 28 GA STRANDED WIRE. \$5.00 PER ROLL (100 FT.)

8 TRACK RECORD/PLAY TAPE DECK



MDRSE MODEL 9A-A

8 TRACK RECORD WITH AUTO STOP. NOT FULLY FUNCTIONAL. REMOVED FROM ASSEMBLY LINE FOR MINOR PROBLEMS. IDEAL FOR PARTS. EACH UNIT CONTAINS SWITCHES, LIGHTS, TAPE MOTOR, BELT, WHEELS, PULLEYS, PRE AMPS, TAPE HEADS, ETC.

SPECIAL PRICE \$4.00 EACH
10 for \$35.00

WALL TRANSFORMER

ALL ARE 115 VAC PLUG IN



4 VDC @ 70 MA	\$2.00
6 VDC @ 100 MA	\$2.50
6 VDC @ 500 MA	\$5.00
15 VAC @ 300 MA	\$3.00
16.5 VAC @ 10 VA	\$3.50
17 VAC @ 500 MA	\$4.00

MULTI-SWITCHES

3 STATION NON-INTERLOCKING

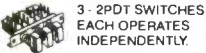

3 - 2PDT SWITCHES. EACH OPERATES INDEPENDENTLY. 1 1/4" BETWEEN MOUNTING CENTERS. \$1.75 EACH

METER

0 - 15 V.D.C.

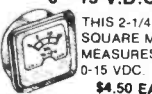

THIS 2-1/4" SQUARE METER MEASURES 0-15 VDC. \$4.50 EACH

COMMUNICATION MICROPHONE



NEW C.B. STYLE MIKE WITH PUSH S.P.D.T. SWITCH. \$5.00 EACH

2K 10 TURN MULTI-TURN POT



SPECTROL #MOD 534-7161 \$5.00 EACH

SPRING LEVER TERMINALS

TWO COLOR CODED TERMINALS ON A STURDY 2 3/4" x 3 3/4" BAKELITE PLATE. GREAT FOR SPEAKER ENCLOSURES OR POWER SUPPLIES. \$1.00 EACH 10 FOR \$9.00



5 STATION INTERLOCKING

MADE BY ALPS



3 - 2PDT AND 2 - 6PDT SWITCHES ON FULLY INTERLOCKING ASSEMBLY. 3/4" BETWEEN MOUNTING CENTERS. \$2.50 EACH

SUB-MINIATURE D TYPE CONNECTOR



SOLDER TYPE SUB-MINIATURE CONNECTORS USED FOR COMPUTER HOOK UPS.

DB-15 PLUG	\$2.75
DB-15 SOCKET	\$4.00
DB-15 HOOD	\$1.50
DB-25 PLUG	\$2.75
DB-25 SOCKET	\$3.50
DB-25 HOOD	\$1.25

PUSHBUTTON POWER SWITCH



DOUBLE POLE POWER SWITCH. PUSH-ON, PUSH-OFF. \$1.00 EACH

SWITCHES MINI-PUSH BUTTON

S.P.S.T. MOMENTARY NORMALLY OPEN 1/4" BUSHING. 35¢ EACH. 100 FOR \$30.00. SPECIFY COLOR: RED, BLACK, WHITE, GREEN, YELLOW.



2 CHANNEL LIGHT ORGAN

EASILY HOOKS INTO STEREO SPEAKERS AND ALLOWS 110 VAC LIGHTS TO DANCE WITH MUSIC. TWO SEPARATE 110 VAC OUTPUTS FOR HIGH AND LOW FREQUENCY AUDIO SIGNALS. USE TWO ORGANS FOR STEREO. \$6.50 PER UNIT. COLOR LIGHT STRING AVAILABLE \$1.75 EA

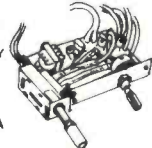

5 STATION NON-INTERLOCKING

SAME AS ABOVE, EXCEPT EACH SWITCH OPERATES INDEPENDENTLY. \$2.50 EACH

"PARALLEL" PRINTER CONNECTOR



SOLDER STYLE 36 PIN MALE USED ON "PARALLEL" DATA CABLES. \$5.50 EACH

NEON W/ RESISTOR

DIRECT OPERATION. 7 for \$1.00 FROM 120 VOLT

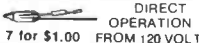

EDGE CONNECTORS

ALL ARE .156" SPACING

10 PIN EDGE CONNECTOR	TRW #50-10A-20 \$2.00 EACH
18/36 GOLD SOLDER EYELET	\$2.00 EACH
22/44 TIN	P.C. STYLE. NO MOUNTING EARS \$1.50 EACH 10 FOR \$14.00
22/44 GOLD	P.C. STYLE \$2.00 EACH 10 FOR \$18.00
28/56 GOLD	28/56 GOLD PLATED CONTACTS 156 CONTACT SPACING \$2.50 EACH 10 FOR \$22.00

FREE! FREE! FREE! SEND FOR NEW LARGER! 48 PAGE CATALOG FREE! FREE! FREE!

LINE CORDS

TWO WIRE 6' 18ga TWO WIRE 3 FOR \$1.00

THREE WIRE 18 INCH 18ga THREE WIRE 2 for \$1.00

8 FOOT 18ga THREE WIRE \$2.00 EACH

KEY ASSEMBLY

5 KEY \$1.00 EACH



CONTAINS 5 SINGLE-POLE NORMALLY OPEN SWITCHES. MEASURES 3 3/4" LONG

6 KEY \$1.25 EACH

CONTAINS 6 SINGLE-POLE NORMALLY OPEN SWITCHES. MEASURES 4 1/4" LONG

ROTARY SWITCH

1 POLE 6 POSITION



1 1/4" DIA x 1 1/2" HIGH 75¢ EACH 10 for \$6.00

COMPUTER GRADE CAPACITORS

2,000 mfd. 200 VDC	1 3/4" DIA x 5" HIGH	\$2.00
3,600 mfd. 40 VDC	1 3/8" DIA x 3 3/4" HIGH	\$1.00
6,400 mfd. 60 VDC	1 3/8" DIA x 4 1/4" HIGH	\$2.50
22,000 mfd. 40 VDC	2" DIA x 6" HIGH	\$3.00
31,000 mfd. 15 VDC	1 3/4" DIA x 4" HIGH	\$2.50
72,000 mfd. 15 VDC	2" DIA x 4 3/8" HIGH	\$3.50
185,000 mfd. 6 VDC	2 1/2" DIA x 4 1/2" HIGH	\$1.50

CLAMPS TO FIT CAPACITORS 50¢ ea.

SLIDE POTS

100K linear tape 2" LONG 1 5/8" TRAVEL 75¢ EACH

500K linear taper 2 7/8" LONG 1 3/4" TRAVEL 75¢ EACH

DUAL 100K audio taper 3 1/2" LONG 2 1/2" TRAVEL \$1.50 EACH

L.E.D.'S STANDARD JUMBO DIFFUSED

RED 10 FOR \$1.50

GREEN 10 FOR \$2.00

YELLOW 10 FOR \$2.00

FLASHER LED 5 VOLT OPERATION RED JUMBO SIZE \$1.00 EACH

BI POLAR LED 2 FOR \$1.70

SUB MINI LED 079" x 098" RED 10 FOR \$1.00 200 FOR \$18.00 GREEN 10 FOR \$1.50

LED HOLDERS TWO PIECE HOLDER FOR JUMBO LED 10 FOR 65¢ 200 FOR \$10.00

SOLDERING IRON STAND

SPRING STEEL IRON HOLDER ON WEIGHTED BASE. \$5.00 EACH



BATTERY OPERATED SMOKE DETECTOR

BRK MODEL #79R UL APPROVED 9 VOLT BATTERY OPERATION FOR CEILING OR WALL MOUNT. \$8.00 EACH 2 FOR \$15.00



RELAYS MINIATURE 6 VDC RELAY

SUPER SMALL SPDT RELAY. GOLD COBALT CONTACTS. RATED 1 AMP AT 30 VDC. DIRECTLY SENSITIVE. TTL HIGH DRIVE POSSIBLE. OPERATES FROM 4.3 TO 6 V. COIL RES. 220 OHM. 1 3/16" x 13/32" x 7/16" AROMAT # RSD-6V \$1.50 EACH 10 FOR \$13.50



MINIATURE TOGGLE SWITCHES

ALL ARE RATED 5 AMPS @ 125 VAC

S.P.D.T. (on-on)	P.C. STYLE NON-THREADED BUSHING 75¢ EACH 10 FOR \$7.00
S.P.D.T. (on-off)	NON-THREADED BUSHING P.C. STYLE 75¢ EACH 10 FOR \$7.00
S.P.D.T. (on-on)	SOLDER LUG TERMINALS \$1.00 EACH 10 FOR \$9.00 100 FOR \$80.00
S.P.D.T. (on-on)	P.C. LUGS, THREADED BUSHING \$1.00 EACH 10 FOR \$9.00 100 FOR \$80.00
S.P.D.T. (on-on)	SOLDER LUG TERMINALS \$2.00 EACH 10 FOR \$19.00 100 FOR \$180.00

CRYSTALS

CASE STYLE HC33/U 2 MHZ \$3.50 EACH

COLORBURST 3579.545 KC \$1.00 EACH

METAL OXIDE VARISTOR

G.E. # V82ZA12 50 VOLTS, NOMINAL D.C. VOLTAGE 5/8" DIAMETER 2 FOR \$1.50



TRANSISTORS

2N706	5 for \$1.00
2N2222A	4 for \$1.00
PN2222	8 for \$1.00
2N2904	4 for \$1.00
2N2905	4 for \$1.00
2N2907	4 for \$1.00

4 PDT RELAY

14 pin style 3 amp contacts 24 volt d.c. or 120 volt a.c. coil Used but fully tested \$1.70 EACH specify coil voltage LARGE QUANTITIES AVAILABLE SOCKETS FOR RELAY 50¢ each



13 VDC RELAY

CONTACT: S.P.N.C. 10 AMP @ 120 VAC. ENERGIZE COIL TO OPEN CONTACT. COIL 13 VDC 650 OHMS. SPECIAL PRICE \$1.00 EACH



PHOTO-FLASH CAPACITORS

170 MFD 330 VOLT 1 1/8" x 7/8" 2 FOR \$1.50 10 FOR \$7.00

750 MFD 330 VOLT 2" HIGH x 1 1/4" DIA. \$1.25 EACH 10 FOR \$11.00

CLEAR CLIPLITE HOLDER

MAKE LED A FANCY INDICATOR CLEAR. 4 FOR \$1.00



POWER SUPPLY W/ PRE-AMP

THIS SUPPLY WAS USED TO POWER AN 8 TRACK/CASSETTE UNIT. IT WILL SUPPLY APPROX. 18 VDC AND INCLUDES A SMALL PRE-AMP TO BOOST SIGNAL LEVEL. RCA PLUGS FOR LINE IN/OUT. \$4.50 EACH



POWER SUPPLY W/ PRE-AMP

THIS SUPPLY WAS USED TO POWER AN 8 TRACK/CASSETTE UNIT. IT WILL SUPPLY APPROX. 18 VDC AND INCLUDES A SMALL PRE-AMP TO BOOST SIGNAL LEVEL. RCA PLUGS FOR LINE IN/OUT. \$4.50 EACH

POWER SUPPLY W/ PRE-AMP

THIS SUPPLY WAS USED TO POWER AN 8 TRACK/CASSETTE UNIT. IT WILL SUPPLY APPROX. 18 VDC AND INCLUDES A SMALL PRE-AMP TO BOOST SIGNAL LEVEL. RCA PLUGS FOR LINE IN/OUT. \$4.50 EACH

POWER SUPPLY W/ PRE-AMP

THIS SUPPLY WAS USED TO POWER AN 8 TRACK/CASSETTE UNIT. IT WILL SUPPLY APPROX. 18 VDC AND INCLUDES A SMALL PRE-AMP TO BOOST SIGNAL LEVEL. RCA PLUGS FOR LINE IN/OUT. \$4.50 EACH

POWER SUPPLY W/ PRE-AMP

THIS SUPPLY WAS USED TO POWER AN 8 TRACK/CASSETTE UNIT. IT WILL SUPPLY APPROX. 18 VDC AND INCLUDES A SMALL PRE-AMP TO BOOST SIGNAL LEVEL. RCA PLUGS FOR LINE IN/OUT. \$4.50 EACH

POWER SUPPLY W/ PRE-AMP

THIS SUPPLY WAS USED TO POWER AN 8 TRACK/CASSETTE UNIT. IT WILL SUPPLY APPROX. 18 VDC AND INCLUDES A SMALL PRE-AMP TO BOOST SIGNAL LEVEL. RCA PLUGS FOR LINE IN/OUT. \$4.50 EACH

TOLL FREE ORDERS ONLY
1-800-826-5432 (ORDER ONLY)
(IN CALIFORNIA: 1-800-258-6666)
ALASKA, HAWAII, OR INFORMATION
(213) 380-8000

ALL ELECTRONICS CORP.

ALL ELECTRONICS CORP.

905 S. Vermont Ave. P.O. BOX 20406 Los Angeles, Calif. 90006

QUANTITIES LIMITED
MINIMUM ORDER \$10.00
USA: \$2.50 SHIPPING
FOREIGN ORDERS:
INCLUDE SUFFICIENT SHIPPING
CALIF. RES. ADD 6 1/2%
NO C.O.D.!

CABLE TV DESCRAMBLERS

All Types — Retail and Wholesale

COD ORDERS ACCEPTED

We will match or beat ANY price!

UNDERGROUND ELECTRONICS

818-346-5071

NOT AVAILABLE IN CALIFORNIA

CIRCLE 63 ON FREE INFORMATION CARD

MODERN ELECTRONICS

Coming Next Month

- Coleco's "Adam" Home Computer.
 - The TV Satellite Picture.
 - Automotive Security Alarms.
 - Santa's Treelight Controller.
 - Cassette-Tape Dubbing for Car Stereo.
 - RGB Monitors for Computers.
 - How to Get Started in Electronics—Integrated Circuits. (Originally scheduled for November, space limitations shifted it to December 1984's issue.)
- ... and more.

Plus a bevy of electronic/computer product evaluations, columns on communications, electronic experimenting, technical book reviews, new products, electronic and computer news, and other regular departments.

SUBSCRIBER SERVICE

CHANGE OF
ADDRESS

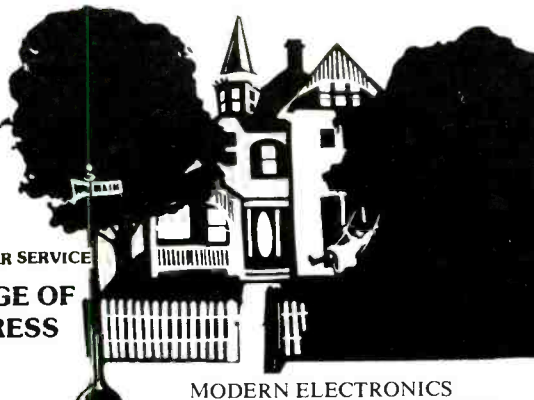

MODERN ELECTRONICS
76 N. Broadway, Hicksville, NY 11801

Planning to move? Please let us know six weeks in advance so you won't miss a single issue of MODERN ELECTRONICS. Attach old label and print new address in space provided. Also include your mailing label whenever you write concerning your subscription to ensure prompt service on your inquiry.

BIGGEST TI-99/4A SELECTION. Newest exciting software and hardware bargains. Hard to get items. Send for free catalog. Fast Service. TYNAMIC, Box 690, Hicksville, NY 11801.

NEW... REPAIR ANY TV... EASY. Anyone can do it. Write, Research, Box 601BY, Colville, WA 99114.

DIGITAL Klock Kit plays 1-of-12 different melodies on the quarter hour. Displays time, date, and other features. Send \$2.00 for complete assembly plans and pricing to **KERBER KLOCK KO**, 36117 Hillcrest, Eastlake, Ohio 44094.

BURGLAR ALARM BUSINESS BOOMING. It's easy. Tremendous employment-business opportunities. Write today: Security Electronics International, P.O.B. 1456-EW Grand Rapids, Michigan 49501.

Atari - Commodore Owners: Send for your free educational catalog to Frost Computer, PO Box 2573 GMF, Woburn, MA 01801.

STAINED GLASS! Supplies, books, tools, patterns, etc. for moneymaking hobby. Whittemore, Box 2065KC, Hanover, MA 02339.

REVERBERATION FOR ORGANS

Solid state with controls for reverberation and room size.
EVERY ORGAN SHOULD OWN ONE. *Send for free flyer—*

DEVTRONIX ORGANS, INC.
6101 WAREHOUSE WAY
SACRAMENTO, CALIFORNIA 95826

CIRCLE 16 ON FREE INFORMATION CARD



7 MILLION TUBES FREE CATALOG

Includes all Current, Obsolete, Antique, Hard-To-Find Receiving, Broadcast, Industrial, Radio/TV types. **LOWEST PRICES**, Major Brands, In Stock.

UNITY Electronics Dept. P.C.
P.O. Box 213, Elizabeth, NJ 07206



CIRCLE 28 ON FREE INFORMATION CARD

SATELLITE DESCRAMBLERS

MOVIES MOVIES MOVIES
SEND \$5.00 FOR CATALOG
MODERN TECHNOLOGY
PO BOX 419-M
BOSTON, MA 02186

CIRCLE 56 ON FREE INFORMATION CARD

ATTACH LABEL HERE

PLEASE PRINT NEW ADDRESS HERE

NAME _____

ADDRESS _____

CITY _____ STATE _____

DATE _____ ZIP _____

1-800-344-4339

NATIONAL SEMICONDUCTOR • PANASONIC • QUALITY - Name brand products from nationally recognized manufacturers. **GHEMICALS • ARIES • PLESSEY • MOLEX • E**
AAVIV • CHEM-K • ATLANTIC DIODES • N **SERVICE** - Computerized order processing and inventory control. **AS INSTRUMENTS • D-K • A P PROTECTIVE • D-K • P**
ARIES • PLESSEY • MOLEX • AAVIV • E • J **Volume Discounts • OEM Quantity Pricing • Toll Free 800 Number** **CHEMICALS • ARIES • PLESSEY • MOLEX • E**
AS INSTRUMENTS • D-K • A P PROTECTIVE • D-K • P **Volume Discounts • OEM Quantity Pricing • Toll Free 800 Number** **CHEMICALS • ARIES • PLESSEY • MOLEX • E**

DISCRETE

Part No.	Package	Price
LM741CN	14	1.75
LM741CN	14	1.75
LM741CN	14	1.75
LM741CN	14	1.75
LM741CN	14	1.75
LM741CN	14	1.75
LM741CN	14	1.75
LM741CN	14	1.75
LM741CN	14	1.75
LM741CN	14	1.75

1% Metal Film Resistors

Part No.	Value	Price
1000	1000	0.40
1000	1000	0.40
1000	1000	0.40
1000	1000	0.40
1000	1000	0.40
1000	1000	0.40
1000	1000	0.40
1000	1000	0.40
1000	1000	0.40
1000	1000	0.40

TEST INSTRUMENTS

TEST SOCKETS
Body: 3V D-sub connector with Copper Alloy contacts. Recommended for use with 0.1" pitch. 60% volume discount. Contact a distributor and oriented to the pinout to ground the board. The D-sub allows for low insertion and high retention forces. Section 101 to enhance mounting density on boards.

SOLDER TAIL DIP SOCKETS
• Single lead
• Low profile
• YOUR CHOICE - TIN OR GOLD

PANASONIC LS Series

Miniature Aluminum Electrolytic Capacitors

Value	WV	Radial	Price
1000	100	100	1.00
1000	100	100	1.00
1000	100	100	1.00
1000	100	100	1.00
1000	100	100	1.00
1000	100	100	1.00
1000	100	100	1.00
1000	100	100	1.00
1000	100	100	1.00
1000	100	100	1.00

DISC CAPACITORS

PANASONIC CERAMIC DISC CAPACITORS

Value	Price
1000	1.00
1000	1.00
1000	1.00
1000	1.00
1000	1.00
1000	1.00
1000	1.00
1000	1.00
1000	1.00
1000	1.00

4000 CMOS

Part No.	Price
74VHC00	0.40
74VHC00	0.40
74VHC00	0.40
74VHC00	0.40
74VHC00	0.40
74VHC00	0.40
74VHC00	0.40
74VHC00	0.40
74VHC00	0.40
74VHC00	0.40

5% Carbon Film Resistors

Part No.	Value	Price
1000	1000	0.40
1000	1000	0.40
1000	1000	0.40
1000	1000	0.40
1000	1000	0.40
1000	1000	0.40
1000	1000	0.40
1000	1000	0.40
1000	1000	0.40
1000	1000	0.40

WIRE WRAP

Standard profile
• Universal mounting and packaging
• Available in 100, 150, 200, 250, 300, 350, 400, 450, 500, 550, 600, 650, 700, 750, 800, 850, 900, 950, 1000, 1050, 1100, 1150, 1200, 1250, 1300, 1350, 1400, 1450, 1500, 1550, 1600, 1650, 1700, 1750, 1800, 1850, 1900, 1950, 2000, 2050, 2100, 2150, 2200, 2250, 2300, 2350, 2400, 2450, 2500, 2550, 2600, 2650, 2700, 2750, 2800, 2850, 2900, 2950, 3000, 3050, 3100, 3150, 3200, 3250, 3300, 3350, 3400, 3450, 3500, 3550, 3600, 3650, 3700, 3750, 3800, 3850, 3900, 3950, 4000, 4050, 4100, 4150, 4200, 4250, 4300, 4350, 4400, 4450, 4500, 4550, 4600, 4650, 4700, 4750, 4800, 4850, 4900, 4950, 5000, 5050, 5100, 5150, 5200, 5250, 5300, 5350, 5400, 5450, 5500, 5550, 5600, 5650, 5700, 5750, 5800, 5850, 5900, 5950, 6000, 6050, 6100, 6150, 6200, 6250, 6300, 6350, 6400, 6450, 6500, 6550, 6600, 6650, 6700, 6750, 6800, 6850, 6900, 6950, 7000, 7050, 7100, 7150, 7200, 7250, 7300, 7350, 7400, 7450, 7500, 7550, 7600, 7650, 7700, 7750, 7800, 7850, 7900, 7950, 8000, 8050, 8100, 8150, 8200, 8250, 8300, 8350, 8400, 8450, 8500, 8550, 8600, 8650, 8700, 8750, 8800, 8850, 8900, 8950, 9000, 9050, 9100, 9150, 9200, 9250, 9300, 9350, 9400, 9450, 9500, 9550, 9600, 9650, 9700, 9750, 9800, 9850, 9900, 9950, 10000, 10050, 10100, 10150, 10200, 10250, 10300, 10350, 10400, 10450, 10500, 10550, 10600, 10650, 10700, 10750, 10800, 10850, 10900, 10950, 11000, 11050, 11100, 11150, 11200, 11250, 11300, 11350, 11400, 11450, 11500, 11550, 11600, 11650, 11700, 11750, 11800, 11850, 11900, 11950, 12000, 12050, 12100, 12150, 12200, 12250, 12300, 12350, 12400, 12450, 12500, 12550, 12600, 12650, 12700, 12750, 12800, 12850, 12900, 12950, 13000, 13050, 13100, 13150, 13200, 13250, 13300, 13350, 13400, 13450, 13500, 13550, 13600, 13650, 13700, 13750, 13800, 13850, 13900, 13950, 14000, 14050, 14100, 14150, 14200, 14250, 14300, 14350, 14400, 14450, 14500, 14550, 14600, 14650, 14700, 14750, 14800, 14850, 14900, 14950, 15000, 15050, 15100, 15150, 15200, 15250, 15300, 15350, 15400, 15450, 15500, 15550, 15600, 15650, 15700, 15750, 15800, 15850, 15900, 15950, 16000, 16050, 16100, 16150, 16200, 16250, 16300, 16350, 16400, 16450, 16500, 16550, 16600, 16650, 16700, 16750, 16800, 16850, 16900, 16950, 17000, 17050, 17100, 17150, 17200, 17250, 17300, 17350, 17400, 17450, 17500, 17550, 17600, 17650, 17700, 17750, 17800, 17850, 17900, 17950, 18000, 18050, 18100, 18150, 18200, 18250, 18300, 18350, 18400, 18450, 18500, 18550, 18600, 18650, 18700, 18750, 18800, 18850, 18900, 18950, 19000, 19050, 19100, 19150, 19200, 19250, 19300, 19350, 19400, 19450, 19500, 19550, 19600, 19650, 19700, 19750, 19800, 19850, 19900, 19950, 20000, 20050, 20100, 20150, 20200, 20250, 20300, 20350, 20400, 20450, 20500, 20550, 20600, 20650, 20700, 20750, 20800, 20850, 20900, 20950, 21000, 21050, 21100, 21150, 21200, 21250, 21300, 21350, 21400, 21450, 21500, 21550, 21600, 21650, 21700, 21750, 21800, 21850, 21900, 21950, 22000, 22050, 22100, 22150, 22200, 22250, 22300, 22350, 22400, 22450, 22500, 22550, 22600, 22650, 22700, 22750, 22800, 22850, 22900, 22950, 23000, 23050, 23100, 23150, 23200, 23250, 23300, 23350, 23400, 23450, 23500, 23550, 23600, 23650, 23700, 23750, 23800, 23850, 23900, 23950, 24000, 24050, 24100, 24150, 24200, 24250, 24300, 24350, 24400, 24450, 24500, 24550, 24600, 24650, 24700, 24750, 24800, 24850, 24900, 24950, 25000, 25050, 25100, 25150, 25200, 25250, 25300, 25350, 25400, 25450, 25500, 25550, 25600, 25650, 25700, 25750, 25800, 25850, 25900, 25950, 26000, 26050, 26100, 26150, 26200, 26250, 26300, 26350, 26400, 26450, 26500, 26550, 26600, 26650, 26700, 26750, 26800, 26850, 26900, 26950, 27000, 27050, 27100, 27150, 27200, 27250, 27300, 27350, 27400, 27450, 27500, 27550, 27600, 27650, 27700, 27750, 27800, 27850, 27900, 27950, 28000, 28050, 28100, 28150, 28200, 28250, 28300, 28350, 28400, 28450, 28500, 28550, 28600, 28650, 28700, 28750, 28800, 28850, 28900, 28950, 29000, 29050, 29100, 29150, 29200, 29250, 29300, 29350, 29400, 29450, 29500, 29550, 29600, 29650, 29700, 29750, 29800, 29850, 29900, 29950, 30000, 30050, 30100, 30150, 30200, 30250, 30300, 30350, 30400, 30450, 30500, 30550, 30600, 30650, 30700, 30750, 30800, 30850, 30900, 30950, 31000, 31050, 31100, 31150, 31200, 31250, 31300, 31350, 31400, 31450, 31500, 31550, 31600, 31650, 31700, 31750, 31800, 31850, 31900, 31950, 32000, 32050, 32100, 32150, 32200, 32250, 32300, 32350, 32400, 32450, 32500, 32550, 32600, 32650, 32700, 32750, 32800, 32850, 32900, 32950, 33000, 33050, 33100, 33150, 33200, 33250, 33300, 33350, 33400, 33450, 33500, 33550, 33600, 33650, 33700, 33750, 33800, 33850, 33900, 33950, 34000, 34050, 34100, 34150, 34200, 34250, 34300, 34350, 34400, 34450, 34500, 34550, 34600, 34650, 34700, 34750, 34800, 34850, 34900, 34950, 35000, 35050, 35100, 35150, 35200, 35250, 35300, 35350, 35400, 35450, 35500, 35550, 35600, 35650, 35700, 35750, 35800, 35850, 35900, 35950, 36000, 36050, 36100, 36150, 36200, 36250, 36300, 36350, 36400, 36450, 36500, 36550, 36600, 36650, 36700, 36750, 36800, 36850, 36900, 36950, 37000, 37050, 37100, 37150, 37200, 37250, 37300, 37350, 37400, 37450, 37500, 37550, 37600, 37650, 37700, 37750, 37800, 37850, 37900, 37950, 38000, 38050, 38100, 38150, 38200, 38250, 38300, 38350, 38400, 38450, 38500, 38550, 38600, 38650, 38700, 38750, 38800, 38850, 38900, 38950, 39000, 39050, 39100, 39150, 39200, 39250, 39300, 39350, 39400, 39450, 39500, 39550, 39600, 39650, 39700, 39750, 39800, 39850, 39900, 39950, 40000, 40050, 40100, 40150, 40200, 40250, 40300, 40350, 40400, 40450, 40500, 40550, 40600, 40650, 40700, 40750, 40800, 40850, 40900, 40950, 41000, 41050, 41100, 41150, 41200, 41250, 41300, 41350, 41400, 41450, 41500, 41550, 41600, 41650, 41700, 41750, 41800, 41850, 41900, 41950, 42000, 42050, 42100, 42150, 42200, 42250, 42300, 42350, 42400, 42450, 42500, 42550, 42600, 42650, 42700, 42750, 42800, 42850, 42900, 42950, 43000, 43050, 43100, 43150, 43200, 43250, 43300, 43350, 43400, 43450, 43500, 43550, 43600, 43650, 43700, 43750, 43800, 43850, 43900, 43950, 44000, 44050, 44100, 44150, 44200, 44250, 44300, 44350, 44400, 44450, 44500, 44550, 44600, 44650, 44700, 44750, 44800, 44850, 44900, 44950, 45000, 45050, 45100, 45150, 45200, 45250, 45300, 45350, 45400, 45450, 45500, 45550, 45600, 45650, 45700, 45750, 45800, 45850, 45900, 45950, 46000, 46050, 46100, 46150, 46200, 46250, 46300, 46350, 46400, 46450, 46500, 46550, 46600, 46650, 46700, 46750, 46800, 46850, 46900, 46950, 47000, 47050, 47100, 47150, 47200, 47250, 47300, 47350, 47400, 47450, 47500, 47550, 47600, 47650, 47700, 47750, 47800, 47850, 47900, 47950, 48000, 48050, 48100, 48150, 48200, 48250, 48300, 48350, 48400, 48450, 48500, 48550, 48600, 48650, 48700, 48750, 48800, 48850, 48900, 48950, 49000, 49050, 49100, 49150, 49200, 49250, 49300, 49350, 49400, 49450, 49500, 49550, 49600, 49650, 49700, 49750, 49800, 49850, 49900, 49950, 50000, 50050, 50100, 50150, 50200, 50250, 50300, 50350, 50400, 50450, 50500, 50550, 50600, 50650, 50700, 50750, 50800, 50850, 50900, 50950, 51000, 51050, 51100, 51150, 51200, 51250, 51300, 51350, 51400, 51450, 51500, 51550, 51600, 51650, 51700, 51750, 51800, 51850, 51900, 51950, 52000, 52050, 52100, 52150, 52200, 52250, 52300, 52350, 52400, 52450, 52500, 52550, 52600, 52650, 52700, 52750, 52800, 52850, 52900, 52950, 53000, 53050, 53100, 53150, 53200, 53250, 53300, 53350, 53400, 53450, 53500, 53550, 53600, 53650, 53700, 53750, 53800, 53850, 53900, 53950, 54000, 54050, 54100, 54150, 54200, 54250, 54300, 54350, 54400, 54450, 54500, 54550, 54600, 54650, 54700, 54750, 54800, 54850, 54900, 54950, 55000, 55050, 55100, 55150, 55200, 55250, 55300, 55350, 55400, 55450, 55500, 55550, 55600, 55650, 55700, 55750, 55800, 55850, 55900, 55950, 56000, 56050, 56100, 56150, 56200, 56250, 56300, 56350, 56400, 56450, 56500, 56550, 56600, 56650, 56700, 56750, 56800, 56850, 56900, 56950, 57000, 57050, 57100, 57150, 57200, 57250, 57300, 57350, 57400, 57450, 57500, 57550, 57600, 57650, 57700, 57750, 57800, 57850, 57900, 57950, 58000, 58050, 58100, 58150, 58200, 58250, 58300, 58350, 58400, 58450, 58500, 58550, 58600, 58650, 58700, 58750, 58800, 58850, 58900, 58950, 59000, 59050, 59100, 59150, 59200, 59250, 59300, 59350, 59400, 59450, 59500, 59550, 59600, 59650, 59700, 59750, 59800, 59850, 59900, 59950, 60000, 60050, 60100, 60150, 60200, 60250, 60300, 60350, 60400, 60450, 60500, 60550, 60600, 60650, 60700, 60750, 60800, 60850, 60900, 60950, 61000, 61050, 61100, 61150, 61200, 61250, 61300, 61350, 61400, 61450, 61500, 61550, 61600, 61650, 61700, 61750, 61800, 61850, 61900, 61950, 62000, 62050, 62100, 62150, 62200, 62250, 62300, 62350, 62400, 62450, 62500, 62550, 62600, 62650, 62700, 62750, 62800, 62850, 62900, 62950, 63000, 63050, 63100, 63150, 63200, 63250, 63300, 63350, 63400, 63450, 63500, 63550, 63600, 63650, 63700, 63750, 63800, 63850, 63900, 63950, 64000, 64050, 64100, 64150, 64200, 64250, 64300, 64350, 64400, 64450, 64500, 64550, 64600, 64650, 64700, 64750, 64800, 64850, 64900, 64950, 65000, 65050, 65100, 65150, 65200, 65250, 65300, 65350, 65400, 65450, 65500, 65550, 65600, 65650, 65700, 65750, 65800, 65850, 65900, 65950, 66000, 66050, 66100, 66150, 66200, 66250, 66300, 66350, 66400, 66450, 66500, 66550, 66600, 66650, 66700, 66750, 66800, 66850, 66900, 66950, 67000, 67050, 67100, 67150, 67200, 67250, 67300, 67350, 67400, 67450, 67500, 67550, 67600, 67650, 67700, 67750, 67800, 67850, 67900, 67950, 68000, 68050, 68100, 68150, 68200, 68250, 68300, 68350, 68400, 68450, 68500, 68550, 68600, 68650, 68700, 68750, 68800, 68850, 68900, 68950, 69000, 69050, 69100, 69150, 69200, 69250, 69300, 69350, 69400, 69450, 69500, 69550, 69600, 69650, 69700, 69750, 69800, 69850, 69900, 69950, 70000, 70050, 70100, 70150, 70200, 70250, 70300, 70350, 7040

DON'T LET THE ELECTRONICS REVOLUTION PASS YOU BY! BECOME A CHARTER SUBSCRIBER TO



MODERN ELECTRONICS



Now you can reach out every month and learn about the latest innovations in consumer electronics and personal computers—what's new, how products and circuits work, and what leading authorities think of them.

***Stereo *Video *Home & Car Electronics
*Test Instruments *Circuitry & Devices *Servicing
*Personal Computers *Communications *Construction Projects**

In every issue, authors lucidly explain how exciting, new electronics ideas are applied . . . issue forthright buying counsel . . . present complete plans to build electronic devices to enhance products, even unique ones that are not yet being sold in the marketplace.

Feature articles, tutorials, and construction projects are the hallmarks of MODERN ELECTRONICS, the new monthly magazine for electronics and computer enthusiasts. Covering the entire spectrum of these fields, you'll gather insights in every important area to help you make buying decisions for work and play purposes . . . improve performance of your present equipment . . . increase your electronics competence . . . and add to your practical and intellectual knowledge of electronics and computers.

To be sure you get this valuable information delivered to you regularly, and share the experiences of our writers and editors—Forrest Mims, Len Feldman, Stan Prentis, Charles Rubenstein, Glenn Hauser, and many others—you can subscribe to MODERN ELECTRONICS today. As a Charter Subscriber, you'll save 45% off the newsstand price when you buy a one-year subscription for only \$12.97. Or save 51% when you subscribe for two years at \$22.97.

Acting now you won't miss any of our exciting upcoming features, such as Comparing Color TV Sets, Tape Dubbing Methods for Car Stereo, Circuit Designing from Scratch series, Automotive Security Alarms, The TV Satellite Picture, Santa's Tree-Light Controller project, Computer Peripheral Switching, and much more.

Just fill out the coupon and mail with your check, money order, or credit card information (Visa or MasterCard) to enter your Charter Subscription. Do it today to ensure earliest delivery!



MODERN ELECTRONICS 76 North Broadway, Hicksville, NY 11801

Please send me Modern Electronics for 2 Years 1 Year

Name _____
Street _____
City _____
State _____ Zip _____

Charge My Order To: Payment Enclosed \$ _____ 2 Years (24 issues) \$22.97

MasterCard My account number is: 1 Year (12 issues) \$12.97

VISA   _____

ADVERTISERS' INDEX

AP Products	Cov. IV
All Electronics Corp.	89
CQ Magazine	85
Cleveland Institute of Electronics	25
Communications Electronics	31
Devtronix Organs	90
Digi-Key Corp.	91
E.W. Engineering, Inc.	81, 87
Electronic Specialists	80
Elephant Electronics	79
Gilfer Shortwave	88
Global Specialties	43
Grantham College of Engineering	1
Haltronix, Inc.	75
Handy Products	63
Heath Co.	5
Information Unlimited	79
Memotech Corp.	Cov. III
NRI Schools	8, 11
OptoElectronics, Inc.	2
Paia	88
Phillips-Tech	80
Popular Communications Magazine	68
Underground Electronics	90
Uniden Bearcat	Cov. II
Unity Electronics	90
Vertical Antenna Handbook	85

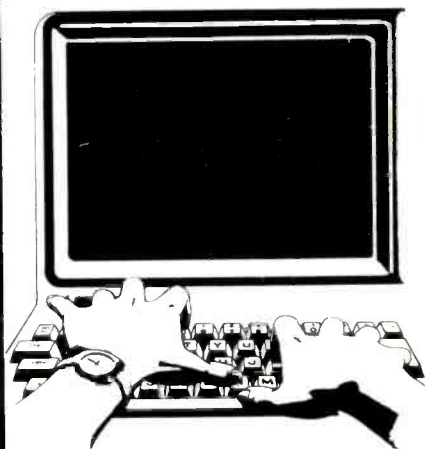

Free Product Information

Readers can obtain free information on products advertised by the above companies, as well as for some editorially mentioned products. Simply circle the appropriate number printed below an advertisement onto the Modern Electronics "Free Information Service" card bound into this issue. After filling in your name and address, just mail the postpaid card. Your request will be forwarded directly to the advertiser with a mailing label prepared by our reader-service department to ensure speedy response.

A WORLD APART FROM THE ORDINARY

Introducing the MTX512



Step into a new realm of microcomputer technology.

Where computers are housed in sleek black metal cases. Computer languages work in interactive harmony. And computer owners finally move up to a system they won't outgrow.

Step into the extraordinary world of the MTX512.

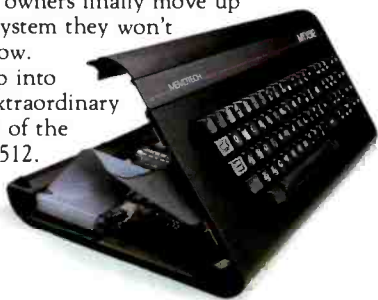

Interactive Software: An MTX Exclusive

This is the way all micros should perform. Interactively.

With the MTX, you can create and manipulate programs using four different languages in dynamic interaction, all coordinated through the FRONT PANEL DISPLAY. And the languages housed in the MTX's 24K ROM will satisfy the needs — and desires — of both novice and highly advanced programmers. In addition to powerful MTX BASIC and MTX GRAPHICS languages, you get NODDY, an 11-command "easy learn" language, and MTX ASSEMBLER, which enables sophisticated programming in assembly language.

Serious programmers will also appreciate our ASSEMBLER/DISASSEMBLER, tied to BASIC, which gives them unprecedented display and keyboard access to Z80 CPU storage locations, memory and program.

64K to 512K USER RAM, And So Much More

Never has so much performance been designed into a single microcomputer. With 64K user RAM, and expansion capabilities that can take you up to 512K, the MTX is the perfect micro for a wide range of applications.

Graphics capabilities? The MTX starts off where other micros usually end up. Delivering 16-color, 256 × 192 high resolution graphics. In a format powered by 32 easily movable, user-defined sprites.

The MTX also gives you eight definable windows, to operate independently or in tandem. And still maintain full screen capabilities. We call them Virtual Screens. You'll call them extraordinary.

Far from ordinary as well are the built-in systems outputs that come standard on the MTX. The Centronics parallel printer port. The two industry-standard joystick ports. The uncommitted parallel I/O port. The 2400 baud Cassette port. Separate TV and Video Monitor ports. The 4-channel sound hifi output. We've even installed a ROM cartridge port for Word Processing and other dedicated programs.



Word Processing for \$999

This is word processing the way it should be. Quick. Easy. Professional. For a limited time, you can purchase a package that includes the MTX512S; the powerful NewWord™, word processing ROM board; and the Memotech DMX80 correspondence quality printer*. An exceptional value!

A Computer That Grows Into a System

The MTX was designed to grow, and to keep on growing. With a full line of Memotech system peripherals that will answer your growing needs. The MTX's Z80A processor, running at 4MHz, enables you to expand into the MTX hard disc, MTX Silicon and Floppy Disc CP/M operated systems. Systems that could provide up to 160 megabyte storage capacity. That's power you might one day need; considering that the MTX can be used in an interactive communications network (OXFORD RING®) linking up to 255 units.

Now, The Bottom Line

The more engineering you put into designing a computer, the less it will cost to produce. Which is why we can sell it for \$595**.

And why we can confidently back it up with a full one-year warranty.

See the MTX512 at your computer dealer now or contact Memotech Corporation, 99 Cabot Street, Needham, MA 02194; or phone (617) 449-6614.

Toll Free Number 1-800-247-5570
MEMOTECH
CORPORATION
CIRCLE 39 ON FREE INFORMATION CARD

LITTLE THINGS MEAN A LOT

Being the first company to make solderless breadboards isn't necessarily what makes us the best. It's all the little things you don't see, like our spring clip terminals, that make AP[®] PRODUCTS ACEBOARDS so big on reliability.

From our largest ACEBOARD with over 5000 tie points, to a single tie point block, our spring clip terminals give you nothing but good, solid contact on every connection. They accommodate a wide variety of leads and have the best electrical properties, because our spring clips are solid alloy, not plated nickel. We've even developed enough normal force to break through any oxides which could occur on solder plated leads. You've come to trust our test clips for the same reason.

Since one bad connection can ruin a whole circuit, we pay close attention to how well our spring clip terminals sit within the insulator cell areas. Spring clip edges are never exposed at the insertion window.

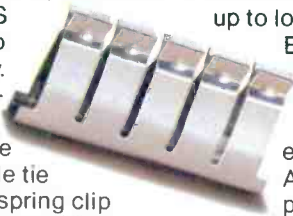

Leads won't buckle, clips won't oxidize, it all adds up to longer life.

Even from the outside there's more to an ACEBOARD than meets the eye. Our durable Acetal Copolymer plastic body is a good insulator with excellent dielectric properties.

And special manufacturing techniques in the insertion of the contacts into the plastic body insure that your Breadboard will always remain flat. No skimping or planned obsolescence here. Again, just good solid contact on every connection.

Turn our breadboard body over...and you'll discover another key to its reliability. The double-sided adhesive foam you'll

see there is more than a pressure sensitive mount. It also insulates to prevent shorts and seals the bottom of the individual spring clip cells.

If solder shavings from resistors or component leads drop into the cell, they can't spread into other cells to short them out.

Take a close look at our ACEBOARDS. AP PRODUCTS has the biggest and most complete line of ACEBOARD sizes. It's also our commitment to you that if your ACEBOARD doesn't

work perfectly, bring it back to your AP PRODUCTS distributor. He'll replace it, no hassles.

To help you see for yourself what a big difference the little things make, we're offering you a 10% discount on the entire AP PRODUCTS ACEBOARD/Breadboard line.

Just fill out the coupon and present it to your AP PRODUCTS distributor.

For the name of the distributor nearest you, call TOLL FREE (800) 321-9668. (In Ohio, call collect: (216) 354-2101).

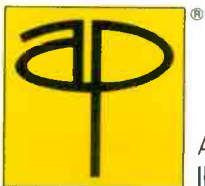

**A P PRODUCTS
INCORPORATED**

9325 Progress Parkway, Box 540
Mentor, Ohio 44060, (216) 354-2101
TWX: 810-425-2250

In Canada, call Lenbrook Electronics • (416) 477-7722

CIRCLE 68 ON FREE INFORMATION CARD

This coupon is worth 10% off the purchase price of any size ACEBOARD or Breadboard product. Offer expires 12/31/84.

Your Name _____

Address _____

City _____ State _____ Zip _____

Dealer Name _____

ACEBOARD # _____

Limit 5 ACEBOARDS or Breadboards per coupon. Offer valid only at participating AP PRODUCTS distributors.