

Home recording studio
page 64

13 easy projects

TV displays for
your home computer
page 31

Beepers:
what a pocket pager
can do for you
page 58

- Joy Drone
- CMOS receiver
- Computer Ignition
- Short locator
- plus 9 one-biters

Digital dashboard
page 82

September 1978 \$1.50

modern electronics

© 06707

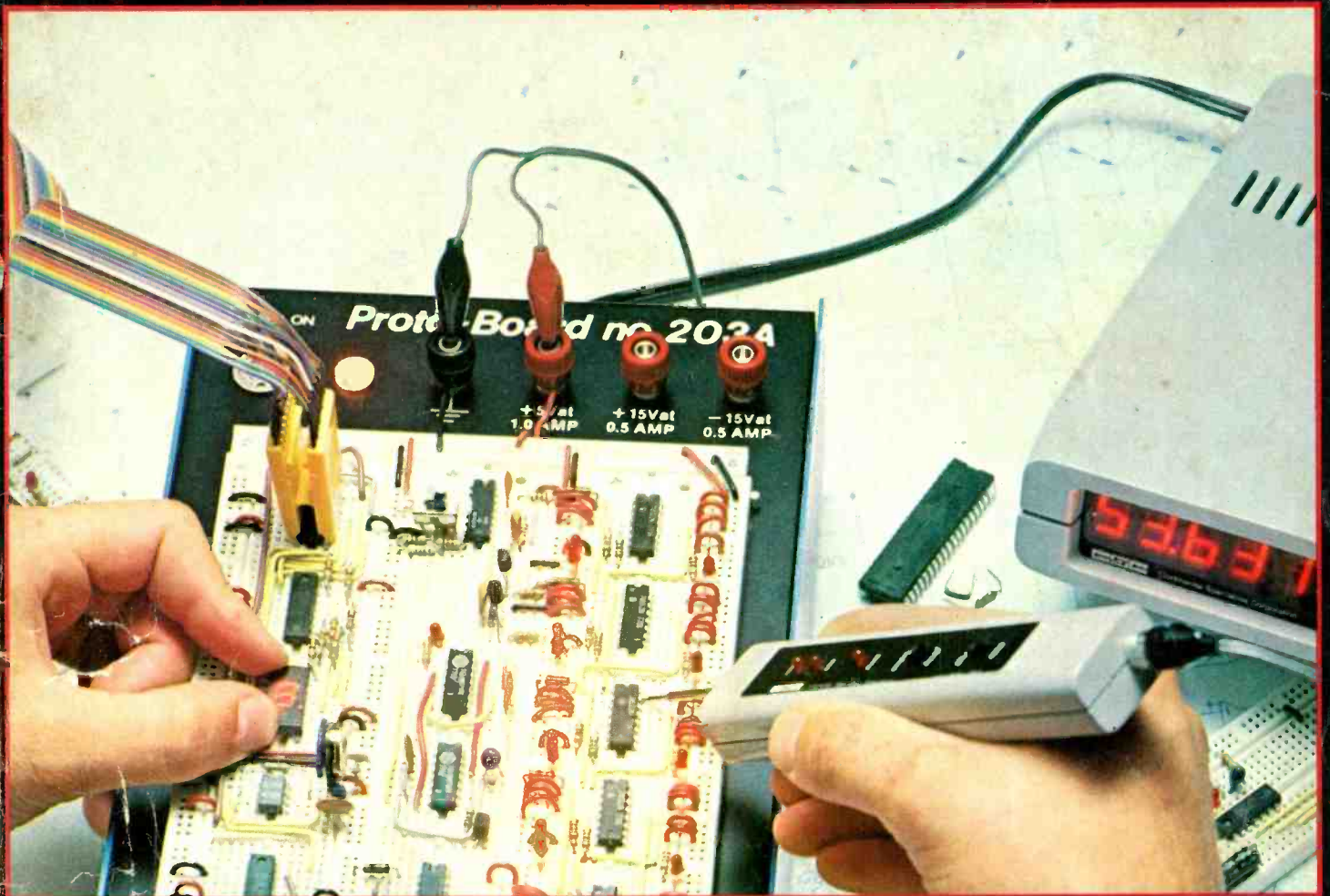

ALRSA451STN99
MR ALVIN I LAP
4519 ST
PENSACCO

radio:
old this month

page 20

hy-gain[®] electronics



3506 VHF Marine hand-held transceiver



3750 Amateur transceiver

Now, better than ever!

We're now a division of Telex Communications, Inc., one of the most respected names in electronics, and we have new corporate management.

We also have a new way of doing business that's based on putting you first. Giving you the products you want, when you want them. We're now in full production and ready to give you immediate delivery on:

- Amateur radios and antennas
- Marine radios and antennas
- Citizens Band antennas
- Monitor antennas
- Land Mobile antennas
- Military and Industrial antenna systems

Our products have the same great quality and reliability that made us famous. And our marketing staff is made up of people who know you. Let them help you get the most from Hy-Gain communications products.

Call or write today. And get growing with the new Hy-Gain Electronics.



Division of Telex Communications, Inc.

Hy-Gain Electronics
Division of Telex Communications, Inc.
8601 Northeast Highway Six
Lincoln, NE 68505
402/467-5321 telex 48-4324

Penetrator CB base antenna

modern electronics

SEPTEMBER 1978

CONTENTS

VOLUME ONE NUMBER SEVEN



FEATURE STORY

27 TV interfaces



How they work on your home computer

EDITOR

Mort Waters
W2NZ

ASSISTANT EDITOR

Bob Margolin
K1BM/KAB 6647

CONTRIBUTING EDITORS

Hans Fantel

Peter A. Stark
K2OAW

Ron Cogan

Jeffrey A. Sandler

Carmine W. Prestia
W83ADI

Roy B. Goshorn
W3TEF

Harry L. Helms Jr.
WA4EOX

EDITORIAL ASSISTANT

Jeanne Lang

PRODUCTION MANAGER

Laura Delaney

PUBLISHER

Richard A. Cowan
WA2LRO/KGB4096

Modern Electronics is published monthly by Cowan Publishing Corp. 14 Vanderventer Ave., Port Washington, NY 11050. Our title is registered with the United States Postal Service. Application for second-class postage is pending at Port Washington, NY.

SPECIAL FEATURES



50 Secret radio signals you can hear from Latin America



60 Beepers pocket pagers, what they can do for you



66 Home recording studio how one man built his

73 Joy Drone is an easy-to-build music project

82 Digital dashboard add these to your car

48 Perry People Harold's folks find fun in electronics

PROJECTS

33 ASCII keyboard how to use the Radio Shack gear

35 9 projects under \$9 easy-to-build one-niters

40 CMOS receiver tune in signals with this project

63 Computer ignition for your car

64 Short locator when you can't find your pants

73 Joy Drone music maker

COLUMNS

8 Computers Pete reads letters

16 Stereo Hans explains

18 Mobile Ron invents power

INFO

57 Electronic symbols how to read our schematics

56 Inbound RFI how to get garbage out of your radio

81 Telephone amplifier you hang on the wall

88 Blind hams see the world through radio

92 Motorcycle mobile how to hang a radio on your bike

MONTHLY

6 Clinic readers try to stump the editors

comment

OUTPUT FROM MODERN ELECTRONICS' EDITOR

by Mort Waters
Editor, Modern Electronics

As you can see, MODERN ELECTRONICS has a new editor. Outside of that one minor fact, little else has changed. You may expect to see future issues very similar to what you've already experienced. Few, if any of the regular contributors will differ.

One thing that will be different somewhat will be this particular column. I've always felt that an editorial should be just that. It should express the opinions of the editor on one or more concrete subjects. While an editorial may not necessarily be controversial, the very nature of controversy shouldn't preclude it's appearing in what, otherwise, is a general interest technical magazine. This is a particularly delicate area nowadays because most, if not all, facets of electronics are governed by one or more government agencies.

If it's not the FCC precluding some great device being manufactured because of radiation or interference problems, it might be the FTC getting into the act on pricing or marketing policies of a manufacturer. I've always felt that the public is entitled to know what the government is doing to them as well as what it's doing for them.

A specific case in point right now is a series of negotiations taking place between the antenna industry and the Consumer Products Safety Commission. As I understand it, the CPSC is attempting to provide regulations to curtail or eliminate electrical accidents related to antenna installations. That, in itself is a worthy effort. To accomplish the end objective, antenna manufacturers are being asked to label their products with safety warning stickers. There's a strong possibility that they'll also be required to add extra insulation to the antennas to cut down on the severity of accidents that might take place. All this is fine. But—and this is the zinger—there's a strong possibility that the results of these regulations might make the costs of antennas so prohibitive as to be unaffordable.

Okay, we must have better safety precautions, granted. But just how serious is the accident situation that's causing all the hula-baloo. Well, according to a CPSC survey (probably made at a considerable expense to us taxpayers) some 123 fatalities occurred in 1976 as the result of accidental electrocution. And of those, about 31% were antenna related. Wow! I think you'll find that more people get killed in slippery bathtubs every month than by antenna accidents in a year. But I don't see any labels required on the bathtubs. Let's push for labels on every light bulb warning people to keep their thumbs out of the socket. Let's require safety stickers on every boat sold in the U.S. After all, you might drown if you get careless and fall off the deck. Or better yet, maybe we should tell the government to take some of its safety stickers and stick 'em. We'll probably be a lot better off.

Oh, well! That's just a sample of some of the things you might see happening in future editions of Comment. Buchwald I'm not. But I won't pull any punches. That I promise.

modern electronics

Business Staff

President and Publisher
Richard A. Cowan
Associate Publisher
Richard A. Ross
Vice President
Jack N. Schneider
Chairman of the Board
S. R. Cowan

Advertising Staff

Display Advertising
Richard A. Cowan
telephone (516) 883-6200
Midwest Sales Director
Jim Reilly
telephone (312) 824-2412
Circulation Manager
Janet Kurtz
Production Consultant
Cary L. Cowan

Art Staff

Art Director
William H. Travis
Assistant Art Director
Liz Beener
Design
Sheryl Stern
Illustrator
Harold Perry
Staff Artist
Fran Vitrano
Staff Artist
Tom Batcher

Property rights

All circuits, designs and construction projects in Modern Electronics are strictly experimental. We can't guarantee any results to be expected from their use or application. The publisher and editors do not know of any proprietary rights which could be violated by the making, building or using of any projects or gear described in this issue.

Freelance writers

Letters to the editors should be addressed to Modern Electronics, 14 Vanderventer Ave., Port Washington, NY 11050. Our editorial telephone is (516) 883-6200. We can't assume responsibility for unsolicited manuscripts but we will try to handle them courteously. Please mark your name, address and telephone number clearly on each page of manuscripts and on all photographs and artwork. Modern Electronics' readers demand manuscripts, photographs and artwork of the finest quality. Writers, photographers and artists meeting the standards of Modern Electronics' editors will receive prompt professional payment for submissions upon acceptance.

Change of address

Send us word of your change of address as early as possible. We need at least six weeks to make the change in our mailing list. Address changes and Postmaster form 3579 to Circulation Department, Modern Electronics, 14 Vanderventer Ave., Port Washington, NY 11050. Include your old address, new address and a mailing label from a recent issue of Modern Electronics.

Subscriptions

Mail subscriptions are available for \$12 a year or \$22 for two years. Newsstand cover price is \$1.50 per issue. Subscriptions are slightly higher for other countries. Write Circulation Department, Modern Electronics, 14 Vanderventer Ave., Port Washington, NY 11050. This magazine is printed in the United States of America.

Copyright

Copyright to the whole contents of Modern Electronics is held by Cowan Publishing Corp. 1978. You may not reprint any of our material without written permission from Cowan Publishing Corp.

If you think you can't learn TV and audio servicing at home, I say, "BALONEY!"

Maybe you don't believe that we can actually teach you to service TV and audio equipment by mail. Yet here at NRI, we're doing it every day. Helping people to bigger and brighter futures. Let me tell you why the NRI way works so well... and challenge you to put us to the test.

One of the secrets of the success of this school is the fact that its founder, J.E. Smith, was a teacher. So, when he originated his first course in radio over 60 years ago, it was carefully designed with training in mind. And that principle has guided us ever since. In every technical course we offer. Today, every aspect of our courses in TV and audio servicing are student-oriented to make learning as fast and as easy as possible.

Exclusive Training Methods

Right off, that means that you get far more than book learning. NRI gives you practical, hands-on experience as you progress. In our Master Course in TV and audio servicing, you actually construct a 25-inch diagonal solid state color TV. You start right with the basic parts and as you build it, you introduce and correct typical servicing problems, ending up with a complete unit, ready to use. That way, you get the actual bench time and intimate knowledge you need to handle real servicing problems. And before that, you even assemble some of your own electronic test instruments so you not only know how to use them, but how they work. That kind of training sticks with you... gives you extra confidence.

And Mr. Smith taught us something else, too. Not to go too fast. So, our courses have what we call "bite-size" lessons. That's another way of saying that they're easy to digest. Big enough to cover a specific subject thoroughly, but not so much that it'll overwhelm you. Written clearly, without a lot of gobbledegook. And we keep in mind that you're learning at home, so you take our lessons at your own pace. That way, you can learn in your spare time without interfering with your present job or eating up too much of your family life. Of course, if you want to move ahead faster, we're behind you all the way. The point is, it's your choice.

Professional Instructor/Engineers

One of the ways we back you up is with a fully-qualified staff of professional instructor/engineers. They're there to help you when you have a problem with any aspect of your studies... lessons, theory, bench training. And because most of them



John F. Thompson, NRI President

actually helped plan your lessons and designed your equipment, you'll get answers right from the horse's mouth, answers that are clear and to the point.

I might add that these are not a bunch of ivory-tower professor types. In between checking your lessons and giving you personal help, they're busy keeping up with the state of the art, designing new equipment and revising lessons to get you ready to handle even the latest equipment. As a case in point, take the audio equipment we added to our course recently. Not just stereo, but *four-channel*. Maybe a little exotic, but when a servicing problem like this hits your bench, you're ready for it. It's the kind of thinking and planning ahead our founder would have liked.

I Dare You To Do It

Now you might think I'm bragging a little too much on how good NRI is, and maybe I am. I'm mighty proud of our accomplishments. But the proof of the pudding is in the eating... how our training works in preparing people for actual jobs. So I'm inviting you to ask the only people who can give you a totally objective answer, professional TV and audio technicians. And here's my bet. Just look in your yellow pages for a couple of TV repair shops, ask to speak with anyone who actually does the repair work, and ask him what he thinks of NRI. I'll bet he says, "Do it!"

I'm not really sticking my neck out, because I know something you may not. Almost half the TV servicemen working out there have taken home-study courses. And among them, it's NRI more than three to one! Ask the pros on the firing line and three to one they'll recommend NRI to you as their first choice. I'll be happy to send you a copy of the national survey that proves it.

Why do the pros like us? Because NRI works. You take it at home so you don't have to go to classes. You take it in your spare time, so you can hold down your job while you get ready for your step forward. And you take it easy, because our

bite-size lessons make it easier, let you set your own pace.

Equipment Designed for Learning

And to top it off, NRI's equipment is exclusive. We design most of our own, so it's not somebody else's hobby kit or a stripped-down and mostly assembled commercial unit. It's designed so you really learn as you build, designed to give you lots of honest bench time, designed to give you the satisfaction of finishing up with a fully operable, top-quality unit that's comparable to any commercial set on the market. But you built it... you learned something on it! That's J.E. Smith's philosophy again.

It all boils down to the fact that we've aimed our training at a very practical goal... giving you the skills you need to move ahead in a rewarding career. Or even to have your own full- or part-time business.

Send for Free Catalog, No Salesman Will Call

There's lots more to tell about NRI training in TV and audio servicing and other courses, but not much space left to do it. So I'm inviting you to send for our free catalog of electronics courses. It contains a complete description of every course, including each lesson, training kits, and experiments. Full color photos show you exactly what your course will include in the way of test instruments, electronic components, and major kits like the 4-channel audio center and color TV.

No salesman will call on you, either. We don't work that way, never have. Our catalog shows you what we have to offer you, what we can do for you. Look it over, then think about it and make your own decision without outside pressure. J.E. Smith always felt that his best students were the self-motivated ones.

I can only add this. With over 60 successful years and more than a million students behind us, we must be doing something right. Just ask anybody we've helped along the way. So get started on your future. Send the postage-paid card and check the course that interests you. If it has already been removed, write me and I'll personally see that your catalog gets rushed to you. And thanks for listening to me.



John F. Thompson, President
NRI Schools
McGraw-Hill Center for
Continuing Education
3939 Wisconsin Avenue
Washington, D.C. 20016

BY JEFF SANDLER

Needs power monitor

I have a regulated, variable voltage power supply, but it has no metering. I can't find any that are small enough at a price I can afford. It seems to me there should be some way of using LEDs and zener diodes to indicate voltage. I'm primarily interested in knowing when the output is five or 12 volts. Do you know a circuit that can do this?

R.S., Petersburg, FL

Your idea of using a zener and LED to indicate an output voltage exceeding a set point is great. The problem with zeners is that they have tolerances, just like resistors. Finding a zener with exactly a five-volt breakdown is rare. The circuit shown here overcomes that problem by giving you a control to adjust the set-point voltage. To do this, you'll need an accurate voltmeter. When the supply output rises to the preset level, the LED will go on. To calibrate the unit, set the output to exactly five volts using your voltmeter. Then adjust the control until the LED just goes on. Using a duplicate circuit, set it for 12 volts.

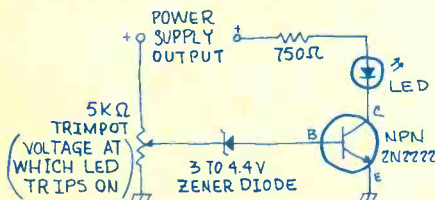

Four-minute motor

I'm a 75 year old electronics nut. I've been building circuits for about a year, and have just started making PC boards. I need a circuit for a timer using a 555 to start and run a 12-volt motor for about four minutes, then cut off for another four minutes, and then repeat the cycle over again. Can you help?

R.T., Abilene, TX

Here's a very simple four-minute timer built

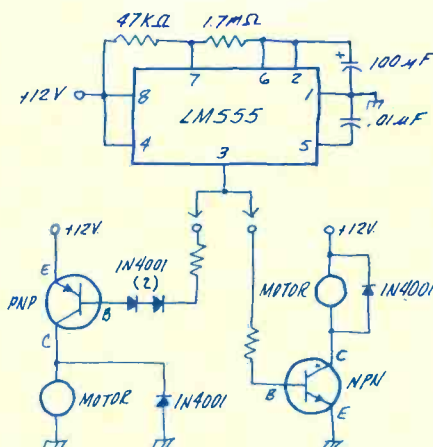

around the 555 IC that should do the trick. In fact, the circuit is so simple, you won't have to bother with a PC board. The circuit as drawn will give you about four minutes on and four minutes off. If you need a precise setting, you can replace the 1.7 megohm resistor with a 1 meg fixed resistor and a 1 meg variable connected in series. You can use either an NPN or a PNP transistor to drive your motor. But, if you use a PNP, make sure to add two 1N4001 diodes in series with the base lead to insure motor turn-off.

Tape talk

I have an am-fm radio with a built-in tape recorder. Whenever I play a tape, I hear a loud buzzing sound. Do you know what it is and how I can get rid of it?

S.W.F., N. Vancouver, BC

Finding the cause of a buzz, or hum as it's called, can be one of the most frustrating aspects of the hobbies. There are so many possible causes that it's very difficult to pin down the cause from the information you've provided. For example, do you get the buzz when you listen to the radio? If you do, the problem is in the amplifier or power supply. If you hear the buzz when operating from ac, but not when on battery power, then it's probably in the power supply. If you get the

buzz only when you use the tape deck, it's in the tape circuits. If you get it only on tapes you make yourself, but not on pre-recorded tapes, then it's in the tape record circuit. It's possible, of course, that the problem is more mechanical in nature; a loose connection or arcing motor for example. As you can see, there are any number of possible causes. When you have a problem you want diagnosed by remote control, make sure to describe every detail of the fault, giving as much information as possible.

Identifying SCRs and triacs

I would appreciate plans to build some sort of device that would separate SCRs from triacs. I always have trouble telling them apart—they all look alike. I usually buy them mixed together in large quantities.

L.L., Raleigh, N.C.

Both SCRs and triacs operate as switches that turn on when triggered by pulse to the gate. The major difference between the two is their mode of conducting. SCRs behave like diodes, conducting in one direction only. Triacs are closer to true switches, once turned on, they conduct in both directions. Put in other terms, SCRs are dc devices; triacs ac. You can identify type with a six-volt battery and lamp. You can use just about any six-volt pilot lamp including the 40, 44, 46, 47, or 1847 types. Connect the lamp in series with the battery and across the two larger leads of the device. Then momentarily connect the remaining smaller lead to one of the larger leads. If the lamp does not turn on, move the small lead to the other large lead. Then reverse the battery polarity and repeat the

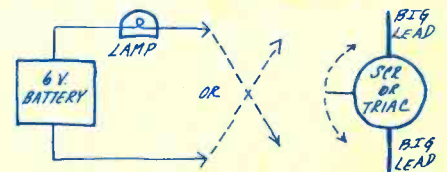

procedure. The lamp should turn on during at least one of these tests. If not, the device is bad, or neither an SCR or triac. If the lamp turned on with either battery polarity, but not both, the device is an SCR. If it turned on with both polarities, it is a triac.

TTL robotics

While working with experimental robotics, I've come up with the problem of forward and reverse control for motors using TTL outputs. Do you have any circuits that could control a 100-150 ma motor with a standard 16 ma TTL output? I'd like to stay away from electro-mechanical relays if possible.

C.L., Cudahy, WI

It's nice to run across a problem that has a simple, inexpensive solution. If you're using a motor that will operate at the same five-volt level as your TTL output, and if reversing polarity reverses motor direction, this circuit should work well. Although 2N2222 and 2N3906 transistors are specified, just about anything you might have in your junkbox should work, as long as it can handle your 150 ma load current. If the motor runs properly and the transistor remains cool, you're home free. What makes this circuit so nice is that you'll only need one TTL output. When it's high, transistors 2 and 3 conduct. When it's low, 1 and 4 conduct. This switching arrangement reverses the motor polarity automatically.

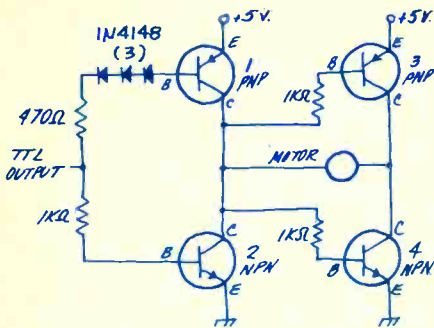

Bungled burglar alarm

Could you please help me with my burglar alarm? I'm very new to electronics. I need to protect nine doors and windows and would like to add an outside alarm bell. I'd like the inside master control station to signal an entry with a Sonalert, and indicate with an LED which entrance was breached. Finally, I'd like to be able to turn off the outside alarm with a switch at the master control station. I'm enclosing an alarm circuit diagram I took from a book on intrusion alarms. Can I use it for my alarm system?

R.M.H., Sacramento, CA

I don't like to review the work of others. What may seem to me to be a poor way to do something may in fact be the best way to handle a specific problem the designer had in

mind. However, the circuit you sent me is overly complicated and expensive. My philosophy is to keep circuits as simply as possi-

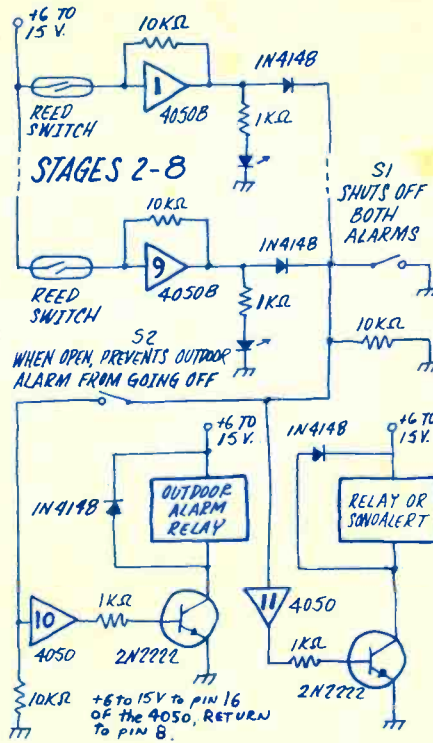

ble. With that in mind, I'd suggest you use this circuit instead. Each entrance is alarmed with a reed switch and permanent magnet detector. The reed switch should be mounted on the jam or sill, with the magnet on the door or window. They should be positioned so that the switch will close momentarily as the door or window is opened. The alarm circuit will latch on at that point, so disconnecting the switch at the door or window won't stop the alarm from signaling. Each entrance has an LED indicator that will light when its detector is tripped. In addition to the LED, both an inside Sonalert and an outside alarm will sound when a detector is tripped. But, you can kill the outside alarm signal by opening the switch marked S2 in the diagram. You can kill both alarm signals, and reset the circuit, by closing the switch marked S1. As shown, the circuit requires a total of 11 4050 sections. Since there are six in each IC, you'll need two ICs. Make sure to tie the input of the unused section to the battery supply voltage to prevent unwanted self-oscillation.

More downcounter update

I'd like to compliment you on what promises to be a first-rate magazine. Even though I am sure each of your subscribers would prefer you to concentrate on his or her favorite topic, variety does keep you/us on your toes. Regarding your timely article on page 21 of the June issue, I'd like to convert the downcounter into a darkroom timer. Can the circuit be modified to prevent the counter from automatically recycling the timer back to its preset time? Can BCD thumb-

wheel switches be used in place of the wire jumpers or toggle switches to preset the timer?

J.E.N., San Francisco, CA

Thanks for the compliment. As far as inhibiting the reset is concerned, I assume you're really talking about stopping the automatic downcounting. As the circuit stands, when time runs out, an alarm sounds. The time shown on the display then recycles from zero to 99:99 and begins counting down again. The reset button must be pushed before the counter will reset to the preset time, and stop sounding the alarm. The pause button, when pushed, freezes the count. The two controls are totally independent of each other. So, all you have to do is push the pause button, freezing the count, and then the reset button, resetting the count back to the preset time. When you're ready to start timing again, just push the pause button, releasing the counter. Your suggestion to use a BCD thumbwheel switch is great. I wish I had thought of it first.

Still more downcounter

The LED readouts used in your downcounter had 22 pins each. The readouts I'm using have only 18. Mine are common cathode. Will these work?

T.G., Dallas, TX

For reasons I don't understand, some manufacturers provide the same device type but with more or less pins. It sure would be nice if everybody agreed on a standard design. You can identify which lead controls what segment of the display using a simple three-volt test setup. The first step is to guess which pin is common. Then connect the resistor-battery test probes as shown. While maintaining contact with what you think is the common pin with one probe, connect the other probe in turn to each of the remaining pins. If every

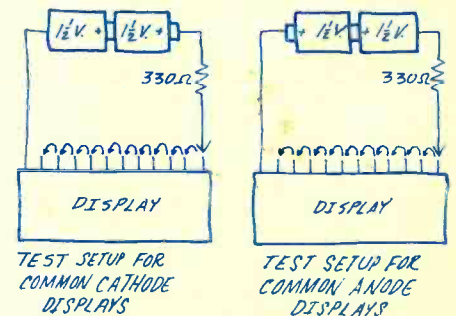

segment lights, you have in fact found the common. If they don't, move the first probe to another pin, and work through each of the remaining pins with the second probe. Eventually you'll find the common. You can then identify the remaining pins by connecting the test probes to the common and pin of interest, and observing which segment lights. Then refer to the diagram for proper identification. The display used in the original downcounter is a common cathode type, so yours should work in the circuit.

computers^{em}

HOW THEY WORK,

HOW YOU USE THEM, WHAT THEY CAN DO FOR YOU

BY PETE STARK

Tune in the computers column each month to find out the latest inside info on what's happening in the world of home computers

A common question in more and more letters is this: "I'd like to learn about microcomputers as fast as I can. How should I go about it?"

Sometimes the question is asked by experimenters who have simply heard that computers can be fun. But often the person asking is a businessman who wants to investigate a small computer for use in his plant, or an engineer or scientist who wants to make use of it in some piece of equipment—or wants to learn about microcomputers to get a better job!

Unfortunately, there is no easy way to become an expert overnight; but some of the ways of learning about these computers are more fun than others.

The first thing to realize is that there is a lot of difference between the traditional large computer and the 'micro' computer. Although both can compute, and both are programmed in similar ways, they are built differently and used differently. As a result, learning about large computers and then trying to apply this knowledge to the micro-computers is likely to take longer than studying micro-computers in the first place.

Going to school

Even though microcomputers are fairly new, a number of schools offer courses in the circuitry and programming involved. But you must choose carefully or you will be disappointed.

Computer courses can be found in your local college or university, business school, engineering school, junior college, or even high school adult ed division in a few exceptional cases.

Liberal arts colleges tend to treat computers as a theoretical subject most often taught by the math or computer science department; either way, these courses would probably be pure gibberish to the beginner, and not related to micro-computers anyway.

Business schools tend to concentrate on large computers and their applications to business data processing, with the result that this too may not be useful to the small computer user.

Last month I described my own computer system and its uses. I mentioned that an important use was for preparing and editing this column, but that this part of the system was not quite complete. I promised to mention it again when it was finished.

Well, here it is. The lines you are reading were prepared and edited on my Southwest Technical Products 6800 computer, and then typed on an IBM Selectric typewriter which is controlled by the computer.

In order to make the printed output a little more pleasing to the eye - and to make it look a bit more like the normal print that Modern Electronics uses - this was printed using a program option called 'right justification', which means that all the lines are the same length and end at the same place on the right. This is done automatically by the computer, which stretches short lines by making the spaces between words longer. The program isn't smart enough to know when to break up a word with a hyphen, and so sometimes lines look somewhat strange if many spaces have to be inserted because the next word is extremely long and doesn't quite fit.

WHY SETTLE FOR LESS— THAN A 6800 SYSTEM

MEMORY—

All static memory with selected 2102 IC's allows processor to run at its maximum speed at all times. No refresh system is needed and no time is lost in memory refresh cycles. Each board holds 4,096 words of this proven reliable and trouble free memory. Cost—only \$125.00 for each full 4K memory.

INTERFACE—

Serial control interface connects to any RS-232, or 20 Ma. TTY control terminal. Connectors provided for expansion of up to eight interfaces. Unique programmable interface circuits allow you to match the interface to almost any possible combination of polarity and control signal arrangements. Baud rate selection can be made on each individual interface. All this at a sensible cost of only \$35.00 for either serial, or parallel type

PROCESSOR—

"Motorola" M6800 processor with Mikbug[®] ROM operating system. Automatic reset and loading, plus full compatibility with Motorola evaluation set software. Crystal controlled oscillator provides the clock signal for the processor and is divided down by the MC14411 to provide the various Baud rate outputs for the interface circuits. Full buffering on all data and address busses insures "glitch" free operation with full expansion of memory and interfaces.

POWER SUPPLY—

Heavy duty 10.0 Amp power supply capable of powering a fully expanded system of memory and interface boards. Note 25 Amp rectifier bridge and 91,000 mfd computer grade filter capacitor.

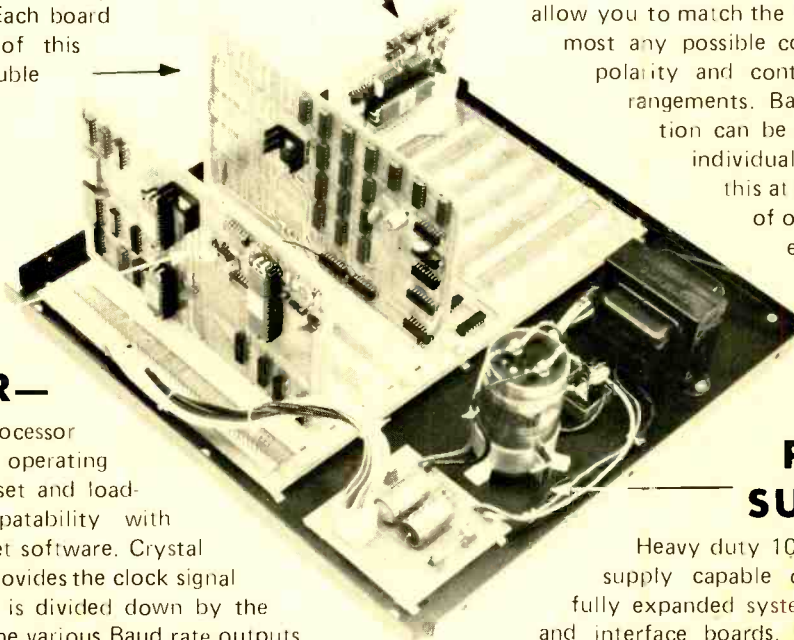

DOCUMENTATION—

Probably the most extensive and complete set of data available for any microprocessor system is supplied with our 6800 computer. This includes the Motorola programming manual, our own very complete assembly instructions, plus a notebook full of information that we have compiled on the system hardware and programming. This includes diagnostic programs, sample programs and even a Tic Tac Toe listing.

Mikbug[®] is a registered trademark of Motorola Inc.

SwTPC 6800
Computer System

with serial interface and 4,096 words of memory. \$395.00



ME-9

Enclosed is \$395 for my SwTPC Computer Kit Send Data

or BAC _____ # _____

or MC _____ Ex Date _____

NAME _____

ADDRESS _____

CITY _____ STATE _____ ZIP _____

Southwest Technical Products Corp., Box 32040, San Antonio, Texas 78284

This leaves the engineering school and junior college or technical institute. In these schools, micro-computer courses are most likely to be taught by the electrical engineering or electrical technology departments.

Although the word 'electrical' implies that only circuits (or hardware) are taught, in practice most of these departments will teach the programming (software) courses as well.

If you have an engineering background, then the engineering school may be quite acceptable to you; otherwise the junior college may be a better bet.

Going Shopping

Although the traditional approach to learning about a college is to send for its catalog and study it, I would recommend that you simply call up the appropriate department at the school and ask to speak to one of the professors.

The reason is that with new topics—such as micro-computers—it may be easier to introduce them into an existing course than to change the description in the catalog. So the catalog and its course descriptions may be out of date.

But be careful here—assuming that you want a quick crash course in computers, you are not interested in an entire series of courses. In a complex subject area like computers, it is not easy to cover everything in one course which perhaps only meets a few hours a week. The material you want may be spread out over several interlocked courses which have to be taken in a certain order.

Then too, the other students in the class may not be as interested as you are, and the instructor may be going slower than you would like.

Check also whether the course is strictly a series of lectures, or whether a laboratory session each week is part of it. Laboratory sessions—assuming that the school has the equipment to go with them and doesn't use them just as additional time for lecturing—can be very useful. The laboratory sessions also help bring the course down to earth, and often help the instructor keep up to date as well.

The major disadvantage of taking a college course is that it is probably not tailored to your needs. Each course is planned to fit into a complete curriculum—a set of courses to take an entering student who knows nothing about an area and take him through several years of material on his way to a degree. Individual courses are not intended to be taken by themselves.

An excellent source of information on small computers is a computer store. Not all areas of the country have them, of course—they are most often found in larger cities or densely populated areas—but if there is one nearby you may be in luck.

The hardest part may be finding one. Look in the yellow pages of local telephone directories under 'Computers' as a start. Look also under 'Computer' or 'Byte' in the white pages. *Heathkit* stores also carry computer equipment and accessories and are a good bet. *Radio Shack* sells only its own brand and so will have less variety, but is worth a visit.

Computer stores are useful in many ways. First off, you might actually buy a computer there. More on this later, but for now let's assume you are not quite ready for that step.

Many computer stores provide lectures or classes to the public. There may be a small charge for them, but it is probably worth it since these classes may be more in line with your needs. In any case, you can probably get a lot of information just by talking with the salesman, assuming that he has the time.

A second advantage of visiting the computer store is that this will put you in contact with other hobbyists. Aside from the possibility of meeting some while browsing in the store, you might ask the salesman whether he knows of any computer clubs in the area.

Look also for a bulletin board where club meetings may be advertised, or where used equipment may be listed.

While in the store, look around at the merchandise being exhibited, but do not panic at the prices. Much of the equipment shown will be intended for business users, not for hobbyists. Since their needs are quite different from the beginner's, the prices reflect the more complex equipment they want.

Finally, computer stores are a source of books and magazines.

Books

Bookstores are not a good place to buy computer books. They tend to carry only the very simple books of the type that start with "Look at the computer. Look at the computer run."

These may be fun to read, but will not really tell you what you want to know. While they can order books out of catalogs for you, they probably only handle the popular paperback or hard cover publishers. Unfortunately, most of the really good small computer books are printed by specialized publishers that the bookstore never heard of.

Above all, stay away from most hard cover computer books. There are very few of these that are really up to date since it takes so long for them to be published.

So where to get good books? The best place is from a computer store. Most stores carry a good selection, and will allow you to thumb through them and select the one you want. The salesman might even recommend one or two. Even if there isn't a computer store in your area, perhaps you can find a *Heathkit* or *Radio Shack* store.

Try also your local library, but most likely you will be disappointed. If there is a college nearby, try their library too. Above all, visit the college bookstore. It will probably have a general collection of books, as well as a carefully laid out display of all the textbooks for each course. If there is a computer course or computer department, those textbooks might be interesting to see. By the way, here is a good way of judging whether the course itself is worthwhile—see what books they use!

Many electronics stores carry books too; perhaps there you might find a good display.

There are several paperback publishers who specialize in computer books for hobbyists. These include *Osborne and Associates*, *Scelbi*, *Dilithium Press*, and to a lesser extent *Sams* and *TAB Books*. Perhaps a local bookstore can get a catalog for you.

Magazines

In addition to the computer coverage you will find in *Modern Electronics*, you may find the specialized computer magazines interesting too. The popular ones are *Byte*, *Creative Computing*, *Dr. Dobb's Journal of Computer Calisthenics and Orthodontia* (how is that for a title?), *Interface Age*, *Kilobaud*, *Personal Computing*, and *ROM*.

Each of these magazines has a different slant; some you will like, some you may not. Don't rush out to subscribe to any of them unless you have had a chance to look at them first. Some of them are strictly descriptive with articles about what computers can be used for rather than how to use them; others tend to concentrate on theoretical material which may interest more advanced hobbyists rather than beginners. Look before you buy. (This is another reason to search out a computer store.)

Many home-study schools offer courses in digital circuits and computers. By taking the full course, you get not only the course notes and textbooks, but also lab equipment for doing your own experiments, exams, and a certificate if you pass the do-it-yourself exams. This certificate can be used to show prospective employers that you have studied the material.

If you are a veteran, then you may be able to get Uncle Sam to pay for your education. This is a valuable plus which is popular with many, and it offsets the high cost of some home-study courses.

Another way to learn about small computers—and possibly the fastest and most enjoyable—is to build one. It isn't hard if you do it from a kit. It needn't be expensive either.

Several companies have computer kits in the range of \$100 and up. But what you need is not just the computer kit, but also a good set of teaching lessons to go with it. One of the best I have come

FREE

The world's largest catalog
of easy-to-build, money-saving
electronic kits



- Personal Computer Systems now including Floppy Disk Storage
- Power Supplies ● Oscilloscopes ● Frequency Counters ● VTVM's and VOM's
- Ham Radio Gear ● Digital Programmable Color TV ● Hi-Fi Components
- Electronic Clocks and Weather Instruments ● Self-instruction Electronics Programs
- Auto, Fishing, Marine and Aircraft Accessories — nearly 400 kits in all!

Every Heathkit product comes with a fully-illustrated, step-by-step assembly manual that tells you everything you need to know to make kitbuilding fun and easy. Thousands of people have discovered the satisfaction — and value — of handcrafting electronic equipment. You can build it better... let us show you how.

Send for your **FREE** Catalog today! ▶

OR pick it up at the Heathkit Electronic Center (Units of Schlumberger Products Corporation) nearest you, where Heathkit products are sold, displayed and serviced. Retail prices on some products may be slightly higher. See the white pages of your phone book.

Heath Company, Dept. 378-450, Benton Harbor, Michigan 49022

HEATH		Heath Company, Dept. 378-450		FREE
Schlumberger		Benton Harbor, Michigan 49022		
Please rush me my FREE Heathkit Catalog.				
I am not on your mailing list.				
NAME _____				
ADDRESS _____				
CITY _____			STATE _____	
CL-659			ZIP _____	

The Sinclair PDM35.

A personal digital multimeter for only \$49.⁹⁵

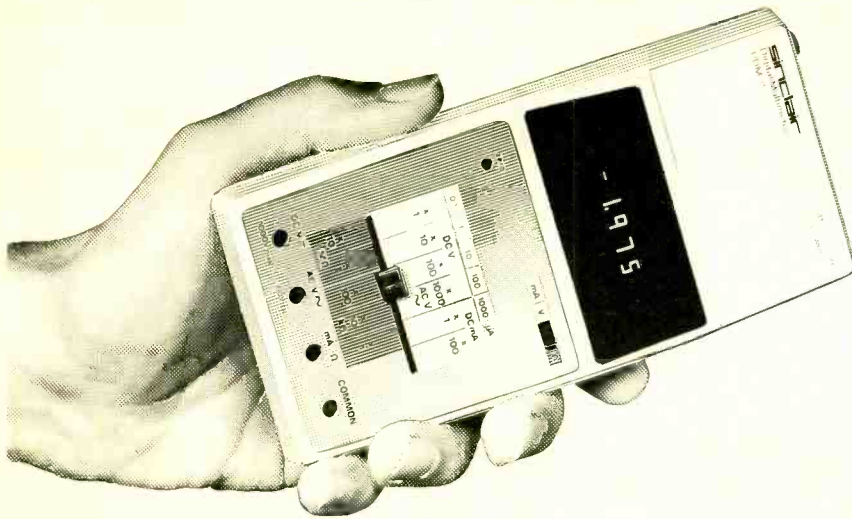

Now everyone can afford to own a digital multimeter

A digital multimeter used to mean an expensive, bulky piece of equipment.

The Sinclair PDM35 changes that. It's got all the functions and features you want in a digital multimeter, yet they're neatly packaged in a rugged but light pocket-size case, ready to go anywhere.

The Sinclair PDM35 gives you all the benefits of an ordinary digital multimeter — quick clear readings, high accuracy and resolution, high input impedance. Yet at \$49.95 it costs less than you'd expect to pay for an analog meter!

The Sinclair PDM35 is tailor-made for anyone who needs to make rapid measurements. Development engineers, field service engineers, lab technicians, computer specialists, radio and electronic hobbyists will find it ideal.

With its rugged construction and battery operation, the PDM35 is perfectly suited for hand work in the field, while its angled display and optional AC power facility make it just as useful on the bench.

What you get with a PDM35

3½ digit resolution.
Sharp, bright, easily read LED display, reading to ±1.999.

Automatic polarity selection.
Resolution of 1 mV and 0.1 nA (0.0001 μA).

Direct reading of semiconductor forward voltages at 5 different currents.
Resistance measured up to 20 MΩ.
1% of reading accuracy.

Operation from replaceable battery or AC adapter.

Industry standard 10 MΩ input impedance.

Compare it with an analog meter!

The PDM35's 1% of reading compares with 3% of full scale for a comparable analog meter. That makes it around 5 times more accurate on average.

The PDM35 will resolve 1 mV against around 10 mV for a comparable analog meter — and resolution on current is over 1000 times greater.

The PDM35's DC input impedance of 10 MΩ is 50 times higher than a 20 kΩ/volt analog meter on the 10 V range.

The PDM35 gives precise digital readings. So there's no need to interpret ambiguous scales, no parallax errors. There's no need to reverse leads for negative readings. There's no delicate meter movement to damage. And you can resolve current as low as 0.1 nA and measure transistor and diode junctions over 5 decades of current.

Technical specifications

DC Volts (4 ranges)

Range: 1 mV to 1000 V.
Accuracy of reading 1.0% ±1 count.

Note: 10 MΩ input impedance.

AC Volts (40 Hz-5 kHz)

Range: 1 V to 500 V.
Accuracy of reading: 1.0% ±2 counts.

DC Current (6 ranges)

Range: 1 nA to 200 mA.
Accuracy of reading: 1.0% ±1 count.

Note: Max. resolution 0.1 nA.

Resistance (5 ranges)

Range: 1Ω to 20MΩ.
Accuracy of reading: 1.5% ±1 count.

Also provides 5 junction-test ranges.

Dimensions: 6 in. x 3 in. x 1½ in.

Weight: 6½ oz.

Power supply: 9 V battery or Sinclair AC adapter.

Sockets: Standard 4 mm for resilient plugs.

Options: AC adapter for 117 V 60 Hz power. De-luxe padded carrying wallet. 30 kV probe.

The Sinclair credentials

Sinclair have pioneered a whole range of electronic world-firsts — from programmable pocket calculators to miniature TVs. The PDM35 embodies six years' experience in digital multimeter design, in which time Sinclair have become one of the world's largest producers.

Tried, tested ready to go!

The Sinclair PDM35 comes to you fully built, tested calibrated and guaranteed. It comes complete with leads and test prods, operating instructions and a carrying wallet. And getting one couldn't be easier. Just fill in the coupon, enclose a cheque/MO for the correct amount (usual 10-day money-back undertaking, of course), and send it to us.

We'll mail your PDM35 by return!

For Instant Service, CALL TOLL

FREE: 1-800-528-6050, EXT. 1052.

Ariz. Res. Call Collect 602-955-9710 or send coupon:

Starshine Group.

Dept. 452, 924 Anacapa Street, Santa Barbara, Calif. 93101
Please promptly send _____ Sinclair PDM35 Digital Multimeter(s) @ \$49.95 (plus \$3 shipping and insurance) each. I have the option of returning it within 1 week of receipt for an immediate refund.

- Also Send AC Adaptor(s) @ \$4.95 ea.
- Also Send Deluxe Padded Carrying Case @ \$4.95 ea.
- Also Send 30 kV probe @ \$29.95
- Check or Money order Encl. (Calif. Res. add 6% Sales Tax)
- Charge to The Credit Card Checked Below:
- BankAmericard/Visa MasterCard (Interbank # _____)
- American Express Carte Blanche Diners Club

Credit Card # _____ Exp. Date _____

Name _____

Address _____

City/State/Zip _____

Signature _____

Advances in recording technology have lifted the once lowly cassette tape deck to the respectability of a top-notch audio component. Here's a rundown of the key specs and features to look for when you do your shopping.

At the recent big audio show in Chicago, sponsored by the Electronics Industries Association, I asked a number of prominent audio manufacturers what's the hottest item in the field. Without exception they replied: "Cassette decks."

Once considered an optional extra, cassette decks are now regarded as a virtually indispensable part of a stereo system as more and more listeners discover the pleasures and advantages of having their own recording facilities. A lot of audio fans who had originally set up their systems without tape decks now seem to be rushing out to remedy that.

A small minority doing semi-pro recording go for reel-to-reel machines because they permit easy editing of tapes. But most listeners prefer cassettes because of their compactness, convenience, and ease of operations. Dealers tell me that cassette decks are now outselling reel models by a factor of more than 10:1.

If you are thinking of adding a cassette deck to your sound rig, it is generally a good idea to match the quality (and cost) of the deck to that of your other components. With this in mind, let me spell out the performance specifications of cassette decks in different price ranges, so you know just what you can expect for your money.

Price range

Just about the lowest price of admission into high-quality tape recording lies between \$175 and \$250, and many models (as in all other price classes) are usually available at discounts of about 20 percent below list.

Typically, such models offer frequency response to about 14,000 Hz, flutter and wow of about 0.12 percent, and a signal-to-noise ratio around 50 dB. The resultant sound is quite good and thoroughly enjoyable. True, some of the

uppermost frequencies are a bit weak, which reduces the sense of "openness" in the sound.

But this effect is so slight that you notice it only if a cassette made on such a deck is compared directly with the original sound source, such as an fm broadcast or a stereo record.

The most important recent improvement in this price range has been in regard to flutter and wow—those slight speed variations that sometimes cause a false tremolo in the music.

Getting the overview

Thanks to improved techniques of speed stabilization (usually speed-monitoring feedback circuits) current models in this class attain performance levels formerly found only in more expensive equipment. As a result, even long-held notes on such telltale instruments as piano, oboe, and pipe organ now come through without wobble.

As for signal-to-noise ratio, the tape hiss underlying the music—thanks to the built-in Dolby—is no louder than the light background noise typically heard on fm stereo broadcasts. It may be perceptible, but it's not disturbing.

I pointed out the limitations of low-cost decks not to criticize them, but to put them in perspective to costlier models. Some of the best models in this range include the Technics RS-615US, the Sony TC-K2A, the Kenwood KX-620, the Aiwa AD-1250, JVC's KD-35, and Radio Shack's Realistic SCT-11.

Stepping up to the next bracket, centering around \$300, we find typical specifications with frequency response extending up to 16,000 Hz and a further improvement of flutter and wow to less than 0.1 percent. Signal-to-noise ratios may be as low as 60 dB. Such decks provide sound on par with that of fm broadcasts (which are limited by law to 15,000 Hz.)

In this price range you will also find extra features which, though they don't affect the sound as such, add convenience of operation. Some have input mixers that let you record two different inputs simultaneously. That way you can add your own narration via microphone to some background music—for example, to make a sound track for your home movies or slide shows.

Many recent models also have a "standby" control that permits everything to be set in motion by an external timer, so you can record radio programs even when you are not at home.

A highly useful convenience feature has been introduced by Optonica in their Model RT-6501. It uses a microprocessor to find the start of any selection on a cassette. The device counts the silent intervals between the separate musical selections, which are coded by number.

By punching the number into a keyboard, you can pick out just the pieces you want to hear. The machine searches the tape in either forward or reverse motion for the wanted item. Other capable models in the middle price range include the Teac A-400, the Pioneer CT-F8282, the Yamaha TC-511S, and Sony's TC-K5.

In the more expensive models (from about \$400 up) you may find multiple motors—one to drive the tape through the capstan during recording or playback, the other to spin the tape in fast-forward or reverse. This optimizes both functions, providing faster rewind and more accurate speed control, reducing wow and flutter to imperceptible levels as low as 0.05 percent.

Frequency response may go to 17,000 Hz and beyond, reaching the limits of human hearing, while noise disappears at ratings beyond 60 dB. Used with high-quality tape, such decks produce sound as clear as most lp records. Of course, it

please turn to page 87

Interested in Ham Radio?

Then

CB RADIO

S9's

Sister

Publication



is for YOU

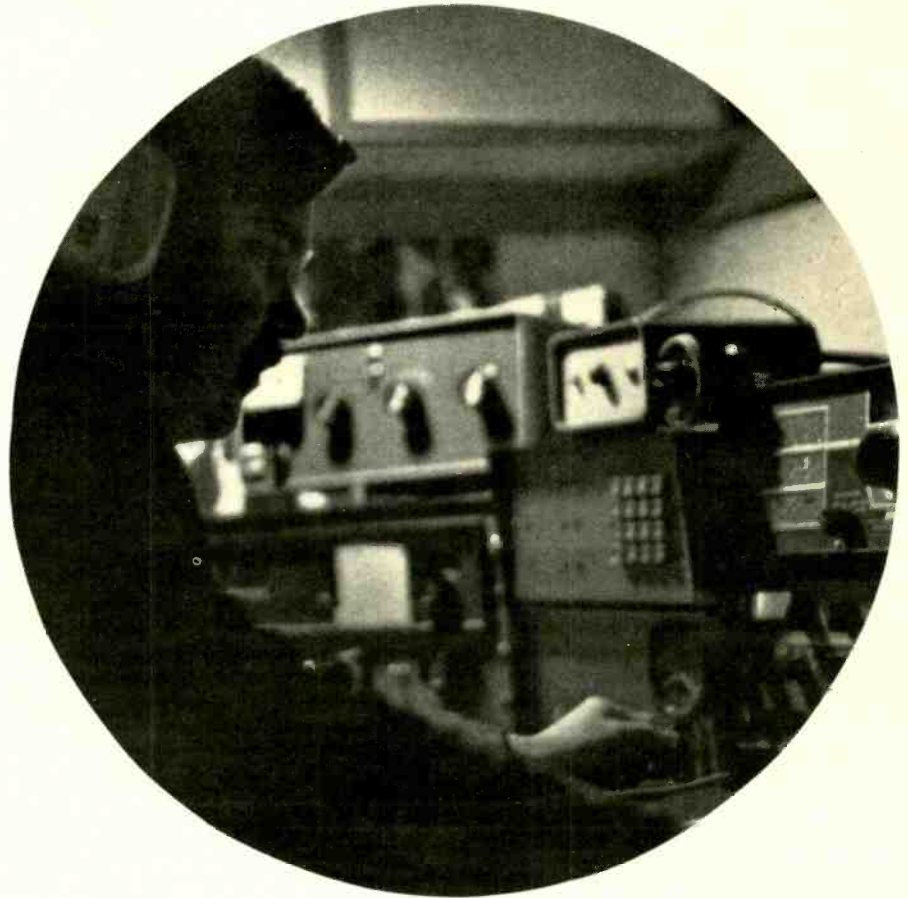

A recent survey of CB Radio/S9 readers indicated that two out of every three replying to our questionnaire would like to become an amateur radio operator. And we're all for that, because CQ, the Radio Amateur's Journal, is the oldest magazine in our company's stable.

CQ is not just another ham publication; it's the only ham publication aimed at the beginner as well as the old timer. It's the only ham magazine that recognizes that every new ham isn't an electronic engineer. The editorial features in CQ are aimed at people — people like yourself who turn to amateur radio as a means of having fun.

CQ caters primarily to the operating end of radio, with just a smattering of technical material to keep you up to date on what's happening. And even the technical portions of CQ are presented in a manner that every new amateur will understand.

In other words, CQ is the fun magazine in the amateur radio field. It's the amateur magazine that you'll enjoy from cover to cover. And remember, CQ is brought to you by the same folks who bring you CB Radio/S9. What more could you ask for?



The Radio Amateur's Journal

809-F

14 Vanderventer Avenue, Port Washington, L.I., N.Y. 11050

<input type="checkbox"/> NEW	One year.....	<input type="checkbox"/> Domestic \$9.95	<input type="checkbox"/> Foreign 12.95	<input type="checkbox"/> Foreign Air Mail 47.95
<input type="checkbox"/> RENEWAL	Two years.....	<input type="checkbox"/> \$16.95	<input type="checkbox"/> 22.95	<input type="checkbox"/> 92.95

Dear OM:

Enclosed please find \$_____ for _____ Year(s) Subscription to CQ, The Radio Amateur's Journal.

Name _____ Call _____

Address _____

City _____ State _____ Zip _____

Signature _____



Interbank No.	Exp. Date	Mo.	Year

BankAmericard Mastercharge

Please allow approximately 8 weeks for the first issue.

BY RON COGAN

The wide wonderful world of outdoors and how it interfaces with electronics can be found every month in this column.

Most motorists are perfectly content to stick with their car's 12-volt DC power capabilities, and rightly so. What more could be needed than a good automotive sound system, a few standard 12-volt add-ons, and a pleasurable ride?

All too true. But for some, an alternative power source would come in mighty handy when camping time arrives or when there's work to be done far from a 110-volt AC outlet. What to do?

Many have found a viable answer to be in the form of the various inverters and converters found on electronics store shelves. These devices, engineered exclusively for the purpose of converting an automobile's standard 12-volt DC system to a desired power output, vastly increase a car's versatility in many ways.

You can purchase smallish converters that plug into your cigarette lighter receptacle for drop-downs to 9, 6, or 3-volts DC, or you can even opt for a larger, permanent-mount inverter that will power standard household gadgets at 110-volts AC (up to a specified wattage).

And what possible uses could you have for these various types of power outputs? With a 12V DC to 110V AC inverter, for example, camping trips will find added convenience with the addition of a toaster, electric fry pan, or even an electric razor to your regular assortment of gear.

Need to do some cutting or drilling at a secluded construction site but the electrical hasn't been run yet? It's no sweat with a car, an inverter, and a few of your favorite shop tools. And drop-down DC converters can handily power an assortment of portable gadgets ranging from tape recorders to pocket scanners.



While you have a choice of many accessories that will run on the 12-volt dc in your mobile, there are still many devices that require 110-volt ac. With a power inverter, such as this Vista CXV, you can use just about any ac powered device in the mobile. The inverter changes your vehicle's 12-volt dc into a chopped ac.

The cost of these various converters and inverters covers a wide range, with most of 'em falling within the inexpensive category. The most expensive are the 12V DC to 110V AC inverters that furnish the increased power without the need for the engine to be running.

These goodies start about forty bucks and go upwards of two hundred depending upon their wattage output. An example of this is the Vista CXV-1, manufactured by Clifford Industries, P.O. Box 436, Camarillo, California 93010, which provides square wave 110-volt AC current from a standard car battery. Less expensive 110-volt DC converters will run most power tools and a variety of other 110-volt items (but not all), but the

car's engine must be running during use.

Most all of the converters and inverters available offer an extremely simple installation that anyone can handle with simple tools and basic skills. Additionally, most offer installation instructions that make the job easy even if you don't possess a working knowledge of your car's electrical system.

The bottom line is that motorists have the ability to easily power most any gadget with their car's basic electrical system and one of these nifty components—so why wait? There are probably a score of items that would prove handy on the road if only you could power 'em. And now you can!

How to identify & resolve

Radio-TV Interference Problems

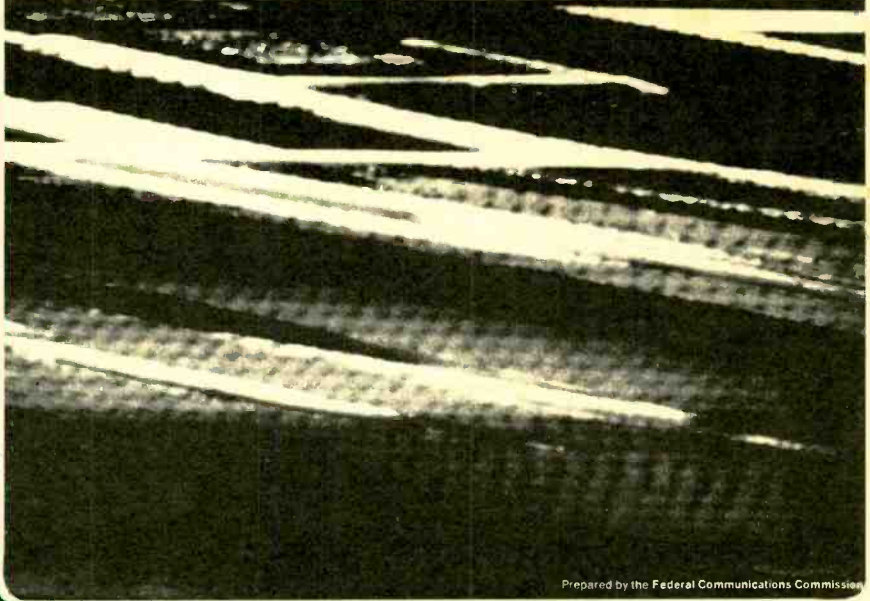

Prepared by the Federal Communications Commission

Let the FCC's own Radio- TV

Interference

**booklet be your
club's first line of defense on the TVI front.**

For the first time here's an easy-to-read guide showing all of the classic TVI symptoms and their cures.

Use it as a "handout" by the local TVI committee, defuse tricky "irate neighbor" situations, help the local TV repair shop root out RFI/TVI problems in your area.

This top-quality booklet (40 pages 10¼ x 8") is available in quantities of 12 at \$9.00 plus \$1.00 shipping. Single copies are available for \$1.25, postpaid. Note that the FCC offers the self-same booklet for \$1.50 per copy with no quantity discount.

Prepared by the Field Operations Bureau of the Federal Communications Commission and reprinted at low cost by the Publishers of ME, the booklet offers guidelines for the amateur, non-amateur and CBer alike in dealing with RFI and TVI. A dozen full-color illustrations show most interference patterns with descriptions and solutions for each problem.

The booklet should be on your "must" list for reading and your "do" list to help eliminate the problem. Order a dozen copies today!



14 Vanderventer Ave.
Port Washington, N.Y. 11050

**12 copies \$9.00
plus \$1.00 shipping**

- Enclosed is \$10 for each 12 copies.
- Enclosed is \$1.25 for each single copy.

Quantity ordered _____
Amount enclosed _____

Single copies \$1.25 Postpaid.

Check One: Check Money Order
 Master Charge Bank Americard

My account number is

--	--	--	--	--	--	--	--	--	--	--	--	--	--	--	--	--	--	--	--

Name _____ Call _____

Address _____

City _____ State _____ Zip _____

809-F

CB radio: 20 years old this month

Can you believe it? CB radio celebrates its 20th anniversary this month. Here's the inside story of where we've been and where we're headed.

by Tom Kneitel/TOMCAT, K2AES
Editor, CB Radio/S9 magazine



Where were you 20 years ago? It's a safe bet that you were absolutely unaware of a monumental birth taking place on the 11th day of that fateful September of 1958. The birth of the blues? Well, not quite; unless you happen to be an FCC monitor. You guessed it; it was the opening day, Goodbuddy, of the 27 MHz CB service.

Of course, unlike today, there weren't 25-million operators there to mark the occasion, only a few hundred rag-tag and brave souls who rose to meet the challenge of CB Radio in those pioneer days. The very first CB'ers used homebrew gear (legal in those days), but it only seemed to take a few weeks for the first commercially produced rigs and kits to become available, sets like the International Crystal *Executive* (its boxy shape gained it the nickname of "The Icebox"), the Heathkit CB-1 "Lunchbox" (another loving nickname), the Gonset CB-1 ("Gooney Box"), the Globe CB-100, Vocaline ED-27, and a few others.

Chrome-plated '78 model

Sure, sitting there now with your gleaming, chrome plated, solid state, 40-channel PLL rig with the pretty red LED's, you will probably find it difficult to grasp what most of these early CB sets were like. First of all they were filled wall to wall with tubes, y'know those glass bulbs with names like 6AL5's, 6CX8's, and other similar prehistoric monsters. So, right off, these rigs

were rather large and cumbersome when compared to modern CB equipment.

Most of the early sets were designed to transmit on one single channel, although a few offered tunable single-conversion or superregenerative receivers. A single channel was all that was needed in those days, hopefully your set came through equipped with crystals for the same channel as the other handful of stations within talking range of you!

Rather than an inducement for CB'ers to scan the channels and make new friends, the tunable receive feature was more of an economy move, for in the pre-PLL and pre-synthesizer days, a separate crystal was required for each transmitting and fixed tuned receiving channel. You know the price of crystals—figure out what it would cost to outfit a 23 channel rig with a full set of 46 crystals. *Ouch!* Something like \$200 for those little hunks of quartz!

But you could talk!

Ah yes, you could talk! And what days they were! In 1958 there was a high point going on in the 11 year sunspot cycle and "skip was in." Sure, it was as "illegal" to work skip on CB then as it is now, but the exotic lure of "the forbidden" was irresistible to the early CB'ers. And, after all, after you said all you had to say to the 20 other operators who were local to you, it just "seemed like the natural thing" to try to meet other CB'ers whose voices were presented to you via the courtesy of the ionosphere!

In those days there weren't any of the giant super-

Tom Kneitel is editor of CB Radio/S9, the oldest and largest CB radio magazine.

monster base station beam antennas available to CB'ers, and mobile antennas were much less sophisticated than what you see around these days.

The most popular base station antennas were ground planes, or if you were clever you added an extra set of four "ground" radials and made yourself a *dual* ground plane. Some operators had coaxial type base station antennas, popularly known as *thundersticks*. Mobile antennas were invariably 102-inch steel whips, which were bumper mounted and *clanked* and *clunked* on garage doors, tree limbs, and low hanging signs. You may be tempted to chuckle at some of this quaint apparatus, but it really did quite well; and, of course, there were only a handful of stations on the air then; you didn't have to battle to wedge your voice onto a channel for your 30 seconds of glory before someone called for a *break*. In fact, there were those lonely days when you had to make an effort to locate another station to talk with you. Some channels were totally devoid of any operation at all!

Wheels of progress

Starting out slowly at first, by the end of 1958, the FCC was handling a paltry 500 CB licenses per month, but by mid-1959 the word had started to spread amongst communications buffs that something good was going on. Licenses jumped 10-fold in those few short months to almost 6,000 per month! By today's yardstick (where the FCC has been known to receive almost 1/2-million per month) this may seem insignificantly small, but you have to try to imagine what it



CB clubs were a very early manifestation of the friendship which has always been a part of CB. Here's a snapshot taken back in 1968 of most of the members of the Mohawk Valley CB Radio Club of Turners Falls, Mass. The occasion was their 4th Annual Jamboree.

Utica, Sampson, Arkay, Acton Labs, Babb, United Scientific Labs, Grove, Polytronics, Kaar, Hallmark, e.c.i.—some of these companies are still in CB but are known under different names; others are still in business but no longer making CB rigs; while most are simply out of business altogether. A listing of all of the many companies producing CB transceivers in the early 1960's would fill several pages!

Friends one and all

By the early 1960's CB clubs, jamborees, and coffee breaks were commonplace. Clubs and teams had started voluntarily monitoring Channel 9, which CB'ers had unofficially designated as an emergency channel.

Basically, the roots of CB had started sending up the trunk of the CB tree between 1963 and 1965; it was still in a formative stage but it would nevertheless be recognizable as "CB" by a 1970's operator. Although truckers' talk and CB lingo had not shown up on the channels, 10-Codes were heard regularly and *handles* had started making their early bow.

More often than not, *handles* were used as an attempt at achieving anonymity by those who came to feel that



Don't laugh at this ugly duckling, it's the e.c.i. Courier 1-M. Not only was it one of the first CB rigs featuring a high-selectivity dual conversion receiver, but it was in such high demand that the manufacturer could hardly keep up with the orders for them! The company which made these in the 1960's evolved into today's Fanon/Courier Company.

sounded like to early CB'ers when the channels suddenly started to buzz with activity, even those channels that "nobody ever used."

And the equipment itself was also undergoing some changes, mostly in the fact that new gear being offered for sale had capabilities of transmitting on 3, 6, 8, or, *gasp*, even 12 channels. There were even a couple of *deluxe* rigs offering full 23 channel operation.

There were lots of companies producing CB rigs in this first flush of CB life; well known companies such as RCA, Raytheon, Lafayette, Allied Radio, Heath, Tram, Regency, Browning Labs, Hammarlund, Amphenol, E.F. Johnson, EICO, and Hallicrafters.

In those days the CB'er could also select equipment from a vast array of smaller companies too, names which may be mostly unknown to modern CB'ers: Philmore, Miratel, Cadre, DeWald, Shell, LaSalle,



For your fantasies and the days when you thought you would get that big bonus at work, you could picture yourself buying this super deluxe 23-channel Polycomm Sr. 23, which was expensive but an absolutely beautiful hunk of electronics. Somehow or other its manufacturer managed to go out of business despite the swanky product.



The Heath GW-12 was an early kit, in the days when the FCC allowed CB'ers to build their own sets. A single channel rig, it did a most respectable job.

the FCC's anti-hobby CB regulations were a bit too difficult for their personal operating preferences to justify "advertising" by means of a traceable FCC call sign.

Single sideband had made a flickering appearance on 11 meters in the early 1960's, and a few years later frequency synthesizers had become a regular feature of better CB equipment, opening up 23-channel capabilities at reasonable costs to the CB users.

But still, *something* was missing. Why? Because, even with all that CB had going for itself, it was one of those things that was known to relatively few people outside those who were electronics enthusiasts. Would you believe that only 10 short years ago you could ask 100 random people to tell you anything at all about CB



It wasn't that tube-type CB rigs weren't good pieces of electronic equipment, but they did tend to become a bit bulky when mounted in mobile units.

Radio and you would have been lucky if you hit the jackpot with 5 to 8 of them! Somehow, CB Radio was still an idea whose time had not arrived. It just hadn't managed to hit the big time.

And that's the way CB finished out its first 10 years of life, a minor success, well beloved by thousands of enthusiasts who comprised what was essentially a CB "cult." And that's the way it strolled into its teen years.

Bingo!

Maybe the stars and planets were right, or perhaps it was an idea whose time had finally arrived, or else it was a unique combination of events (truckers' strike, fuel shortage, imposition of a national speed limit—followed by supporting media coverage, sings, movies, tv programs, and the like) which did the trick; but in 1974 CB was in the big leagues!

That's when CB lingo became an ingredient of CB Radio, and that's when the solid wall of humanity came barging onto the channels demanding to be fed a



International Crystal Manufacturing Co., produced an extensive line of Executive model transceivers, all quite popular. This was the set by the time CB had grown to the point where operators wanted operating capabilities extending past "single channel" rigs. This set offered 3 transmit channels and a tunable receiver, plus 3 crystal controlled receive positions.

generous supply of CB equipment. That about coincided (or *caused*, to be specific) the FCC's absolute frustration at making any valid headway in controlling the varied directions which the CB service was heading under its own inertia.

Today, 20 years and 25-million CB'ers later, we are again heading into another peak sunspot cycle. Who was it that once observed that "the more things change, the more they remain the same?"

There are millions more CB'ers today than there were 20 years ago, and that's the number you can use to multiply the number of skip working violations which the FCC expects on CB.

Old habits die hard, they also say, and maybe there aren't too many traces left of the "old CB of 20 years back; there isn't a 6AL5 *anywhere* in sight! But the CB'ers themselves haven't changed all that much, most still like to work skip—it's just as enticing (and illegal) as it was the day CB was born, 20 years ago this very month!



THE NEW INDUSTRY STANDARD OF PERFORMANCE... IS THE **Wilson** SYSTEM ONE!

A DX'er's delight operating 20 meters on a full 26' boom with 4 elements, 4 operational elements on 20-15-10, plus separate reflector element on 10 meters for correct monoband spacing. Featured are the large diameter High-Q traps, Beta matching system, heavy duty taper swaged elements, rugged boom to element mounting... and value priced! Additional features: • SWR less than 1.5 to 1 on all bands • 10 dB Gain • 20-25 dB Front-to-Back Ratio.

- Full 4 Elements on 20 Meters with a Long 26' Boom
- 4 Element Monoband Performance
- Separate 10 Meter Reflector

Model Antenna
— not to scale.

SYSTEM ONE™



The mechanically superior construction uses heavy duty boom to element extrusion.



Advanced design large diameter High-Q Traps for minimum loss and maximum power capacity

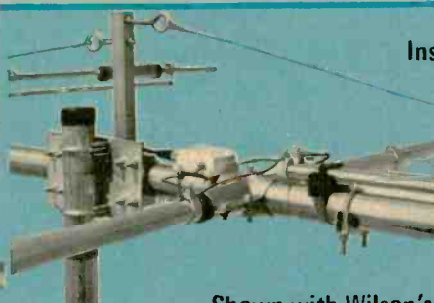

Insulated driven element with precision Beta match and heavy duty element mounts.

Shown with Wilson's new optional Toroid Core BN-50-A Balun.

SPECIFICATIONS: SY-1

Matching Method	Beta	Boom Length	26'	Required Mast Diameter	2" O.D.
Band MHz	14-21-28	Boom Diameter	2" O.D.	Surface Area	8.6 sq. ft.
Maximum Power Input	Legal Limit	No. of Elements	5	Windload at 78 mph	215 lbs.
VSWR (at Resonance)	1.5 to 1	Longest Element	26' 7"	Shipping Weight	65 lbs.
Impedance	50 ohms	Turning Radius	18' 6"	UPS Shipment in 2 Cartons	
Gain	10 dB	F/B Ratio	20-25 dB		

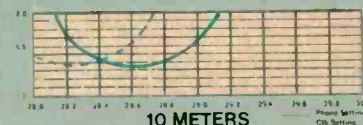
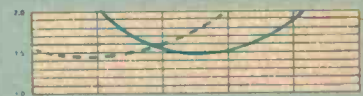

DEALERSHIPS AVAILABLE!!!

We are looking for new Dealers for certain areas of the country. If you are interested, contact us for details.

Wilson Electronics Corp.

4288 So. Polaris • P. O. Box 19000 • Las Vegas, Nevada 89119
Phone (702) 739-1931 • Telex 684-522

on interfaces home computer



**DON'T
MISS
THE NEXT
ISSUE...
Subscribe
NOW!**

**TO
modern
electronics**

computer systems.

output method for producing... text output.

As it turns out, an alphanumeric keyboard is often one of the cheapest parts of a small computer (see the article on keyboards in the June 1978 Modern Electronics), while an alphanumeric printer can be one of the most expensive.

With some work and ingenuity, an old Baudot teleprinter—a device which looks like a monster typewriter which prints under computer control—can be salvaged from a flea market and adapted to computer use fairly cheaply. Most of the time, however, a more expensive printer may be needed.

New teleprinters go for \$900 and up; more modern printers which either go faster or provide neater output with perhaps small letters as well as capitals may cost upwards of \$3000.

A good compromise may be a TV-type display which 'prints' the same information on a standard TV set, rather than on paper. It may not be as good for serious business or technical uses, but for games or hobby use it works almost as well. The nice feature is that a TV display is often cheaper than a printer—as low as \$100.

TV display systems come in two types: complete terminals, called CRT or cathode ray tube terminals, which include a keyboard, a TV tube, and all the electronics to drive them, or stripped interfaces which simply accept computer data and convert it into a signal which can be

sent to a slightly modified regular TV set. Either way, the circuitry to change computer data into a TV picture works the same way.

To understand how this is done, we first have to see how television works.

The principal part of a TV set is its CRT or cathode ray tube. This tube has a large screen which is coated with a phosphorescent material; this is a chemical which glows when it is hit by electrons.

In the back of the tube is an electron gun which shoots a thin beam of electrons at the screen. When the beam hits the screen we get a tiny, bright spot of light. You may have noticed this spot just after you turn off the TV set. In normal use, the spot is moving so fast that it is not visible.

Television fundamentals

The electron beam—and therefore the spot of light it produces—is controlled in two ways. Two coils of wire wrapped around the neck of the tube, part of the yoke assembly, generate a magnetic field which aims the beam at different parts of the screen.

When the TV set is operating, these deflection coils rapidly move the beam from side to side, and from top to bottom, so that the beam covers the entire screen. The motion happens so fast that it looks as though the entire screen is evenly lit up, although if you look closely at it you will see horizontal lines across it, which are caused by the movement of the beam across the screen from left to right.

At the same time, the strength of the beam—the brightness of the spot it produces—is controlled by a voltage placed on the control grid; this is an opening through which the beam must pass on its way to the screen. Putting a negative voltage on the grid makes it harder for the electrons to get through, and so the light produced by the beam is weaker.

The TV picture is produced by continuously scanning the entire screen

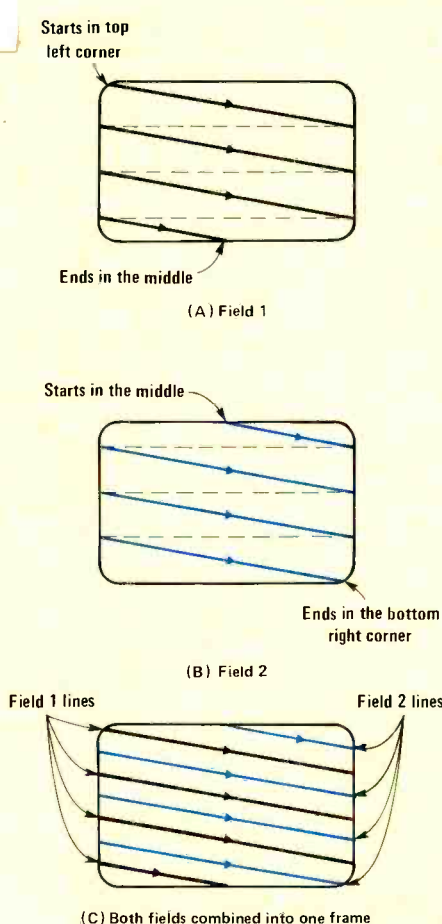

Figure 1 Two sets of interlaced fields make up one frame.

with the beam, but controlling its strength so that some parts of the screen are light and others are dark.

The pattern that the beam follows in covering the screen is called a raster. The precise speed at which the beam moves, and the number of times that it sweeps across the screen in each second, is precisely controlled by the TV station you are watching.

This is because the beam movement in your TV set must be exactly in step with the movement of the beam in the TV camera in the studio, or else the picture will roll up or down, or tear sideways.

The movement of the beam up and down is called the vertical sweep, and occurs exactly 60 times per second. Sideways movement is called the horizontal sweep, and occurs exactly 15,750 times per second. If you divide the hori-

262- $\frac{1}{2}$ lines across the screen during this one trip of the beam from top to bottom. This is difficult to show on a drawing, so Figure 1(a) only shows a few lines. But the important thing to notice is that there are 262 and one-half lines; this means that down at the bottom of the screen there will be one horizontal sweep which covers only half the width of the screen—a half of a line, which ends half-way across the bottom. What happens now?

Just as the beam reaches the half-way point, a vertical sweep occurs which moves the beam back up to the top. This time, it starts its first sweep across the top from a point midway across—in other words, the next line at the top is only half of a line, as shown in Figure 1(b). But this time, the beam will start with a half-line, and follow it up with 262 complete

make sure that the eye doesn't notice it, the flicker rate has to be more than about 40 times per second, with 50 or 60 being even better.

That means that the picture must be refreshed—repainted on the screen—many times per second. A refresh rate of 60 times per second has been chosen for various reasons, but if a complete 525-line picture had to be transmitted from the TV station each sixtieth of a second much more of the TV band would be needed and there would be room for fewer TV stations on the band. Sending only 262- $\frac{1}{2}$ lines in a sixtieth of a second is a good compromise which reduces the bandwidth, but eliminates flicker and fools the eye into thinking it sees a complete 525-line picture. (If the picture had fewer lines, it would appear coarser and lack sharpness.)

The circuitry to provide complete interlacing is needed for a good picture on TV stations, but it provides more detail than is needed for most computer TV displays; it also makes the terminal design more complicated. Most CRT terminal designers don't bother to interlace.

When interlacing is not used, then there is no need for the extra half line at the top and bottom of alternate fields. Many CRT terminals use an even number of horizontal lines per field—262 or 264 lines being most popular. Every field is the same, and so the lines from one field fall on top of the lines in the next field. Hence the picture has only 262 or 264 lines.

To reduce the effect of hum or ripple in the TV power supply, CRT terminals still use 60 vertical sweeps per second, but now the horizontal sweep is different. For normal TV stations it is 15,750 sweeps per second. For a terminal with 262 lines per field, the horizontal sweep frequency is 60×262 or 15,720 sweeps per second. With 264 lines per field, the horizontal frequency is 15,840 sweeps per second. This is close enough to the normal 15,750 that most normal TV sets can still be used. If need be, the horizontal hold control on the back of the set may be adjusted slightly to provide a steady picture.

TV set circuitry

Figure 2 shows a block diagram of a typical black and white TV set (color sets are quite a bit more complicated.) The TV signal is received by the antenna, tuned in by the tuner, amplified, and then decoded at the video detector. The output of the video detector is a signal called the composite video.

This signal contains not only the picture or video information, but also synchronizing signals which drive the vertical and horizontal sweep circuits to make sure they stay exactly in step with the sweep signals being used in the studio camera.

The composite video signal does three

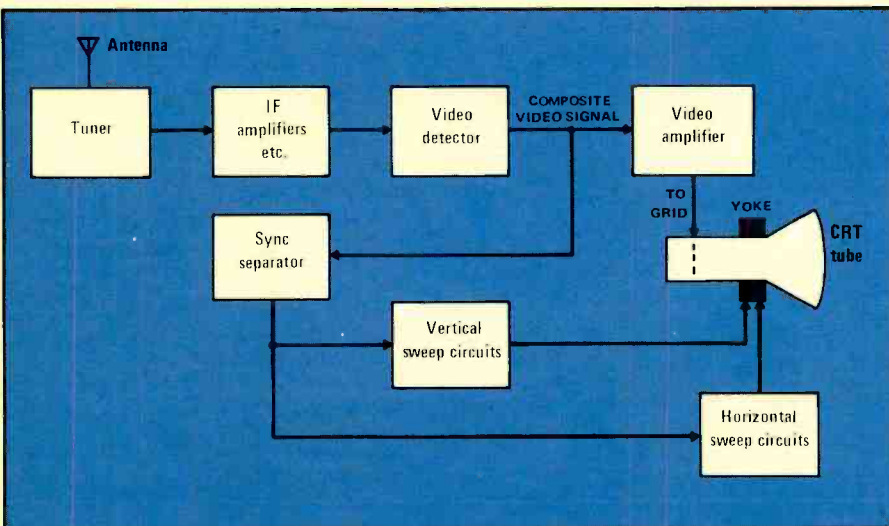

Figure 2 Simplified block diagram of a TV set.

zontal sweep frequency by the vertical sweep frequency, you will see that there are exactly 262- $\frac{1}{2}$ horizontal sweeps for every vertical sweep.

Let's follow the beam across the screen on one of its travels from top to bottom; a typical trip is shown in Figure 1(a). The beam starts in the upper left corner and starts to move across the screen, left to right. All of the time that it moves sideways, it is also moving very slowly down. As a result, it really moves at a very slight diagonal toward the bottom, as shown by the top solid line in the drawing.

When it reaches the right end of the screen, it suddenly reverses direction and returns back to the left; this is called the retrace, and is shown by the dotted line. When it reaches the left end of the screen, it starts to move right again. Each time it travels from left to right, it draws a line on the screen. If you look closely, you can see it, although it seems to constantly be on the move and is difficult to watch.

As you remember, each vertical sweep corresponds to 262- $\frac{1}{2}$ horizontal sweeps. This means that there will be

lines, so that it will end up in the right bottom corner of the screen.

Each of these pictures is called a field. Both fields have 262- $\frac{1}{2}$ lines, but the half-line alternates between being at the top and being at the bottom: field 1 has it at the bottom, and field 2 has it at the top. (This description is slightly simplified because the beam doesn't return instantaneously to the top or to the left, and so some of the horizontal sweep lines never really appear on the screen. But for this description we need not be that exact.)

Fields are flashed on the TV screen every sixtieth of a second. Since this is too fast to be noticeable to the eye, the two fields blend together. But since the sweep lines in the two fields are in slightly different places, they mesh together as in Figure 1(c). The overall effect is to give a picture which looks as though it has twice as many lines—a total of 525 lines from top to bottom.

Why such a complicated arrangement? There is a very good reason: as soon as the electron beam passes a particular spot on the screen, the light it generates starts to fade. In other words, the picture is continuously flickering. To

things. First of all, it has the video information which is amplified by the video amplifier and fed to the CRT tube to control the brightness of the beam. It also has sweep synchronizing pulses, which are removed by the sync separator and sent to the vertical and horizontal sweep circuits. These then feed the yoke, which moves the electron beam back and forth.

For computer use, the tuner, I. F. amplifier, and video detectors are not needed, since a composite video signal can be directly provided by the computer interface and sent to the video amplifier and sync separator. Although a standard TV set can be used by simply disabling these sections with a switch, a better alternative is to use a TV monitor which is designed to accept a composite video signal and display it.

Such video monitors are often used with videotape recorders; even though they cost more than a cheap, mass-produced TV set, they often provide a clearer, sharper image. (In some cases, the composite video output of a computer terminal or TV game is fed into a small TV transmitter which then feeds the antenna input of an unconverted TV set.)

This is perhaps the cheapest and simplest approach, but it produces fuzzy pictures since the I.F. amplifiers of a normal TV set are not designed for the sharpness needed for computer printouts.

Composite video

Figure 3 shows what the composite video signal looks like if we observe it on an oscilloscope. It is a very irregular signal with many peaks and valleys, but at regular intervals—every horizontal sweep—it has a high flat plateau on which sits a small square pulse. That pulse is the horizontal sync pulse. Every

15,750 horizontal sync pulses there is a rapid series of small pulses which provide the vertical synchronization.

The space between two horizontal sync pulses carries the picture information for one sweep line. A high voltage, near that for the sync pulse, represents a black spot on the screen; a low voltage represents a white spot. Various shades of gray are represented by voltages between white and black. (Since the sync pulse is represented by a voltage slightly greater than that for black, the electron beam is completely turned off during its return from the right side of the screen to the left.)

For example, the signal shown in Figure 3 shows two successive sweep lines which are fairly similar, but not quite identical. In both there is a left portion which is mostly white, followed by a dark grey—almost black—peak, followed by more white. In general, since each line of a typical picture is different from every other line, each portion of the composite video is different also. If we tried to watch the composite video signal on an oscilloscope for a while, we would see only a blurred area between the sync pulses.

Now suppose that one line of the composite video looks like Figure 4. Instead of a smoothly varying but irregular signal between the sync pulses, we now have a square wave signal which rapidly switches from white to black and back. This signal would turn the electron beam on, off, on, off . . . for an entire sweep line. The result would be a row of dots. If we switched the signal back and forth between white and black very rapidly, the dots would be smaller and closer together.

Next, if every line of the picture was just like this one, then the entire screen would be covered with dots. Since there

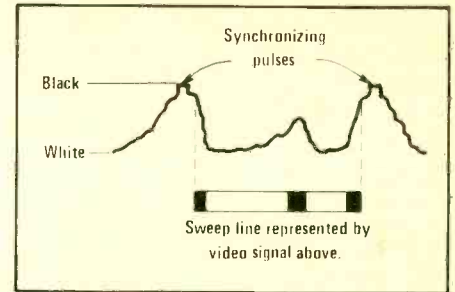

Figure 3 Two lines of composite video.

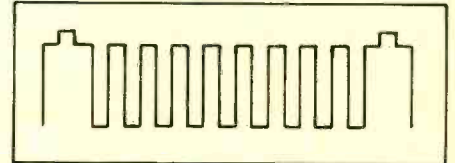

Figure 4 Composite video as generated by a digital circuit.

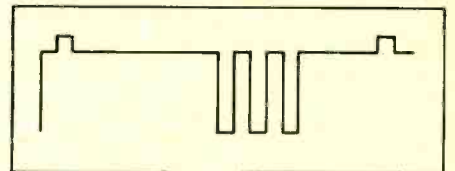

Figure 5 This composite video signal would draw three dots.

are approximately 262 sweep lines, we would have 262 dots lined up from top to bottom on the screen.

A typical TV screen is 33 percent wider than it is high. To make the dots evenly spaced top to bottom, side to side, we would need about 33 percent more dots per line than there are lines. This works out to approximately 350 dots per line. Since the horizontal frequency is about 15,750 sweeps per second, the frequency of the square wave which produces the dots should be approximately 350 times higher than this, or somewhere near 5.5 million pulses per second. This is equivalent to 5.5 MHz.

Actually, the dots need not be that evenly spaced, and so the dot frequency could be somewhat higher or lower.

Now you have the basic idea behind a computer CRT terminal—we generate a high frequency dot signal which covers the screen with a fine pattern of dots. The rest of the circuitry is used to turn these dots on and off in precise patterns to make letters and numbers.

This is done by turning the high frequency on and off at the right instant of time. For example, the composite video signal in Figure 5 would give a sweep line which is completely black except for three white dots a bit to the right of center.

Each character is shown on the screen using a small rectangle full of dots; this rectangle is called a matrix. One popular matrix size is 5x7, meaning that it is five dots wide by seven dots high. This kind

GLOSSARY

Counter. A digital device consisting of flip-flops connected so that it counts the number of pulses it receives on its input. The count is provided as a binary number output. A counter has a maximum count, depending on its size, called a modulus or just mod. For example, a mod-8 counter can count up to seven, and on the eighth input it resets itself back to a count of zero. When it resets, it also provides an output pulse which could be counted by another counter. Thus a counter divides an input frequency by its modulus. The mod-8 counter, for example, would provide an output pulse every eight input pulses, so if its input frequency was 1000 pulses per second, the output would have only 125 pulses per second.

Decoder. A device consisting of gates which is usually connected to the output of a counter. It provides an output when the counter is at a specific count or range of counts. For example, if a counter was used to count the number of cookies being packed into a box, a decoder could be wired to provide an output when exactly 50 cookies had been loaded.

One-shot. A type of multivibrator which provides an output pulse of a specific length whenever it receives an input pulse. Often used to provide delays, or stretch or expand pulses that are the wrong length or shape.

Pulse. A short burst of voltage or current. In most digital circuits, pulses are usually short 5-volt bursts which may last from a few nanoseconds (thousandths of a millionth of a second) up to many minutes or hours.

RAM. Random Access Memory; a type of computer memory which can both be written into and read out of. It is divided into many locations, each of which can store a fixed-length binary number, and each of which has an address by which we identify which number is where.

ROM. Read Only Memory; a computer memory which can be written into during manufacture or installation, but is only read out of after that.

Shift Register. A digital circuit consisting of flip-flops, which is used to convert parallel data (where several binary digits arrive at once), to serial (where the same digits travel one after another), or back.

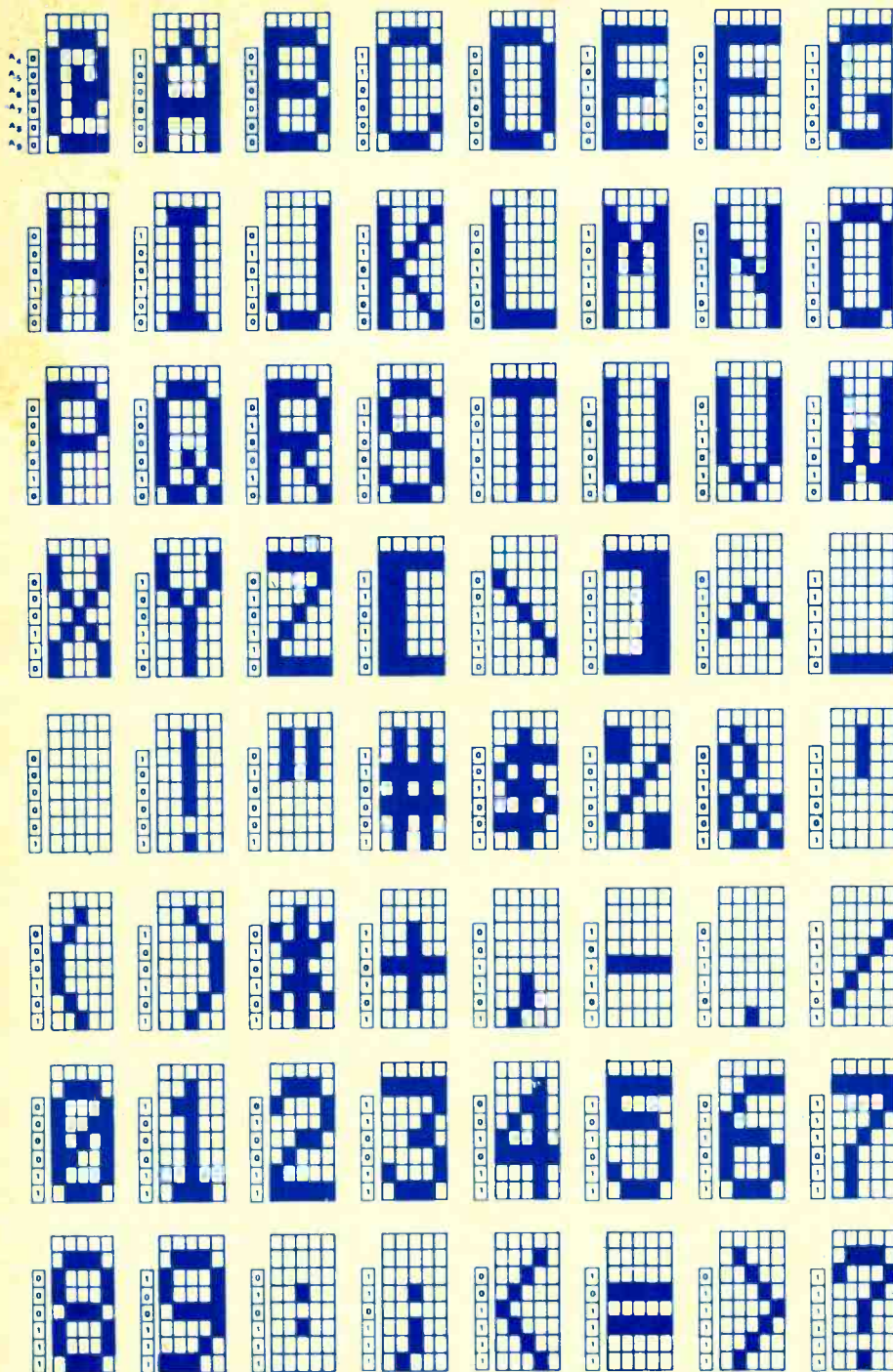

Figure 6. Alphanumeric character dot patterns.

of a matrix is said to have five rows and seven columns.

Although the correct name for the letters, numbers, and punctuation marks used by a computer in text is 'alphanumeric characters' or just characters, for the rest of this article I will use the word 'letters' to keep from getting bogged down in terminology.

Figure 6 shows how the various letters and numbers would be made up of the 35 dots in this matrix. The 5x7 matrix is about the smallest that can produce readable letters and numbers, but it is hard to use for lower case letters, so some CRT terminals use a 7x9 matrix of 63 dots. This gives a slightly better appearance to

many of the letters.

Actually, it's necessary to add an extra set of blank boxes to the side of each letter, and also either above or under each, so that adjacent letters will be separated by a small area of black. Then the 5x7 matrix really takes up a 6x8 space, while the 7x9 matrix takes up a space which is 8x10.

Timing circuits

In order to control exactly which dot goes on and which off, the CRT terminal needs to know which dot on the screen belongs to which letter or number. This is done by timing circuits and digital counters, which count each dot as the

electron beam passes its position.

There are many ways of doing this. In some schemes all of the sweep frequencies will be generated by an internal oscillator and counter chain, based on a master dot oscillator using a crystal. This is the most simple way, but it has the disadvantage that the vertical sweep frequency may not be exactly 60 Hz. As mentioned before, the vertical frequency should be 60 Hz to avoid problems with power supply ripple. If the frequency is not quite the same as the power line frequency (which itself may not be 60 Hz either), then dark bars called 'hum bars' may move up or down on the screen.

A common way of avoiding this problem is to use a circuit called a phase locked loop to exactly synchronize the vertical and horizontal sweep frequencies to the power line. But this circuit is somewhat harder to explain and understand, so let's look at the first way.

Let's examine a typical design, assuming we need a CRT display which uses a 5x7 matrix (which really assigns a 6x8 space to each letter so as to leave a black border around each), and that we want a 16x32 display; that is, 16 lines of text, with 32 letters on each line.

As mentioned before, the electron beam does not retrace instantaneously—there is a slight delay in its returning back to its starting position. If we put letters too close to the edge of the screen, there is a possibility that they may be garbled or distorted.

There is in fact a second problem—most TV sets are purposely adjusted to overscan. That is, the picture on the CRT screen is intentionally adjusted to be larger than the screen, so that part is covered by the cabinet mask. This is another reason why we cannot put letters close to the edge of the screen.

Thus to get a 16x32 display, we must design the circuits to plan for more lines of letters, and more letters per line, but then blank out the top, bottom, and sides and use only the middle part of the screen. One possible choice would be to plan for 33 lines of text (and use only 16), and for 60 letters on a line (and use only 32).

Figure 7 shows the timing circuits we need, consisting of a master oscillator which generates the dot signal, and four counters (see the Glossary for an explanation of counters and some other circuits needed in the CRT terminal.)

In this case, the dot oscillator provides an output of 5.7024 MHz (the frequency is found by calculating backward from the fact that we need an output of 60 Hz at the right.) Since there are six columns to each letter (five dots plus a blank one), the first counter is a mod-6, which divides the 5.7024 MHz frequency by 6 to provide 950.4 kHz to the next counter.

This counter also counts off six dots at a time. As long as we make sure that it starts off at a count of 0 at the left end of

the first letter, this counter will be at 0 at the start of every letter across the screen, and will count off the dots: 0, 1, 2, 3, 4, 5, and then back to 0. This is then the column counter.

Every six dots across the screen—at the end of each letter—the column counter provides an output signal to the letter counter. The frequency of this signal is 950.4 kHz. The letter counter is a mod-60 counter which divides this to provide an output of 15,840 Hz, very close to the 15,750 normal horizontal sweep frequency. In this case, we run the horizontal sweep a little faster than normal.

The letter counter starts off at a count of 0 at the left end of the screen, and counts off letter positions across the screen. It can count up to a total of 60 letters, although only 32 letters will actually appear (in the center of the screen.)

After 60 letters—at the right end of the screen—this counter provides a horizontal sync pulse, and also a signal to the next counter which counts dot rows within letters, or sweep lines. This is a mod-8 counter, which can only count to 8, so every eight input pulses it goes back to a count of 0.

Since the counter starts off set to 0 at the very top of the screen, it starts with 0 for the top of every letter, all the way to the bottom of the screen. Thus it counts the eight rows of dots within each letter.

Since this is a mod 8 counter, its input frequency of 15,840 Hz is divided down to 1980 Hz, which is then applied to the text row counter. After division by 33, the output of this counter will be almost exactly 60 Hz. It may not be exact, since the original master oscillator may not have been quite exact, and so each of the other frequencies may be slightly off.

Since the text row counter starts at 0 at the top of the screen and gets an input pulse at the bottom of each row of letters, it counts the rows of letters down the screen. It can count up to 33 rows of letters, but only 16 rows will actually be used; a number of rows at the top and bottom will be blanked.

Keep in mind the function of these circuits as we go on; their purpose is to keep track of the position of the electron beam at every instant of time, and generate some basic timing pulses.

Sync generation

Although the timing circuits generate the sync timing, they don't quite provide the correct sync pulse shape or duration. The horizontal sync pulse should be a single pulse a few microseconds (millionths of a second) long. The vertical sync pulse should be a series of pulses lasting a little less than one millisecond (a thousandth of a second.) Thus the outputs from the timing circuits should be fed to a delay and shaping circuit which will provide the correct form.

The simplest circuit for accomplishing

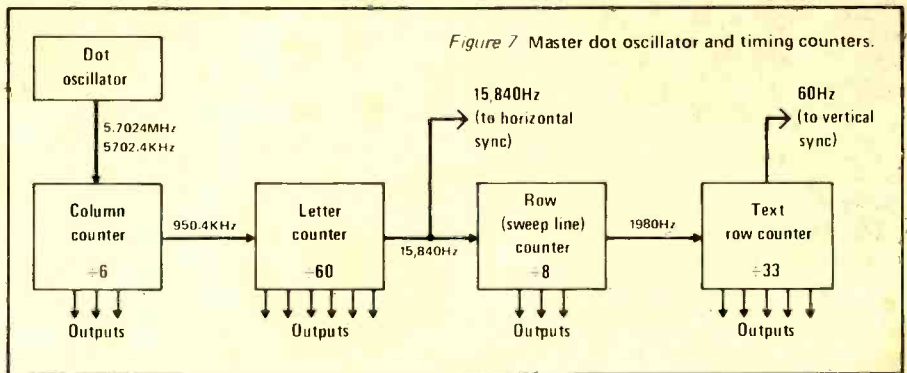

Figure 7 Master dot oscillator and timing counters.

this is a series of several one-shots and some gates. While this is being done, adding two more one-shots can allow moving the sync pulses back and forth a bit to position them properly in relation to the rest of the picture.

Due to variations on TV sets, it is often necessary to provide centering controls so that the display can be moved into the exact center of the screen. Rather than

pulses, and video.

The video is simply the dot signal from the master oscillator, except that the dots are sent through an AND gate. They can only get through the gate to the mixer if all of the inputs to the AND gate are present. This occurs only when (1) a 5x7 dot decoder (a memory integrated circuit which has stored in it the dot pattern for every letter) calls for a bright dot, (2) this

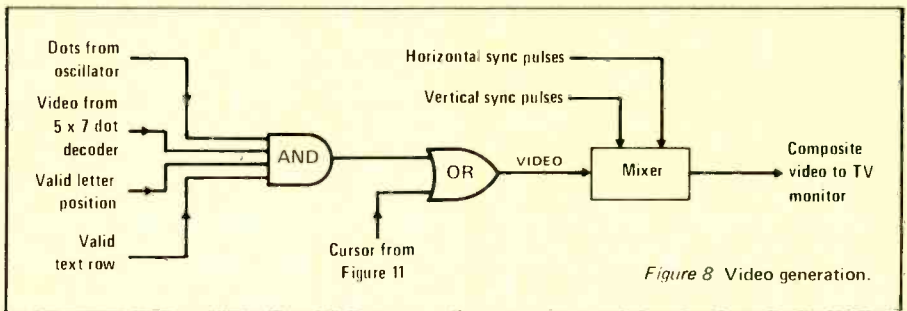

Figure 8 Video generation.

move the letters, it is easier to move the sync pulses in relation to them so that the TV sweep circuits will operate a bit sooner or later. This has the same result.

How do the sync pulses get to the TV set? Figure 8 shows how. The composite video which goes to the monitor or modified TV set is generated at a mixer circuit which combines three signals: horizontal sync pulses, vertical sync

is a valid letter position in the center of the screen, and (3) this is a valid row, again in the center of the screen. The latter two inputs simply turn off the video at the edges of the screen and force it to go black.

An additional signal is added to the video from the cursor circuit. We will discuss this signal later, but for now we'll simply say that this is a signal

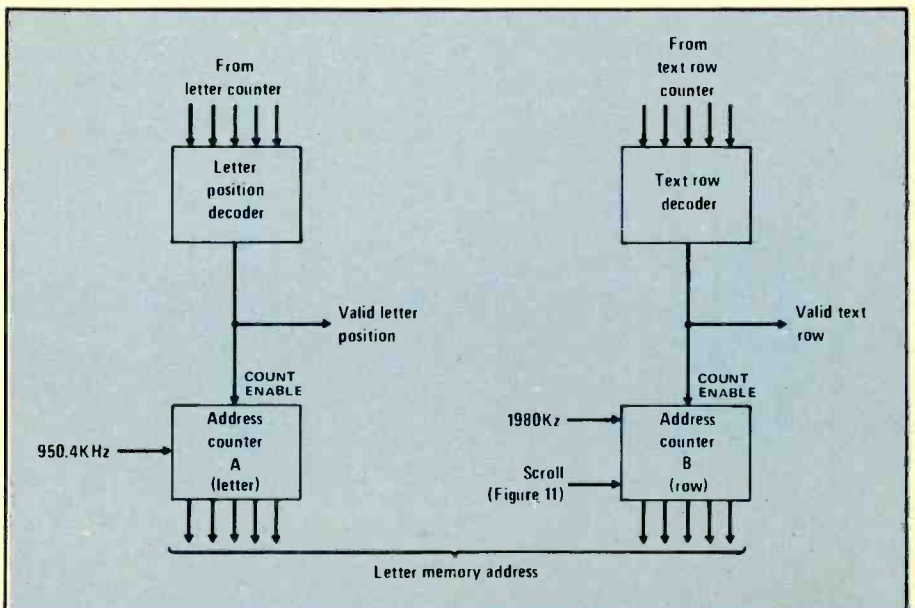

Figure 9 Valid position decoders and address counters.

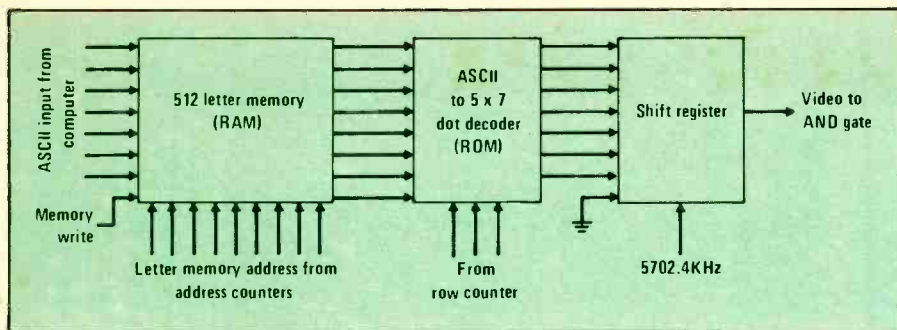

Figure 10 Character (letter) memory and 5 x 7 dot decoder.

which places a marker at a specific place on the screen to indicate where the next incoming letter will be placed when it comes from the computer.

Letter and row decoders

How does the circuit know whether this is a valid letter and row position, in the center of the screen? This is done by the decoders at the top of Figure 9.

The mod 60 letter counter in Figure 7 has six binary outputs which send out a binary number indicating which letter position the beam is on. Though it can count to 60 letters, we intend to use only the center 32 positions, and leave the other 32 blank. The letter position decoder in Figure 9 monitors these outputs, and provides a valid position output only when the counter is on positions 17 through 48.

In other words, the first 16 counts and the last 16 counts of the letter counter will not be used, and only the center 32 counts will be used to indicate that the electron beam is in the center 32 positions on the screen.

The text row decoder at the top of Figure 9 does the same job, but for rows. As you remember, we have planned enough space for 33 rows of text, but intend to only use the center 16. Hence the text row decoder will provide an output only when the text row counter is at rows 9 through 24. This skips the first 8 and the last 9 rows.

Memory address counters

All of this time, the letter and text row counters in Figure 7 have kept counting away as the electron beam is scanning the screen. But they indicate not only when the beam is in the center or valid area of the screen—they count all the time.

What we need is a set of counters which will operate only for valid letters. That is, a set of counters which will give us a unique number for each letter on the screen, and not run when nothing is being displayed near the edges of the screen.

This job is done by the two address counters at the bottom of Figure 9. Address counter A is a letter counter—it

gets the same 950.4 kHz input signal that the letter counter of Figure 7 gets. But it is only allowed to count when it gets a count enable signal—which is the valid letter position signal. So it only counts when the beam is in the center portion of the screen.

Address counter B is a text row counter—it gets the same 1980 Hz input signal as the text row counter in Figure 7 gets. But it only counts when the beam is in a valid text row in the center of the screen.

Since every letter on the screen is in a different row and also in a different position from the left end of the screen, these two counters have a unique count for each letter on the screen. Their nine output lines are called memory addresses because they uniquely identify the position of each letter both on the screen and in memory.

In addition to all of the circuitry we have just discussed, the CRT terminal must have a fairly complex memory section used for refreshing.

Since the picture on the CRT screen would fade out unless refreshed 60 times a second, the circuitry must continuously be feeding letters to the cathode ray tube's grid. If the terminal were connected directly to a computer and we didn't mind wasting computer time on this job, letters could be constantly fed from the computer to the terminal. But it is much more efficient to do the refreshing locally.

Character memory

This is done by having all 512 letters being displayed (32 across and 16 rows down) stored in a memory in the terminal. They are then constantly being pulled out of memory, one at a time, and sent to the CRT as composite video.

This is shown in Figure 10. The 512-letter memory stores all of the letters being shown on the screen. At the left are some inputs from the computer (more on those in a moment), and on the right are the outputs. The letter memory address from the two address counters enters at the bottom.

The letters are stored in the memory as ASCII characters. (See the article on computer keyboards in the June 1978 *Modern Electronics* for an explanation of parallel ASCII.) Each letter is stored in one memory location, whose address corresponds with the address that is in the two address counters at the instant that the CRT beam is over the spot on the screen where the letter is to be displayed.

The memory is a read-write memory, called a RAM, which is in the read state

please turn to page 87

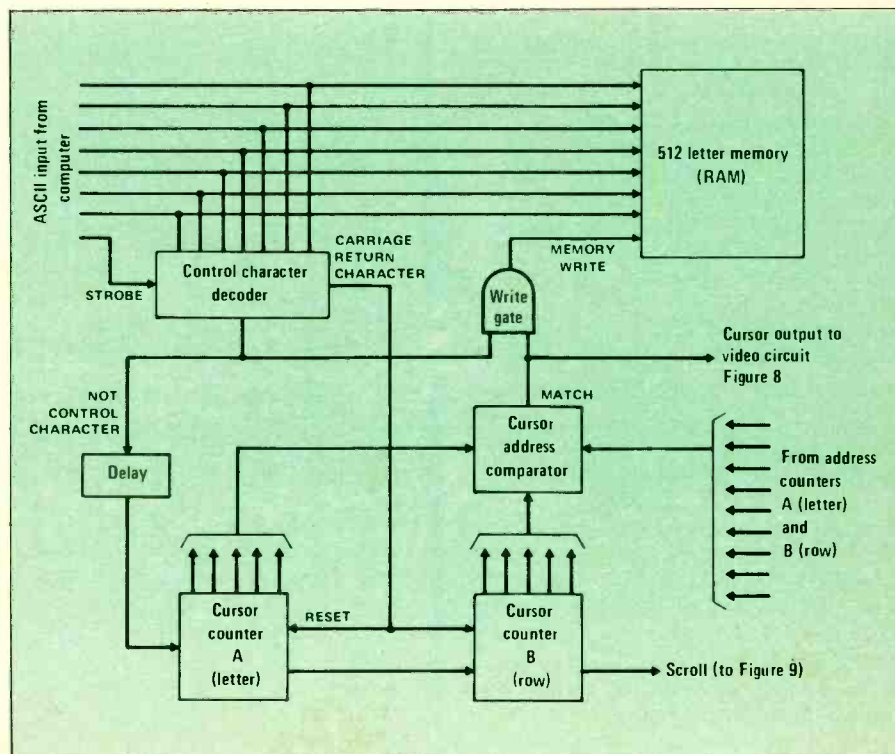

Figure 11 Cursor control and scrolling.

Build a keyboard for your home computer

Looking for an inexpensive keyboard for your homebrew computer system? Radio Shack has what you need in an easy-to-build project. Here's what we found when Modern Electronics checked out the full package.

by H. Dick Breidenbach



The Radio Shack ASCII encoder project board and keyboard is an inexpensive way to obtain a workable *encoded keyboard* and I can recommend it as a basically well designed package. I did, however, encounter some minor snags in finding the necessary parts not included with the project board and in making the keyboard work properly. My experience may help you avoid these minor hassles when you assemble the keyboard and encoder.

The encoder keyboard is not sold as a kit—it is sold as separate components. The keyboard itself is composed of a one piece plastic base into which are molded 63 SPST normally open switches. The keycaps simply slip into slides in the base and they may easily be removed to adjust the contacts. The printed circuit board is double-sided, drilled, with plated-through holes.

All component locations are clearly marked, and all of the switch contact locations are marked with the letter or function to which they correspond. The printed circuit board comes in a package which contains the instruction manual and one high speed integrated circuit which could prove hard to find, the 74H193 flip-flop.

The keyboard and circuit board may be purchased separately or together, and Radio Shack has run several specials on them. At the time I purchased mine, the best deal was to buy the two at the same time at a total price of \$39.95. Remember that this includes none of the electronic components except for the one high-speed flip-flop.

The fact that the parts are sold separately was a chance to save money for me. Over the years I've accumulated many miscellaneous components in my parts drawers, and I was certain I could reduce the cost of building the keyboard encoder by using parts I already had. Radio Shack calculates that all the necessary parts except hardware and case should cost \$57.80. Determining which parts were needed before I bought the project board was the problem.

Save bucks

The neatly stapled package with the circuit board contains a parts list all nicely printed inside the manual and unavailable for easy inspection. The manager of the store came to my aid by reaching under the counter and pulling out a little book which lists all the parts required for project boards.

Unfortunately, the list did not tell me if I had the parts—the list gave only the Radio Shack stock numbers. Still helpful, the manager opened the neatly stapled package and found the parts list with the standard part numbers, although Radio Shack puts an RS in front of the standard 7400 series TTL numbers.

Other than the keyboard and circuit board, only one special component is needed: the 74H193 high-speed flip-flop which is included with the circuit board. All other components should be readily available. I would have been happy to purchase the parts I didn't already have from the Radio Shack store, but it was short on stock.

I stopped in four different stores, buying different parts at each store, but was still unable to buy all of the parts for the project. I ordered the remaining parts from a mail order company with a two week delay in completing the project. A kit of all the parts would solve the problem, but then there would be no possibility of saving money by using parts already on hand. In all, I spent about \$6 more for the parts I did not already have, saving almost \$12 over what a kit would have cost.

Construction is straight forward. The instructions are very complete and easy to understand. Some care should be taken in attaching the keyboard to the circuit board, especially if the circuit board is slightly warped as mine was. The instructions do alert you to this potential difficulty, but it turned out that it was not much of a problem.

Easy to build

I used sockets for the IC's even though the manual did not suggest them. While it is not likely that an IC will need replacing, the cost of a socket as insurance for the easy removal of a suspect IC is not very high. If you have ever had the frustration of ripping away the printed circuit while trying to remove an IC, you very likely will share my view.

I also constructed the optional test module which is simply a nine bit LED readout constructed on a standard 44 pin connector socket. I found the test module to be useful for checking the operation of the keyboard encoder, and it is very easy to construct. Be wary, though,

INPUT	Unshifted (Normal)			Shifted		
	Z7 Pin 6	Z6 Pin 6	Z7 Pin 3	Z7 Pin 6	Z6 Pin 6	Z7 Pin 3
Line a	0	0	0	0	0	0
Line b	0	1	0	0	0	0
Line c	0	1	1	0	1	1
Line d	1	0	0	1	1	0
Line e	1	0	1	0	0	0
Line f	1	1	1	0	1	0
Line g	0	0	0	1	1	0
				0	0	0

Figure 1 This table shows the correct row line codes at the latch inputs during the Normal and Shifted mode.
 * Only during 0000 of the 4 least significant bits.
 ** During all other values of the 4 least significant bits.

of the 22 letter alphabet used to label the positions on the socket.

As I found out, it doesn't take long to move leads from the incorrect pins to the correct ones after discovering which letters are missing. The shortened alphabet is standard for this type connector, but if you are unfamiliar with it, or if you start rushing as I did, you may connect the LED's to the wrong pins.

Pep it up

While the keyboard works well without changes, the manual suggests a capacitor change which makes the repeat key operate faster. The standard 3½ Hz rate is agonizingly slow, slower than can be executed by repeatedly operating a key. A computer terminal which I use regularly has a repetition rate of 16 Hz which allows filling an 80 character line in about 5 seconds, which is quite fast.

Replacing capacitor C3, 3.3 mfd, with a 1 mfd capacitor, as the manual suggests, provides a repeat rate of about 10 Hz which turns out to be a very comfortable compromise between the two.

The only problems I found when I first tested the assembled board were the malfunctioning of two keys. The key switches are quite simple. They consist of two metal prongs sticking up from the plastic base in which they are molded, with a movable piece of plastic holding the prongs apart.

Depressing a key moves the plastic down, and the two metal prongs move together and make contact. The key tops are easily removable by looping a piece of wire under them and pulling directly away from the keyboard.

One of the malfunctioning keys was making contact intermittently. It was easily fixed by bending the prongs closer together with a small screwdriver. The other was never breaking contact and it was easily fixed by straightening the one bent contact with small needle-nosed pliers.

The manual contains extensive trouble

shooting guides, along with an example which covers some of the most likely problems. The guides looked good, but I never had a chance to try them since I had so little trouble!

Read the book

The manual also contains an extensive description of the theory of operation of the encoder. It is heavy reading, but well worth the effort.

A number of both basic and clever techniques have been used in the design of the encoder. Basically, the encoder scans the keyboard to generate the proper low-order bits for a depressed key depending on the state of a 4 bit counter when one of 16 clock signals is detected. At the same time the high order bits are generated depending on which group of keys contains the depressed key.

The high order bits are modified if the shift key is depressed, the 8 bits are entered into latches, and a strobe signal is generated. Two additional clock signals set up the logic for the next input. The circuit uses counters, shift registers, and a multiplexer in addition to commonly used logic gates.

Text typo

I found one minor typographical error in the text of the theory, in the shift and shift lock section, where it claims that IC Z15 stores the shift and shift lock instructions, while it is really IC Z13 that performs this function.

The other error I found is larger. Three of the seven lines in the table giving the shift codes are in error. The correct table is shown in our figure 1.

I was impressed with the keyboard encoder. It is a well designed, easily constructed piece of hardware. I was even more impressed with the manual. It is obvious that a great deal of effort was put into making it clear and complete. If you are looking for an inexpensive ASCII encoded keyboard, you should certainly consider this one. 

\$1,000 Reward Offered by Mad Train Collector

For the reader who can come up with the following old Lionel Electric train for my fast-growing collection:

Model No. 700E Scale Hudson (No. 5344 appears on the side of the cab). If any reader can get this set for me together with either the scale freight cars No. 714-717 or the passenger cars No. 792, 793, and 794, I will gladly pay up to \$1,000 for the set. Actual price will be based on condition.

There are many other old pre-WW II Lionel engines and cars that I need, both in Standard Gauge and in "O" Gauge. Blue Comet sets, state cars, and Stephen Gerard cars are desirable Standard Gauge items. Hiawatha and others of the better passenger sets are worth lots of dollars to me in clean condition.

Old trains are not just my hobby. They're an obsession that I simply cannot overcome. So, if you've got old Lionels around, don't be bashful. Give me a call or drop me a note. To determine the value of your trains I'll need the numbers that appear on all the cars, the colors, and the approximate condition. Remember, those old trains that are gathering dust in the attic could be bringing joy and pleasure to a mad collector.

Dick Cowan, Mad Train Collector
 Publisher, Modern Electronics
 14 Vanderventer Avenue
 Port Washington, NY 11050
 Phone: 516/883-6200

9 projects under \$9

Need to turn off your tv? Control flashes? Want a sexy door chime which travels around the door? These and more are part of our easy-to-build projects for September.

by Jeff Sandler
Contributing Editor

1 Traveling chimes

Why settle for a simple one-sound source doorbell when you can build this interesting multi-sound chime set. When the doorbell button is pushed, your guest will be treated to a six-tone chime, with each tone coming from a different location.

Each tone is generated by a separate oscillator built around a pair of gates. The oscillators are gated on by a six stage time delay circuit. Each stage of the time delay is built around one element of a 4050 hex buffer, and has an independent time delay control. These controls let you vary the length of each tone.

Because each stage of the time delay circuit inverts—due to circuit configuration, not the element itself—the tone generators connected to points A, C and E are built around 4011

NAND gates while those connected to points B, D and F are built around 4001 NOR gates.

When the doorbell button is pushed, the tone generators are turned on in sequence, each for the period determined by the individual controls. If you prefer, you can use one or two of the 4050 stages to produce silent pauses. You might, for example, use five generators to produce three tones, a pause, then two final tones.

Each generator's tone can be individually set by adjusting a 100K variable resistor. Although a 2N3904 is specified for the audio amplifier, you can use any suitable NPN transistor. Most any speaker can be used.

The circuit shown produces a six-tone chime. However, you can use

additional 4050 hex buffer chips to the time delay generator, and 4001/4011 audio oscillators. There's really no limit to the number of tones and pauses in the chimes you build.

Construction is straightforward, and the parts layout isn't critical. However, if one or more elements of any IC is not used in your chime circuit, make sure to tie the input lines to ground or the supply rail. This will prevent self-oscillation in the element, with its added current drain and possible effects on circuit operation.

CMOS logic draws very little current in standby. In normal use, a nine-volt battery will provide power for a period almost equal to its shelf life.

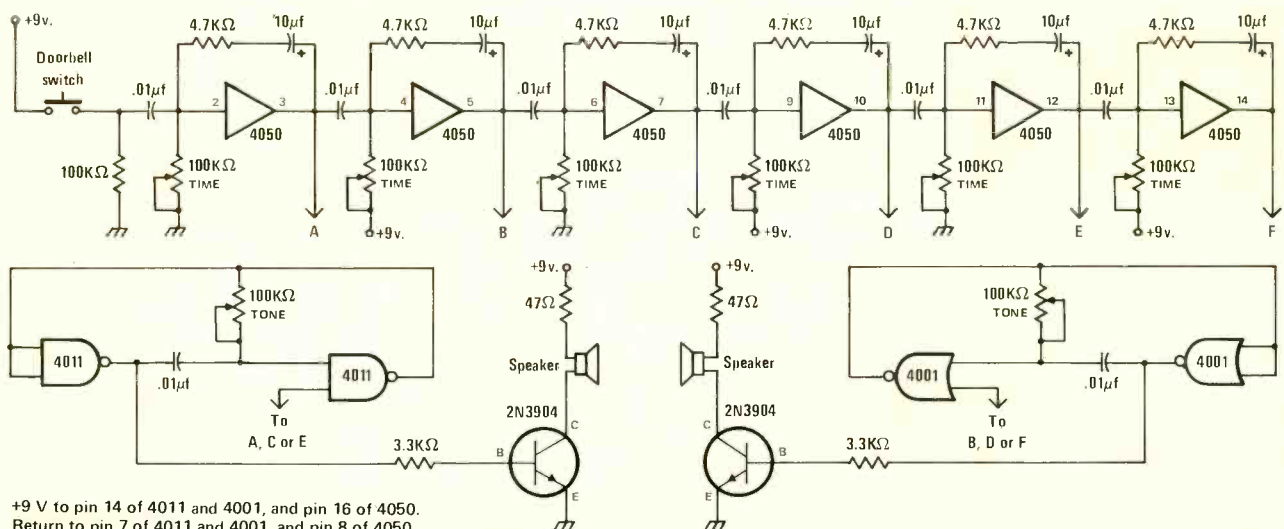

+9 V to pin 14 of 4011 and 4001, and pin 16 of 4050. Return to pin 7 of 4011 and 4001, and pin 8 of 4050.

6 Speed control

Now that summer's half gone, you've probably gotten yourself into pretty decent shape. Now's the time to get into some long distance, sustained-speed bicycling. All you need is this handy minimum-speed alarm to keep you pedaling at a nice, steady pace.

All you have to do is set the control to the minimum speed you want. Then, whenever the speed falls below the preset level, your horn or any other electrical signaling device will let you know. Just pick up the pace a little, and the signaling will stop.

The circuit is built around a 4081 CMOS integrated circuit. Bicycle speed is measured with a permanent magnet attached to the wheel passing across a reed switch attached to the frame. Each revolution of the wheel will cause the reed switch to close once. The faster the wheel turns, the more times per minute the reed switch will close.

The rate at which the reed switch closes determines the level of the dc voltage produced by the circuit. When it falls below the preset level, the output transistor turns on. As shown in the diagram, turning on the transistor energizes a relay, the contacts of which can be used to operate

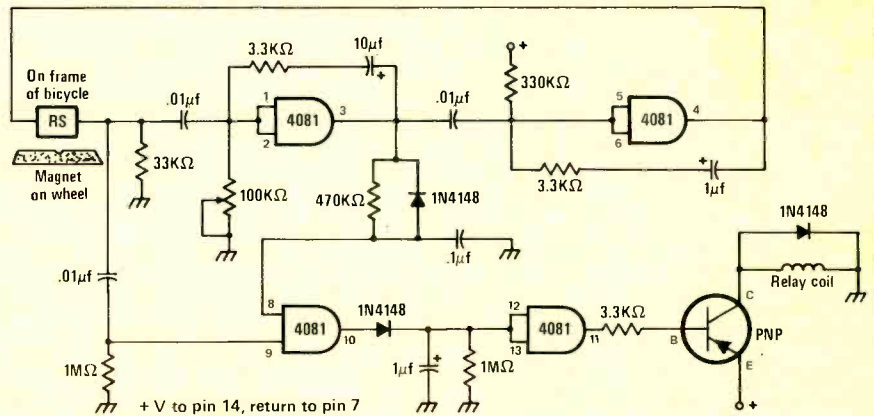

any signaling device. The actual connects are left to you.

Construction is straightforward, and parts layout isn't critical. However, some care should be taken in placing the bar magnet and reed switch. The magnet should be located between four and six inches out from the axle and along the spoke. For best results, it should be mounted on a non-magnetic material which is in turn attached to the wheel.

The reed switch should be positioned on the fork so that the magnet passes directly beside it, with a gap of

about one-eighth inch between the two. The reed switch itself should be mounted on a non-magnetic material attached to the fork. The idea is to keep both the magnet and reed switch as far removed from the metal in the bike as possible.

You can use almost any small signal PNP transistor with ratings high enough to handle the relay used. The circuit can be powered by a nine-volt transistor battery. If your bike is equipped with an electric horn, you can connect the relay in parallel with the horn button.

7 Electronic thermometer

If you have a VOM or a sensitive milliammeter handy, you can build this nifty thermometer for about \$5, and less if you have a well-stocked junk box.

The heart of the thermometer is the 3911 IC. This amazing device has an output equal to 10 mV/degrees Kelvin.

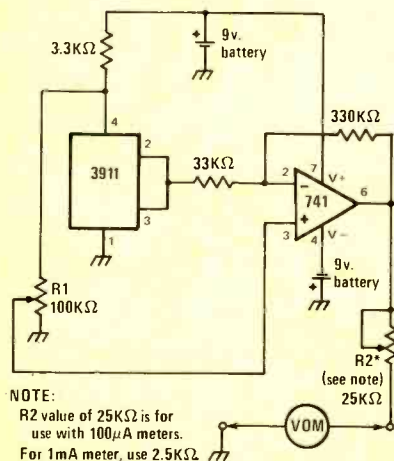

So, at zero degrees Celcius, the output is 2.73 volts. And since a degree Kelvin is the same as a degree Celcius—the base differs, however, with zero Kelvin equal to -273 Celcius—a one degree Celcius change results in a 10 mV change in the 3911 output.

This swing can be amplified to produce greater output change per degree change. In this circuit, the amplification is provided by a 741 op-amp. The output of the 741 is 0.1 volt/degree Celcius.

It is the low impedance output of the 741 that drives your meter movement. To expand the scale, and let you set the meter needle to zero, the circuit has two controls built-in. R1 sets the zero point, which can be any temperature you wish. But, it's convenient to make your meter zero equal zero degrees.

You can set your thermometer to readout in degrees C or F by properly adjusting R2, which sets the scaling factor. Remember that one degree C equals 5/9 degrees F.

Calibrating the thermometer circuit is easy, but does require an accurate mercury thermometer. The easiest way is to use your refrigerator or freezer. Adjust the refrigerator or freezer controls to get zero degrees C or F. Then put the thermometer circuit in and wait till it cools to zero.

Once you've set the zero point, take the circuit out of the refrigerator and allow to warm to room temperature. Then place the circuit in an oven you've preheated to the maximum temperature you want your meter to read.

Once the 3911 stabilizes at the oven temperature, set R2 for full-scale deflection of the meter movement. Since the output of the 3911 is linear, all you have to do to calibrate the meter is divide the scale into equal divisions from zero to the top temperature.

Construction of the thermometer is easy, and the parts layout isn't critical. The circuit can be powered by a pair of nine-volt batteries.

8

Telephone ESP

Have you ever picked up your telephone only to find someone on the line waiting to talk to you? It's eerie. And imagine how your caller must feel. No ringing at the other end. There's only the sound of switching at the exchange, then the voice of the person being called.

Of course, it happens only once in a great while. The odds of picking up your phone just as a call is coming in are astronomical. But, with this handy circuit you can really improve those odds—if your phone company uses a system that connects the line before ringing the bell. Even if yours rings the instant the connection is made, the circuit can still be used for remote signaling.

Normally, when an incoming call arrives, the voltage across the phone line drops. If the incoming call arrives between rings, you can use the voltage drop to trigger an alarm.

The circuit is built around a 4011 quad NAND gate. The input impedance is in the megohm range, so there's no phone-line loading problems. Powering the circuit with a nine-volt battery will eliminate any problems of hum feeding back into

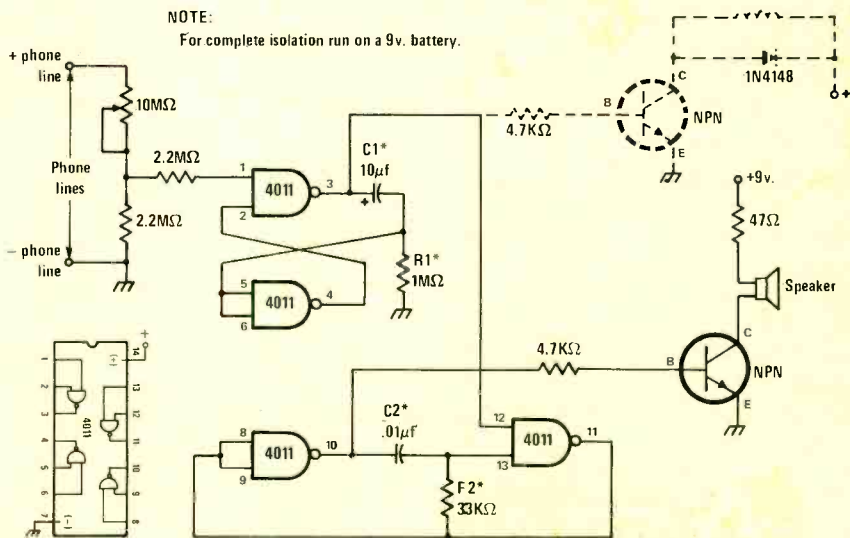

the line. Bear in mind, however, that the telephone company does not look kindly on unapproved devices being connected across their lines.

The alarm will sound for a period of time set by the values of R1* and C1*. The values shown will give you about 10 seconds of alarm tone. The frequency of the tone is determined by

the values of R2* and C2*. You can use any handy NPN transistor—a 2N2222 or a 2N3904 will work well.

If you'd rather use some remote signaling device, such as a gong or lamp, you can eliminate the audio oscillator and transistor amplifier, replacing them with the relay circuit shown in dashed line.

9

TV turnoff

Here's a time-delay tv turnoff with a twist—it beeps about a half-minute before turnoff to give you time to recycle the timer, or lock it on. The warning gives you time to take action

before the tv goes off—usually at the most dramatic moment in the show you're watching.

The circuit can be mounted inside the tv cabinet with the control switch

connected by cable. Or, you can build the circuit into a small box kept at chairside, with only the relay inside the tv cabinet. One other alternative is to substitute a photocell for the on-off switch. Then, all of the electronics can be left in the tv cabinet. All you'd need to control the set would be a small flashlight.

The circuit itself is built around a pair of 4011 CMOS ICs. Parts layout isn't critical. If you can find low-voltage dc inside the tv, it can be used to power the circuit. Otherwise, a nine-volt battery will work well.

The timer is operated by momentarily closing the on-off switch. Your tv will turn on when the switch is closed. The time delay begins when the switch is opened. The delay time, in seconds, is set by adjusting R*, and is roughly equal to the value of R* in ohms multiplied by the value of C* in farads. Using the 1000 mfd capacitor shown, an R* of 3.6 megohms will give you a one-hour delay. For a one-half hour delay, R* should be 1.3 megohms.

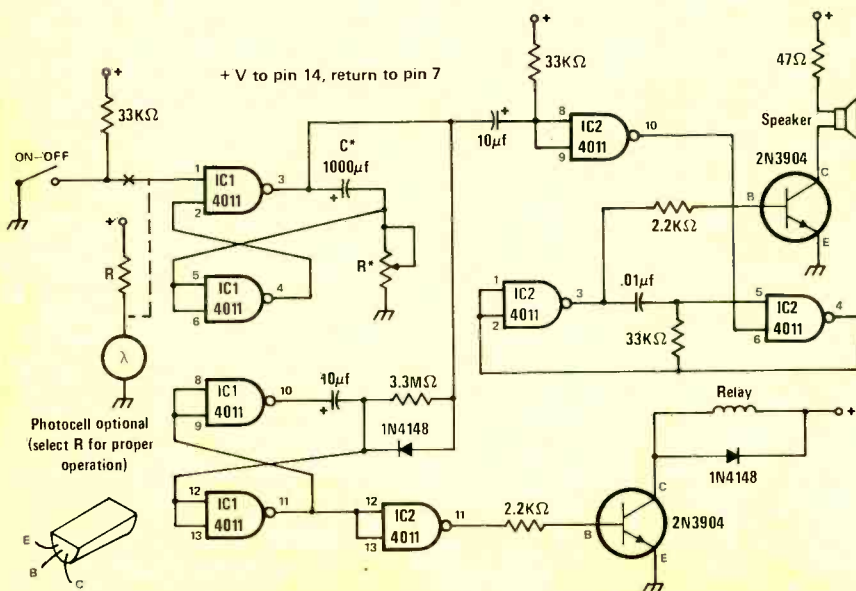

Easy-to-build CMOS



radio receiver

Fun for tonight! Build our easy receiver and learn how to handle CMOS integrated circuits.

by Charles Green

One of the most fun things you can build always is a new and different version of the good old fashioned am broadcast radio.

Everybody loved the crystal sets of the Twenties; the one-tube jobs of the Forties; the two-transistor rigs of the Sixties. As we head into the Ex-

citing Eighties, here's a new version of the old favorite, built around the latest electronic technology available to experimenters. It's easy to build and will provide hours of entertainment fun.

CMOS integrated circuits (ICs) are being used with increasing frequency today because, in digital circuits, they use less power, operate over a wider voltage range and require a higher input impedance.

CMOS ICs are fabricated with Complementary MOS field-effect transistors (FETs) and have certain very interesting features, including the use of both P and N types of semiconductors in the same IC package.

In fact, there's one type of CMOS IC which can be used in linear circuits, such as am broadcast radio receivers!

It's the CD4007A dual complementary pair plus inverter IC. It has six FETs inside. You can experiment

with this IC by building our simple receiver project.

We'll use the 4007 as an audio amplifier fed by a germanium diode detector and a loopstick antenna tuned circuit for the broadcast band.

The receiver is housed in a compact metal cabinet with a 9-volt battery for power, and can drive a small speaker or low impedance headphones.

The receiver circuit

Signals from the antenna are fed through J1 and tuned by the broadcast-band tuned circuit of L1 and C3. The signals are detected by the germanium diode D1 and coupled through C2 to the input of the first section of the CD4007A (IC1A).

This section is biased by the two series resistors R1-R2 and the amplified signal is coupled through C6 to the volume control R4 and to the input of the second IC section (IC1B).

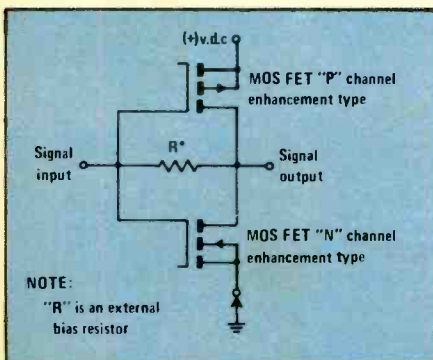

The basic CMOS amplifier consists of a pair of complimentary p- and n-channel MOS enhancement type FETs.

The CMOS IC

The complementary metal-oxide semiconductor (CMOS) IC employs both p-channel and n-channel FET's on the same silicon substrate as shown in the basic schematic. Only one of the FET's is operational at a time as each of the devices are enhancement mode types.

The gate voltage input signal swing will only turn on the FET that will operate in the same polarity direction as the signal. For example, the n-channel device will conduct on a positive going signal, and the p-channel device will conduct on a negative going signal. At zero input, neither device will conduct.

As each of the FETs conduct, the CMOS output is connected to either the power supply, or to ground, depending upon the input signal polarity. The circuit operates as an inverter as the output signal is the logical complement of the input.

As the FET devices are insulated gate types, the input resistance of the CMOS is very high, in the millions of megohms. The power consumption of the CMOS (when used in digital applications) is very low, as only one of the

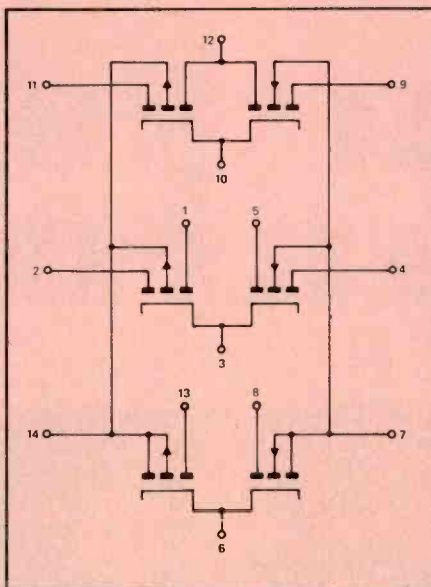

FETs are turned on at one time.

When CMOS are biased in the linear portion of their voltage transfer characteristics, they can be used in linear applications as well as the more common digital uses. The simplest way of biasing is to connect a high value resistance (R in the schematic) between the input and the output of the CMOS.

The CMOS IC used in our receiver circuit is an RCA CD4007A in a 14-pin dual in-line plastic package. It is listed as a dual complementary pair plus inverter device.

As shown in the IC schematic, the CD4007A has six FETs fabricated on its substrate; three p-channel and three n-channel types.

Two of the p-channel and two of the n-channel FETs are connected with separate outputs (pins 8-13 and 1-5). These are the complementary pairs.

The third pair of FETs are internally strapped and has a single output pin (12). This section is the inverter.

The other two sections are strapped externally in our receiver circuit to also function as inverting amplifiers. Protective diodes for electrostatic punctures are included in the circuits.

This section is biased by R5 and the amplified output is fed through C9 to IC1C and further amplified.

The output is coupled through C11 to the output transformer T1 to J2 and external 8-ohm speaker or headphones.

C4 and R3-C5 act as RC decoupling

circuits to minimize any audio feedback through the dc power circuit from B1. S1 is the on-off switch and is coupled to R4. C7-C10 are rf bypass capacitors.

Most of the receiver components are mounted on a 2⁷/₈-inch by 2¹/₂-inch section of Radio Shack experimenter's

printed circuit board (part number 276-151). As shown in the wiring diagram, this particular pc board is composed of copper foil squares used for soldering component lead connections, and solder pads for mounting an IC socket.

If desired, the circuit can be wired

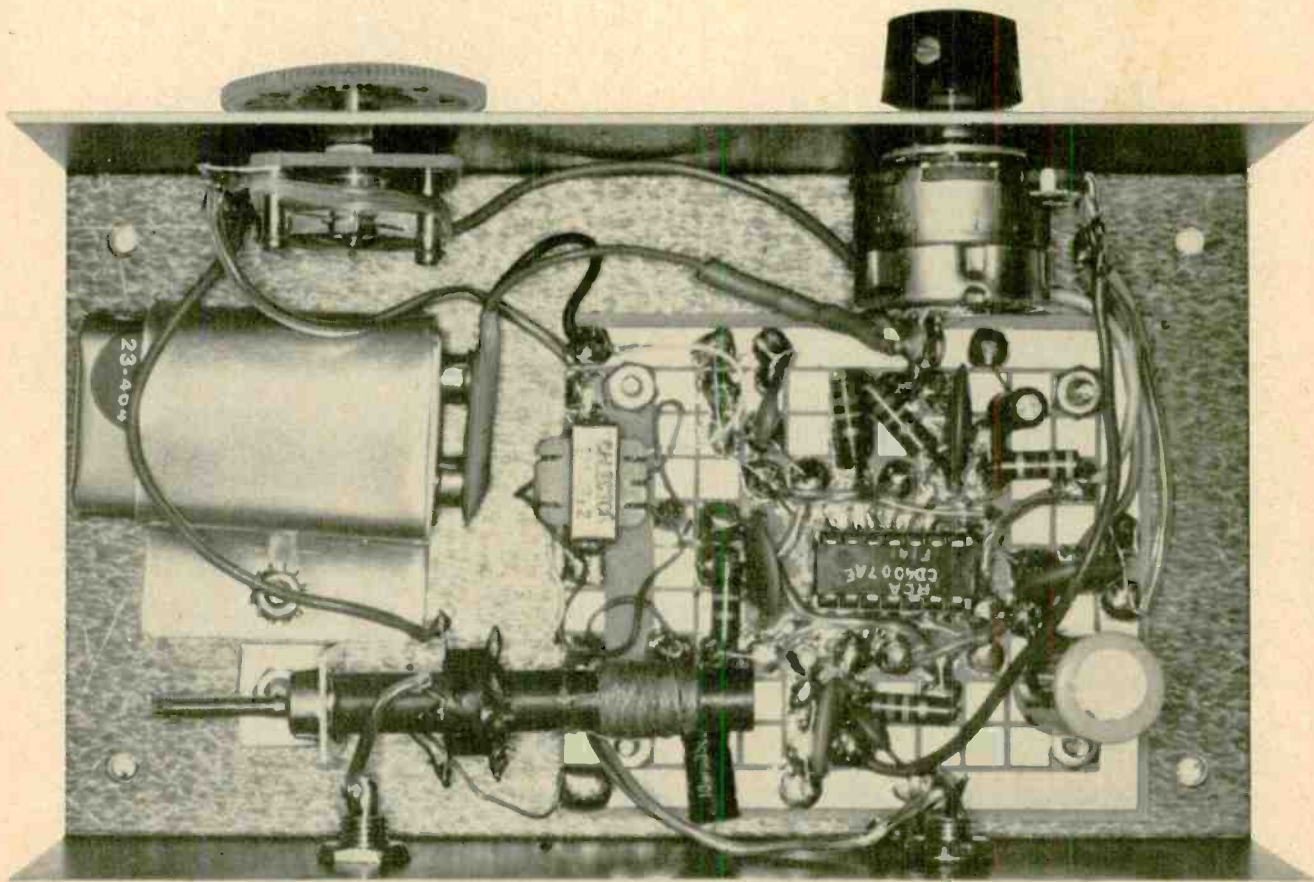

You gotta shop around.

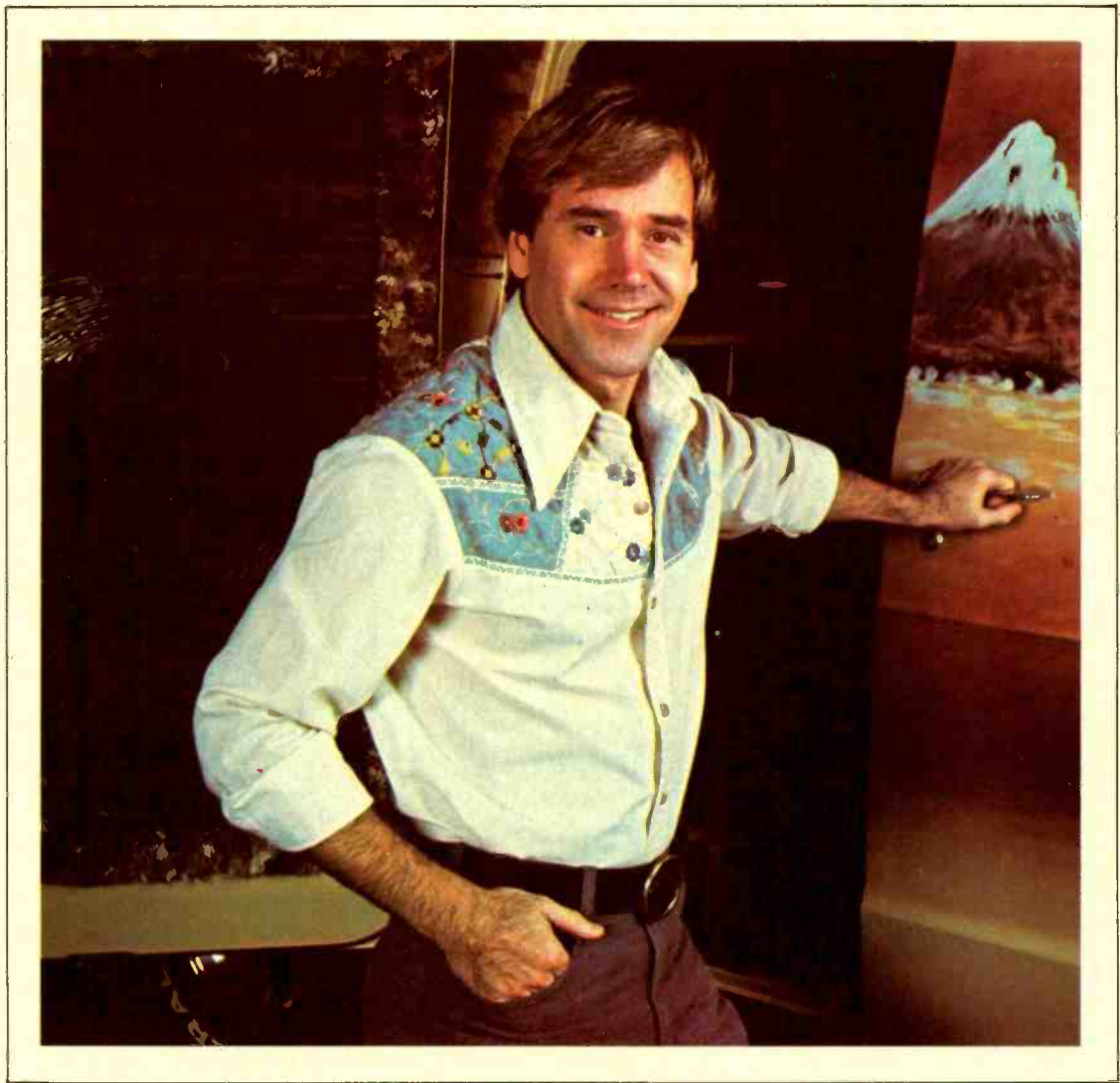

**When you do, you'll probably pick CIE.
You can't afford to settle for
less when it comes to something like
electronics training that could
affect your whole life.**

When you shop around for tires, you look for a bargain. After all, if it's the same brand, better price — why not save money?

Education's different. There's no such thing as "same brand." No two schools are alike. And, once you've made your choice, the training you get stays with you for the rest of your life.

So, shop around for your training. Not for the bargain. For the best. Thorough, professional training to help give you pride and confidence.

* * *

If you talked to some of our graduates, chances are you'd find a lot of them shopped around for their training. They pretty much knew what was available. And they picked CIE as number one.

Why you should shop around yourself.

We hope you'll shop around. Because, frankly, CIE isn't for everyone.

There are other options for the hobbyist. If you're the ambitious type — with serious career goals in electronics — take a close look at what we've planned for you at CIE.

What you should look for first.

Part of what makes electronics so interesting is it's based on scientific discoveries — on ideas! So the first thing to look for is a program that starts with ideas and builds on them!

That's what happens with CIE's Auto-Programmed® Lessons. Each lesson takes one or two principles and helps you master them — before you start using them!

How practical is the training?

This is the next big important question. After all, your career will be built on what you can do — and on how well you do it.

Here are ways some of CIE's troubleshooting programs help you get your "hands-on" training...

With CIE's Experimental Electronics Laboratory...

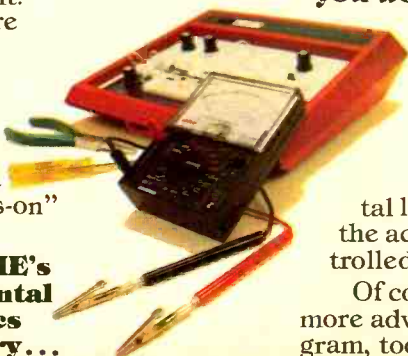

you learn and review the basics — perform dozens of experiments. Plus, you use a 3-in-1 precision Multimeter to learn testing, checking, analyzing!



When you build your own 5 MHz Triggered-Sweep, Solid-State Oscilloscope you take your first real professional step. You use it as a doctor uses an X-ray machine — to "read" waveform patterns... lock them in... study, understand and interpret them!

When you get your Zenith 19-inch Diagonal Solid-State Color TV you



Pattern simulated.

apply your new skills to some real on-the-job-type troubleshooting! You learn to trace signal flow... locate malfunctions... restore perfect operating standards — just as with any sophisticated electronics equipment!



When you work with a completely Solid-State Color Bar Generator — actually a TV signal transmitter — you study up to ten different patterns on your TV screen... explore digital logic circuits... observe the action of a crystal-controlled oscillator!

Of course, CIE offers a more advanced training program, too. But the main point is

simply this:

All this training takes effort. But you'll enjoy it. And it's a real plus for a troubleshooting career!

Do you prepare for your FCC License?

Avoid regrets later. Check this out before you enroll in any program.

For some troubleshooting jobs, you must have your FCC License. For others, employers often consider it a mark in your favor. Either way, it's government-certified proof of specific knowledge and skills!

More than half of CIE's courses prepare you for the government-administered FCC License exam. In continuing surveys, nearly 4 out of 5 CIE graduates who take the exam get their Licenses!

Shop around... but send for CIE's free school catalog first!

Mail the card. If it's gone, cut out and mail the coupon. If you prefer to write, mention the name and date of this magazine. We'll send you a copy of CIE's FREE school catalog — plus a complete package of independent home study information! For your convenience, we'll try to have a representative contact you to answer your questions. Mail the card or coupon — or write: CIE, 1776 East 17th St., Cleveland, OH 44114.

CIE Cleveland Institute of Electronics, Inc.

1776 East 17th Street, Cleveland, Ohio 44114
Accredited Member: National Home Study Council

YES... I'm shopping around for the **right** kind of career training in electronics troubleshooting — and CIE sounds well worth looking into. Please send me my FREE CIE school catalog — including details about troubleshooting courses — plus my FREE package of home study information! MO-11

Print Name _____

Address _____ Apt. _____

City _____

State _____ Zip _____

Age _____ Phone _____
(area code)

Check box for G.I. Bill information:
 Veteran Active Duty

Mail today!

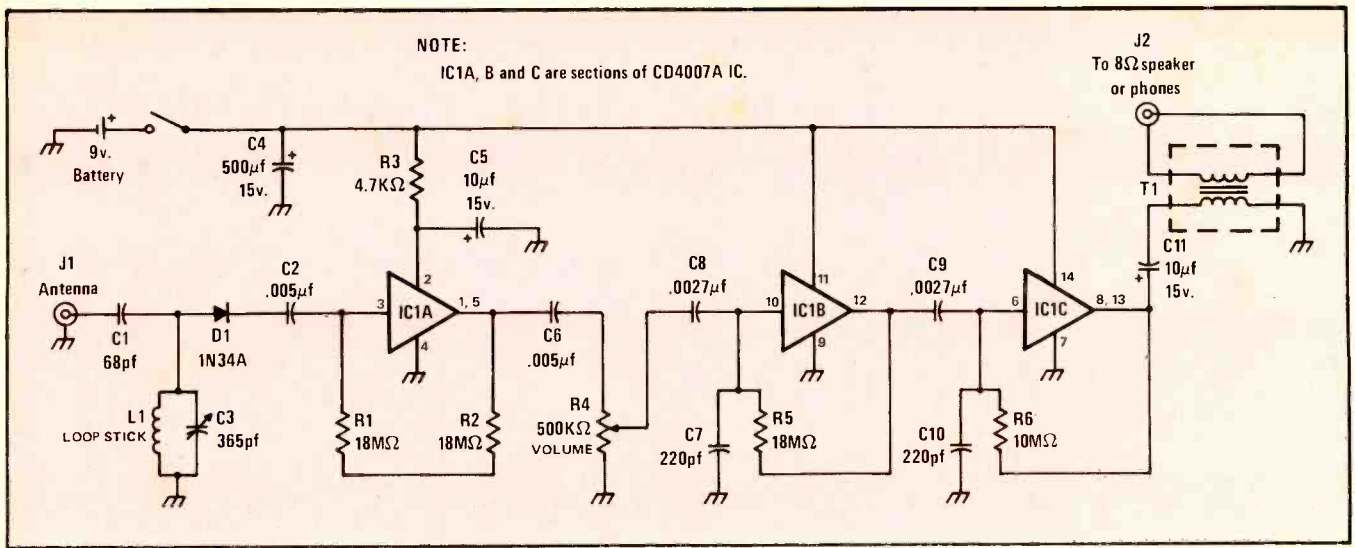

with a perf-board and push-in solder pins in place of the pc board section.

As shown in the photos, the pc board is mounted on the bottom of a Radio Shack 2 $\frac{3}{4}$ by 6 by 4-inch metal cabinet (part number 270-260) with 4 screws and spacing nuts. The cabinet size is not critical, and you can use any convenient size cabinet to fit your components.

Begin construction by cutting the pc board to size. Inasmuch as both

sections of the pc circuits are identical, either side can be used, and the remaining section cut-off. For convenience, the section used in our model was cut one vertical line of copper foil squares past the pc board center line.

This line of squares is used to mount T1 and the connections of the leads to B-, GND, and J2. Check the wiring diagram before cutting the pc board.

Before soldering the IC socket to the

pc board pads, check its position; the pc pattern has pads for a 16 pin-socket and the IC used in our model is a 14 pin type.

The unused two pads can be peeled off the board with a sharp knife or razor to prevent possible confusion in wiring the board. The unused pads are the ones located near R6 and C9 connection foil squares.

Wire the pc board with small diameter solid wire (#24) and lengths of insulated tubing to prevent any possible shorts. Mount the components vertically on the foil squares with short leads to minimize movement, except for C11 which should be laid horizontally to prevent any interference with L1.

Bend out the tabs of T1 and solder them to the foil squares to hold the transformer securely in place, and cut the leads to size before connecting them to the foil squares to keep them away from the IC1 circuits to prevent any possible feed-back coupling. After mounting the pc board components, set the board aside.

Locate and mount the cabinet components, R4 and C3, on the front panel in the approximate locations shown in the photos. Then mount J1 and J2 on the rear panel and install a ground lug on J2. Use lockwashers under the mounting nuts to prevent accidental movement of the components. Position the pc board on the bottom of the cabinet and locate the four corner mounting holes.

Drill the holes and mount the pc board with machine screws and spacing nuts to keep the board bottom approximately 1/16-inch up from the cabinet bottom.

Bend a 1/2-inch wide by 1 $\frac{1}{4}$ -inch high (with a 1/2-inch foot) bracket from the sheet aluminum and cut a hole near the top to fit L1. Mount the bracket on the box bottom with a machine screw and nut so that the L1

please turn to page 57

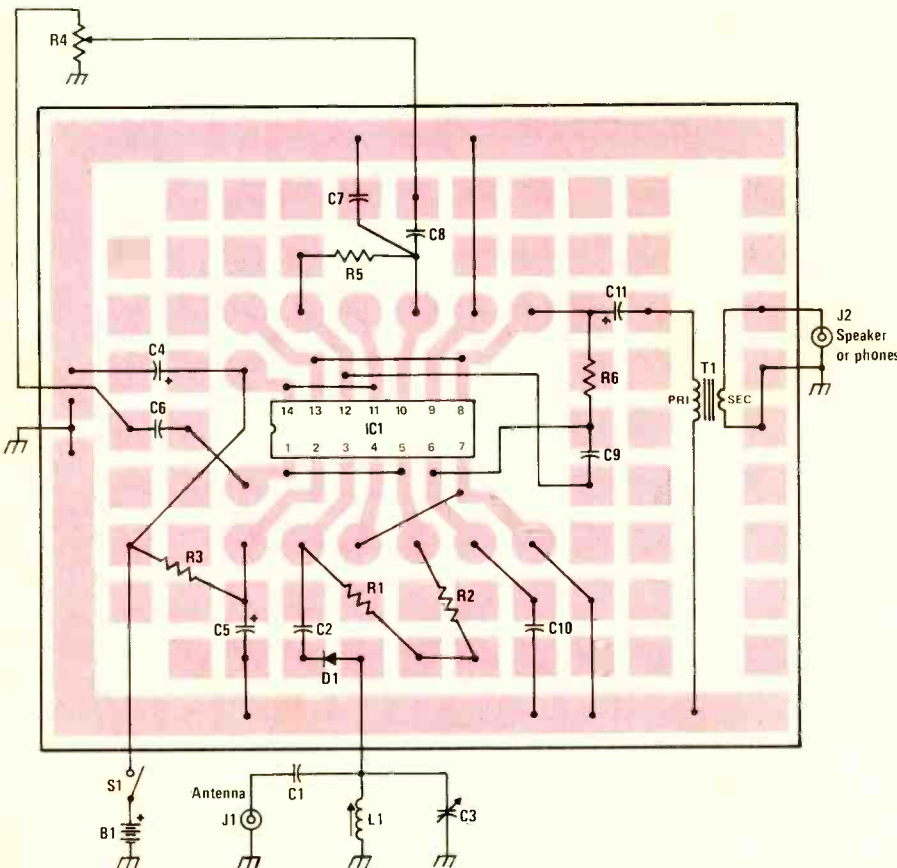

The Radio Shack 276-151 experimenter PC board is ideal for building the CMOS receiver. You'll only need one section of the board. The parts layout shown is neat and provides ample clearance between components.

Most shortwave radio is above board and in the open. But lurking throughout the shortwave spectrum are what SWLs refer to as *clandestine* stations. A clandestine station is any radio outlet that disguises its true purpose, location, or identity. Some clandestines are hidden, illegal transmitters located within a nation broadcasting their opposition to the country's ruling regime. Others are hidden stations located outside of a country broadcasting propaganda designed to incite revolution. Still other clandestines are used to actually transmit instructions to real-life spies in the field! And anyone who owns a shortwave receiver can easily tune in this activity. Moreover, some of the hottest action is happening next door to the United States in Latin America, with some clandestines maybe located in the United States!

A station reincarnated

Back in the early 1960's, shortly after Fidel Castro came to power, Cuba was the target of numerous clandestine radio stations operated by Cuban exiles and American intelligence services. The most famous of these was *Radio Swan*, which claimed to be broadcasting from Swan Island in the Gulf of Mexico. Radio Swan transmitted on 1160 kHz in the broadcast band and on 6000 kHz in the 49 meter shortwave band.

An exciting moment for many SWLs was hearing Radio Swan transmitting instructions to the Bay of Pigs invaders during the ill-fated 1961 invasion of Cuba sponsored by the CIA. After the Bay of Pigs incident, Radio Swan changed its name to Radio Americas and continued to broadcast anti-Castro programs in Spanish until it abruptly left the air in 1968. It has been subsequently revealed that both Radio Swan and Radio Americas were operated by the Central Intelligence Agency.

Given such a history, it's little wonder that SWLs were startled in the autumn of 1975 to hear a station calling itself Radio Swan broadcasting anti-Castro programs in Spanish on various frequencies in the 49 meter band, 5950-6200 kHz.

Careful listening revealed that the station was on the air 24 hours a day and claimed to be broadcasting from San Pedro Sula, Honduras. Listeners who reported reception of the new Radio Swan received letters from Ralph H. Nodarse, station president, which seemed to hint that there was some connection between the old Radio Swan/Americas and his operation.

Currently the station identifies itself as Radio Swan de Honduras, and still operates around the clock on 1160 kHz, the old Radio Swan/Americas broadcast band frequency. Shortwave operation is more erratic, with both 6000 and 6185 kHz claimed to be in use by the station. Around 1160 kHz will be easiest in the East after midnight, Eastern time, while listeners in the West will likely find the channel blocked by station KSL in Salt Lake City, Utah.

Operation on 49 meters is often erratic, but try both 6000 and 6185 kHz from 0600 GMT (1:00 a.m. EST) until sunrise at your listening post. If you hear them, you can mail your reception report to Radio Swan de Honduras, Apartado Postal 882, Rio de Piedras, San Pedro Sula, Honduras.

The 40 meter amateur radio band (7000-7300 kHz) has been the location for the past few years for several *amateur clandestines*, which are ordinary amateur stations temporarily pressed into service as broadcasting stations. Amateur clandestines are al-

most always reported between 7000-7100 kHz and in the Spanish language.

One well known station of this type was Radio Cuba Libre, which was reported by many SWLs during 1972-3 and during 1975. This outlet claimed to be actually broadcasting from inside of Cuba itself, although this could not be confirmed, nor did any DXer ever secure a QSL from them.

Recently there has been extremely heavy amateur clandestine activity, with at least one of the outlets actually being within Cuba itself. Listeners heard a station identifying itself as Radio Abdala on 7085 kHz during November, 1977. The Spanish language station carried bitter denunciations of Cuban involvement in parts of Africa, and used the theme from "2001, A Space Odyssey" in its identification announcements.

Speculation put Radio Abdala in southern Florida due to signal strength, and this was unofficially confirmed by a member of a Miami-based anti-Castro group. Well known DXer Glenn Hauser heard Radio Abdala on Christmas Day, 1977, carrying religious music and anti-Soviet talks.

A different station reported during November and December of 1977 was Radio Rebelde, operating in the 7000-7025 kHz range. It featured Spanish language programming opposing Castro and was apparently actually in Cuba!

Miami SWL Timothy Hendel heard the station on both December 25 and 26, 1977, on 7000 kHz at 2000 and 2200 GMT. Transmissions started with two way contacts with other stations, like an ordinary amateur station, but switched to anti-Castro talks, including a letter from a Cuban mother protesting the use of Cuban troops in Angola.

Broadcasts were often interrupted. The station used the slogan "la voz que no tiene mordaza"

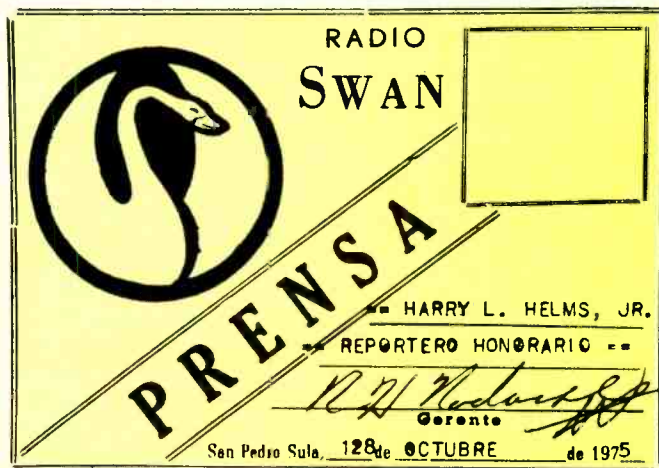

(the voice without a gag). A key moment came when Radio Rebelde began operating like an ordinary amateur station, calling "CQ" and giving the call sign actually assigned to a Cuban amateur station! Listeners in Florida noted fading on the signal of Radio Rebelde, indicating that the station was located some distance away from Miami. Many experienced SWLs believe that Radio Rebelde actually did transmit from within Cuba.

Another Florida listener, Terry Kreuger, has reported hearing a net of amateur clandestines meeting on 7085 kHz Sundays at 1700 GMT. He reports hearing one station identifying as Radio Rebelde and another as Radio Escuchas Nacional. All transmissions are in Spanish and in the am mode.

Listeners in the Southeast should keep an especially close watch on these frequencies all day, while listeners over 1000 miles away from Cuba will find best reception after local sunset until 1000 GMT.

If you do a lot of late-night tuning on the shortwave bands you've probably run across a woman's voice in Spanish reading out four or five digit number groups. You may not have realized it at the time, but you were hearing coded instructions transmitted to spies in Latin America!

These "numbers stations," as DXers refer to them, are heard in numerous other languages besides Spanish; such as English, German, and Czech. The German and Czech transmissions are believed to originate in Europe, while the English and Spanish transmissions originate much closer to the United States due to their signal strength. Almost all numbers stations use am (although some scattered transmission are in ssb) and use the recorded voice of a woman.

If you listen carefully, you'll find that each digit has the same inflection. This indicates that some sort of electromechanical recording device is used to produce the numbers broadcasts from a prerecorded set of ten digits and only two words: "atención" and "final."

A numbers transmission I heard on April 5, 1978, beginning at 0500 GMT (midnight, EST) is typical of many heard over the years. Listening on 3815 kHz, I first heard an open carrier without modulation on the frequency. At 0502, two brief tones were heard, followed at 0503 by a female voice repeating "atención 010 86, atención 010 86, atención 010 86" over and over.

"Atención" is the Spanish word for "attention," the number group "010" is believed to be the "addressee" to whom the message is being sent. The second number group, "86," was the number of coded groups in the message that followed. In numbers transmission, the second group following "atención" is *always* the number of coded groups in the message. I listened until 0513 GMT, when the female voice said "final, final," indicating the message was finished. Open carrier followed until 0515, when the carrier also left the air.

Where do these mysterious signals come from? For many years, SWLs have suspected that the numbers stations were in Cuba. In 1975, several SWLs reported hearing audio from Radio Havana Cuba in the background of some numbers transmissions.

Where to tune numbers stations

A numbers station is likely to pop up anywhere between 3000 to 12000 kHz from 0200 through 1000 GMT. Yet certain frequencies and times are "hotter" than others. Here are some frequencies and times that have been particularly active in recent months:

Frequencies (kHz)	Times (In GMT)
3000-3100	0200-0300
3200-3300	0400-0500
3800-3900	0500-0600
4600-4700	0300-0330; 0400-0430
6700-6900	0600-0630; 0700-0730
7800-8050	0600-0630; 0700-0730 0800-0830

Other numbers stations

As mentioned in the accompanying article, numbers stations operate in languages other than Spanish. Most of these other stations are believed to be in Europe, although some of the English transmissions may be from the same source as the Spanish numbers transmissions.

Frequencies (kHz)	Languages and times (GMT)
3200-3400	German 2300-2330 and 0400-0500
4500-4800	German 2100-2200
7300-7600	German 2200-2300 and 0330-0400
8100-8200	English 2100-2200
8100-8200	Czech 0200-0300
9000-9100	English 0300-0400
9100-9400	German 0100-0130, 0300-0330 and 0400-0430
10100-10200	English 2130-2200
14900-15000	English 2100-2200 and 2200-2230

Text of Actual Spy Message

Here's the text of the message sent by numbers station "atención 010 86" on 3815 kHz at 0503 GMT on April 5, 1978. No SWL has so far been able to break the code used by the numbers stations, but if you want to try your luck, be our guest!

02075 67554 88973 22759 13723 59510 67902 15892 75124 05495 02221 05067 83485
33028 60571 09725 05070 89583 61585 79394 62527 30912 25603 08449 39156 28036
57609 62105 15347 90383 16013 72279 38914 60321 58986 67162 78104 94790 68124
23607 31937 42933 14493 41330 86102 75267 21688 84343 34016 47114 75704 63454
35722 16757 40041 55683 82537 96895 26446 71762 58003 40172 95345 50628 09424
35814 21710 29923 34218 97983 19380 56703 16631 38457 76134 85940 06954 64667
73123 49356 98497 34023 11564 52398 21505 65314

Clubs

To keep up with late-breaking news about clandestines, the active SWL needs to be a member of one or more SWL clubs. All of the following clubs are non-profit and operated by unpaid volunteers. Enclose \$1.00 when writing for a sample bulletin. **North American Shortwave Association**, P. O. Box 13, Liberty, Indiana, 47353. Publishes "Frendx," a monthly bulletin devoted entirely to shortwave broadcasting. Each issue contains member loggings, a QSL column, station schedules, and feature articles. Dues are \$13 per year.

SPEEDX (Society to Preserve Engrossing Enjoyment of DXing), P. O. Box E, Lake Elsinore, California, 92530. Monthly bulletin with member loggings, QSL report, technical column, and feature articles. Covers utility stations (military, aircraft, ships, radioteletype) as well as shortwave broadcasting. Most extensive coverage of the numbers stations of any SWL club. Dues are \$12 per year. Also publishes the **SPEEDX Utility Guide**, a listing of utility stations with information on frequencies and QSLs. It also has a chapter on DXing the numbers stations. Cost is \$6.95 postpaid from address above.

American Shortwave Listeners Club, 16182 Ballad Lane, Huntington Beach, California, 92649. Monthly bulletin covers shortwave broadcasting, utility DX, broadcast band DX, QSLs, and other topics relating to the DXing hobby. Dues are \$13 per year.











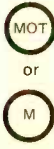







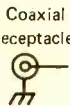
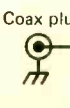



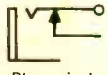
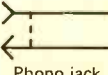
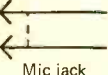
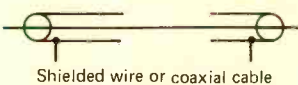



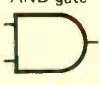

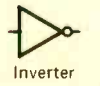
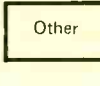

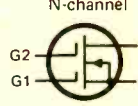

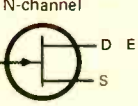
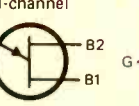
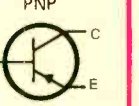
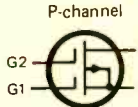

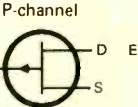
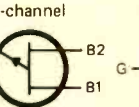
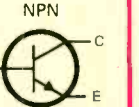
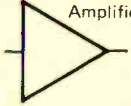
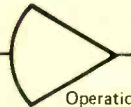









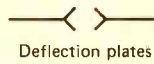







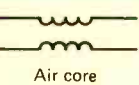
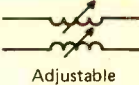
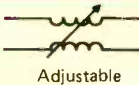
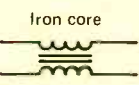
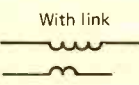



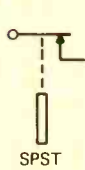
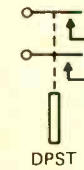



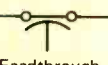
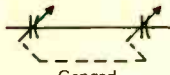

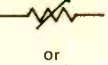
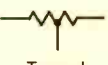
There were even a few reports of numbers stations using the same interval signal as Havana.

Yet other evidence points to the conclusion that at least some of these stations operate from within the United States! Rough direction-finding backs this theory, as does the fact that many listeners have reported hearing numbers stations which put in stronger signals at their listener posts than broadcast band stations a few miles away!

So currently there is no definite conclusion that can be reached as to the origin of these signals. Some DXers have suggested that both Cuba and the United States use this method of contacting their agents, while other SWLs have suggested that one nation may be trying to mislead the other's spies with bogus transmissions!

Electronic symbols

as used in Modern Electronics magazine

 <p>A = Ammeter V = Voltmeter mA = Milliammeter</p> <p>*Insert appropriate designations</p> <p>METERS</p>	 <p>MOTOR</p>	 <p>Single cell</p>  <p>Multicell</p> <p>BATTERIES</p>	 <p>Chassis</p>  <p>Earth</p> <p>GROUND</p>	 <p>Aerial</p>  <p>or Loop</p> <p>ANTENNA</p>	 <p>HEADSET</p>	 <p>CRYSTAL</p>
 <p>Coaxial receptacle</p>  <p>Coax plug</p>  <p>Female</p>  <p>Male</p>  <p>230v.</p> <p>CONNECTORS</p>	 <p>Phone plug</p>  <p>Phone jack</p>  <p>Phono jack</p>  <p>Mic jack</p> <p>CONNECTORS</p>	 <p>Shielded wire or coaxial cable</p>  <p>General</p>  <p>Enclosure</p>  <p>Enclosure</p> <p>SHIELDING</p>	 <p>AND gate</p>  <p>OR gate</p>  <p>Inverter</p>  <p>Other</p> <p>LOGIC</p>			
 <p>Neon</p>  <p>Pilot</p> <p>LAMPS</p>	 <p>N-channel</p>  <p>N-channel</p>  <p>N-channel</p>  <p>N-channel</p>  <p>PNP</p>  <p>P-channel</p>  <p>P-channel</p>  <p>P-channel</p>  <p>P-channel</p>  <p>NPN</p> <p>DUAL-GATE MOSFET MOSFET JUNCTION FET UJT BIPOLAR</p> <p>TRANSISTORS</p>	 <p>Amplifier</p>  <p>Operational amplifier</p>  <p>Other</p> <p>LINEAR INTEGRATED CIRCUITS</p>				
 <p>Ferrite bead ring</p>  <p>Air core</p>  <p>Tapped</p>  <p>Adjustable</p>  <p>Plug in</p>  <p>Iron core</p> <p>INDUCTORS</p>	 <p>Grid</p>  <p>Plate</p>  <p>Deflection plates</p>  <p>Heater or filament</p>  <p>Indirectly heated cathode</p>  <p>Cold cathode</p>  <p>Gas filled</p> <p>ELECTRON TUBE ELEMENTS</p>	 <p>Photoemissive (LED)</p>  <p>Zener</p>  <p>Diac (SCR)</p>  <p>Triac</p> <p>DIODES</p>				
 <p>Air core</p>  <p>Adjustable inductance</p>  <p>Adjustable coupling</p>  <p>Iron core</p>  <p>With link</p> <p>TRANSFORMERS</p>	 <p>Triode</p>  <p>Pentode</p>  <p>Voltage regulator</p> <p>COMPLETE TUBES</p>	 <p>SPST</p>  <p>DPST</p>  <p>SPDT</p> <p>RELAYS</p>				
 <p>Electrolytic</p>  <p>Fixed</p>  <p>Variable</p>  <p>Feedthrough</p>  <p>Ganged</p> <p>CAPACITORS</p>	 <p>Fixed</p>  <p>or</p>  <p>Tapped</p>  <p>Adjustable</p> <p>RESISTORS</p>	 <p>SPST</p>  <p>Rotary</p>  <p>SPDT</p>  <p>Push-Pull</p> <p>SWITCHES</p>	 <p>No connection</p>  <p>Terminal</p>  <p>or</p>  <p>Connection</p> <p>WIRING</p>			

Inbound rfi

Tired of having your shortwave, CB and ham radios knocked out by incoming noise? Most hams and CBers are familiar with the dangers of radio-frequency interference to nearby stereos, television sets and music radios. But what about interference to your own SWL, CB or ham operations? What can you do about it? Here's the lowdown on rfi in reverse from an amateur radio operator who has fought the problem for years.

by Karl T. Thurber Jr., W8FX/4

How many times have you started to operate your ham transceiver, CB set or shortwave receiver, ready for fun and possibly even to snare some choice DX, when your enjoyment is short-lived because of man-made or atmospheric noise that jams the signals you expected to hear when you turned on your equipment?

It's happened to all of us at one time or another, and it's a frustrating experience. But there *are* some things you can do to minimize this kind of disruption.

Here's the complete story on the different kinds of interference you may be bothered with, how to identify and zero-in on different kinds of interference and some simple remedies you can try to give both your ears and your nerves a break.

Kinds of interference

There are literally hundreds of types of interference that can crimp your operating. Rfi sources can range from motor static, atmospheric noise, contact arcing, and loose power line hardware, to tv-set sweep generator buzz and errant harmonics.

Figure 1 shows a representative listing of the most common forms of interference you are likely to encounter. To effectively cope with rfi, you have to understand where and how it's generated and transmitted. Once you recognize the nature of the interference you're

experiencing, you can try to find and eliminate the source. Let's take a look at some of the rfi sources listed in figure 1.

Switching and discharge rfi is caused by electric motors in household appliances; passing automobile ignition systems, fluorescent lights; contacts on telephone dials, thermostats and electric blankets; and faulty power-line equipment, to name some of the most common sources. This type of interference is characterized by its raspy, buzzy, or "clicky" sound.

Harmonic-type rfi can be caused by such culprits as strong local transmitters, various kinds of radiation from nearby fm, tv, and shortwave receivers; and even from corroded connections in house wiring and antenna systems (which can *rectify* and *re-radiate* harmonics, even though the original signals are themselves "clean").

One of the most common and persistent forms of harmonic rfi is known as "ITV," and is caused by your own and neighbors' tv-set *horizontal sweep oscillator*. It operates on a low 15,750 cycles, but can act as an efficient "jammer" as high as 15 or 20 MHz, sometimes higher.

Harmonic-type interference can be hard to recognize, since it often sounds like "ordinary" signals.

Other types of rfi you may encounter are cross-modulation or "beating together" of strong signals such as broadcast, fm or tv channels to produce unusual frequency combinations that can

wreak havoc with your equipment. Fortunately, this type of rfi is fairly rare.

Another kind of rfi, of sorts, is simple *atmospheric noise* known by amateurs as "QRN", a shorthand "Q-code" abbreviation, which can override even the strongest signals during periods of intense thunderstorm activity. Although this isn't rfi, strictly speaking, we'll discuss how to minimize the effects of "QRN" later on.

Before you can do much about pinpointing and tracking down electrical interference, you need to be able to identify it. Switching-type rfi is usually easy to spot, as it normally follows the operating pattern of the equipment that generates it.

For example, household motors can be audibly correlated with the noise they produce in your receiver, telephone dialing clicks stand out clearly, fluorescent lights may emit a buzzing sound, and ignition noise is present only when a vehicle passes by.

Power line static is not so easy to detect, but it often gets worse in very dry or very wet weather and may change its pattern in periods of high winds.

Harmonic-type rfi can also be hard to spot, although you can try a little "stubby pencil" work, using a frequency allocation chart and a hand calculator, to check out the many possibilities.

Atmospheric noise, on the other hand, is easily distinguished by the way in which it "peaks and wanes" as electri-

cal storm activity approaches and passes by.

With a little effort, you can eliminate most kinds of interference—once you know the source. The first thing you should do is to determine whether the interference is entering your equipment through the power line or is coming in via your antenna. To do this, you need to disconnect the antenna from the receiver at its antenna terminals and short the terminals to ground.

You'll find with well-shielded receivers and transceivers that the noise usually enters via the antenna. However, if you find that it's coming in via the power cord, installing a "brute force" ac power line filter should do the trick.

The filter can either be built right inside the receiver's cabinet or be mounted in a small metal "mini-box" attached to the back panel of the set. For best results, the filter case and receiver cabinet should be grounded to the "third wire" of your home's electrical wiring system and also to a cold-water-pipe connection or ground-rod.

If you find that the noise is entering through the antenna, the most common situation, try all your antennas and, if you have a rotatable beam antenna, rotate it to try to determine from which direction the interference is coming.

To get a fix on the source, you can use several methods. Probably the easiest is to use a multi-band portable receiver that covers the frequency ranges you're interested in. A combination am/fm/sw receiver will usually sample enough of the rf spectrum for our purposes.

You can carry the receiver around with you to look for spots where the interference peaks for a sort of rfi locator. An "S" meter on the receiver is helpful to get a more accurate check on the noise's signal strength; CB walkie-talkies can also be used for this purpose.

If it turns out that the interference is coming from some distance, you can use your auto radio and/or mobile CB set to track down the general area of interference, stepping out of your vehicle with the portable for more precise "sleuthing."

If your suspicions lead you to utility power lines, you will find that this kind of noise can be very difficult to precisely locate and impossible for you to cure yourself.

If driving around suggests that power company poles are the culprits, you can sometimes localize the source by observing nearby power lines and poles through binoculars for cracked insulators, rubbing ground cables, tree limbs on the wires, etc.

A light tap on the suspected pole may change the pattern of interference, allowing you to confirm its source. You shouldn't try to take any corrective action yourself, however—it's much too dangerous!

Common rfi sources

Here are some of the prevalent types and sources of radio frequency interference experienced by CBers, amateur radio operators and shortwave listeners.

Switching discharge types of rfi

- Automobile ignition
- Electric motors
- Defective powerline equipment
- Oil burners
- Belt static
- Arc welders
- Traffic lights
- Fluorescent lamps
- Thermostats
- Telephone dials
- Neon signs
- Home laundry equipment
- Electric fences
- Kitchen mixers
- Blenders
- Hair dryers
- Loose hardware on power poles
- Electric shavers
- Light switches
- Furnaces
- Doorbells
- Lawn mowers
- Fish tanks
- Electric light dimmers

Harmonic kinds of rfi

- Horizontal sweep circuit in home tv sets
- Calculators
- Ultrasonic cleaners
- "Non-linear rectification" and reradiation of signals caused by corroded hardware and wiring such as in antenna systems, pipes, masts and towers, and home gutter-work (downspouts)
- TV-set if (intermediate frequency) harmonics

Radio frequency leakage

- Diathermy radiation
- Oscillator radiation from nearby sw, bc, fm, and tv sets
- Regenerative receivers (such as in some garage-door openers and toy CB sets)
- High-frequency industrial heating equipment
- Direct radiation from strong nearby transmitters (CB, amateur, etc.)

Other kinds

- Atmospheric noise or static (QRN)
- Cross-modulation (caused by strong local signals mixing together to produce combination "third" frequencies)

Note that some rfi sources can produce interference in more than one category. Also, interference can be transmitted to your receiver either directly, through your antenna, or via the power lines to your equipment.

Most power companies have departments that specialize in rfi detection and elimination, and a call to them with some specifics about the interference should do the trick without any need for you to climb the poles.

If your sleuthing indicates that the interference may be coming from within your own home, you can again use the small portable to search out the interference source, looking critically at thermostats, washing machines, tv sets, and almost all other household gadgets and appliances.

Or, you can use a small six inch rfi probe, made by stripping the shield braid off the end of a piece of coaxial cable, at the end of a long length of coax connected to your receiver, as shown in figure 2.

Route it throughout your house, outdoors, too if necessary, "probing" for the exact source of interference, working in tandem with a friend monitoring your receiver. Another way to check out household rfi is to pull your circuit breakers, thereby isolating circuits, until the interference disappears.

If you find that it disappears when you do this, you can go around unplugging individual appliances until the offender is found. Suspect anything and everything as the source of your rfi, but be sure that before you blame neighbors and the power company for interference problems, your own house is in order!

Of course, if your neighbors are cooperative, and if you suspect a neighboring house, you can pull its circuit breakers and check the electrical and electronic appliances in similar fashion.

If you find that the source of rfi is outside your home, you must exercise some psychology in eliminating the interference. People don't like being told that their appliances, tv sets, and tools are defective and are causing interference with your operations—though they are likely to be the first to complain about your CB or amateur operations. *Be tactful!*

Power companies are usually quite cooperative, and most have at least one mobile "rfi van" crammed with receivers and antennas that can be of real value to you in tracking down power-line rfi sources that are far removed from your home. The use of their equipment will sometimes reveal that the real source of interference isn't in the power lines themselves, but in a home, shop or factory, feeding rfi into the lines.

Since rfi violates Federal Communications Commission radiation rules, the FCC holds the ultimate "cards" on getting action in persistent cases. But it's far better to try to solve rfi problems on a local, individual basis.

FCC resources are limited, and you will almost certainly be delayed in solving your interference problems if you pin your hopes on FCC assistance. The key



Figure 2: Try this simple rfi probe

Construct this simple rfi probe from a 50 to 100-foot length of RG-58/U or RG-59/U coaxial cable. Strip back about six inches of the outer plastic cover and the braided shield to expose the center conductor wire. That center wire is used as the rfi sensor. Connect the other end to a PL-259 connector or whatever kind will mate to your receiver's antenna terminals. The probe is used to pinpoint rfi sources within your house or apartment. It is connected to your receiver which is tuned to the frequency where interference sounds strongest. Move the probe about to track down and identify the rfi bad actor. A small multiband portable radio would be handy in the search. A handheld CB walkie-talkie also could be used. Another way to track down household rfi is to pull fuses and circuit breakers successively until you find the house wiring circuit carrying the interference. Channel Master's model 5270 (\$17) noise detector is called The Sleuth and is designed to track down automobile noise sources. It's used in the car like the home-made device described here is used in the house.

to successful rfi elimination is tracking it down yourself; "Seek and ye shall find!"

Remedies you can try

Once you've located the source, the rfi battle is half won. It's usually far more effective to try to cure interference on a case-by-case basis at the source rather than at the receiving end.

While we can't get into all possible kinds of rfi cures in this short article, suffice it to say that many kinds of appliances, fluorescent lights and "switching" type interference can be reduced or eliminated with a small capacitor (.005 to .1 mfd) connected across the sparking terminals, motor commutator, switch contacts or power line.

A bypass capacitor from either side of the ac line to ground also helps. Securely grounding the appliance often works wonders; you will find many appliances which should be grounded for safety, not to mention rfi reduction, just aren't. A heavy, direct wire to a cold-water pipe ground may help, too.

Shielding and filtering are often required to eliminate interference from rf-producing equipment; "brute force" line filters such as shown in figure 3 can be highly effective if the interference is conducted through the power line.

If it's tv set sweep harmonics that are giving you problems, a couple of bypass capacitors across the set's power cord

(near where it enters the set) usually helps in reducing "sweep" interference, as does installation of either a twin-lead trap across the tv antenna terminals as shown in figure 4, or a commercial high-pass filter in series with the antenna lead. (Note: many major set manufacturers will provide free of charge a high-pass filter for rfi reduction if you contact them stating the particulars and requesting the filter.)

From a practical standpoint, *short-duration* interference, such as that from electrical drills and saws, as well as from microwave ovens, may be "more trouble than it's worth" to attempt to eliminate; you may simply decide to live with such interference.

Also, you may want to think twice before purchasing some devices that are notorious rfi generators. For example, the ordinary household light dimmer produces tremendous interference that is very difficult, if not impossible to eliminate.

Making the most of it

Assuming you've done all you can to reduce or eliminate rfi at the source, your final task is to use your receiving equipment to best advantage to overcome any noise or interference remaining.

It's a good idea to install an ac line filter, such as that shown in figure 2, in the power line to your equipment as a matter of standard procedure. This will not only help you with inbound rfi but will help assure that any rf your own CB or amateur transceiver produces won't get into the ac lines and cause problems for others.

A good *noise blanker* (NB) or *automatic noise limiter* (ANL) on your receiver or transceiver, preferably both, are especially important, not only because they can help eliminate any residual man-made noise, but they will also reduce the annoying static crashes caused by atmospheric interference—something you can't do anything about at the source.

An audio *clipper/filter* circuit connected to the speaker leads is also helpful in reducing strong static crashes and sharp man-made noise peaks, and a *selective audio filter* is an especially good bet to narrow the set's if passband and reduce the annoying effects of audible "beats" cause by reception of tv set sweep harmonics.

Your antenna system itself has some bearing on the amount of noise your receiver will pick up. Generally speaking, a *horizontal* dipole antenna fed with coaxial cable minimizes reception of man-made noises, while a *vertical* antenna tends to accentuate noise pick-up. If you live in a very high-noise area, think twice before you install and use a vertical antenna!

A coaxial lightning arrestor installed in your transmission line will offer more than lightning protection.

The tiny spark gap these devices contain are just right to drain off small accumulations of static electricity which are produced on your antenna near storm areas, and which would otherwise tend to produce a "frying" noise in your equipment and could even build up to the point of damaging your receiver's "front end" rf stage.

We haven't been able to cover rf interference in any great depth here; whole books have been written about this difficult subject. If you're stumped with an rfi problem, try the *ARRL Radio Amateur's Handbook*, or one of the several excellent, specialized Tab Books or Howard Sams publications on rfi. Back issues of amateur magazines such as *CQ*, contain in-depth articles about noise.

An excellent publication covering the whole spectrum of rfi is the Federal Communications Commission's own booklet on interference, *How To Identify and Resolve Radio-Television Interference Problems*. You can have your own copy of this complete, easy-to-read book, avail-

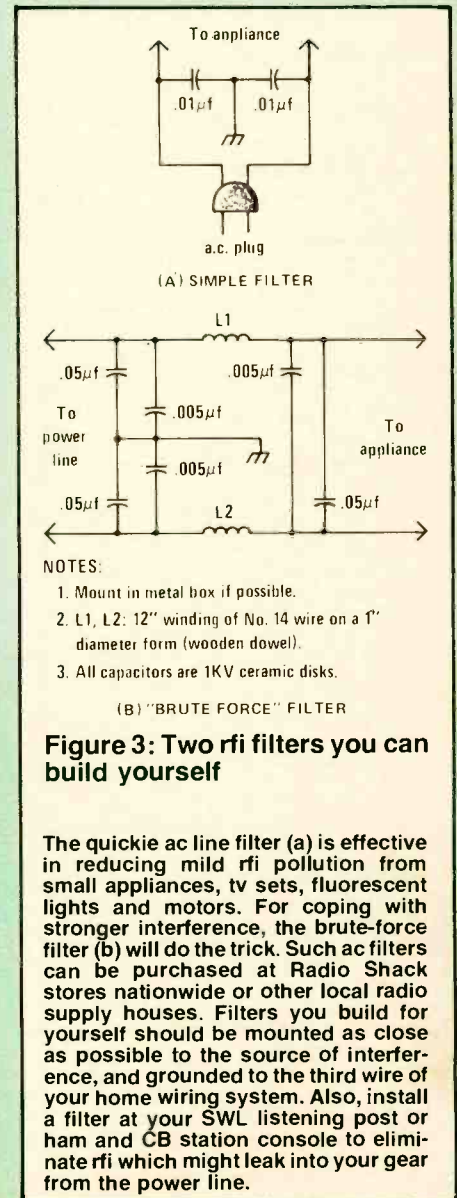

NOTES:

1. Mount in metal box if possible.
2. L1, L2: 12" winding of No. 14 wire on a 1" diameter form (wooden dowel).
3. All capacitors are 1KV ceramic disks.

(B) "BRUTE FORCE" FILTER

Figure 3: Two rfi filters you can build yourself

The quickie ac line filter (a) is effective in reducing mild rfi pollution from small appliances, tv sets, fluorescent lights and motors. For coping with stronger interference, the brute-force filter (b) will do the trick. Such ac filters can be purchased at Radio Shack stores nationwide or other local radio supply houses. Filters you build for yourself should be mounted as close as possible to the source of interference, and grounded to the third wire of your home wiring system. Also, install a filter at your SWL listening post or ham and CB station console to eliminate rfi which might leak into your gear from the power line.

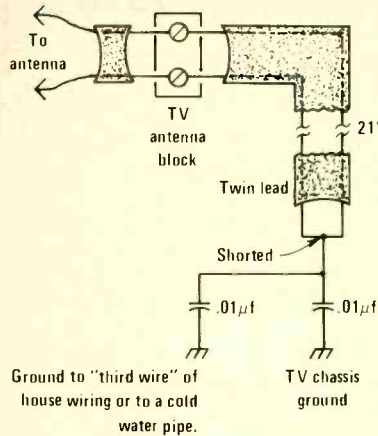

NOTE:

Do not eliminate the bypass capacitors. They are needed for safety reasons. All capacitors are 1KV ceramic disks.

Figure 4: ITV stub

A shorted stub across your tv set's antenna terminals can help to eliminate annoying buzz-saw harmonics from your set's 15,750 hertz horizontal oscillator. Here's how to build such a stub. A piece of 300-ohm tv lead-in twinlead wire is cut to a length of exactly 21 inches and the far end, away from the tv set connection, is shorted together and grounded. If tv signals are reduced, try shortening or lengthening the stub. A high-pass filter installed at your set's antenna terminals also can be very effective in reducing interference as well as helping to insulate your set against tvi from CB or ham transmitters. An excellent high-pass filter is available from R.L. Drake Co., 540 Richard St., Miamisburg, OH 45342.

able from *Modern Electronics*, 14 Vandeventer Ave., Port Washington, NY 11050, for \$1 plus 25¢ postage and handling.

The FCC book is especially good since it lists addresses of most electronic appliance manufacturers. It also tells you how to register an official rfi complaint with the FCC if your best efforts otherwise fail.

Work around it

While you can tolerate some noise and interference and can often work around it, it's better to get rid of as much as you can in order to make listening and communicating a great deal easier and more enjoyable.

Experiencing interference, you need to identify just *what* is causing the interference, take its "electronic fingerprints," and track it down. It's best to try to cure man-made noise at the source, and if you can't, there are several things you can do to our equipment to help filter out what noise you will have to live with.

We'll never get rid of all "inbound rfi" but you can certainly do a good job or "riding herd" on it!

"YOU DON'T HAVE TO CLIMB A MOUNTAIN TO GAIN ENLIGHTENMENT."



Just send away for the Consumer Information Catalog and a key to enlightenment will appear in your mailbox.

The Consumer Information Catalog is put out by the Federal Government. And it lists over 200 of their booklets that you can send away for. Most are free. And they can help you with things like how to buy a home, how to grow vegetables, how to deal with headaches, simple plumbing repairs and many other everyday and not-so-everyday problems.

So if you wish to learn about the mystic sensibilities of the wayward ancients, put on your climbing gear.

But, if you wish to know about how to fix a leaky faucet, send for the catalog. Write: Consumer Information Center, Dept. A, Pueblo, Colorado 81009.

Remember, it's free. Which is only right. After all, the first step towards enlightenment shouldn't enlighten your pocketbook.

THE CONSUMER INFORMATION CATALOG

A catalog of over 200 helpful publications.

CMOS receiver

continued from page 46

lugs are near J1 and connect C1 between J1 and L1 as shown in the schematic.

Bend a section of sheet aluminum around B1 to form a mounting bracket for the battery and install it with a machine screw and nut on the box bottom. Complete and check the wiring of the receiver, and then install IC1 into its socket.

Parts List

Part number	Description	Radio Shack number
B1	Nine-volt battery	23-151
C1	68 pf capacitor	*
C2,C6	.005 mfd disk ceramic	272-130
C3	365 pf variable capacitor	*
C4	470 mfd, 16 V electrolytic	*
C5,C11	10 mfd, 16 V electrolytic	272-952
C7,C10	220 pf disk ceramic	272-124
C8,C9	.0027 mfd capacitor	*
D1	1N34A germanium diode	276-1123
IC1,IC2	CD4007A integrated circuit	*
J1,J2	RCA phono jacks	*
L1	Loopstick antenna	270-1430
R3	4.7K resistor	*
R1,R2,R5	18M resistor	*
R4	500K volume control w/switch	*
R6	10M resistor	*
T1	Output transformer—500 ohm primary to 8 ohm secondary	*

Notes: All resistors, except R4, can be 1/4-watt composition type such as Radio Shack's 271-1300 series. You'll also need a cabinet, such as Radio Shack's 270-260, tuning knob, a section of Radio Shack's 276-151 Experimenter's Board, a 14-pin DIP IC socket such as Radio Shack's 276-1999, and miscellaneous hardware.

For best results a good external antenna and a ground connection are required. Connect the antenna to the center connector of J1 and the ground connection to the outside shell or cabinet. Connect either a small 8-ohm speaker or a pair of 8-ohm headphones to J2, and turn the receiver on by rotating R4 clockwise (actuating S1).

Tune C3 for a station, and adjust the volume with R4. If the volume lowers as the control is turned clockwise, change the connections to the outside terminals of R4 (connections to the resistance element).

The selectivity of the receiver will not be very great because it has only one tuned circuit, but improvement can be made by adjusting the antenna loading by changing the value of C1. A smaller capacity will have lighter loading, more selectivity, but less sensitivity. Adjust the inductance of L1 as required to tune for stations on the low end of the band.

Beepers: get a pocket pager

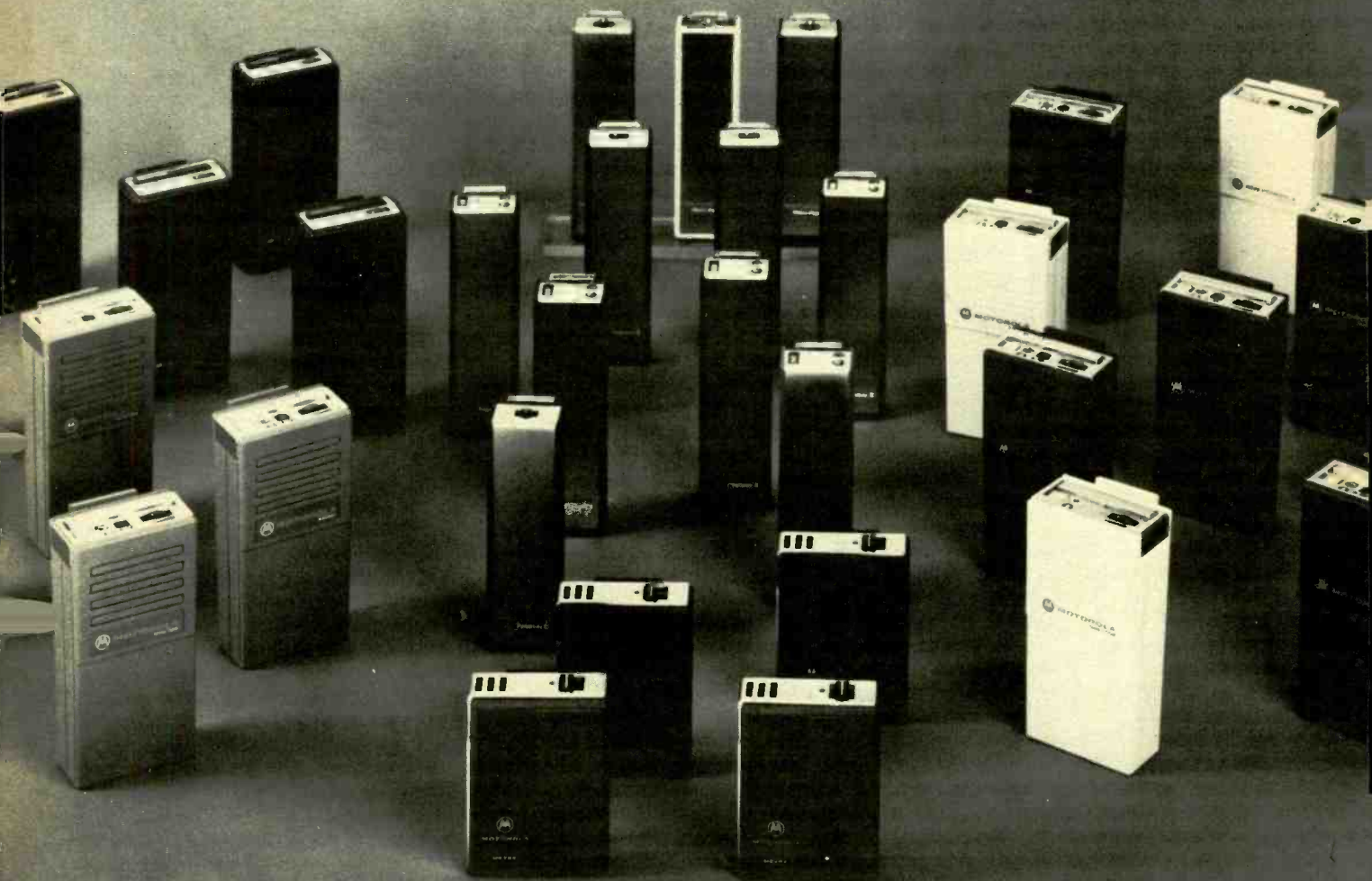

someone is calling you

It's a status symbol. It's a useful tool. It's a fun gadget to have around. It's a pocket pager. Beeper, for short. Here's how to get one for your very own private use.

by Wes Thomas

It's a little past midnight and you're doing 55 on the expressway. Suddenly, the car comes alive with *beep, beep, beep*. You pull off at the next exit and find a telephone. It's your daughter. She has a 104 degree temperature and has to get to the hospital.

That's just one of the many reasons why more and more people from all walks of life are buying or

renting pocket pagers. Volunteer firemen. Party-goers who want to keep in touch with babysitters. Campers. Even hookers not wanting to miss an important call.

You can join the growing number of paging service users for about \$25 a month in most U.S. cities. Or, you can buy your own pocket pager for

between \$200 and \$300, and pay \$10 or less each month for the paging service.

Most beepers in use are *tone-only* signaling devices. They're relatively inexpensive and trouble-free.

The big disadvantage of a *beeper* is that it can only let you know there's a message waiting for you. You'll still have to find a telephone and call in to get that message. And that means someone has to stay by their phone until you call.

If it's a business call, it probably won't matter—your secretary or dispatcher will be on duty throughout the day. But, if your messages are handled through your home, it can be a real problem, especially if the message is from a third party.

You can get around this problem by using a *dual-address* pager. These units have two different signals, each representing a different call-back address. So, depending on the signal, you can tell if the message is personal or business.

If you travel around a lot, and spend time in areas where telephones are scarce, you can subscribe to an answering service that will use the pager to contact you. Then, your caller can leave his message and be on his way. Your beeper will signal a message is waiting, and when you get a chance, you can call the answering service.

Call your office

Using a dual address pager or an answering service is an improvement over the ordinary beeper, but still requires you to call in for your message. You can avoid having to make that call by getting a voice pager. Your caller then gives a short message to the paging service operator, who relays it to you through your voice pager. So, instead of beeping, your pager might sound-off with, "Bob, call your office. It's urgent."

Some paging services use computers that can be programmed to automatically transmit often repeated messages. If you use one of these paging systems, a member of your family would dial a special telephone number, then a special code. The message would then be transmitted to your pager for you to "call your home."

Voice pagers are not without their disadvantages. Their range is limited to about 20 miles from the transmitter. And you can't control when the pager sounds-off, and what message it delivers. Imagine your embarrassment if you were a copier salesman making a pitch when your pager suddenly screamed out, "Service call. 123 Main Street. The copier broke down again."

Dick Tracy wristwatch

Of course, voice pagers aren't the only kind that can cause embarrassment. Having a beeper go off in the middle of a religious service, or in a theater can be just as embarrassing. One way around this problem is the *vibrating* pager. Instead of an audible tone, these pagers signal you with vibrations.

Another way around the problem is the *Mem-O-lert* pager. This handy device receives the paging signal, and stores it. So, you don't have to worry about it sounding-off when it shouldn't.

Later, when you're alone, just press a button. If there was a page, the Mem-O-lert will signal you.

Engineers at Motorola and NEC are working on a new generation of pagers. Build around *integrated circuits* and liquid crystal displays, these pagers will resemble ordinary wristwatches. But instead of showing the time of day, these watches will readout the caller's telephone number. It may even be possible some day to receive a message directly through the watch, Dick Tracy style.

How soon will these devices be available? Perhaps by 1980. A similar system already has been installed by Motorola in Europe. An eight-segment LED readout built into a standard pager lets the caller leave any one of eight different messages.

The European paging service uses different technical standards than its U.S. counterparts, however. Their transmitter runs 40,000 watts while our paging services are limited to 250. That added power gives the increased signal strength needed to insure reliable reception—a must if the right number is to be displayed.

Another advantage of the European system is bandwidth. Operating between 78 and 80 MHz, the system has enough room to accommodate up to

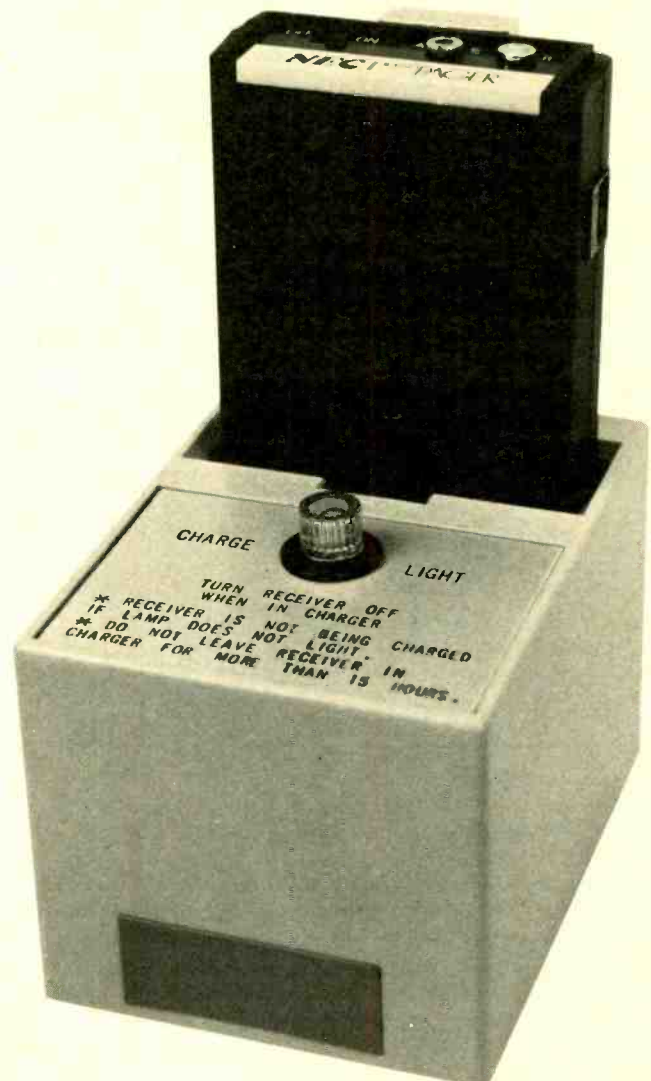

Many pagers use rechargeable NiCad batteries and come with plug-in chargers. So, after a long day on the road, just plug your pager into the charger, and next morning it's ready to go.

400,000 users. In the U.S., however, many paging services in larger cities have waiting lists because of restricted bandwidths.

Over the rainbow

As the technology of pager service advances, it's possible that many additional services will become available. Once an alphanumeric readout becomes available direct access to stock market tickers becomes possible.

Another possibility is hard copy readout. Using a miniature printer such as those now found in some Hewlett-Packard and Texas Instrument calculators, it may be possible for you to receive printed messages through your pager.

The future may also bring two-way pager service. You might be able to confirm reception by pressing a button on the side of the pager. A network of sensitive receivers would pick up the low-power signal transmitted by the pager, and relay it back to the service's headquarters.

You might also be able to do your own paging someday. Then if you get a message to do something or go somewhere and you need more information or assistance, you'd simply push a button on the pager. The paging service would then

signal your office or home. Two-way voice paging may also become available letting you converse with your caller.

One service you won't have to wait for is paging by *satellite*. At least one paging service now offers extended coverage via satellite. Radiofone, one of the larger services in the East, will page you through a Western Union satellite for a \$10 monthly surcharge over your regular service cost. At present the service is limited to the Chicago and Los Angeles areas, but will be extended as demand for it builds.

Paging services

In some areas, there is only one paging service in operation. That's the service you'll use if you want paging. In other areas, especially around the larger cities, you'll have several to choose from.

In making a selection, check out the *cost* of the service. How much do they charge to rent a pager? What's the monthly paging service charge? Is a deposit required, and if so, how much? Is insurance against loss or damage of the rented pager included or will you have to pay extra. Is a maintenance plan included?

Another consideration is the kind of *service* offered. Does the service have only single-tone beepers? Are dual address units available? Is voice paging offered? How many incoming telephone lines do they have?

A very important consideration in choosing a paging service is the *coverage* provided. Some services only cover a local area—perhaps a city and its suburbs. Others provide state-wide, or even regional coverage. Radiofone, for example, covers virtually all of New Jersey, the Philadelphia metropolitan area, northern Delaware, New York City and nearby counties including Long Island, and southern Connecticut as far north as New Haven.

One important factor in coverage is the number and location of the paging *transmitters*. The greater the number of transmitters, the better the coverage. Radiofone uses 50 transmitters to service its territory. Other services use fewer transmitters to cover the same area. Depending on the terrain, fewer transmitters might mean more dead spots where the paging signal can't be received.

The number of transmitters and their location is one-half of the story. The other half is the *frequency* used. If you spend a great deal of time inside buildings, you'll get better coverage using a uhf pager. On the other hand, if you spend a lot of time on the road, you'd be better off with a vhf pager.

Other points to question are the number of customers using the service, the kind of encoding used, if a computer is used, and if there is any limit on the number of calls you can receive for your monthly service charge. You should also inquire if you can call the service to ask if you had any pages during the day that you might have missed.

If you spend a lot of time away from your home or office, and want to keep in touch, a paging service is ideal. But before signing up, make sure you know what you're getting and how much it will cost. Choose the right kind of pager for the job you want done. If you do, you'll soon be wondering how you ever got along without one. 

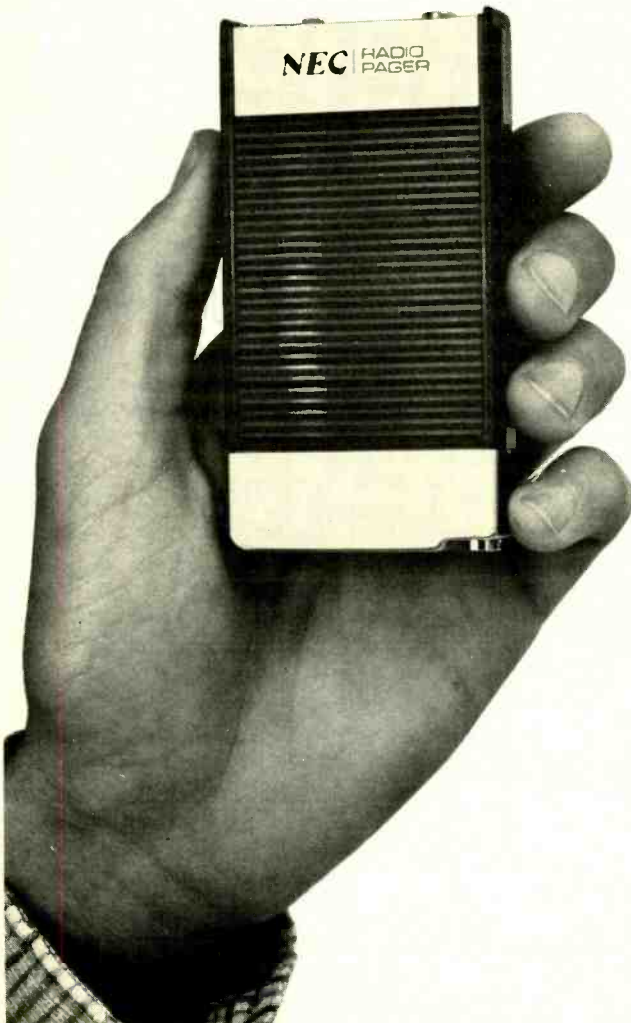

Modern pagers use state-of-the-art solid-state circuitry to keep size to an absolute minimum. Except for some larger specialized units, most will fit into a shirt pocket.

Computer ignition: easy auto add-on

Zap the cylinders in your car engine with the perfect electronic spark to get more power and better gas mileage.

BY RON COGAN

With the array of standard and exotic electronic ignition systems now on the market, motorists may well feel a bit confused when it comes time to choose a system for their vehicle.

Most systems promise a hotter spark for more complete combustion and all, by design, save tune-up time and money by eliminating the need for ignition points. And we can all live without the hassles of working with the critical tolerances and tiny parts that are involved in periodic ignition care, agreed?

What we can also live without are "do-nothing" aftermarket devices that promise much and accomplish little. Many consumer-conscious companies—Hays, Mallory, Accel, Edelbrock, and others—produce quality electronic ignition systems that serve their purpose well. Unfortunately, there are a score of other companies marketing mysteriously finned boxes also, and it can be fairly difficult to determine if you're really getting the quality system you're paying for.

When first introduced to the Clifford/Jacobs CompuSensor Ignition, one might naturally assume the defensive. The system is guaranteed to increase gas mileage a minimum of 10-20 percent in cars (7-15 percent in trucks), keep your engine in perfect tune for at least 40,000 miles, and make your car start faster and run smoother and stronger than ever before.

Beginning to sound like those familiar claims that are predominant on most do-nothing whatsits? But the key word here is *guaranteed*. Clifford/Jacobs guarantees that these promises will be fulfilled or your money will be refunded up to 120 days from the purchase date. That's confidence.

The CompuSensor is similar to the newer capacitive discharge (CD) systems found on some late-model automobiles, but differs in that it utilizes an on-board computer to "read" exacting spark requirements and then

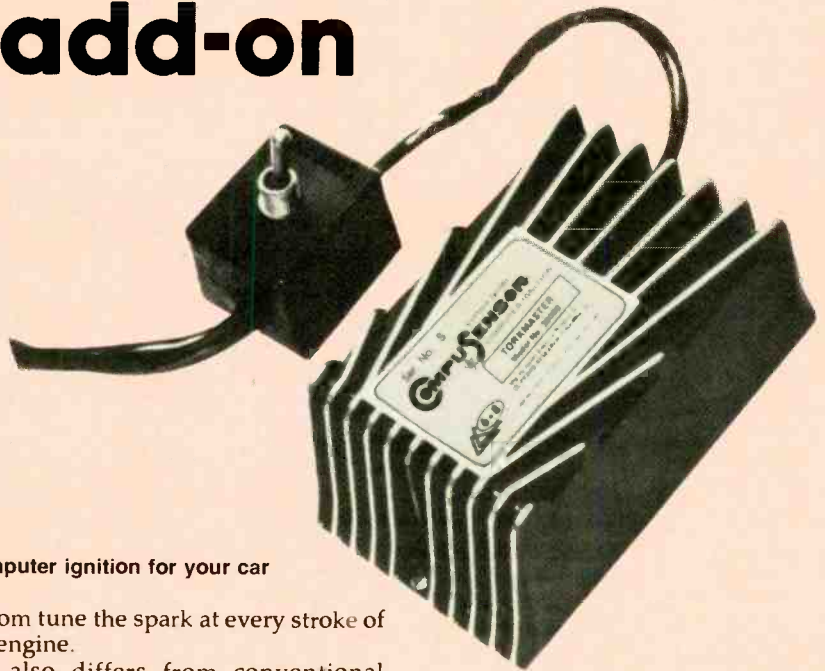

Computer ignition for your car

custom tune the spark at every stroke of the engine.

It also differs from conventional electronic ignitions because it retains the ignition points in your distributor—not to work in a conventional manner, but to work in a breakerless mode and merely serve as a point-of-reference to signal the CompuSensor when to fire and what rpm the engine is running at.

The points should last up to ten times longer than usual since only 3 percent of normal voltage will be passing through them.

When your engine is cold and you first flick the ignition key, it is turning over from approximately 0-150 rpm. Sensing this, the CompuSensor is programmed to direct the capacitive discharge to give the hottest spark available, since the gasoline is cold and will require a super hot electrical charge to fire it instantly.

At 150 to 1100 rpm the system knows that the engine is idling and directs the cd to provide a hot spark. Such a spark is needed because the air-fuel mixture is bad and a hot spark is required to ignite the mixture.

At cruising speeds (1100-4000 rpm), however, the CompuSensor knows that the momentum of the vehicle is helping to propel the car and a really hot charge is detrimental to firing the mixture and therefore wastes gas. The system then automatically adjusts so a perfect spark for this mode is tuned in.

When the engine is put into the power mode, passing and wide-open throttle, the CompuSensor reads this and tells the cd to immediately give a hotter spark in order to facilitate more and smoother engine power.

At the same time, the system is reading the resistance of the spark of

each plug at every stroke of the engine. By reading the differences of the resistance to the spark, the system can determine if the spark is firing through either a fuel-laden mixture or a correctly burning plasma.

The CompuSensor will shut off the voltage once correct burning has started; if proper burning doesn't start the system will signal the cd to come back with a higher, more intense voltage until the gasoline does ignite. This change in spark voltage occurs at each cylinder as needed so that optimum combustion takes place in each and every combustion chamber.

Spark energy

The CompuSensor system works by using the "requirement controlled" discharge of a previously-charged capacitor to supply the spark energy. The standard ignition coil then functions merely as a voltage transformer rather than as the storage medium for spark energy.

The stock points are used in the breakerless mode as the signaling device to control the energy, and the adaptive features ensure that the plugs are never supplied with that is hotter than necessary. This intriguing concept is the work of Dr. Christopher Jacobs, a USC PhD in electrical engineering who has spent over ten years working in the field of ignition systems.

Further information on this system may be obtained by writing Clifford Research & Development Company, at 1670 Sunflower Avenue, Costa Mesa, California 92626. 

Short locator find your problems

Lost your short? Here's a handy, easy-to-build gadget you can use to find it.

by Ron Cogan
Contributing Editor

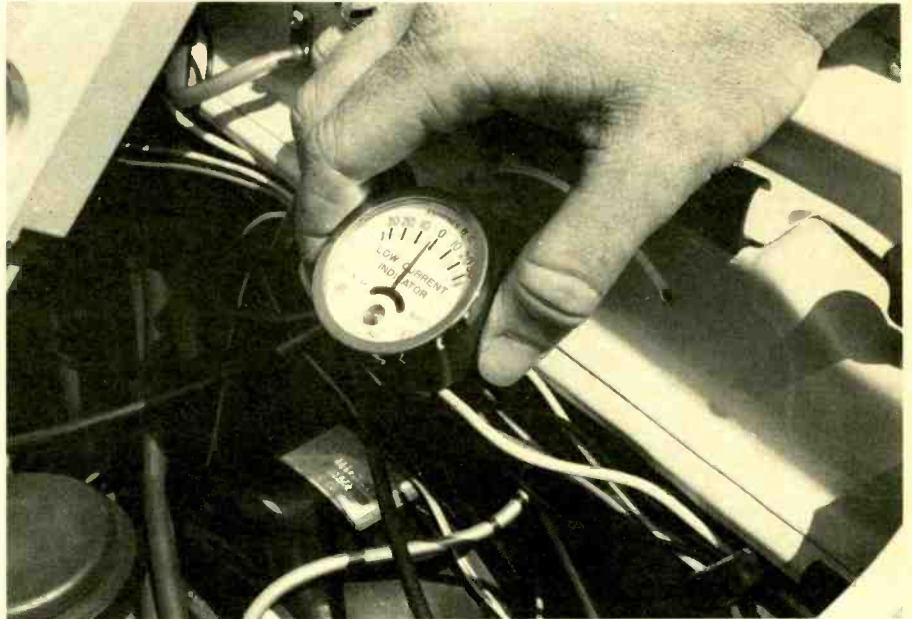

Hold the indicator in one spot of the suspect wiring and wait for the current pulses that are introduced into the shorted circuit every ten seconds. If the needle jumps sharply, then you're on the right track and should proceed to the next branch of wiring. If you're on the right track and proceed just a bit further but the needle doesn't move, it either means that you've passed the point where the short is originating or you've followed the wrong branch. This basic procedure will lead you directly to the shorted section of the wiring.

Many of our readers have found out first-hand that their automobile's electrical system can be a pain in the neck. And no wonder—with thousands of feet of bundled wiring routed to and fro, running inside metal channels, through firewalls, and adjacent to various components inside and out. The bumping, jarring, and bouncing of a car during everyday travels alone can cause plastic insulation to wear away and expose bare wiring to sheet metal or frame.

The problem is compounded when auxiliary electrical components are added to a vehicle such as a stereo system, cruise control, or instrumentation. Even though these items might have been conscientiously installed at a local garage or even at home, the fact remains that extra wiring has been run and that chances of a short circuit increases. This is especially true if the wiring is routed underneath floor carpeting where it might be stepped on (and insulation subsequently frayed), or run through a hole in the firewall without the aid of a protective rubber grommet.

But back to the subject at hand. Since tackling a short circuit in your car often proves to be a rather lengthy project, a great many motorists turn to automotive electrical shops to find the problem for them. This often works out to be the best method, as plenty of free time would have to be given up for a person to

accomplish the job at home—and results are not guaranteed at home, either. However, the small businessman who maintains an array of delivery trucks, independent mechanics, or even a do-it-yourselfer who prefers working on his own vehicles may well tackle the problem to save the extra bucks that would be spent by having it taken care of by a professional.

These type of people will save plenty of time and trouble by undertaking the project with a new device call the *Short Locator*. A product of Bright Auto & Diesel Electric (5412 E. Gage Ave., Bell, California), the Short Locator is a versatile electrical instrument that allows you to troubleshoot and pinpoint shorts in any 12-volt system. The device is easy to use with just a few simple steps involved and, most importantly, no previous experience in electrical troubleshooting is required. A first-timer can expertly trace a shorted circuit to the problem area within moments.

The Short Locator's highly visible, rugged plastic case makes the device a practical tool that can go anywhere and perform reliably, and handy hanger is built into the top of the case for storage during non-use or for hanging it on a hook during operation. Once in oper-

ation, its built-in audio and visual signals will guide you in tracking down the short in your electrical system.

To operate the Short Locator, you begin by disconnecting the battery cable from the positive post and connecting the copper-colored lead from the device in its place. Next, the remaining lead on the Short Locator should be touched against each terminal in your car's fuse block until you find a terminal that sparks. This will be the circuit that is shorted, and its fuse should be blown. The device's buzzer and warning light will activate as soon as the lead touches the shorted circuit, also. Once located, the lead's spring clip should be attached to the terminal.

Continue by removing the current indicator meter from its recess in the device's housing and positioning its 'U' guide (at the backside of the meter) over the wire running to the shorted terminal. The Short Locator will send current through this circuit every ten seconds; if the meter is positioned over the shorted wire, then a current reading will be obtained every time the Short Locator sends out a pulse. This will let you know you're on the right track.

Proceed along the wiring harness to the next branch or division and wait for

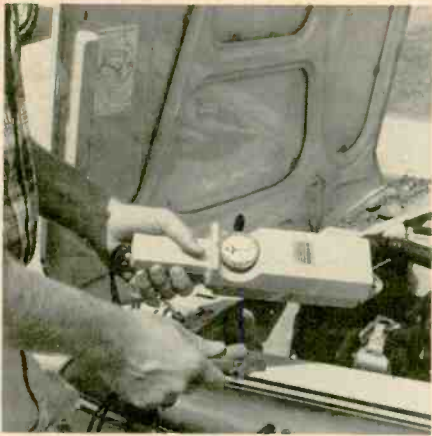

The Short Locator consists of a main electronics package housed in rugged plastic, two leads with spring clips, and a low current indicator held in a recessed area of the housing. The current indicator slips out easily when needed.

the next reading. If you go beyond the short or take a division in the wiring without the short, you will not realize a current reading and therefore should try a different branch or simply backtrack. This simple procedure should be followed until you have located the precise area where the short is taking place. The real beauty of this system is that the meter will read the current pulses from the Short Locator through floor carpeting, metal channels, and paneling and carpeting (as found in vans and motor homes). This in itself can save plenty of time by eliminating the need to remove floor carpeting, mats, or other obstructions during the troubleshooting process.

There is one consideration that will keep this unique device out of the hands of occasional do-it-yourselfers: price. The Short Locator sells for a tad more than a hundred bucks, which immedi-



Next, the device's copper-colored lead clip is secured to the positive post. This will supply the power so the Short Locator can send out current pulses every ten seconds through a shorted circuit when in use.

ately takes it out of the same class as minor tune-up equipment and tools. However, there are many people who would find this device quite a bargain at any price, especially auto electric shops, mechanics who dabble in electrical problems, school districts who maintain bus fleets, heavy do-it-yourselfers, and even the military for their motor pools. Since taking an automobile or truck to an electrical repair shop is usually a costly endeavor, the device could well pay for itself within an extremely short period of time. And time—or rather, the saving of time—is what this device is all about.

Further information on the Short Locator can be obtained by writing the manufacturer at the address given earlier in the article, or by contacting the distributor, Philatron International, at 11823 E. Slauson Ave., Santa Fe Springs, California 90670.



Remove the low current indicator from the Short Locator housing and move to the wiring in question. The "U"-shaped piece at the back of the indicator should be run along the wiring as shown.

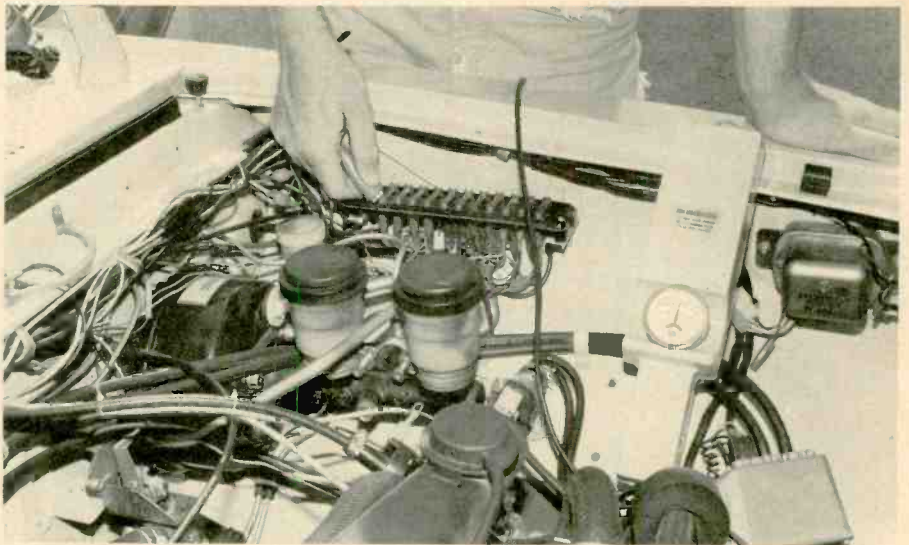

The remaining lead clip from the device should now be touched to each of the terminals in your fuse block until you find one that sparks, which indicates a shorted circuit. Now clip the lead securely to this terminal.

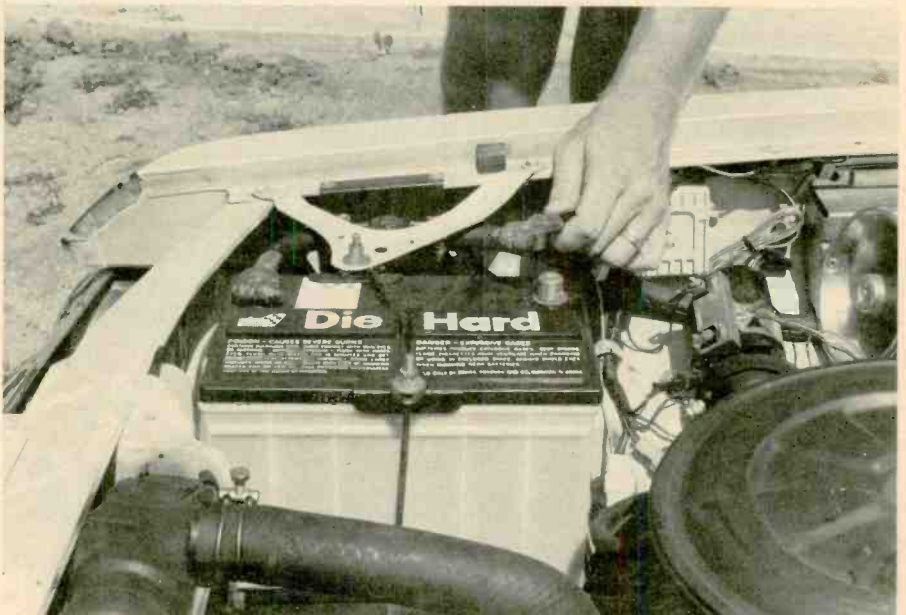

Your first step is to loosen and remove the car's battery cable from the positive battery post as shown.

Build a recording studio in your garage

Got your own rock group? Like the sound of the local high-school band? Aunt Maude sing real pretty? Record them! In your own home sound studio. Here's how one guy turned his garage into a pro studio. You can do it too.

by Roy Goshorn

This year's edition of my local high school band was an exception. Listening to the final concert of the year I was impressed with the instrumental harmony and the selection of music on the program. If someone only had thought to make a tape recording of the performance, I would have enjoyed hearing it again.

Since the days of Thomas Edison, the audio recording has been one way to preserve the lifelike sounds that are so important to us. Millions of recordings, be they discs or magnetic tapes, are sold each year worldwide. Yet that total is only a fraction of the potential that could be sold to specialized groups.

A high school band or chorus is such a specialized group. So are church choirs, barbershop quartets, rock bands, and polka orchestras. There are thousands of groups with regional followings and, therefore, a potential profit to a recording company.

But how could you get a major company to record a performance and sell records of it? The answer is you couldn't. Even with the right connections major record companies wouldn't be interested. The price they would have to charge for the finished product would be high.

Major firms don't take on small jobs that sell only a few dozen or a few hundred records or cassettes. Their profit comes from volume sales. For this reason alone, fine local groups can't afford a contract with a major recording studio. But there is an answer.

Many smaller musical organizations



Garber adjusts one of two tape recorders in the control room of his Bellwood, PA, recording company. A custom designed sound mixing console he built is in the foreground. The large vertical equipment rack, right, contains equipment for mass duplicating cassettes. A large bookcase along the control room rear wall serves as a storage vault for several hundred master tapes and discs recorded in the studio over the years.

are turning to semi-professional home recording studios. Home recording is really a misnomer because much of the so-called home recording equipment available today is very professional.

One man's studio

Small recording studios are springing up all over the country, catering to small volume work. These studios have a modest investment in gear that is readily available. They turn out professional-sounding *master tapes* in mono or stereo. Some even have gone into the mass tape cassette duplication sideline. Because of the number of cassette player-recorders on the market, some studios find it easier to mass duplicate cassettes rather than go through the complicated process of

having discs pressed by a record laboratory.

A word of warning, however, Duplication of cassettes containing copywritten or licensed music or programs is *illegal*. This means it is unlawful to duplicate a pre-recorded tape or disc even for home use. Federal authorities during the past year have sought out and closed down several basement illegal tape dubbing operations. Make sure that you have *written* permission from the group or its manager before you do any recording with the intent to produce copies for sale.

Asbury Recording Company of Bellwood, PA, is an example of a tiny professional firm that caters to the small recording market. It's owned and oper-



Garber checks a microphone volume level for proper setting during a recording session. The row of switches above the mixing controls operate equalizers which are used to enhance or diminish certain frequency ranges during a recording session or in making a copy or dub taping. A professional Crown stereo tape recorder is at Garbers right.

ated by Earl Garber, an electronics instructor and broadcast engineer. Garber, through his broadcast experience, saw a potential for recordings and custom designed his studio to cater to it.

Although the operation is strictly afterhours fun for Garber, it keeps him busy recording high school band and choral concerts. And he's branched into religious, country-western, polka, and organ music. Garber even is experimenting with production of a television show. *Asbury* also is involved in making radio commercials for stations or advertising agencies who do not have facilities for involved production.

Garber now uses Ampex and Crown professional tape recorders and microphones in his studio but he actually began operation with a home-type recorder. Today he has the only cassette mass duplication facility between Pittsburgh and Philadelphia.

How to start your own

The average hi-fi enthusiast probably has a recorder, suitable for semi-professional work, as part of his playback equipment. For serious recordings, however, a *reel-to-reel* machine should be used, although many cassette recorders may work nearly as well. Reel-to-reel machines are more flexible and easier to operate, maintain, and transport to different locations. Forget about using cheap battery-powered cassette or *toy* reel-to-reel recorders. They have limited capabilities and don't give good results.

There are many variations in quality among recorders. So, before purchasing one outright or thinking seriously about using the one you may have as a part of your hi-fi setup, you need to know how to judge a good quality tape recording.

One quick and easy test of the quality of any tape recorder is to listen for *wow* or *flutter*. These are the warbling sound distortion caused by non-uniform speed of the recorder. Try making a recording of a piano solo. *Wow* and *flutter* distortion, if there is any, will show up quickly.

What's a good recorder?

Another quick check of a recorder's capabilities is to record a small instrumental or choral group. Listen very closely. See if each instrument or voice retains its characteristic. The high notes should be clear and sharp. The low and mid-range notes should not interfere with each other. There should never be a *hiss* or a background noise of any kind in the recording that you make.

The recorder also should be able to cope with wide volume ranges from very loud *crescendos* to soft *pianissimo* passages in music. Cheaper recorders have poor dynamic ranges.

If your equipment passes these simple tests, your chances of obtaining exacting reproduction are good.

Examples of semi-professional tape recorders used by smaller studios are the Crown 700 and 800 series, the Sony Superscope model 850, and the Pioneer 1011 machines. Other brands may do just as well. But a word of warning before you accept any recording contracts. Be sure you thoroughly check out

your machine with a critical ear. Imperfections showing up on the completed tape can't easily be removed, if at all.

The choice of tape is another important consideration that is sometimes overlooked. There are hundreds of types of magnetic tape on the market. Not all of it is suitable for your particular recorder no matter how much it costs. The most expensive isn't necessarily the best choice. Above all, don't record on the cheapest you can get your hands on. Many bargain-price tapes are really no bargain. They could cause serious damage to the recording heads in your machine. Cheaper tapes lack the ability to capture portions of information that your recorder delivers to the recording head. Bargain price tapes simply aren't capable of storing the total information.

For additional details on tapes and the proper selection of them, see *Modern Electronics*, May 1978, page 44.

Microphones are important

Also important is the choice of microphones. Here, the cheapest is not necessarily inferior to higher-priced products. Most recorders come with microphones that are balanced for that particular machine, although some budget-priced recorders do have poor quality mikes. Again, some quick and positive tests should be made.

Make a recording of something musical, preferably a piano where a wide



Asbury Recording Company owner Earl Garber sits in the center of his custom designed and built sound mixing console in the control room. Crown stereo tape recorders are located at his right and left. A large window looks directly into the studio from the control room affording Garber a direct view of the recording artist or orchestra. The slightly tilted glass pane in the window provides protection from sound reverberation.



Asbury Recording Company owner Earl Garber uses a stop watch to accurately time a segment from a master tape playing on one of two stereo recorders in the control room. Exact timing is essential so a selection will fit on a disc or tape cassette. The master mixing and control panel is at Garbers left.

range of pitches can be recorded. Listen very carefully to the recording with particular emphasis to any distortion and frequency response. The tape should not sound as if some passages are overwhelming or muted. The recording's high notes should be as clear as the bass notes. All in-between audio frequencies should be detected or felt to be there.

The microphone also should be able to avoid pickup of reverberations or echos, although this can be eliminated somewhat by mic placement. A microphone with directional capabilities is best.

Some brands of microphones in use at amateur and professional studios are Sure model 546 Unidyne, the Electro-Voice model 666, and an old standard, the RCA 44 BX.

Sound mixers

If you choose another microphone, be sure it will *match* your particular recorder. A microphone not only has to be distortion free and have a smooth level frequency response, it also has to have the correct impedance and output level for the recorder's input. Professional help is recommended when purchasing microphones or matching them to a recorder. Remember, too, that there are many microphones not suitable for recording. For example, public address mics are strictly for voice reproduction.

Most studios use several microphones during a recording. Through trial and error during a rehearsal you find the best location.

Some home tape recorders are not capable of directly accepting two or more microphones. Solve this problem by using a *mixer*, a device which accepts several microphone inputs while feeding a combination of any or all to a tape recorder's single input. Most mixers have volume controls so that audio

levels from each mic can be adjusted. The volume control on the tape recorder can then be used as a *master* control.

Several types of mic mixers are available commercially at hi-fi outlets. The Lafayette 2-channel stereo microphone/phone mixer, catalogue number 80 C 83057, is a good choice.

To house all of your recording equipment you'll need a properly prepared studio. It doesn't have to be an elaborate construction project, but you'll need a place to make recordings. It can be as simple as a living room or as in the case of *Asbury Recording Company*, a specially prepared building.

Studio in garage

Asbury owner Garber converted his two-car garage into a combination studio and control room. Extra sound proofing was added to the cement block walls. The ceiling was carpeted along with the floors. A control room, which houses recorders and a complex audio mixing panel he built himself, was added to one end of the structure. There's ample room to store tapes, records, and equipment. The control room is about one third the size of the studio with enough room to work comfortably.

In making your choice of location the main thing to remember is that you are dealing entirely with *sound*. Any sound that you don't want in the final recording should be eliminated *before* it enters the microphones.

Sound that originates outside the studio must not leak through the walls, flooring, duct work, or ceiling. At the same time sounds that are to be recorded should not leak outside the studio and be lost.

Remember high school physics? When sounds strike a smooth surface they reflect and reverberate throughout a room. Unless reverberation or *echo* is desired during a recording session, you'll have to take steps to eliminate it.

There are cheap and easy methods to deaden a room. Heavy drapes hung on the walls, and thick rugs on the floors make excellent sound absorbers. Some home recording studios and several radio stations that have extensive recording facilities use ordinary fiber egg cartons tacked to studio walls by the hundreds to act as baffles. In some cases, the egg cartons work as good or better than sound proofing tiles or cork blocks.

If your proposed studio has windows they must be heavily sound proofed to eliminate reverberation, outside noises, and traffic vibration. If you are planning a window between the studio and control room, be sure to construct it so the glass pane is tilted slightly to deflect any sound waves caught by the pane toward the carpeted floor or sound proofed ceiling.

Another tip in sound proofing is to construct *gobo boards* or sound absorbing

room dividers that can be stationed in a problem area of the room. Gobo boards also are used to isolate a vocalist from an orchestra or a particular instrument from the band itself to enhance or diminish its quality or volume.

A good studio sound comes mainly by trial and error. Different studio arrangements are needed for different types of recording, so final plans shouldn't be fixed or so complicated that a major reconstruction project is necessary when changing from one session to another.

Many times, by the nature of the event itself, recordings will have to be made *on location* or outside the controlled environment of the studio. In such cases the recording engineer is at the mercy of the location itself. The event may be outdoors or in a large auditorium where conditions cannot be fully controlled. In these circumstances, the simpler the set up the better because you probably can't improve the acoustics beyond whatever is already there. It is possible the environment might even add to the recording.

Away from home

Take the case of an outdoor band concert. If audience noise, clapping, and traffic sounds were part of the event and are picked up by the mics, it adds to the *live* effect of the recordings. Microphone placement for *remote* or on location recordings is super critical to eliminate as much background noise as possible. Again it's a trial and error task best done during a rehearsal.

Don't be afraid to tackle a remote recording. Many amateur and professional recording companies have had spectacular results from on location recording sessions. Unless you have a very large studio, a high school band isn't exactly the easiest thing to cram into a living room.



Garber stands beside his custom designed cassette duplication equipment to check the volume level for proper range. Asbury Records can duplicate cassettes at the rate of six at a time. The large bookcase stores master tape recordings.

NO MATTER WHAT YOU WANT TO LISTEN TO

Vhf engineering
HAS A RECEIVER FOR YOU!

SPECIFICATIONS

Dual conversion receiver with squelch and COR output
Frequency range: Any 4 MHz range from 30-60 MHz, 140-175 MHz, 200-240 MHz, or 420-480 MHz
Sensitivity: .3uV for 20 db quieting
Squelch threshold: .2uV
Audio output: 2 watts
Spurious rejection: Greater than 60 db
I.F. rejection: 80 db
First I.F.: 10.7 MHz, 2nd I.F.: 455 KHz
Bandwidth: 15 KHz and 3 db, 60 KHz at 30 db
Power requirements: 12-14 VDC
Antenna input: 50 ohms
Size: 4. x 6" x 1 1/4"

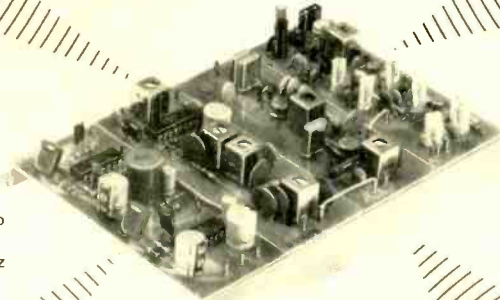

RX50C Kit	30-60 MHz	\$64.95
RX144C Kit	140-170 MHz	74.95
RX220C Kit	210-240 MHz	74.95
RX432C Kit	420-470 MHz	84.95

Vhf engineering

DIVISION OF BROWNIAN ELECTRONICS CORP.
320 WATER STREET / BINGHAMTON, N.Y. 13901
Phone 607-723-9574



VHF ENGINEERING has a complete line of receivers, transmitters, scanners and accessories. Send for full line catalog.



CIRCLE 47 ON READER SERVICE CARD

AMATEUR RADIO NOVICE CLASS THEORY COURSE

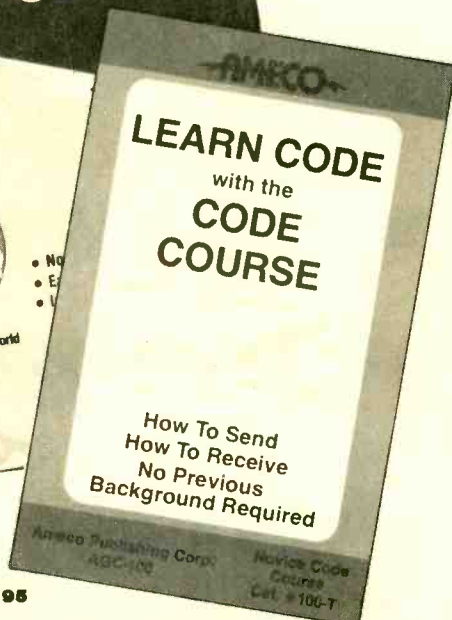

Complete Package... \$6⁹⁵

GET YOUR HAM RADIO LICENSE THE EASY WAY

The Fun Way, The Quickest Way with the CQ/S9 learning program

The publishers of S9 and CQ Magazines have collaborated with Ameco to bring out the best ham radio training program ever offered. Just a few minutes a night, for just a few weeks will bring you the joys and rewards of being a fully licensed radio amateur.

This complete novice package includes a 1 hour code cassette course, a 32 page code instruction book, and an easy-to-use theory book with sample FCC exam questions.

All for just \$6.95.

The best training program on the market at the very best price. Order today.

Order from Circulation Department
Cowan Publishing Corp.
14 Vanderventer Avenue
Port Washington, N.Y. 11050

PERRY PEOPLE

BY HAROLD PERRY

WILD TURKEY AIR LINES FLIGHT 222 HAS BEEN, FOR THE LAST SIX HOURS, HELD UNDER THE GRIP OF TWO HI-JACKERS: WHO HAVE HATE IN THEIR HEARTS, DEATH IN THEIR EYES AND BAD SMELLS UNDER THEIR ARMS.

... AND AFTER WE PEEK UP SOME COMRADS IN CUBA, WE'LL ALL FLY ON OVER TO AFREE KA FOR - SHALL WE SAY SIGNORE - A LEETLE VACATION. A - WHAT YOU CALL IT - A **SHOOTING SAFAREE!** YUK, YUK YUK YUK

CAN WE, MAYBE, FLY OVER DIZANEE WORLD? SI?

I WISH YOU FURRY CHINS WOULD FINISH YOUR HIJACKING ALREADY - SO I CAN VISIT MY SISTER.

GAS GRENADE.

FWUMP

DOWN AT FLIGHT TRAFFIC CONTROL

IT SEEMS THAT A PASSENGER, MRS. IRMA GOLDBERG OF HOBOKEN, IS NOW IN CONTROL OF THE PLANE. A GAS GRENADE KNOCKED OUT THE HIJACKERS AND FLIGHT CREW.

WHY DIDN'T THE GAS KNOCK HER OUT, TOO?

KNOCK ME OUT? HA! I'VE BEEN SMELLIN' WORSE ON THE JERSEY TURNPIKE FOR YEARS.

NOW DON'T WORRY, BUBNIK. I'VE BEEN FLYING PLANES FOR WELL OVER SIXTY YEARS.

SO, MAYBE THIS ONE HAS MORE OF THOSE FANCY THINGAMABOB CONTROLS THAN MY OLD SOPWITH BIPLANE.

IRMA IS JOINED IN THE COCKPIT BY HER GRANDSON, EDWARD.

WE'RE ALMOST OUT OF FUEL, GRANNY. THIS AIRPORT IS OUR BEST BET.

BUT THE OTHER AIRPORT IS TWO MILES CLOSER.

DON'T WORRY! I FIGURED IT ALL OUT ON MY HEWLETT PACKARD 29C PORTABLE CALCULATOR WITH CONTINUOUS MEMORY, 30 DATA REGISTERS, PROGRAMMABLE WITH A 98 STEP PROGRAM MEMORY, LOGIC SYSTEM, SCIENTIFIC KEYS INCLUDING LOGS, EXPONENTS, TRIG CALCULATIONS, ROOTS, RECIPROCALLS, POLAR AND RECTANGULAR CONVERSION AND STATISTICAL FUNCTIONS LIKE MEANS AND STANDARD DEVIATIONS....

CUT THE COMMERCIAL ALREADY AND JUST TELL ME IN PLAIN AMERICAN

WE'LL FLY LONGER WITH THE WIND AT OUR BACKS.

OY! ARE WE IN TROUBLE. THE PROPELLERS FELL OFF OF THE AEROPLANE.

BUT GRANNY THIS IS A **JET** PLANE!

OK, OK! SO, THE PROPELLERS FELL OFF THE **JET** PLANE.

OH GOD, WE'RE DOOMED.

THERE'S THE RUNWAY, GRANNY. LOWER YOUR GEAR AND LET DOWN THE FLAPS.

WATCH YOUR MOUTH BOY!

WHIMPER

JUST THEN THE FUEL RUNS OUT!

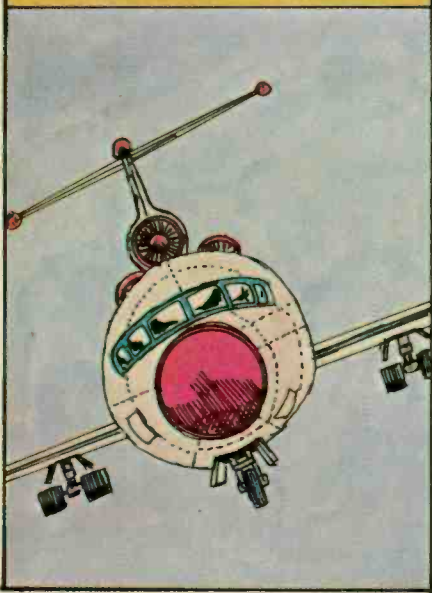

THE CO-PILOT AWAKENS ...



...AND TAKES OVER THE CONTROLS



PLACED ON A FULL RED ALERT, THE AIRPORT EMERGENCY SERVICES STAND BY AT FULL READINESS.



Y'SEE THE PLANE YET?

NAW - BUT I THINK I HEAR SOMETHING.

LOOK AT ALL THOSE PEOPLE BEING TAKEN AWAY TO HOSPITALS! WERE THEY ALL HURT WHEN THAT PLANE MADE IT'S EMERGENCY LANDING??

NO! NOBODY GOT HURT ON THE PLANE. THESE PEOPLE WERE INJURED WHEN THEY WERE TRYING TO GET THEIR LUGGAGE AT THE BAGGAGE CLAIM.



THANKS TO ADVANCED TECHNOLOGY AND AMERICAN INGENUITY, A POTENTIAL DISASTER HAS BEEN AVERTED.

SO-LITTLE PUSKA, CAN YOUR FANCY PANTS ADDING MACHINE TELL US HOW LONG WE'LL HAVE TO WAIT FOR A CAB?

FOUR MINUTES THIRTY SEVEN SECONDS.



THE END

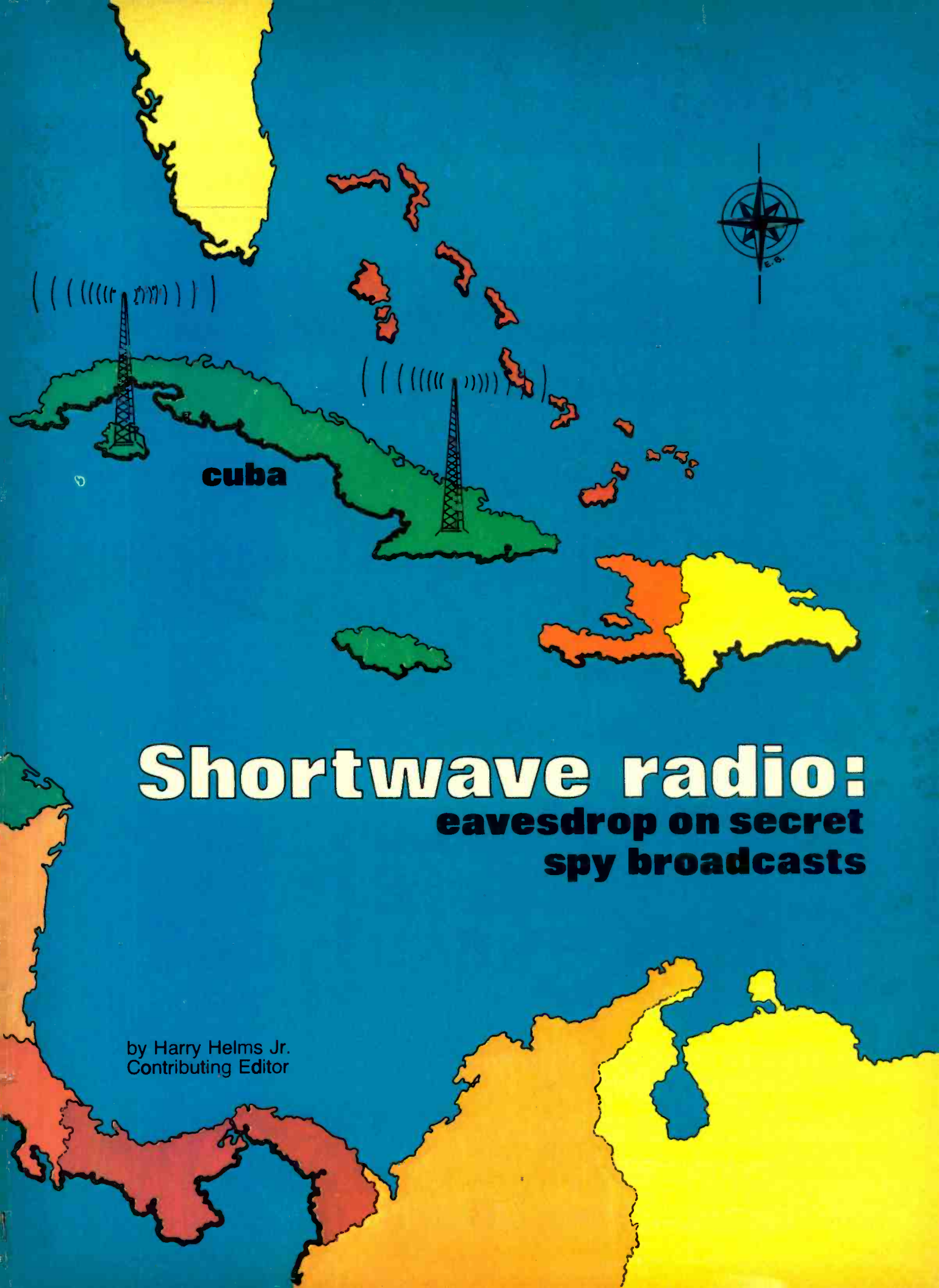

cuba

Shortwave radio: **eavesdrop on secret** **spy broadcasts**

by Harry Helms Jr.
Contributing Editor

Now that you have assembled equipment and outfitted a studio, where do you find groups to record? It's mainly a matter of being able to make contacts with groups or organizations interested in owning a recording of their work. Remember, the name of the game is to record a group or performance that will have the greatest potential to sell records.

We already mentioned the local high school band and chorus. You might approach the director for a start. He just might be interested in a recording of a special performance. Perhaps your social club has a musical group or an annual variety show or entertainment that would be good for recording.

Other potentials are a popular rock group; ethnic music has a large following in certain parts of the country; church choirs or organ recitals are another possibility; and don't overlook the Saturday night country-western group that packs them in at the local hoe-down.

Smaller studios do well recording those small groups with a large local following. Should you be lucky enough to discover talent of interest to a major recording studio, you can negotiate to sell the rights to your master tape recording.

Once the final or *master* tape of the recording session is completed, you will have to come up with some sort of timing sequence. Each long playing record usually has a maximum playing time of 12 to



Closeup view of Asbury Recording Company master control and sound mixing console in the foreground. Eight separate microphone inputs can be feed to two professional stereo tape recorders either individually or combined. A Crown stereo professional tape recorder sits to the left of the master console. The microphone near the top of the control panel is used for control room-studio talk back communications.

15 minutes per side. Cassette tapes are a bit different because of their construction permitting continuous lengths of recording surface. Normal playing time is one hour, although there are 90-minute and 120-minute cassettes available. The 60-minute tape is the most popular.

In order to have a recording fit the finished product, carefully time each individual number of the master tape. Then, in conjunction with the group or its director, decide which numbers will best fit the time available. Use a stop watch.

Another decision facing you is the total number of discs and or cassette tapes that will be needed. This is tricky. Again, it is best to work closely with the group and its director. He should be able to give you some rule of thumb as to how much interest would be generated by the public in record demand. Remember, however, record pressing and tape duplicating firms work on volume amounts. The larger the order, the cheaper the cost per unit to you. An order for, say, 200 discs or cassettes would be cheaper per unit than an order for, say, 50 or 100 units.

There are numerous pressing and duplicating firms worldwide. For a negotiated price they will transform your master into finished products that are playable on any home recorder. Selecting one is a matter of price, availa-

bility, and extra services that your particular need might require.

Most, through the use of sophisticated electronic equipment, are able to correct slight errors or imperfections in the master tape you send them. Through this equipment it is possible to add or subtract high or low frequencies to enhance the overall response of the finished product. Labs also are able to add *presence* or *echo* to make a recording sound alive. Some firms also are able to make monaural recordings sound like stereo. Ask about those additional services, but remember there probably will be an additional charge. Shop around and see which firm gives you the best price and the fastest service.

Many pressing firms also offer an extra-charge service to design an album cover and special disc labels. If you have the budget, it's a nice touch to the finished product. But someone who is handy with a camera or a paint brush can do just as well. By combining talents you can design your own cover, have a local printer duplicate it, and then paste them on the blank sleeves that cover the discs or cassettes when shipped from the manufacturer.

As you become familiar with recording techniques, it may be possible to rent your facilities or equipment to advertising agencies and radio stations who produce their own commercials. Many times because of budget and space limi-



Asbury Records' studio features heavily carpeted flooring and semi curved walls (left) to inhibit sound reverberation. The glass pane in the studio-to-control room window is tilted slightly for additional protection from reverb. Microphones are attached to booms to insure exact positioning during recording sessions. The dual multi-coned speakers on either side of the control room window are used for playback of recordings. A row of microphone connectors seen between the two boom mics lead directly to the control room mixing console on the other side of the wall. Album covers serve as decoration around the control room window.

Where to get dupes

Now that you have your master tape recording, here's where to get information concerning the transfer of your recording to discs or cassettes. Note that some firms are interested in small quantity jobs, while others only take orders for large volume duplication.

Discs and cassettes (Small volume duplication)

Asbury Recording Company, Bellwood, PA 16617.

Earl E. Garber, Owner and Manager
Asbury Lane, Altoona, PA 16601

facilities: studio or on location mono or stereo recording. Cassette duplication, tape mastering, tv audio and film/video production, commercial recording, tape mastering and correcting services, album cover custom design and printing services.

Recorded Publications Company, Camden, NJ

1558 Pierce Avenue, Camden, NJ 08105

facilities: disc pressing and tape mastering-correcting services. Caters especially to the nonprofessional or educational institutions. Album cover services.

Allentown Record Company, Allentown PA

10th and Walnut Streets, Allentown, PA 18102

Harvey Solomon, Manager

facilities: complete tape to disc transfer, tape mastering and correcting services, small and large volume disc pressing, album cover design and printing services.

Southern American Record Company, Nashville, TN

207 Dembeurn Street, Nashville, TN 37023

John Ivanits, President

facilities: complete disc duplicating services, large and small volume, tape mastering and correcting services, album cover design and printing.

Discs only (large volume)

Capitol Records Inc., Scranton, PA

facilities: high volume disc pressing, and tape cassette dubbing.

RCA Recording Company, Camden, NJ

facilities: high volume disc and tape cassette duplication. Full tape mastering and correcting services, album design and printing facilities. Full studio recording facilities.

tations these organizations find it easier to use someone else's facilities.

The recording of *production* radio commercials takes skill and usually means working with *talent* or hired professionals. Recordings usually are of short duration, one minute maximum to 10 seconds minimum. Professionally done radio commercials include sound effects, music, and theatrical acting.

The actual recording sessions, although long in total time spent in the studio, consist of many *takes* or recordings of the same commercial. Timing must be exact and if the commercial involves complicated production techniques, it may take numerous recordings of the same thing to get just one that is exactly right. For this reason, most studio and equipment rental is charged by the hour or day plus costs.

Another possibility for work is the recording of material for distribution to blind persons. Talking-book records have been around for some time. Check with your local handicapped agency to see if they have a need for such a service.

The possibilities are actually limitless in the recording world once you have the proper equipment and a studio. Don't be fooled into thinking you can compete with well-established major recording companies. But, for the technically-inclined, there is plenty of recording work right in your own hometown to keep you busy. ☐

CRAIG ANDERTON MEETS COMBO ORGAN, THE RESULT:

ORGANTUA™

from: **PAIA**

FORGET ABOUT
THIN-SOUNDING
COMBO ORGANS;
ORGANTUA HAS:

THREE INDIVIDUAL
RANKS (EACH
WITH 5 POSITION
OCTAVE SELECT
SWITCHES) FOR
A RICH, THICK
SOUND.

ORGANTUA REPRESENTS THE
FIRST MAJOR ADVANCE IN
COMBO ORGANS IN 10 YEARS.
SEND FOR OUR INSTRUCTION
MANUAL IT TELLS THE FULL
STORY.

ORGANTUA KIT - \$279.95
(shipped freight collect)
ALSO AVAILABLE CUSTOM
ASSEMBLED



- () I'm convinced - Send Organtua Kit - \$279.95 enclosed.
() Send Organtua Instruction manual (\$5 refundable w/kit purchase) () Send FREE Catalog

name: _____
address: _____
City: _____ State: _____ Zip: _____

PAIA DEPT. 9 E , 1020 W. WILSHIRE, OKLAHOMA CITY, OK 73116

TAB POPULAR CB BOOKS

CB Radio Operators Guide—2nd Edition

Tells what CB is, how it is used, how to buy and install equipment—PLUS Part 95, the FCC rules regulating CB. 256 pps.

Order No. 799 Paper \$5.95 Hardbound \$8.95

Practical CB Radio Troubleshooting & Repair

Complete details on CB operation, installation and repair, including 21 programmed troubleshooting charts and complete schematics for 18 popular transceivers. Also an in-depth section on antennas and feedlines. 238 pps.

Order No. 754 Paper \$5.95 Hardbound \$8.95

Pictorial Guide to CB Radio Installation & Repair

Step-by-step guide to car and base systems installation and basic maintenance. 256 pps.

Order No. 683 Paper \$5.95 Hardbound \$8.95

Citizens Band Radio Service Manual

All-in-one troubleshooting and maintenance guide for all types of CB sets, including a 36-page schematic foldout section. Step-by-step repair procedures and trouble-analysis charts. 192 pps.

Order No. 581 Paper \$5.95 Hardbound \$8.95

ORDER FORM

Modern Electronics

809-F

14 Vanderventer Avenue
Port Washington, NY 11050

Ship the books listed below. To cover shipping, I've added 50¢ for the first book and 25¢ for each additional book. Enclosed \$

No.	Price	Name
_____	_____	_____
_____	_____	Address _____
_____	_____	_____
_____	_____	City _____ State _____ Zip _____

Make better music with a Joy Drone

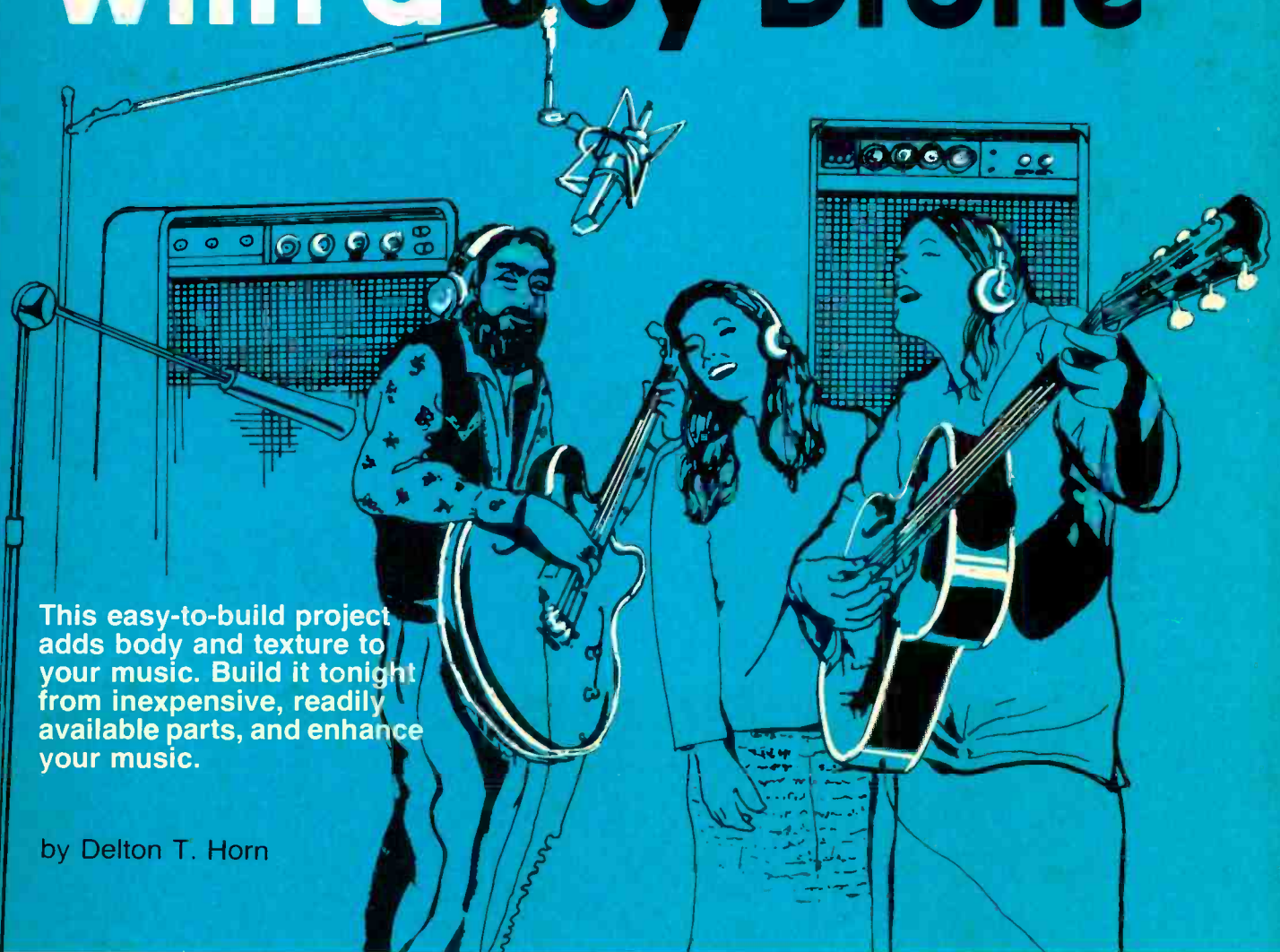

This easy-to-build project adds body and texture to your music. Build it tonight from inexpensive, readily available parts, and enhance your music.

by Delton T. Horn

If you've ever gotten involved with electronic music, you know that some sort of drone is often used to add body and texture to the over-all sound.

It's a more or less constant tone below the volume of the main acoustic events. The tone is usually of a fairly indefinite pitch, and any movement is usually restricted to timbral variations, or subtle changes in the textural quality of the tone.

As musically useful as the drone so often is, it's really a pretty simple function. Although most musicians use expensive voltage-controlled oscillators and filters to produce the drone, you can do it with this inexpensive special purpose drone box. And, even if you're not into electronic music, this simple project makes an amusing do-nothing box.

Description	Parts List	Quantity required	Radio Shack part number
1K resistor, ¼ watt		8	
4.7K resistor, ¼ watt		4	271-1300
18K resistor, ¼ watt		8	series
39K resistor, ¼ watt		4	
10K joystick (or 4 10K pots)		2	—
.02 mfd disk ceramic capacitor		4	—
.01 mfd disk ceramic capacitor		8	272-131
0.1 mfd disk ceramic capacitor		4	272-135
324 quad op-amp IC		1	276-1711
1N34 germanium diode		8	276-1123
SPST switch		4	275-324*
DPDT switch		4	275-1546*
RCA or phone jack		1	—
9 volt batteries and clips		2	

*The switches listed are subminiature types that work well. You may, however, substitute any switches you happen to have on hand.

gear parts tests books

The editors roundup exciting new products you should know about.



Moisture-analyzing microcomputer

Got some cereal, coffee, tea, candy, paper, plastic, sand, cement, tobacco, chemicals, soap, flour, paint, cosmetics, drugs, baked goods, or dry pet food which you suspect of being too moist? Check them with Motorola's Compu-Trac moisture analyzer. It's automatic, requiring little operator skill. Push a button, dump your material into the sample tray, close the lid and walk away. Within minutes, the gadget gives you an estimate of moisture content from zero to 100 percent via digital readout. It's all electronic and has a microcomputer for a brain. For more information, circle number 117 on our reader service card.

Two-motor three-head cassette deck

More and more high-quality cassette decks are making their appearance in the audio market place. Among them is this new Pioneer CT-F900 with a claimed wow and flutter of less than .05%, and frequency response with standard tapes of 30 Hz to 15,000 Hz, +3 dB. With chrome dioxide or ferrichrome tape, the response moves out to 17,000 Hz. Among the other niceties are built-in Dolby, a digital tape counter, automatic memory rewind that lets you get back to a preset point on your tape, and fast-acting fluorescent level indicators. You can also preset the maximum audio level to prevent distortion due to overdriving the heads and saturating the tape. For information about this top-notch deck, circle number 105 on our reader service card.



gear parts tests books

The editors roundup exciting new products you should know about.



Attention, fan fans

Remember those nifty Casablanca-style fans from the movies? Well, now you can build your own as a Heathkit! Heath Company has a \$99 kit for house or apartment to cool your rooms on one of these hot August dog-day afternoons. And, this winter, you can use it to push heat back down from the ceiling to where you sit. It's finished in baked bronze enamel with a 52 inch wood-grain-look-alike blades. You adjust the speed and pull the chain to turn it on. The fan is kit GD-1238; swag chain is GD-1238-1; glass globe light is GD-1238-2. The light, mounted below the fan, can be operated separately from the fan. For more information, please circle number 116 on our reader service card.

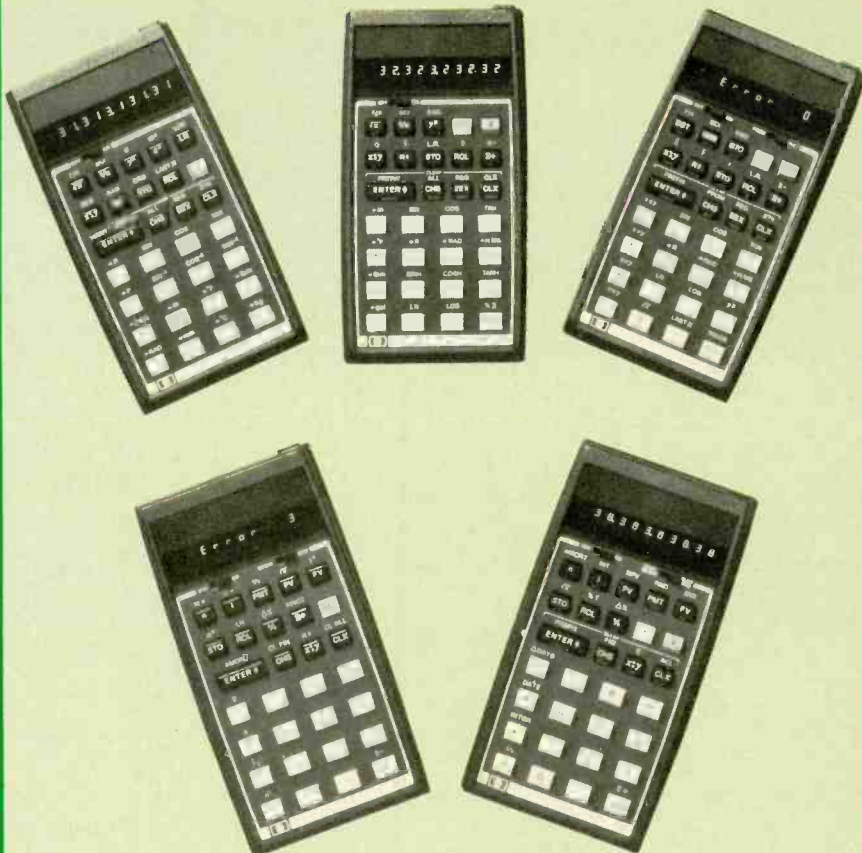

New H-P five

Even the best gets less expensive eventually! Hewlett-Packard has a new family of five calculators for both scientific and financial applications at the lowest prices yet for H-P. The new line also has a new readout size display size, error messages and operating manuals. Called the E series, the scientific models are the HP-31E, HP-32E, and HP-33E, left to right above. Financial models, left to right below, are HP-37E and HP-38E. The new displays are the largest ever used by H-P. Error messages for nine different errors now are displayed in code. The HP-31E, at \$60, is the lowest priced calculator ever offered by H-P. For more info, please circle number 119 on our reader service card.

Custom tailor auto audio



Auto interiors really aren't the best listening rooms—and what qualities they do have change when the windows are opened or closed. Even the best auto stereo won't sound as good in a car as it would in your

living room. But you can significantly improve the sound with Kraco's new line of graphic equalizers. Currently, there are two models to choose between. Both offer separate low, mid-range and high frequency equalizer controls, and a built-in power meter. The difference between the two models is power. The KE-3 gives you 25 watts per channel; the KE-5 30 watts. For info on these equalizers and other Kraco auto products, circle number 103 on our reader service card.

Topple tinny tv tones

Tired of tinny sound from your portable tv? Here's just about the ultimate in bringing hi-fi to your viewing. Pioneer's TVX-9500 is a tv tuner you add to your stereo system for top-notch sound reproduction. After all, tv sound is fm, and that means good reproduction. But most sets have small speakers which produces poor sound. The TVX-9500 tunes vhf channels 2-13 with soft-touch buttons and LED readouts. UHF tuning is via a large-knob detent selector with fine-tuning control. For more info, circle number 115 on the reader service card.



Third-hand holder

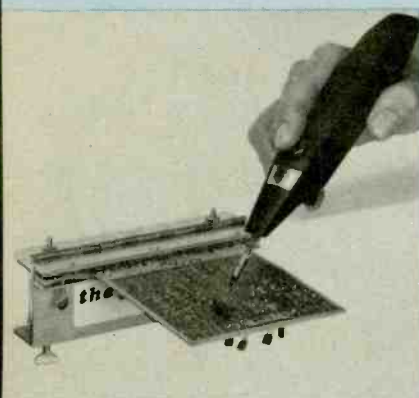

If you've ever suffered the frustration of trying to solder a connection on a small circuit board while it slowly slides along the bench top, you'll just love this 3rd Hand from Studio 3. Once you've used this marvelous \$10 circuit board holder, you'll wonder how you ever got along without it. The 3rd Hand clamps on the edge of your workbench and holds your circuit board in vinyl-covered jaws at just the right angle for parts stuffing. Then just flip the board over and the 3rd Hand holds it for soldering. For more info, circle number 109 on our reader service card.



100 MHz portable counter

Digital counters have been swept up in the rush for smaller, lighter test gear. Continental Specialties now offers an eight-digit 100 MHz battery-powered portable counter packed in a cabinet slightly less than 2 x 6 x 8 inches. A very handy feature is the autoranging circuit that always gives as the least significant figure in the readout the unit hertz count. This means you'll never see the same readout for different

frequencies because of a misplaced decimal point. And there's automatic overflow indication and leading zero blanking. Accessory ac and dc battery eliminators let you put your counter through a full day of work and then recharge its batteries at night. For more information about this \$135 counter and other Continental Specialties gear, circle number 108 on our reader service card.

The editors roundup exciting new products you should know about.

gear parts tests books

gear parts tests books

Radar detector tester

Get your Bearfinder or other speed-radar detector tested to make sure it really is picking up police signals. Dealers now are using this handheld tester by Bearfinder Inc. It's a cigarette-pack sized transmitter powered by a 9-volt battery. Point the tester at your detector and press a button. A red LED lights up, showing that the tester is transmitting. As when activated by highway-speed radar, the detector emits a signal if it is in working order. The \$63, four-ounce tester is sold only to dealers. For more information about Bearfinder products, circle number 112 on our reader service card.

Super new Bearcat



Bearcat has added an even more versatile new programmable scanning monitor receiver to its popular model 210 scanner. The new, higher priced scanner automatically searches out any active local public-service radio frequency, stores that frequency in memory, recalls it on demand and displays the active frequency. It also has a digital clock built in. The 250, listing at \$399, has a priority channel which it will

check every two seconds as it scans other frequencies. And a counter displays the number of times a particular frequency of your choice has been active. You can change the rate of scan and search speed. The scanner will turn on a light, tape recorder or outboard gadget of your choice when a particular channel becomes active. For more information, circle number 118 on our reader service card.

Working-wall car speaker

Acoustic Fiber Sound Systems Inc., otherwise known as AFS, makers of Kriket speakers, has pushed the reproduction of audio in your car to a new high with the model 6099 speaker. It's a butyl-edged, 5¼-inch long-throw bass and one-inch soft-dome tweeter capable of carrying 40 watts power to your ears. Frequency response is listed at 50-20,000 Hz with very little intermodulation distortion and excellent clarity. The so-called Working-Wall enclosure controls the sound to provide stereo separation which unbaffled speakers can't muster. The tweeter has a five-ounce ceramic magnet and a one-inch aluminum voice coil. The woofer has a 10-ounce ceramic magnet and one-inch voice coil. The speakers are compatible with 4 and 4 ohm and 8 ohm systems. They're \$80 each and measure roughly 5x11x9 inches. For more info, circle number 114 on our reader service card.

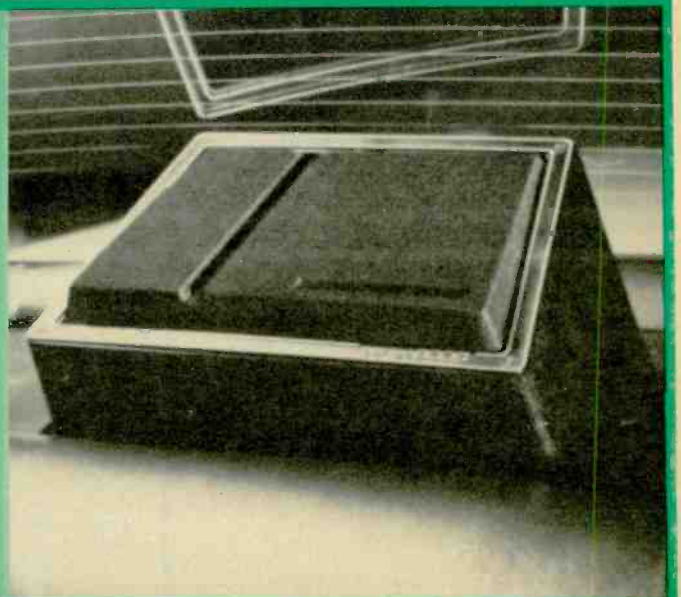

Fantastic Offer

on the
BEARCAT 210
Programmable
Scanner

SPECIAL
\$224.95

(Add \$5 for shipping
and insurance.)



Bearcat[®] 210 Features

- **Crystal-less**—Without ever buying a crystal you can select from all local frequencies by simply pushing a few buttons.
- **Decimal Display**—See frequency and channel number—no guessing who's on the air.
- **5-Band Coverage**—Includes Low, High, UHF and UHF "T" public service bands, the 2-meter amateur (Ham) band, plus other UHF frequencies.
- **Deluxe Keyboard**—Makes frequency selection as easy as using a push-button phone. Lets you enter and change frequencies easily... try everything there is to hear.
- **Patented Track Tuning**—Receive frequencies across the full band without adjustment. Circuitry is automatically aligned to each frequency monitored.
- **Automatic Search**—Seek and find new, exciting frequencies.
- **Selective Scan Delay**—Adds a two second delay to prevent missing transmissions when "calls" and "answers" are on the same frequency.
- **Automatic Lock-Out**—Locks out channels and "skips" frequencies not of current interest.
- **Simple Programming**—Simply punch in on the keyboard the frequency you wish to monitor.
- **Space Age Circuitry**—Custom integrated circuits... a Bearcat tradition.
- **UL Listed/FCC Certified**—Assures quality design and manufacture.
- **Rolling Zeros**—This Bearcat exclusive tells you which channels your scanner is monitoring.
- **Tone By-Pass**—Scanning is not interrupted by mobile telephone tone signal.
- **Manual Scan Control**—Scan all 10 channels at your own pace.

- **3-Inch Speaker**—Front mounted speaker for more sound with less distortion.
- **Squelch**—Allows user to effectively block out unwanted noise.
- **AC/DC**—Operates at home or in the car.

Bearcat[®] 210 Specifications

Frequency Reception Range

Low Band	32—50 MHz
"Ham" Band	146—148 MHz
High Band	148—174 MHz
UHF Band	450—470 MHz
"T" Band	470—512 MHz

*Also receives UHF from 416—450 MHz

Size
10 $\frac{5}{8}$ " W x 3" H x 7 $\frac{7}{8}$ " D

Weight
4 lbs. 8 oz.

Power Requirements
117V ac, 11W; 13.8 Vcc, 6W

Audio Output
2W rms

Antenna
Telescoping (supplied)

Sensitivity
0.6 μ v for 12 dB SINAD on L & H bands
U bands slightly less

Selectivity
Better than -60 dB @ \pm 25 KHz

Scan Rate
20 channels per second

Connectors
External antenna and speaker, AC & DC power

Accessories
Mounting bracket and hardware
DC cord

Send certified check or money order for immediate shipping. Also available C.O.D.

We've stocked up on a sizable inventory of these fine Bearcat scanners. But even our healthy inventory won't last long at this price. Place your order today and be certain of getting in on this exciting offer.

JAY NORMAN SALES COMPANY
2936 Merrick Road, Bellmore, New York 11710
Phone: (516) 826-8090

for the experimenter!

INTERNATIONAL CRYSTALS & KITS
 OSCILLATORS • RF MIXER • RF AMPLIFIER • POWER AMPLIFIER

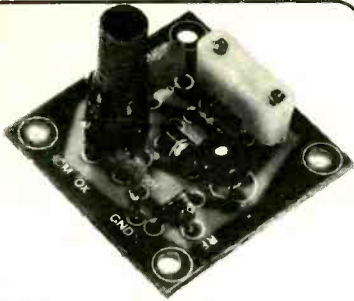

OX OSCILLATOR

Crystal controlled transistor type. 3 to 20 MHz, OX-Lo, Cat. No. 035100. 20 to 60 MHz, OX-Hi, Cat. No. 035101
 Specify when ordering.

\$4.95 ea.

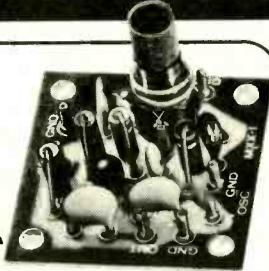

MXX-1 TRANSISTOR RF MIXER

A single tuned circuit intended for signal conversion in the 30 to 170 MHz range. Harmonics of the OX or OF-1 oscillator are used for injection in the 60 to 179 MHz range. 3 to 20 MHz, Lo Kit, Cat. No. 035105. 20 to 170 MHz, Hi Kit, Cat. No. 035106
 Specify when ordering.

\$5.50 ea.



PAX-1 TRANSISTOR RF POWER AMP

A single tuned output amplifier designed to follow the OX or OF-1 oscillator. Outputs up to 200 mw, depending on frequency and voltage. Amplifier can be amplitude modulated. 3 to 30 MHz, Cat. No. 035104
 Specify when ordering.

\$5.75 ea.

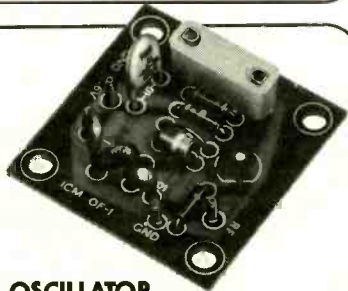

OF-1 OSCILLATOR

Resistor/capacitor circuit provides osc over a range of freq with the desired crystal. 2 to 22 MHz, OF-1 LO, Cat. No. 035108. 18 to 60 MHz, OF-1 HI, Cat. No. 035109
 Specify when ordering.

\$4.25 ea.

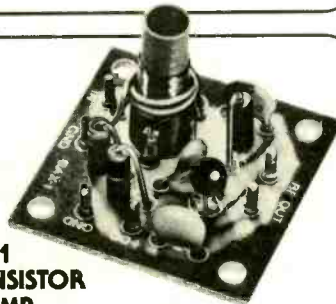

SAX-1 TRANSISTOR RF AMP

A small signal amplifier to drive the MXX-1 Mixer. Single tuned input and link output. 3 to 20 MHz, Lo Kit, Cat. No. 035102. 20 to 170 MHz, Hi Kit, Cat. No. 035103
 Specify when ordering.

\$5.50 ea.

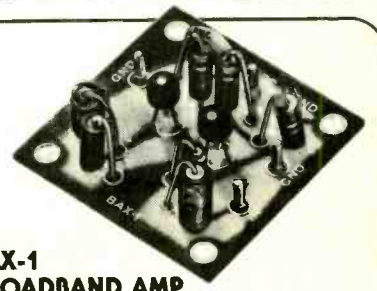

DAX-1 BROADBAND AMP

General purpose amplifier which may be used as a tuned or untuned unit in RF and audio applications. 20 Hz to 150 MHz with 6 to 30 db gain. Cat No. 035107
 Specify when ordering

\$5.75 ea.



.02% Calibration Tolerance EXPERIMENTER CRYSTALS (HC 6/U Holder)

Cat. No.	Specifications	
031080	3 to 20 MHz — for use in OX OSC Lo Specify when ordering	\$5.95 ea.
031081	20 to 60 MHz — For use in OX OSC Hi Specify when ordering	\$5.95 ea.
031300	3 to 20 MHz — For use in OF-1L OSC Specify when ordering	\$4.75 ea.
031310	20 to 60 MHz — For use in OF-1H OSC Specify when ordering.	\$4.75 ea.

Shipping and postage (inside U.S., Canada and Mexico only) will be prepaid by International. Prices quoted for U.S., Canada and Mexico orders only. Orders for shipment to other countries will be quoted on request. Address orders to:
 M/S Dept., P.O. Box 32497,
 Oklahoma City, Oklahoma 73132.

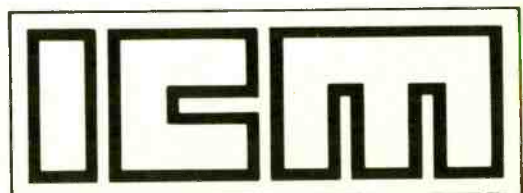

International Crystal Mfg. Co., Inc.
 10 North Lee
 Oklahoma City, Oklahoma 73102

How to talk on a telephone without bending your ear

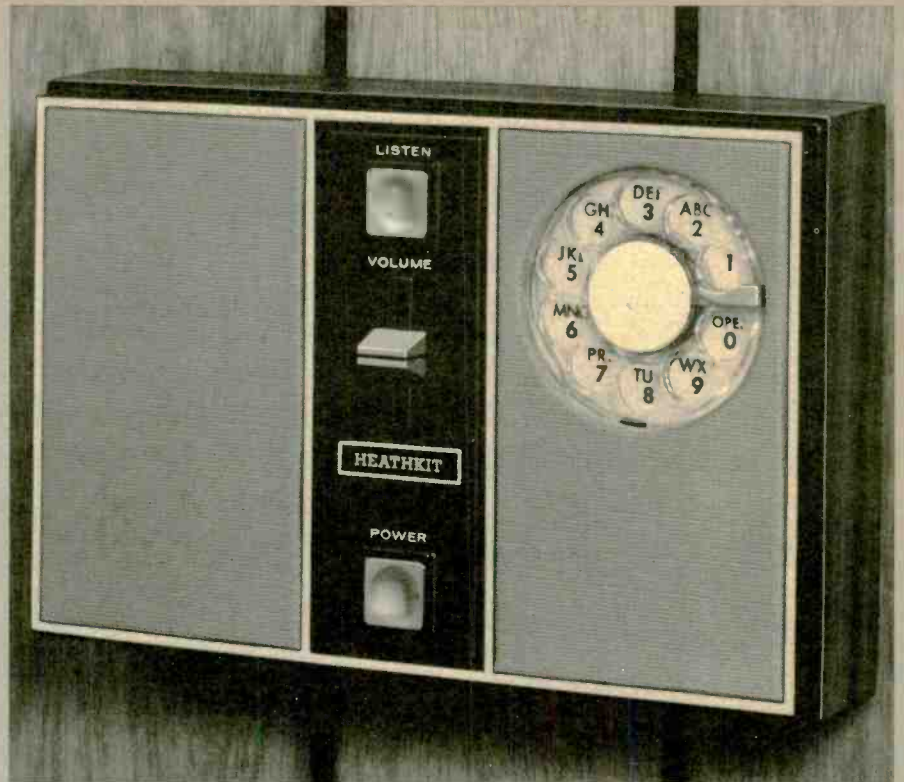

Heathkit GD-1162 telephone amplifier sits on a desk or hangs on the wall for convenient hands-free chatting.

Tired of holding a phone up to your ear while conversing? Want Aunt Emma and the kids in the room to hear both sides of your conversation? Get a phone amplifier for your desk or to hang up on a wall.

Finally! There's a hands-free telephone gadget attractive enough to put in your living room. It's the Heathkit GD-1162 telephone amplifier which lets you talk all day without wearing out your arm or your ear.

Plug it into a phone line and the words coming down the wire are amplified for all within earshot. You even can listen in while others talk on different extensions of your home phone.

It's a convenient gadget, easy to build and fun to use. Here's a review of what happened when *Modern Electronics* set out to build it:

As with all Heathkits, construction was easy. The only problem came during soldering an IC socket onto the board. Two of the conductor islands lifted off of the board from the soldering iron heat. Why, I don't know since no similar problem occurred on the rest of the board.

Total construction time here was 7.25 hours. However this is a little fast. Any new builder should take his time as the

circuit board is not too large and tends to get a little crowded.

On nearly all of the Heathkits I have built lately the circuit board has been masked with a solder resist that is supposed to help keep solder bridges from forming. It works well as none of my kits have had a bridge form.

Installation is the disappointing part of this kit. I called a business office of Bell of Pennsylvania and asked for price quotes on the three types of coupling suggested in the Heath manual: STC, QKT, and Direct Hookup.

■ STC is the most expensive; \$6.50 per month and a total of \$36.00 installation and service call fees. This coupler permits the unit to perform all of its functions.

■ QKT coupler is more reasonable 53¢ per month for the coupler, 95¢ per month for the phone set that is needed with the coupler, and \$25.00 installation and service call fees. With this coupler you can only talk and listen, ringing and

dialing are done with the associated phone set.

■ Direct Hookup is the most practical since no coupler is needed and the Amp/Dialer can perform all of its functions. The cost is only for the extension line to the Amp/Dialer.

Unfortunately Bell will not allow this unless the device has what they call a "Compliance Number". There is none stated in the book so I called Heath and was told that since it is a kit they do not give it a compliance number. To me this is somewhat of a waste, causing the builder to have to go through a lot of extra expense and the trouble of other devices when Heath claims that the Amp meets all domestic standards.

I wouldn't attach the unit since most phone companies can detect the equipment on a line now. In most states, hookups without paying charges is a form of theft and can be prosecuted under the criminal laws. ☒

—Carmine Prestia

Digital dashboard

Make your dashboard
light up in a blaze of glory.



by Ron Cogan
Contributing Editor

Ever since the first digital calculators with LED displays, we've seen a never-ending onslaught of digital gadgetry hit the shelves to serve just about any purpose imaginable. The automotive field in particular (as we reported in an earlier *Modern Electronics* article on automotive digital instruments) has received its share of attention with mobile computers, digital tachs, and so on—but the onslaught continues. And one of the newest digital entires represents about the best we've seen: The Avatar 8000.

A product of Grass Valley Instruments (12555 Loma Rica Dr., Grass Valley, California 95945), this top-of-the-dashboard cluster offers more conventional engine monitoring functions than most other components in its class. Its functions include a digital speedometer, elapsed time counter, digital clock, two digital temperature readouts, battery voltage, and linear and digital tachometers. The digital thermometers include a threaded probe and a surface sensor that can be used to monitor any two of either engine coolant, oil, intake, cylinder head, drivetrain temperatures, or ambient air temperatures inside or

outside your vehicle as desired.

One of the nicer features of this cluster is the digital speedometer. Accurate at all speeds, with bright, full half-inch display, this digital speedometer can be set to compensate exactly for your accessory tires or gearing changes. The speedometer's infra-red optoelectronic speed sensor is easily installed in-line on your speedometer cable and will not affect the operation of your existing speedometer. This instrument allows instant driver recognition of speed at the slightest glance.

With a faster response than the quickest revving engine, the linear tach display flows sequentially from left to right precisely tracking the full dynamics of crankshaft speed. The component is totally electronic and the first of its kind available with three owner-programmable, full-scale RPM ranges: 6,000, 9,000, or 12,000 RPM, making it field-resettable to suit the performance range of your engine. This unit is also programmable for 4, 6, or 8 cylinder engines. (Model 8000-C is available for 12 cylinder applications, also.)

The Avatar 8000 comes complete with

the main display unit, an umbilical cable (which connects between the display unit and wiring harness), a wiring harness, and an installation kit designed for easy installation with only basic hand tools. The kit includes a speed sensor and clamps, two temperature sensors, velcro mounting strips, calibration screwdriver, grommet, cable ties, wire splice connectors, and a complete installation/operation manual. As opposed to many of the latest electronic gadgets designed for automobiles, Grass Valley Instruments has gone to great lengths to provide all of the hardware and information necessary to make the installation a very easy one for do-it-yourselfers.

Another outstanding feature of this product is that plenty of time has been spent in making the unit a stylish one that actually enhances the appearance of your dashboard. This, combined with the fact that it can either be mounted atop the dash or flush-mounted in a console, makes the Avatar 8000 an extremely handsome package. The housing boasts a recessed display with sun shield to make the displays highly visible even in bright sunlight, and a dimmer



First step in the installation sequence is to route the umbilical cord up to the top of the dash where the housing will be located. Next, run the wiring harness through the car's firewall and into the engine compartment.



The wiring harness should be carefully pulled through the hole in the firewall so no slack is left inside the cab.

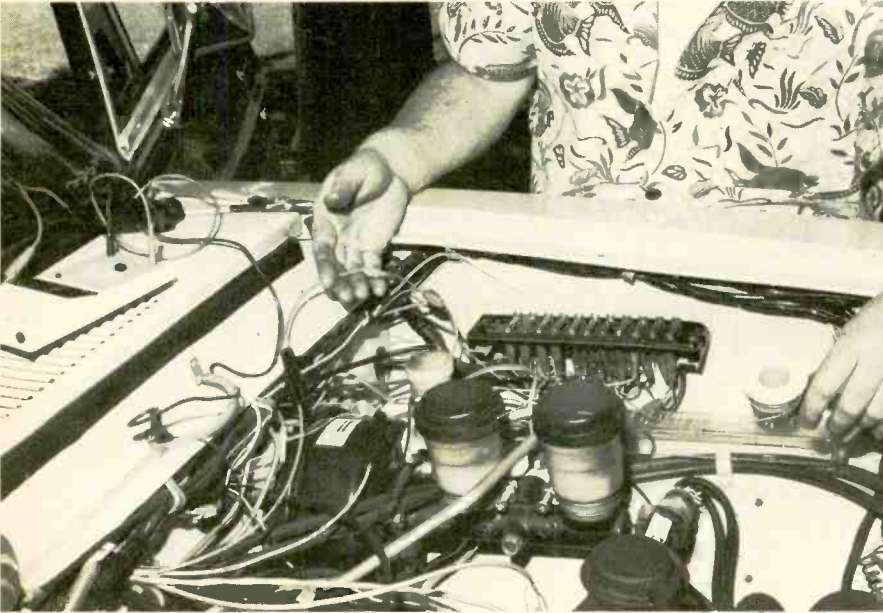

The Avatar 8000 installation kit provides assorted insulated connectors that make tying into existing power wires a cinch if you choose not to hook them up directly to the terminals at the fuse block.



You will need two power wires for the cluster instruments: one that is hot all the time, and one that is hot only when the ignition key is turned on. Use a meter to locate the appropriate terminals for this at the fuse block.

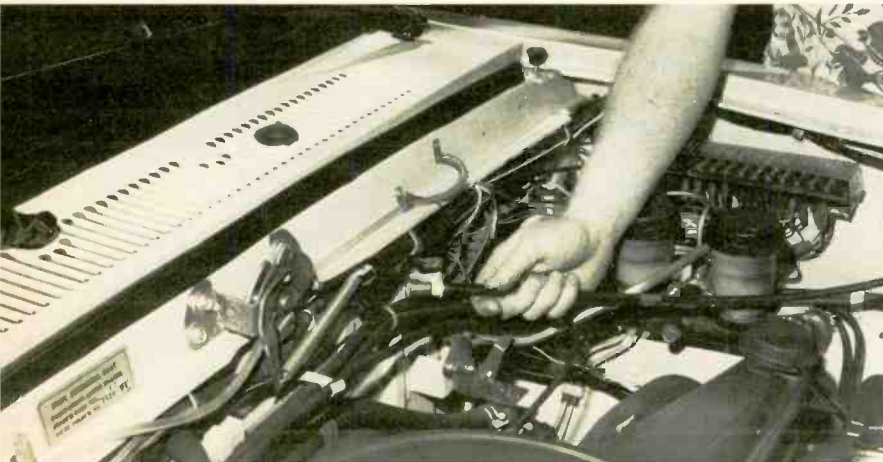

Disconnect your car's speedometer cable at the rear of the speedometer and pull it completely outside of the vehicle.



The installation directions outline how the speedo's plastic must be cut and the unique speed sensor installed in-line on the cable. The cable itself is not cut in this procedure.

switch so the brightness of the display can be toned down at night.

An offshoot of the basic Avatar 8000 is the 8000-C that offers the *Qualifier* in lieu of the digital clock. The *Qualifier* is a high resolution elapsed-time timer that allows a driver to measure and confirm the effect of performance adjustments performed on his machine. With the vehicle stopped, pre-set the *Qualifier* to the speed desired at the end of the acceleration run and push the 0-MPH button. The system is now ready to make a timed run. The timer automatically starts the instant your vehicle begins to move and, when the present speed is reached, the elapsed time for the run will be locked into the display until reset. This unique system eliminates the need for external starting lines or traps and allows a driver to devote full attention to driving for a minimum ET. Of course, the *Qualifier* is recommended for off-highway use only.

Overall, we're very impressed with the Avatar digital cluster system. A sample installation and field testing proved that the Avatar 8000 is easy to work with and a viable addition to a vehicle's existing instrumentation system. In fact, if the cluster is positioned at a spot within easy eyeshot on the dashboard, you'll likely find that you'll be reading the digital speedometer display instead of the standard one in your stock cluster without even thinking about it. Its high visibility and digital readout simply makes the job of keeping track of highway speed an easier one at a glance.

Further information on the Avatar 8000 may be obtained by contacting the manufacturer or writing RLS Industries, 799 E. 7th St., Upland, California 91786.



Certain wires from the wiring harness are then connected to the terminals on the speedometer sensor. Again, plastic insulated connectors are utilized.



The linear tachometer, digital tachometer, and clock are programmed at a programming switch array found at the bottom of the cluster housing.

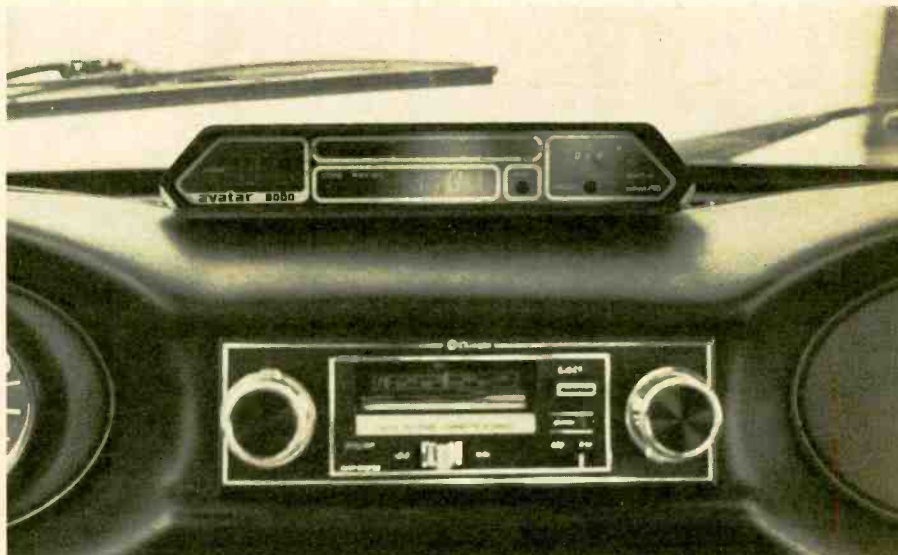

The self-stick velcro mounting strips are secured to both the bottom of the cluster housing and the top of the dash — then the two are pressed together. The cluster is now securely held in place and ready for action.

TV Interfaces

continued from page 36

most of the time. Each time the beam moves to a new letter position, the RAM memory outputs the code for that letter because it is in the read state and it gets the address for that letter from the address counters.

The ASCII letter code is sent to an ASCII to 5x7 dot decoder integrated circuit. This is a special kind of ROM or read-only-memory IC which holds the

The cursor position—the location where the cursor box or underline is, and where the next incoming letter should appear—is sent from the cursor counters to the cursor address comparator just above them. This address comparator also gets the outputs from the two address counters in Figure 9.

Every time the two incoming addresses match, indicating that the CRT beam is in the spot where the cursor should be, the comparator outputs a pulse to the write gate, enabling it to do a memory write (store) if its other input is also present. The match signal also goes to the video generator circuit of Figure 8 to put a marker at that spot on the screen.

The remaining portion of the circuit receives characters from the computer and processes them. Each time the computer sends a new letter or other character to the terminal, it provides the ASCII character on the input lines, plus a strobe signal which tells the terminal, "Here's the next character!" The ASCII character is sent to the RAM memory, but not written into it just yet.

The character is also sent to the control character decoder shown in Figure 11. The decoder looks at each character as it comes in and analyzes it. Characters coming in could be letters, numbers, punctuation marks such as periods or quotes, or special characters called control characters. Letters, numbers, and punctuation should be stored and displayed, but control characters shouldn't.

Whenever the decoder recognizes something other than a control character, it sends out an output called 'not control character' which goes to the memory write gate. Finally, when the memory address—and beam location—matches the cursor position, this new character will be written into the correct place in memory.

The 'not control character' signal also goes through a delay circuit and then to the cursor counter. Thus, a short time after the new character has been stored in memory, the count in the cursor counter is increased by one, and the cursor moves over to the next empty spot.

When the cursor has moved all the way over to the end of the line and the counter reaches its maximum count, the next incoming character makes the letter counter go back to zero, while the cursor row counter goes up by one. Thus the cursor moves all the way left, and one row down. The same thing occurs if the control character decoder detects a CR or carriage return character.

One last part to be explained is scrolling. One way to achieve scrolling—moving every letter in the display one row up—is by actually moving every letter inside the memory to a new location corresponding to where it should be. The easier method is to fool the memory into thinking everything has been

moved without actually doing it.

This trick is done by simply sending an extra pulse into the row address counter, counter B in Figure 9, adding one to the row counter. This makes the row address counter fall out of step with the text row counter in Figure 7. Now the memory thinks it's in one place on the screen, when in fact the actual beam position on the CRT is one row higher. As a result, everything moves up one row.

Conclusion

There you have it! If you have stuck through to the end, you now know what is inside those CRT terminals which you see not only attached to home computers, but also in banks, stores, and even in the Motor Vehicle Bureau. We have not covered every circuit in the terminal, and certainly haven't gone down to look at actual components that do every function, but we have looked at the overall operation of every major block.

There are, of course, other major parts in a typical CRT terminal, such as a keyboard for input, or a communications adapter which allows both the keyboard and the video interface to communicate with the computer through either just one small cable, or perhaps through a telephone line.

We covered keyboards in a June article, and we will cover computer data communications in a future article. ☐

Stereo

continued from page 16

takes a first-rate amplifier and speakers to bring out the full quality of sound from these top-notch decks.

Multiple motors

Operating features vary considerably from one model to another in these top-rank designs. Many now have a third head for monitoring the tape while it is being recorded. This lets you hear what is actually getting on the tape. In the more common 2-head models you only hear the signal going into the recorder.

Most decks in this class also have vernier controls for adjusting the bias current precisely to the requirements of any particular tape type. You will also find many different kinds of recording level meters, some using LEDs rather than dials and pointers for quicker indication of level peaks, and some have special adjustments to "hold" peak readings, so you can tell afterward if the tape has been overloaded at any point by a loud passage.

To single out just a few excellent models, Kenwood's KX-1030, and JVC's KD-75 sell below \$400, while the Pioneer CT-1000 (\$600), the Aiwa AD-6900U (\$800), and the Tandberg TCD 310 Mk II (\$500) are among the finest recorders anyone might wish. There are even more expensive models, but to my ears they don't sound any better. ☐

come from the computer will be placed.

The cursor control circuit not only does this, but also allows the new letter to be written into the memory, replacing whatever was there before. Moreover, when an entire screen is filled up, the circuit provides scrolling of the display. Scrolling erases the top row of letters, moves all other letters up one row, and then fills incoming letters into the bottom row, which has just been emptied.

Figure 11 shows the basic cursor and scrolling circuit. At the heart of this circuit are the two counters at the bottom. These counters indicate the row and letter where the cursor should be.

Blind hams see the world through radio

Sightless amateur radio operators use their hobby to find the world.



by Bob Margolin, K1BM
Assistant Editor

"I don't want to be thought of as being just a blind man!" The words are those of Ray McGowan, WB0BVI, but express the feelings of most handicapped people. Yet, for those who are able to leave their homes, handicapped people are judged on the basis of their handicap.

How many times have you heard someone described as that "blind lawyer" or that "crippled accountant"? Perhaps that's why amateur radio plays such an important part in the lives of handicapped amateurs. It is one of the few activities in which the handicapped are judged solely on the basis of their individual merit—the manner in which they operate their stations.

To the blind amateur, ham radio also serves as a window to the world; a way to "see" the people and places that would otherwise be part of the external darkness in which he lives.

"Ham radio allows me to 'see' the world better than if I were sighted . . ."

Keith Harlow, WA7RKN, puts it this way: "It's a fascinating avocation that allows me to 'see' the world better than if I were sighted and on tour or just riding around the countryside. Ham radio affords me a chance to meet a great many interesting people I would other-

wise never know. It broadens my life experience by exposing me to people from all over the world with whom I can talk about most anything."

These sentiments are seconded by Craig Martin, WB0WPI, also sightless, who says: "The most important things a person can have is friends, and ham radio has been responsible for giving me more friends than I ever thought possible."

Lack of encouragement

If amateur radio has so much to offer the blind, why then aren't there more blind hams? The answer is probably the same reason there aren't more sighted hams—lack of exposure to ham radio, and lack of encouragement and help in getting a ham license. Most blind hams followed the same route to their tickets as did sighted hams.

Take Keith Stowell, WA0YQO, for example. Except for the fact that he is blind, he is pretty much like any other teenager. When he was 10, he discovered two-way radio through a neighbor who was an active CBER. Because of his interest in CB, he was given a CB walkie-talkie as a gift.

It was then just a matter of time before he decided to graduate to ham radio, or as he puts it, "to get on the good bands." With the help of some friends, he tracked down a local ham and got started on the code and theory. In a short time he had a Novice ticket. Not content, he is now working on upgrading and has his "sights" set on the Amateur Extra class.

Irv Sallee, KØPRR, also became interested in two-way radio as a youngster, but that was during the Great Depression of the 1930s. In those days, money for food and shelter, let alone any hobbies, was in very short supply. "I was really interested in ham radio, but without the means of putting together a station, I didn't even bother trying to get a license."

And so Irv forgot all about ham radio and went about the business of living. But, in 1957, he met some hams who reawakened his long dormant interest. Within a year, Irv had his ticket.

The Great Depression

Not all blind hams were sightless when they became interested in amateur radio. Carl Slavens, WAØZIN, is a good example. Carl first became interested in ham radio when he was just 12 years old. A neighbor, it seems, made a practice of cleaning house every so often, and carting the refuse down to the dump. In hopes of finding some "goodies" Carl followed him on one of these trips. The goodies, it turned out, consisted of several issues of a ham magazine. Carl had discovered ham radio.

"I lost my sight, and as far as ham radio is concerned, that was that."

"My first real taste of ham radio was listening to amateurs on a WB12 single-tube receiver. It wasn't much, but I could hear hams all over the country talking to each other." Carl thought ham radio was just fantastic. But it was during the Depression and he had no money with which to put a transmitter on the air.

"I had to content myself with just being an SWL. A few years later, I lost my sight, and as far as ham radio was concerned, that was that." But he did continue to SWL and keep up with developments in radio technology.

Make believe

By 1970, Carl felt ready to try for a license of his own. It was hard work, but he made it. "Ham radio means a lot to me. I've met a lot of people both on and off the air. Through ham radio, I've learned quite a bit about geography, and have expanded my technical knowledge as well. The best part of it is the social contacts I've made through the several radio clubs I belong to. As far as I'm concerned, everyone should be a ham radio operator. It would help make this a better world in which to live."

Another blind ham who got into amateur radio while still sighted is Vince Mader, KØLHG. "When I was a kid, I used to pretend to be a radio operator. I'd string wires up in the trees and connect them to a little audio oscillator and key. But a buddy of mine got his Novice ticket, and I thought, 'if he can do it, I can do it.' And I did." A few years after getting his license, Vince lost his vision.

"Ham radio is a real blessing to me because it lets me continue an activity that I enjoyed before losing my sight. It's one of the few things I can still do more or less just as I did before losing my sight. I do have some problems, though. The problem that most hams notice

is my poor showing in the QSL department. But that's only because I can't read the ones I get, and I can't fill out those I have to send."

Operating achievements

QSLing is a real problem for blind hams. Although they can't really see the QSL cards they receive, most blind hams treasure those they receive every bit as much as do sighted hams. One reason is that QSLs are more than just a record of a previous contact. They also represent to a great many hams the purchase price for operating achievement awards.

One blind ham who is very interested in operating achievement awards is Ray McGowan, WBØBVI. "I have always been interested in meeting challenges and working toward goals. When I got started in ham radio, I became really fascinated with DX. I worked a new country now and then, but all I had was a low power rig. I just could not compete with the high power stations and lost interest. About that time, though, I came across the 20 meter Independent County Hunters Net."

County hunting is one aspect of ham radio that's not too well known by most hams. The basic idea is to make a two-way contact with other hams in each of the 3075 counties in the United States.

Since a great number of counties contain no active hams, and others contain hams that operate on different bands, or use different modes than the county hunter, the only way to work them all is to work mobile stations passing through. To make it easier for the county hunters and the mobiles to get together, several county hunters' nets have been established.

Ray McGowan again: "I really got hooked by the challenge of working all 3075 counties. One nice thing about county hunting is that the nets are set up to help the poor little low power station that always gets frozen out in DX pileups. The only thing that kept me from jumping right in was my inability to QSL. County hunters always send the station they worked a reply card. It has all the contact data on it so the other operator only has to sign it. Makes the QSL return rate much higher. But being blind, I couldn't make out those reply cards."

"Without my QSL manager, I'd still be listening to everyone else having all the fun."

Ray's reply card problem was solved when a local ham offered to act as his QSL manager. "Today," says Ray, "I have a very large collection of QSLs and a wall full of certificates and plaques. You can believe me when I say that no ham takes greater pride in his operating awards than I do. But, without my QSL manager, I'd still be listening to everyone else having all that fun."

Ray's QSL manager is Jackie Mahoney, WAØSHE, better known on the air as Cleo. Although Jackie is sighted, her son lost his sight while in the armed forces.

Because of this, she became interested in the problems of the blind. One problem she is doing something about is that of written communications. "The blind

Kansas City hosts the Kansas State School for the Blind, and is the home of many public service oriented hams. Here's what one group of these hams did to bring the world of amateur radio to seven students at the School for the Blind.

Several of the blind youngsters at the school had at one time or another been exposed to ham radio. Though interested, they had no means of following through and getting their ham licenses. But their desire became known to several of the teachers at the school.

One of these teachers happened to mention the interest in ham radio to a teacher friend not connected with the school. It happened that the friend, Ella Koons, was also a ham, W0AYL. Ella took the request for help to the Jay Hawk Amateur Radio Club, which was already conducting licensing classes for sighted individuals. In addition to Ella, her OM Charles, K0YGP; Jackie Mahoney, WA0SHE; Irene Nichel, WA0SHG; instructor Rich Frenick, WA0OQD; and a non-ham Morse code expert, Joe Bidnick all expressed interest in the project.

The school was very cooperative in setting up the classes and provided a classroom and a radio shack. Some of the students used typewriters, others Braille. All eventually resorted to memorizing everything. All of the instructors agreed that the students were the most eager to learn bunch they'd ever come across. Of the seven who began the class, all made it through to the Novice license. Seven out of seven isn't a bad average for any licensing class. The key to that success was the availability of individual help; there were six instructors for the seven students.

Because of the success rate, and a continued interest by the students to upgrade, it was decided that a General level class would be held. But, for various personal and business reasons, all of the original gang except for Ella and Jackie had to drop out.

The two gals decided to go it alone. The students absorbed the new material with amazing speed. Jackie recalls that it would take her hours to prepare diagrams in Braille, but that within 15 minutes the students had them totally memorized. As the class progressed, it became clear that the two girls just couldn't handle seven exuberant youngsters. With some reluctance, they bowed out in favor of an experienced instructor, Jack Rybern, W0WXX.

Because of the lack of individual instruction that marked the Novice class, and because of the difficulty experienced by the students at copying higher speed code, four of the seven dropped out. Of the remaining three, only one, Craig Martin, WA0WPJ, upgraded. But the material contained in the course provided a good background for the other two who did upgrade later.

Was it worth the effort. You bet it was. Says Jackie Mahoney: "We all had a hand in widening the worlds of three blind youngsters through ham radio. It's very satisfying to know that."

need more than just a QSL manager. They need to keep just as informed about ham radio as does the sighted ham. But, the blind amateur can't make use of the printed newsletters and bulletins used by sighted hams.

To the county hunter, the monthly MARAC Newsletter is the bulletin to read. It contains comments of other county hunters, contest notices, and most importantly, itineraries of proposed mobile station operations.

Recorded newsletter for the blind

Though the actual number varies there are at least a dozen blind amateurs actively involved in county hunting. And all of them really need the information contained in the MARAC Newsletter. A few years ago, MARAC, which is the Mobile Amateur Radio Awards Club, was asked to provide recordings of the Newsletter for the blind county hunters. Because of her other work with the blind, Jackie was asked to make the recordings—and she eagerly agreed to do so.

"Individual members of MARAC donate the funds to cover the cost of blank tape and postage. At first I just recorded the monthly Newsletter. But now I have

available on tape not only the complete MARAC awards program, but the awards programs of several other organizations. I also provide recordings of convention news, and excerpts of articles that would interest blind hams."

Jackie's tapes are used by blind hams from coast to coast. One of these is Ben Scothorne, K1UNM. "I first became interested in ham radio back in the '30s when I was in high school. I even learned the code, but it wasn't until 1962 that I got my first license. I've always enjoyed ham radio, but after losing my sight in 1975, it's played a much larger part in my life. I'm very fortunate that I had my station all set up before losing my vision. It would have been a lot more difficult starting from scratch now."

For the sightless individual, setting up a station is a near impossibility.

Ben, in his comments, has pinpointed another problem facing the blind amateur. For the sightless individual, setting up a station is a near impossibility without help from sighted hams. Imagine trying to erect an antenna without vision! Or connecting the right cable to the right jack.

Some blind amateurs are fortunate enough to have neighbors who are willing to lend a helping hand. Ben is one of the fortunate: "I can truthfully say that I have had no problem whatsoever in getting help—my friends, neighbors and fellow hams are most anxious to continue their help. This is what ham radio is all about."

For those not as fortunate as Ben, getting a station on the air is only the beginning.

Ray McGowan puts it this way: "A blind person can quite easily adjust the wrong control or make an incorrect setting that blows his rig. A sighted person would have little trouble getting himself back on the air. A blind person, however, must either get outside help or trade the rig in for another one in working condition. That can get to be pretty expensive."

As great as the problems facing the blind amateur may be, the rewards are even greater. Not only does the blind amateur gain from the on-the-air activities, but also from an expanded person-to-person social life. Consider, for example, the Kansas City Association for the Blind Amateur Radio Club.

The club is an outgrowth of the desire by six blind amateurs working at the Federation for the Blind Workshop to have a club of their own. What they needed was a sighted ham to help them organize the club, keep records, act as trustee for the club station, and of course, help set up the station. But, for a while anyway, there was no outside help available, and the club remained just one more frustration in the lives of the blind hams.

Blind hams radio club

Eventually, word of the proposed club reached the ears of Jackie Mahoney, who was already involved in recording material for the blind and acting as QSL manager for Ray McGowan. But always willing to pitch in, Jackie rounded up two other sighted hams to help get the club started.

"We had a lot of fun getting it off the ground. Today," Jackie reports, "we have more than 60 members, only about half of whom are blind. About 40 of the members are licensed amateurs. But, the non-ham members are among the club's most enthusiastic supporters, probably because of social contacts it provides. We have a year-end dinner dance and a summer picnic. Field Day is also very popular."

The club owes quite a bit to the generous support provided by the Federation for the Blind Workshop. The Federation donated a meeting room and provided a ham shack for the club's station, WBØLIG. It also takes care of the club's insurance. Most of the club's treasury, though, is generated by its annual auction at which donated goods are sold.

The club has had a large influence on the lives of its members. A good example is Burl Masters, WBØEJJ. One of the original six who founded the club, Burl served as its second President, and has served since then in various other club posts.

Ham radio licensing classes

Says Burl, "Ham radio means the world to me. It's a great hobby for the blind because it lets them make friends all over the world from the safety of their own homes. One of the first things we did after starting our club was form a licensing class so more handicapped people could get into ham radio."

One of the first to take advantage of the classes was Dorothy Swearingen. Although a non-ham, she had worked very hard to get the club going. Because of her exposure to the hams at the Workshop, she became interested in the hobby herself. But, it wasn't easy. "I had a lot of trouble with the code. Not the usual trouble everyone has with it, though. The problem I had, and for that matter, every blind person has, is copying it. For the sighted person, it's easy—he just writes it down on paper. But a blind person can't write. We have to either remember what we heard, letter for letter, or try to simultaneously translate it into spoken words. If you think it's easy, you try it!"

As difficult as it was, and as difficult as it was to master radio theory, Dot did master it. Today, she is WBØMCK. In addition to serving as the present club Secretary, she has the distinction of being the club's only sightless woman op. "My interests in ham radio have expanded my activities far beyond the Workshop. I'm very active in several nets including the Handicap Net and the Handicap Internationals Net. I also serve as the Recording Secretary for the Allied Workers of the Blind."

Schematic diagrams in Braille

Ham radio does indeed have a lot to offer everyone, but especially the blind. Yet getting a ham license is much more difficult for the blind than for sighted individuals. As Dot Swearingen pointed out, copying the code is a real problem.

There are some theory books available in Braille, but they are very large and bulky. And, as far as the rules and regulations are concerned, they are outdated. While many blind hams succeeded on their own, special licensing classes for the blind make it much easier to succeed.

Conducting a licensing class for the blind is not an easy matter. For one thing, schematic diagrams must be produced in Braille; not just the wording, but each line,

each symbol. Producing a schematic diagram in Braille can take hours.

Blind students, not being able to see what's happening, tend to ask a great many more questions—many of which sound idiotic to the sighted person. It takes a great deal of patience to handle such a class, but it's worth it. After all, where else can you give someone the opportunity to meet the world?

If you are reading this and you are a licensed ham, the blind need your help. They need you to encourage them and to help them with the code and theory so they too can get a ham license. They need you to help them select good equipment. Then need you to help set up their stations, erect their antennas, and generally get them on the air. They need your help in keeping their stations on the air—replacing damaged parts, getting their antennas back up after a storm, and performing general maintenance. They need your help in QSLing and in applying for operating achievement awards. They need your help in learning about rules changes, advances in technology, new equipment, and social activities.

Yes, the blind do need our help. But, although sightless, the blind are people, just like you and me. It's difficult for any of us to ask for help. It's doubly difficult for the blind because for the most part, their friends are non-technical people; some are also handicapped. That means the burden is on us. It's up to us to find the blind or handicapped ham who needs our help. It's up to us to find the blind or handicapped individual who wants to become an amateur, but doesn't know how. It's up to us to tell the blind and handicapped individual what ham radio can mean to them. It's up to you. ☐

"Maybe it will go away."

The five most dangerous words in the English language

American Cancer Society
We want to cure cancer in your lifetime

Motorcycle mobile: how to put a radio on your bike

Here's how one experimenter built a CB radio, a ham radio, a linear amplifier, a music radio and an electrical control box into his motorcycle for drive-around mobile fun.

by Roy Goshorn

Two way radio communication from moving vehicles has been around since the 1930's when transmitters and receivers were first installed in police cruisers. The tube type equipment was bulky, relatively low powered, and prone to all types of interference because of the frequencies just above the standard broadcast band that it operated on.

Refinements were relatively few until the advent of World War II when good mobile communication became a necessity. Extensive research and development went into all sorts of mobile communication gear that could be installed in various types of military vehicles.

Following the war, mobile communication reverted once again to experimental work done mostly by amateur radio buffs using surplus gear that formerly saw duty in a tank or a jeep. It wasn't until the early 50's that major manufacturers seized the opportunity to better equip police and taxi vehicles with more reliable vhf (very high frequency) equipment. The mode of transmission was also switched from am (amplitude modulation) to fm (frequency modulation), which helped somewhat to lick the interference problems.

Solid state devices

Refinements brought on by the development and wide spread use of the transistor and other solid state devices in the 1960's now make it possible for everyone to have good reliable mobile communications, even on motorcycles!

Millions of CB (citizens band) radios are connected to whip antennas that protrude from all sorts of motor vehicles.

Ham radio operators joined the craze due to the widespread availability of *two meter* transceivers and the installation of *repeaters* on mountaintops or high buildings across the country.

Ma Bell and other commercial telephone systems and answering services hopped on the band wagon so that just about anyone for about any price can have some form of mobile communications.

All of this is fine if you own a truck, car, or van. But what about all those two wheeled cycles on the road? Not to be outdone, motorcycle enthusiast James Young, of Bellwood, Pennsylvania, has combined a CB, ham, am-fm radio, intercom, public address system, and control panel onto *one* handlebar.

Young, operator of amateur radio station K3FGL and CB station KDY-1033 is both an avid radio amateur and a CB'er. He is the first person I know of who has



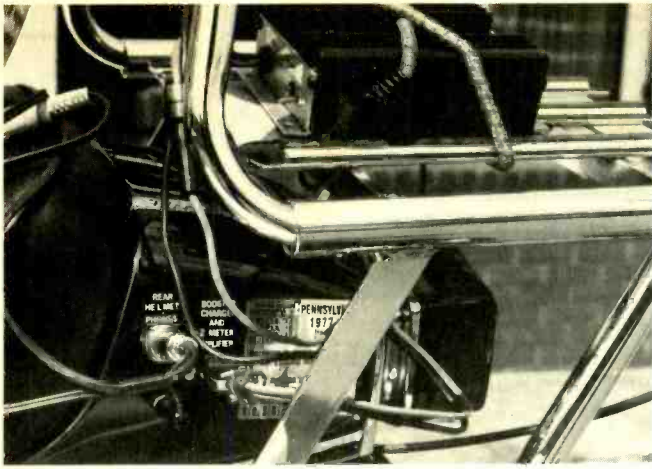

successfully conquered the communications gap, motorcycle wise.

Adapting all the electronics to a Honda-750 Supersport was no easy task. He says it took many months of mental planning, and even longer to construct, with delays of weeks to months from problems that he didn't even anticipate.

The hardest problem to deal with was the elimination of *ignition noise* from the Honda's 4-cylinder engine. Motorcycle manufacturers usually aren't interested in completely suppressing electrical interference caused by the engine's spark plug and alternator, so Young was forced to completely re-work the entire electrical system to eliminate that familiar *pop pop* noise generated by plugs and picked up by radio receivers.

Using the *braid* or woven copper outer covering from good quality RG-8 coax cable, Young completely shielded all electrical circuits by re-routing them through the braid and then grounding it to the cycle's frame.

Every circuit from headlight to rear turn signal lights was shielded in a similar manner. The braid was then wrapped in plastic tape, harness like, to protect it from weathering and to enhance its appearance.

Extra care was taken when shielding the cycle's four high voltage spark plug leads to each cylinder. Here again, he used RG-8 shield to cover the high tension leads along their entire length. Both ends were grounded, one to the cycle frame and the other end to the cylinder head near the spark plug. More than 60 feet of braid was used in the shielding operation.

Next Jim added two additional electrical circuits to the fuse panel located just under the saddle on the bike. Both circuits are designed to provide 10-amps of current; one circuit to the transceivers and control panel mounted on the handlebars, and the other circuit to a female *Cinch/Jones* connector mounted about midpoint on the left side of the rear fender.

This 12-volt power source is used to power a 50-watt two meter amateur amplifier that he uses to boost the output power of the ham radio transmitter. Again all electrical wiring was shielded.

Stainless steel coiled straps were fashioned out of heavy stock metal so that he could provide three separate mounting brackets for the radios and control panel on the cycle's handlebar.

The brackets attach directly to the handlebar at an angle so that the ham and CB radios are just slightly

below the mid-point of the bar. The brackets are coiled to act as a shock absorber preventing road and motor vibrations from reaching the delicate electronic components inside the transceivers.

The master control panel, mounted on it's own bracket is installed slightly above the handlebar directly in the center of the bike. The am-fm radio rests next to it and slightly to the right. Prior to installation all three mounting brackets were wrapped with aluminum reflective tape to enhance their appearance next to the chrome handlebar.

Radio control panel

A 10-amp circuit running from the motorcycle's main fuse block feeds the 12-volts of electricity needed to power each radio and the control panel. Each radio and the control console is wired directly into this circuit through a set of connectors.

Coax cables from the antenna outputs of an Icom-22S, two meter amateur radio, and a Teaberry T-Charlie 40-channel CB radio are routed along the bike's main frame to the rear fender antenna mounting bracket. There, a Francis four-foot fiberglass motorcycle CB antenna is coupled to the Teaberry T-Charlie radio.

The Icom-22S ham rig couples to a Newtronics 5/8 wave whip antenna via a 50-watt M Tec power amplifier mounted on the rear fender luggage rack directly in front of the antennas. Both whips are mounted on a common steel plate bolted to the rear fender at about the tail light level.

The Honda's heavy steel frame and fenders provide an adequate counterpoise or ground plane for both antennas. Jim reports no difficulty in tuning each transmitter to its antenna, and he says that the SWR (standing wave ratio) is very good.



The control console, which switches and monitors all electrical and two-way functions, is constructed in miniature and housed in a 2 x 6 x 3 inch aluminum box. Basically the control console switches the crash helmet mounted Super Ex combination microphone and headset from ham transceiver to CB set.

The control panel also routes audio from the output of both transceivers or the am-fm radio to the rider and passenger's headsets.

That same audio can also be switched to an external public address speaker mounted on the left front wheel fork near the turn signals. Audio from any or all accessories can be monitored this way when the cycle is



parked or the driver is away from the unit.

He wired the output from the CB public address function to the front speaker so that he can use it as a hailer should he need it. This same audio normally is switched to the helmet headsets combination so as to serve as an intercom between driver and passenger while in motion.

Other switches permit Young to switch on and off the two meter ham amplifier while in motion. When parked he can plug the entire electrical system into an external power supply and run it from the power mains so as to not discharge the bike's wet cell battery. LED's (light emitting diodes) serve as pilot light indicators to show what function the control console is switched to.

The main rotary switch in the control box uses 32-separate contacts to do all the switching. He extensively modified the switch by extending the selector shaft and adapting it to another set of eight contacts. An *L pad* audio volume control circuit was also installed in the console so that some control over volume levels between each function could be obtained.

Telephone calls

A CES telephone tone pad was installed on the amateur transceiver so that Jim can use repeater autopatches and make telephone calls directly from the cycle. The tone pad, when coupled to the ham transmitter, acts like a telephone dial. The amateur radio two meter transceiver carries the audio to and from the repeater which automatically switches Jim's call to a telephone line.

Hundreds of amateur radio repeater autopatches are in use across the country. Many can be accessed by hams from their vehicles or portable units for non business phone calls or emergency messages.

Power consumption was a major factor in his selection of equipment when designing the cycle. The Honda's alternator puts out about 15 amps at 14 volts when the motor is running. The electronic equipment when running uses about the same amount of power. Total drain on the system with the bike's lights on is 19 amps. So it's obvious that he can't have all the lights burning when the radios are playing.

But Jim says this high current drain never happens because even at night with all the lights on, you can listen and transmit on only one radio at a time. Nevertheless he does practice power conservation until an experimental high output power system he is attempting to match to the Honda is further developed.

He has experienced no major power problems yet,

not even a blown fuse!

Extensive on the air testing of both transceivers from various locations near Jim's central Pennsylvania home have proven successful. Because of QRM (interference) and the general overcrowded conditions of the citizens band frequencies, his normal CB coverage is about 15-miles depending upon location.

He has talked farther when he has taken the cycle to mountaintop parks where the higher altitude and line of sight transmission increased his normal range to 30-miles. For on the road driving, Young says coverage is about the same as one would expect for a car or truck.

Because of amateur repeaters, Jim's ham two-meter transceiver has a much wider coverage from the cycle. Even without his 50-watt amplifier, he normally can use five or six repeaters within a 60-mile area. When operating on a mountaintop, Young claims coverage of at least 100-miles or more. In on-the-road general mobile use, however, his normal operating range is about 40 to 60 miles.

He is never out of range of someone to talk to either on CB or ham radio. Jim says that his am-fm radio is always in range of a local broadcast station.

Jim and his wife have taken numerous day-long and weekend trips on the radio equipped cycle. They are never out of touch with the homebase and thanks to other good buddies, know the 10-20 of every smokie along the highways. Both radios also have been used to summon police and emergency vehicles to highway accidents that Young has happened upon.

They feel that the installation has been a great aid while out on the road and away from home.

His next project is a similar installation geared to police communication needs. His plans, which are already well underway, envisions a police vhf (very high frequency) transceiver, a CB radio and a scanner on the handlebars of the police model. 



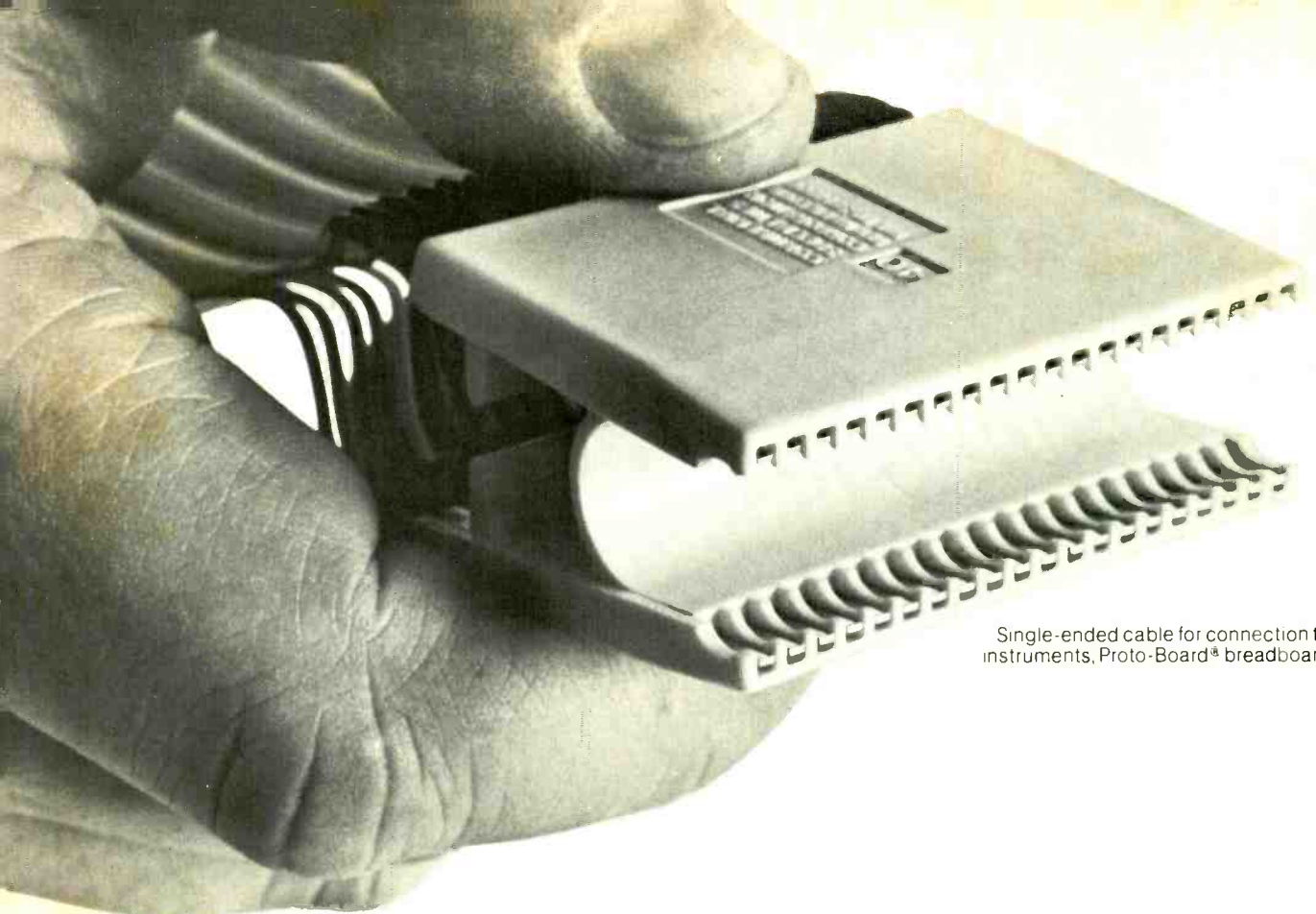

Single-ended cable for connection to test instruments, Proto-Board® breadboards, etc.

WHEN IT COMES TO DIP's, WE'VE GOT THE BEST CONNECTIONS.

With today's high-density packaging, one accidental short can wipe out an expensive IC, turning test procedures into painstaking manual labor. And minor problems into major repairs.

The answer? *DIP insurance*. Fast, fail-safe, short-proof access to DIP nodes. In other words, CSC's patented Proto-Clip™ IC test connectors.

Proto-Clip IC test clips are available with easy-access top pins shaped to prevent hook-clip slip-off; or attached to one or both ends of color-coded cables. The double-ended cables make the job of patching-in

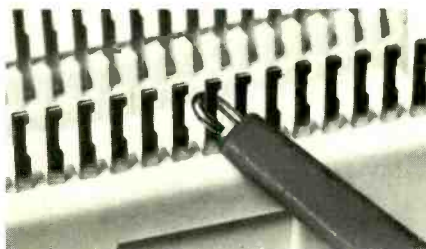

Basic Proto-Clip™ with no-slip terminals for use with hook clips or test probes.

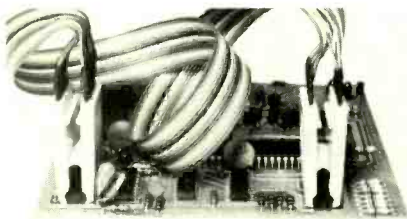

Double-ended cable for convenient IC patching, bypassing, etc.

an IC, or getting to an unused logic block easier.

Order Proto-Clip connectors in 14, 16, 24, or 40-pin configurations, for all popular IC's. And single or double-ended connector/cable combinations in 18" and 36" lengths. Whatever sizes suit your needs, you'll find that in time and components saved, they'll pay for themselves the first time.

Order today. Call 203-624-3103 (East Coast) or 415-421-8872 (West Coast): 9 a.m.-5 p.m. local time. Major credit cards accepted. Or see your CSC dealer. Prices slightly higher outside USA."

CONTINENTAL SPECIALTIES CORPORATION



© 1978 Continental Specialties Corporation

70 Fulton Terrace, Box 1942, New Haven, CT. 06509, 203-624-3103 TWX 710-465-1227
WEST COAST: 351 California St., San Francisco, CA 94104, 415-421-8872 TWX 910-372-7992
GREAT BRITAIN: CSC UK LTD., Spur Road, North Feltham Trading Estate, Feltham, Middlesex, England, 01-890-8782 Int'l Telex: 851-881-3669
CANADA: Len Finkler Ltd., Ontario

CIRCLE 97 ON READER SERVICE CARD

