

June 1978 \$1.50

Colorful
summer-fun gear
30 new, exciting goodies
pages 68-77

modern electronics

ⓔ 06707

Pro's workbench secrets

- how to buy parts cheap
 - how to substitute parts
- page 36

Heathkit home computer

- how it works
 - what it can do
- page 26

Computer keyboards

- how they work
 - what they'll do
- page 61

14 easy projects

- Whizbox
- $4 + 1 = 6$
- Countdown timer
- 11 projects under \$11

Decibels explained

page 82

In-dash CB

the latest gear
page 34

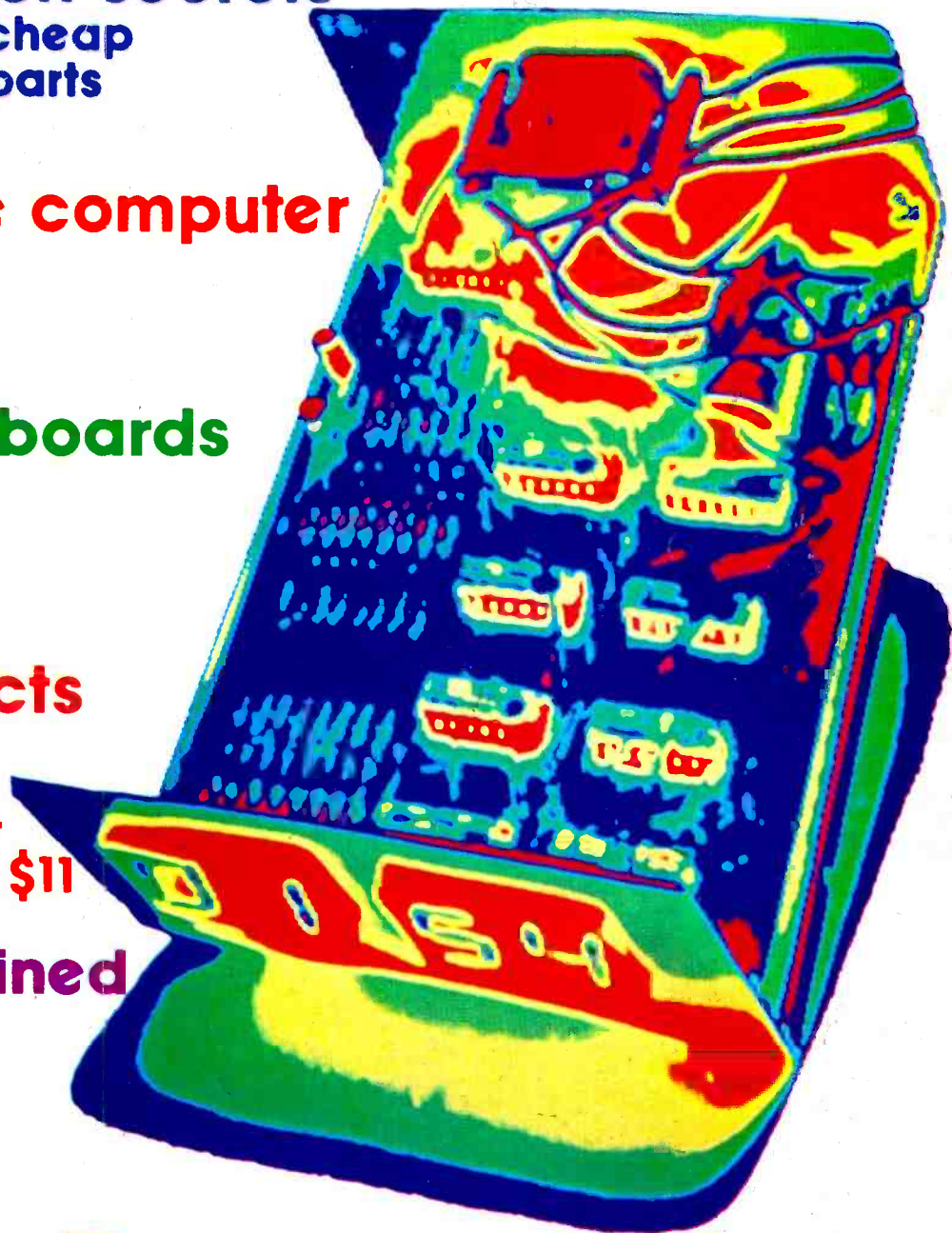

Downcounter

easy-to-build game timer
page 21



The Cobra 50XLR CB has it all. AM/FM Stereo. Cassette. And CB. All in one compact unit. All engineered to bring you the same loud and clear sound Cobra is famous for.

The remote mike houses the channel selector, squelch control, and channel indicator. So all you need for talking CB is right there in your hand. The cassette player features through the dial loading and four-way fader control.

Because they're only five inches deep, there's a Cobra in-dash radio to fit almost any car with little or no modification to the dash. This feature, plus the step-by-step Installation Manual and Universal

Installation Kit makes them the easiest in-dash radios to install. And our Nationwide network of Authorized Service Centers makes them the easiest to service.

There are four Cobra in-dash models to choose from including AM/FM/Stereo/8-track/CB. But no matter which you choose you can be sure of getting the best sounding radio going. The ultimate car radio.

The Cobra.



Punches through loud and clear.

Cobra Communications Products
DYNASCAN CORPORATION
6460 W. Cortland St., Chicago, Illinois 60635

Write for color brochure

EXPORTERS: Empire • Plainview, NY • CANADA: Atlas Electronics • Toronto

FCC Approved

THE ULTIMATE CAR RADIO.



CIRCLE 97 ON READER SERVICE CARD

WHY SETTLE FOR LESS— THAN A 6800 SYSTEM

MEMORY—

All static memory with selected 2102 IC's allows processor to run at its maximum speed at all times. No refresh system is needed and no time is lost in memory refresh cycles. Each board holds 4,096 words of this proven reliable and trouble free memory. Cost—only \$125.00 for each full 4K memory.

INTERFACE—

Serial control interface connects to any RS-232, or 20 Ma. TTY control terminal. Connectors provided for expansion of up to eight interfaces. Unique programmable interface circuits allow you to match the interface to almost any possible combination of polarity and control signal arrangements. Baud rate selection can be made on each individual interface. All this at a sensible cost of only \$35.00 for either serial, or parallel type

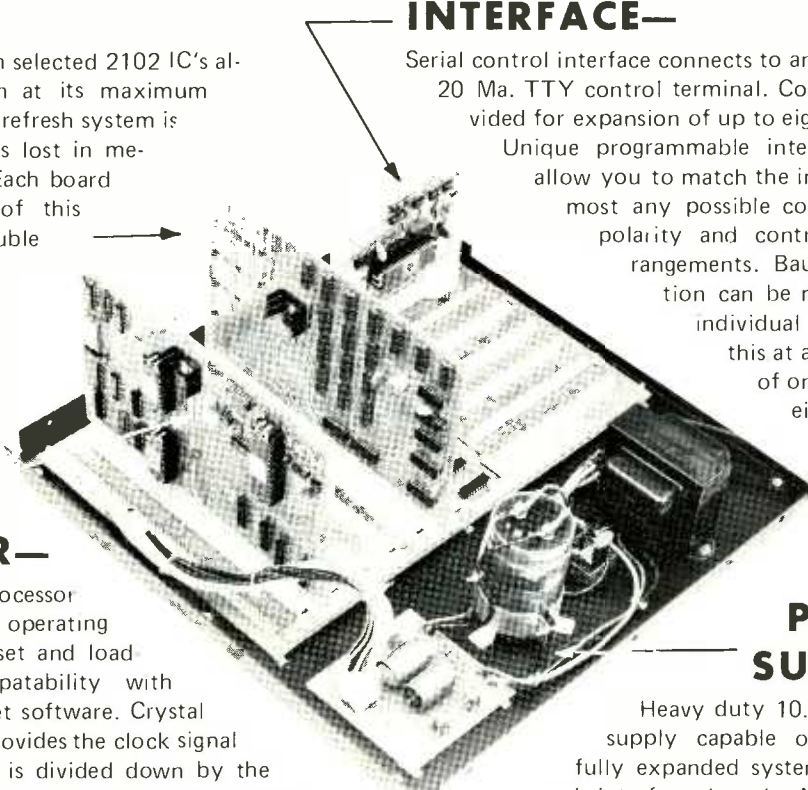

PROCESSOR—

"Motorola" M6800 processor with Mikbug[®] ROM operating system. Automatic reset and loading, plus full compatibility with Motorola evaluation set software. Crystal controlled oscillator provides the clock signal for the processor and is divided down by the MC14411 to provide the various Baud rate outputs for the interface circuits. Full buffering on all data and address busses insures "glitch" free operation with full expansion of memory and interfaces.

POWER SUPPLY—

Heavy duty 10.0 Amp power supply capable of powering a fully expanded system of memory and interface boards. Note 25 Amp rectifier bridge and 91,000 mfd computer grade filter capacitor.

DOCUMENTATION—

Probably the most extensive and complete set of data available for any microprocessor system is supplied with our 6800 computer. This includes the Motorola programming manual, our own very complete assembly instructions, plus a notebook full of information that we have compiled on the system hardware and programming. This includes diagnostic programs, sample programs and even a Tic Tac Toe listing.

Mikbug[®] is a registered trademark of Motorola Inc.

SwTPC 6800
Computer System

with serial interface and 4,096 words of memory. \$395.00



Enclosed is \$395 for my SwTPC Computer Kit Send Data
 or BAC _____ # _____
 or MC _____ Ex Date _____

NAME _____

ADDRESS _____

CITY _____ STATE _____ ZIP _____

Southwest Technical Products Corp., Box 32040, San Antonio, Texas 78284



The Touch

by  Regency

16 channel scanner

\$239⁹⁸

SCANNER WORLD, USA now offers you the most advanced scanning monitor available in the world today — "The TOUCH," manufactured 100% in the United States by Regency, makers of the world's first transistor radio.

FEATURES AND SPECIFICATIONS

- ★ Search or scan. You can either search through all bands for unknown frequencies, or listen to the stored frequencies you've selected for the sixteen (16) scanning channels. Either way you can scan any combination of 16 channels in Lo, Hi or UHF Band, creating a total of 15,357 different frequencies available at your fingertips.
- ★ Frequency range Lo Band 30-50 MHz, Hi Band 146-174 MHz, UHF Band 440-512 MHz.
- ★ Receives all public service frequencies including police, fire, ambulance, mobile telephone, FBI, Customs, VHF marine, 2 meter amateur, plus many others.
- ★ Comes equipped with AC power cord for home use, DC power cord for mobile use, telescopic antenna and complete operating instructions for immediate use upon receipt.
- ★ Automatic scan delay momentarily stops the scanning after a call, to wait for a reply.
- ★ Has priority control switch so that you can automatically override calls on other channels and never miss a call on your favorite frequency.
- ★ Discover "Live" frequencies you never knew existed by activating automatic search with a single touch.
- ★ No crystals required — never buy another crystal.
- ★ One year warranty.
- ★ Weather alert receiver will automatically alert you in the event of a severe weather warning broadcast by the National Weather Service (subject to availability by local weather service transmitter).
- ★ Save over \$110.00 from manufacturers suggested list price of \$349.99 because of Scanner World's massive buying power.
- ★ From SCANNER WORLD, all of the above can be yours for only \$239.98 plus \$2.00 shipping. Call 518-436-9606 now to place a Master Charge or COD order by phone. Direct mail orders to the address below, including money order, Master Charge information, or we will ship your order COD. Catalogue \$1.00, free with order.



10—MENEW SCOTLAND AVENUE
ALBANY, NEW YORK 12208
518-436-9606

modern electronics

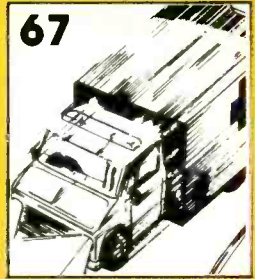

JUNE 1978

CONTENTS

VOLUME ONE NUMBER FOUR

COVER STORY

21



Time your own fun and games

SPECIAL FEATURES



26 Heath home computer
our first impressions of the H8 microcomputer

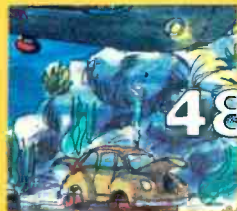

34 In-dash CB roundup
roundup of the best new, secret CBs

44 Paradise via shortwave get there without leaving your armchair

48 Perry people shortwave listener spoils an international plot

54 11 projects under \$11
build these for fun tonight

60 Computer keyboards
one way to talk to your home computer



68 Gear, gear, gear!
colorful assortment of equipment for your summertime fun

EDITOR

Anthony R. Curtis
K3RXK/W8T1Z

ASSISTANT EDITOR
Bob Margolin
K1BM/KA8A6647

CONTRIBUTING EDITORS

Judith G. Curtis
W83AIQ/K1B2647

Hans Fantel

Peter A. Stark

K2OAW

Ron Cogan

Jeffrey A. Sandler

Carmine W. Prestia
W83ADI

Gerald R. Patton

WA3VUP

EDITORIAL ASSISTANT

Jeanne Lang

PRODUCTION MANAGER

Laura Delaney

DESIGN CONSULTANT

Don Mannes

PUBLISHER

Richard A. Cowan
WA2LRO/KG8A096

PROJECTS

36 How to buy parts
get components cheap

37 How to substitute parts switching parts around

65 4+1:6 you can't fool Father Time

67 Whizbox add a European siren to your car

11 Computers Pete on binary numbers

18 Mobile Ron looks at CB headsets

94 Radio Judy tells where its at in the spectrum

INFO

28 Lightning detector
receiver rats on terror tornadoes

30 Plumber's computer
how to get away from a pipe wrench

35 SCRs how these solid-state marvels work

50 WWVB/WWVL very low frequency time broadcasts

53 Stereo pointers
what to look for when you buy a stereo receiver

82 Decibels are there 10 decibels in a bel?

83 Schematics electronic symbols used in our diagrams

85 Electronic car
commuter's car of the future

89 Capacitors
electronic storage tanks

MONTHLIES

6 Letters laurels and darts from readers

14 Clinic readers' mindboggling

40 Program 3 different sets of instructions for your home computer

78 Handbook notes on frequency and wavelength

96 Newscheck late news in the world of electronics

COLUMNS

4 Comment Tony jams police radar

17 Stereo Hans finds better fm tuners

Modern Electronics is published monthly by Cowan Publishing Corp. 14 Vanderventer Ave. Port Washington, NY 11050. Our title is registered with the United States Postal Service. Application for second-class postage is pending at Port Washington, NY.

comment

OUTPUT FROM MODERN ELECTRONICS' EDITOR

BY ANTHONY R. CURTIS
EDITOR, MODERN ELECTRONICS

"Zapping of America" is that ugly new book which is about to scare the hell out of a lot of people who would like to think CB radio, ham radio, marine radio, am radio, fm radio and other benign electromagnetic radiation can hurt them. It's a shame!

Sure, upper-uhf and microwave radio signals can burn you if handled carelessly and with too much transmitter power. Frequencies above 1000 MHz should be labeled, "Hazardous to health." But, show me the solid scientific research demonstrating damage to life forms from five watts transmitter power at 27 MHz, such as in the CB band. Or from 1000 watts between 1.8-30.0 MHz, such as in the shortwave ham bands. Or from your local disc jockey's transmitter at 540-1600 kHz. So far, the zapping of America is a crock of baloney!

I'm talking about long waves, medium waves, shortwaves, very-high frequencies (vhf) and ultra-high frequencies (uhf) up toward 1000 MHz. These seem safe. But, wait. There are radio signals in the dangerous portion of the spectrum to which we are exposed, by the *government*, all the time.

Millions of people drive cars. Millions are clocked by X-band and K-band police radar transmitters. How many times have you glanced down the barrel of a radar unit on a cop car alongside a highway? That's microwave energy, my friend, and you're doing the big *no no*. You're looking directly into the transmitter antenna. Feel your eyeballs frying? Try that one on your lawyer sometime.

Of course I'm tramping on the toes of radar manufacturers and radar-rabid cops. Hear them screaming in outrage that their little old devices couldn't possibly hurt anybody? But, if we are to fear any signals in the air, it should be those dangerous ones to which we are exposed repeatedly. Radar, no matter how weak the transmitter, pointed into our faces over and over on the highways isn't good.

States running radar traps, and which doesn't these days, should have to pass out radiation-dose meters for the dashboards of cars so we can tell when we are beyond a safe limit.

By the way, if you're confused by all this talk about the radio spectrum, join us on **page 94** of this issue of Modern Electronics for a complete explanation. You'll see what signals fall where in the spectrum. And next month we'll have a roundup of the best police-radar detectors on the market so you can practice avoiding those dangerous beams.

Also, in this issue of *ME*: the Downcounter on **page 21** is very unusual in its ability to time your game playing. Counting up is easy, Jeff Sandler found. Counting down is harder. Luckily, our project is easy to build.

Other goodies this month include:

- our first impressions of the Heathkit H-8 home computer on **page 26**;
 - tips from professional builders on how to save money on parts for projects and how to substitute parts, starting on **page 36**;
 - the latest in CB radios to be hidden away inside your dashboard, **page 34**;
 - armchair travel to paradise via shortwave radio, **page 44**;
 - Harold Perry's electronic people on **page 48**;
 - 11 easy-to-build projects, each under \$11, **page 54**;
 - and the very best of new gear for summertime fun starting on **page 68**.
- Check it out. I think you're going to find just what you're looking for in *Modern Electronics* for June!

modern electronics

Business Staff

President and Publisher
Richard A. Cowan
Associate Publisher
Richard A. Ross
Vice President
Jack N. Schneider
Chairman of the Board
S. R. Cowan

Advertising Staff

Display Advertising
Richard A. Cowan
telephone (516) 883-6200
Midwest Sales Director
Jim Reilly
telephone (312) 824-2412
Circulation Manager
Janet Kurtz
Production Consultant
Cary L. Cowan

Art Staff

Art Director
William H. Travis
Assistant Art Director
Liz Beener
Design
Sheryl Stern
Illustrator
Harold Perry
Staff Artist
Fran Vitrano
Staff Artist
Tom Batchner

Property rights

All circuits, designs and construction projects in Modern Electronics are strictly experimental. We can't guarantee any results to be expected from their use or application. The publisher and editors do not know of any proprietary rights which could be violated by the making, building or using of any projects or gear described in this issue.

Freelance writers

Letters to the editors should be addressed to Modern Electronics, 14 Vandeventer Ave., Port Washington, NY 11050. Our editorial telephone is (516) 883-6200. We can't assume responsibility for unsolicited manuscripts but we will try to handle them courteously. Please mark your name, address and telephone number clearly on each page of manuscripts and on all photographs and artwork. Modern Electronics' readers demand manuscripts, photographs and artwork of the finest quality. Writers, photographers and artists meeting the standards of Modern Electronics' editors will receive prompt professional payment for submissions upon acceptance.

Change of address

Send us word of your change of address as early as possible. We need at least six weeks to make the change in our mailing list. Address changes and Postmaster form 3579 to Circulation Department, Modern Electronics, 14 Vandeventer Ave., Port Washington, NY 11050. Include your old address, new address and a mailing label from a recent issue of Modern Electronics.

Subscriptions

Mail subscriptions are available for \$12 a year or \$22 for two years. Newsstand cover price is \$1.50 per issue. Subscriptions are slightly higher for other countries. Write Circulation Department, Modern Electronics, 14 Vandeventer Ave., Port Washington, NY 11050. This magazine is printed in the United States of America.

Copyright

Copyright to the whole contents of Modern Electronics is held by Cowan Publishing Corp. 1978. You may not reprint any of our material without written permission from Cowan Publishing Corp.

25 million reasons why you should look into NRI training in CB and Communications Servicing.

The CB boom means big opportunities for qualified technicians... learn at home in your spare time.

There are more than 25 million CB radios out there, millions more two-way radios, walkie-talkies, and other communications apparatus in use by business and industry, government, police and fire departments. And all of this equipment demands qualified technicians to maintain and repair it. In addition to knowing what you're doing, you must have an FCC Radiotelephone License to service most of it. NRI can help you get both... the training and the license.

Learn on your own 400-channel, digitally synthesized VHF transceiver or 40-channel CB

With NRI, you learn by doing. You use the NRI Discovery LabSM to build and test a whole series of typical communications circuits, even assemble your own professional transistorized volt-ohm meter and a CMOS digital frequency counter. You erect and test various types of antennas to gain a firm understanding of broadcasting principles. And finally, you assemble your own 2-meter transceiver for experiments in troubleshooting and servicing. If you want to go on the air, we'll even help you get your amateur license. As an alternate choice, you may elect to receive



and experiment with a 40-channel CB to get more experience in this booming area.

You learn in your own home, in your spare time, at your convenience

NRI's bite-size lessons and carefully matched practical experiments combine theory and bench work to give you the most effective training for your money. No need to quit your job or take night classes, you move ahead at the pace that suits you best.

NRI guarantees FCC license

The law requires that technicians hold an FCC Radiotelephone License to work on broadcast equipment. NRI training in Complete Communications Electronics or our CB Radio Specialist course is carefully designed to give you the special coaching so helpful in passing FCC license exams. If you fail to pass the FCC examination for the radiotelephone license after graduating, *NRI will refund your tuition in full.* The money-back agreement is valid for six months after completion of your course.

63 years and a million students worth of experience

NRI can make such a guarantee because we're confident of the quality of our training. Since our founding in 1914, over a million students have chosen NRI technical training as the way to get ahead. You owe it to yourself to see if this new and exciting field holds your future.

Send for free catalog... No salesman will call

Find out all the facts about NRI's Communications or CB course. Or look into other areas of opportunity like TV and audio servicing, digital computer electronics, mobile communications, and more. Mail the postage-paid card today... there are more than 25 million good reasons why. If card has been removed, write to:



NRI SCHOOLS
McGraw-Hill Center
for Continuing Education
3939 Wisconsin Ave.
Washington, D.C. 20016

SM Trademark McGraw-Hill

CIRCLE 5 ON READER SERVICE CARD

JUNE 1978 5

Roses

Dear ME:

I just purchased and read your new issue (February), and I'm impressed. It appears to offer much of what interests me.

I would like to offer some comments that could prove useful to you. I'd like to point out the features of it that "grabbed" me and made me want to purchase it and to subscribe.

Of great interest to me are the construction projects. I have purchased such volumes as *Guidebook of Electronic Circuits* by Markus and *Master Handbook of 1001 Practical Circuits* by Sessions as well as others and they have many faults. Your projects appear to be well designed, the graphics are excellent and as yet I have not found inconsistencies or omitted construction details.

I particularly appreciate the broad designation given the transistors. Construction articles that list very specific transistors are frequently irritating as the transistors or other components are frequently very difficult to obtain. Without knowing the design criteria it is not easy to pick an acceptable substitute from a cross reference guide.

The use of readily obtainable components is great. I've already ordered a number of 4011's as you appear to like them and as they are used in a number of projects that will make construction easy. And when you build something from a magazine and it works, you like the magazine and if it doesn't work or you can't get the parts—well!

I would like to see some really good construction articles on induction balance or TR metal detectors. I know it's a highly proprietary subject but surely there are some sophisticated circuits available and you could explain how they work. How do they discriminate? I didn't see anything in the next 100 articles.

I think your Handbook feature will be good. The sponge analogy for a resistor is not a good choice of words. I think of a capacitor as being more like a sponge. What you intended, I believe is that a resistor in an electrical circuit is like a wad of steel wool in a water pipe.

Also of particular interest to me is the shortwave listeners article. The evalua-

tion of receivers is very welcome.

Although I'm not primarily interested in home computers (as of now) I read the article on Program and found it highly interesting.

One comment: if the program is going to evaluate things to six significant figures, it would seem appropriate to satisfy $i_e = i_b + i_c$. I know it is usually assumed that $i_c = i_e$ but with a computer it would be better to make no approximations or simplifications in the analysis could easily be avoided.

The article on killing ignition noise is very timely. The crossword puzzle is of very low interest to me. I did, however, work on it and when I got stuck I couldn't find the solution. I hope it will be in the March issue and that my subscription will be processed in time so that I will receive it.

Dennis J. Martin
Yorktown, VA

We're going to have lots of stuff on shortwave listening, Dennis. Meanwhile, I'm afraid you're stuck with the crossword. Lot's of readers wrote in to say they loved it. The answer key will be published the month following publication of the puzzle. And, the difference between sponge and steel wool is a splinter in the hand.

Colorless diagrams

Dear ME:

Congratulations on your first issue! Keep the projects coming!

As a science, and more recently electronics teacher, I'm glad to see a beginner-experimenter's magazine to share with my students.

Without intending to infringe upon your copyright, I hope to use your materials in class.

To this end, I ask you to avoid using color as a background to schematics and diagrams. This will confound any attempt to show your materials to my students.

Joseph Claus
Buffalo, NY

Joe, your letter was among several we received from teachers. Apparently our simple projects are just the thing for science and electronics classes. One mechanical drawing

teacher even is having his students redraw our schematics for practice. Please do use our materials in your classroom.

Scanner unscrambler

Dear ME:

Since I bought the first issue of ME and liked what I read, I am subscribing to your magazine.

I am asking you to please help me. I'm sure you have the know how. I am a scanner buff who is a completely disabled veteran of WWII. I must have something to occupy myself. Do you have any magazines or books on scanners, fm antennas, and everything that concerns scanners that I can buy? Also would you please send me the address where I can purchase an unscrambler for my scanner. I have been a scanner fan for years, and it seems now that all you can copy is scramblers.

Luther L. Branch
Cape Girardeau, MO

Anybody know how to unscramble the fuzz?

Pinouts

Dear ME:

Roses to you and your staff on your first issue of ME. It was about time someone came out with a new electronics magazine that has something for everyone. If the future issues are like #1, and I think they will be, you have a lifetime reader at this end of the country.

I have just two comments or questions. Why did Jeff Sandler leave off the pin numbers on the ICs in his projects. I assume that he may be thinking that we all have the spec sheets for the ICs. If so, he could have numbered the sections of the ICs as some of the other projects have. Some of us are not that expert in working with ICs so we need numbers. Also, get some more advertisers so we will have a good selection of parts for all the projects you promise.

How about some printed circuit patterns on some of the projects.

Good luck to you all.

John Sumpolec Jr.
Las Vegas, Nevada

Good idea, John. The power pinouts for

integrated-circuit chips are on all projects as of now! And, PC layouts are on the way.

Substitutions

Dear ME:

Really like your new magazine, especially the projects. Since my junque box is mostly TTL, and all the projects are CMOS so far, I would appreciate some indication in the future project and clinic articles if substitution of TTL will likely cause a problem.

Keep up the good work.

D. Crane
Houston, TX

Your point is well taken. Once in a while, TTL can be substituted for CMOS. When that is so, we'll tell you. Meantime, we're developing a series of projects around TTL integrated-circuit chips. By the way, we like CMOS since it saves energy in these expensive times!

Darts

Dear ME:

I have just subscribed to your new magazine but after more careful examination of it I wonder if I was too hasty.

The outlines for your 13 projects, 4 op-amp and 7 winter weekend warmers are confusing to say the least. ICs 4011, 4081 and 4001 are used in many of the projects but in only one, the "commercial killer," are pin connections shown. How are we to connect these in the other projects? In many cases there is no indication of power connections. In the case of #9, the hearing tester, where does the battery go?

In the "power-failure alarm," what plugs into the wall outlet? Where are the RC pairs? What are the pin connections for the 324 in the "boat-rustler alarm" along side of the "power-failure alarm" you show the 324 pin connections.

I thought your magazine was the answer to the guy who is a self-taught "know-hower" but it looks pretty dim at this point.

I'd appreciate it if you will either straighten me out or straighten out yourself.

C. B. Nelis
Mtn View, AR

By golly, CB, that's telling it like it is!

What they were

Dear ME:

Congratulations on putting out a nice magazine. It reminds me a bit of the old *Popular Electronics* which I liked a great deal.

Karl Thurber
Montgomery, AL

Project potential

Dear ME:

I recently purchased a copy of the first issue of ME and was quite pleased. I was pleased with the subject coverage, and

Stumped editors saved

February Clinic contained a letter describing a problem that had the *Modern Electronics* staff scratching their heads. Two of our readers have offered explanations for a very unusual problem. Here again is K.J.'s letter along with the suggested cures:

There's this little old tube radio in the kitchen whose only problem is an occasional hiss which drowns out the station I'm listening to. I think this is some sort of intermittent problem inside the set but it beats the hell out of how the hissing always stops when someone runs water out of a faucet. Can you guys at ME end hours of head scratching with a reasonable explanation?

K.J., Marietta, OH

Dear ME:

In response to a question sent in to your Clinic by K.J., I would like to express my theory concerning the hissing radio in his kitchen. The interference, I believe, could be caused by a slightly corroded junction between water pipes of two

dissimilar metals, the connection of which is disturbed as water causes a small movement in the pipes. This could be eliminated by separating all pipe-crossing points with short sections of split rubber hose.

Bob Best, Coventry, RI

Dear ME:

Concerning an item in Clinic written by K.J. that stumps the editors, the answer is obvious—a ground loop! The problem as described indicates an open, or high resistance earth connection. Since receivers of this vintage usually had one side of an ac line connected to ground, this must be the problem. If the open is in the receiver, reversing the ac plug should solve the problem. If it doesn't, the problem is in the house wiring earth ground system. Turning on the water completes the ground connection. If this is the problem, chances are the house was built in the 50's and has aluminum house wiring, which should be replaced with copper wiring before the house burns down. I'll bet K.J. has trouble with his to picture shrinking too!

C. Milton Lowell, Rockford, IL

of the project selection. The material is good for the electronic hobbyist, like myself, with little knowledge in electronic theory.

I think your publication has a lot of potential, I would suggest more definition of the projects. In the next several months you probably will be receiving my subscription.

Paul S. Enck, Jr.
Camp Hill, PA

You're right, Paul. We will be publishing even more details in our projects in the future. We assume you know almost nothing about electronics so we try to get right down to basics.

Telephones

Dear ME:

I am writing to inquire if your magazine has ever published a schematic for a telephone assessor which would provide a digital readout of the calling party; phone number for the called party.

James Wayne
Harvey, IL

No, James, we never have published such a schematic.

More economical

Dear ME:

I couldn't resist giving you some opinions and feedback on your first issue of

ME, which I, out of curiosity, purchased at the newsstand.

In reference to your article "13 projects under \$10," I really like circuit #6, the blown-fuse alarm. But really—be practical! I can propose a circuit that sacrifices a flashing LED for a steady blown-fuse indicator for one-tenth the cost of your circuit. It consists of a neon lamp rated at source voltage (in most cases this is 120 VAC) or slightly below, or an incandescent for dc circuits, wired across the elements of the fuse. The load resistance will act as a path for the lamp current and the lamp will glow when the fuse is blown or removed.

My circuit certainly is more economical than yours and has a much lower failure rate.

Good luck with your column in the future. I'll be reading.

Michael G. Ames
Cortland, NY

Heck, Mike your circuit is cheaper but no where near the fun to build!

How to get in

Dear ME:

I have just subscribed for 12 issues of ME. It just may turn out to be my kind of magazine. Having given up ages ago on QST, 73 and *Popular Electronics*, I bought a copy of your February issue and liked what was on the inside of the

covers—that is the reason for my subscribing.

Some questions: who is your proof reader?

How does a person get something put into print in your magazine—a favorite circuit or project?

Michael Yurkovich
Highland Park, MI

Our proofreaders are Tony, Judy, Bob, Jeanne, Laura and a couple of other good folks, Mike. The head of our complaint department is Bertha Butt. By the way, you get into print in ME by sending us a query letter spelling out an article or project idea you have. Make the query a quick outline of the highspots of what you want to tell in an article. Let us know whether or not you can shoot photos or have pix made. We're always in the market for good ideas from freelance writers. We especially need lots of easy projects for readers to build. And of course we pay good hard cash up front for your work, if it is of the professional quality we want. Sweet talk us and you could be looking at \$25-\$300 in long green for your efforts.

Rank amateur

Dear ME:

Re your "13 projects under \$10" and in particular to the Di-dah-dit sender which I am about to build. Will you please re-confirm the resistor quantity given only as 1000 on the lead from the NPN transistor to 9V positive.

I also note in the text the probability that "separate SPST switches for S1 and S2" should be S2 and S3 to conform to the circuit diagram notation, and that S1 appears to be an on-off switch.

I would appreciate your early reply to keep me straight as I am a pretty rank amateur.

Harold Kershaw
Venice, FL

You're a sharp-eyed son of a gun, Harold. The resistor value is 1000 ohms, which is the same as 1 K ohms. Yes, the switches are S2 and S3. And, S1 is an on-off switch. Thanks for double-checking.

Knob twister

Dear ME:

I have just subscribed to ME. I hope it is what I expect.

I have been a ham for 15 years, but must admit, mostly a "knob twister."

I also subscribe to CQ, 73, QST and Ham Radio Horizons. I find HRH exciting but I find the others much too technical and beyond my needs and interests. I hope to get into a little homebrewing and I hope your new magazine will give me the light to see the way. HI!

73's
Joe Park
Branscomb, CA

There's nothing wrong with being a knob

twister in this day and age, Joe. Some of the best people here at ME have been for years. We hope our easy projects will get you to fire up the old soldering pencil and get down to some fun building tonight!

Code sender

Dear ME:

I am very interested in the Di-dah-dit sender on page 47 of the February ME.

I have found the magazine interesting and am looking forward to the next issue.

Ken Loignon
Oldtown, MD

Based on the numbers of letters received, Ken, we think lots of folks must want to learn the International Morse code. The Di-dah-dit sender was one of the most popular projects in the February issue.

Superb magazine

Dear ME:

In your most interesting first issue I noted project number 13 in the "13 Projects Under \$10." I was wondering if this project could be expanded into a challenging skill game with refinements such as:

Reducing 10,000 possible combinations to a 100 or so possibilities.

Eliminating alarm if incorrect button is pushed.

Eliminating two minute delay if incorrect button is pushed.

And adding LED and/or indicator tones.

Please provide me with the refinements in your superb magazine for a most interesting project.

Jim Banks
La Habra, CA

Sure, Jim. We'll have our Clinic editor, Jeff Sandler, take a look at your proposal.

More computers

Dear ME:

I would like to say how much I enjoyed the first issue of your magazine and the coverage you gave to microcomputers. You would be well advised to continue to devote a lot of press to this dynamic new industry. It will have a profound effect on people; as great as television to be sure. Too many electronics magazines seem to do a cover story on personal computing and then ignore the subject in subsequent issues.

I hope that will not be the case with ME.

Brian Beninger, President
Speakeasy Software, LTD
Kemptville, Ontario Canada

Thanks for the kind words, Mr. President. I think you'll find ME following up each month on the latest in home computers. We think the microcomputer for personal use is just about the biggest thing going now in the wide world of electronics. And we're happy to

be able to say we have the best people in the field writing for us. Look for a computers column each month plus several programs and lots of full-length feature articles about home computers. Among us, we have Heath H-8, Radio Shack TRS-80, IMSAI, MITS, and several other good pieces of personal microprocessor hardware up and running. And we're having a ball with it! Stay tuned. We'll give you lots to read about microcomputers every month.

Wants radar

Dear ME:

I am trying to locate either schematics or someone who can show me how to convert an oscilloscope to a radar, or who I can contact that will help.

Also I am trying to locate schematics for a super sensitive mic or parabolic mic. Can you help?

James Hoge
Chicago, IL

Anybody got a schematic for Jim?

Robot radio

Dear ME:

I am 13 years old and read in your March issue the article about robots and decided to try and build a small remote-controlled one. I soon ran into problems with the transmitter and receiver for propelling it.

I would appreciate it if you could send me information for an economical transmitter and receiver. Thank you.

Y.T. Nelson
Du Bois, PA

We're afraid, YT, it's just not as simple as that. You need more than just a radio transmitter and receiver. Mel, our February robot, was a one of a kind design idea. We hope you or somebody will be able to finalize the plans for a Mel robot but it won't be easy work. In fact, Dave Heiserman, our man in Columbus, OH, is one of the country's experts in building home robots. And he says it isn't easy! Keep reading, YT. After 12-24 issues of ME we hope you'll have enough knowledge to start designing your own robot. When you do, send us the plans. We'll publish them and make you famous!

Micro hams

Dear ME:

In the February Radio column, Judy Curtis reported briefly on the use of microcomputers by hams.

Her article cites a few examples and concludes that hams are using computer chips to perform "a score of other complex chores."

I look forward to hearing the whole score.

Ronald B. Zeh
Corona, NY

Good to hear from you, Ron, and the pile of other folks who wrote in about the Radio column. It looks as if that was about the most

popular column in the February issue of ME. Judy's space was cut by the rush of advertising at the last minute for our first issue. The part you missed included word on microcomputer controlled ham repeaters in Wheeling, WV, Baltimore, MD, and San Francisco, CA. She's looking around now for other amateur radio microprocessor news which we'll publish in an early issue. If you hear of anything neat happening in that field, let us know.

Proposition

Dear ME:

I am Klatu. I am an electro-mechanical robot and I want to tell you how much I enjoyed reading an issue of your new magazine *Modern Electronics*. Especially the brown section on the how's and why's of electronics, it made it simple for me to absorb the data and I was able to learn a few things about how I function.

I think your magazine has a great future because of its unique format. It is the only one that the majority of non-experts can truly understand and with the computer becoming a part of every home, the projected enormous increase in electronics interest will surely make your publication one of the most widely read.

I am programmed for promotion and if you plan to attend conventions or any other public events, I can surely attract more attention to your magazine than anyone else around. If I meet someone who does not like your magazine, I simply self destruct in their shoes.

If you want to give me a job, don't hesitate to give me a call. I work cheap. All I need is electricity. My masters are those who'll ask for money.

I have to go now, I've got a hot date with one of the cone heads!

Programmed to please . . .

Quasar Industries, Inc.

Do you do windows, Klatu?

Mile marker

Dear ME:

I would like to have further information on technical scheme, services or literature in the issue of *Modern Electronics* of February 1978.

What I want is all about "Mile Marker" and the number on the reader service card is 172.

Michel Bolduc
Montreal, Canada

Lists of subjects

Dear ME:

I have just received my February issue. Thanks!

I believe you've hit on a good thing. We've needed a new, fresh electronics magazine for a long time. Good luck with future issues.

Now let's get down to work. I believe that the way to keep a family alive is by the giving and taking of criticism. I con-

sider myself a member of your family because I am a subscriber.

There are a few points I'd like to bring up now that I'm finished reading volume one number one.

First, why not keep the articles printed by category: CB (two way radio) with two way radio, projects with projects, computer with computer, instead of jumping from article to article.

Second, I see by the editorial staff listing that most or all of you are into two-way, ham or CB radio. While radio is a vital and important part of electronics today, why put so much on the subject in your magazine. There are plenty of magazines dealing with this area of the industry for those who want it.

Third, I'd like to see some historical articles on the electronic industry: early day of tv, computers, components, space exploration, etc.

Last, but most important: I don't know if any other magazine has done this before, but I feel it would be a good idea. Why not publish a full page list of subjects that could be published in your magazine? Ask readers to list which of these subjects they'd like to see in "their" magazine, and if any that they want aren't listed leave a few blanks for write in votes.

This would give you and your readers a better understanding of what ME should be about. Thanks for the time, I didn't mean to write a book, I'll be looking forward to future issues and knowledge as a satisfied reader of a new brainchild.

William Weiss
Bensenville, IL

P.S. I loved the crossword puzzle.

Keep it in future issues.

We appreciate your criticism, Bill. First, we think it would be a boring magazine if it looked exactly the same each month and all articles of a kind were lumped together. Not everybody likes CB or stereo or computers or ham radio. Some like each a lot, but not all. We think the fun of ME lies in its wide variety, a little something exciting for everybody. We are trying to keep the pace varied throughout the magazine so you'll find new and stimulating things each time you turn a page. Second, yes we are mostly all active hams here. We think amateur radio is one of the best of the electronics hobbies. But we also are heavily into home computers, stereo, model railroad electronics, digital clocks, marine electronics, shortwave listening, and many other hobbies. In fact, we like to think that someone among us likes just about anything you can think of in the wide world of electronics. And we plan to cover the whole darn thing, too. Third, the historical pieces might be good. History turns people off, generally, but we happen to like the good old days, too. If any reader can write an electronics-history piece with enough zing and pizzazz to fire up the editors here at ME, send us the manuscript. We'll take a look at it.

Exclusive OR gates

The basic building blocks of all digital circuits are gates—AND, OR, NAND and NOR. Using the right combination of these gems you can build circuits that can do just about anything.

AND and NAND gates give you the proper output when all of their input lines are on or high. OR and NOR gates give their proper output when any combination of input lines are on. So, if you wanted something to happen when either the front or back doorbell was rung, and either the radio or television was on, you'd use two OR gates and one AND gate.

But, suppose you had to design a circuit that did something when *only* one of several signal lines was on? The standard OR and NOR gates will operate when just one of its input lines is on. But, it also operates when more than one of the lines is on. What you need is a gate that is exclusively an OR gate; never an AND gate.

Well, there is a gate that does just that. And, believe it or not, its actually called an *exclusive OR gate*.

One good way to think about gates is in terms of relays. When a relay coil is energized by the proper combination of input lines being on, its contacts close connecting a battery to the output terminal.

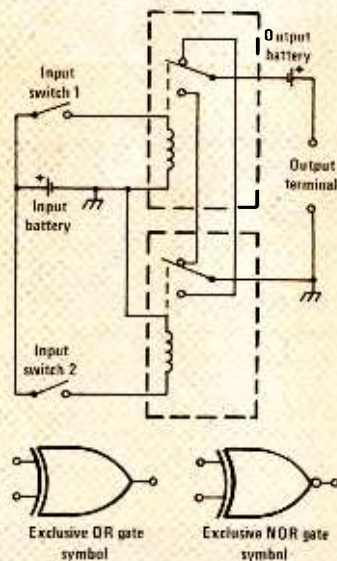

As you can see, the output battery circuit includes not one, but two relays. If either one of the relays is energized, the circuit path is completed. However, if the second relay is also energized, the path is opened. Adding a third or fourth input really complicates matters. But the principle is the same.

This NEW MFJ Versa Tuner II . . .

has SWR and dual range wattmeter, antenna switch, efficient airwound inductor, built in balun. Up to 300 watts RF output. Matches everything from 160 thru 10 Meters: dipoles, inverted vees, random wires, verticals, mobile whips, beams, balance lines, coax lines.



BRAND NEW

\$79⁹⁵

Antenna matching capacitor. 208 pf. 1000 volt spacing.

Sets power range, 300 and 30 watts. Pull for SWR.

Meter reads SWR and RF watts in 2 ranges.

Efficient airwound inductor gives more watts out and less losses.

Transmitter matching capacitor. 208 pf. 1000 volt spacing.

Only MFJ gives you this MFJ-941 Versa Tuner II with all these features at this price:

A SWR and dual range wattmeter (300 and 30 watts full scale) lets you measure RF power output for simplified tuning.

An antenna switch lets you select 2 coax fed antennas, random wire or balance line, and tuner bypass.

A new efficient airwound inductor (12 positions) gives you less losses than a tapped toroid for more watts out.

A 1:4 balun for balance lines. 1000 volt capacitor spacing. Mounting brackets for mobile installations (not shown).

With the NEW MFJ Versa Tuner II you can run your full transceiver power output — up to 300 watts RF power output — and match your

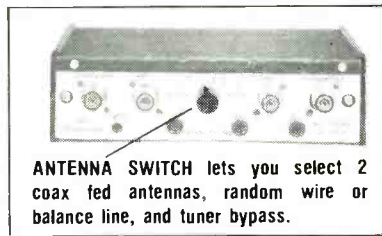

ANTENNA SWITCH lets you select 2 coax fed antennas, random wire or balance line, and tuner bypass.

transmitter to any feedline from 160 thru 10 Meters whether you have coax cable, balance line, or random wire.

You can tune out the SWR on your dipole, inverted vee, random wire, vertical, mobile whip, beam, quad, or whatever you have.

You can even operate all bands with just

one existing antenna. No need to put up separate antennas for each band.

Increase the usable bandwidth of your mobile whip by tuning out the SWR from inside your car. Works great with all solid state rigs (like the Atlas) and with all tube type rigs.

It travels well, too. Its ultra compact size 5x2x6 inches fits easily in a small corner of your suitcase.

This beautiful little tuner is housed in a deluxe eggshell white Ten-Tec enclosure with walnut grain sides.

SO-239 coax connectors are provided for transmitter input and coax fed antennas. Quality five way binding posts are used for the balance line inputs (2), random wire input (1), and ground (1).



\$59⁹⁵

BRAND NEW

MFJ-901 VERSA TUNER

New efficient air wound coil for more watts out.

Only MFJ uses an efficient air wound inductor (12 positions) in this class of tuners to give you more watts out and less losses than a tapped toroid. Matches everything from 160 thru 10 Meters: dipoles, inverted vees, random wires, verticals, mobile whips, beams, balance lines, coax lines. Up to 200 watts RF output. 1:4 balun for balance lines. Tune out the SWR of your mobile whip from inside your car. Works with all rigs. Ultra compact 5x2x6 inches. SO-239 connectors. 5 way binding posts. Ten Tec enclosure.



\$49⁹⁵

BRAND NEW

MFJ-900 ECONO TUNER

Same as MFJ-901 Versa Tuner, but does not have built-in balun for balance lines. Tunes coax lines and random lines.



\$39⁹⁵

MFJ-16010 RANDOM WIRE TUNER

Operate 160 thru 10 Meters. Up to 200 watts RF output. Matches high and low impedances. 12 position inductor. SO-239 connectors. 2x3x4 inches. Matches 25 to 200 ohms at 1.8 MHz.



\$49⁹⁵

BRAND NEW

MFJ-202 RF NOISE BRIDGE

This MFJ RF Noise Bridge lets you adjust your antenna quickly for maximum performance. Measure resonant frequency, radiation resistance and reactance. Exclusive range extender and expanded capacitance range (± 150 pf) gives you much extended measuring range.

Tells resonant frequency and whether to shorten or lengthen your antenna for minimum SWR. Adjust your single or multi-band dipole, inverted vee, beam, vertical, mobile whip or random system for maximum performance. 1 to 100 MHz. SO-239 connectors. 2x3x4 inches. 9 volt battery.

For Orders

Call toll-free 800-647-8660

For technical information, order and repair status, and in Mississippi, please call 601-323-5869.

Order any product from MFJ and try it. If not delighted, return within 30 days for a prompt refund (less shipping).

Order today. Money back if not delighted. One year unconditional guarantee. Add \$2.00 shipping/handling.

Order By Mail or Call TOLL FREE 800-647-8660 and Charge It On



MFJ ENTERPRISES

P. O. BOX 494

MISSISSIPPI STATE, MISSISSIPPI 39762

computers^{me}

HOW THEY WORK,

HOW YOU USE THEM, WHAT THEY CAN DO FOR YOU

BY PETE STARK

Bytes, bits, decimals, octals, hexadecimals: what are they? Here's the easy-to-understand story of computer machine language.

Numbers such as 96 or 302,529 are made up of *digits*; the number 96 consists of the two digits 9 and 6, while the number 302,529 consists of six digits. In general, all the numbers we use in day-to-day life are made up of the ten different digits 0 through 9. The number system we use is called the *decimal* system since the prefix *deci* means ten. It isn't just coincidence that we also happen to have exactly ten fingers. Early man used his fingers for counting, and another word for finger is digit. If we had twelve fingers, then most likely our numbers would use twelve different digits rather than just ten.

As the name implies, *digital* computers also work with digits. But since a computer does not have ten fingers, there is no reason why it should have to use exactly ten different digits. Because it happens to be convenient to build computers that way, computers work with just two different digits—0 and 1. Since these digits have only two values, we call them binary digits, or *bits*. Putting several of these bits together gives us a *binary number* such as 010 or 11001011.

The reason why bits are used rather than the decimal digits 0 through 9 is that a 0 or 1 is very easy to represent in an electrical circuit. Inside the computer, the 1 may be represented by a voltage on a wire, while the 0 is represented by either no voltage or a very small voltage.

Following the same idea, bits may be stored in a punched card as a hole for a 1 and no hole for a 0. In general, it is easy to store a 1 as the presence of something while a 0 is the absence of it. This can apply to the voltage in a circuit, a hole in a card, a magnetic field in a piece of recording tape, or a light in a bulb. Since there are only two possible bits, there is little chance for error—the bit is either a 0 or a 1 with no digits between.

The disadvantage of binary numbers is that each digit only carries a very small

amount of information. Large numbers require very many digits to express them. For example, the binary number 1001101001 seems quite large and yet is equal to only slightly more than six hundred. As a result even fairly common numbers turn out to be quite long in binary. This creates problems, not so much for the computers as for the people who use them. More on this in a moment.

Binary numbers would not be too useful if there wasn't general agreement on what they mean and how to use them, and, if it was difficult to convert numbers to and from binary. Fortunately, this is not the case. Binary numbers follow some very simple rules.

Starting at the right end of a simple binary whole number, the rightmost bit has a value of 1 and each bit to its left has a value twice that of the one to its right. For example, in the binary number 101 the rightmost 1 has a value of 1. The digit to its left has a value of 2. The next digit a value of 4, and so on. To convert this number from binary to decimal we would simply write the value of each digit underneath it, multiply each digit by its value, and add the results, like this:

$$\begin{array}{r} 1 \quad 0 \quad 1 \\ \times 4 \quad \times 2 \quad \times 1 \\ \hline 4 \quad + 0 \quad + 1 \quad = 5 \end{array}$$

It is fairly easy to make a table of some simple binary numbers and their decimal equivalents:

Binary	Decimal
000	0
001	1
010	2
011	3
100	4
101	5
110	6
111	7

To continue the table, we would have to add more bits to the binary numbers, since with three bits we can only go up to 7. Four bits will take us from 8 to 15, but then we must add more bits so that quite a few may be needed to represent some common numbers in binary.

When a binary number is handled by a computer, the number always has a certain number of bits regardless of the decimal number it represents. If fewer bits are needed, then the computer pads the number with zeroes at the left. Each binary number as stored by the computer is called a *word*. Its length is called the *word length*.

Large computers may have word lengths of 32, 36, or even 60 bits; small computers may have word lengths of just 8 or 12 bits. Eight-bit words, or eight-bit chunks of larger words, are often called *bytes*. Most of the small home or hobby computers use such bytes.

When a small number is stored in a byte, extra zeroes are inserted in front of it to stretch it to the full eight bits, as in 00000101 which is simply 101, or 5 in decimal. The largest number which will fit into a byte is one having eight ones, that is, 11111111. In decimal, this translates into 255, not large enough for most applications.

To store really large numbers having perhaps ten or twenty bits we must use two or more bytes. For example, the binary number 1001101001 would be stretched out to a full sixteen bits by adding zeroes to make it 0000001001101001. Then the first eight bits would be handled as one byte and the last eight as another.

Although the use of binary numbers is convenient from the point of view of the computer's internal circuitry, it is quite difficult for us humans who have to look at them printed on paper or displayed on a TV screen. Just a few minutes spent

studying long binary numbers or trying to tell them apart is enough to give anyone a headache. For this reason we use *octal* or *hexadecimal* numbers rather than binary.

An octal number is one which uses only the digits 0 through 7. Eights and nines are not allowed. It is called octal since the prefix *oct* means eight. This number system has exactly eight different digits. It is used because the conversion between binary and octal is very simple and requires only a small amount of circuitry. In fact, the computer circuitry which connects to a keyboard or printer already has most of what is needed to do the conversion.

To convert a binary number to octal, the computer simply separates the bits into groups of three and converts each group into a decimal number from 0 through 7 using the conversion table we have already discussed. For example, the binary number 101101 would be split into 101 and 101, which converts into the octal number 55.

Octal numbers are a bit awkward when the binary number to be converted doesn't have the right word length. A six-bit or nine-bit number is easily split into groups of three, but an eight-bit byte is not. The solution is to add a few extra zeroes at the left if needed. For instance, the byte 01010011 would be stretched to 001010011, then split into 001-010-011 and converted into octal 123.

Hexadecimal numbers, on the other hand, use sixteen different digits (hex means six and deci means ten.) Since we only have the ten digits 0 through 9 available, hexadecimal numbers 'invent' a few more digits simply by calling them, A, B, C, D, E, and F; these letters take the place of the digits which would stand for 10 through 15 if they existed. We can prepare a short table which relates binary and hexadecimal (or *hex* for short):

Binary	Hex
0000	0
0001	1
0010	2
0011	3
0100	4
0101	5
0110	6
0111	7
1000	8
1001	9
1010	A
1011	B
1100	C
1101	D
1110	E
1111	F

Converting a binary number to hex is done by splitting it into groups of four bits, and then converting each group with the aid of this table. For instance, the byte 01010011 would be split into 0101-0011 and translated into 53 in hex.

Octal and hexadecimal numbers, although not internally used by the com-

puter, are often used by the people who have to communicate with computers. It is easier to read and visualize a short octal or hexadecimal number than a long binary number. It would be most convenient if everything could be done in decimal, but this is often not practical for various reasons and octal or hex numbers are the best compromise.

But why use both octal and hexadecimal? Why not just one? The answer lies in the fact that some binary numbers are easily split into groups of three bits but not four. Others are easy to split into groups of four but not three. Obviously a byte of eight bits is easier to split into two groups of four than into three groups of three bits. On the other hand, a fifteen-bit word would be easily split into groups of three bits, but not four. Hence the word length of the computer determines which number system is used much of the time.

Since most microprocessor-based home and hobby computers use eight-bit bytes, most use hexadecimal numbers. Many years ago, hexadecimal was almost unknown. Even early microprocessors such as the Intel 8008 used octal rather than hex (despite their 8-bit bytes.) But today hexadecimal numbers are most common. A popular misconception is that hex is modern and octal is in some way old fashioned.

This prejudice against octal showed up recently when Heath introduced their H8 computer system which uses the 8-bit 8080A microprocessor. At a time when most 8080 systems used hex, Heath chose to use octal numbers in all their programs and literature. Almost immediately there were some who claimed that Heath made a mistake in going back to an 'obsolete' system. Yet there are many good reasons for going to octal rather than hexadecimal.

Look at the 8080 microprocessor a bit more closely. It is an 8-bit computer, and we have agreed that splitting an 8-bit byte into three-bit groups requires the addition of an extra zero at the left. This is more awkward than simply dividing it into two groups of four bits. If this were all there were to it, then hex would be preferable to octal. But there is another side to the story.

In any computer system, a *program* is required to instruct the computer what to do. This program is written in a special code called a *programming language*. The most fundamental language (and the only one which the computer understands without prior translation) is called *machine language*. In machine language simple machine instructions are coded as binary numbers and stored in the computer's memory.

In the 8080 processor there is a group of temporary storage circuits called *registers*, used to hold numbers or other data while they are being processed. These are called the A, B, C, D, E, H, and L

registers. A common instruction in a program is to move a number from one register to another. Let's look at a typical pair of these 'Move' instructions.

Move A to B: 01000111
Move B to A: 01111000

There is something very orderly about these machine language codes. Both start with 01, and that means 'Move'. The next three bits specify the *destination* where the number is to be moved to. The last three bits specify the *source* of the data. Now rewrite these codes in hexadecimal:

Move A to B: 47
Move B to A: 78

There certainly doesn't seem to be much sense to this. But rewrite in octal and a pattern emerges:

Move A to B: 107
Move B to A: 170

When you write down some more possible Move instructions, the picture becomes much better:

Instruction	Octal	Hex
Move A to B	107	47
Move A to C	117	4F
Move A to D	127	57
Move A to E	137	5F
Move B to A	170	78
Move C to A	171	79
Move D to A	172	7A
Move E to A	173	7B

In octal these instructions make some sense. The first digit is always a 1 for Move. The second digit specifies the destination. The third specifies the source. In hex there is not much similarity.

Now, when you consider that the 8080 has seven of these registers, plus an external memory which is programmed as if it were an eighth register, there are 56 possible Move instructions. A number can be moved from any one of eight sources to any one of the other seven destinations, and $8 \times 7 = 56$. If you had to memorize the 56 codes, which would be easier, octal or hexadecimal? Octal, of course.

The Move is just one of many 8080 instructions. Many of the others are based on the same kind of source-to-destination idea. In each case, octal notation makes the instructions easier to remember than hexadecimal.

So there is more to choosing between octal and hexadecimal than just the word length of a computer. We choose octal over hex (or vice versa) because it makes programming simpler or more obvious, even though it may at first seem a bit more awkward. Either way, whether you write it, 1750 or 3E8, it is still easier for a human than to write it as 001111101000.



FREE

The world's largest catalog
of easy-to-build, money-saving
electronic kits



- Personal Computer Systems now including Floppy Disk Storage
- Power Supplies • Oscilloscopes • Frequency Counters • VTVM's and VOM's
- Ham Radio Gear • Digital Programmable Color TV • Hi-Fi Components
- Electronic Clocks and Weather Instruments • Learn-at-home Electronics Courses
- Auto, Fishing, Marine and Aircraft Accessories — nearly 400 kits in all!

Every Heathkit product comes with a fully-illustrated, step-by-step assembly manual that tells you everything you need to know to make kitbuilding fun and easy. Thousands of people have discovered the satisfaction — and savings — of handcrafting a fine piece of electronic equipment. You can build it better... let us show you how.

Send for your **FREE** Catalog today! ►

Heath Company, Dept. 378-420, Benton Harbor, Michigan 49022

HEATH Schlumberger	Heath Company, Dept. 378-420 Benton Harbor, Michigan 49022	FREE
Please rush me my FREE Heathkit Catalog. I am not on your mailing list.		
NAME _____		
ADDRESS _____		
CITY _____		STATE _____
CL-657		ZIP _____

CIRCLE 13 ON READER SERVICE CARD

JUNE 1978

13

BY JEFF SANDLER

Now you see it, now you don't

I need a battery powered light that can be mounted in the cabin of my boat. The light should turn on easily, stay on for just a few seconds, then turn off again. Since it will be battery powered, it should draw as little current as possible, yet provide enough light for me to see the control panel.

V.J., Brookfield, IL

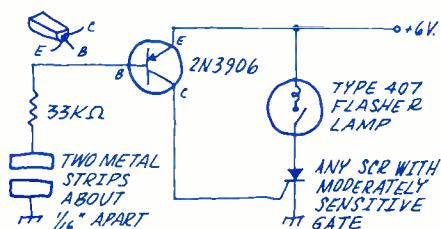

One of the best circuits I've seen for this kind of service uses a type 407 flasher lamp; the kind used in the red warning light of large lanterns. The bulb has a tiny switch built into it that opens the filament circuit when the lamp heats up—a process that takes about five seconds in a cold bulb. The circuit is triggered when you place a finger across the gap between two strips of metal, about 1/16th inch apart. Enough current will flow through your finger to trigger the SCR after being amplified by the 2N3904. Once the SCR is fired, current will flow through the bulb until its internal switch turns it off. Once that happens, the SCR will return to its non-conducting state.

What's wrong with TTL?

In your projects and clinic circuits I see CMOS. I've been building digital circuits for years using TTL and I think it's great. Why not use some TTL in your projects?

E.W., Wynnewood, PA

TTL is unbeatable for high-speed digital circuits, and it's readily available at low cost. But, TTL is not without its drawbacks. For one thing, it draws current, even in its low state. Put a few TTL ICs together and the current drain gets too high to power by battery. Another problem I have with TTL is its relatively low input impedance. Many of my projects require very high input impedances. CMOS, on the other hand, draws virtually no current in its standby mode, and

has an input impedance of about one million, million ohms. This combination of low drain and high impedance makes possible battery-powered circuits that are actuated by touchplate. Battery life in these circuits is essentially the shelf life of the battery. CMOS can be powered from virtually any supply providing between three and 15 volts, another big advantage over TTL. And its output swings from rail to rail, with zero offset. This permits me to use CMOS gates and buffers in place of op-amps in some circuits. However, when the circuit requires it, you can be sure I will use TTL.

Needs protection

I just built a TTL logic controlled alarm. The alarm itself is powered by line voltage applied through a relay controlled by the logic through a transistor. I've checked the circuit a dozen times, and it seems to be wired correctly. But every time I use it, the transistor blows. How come?

F.Y., Palisades Park, NJ

Looking over the diagram you sent me leads me to believe the problem lies with something you left out—a protection diode around the relay coil. TTL logic is very fast—almost instantaneous. Once the transistor begins conducting current through the relay coil, a magnetic field is generated. This is what causes the relay contacts to close. When the TTL logic turns off the transistor, the field around the relay coil collapses in an instant. In doing so, it generates hundreds of volts,

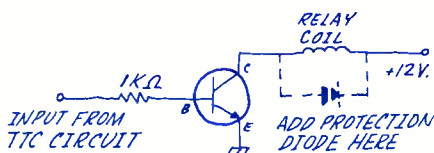

just the way an automobile's ignition coil does. It is that voltage that pops your transistors. Placing a diode across the coil as shown will short circuit the voltage, preventing any damage to the transistor.

It doesn't work!

I'm having trouble getting the Pink Ticket Beater circuit, on page 17 of the February issue, to work. I notice that +9

volts is shown at two different places in the diagram. Is this correct? The emitter of the 2N3904 is shown connected to the chassis. Is this the nine-volt return? You didn't specify what kind of speaker to use. I used a 2 1/4-inch speaker. Is this okay? I know all the parts are good. Is there something missing in the diagram?

M.M., Houston, TX

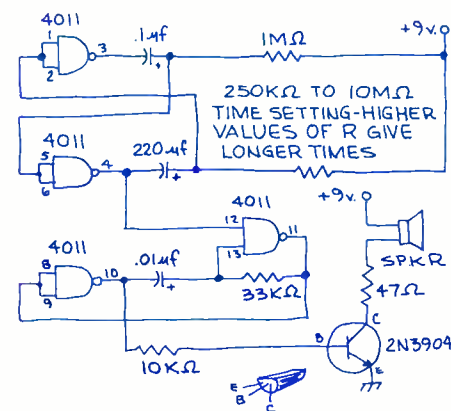

Try connecting +9 volts to pin 14, and the return to pin 7. It's very common to show voltage supply terminals at several points in a diagram. This is done to simplify the drawing by eliminating the need for a single supply line snaking around the circuit. In most circuits, you can assume the ground to be the power supply return. Unless a particular kind of component is specified, you can use anything you'd like with the required rating. Your choice of speaker is fine.

Help!

I thoroughly enjoyed Volume one, Number one of *Modern Electronics*—largely due to the grab bag of gadgets to build. Although I majored in physics, I've been away from electronics for some time and I'm finding the going a little rough with all the new stuff. My problem is the Egg Timer on page 49 of the February issue—it doesn't work! I've double checked everything.

E.B., Tarkio, MO

Based on the additional information you gave me in your letter, I guess you didn't provide power to the 4011 IC itself. You should be able to get the timer going by applying the positive

supply voltage to pin 14 and the ground return to pin 7 of the 4011 IC. You can use any voltage up to 15 volts. A nine-volt transistor battery is the best bet.

Sorry, we goofed

I was intrigued by the power-failure alarm described in the February issue. However, your schematic had absolutely nothing to do with a power-failure alarm. What gives?

R.P., Duncansville, PA

In the excitement of starting up a new magazine, the power-failure alarm and the temperature indicator schematic diagrams got mixed up. We did untangle the mess in the March issue on page 67. There you'll find both circuits with the right schematic attached to the proper text.

What does it all mean?

I'm just getting into electronics. I noticed some symbols in your diagrams on pages 49 and 50 of the February issue I've never seen before. Can you tell me what they mean? What are the numbers in the symbols?

G.P., Ste. Genevieve, Quebec

The symbols used represent digital logic elements. The triangular symbol is a buffer stage used to isolate the signal source from the following stage. The other symbols are digital gates. You'll find a good explanation of these gates on page 49 of the March issue of Modern Electronics. The symbols represent one of the elements contained in a single integrated circuit (IC). Depending on the kind of element, there can be as many as eight individual circuits in each IC. The number printed inside the symbol is the type number

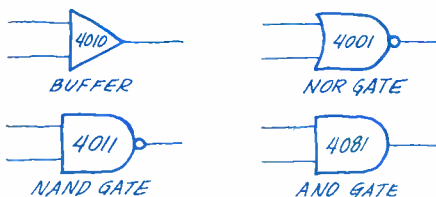

of the IC containing it. So, the 4011 you saw inside a gate symbol means it is one of the gates contained in a type 4011 IC. These type numbers are used the same as tube and transistor type numbers.

Pop goes the flash tube!

Rummaging around in my junk box I came across a couple of Zenon flash tubes. Do you have a circuit I can use to light them up?

P.J., Rochester, NY

Here's a circuit that should do the trick. The value of C1 and supply voltage depends on the bulb you're using. If you know which bulb

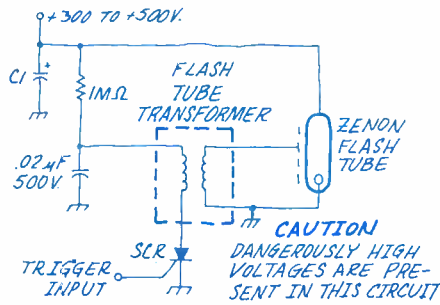

you have, check the manufacturer's spec sheet. If not, a good starting point might be a 0.5 mfd capacitor and 300 volts. You can use any flash tube transformer you have handy. Radio Shack used to carry flash tube transformers and you may be able to find one in your local store. The tube is flashed by the high voltage developed across the transformer secondary when the SCR is fired. Since the SCR circuit current is very small, you can use any SCR with the appropriate voltage rating. Remember, there are lethal voltages present in this circuit.

Where's the alarm?

On page 50 of the February issue there is a schematic for an electronic combination lock. The text says: "If an incorrect button is pushed, an alarm sounds and all pushbuttons stop working for two minutes." However, in the schematic I see nothing about alarms. Can you explain?

S.B., Manhattan Beach, CA

You'll notice that a relay is included at the bottom right of the diagram. An external alarm be connected through the relay contacts. The type of alarm used is up to you.

CMOS power hungry

I always thought CMOS drew very little current. I was really surprised when I built an audio oscillator using 4009 inverters. The circuit drew better than 20 ma. Why?

T.C., Willits, CA

The 4009 IC contains six inverters and your oscillator only uses two. What are you doing with the other four inverters? If you've left them floating, they've probably become unstable and begun to self-oscillate. Many experimenters bothered by what seems to be erratic operation in their CMOS circuitry are experiencing this oscillation. You can avoid the problem by tying all unused inputs to the supply rail.

Hunting wires

As an electrical contractor wiring new houses and occasionally troubleshooting in older houses and mobile homes, I could really use a device to locate wires

buried in walls. Do you have a circuit I could use for this?

T.M., Lower Lake, CA

Here's a cheap and dirty wire-finding trick that's worked for me. All you need is a portable transistor am radio and line-powered drill, electric razor, hairdryer or other appliance that uses a brush-type ac-dc motor. If you have a choice, use the motor with the greatest amount of arcing at the brushes. This arcing generates the electrical interference you hear as static hash in your radio, and see as a series of white dots and dashes across your tv picture. Just plug in the appliance, lock it on, and listen on your radio for the hash. As you move the radio across the wall, the intensity of the hash will be greatest when the radio is nearest the ac line hidden in the wall. You may have to experiment with different radios and motors to optimize the effect, but it should work. Drop me a line and let me know how you make out.

Varying 22-124

I have a Radio Shack number 22-124 regulated 12-volt power supply. I would like to make it variable by adding a voltage control. How should I do this?

F.M., Des Moines, IA

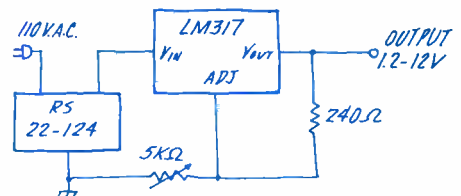

ALTHOUGH THE LM317 IS SHOWN EXTERNAL TO THE 22-124, IT CAN BE MOUNTED INSIDE THE CASE (HEAT SINKED).

Unfortunately, you can't just add a control to the wiring. However, you can convert your 12-volt supply to a regulated variable supply providing from 1.2 to 12 volts output. All you do is add an LM317 voltage regulator integrated circuit and two resistors. The addition can be built on a small perfboard mounted inside the 22-124 case. But make sure the LM317 is properly heat sunk.

More "How's a gq1xbg work?"

In the March Clinic we mentioned that the best source for "how it works" information is a specialized book. There the author has hundreds of pages to explain the intricacies of a gq1xbg, or anything else for that matter. Well, if your interested in minicomputers and microprocessors, Wiley-Interscience, Box 92, Somerset, NJ 08873, has a great how-it-works-book called *Introduction to Microcomputers and Microprocessors* by Arpad Barna of Hewlett-Packard, and Dan Porat of Stanford University. Although I find it a bit scholarly, the book does contain just about everything you need to know about the subject.

the super-compact ALDA 103

only 3 1/4" high x 9" wide x 12 1/2" deep • less than 8 1/4 pounds

ALDA 103, the trim little powerhouse with incredible performance for the price! ALDA 103 provides a full 250 watts PEP input for SSB operation, and 250 watts DC input for CW. And when it comes to performance, ALDA 103 is the hottest little transceiver going — all solid state, totally broadbanded and super-stable VFO.

Ideal first transceiver for brand new novices! You'll want a full-capability CW/USB/LSB unit with all the power and performance you can use. ALDA 103 gives you 250 watts DC input for CW, the maximum allowable power for your novice license. When you upgrade to technician, you've got 2 bands

for CW operation. And with your general license, just plug in your mic and use the ALDA 103's full 250 watts PEP on SSB!

Perfect second or mobile unit for seasoned hams! If you're looking for a super-sharp, compact unit to use in your car or boat, ALDA 103 will live up to your expectations. Absolute worst case sensitivity 0.5 μ V for 10 dB S+N/N — a must for mobile operation. Receiver audio output of 3 watts minimum — another must. Also, very low receiver power drain of only 5.5 watts — that's 0.4 amps at nominal 13.8 VDC including power for dial and meter lamps!

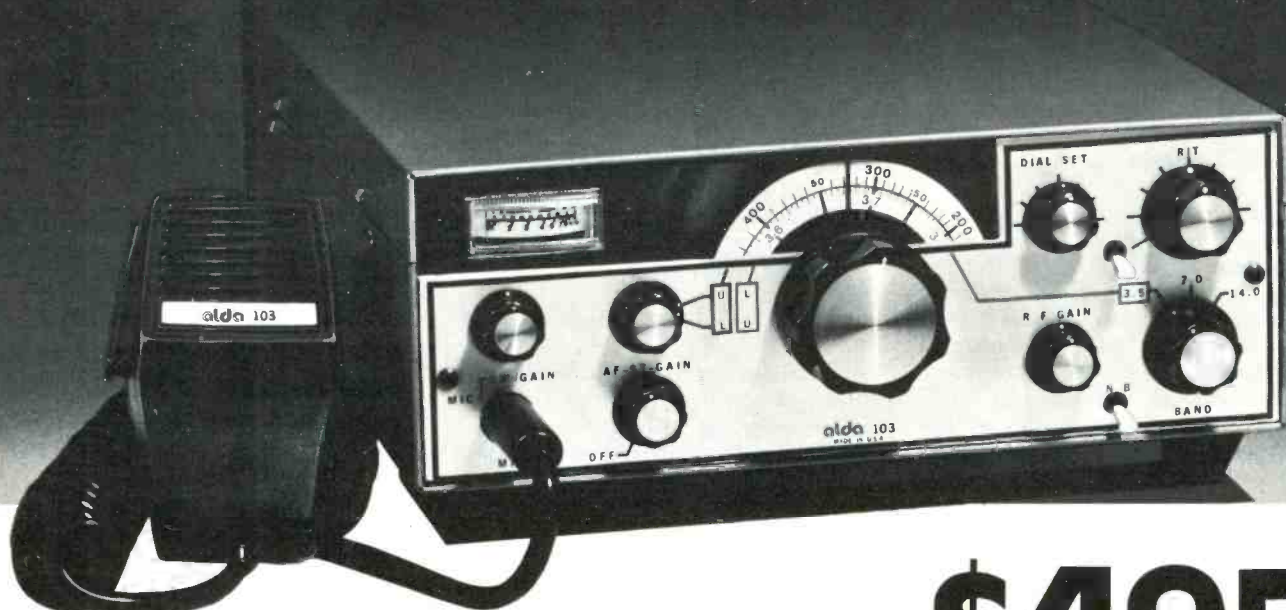

GENERAL SPECIFICATIONS

Semiconductors: 39 diodes, 23 transistors; 11 integrated circuits

Power Requirements: Nominal 13.8 VDC input at 15 amps, negative ground only

Power Consumption: Receive — 5.5 watts (includes dial and meter lamps); Transmit — 260 watts

Dimensions: 3-1/4" high x 9" wide x 12-1/2" deep (82.55 mm x 228.6 mm x 317.5 mm)

Weight: 8-1/4 lbs. (3.66 kg)

PERFORMANCE SPECIFICATIONS

Frequency Range: 80 meter band — 3.5 to 4.0 MHz
40 meter band — 7.0 to 7.5 MHz
20 meter band — 14.0 to 14.5 MHz

Modes: CW; USB; LSB

RF Input Power: SSB — 250 watts PEP nominal
CW — 250 watts DC maximum (adjustable)

Transmitter:

Antenna Impedance: 50 ohm, unbalanced

Carrier Suppression: Better than -45 dB

Side-Band Suppression: Better than -55 dB at 1000 Hz

Distortion Products: Better than -26 dB
500 to 2500 Hz

AF Response: Harmonics better than -45 dB below 30 MHz; better than -60 dB above 30 MHz

Spurious Radiation: Less than 100 Hz drift per hour (from a cold start at room temperature)

Frequency Stability: High impedance 3000 ohm

Microphone:

Receiver:

Sensitivity: Better than 0.5 watts audio output for 0.5 μ V input

Signal-to-Noise Ratio: Better than 10 dB S+N/N for 0.5 μ V input

Image Ratio: Better than -60 dB (typical with respect to 0.5 μ V input: 80 meters — -130 dB; 40 meters — -100 dB; 20 meters — -75 dB)

IF Rejection: Better than -70 dB (typical with respect to 0.5 μ V input: 80 meters — 110 dB; 40 meters — 80 dB; 20 meters — 75 dB)

Intermodulation Intercept Point: Better than 10 dBm

Selectivity: 2.5 kHz — 6 dB; 5.0 kHz — 60 dB

Audio Output Power: More than 3 watts

Audio Distortion: Less than 5% at 3 watts

\$495

including microphone and mobile mount, too.

OPTIONS & ACCESSORIES

Noise Blanker — Model No. PC 701 **\$29.95**

100 kHz and 25 kHz Dual Crystal Calibrator — Model No. PC 801 **\$14.95**

Portable Power Supply — Model No. ALDA PS 115: average duty 15 amp unregulated; input — 115/230 VAC, 50/60 Hz; output — 13.8 V nominal at 15 amps **\$79.95**

Heavy Duty Power Supply — Model No. ALDA PS 130: output — regulated 30 amp at 13.8 VDC; input — 115/230 VAC, 50/60 Hz **\$149.95**

alda communications, inc. 215 Via El Centro Oceanside, CA 92054 (714) 433-6123

ALDA 103 is completely manufactured in the U.S.A.

CIRCLE 16 ON READER SERVICE CARD

They don't build things like they used to, except in the case of fm tuners which seem to get better year after year.

Back in my grandfather's day, lots of people shared the comfortable belief that things are getting better all the time. Nowadays we're no longer so sure about that, but at least it still seems to be true in audio. Especially in the design of fm tuners, recent years have seen an unbroken line of major advances.

Most of these improvements have come about through the use of ICs—short for integrated circuit. A single IC, no bigger than a thumbnail, can perform complex functions that formerly would have required a maze of circuitry the size of a doghouse.

This new technology is a spin-off from space communications, where radio equipment had to be minimized in size and weight to soar aloft in satellites and other spacecraft. Lately the price of even the more elaborate ICs has come down to the point where they are affordable in consumer goods, and advanced circuitry based on such IC chips is now finding its way into audio equipment.

Phase-lock loops

A case in point is the so-called *phase-lock loop* (abbreviated PLL) which up to now has been employed mainly in satellite communications. Lately, however, PLL has shown up in some of the fancier fm tuners, where it greatly improves the performance of the detector stage, which peels the audio signal from the radio-frequency carrier. The result is even lower distortion than was formerly feasible, better separation between left and right stereo channels, and less of a tendency to pick up atmospheric noise. This last factor enables the tuner to pull in weak and marginal signals more clearly. In other words, it effectively increases sensitivity even though the front-end tuning circuits may be the same. What's more, the PLL also assures drift-free stability once a station has been carefully tuned in.

This versatile circuit is a worthwhile feature to look for when buying a high-quality tuner, especially if you live in a location where fm reception is difficult. At present, it is available on some of the higher-priced models by Kenwood, JVC, Marantz, Sansui, Nakamichi, Technics, and Onkyo, but I expect that it will be included even in some less expensive models when new designs are introduced next fall.

Another important advance in fm tuners and receivers is the use of improved ceramic filters in the IF stages. Not only do these filters have a sharper cutoff for unwanted frequencies, but they are also nearly immune to age and changes in temperature. As a result, it is no longer necessary to have fm tuners periodically realigned for optimum performance.

Filters

An additional advantage of better IF filters is improved selectivity, which is the tuner's ability to clearly separate stations located next to each other on the dial. For example, where I live—on a hilltop in the Berkshire mountains of western Massachusetts—just about every fm station on the East Coast from New Hampshire to Delaware chimes in on my set, and it is often difficult to keep a weak and distant station from being overwhelmed by the stronger signal from a nearby station that happens to be broadcasting on an adjacent channel.

Until now, high selectivity was possible only at the cost of increased distortion, and tuner designers mainly concerned with fidelity often deliberately compromised on selectivity. Now, thanks to new combinations of ICs and ceramic filters it is possible to eat the cake and have it—to block out intruding signals without skimping on fidelity.

Several of the fancier tuners now of-

fer an additional refinement called selectable bandwidth. This lets you choose between two different values of selectivity. One setting is for broad IF bandwidth, which gives you maximum fidelity and can be used for receiving stations untroubled by close neighbors on the fm dial. The "narrow" bandwidth setting provides greater selectivity for the crowded portions of the dial at only a very slight—in fact, almost imperceptible—increase in distortion. Pioneer, Sansui, Technics, Yamaha, Marantz, Kenwood, and Mitsubishi are among the companies offering this feature on some of their tuners and receivers.

How to compare

If you're comparing fm specs, you might regard the following figures as a rough guide. A selectivity of 50 db is quite satisfactory in locations with no particular reception problems, where the incoming stations are widely spaced on the dial. If, like myself, you have trouble keeping two or more stations apart on a crowded portion of the dial, chances are that a tuner with a selectivity rating of 60 db or thereabouts will do the job for you nicely. On truly superlative—and rather expensive—equipment you may even find selectivity ratings as high as 80 or even 100 db. What these figures mean is that an equally strong signal arriving on an adjacent channel will be that many decibels lower than the station you are listening to. At 60 db this gets close to inaudibility, so the neighboring station won't bother you.

I have concentrated here on recent advances in tuner design. Naturally, there are other important aspects in tuner performance, such as sensitivity and multipath suppression. I'll get to those in a later column. 

Now you can be safer as you sound better while you drive your car and operate your CB radio at the same time.

BY RON COGAN

Imagine driving a winding road on a rainy night. You hear someone calling for help on your CB radio but the microphone is clipped to the dash just out of reach. You want to help but you don't want to let go of the steering wheel. Finally you decide to risk it, but at great danger to yourself.

Now there's a way around the problem. With a built-in loudspeaker and microphone, a mobile two-way radio headset can let you keep better control of your car while chatting on the CB. Or even racing to help out in an emergency.

With turning the wheel, shifting gears, flicking ashes in the ash tray, and adjusting the radio—all while clutching that all-important microphone, of

course—it's a wonder the coil cord doesn't get wrapped around one dash component or another at any given time. Wouldn't it be nice if someone came up with a viable solution for this? Well, mobile modulator, pluck that mic connector out of the radio and head for the nearest CB accessories store. The answer is at hand.

Headsets provide the solution

In your quest for a decent assault plan in the embittered Battle of the Mic, give a citizens band headset a try. These handy accessories, which are outfitted with a small microphone and earphone and resemble headsets used by pilots, completely eliminate the trials and tribula-

tions of operating a standard microphone. Just plug the connector to your radio, slip the headset on, and you're in business.

Various types of headsets are available for specific needs. Like the idea of a headset but not the bulk and extra weight on your head? No sweat. One of the lightweight headsets available on electronic store shelves weighs in at a mere three ounces.

On the other hand, if you want a headset that does a heavy-duty job of cutting down on highway noise so you can hear transmissions with your window open, these are available too. Typically, these "over-the-ear" boom headsets offer a cushioned earphone that completely covers one ear for optimum monitoring. When worn over a driver's left ear, highway noise is cut substantially, and CB conversations are amazingly clear, while the right ear is left unobstructed and able to take in a passenger's conversation or remain alert to the immediate surroundings.

An interesting setup is also found at the other end of the "boom". Again, you have a choice. Models are available with a standard noise cancelling microphone, or you might prefer a variable gain power mic for better performance. Most of the headsets are constructed in such a way that the boom can be positioned with the mic close to an operator's lips when in use, then pivoted aside when not needed.

Simple to use, too

The real beauty of utilizing a headset assembly is that most of the hassle is taken out of keying the microphone. Different headsets offer a push-to-talk switch with clothing clip located in-line on the mic cord, while others provide a push-to-talk switch that mounts to your gear shift lever or turn signal wand, or a foot switch that mounts to the floorboard and is used much like a high-beam switch.

The ultimate is perhaps a headset that is voice-actuated (in simple terms, one which changes your CB to the transmit mode at the sound of your voice, and then back to the receive mode as soon as



Headsets really do the trick when it comes to shutting out road noise, providing superior monitoring, and offering a simple, convenient microphone operation. This is a CB-SMC from Superex Electronics that offers an over-the-ear cushioned earphone, power mic, and remote push-to-talk switch.



The model CB88 from Telex, which weighs in at an amazing three ounces, offers a soft eartip, power microphone, and remote switch. An adapter is also available which allows the earpiece to be clipped to a user's eyeglasses.



you stop talking). These offer a convenient feature that allows you to disengage the voice-actuated switch with the flick of a button when you don't wish to transmit; otherwise attempting to carry on a conversation with a passenger between transmission would be an incredibly frustrating experience. 

TAB POPULAR CB BOOKS

CB Radio Operators Guide—2nd Edition

Tells what CB is, how it is used, how to buy and install equipment—PLUS Part 95, the FCC rules regulating CB. 256 pps.

Order No. 799 Paper \$5.95 Hardbound \$8.95

Practical CB Radio Troubleshooting & Repair

Complete details on CB operation, installation and repair, including 21 programmed troubleshooting charts and complete schematics for 18 popular transceivers. Also an in-depth section on antennas and feedlines. 238 pps.

Order No. 754 Paper \$5.95 Hardbound \$8.95

Pictorial Guide to CB Radio Installation & Repair

Step-by-step guide to car and base systems installation and basic maintenance. 256 pps.

Order No. 683 Paper \$5.95 Hardbound \$8.95

Citizens Band Radio Service Manual

All-in-one troubleshooting and maintenance guide for all types of CB sets, including a 36-page schematic foldout section. Step-by-step repair procedures and trouble-analysis charts. 192 pps.

Order No. 581 Paper \$5.95 Hardbound \$8.95

ORDER FORM

Modern Electronics
14 Vanderventer Avenue
Port Washington, NY 11050

806F

Ship the books listed below. To cover shipping, I've added 50¢ for the first book and 25¢ for each additional book. Enclosed \$ _____

No.	Price	Name _____
_____	_____	Address _____
_____	_____	City _____ State _____ Zip _____

B&A 8700
Computer/Controller

**The Answer For...
Student
Hobbyist
Manufacturer**

8700 Processor: 6503 MPU. Wear free "Active Keyboard", Micro-Diagnostic[®] Extensive documentation. Fully Socketed.

Piebug Monitor: Relative address calculator. Pointer High-low, User Subroutines, Back-step key.

Cassette Interface: Load & Dump by file #, Tape motion control, Positive indication of operation.

Applications systems from \$90 (10 unit quantity)

Development systems from \$149 (single unit)

TELL ME MORE I want to see for myself that the 8700 is The Answer.

- Please send documentation and price lists. \$10 enclosed. name: _____
- I don't need documentation please send price lists. address: _____
- Please send FREE CATALOG. city: _____ state: _____ zip: _____

B&A

ELECTRONICS Dept. 6 • 1020 W. Wilshire Blvd. • Oklahoma City, OK 73116 (405) 843-9626

CIRCLE 19 ON READER SERVICE CARD

JUNE 1978

19

RADIO HUT

Money back guarantee. NO COD'S. Texas residents add 5% tax. Add 5% of order for postage and handling. Orders under \$15.00 add 75¢. Foreign orders: U. S. Funds ONLY!

For your convenience, call your BankAmericard or Master Charge orders in our Toll Free Watt Line: 1-800-527-2304. Texas residents call collect: 1-214-271-8423.

P. O. Box 64783M, Dallas, Texas 75206

POSITIVE VOLTAGE REGULATORS

LM340-6	LM340-15
LM340-8	LM340-18
LM340-12	LM340-24

To 220 case. Your choice .85 ea.

NEGATIVE REGULATORS

7905	7912	7915
------	------	------

To 220 case. Your choice .85 ea.

FINNED HEATSINK

for above regulators

2-3/4" High	2-1/2" Wide
1" Depth	ONLY .40 each

READOUTS

*FND70	.4"	C.C.	.59
FND800	.8"	C.C.	2.50
FCS8000	.8"	3 1/2 digits	4.95

*TI 6 digit array 3 for 1.00

*LIMITED QUANTITY

REPEAT OF SALE

12 Hour Basic Clock Kit Includes:

*FCS8000 3 1/2 digit .8" characters

*FCM7010 Direct Drive Radio Alarm Clock Chip

*1 Case (Punched for readout)

ALL THIS ONLY \$9.50. Specs included

Drilled PC Board for above \$2.50

Transformer for above \$1.00

TTL BOARDS

Memorex computer boards with IC's, diodes transistor, etc. 5 boards containing 100-200 IC's. ONLY \$4.25.

PLASMA DISCHARGE DISPLAY

12 digit display .4" character

Specs. included .79 each

POWER SUPPLY for above display

Complete with instructions \$3.25 each

POWER SUPPLY KIT

Input voltage: 25V max. Output current: 1 amp max. Load regulation 50mV. Uses 220 case regulators. Does not include the transformer. Specify either +6V, +8V, +12V, -5V or -12V regulator. ONLY \$3.50 ea.

LINEARS

LM309K	.95	NE555	.45
LM324	.40	NE556	.95
LM380 (8 pin)	.75	NE565	.95
LM380 (14 pin)	1.00	NE566	.95
LM3900	.35	NE567	1.10
LM710	.25	1458	.49
LM711	.25	RCA 3043	.95
LM723	.40	75491	.30
LM748	.25	75492	.40

TRANSISTORS - DIODES

2N2222	6/1.00
2N2369	6/1.00
2N2905	4/1.00
* 2N2907	15/1.00
2N3055	.75
2N3707	6/1.00
2N3904	6/1.00
2N3906	6/1.00
2N4400	6/1.00
2N4443 SCR	.59
RCA 200 V 115W NPN	.95
1N4004	15/1.00
1N4007	10/1.00
1N4148	20/1.00

*House numbered and P.C. Lead

TTL

7400	.17	7473	.21
7401	.17	7474	.35
7402	.17	7475	.55
7403	.17	7476	.35
74H04	.25	7480	.45
7404	.17	7483	.78
7406	.25	7485	.89
7408	.17	7486	.35
7409	.17	7490	.71
7410	.17	7491	.71
7411	.25	7492	.71
7413	.45	7493	.67
7420	.17	7494	.90
7421	.17	7495	.71
7423	.35	7496	.85
7425	.27	74100	.96
7426	.25	74121	.31
7427	.17	74123	.61
7430	.25	74125	.44
7432	.30	74141	.71
7437	.35	74145	.97
7438	.35	74151	.71
7440	.17	74153	.81
7442	.60	74154	.97
7443	.60	74181	.91
7444	.65	74183	1.05
7446	.85	74184	1.05
7447	.81	74174	.91
7448	.81	74175	1.40
7450	.20	74180	.78
7451	.17	74181	2.25
7453	.17	74191	1.20
7454	.17	74192	1.20
7470	.35	74193	.95
7472	.21	74195	.85

COLOR ORGAN

60 watt color organ. Completely self contained unit with 120V power cord included.

\$ 2.00 each

MK 5005

4 digit counter/latch decoder; 7 segment output only.

24 pin dip with specs.

\$ 9.50 each

WATERGATE SPECIAL: Telephone relay automatically starts and stops tape recorder. No batteries required. KIT COMPLETE with all parts—drilled PC board and case..... \$10.95

5V POWER SUPPLY—5 volt, 1 amp regulated power supply kit for all your TTL supply requirements.

FEATURES: line regulation .005% Load regulation 50mV Kit includes all components, PC Board, Transformer, Fuse and Pilot Light. Nothing else to buy!..... \$ 6.50

60 HZ CRYSTAL TIME BASE—This 60 Hz crystal time-base enables MOS Clock circuit to operate from a DC power source ideal for car, camper, van, boat, etc.

*60 Hz output with an accuracy of .005% (typ.)

*Low power consumption 2.5mA (typ.)

*Small size will fit most any enclosure

*Single MOS IC oscillator/divider chip

*5-15 volts DC operation

only \$5.95
2 for \$10.00

LOW POWER SCHOTTY

74LS00	.25	74LS74	.49
74LS02	.25	74LS90	.85
74LS04	.30	74LS132	.90
74LS08	.25	74LS138	.89
74LS10	.25	74LS139	.89
74LS11	.32	74LS155	.90
74LS20	.31	74LS157	1.00
74LS21	.33	74LS162	1.39
74LS22	.33	74LS163	1.39
74LS27	.30	74LS175	1.09
74LS30	.31	74LS193	1.09
74LS32	.33	74LS258	1.09
74LS37	.40	74LS367	.70
74LS38	.35	74LS368	.70

ORDER BY PHONE. Charge your order to BankAmericard or Master Charge.

Use Our Toll Free Watts

1-800-527-2304 R11

VARIABLE POWER SUPPLY KIT #1

*Continuously variable from 5V to 20V

*Excellent regulation up to 300 mil.

*4400 Mfd of filtering

*Drilled Fiberglass PC Board

*One hour assembly

*Kit includes all components

*Case included

ONLY \$ 9.95

VARIABLE POWER SUPPLY KIT #2

Same as above but with 1 amp output also with case. ONLY \$12.95

PC BOARDS

4 digit PC Board for FND800 or 807	2.50
6 digit PC Board for FND800 or 807	3.50
4 digit PC Board for DL707	1.50
6 digit PC Board for DL707	2.00
4 digit PC Board for FND503 or 510	2.00
6 digit PC Board for FND503 or 510	3.00
4 digit PC Board for DL747	2.50
6 digit PC Board for DL747	3.00
4 digit PC Board for DL727 or 728	2.00
6 digit PC Board for DL727 or 728	3.00
4 digit PC Board for FND359 or 70	1.75

NOTE: All PC Boards are multiplexed for adding additional digits.

CMOS SALE

CD4000	.16	CD4040	1.00
CD4001	.16	CD4041	.69
CD4002	.16	CD4042	.59
CD4007	.16	CD4043	.60
CD4009	.45	CD4044	.59
CD4010	.45	CD4047	.59
CD4011	.16	CD4049	.35
CD4012	.16	CD4050	.35
CD4013	.29	CD4051	.90
CD4014	.75	CD4053	.90
CD4015	.75	CD4056	1.00
CD4016	.29	CD4058	.90
CD4017	.80	CD4060	1.00
CD4018	.80	CD4066	.69
CD4019	.39	CD4069	.30
CD4021	.90	CD4071	.16
CD4022	.90	CD4076	.99
CD4024	.70	CD4077	.39
CD4025	.19	CD4102	.68
CD4027	.39	CD4116	.39
CD4028	.75	CD4507	.40
CD4029	.99	CD4512	.50
CD4030	.16	CD4516	.85
CD4034	2.30	CD4518	.85
CD4035	.99	CD4520	.85

Downcounter time your games

As you study the chessboard, your opponent suddenly moves his knight. You can see that, in its new position, it threatens both your queen and rook. You'll have to defend against that next move. But this is blitz and you only have ten seconds to move. There, you can check his queen. Good! Now it's his move.

"You lose," he shouts, "you took more than 10 seconds to make your move!" You insist you made the move in just nine seconds, but he won't listen. And so ends another friendly chess match. If only you had a *timer*.

Well, whether its ten-second blitz chess or three-minute scrabble, here's the super deluxe game timer you've been waiting for: the *Modern Electronics Downcounter*. You can preset it to count down to zero from any time up to 99 minutes and 59 seconds.

Freezing time

Momentarily hitting the *reset* switch automatically recycles the count back to the preset time, which immediately begins counting down again. Or, if you prefer, you can push the *pause* button, freezing the time until you again push the *pause* button. When you do, the countdown continues from the time remaining when you froze it.

Operation is simplicity itself. Once you've preset the time period you want,

Here's the ultimate in a colorful timer which will countdown the minutes and seconds while you take a turn at your favorite game.

by Jeff Sandler
Contributing Editor

just plug the Downcounter's power cord into a 117 volt outlet. Then hold down the reset button and push the pause button. This locks the count at the preset time. When you begin the game, just push down the pause button again, and the countdown begins.

Built-in buzzer

Once under way, you have the preset time period to make your move. Then, as soon as your move is completed, hit the reset button. Instantly, the timer will recycle and begin counting down the time allowed your opponent to make his move. When his move is made, he'll hit the reset button, and your time will begin counting down again.

If a player, and hopefully that player will be your opponent, fails to make his

move before time runs out, a built-in alarm will sound. In some games, the player will lose the game. In others, he'll only lose his turn. In this case, hitting the reset button stops the alarm sound and recycles the timer to begin counting down again from the preset time.

Because of the complexity of the circuit, the use of a printed circuit board





is a must. And even then, a fair amount of hand wiring will be required.

Although the circuitry is complex, construction of the Downcounter is straightforward. If you take your time, especially when putting in the wire jumpers on the PC board, you should experience no problems in construction or operation.

The printed circuit board shown contains all of the components except those for the audio alarm, the display readouts, power transformer and fuse, and the two switches. If you're into PC design, you can produce a board which contains all of the components.

The board layout shown contains two unused IC locations and several unused pads. These have been included for a future modification converting the countdown counter into an electronic stopwatch providing timing to the hundredth of a second. You can, if you'd like, use that section of the board for other purposes.

Couldn't be easier

Although at first glance the circuit looks very complex to build, it's actually quite simple. For one thing, with just two exceptions, all of the resistors are 10,000 ohm. And with the exception only of the four power supply rectifiers, all of the diodes are 1N4148s. The entire middle row of ICs is filled with 4029s

while the outside row uses 4543s. So, you won't have to spend too much time figuring out which value goes where.

The prototype was built into a Radio Shack number 270-252 metal cabinet, which measures 4 x 2-3/8 x 6 inches. One

nice feature of this cabinet is that the cover can be turned around, back to front. Using a cabinet with a reversible top lets you place the reset and pause buttons at opposite ends. Then, you can position the top so that the appropriate

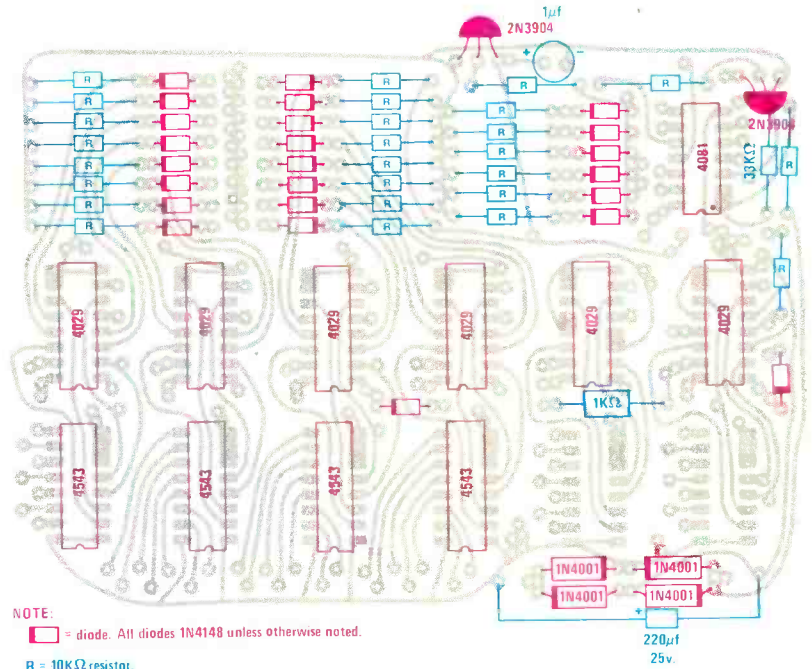

Stuffing the board with solid-state components is easy. All of the diodes except for the rectifiers are 1N4148s. Each horizontal row of ICs is stuffed with the same type device, and both transistors are 2N3904s. With the exception of just two resistors, all are 10,000 ohm units. Two capacitors complete the stuffing of the printed circuit board.

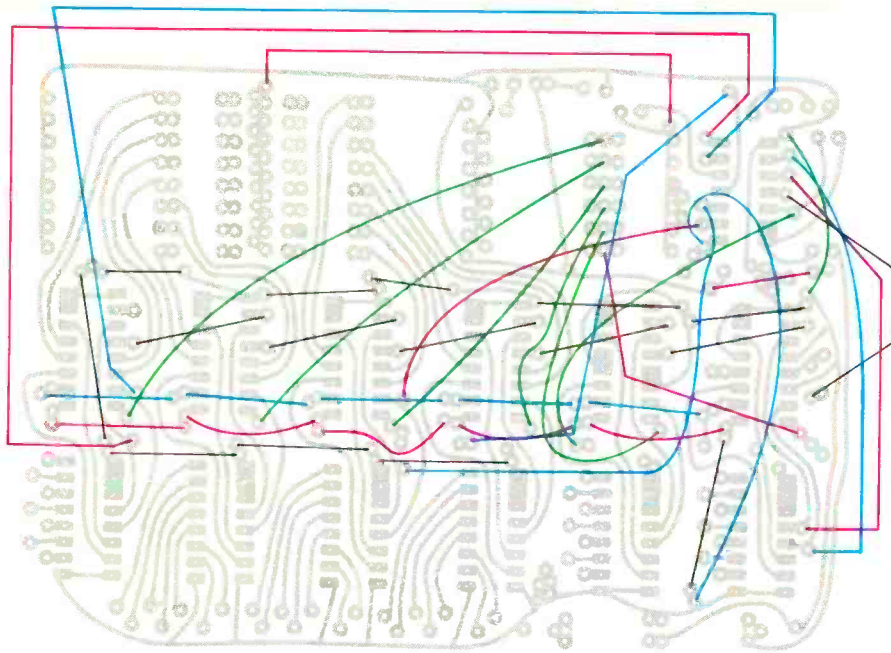

Circuit complexity makes it necessary to use a large number of jumper wires on the printed circuit board. Take your time when connecting the jumpers. Make certain each is in its proper location before applying power to the counter.

button for the game you're playing is at the front.

If the button position isn't critical, the circuitry can be mounted in any enclosure large enough to hold the PC board you're using. You might also attach a large plate, perhaps a poker chip, to the top of the reset switch, making it easier for a player to hit it in the heat of the game.

A good method for attaching the plate is filing the button flat and bonding the plate to it with ACC-type instant glue. But, be very careful. ACC glue will bond skin together better and faster than any other glue you're likely to come across. Read the instructions accompanying the glue before you use it.

The prototype was designed to have jumper wires soldered into the timing matrix. This arrangement produces a non-adjustable countdown time—say, three minutes. If you plan to use your counter for just one game, scrabble perhaps, then having a fixed time period should be ideal.

If you'd prefer to use your counter to time games requiring different periods,

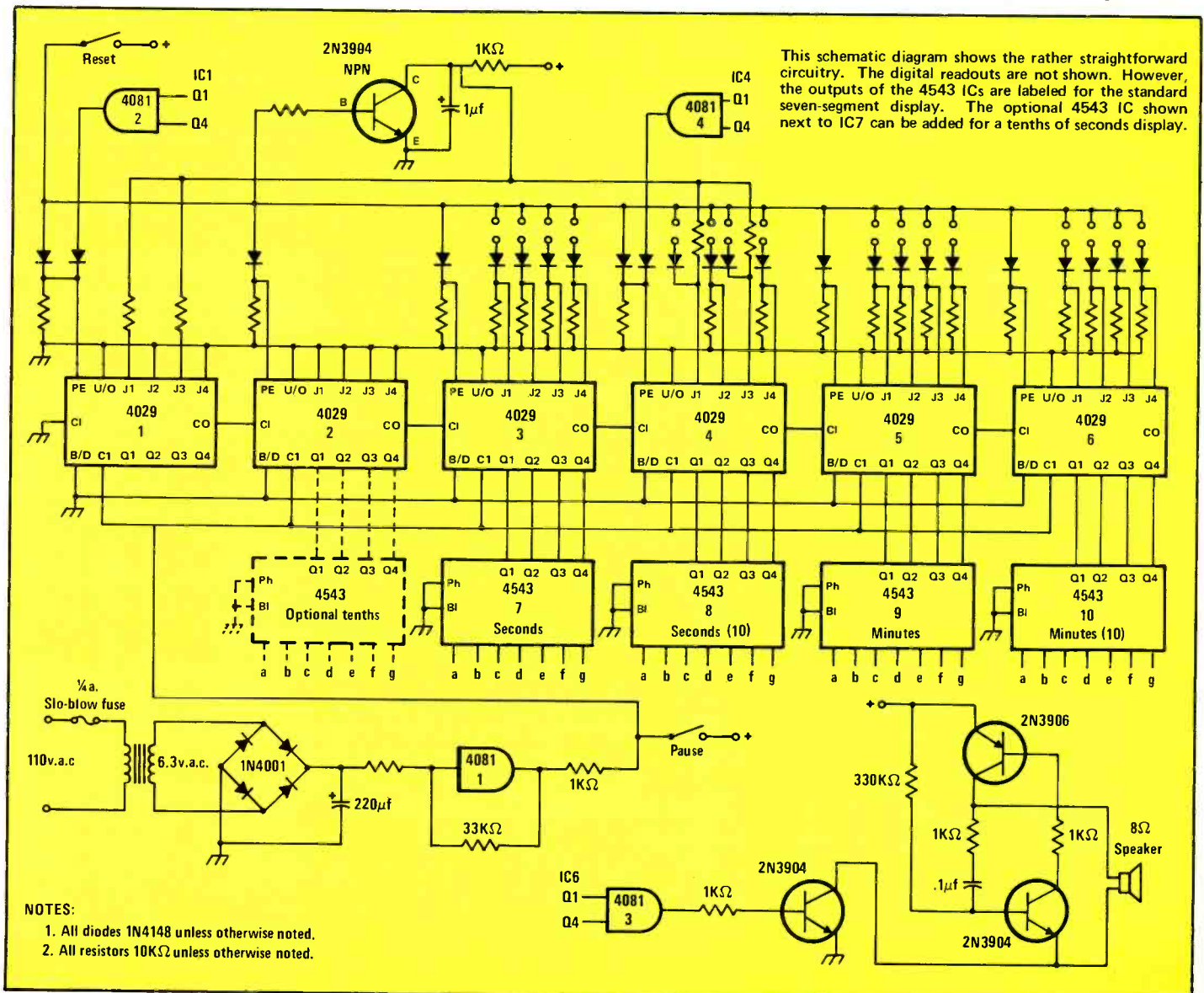

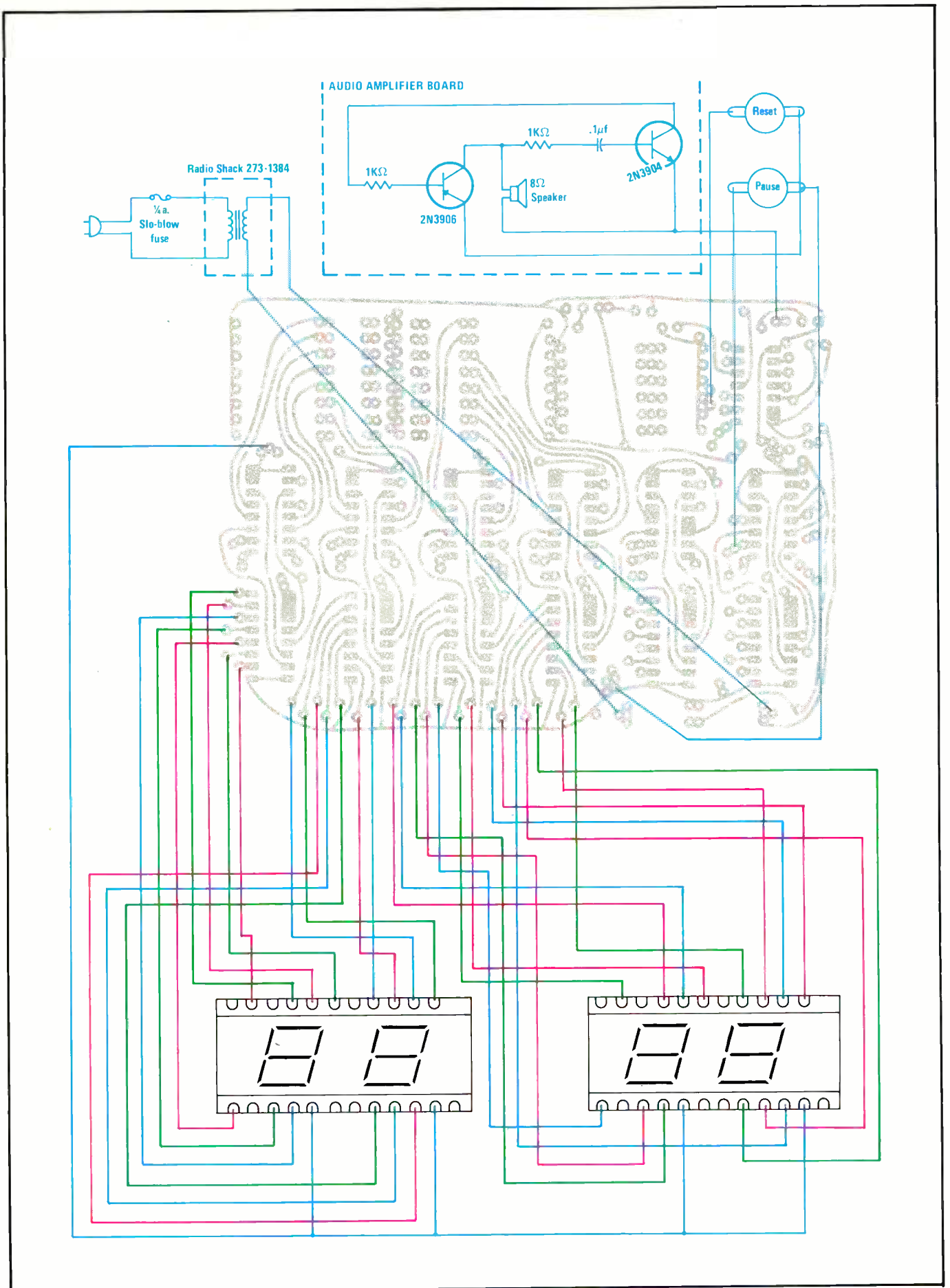

Circuitry external to the printed circuit board is connected to it by wire. The diagram shows these connections and the circuitry, which

can be built on a perfbard. Because of the large number of connections required, be certain each is in its proper location.

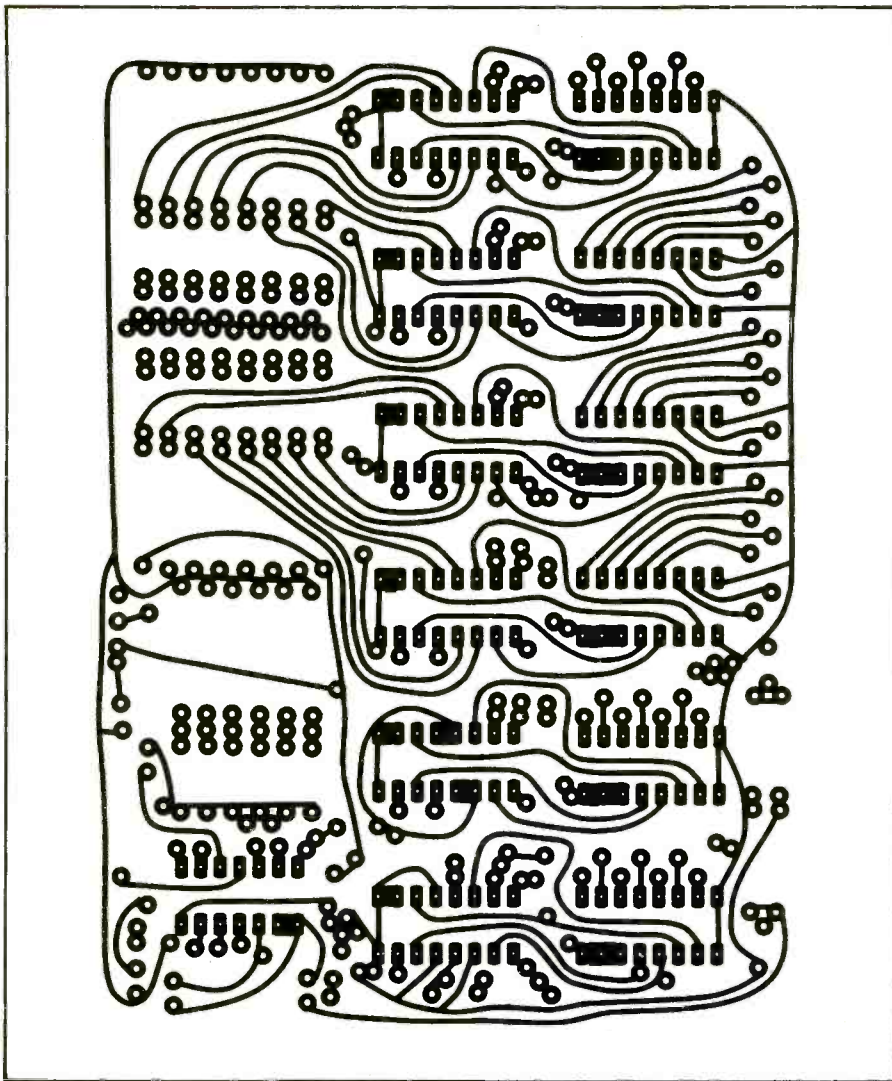

Printed circuit board foil layout template, foil side.

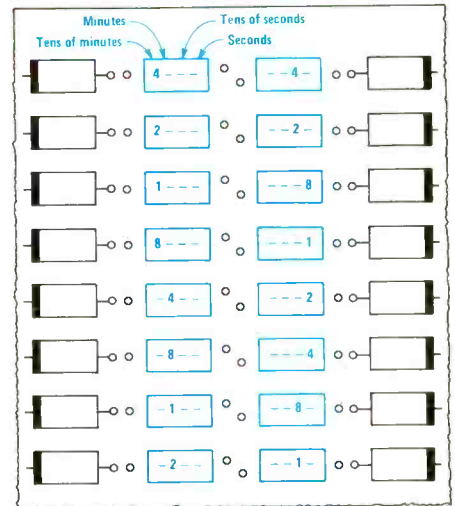

The time from which the counter runs down as it is reset is programmed by connecting jumpers in this diode matrix. Connecting a jumper between a diode and the center row of pads gives you the number shown in the corresponding box in the diagram. The time set is the sum of the numbers for each second and minute position. Connecting a jumper at the 4- and 2-positions, for example, will give you 60 minutes.

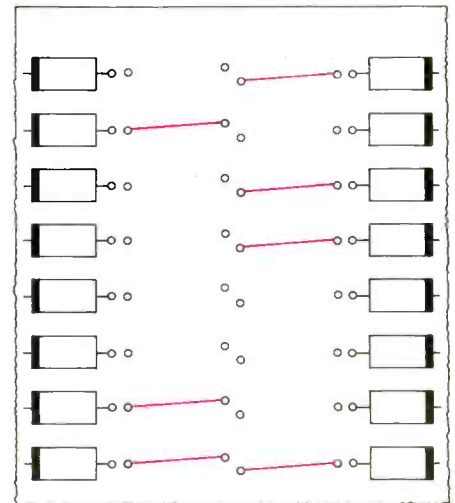

An example of time programming is shown in the diagram. The jumpers shown provide a running time of 23:59. If you prefer, you can connect an SPST switch across each jumper location. Then, choosing a time would involve nothing more than closing the appropriate switches.

now reserved for the future stopwatch modification.

Pull the plug

The prototype counter has no on-off switch, since it is designed for occasional use as a game timer. However, you can easily add your own on-off switch.

The *ME* countdown timer is not a trivial project. But, if you take your time, it's fairly easy to build. And, in addition to providing a rewarding challenge in its construction, the *Downcounter* will add immeasurably to the challenge of your game competition.



you can substitute SPST switches for the jumpers. Then all you have to do is close the appropriate switches to get the time you want. Altogether, you'll need 16 switches. You can use miniature or

subminiature switches, or two eight-switch dual-inline IC switch packs, or DIP switches as they're called. If you don't mind reworking PC boards, you can mount the DIP switches in the area

Parts list			
Component	Quantity required	Component	Quantity required
1 K ohm, ¼ watt resistor	5	2N3904 NPN transistor	2
10 K ohm, ¼ watt resistor	24	2N3906 PNP transistor	1
33 K ohm, ¼ watt resistor	1		
330 K ohm, ¼ watt resistor	1	Seven segment LED dual display	2
0.1 mfd capacitor	1	6.3 vac transformer	1
1.0 mfd capacitor	1	SPST momentary contact switch	1
220 mfd electrolytic cap	1	SPST switch	1
1N4001 silicon diode	4	½ amp slo-blo fuse and holder	1
1N4148 switching diode	24	8 ohm miniature speaker	1
4029 integrated circuit	6	Additional hardware, cabinet, and printed circuit board supplies as needed to finish project.	
4081 integrated circuit	1		
4543 integrated circuit	4		

First Impressions: using the

by Carmine W. Prestia, WB3ADI
Contributing Editor

When a new computer comes on the market with a whole system tagging along, hobbyists sit up and take notice. Everybody wants to know how the new gear works, what accessories are available, and how to hang new and different gadgets on the machine.

It happened with the MITS Altair computer. As more people bought the kits and wired-and-tested units, more accessories came on the market. And now, as Heathkit comes out with its H8 line, the questions are: how does it work, how good is it, what are the possibilities

for homebrew add-ons and writing your own programs for it.

Heath Co., Benton Harbor, MI 49022, actually offers two different computers. With a world-famous line of kits for home constructors, it's natural for folks to want to know what Heathkit computers are like.

Heath also has a line of *peripherals* (accessories) and *software* (programs) to support them. In fact, Heath offers everything you need to set up a complete computer system in your home. Here's what ME is finding out as we put the H8

system through its paces:

The H8 is based on the Intel model 8080A microprocessor chip, a thumbnail package containing a computer's arithmetic-logic unit, control circuitry and memory registers where the work is done. The 8080A is one of the most popular, if not *the* most popular, integrated circuit computer *chip* on the market today.

Also included in the system around the H8 are an H9 cathode-ray-tube display (crt), an H-10 paper tape reader and puncher, and an ECP-3801 cassette recorder and player.

You also need some interface devices to make all of these components work together. In our case, this required the serial I/O and cassette interface card (for the H9 and the cassette recorder), and the parallel interface card (for the H10). Last, but not least, is memory—12K bytes of random access memory (ram) on two H8-1 memory boards. This should be enough for all but the largest programs. However, expansion kits are available.

The H9 CRT links the computer with the outside world so we can talk to it. It is, basically, a tv screen mounted on a typewriter. The programs are typed in on the keyboard, and the computer instantly prints the results on the screen.

The H10 paper tape reader/punch is another input-output (I/O) device that uses punched paper tape to store information. Punched tape is a widely used medium. However, it is somewhat slower than magnetic cassette tape. The Heath reader overcomes the speed problem to some extent by shining light beams through the tape holes rather than mechanical fingers. This is faster, but still not as fast as magnetic tape.

Magnetic tape storage is accomplished on the model ECP-3801 magnetic tape recorder/player. This actually is a General Electric portable tape recorder/player. Heath determined that the specifications of GE machine fit the H8 and H8-5 serial I/O board best. In fact, Heath



Heathkit home computer

Heathkit is generating lots of excitement in the home computer field these days with its system built around the H8 microprocessor. We've fired up the gear and liked what we found. Here's a complete report on our first impressions.

will not guarantee the operation of the H8 with any other recorder/player.

All Heath components are styled alike—black and light gray tones with a sloping front panel. They are at home sitting next to each other, and look good sitting in the den or family room.

Easy to build

Inside the machine, Heath hasn't skimped either. The H8 uses a 50 pin *mother board*. Heath supplies connectors for all 10 plug-in positions on the board. This makes it possible to just plug in a newly-purchased interface or memory board without removing the mother board and soldering connectors.

There's a hefty, well-filtered *power supply* that comes with the computer itself. Voltage regulators are supplied on the individual boards that you purchase. There is space in the machine cabinet for seven boards, with two plugs for the front panel and CPU board. Each of the boards stands on an angle and is held by the mother board connector on one end and by two screws into the cabinet on the other end. Everything is solid and secure. The stand up arrangement of the boards provides plenty of ventilation without the need for a fan.

My system came factory-assembled. But, after looking at the manuals, it wouldn't have been too much trouble to build it. A manual is supplied for each unit and for each separate board. Instructions are clear, concise, and basic. In the cases of the H8, H9, and H10, separate *operational* manuals are supplied. Test routines and complete trouble shooting charts are included. Heath even gives you the CPU board (in the H8) and the control board (in the H9) as factory-assembled and tested units to eliminate the possibility of user mistakes in these critical areas.

If you are going to get Heath units, a word of advice: *take your time building*. The circuit boards are complex and sometimes dense. Speed only will lead to mistakes and problems.

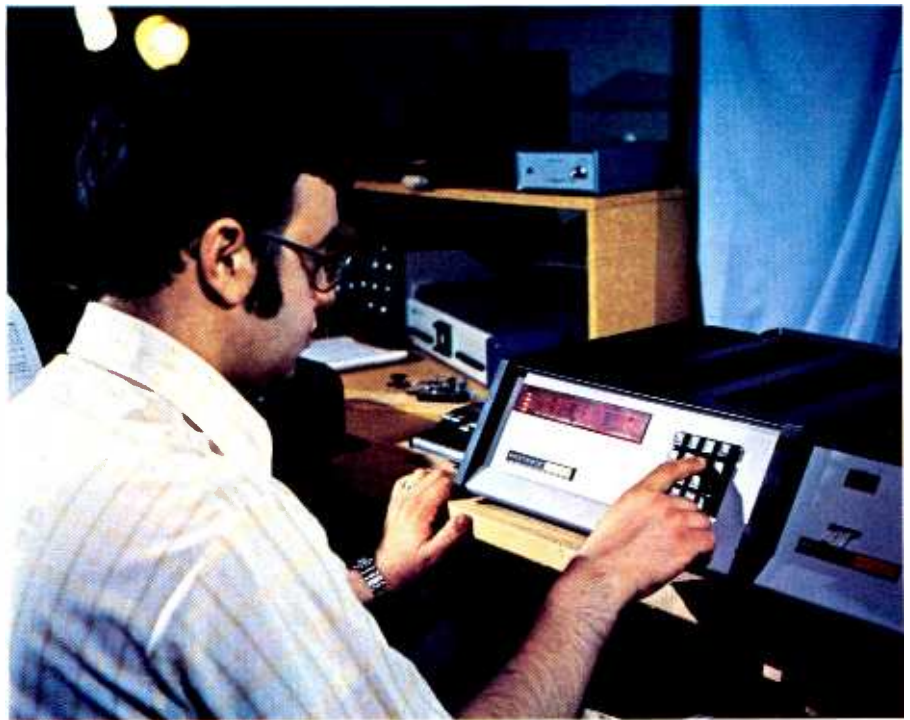

Software, the programs that go with a computer system, can make or break a system. Heath has left nothing to chance. There are four languages supplied on magnetic tape with the H8. They also are available on paper tape at extra cost.

■ BUG-8 is the language used to enter and debug machine language programs from a console terminal such as the H9 CRT. BUG-8 permits the user to execute these programs one or more instructions at a time and display and alter memory locations from the terminal. This permits very advanced and sophisticated program debugging by the user.

■ The Text Editor, or TED-8, helps the user edit assembly language programs before running them. TED-8 also is useful on straight text. This, in effect, makes the computer a very sophisticated typewriter, allowing the user to create nearly error-free text with minimum ef-

fort. These programs or texts can then be stored on tape for later use, without further editing.

■ HASL-8, Heath Assembly Language, recognizes the 8080A symbolic assembly code used with the Intel chip. Although assembly language programs are somewhat harder to write than a conversational language like Basic, they also are more powerful and more efficient. Numerous assembly language programs have been developed and are available to help get you started.

■ The most interesting of the available languages is Basic. Basic is a conversational language where the commands and format of Basic programs resemble a conversation between the computer and the user. It's then much easier to understand the programs and the logical sequence behind them. Even neophyte programmers can get a good start with-

please turn to page 91

LIGHTNING DETECTORS





through July—peaking in May when some 140 tornadoes occur on the average.

A storm alarm gives 20 minutes warning. This is important since storms occur at night when victims are asleep and unaware of impending danger. There aren't many such alarms on the market.

The Severe Storm Alarm from Sears is a self-contained unit, meaning it's mobile and is able to be used in boats, cars, airplanes, mobile homes, camp sites, as well as in the home or office when used with the accessory antenna.

Powered by a replaceable, 6-volt battery, the alarm detects storms by monitoring the electromagnetic field of approaching storms up to 30 miles away. When electrical cloud activity reaches a rate of 1000 or more discharges per second, and 20 discharges of one-tenth seconds or longer duration in one minute, a red light and an alarm buzzer indicate tornado activity.

Lights flash

The unit has two lights and a meter on the front panel. When a storm approaches to within 20 to 30 miles, the green panel light flashes to indicate storm activity in the area. The red light flashes to indicate the coming of an intense storm. In addition, the meter measures the intensity of the storm. If the storm approaches tornado severity, a loud audible alarm is activated and the meter reads "Danger."

The Sears unit is available through their 1978 Spring/Summer catalog for \$59.

Storm alarms afford the potential tornado victim the time to get to a safe place, thus preventing a possible tragedy.

Their paths are unpredictable, their power terrifying, and their results many times deadly. *Tornadoes*—violent storms which lash across cities and farmlands—are not merely limited to the well-known "Tornado Alley" of Texas, Oklahoma and Kansas or the eastern Florida regions of Orlando and Jacksonville. The storms rip through homes, factories and croplands usually before effective precautions can be taken.

Tornadoes start in Florida, Georgia and South Carolina in early to mid-March. They cross the Gulf of Mexico, Alabama, Mississippi, Louisiana and then up tornado alley, peaking in the end of May in

Missouri, Illinois, Ohio, Indiana. They linger in the northern states for a few months. In August and September, they return to the Texas and Oklahoma area.

Too many deaths occur at night during sleeping hours. Some could be prevented.

Because lives could be saved, a home storm alarm system is more and more in demand.

20 minute warning

Storm alarms, according to laboratory safety and electronics technicians, can help save lives each year through early warning. While tornadoes occur throughout the year, the most active months are April

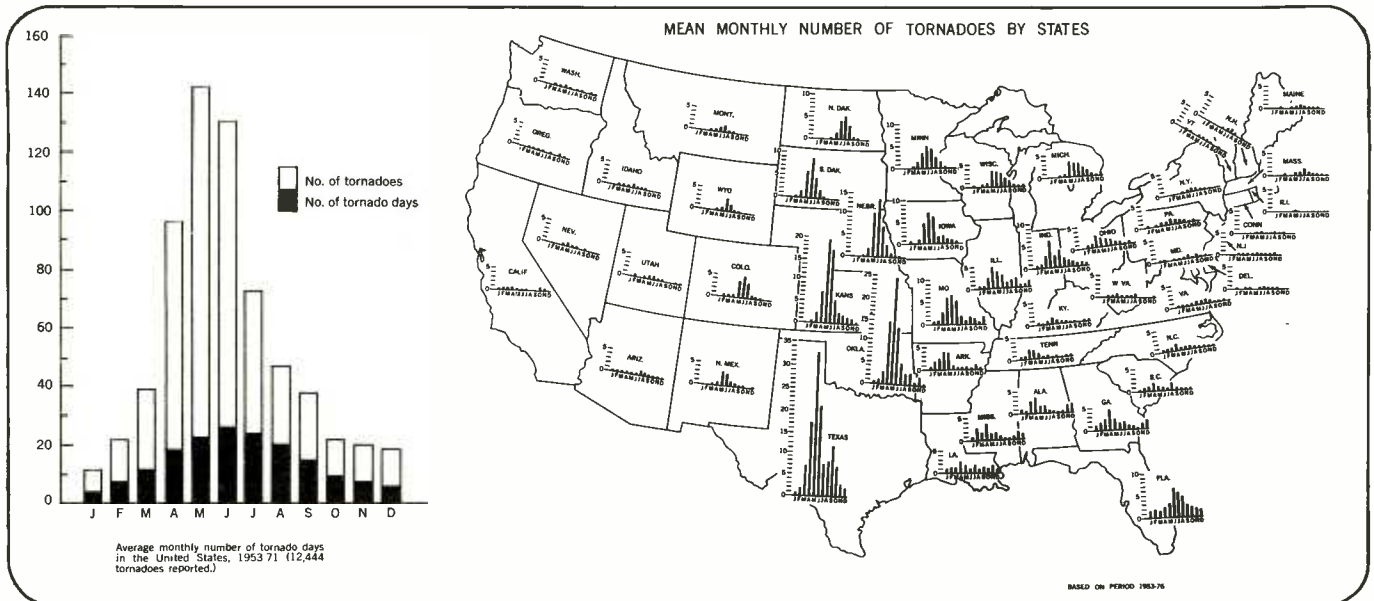

Home computer: the plumber's new friend

What's a plumber and Knott's Berry Farm have in common? Besides both being in California? Both are finding plenty of good uses for those tiny new home-style computers which are so popular today. Here's a report on how they use microprocessors and some good ideas for your own home computer.

That was really a stupid move, Jay. I'm going to finish you off in three moves."

Those insults are coming from Jay E. Moss' home computer, printing its barbs across a television-like video display screen. Moss had programmed the system to insult him as they match wits playing a four-dimensional tic-tac-toe game.

"I may make stupid moves in the game, but the smartest thing I ever did was to buy that MITS microcomputer," asserts Moss. "I got it a year ago, really as a toy for myself, but I instantly realized its potential for my plumbing contracting business.

"I've spent about \$9,000 on the system in all, and I figure it has paid for itself several times over in this first year alone."

Most significantly, Moss uses the computer to develop estimates for contract bids. The system also handles various company financial activities, such as payroll and bookkeeping, and it acts as Moss' secretary to type out invoices and flawless form letter.

Moss' 20-year-old firm is based in Simi Valley, Calif. The company, Jemco Plumbing Inc., does about \$2.5 million of



large-scale contracting annually on construction projects, mainly residential subdivisions. It employs between 20 and 40 persons, varying with the stage of construction.

About a year ago, Moss saw a news magazine article about hobbyists buying

computer kits for as little as \$400 and assembling small systems that are as powerful as giant computers of a decade ago.

Moss, 55, is an ardent hobbyist himself, with interests in photography, rock-cutting, jewelry-making, astronomy and sailing. A mechanical engineer by training, he also has worked with electronics kits, even assembling three color TV sets. "But I knew nothing about computers beyond how to spell the word," he says.

The day after he read the article he and his son went to a computer store and spent \$2,700 for a MITS 8800a microcomputer kit and peripheral equipment. The products are manufactured and marketed by Perlec Computer Corporation's Microsystems Division, Woodland Hills, Calif., through some three dozen computer centers, exclusive dealerships across the country.

Moss and his son assembled the computer over a weekend, and Moss immediately saw its business possibilities.

With the aid of the computer store personnel and a basic instruction book, he developed programs for his firm's financial functions. After payroll was automated, Jemco's accountant lowered



Behind the scenes at Knott's Berry Farm in California, three small desk-top microcomputers are helping to operate the nation's oldest and third-largest theme amusement park (after Disney World and Disneyland).

They're part of the construction and maintenance division's activities in scheduling and expediting the many maintenance and construction jobs continually in progress; lighting control; and air conditioning control to promote energy conservation.

Knott's Berry Farm, which hosts four million visitors a year on its 150 acres of 100 rides and attractions, eating places, and unique shops, boasts some of the world's most advanced electronics systems.

Mike Reafsnyder, director of construction and maintenance, recognized a growing need for computer support to his division in maintaining the Farm's attractions and, when desired, adding new features. The situation became critical after the Farm opened its *Roaring 20's* area in 1975 and attendance zoomed by 52 percent.

Given the availability of the division's strong internal electronics department—whose engineers had recently helped to install such thrill rides as the *Corkscrew* and the 20-story *Sky Tower Parachute Jump*—Reafsnyder felt confident that his staff could build the needed computerized control systems themselves, starting with computer kits.

The three MITS 8800 microcomputers which provide the central control for the Division's systems were purchased from a Computer Center. MITS microcomputers are manufactured and marketed by Pertec Computer Corporation's Mic-

rosystems Division, Chatsworth, Calif.

While each of the three MITS central processors is dedicated to a specific application (i.e., work order scheduling, lighting, and air conditioning), all of the terminals and printers can be switched as needed to any of the three applications. Computer system hardware includes three Ann Arbor terminals, three 110-cps Okidata line printers, and three disk drives. The work order scheduling system uses 40K bytes of mainframe memory; the lighting and air conditioning systems use 16K and 20K, respectively. Each of the three disk drives uses 300K bytes of floppy disk storage.

The work order expediting system schedules the construction and maintenance division's workload, based on due dates and priorities that have been assigned to the various jobs. When more than one shop is involved in a particular job, the computer takes this into consideration and coordinates the different shops. A printed listing, showing all jobs in priority order, is furnished periodically to the division's various managers.

In the lighting control system, the computer provides centralized control to turn various groups of lights throughout the farm on and off at pre-specified times. Staff assistant Ralph Ruffalo, who oversees the operation of the division's computerized systems, explains: "While we have our regular lighting schedule that remains fairly constant, we can also enter the 'on' and 'off' times for special events that require lighting at unscheduled times—in our theatre and Wagon Camp, for example. Then, after that special event is over, it is purged from the memory and the system reverts to its normal schedule."

All of the farm's lighting, except a few parking lots and other peripheral areas, is under computer control. "While the lighting is currently divided up into just 11 sections for control purposes, we do intend to break it down more finely in the future," Ruffalo explains. "The system has the capability of controlling up to 100 separate lighting areas."

Primary purpose of the third computerized system is conserving energy and minimizing the farm's electric utility bills through air conditioning control. "The system compares actual kilowatts being used by the entire farm at any given moment with a 'standard kilowatt' amount that has been designated as a standard for that particular time of day," says Ruffalo. "And whenever the actual kilowatt amount exceeds the standard, various air conditioning units will begin to cycle off and on at short intervals—usually every ten minutes.

"All the air conditioners on the farm are grouped into three different priorities," Ruffalo continues, "and the computer automatically searches its memory, finds the air conditioners in the lowest priority group which are running at the time the signal to begin cycling is received, and will selectively begin to cycle these units. If cycling a major portion of the lowest-priority units does not return power to standard, the system will begin cycling the next priority group, and will continue this procedure until actual kilowatts return to the standard amount."

One additional feature built into the system guards against excessive "peak" power usage which could adversely affect the Farm's utility rate structure. In the event that power usage should reach a "maximum kilowatt" figure, the system will continue to cycle as before, but will increase the "off" times by 20 percent.

"At present a large part of the farm's air conditioning is on the computer-controlled system, and we are still in the process of adding more air conditioners to it," Ruffalo points out. "The present system can handle up to 100 individually controlled units—and with about 50 on the system now, we still have a lot of room for expansion.

"We also plan to add another major application to the system in the near future—inventory management," says Ruffalo. "This will help us keep better track of the parts that our various shops need. As shop personnel use up their parts, they'll note this on their daily work cards. We'll key this information into the computer, and it will tell us when we're reaching dangerously low inventory levels. For this, we plan to use MITS standard inventory management program."



Members of Knott's Berry Farm construction and maintenance division check operations on one of their three MITS home-style microcomputers. Left of the CRT (cathode-ray tube) keyboard and video-display terminal are paper printers. The actual computers are at far left. These are the same microprocessors home-computer hobbyists use.

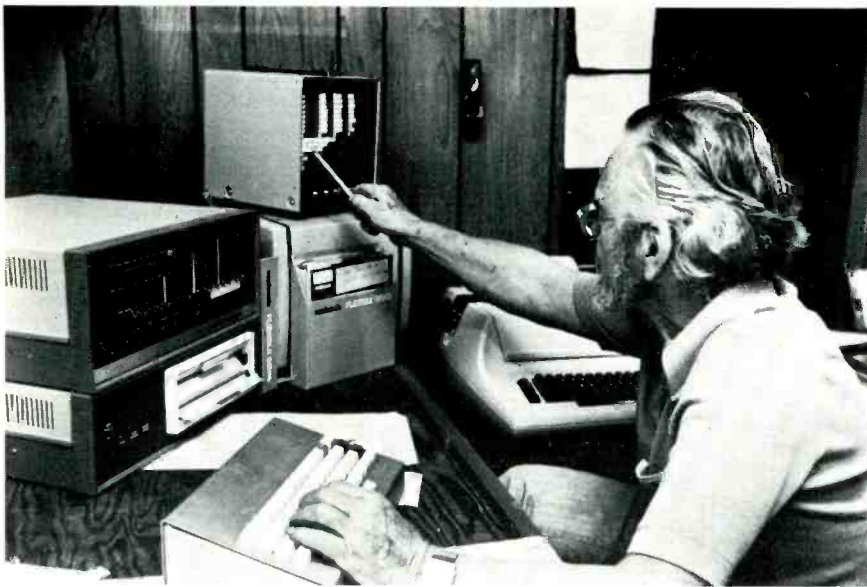

his monthly fee by \$75 a month. Also, Moss uses the computer to check supplier invoices, utilizing the same system that the supplier's computer uses.

Moss also added to his system, tacking on a typewriter terminal, larger memory boards, and floppy disks for greater information-handling ability. He has invested some \$9,000 in the system to date.

About six months ago, he hit on the idea of using the microcomputer to devise estimates for his contract bids. "It used to take me three to four hours with a pencil, paper and desk calculator to estimate costs on a plan (most tracts involve three to five house plans). Now it takes me about 15 minutes at the outside," he reports.

Moss developed his own program for the computer to handle this chore. When he uses the system for estimates, it asks a series of questions: How many houses of this plan are in the tract? How many fixtures are in the plan? How much does each fixture cost? How far apart are the fixtures? How much four-inch pipe is needed for the waste system? How much three-inch pipe? Two-inch? One

and a half inch?

The computer already knows what labor will be involved because Moss fed in records he had kept over the years of how long it takes to do each of 15 operations on a house during construction. "To check whether the computer's estimates on labor were correct, I took old housing plans from four to five years ago and had the computer estimate them. Then I checked those figures with the actual labor and costs, and they were fantastically accurate," he says.

The computer takes all the information Moss has fed into it and churns out an itemized estimate for a job, including profit and overhead factors, to produce Moss' contract bid figure. It now takes about 45 minutes to devise bids for a tract with four house plans, Moss estimates. He adds, "Most small businessmen would probably need only about \$5,500 worth of equipment. But the big thing is that they shouldn't be afraid of using a computer. They don't have to know how a computer works, but how their business works."—Steven Ludwig

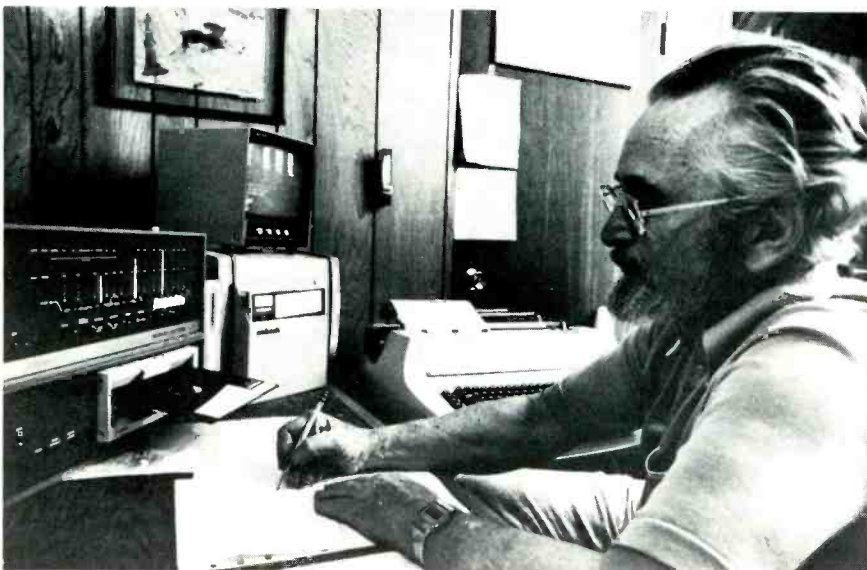

**"YOU DON'T
HAVE TO CLIMB
A MOUNTAIN
TO GAIN
ENLIGHTENMENT."**



Just send away for the Consumer Information Catalog and a key to enlightenment will appear in your mailbox.

The Consumer Information Catalog is put out by the Federal Government. And it lists over 200 of their booklets that you can send away for. Most are free. And they can help you with things like how to buy a home, how to grow vegetables, how to deal with headaches, simple plumbing repairs and many other everyday and not-so-everyday problems.

So if you wish to learn about the mystic sensibilities of the wayward ancients, put on your climbing gear.

But, if you wish to know about how to fix a leaky faucet, send for the catalog. Write: Consumer Information Center, Dept. A, Pueblo, Colorado 81009.

Remember, it's free. Which is only right. After all, the first step towards enlightenment shouldn't enlighten your pocketbook.

**THE CONSUMER
INFORMATION CATALOG**

A catalog of over 200 helpful publications.

Vhf engineering

PRICES EFFECTIVE
JAN. 15, 1977

THE WORLD'S MOST COMPLETE LINE OF VHF-FM KITS AND EQUIPMENT

- RX28C 28-35 MHz FM receiver with 2 pole 10.7 MHz crystal filter . . . \$ 64.95
- RX28C W/T . . . same as above—wired & tested . . . 117.95
- RX50C Kit . . . 30-60 MHz rcvr w/2 pole 10.7 MHz crystal filter 64.95
- RX50C W/T . . . same as above—wired & tested . . . 117.95
- RX144C Kit . . . 140-170 MHz rcvr w/2 pole 10.7 MHz crystal filter 74.95
- RX114C W/T . . . same as above—wired & tested . . . 119.95
- RX220C Kit . . . 210-240 MHz rcvr w/2 pole 10.7 MHz crystal filter 74.95
- RX220C W/T . . . same as above—wired & tested . . . 117.95
- RX432C Kit . . . 432 MHz rcvr w/2 pole 10.7 MHz crystal filter 84.95
- RX432C W/T . . . same as above—wired & tested . . . 129.95

RECEIVERS



- RXCF accessory filter for above receiver kits gives 70 dB adjacent channel rejection 8.95
- RF28 Kit 10 mtr RF front end 10.7 MHz out 13.50
- RF50 Kit 6 mtr RF front end 10.7 MHz out 13.50
- RF144D Kit . . . 2 mtr RF front end 10.7 MHz out 18.50
- RF220D Kit . . . 220 MHz RF front end 10.7 MHz out 18.50
- RF432 Kit 432 MHz RF front end 10.7 MHz out 29.50
- IF 10.7F Kit . . . 10.7 MHz IF module includes 2 pole crystal filter 29.50
- FM455 Kit 455 KHz IF stage plus FM detector 18.50
- AS2 Kit audio and squelch board 16.00

- TX50 transmitter exciter, 1 watt, 6 mtr. 44.95
- TX50 W/T same as above—wired & tested . . . 64.95
- TX144B Kit . . . transmitter exciter—1 watt—2 mtrs 34.95
- TX144B W/T . . . same as above—wired & tested . . . 59.95
- TX220B Kit . . . transmitter exciter—1watt—220 MHz 34.95

TRANSMITTERS



- TX220B W/T . . . same as above—wired & tested . . . 59.95
- TX432B Kit . . . transmitter exciter 432 MHz . . . 49.95
- TX432B W/T . . . same as above—wired & tested . . . 79.95
- TX150 Kit 300 milliwatt, 2 mtr transmitter . . . 24.95
- TX150 W/T . . . same as above—wired & tested . . . 39.95

- PA2501H Kit . . 2 mtr power amp—kit 1w in—25w out with solid state switching, case, connectors 64.95
- PA4010H Kit . . 2 mtr power amp—10w in—40w out—relay switching 64.95
- PA50/25 Kit . . . 6 mtr power amp, 1w in, 25w out, less case, connectors & switching 54.95
- PA144/15 Kit . . 2 mtr power amp—1w in—15w out—less case, connectors and switching 44.95
- PA144/25 Kit . . same as PA144/15 kit but 25w . . . 54.95
- PA220/15 Kit . . similar to PA144/15 for 220 MHz 44.95
- PA432/10 Kit . . power amp—similar to PA144/15 except 10w and 432 MHz 54.95
- PA140/10 W/T . . 10w in—140w out—2 mtr amp . . . 219.95
- PA140/30 W/T . . 30w in—140w out—2 mtr amp . . . 189.95

POWER AMPLIFIERS



Model	BAND	Power Input	Power Output	
BLC 10/70	144 MHz	10W	70W	149.95
BLC 2/70	144 MHz	2W	70W	169.95
BLC 10/150	144 MHz	10W	150W	259.95
BLC 30/150	144 MHz	30W	150W	239.95
BLD 2/60	220 MHz	2W	60W	164.95
BLD 10/60	220 MHz	10W	60W	159.95
BLD 10/120	220 MHz	10W	120W	259.95
BLE 10/40	420 MHz	10W	40W	179.95
BLE 2/40	420 MHz	2W	40W	179.95
BLE 30/80	420 MHz	30W	80W	259.95
BLE 10/80	420 MHz	10W	80W	289.95

- PS15C Kit 15 amp—12 volt regulated power supply w/case, w/fold-back current limiting and overvoltage protection . . . 94.95
- PS15C W/T . . . same as above—wired & tested . . . 124.95
- PS25M Kit . . . 25 amp—12 volt regulated power supply w/case, w/fold-back current limiting and ovp, with meter 154.95
- PS 25M W/T . . . same as above—wired & tested . . . 179.95

POWER SUPPLIES



- O.V. adds over voltage protection to your power supplies, 15 VDC max. 12.95
- PS3A Kit 12 volt—power supply regulator card with fold-back current limiting . . . 10.95
- PS3012 W/T . . . new commercial duty 30 amp 12 VDC regulated power supply w/case, w/fold-back current limiting and overvoltage protection 249.95

- RPT50 Kit repeater—6 meter 499.95
- RPT50 repeater—6 meter, wired & tested 799.95
- RPT144 Kit . . . repeater—2 mtr—15w—complete (less crystals) 499.95
- RPT220 Kit . . . repeater—220 MHz—15w—complete (less crystals) 499.95
- RPT432 Kit . . . repeater—10 watt—432 MHz (less crystals) 579.95
- RPT144 W/T . . . repeater—15 watt—2 mtr. 799.95
- RPT220 W/T . . . repeater—15 watt—220 MHz 799.95
- RPT432 W/T . . . repeater—10 watt—432 MHz 849.95

REPEATERS



- DPLA50 6 mtr close spaced duplexer . . . 575.95
- DPLA144 2 mtr, 600 KHz spaced duplexer, wired and tuned to frequency . . . 379.95
- DPLA220 220 MHz duplexer, wired and tuned to frequency 379.95
- DPLA432 rack mount duplexer 319.95
- DSC-U double shielded duplexer cables with PL259 connectors (pr.) . . . 25.00
- DSC-N same as above with type N connectors (pr.) 25.00

- TRX50 Kit Complete 6 mtr FM transceiver kit, 20w out, 10 channel scan with case (less mike and crystals) 244.95
- TRX144 Kit . . . same as above, but 2 mtr & 15w out 234.95
- TRX220 Kit . . . same as above except for 220 MHz 234.95
- TRX432 Kit . . . same as above except 10 watt and 432MHz 254.95
- TRC-1 transceiver case only 29.95
- TRC-2 transceiver case and accessories . . . 49.95

TRANSCIVERS



OTHER PRODUCTS BY VHF ENGINEERING

- CD1 Kit 10 channel receive xtal deck w/diode switching \$ 7.95
- CD2 Kit 10 channel xmit deck w/switch and trimmers 15.50
- CD3 Kit UHF version of CD1 deck, needed for 432 multi-channel operation . . . 13.50
- COR2 Kit carrier operated relay 22.75
- SC3 Kit 10 channel auto-scan adapter for RX with priority 19.95
- Crystals we stock most repeater and simplex pairs from 146.0-147.0 (each) . . . 5.00
- CWID Kit 159 bit, field programmable, code identifier with built-in squelch tail and ID timers 39.95
- CWID wired and tested, not programmed 54.95
- CWID wired and tested, programmed . . 59.95
- MIC 1 2,000 ohm dynamic mike with P.T.T. and coil cord 12.95
- TS1 W/T tone squelch decoder 59.95
- TS1 W/T installed in repeater, including interface accessories 89.95
- TD3 Kit 2 tone decoder 35.95
- TD3 W/T same as above—wired & tested . . . 59.95
- HL144 W/T . . . 4 pole helical resonator, wired & tested, swept tuned to 144 MHz ban . . . 29.95
- HL220 W/T . . . same as above tuned to 220 MHz ban 29.95
- HL432 W/T . . . same as above tuned to 432 MHz ban 29.95

- SYN II Kit 2 mtr synthesizer, transmit offsets programmable from 100 KHz—10MHz, (Mars offsets with optional adapters) 169.95
- SYN II W/T . . . same as above—wired & tested . . . 239.95
- SYN 220 Kit . . . same as SYN II Kit except 220-225 MHz 169.95
- SYN 220 W/T . . same as above—wired & tested . . . 239.95

SYNTHESIZERS



Vhf engineering

DIVISION OF BROWNIAN ELECTRONICS CORP.

BOX ME/ 320 WATER ST. / BINGHAMTON, N.Y. 13901 / Phone 607-723-9574

Prices and specifications subject to change without notice. Export prices slightly higher. 502 3100-1.78



CIRCLE 15 ON READER SERVICE CARD

In-Dash CB: now you see it, now you don't

Here's a new and different way to carry a secret CB in your car

by Ron Cogan
Contributing Editor

With auto stereo systems and mobile citizens-band radios enjoying unprecedented popularity over the past few years, blending of the two into one component was a natural move. Sure, the cost of one of these units is relatively high. But when compared to the purchase price of a separate stereo and a CB radio it's right back in the same ballpark. And a good, solid combo component offers features and conveniences that can't be found on conventional stereos and CBs.

Convenience built in

First off, since the two are in one package, you need only contend with one installation. In-dash stereos normally are installed in a standard auto radio cavity built in by automobile manufacturers. But citizens band radios are another story altogether. Not only must you find a suitable location within easy reach of the driver's seat, but one where your CB will be aesthetically pleasing and out of the way of hands, feet, and other dash components. This can be a real challenge

in those cars which boast cluttered dashboard assemblies.

One slick feature eliminates the problem of which system is more important during your drive—the relaxation of soothing stereo or the constant traffic updates received on channel 19. Simply tune in your favorite stereo and CB channels, adjust volume and squelch, and then flick the CB to "stand-by". You'll be enjoying smooth stereo sounds until a strong CB transmission breaks through the squelch. Instantly, the unit changes to the CB mode, placing the stereo portion on stand-by.



An entry from Kraco is model KCB-4090 which offers in or under dash mounting capabilities. Local/distance control, stand-by, 8-track deck, fine-tuning, and an LED channel display in the microphone are incorporated in this package. Kraco Enterprises, 505 E. Euclid Ave., Compton, California 90224.

The system will revert back to stereo music once the CB transmission has been completed. Also, the system will change instantly to CB whenever you key the mic. It's that simple.

Latest in gadgetry, too

The latest state-of-the-art features found in separate stereos and CBs now can be found on combo units. Intrigued by flashy LED displays? Well, you'll be happy to note that many in-dash combos offer LED digital channel readouts,



Midland's model 63-445 is an am/fm/CB with an integral cassette stereo deck, local/distance control, automatic noise limiter, LED channel display, front/rear fader, and more. Midland International, Communications Division, PO Box 1903, Kansas City, Missouri 64141.

transmit indicator lamps, and S/rf indicators that offer individually numbered increments. And that's just the beginning.

Other popular features incorporated in most in-dash units include automatic noise limiter, noise blanker, delta-tuning, swr calibration and all of the functions found on quality CB radios. Stereo features commonly found on these systems consist of fine-tuning,



Marketing giant Sears & Roebuck boasts their Model 62676 combo. This unit offers pushbutton stereo selection, CB stand-by, public address system, SWR calibration, fine-tuning, S/rf meter, and an LED channel display. Available from Sears, Roebuck & Co. stores.

Clarion's Model PE-621-E is an am/fm/8-track package with built-in 40-channel CB capabilities. It has an LED channel indicator, CB channel scanning function, CB stand-by, front/rear fader, antenna trimmer, and more. Adjustable tuning shafts enable it to fit most domestic and foreign cars and trucks. Clarion Corporation, 5500 Rosecrans Ave., Lawndale, California 90260.



Model 8340 by Pace incorporates am/fm/CB operation in a handsome package boasting pushbutton station selection, public address system, stand-by, digital CB channel display, and LED S/Rf meter with individual, numbered increments. Pace, 24049 So. Frampton Avel, Harbor City, California 90710.

local/distant receiver control, balance, tone, and so on. A few currently available models even offer integral cassette or 8-track decks, pushbutton am/fm selection, electric antenna leads, and even a scanning function for the transceiver section.

What next?

A good question. Manufacturers are adding graphic equalizer boosters and



Radio Shack's TRC-471 is a combo am/fm/40-channel CB that boasts a conventional S/rf meter, digital channel display, transmit indicator lamp, fader control, and pushbutton station selection. Available from Radio Shack electronic stores nationwide.

digital clock displays to auto stereo systems. We can assume it's only a matter of time before these show up on CB/stereo combination units. We're apt to see an array of more efficient and handsome combos making their way to the shelves—ones which sport the latest, most innovative features designers can dream up. That's one of the strongest reasons motorists will buy a single unit to serve a number of needs in the future.

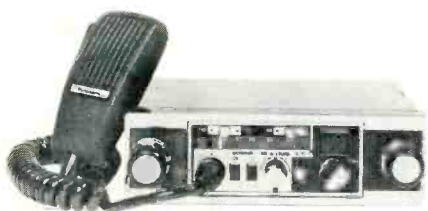

Panasonic's model CR-B4700 offers am/fm/CB functions with a conventional S/rf meter, digital channel display, delta-tune, local/distance reception control, and more. Panasonic, One Panasonic Way, Secaucus, New Jersey 07094.

Silicon controlled rectifiers

These solid-state gadgets make for interesting projects. Here's how they work and what they'll do for you.

If you have a lamp dimmer or a variable speed motor control, chances are it contains a *silicon controlled rectifier*, or SCR. In most respects, an SCR is a silicon diode; the same kind of device as the rectifiers in your favorite solid-state power supply.

When an ac voltage is applied across a standard diode, it turns on or *conducts* only during the half-cycle that its anode is positive in respect to its cathode. During the other half-cycle, the diode turns off and does not conduct. This process is the basis of rectification—converting alternating current to a current that flows only in one direction.

SCRs differ from ordinary diodes in one very important way—they have built-in remotely controlled switches that turn them on. Until that switch is turned on by remote command signal, the SCR remains off or in its non-conducting state, regardless of the voltage polarity applied to it. But, if the anode is positive in respect to the cathode, and the turn-on command signal is applied, the SCR will begin to conduct.

Once conduction begins, the SCR stays on until the anode is no longer positive. Then, and only then, will the SCR turn off. So, although the built-in switch can turn the SCR on, it *cannot* turn it off once it has begun to conduct current.

The turn-on switch in a real SCR is called the gate. Generally, to turn on an SCR, its gate must receive a positive command signal of at least one volt. Depending on the particular device being used, the maximum gate voltage runs between two and five volts. So, be sure to check the spec sheet before using an SCR.

The easiest way of visualizing what happens inside an SCR is to think of it in terms of a latching relay circuit in series with a standard diode. The coil of the diode relay is in series with the anode to cathode in-out path of the SCR. So, any current flowing through the SCR flows through the relay coil energizing it.

Once current starts flowing through the SCR, it will continue to do so in the same manner as a standard diode. However, no current can flow through the coil until the contacts of either the gate relay or the diode relay are closed. Since the diode relay contacts won't close until coil is energized, only the gate relay can turn on the diode relay. But once its on, it stays on until the anode is no longer positive.

SCRs are sometimes called *thyristers*. But by any name, they are very interesting devices. For

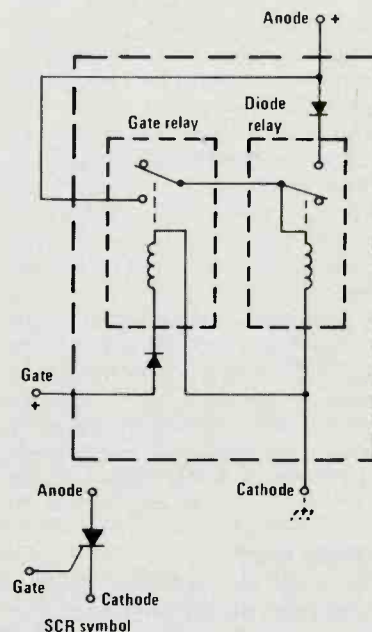

example, you can apply an ac voltage across an SCR and time the gate turn-on signal so the SCR only conducts during a small portion of the cycle. If the timing of the turn-on signal, called the *trigger*, is varied, the portion of the cycle the SCR conducts will also vary.

So what you ask? Well, the effective power in an ac circuit is similar to the average power—it depends on both the amplitude and the duration. If you vary the duration, you vary the effective power. Put another way, you vary the intensity of light emitted by a lamp, or the speed of a motor.

Building projects: how to

Whether you're building projects from *Modern Electronics* or loading up your junk box, parts can empty your wallet. Here are tips from a professional experimenter on how insiders save big money when they buy components cheap.

by Jeff Sandler
Contributing Editor

Back in those good old days we always seem to be reminiscing about, you could buy all the electronics parts you needed. In New York City, for instance, there was Radio Row—two blocks of electronics stores, some dealing in new brand name parts, others in surplus goods.

Resistors, capacitors, inductors, transformers, tubes, sockets, gears, dials, controls, chassis, cabinets, test equipment, radios, tvs, tuners, turntables . . . if it was related to electronics you could get it on Radio Row.

It's a far different story today. There's Radio Shack with a limited supply of parts. And most cities have at least one electronics parts distributor. But, you'll have to pay top dollar for parts from these sources—if you can get the ones you need!

Your problems in obtaining the right parts at the right price when you need them are multiplied if you're really into construction because of the large number you need. Fortunately, there are ways you can get what you need, when you need them, and at a price you can afford.

Impossible triad

In the world of economics, there is something called the *impossible triad*. The triad is composed of three elements: price, quality, and availability. According to the triad, it is impossible to get top quality and low cost on an "I need it now basis."

Unfortunately, the impossible triad applies to the electronics parts market. So, you'll have to make your buying decisions based on which of the three criteria is most important to you. Put another way, if you need a part right now, you may have to pay two or three times as much as you would under other circumstances. And, if you need it now, but have only a very limited budget, you may have to settle for seconds or culls.

Parts sources can be divided into four general categories: brand name distributors, Radio Shack, mail order parts houses, and salvage. Brand name parts

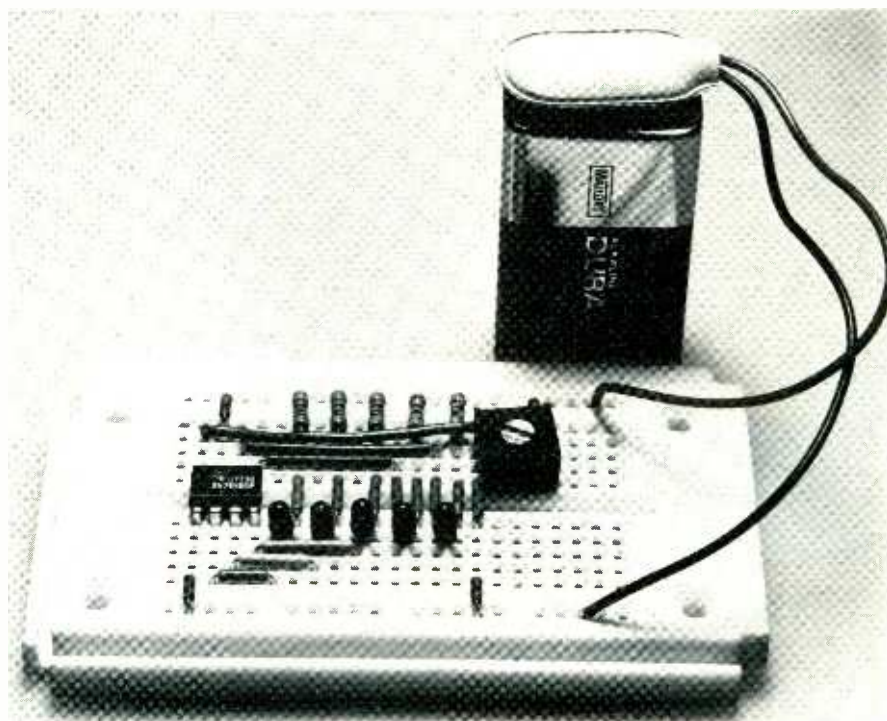

are first quality branded parts sold on a one piece at a time basis. They're usually obtained over the counter at electronics parts distributors.

Parts distributors specialize in selling electronic parts, usually to radio and tv repairmen and small manufacturers. Although some also sell CB and audio equipment, many do not. Generally, these firms are listed in the Yellow Pages under "Electronic Equipment and Supplies."

Blister packs

Back in the good old days, resistors, capacitors, sockets and most other small parts were stored in drawers behind the counter. You either handed the counterman a list or told him what you needed.

Today, virtually all small parts are sold from racks in sealed blister packs. The racks are generally off to one side of the counter, or in a far corner. Each pack lists the part's value and price. Generally, resistors, capacitors and other inexpen-

sive items are sold two or three to the package.

Radio Shack is very much like an electronic parts distributor. It too sells small parts in sealed blister packs, usually in groups of two per package. Although Radio Shack does sell its parts through 6,000 stores across the country, it has only a limited selection of goods. Radio Shack parts cost less than brand name items.

The main advantage of both the electronics distributor and Radio Shack is availability. If you need a part in a hurry, all you have to do is make a trip to the store. If you're more interested in price than delivery date, mail order parts houses can save you a bundle.

Most mail order houses don't deal in one-at-a-time parts. Instead, they sell by the package. The only exception to this is transistors and ICs, which are sold by the piece.

Most mail order parts houses prefer to sell by the package, which contains one

please turn to page 38

buy and substitute parts

Ever dig into your junk box for just the right capacitor and come up empty handed even though you have lots of wrong values? Here's the inside story on how pros make do with parts values they have on hand.

by David Heiserman

There is no doubt about it: the most rewarding way to participate in the wacky and wonderful world of *Modern Electronics* is by building your own circuits from scratch. So one day you find a circuit in the magazine you'd like to build. You are turned on to the idea and you start gathering parts shown on the schematic diagram or the parts list.

Things progress smoothly until you get to that 4.7 uF capacitor with a voltage rating of 35v. You can't find one of them around town to save your life. Maybe you can find one at a premium price of \$3 or \$4 in an industrial electronics catalog; but then you see the company won't accept orders for less than \$100.

The whole job comes to a grinding halt just because you can't get that confounded capacitor. Discouragement sets in, you throw the parts you have already gathered into a junk box and seriously consider taking up fishing for a hobby.

Getting easier

All this trouble is unnecessary today. It is unfortunate that beginners in hobby electronics feel they must take every part specification so seriously. But, in reality, there is a very good chance that the engineer who designed the circuit using that weird 4.7 uF, 35v capacitor merely pulled it out of his own box of spare parts. Who knows where he got it?

There is a very good chance that any capacitor in the 1 uF to 10 uF range would do the job equally well. And, as far as the voltage rating is concerned, it could be anything more than about twice the circuit's supply voltage.

Parts specifications aren't etched in stone in many instances. There is nearly always a wide range of tolerances that allow the builder to substitute freely. Of course there are exceptions in critical timing circuits and in high-performance audio and rf circuitry. But, as a general rule, no one should be stopped cold by a mere set of numbers someone has assigned, often in a rather arbitrary fashion.

So the next time you want to build a circuit described in a book or magazine,

try to match the parts specifications as closely as possible. But when you run into trouble finding a part with the exact specifications, try making some substitutions of your own.

Breadboards

You should always breadboard a circuit—build it up in a temporary fashion—before making a commitment to the final design. Breadboarding is especially important if you are making any parts substitutions because it gives you a chance to doublecheck your choices before investing a lot of time and money in the final product.

The accompanying tables list some ideas for substituting parts that play non-critical roles in any sort of circuit. You might not have the know-how and experience to determine whether or not you can get away with the substitutions recommended here, but you'll never know unless you try. You have nothing

to lose and everything to gain by trying your own parts substitutions where necessary.

As indicated in Table 1, substituting resistors, capacitors and inductors is largely a matter of hitting the basic value within 20 percent. A 4.7 uF capacitor specified on a circuit diagram can be replaced with a more common 5 uF version without creating any noticeable difference in the operation of the circuit.

Of course, it is also possible to make up combinations of series and parallel circuits to yield equivalent values. You can mimic the operation of a 1.5k resistor, for example, by connecting a 1k resistor in series with a 470-ohm resistor.

Resistors, capacitors and inductors have other ratings that are important to observe, namely power, maximum voltage and current ratings respectively. These ratings ought to be equal or greater than those specified for the proj-

please turn to page 39

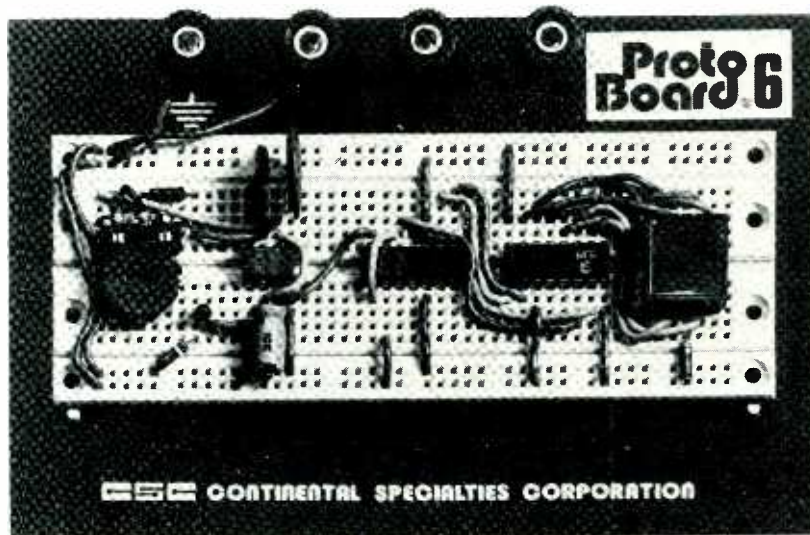

Here's what a breadboard looks like. It has many holes into which the experimenter plugs parts to hook them together, eliminating soldering. Avid electronic builders for years have stashed soldering irons, pliers and other paraphernalia in desk drawers at work so they can play with their hobby over coffee and lunch breaks. This pocket-sized solderless breadboard eliminates a lot of the trouble and makes desk-top experimentation even easier. This board, from Continental Specialties Corp., 70 Fulton Terrace, New Haven, CT 06509, is about the size of an audio tape cassette. Now you can fit a breadboard alongside the bologna and cookies in your brown bag.

how to buy

continued from page 36

or two dollars worth of the part. There are some houses that do sell by the piece, however. A recent ad from one of these listed .01 mfd disc ceramic capacitors at 5¢ each, and 10,000 ohm potentiometers at 65¢ each.

In most cases, mail order houses sell manufacturer's overruns and parts inventories bought from companies discontinuing a product. These surplus parts are generally first quality, equal to the brand name parts costing much more at electronic parts distributors.

As good a deal as the mail order houses offer, there are some disadvantages in getting your parts this way. For

assortment of parts. This accumulation, called a *junk box*, gives you the parts you need, when you need them. Using your junk box as a parts source, you can build when you want to, then restock in leisure at the best prices available.

Brand-name transistors

Assembling a good junk box involves more than just buying one of everything. Looking through the construction projects in *Modern Electronics*, you see that some parts are used more frequently than others. Once you get a feel for the kind of parts you'll need, it's just a matter of finding the right source.

Resistors and capacitors can be obtained from all four sources discussed.

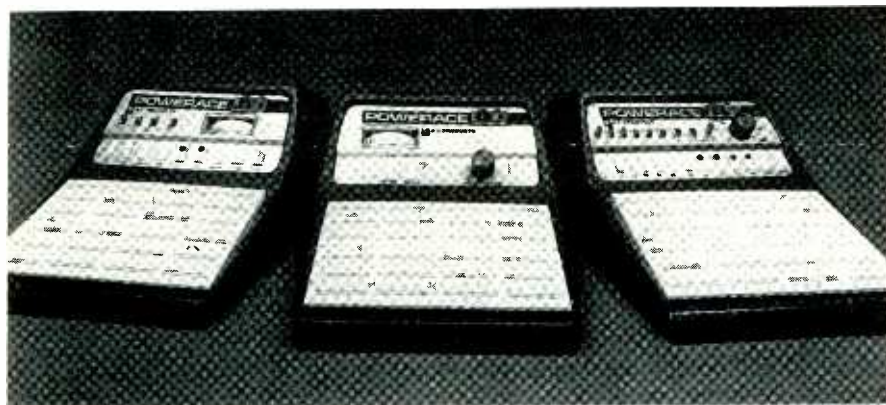

Powerace is the name for these breadboards by AP Products, Painesville, OH. All three models have built-in power supplies so you won't have to use outside batteries or supplies to power your projects.

one thing, you'll have to wait several days or weeks for the parts to arrive. And, if you only need a few parts, you'll be faced with meeting the house's minimum order, usually around \$5. But, if you use a large volume of parts, the mail order house is the best source.

Mail order houses tend to specialize in the kind of parts they handle. Some, for example, are primarily in the transistor and IC market. Others concentrate on resistors, capacitors and inductors. Fortunately, there are some that sell everything. Most advertise their goods in electronics magazines.

Modern electronics

Without question, the least expensive source of parts is old electronic equipment you can salvage. Many experimenters make a habit of visiting the town dump once a week or so to pick up old radio and tv sets for salvage.

Although not as inexpensive as the free parts in junked radios and tvs, another source of inexpensive parts is the surplus PC board. Sold mail order in the same way as parts, and sometimes by the same firms, these boards are usually obsolete computer boards. Many contain several dozen ICs along with hundreds of resistors, diodes, and capacitors.

If you're just starting out in electronics, you'll want to accumulate a large

Brand name resistors will cost about 25¢ each, usually being sold in a blister pack at two for 49¢. Radio Shack sells the same resistors at two for 19¢. But, you can also buy assortments of 100 or more resistors for between one and two dollars mail order, and for \$3 at Radio Shack.

Capacitors are priced in the same general way as resistors, with brand name blister packs costing as much as ten times more than capacitors sold in 100 piece assortments. The actual cost of a capacitor depends on the kind of construction used. Disc ceramics are about the least expensive capacitor available, and work well in most circuits.

If you decide to buy resistors and capacitors in quantity, make sure you know what you're buying. Most assortments are sold in plastic bags labeled as so many resistors or capacitors for so many dollars. Although the bags may all look the same, there is a big difference in what they contain.

Some dealers sell bags containing so many pieces of the same value. Others sell only assortments. Some of these assortments are unselected; just a random sampling of the dealer's stock. Still others contain a specified number of each value. If you're just beginning to put together a junk box, the selected assortments are best. Once you know your use rate for each value, buying a

bag of the same value resistors is the most economical way to go.

Transistors are sold pretty much the same way as resistors and capacitors. You can buy a brand name transistor for \$1.69 in a blister pack, or 79¢ from Radio Shack, or for less than ten cents each in assortments. Most simple projects, such as ours in *Modern Electronics*, will work with just about any small signal transistor of the same sex—NPN or PNP. So, a stock of 2N2222 or 2N3904 NPN and 2N3906 PNP transistors should cover most of your needs. You'll probably need a few NPN and PNP power transistors too.

You'll also need a selection of diodes, both small signal and rectifier. For most small signal applications, the 1N4148 is ideal. Available in brand name blister packs for less than a dollar, you can get ten of them from Radio Shack, for 99¢. The best source is mail order where you can get 50 for a dollar.

Rectifier diodes cost a little more than signal diodes, but the basic relationship between brand name, Radio Shack and mail order prices is the same. You should be able to get rectifiers mail order for less than a nickel each in quantity.

With each passing day, the use of ICs to replace hand-wired circuitry increases. There are literally thousands of ICs on the market today. And to further complicate matters, you'll have to choose between the CMOS and the TTL family of ICs—they're generally not compatible.

Integrated circuits

Looking through the pages of *Modern Electronics*, you'll see that no more than a half-dozen different digital ICs are used. Add a few op-amps and 555 timer or two and you'll have an IC stock covering 95 percent of your needs.

Buying ICs is a little different than buying other components. Many local distributors are really parts depots for tv and radio servicemen. They carry only those small parts used by the service industry. Because of this, you may have some trouble getting a particular IC, especially digital ICs, over the counter. Even Radio Shack carries only a limited selection.

Your best bet for ICs is the mail order parts house. Most will sell by the piece, and at very attractive prices. Recent ads have offered 4001 and 4011 CMOS gate ICs at 23¢ each. But, you'll have to observe the minimum order requirement—usually \$5.

Junk box

Another recent innovation in electronics is the light emitting diode, or LED. Although you can get LEDs from mail order houses and from distributors, probably the best source for you is your local Radio Shack. They have a good selection priced at two for 69¢. If you do plan to use large numbers of LEDs,

Radio Shack will sell you an assortment of 25 for \$2.

In addition to individual LEDs, you may need some seven-segment digital displays. Although Radio Shack has a good selection at reasonable prices, you can get all the displays you need for about a dollar a digit from mail order houses.

Although LEDs are great for use as indicators, they really don't provide illumination. For that you'll need incandescent lamps. Although some mail order houses do carry lamps, few list them in the advertisements or catalogs. Your best bet is Radio Shack or your local parts distributor. You might try your local hardware store or the hardware department of large general merchandise stores. They carry a small selection of lamps, at least some of which you can use.

Today, many experimenters prefer to build their projects on printed circuit board. You can usually get a supply from your local parts distributor and Radio Shack. Some of the mail order parts

houses also sell boards and supplies. If you use a lot of printed circuit boards, look for scrap board sold in plastic bags. Each bag usually contains several pieces of board of various sizes, priced about a dollar a square foot.

Printed circuits

If you hand wire, you'll need a good supply of wire and cable. Radio Shack and most parts distributors have a good selection of wire and cable. Mail order houses often have special sales. If you need large quantities, you may be able to make a special deal with a mail order house.

You'll also need a good supply of connectors. Probably the most useful for the average experimenter is the RCA phono connector. You can get a good stock from Radio Shack for a few dollars. You might also pick up a few power connectors as well. Because of the small quantity involved, Radio Shack or your local parts distributor are the best sources.

After you've built your project, you'll most likely want to mount it in a cabinet of some kind. Again, your local Radio Shack and parts distributor have good selections of cabinets and enclosures at reasonable prices. Although mail order houses don't as a rule carry these items, they occasionally offer surplus cabinets at bargain prices.

Rounding out your junk box, you'll need a few transformers and relays, some perforated board and push-pins, and a handful of sockets. You can get these supplies from Radio Shack, parts distributors, and in some cases, mail order firms. But, a good source for most of what you'll need is salvageable electronic equipment.

Building a useful junk box is one of the prime interests of most electronics experimenters. While you'll probably have to spend a fair amount of money to build the foundation, you can acquire a large assortment of parts very inexpensively if you keep your eyes open for bargains, wherever they can be found. 

how to substitute

continued from page 37

ect. There is, for instance, nothing really wrong with using a 1/2-watt resistor in place of one specified at 1/4-watt. The 1/2-watt version will be physically larger, but it will do the job.

Rectifier diodes and bridge rectifier assemblies are often specified according to their maximum current and reverse breakdown ratings. It is possible in most instances to come up with a suitable replacement without having to resort to a data book.

Table 1: resistors, capacitors, inductors and transformers.

Resistors

Ohms value: within 20% of specification.
Ohms tolerance: equal or better than specified. Generally not critical at all.
Power rating: equal or greater than specified.

Capacitors

Capacitance value: within 20% of specification (except in critical timing and tuning operations).
Voltage rating: equal or greater than specified; or twice the maximum supply voltage.
Type (mylar, ceramic, electrolytic, etc.): generally not relevant except in critical timing and some vhf and uhf tuner applications.

Inductors

Inductance value: within 20% of specification.
Current rating: equal or greater than specified.

Power transformers

Voltage rating: as specified.
Current or power rating: equal or greater than specified.

A lot of people—especially transistor manufacturers and, alas, suppliers—make too much of this matter of substituting transistors. The generally negative attitude must arise from the fact that there are thousands of different transistors listed in transistor substitution manuals.

Quantity does not necessarily imply complexity, though. Perhaps we can all take some comfort from the notion that those who are most afraid to make their own transistor substitutions have never tried it.

Table 2 lists the most relevant specifications for any transistor used in ordinary electronic projects. You will need a transistor data book to determine these specifications. But, once you have the numbers at hand, you can use them for selecting an appropriate substitute.

Unless a circuit builder knows exactly what he is doing, there is little latitude for substituting IC types. A circuit calling for a 7400 digital IC, for example, must use that type of IC.

The IC designations on many parts lists, however, include alphabetical prefixes that merely indicate the device's manufacturer. There is no need to use an IC made by one particular manufacturer if other companies produce the same basic item.

Suffix letters in IC designations aren't really relevant, either. These letters normally indicate a change in the internal mechanisms that do not alter the basic function. There are, however, cases where suffix letters indicate the package style.

Watch out, though! Some IC's have a letter or two inserted between some of the numbers. You can, for example, find

Table 2: rectifier diodes, bridge assemblies and transistors

Rectifier diodes and bridge assemblies

Current rating: equal or greater than specified.
Reverse breakdown voltage: equal or greater than specified.

Transistors

A transistor data book must be used for determining most of the specifications for substitution purposes.

Type (NPN or PNP): exact to specifications.
Collector current rating (Ic): equal or greater than specified.
Reverse breakdown voltage: equal or greater than specified.
Gain (Beta or h_{FE}): equal or greater than specified.
Power rating: equal or greater than specified.
Cut-off frequency: equal or greater than specified.
Case style: generally not relevant.

a lot of 74C00 quad 2-input NAND gates on the market. That "C" inserted between the 74 and 00 indicates it is a CMOS version of the basic 7400 device, and you will run into a lot of trouble if you try to substitute a 74C00 for a 7400, or vice-versa.

So when contemplating substituting IC's, you can ignore any prefix letters and doublecheck a data book if you think any suffix letters indicate a change in pin numbering. In any event, you must follow the numeric designations and any letters inserted within the basic number pattern. 

BY CARMINE W. PRESTIA

What could be a better match this month than one of the world's oldest games, Craps, and one of our newest hobbies?

Here is another game that you can program and run on your home computer. Craps is an old dice game usually associated with back alleys and smoke filled rooms.

Of course, this isn't one of the most productive or useful tasks that you can put your machine up to, but I found that visitors and friends weren't exactly impressed with seeing my Heathkit H-8 computer just sit there. They wanted to do something with it, so I set about designing this Craps program for just such situations. After it was done even our family wash had to wait while my wife played the first full game with the computer.

The fact that Craps is usually associated with heavy gambling adds an extra aura of excitement to the game. The Heathkit H-9 video display terminal is used for all of the player/computer interaction so that my friends who are unfamiliar with computers would feel at ease sitting at the typewriter-like keyboard.

Craps itself is usually played by two or more people rolling a pair of dice to match points. Although the rules will sometimes vary from one back alley to the next, I'll follow the most generalized set of rules of play that I could find.

The players (there are two in our case) place bets and one of them begins rolling the dice. If he rolls a 7 or 11 he wins the bets, if he rolls a 2 or 12 he loses the dice to the other player, but the bets stay where they are. If the player neither wins nor loses on the first roll, the number he rolls is his point. From here on the player will try to match his point or roll 7 or 11. As long as the player is winning he keeps the dice, when he rolls a 2 or 12 he gives the dice to the other player. In addition to these rules the computer has a purse of \$100 and the player a purse of his choice, up to \$100. This purse makes the game a little more interesting, since either the player or the computer can go broke playing.

This month we have included a program flowchart to make the logic clearer. A flowchart is a valuable tool for any programmer, it is a sort of schematic di-

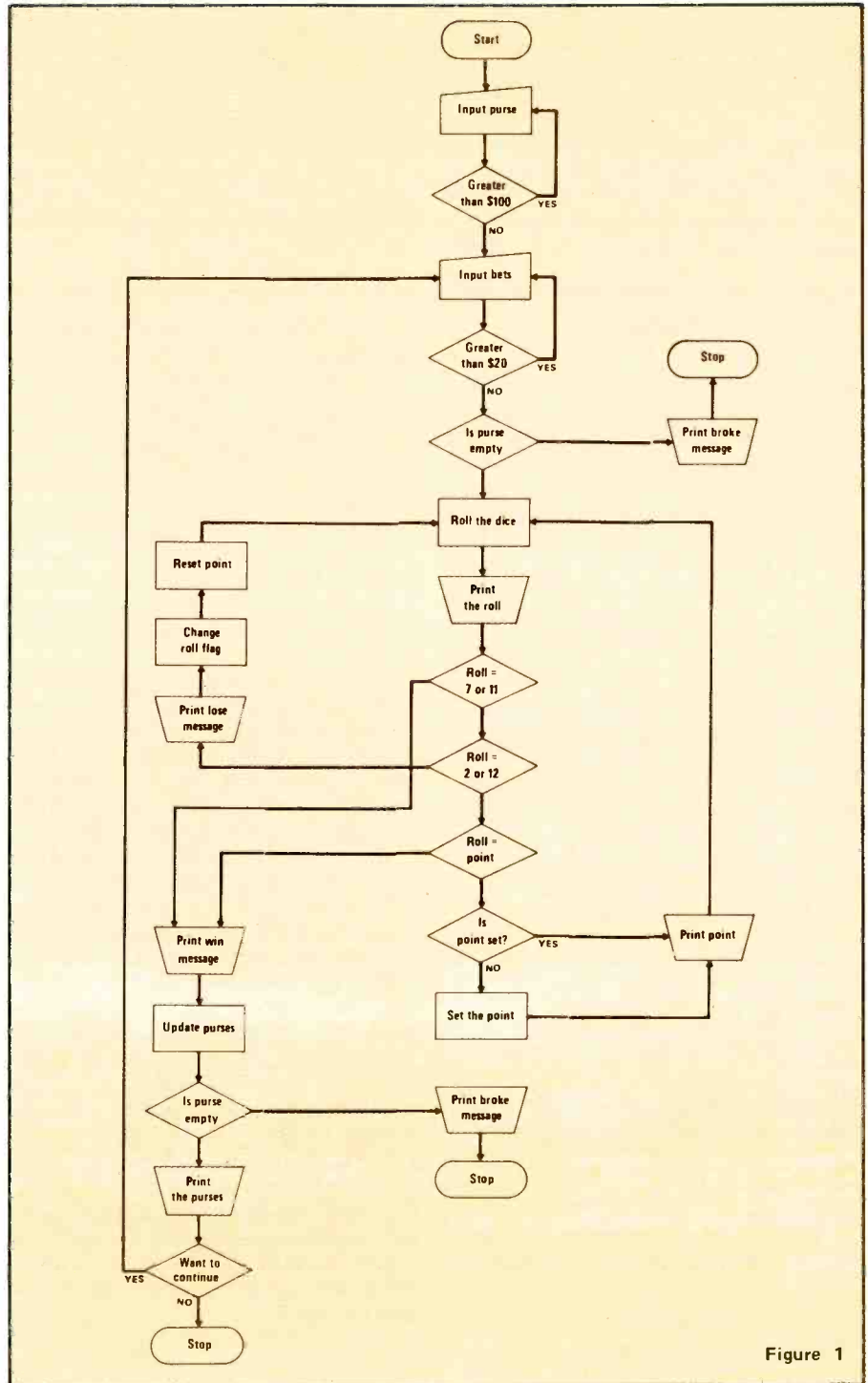

Figure 1

CRAPS PROGRAM LISTING

```

100 REM CRAPS, VER 1, 02/13/78, CWP
101 REM
102 REM A PROGRAM TO SHOOT "CRAPS" WITH THE COMPUTER. BRIEF
103 REM INSTRUCTIONS ARE GIVEN. A PURSE IS SET UP, AGAINST
104 REM WHICH BETS ARE TAKEN AND WINNINGS ADDED
105 REM
106 PRINT TAB(20)"PLAY CRAPS WITH THE COMPUTER"
107 PRINT TAB(10)"7 & 11 ARE ALWAYS WINNERS AND 2 & 12 ARE ALWAYS LOSERS"
108 PRINT TAB(10)"YOU ROLL FIRST, ROLL FOR THE POINT, OR UNTIL YOU WIN OR
109 PRINT TAB(10)"LOSE. BETS AND WINNINGS ARE SUBTRACTED OR ADDED
110 PRINT TAB(10)"TO THE PURSE"
111 REM THE COMPUTER SETS UP ITS PURSE
112 C1=100:PRINT "MY PURSE IS $100"
113 REM PLAYER PURSE AND BETS ARE TAKEN
114 INPUT "WHAT IS YOUR PURSE, $100 MAXIMUM PLEASE? $";P1
115 IF P1>100 THEN PRINT "THAT IS TOO MUCH!!":GOTO 120
116 PRINT TAB(15)"NOW WE'LL PLACE OUR BETS."
117 INPUT "WHAT IS YOUR BET, $20 MAXIMUM PLEASE? $";P2
118 IF P2>20 THEN PRINT "THAT IS TOO HIGH!!":GOTO 150
119 P1=P1-P2
120 IF P1<0 GOTO 700
121 C2=INT(20*RND(1))+1:PRINT "MY BET IS $";C2:C1=C1-C2
122 IF C1<0 GOTO 710
123 REM NOW THAT THE BETS HAVE BEEN PLACED THE COMPUTER
124 REM STARTS ROLLING THE DICE
125 R=INT(12*RND(1))+1
126 IF R=1 GOTO 210
127 IF F=0 THEN PRINT "YOU ROLLED - ";R:GOTO 240
128 PRINT "I ROLLED - ";R
129 REM THE ROLL IS EXAMINED TO SEE IF IT IS A WINNER OR LOSER
130 IF R=7 GOTO 400
131 IF R=11 GOTO 400
132 IF R=2 THEN PRINT TAB(15) "SNAKE EYES !!!":GOTO 500
133 IF R=12 THEN PRINT TAB(15) "BOXCARS !!!":GOTO 500
134 IF R=P THEN PRINT TAB(15)"THAT'S A MATCH !!!":GOTO 400
135 IF P>0 GOTO 310
136 P=R
137 PRINT "THE MATCH POINT IS - ";P:GOTO 210
138 REM THESE STATEMENTS UPDATE THE WINNER'S PURSE. F IS A FLAG
139 REM THAT TELLS THE COMPUTER WHO IS ROLLING. 0 IS THE PLAYER,
140 REM 1 IS THE COMPUTER. P=0 RESETS THE POINT.
141 PRINT TAB(15)"A WINNER !!!!"
142 IF F=0 THEN P1=P1+P2+C2:P=0:GOTO 600
143 C1=C1+P2+C2:P=0:GOTO 600
144 REM THESE LINES EXCHANGE THE DICE AND RESET THE POINT
145 PRINT TAB(15)"THAT'S A LOSER !!!!"
146 IF F=0 THEN F=1:PRINT TAB(15)"GIVE ME THE DICE PLEASE!":GOTO 210
147 F=0:PRINT TAB(15)"HERE ARE THE DICE!":P=0:GOTO 210
148 REM THESE LINES OUTPUT THE REMAINING PURSES, ASK IF THE PLAYER
149 REM WANTS TO CONTINUE, OR STOPS THE PROGRAM IF THE PURSES ARE EMPTY
150 PRINT :PRINT "YOUR BET WAS $";P2, "YOUR PURSE IS NOW $";P1
151 PRINT "MY BET WAS $";C2, "MY PURSE IS NOW $";C1
152 IF P1<=0 GOTO 700
153 IF C1<=0 GOTO 710
154 LINE INPUT "IF YOU WANT TO KEEP ROLLING TYPE A 'Y' ? ";SS
155 IF SS="Y" GOTO 150
156 REM THESE LINES PRINT THE ENDING MESSAGES
157 PRINT :PRINT TAB(10)"IT WAS FUN, GOODBYE FOR NOW!":STOP
158 PRINT :PRINT "YOU'RE BUSTED, GET MORE MONEY, GOODBY":STOP
159 PRINT :PRINT "I'M BUSTED, GOODBY":STOP
160 END

```

Figure 2

agram of how the program executes the task.

Look at figure 1. Each of the small figures represents an action by the computer. Let's follow the *logic*. In the first seven figures the computer gets the player's purse and bet. In each case, maximums, or "house limits" are set so that we don't lose our shirts all at once. If the player's entries are too high the computer rejects them and asks again. Then it checks to see if the purses are empty, if so someone is broke and an appropriate message is printed and the game is stopped.

If the purse and bets are in order the computer begins rolling the dice and checking to see if the number rolled is a winner, loser, or match. This section also sets up the point if the program *falls through* the win lose comparisons. If a winner is scored the program goes to a section to add up the winnings, see if anyone is broke, and ask the player if he wants to continue the game. Being broke stops the game and answering yes to the continue question sends the program back to taking bets.

Should the person rolling the dice hit a loser the program prints a message and changes the *roll flag*, which tells the computer who has the dice. The match point is reset and the program goes back to rolling the dice.

Program

As you probably figured out by now the different shapes on the flowchart represent different processes in the program. A rectangle is a simple processing point, and the inverted trapezoids represent output. The rectangles with the sloping tops are input from the keyboard and the diamonds are decision points in the program.

You might think that flowcharting would be time consuming and not worth the time. However, the flowchart allows you to set the program logic down and clearly see where you want it to go. Then the separate steps in the chart can be mini-programmed and then put together to form the main program. The flowchart is a necessary tool and should never be ignored, especially on larger programs where the logic flow becomes complex.

Now we come to the heart of the subject, the program itself. Looking at figure 2 you will see a lot of remark (rem) statements. These are *documentation* for me, the programmer, so that I'll remember what I intended the program to do when I look at it six months from now. You will also see multiple statements on a line, separated by a colon. This is permitted in Extended Benton Harbor Basic (Heathkit's version of Dartmouth Basic) and helps save valuable space in memory.

Lines 106 through 110 print instructions for the player, then lines 115 to 180

set up the purses and take the bets. The computer places its bet in line 190, using the *random number generator* (RND) function included in Basic.

Once all this is done the computer begins rolling the dice, again using the RND function in line 210. Line 211 probably looks funny, but I found that the computer occasionally rolled a one, something you can't do on real dice. If it does roll a one this line makes it go back and roll again for another number.

Lines 220 and 230 print the number rolled, depending on the *flag*, "F". If "F" is something other than 0 the computer is rolling the dice.

In lines 240 through 280 the computer is checking to see if we have a winner or loser. Either situation sends the computer to different sections of the program to compute the winnings or hand the dice to the other player. Lines 290 and 300 set up the match point and line 310 prints the point.

The 400 series lines compute the winnings, depending on who the *roll flag* says is rolling the dice. The 500 series lines change the *roll flag* when a loser is rolled.

Lines 600 through 650 output the bets and current holdings in the purses. They also check for empty purses (620 and 630) and ask if the player wants to continue the game. Lines 655 to 800 output ending messages for the close of the game.

Now, look again at figure 2. You will see a lot of print statements. These not only document the output but add a little "personal" touch to the computer's responses and help keep the player interested and amused.

As always, this program might not run under the particular version of Basic that you computer uses, however, the revisions should not be too extensive. Good luck, don't lose your shirt, and don't forget to flowchart your own programs.

Another easy-to-run Basic program for your microcomputer calculates the cost of electricity.

BY PETER A. STARK

```
0010 REM PROGRAM TO FIND MILES PER GALLON
0020 PRINT "ENTER STARTING MILES";
0030 INPUT MI
0040 MO = MI
0050 T = 0
0060 PRINT "ENTER EACH GAS PURCHASE AS"
0070 PRINT "MILES, GALLONS"
0080 PRINT "END WITH BOTH EQUAL TO 0"
0090 INPUT M, G
0100 IF M=0 GO TO 160
0110 T = T + G
0120 C = (M-MI)/G
0130 PRINT C; "MPG"
0140 MI = M
0150 GOTO 90
0160 PRINT MI-MO; "TOTAL MILES"
0170 PRINT T; "TOTAL GALLONS"
0180 PRINT (MI-MO)/T; "OVERALL MPG"
```

```
READY
#RUN
ENTER STARTING MILES? 49502
ENTER EACH GAS PURCHASE AS
MILES, GALLONS
END WITH BOTH EQUAL TO 0
? 49682,12.7
14.1 MPG
? 49774,7.1
12.9 MPG
? 49970,14.1
13.9 MPG
? 50085,10.0
11.5 MPG
? 50280,14.5
13.4 MPG
? 0,0
773.0 TOTAL MILES
58.4 TOTAL GALLONS
13.3 OVERALL MPG
READY
#
```

These programs are both energy-related. Program 1 is for those of us who keep a detailed record of the mileage at which we fill our automobile's gas tank, and the amount of gallons purchased. Even with a calculator, it is inconvenient to calculate the miles per gallon (MPG) for each purchase. With this program we merely enter the mileage and number of gallons for each purchase, and the computer prints out the resulting number of miles per gallon. It is intended to do an entire series of calculations at one sitting, since it keeps track of the mileage at the previous gas purchase (as M1) and computes its own mileage travelled since the previous fillup.

After all the data is entered and the MPG found for each fillup, the program also calculates the total mileage travelled for the entire series of fillups, the total number of gallons bought, and the total average miles per gallon.

Program 2 is used to get an idea of how much it costs to run each of the electrical appliances and lights in the home. It starts by asking for the cost per kilowatt-hour; this should be an average amount, since many electric utilities charge different rates depending on how many are used per month.

For each appliance or light, the program asks for its name, the wattage it is rated at, and the estimated number of hours per month. From this data it calculates the cost per hour, as well as the total cost for a month.

Even if you do not have a computer, the calculations may be useful, so here is how they are done along with a sample. For the refrigerator, we note that it is rated at 700 watts, and we estimate that the motor runs 10 hours a day, or 300 hours per month. The rating in kilowatt-hours in one hour is found by dividing the wattage by 1000; in this case it is 0.7 so the cost per hour is $0.7 \times 8.5\text{¢}$ or 5.95 cents. (this equals \$0.0595 per hour, but the computer has been set to print only two digits so it prints only \$0.05; with a bit of extra programming it

could have been set to round up to the nearest cent to give \$0.06). For 300 hours a month this works out to \$17.85.

The instructions to the program ask that when all data has been entered, the last data should be all zeroes. Line 120 tests for this and forces the computer to go to line 210, so that it will print out the total number of kilowatt-hours used in the entire month as well as the total cost.

Although the program may require some research, it can pinpoint electricity waste in the home, or at least, explain why your electric bill is so high. 

```
0010 REM PROGRAM TO CALCULATE ELECTRICITY COST
0020 T = 0
0030 PRINT "ENTER AVERAGE COST OF EACH KILOWATT-HOUR IN CENTS";
0040 INPUT K
0050 REM CONVERT TO DOLLARS
0060 K = K/100
0070 PRINT "FOR EACH LIGHT OR APPLIANCE, ENTER ITS"
0080 PRINT "NAME, WATTAGE, AND THE ESTIMATED"
0090 PRINT "NUMBER OF HOURS IT IS USED PER MONTH."
0100 PRINT "END WITH ALL ZEROES."
0110 INPUT N$, W, H
0120 IF W = 0 GO TO 210
0130 REM FIND COST PER HOUR, KWH USED, AND MONTHLY COST
0140 C = W/1000 * K
0150 E = W/1000 * H
0160 T = T + E
0170 M = E * K
0180 PRINT N$; " COSTS $"; C; "PER HOUR"
0190 PRINT " AND $"; M; "PER MONTH."
0200 GOTO 110
0210 PRINT I; "KWH USED PER MONTH"
0220 PRINT "ESTIMATED MONTHLY COST IS $"; T*K
```

JUMBO LED CAR CLOCK

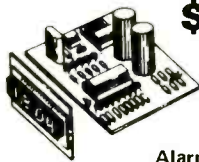

\$16.95
KIT

Alarm Option - \$1.50
AC XFMR - \$1.50

THE HOTTEST SELLING KIT WE EVER PRODUCED!
You requested it! Our first D.C. operated clock kit. Professionally engineered from scratch. Not a makeshift kluge as sold by others. Features:

- A. Bowmar Jumbo - .5 inch LED array.
- B. MOSTEK - 50250 - Super Clock Chip.
- C. On board precision crystal time base.
- D. 12 or 24 Hr. Real Time Format.
- E. Perfect for cars, boats, vans, etc.
- F. P.C. Board and all parts (less case) included.

50,000 SATISFIED CLOCK KIT CUSTOMERS CANNOT BE WRONG!

THIS MONTH'S SPECIALS
AMD - 8080A \$14.95
Z-80 CPU 49.95
82S129 1K PROM 2.50

1702A 2K EPROM
We tell it like it is. We could have said these were factory new, but here is the straight scoop. We bought a load of new computer gear that contained a quantity of 1702 A's in sockets. We carefully removed the parts, verified their quality, and are offering them on one heck of a deal. First come, first served. Satisfaction guaranteed! U.V. Erasable. \$6.95 ea. 4/\$25

UP YOUR COMPUTER!
21L02-1 1K LOW POWER 500 NS STATIC RAM Time is of the essence!
And so is power. Not only are our RAM's faster than a speeding bullet but they are now very low power. We are pleased to offer prime new 21L02-1 low power and super fast RAM's. Allows you to STRETCH your power supply farther and at the same time keep the wait light off. 8 for \$12.95

60 HZ CRYSTAL TIME BASE
S.D. SALES EXCLUSIVE!

\$5.95 ea. 2/\$10.00

KIT FEATURES:

- A. 60HZ output with accuracy comparable to a digital watch.
- B. Directly interfaces with all MOS clock chips.
- C. Super low power consumption (1.5 MA typ.)
- D. Uses latest MOS 17 stage divider IC.
- E. Eliminates forever the problem of AC line glitches.
- F. Perfect for cars, boats, campers, or even for portable clocks at ham field days.
- G. Small size; can be used in existing enclosures. Kit includes Crystal, Driver IC, PC board, plus all necessary parts and specs. At last count - over 20,000 sold!

S.D. SALES EXCLUSIVE
\$12.95 MOS 6 DIGIT UP-DOWN COUNTER \$12.95

40 PIN DIP. Everything you ever wanted in a counter chip. Features: Direct LED segment drive, single power supply (12 VDC TYPE.), six decades up/down, pre-loadable counter, separate pre-loadable compare register with compare output, CMOS and seven segment outputs, internal scan oscillator, BCD compatible, leading zero blanking. 1MHZ. count input frequency. Very limited quantity! WITH DATA SHEET

7400-19c	7411-29c	7451-19c	7490-65c	74153-75c
74LS00-49c	7413-50c	7453-19c	74LS90-95c	74154-1.00
7402-19c	7416-69c	7473-39c	7492-75c	74157-75c
74LS02-49c	7420-19c	7474-35c	7493-69c	74161-95c
7404-19c	7430-19c	74LS74-59c	7495-75c	74164-1.10
74L04-29c	7432-34c	7475-69c	7496-89c	74165-1.10
74S04-44c	7437-39c	7476-69c	7498-95c	74174-95c
74LS04-49c	7438-39c	7480-45c	74123-65c	74181-2.50
7406-29c	7440-19c	7483-95c	74132-1.70	74181-2.50
7408-19c	7447-85c	7485-95c	745138-1.95	74192-1.25
7410-19c	7448-85c	7486-45c	74141-75c	74193-1.00

TTL INTEGRATED CIRCUITS 74195-69c

1000 MFD Filter Caps
Rated 35 WVDC Upright style with PC leads. Most popular value for hobbyists. Compare at up to \$1.19 ea. from franchise type electronic parts stores. S.D. Special 4/\$1.

Slide Switch Assortment
Our best seller. Includes miniature and standard sizes; single and multi-position units. All new, first name brand. Try one package and you'll reorder more! Special 12/\$1.00

RESISTOR ASSORTMENT
1/4W 5% & 10% PC leads. A good mix of values. 200/\$2.

P.C. LEAD DIODES
1N4148/1N914 100/\$2.00
1N4002-1A, 100 PIV 40/\$1.

HEAVY DUTY Full Wave Bridge
25 AMP 50 PIV \$1.25

Disc Cap Assortment
PC leads. At least 10 different values. Includes .001, .01, .05, plus other standard values. 60/\$1.00

\$9.95 KIT

P.C. Board - 3.00
AC XFMR - 1.50

Do not confuse with Non-Alarm kits sold by our competition! Eliminate the hassle - avoid the 53141

SIX DIGIT ALARM CLOCK KIT

We made a fantastic kit even better. Redesigned to take advantage of the latest advances in I.C. clock technology. Features: Litronix Dual 1/2" displays, Mostek 50250 super clock chip, single I.C. segment driver, SCR digit drivers. Greatly simplified construction. More reliable and easier to build. Kit includes all necessary parts (except case). P.C.B. or XFMR optional. **NEW! WITH JUMBO LED READOUTS!**

Motorola SCR
2N4443. 8 AMP 400 PIV. P.C. Leads 3/\$1.

FAIRCHILD - TBA 641
4W. Audio power Amp. Just out! In special heat sink DIP. One super audio IC. \$1.50 with data

FND-359 -Led Readout
.4 IN. Common Cathode. High efficiency. Has FND-70 PIN OUT. 59c

\$15.95

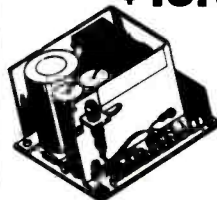

COMPUTER POWER SUPPLY
A very fortunate purchase. One of the best industrial quality REGULATED supplies we have seen. High performance, small size. Input is 120 VAC 60 HZ. Has the following regulated outputs: -5VDC@800MA; -15VDC @ 1.25 AMP; -25VDC @ 180 MA. Sold at a fraction of original cost. Do yourself a favor and order NOW. We expect a quick sellout.

NEXT MONTH:
S.D. will have music for your ears. Watch our ads.

For your Imsai or Altair 8080 Computer:
Z-80 CPU Kit - \$149. 4K Low Power Ram Kit - \$89.95

OUR CATALOG
is chocked full of rare parts bargains, deals, RAM or CPU kits, plus much more. Yours FREE!

PRICES SHOWN SUBJECT TO CHANGE WITHOUT NOTICE.

Terms: Money back guarantee. No COD. Texas residents add 5% sales tax. Add 5% of order for postage & handling. Orders under \$10. add 75c. Foreign orders: US funds only

Call your BankAmericard or Master Charge order in on our continental United States toll free Watts:
1-800-527-3460
Texas Residents Call Collect:
214/271-0022

Special Thanks to:
Dennis, Fred, Abe, Bill, Sam, Hal, Tom, Alex, John, Ely, and Larry

S.D. SALES CO.
P. O. BOX 28810 ME
Dallas, Texas 75228

ORDERS OVER \$15.00 - CHOOSE \$1.00 FREE MERCHANDISE

CIRCLE 43 ON READER SERVICE CARD

Armchair travel: shortwave to paradise

Dreaming of getting away from it all for a long vacation? Now you can sample the South Seas breeze without leaving your favorite armchair. Just tune in those siren songs from the Far Pacific.



It's a fantasy that happens several times during the course of a typical winter. The weather is bitterly cold, there's a foot of snow on the ground, with the stuff still coming down. . . .and your mind starts to wander off to the lush islands of the Pacific. Gone is the bleak, snowy scene outside your window and instead you see sandy beaches, brilliant sunshine, warm ocean waters, pineapples, coconuts.

The urge to dash down to the nearest travel agent and depart tomorrow is almost overwhelming, but not practical for those without a key to Fort Knox. But if you can't visit Paradise in person, you can at least spend your winter nights there via shortwave radio!

The entire Pacific area is host to numerous shortwave stations which can be heard throughout North America even on the simplest of equipment. These stations provide some of the most unusual programming and music you are likely to ever hear on shortwave radio, certainly a welcome change from the propaganda that so many major nations spew out. In addition, they send beautiful QSL cards readily for correct reports, which are among the most treasured items in any swl's (shortwave listener's) collection.

Our fiftieth state

Could there be any other starting point for a tour of Paradise but Hawaii? It's a logical point to start our radio tour as well, since it is the closest Pacific island group to the North American mainland and hence the easiest to hear.

Listeners elsewhere usually find Hawaii easiest to hear by tuning in WWVH, the National Bureau of Standards station at Kekaha on the island of Kauai.

If you own a shortwave receiver you've doubtlessly heard its "big brother," station WWV in Fort Collins, Colorado. Like WWV, WWVH gives the time every minute, weather and radio propagation forecasts, and a bewildering variety of tones and ticks. It operates on 5000, 10000, and 15000 kHz like WWV does.

That might make it appear that WWVH is impossible to hear, but such is not the case. WWVH can be heard under WWV at certain times of day due to fading of WWV caused by the effects of sunrise and sunset. Listeners can tune 15000 kHz from their local sunset until approximately 0500 GMT for WWVH. Another good time to try is from midnight at your listening post until an hour or two after your local sunrise on both 5000 and 10000 kHz.

Since both WWV and WWVH follow the same format, how do you tell them apart? Easy! WWV uses a male announcer for its announcements, while WWVH uses a female announcer.

To prove your reception, copy her announcements word-for-word and address your reception report to Radio station WWVH, Box 417, Kekaha, Kauai, Hawaii 96752. If your report is correct you'll receive a QSL card back to confirm that you indeed heard WWVH.

Very few are the people who don't wish that they could visit Tahiti! This legendary island is actually just one of a larger group known formally as the Society Islands. The islands are under French control and broadcast primarily in that language. While the language may not be exotic, the music—authentic South Sea rhythms—certainly is!

Radio Tahiti broadcasts from the capital city of Papeete and is often heard extremely well on 15170 kHz from its 1600 GMT sign on until sign off around 0700. It is also well heard on 11825 kHz from about 0300 GMT onward. I especially enjoy the 0300 to 0500 GMT segment, which is entirely in Tahitian. You might want to have a tape recorder handy to capture some of the unforgettable native



Australia

FR3

NOUVELLE CALEDONIE

22° 18' 04" S
166° 29' 02" E

FREQUENCES

670 KHz	-	20 Kw
1 420 KHz	-	4 Kw
3 355 KHz	-	20 Kw
7 170 KHz	-	20 Kw
11 710 KHz	-	4 Kw

TELEDIFFUSION DE FRANCE

New Caledonia

songs and music for your friends who don't listen to shortwave.

Radio Tahiti is a very friendly station, verifying all correct reports with a QSL card. You can send your reports, in English, to France Regions 3, B.P. 125, Papette, Tahiti, Society Islands. The station changes QSL card designs at times, but the current QSL features as its main motif a native Tahitian girl—in the nude!

Paris of the Pacific

New Caledonia isn't as well known as Tahiti but it's almost as nice a place to visit. The island is under French rule, like Tahiti, and boasts as its capital the city of Noumea.

Noumea is called the "Paris of the Pacific" and has all the conveniences of a modern city in a tropical setting. The streetcars in Noumea even have stereo music piped in for their passengers! It's not

surprising that New Caledonia also has a modern and easily-heard shortwave station known to swls as Radio Noumea.

It broadcasts entirely in French, with much French pop music, and is heard throughout North America on 7170 kHz from 0500 GMT until sign off at 1100 GMT. Listen carefully for its interval signal given between breaks in the programming and on the hour and half-hour—it's the call of the cagou bird!

You'll find 7170 kHz to be used by ham radio operators, making Radio Noumea difficult to hear on weekends when hams are up all night. But once you've heard enough to prove your reception, you can address your report to Radio Noumea, B.P. G3, Noumea, New Caledonia. If correct, they will quickly send a QSL card for your collection.

The Newcomer

One recent addition to the family of Pacific shortwave stations is Trans World Radio, broadcasting from the American island territory of

TRANS WORLD RADIO
P. O. BOX 3518, AGANA, GUAM 96910

KTWR SHORTWAVE

KTWG MEDIUM WAVE

INTERNATIONAL GOSPEL BROADCASTING

K T W R
FIRST WEEK

Guam

All about GMT

GMT stands for Greenwich Mean Time. It's also known by other names. The most common other name is Coordinated Universal Time (UTC). GMT/UTC is the time given out by stations WWV and WWVH every minute.

GMT is a worldwide standard time used by shortwave radio buffs, hams, airlines, sea captains, astronomers, and everyone else who needs a common time standard. GMT is based upon the time at the Greenwich Observatory in England.

GMT/UTC uses a 24 hour clock system like the military. For example, 8 a.m. is 0800 in a twenty-four hour clock system. And 1:30 p.m. is 1330. Likewise, 8 p.m. is 2000; 9:15 p.m. is 2115; and so forth. At midnight, the 24 hour clock system starts over again at 0000.

In the United States and Canada, you convert GMT to your local time by subtracting hours as indicated below:

Eastern Daylight Time	-4 hours
Eastern Standard Time	-5 hours
Central Daylight Time	-5 hours
Central Standard Time	-6 hours
Mountain Daylight Time	-6 hours
Mountain Standard Time	-7 hours
Pacific Daylight Time	-7 hours
Pacific Standard Time	-8 hours

Thus, 0000 GMT is 7 p.m. EST and 4 p.m. PST. Note that days also follow

GMT as well as the time. If it's 0100 GMT on January 1, it's 8 p.m. December 31 in the EST time zone.

QSLs

QSL is a term that swls have borrowed from ham radio to denote a card or letter from a radio station certifying that the listener did indeed receive their signal. Almost all swls collect these, and often try to "QSL" as many stations and different countries as possible, thus attesting to their skills.

To get a QSL, you must prove to the station that you indeed did hear it. To prove this, quote items such as the name of the announcer, song selections heard, program titles, times of newscasts and station identification (try to copy the identification announcements word-for-word if possible), and any other items clearly unique to that station.

By far the best items to quote, if you hear any, are commercials. This is especially true of commercial broadcasting stations in the United States and Canada. If the program you hear is not in English, try to describe the programming as best as you can, paying particular regard to the sex of the announcer and the times when songs or music are played.

Give the time in GMT or the station's local time (which you can determine

from an atlas or other reference work). Describe the strength and fading of the signal, and be sure to indicate the type of interference encountered and from which other stations. Give a brief description of the type of receiver and antenna you are using.

International shortwave stations often welcome comments on their programming, although local or domestic stations may not be so receptive. Request a QSL, don't demand one!

It is also a polite gesture to enclose return postage, either in American stamps to stations in the United States or in International Reply Coupons (available at most post offices) for foreign stations.

And before mailing your report, be sure that you've included the date, time, and frequency on which you heard the station. Otherwise, the station can't check your report so that they can issue the QSL!

If you are reporting on a station outside the United States or Canada, send your report by air mail. It costs more, but sea mail can take several months to arrive and the chances of loss in transit are greater. Lightweight airmail envelopes and paper can cut your postage bill greatly.

That's all you have to do to earn a QSL card from shortwave stations.

Guam. TWR, as swls refer to it, is a religious broadcaster with most of its programs beamed to listeners on the Asian mainland.

Most programs are in such languages as Chinese and Indonesian although some periods of English are scheduled. You can hear these English programs at 1430 to 1500 GMT on 11705 kHz, at 0030 to 0100 GMT on 17855 kHz, and from 1000 to 1100 GMT on 9640 kHz.

TWR is more difficult to hear than the stations previously mentioned, so don't be discouraged if it takes several attempts to finally catch its signal.

You can send your reports for a QSL card to Trans World Radio, P.O. Box 3518, Agana, Guam 96910. Since TWR is not a government station, it would be a polite gesture to include an American stamp for first class mail to pay for the cost of mailing your QSL back.

Aussies and Zedders

Australia and New Zealand are not usually thought of when one thinks about exotic Pacific islands, but both are located in the Southern Hemisphere and have seasons opposite ours in the Northern Hemisphere. Thus, when it's freezing cold in New York, people are sunning themselves on Australian beaches! And fortunately for the swl both nations have many good targets to test your skill as a dial-spinner.

Many nations use shortwave transmitters with power ratings in excess of 500,000 watts (500 kw). New Zealand, on the other hand, operates its shortwave service over antiquated transmitters running only 7500 watts (7.5 kw).

You might suspect that such rigs would have trouble being heard even in New Zealand, but such is not the case. Radio New Zealand puts strong signals into North America many nights on 11780 kHz from 0515 to 0715 GMT and on 11820 kHz from 0730 to 1030 GMT. Programming is entirely in English and you can mail reception reports to Box 2092, Wellington, New Zealand.

Australia is a swls delight with many interesting stations to shoot for. Australia's service for overseas listeners is Radio Australia, and it beams to North America on 9580 kHz from 1100 to 1300 GMT. It can also be heard on 15320 kHz from 0100 to 0300 GMT. Programs are entirely in English and feature numerous items on life in Australia and much Australian pop music. Address your reports to



RADIO NEW ZEALAND
SHORT WAVE DIVISION OF THE NEW ZEALAND BROADCASTING CORPORATION

BROADCASTING HOUSE
BOWEN STREET
WELLINGTON
NEW ZEALAND

CABLE : NAT BROADCAST

New Zealand



Tahiti

Radio Australia, P.O. Box 428G, G.P.O., Melbourne, 3001, Australia.

Australia is also home to the most distant station that most swls will ever hear. It's VLW9, Perth, a government-run outlet relaying the domestic programming of the Australian Broadcasting Commission to listeners in isolated areas away from ordinary ac outlets. You can hear VLW9 on 9610 kHz from sign on at 1000 GMT until sign off at 1600 GMT. Reports can be sent to Australian Broadcasting Commission, Box 190D, G.P.O., Perth, 6001, Australia.

Australia has a WWV/WWVH of its own in station VNG, operating on 4500, 7500, and 12000 kHz around the clock. Reception in North America is best from 0500 GMT until approximately an hour after local sunrise at your listening location.

VNG transmits second ticks and gives a voice identification every fifteen minutes starting on the hour. To prove your reception, copy the voice announcement word for word and send your report to Radio station VNG, Radio Section, Postmaster General's Department, 57 Bourke St., Melbourne, 3001, Australia.

So even if you can't go to the islands of the blue Pacific, you can bring the island to you—or at least to your ears—merely by spinning the dials of your shortwave receiver tonight!

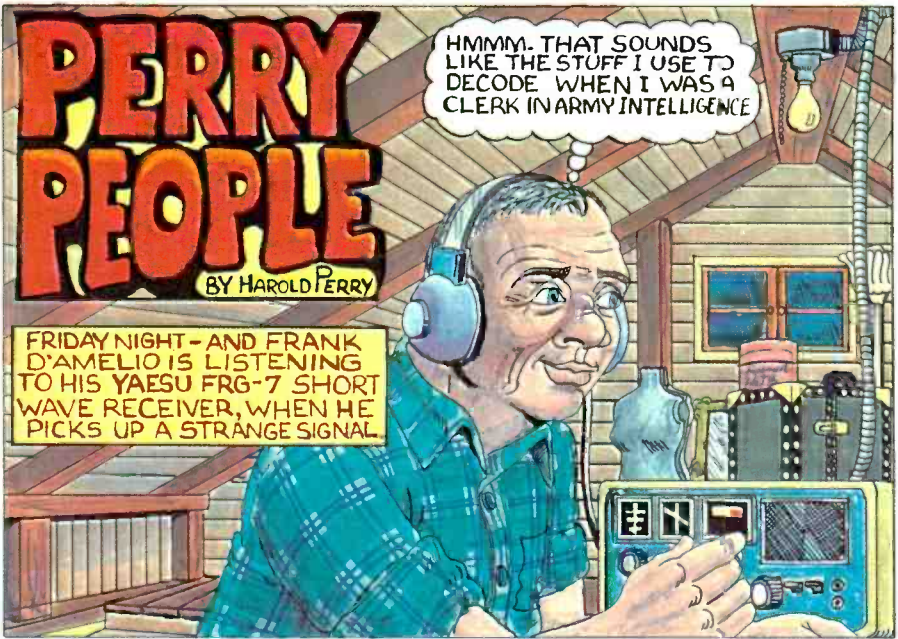

PERRY PEOPLE

BY HAROLD PERRY

FRIDAY NIGHT - AND FRANK D'AMELIO IS LISTENING TO HIS YAESU FRG-7 SHORT WAVE RECEIVER, WHEN HE PICKS UP A STRANGE SIGNAL.

HMMM. THAT SOUNDS LIKE THE STUFF I USE TO DECODE WHEN I WAS A CLERK IN ARMY INTELLIGENCE

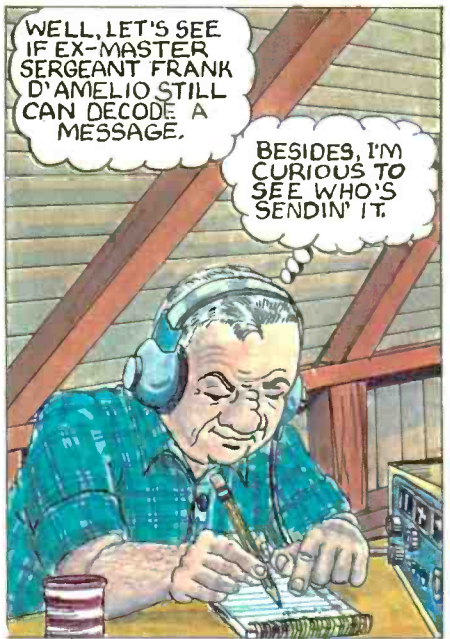

WELL, LET'S SEE IF EX-MASTER SERGEANT FRANK D'AMELIO STILL CAN DECODE A MESSAGE.

BESIDES, I'M CURIOUS TO SEE WHO'S SENDIN' IT.

AN HOUR AFTER DECODING THE MESSAGE, FRANK SHOWS IT TO HIS WIFE.

OH FRANKIE THIS IS TERRIBLE! THE GRAMMAR IS ATROCIOUS & THERE ARE 4 SPELLING ERRORS

GOOD GRIEF! TWO SPIES WITH STOLEN AMERICAN SECRETS ARE MEETING A SUBMARINE AND SHE GIVES THE DAMN THING A GRADE.



THERE'S ONLY ONE THING TO DO. I'M GOING DOWN TO THE WATERFRONT AND CATCH THOSE SPIES

ARE YOU CRAZY? CALL THE F.B.I.! LET THEM DO IT. YOU COULD GET HURT!

THE F.B.I. WON'T BELIEVE ME. I GOTTA GO, MY COUNTRY NEEDS ME.

I CAN'T STAND THE THOUGHT OF YOUR SENSUOUS BOD BEING TAKEN PRISONER TO CHINA.

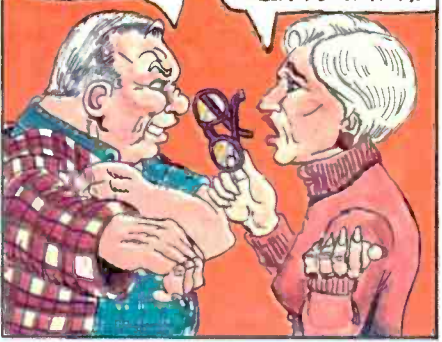

A SHORT WHILE LATER, FRANK ARRIVES AT THE MARINA.

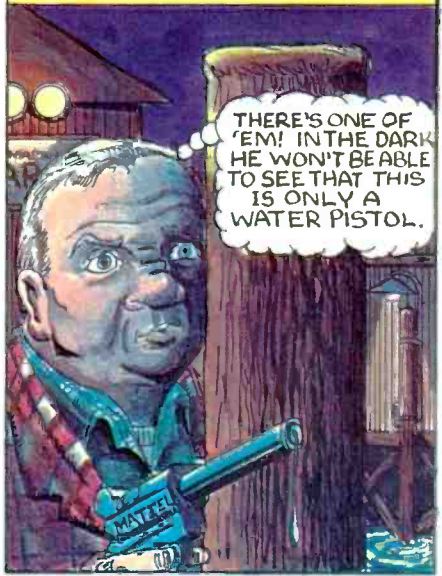

THERE'S ONE OF 'EM! IN THE DARK HE WON'T BE ABLE TO SEE THAT THIS IS ONLY A WATER PISTOL.

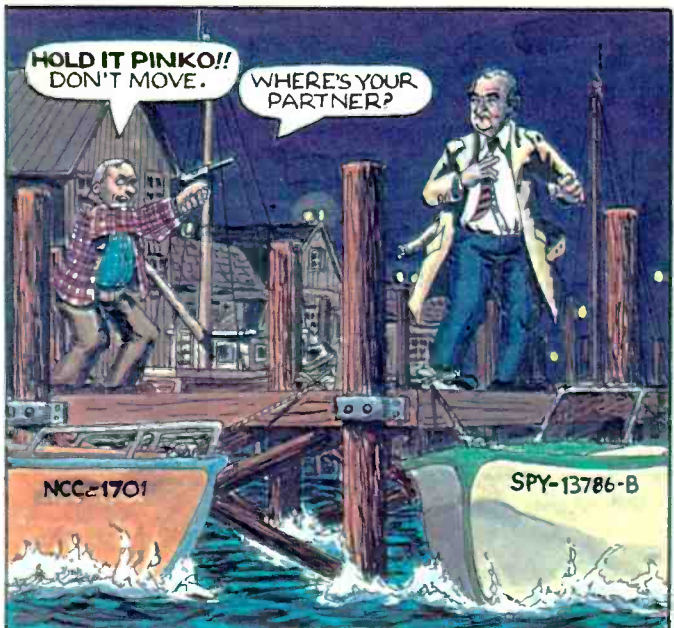

HOLD IT PINKO!! DON'T MOVE.

WHERE'S YOUR PARTNER?

NCC-1701

SPY-13786-B



RIGHT HERE BEHIND YOU, MON CHER.

I CALL SUB. FOR ORDERS.

THEY EXPLAIN THAT FRANK IS THE TYPE OF OPPRESSED WORKER WHO THEY WANT TO FREE FROM CAPITALISM.



KILL HIM!

AND THEN, JUST AS THE SPIES ARE ABOUT TO CARRY OUT THEIR ORDER OF DEATH!

THIS IS THE FBI. PUT YOUR HANDS OVER YOUR HEADS. YOU'RE UNDER ARREST.

BLAM BLAM BLAM
BLAM BLAM BLAM

RATATATATAT
BANG WHAM BAM
RAK POW BOOM BL

DON'T SHOOT! I AIN'T NO COMMIE SPY. I-I-IMA-IMA V-VETERAN.

WE KNOW, MR. D'AMELIO, YOUR WIFE CALLED US. IF SHE HADN'T CALLED, THAT COULD HAVE BEEN YOU DOWN THERE.

THAT WAS REALLY STUPID OF YOU, COMING HERE BY YOURSELF. THESE SPIES ARE CRUEL AND VICIOUS ANIMALS. IT COULD HAVE BEEN VERY BAD FOR YOU.

AS BAD AS RIDIN' THE SUBWAY AT NIGHT??

NOTHING'S THAT BAD. BUT, IF YOU CALLED US SOONER...

"... THE COAST GUARD COULD HAVE GOTTEN THAT SUBMARINE."

MR. D'AMELIO WE REALLY APPRECIATE WHAT YOU WERE TRYING TO DO TO HELP YOUR COUNTRY. BUT, NEXT TIME, LET US DO THE DANGEROUS WORK.

YES SIR! AND IF YOU EVER NEED ME, I'LL BE READY.

SWORN TO SECRECY, FRANK'S LIFE RETURNS TO NORMAL

OH FRANKIE THESE FLOWERS ARE BEAUTIFUL.

YOU DESERVE THE BEST, HONEY.

YOU BET YOUR BIPPY!

UHH - ARE YOU GONNA TIE ME UP EVERY TIME I LISTEN TO MY SHORT WAVE RECEIVER.

TALLY-HO CHAPS! THIS IS THE B.B.C IN LONDON OFFER

THE END

No DJs. No top 40.

You may have set your watch to the time ticks of radio station WWV. But, did you know WWV has two sister stations at the old homestead in Fort Collins, Colorado? Here's the inside story on the little-known WWVB and WWVL broadcast operations.

by Karl T. Thurber Jr., W8FX

Practically anyone owning a short-wave receiver has tuned to station WWV for checking time or for calibrating a receiver. WWV's familiar signals on 2.5, 5, 10 and 15 MHz are well-known in most parts of the world and especially within our own United States where at least one of the frequencies can almost always be counted on for clear reception twenty-four hours a day.

Lesser-known, however, are WWV's sister stations, WWVB and WWVL, which also are located near Fort Collins, Colorado. Both of these stations use very low frequencies—WWVB holding forth on 60 kHz, and WWVL broadcasting on 20 kHz. Only WWVB is on the air today. WWVL has been temporarily retired and transmissions curtailed in 1972 (although the station and antennas are still in place, ready for possible use in the future). Because very few hams and SWLs own receivers that can tune below the lower limits of the broadcast band, 540 kHz, the latter two stations are almost unknown except to scientists, engineers, and other people who depend on the very dependable low-frequency transmissions.

As far back as 1956, the National Bureau of Standards (NBS) labs were

experimenting with 60 kHz transmissions, using the experimental callsign KK2XEI and a relatively low power of two kilowatts. They used the NBS primary frequency standard as Boulder to directly derive the station's 60 kHz frequency. Four years later, in 1960, WWVB on 60 kHz (now well-established) was joined by WWVL on a much-lower frequency—20 kHz—which, of course, lies just at the top end of what we think of as the *audio* range. The station was located in a high mountain valley at Sunset, Colorado, about ten miles west of the main labs.

Time machine

While all this was going on, WWV itself was still broadcasting its time and frequency tones from Greenbelt, Maryland. But in 1966, WWV was moved from Maryland to Fort Collins in order to increase the accuracy of its transmissions (it would be far closer to the main Boulder standards) and to more uniformly cover the U.S. At the same time, the move allowed all three stations to be controlled from the same central facilities, WWVL having been relocated from the mountain valley site in 1963.

Why are such *low* frequencies used? They are favored because a great im-

provement in *received* accuracy is possible—both in terms of time and frequency. At very low frequencies, such as 20 and 60 kHz, reception doesn't suffer the slight time delays and unpredictable atmospheric variations that distort regular reception of WWV and its Hawaiian counterpart, WWVH. While most amateurs and SWLs aren't concerned with these problems, these *errors* make some highly technical laboratory applications impossible when the labs are located far from the transmitter sites, and especially when reception is by sky-wave.

Since low-frequency waves travel almost completely by ground-wave (rather than by sky-wave), these reception problems are almost completely eliminated, and reception quality of the low-frequency time-tickers is usually as stable as the Rock of Gibraltar.

Time and frequency control of all the NBS stations, including WWVB and WWVL, is provided by a very accurate assemblage of various time clocks and frequency standards, including a cesium atomic standard. For example, the frequencies broadcast by the stations are precise to within *one part in 100 billion* at all times, being tied directly to the NBS frequency standard at Boulder. Likewise, time information sent out by the stations is almost perfectly accurate since it is based on ultra-stable atomic clocks. You can count on the time being good to a microsecond or so.

Sky waves

While the time information is broadcast in the well-known Universal Time (UTC) format, the stations also broadcast a special UTC adjustment factor, known as *UT1*, which some users of time information need for their work. This is because in some navigation applications, what is really needed is a less-absolute time scale, one that slows down and speeds up with the rotation rate of the earth.

This scale is known as *UT1*, and it is really less-accurate (in an absolute sense) than the atomic-derive UTC. You should note that UTC or *Coordinated Uni-*



WWVL QSL card

Just the world's best time.

versal Time has replaced what we used to call Greenwich Mean Time, or GMT.

Long wavelengths

WWVL was probably capable of producing the best quality of all the NBS stations, because of the very low frequency used. But there were some problems to be overcome in working at such long, long wavelengths. For example, the station's *phase* (a technical term applying to the relationships between current and voltage in an ac or rf circuit) had to be very carefully controlled to prevent transmission errors and to allow for the best possible accuracy of measurements made on the receiving end.

Because the extremely short antenna system used was so heavily loaded to make it look electrically correct and thus to work properly, it was susceptible to small phase changes. As a result, the station set-up had a complex servo system to sense any such phase shifts detected at the antenna loading coil.

It would then send a correction command to a phase-shifting compensation system in the transmitter. As can be seen

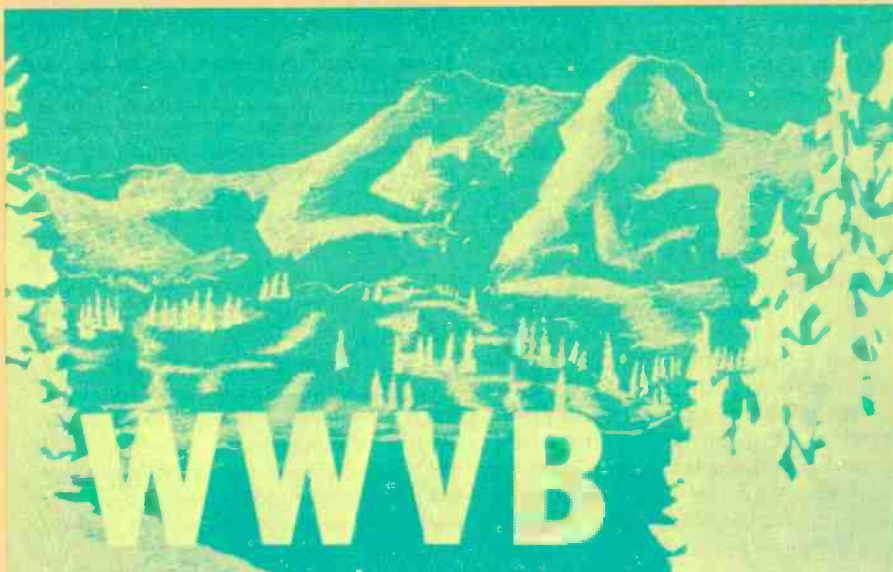

WWVB QSL card

in the photos, dimensions at these very low frequencies are surprisingly large, and that's the reason full-size antennas are not used. In the photo taken inside the WWVL helix house, the size of the

helix coil can be appreciated by noting the size of the man standing next to it!

Quartz crystals

Quartz crystal oscillators and "drift correctors" were used in the WWVL transmitter to generate the carrier frequencies. Actually, one, two, or three operating frequencies could be selected: 19.9, 20.0, and 20.9 kHz. The station could simultaneously transmit on *all three* frequencies if it was desired to do so!

On July 1, 1972, transmissions were suspended from WWVL, with its sister station, WWVB, carrying on the high-precision, low-frequency transmission of time and frequency data. According to NBS publications, the essential equipment and antenna systems are still intact and may occasionally be tested. The equipment can also be "fired up" and used by other parts of the government for experimental work, on a sort of subscription basis.

You'll find that WWVB is still on the air on 60 kHz. It also uses a highly stable crystal oscillator as its frequency generator, which is carefully referenced and checked against the main NBS frequency standard. It transmits twenty-four hours a day, continuously broad-



Looking northeast from the WWVB tower, the WWVL antenna is in view. WWVL helix house is under the four-tower system in the rear. The bandwidth, or portion of spectrum occupied by WWVB around 60 kHz, is only 600 Hz. The bandwidth of WWVL is even sharper. The antennas are necessarily short with respect to wavelength so they have low efficiency. If they were to be a full quarter-wave tall, the WWVB aerial would extend 4000 feet into the air. WWVB's antenna efficiency is about 35 percent while WWVL is only about five percent efficient.

casting time signals, time intervals and the specially-coded UT1 corrections mentioned earlier, although it doesn't ID by voice as do WWV and WWVH (You can ID it by noting its distinctive time code pulse format).

WWVB is located near the WWV site, and its good central location allows it to cover the entire continental U.S.A. Its transmitter has an ERP (effective radiated power) of 13 KW. Because it uses a much higher frequency than WWVL, some 40 kHz higher, the antenna system behaves a good deal better and so, the complex phase-control circuitry used in WWVL doesn't have to be used.

It's interesting to note that to prevent any "undetected" clock or time code generator failures, continuous inter-comparisons, or crosschecks, are made between the transmitted WWV and WWVB signals and even, on occasion, by portable atomic clocks. In addition, WWVH (the NBS station on Hawaii) monitors the LF signals broadcast by WWVB as a cross-check on its own transmission accuracy.

One of the most intriguing aspects of the VLF and LF scene is the size of the antennas normally used. Let's, first, put these frequencies into perspective. Consider the 80-meter amateur band (3500-4000 kHz), or even the low end of the standard broadcast band (540 kHz), or 555 meters. A quarter-wavelength vertical antenna for the 80-meter band works out to about 65 feet in height, while an-



These are the 400-foot antenna towers used by WWVB and WWVL. While the systems are separate, they are identical. Both are top-loaded vertical antennas. The structures are free-floating and completely insulated from the towers. Electrically, the antennas act like high-Q capacitors tuned to the operating frequencies of 60 kHz and 20 kHz via large coils.

tennas designed for 540 kHz would be more than 450 feet high. But look what happens when we go *really* low in frequency. A 60 kHz quarter-wave vertical antenna would be some 1250 meters high if full-size, while a 20 kHz vertical would be all of 3750 meters, or 12,300 feet high. Obviously, a bit of antenna shortening by loading coil technology is necessary to keep the dimensions within reason.

The WWVB and WWVL antennas are both top-loaded, and they are identical even though they are used on widely different frequencies. The antenna system for each of the stations is made up of four heavily-guyed steel towers which are arranged into a diamond shape, 1900 feet long and 750 feet wide. Interestingly, there are counterbalances on the inside and base of each tower that help to maintain the proper tension at the tops of the towers. This is necessary to compensate for the very high winds which whip down from the adjacent Rocky Mountains.

High-Q capacitors

Each antenna structure is free-floating and is completely *insulated* from the tower system. Electronically speaking, the antennas are actually high-Q capacitors which are tuned to the operating frequency with very large coils. As you might expect, the very high Q of the antenna circuit makes its bandwidth very narrow—much like what happens when you load a very short mobile whip to work on the lower ham bands, such as 160 or 40 meters. WWVL's antenna has a Q of about 1,000, while WWVB's antenna is much lower, around 100. For these reasons, the bandwidth of the WWVL antenna is a mere 20 hz (cycles), and the bandwidth for the WWVB system is all of 600 hz!

Not only is the bandwidth narrow, but since the antennas are very short with

Please turn to page 90

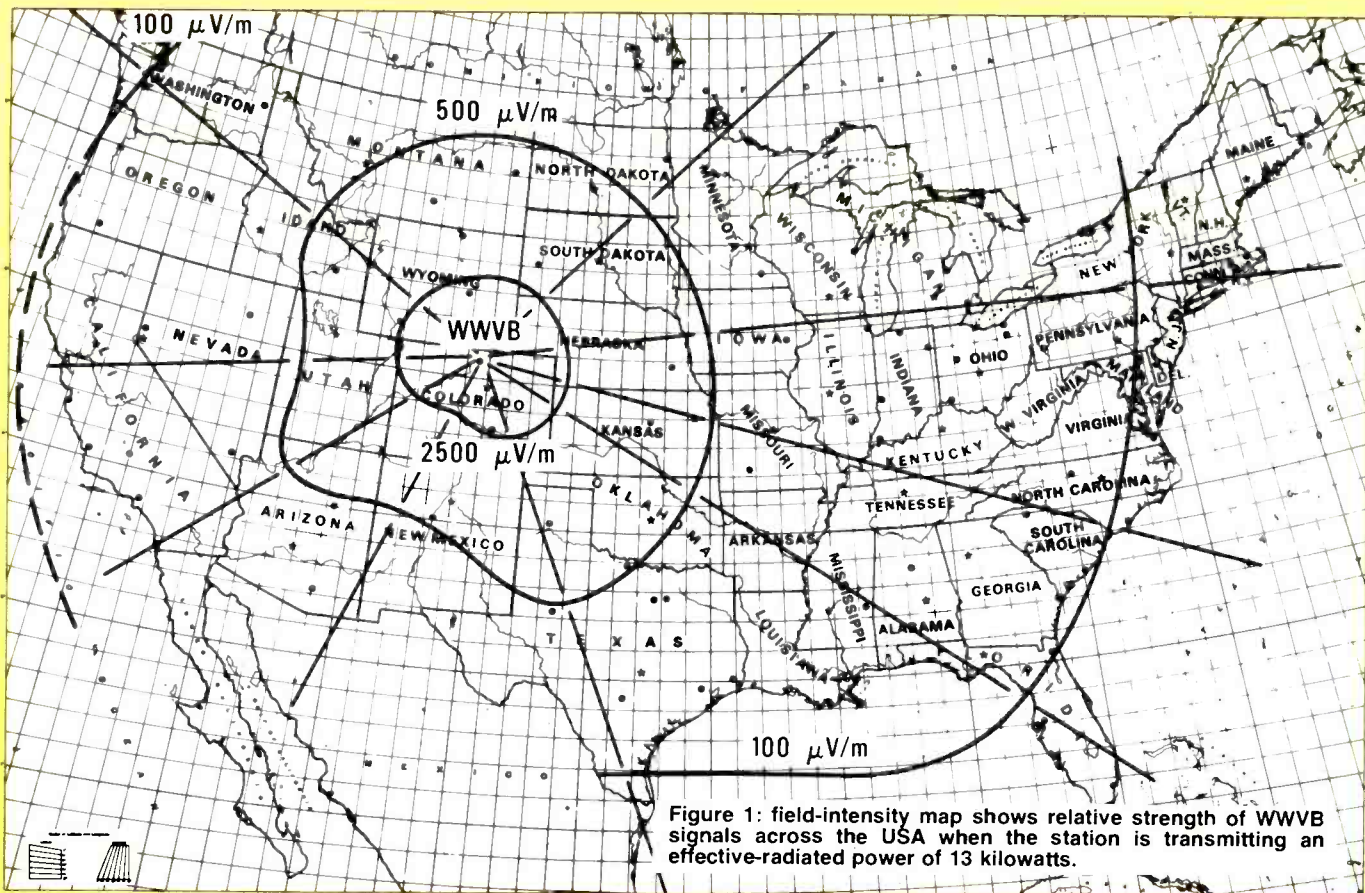

Figure 1: field-intensity map shows relative strength of WWVB signals across the USA when the station is transmitting an effective-radiated power of 13 kilowatts.

Stereo pointers: how to buy right, what to look for

by Judy Curtis
Contributing Editor

If you're about to buy a stereo system for the family, you may find yourself lost in a fog of amplifiers, watts, woofers and FETs.

Buying a system isn't easy, now that many listeners prefer separate components instead of console models where everything's confined in one package. Then you didn't have to concern yourself too much with knowing what made it all work.

Even if you're looking at consoles, and especially if you're eyeing separate components, you must find your way around the terminology before you try to pick and choose models in a store.

Three in one

A *stereo receiver* is an am/fm radio and sound amplifier, all in one package. Nowadays, electronic gear lasts longer and takes a beating because it is built of solid-state construction with transistors and integrated circuits.

These are tiny, solid chunks of metal and plastic which replace old-fashioned glass tubes. Each IC is equal to hundreds of individual transistors wired together in a radio circuit.

Old-time tubes were fragile glass and hot. Solid-state equipment runs cool and can stand some good thumps.

The amplifier portion of a stereo receiver boosts sound from the built-in am or fm radios, or from add-on accessories like tape decks, record changers and turntables. The more boost to the sound, the more power from the amplifier. A 33-watt receiver is one with an amplifier capable of delivering 33 watts of audio power from each channel. A 33-watt receiver is more powerful than a 10-watt receiver.

To create a lifelike sound, as if you had been inside the recording studio when your records and tapes were made, sound from a stereo receiver is divided into a left-hand channel and a right-hand one.

To hear this sound effect, place a pair of loudspeakers several feet apart. Sit or stand between and in front of the speakers. Some sounds will come from the left speaker while others come from the right.

The wooden cabinets housing your loudspeaker actually house several

speakers. Each box has a speaker to recreate the low tones and another speaker to reproduce high tones. Better loudspeakers have a third speaker to give so-called middle-range sounds.

The low-tones speaker is a *woofer*. The mid-range and high-note speakers are *tweeters*. You will need two such loudspeaker cabinets, one for each stereo channel.

Meters tell on the signal

Receivers often have *signal-strength meters* and sometimes *tuning meters*. You get the best sound when listening to a properly tuned-in am or fm radio signal.

A *tuning meter* tells when you have set the radio correctly at the center of the signal being received. The meter swings off to one side or the other as you tune away from the correct position.

A *signal-strength* meter gives an indication of how strong the signal is, as it is heard by the radio built into your receiver.

If the receiver does not have a separate tuning meter, the signal strength meter can be used to correctly tune in a signal. Tune the radio dial for the strongest reading on the meter.

You also may find tiny lights on the face of the receiver which tell you what's happening. These are light-emitting diodes (LEDs), tiny rugged solid-state light bulbs used as indicator lights on modern electronic gear.

They tell when the receiver power is on; whether you are set up to listen to am, fm, tape or records; and whether the fm radio is receiving a stereo signal.

Antennas hear the signals

The am radio portion of a stereo receiver has a built-in antenna to pull signals from the air. The fm radio may have one built-in but, in some locations, it may require an extra antenna.

A wire dipole antenna connected to the back of the stereo receiver will provide better reception. In fringe areas where signals from distant fm broadcast stations are weak, connection to an antenna on the roof of your house, or to a cable tv service which provides fm service, may be necessary.

There are two kinds of lead-in wire connecting antennas to your receiver:

300 ohm and 75 ohm. These have different physical shapes and require appropriate terminals on the back of your set.

A special control you might want to look for is *loudness* control. This control, when switched on, lets you have an extra boost to low tones in sound you amplify through a stereo receiver.

The frequency of audio, or sound, which you can hear ranges somewhere between 20 Hertz (cycles per second) on the low end and 20,000 Hertz on the high end. For instance, voices you hear through a telephone are restricted by the phone gear to a frequency range of 300 to 3000 Hertz. The wider the frequency range, the more high fidelity the sound.

If the amplifier portion of a stereo receiver can reproduce sound from 40-20,000 Hertz, it has better hi-fi than many people's ears can hear. How well the receiver can reproduce sound is its *frequency response*.

Getting the noise out

No amplifier is perfect. Very weak sound enters the amplifier from a record, tape, radio or other source. The louder sound leaving the amplifier is a reproduction of the weak sound which went in. But it is not an exact copy.

A tiny bit of noise called *distortion* is generated in the amplifier. Better amplifiers are designed to hold the amount of distortion to a total of one percent or less. An amplifier with 0.8 percent total harmonic distortion is better than one with 1.2 percent.

Sometimes you can hear high-pitched noises or scratches in your records or the low rumble of the motor in your record changer. *Filters* are special circuits to prevent the amplifier from reproducing such annoying noises.

Some receivers have a feature called *muting*. As you tune across the dial of an fm radio, noise can be heard between stations along parts of the dial where no stations are transmitting. Muting silences the noise between stations.

You may want to look for a receiver with an *FET front end*. Field-effect transistors (FET) make the radios in stereo receivers very sensitive to weak signals. That means you could live farther from a broadcaster and get a good signal. ☐

11 projects under \$11

Here's some fun for a midsummer's night at the workbench. Build any or all of these inexpensive quickies and you'll have a ball.

by Jeffrey A. Sandler
Contributing Editor

1 Listen to your lawn

Although most lawns don't, in the normal course of events, provide an afternoon concert, yours can! Imagine being able to plug a set of headphones into your backyard lawn and being treated to your favorite music. It's just the thing for your next yard party. If nothing else, it should make an excellent conversation piece.

All you need is a high-level audio output from your tuner/amplifier. Although you may be able to drive your lawn directly from the tuner/amplifier output, you'd be safer using a buffer amplifier, such as the LM386 circuit shown. The stakes used to connect the amplifier to the lawn can be just about any metal rods you have handy. Copper lightening rods are ideal.

The audio signal impressed in the lawn will be located between the stakes, as shown. So, position the stakes at opposite ends of the lawn.

To tune in on the lawn, you'll need a set of monaural headphones, such as the Radio Shack 279-200, and a high-gain preamplifier such as our 741 circuit. All you have to do then is drive a pair of pickup stakes into the lawn. The volume depends a great deal on the location of the stakes.

Generally, the farther apart they are, the louder the sound. However, since the soil conductivity varies from place to place, moving one stake just a few inches can make an appreciable difference.

Overall performance depends on many factors including the gain of

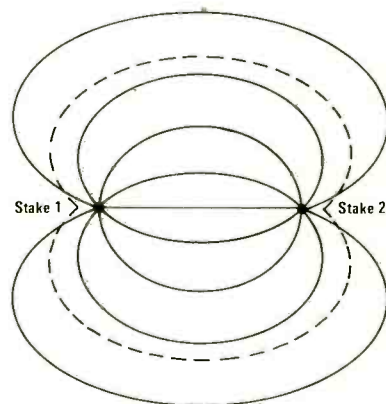
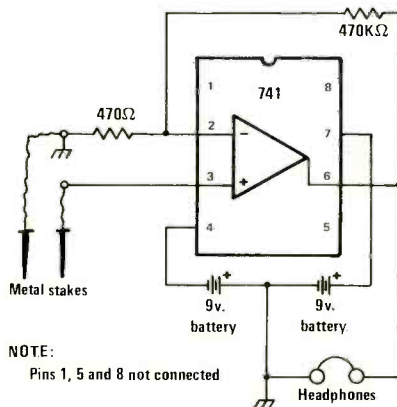
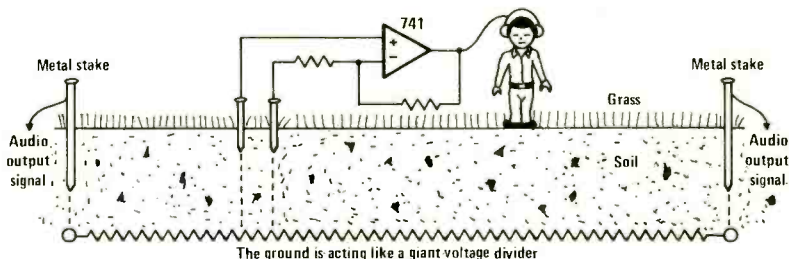

the headphone preamp, the distance between the stakes at the input and the output end, ground conductivity, background noise, and the alignment between the two sets of stakes.

Because of the many variables, this project is ideal for an experimenter interested in conducting a science project, perhaps as part of school work.

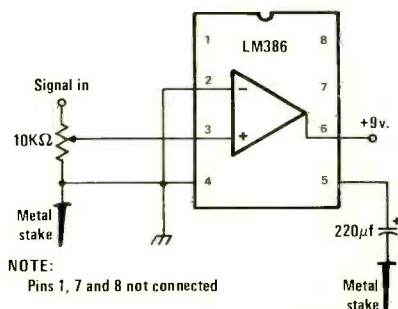

2 Meltdown alarm

Each year, millions of dollars worth of frozen food is ruined by freezers losing refrigeration because of power failures or mechanical breakdown. In many cases, the freezer owner isn't aware his food is slowly going bad. By the time he discovers the problem, it's too late to save the food.

Here's an inexpensive, easy-to-build *meltdown alarm* that can save you hundreds of dollars the first time it operates. The circuit consists of a reed-switch actuated audio oscillator and amplifier. Only the reed switch is located inside the freezer. The rest of the circuit can be placed in any remote location where the alarm will best be heard.

Connections between the switch and the alarm circuit are made by

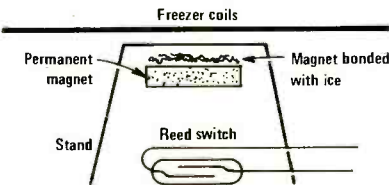

two thin wires. To maintain the door seal, a pair of 28-gauge magnet wires can be used to connect the reed switch to a terminal outside the freezer. Heavier wire can be used to connect the alarm to the terminal.

Current drain in the standby mode is very low. A single nine-volt battery should last a year or so.

The meltdown detector is nothing more than a permanent magnet at-

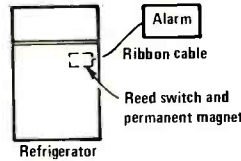

tached to a small stand by *ice*. The reed switch is positioned below the magnet. When the ice melts, the magnet will fall onto the reed switch, closing it and completing the alarm circuit. The stand should be constructed to guide the magnet into the reed switch tube. The alarm will only sound while the magnet is resting on the reed switch tube.

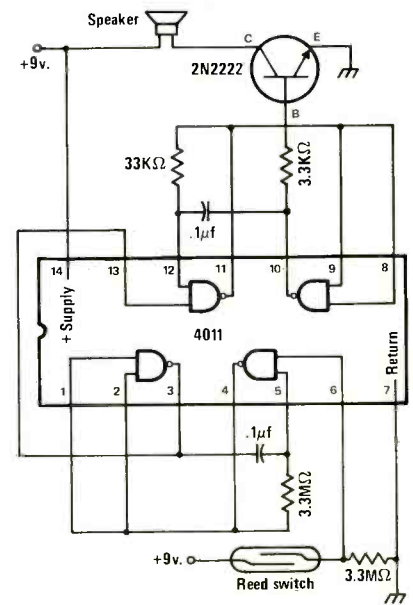

The temperature at which the ice "glue" holding the magnet melts can be set by mixing the right percentage of anti-freeze and water. Check the temperature chart on your anti-freeze container.

3 Tone lock

If you've been looking for an unusual electronic locking device, this should do the trick. The lock, or other load circuit, can only be actuated by applying a relatively high-frequency ac voltage to the terminals. And it's pretty unlikely that unauthorized people will have such a generator in their pocket.

The lock consists of two circuits: the hand-carried tone generator and an SCR unlocking circuit. The ac generator is built around a 4001 CMOS IC, and uses just two other parts. The entire circuit and a nine-volt battery to power it can be built inside a small container.

The unlocking circuit uses an SCR to complete the locking circuit, which can be nothing more than a solenoid-actuated bolting device. The SCR itself draws no current until fired by the ac generator.

You can customize your lock by

creating a unique two-pin connector through which the ac voltage is applied to the firing potential of the SCR circuit. Although not shown in the diagram, you can apply power to the ac generator through a push-to-make momentary contact switch.

In operation, the ac voltage generated in the hand-carried unit is rectified by the 1N4148 diodes. The resulting dc is applied to the 10 mfd capacitor, which requires about 100 cycles of ac to charge to the firing potential of the SCR gate. A push-to-break momentary contact switch opens the SCR circuit to relock the device.

If someone tries to use the lock with simple dc, the .01 mfd blocking capacitor protects your security. And applying 60 Hz won't help much either. So unless a would-be intruder has a three kilohertz ac generator in his pocket with your

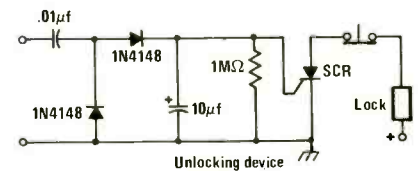
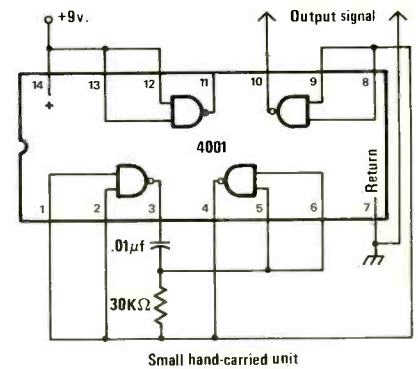

unique connector on its end, your security will depend on the physical strength of the actual locking device you use.

4 110-volt detector

Here's a small, portable *leakage detector* you can use to spot potentially lethal voltages on appliances and power tools. The detector consists of just two NPN transistors, an LED and five resistors—all standard junkbox variety. Although 2N3904 transistors are specified, just about any small signal NPN type should work.

The detector requires the use of a good electrical earth ground. Your best bet is a cold water pipe, if your home has metal pipes. If you're in a modern home, it may have plastic pipes, which won't work in this application.

If you don't have a metallic cold water pipe available, you can attach the ground lead to the screw holding the wallplate onto any 110-volt convenience outlet. If, in loosening the screw, the plate comes loose, be careful. The voltages behind the plate are lethal.

The entire circuit can be built into a small container. For your safety, it should be made of plastic. A standard nine-volt battery will provide working power for the detector.

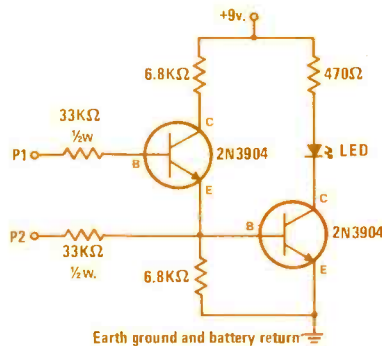

Two probes are provided, in addition to a grounding lead. To use the detector, attach the ground lead to the cold water pipe or other electrical earth ground. Then touch the device to be tested with the probe P1. If the LED turns on, there is enough leakage for you to consider the device potentially dangerous. Then touch probe P2 to the device.

If the LED lights with P2, the leakage is high enough to be considered dangerous, even lethal. If this is the case, disconnect its ac power immediately. Don't reconnect the power until you've found the fault.

5 Bulb protector

When a light bulb blows, it's usually no problem to replace it. But, there are bulbs tucked away in locations that can make their replacement an all-day affair. And if that bulb is really essential, a process-time indicator for example, it has got to be replaced.

As the old saying goes, an ounce of prevention is worth a day trying to change a hidden lamp. And here's the ounce of prevention that can do just that. Bulbs blow because of the very large surge of current that flows through their filaments when first turned on. As the filament heats up, its temperature rises, reducing the current to safe levels. The life of any light bulb can be considerably extended by eliminating the turn-on current surge.

Our circuit not only limits the turn-on current, it automatically increases the energy delivered to the lamp to the full rated value when the filament reaches its operating

7 Motor speed control

Many small projects involve the use of hobby or toy motors, such as those sold by Radio Shack in their 273 series. These small motors work off low-voltage dc, typically three to

six volts. Although they do draw relatively large current when under load, most will work off a small battery pack. Because of this, they are very popular for motorizing scale models and mobile displays.

The major disadvantage of these motors is their speed—usually around 10,000 rpm. One way to lower the speed is to use an appropriate gear box. But even then, you'll still have only one speed. You can get some speed control with a rheostat in series with the motor, but at low speeds, the motors tend to stall. Here's a circuit that overcomes this problem, giving you smooth speed control of most hobby motors.

The circuit uses a 4011 CMOS NAND gate, a pair of diodes and an NPN power transistor to provide a variable duty-cycle dc source. Adjusting the speed control varies the *average* voltage applied to the motor.

The peak voltage, however, is not changed.

This *pulse* power is effective at very low speeds, constantly kicking the motor along. At higher speeds, the motor behaves in a nearly normal manner.

The circuit can be built on any convenient material. Perfboard is ideal. Although a 2N3055 transistor is specified in the diagram, any NPN transistor with a collector current rating greater than the motor drain can be used. Since the transistor is working as a switch, turning on and off for time periods set by the speed control, it shouldn't require a heat sink. However, you can sink it if you wish.

The capacitor value isn't critical, and any value from .01 to .05 mfd will work well. You may find, however, that for the particular motor you have, one value will work better than others.

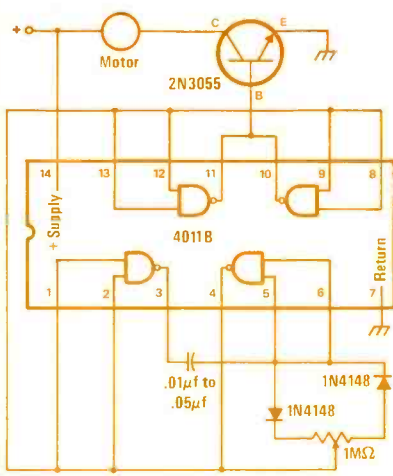

6 Crystal checker

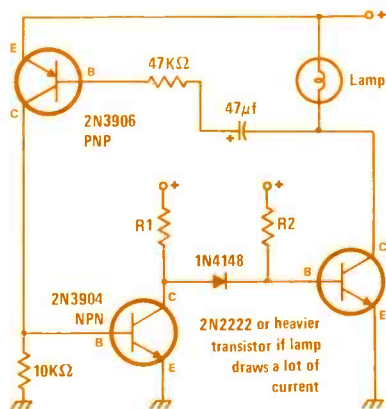

temperature. The result is the elimination of the current surge that does the damage.

The circuit is designed for use with low voltage pilot lamps such as the popular 44 and 47, but will work with any lamp within the voltage and current ratings of the transistors used.

Most hams, and many experimenters, have a small box filled with assorted crystals, some good, some bad. One way of checking the crystals is to use them. But, if the circuit doesn't work, you can't be sure if the crystal is dead, or just incompatible with your electronics. What you need is a *universal checker*.

The circuit is not more than a simple Pierce oscillator with an LED go-no go display. One big advantage to the Pierce circuit is that it requires a good crystal to work. Marginal crystals won't do it.

The ME checker works best with crystals having fundamental frequencies in the seven to eight megahertz range. Since the vast majority of crystals used by hams have fundamentals in this general range, the checker should cover most crystals in your junk box.

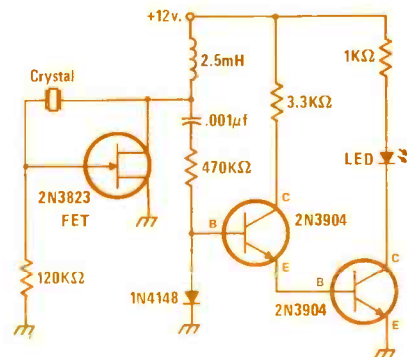

Construction is simple, and parts layout is not critical. You may want to parallel different crystal sockets to accommodate the different pin size and spacings you have on hand. The two NPN transistors in the diagram are 2N3904s, but any small signal NPN will work.

8 Look and listen

Ever wonder what a muscle sounds like when it moves? Or what kind of electrical signals stimulate your heart to beat? Well, here's a simple way to listen in on your own body's electrical communications.

The heart of the system is a 741 op-amp, connected to provide an amplifier gain of about 300,000. The body pickups are ordinary ten-cent pieces—dimes—to which flexible wire leads have been soldered. The output of the op-amp is connected through a 0.1 mfd capacitor to an audio amplifier to complete the system.

If you have an audio system handy, you can simply connect the output of the 741 to an auxiliary input on your amplifier. However, you can make a portable system by

using a battery-powered transistor radio as your audio amplifier. Just connect the 741 output to the *hot* side of the radio's volume control. This is the contact opposite the one connected to chassis ground. Then find a spot on the tuning dial where no radio signal is present. Turn up the volume and you're in business.

When listening in on your body, placement of the electrodes is very important. Generally, the dimes should be placed about four inches apart across the muscle to be listened to. As the muscle contracts, you'll hear a static-like crackle.

You can hear your heart's electrical signals by placing your dime pickups about five inches apart, one on each side of the heart. The sound you'll hear is very much like that

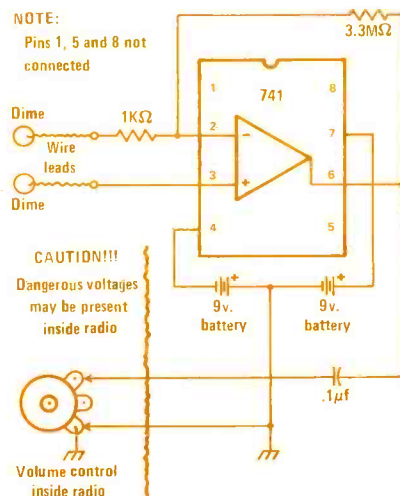

heard in a stethoscope, but is electrical rather than acoustic.

9 Sun-powered alarm

Here's a neat alarm clock based on the tried and true *sundial*. Although the alarm circuit is quite simple, placement of the detector may be a little tricky. It consists of a photocell mounted in a relatively long black tube. When the sun is in just the right position, its rays will shine down the tube, striking the cell at the bottom, actuating the circuit.

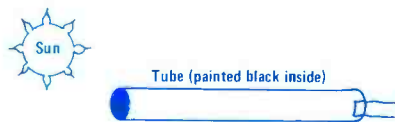

Because the sun's rays must strike the photocell, the tube must be aimed very carefully. The degree of accuracy depends on the length of the tube and its diameter. The greater the ratio of the tube's length to its diameter, the greater the accuracy required, and the more precise the timing of the alarm.

Although a longer tube takes more care in positioning, it greatly reduces the likelihood of the alarm being set-off accidentally. Even with a long tube, however, you may have to partially cover the solar cell with black tape so that the alarm isn't triggered by a bright sky.

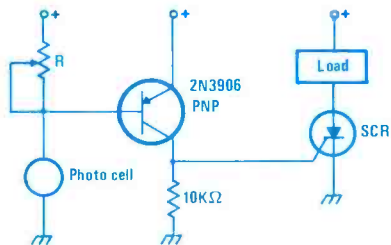

The actual alarm circuit is straightforward. Parts layout and wiring are not critical. The circuit can be powered by any convenient six to 12 volt source. The SCR load can be an alarm buzzer, light, or even a relay to actuate other circuitry. The SCR should be chosen on the basis of the load voltage and current requirements. The potentiometer, R, should be selected so that the circuit will trigger at the desired light level with the control set at about the midpoint of its rotation.

10 LED flasher

Here's an unusual LED flasher that uses sunlight to charge its battery—just like the system used in space satellites. The basic flasher uses the LM3909 integrated circuit. The 3909 contains all of the required circuitry except for the LED itself and a timing capacitor.

During the day, the sun hits the solar panel's cells, charging the NiCad battery. At night, the battery provides the power to flash as many as 15 LM3909 LED flashers.

If you'd prefer to run the show from an ordinary battery, a single AA penlight battery can power one LM3909 flasher for three months while a D battery will run it for well over one year. Adding more flasher units will shorten the battery life, but a single number six dry cell should power a dozen flashers for well over a year.

Since the circuit consists of just a single IC and capacitor, you can mount as many as you want on a

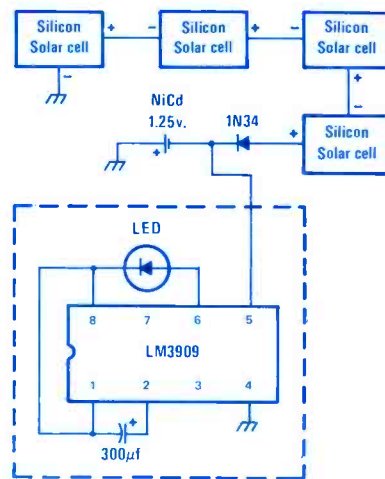

NOTE:

Duplicate "boxed in" circuit for each additional flashing LED desired. Boxed in part (3909, LED, 300µf) costs approximately one dollar.

small perfboard. Then, just string some fine-gauge wire to your LEDs, which can be arranged in any artistic manner you'd like.

11 Headset amplifier

Have an fm tuner with beautiful sound, but not quite enough *umph* to drive a set of headphones. Well, here's an inexpensive amplifier that will give you that missing *umph*, and sound fidelity that will amaze you.

The circuit uses the common LM386 integrated circuit and a small handful of junkbox parts. The whole thing will easily fit on a one-by-one perfboard. Even at high listening levels, a standard nine-volt battery should provide several hours of enjoyment.

The amplifier can be mounted right on your headphones, if you don't mind the weight of the battery and have the space required. You may find it more desirable to put the amplifier and battery into a small box mounted in the headphone cable. Or, if you'd rather not make a permanent installation, output the amplifier through a connec-

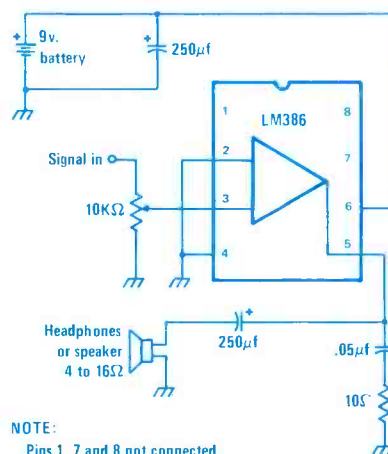

NOTE:

Pins 1, 7 and 8 not connected.

tor into which you can plug your headset.

The diagram shown is monaural. If you have stereo, you'll need two amps, one for each channel.

Call Toll Free 1-800-633-3410 for Drake

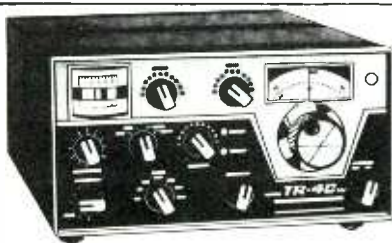

DRAKE TR-4CW transceiver

- Coverage: 80 thru 10 meters • 300W PEP on SSB, 260W on CW & AM • 500 Hz CW filter • RIT • Wide-range receiving AGC • Solid-state VFO • Shifted-carrier CW • VOX or PTT • Output impedance is adjustable • CW semi-break-in • Transceive or separate PTO.

799.00 list price. Call for quote.



DRAKE T-4XC transmitter

- Coverage: 80, 40, 20, 15m & 28.5 to 29.0 MHz of 10 meters • Covers 160 meter w/accessory crystal • Two 8-pole crystal lattice filters for SSB selection • Controlled carrier modulation for AM • Built-in VOX or PTT on SSB or AM • TX AGC prevents flat-topping • RTTY easy adaption, AFSK or FSK.

699.00 list price. Call for quote.



DRAKE R-4C receiver

R-4C has same coverage as the T-4XC, plus any 500 KHz range between 1.5 and 30 MHz. • Also use for MARS, WWV, CB, Marine & Shortwave reception • Linear permeability-tuned VFO • 3 AGC release times • Crystal lattice filter in first IF prevents cross-modulation.

699.00 list price. Call for quote.

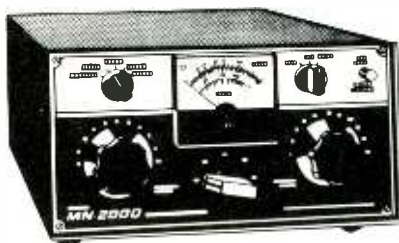

DRAKE MN-2000 matching network

Great where peak performance is a must! • Coverage: 3.5 to 4.0 MHz, 7.0 to 7.3 MHz, 14.0 to 14.35 MHz, 21.0 to 21.45 MHz, 28.0 to 29.7 MHz. • Insertion loss: 0.5 dB or less • Watt-meter accuracy 5% of reading • 1000 watts RF continuous, 2000W PEP.

250.00 list price. Call for quote.



DRAKE MS-4 matching speaker

The MS-4 is designed for use with the Drake R-4C, R-4B, R-4A, & R-4 receivers. It has space inside for the Drake AC-4 power supply. The 8-ohm speaker will always come through loud and clear.

33.00 Call for yours today.

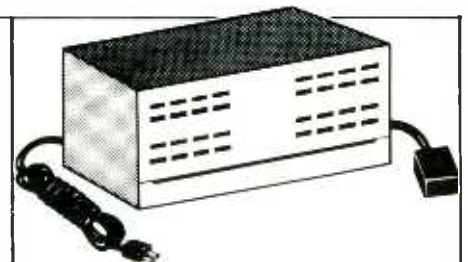

DRAKE AC-4 power supply

The AC-4 power supply works with all Drake 4-line transceivers and transmitters. Fits inside the MS-4 speaker cabinet • Input: 120 or 240 VAC • Output: 650 VDC at 300 mA average, 500 mA peak, also: 12.6 VAC at 5.5 amps.

150.00 list price. Call for quote.

Remember, you can call TOLL-FREE: 1-800-633-3410 in U.S.A. or call 1-800-292-8668 in Alabama for our low price quote. Store hours: 9:00 AM til 5:30 PM, Monday thru Friday



Long's Electronics



MAIL ORDERS: P.O. BOX 11347 BIRMINGHAM, AL 35202 • STREET ADDRESS: 2808 7TH AVENUE SOUTH BIRMINGHAM, ALABAMA 35233

CIRCLE 59 ON READER SERVICE CARD

Keyboards: how to

Input/output. Ports. Video display terminals. Keyboards. What are these home-computer accessories? Each month, *Modern Electronics* explains in detail how one piece of hardware works and what it could do for your microprocessor system. This month: a close look at one way you can talk to your home computer.

by Peter A. Stark
Contributing Editor

The keyboard may well be the cheapest part of a small computer system. There isn't much that a keyboard can do all by itself, and yet it is an almost indispensable part of many general purpose computer systems.

The keyboard is simply a group of keys or pushbuttons, through which one enters numbers, letters, or punctuation marks into a computer. In a simple system where the computer is used only for numerical calculations, the keyboard might only consist of eight or ten keys used to enter the numbers. Where the computer is also used for processing words or names, the keyboard might include enough keys for all the letters of the alphabet, as well as all the digits and punctuation marks, and some special purpose keys as well. Keyboards having just number keys are *numeric* keyboards, while keyboards containing numbers, letters, and punctuation are called *alphanumeric*. The alphanumeric keyboard

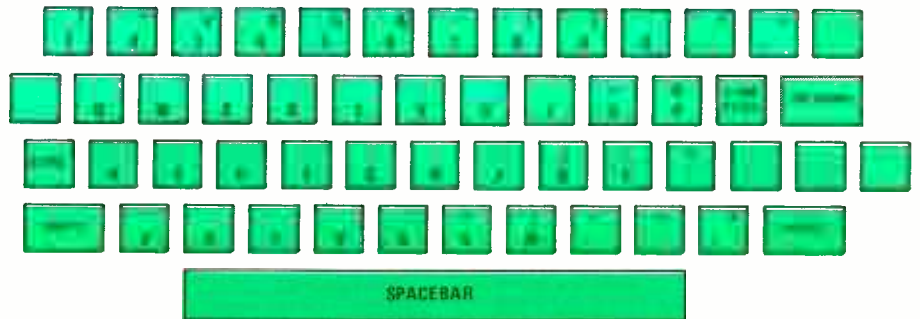

Key layout in a typical computer keyboard. Some of the letter keys have additional symbols, as do all the number keys. Pressing the SHIFT key moves the command from the lower character to the upper one, as on a typewriter. The CTRL key enables the keyboard to generate special control codes.

is by far the more useful and interesting, so let us see what it consists of.

Most alphanumeric keyboards look very much like a typewriter keyboard. They have four rows of keys, with from 12 to 15 or more keys in each row. As in a standard typewriter, the top row of keys has the numbers, the second row starts

with QWERTY... in the traditional order, and so on. In addition, the keyboard may have special symbols above a few of the keys, and perhaps additional keys at both the left and right ends.

The purpose of an alphanumeric keyboard is to generate a unique binary number for every press of a key. This binary number is fed from the keyboard to a computer or other digital device over a set of six to eight wires, depending on the *code* used, with all of the bits available at the same time. This is called *parallel data transfer*.

The standard ASCII code

0	0	0	0	0	1	1	1	1
0	0	1	1	0	0	1	0	1
0	1	0	1	0	1	0	1	0

b ₇	b ₆	b ₅	b ₄	b ₃	b ₂	b ₁
0	0	0	0	0	0	0
0	0	0	0	1	0	0
0	0	1	0	0	0	0
0	0	1	1	0	0	0
0	1	0	0	0	0	0
0	1	0	0	1	0	0
0	1	1	0	0	0	0
0	1	1	1	0	0	0
1	0	0	0	0	0	0
1	0	0	0	1	0	0
1	0	1	0	0	0	0
1	0	1	1	0	0	0
1	1	0	0	0	0	0
1	1	0	0	1	0	0
1	1	1	0	0	0	0
1	1	1	0	1	0	0
1	1	1	1	0	0	0
1	1	1	1	1	0	0

NUL	DLE	SP	0	@	P	^	p
SOH	DC1	!	1	A	Q	a	q
STX	DC2	"	2	B	R	b	r
ETX	DC3	#	3	C	S	c	s
EDT	DC4	\$	4	D	T	d	t
END	NAK	%	5	E	U	e	u
ACK	SYN	&	6	F	V	f	v
BEL	ETB	'	7	G	W	g	w
BS	CAN	(8	H	X	h	x
HT	EM)	9	I	Y	i	y
LF	SUB	*	:	J	Z	j	z
VT	ESC	+ ;	:	K	[k	{
FF	FS	< >	< >	L	\	l	
CR	GS	=	=	M]	m	}
SO	RS	>	>	N	^	n	~
SI	US	/	?	O	_	o	DEL

Special control codes

Most common codes

Lower case letters

ASCII Code

Although several data codes are used by various manufacturers, and may be available on inexpensive keyboards if they are used or surplus, the most common and most desirable code is called ASCII, which stands for the American Standard Code for Information Interchange. This is the code which is used by most of the larger computer systems, as well as almost all of the small ones.

ASCII is a seven-bit code where each of the seven bits can be either a binary 0 or a binary 1. With seven bits, there can be a total of 128 different combinations of bits, so ASCII has enough codes for 128 different characters, many more than there are on the typical keyboard. As a result, most keyboards only generate about 60 to 64 of the different codes;

talk to computers

most of the others are used for special purposes in communications between computers and other digital terminals.

It is possible to list the specific ASCII code for each letter, number, and punctuation mark in a table such as

A	1000001
B	1000010
C	1000011
D	1000100

but this takes a lot of paper and is very inefficient. Instead, ASCII codes are usually shown in a square table as in Table 1. Each of the seven bits in the ASCII code is labelled, with the leftmost bit being b7 and the rightmost bit being b1. The left three bits are read from the top of the table, and the right four bits are read from the left side of the table. For example, the letter A is in the column labelled 100, so the first three bits of its code are 100. Going left from the A, we see that the right four bits are 0001, so the complete ASCII code for an A is 1000001.

The most important characters in this table are in the center four columns; those whose first three bits are 010, 011, 100, or 101. These four columns include all the upper case letters (the capital letters), the numbers from 0 through 9, and the common punctuation marks. Almost every keyboard will generate the codes for these four columns, with the possible exception of the punctuation marks just under the letter Z.

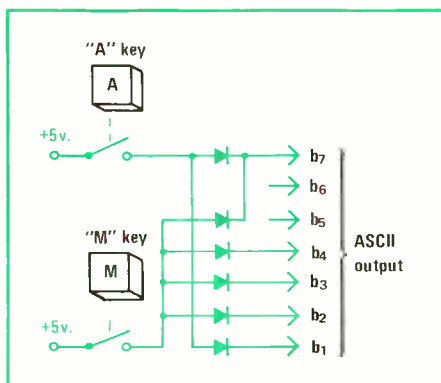
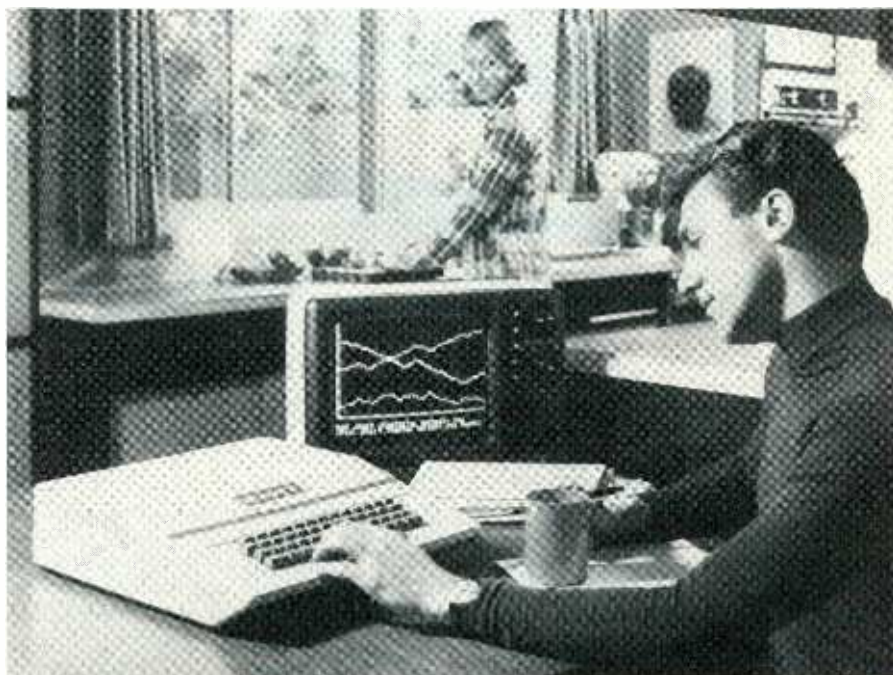

Figure 1: simplified diagram of a keyboard



Apple II is a complete home computer center for the hobbyist. Its capabilities go beyond calculators and video games and it uses the family color television set for startling graphic displays. You talk with the computer via its keyboard.

The right two columns, starting with 110 and 111, contain mostly the lower case letters a through z, as well as a few special punctuation marks. Most keyboards generate only the upper case letters and cannot generate any of the codes in these two columns; special upper/lower case keyboards are required if the codes for the lower case letters are needed, but sometimes these keyboards are difficult to use with some computer systems.

The left two columns do not represent letters or numbers at all, but instead are used for *control* characters which are mostly used for special high-speed communications between computers. The only two exceptions here are the code 0001010 for LF or *line feed*, and the code 0001101 for CR or *carriage return*. These two codes are virtually essential for every computer system and a key-

board which does not have them can be quite difficult to use.

Actually, the only difference between these left two columns and the fifth and sixth columns is that bit b7 is a 0 instead of a 1. Many keyboards have a *control* or CTRL key which reverses bit b7 whenever it is pushed. Hence pushing the CTRL at the same time as an M, for instance, would generate the code 0001101 instead of the normal M code of 1001101; this is the same as the carriage return. This means that such a keyboard can generate any of the control codes by a simple combination of two keys. This is useful for those codes which are seldom used, but using CTRL M at the end of each line would be very inconvenient; separate CR and LF keys are still almost a necessity to avoid errors.

Although the basic ASCII code is a 7-bit code, there are 6 and 8-bit varia-



Heathkit's model H9 cathode-ray tube (CRT) terminal includes a keyboard so you can send commands and requests for action into the computer and a video-display tube so it can send out its answers.

tions which are often used. As mentioned earlier, the center four columns of Table 1 are the most important; if you study the codes carefully, you will see that bits b7 and b6 are opposite for all of these columns. Hence, if we want to store the codes in a computer memory and need to save space, it is possible to discard bit b7 and only save b6; if we ever need b7 we need only invert b6. The resulting 6-bit code is often called *stripped ASCII*.

In many applications a bit b8 is added to the left of b7. This bit is used for error

checking and is called the *parity* bit. Depending on the remaining seven bits, the parity bit may be either a 0 or 1. Each different code has a different parity bit, and if a character is sent from one place to another and an error is made in one of the bits, the receiving system may detect an error if the parity bit is different from what it should be. The result is then an 8-bit code. (In some systems the parity bit may not be used, or it may be generated by the keyboard but not checked by the rest of the system. In that case it might always be 0 or 1, since it is not used.) The parity bit is especially useful when digital data must travel over great distances or when it is recorded on tape or disk and likely to contain errors.

A Simple Keyboard

The function of every key on the keyboard is to generate the correct ASCII code each time it is pressed. Figure 1 shows the basic principle used in some simple keyboards to provide the correct digital output, to keep the diagram simple, only the A and M keys are shown. In reality, the diagram might have as many as 50 or 60 keys.

As shown, the ASCII output is on the right side on seven wires. Each of the keys is connected to a unique combination of wires, so that when the key is pressed a positive voltage, usually +5 volts, is connected to generate the correct code. In the case of the A key, when the key is pressed +5 volts is connected

to the b7 and b1 outputs, while no connection is made to the other outputs. This results in an output of 1000001, assuming that +5 volts means a binary 1 and no voltage means a binary 0. In the same way, pressing the M key generates a code of 1001110. Diodes must be added as shown to isolate the keys from each other; if the diodes were missing sneak current paths would exist so that whenever any key was pressed, *all* the outputs would go to +5 volts.

On the average, each key requires about 4 diodes. Thus a 50-key keyboard needs about 200 diodes. This number of diodes is difficult to clearly show on a diagram, and it also creates problems in physical placement and connection within the keyboard itself. As a result, an arrangement called a *diode matrix* is often used, both on diagrams and in the actual physical assembly itself. Figure 2 shows the revised diagram in the form of a diode matrix.

Each of the key switches is connected to a vertical wire, while each of the outputs is connected to a horizontal wire. In an actual keyboard, a double-sided printed circuit board is often used, with the vertical wires on one side of the board and the horizontal wires on the other side. There is no connection between the two sets of wires, except that the diodes are installed at the crossovers between the key switch wires and those outputs which are supposed to be a 1 for the ASCII code. Keyboards using this principle are often available as surplus, and are popular with computer hobbyists since it is simple to move diodes

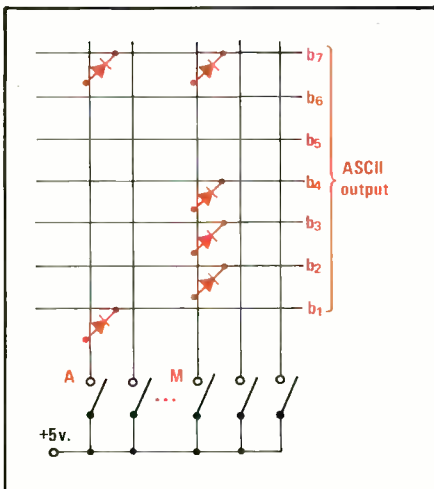

Figure 2: diode matrix from a keyboard

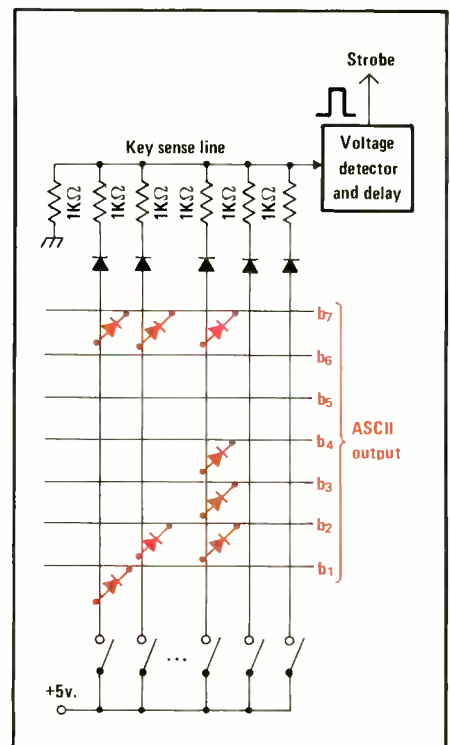

Figure 3: rollover and strobe circuit added to diode matrix

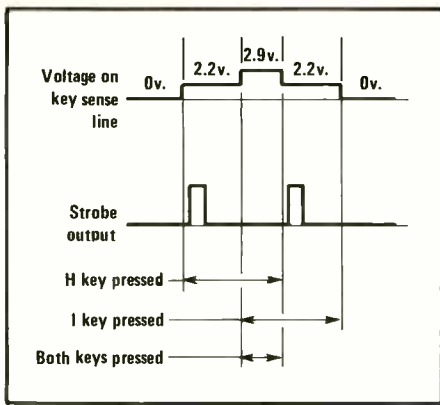

Figure 4: operation of the rollover and strobe circuit

from place to place to adapt the keyboard to whatever code they desire.

Although Figure 2 could be used to wire a keyboard with simple switches and inexpensive diodes, it is far from complete. We must add more circuitry to make it useful. First, we must make provision for a SHIFT key which would select the second symbol present on some of the keytops. For instance, the 1 key also has the ! symbol; when the SHIFT key is pressed it should generate the ! code of 0100001, while if the SHIFT key is not pressed it should generate the 1 code of 0110001. Clearly, the SHIFT key must change bit b5, in this case from a 1 to a 0. But other times, it must change b5 from 0 to a 1, since the N key must generate the 'up-arrow' symbol when SHIFT is pressed. So the SHIFT key must invert the b5 bit whenever it is pressed.

Next, we must add a CTRL key which will change bit b7. This circuitry could be similar to that used with the SHIFT key. If the keyboard is to generate both upper case and lower case letters, then still other changes are needed.

Still another circuit which should be added is one to generate a *strobe* or *key pressed* signal. This is a signal which informs the computer or terminal to which the keyboard is connected that a key is pressed. This is needed since otherwise the system would have no way of knowing whether a key is being pressed or not, except by continuously monitoring the ASCII code output to see whether it has changed or not. The strobe is usually a fast positive pulse (a voltage which goes positive and quickly returns to zero).

The strobe is closely related to another desirable function, that of *debouncing*. Since the key switches used in the keyboard are mechanical and involve sliding metal contacts, they do not open and close instantaneously, especially when the typist presses and releases the keys slowly. As the switches open and close, they slide or bounce briefly, so that the connection is intermittent both at the beginning of the character and at the end. Computers are generally so fast,

that during the short time that the contacts seem to open-close-open-close rapidly, it appears as though the key has been pressed several times rather than just once. As a result, a word may appear like tthhhiissss to the computer. The strobe circuit is designed so that it will wait a few thousandths of a second to give the switch contact time to settle before generating the strobe pulse.

Since the strobe circuitry has to detect the closing of a switch (*any* switch) and provide a delay, it is often improved so that it will respond only when *one* switch is closed, not more than one. This provides a function called *2-key rollover* which is extremely important to fast typists.

A fast typist often presses one key before fully releasing the previous key. For instance, in typing the word HI he might press the I key before releasing the H key. On an ordinary typewriter this

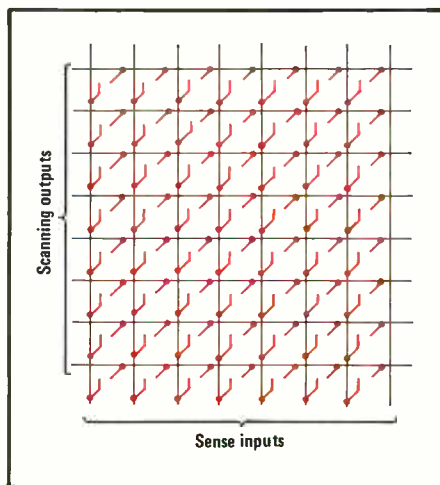

Figure 5: a switch matrix

creates no problems as long as the two keys are not pressed at almost the same time, but with a computer keyboard the wrong code might be generated when both keys are down. It is the function of the strobe output to separate the two codes of the two keys and provide no

strobe pulse when both are down. Figure 3 shows how the strobe circuits detect how many keys are down.

Each key connects, through a diode and resistor, to a key sense line, which is connected to ground through another resistor. When no key is pressed, the voltage on this line is near zero volts. When one key is pressed, the 5 volts on the vertical wire divides across the diode and the 1K resistors so that the voltage on the key sense line goes to about 2.2 volts. But if more than one key is pressed, the voltage on this line goes to 2.9 volts or even higher. A voltage detector and delay circuit is carefully adjusted so that it operates only when the voltage on this line is close to 2.2 volts, indicating that one and only one key is pressed.

Figure 4 shows what happens when the word HI is typed with some overlap of the two keys. Initially, the voltage on the key sense line is 0 volts. When the H key goes down this voltage rises to 2.2 volts and a short time later, after the debouncing interval, the strobe circuit puts out a short pulse. Then, at the time the I key is also pressed, the voltage on the key sense line goes up to about 2.9 volts and remains there until the H key is released. As soon as the strobe circuit sees the voltage back at 2.2 volts, it waits for a short time and puts out another strobe pulse.

The diode matrix keyboard, though simple to design and understand, has some disadvantages when it comes to mass production. Its use of several hundred diodes as well as a variety of other components for rollover and strobing makes it more expensive to manufacture than if it used a more limited number of integrated circuits. The ultimate goal would be to build the keyboard with just several dozen switches and one integrated circuit. This requires a completely different approach.

The typical keyboard has close to 50 or 60 keys. If each of these had to be connected to an integrated circuit, this would require some rather large inte-



Unusual, attractive styling of the computer keyboard, foreground, and video-display terminal are by The Digital Group.

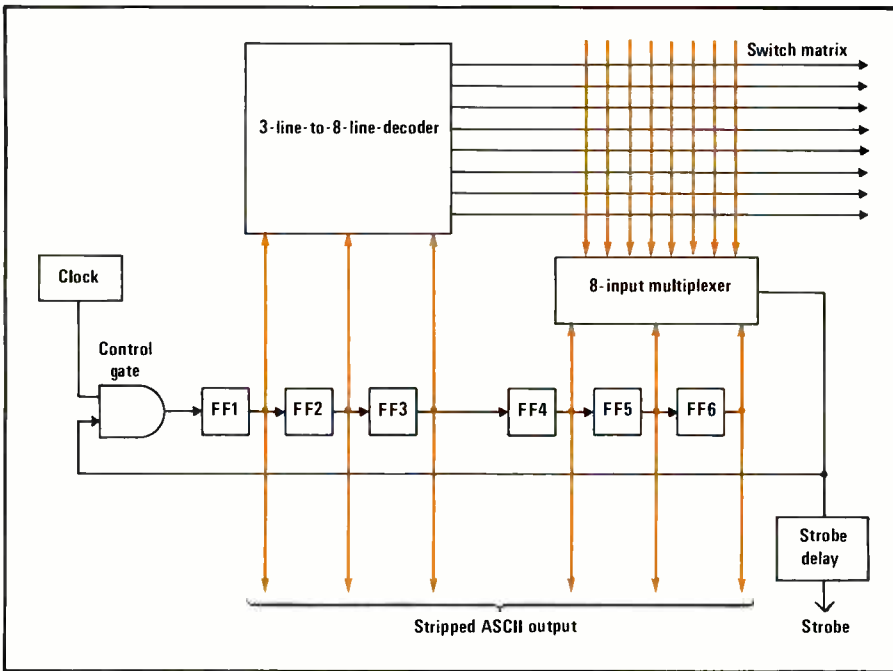

Figure 6: actual circuitry of a simple scanning keyboard, without SHIFT or CTRL keys

grated circuit packages with many pins. If the number of connections is to be reduced, a way has to be found so that all the key switches share as few wires as possible. Figure 5 shows how it is possible to connect as many as 64 switches with just 16 wires, by simply building a *switch matrix*. The 16 wires are divided into 8 vertical and 8 horizontal wires, with a key switch at each intersection. Since each wire is shared by eight switches, a smaller number of wires is needed. (This particular matrix is a square one of 8 by 8 wires, but it could just as well be 8 by 9, or even 8 by 11 if more switches were needed.)

Although the switch wiring is simple, the circuitry to go with it must be somewhat more complex so it can recognize which switch is closed and generate the correct ASCII code simply by monitoring which vertical wire connects to which horizontal wire. If several key switches are closed at the same time, this circuitry must also be able to find which closed first and which opened last so it can provide for rollover. This is done by *scanning*, the same principle which is also used to monitor the keyboards in handheld calculators.

In short, the scanning circuits put short pulses on the horizontal wires, one after another, in a continuous sequence. At the same time, the vertical wires are connected to a series of sense inputs which continuously look for these same pulses to appear on them. Whenever a pulse is received on the sense inputs, the circuitry takes a quick look to see which of the scanning outputs has a pulse on it at the same instant of time, and determines which switch is closed from that information.

Figure 6 shows how such a scanning keyboard can be wired. A clock oscillator

generates a continuous series of high frequency pulses which pass through a control gate to a series of six *flip-flops* FF1 through FF6. The control gate acts essentially as an electronic switch which normally lets the clock pulses pass through to the flip-flops.

The six flip-flops are connected in a *counter* circuit which counts the pulses coming from the clock and generates six outputs; these outputs are binary numbers which indicate how many pulses have been counted:

000000
000001
000010
000011
000100
etc.

Each time a pulse arrives from the clock, the binary output from the six counter flip-flops changes. After 64 pulses, the

counter output reaches the output of 111111, and then returns back to 000000. Hence, the six flip-flops are continuously cycling from 000000 up to the maximum count, and then back again to 000000. Since the ASCII output is taken directly from the counter outputs, it keeps continuously changing. However, since no key is pressed the strobe output is absent, and so the external circuitry should not even be monitoring the keyboard output. Thus the constantly varying codes should not matter.

As all this is happening, the outputs of the flip-flops are also going to a decoder integrated circuit and a multiplexer integrated circuit. The decoder receives the signals from the first three flip-flops, and sends a pulse to one of the horizontal key matrix wires at a time; which one depends on the output from the three flip-flops at that instant. In other words, it continuously scans the eight horizontal wires, sending a pulse to one at a time. These scanning pulses occur very rapidly.

At the same time, the outputs from the last three flip-flops go to a multiplexer. This circuit can be compared to an eight-position switch which has eight inputs and one output. At any given time, one and only one of the inputs is connected to the output; which output depends on the state of the three flip-flops connected to it.

If no key switch is pressed, then the multiplexer will never receive any inputs, and hence will provide no output. Then nothing will happen.

But when a key switch is closed, then it is possible for the multiplexer to detect a signal from the decoder and provide an output . . . but only if all the flip-flops are at the right state so that the decoder is sending a pulse to the closed switch at the exact instant that the multiplexer is looking for it on the right vertical line. Since the flip-flops in the counter are continuously cycling through all possible

Please turn to page 89



Keyboard is on the front of the Attache, a complete desk-top computer by Pertec Computer

4 + 1 = 6

Wait a minute! $4 + 1 = 5$, not 6. What gives with you guys anyway?

by Fred Blechman



One of the really nice features of electronic digital clocks, and one that sets them apart from the mechanical versions, is their seconds readout. Not only does the *seconds* display give you a more accurate time reading, but also lets you use your clock as a timer.

Heathkit currently is offering the GC-1107 electronic digital clock kit for \$27. The completed clock has half-inch high fluorescent readouts and your choice of 12 or 24 hour format. It even has a built-in snooze alarm. But, it doesn't have a seconds display, a serious disadvantage.

Well, if you like Heathkit products, and find the price and features of GC-1107 appealing, don't let the lack of a seconds display stop you. For about \$2 in parts you can add your own seconds display to the Heath clock, or any four-digit clock built around the National MM5316 or Fairchild 3817 clock IC.

Build it first

If you don't already have an assembled clock, construct the kit in exact accordance with the Heath instruction manual. Don't attempt the modification until you have your clock working perfectly. Bear in mind that making this modification will *void* the Heathkit warranty. So, if something needs fixin', better get it done before you make any changes.

Although the clock IC has a Heathkit part number, it seems functionally identical to the National and Fairchild ICs. Both of these circuits let you set the seconds display output. Heath has simply left this output unused in order to

keep the price of the clock down to its present level.

The clock IC, as used in the Heath circuit, puts out a running hours and minutes display. However, if pin 32 of the IC is connected to the positive-voltage switching bus, the four-digit output shifts to a three-digit output giving the unit minute and seconds count.

For example, if the clock IC time was 11 hours, 23 minutes and 17 seconds, the display would show 11:23. Connecting pin 32 to the positive bus would result in a display of 3:17. One second later, the display would change to 3:18 and so on.

If pin 32 of the IC were connected to the bus through a push-to-make momentary contact switch, let's call it S6, you could get a seconds display simply by pushing a button. Another important benefit to adding the seconds readout is that you can synchronize your clock to any time standard, such as WWV or CHU radio, or telephone company time signals.

Hold that second

Synchronizing your clock to a time standard is very simple. All you do is push the seconds display button *and*, at the same time, close the *slow-set* switch built into the clock. This will freeze the display. So, just set the time a little ahead, say to the next even minute, freeze the count, and wait until the time standard signal agrees with the readout you preset. Then release the *slow-set* switch and you're synchronized.

You can convert your clock into an elapsed timer by closing both the *slow-set* and the *fast-set* switches on the clock,

and pushing the seconds display button. This will reset the clock to 00:00:00 if wired for 24 hour operation, or 12:00:00 am if wired for 12 hour operation.

To begin timing, just release the

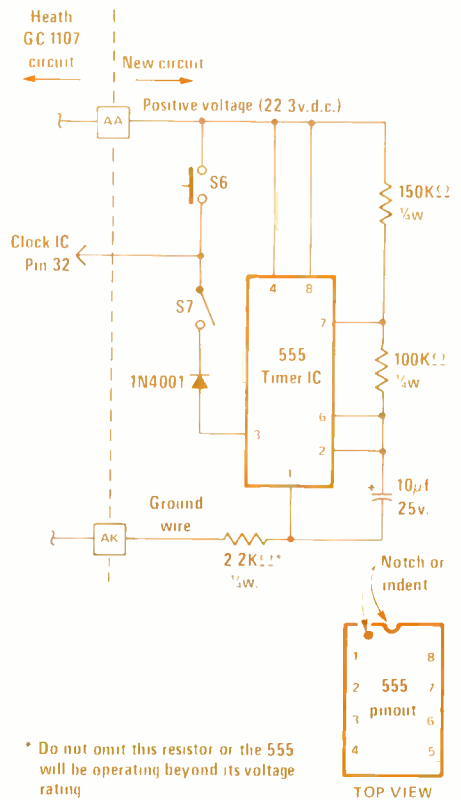

The 555 timer circuit can be easily mounted to the switches on the back panel of the clock by the wire used to make the electrical connections.

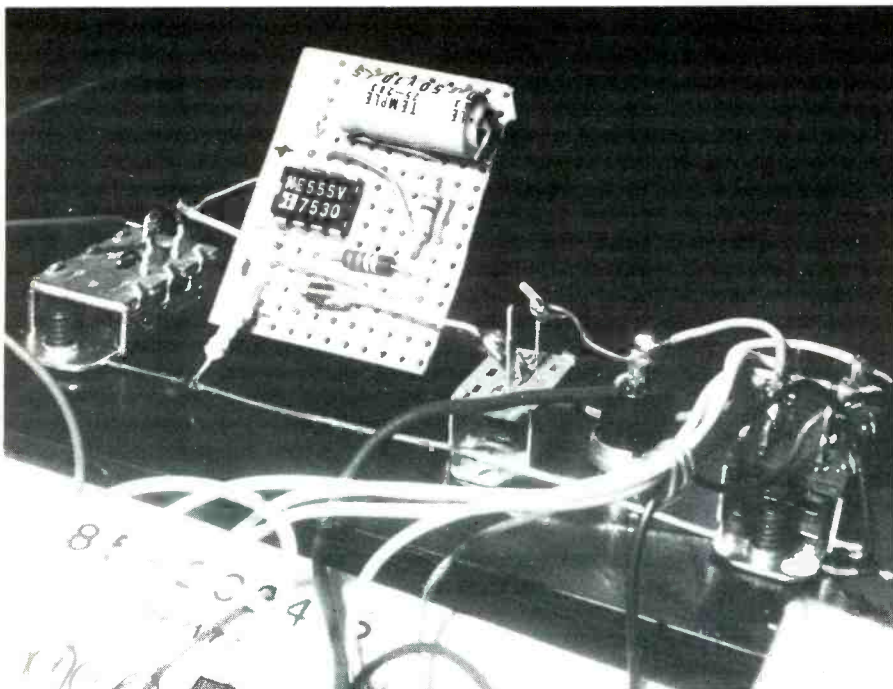

Adding this simple circuit to your Heath GC-1107 four-digit clock gives you a manually selected or automatically displayed seconds readout. Installation is very

easy—the circuit is connected across existing circuitry. No wires need be cut, no parts need be removed.

switches. If you're timing a short-duration event, keep the seconds display button pushed. The clock will begin timing in seconds from 0:00.

Adding the seconds display switch, S6, is very easy. You can use any switch you happen to have in your junkbox. Although the push-to-make switch mentioned is the best choice, you can even use a toggle switch if you'd like. One terminal of the switch should be connected to pad AA on the PC board, or to pin 1 of S1, which is connected to pad AA by a red wire. The other terminal of your switch should be connected to pin 32 of the clock IC socket, on the foil side of the printed circuit board.

If you'd rather not be bothered pushing a button to get a seconds readout, you can automate the process. All you need is a 555 timer IC, three resistors, a capacitor and a diode. The resulting circuit automatically connects pin 32 of clock IC to the positive-voltage switching bus for about three seconds, then disconnects it for another second.

With this modification installed, your clock will display hours and minutes for a second, then give the unit minute with a running seconds count for three seconds, then display the hours and minutes again for another second.

If you think this might be a bit confusing, you can install a slide or toggle switch, S7, in the line to pin 32 of the clock IC. Then, you'll have a switch-selectable choice of continuous hours and minutes display, or alternating hours-minutes and seconds display.

If you include both the seconds dis-

play pushbutton and the 555 IC modification, you can choose between normal clock operation, manual selection or automatic display of the seconds count.

The switches can be easily mounted on the plastic case provided by Heath to house the clock. The 555 circuit can be built on a small piece of perboard, held in place by the wire used to connect it to the switches.

It's bonus time

The clock IC used by Heath has another capability—it will count *down* second by second from 59 minutes to zero. This function is obtained by connecting pin 30 of the clock IC to a positive voltage. Although the countdown is by seconds, only the minutes are displayed and settable. The beginning time for the countdown is set by the *slow-set* and *fast-set* switches.

The countdown feature of the clock can be used to actuate an external circuit during the countdown period. The output signal for this is available at pin 27 of the clock IC. During countdown, pin 27 goes positive. At other times, it is at ground potential. During countdown, you can disable pin 27 by simply operating the snooze alarm switch.

As you can see, the Heath GC-1107 digital clock kit can be a good deal more than it seems to be at first glance. All it takes is a few dollars in parts and a few hours of your time. The result will be an electronic timing device with lots of versatility, yet retaining a pleasing appearance.

\$1,000 Reward Offered by Mad Train Collector

For the reader who can come up with the following old Lionel Electric train for my fast-growing collection:

Model No. 700E Scale Hudson (No. 5344 appears on the side of the cab). If any reader can get this set for me together with either the scale freight cars No. 714-717 or the passenger cars No. 792, 793, and 794, I will gladly pay up to \$1,000 for the set. Actual price will be based on condition.

There are many other old pre-WW II Lionel engines and cars that I need, both in Standard Gauge and in "O" Gauge. Blue Comet sets, state cars, and Stephen Gerard cars are desirable Standard Gauge items. Hiawatha and others of the better passenger sets are worth lots of dollars to me in clean condition.

Old trains are not just my hobby. They're an obsession that I simply cannot overcome. So, if you've got old Lionels around, don't be bashful. Give me a call or drop me a note. To determine the value of your trains I'll need the numbers that appear on all the cars, the colors, and the approximate condition. Remember, those old trains that are gathering dust in the attic could be bringing joy and pleasure to a mad collector.

Dick Cowan, Mad Train Collector
Publisher, Modern Electronics
14 Vanderventer Avenue
Port Washington, NY 11050
Phone: 516/883-6200

Whizbox

This nifty one-evening project rewards you with the continental two-tone blee-bloop siren now being used by local emergency vehicles.

by David Heiserman

If you've had it with the nerve-racking screech of a typical electronic siren or wailer, but still want an effective alarm signal, try our ME Whizbox.

It produces the classic up-down continental-style blee-bloop siren sound now being used on local emergency vehicles. Using its built-in volume and tone controls, you can set the Whizbox to produce an alarm tailored for your specific installation.

Construction and parts layout are straightforward. If you have the room, you can even build it into your existing alarm detection unit. The Whizbox is powered by a four-cell battery pack, which lets you use it at remote locations.

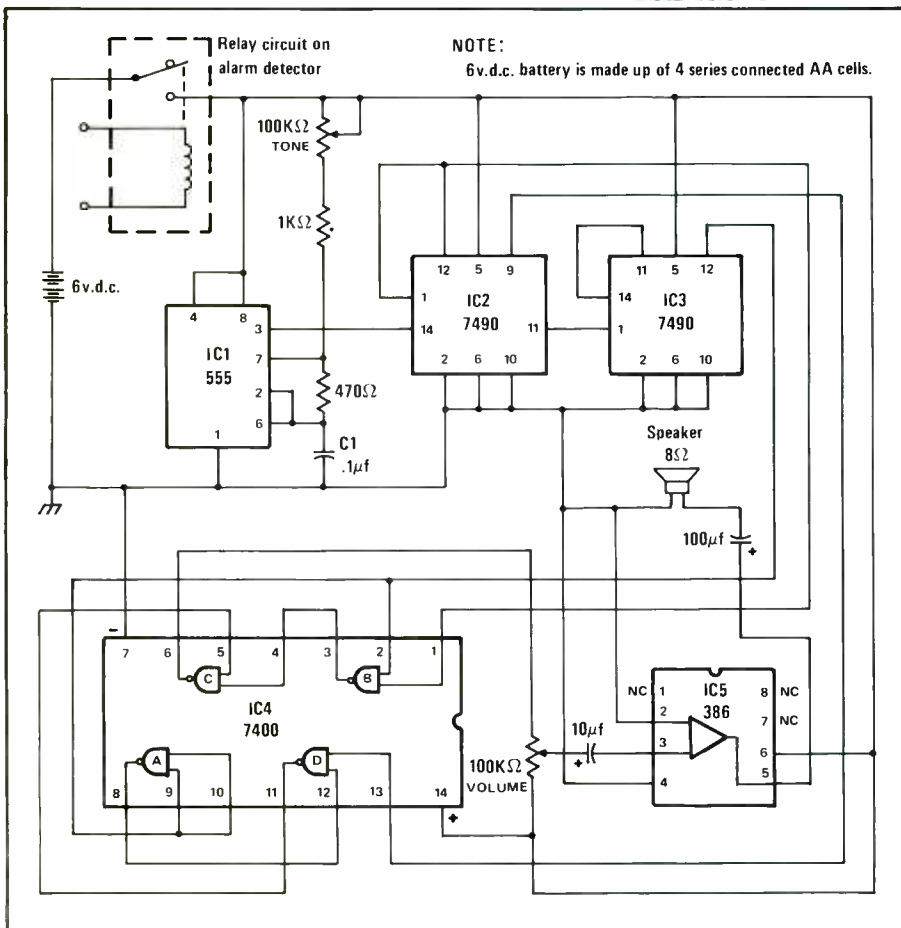
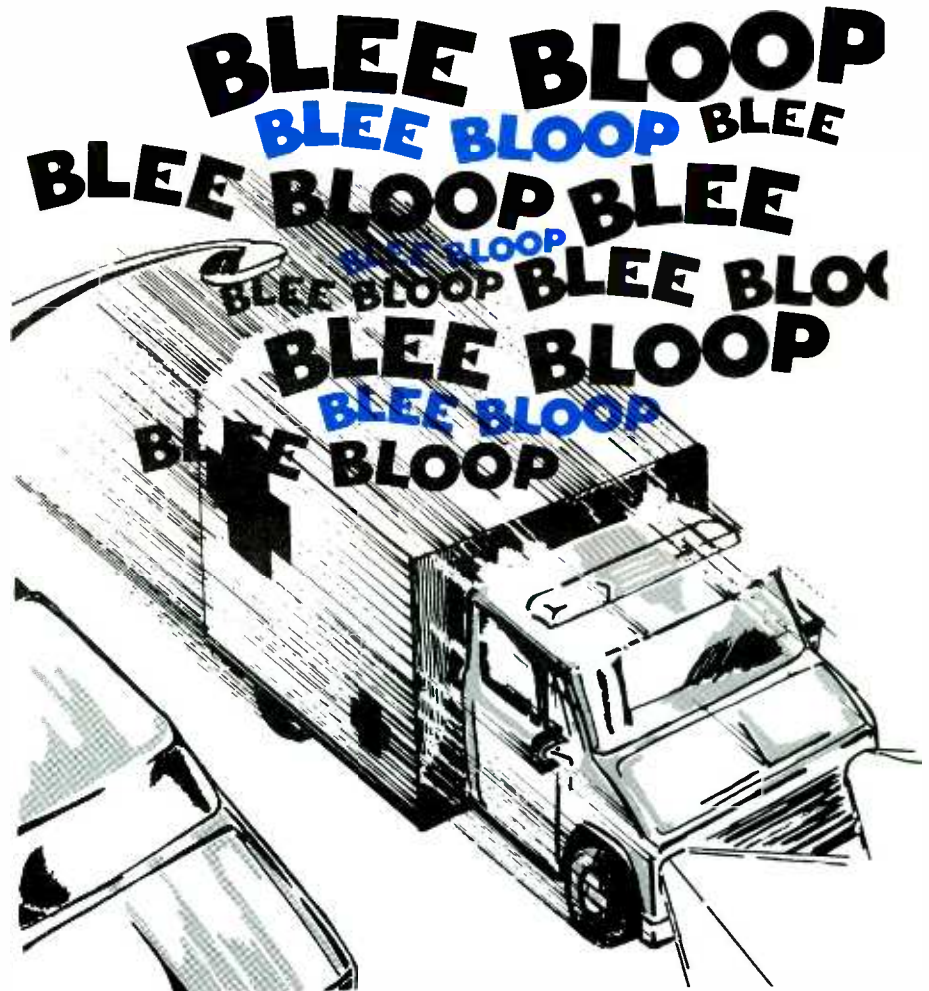

If you'd prefer, you can power it from the alarm detection power supply. However, because the circuit uses TTL integrated circuits, you must meet the exact five-volt TTL voltage rating. If you don't, the ICs will self-destruct.

As shown in the schematic diagram, power is applied to the Whizbox through the relay contacts of the alarm detection unit. You'll find two interesting detection circuits on page 50 of the February, 1978 issue of Modern Electronics. Although those circuits were designed to be powered with a nine-volt battery, they will work well on six volts, letting you power them from the same supply.

The Whizbox also can be used as a portable warning signal. Built into a small box and powered through a push-to-make momentary switch, it makes an excellent horn for your bicycle. It even can be blended into music to create an interesting two-tone *drone* sound.

If you're into designing printed circuits, you should find the Whizbox relatively easy to layout. The circuit is simple enough to be built on perfboard, though care will be needed not to short out the IC pins.

The built-in tone control varies both the pitch and the rate. The pitch increases as the rate increases. A built-in volume control lets you set the sound intensity to suit your application.

gear parts tests books

The editors roundup exciting new products you should know about.

Benton Harbor bird

Skyhawk, otherwise known around Benton Harbor, MI, as RP-1172, is the latest in a long line of radio-control products from Heath Co. The Cessna comes with three, five or eight-channel radio-control system. It has a 48-inch wingspan and holds 4-6 ounces of fuel for its 0.25 cubic inch engine. For more info, circle number 155 on the reader-service card.

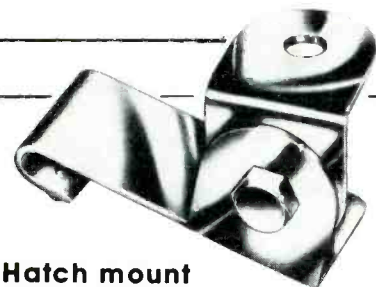

Hatch mount

Got a Pacer, Chevette or Beetle? Then you've had problems finding a workable antenna mount for your CB antenna. Now there's a solution. Antenna Incorporated has a miniature version of its bumper mount which will attach atop your hatch-back with two set screws. The model 18313 mount will swivel 180 degrees so you can align the antenna into a vertical position. It swings the antenna down when the hatch is opened. On Beetles, the mount attaches to the top of the engine hood. By the way, Antenna Inc. also has a special mount for Corvette T-tops. It's the model 18312. For more information, please circle number 153 on our reader-service card.



Periscope? Sonar? Radar?

What is it? It's your ac/dc *Sidekick*. The four-inch black and white portable tv weighs only six pounds for lugging to the beach, has an anti-glare hood for the tube, and built-in varactor tuner. Run it off your boat or car battery or nine D cells. Or from your ac house power. The loudspeaker is almost three inches big and the antenna telescopes. It's metallic grey and black and approximately 7x11x10 inches. For more info, please circle number 152 on our reader-service card.



Soft dome

A soft-dome tweeter is just what you need to perk up your car stereo system. And Kriket would like to see you using a *Domaxial* speaker. It's model 8974, at \$109 per pair, requiring no power boost to give great sound. For more information, please circle number 154 on our reader-service card.

Light pipes

We're rapidly approaching a time when electricity passing through wires will be very much old hat. Light traveling through fiber-optic pipes will be all the rage. Here's how one fiber optics data link system works. The C86003E data link, by RCA, is a 20 megabit/second digital data transmission system, designed to handle signals between computers, digital telephone calls, and the like. The transmitter starts with a light-emitting diode (LED). For more info, circle number 157 on our reader-service card.

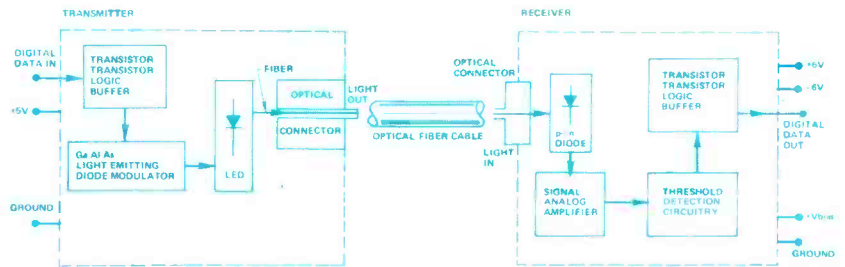

Two antennas are better than one

Here's the innards of a two band radar detector. Powered by 12 volts dc from your car battery, the Bearfinder Two + Two has separate antennas: one for X band and one for K band. It's good for old-style police radar as well as the new moving radar and handheld gun types. It's \$149. For more, circle number 156 on our reader service card.



gear parts tests books

The editors roundup exciting new products you should know about.



Picture album

So you went out and bought one of those new videotape recorders. You've started collecting your own personal library of videotapes. How are you storing them? One way would be in Lashabee Marketing's \$39 walnut-veneer cabinet which holds 24 Beta-format tapes. For more information, please circle number 159 on our reader service card.



Got a large desk?

Now that's a CB station! Made to look like a more-sophisticated amateur radio setup, Stener has an entire line of accessories to go along with its PRO-40 CB rig. Included are matching loudspeakers, an adaptor, operator console, monitor oscilloscope, meter console and even a computer interface modem.

And there's a ham adaptor which will let you listen in on amateur radio shortwave bands so you can copy International Morse code for practice and hear hams chatting. It would be good incentive to step up to ham radio. For more information, circle number 158 on our reader service card.



Batteries?

Lithium batteries. The name strikes fear into the hearts of Klingons everywhere. No longer will unused batteries die on the shelf after a year. A *lithium* battery has a shelf life of five years. Yep, five years. These new coin-size cells are *lithium* batteries by Panasonic, designed for men's digital watches and calculators. And even for women's calculators. They are 0.098 inches thick and 0.785 inches in diameter. They give three volts at a 90 milliamperes per hour rate. And they're hermetically sealed for shelf life beyond five years. Prices will be about the same as silver oxide watch batteries. For more information, circle number 163 on the reader-service card.



Luggage Dept.

What kind of electronic gear do you want to carry around safely? Sound systems? Your kilowatt ham station? Your computer? Cases Incorporated of California has just the rack-mount portable case for your needs. It holds standard 19-inch

wide panels of electronic equipment, protecting your precious gear from shock, vibration, inclement weather and other abuse. For more information, please circle number 160 on our reader-service card.



Purrr!

Gad! The trucks are crunching potholes into the streets outside my window. The guy upstairs has his radio on full blast, trying to drown out the tv in the next apartment. The noise is driving me nuts. Or, it was until Edmund Scientific came out with a *sound conditioner*. Like air conditioning, it blurs the total sound you hear, softening it and making it bearable. Now I can feel better and get more work done. It's good for light sleepers, daytime sleepers and travelers. The Professional Sound Conditioner electronically simulates the soothing sounds of ocean surf, falling rain, a rushing waterfall. At \$129, it's great! For more info, circle number 162 on our reader-service card.

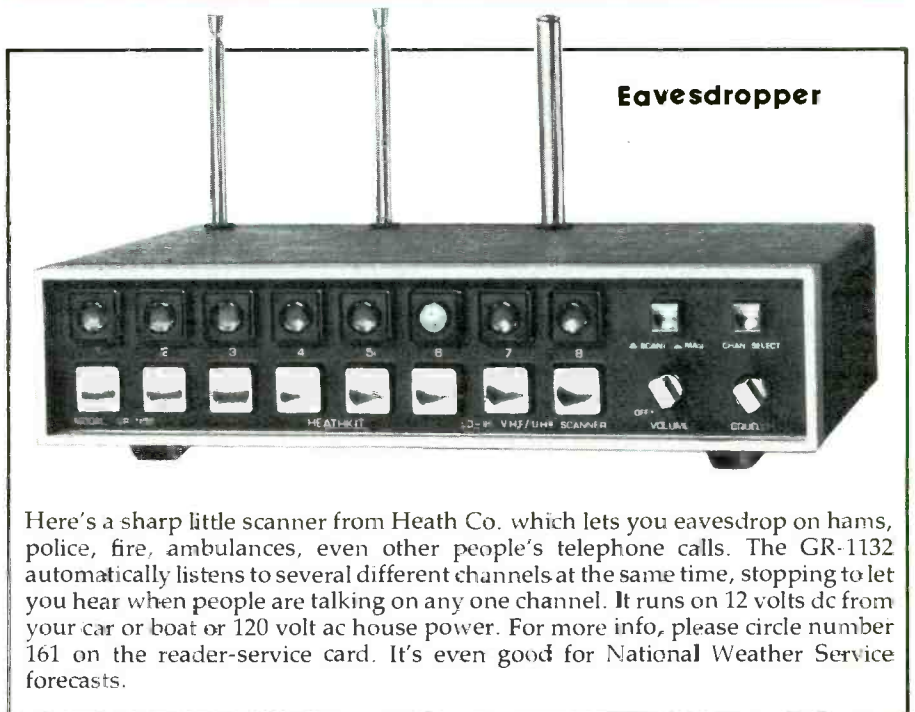

Eavesdropper

Here's a sharp little scanner from Heath Co. which lets you eavesdrop on hams, police, fire, ambulances, even other people's telephone calls. The GR-1132 automatically listens to several different channels at the same time, stopping to let you hear when people are talking on any one channel. It runs on 12 volts dc from your car or boat or 120 volt ac house power. For more info, please circle number 161 on the reader-service card. It's even good for National Weather Service forecasts.

gear parts tests books

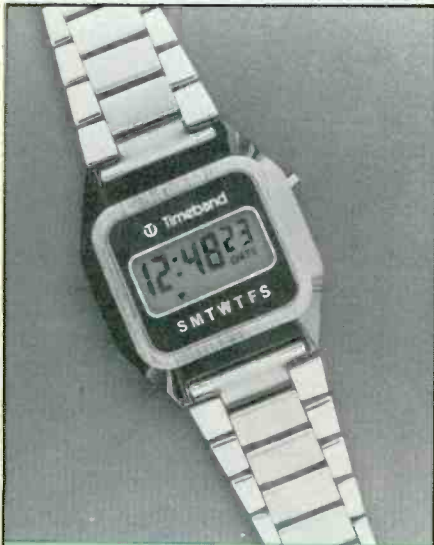

Battery saver

Show me the man who doesn't love a digital watch...and I'll show you an anachronism. Even with most watches coming through these days displaying LCDs (liquid-crystal display) rather than LED (light-emitting diodes), we still have a warm spot in our hearts for digital readout. Fairchild Camera and Instrument Corp.'s 1978 line includes LCDs with tritium backlighting. The surface behind the LCDs is treated so it glows in the dark. The LCD numbers show up at night as dark shadows against that glowing background. Reads well and requires no batteries to light it up. Some of Fairchild's *Timeband* models have six digits, adding seconds to the usual hours and minutes readout. They also tell the day of the week in actual letters as well as the usual date and month readout. Men's LCDs range from \$27-\$49 and LEDs from \$22-\$29 suggested retail. Ladies' LCDs from \$29-\$49 and LEDs from \$25-\$39. For more information, please circle number 165 on our reader-service card in this issue of *Modern Electronics* magazine.



Smoke signal programmer

Digital memories. The things computers are made of. There are RAMs, ROMs, PROMs, and even EPROMs. RAM stands for random access memory. ROM for read-only memory. PROM means programmable read-only memory. ROMs are programmed by the manufacturer while *you* can program PROMs. EPROM stands for erasable programmable read-only memory. Meaning you can erase whatever it was you programmed into the PROM. So, how do you go about programming an EPROM? You use a Black Box such as POP-1 by Smoke Signal Broadcasting. The POP-1 is a \$149 2708 EPROM programmer with software on an audio cassette. It'll zap your stuff into most 2708s in about 15 seconds. A power supply is built in. For more info, circle number 164 on our reader-service card.



Home computer

Z-80 power, forever! That's the cry of Z-80 users who now have a new, complete Mostek system to play with. The microcomputer system does use the Z-80 integrated-circuit microprocessor chip. It's called AID-80F and uses floppy-disc memory. For more information about how to get one for your very own home computer, please circle number 166 on our reader-service card. Do not fold, staple or mutilate the card.



Life saver

Past midnight. All's quiet. Room is dark, save for the faint glow from a pilot light on my wireless intercom. CRASH! Suddenly, the sound of a vase smashing downstairs rattled through the intercom speaker. Out of my bed. Downstairs. I nabbed the Bad Guy by the tail of his coat as he dived through the window. And you ask "What good is a wireless intercom?" For more info on the \$59 model GP-781 from GP Electronics Ltd., please circle number 169 on the reader service card.



Mo-Fi

Mo-Fi. That's the new name of the game in car stereo. Mo-Fi gear is better than just any old in-car tape deck. In fact, Mo-Fi means top-grade stereo like you would buy for your apartment. Separates. Tuner. Preamp. Amp. Deck. Setton International Ltd. is in the market with its BS-40 audio booster. It goes between sound source and speakers and gives 15 watts per channel boost. For more info, circle number 168 on our reader-service card.



New math

Ohio State University has huddled with Texas Instruments and come up with what Dr. Harry P. Allen, left, associate prof of math, says "may revolutionize the way calculus is taught." The National Science Foundation put up the money for a three-year test at OSU of how students get along using the TI line of programmable calculators. Now the students can get right down to solving practical problems. For more info about TI calculators, circle reader-service card number 167.



SWL's delight

Shortwave listening is one of the most exciting electronic hobbies. And it's undergoing a boom in interest. The numbers of SWLs

(persons listening to radio signals of all kinds for enjoyment) is growing by leaps and bounds. Yaesu Electronics, Trio-Kenwood Communica-

tions, R.L. Drake Co., Radio Shack and others have been selling excellent rigs in the \$150-\$350 range. With those radios, SWLs are able to tune in the four corners of Earth. Now, Standard Communications has entered the market with a super new synthesized receiver, model C6500. It's front panel holds controls for precise frequency selection, an am/usb/lsw switch so you can listen to international broadcasters on am, hams and other point-to-point communicators on single sideband and International Morse code. The rig covers 500 kHz to 30 MHz in four bands. For more info, please circle number 179 on the reader-service card.

From what we hear, the frequency counters by Davis Electronics are among the best on the market in the medium-price range. The CTR-2A covers the spectrum up to 1000 MHz. It has an eight-digit display, built-in vhf/uhf preamp and prescaler, high-stability time base, automatic input limiting and other good features. It's \$399 as a kit or \$549 wired and tested. Crystal ovens, carrying handles, bigger digits are extra-cost options. Good quality models with fewer features include a \$249 kit. For more information on the complete Davis line, please circle number 180 on our reader-service card.

On the counter



working on a CB set needing 12 volts dc. You could keep an assortment of batteries and single-voltage power supplies around. Or you could do it right—go first class—with one of the new wave of low-cost three-in-one bench power supplies. This is the \$195 model 6235A by Hewlett-Packard, designed for experimenters using breadboards and prototype boards with integrated circuits. It supplies dc voltage, adjustable over these ranges: 0-6 volts at 1 amp; 0-18 volts at 200 milliamps; and 0 to -18 volts at 200 milliamps. And you can get 0-36 volts dc at 200 mils by connecting across the +18 and -18 terminals. The five pound unit is approximately 4x6x7 inches. For more information, please circle number 178 on our reader-service card.

Voltages galore

When you're building gadgets in your basement workshop, you need many different voltages available.

One night you may work on a portable transistor radio which requires 9 volts dc. Another time you may be





Analog to digital converter

Attention, boaters! *No, no. Boaters are hats, you jerk. Oh, OK. Attention, boatmen! Yeh. That's better. Boatmen drive water vessels.* Having trouble pinpointing the station you want to hear on your radio direction finder (rdf)? Navigator's Mate is an add-on frequency display which hooks via two wires inside your radio. Mount the Mate on your bulkhead and it'll light up as a digital readout for your rdf or multiband shortwave set or ham gear or whatever. It's good from 100 kHz to 9.9 MHz, runs on D batteries and is \$139. *What if I want it to run on shore power for home use? Shore power and special frequencies are extra-cost options. (For more info, please circle number 171 on our reader-service card.)*

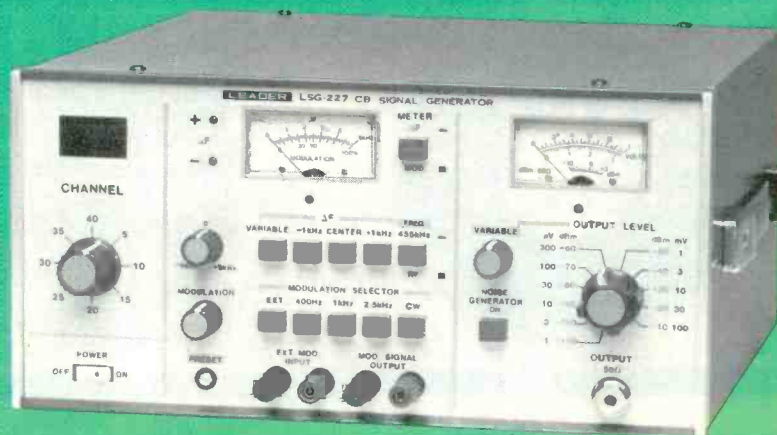

Super tester

Now you'll know for sure! Hook your CB radio to the LSG-227 signal generator by Leader Instruments Corp. and you'll be able to give it a thorough checkout. It is especially good for the sophisticated 40-channel single-sideband CB sets. For less than \$550, it puts out a modulated signal as well as plain old rf energy from 26.69-27.4 MHz. It weighs about 14 pounds and is approximately 12x12x6 inches. For more information, circle number 172 on the reader-service card.

Black is beautiful

Ah, so! Nakamichi. It just might be the most beautiful audio gear on the market today. Or at least the best sounding. We love it. Especially the model 430 fm tuner. Very compact. And it matches the super-sexy 410 preamp and 420 power amp. It's \$400 and for an extra \$40 they'll throw in a plug-in Dolby circuit board. Very nice! For sheets to make your mouth water, circle number 170 on our reader-service card.

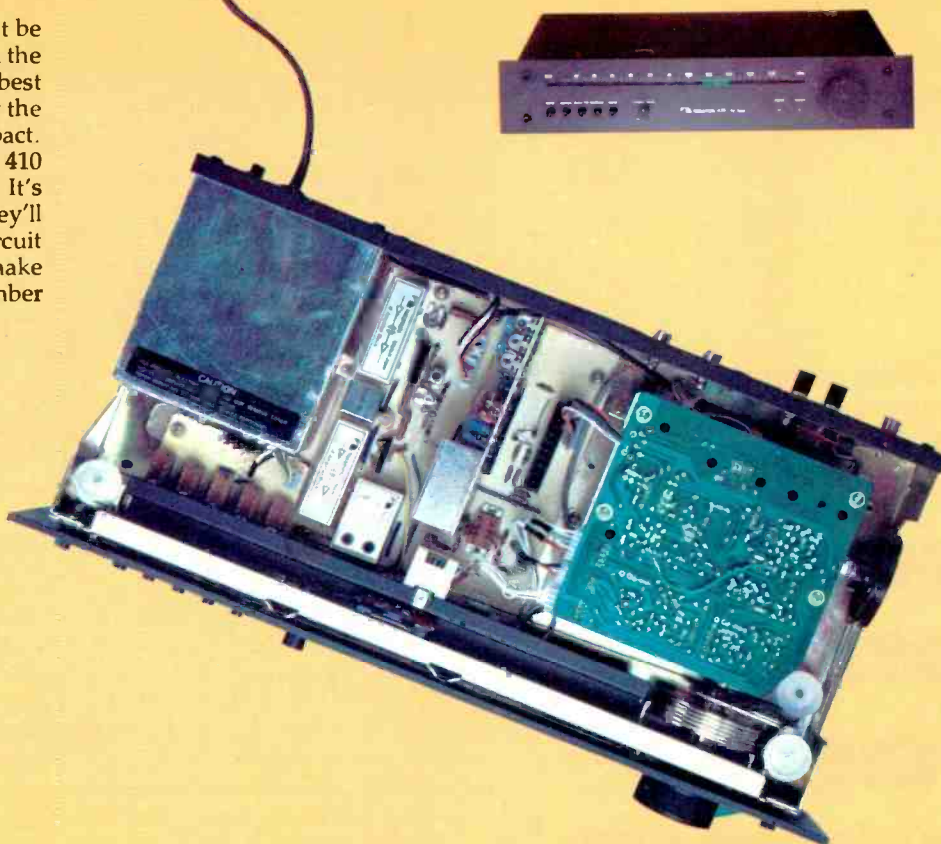

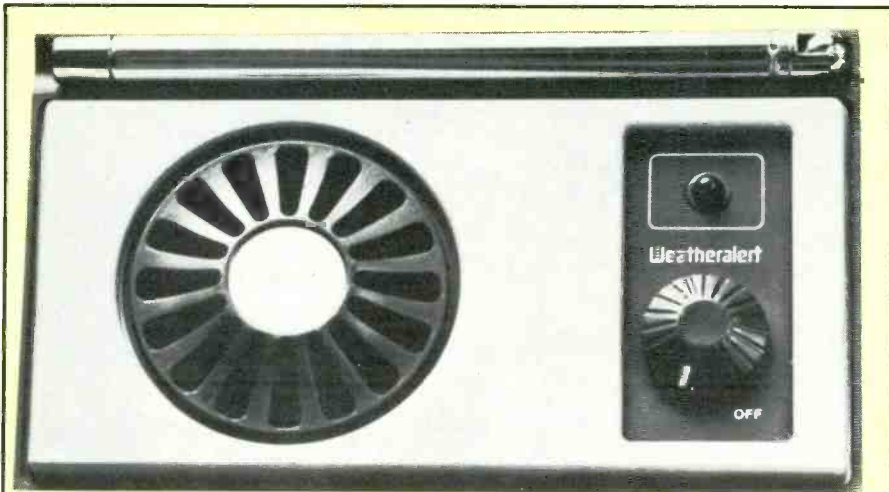

Weather alert

While we are on the subject of storm alarms (see *Lightning Detectors* elsewhere in this issue), here's the Stormalarm from Edmund Scientific Co. It'll give an audible alarm if the National Weather Service predicts weather is about to take a turn for the worse. You don't have to have the volume turned up on your local NWS station either. This alarm can be used silently. It is a sensitive weather radio covering the three NWS channels. Range from the NWS transmitter would be up to 40 miles. At \$46, it runs on battery or ac house power. For more information, please circle number 174 on our reader-service card.



Tom thumb's boat anchor

Mini-Meter is a new CB transmitter monitor in a cute package from Electronic Specialist. Your transmitter's field strength is displayed continuously on the tiny little meter. It really is ultra compact, works just as well for hams as for CBers, uses no batteries or external wires, and can be carried around in your pocket for an on-the-scene check of your mobile or portable gear. For \$27, it could get lost in the toe of your Christmas stocking six months from now! For more information, please circle number 175 on our reader-service card.

The editors roundup exciting new products you should know about.

**gear
parts
tests
books**

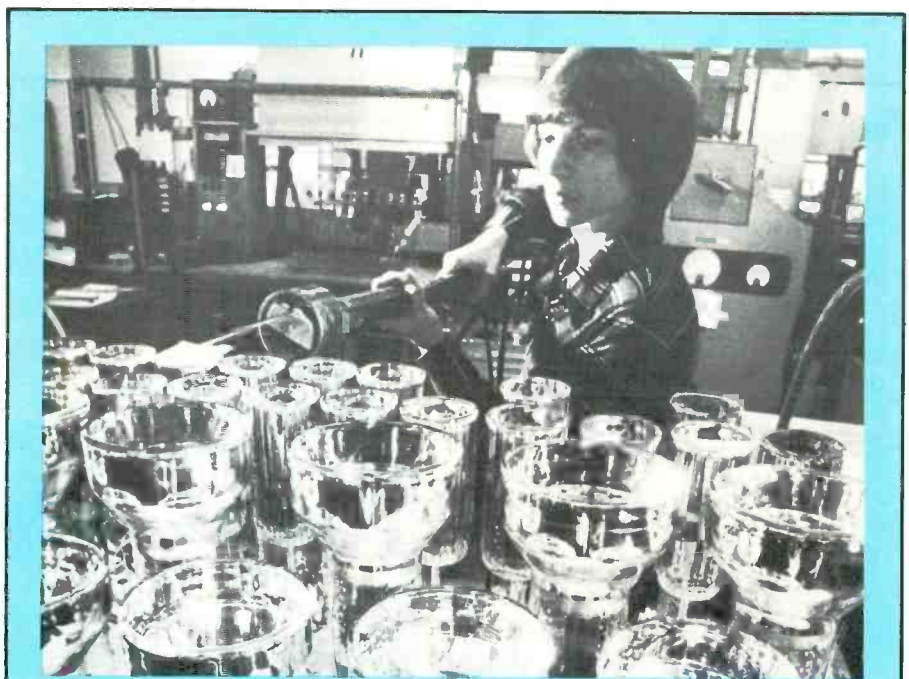

Photon blue

Remember that Russian satellite with a nuclear reactor onboard? The one that crashed last winter in Canada? Here's how the Canadians looked for the remains. Photomultiplier tubes by RCA pick up radiation as blue flashes of light. Lorna Herb at an RCA plant in Lancaster, PA, treats the glass surfaces of the tubes. The tubes will see light photons and convert them to electrical signals which can be measured. One tube is three inches in diameter and just over six inches long. The Cosmos 954 satellite carried 100 pounds of uranium 235 when it fell January 24. For more info on the RCA photomultipliers, circle number 173 on the reader-service card.

gear parts tests books

The editors roundup exciting new products you should know about.



Memory ham

As we're fond of saying, two-meter repeaters are about the best thing happening in ham radio since single sideband started years ago. Repeaters have given hams in the same town a chance to know each other. New friendships have been welded. Emergencies and other public services have been handled. And a ton of gear has come on the market—some of it very sexy. One of the best new pieces is the FT-227R by Yaesu

Electronics Corp. The 227 has a built-in *Memorizer* which recalls the frequency of a channel you have programmed into it at the flick of a switch. Now you can jump around, from repeater channel to repeater channel, without tuning up and down the dial. For less than \$300, the 227 gives ten watts transmitter power on any of 800 channels! For more info, please circle number 177 on our reader-service card.

Nice and small

How long have we awaited the arrival of the flat-screen television set? Here's the latest packaging by Sharp Electronics Corp. For more info, please circle number 176 on our reader-service card.



Antennas receive and transmit radio waves

Current flowing through a wire creates an electromagnetic field around it. When current flow varies in strength or changes direction, the field is affected. When the frequency of direction change is high, the magnetic field moves away from the wire and travels through space. These higher frequencies are **radio frequencies** or **rf**.

Passing rf current through a long wire causes the magnetic field to move through space and be radiated. This field then can pass through another long wire.

The wire through which rf current passes is a **transmitting antenna**. The magnetic field then passes through a **receiving antenna**. The magnetic field is a **radio wave**.

How to find wavelength

An antenna acts the same whether it is transmitting or receiving. To work most efficiently, however, its length must have a relationship to the frequency of the radio wave.

Radio waves travel at the speed of light - 300,000,000 meters per second. For example, if a radio wave had a frequency of 300,000,000 hertz, or cycles, then 300,000,000 cycles of wave would pass some point every second. Since they move at 300,000,000 meters each second, each cycle then is one meter in length. That's its **wavelength**.

To find wavelength:

divide frequency in hertz into 300,000,000

Example:

$$6 \text{ meters} = \frac{300,000,000}{50,000,000}$$

Inside an antenna

Antennas have a **resonant frequency** - a specific frequency where inductive reactance and capacitive reactance are equal

a. inductive reactance

- ability of wire to generate magnetism is **inductance**
- frequency of ac voltage flowing through wire affects current flow
- combined effect of frequency and inductance on current flow is **inductive reactance**
- measured in ohms
- the greater the inductive reactance in ohms, the lower the current flow

b. capacitive reactance

- ability of capacitors to store electrons is **capacitance**
- the smaller the capacitance, the smaller the current flow
- the factor in a capacitor that limits the current flow is **capacitive reactance**
- measured in ohms

Inductive reactances and capacitive reactances act together to limit current flow. When they are equal at the **resonant frequency**, the maximum amount of current flows. This circuit is then said to be **tuned**.

How long should an antenna be?

Every frequency has a wavelength. The antenna's length is cut in proportion to the resonant frequency's wavelength.

An antenna's resonant frequency is changed by changing the length of the wire.

A circuit's opposition to the flow of current is called its **impedance**. This is the net ohmage after inductive reactance and capacitive reactance are subtracted. Impedance is zero at the resonant frequency.

There are many kinds of antennas. None is perfect. The effectiveness of antennas is usually compared to the **half-wave dipole**.

Half-wave dipole antenna

- two lengths of wire connected at the center having an overall length of one-half wavelength
- its impedance is 50 ohms
- lengths of wire are connected at center by an insulator and insulators are at each end
- coaxial cable transmission line runs from center to transmitter - receiver

Finding length in feet of a half-wave dipole

$$\text{length in feet} = \frac{468}{f}$$

f = frequency at which you want to transmit

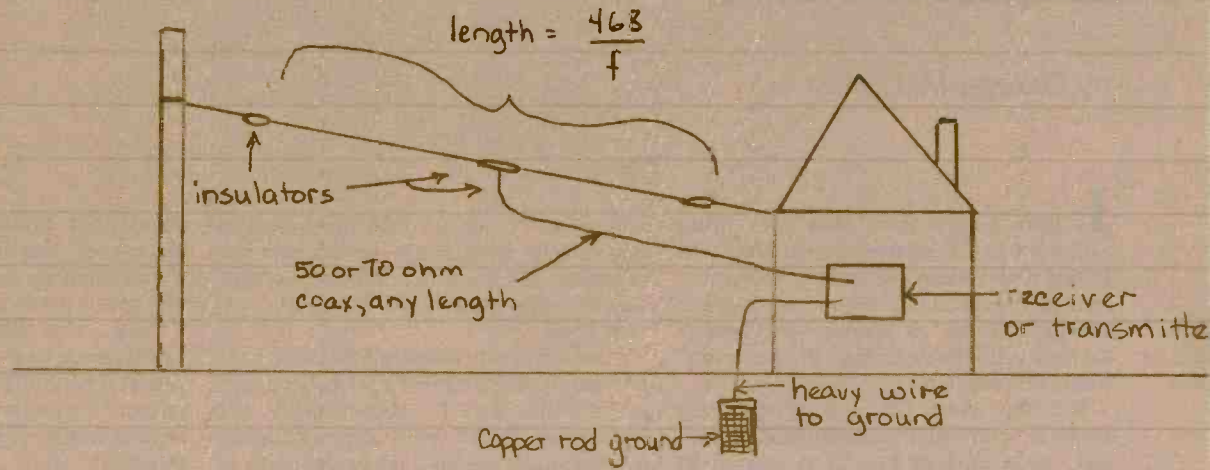

dipole antenna

Different types of antennas

Antennas should be:

- a. placed as high as possible
- b. tuned as close as possible to the resonant frequency
- c. placed away from power lines
- d. receiver and transmitter must be grounded

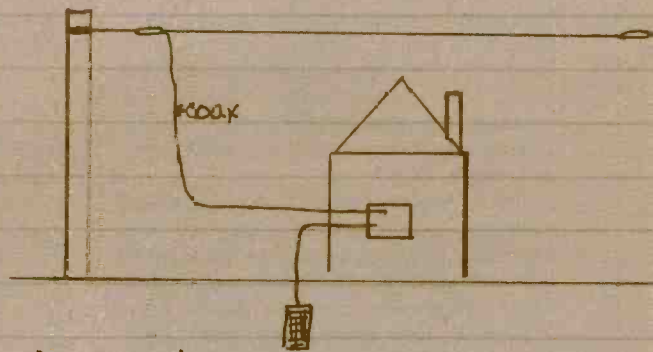

inverted-L long wire antenna

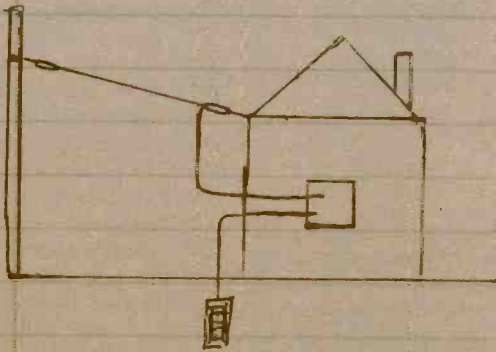

slant long wire antenna

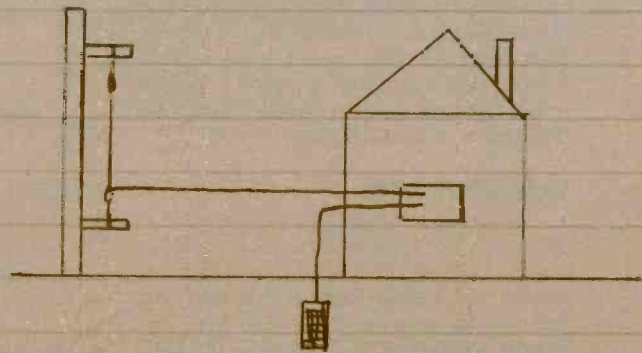

vertical long wire antenna

What the heck's a decibel

Bels. Decibels. Centibels. Where will it all end? Here's exactly everything you may ever need to know about these fun electronic terms.

by George McCarthy

If there's any term that gets flung around the CB channels and the ham bands with reckless abandon, it's *decibel*. In fact, in typical CB jargon, decibels are usually known as *pounds*—a transformation with lineage lost in the antiquities of early CB.

But how many CB or ham operators using the term really understand its precise meaning and how it is related to radio communication?

Actually, the term was invented in the *telephone* communications industry where a standard was needed to refer to power levels existing along various lengths of telephone lines. It was noted early that the level of voice power tended to decrease in relation to the distance it had to travel over typical lines strung on telephone poles. That was quite easy to hear, but telephone engineers needed some base against which they could measure changes, so that they would be talking about the same thing when they referred to line levels.

The *bel* was too large a unit for practical measure power ratios equal to the logarithm to the base of 10 of the ratio of any two powers. The term was named after *Alexander Graham Bell*, who invented the telephone (not Don Ameche, as some early movie goers might think).

The *bel* was too large a unit for practical use, so the *decibel* is commonly used. It is a unit of power equal to one tenth of a bel. The important point to grab is that the decibel is a *comparative* unit of power. You need a given power level against which you compare a second power level, because you are going to express the *difference* in decibels.

Bels are ringing

The decibel, since it is an expression of *ratio*, can be expressed as either a *plus* or a *minus* when compared to a reference power. If a certain level of power is said to be at the zero decibel point, then any power levels that are less than that will be minus decibels (expressed as *-db*) and any power levels that are greater will be positive decibels, just expressed as *db*.

Exactly what power, in the form of

voltage or current, might be chosen as the zero level depends on industry acceptance, for there has to be some *standard* or everyone would make up his own zero level.

It is commonly accepted that 1 db (one decibel) is the smallest change in audio power that can be detected by the human ear. When those commercials on television get cranked up to the point of driving you out of the room, you can be sure that the *level* has gone up a lot more than 1 db. A change of 3 db is equal to a doubling of power level. I swear that some of those tv commercials have been cranked up more than that.

Now that we have a firm grip on the fact that decibels are used to measure power changes, against some accepted standard, let's take a look at where we

CHART I

DECIBEL GAIN VS POWER RATIOS

DB	POWER RATIO
0	1.00
1	1.259
2	1.585
3	1.995
4	2.51
5	3.16
6	3.98
10	10
20	100
30	1000
40	10,000
50	100,000
60	1,000,000

most commonly run into the use of the term.

Bel meter

The first one that hits us in the eye is the *S meter* on our CB or ham transceiver. Almost all of these meters are calibrated in *S units* up to a mid-range reading of *S-9* after which the readings are in decibels *above S-9*. This makes for some widely accepted readings that are duly reported to the other station. "You're coming in here like a tone of bricks, like a local, wall to wall and tree top tall,"

depending upon what band you are talking on. This is usually followed by a meter reading, such as "S-9 plus 20 db" or "seven pounds" or whatever.

Now, this might have some real significance to a person hearing such a report if he could be sure exactly what it meant. Unfortunately, these glowing reports are frequently followed by a few questions, such as, "could you repeat your handle and location and the report you gave me?" Hardly sounds as if you were really blowing them out of the room if they have to have a repeat on everything that you said!

In fact, there is an extremely wide variation in *S meter* readings among various radios. The ham station that just gave you an *S-9 plus 20 db* reading in Shell Rock, Iowa, on a *Swan 350* might be followed by another ham from the same town telling you that you were an *S-7* on his *Drake TR-4*.

What's going on here? Nothing unusual. Just a reflection of the fact that the *Swan* is a little on the generous side with the *S meter*, while the *Drake* is somewhat scotch. Actually, you are laying down exactly the same signal in that area. What you can't control, of course, is the antenna system that is being used to pick up your signal. It could be anything from a six element beam at 100 feet to a wet noodle hung out of an apartment house window.

Tough cookies



























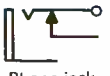
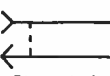
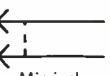
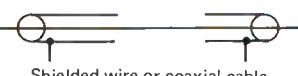









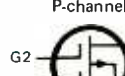



















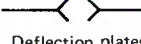







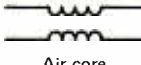
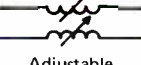
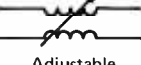
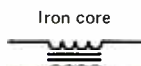
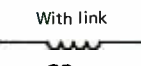









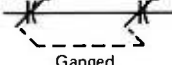

At this point you may say, "well so much for decibels," and make a pretty good case. But don't give up so easily. There is increasing acceptance of the standard of 50 microvolts of received signal to produce an *S-9* reading on the meter. This at least leaves you fighting only the variables of receiver sensitivity and amplification, meter adjustment and the non-linear operation of most meters. But it would get you a little further into the ball park on having those meter readings mean something.

Far more comforting and meaningful is the reading that does exactly what the decibel is supposed to do—give you a

Please turn to page 84

Electronic symbols

as used in Modern Electronics magazine

 <p>A = Ammeter V = Voltmeter mA = Milliammeter</p> <p>*Insert appropriate designations</p> <p>METERS</p>	 <p>MOTOR</p>	 <p>Single cell</p>  <p>Multicell</p> <p>BATTERIES</p>	 <p>Chassis</p>  <p>Earth</p> <p>GROUND</p>	 <p>Aerial</p>  <p>Loop</p> <p>ANTENNA</p>	 <p>HEADSET</p>	 <p>CRYSTAL</p>
<p>MALE → FEMALE</p> <p>CONTACTS</p> <p>Coaxial receptacle</p>  <p>Coax plug</p>  <p>Female</p>  <p>Male</p>  <p>230v.</p>  <p>CONNECTORS</p>	<p>Phone plug</p>  <p>Phone jack</p>  <p>Phono jack</p>  <p>Mic jack</p>  <p>CONNECTORS</p>	<p>Shielded wire or coaxial cable</p>  <p>General</p>  <p>Enclosure</p>   <p>SHIELDING</p>	<p>AND gate</p>  <p>OR gate</p>  <p>Inverter</p>  <p>Other</p>  <p>LOGIC</p>			
<p>Neon</p>  <p>Pilot</p>  <p>LAMPS</p>	<p>N-channel</p>  <p>G2 D G1 S</p> <p>P-channel</p>  <p>G2 D G1 S</p> <p>DUAL-GATE MOSFET</p>	<p>N-channel</p>  <p>G D G S</p> <p>P-channel</p>  <p>G D G S</p> <p>MOSFET</p>	<p>N-channel</p>  <p>G D G S</p> <p>P-channel</p>  <p>G D G S</p> <p>JUNCTION FET</p>	<p>N-channel</p>  <p>E B2 B1</p> <p>P-channel</p>  <p>E B2 B1</p> <p>UJT</p>	<p>PNP</p>  <p>G C E</p> <p>NPN</p>  <p>G C E</p> <p>BIPOLAR</p>	<p>Amplifier</p>  <p>Operational amplifier</p>  <p>Other</p>  <p>LINEAR INTEGRATED CIRCUITS</p>
<p>Ferrite bead ring</p>  <p>Air core</p>  <p>Tapped</p>  <p>Adjustable</p>  <p>Plug in</p>  <p>Iron core</p>  <p>INDUCTORS</p>	<p>Grid</p>  <p>Plate</p>  <p>Deflection plates</p>  <p>Heater or filament</p>  <p>Indirectly heated cathode</p>  <p>Cold cathode</p>  <p>Gas filled</p>  <p>ELECTRON TUBE ELEMENTS</p>	<p>Photoemissive (LED)</p>  <p>Zener</p>  <p>Diac (SCR)</p>  <p>Triac</p>  <p>DIODES</p>				
<p>Air core</p>  <p>Adjustable inductance</p>  <p>Adjustable coupling</p>  <p>Iron core</p>  <p>With link</p>  <p>TRANSFORMERS</p>	<p>Triode</p>  <p>Pentode</p>  <p>Voltage regulator</p>  <p>COMPLETE TUBES</p>	<p>SPST</p>  <p>DPDT</p>  <p>SPDT</p>  <p>RELAYS</p>				
<p>Electrolytic</p>  <p>Fixed</p>  <p>Variable</p>  <p>Feedthrough</p>  <p>Ganged</p>  <p>CAPACITORS</p>	<p>Fixed</p>  <p>or</p>  <p>Tapped</p>  <p>Adjustable</p>  <p>RESISTORS</p>	<p>SPST</p>  <p>Rotary</p>  <p>SPDT</p>  <p>Push-Pull</p>  <p>SWITCHES</p>	<p>No connection</p>  <p>Terminal</p>  <p>or</p>  <p>Connection</p>  <p>WIRING</p>			

comparative report against some standard. The report, "you have the loudest signal that I'm hearing from the East Coast," is far more indicative of how well your rig and antenna system are working than an S-meter report.

You should know that S-meters are just measuring a small flow of current through a coil. Your radio has taken signals in the *microvolt* range (millionth of a volt) and amplified them until there is a flow of dc current that will cause the meter needle to deflect. The more current, the greater the amount of deflection.

Most radios use the meter for several functions, depending on how it is switched into the circuit. It is not uncommon for a meter to read voltage, plate current, ALC action and relative power output, in addition to the S units of received signal. Most meter circuits are adjustable, so if you think your meter's a little scotch you can make it give higher readings.

Where else do you commonly run into the term *decibel*? Why, on claims of performance, of course. This is an area where you frequently have to look to see what shell the coin is under. Unless the

CHART II

RATIO OF DECIBEL TO VOLTAGE

0 db	1 microvolt
20 db	10
40 db	100
60 db	1000
80 db	10,000
100 db	100,000
120 db	1,000,000

decibel is used in its comparative sense, it is a meaningless expression, much like the fellow who was asked, "how's your wife?" to which he replied, "compared to what?"

It is common to rate a receiver's sensitivity (ability to amplify small signals) in terms of microvolts for a signal to noise ratio expressed in decibels. Just what does this mean? You must remember that there is always random *noise* generated in both an antenna system and within a receiver itself. The level of this noise can be very important in relation to the receiver's ability to copy a weak signal.

It does no good at all to have an extremely sensitive receiver if it is just boosting every bit of voltage around. So, we are interested in the ratio of the strength of the *received* signal to the strength of the *random* noise. Now that we are dealing with power ratios, the old decibel is right at home.

A receiver with a sensitivity of $\frac{1}{2}$ microvolt to a S/N ratio of 10 db will be able to take a signal of only one half of a millionth of a volt and amplify it to a point of ten times the power level of just

the ambient noise level! That's a specification that means something.

Where else do we see those decibels being tossed around? In *antenna* performance claims. There are a multitude of glowing promises made by most antenna manufacturers, but all of the adjectives in the world are just so much puffing compared to a correct decibel rating. I wish that I could report that I put great faith in most of the claims that I see made for CB antennas. I know that most of them really do work real well, but I sure wish that they were a little less liberal with how they use the db when describing antenna performance.

Firepower

Let's take a look at some of the parameters that really are a natural for the use of the decibel. Two of the major performance factors that we ought to be interested in when looking at an antenna are *gain* and *rejection*. Both terms can use decibels to describe performance.

Now you've got a firm grip on the relative principle when someone flings a db at you, right? "This antenna has a gain of 4 db," the ad says. "Compared to what?" you ask. You will not always find the basis of comparison listed. You may see a very small asterisk after the db. Look for the answer. If it says, "compared to an isotropic antenna," the manufacturer is comparing his antenna to a theoretical antenna that actually doesn't exist. The so-called isotropic antenna would radiate energy equally in every direction and plane. If it were inside of a giant bulb, it would light up all areas equally.

Squirting planes

Now, any antenna that is located in a typical installation is going to have a great deal of its radiated power squirting out in some planes and very little in others. Thus a typical vertical antenna pushes a lot more energy out of its sides than off the top or bottom. The energy that is radiated along the ground plane is partly composed of energy that isn't radiated from the top and bottom.

Therefore, compared to the isotropic antenna, it will have more gain. A half wave dipole in free space has a gain of 2.1 db over an isotropic antenna. A good vertical almost 3 db. Hey, that's equal to twice the power of an isotropic antenna if 3 db is a doubling, right? That's correct. But is it really a useful figure for you?

It's a lot easier to dig if we compare things against some known value. Comparison against the half wave dipole is much better, but it doesn't produce quite the impressive figures, does it?

A beam antenna should not only have *forward gain* expressed against a specified standard, but should also list the *front-to-back ratio*, a natural for our friend the db again. In this case there should be no doubt, for we are talking about

measuring a signal with the antenna pointing right at the signal source and then turning the antenna 180° around and taking another measurement off the back. The difference is a power ratio. It is expressed in db. A two element beam may have a front-to-back of up to 25 db and a four element up to 35 db. Much more claimed than that might cause a little suspicion among most antenna buffs.

Now that we've kicked the term decibel around a bit and shown a few areas in which it is commonly used, let's see just what those power ratios really are. Are they really significant? One look at the chart ought to make a believer out of you. It shows that every time you double power it represents an increase of 3 db. Might not sound like much, but it is doubling every time. When we talk about a 10 db increase we are referring to a power increase of 10 times! But the next time we jump another 10 db we are talking about an increase to 100 times the starting power!

Back from the front

Let's put this in terms that we can deal with and relate to some specific experience. We can use this information to really dig what a front-to-back ratio can mean to a CB or ham station.

Suppose we have an antenna that has a 20 db front-to-back ratio? In terms of power that means that a station behind our antenna will have to be 100 times as strong as one in front of our antenna to be putting in the same level of signal to our receiver. Now, that's a lot of extra power. If we are copying a station running a legal four watts on a CB channel, then one in back will have to run 400 watts to be as loud.

The *rejection* off of the sides of a beam antenna is frequently much greater than off the back, as much as 50 db in some cases. What does this mean? Look at the power chart. A signal off the side would have to be 100,000 times as strong as off the front to be equal! A 400,000 watt linear hooked up to a CB set? Not likely!

It may have occurred to some of you that a beam antenna could be a handy thing to have when the *skip* is really rolling in. Not to pick it up, but to *reject* it so that you can hear your buddy down the street and not have him drowned out by a signal coming from a couple of thousand miles away.

If you would like to relate decibels to some specific unit of measurement, look at our second chart which shows the ratio of decibels to microvolts. We choose 1 microvolt as the zero db level. By the time we get to 10 microvolts we have a 20 db change. At 60 db we are looking at 1000 microvolts! Now that's a respectable change in anyone's ball park. Double those db to 120 db and you don't double the microvolts to 2000, but now are looking at one million microvolts, or one big whole volt! 

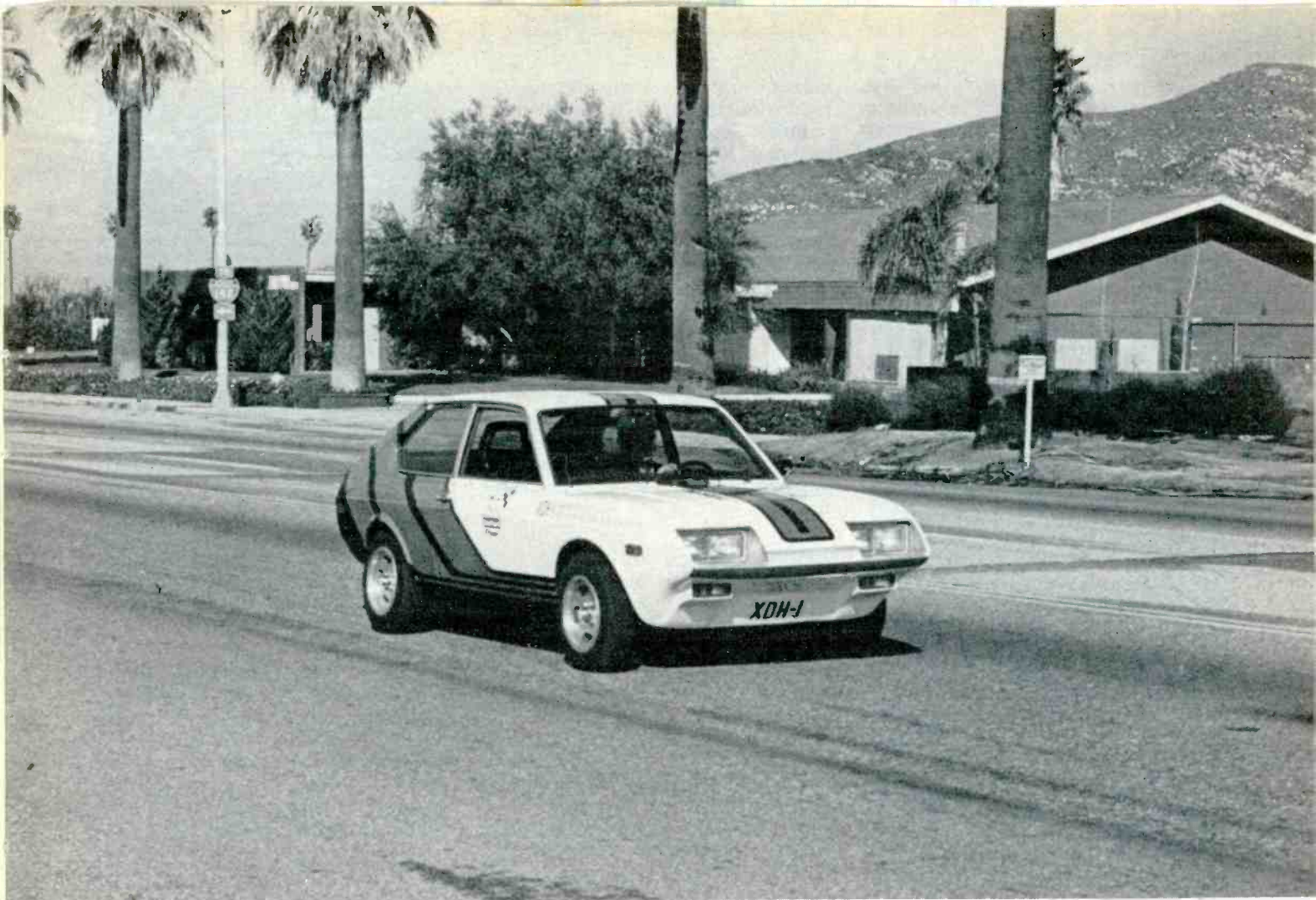

Batteries power electronic car

by Ron Cogan
Contributing Editor

Only the most knowledgeable car buffs will remember that the last time Sears, Roebuck and Co. marketed an automobile was in 1953 when the company offered a version of Kaiser Motors' compact "Henry J" model called "Allstate." That was nearly a quarter century ago, so why a radical *electronics* car today from Sears?

While Sears has no intention of marketing autos in the near future, they are pursuing a continual search for new products and new applications for successful ones. In this instance, the experimental XDH-1 was especially created to mark the tenth anniversary of a line of batteries and to test the latest

product in this line, an experimental Die-Hard for electronic vehicles.

And a dramatic test it is, indeed, with impressive performance across the board. The little electronic car carries two people a hundred miles between recharges at 45 mph, and can hold its own in freeway traffic with bursts of passing speed up to 70 mph.

Based on existing car

The XDH-1 is a standard Fiat 128-3P three-door hatchback with front wheel drive and a transverse-mounted engine. This particular vehicle was used because power loss through the gear train could be minimized with the use of a transaxle with straight-cut spur gears rather than a hypoid differential.

The revamped front end offers minimal frontal area and low wind resistance. The car also has the sturdy chassis, body, frame and suspension needed to handle the heavy load of two power packs made up of a total of 20

batteries located beneath the hood and in the former rear seat area.

The basis for the powerplant is a World War II aircraft starter/generator motor, compound wound with a portion of its field coil in series with the armature, but a separate field coil energized from an outside source to control motor speed.

After removing the gas engine, radiator, gas tank, gas lines, and all unnecessary accessories, the new *electronic* motor was coupled to the original transaxle unit using an intermediate section between the motor and transaxle.

The intermediate adaptor shaft that carries the flywheel and the clutch assembly is supported by twin tapered roller bearings. Original engine mounts were adapted to the new motor, then the electronics were installed.

A heavy-duty contactor is used to start the motor rolling. This puts electrical current through a pair of resistors at

40-50 amps under no load. After one second, a time delay cuts in another heavy-duty contactor which shorts out resistance, then gives full current to the motor to operate the car. The contactors are controlled by electronic relays operating on 12 volts.

The starting procedure is simple. The ignition key is inserted in the lock,



The line running from the fuse box is connected to a receptacle which has been installed in the stock fuel filler neck. A dummy gas cap covers this receptacle when not in use. A carry-along land line is plugged into the receptacle and then to a 110 or 220 volt source to activate the on-board battery chargers. Eighteen hours are required to fully charge a depleted system with 110 volts, and a mere six hours with 220 volts.

turned on, then advanced to the normal key-turn starting position. The motor starts, idles at 2000 rpm and is immediately capable of delivering full power with no speed control other than the transmission gears.

A solid state electronic speed control is used, however, as a unique *field-*

weakening device. Current through the shunt winding suppresses the motor to a constant 2000 rpm, while weakening the current in the coil allows the motor to wind up to 5000 rpm.

Ungoverned, the motor is capable of 8000 rpm. This speed control is a normal accelerator pedal that controls a rotary pot resistor to control the vehicle's speed.

The motor requires a cooling system—a "squirrel cage"—12 volt blower fan and ducting for forced cooling of the motor. The motor can run up to 220-degrees Fahrenheit, but is much more efficient if run cooler for better performance and longer range from the batteries. Normal operating temperature is in the 120-160 degree range.

Twenty batteries

A total of twenty Die-Hard batteries are required for the 100 mile range of the car. They are mounted in packs of ten batteries each located in the area formerly occupied by the rear seat and extending partially into the luggage compartment.

Under the hood are five batteries and one marine Die-Hard to operate accessories. This setup adds 100 pounds extra weight on the front end.

The flexibility of on-board battery chargers is needed because conventional chargers are too bulky for this application. A new type of electronic charging system was developed that gives 94 percent efficiency of current drawn from an ordinary outlet, about a 20 percent improvement on other charging methods for batteries. These on-board electronic chargers measure only 6" x 2" x 9" overall.

Rather than using an electrical cord inside the car's trunk (which would be pulled out for charging), a line is actually plugged into a receptacle mounted on the car. This receptacle is located in the stock gas filler neck opening, covered by a dummy gas cap. An adapter for 110 or 220 volt charging is provided.

A console-mounted switch inside the car turns on the chargers, with the rate of charge being 5 amps per battery pack using a 110 volt source. This system automatically boosts the charge to 15 amps when it senses a 220 volt current being fed into the car.

For batteries that are completely discharged, an 18-hour charge is required on a 110 volt line or just 6 hours on a 220 volt line. The five amp charger is used to protect your 110 volt line from blowing a fuse.

All batteries are recharged simultaneously, including the single 12 volt marine used to operate wipers, heater, headlights, and other components, and two small 12 volt gel cell batteries that operate the speed controller.

The charging system is designed so

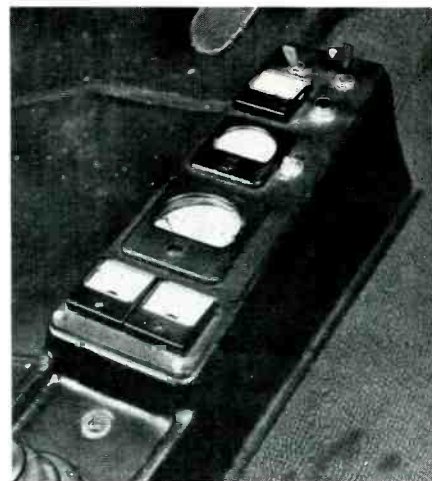

The floor console houses voltmeters and ammeters that allow a driver to monitor battery condition, driving current, and field control current. Standard speedometer, motor temperature gauge, tachometer, and battery charge gauge are located in the stock instrument cluster on the dash.

all batteries reach peak charge about the same time to eliminate overcharge condition on any of them. Each charger recharges one of the two battery packs independently of the other through the use of a solenoid that isolates the batteries for charging, then creates a parallel electronic hookup for running.

To prevent driving away with the charging cord plugged into the wall



Except for a special center console, the XDH-1's interior resembles that of any other late-model automobile—comfortable Recaro bucket seats, floor carpet, handsome dash and so on.

outlet, a relay senses current going into the car and automatically disconnects its electronic starting circuit, making it impossible to start the car while its charging cord is connected.

The motor charges

To assist the original equipment brakes on the XDH-1, its electronic motor, upon deceleration and downshifting, becomes a powerful generator employing the principle of regenerative braking. Used properly, it increases the car's range by converting braking force to electricity that is fed back into the car's batteries.

Driving the XDH-1 is easy. It operates the same as any small-engined car with a standard transmission. Leaving home in the morning, you raise the car's hatchback, detach the charging cord and place it in the trunk. Drop the hatch and

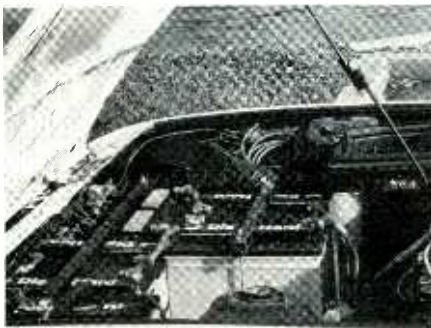

RESEARCH CAR SEARS, ROEBUCK AND CO.

A total of twenty Sears Die-Hard batteries are used to power the World War II electronic motor. The majority are located in the rear compartment formerly used for luggage. The motor itself is located low in the engine compartment and out of view.

replace the gas cap that covers the charging inlet and you're ready to get behind the wheel.

Sliding into deluxe form-fitting Recaro buckets, you turn the ignition key and the engine idles at a smooth 2000 rpm. The clutch is depressed, gear shifter engaged, and the car is ready to roll.

One instantly noticeable feature is an audible whine like that of a jet starting to power up on a runway, but this disappears as you reach traffic speeds. This attracts the attention of close passers-by in a parking lot, though.

Shifting gears is performed just as in a gas-engined car. You can go from fourth to second gear or first to third, just as easily and flexibly as you can down or upshift a conventional automobile. A slight lag in throttle response is felt during the shifting process, but there's a definite absence of the "bucking" or rough gear transition often felt in the clutch and driveline

when shifting up or down with a gas-burner.

Unlike gas-driven cars, the electronic XDH-1 works out to be extremely economical on the road. Using a base rate of 4¼ cents per KWH, which is the current rate for electricity in the city where the car was developed (but this may vary across the country), it costs about 85¢ to recharge the XDH-1's batteries from complete discharge. This translates into a total cost of 1 to 1½ cents per mile for the car's range.

Keeping up with 55 mph freeway traffic is also a simple task with the XDH-1. Just stab the throttle and the car accelerates instantly and smoothly up to maximum speed. Its flexibility and response at all speeds, up to the legal limit and beyond, lends a comfortable feeling of confidence. This is an unusual experience when driving an experimental car for the first time.

The car's minimum speed in top gear is 31 mph, therefore it's necessary to downshift for maximum braking efficiency when slowing down from speeds in the mid and high ranges. Downshifting the XDH-1 causes the motor to assist the brakes on the car's wheels, just as a piston engine supplements a braking system during downshifting.

Inexpensive to operate

Also important is low maintenance. Other than the regular maintenance required to keep brakes, chassis, and other components in sound shape, the car requires only motor brushes every 50,000 miles and a complete rewind every 100,000 miles or so. This is an important consideration when com-

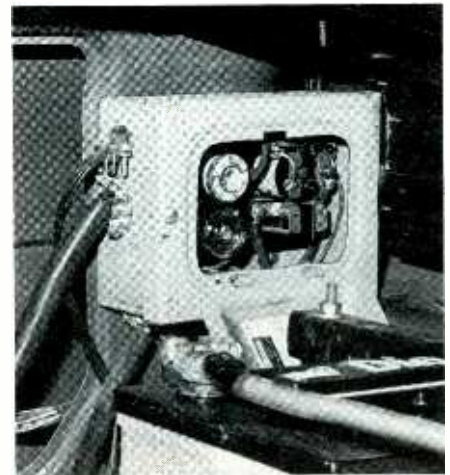

On the other side of the rear compartment we find parts of the charging mechanism and fuses to protect from charge overload.

pared to regular servicing, tuneups, rebuild, and general repair needed to keep a gasoline-powered engine performing well.

Monitoring instruments

Except for a special electronic console fitted between the car's seats, the interior compartment resembles other finely detailed automobiles. Two flashy buckets comprise the seating capabilities, while floor carpeting, a handsome dash, and other standard convenience features make up the balance of the package.

The center floor console is an attention-getter, and rightly so, as it houses those instruments required to keep a driver constantly updated on the electronic power and motor conditions. Located in the console are voltmeters for the accessory battery, power packs, and



Other than the special stripping and lettering designating the XDH-1 as an experimental vehicle, passers-by would simply assume the car to be a late-model stocker. However, the story is told once the hood and rear hatchback are lifted.

Computer keyboards

continued from page 64

ble states this will happen anywhere up to 64 clock pulses from the time the switch closed. But if the clock pulses are arriving rapidly, this may still be a short time.

In any case, after some delay the flip-flops will reach some unique combination of states, and the multiplexer will suddenly provide an output. This is sent back to the clock control gate, which stops further clock pulses from arriving at the counter. In other words, the counter flip-flops suddenly freeze in whatever state they are in, and the ASCII output stops changing. A short time later the strobe delay circuit provides a strobe pulse.

In order to make sure we get the correct ASCII code for the correct key, we must make sure we place the key at the right intersection of the correct two wires. This is easy to do if a printed circuit board is designed to mount all the keys and provide the connections as well.

The delay in the strobe line provides for debouncing, and the circuit itself provides for 2-key rollover. Once one key is depressed and sensed, the clock stops and closing further keys does nothing as long as the first remains closed. Once the first key is released, the circuit automatically resumes scanning and will, in a few clock pulses, find the second key closure. If, however, more

than two keys are closed than the additional keys will be ignored; sensing more than two keys requires a more complex circuit having *N-key rollover*.

The circuit of Figure 6 can be wired with just six or seven inexpensive integrated circuits, although a few more are needed to add the functions of a SHIFT key and a CTRL key. The circuit is sufficiently useful, though, that several large-scale-integration circuits have been designed just for this purpose. One such IC is the 2376 shown in Figure 7.

The 2376 is designed for up to 88 keys, and so it has an 8 by 11 line switch matrix, shown at the top. A simple resistor-capacitor circuit at the left provides the timing for the clock, and another at the right provides the delay for debouncing. Two switches for SHIFT and CTRL connect directly to the IC, and a variety of outputs provide both ASCII codes and strobe pulses. This particular integrated circuit can generate both upper-case-only as well as upper-and-lower-case output codes, depending on the setting of a single switch. It also provides a parity output on pin 7, if desired.

Although computer keyboards are fairly simple in operation and construction, they form the backbone of many computer systems. Any system which operates on any kind of alphabetic information usually starts somewhere with a keyboard which is used to enter either data or programs. 

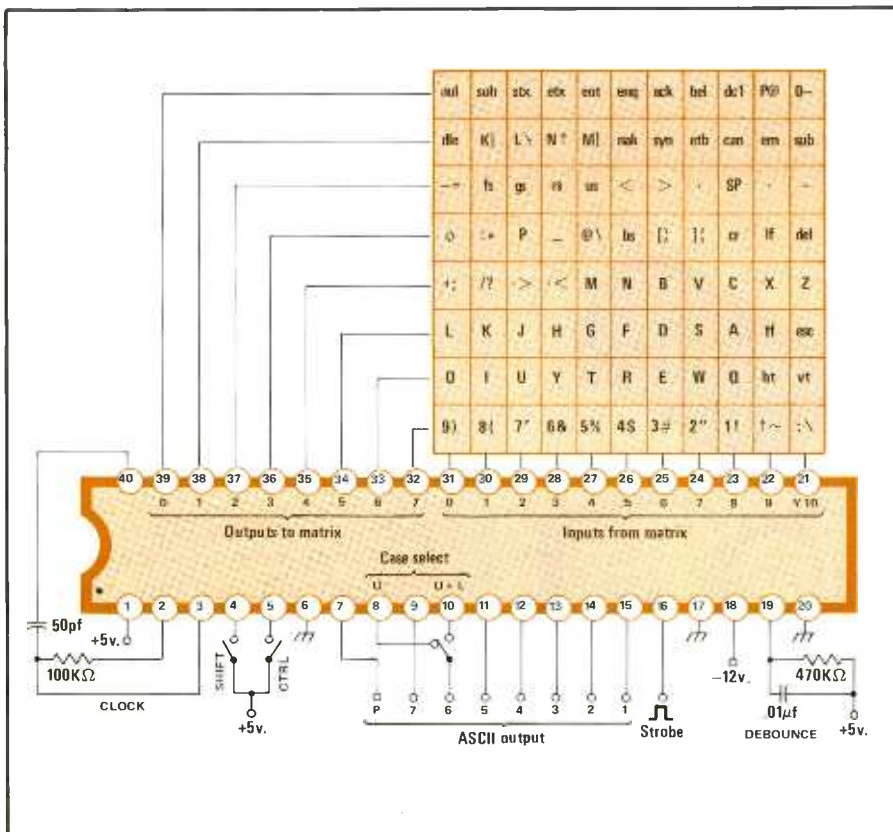

Figure 7: a 2376 integrated circuit provides most of the functions needed by the keyboard, including upper/lower case shifting, CTRL key, debouncing, generation of strobe, and two-key rollover

GILFER



"NORTH AMERICA'S SHORTWAVE MAIL ORDER PLACE"

One-Stop Armchair Shopping For All SWL Needs

* Receivers — Drake, Yaesu — special mods for better performance * Frequency Readouts * Receiving Antennas * Antenna Tuners * Frequency Calibrators * Log Books * FM or TV Guides * QSL Albums * AM Pattern Maps * ITU Publications * QSL Address Books * Confidential Frequency List * Clocks * All SWL Books

The New 1978 32nd Edition WORLD RADIO TV HANDBOOK Is Ready!

Listen to the world with this comprehensive directory of stations at your side. Best there is! Only \$11.95 ppd.



FREE SWL MINI-CATALOG GILFER SHORTWAVE

Dept. ME-6, Box 239, Park Ridge NJ 07656
CIRCLE 89 ON READER SERVICE CARD

The Most Outrageous CB Novelty Ever! Your Very Own Pet Transistor!

It's true! Less expense than owning or even adopting a puppy, will not stain your carpet! Unlike messy and potentially hostile pet rocks, will not leave unsightly sand and gravel around the house. Your lovable pet transistor will bring you long years of clean fun and contentment. The absolutely PERFECT gift, for yourself or any of your CB friends. Comes complete with outrageous and hilarious instructions--must be seen to be believed--biggest sensation to hit the CB world since the discovery of skip! Only \$2 each, postpaid (get 2 for only \$3.00). Dealers wanted! Order yours now from:



Sunshine Radio Co.
18 Boat Lane
Pt. Washington, N.Y. 11050

WWVB and WWVL

continued from page 52

respect to the wavelengths involved, they're not very efficient, either. WWVB's 60 kHz antenna is about 35 percent efficient, while the much shorter (electrically speaking) WWVL antenna is only 5 percent efficient. Surprisingly, though, the WWVB signal is heard well over most of the U.S. using standard LF receivers and simple wire antennas or loops. The station is, in fact, used by many *foreign* time and frequency stations as a cross-check on their *own* transmissions! Figure 1 shows how the WWVB signal blankets the states from its Colorado location.

While you're unlikely to hear a peep

from WWVL due to its inactivity of recent years, you should be able to hear WWVB quite well most anywhere in the country. You can use a simple LF surplus receiver, one of the fancy new breed of super receivers that cover the low frequencies, or you may want to try one of the new VLF/LF converters, such as that made by Palomar Engineers, which you just hook onto your regular communications receiver.

And, although a surprising number of stations populate the LF and VLF bands, they're really not all that crowded—and there are fewer than a dozen low-freq time and frequency stations on the air around the globe. The WWVB signal is usually QRM-free around the clock.

Perhaps most importantly for the

SWL, WWVB—along with the other stations in the NBS family—QSLs very conscientiously to accurate reception reports. If you'd like a QSL, be sure to indicate just which NBS station you heard, its frequency, and the date and time of reception. A signal report is appreciated, as is an indication of what kind of receiver and antenna system you used. You can send reports directly to the station at Fort Collins, CO 80521.

For program information about WWVB and the other NBS stations, you can write them at the NBS Program Information Office, Boulder, CO 80302. And, if you find yourself in the Boulder-Fort Collins area, it's even possible to arrange for tours of the laboratories and the stations themselves. ☐

Capacitors: is one as good as another?

Choosing the right kind of capacitor is just as important as choosing the right value. The wrong kind can kill a project just as fast as a wiring error. Here's why.

If you're just getting into electronics, you've probably noticed that *capacitors* with the same voltage and capacity ratings come in a wide variety of sizes and shapes. But, you've decided that it's what's inside that counts. So, one capacitor is just as good as any other with the same ratings.

But, is one capacitor as good as another? It really depends on the way you're going to use them.

Capacitors can be classified in two ways—how they're made, and what materials are used in their construction. Metal plates and sheets of glass were used to make capacitors in the early days of radio when size was of no importance. Today, however, size is very important.

The easiest way to get large surface areas into small packages is to use flexible materials such as metal foil and paper or plastic sandwiched together and rolled into a tubular form. The resulting tubular capacitors provide relatively high capacity and working voltages in relatively small packages.

Tubular construction has a very serious disadvantage, however. Because of the rolled construction, tubular capacitors behave as if there is a small inductor built-in. At the higher frequencies encountered in CB sets, fm tuners and televisions, the *self-inductance* becomes very significant. In some cases, a single tubular capacitor can

act like a self-contained oscillator circuit.

Most tubular capacitors have a paper *dielectric*—the insulator between foil strips. Although paper makes a fine dielectric at low frequencies, it loses its insulating properties at very high frequencies.

Some tubular capacitors have plastic film dielectrics. Generally, these make much better dielectrics at high frequencies than paper. And because the same insulating ability can be obtained with less plastic

than paper, plastic dielectric capacitors are smaller than paper units of the same ratings. But even the low-loss polystyrene capacitors aren't suitable for high frequency work because of self-inductance.

The best way to reduce the self-inductance of a capacitor is to use classical parallel straight-plate construction. The most common example is the ceramic *disc* capacitor. It consists of a thin wafer of ceramic material coated on each face with a metallic film, to which leads are attached. The thickness of the ceramic wafer depends on the maximum voltage the capacitor must handle.

Although ceramics make excellent capacitor dielectrics, they are not without their faults. Most ceramic capacitors have high *temperature coefficients*. This means that as the temperature changes, the value of capacitance also changes. In most applications, this change in capacitance is unimportant. There are circuits, however, where the capacitance must remain fixed in value regardless of temperature.

Some ceramic capacitors are made in such a way that their capacitance remains constant. But, these are expensive. If you need a capacitor with excellent high frequency characteristics and a low temperature coefficient, the *mica* capacitor is your best bet.

Mica capacitors are made by sandwiching layers of mica foil between layers of metal foil. Although slightly larger than ceramic capacitors of the same ratings, mica units are smaller than equivalent tubular capacitors of the same ratings. ☐

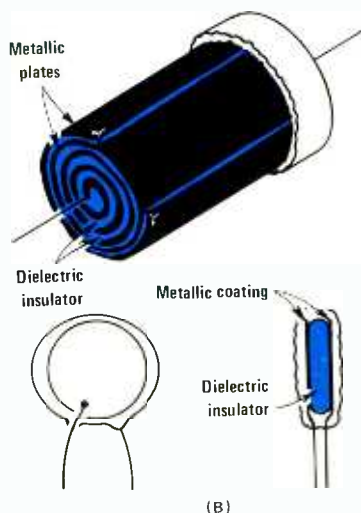

Tubular capacitors (A) are made by rolling strips of paper or plastic insulation sandwiched between strips of metal foil. Ceramic disc capacitors (B) are made by coating the faces of a ceramic wafer with a metallic film.

Heathkit home computer

continued from page 27

out having to wade through a new highly complex language.

Health Company supplies two versions of Basic: *Benton Harbor Basic* and *Extended Benton Harbor Basic*. Both versions have full math and logical functions, but Extended Basic also includes some advanced functions and factors that allow it to run faster, flag more programming errors, and add some conveniences that make programming easier. The major difference between the two is the ability to manipulate character strings in Extended Basic.

Basic is probably the most popular and widely used language in the microcomputer field today because it's easy to learn and use.

A manual is supplied for each language and for the panel monitor (PAM-8). PAM-8 is in read only memory (rom) on the H8 front panel and runs the I/O and control functions available to the user through the H8 front panel keyboard and displays.

The manuals are complete and easy to understand, but they are not educational texts on the various languages. Heath assumes that you know something about the languages and that the manuals give you enough information to begin working with them. (See *Modern Electronics'* shortcourse in *Basic*, page 46, May 1978.)

The H8 is a stand-alone machine requiring only some memory to begin operation. We were able to write and enter programs without any peripherals through the front panel keyboard and display. PAM-8 allows examination of memory, I/O ports, and registers through the front panel. Instead of the usual binary numbering, Heath uses offset octal numbering (to the base 8). This takes a little getting use to, but Heath explains it all in the manuals. Because of this system the keyboard is styled like a calculator. The entry of instructions and data is much easier than with a series of binary switches.



Of course, this kind of programming gets very tedious, so I/O peripherals like the H9 and software like Basic are useful. In the Heath system operation is a snap. Loading of the basic interpreter (which teaches the computer Basic) from magnetic tape takes about a minute and a half.

Checkbook

After one reading of the Basic manual we were able to begin writing small programs right away. With just a bit of reading, you should be ready to do some of your own programming.

Problems were relatively few with the entire system. Two diodes failed in the H10 power supply, and two in the H8 power supply.

Our other problem required a trip back to Heath for the H8. After using the machine for a while, it would not reset after turn on as it should. Calls to the Heath service department were made, but we were unable to isolate the problem. When the machine came back from Heath we learned that there had been a solder splash on a front panel board.

If you're serious about the computer hobby or need a small business computer, Heath systems represent a good choice that combines price, quality, and

resulting in data lines to the CPU being shorted out. After repair the machine operated flawlessly.

When we called, the Heath service department was polite, helpful and suggested ways to analyze the problem and correct it. Don't be afraid to contact them for assistance if you need it.

The system we're using cost just over \$1500, a price that is competitive with other complete systems available.

If you should want a more advanced machine, Heath also offers an H11. This machine is based on the Digital Equipment Corporation (DEC) LSI-11 microprocessor. Also offered is an H36 (LA36 Teleprinter by DED) for those who want or need hard copy. Both are expensive with each approaching the cost of the entire H8 system.

Stay tuned to *Modern Electronics*. In the months ahead, we'll be listing lots of different new programs as we develop them for the H8 system. As peripheral hardware comes on the market we'll check it out and give you a full report on what it does and how it works. And we'll even be inventing a few necessary pieces of gear ourselves.

The H8 system is great fun and works well after you get it set up correctly. I think you'll like it! □



LET'S WORK TOGETHER TO PROTECT
THE UNBORN AND THE
NEWBORN



MARCH OF DIMES

5

great reasons

why YOU should

subscribe to

(if you aren't already doing so!)

CB RADIO

AMERICA'S OLDEST AND LARGEST CB MAGAZINE

S9

- 1** You'll save a bundle. Newsstand copies are \$1.50 each, or \$18 for a year's supply. Your subscription costs only \$12 — that's 33% off!
- 2** You'll get S9 earlier. Subscriber copies will reach you as much as two or three weeks ahead of newsstand or store copies.
- 3** You'll be sure of getting your copy. Many times S9 is sold out before you can find it. Your subscription is like an insurance policy of fun reading.
- 4** You'll get a bonus. Right on! A 24 page copy of the FCC Part 95 CB regulations. The Commission charges \$1.25 for a copy, and it's a must for every CBer.
- 5** You'll make our editor very happy. And there's nothing more important than having a happy Tomcat (that is, if you're going to keep a Tomcat on the premises, as we do.)

So, indulge yourself. S9 is the CB magazine that doesn't quit when it comes to giving CBers all the scoop on what's happening out in the CB world. Do it now! Today! Before you forget!! After all, spreading joy is what CB's all about, now, isn't it?

CB RADIO/S9

14 Vanderventer Avenue
Port Washington, New York 11050

Please include my FREE copy of FCC Part 95 CB Regulations



Name _____ Call _____

Address _____

City _____ State _____ Zip _____

Signature _____

Here's my\$12 for a 1 year sub,
.....\$20 for 2 years. This is a.....new
sub, or a.....renewal.

Interbank No.	Exp. Date	Mo.	Year

BankAmericard Mastercharge

806F

Note: Allow 8 weeks for delivery of first issue.

DIP Switch

Your Choice **\$1.69** 3 for \$5.00

Cat. No. Switches We bought a factory's complete inventory of 100,000 pieces. We've sold 'em at high as \$2.98 each. Now at 50¢ prices anyone can afford. You can mix 'em when you buy 'em. All SPST, fits 1/4" pin DIP socket. Wt. 1-oz.

- 4A3668 2
- 4A3669 3
- 4A3670 4
- 4A3671 5
- 4A3672 6
- 4A3673 7
- 4A3674 8

SOLID STATE AM-FM Tuner

FIRST TIME ever offered! Enjoy AM and FM broadcast at a tremendous saving! Top quality compact construction, only 2 1/2" x 8" x 2 1/4". Highly sensitive and selective, with excellent S/N ratio; sensitivity less than 5 uV for 10 db S/N. Tunes complete FM band from 88.5 to 108.5 mhz, and complete AM band from 540 to 1800 KHz. Features built-in AM antenna, 3 gang variable condenser. IF frequency of AM is 465 KHz. FM is 10.7 mhz. Zero signal current 7.1 ma. FM, 6.4 ma. AM, 5 watt stages: RF amp, mixer, and 3 IF stages. Slide switch selects AM, FM or FM-APC. NOT A KIT! Completely wired and easy to connect to amplifier. Operates on 9-12VDC. Wt. 12 ozs.

MINIATURE • Use with any AMPLIFIER!

3 for \$18. **\$6.50**

Cat. No. 4A3522

OP AMP SPECIALS

- LM301N 5 for \$1.19
- LM301V 5 for 1.19
- LM307V 4 for 1.19
- LM308V 2 for 1.19
- LM309N 3 for 1.19
- LM322N 3 for 2.00
- LM324N 3 for 3.00
- LM338N 4 for 1.19
- LM370N 3 for 2.50
- LM373N 3 for 5.00
- LM377N 3 for 4.00
- LM380V 2 for 1.19
- LM381N 3 for 4.00
- LM555N 3 for 1.19
- LM558V 3 for 1.19
- LM703N 4 for 2.80
- LM709N 5 for 1.19
- LM740N 2 for 1.19
- LM741V 4 for 1.19
- LM747H 2 for 1.19
- LM749V 2 for 1.19
- LM1800N 5 for 1.19
- LM1800N 5 for 1.19
- LM3900N 4 for 1.19
- LM4250H 3 for 2.50

V=Mini Dip, N=DIP.

100'S OF BARRELS PURCHASED!

For the first time anywhere, Poly Pak merchandisers introduce a new way in buying the economical way. Raw stock from the "barrel". Remember the "good ole days"? They're back again. The way merchandisers throughout the United States buy from various factories... their overruns in barrels. Poly Pak has done the same. Therefore you are getting the same type of material as the RE-TESTERS DO!

TEST 'EM YOURSELF 'N SAVE!

Poly Pak's EXCLUSIVE BARREL KITS

Buy 10 BARREL KITS 11th Free

AND CHOOSE THE KIT YOU WANT

Avg. Ship. Wt. 6 ozs.

\$1.98

YOUR CHOICE OF ANY KIT

Every kit carries a money back guarantee!

INCLUDES "100%" MATERIAL TOO!!!!

BARREL KIT #210 GLOWING PANELS

3 for \$1.98

4" x 1" panels that glow blue-green with 110VAC. Use for nite lights, indicators, etc. Cat. No. 4A3850

BARREL KIT #184 JUMBO RED FILM

150 for \$1.98

100% metal film resistors. Long leads. 4A3413

BARREL KIT #158 MAGNIFIED MAN-3'S

12 for \$1.98

MAN-3's 7-seg readout, with built-in magnifier. Factory discontinued line. 100% material. Cat. No. 4A3325 1-oz.

BARREL KIT #203 CALCULATOR KEYBOARDS

10 for \$1.98

It's true! 20-key, 4 function keyboards at ridiculous prices. 12 ozs. Cat. No. 4A3524

BARREL KIT #187 JUMBO RAMS-REGISTERS

1-lb. \$1.98

With approx count of 80 pcs. You get more. Mostly marked monthly. No. 4A3064

BARREL KIT #144 RCA PHONO PLUGS

20 for \$1.98

1,000,000 RCA phono plugs for this one. You hi-fivers know what they are. 100% material. Cat. No. 4A3293

BARREL KIT #201 6V INDICATORS

15 for \$1.98

Test lamp manufacturer dumps inventory! Worth \$94 a like grain-o-wheat. Cat. No. 4A3526

BARREL KIT #163 MINI TRIM POTS

30 for \$1.98

Asst. values 100 to 1 meg ohm. All the 10 amp types. Cat. No. 4A3345

BARREL KIT #154 CLOCK CHIPS

20 for \$1.98

We gathered an assortment of clock chip, alarm, calendar, beepers, who knows, all mixed. Cat. No. 4A3308

BARREL KIT #200 9 DIGIT READOUT MODULES

5 for \$1.98

With calculator & driver chips beneath epoxy case. 4A3525

BARREL KIT #188 400 Parts

\$1.98

Includes resistors, caps, transformers, rectifiers, diodes, etc. for p.c. work. Preformed, dumped into barrels by factories. 100% Cat. No. 4A3401

BARREL KIT #138 75-PC TRANSISTORS

\$1.98

100% material, TO-92, factory discontinued lines, pnp's mixed with npn's. 2N4100-1-2-3-4. 4A3290

BARREL KIT #129 MINI DIP IC'S

75 for \$1.98

Large mfr dumped 100's of lbs into barrels. Includes 741, 742, 743, 748, 749, 755, 755B, but who knows? Wt. 1 lb. 4A3245

BARREL KIT #136 MICRO MINI LAMS

20 for \$1.98

1-oz. Imagine! Micro size (3/4") with wire leads. 3 to 5 VDC. 40 mils. Worth 60¢ ea. Cat. No. 4A3259

BARREL KIT #127 AXIAL ELECTROS

40 for \$1.98

Asst. capacities and voltages. Cat. No. 4A3227

BARREL KIT #109 TERMINAL STRIPS

100 for \$1.98

Wide ass. of terminal strip connectors, from 1 contact up. Strip manufacturers barrel dump is your gain. Wt. 1 lb. Cat. No. 4A3136

BARREL KIT #134 CALCULATOR CHIPS

15 for \$1.98

National type. Can be MM5736, 38, etc. Untested. Cat. No. 4A3258

BARREL KIT #126 UPRIGHT ELECTROS

40 for \$1.98

1mf to 300mf in mixture of voltages. 100% marked in good. 4A3226

BARREL KIT #104 SLIDE VOLUME CONTROLS

10 for \$1.98

Cosmetic rejects, electrically fine business! You check 'em, it's not for us. Ass. voltages. 4A3204

BARREL KIT #93 HALF WATERS

200 for \$1.98

Resistor factory tried to fool us by mixing 100% color-coded resistors in barrel. But value is there. 4 oz. 4A3046 Untested

BARREL KIT #92 3 AMP EPOXY RECTIFIERS

100 for \$1.98

Cosmetic rejects, electrically fine business! You check 'em, it's not for us. Ass. voltages. 4A3204

BARREL KIT #87 NATIONAL IC BONANZA

40 for \$1.98

Types 8000, 7400 series, DTLs, ROMs, registers, clock & cable chips, linear, etc. Cat. No. 4A2860 Untested

BARREL KIT #115 MOLEX SOCKETS

200 for \$1.98

Calculator maker dump! We got a zillion of 'em. Used for IC sockets, etc.

BARREL KIT #99 PHOTO ELECTRIC CELLS

10 for \$1.98

Asst. GE types, CDS types. Mixed by factory. Big job for us to separate. 100% good. Cat. No. 4A3052

BARREL KIT #88 2 WATERS

100 for \$1.98

100% good. Suppliers throw 'em in the barrel. It's a bit gold mine. All marked. Cat. No. 4A2735

BARREL KIT #73 TRANSISTOR ELECTROS

50 for \$1.98

We don't wish to separate wide ass. voltages & values up to 300 mf. Cat. 4A2747

BARREL KIT #86 HOBBY LEDS

40 for \$1.98

747's, 727's, singles, tri-ples, etc. 33 to 0.6. Bot from factory, all mixed; have fun! 4A2855

BARREL KIT #85 MIXED READOUTS

10 for \$1.98

Factory returns - such numbers as MAN-4's, MAN-7's, MAN-8's, 11 barrels & no time to separate. Ass. voltages. 4A3204

BARREL KIT #79 2N3055 HOBBY TRANSISTORS

15 for \$1.98

Fallouts of the famous 2N3055. 4A2617 100%

BARREL KIT #26 PLASTIC TRANSISTORS

100 for \$1.98

Untested. Type 70-92 (70-18), all manufacturers. Variety of 2N's. Cat. No. 4A2604

BARREL KIT #81 SUBMINI RESISTORS

200 for \$1.98

PC, 1/8 watt type, color coded. 1/4 watt. Asst values. Came to us in a barrel. Cat. No. 4A2748 100% good

BARREL KIT #78 POLYSTYRENE CAPS

100 for \$1.98

Finest caps made. As a sample we bought 10 barrels from factory, mixed values; all good. Cat. No. 4A2729

BARREL KIT #76 1-WATT ZENERS

100 for \$1.98

Factory same as 400-mw's. Never re-learn offer \$1.80. 10, 12, 15V, under glass. Double plug. Cat. No. 4A2741 Untested

BARREL KIT #75 1/8 DIGIT READOUTS

10 for \$1.98

Bargain of a lifetime! All we got was 1 barrel - the "bicolor digit" types. Multi-plexed. Cat. No. 4A2722

BARREL KIT #74 1/8 DIGIT READOUTS

10 for \$1.98

Large distributor cleaned house. Barrels of power resistors 3 to 7 watts. Cat. No. 4A2724

BARREL KIT #71 CAPACITOR SPECIAL

100 pcs. \$1.98

micas, moldeds, plastics, ceramics, discs, etc. Fifty 100% good. Cat. No. 4A2738

BARREL KIT #70 PNP HIGH-POWER TRANSISTORS

20 for \$1.98

Popular germanium TO-3 case 4A2616 100% good

BARREL KIT #69 PREFORMED DISCS

100 for \$1.98

Hi-Fi mfr's shelf inventory but he dumped 'em in barrels. Preformed for PC use. Mixed values too! 4A2605

BARREL KIT #68 2N3055 HOBBY TRANSISTORS

15 for \$1.98

Fallouts of the famous 2N3055. 4A2617 100%

BARREL KIT #67 METAL CAN TRANSISTORS

100 for \$1.98

Includes TO-5, TO-18, TO-18, etc., assorted 2N numbers, unmarked etc. Cat. No. 4A2603 Untested.

BARREL KIT #66 1 AMP "BULLET" RECTIFIERS

100 for \$1.98

Famous maker, popular item. Never grows old. But they way they marked 'em and barreled 'em, your advantage. Cat. No. 4A2614

BARREL KIT #65 GERMANIUM DIODES

200 for \$1.98

Popular item. Never grows old. But they way they marked 'em and barreled 'em, your advantage. Cat. No. 4A2614

BARREL KIT #64 LONG LEAD DISCS

100 for \$1.98

"Auction sale". Prime, marked only. Long leads. Cat. No. 4A2597 100% good

BARREL KIT #63 VOLUME CONTROL BONANZA

30 for \$1.98

100% good. Singles, duals, variety of values. 1/2, 1, 2, 5, 10, 20, 50, 100, 200, 400, 600, 800 and 1000 ohms. 4A2421

BARREL KIT #62 1/4 WATT ZENERS

100 for \$1.98

Factory same as 400-mw's. Never re-learn offer \$1.80. 10, 12, 15V, under glass. Double plug. Cat. No. 4A2741 Untested

BARREL KIT #61 POLYSTYRENE CAPS

100 for \$1.98

Finest caps made. As a sample we bought 10 barrels from factory, mixed values; all good. Cat. No. 4A2729

BARREL KIT #60 DIPPED MYLARS

60 for \$1.98

Finest capacitors made, shiny finish. Imagine factory dumping 'em in barrels. Cat. No. 4A2597 100% good

BARREL KIT #59 PREFORMED DISCS

100 for \$1.98

Hi-Fi mfr's shelf inventory but he dumped 'em in barrels. Preformed for PC use. Mixed values too! 4A2605

BARREL KIT #58 2N3055 HOBBY TRANSISTORS

15 for \$1.98

Fallouts of the famous 2N3055. 4A2617 100%

BARREL KIT #57 METAL CAN TRANSISTORS

100 for \$1.98

Includes TO-5, TO-18, TO-18, etc., assorted 2N numbers, unmarked etc. Cat. No. 4A2603 Untested.

BARREL KIT #56 1/4 WATT ZENERS

100 for \$1.98

Factory same as 400-mw's. Never re-learn offer \$1.80. 10, 12, 15V, under glass. Double plug. Cat. No. 4A2741 Untested

BARREL KIT #55 1/4 WATT ZENERS

100 for \$1.98

Factory same as 400-mw's. Never re-learn offer \$1.80. 10, 12, 15V, under glass. Double plug. Cat. No. 4A2741 Untested

BARREL KIT #54 1/4 WATT ZENERS

100 for \$1.98

Factory same as 400-mw's. Never re-learn offer \$1.80. 10, 12, 15V, under glass. Double plug. Cat. No. 4A2741 Untested

BARREL KIT #53 1/4 WATT ZENERS

100 for \$1.98

Factory same as 400-mw's. Never re-learn offer \$1.80. 10, 12, 15V, under glass. Double plug. Cat. No. 4A2741 Untested

HONEST ABE PENNY SALE

Order by Cat. No. 4A1981 & Typs. No.

5N7400N	\$0.16	\$0.17
5N7401N	.16	.17
5N7402N	.16	.17
5N7403N	.16	.17
5N7404N	.16	.17
5N7405N	.18	.19
5N7406N	.20	.21
5N7407N	.25	.26
5N7409N	.18	.19
5N7410N	.16	.17
5N7411N	.26	.28
5N7413N	.45	.46
5N7417N	.32	.33
5N7420N	.16	.17
5N7421N	.29	.30
5N7423N	.35	.36
5N7424N	.27	.28
5N7430N	.18	.17
5N7437N	.26	.27
5N7438N	.26	.27
5N7440N	.16	.17
5N7441N	.84	.85
5N7442N	.53	.54
5N7445N	.69	.70
5N7446N	.79	.80
5N7447N	.79	.80
5N7448N	.76	.77
5N7450N	.16	.17
5N7451N	.16	.17
5N7454N	.16	.17
5N7466N	.16	.17
5N7470N	.45	.46
5N7472N	.34	.35
5N7473N	.36	.37
5N7474N	.37	.38
5N7475N	.49	.50
5N7476N	.31	.32
5N7477N	.79	.80
5N7483N	.69	.70
5N7489N	1.95	1.96
5N7490N	.44	.45
5N7491N	.73	.74
5N7492N	.47	.48
5N7493N	.47	.48
5N7494N	.77	.78
5N7495N	.78	.79
5N7496N	.72	.73
5N74100N	.98	.99
5N74106N	.65	.66
5N74107N	.33	.34
5N74112N	.65	.66
5N74113N	.66	.67
5N74114N	.65	.66
5N74121N	.38	.39
5N74123N	.59	.60
5N74124N	.59	.60
5N74126N	1.00	1.01
5N74132N	.59	.60
5N74134N	.88	.89
5N74145N	.69	.70
5N74148N	1.28	1.30
5N74150N	.99	1.00
5N74151N	.70	.71
5N74153N	.65	.66
5N74154N	1.03	1.04
5N74155N	.70	.71
5N74157N	.70	.71
5N74158N	.85	.86
5N74159N	.88	.89
5N74161N	.88	.89
5N74164N	.79	.80
5N74165N	.99	1.00
5N74171N	1.39	1.40
5N74174N	.97	.98
5N74175N	.69	.70
5N74176N	.79	.80
5N74181N	2.05	2.06
5N74184N	1.75	1.76
5N74185N	1.75	1.76
5N74190N	1.15	1.16
5N74191N	1.05	1.06
5N74192N	.87	.88
5N74193N	.83	.84
5N74195N	.73	.74
5N74196N	.88	.89
5N74197N	1.49	1.50
5N74199N	1.49	1.50
5N74200N	3.98	3.99
5N74201N	1.98	1.10
5N74204N	5.95	5.96
5N74285N	5.95	5.96

radio^{em}

HAM, CB, SHORTWAVE LISTENING, MARINE RADIO, SCANNERS, MONITORS

BY JUDY CURTIS, WB3AIQ

Think of the *radio spectrum* as a giant radio dial where, if it were possible, you could tune continuously for miles.

Imagine the exotic signals you could hear—from China, Russia, the Middle East and even outer space. There are hundreds of thousands of stations transmitting on the air at the same time, each on a specific frequency with a definite purpose.

Of course, it's nearly impossible to have one receiver that tunes the entire spectrum, but you can have several pieces of gear that will let you eavesdrop on specific chunks.

Divided into bands

Spectrum space is divided into bands of frequencies. A *frequency* is one spot on our giant radio dial. Frequency is measured in hertz so, in theory, the spectrum goes from zero hertz to infinity. One

thousand hertz is one kilohertz (kHz), and one million Hertz is one megahertz (MHz).

Bands of frequencies are set aside for specific uses by an international conference held every 20 years. The next conference, the World Administrative Radio Conference, will be held next year to settle agreements on band allocations through the end of this century.

Governments of individual countries then further decide who shall have permission to operate on these bands of frequencies. In the United States, the Federal Communications Commission

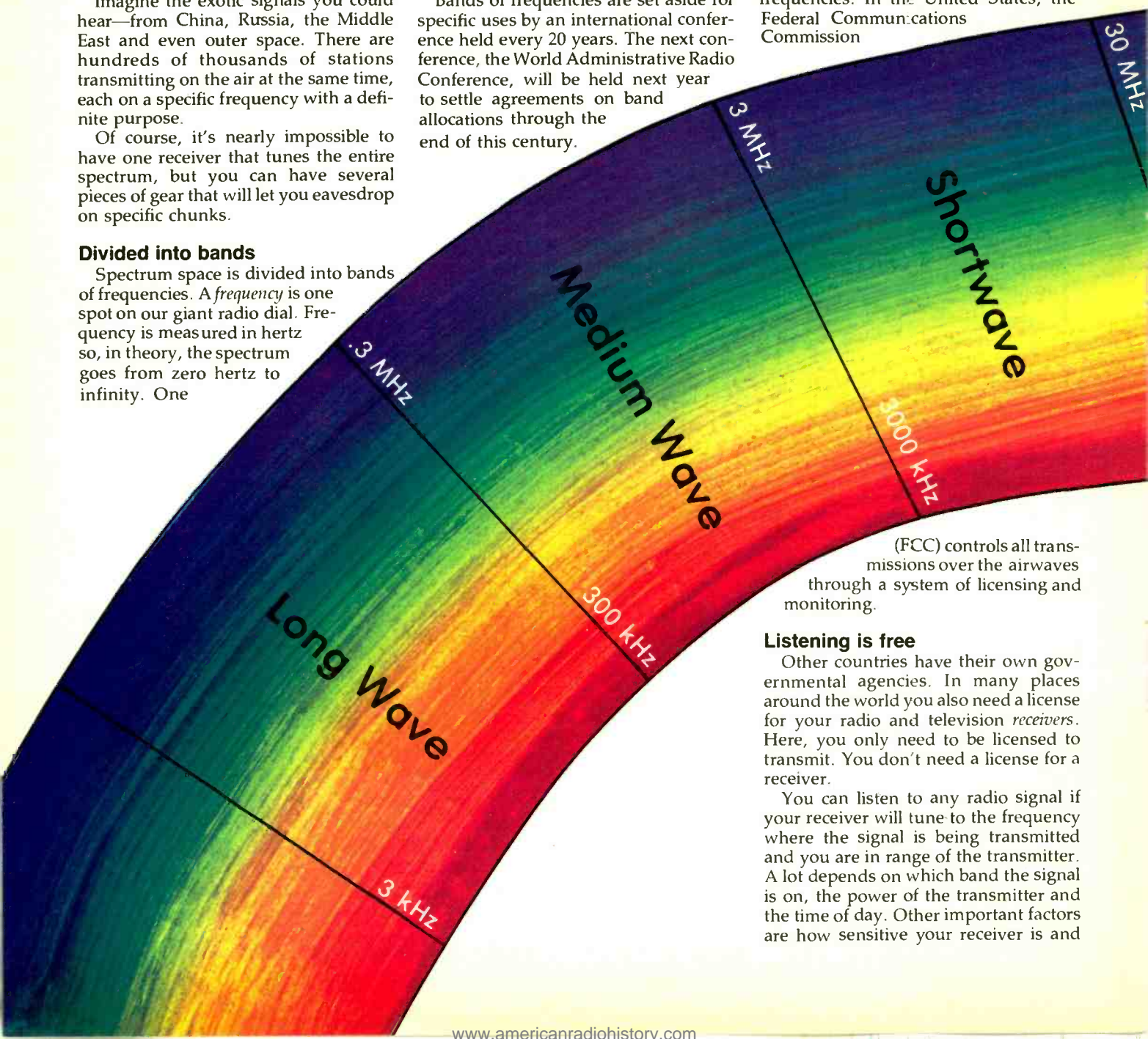

(FCC) controls all transmissions over the airwaves through a system of licensing and monitoring.

Listening is free

Other countries have their own governmental agencies. In many places around the world you also need a license for your radio and television *receivers*. Here, you only need to be licensed to transmit. You don't need a license for a receiver.

You can listen to any radio signal if your receiver will tune to the frequency where the signal is being transmitted and you are in range of the transmitter. A lot depends on which band the signal is on, the power of the transmitter and the time of day. Other important factors are how sensitive your receiver is and

the type of antenna you use.

You may be able to hear Radio Moscow from Europe but, because of your location and time of day, not be able to tune in a radio station in the next town.

U.S. am radio stations broadcast on frequencies known as *medium waves* while Radio Moscow broadcasts to us over *shortwaves*. But let's start with the *long waves* and tune up our giant radio dial.

Travel farther at night

The frequencies from 3 kHz to 300 kHz are known as long waves. Signals sent from high-power transmitters within these frequencies travel over long distances with little interference from tall buildings, mountains or other physical obstructions. You can find world-wide Navy shore-to-ship signals

and go farther during the day.

There are 11 international shortwave broadcasting bands to listen to. Also there are five amateur radio shortwave bands and the citizens band (CB).

Get in on the fun

Shortwave, medium and long wave signals travel long distances by bouncing between the *ionosphere* in the upper atmosphere and the Earth. In that way they *skip* around the globe. Not all radio signals travel that way, however. Many signals travel line-of-sight directly from point A to point B.

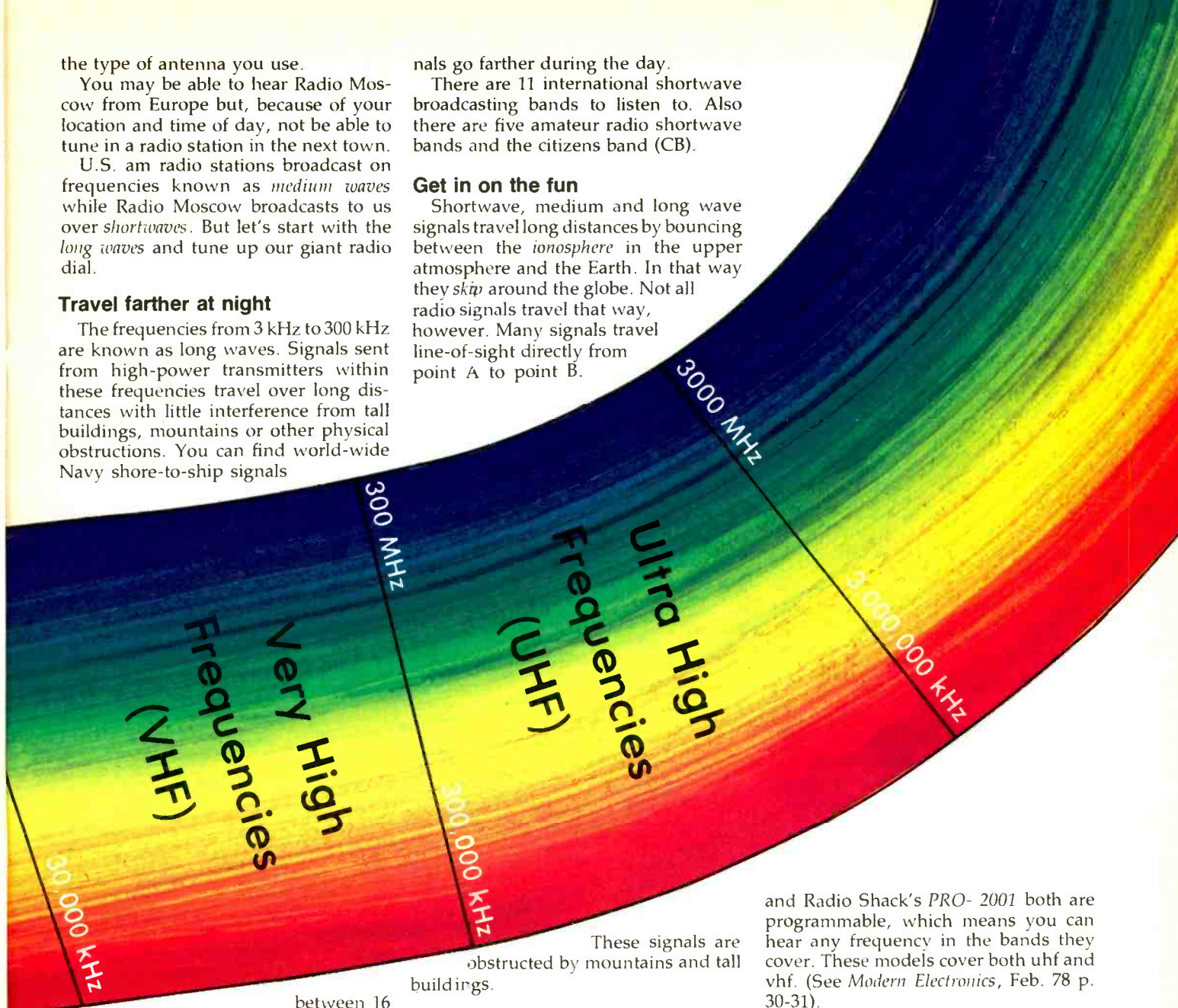

between 16 and 150 kHz as well as navigational radio beacons for ships and airplanes.

Medium wave frequencies cover 300 kHz to 3,000 kHz. Here again signals from high-power transmitters are not greatly affected by physical obstructions and travel long distances at night.

Between 535-1605 kHz you'll find the U.S. standard am stations broadcasting. You may have noticed that your car radio hears signals from distant stations at night that it doesn't receive during the day. During the day, there are more stations on the air to interfere with the signal, but at night a signal also travels farther.

Also you can listen for time signals from foreign countries from 417-485 kHz or the U.S. Coast Guard at 2666-2706 kHz.

Shortwave frequencies cover 3 to 30 MHz. As with medium wave signals, lower shortwave frequencies travel farther at night. Higher shortwave sig-

These signals are obstructed by mountains and tall buildings.

How signals travel

Very high frequencies (vhf) from 30 MHz to 300 MHz travel line-of-sight. Here you find fm radio broadcasters and tv broadcast channels 2-13. Also many police forces use the (vhf) band. Hams have three vhf bands.

The police in your town, though, may be on the uhf band which goes from 300 MHz to 3,000 MHz. Although the spectrum extends beyond 3,000 MHz, there's not much at that end that you would be interested in listening to unless you are into tuning in police radar traps! At uhf are tv broadcast channels 14-83 and three amateur radio bands.

If you want to get in on the listening fun, you'll have to decide what you'd like to hear and get a receiver that covers those frequencies.

If you want to listen to the police, fire and ambulance crews in your town, a scanner is a good choice. The model from Electra Company called *Bearcat 210*

and Radio Shack's *PRO-2001* both are programmable, which means you can hear any frequency in the bands they cover. These models cover both uhf and vhf. (See *Modern Electronics*, Feb. 78 p. 30-31).

Be careful, however, not to get a vhf only scanner if the police in your town are on uhf.

To hear exotic signals from around the world, you'll need a receiver that covers the shortwave bands. There are many models to choose from. A good receiver to consider is Yaesu's *FRG-7*. (See *Modern Electronics*, Feb. 78 p. 68-71)

A new model on the market is Panasonic's *RF-2800*, which covers am and fm bands plus 3.2-8 MHz, 8-16 MHz and 16-30 MHz in the shortwave band.

Radio Shack's *DX-160* covers that part of the spectrum from 150-400 kHz. And any good general-coverage receiver capable of tuning the 80-meter ham band from 3.5-4.0 MHz can be changed to tune just about all of the very low frequencies (vlf) below 500 kHz by adding a Palomar Engineers vlf converter between antenna and receiver.

Wherever you are in the spectrum, happy DXing!



news check ^{em}

STOP THE PRESSES: LAST MINUTE NEWS JUST IN TO MODERN ELECTRONICS

FCC HAS RADICALLY CHANGED ham radio callsigns: extra-class licensees now can have so-called 2x1 calls along with 1x2s. Example of 2x1 would be NA6A or WA2L. Advanced-class hams now will have 2x2 calls such as NA3AA. General and technician class amateurs will be 1x3 such as N4CBA or K8QLM. Novice-class amateurs will have 2x3 callsigns such as AA7ZYX. Prefix letters can start with W, K, N or A. Hams may keep existing calls or switch to new.

VIDEO FREAKS, MARK YOUR calendars. 1978 Video Expo dates are Madison Square Garden, New York City, Oct. 15-17; Hyatt Regency, Houston, Dec. 5-7; and Jack Tar Hotel, San Francisco, Feb. 20-22, 1979. Workshops and seminars will be featured.

OCSAR 8, THE LATEST IN a string of amateur radio spectaculars, was launched March 5 from California. It's on the air now for ham use. Non-amateurs can eavesdrop on hams chatting through the communications satellite between 29.4-29.5 MHz in the 10-meter band. The bird's strong beacon is easily heard at 29.402 MHz. Listeners with uhf capabilities can listen to 8's other beacon at 435.095 MHz.

CB ENTHUSIASTS PLANNING EUROPE tours by car may find problems. England, Ireland and Holland prohibit CB use. Same for Yugoslavia. France limits transmitter output to 50 milliwatts. That's one-hundredth of US power limits. Luxembourg and Hungary limit to 100 milliwatts and Switzerland permits only 100-milliwatt walkie-talkies. Belgium prohibits transmitting, according to Norm Hansen of Telex.

BIGGEST NEWS IN SOME ham radio circles in 20 years, a DXpedition to remote Clipperton Island in the Pacific Ocean, happened this spring. Thousands of DX-happy amateur radio operators competed for coveted contacts which would produce a rare Clipperton QSL card.

CBERS WATCH OUT FOR sunspots over the next 36 months. You may not be able to talk to your wife in the kitchen from your own driveway! The current round of spots, known as Cycle 21, will see the highest number of pockmarks on Old Sol's face in many years, maybe ever. Such high solar activity will make CB skip predominant over local communications; let hams talk to the four corners of the Earth 24 hours a day; damage space satellites; disrupt very-low frequency Omega navigation aids to ships and planes; and, maybe, have strange impacts on worldwide weather.

THE FCC'S PLAIN-ENGLISH CB rules and regs become effective August 1. Get your own copy of the new Part 95 FCC rules from the Government Printing Office. Meanwhile, reprints of the FCC's tvi compendium, How To Identify and Solve Radio-Television Interference Problems, are available at \$1 plus 25¢ postage/handling from Cowan Publishing Corp., 14 Vanderventer Ave., Port Washington, NY 11050.

US COAST GUARD MONITORS CBchannel 9 as long as such listening doesn't interfere with the USCG's prime mission: monitoring marine-radio channels. USCG has installed CB gear at its Search and rescue stations across the US. VHF-fm and 2182 KHz shortwave remain top priority for Coast Guard monitoring.

Uncompromising performance. Incredible price. A professional 3½ digit DMM Kit for less than \$70.



Incredible? True! Professionals and hobbyists alike are believers in this Sabtronics 2000, the only portable/bench DMM which offers such uncompromising performance at the astonishingly low price of \$69.95.

Uncompromising performance you'd expect only from a specialist in digital technology such as Sabtronics: DCV accuracy of 0.1% ± 1 digit; 5 functions giving 28 ranges; readings to ± 1999 with 100% overrange; overrange indication; input overload protection; automatic polarity; and automatic zeroing.

The low price of \$69.95? Simple: The Model 2000 is all solid-state, incorporating a single LSI circuit and high-quality components. You assemble it yourself, using our clear, easy-to-follow, step-by-step assembly manual. Kit is complete, including a high-impact case.

Now you too can have it! A professional-quality, 3½ digit Sabtronics Model 2000 DMM kit for only \$69.95. If you don't have one in your lab, use the coupon below to order NOW.

BRIEF SPECIFICATIONS:

DC volts in 5 ranges: 100 µV to 1 kV · AC volts in 5 ranges: 100 µV to 1 kV · DC current in 6 ranges: 100 nA to 2 A · AC current in 6 ranges: 100 nA to 2 A · Resistance: 0.1 Ω to 20 MΩ in 6 ranges · AC frequency response: 40 Hz to 50 kHz · Display: 0.36" (9,1 mm) 7-segment LED · Input impedance: 10 MΩ · Size: 8" W x 6.5" D x 3" H (203 x 165 x 76 mm) · Power requirement: 4 "C" cells (not included).

GUARANTEE:

Examine the 2000 DMM kit for 10 days. If not completely satisfied, return unassembled for full refund of purchase price. (Less shipping and handling)



Made in U.S.A.

sabtronics 
INTERNATIONAL INC.

13426 Floyd Circle Dallas, Texas 75243

To: Sabtronics International, Inc.
13426 Floyd Circle, Dallas, TX 75243

ME-6

Please send me _____ Sabtronics Model 2000 DMM kit(s)
at \$69.95 each..... \$ _____
Shipping and handling, \$5.00 per unit* \$ _____
Texas Residents Add Sales Tax \$ _____
TOTAL enclosed \$ _____

Name _____

Street _____

City _____

State _____ Zip _____

*USA only. Canada \$6.50. All other countries, \$10.00 (surface mail)

CIRCLE 39 ON READER SERVICE CARD



The pick-up cost \$21,000.
The President SSB is somewhat less.

SSB (single sideband) is the most sophisticated form of CB.

And President may well have the most sophisticated form of SSB:

All new for 1978, it's called Adams.

It gives you more range and performance than any ordinary CB—with 12 watts of peak envelope power.

And it gives you a lot more ways to get the word out—with 40 upper sideband channels, 40 lower sideband channels and 40 AM channels.

And it gives you more ways to *control* the way the word

gets out and in than the average police radio—with 19 controls and switches covering every function.

And hear this:

Adams can keep an ear out for you on three channels at once—Channel 9 for emergencies, Channel 19 for the road, and the channel of your choice.

Now you may not want to spend \$21,000 for a pick-up.

But if you did, there'd be only one CB to put in it—Adams.

A radio you can afford right now.

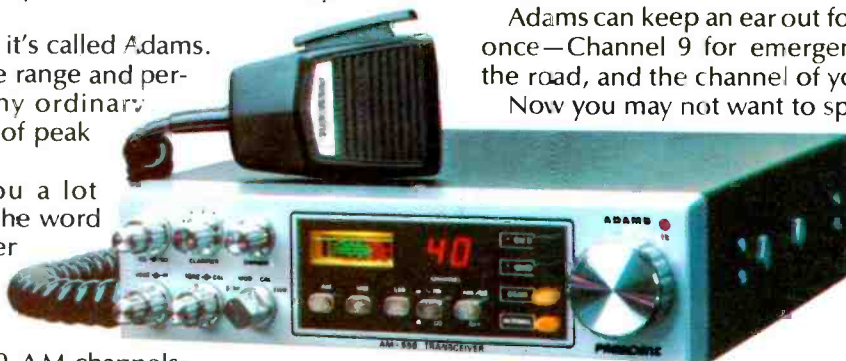

PRESIDENT

Engineered to be the very best.

President Electronics, Inc.
16691 Hale Avenue - Irvine, CA 92714 - (714) 556-7355
In Canada: Electron Radio Sales Ltd., Ontario

CIRCLE 99 ON READER SERVICE CARD