

March 1978 \$1.50

modern electronics

Buyer's guide to
19 microcassette recorders

Ⓕ 06707

What's in a computer
page 44

Robots:
report from the man
who built his own
page 78

Exclusive interview:
the man who builds space
satellites in his basement
page 29

FCC strike force:
how it works, who it catches
page 25

9 easy projects

**Videogames
roundup:
the best,
most fun**

page 36

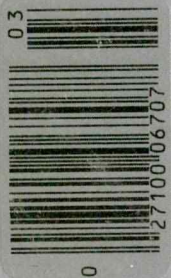
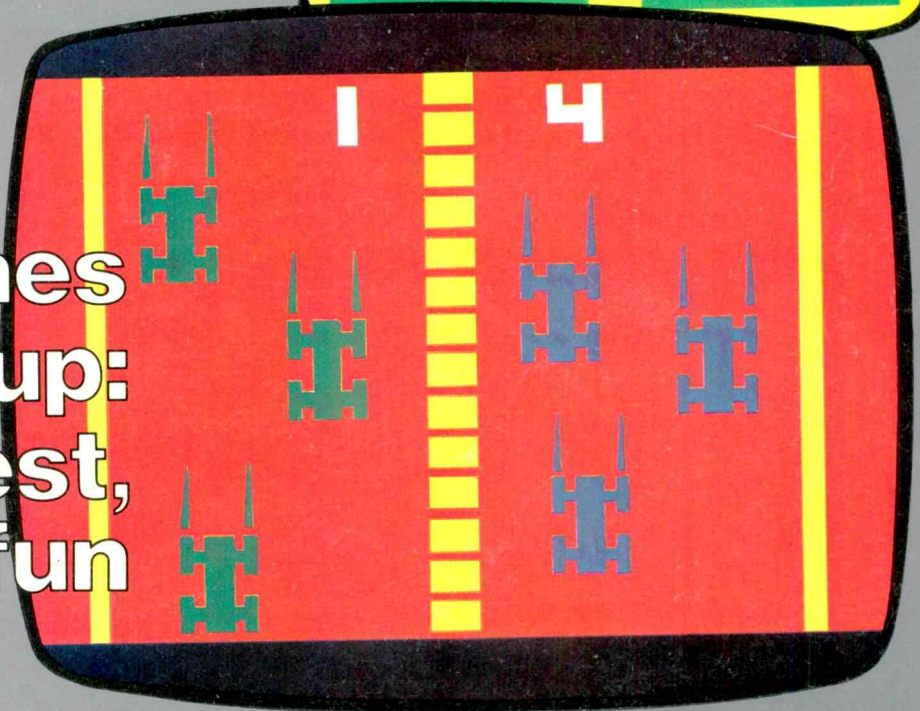
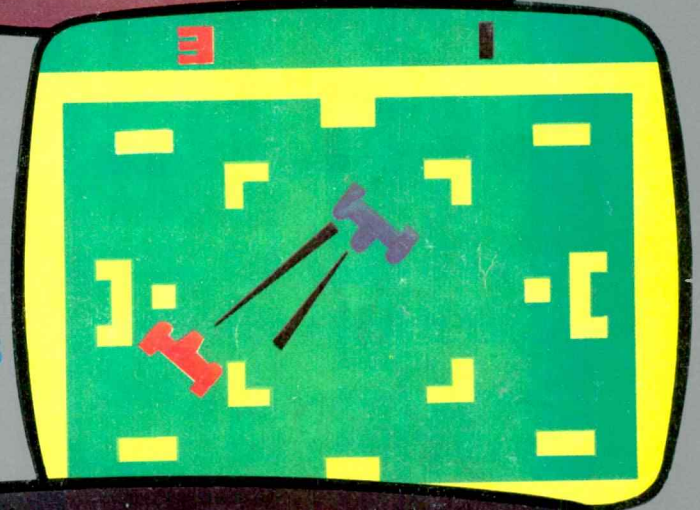
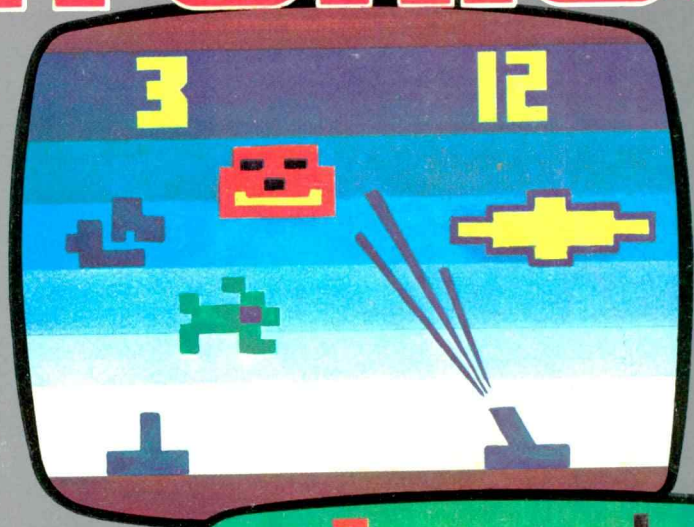

avanti ASTRO BEAM is the most efficient 3 element antenna for CB

Pin lock design prevents twisting and aligns elements for efficiency.

6061-T6 aluminum tubing for long life.

**40
CHANNEL
ENGINEERED**

High strength weather resistant Cyclocac hubs for durability

Low wind load and mechanically balanced configuration.

CO-INDUCTIVE COUPLING IS THE KEY TO BETTER PERFORMANCE...

we started with another Avanti antenna — the Astro Plane (patented) — as a radiator, then added a reflector and a director to achieve the co-inductive beam configuration. The Astro Plane has more gain to begin with than a dipole which is commonly used as the radiator of a beam and it couples to the director and the reflector more efficiently. This close coupling results in an unprecedented 40 db front-to-back ratio. A 40 db+ rejection means that if a signal is coming in at a certain strength and the ASTRO BEAM is turned around so that the back is toward the signal, the signal will drop 40 db or more*.

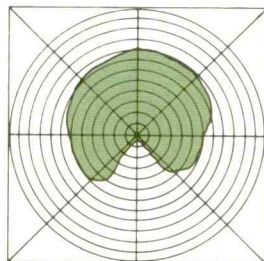

*The Actual Astro Beam Polar Plot Shows Signal at 41 db Power Level Reduced to Almost 0 db on Back of Antenna. Think of how you can cut out unwanted signals with this kind of rejection.

Forward gain of 11 db over an isotropic source is a means of rating the antenna's ability to increase, receive, and transmit signals. The point here is that the ASTRO BEAM has about 1 db more than the best 3 element beam currently on the market. This gain has the equivalent of multiplying your power about 12.5 times.

SPECIFICATIONS

Rejection — 40 db+ front-to-back
 Forward Gain — 11 db over an isotropic source
 Impedance — 50-52 ohms
 Boom Length — 10½ feet, Weight — 14 lbs.
 Mode — Vertical Beam Wind Load Area — 2.6 sq. ft.
 Light to Medium duty rotor needed
 Turning Radius — 63 inches Power Multiplication — 12.6x
 AV-150 \$79.95

Avanti has a complete line of High Performance Mobile Antennas from \$11.95 to \$72.50.



Avanti Research & Development, Inc. 340 Stewart Avenue Addison, IL 60101
 CIRCLE 97 ON READER SERVICE CARD

from the makers
of the famous

MOONRAKER

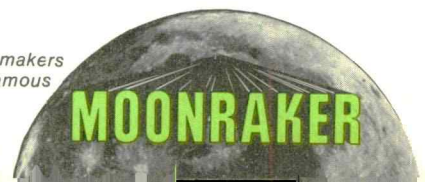

WHY SETTLE FOR LESS— THAN A 6800 SYSTEM

MEMORY—

All static memory with selected 2102 IC's allows processor to run at its maximum speed at all times. No refresh system is needed and no time is lost in memory refresh cycles. Each board holds 4,096 words of this proven reliable and trouble free memory. Cost—only \$125.00 for each full 4K memory.

INTERFACE—

Serial control interface connects to any RS-232, or 20 Ma. TTY control terminal. Connectors provided for expansion of up to eight interfaces. Unique programmable interface circuits allow you to match the interface to almost any possible combination of polarity and control signal arrangements. Baud rate selection can be made on each individual interface. All this at a sensible cost of only \$35.00 for either serial, or parallel type

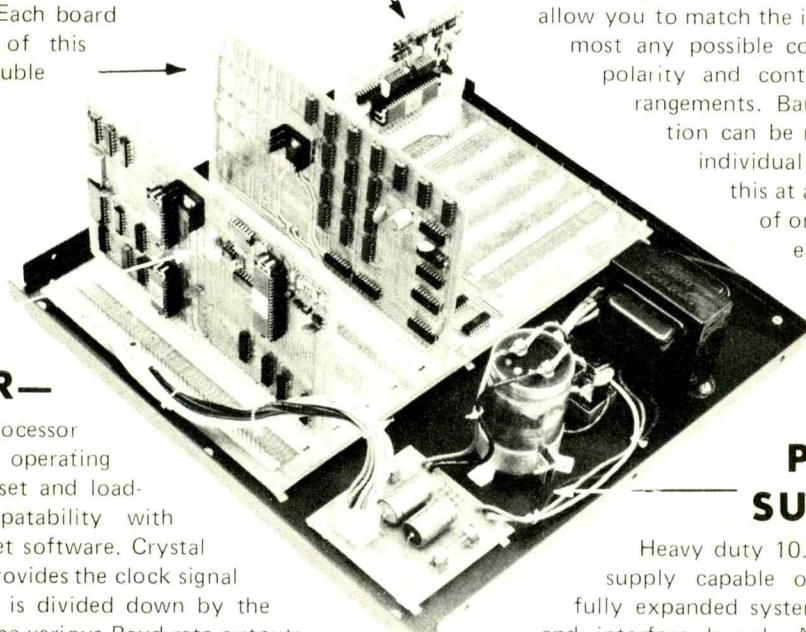

PROCESSOR—

"Motorola" M6800 processor with Mikbug[®] ROM operating system. Automatic reset and loading, plus full compatibility with Motorola evaluation set software. Crystal controlled oscillator provides the clock signal for the processor and is divided down by the MC14411 to provide the various Baud rate outputs for the interface circuits. Full buffering on all data and address busses insures "glitch" free operation with full expansion of memory and interfaces.

POWER SUPPLY—

Heavy duty 10.0 Amp power supply capable of powering a fully expanded system of memory and interface boards. Note 25 Amp rectifier bridge and 91,000 mfd computer grade filter capacitor.

DOCUMENTATION—

Probably the most extensive and complete set of data available for any microprocessor system is supplied with our 6800 computer. This includes the Motorola programming manual, our own very complete assembly instructions, plus a notebook full of information that we have compiled on the system hardware and programming. This includes diagnostic programs, sample programs and even a Tic Tac Toe listing.

Mikbug[®] is a registered trademark of Motorola Inc.

SwTPC 6800
Computer System

with serial interface and 4,096 words of memory. \$395.00



Enclosed is \$395 for my SwTPC Computer Kit Send Data
 or BAC _____ # _____
 or MC _____ Ex Date _____

 NAME _____

 ADDRESS _____

 CITY _____ STATE _____ ZIP _____
 Southwest Technical Products Corp., Box 32040, San Antonio, Texas 78284

At last... a no compromise, ultimate specification SSB radio has been developed for the dedicated sidebander. Would you like total freedom from overload, dual crystal filters, microprocessor channel selection, speech processing, a true frequency counter, 10 turn clarifier, AM suppression, PEP reading wattmeter, discriminator SWR meter? You get all this and much more when you own the world's

most professional 11 meter SSB radio, the STONER PRO-40. Of course, it's totally produced in the U.S.A.

For more information, contact a CB sideband specialist in your area or write for our free full color brochure.

STONER

The Sideband People

John Hancock Building, Mercer Island, WA 98040
Phone (206) 232-9464

The Professional.



CIRCLE 2 ON READER SERVICE CARD



modern electronics

MARCH 1978

CONTENTS

VOLUME ONE NUMBER TWO

COVER STORY

36 Videogames roundup: the best and most fun



Dr. Bob's colorful compendium of tv fun

EDITOR

Anthony R. Curtis
K3RXK/W8TIZ

ASSISTANT EDITOR

Bob Margolin
K1BM/KABA6647

CONTRIBUTING EDITORS

Judith G. Curtis
WB3AIG/KIB2647

Hans Fantel

Peter A. Stark
K2OAW

Gerald R. Patton
WA3VUP

Ron Cogan

Jeffrey A. Sandler

Carmine W. Prestia
WB3ADI

DESIGN CONSULTANT
Don Mannes

PUBLISHER
Richard A. Cowan
WA2LRO/KGB4096

Modern Electronics is published monthly by Cowan Publishing Corp., 14 Vanderventer Ave., Port Washington, NY 11050. Our title is registered with the United States Postal Service. Application for second-class postage is pending at Port Washington, NY.

SPECIAL FEATURES



25

FCC strike force how Uncle Charlie tracks down lawbreakers



29

74 car security unique new alarm installs easily

78 Robots first there was Mel, now there's Rodney and Buster

82 Filters understanding sensitivity in CB, ham, SWL receivers

Basement satellite builder Jan King tells how OSCAR was built



58

44 What's in a computer complete story of what goes on inside

48 Microcassette recorders buyer's guide to 19 of the best

Ham autopatch how it can work in action

PROJECTS

- 90 Raindrop counter** now you can know how many splash against your windows
- 56 Ultimate do-nothing box** world's most elaborate light blinker and useless beeper
- 66 5 spring weekenders** easy to do things for this Saturday
- 70 Code practice oscillator** build this quickie and get started in ham radio
- 86 Portable PA** out-shout your friends with this homebrew loudhailer

- 96 Newscheck** late news in the world of electronics

COLUMNS

- 4 Comment** Tony's soapbox
- 11 Computers** Pete explains the difference between computers and calculators
- 14 Stereo** Hans finds more quality for less money in '78 audio gear
- 16 Radio** Judy tells how to put your own repeater on the air
- 21 Mobile** Ron finds a computer you can add to your car

MONTHLIES

- 6 Clinic** readers try again to stump the editors. Score: readers 1, editors 10
- 8 How it works** wait'll you see what they've done with the HP-25 calculator
- 54 Program** two easy sets of instructions for your own home computer this month
- 60 Handbook** batteries supply electricity

INFO

- 64 Home study** 13¢ stamp brings a new hobby
- 69 Frequency counters** how the hot new CB and ham add-on works
- 77 Sunspots** solar flares can wreak havoc with your two-way radio anytime
- 88 Relative jump ruler** quick tool you can make for your home computer

comment

OUTPUT FROM MODERN ELECTRONICS' EDITOR

BY ANTHONY R. CURTIS
EDITOR, MODERN ELECTRONICS

March! In like a lion. That's how we've put together this second issue of *Modern Electronics*. Our fierce line-up of features starts with the growl of Uncle Charlie as he pounces on a CB bootlegger (page 25).

We're mighty proud of the ME exclusive interview with Jan King, the ham who builds honest-to-goodness space satellites in his own home (page 29). Contributing Editor Randy Patton delivered strong journalism in digging out the human side of electronic technology.

We thought about calling Assistant Editor Bob Margolin's videogame roundup (page 36) *Everything you ever wanted to know about videogames* or *Dr. Bob's colorful compendium of tv fun*, mainly because you'll find everything there except the kitchen sink. With the game market changing so rapidly, it's hard to get a complete handle on what's available. This roundup freezes a frame of the moving picture as things stand this month.

Other goodies this month include:

- a buyer's guide to 19 of the best microcassette recorders (page 48);
- Pete Stark's sharp-eyed look at just what exactly is inside a home computer (page 44);
- an action cartoon depicting how ham autopatch telephone calls work (page 58);
- the science of robotics is explained by Dave Heiserman who builds robots in Ohio (page 78);
- good receiver sensitivity, a feature to shop for in CB, ham, SWL, marine or other radio receiver, is easy to understand in George McCarthy's description (page 82);
- a barrel of good one-night and weekend projects including a raindrop counter (page 90), our design for the ultimate in a do-nothing box (page 56), something different in a code-practice oscillator (page 70), a portable PA (page 86), and an assortment of five other spring quickies (page 66).

We also have Basic computer programs you can use today, explanations of power supplies and gates and frequency counters, a look at what promises to be a super-popular new programmable hand calculator, a report on sunspots, car security and even a new computer for your car.

Try us. We think you'll like what you find in *Modern Electronics*. 

COMING NEXT MONTH

We're lining up a world of colorful, exciting features, columns, projects and other informative articles for the coming months in *Modern Electronics*. Here's a quick peek:

APRIL

Build an R2-D2 sound-effect box. Roundup of digital-readout electronic instruments for your car. Complete story of OSCAR satellites. Late word on the new Russian ham satellite. Thumb Thing project. TI-59 calculator evaluated. Build the Modu-Clock. How home computers work and what to look for when you buy one. What's a NiCad battery. Late news on new shortwave stations you can tune in. Lots of projects for April-showers weekends. Plus our every-month line-up of reports and evaluations of useful new gear; easy-to-understand instruction in basic electronics; and exciting accounts of the many different hobbies within electronics by hobbyists actually in those fields.

FUTURES

Here's a short sample from beyond April:

1. CMOS projects. 2. CB repeaters. 3. Summer-nights projects. 4. Stereo add-ons. 5. Pocket scanners. 6. National Weather Service broadcasts. 7. Nine uses for SCRs. 8. Computer tape punchers. 9. How to SWL RTTY signals. 10. Digital logic made simple. 11. Supermeter. 12. MoFi. 13. In-dash CB roundup. 14. LED field-strength meter. 15. Electronics home-study schools for FCC first-class licenses. 16. Reel-to-reel tape decks. 17. Op-amp projects. 18. Pocket beepers. 19. Capacitance in the Handbook. 20. Batteries explained. 21. How a Z80 differs from an 8080. 22. I/O explained. 23. Light-wave telephones. 24. Tapes in outer space, and LP records, too. 25. Crossword puzzles. 26. Recipe card projects. 27. New gear. 28. Video recording. 29. Scanners and monitors. 30. How to get started in ham radio. 31. Best shortwave receivers.

modern electronics

Business Staff

President and Publisher
Richard A. Cowan
Associate Publisher
Richard A. Ross
Vice President
Jack N. Schneider
Chairman of the Board
S. R. Cowan

Advertising Staff

Display Advertising
Richard A. Cowan
telephone (516) 883-6200
Advertising Manager
Bill Edwards
telephone (603) 924-3360
Midwest Sales Director
Jim Reilly
telephone (312) 824-2412
Circulation Manager
Janet Kurtz
Production Consultant
Cary L. Cowan

Art Staff

Art Director
William H. Travis
Assistant Art Director
Liz Beener
Design
Sheryl Stern
Illustrator
Harold Perry
Staff Artist
Fran Vitrano
Staff Artist
Tom Batcher

Property rights

All circuits, designs and construction projects in *Modern Electronics* are strictly experimental. We can't guarantee any results to be expected from their use or application. The publisher and editors do not know of any proprietary rights which could be violated by the making, building or using of any projects or gear described in this issue.

Freelance writers

Letters to the editors should be addressed to *Modern Electronics*, 14 Vanderver Ave., Port Washington, NY 11050. Our editorial telephone is (516) 883-6200. We can't assume responsibility for unsolicited manuscripts but we will try to handle them courteously. Please mark your name, address and telephone number clearly on each page of manuscripts and on all photographs and artwork. *Modern Electronics*' readers demand manuscripts, photographs and artwork of the finest quality. Writers, photographers and artists meeting the standards of *Modern Electronics*' editors will receive prompt professional payment for submissions upon acceptance.

Change of address

Send us word of your change of address as early as possible. We need at least six weeks to make the change in our mailing list. Address changes and Postmaster form 3579 to Circulation Department, *Modern Electronics*, 14 Vanderver Ave., Port Washington, NY 11050. Include your old address, new address and a mailing label from a recent issue of *Modern Electronics*.

Subscriptions

Mail subscriptions are available for \$12 a year or \$22 for two years. Newsstand cover price is \$1.50 per issue. Subscriptions are slightly higher for other countries. Write Circulation Department, *Modern Electronics*, 14 Vanderver Ave., Port Washington, NY 11050. This magazine is printed in the United States of America.

Copyright

Copyright to the whole contents of *Modern Electronics* is held by Cowan Publishing Corp. 1978. You may not reprint any of our material without written permission from Cowan Publishing Corp.

Don't Settle for an Imitation . . .

Alpha V58

Omni-Directional $\frac{5}{8}$ Wave, Vertical Ground Plane with Four Full Length Radials, CB Base Station Antenna

Superior to all other verticals, the Alpha V58 is a $\frac{5}{8}$ wave ground plane antenna with a 5.14 dB gain. Four full-size radials provide a DC ground to eliminate ignition and other static noise. Loop loading eliminates the need for a coil, so nothing can burn out. Wilson's unique ACC (*Adjustable Capacitive Coupling*) system enables a flat 1.1 to 1 SWR in the widest range of installations.

Durable Alpha V58 stands at 21 feet and can handle up to 2 kW of power.

Specifications

- Gain 5.14 dB
- 4 full length radials
- Loop loading
- 1.1 to 1 SWR
- No coils to burn out
- Frequency range 26.5 to 29 MHz
- Will handle 2,000 watts
- Height, 21 ft.
- Weight, 7 lbs.
- New radial hub design

Available at Better CB Dealers Nationwide

Dealers wanted...For many areas of the country! Write for details on the coming and authorized Wilson dealers.

V1

Omni-Directional $\frac{5}{8}$ Wave, Vertical Ground Plane CB Base Station Antenna

Ideal for campers and mobilers who want portable operation, the V1 is the perfect antenna. A $\frac{5}{8}$ wave vertical ground plane antenna without radials, it can be set up or taken down in less than five minutes. Without radials, the space required for installation can be cut to a minimum, thus making it the logical choice for apartment or condominium use.

The V1 has a gain of 3 dB and features the loop loading ACC (*Adjustable Capacitive Coupling*) system, and durability of the Alpha V58 antenna. It stands 21 feet high, weighs only five pounds, yet will handle up to 2 kW of power.

Specifications

- Gain 3 dB
- No radials
- Loop loading
- 1.1 to 1 SWR
- Frequency range 26.5 to 29 MHz
- No coils to burn out
- Will handle 2,000 watts
- Height, 21 ft.
- Weight, 5 lbs.

Insist on Wilson

Also Available from:

Wilson

- Mobile Antennas
- Rotors
- Crank up Towers

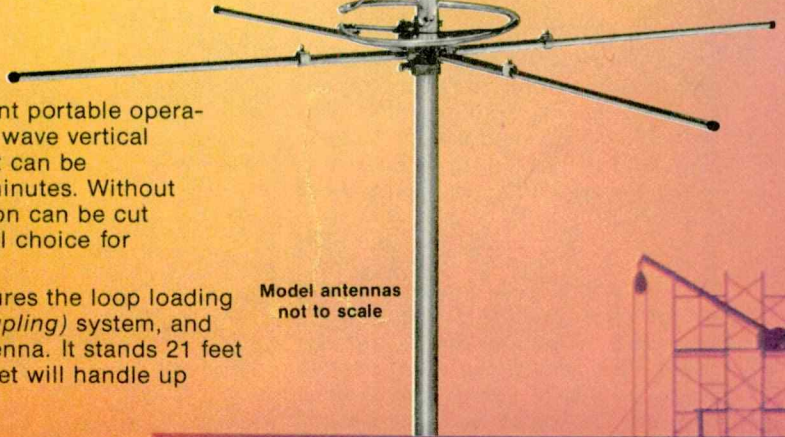

Model antennas not to scale

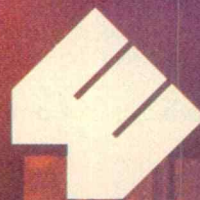

Wilson Electronics Corp.

Wilson Electronics Corp.
4288 S. Polaris Avenue, P.O. Box 19000
Las Vegas, Nevada 89119
Phone 702-739-1931 • TELEX 684-522

CIRCLE 5 ON READER SERVICE CARD

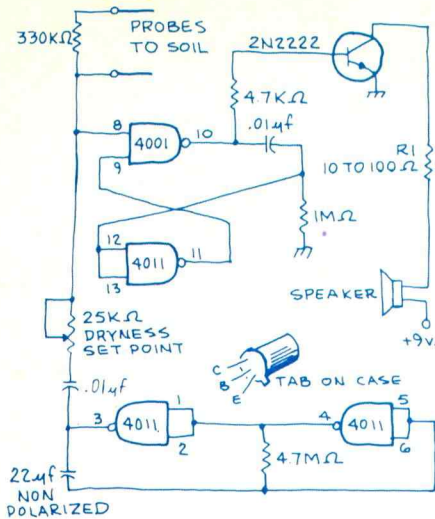

I think you'll like this circuit—it will remind you to get the water can by sounding a "click" every second or two when the soil moisture falls below a preset level, controlled by a variable resistor. You can vary the loudness of the clicks by selecting the value of R1—lower resistance values produce louder clicks. A standard nine-volt transistor battery should last a year.

Magnet flasher

I've just built an HO gauge train layout with a single-track mainline. I'd like to install a working highway crossing flashing signal turned on and off by the train. The flasher uses "grain of wheat" bulbs.

W.B., Conneaut Lake, PA

Since your layout is relatively small, all of your trains will be about the same length. If you'll place a reed relay between the rails on each side of the crossing at distances equal to the longest trains you run, your flasher will

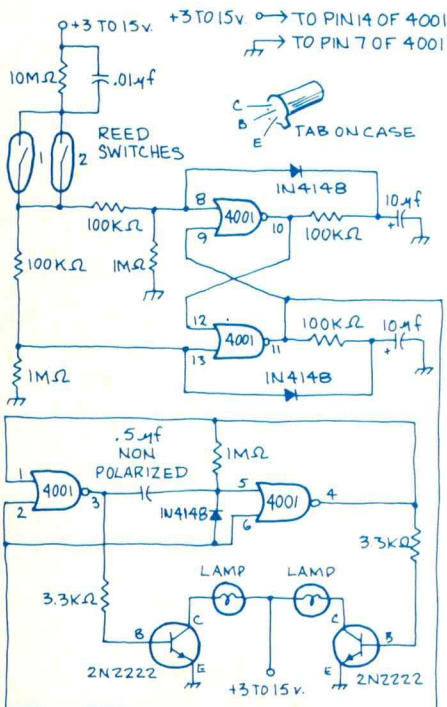

work just like the prototype—start flashing before the train arrives and stop just after the last car passes, regardless of which direction it travels. The relays are activated by small permanent magnets glued to the bottom of your locomotives.

Micrometronome

My daughter just began taking music lessons. The mechanical metronome she uses is too large for her to carry around. Can you come up with a compact unit she can take wherever she goes?

C.J., Ferndale, MI

Here's a compact electrical metronome that will run for years on a single nine-volt transistor battery, has both tone and pulse rate controls, and uses touch plates to start and

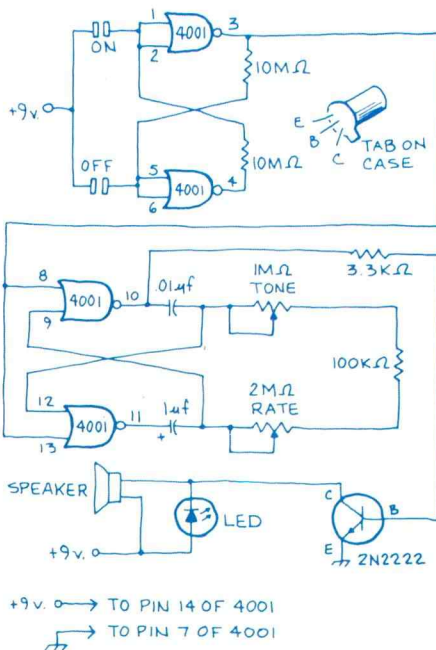

stop it. The whole thing, including battery and speaker, can be built in a case no larger than a pack of cigarettes. The touch plates consist of two strips of metal about 1/16-inch apart mounted on, but insulated from, the case. When your daughter bridges the gap, she in effect closes the switch.

Jet flutter-by

I live about 20 miles from the local television transmitting antennas and usually get a really great picture—no ghosting or anything. But, every few minutes the picture seems to shake or jump back and forth. A friend says it's because there's an airport near here. Is that true? Is there anything I can do about it?

V.M., Arlington, TX

Your friend is right. What you're seeing is called "flutter." It's caused by some of the tv signal being reflected off those airplanes landing and taking off nearby. When your tv set gets two signals, it will lock onto the strongest one, with the other appearing as a ghost. But with flutter, sometimes the

reflected signal is stronger, sometimes the direct signal is stronger. So, your tv alternately locks onto the real picture and onto the ghost. There's nothing you can do about it now. In 10 years or so, broadcasting methods may change enough to eliminate the problem.

How's a gqzlxbg work?

One of the most frequently asked questions is: "How does a ---- work?" While we'd like to answer these questions, there just isn't enough room in *Clinic* to do an adequate job. You'll find answers to some of these questions in our *Handbook* series, and in occasional articles, such as one on digital gates elsewhere in this issue.

A much better source of such information, however, is in specialized books on the subject. One such book is the recently released *The Design of Operational Amplifier Circuits, with Experiments* by H.M. Berlin, published by E&L Instruments, 61 First St., Derby, CT 06418. This 155-page book covers just about everything you'll ever need to know about op-amps, and at \$8.50 it's a must for your technical library.

Y music

I have a manual turntable in my stereo set up. I'd like to install an automatic shut-off switch that kills the amplifier as well as the turntable when the record has finished playing. I'd rather not get into the internal wiring of either unit if I can help it.

S.D., Atlanta, GA

The circuit shown here requires only a connection to the phono output. You can even use a "Y" connector at the amplifier input for the connection. Make sure that the relay contacts are rated to handle the combined load of both the turntable and the amplifier. Two minutes or so after you depress the

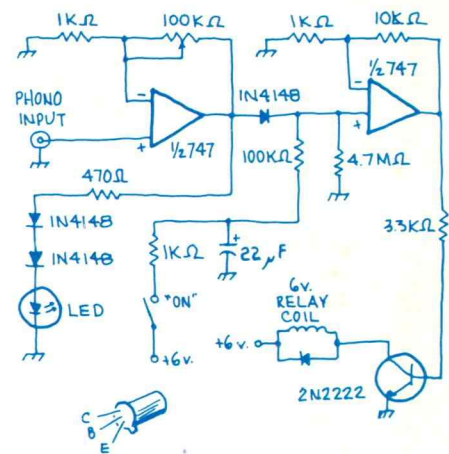

"on" pushbutton, or after the music ends, the amplifier and turntable will automatically turn off. You can change the delay by changing R1 and C1; larger values provide more time delay.

how it works ^{EM}

ONE PIECE OF GEAR EXPLAINED

BY GERALD R. PATTON

If you thought the HP-25 was the cat's meow, wait'll you see what they've done to it now.

There's a new round underway in the continuing battle between two calculator giants: Hewlett-Packard and Texas Instruments. TI is in the marketplace with its brand-new high-powered TI-59 and TI-58 handheld adders. And H-P is out with new and better versions of the popular HP-25 continuous memory portable.

This month we'll take apart the new H-P entries. Next month we'll dig into

systems in the display: fixed decimal point for your family budget, scientific and engineering.

Scientific function keys include logs, exponents, trig calculations, roots, reciprocals, polar and rectangular conversions and statistical functions like means and standard deviations.

If you need a hard-copy record of what you calculate, the HP-19C is the same as the 29 but with a paper-tape

Ten addressable labels are available to insert in a program or to mark the beginning of another program. The Go To key let's you search for the specified label or go to a designated step number in a program. Using the labels together with the calculator's continuous memory, which keeps program content and data in the 16 primary storage registers even when it is turned off, lets you store several relatively short, often-used programs.

Programming

Three levels of *subroutines* can be used in a program, and eight decision tests are available to use in programs where *conditional branching* is desired. Four of these tests compare the value in the X register with the value in the Y register of the calculator at any given time. The other four tests compare the X value with zero. If the test specified is true (for example, $X=0?$), the next immediate step in the program is executed. If, however, the test proves false, the next step is skipped over. DSZ/ISZ (Decrement/Increment, Skip if Zero) functions are provided and can be used to establish a desired limit for looping in a program by counting up or down to zero by a factor of one each time the loop is executed. These capabilities, along with others built into the calculators, allow very sophisticated programs to be written.

Reverse Polish Notation

As with all scientific calculators made by HP, the unique logic system known as Reverse Polish Notation (RPN) is used in the 29C and 19C; and for anyone who's never used it, it can take a little getting used to. With this system, numbers are entered before the desired function key, and two sets of numbers in a problem are separated from each other by the use of an *enter* key. For example, the key sequence for multiplying six by two would be: 6 ENTER 2 X. The answer then appears in the display. Actually, entries are made as if you were calculating a problem with pencil and paper—you would write down both numbers and then multiply. Intermediate answers in longer problems appear as calculated and are stored in a special



Hewlett-Packard 19C and 29C calculators

the TI calculators to see what makes them tick. Check both reports and you'll see which features suit your own needs.

The new HP-29C is a tiny pocket calculator with a real continuous memory built out of the latest CMOS solid-state technology. The package is fully programmable with a startling total of 98 steps. That means you can, typically, program in something on the order of 175 separate operations!

The machine has 30 data registers and your choice of three different number

printer built in.

The HP-29C and HP-19C are programmable, with a 98-step program memory, directly from the calculator's keyboard. After entering a program, editing and changing it are simple by using keys that move forward or backward through the program one step at a time. If you want to insert a new instruction, all program steps beyond it will very conveniently advance one to make room for it. Likewise, deleting a step causes the subsequent instructions to move backward and fill in the gap.

When I tell you that you can learn TV and audio servicing at home, you don't have to believe me. Believe 60,000 professionals!

Almost half of America's professional TV technicians have had home training. And among them, NRI is first choice by more than 3 to 1!

I'm proud of a record like that. Because it means we're doing the job... helping thousands of ambitious people start rewarding new careers in a field that constantly needs new talent. And we're doing it in a way that works, with NRI's practical, power-on training!

Learn by Doing with Exclusive 25" Diagonal Color TV

Only NRI training gives you the solid bench experience of constructing a 100% solid-state color TV from the ground up. In our Master Course, your theory lessons are reinforced with over 25 power-on experiments you perform as you build your own TV. And you get even more experience as you build and test circuits in our Discovery Lab™ and assemble your own professional working tools, including a 5" triggered sweep oscilloscope, TV pattern generator, transistorized volt-ohm meter, and more. It all adds up to extra experience and confidence.

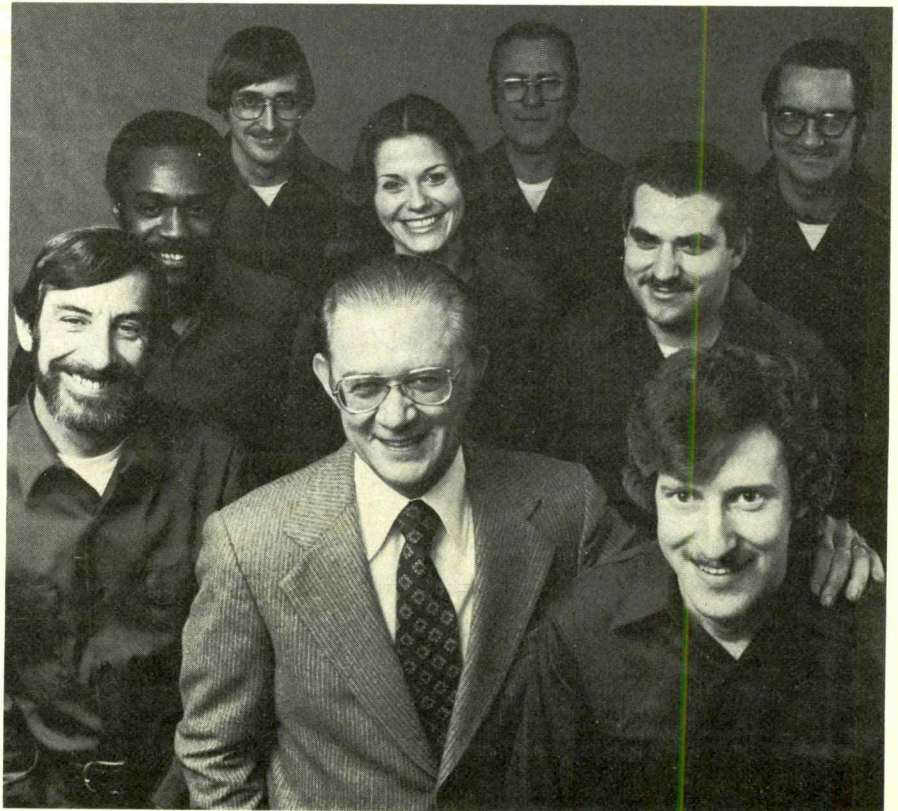

In addition to NRI's exclusive TV, you also get a designed-for-learning 4-channel audio center, complete with enclosed speakers. Only NRI includes this modern equipment as part of its course. Other schools charge extra or even sell audio training as a separate course.

Learn at Home, At Your Own Pace

In the past 63 years, NRI has taught over a million students in their own homes. Specially designed bite-size lessons concentrate on a single subject at a time to cover it completely and clearly. Our own engineer/instructors back you up with personal counseling and help when and if you need it. You decide how fast you want to progress, learn in your spare time without quitting your present job or going to night school.

The NRI way is the practical way, the professional way because it works. That's why two documented national surveys* have shown NRI training to be the

overwhelming choice of the pros. And that's why NRI should be your choice, too.

Send for Free Catalog, No Salesman Will Call

If you're interested in this kind of a future for you and your family, send the postage-paid card for a free catalog describing each course and showing the equipment you get. See the opportunities available in TV and audio servicing, CB servicing, aircraft or marine electronics, communications, and other fields. See for yourself why you can believe the pros when they pick NRI 3 to 1! If card has been removed, write to:



John F. Thompson, NRI President
NRI Schools
McGraw-Hill Center for
Continuing Education
3939 Wisconsin Avenue
Washington, D.C. 20016

*Summary of survey results on request.

™Trademark McGraw-Hill

CIRCLE 9 ON READER SERVICE CARD

MARCH 1978

\$1,000 Reward Offered by Mad Train Collector

For the reader who can come up with the following old Lionel Electric train for my fast-growing collection:

Model No. 700E Scale Hudson (No. 5344 appears on the side of the cab). If any reader can get this set for me together with either the scale freight cars No. 714-717 or the passenger cars No. 792, 793, and 794, I will gladly pay up to \$1,000 for the set. Actual price will be based on condition.

There are many other old pre-WW II Lionel engines and cars that I need, both in Standard Gauge and in "O" Gauge. Blue Comet sets, state cars, and Stephen Gerard cars are desirable Standard Gauge items. Hiawatha and others of the better passenger sets are worth lots of dollars to me in clean condition.

Old trains are not just my hobby. They're an obsession that I simply cannot overcome. So, if you've got old Lionels around, don't be bashful. Give me a call or drop me a note. To determine the value of your trains I'll need the numbers that appear on all the cars, the colors, and the approximate condition. Remember, those old trains that are gathering dust in the attic could be bringing joy and pleasure to a mad collector.

Dick Cowan, Mad Train Collector
Publisher, Modern Electronics
14 Vanderventer Avenue
Port Washington, NY 11050
Phone: 516/883-6200

How it works

Continued from page 8

memory stack, eliminating complicated hierarchies of parentheses.

Many of you already are familiar with the model HP-25 and HP-25C calculators that have been on the market. The HP-29 is fairly close in price to the 25 series but has some advantages. Incidentally, the only difference between the 25 and the 25C is the 25 does not have continuous memory.

The 25C has eight storage registers, compared with 30 in the 29C, and 49 program steps rather than 98. And, the 25C does not use labels, subroutines, insert/delete editing, indirect addressing, or the increment/decrement functions.

Going to print

The paper tape printing feature of the 19C is really convenient for debugging programs, listing register contents, etc. The quiet action of the thermal printer is a real joy.

You have a choice of three different printer modes. When set on manual, the printer operates only when you tell it to; otherwise, only the calculator display is used. When switched to normal, all entered data and functions are printed out. In the trace mode, all entries and results are printed. In addition, when a

	HP-29C	HP-19C
Length, in.	5.1	6.5
Width, in.	2.7	3.45
Height, in.	1.2	1.6
Weight, oz.	6.0	12.4
Price, \$	195	345
Paper, ft.		25
Battery, vdc	2.5	5.0

A quick-charge battery in the HP-29C lasts three hours between charges under normal use. The battery in an HP-19C lasts 4-7 hours under similar conditions.

program is being executed, each step of the program is printed, along with intermediate calculations made within the program.

You can instruct the printer to list the program, the contents of the 30 data registers, the contents of the memory stack, or the results of various statistical calculations that are stored in the registers.

The versatility of the printer, coupled with the fact that it can print both letters and numbers, makes me look forward to a future model calculator that will offer a form of alphanumeric entry so that cue words can be entered in the program memory. In this way, the program could stop at a certain point in its execution to let you enter some data, and it could ask you specifically (using one or more of these cue words) for whatever is needed for the program!

It's fascinating to watch the complex nature of the calculator's internal operation and the tremendous speed at which it operates. For example, you can obtain the sine of a value by entering the value and then merely depressing two keys. The correct result appears in less than

one second; however, to compute this answer, the calculator runs through an internal program of 3,500 steps! The binary-coded digital microprocessor, which is the brain of the calculator, uses 10-bit instructions, and each of these usually performs a complete operation. The processor runs through these internal instructions at the rate of three per millisecond.

Additional information may be obtained by contacting the Inquiries Manager, Hewlett-Packard Co., 1507 Page Mill Road, Palo Alto, CA 94304. 

This printout from an HP-19C shows the entry of a simple program made up of five steps and calculates the area of a sphere. Step 1 is merely an identifying label, and Step 5 tells the calculator to return to the beginning when it is finished executing the program. The formula for solving the area of a sphere is $A = \pi \times d^2$, where A is the surface area of the sphere, d is the diameter of the sphere, and pi is 3.141592654.

The user enters the diameter and starts the program. The calculator then squares the diameter and multiplies that result times pi. The area is shown on the calculator display.

The printout next shows a trace of the program being executed two times, each using a different diameter (6000 miles and 3435.62 miles). Intermediate results are printed, along with the final answer in each case.

```

01 *LBL0
02 X^2
03 PI
04 X
05 RTN

6000.00 0000
01 *LBL0
02 X^2
36000000.00 ***
03 PI
3.14 ***
04 X
113097335.5 ***
05 RTN

3435.62 0000
01 *LBL0
02 X^2
11803484.78 ***
03 PI
3.14 ***
04 X
37881741.88 ***
05 RTN

```

computers ³

HOW THEY WORK,

HOW YOU USE THEM, WHAT THEY CAN DO FOR YOU

BY PETE STARK

The lines are blurred between computers and programmable calculators so that sometimes it's hard to tell which is better.

Which is better: a computer or a programmable calculator? It's easy to jump right in and say *computer*, but that may not always be the right answer. Let's change the ground rules a bit and ask it the way an electronics hobbyist might, "I can spend between \$200 and \$300. Should I buy a computer or a programmable calculator?"

The answer depends on what you will use it for. Each will do some things the other cannot, so your choice depends on what you want to do. Here's the reason: for the price of a stripped-down computer you can buy a top-of-the-line programmable calculator. Although a big computer can run rings around a calculator, a stripped-down one can't.

First, let's see what equipment is in this price range. On the calculator side, top-of-the-line models from Hewlett-Packard and Texas Instruments, giants of the programmable field, are the HP-67 at slightly above \$300, and the TI-59 closer to \$250. Both have a magnetic card to store programs and data to be used for specific problems. Each can hold hundreds of steps or instructions.

If you want a printed record of your calculations, expect to spend more money. On the other hand, if you are willing to dispense with the magnetic card and can live with fewer steps in your programs, then cheaper models from both manufacturers go as low as \$100. So the range of \$200 to \$300 is a good average value, giving you a powerful programmable calculator which only lacks a printer.

On the computer side there is less choice. The cheapest computers which include a keyboard and readout of some kind are the bare-board models such as National Semiconductor's Scamp at \$200 with keyboard, the IMSAI 8048, MOS Technology KIM-1, or the Intersil Intercept Jr. at about \$250. These do not include a case, generally come without power supply, and do not have enough memory to be very useful, except for limited and specialized purposes. Not until you get in the \$400 to \$600 range with the Radio Shack TRS-80 or Commodore's PET do you reach a useful level of performance.



Radio Shack TRS-80 computer

In many ways, computers and programmable calculators are similar. Both have arithmetic circuits which can do simple mathematical or logical operations. Both have a memory which can be used to store numbers as well as complicated sequences of instructions to guide the computer or calculator through an entire problem from start to finish. Both need keyboards and readouts of some kind for entering your problem into the machine and getting your answers.

Alike but different

But the differences are more striking. Calculators come in small cases which fit easily into your pocket. They have built-in batteries for power as well as chargers or ac adapters. They have built-in keyboards and displays and sometimes even printers. In short, they are portable.

Computers, on the other hand, either have no case at all or have large cases which definitely are not portable. Their power supplies require plugging into the ac power line. Their keyboards and displays are often external and require

numerous boxes and cables to make a complete system.

Calculators also are easier to use. They are simpler and more limited than even the small computer in their ultimate uses, so there is less to remember to use them. Since they come as a complete system in one case, there is a single manual which ties everything together. Most computer systems are assembled from various components each of which has its own instruction book with a separate set of rules to follow. Finally, the calculator uses the decimal numbering system and a fairly simple language for writing instructions, consisting simply of the names of the keys. The computer, on the other hand, requires knowledge of binary and octal or hexadecimal numbers as well as one or more programming languages.

Powerful calculator

For mathematical problems, the calculator is also more powerful than the small computer. The computer has a wide variety of very primitive arithmetic operations. It can add and subtract, but



Is it a calculator or a computer? The model 97S input and output (I/O) calculator by Hewlett-Packard is a "computing data acquisition device" that combines the HP-97 portable programmable calculator with computer-like BCD interfacing to make a low-priced machine for instrument data collection and computer applications.

it cannot often multiply or divide without some programming trickery. Even when it adds or subtracts, it can often only handle small whole numbers in the range from -128 to +255.

Larger numbers or numbers with a decimal point again require programming expertise—and plenty of memory. The typical programmable calculator, on the other hand, easily handles numbers from the infinitesimal to the huge. It can find sines of angles, powers and roots, and other math functions which occupy hundreds of computer memory steps, with just the push of one key. There are some simple mathematical equations which can be done in perhaps ten steps on a calculator, but which might need

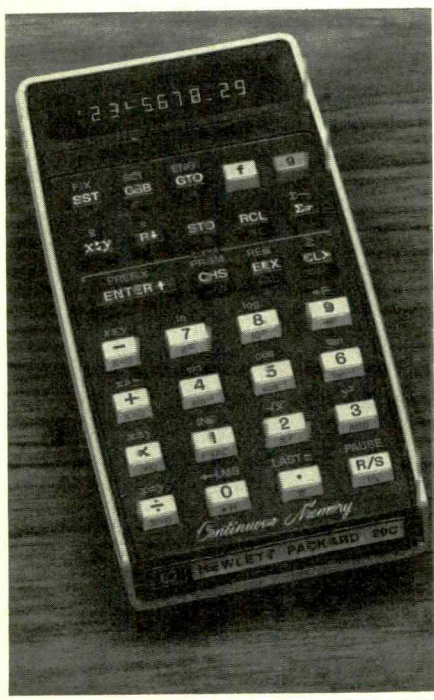

thousands of steps on even a large computer.

Another question is storing your programs. On both calculators and computers, programs are erased when you turn the power off. But some calculators can record a program and data onto a magnetic card for later use; several Hewlett-Packard models use CMOS memories which remember even with the power switch off. Similar features can be expensive options on computers.

From reading so far, you may think I prefer the programmable calculators to computers. Not so—I own one of each, and I use them both. The important thing is to know which to use when.

The calculator will do a better job on mathematical or arithmetic problems unless they are very complex, while the inexpensive computer is better for large math problems or problems which require little or no math.

For example, only the computer will handle problems involving alphabetical information such as mailing lists, parts listings, or the text for writing magazine articles. Only the computer will allow you to control other devices such as lights or a model railroad. The computer is faster on math problems than the calculator. But the most important characteristic of the computer is that it is *expandable*.

With only moderate outlays of money and time, it is possible to enlarge the computer's memory and add a variety of extra devices such as tv displays, printers, plotters, and more. With more memory a world of new uses opens up, including language translators which allow you to program even complex applications in easy-to-use languages such as Basic.

**"YOU DON'T
HAVE TO CLIMB
A MOUNTAIN
TO GAIN
ENLIGHTENMENT."**



Just send away for the Consumer Information Catalog and a key to enlightenment will appear in your mailbox.

The Consumer Information Catalog is put out by the Federal Government. And it lists over 200 of their booklets that you can send away for. Most are free. And they can help you with things like how to buy a home, how to grow vegetables, how to deal with headaches, simple plumbing repairs and many other everyday and not-so-everyday problems.

So if you wish to learn about the mystic sensibilities of the wayward ancients, put on your climbing gear.

But, if you wish to know about how to fix a leaky faucet, send for the catalog. Write: Consumer Information Center, Dept. A, Pueblo, Colorado 81009.

Remember, it's free. Which is only right. After all, the first step towards enlightenment shouldn't enlighten your pocketbook.

**THE CONSUMER
INFORMATION CATALOG**
A catalog of over 200 helpful publications.

IF YOU'RE WAITING FOR SOLDERLESS BREADBOARDS TO BE FASTER, EASIER, MORE VERSATILE AND LOWER-PRICED...

Incredibly inexpensive. EXPERIMENTOR solderless sockets begin at \$5.50* (\$4.00* for the 40 tie-point quad bus strip). A spool of solder costs more.

Mix and match. Use large and small chips in the same circuit without problems. There are two sizes of EXPERIMENTOR sockets with 0.3" and 0.6" centers.

Full fan-out. A CSC exclusive. The only solderless breadboard sockets with full fan-out capabilities for **micro-processors** and other larger (0.6") DIP's.

Microprocessors and other complex circuits are easy to develop. Each EXPERIMENTOR quad bus gives you four bus lines. By combining quads, 8-, 12- and 16-line address and data buses can be created, simplifying complex data/address circuits.

Infinitely flexible. Circuits can go in any direction, up to any size. All EXPERIMENTOR sockets feature positive interlocking connectors that snap together. Horizontally and/or vertically. And un-snap to change a circuit whenever you wish.

Easy Mounting. Use 4-40 screws from the front or 6-32 self-tapping screws from the rear. Insulated backing lets you mount on any surface.

EXPERIMENTOR 350. \$5.50* 46 five-point terminals plus two 20-point bus strips. 0.3" centers; $\frac{3}{8}$ x 3 $\frac{1}{2}$ x 2".

EXPERIMENTOR 650. \$6.25* 46 five-point terminals plus two 20-point bus strips. 0.6" centers; $\frac{3}{8}$ x 3 $\frac{1}{2}$ x 2 $\frac{1}{4}$ ".

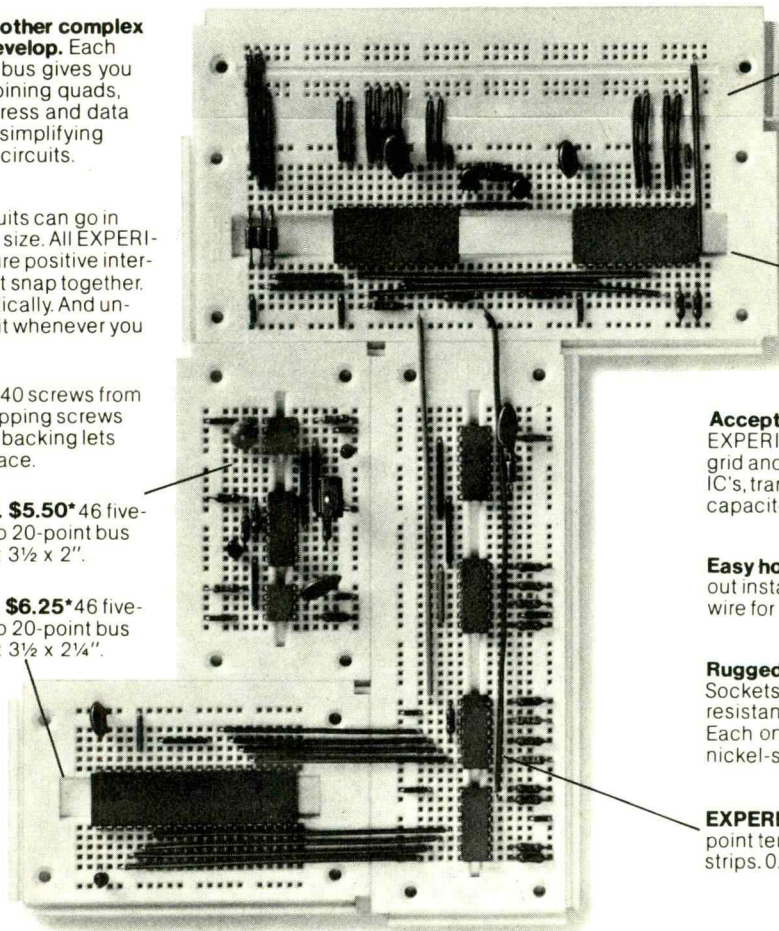

EXPERIMENTOR QUAD BUS STRIP. \$4.00* Four 40-point bus strips. $\frac{3}{8}$ x 6 x $\frac{3}{4}$ ".

Designated tie-points. Simplify translation from breadboard to PC-boards or wiring tables.

EXPERIMENTOR 600. \$10.95* 94 five-point terminals plus two 40-point bus strips. 0.6" centers; $\frac{3}{8}$ x 6 x 2 $\frac{1}{4}$ ".

Accepts all standard components. EXPERIMENTOR sockets conform to an 0.1" grid and are DIP compatible. Also accept IC's, transistors, diodes, LED's, resistors, capacitors, transformers, pots, etc.

Easy hookup. Components push in and pull out instantly. Use #22-30 solid AWG wire for jumpers.

Rugged, dependable construction. Sockets are constructed from abrasion resistant materials and withstand 100°C. Each one features non-corrosive nickel-silver contacts.

EXPERIMENTOR 300. \$9.95* 94 five-point terminals plus two 40-point bus strips. 0.3" centers; $\frac{3}{8}$ x 6 x 2".

WHAT ARE YOU WAITING FOR?

Discover today how solderless breadboarding can save time and money on every circuit you build. Get acquainted with EXPERIMENTOR™ sockets† and how they simplify circuit design, assembly and testing. Eliminate the hassles and component damage of soldering. No special hardware or jumper cables required, either. And the price is so low, it's hard to believe.

See your CSC dealer today. Or call 203-624-3103 (East Coast) or 415-421-8872 (West Coast) for the name of your local stocking distributor and a full-line catalog.

CONTINENTAL SPECIALTIES CORPORATION



70 Fulton Terrace, Box 1942, New Haven, CT 06509, 203-624-3103 TWX 710-465-1227
WEST COAST: 351 California St., San Francisco, CA 94104, 415-421-8872 TWX 910-372-7992
GREAT BRITAIN: CSC UK LTD., Spur Road, North Feltham Trading Estate,
Feltham, Middlesex, England, 01-890-8782 Int'l Telex: 851-881-3669

*Manufacturer's recommended resale.
© 1977, Continental Specialties Corporation

†U.S. Patent No. D235,554

CIRCLE 13 ON READER SERVICE CARD

MARCH 1978

13

BY HANS FANTEL

The big news in stereo for '78: quality audio equipment is getting cheaper. Here's how to shop for what you need.

Progress in audio is not merely confined to technical matters; it also involves economics. Surprising as it may seem, quality equipment is getting cheaper. And that's quite a feat in these inflationary times.

I'm not talking about top-of-the-line models, of course. As always, they command a hefty price, and it's quite possible today to spend as much for a top-notch stereo system as you would expect to pay for a medium-priced car. But, if all you want is basic good sound without the frills, you can have it now without going into hock.

Some current audio progress has brought refinements formerly found only in very expensive equipment down into the ranks of lower-priced models. The result is that many budget items now deliver the kind of sound once available only at the top. For example, many low-priced receivers selling for about \$200 now have distortion ratings as low as 0.1 percent. For that kind of fidelity you had to shell out about twice as much just a few years back.

Top dollar value

Naturally, these receivers have only moderate power because it's the extra wattage that runs into money—you need heavier power supplies, beefy output stages, and bigger heat sinks and cooling fins to draw off the heat. So these new low-cost receivers won't let you turn an orchestra into a minor earthquake. But they'll give you plenty of clean, musical sound at volume levels loud enough to seem quite realistic even in a large room. Standouts among these new low-distortion, medium-power receivers are the Pioneer SX-450, the Sony STR-2800, Kenwood's KR-2600, JVC's JR S100II, and Sansui's G-2000. They range in power between 15 and 20 watts per channel. With a price tag of \$200 or less, they offer top dollar value.

To make the most of the limited wattage available from these receivers, you need a pair of highly efficient speakers. Fortunately, a new trend in speaker design offers you just that. Until quite recently, most good loudspeakers had

low efficiency—they gobbled up a lot of watts to reach room-filling loudness levels. The reason for this inefficiency was the traditional "acoustic suspension" principle, in which the speakers were mounted in a sealed enclosure. Half the sound energy produced by a speaker radiates from the front of the cone, the other half from the rear. So if



Either covered, left, or naked, right, it's the model HPM-150 by Pioneer Electronics.

you put a speaker in a sealed enclosure, all the rear radiation is trapped in the box. It never reaches the ears but gets converted into frictional heat.

More efficient speakers

To get more sound per watt, many speaker designers recently have abandoned the sealed enclosure. To free the "lost" sound energy from the box and make it audible, they switched to a so-called passive radiator, sometimes dubbed a "drone cone." It is a regular woofer cone stretched over an opening in the enclosure but without a driver magnet and coil. In other words, the drone cone is not energized by an electric signal. Instead, it flaps back and forth in rhythm with the main woofer, being pushed by the dammed-up back pressure in the box. The two cones moving in tandem make for more efficient conversion of electric wattage into audible sound by utilizing the back radiation from the woofer cone. An outstanding example of this type of design is Radio Shack's new Realistic Optimus 10 (\$140), in which a 10-inch drone cone

pumps out plenty of bass all the way down to 42 Hz and makes the speaker so efficient that you can drive it with as little as five watts, giving you a big power margin even with a very modest amplifier. Other manufacturers using the drone cone include Sony, Panasonic, Fisher, Polk, Koss, and Electro-Voice.

Another kind of high-efficiency speaker does not use a drone cone but simply lets the back pressure out into the room through an open duct. This idea is hardly new. It dates back to the early days of audio. But now there's a difference. Those old bass-reflex speakers of yesteryear sounded boomy and hollow—like someone talking into a barrel—because the box resonance was added to the low notes of the music. For example, you couldn't really tell the exact pitch of a plucked note on the bass fiddle. All you got was a thud. The new designs have overcome this drawback, and the music stays clear all the way down to the bottom.

Top sound at good price

Credit for this goes to new design techniques that just didn't exist when bass-reflex speakers first were introduced almost 30 years ago. Nowadays, computers whiz through complex design formulas, analyzing the complicated interaction between enclosure resonance, duct shape, and the area of the open vent. With such sophisticated design aids, engineers succeeded in combining high efficiency with accurate sound. Current models of this kind include Pioneer's HPM Series speakers (priced from \$150), the B.I.C.-Venturi speakers (prices start at \$80), and the multi-directional Bose 301 (\$109) which uses reflected sound bouncing off the walls to create a feeling of greater sonic space.

See now what I mean by economic progress in audio? By combining any of these high-efficiency speakers with the new low-cost receivers mentioned before, you can put together a stereo system rivaling the sound of components costing several times as much. 

For the first time, a power microphone with tone and volume controls



Introducing the new Astatic 575 series CB microphone. The **first** ever with self-contained tone and volume controls. Designed to put talk power and sound quality in your hand. Made tough to last.

Fingertip slide controls on the mike allow quick volume and tone adjustment. You get the right modulation level and tone quality for each operator's voice with amazing ease!

Take complete control with the convenient press-to-talk lever. A spring return switch disconnects the battery in off position and operates the control circuit and amplifier

in **on** position. Easy to use with either hand.

Talk power? You bet! The contemporary tear-drop styled mike has an easily replaceable nine-volt battery power source. The 575 series is available in four or six wire coil for relay, electronic or special hook-up. The audio circuit is open during receive.

The first time you use the Astatic 575 series you'll know it's the right CB microphone for contouring your voice! See your electronics distributor or dealer about this Astatic **first**. Or write for more information.

...and powered by a 9-volt battery.



Imagination in communications

THE ASTATIC CORPORATION

CONNEAUT, OHIO 44030 (216) 593-1111

IN CANADA: 1820 Ellesmere Road, Scarborough,
Ontario M1H 2V5, (416) 438-6384

CIRCLE 15 ON READER SERVICE CARD

BY JUDY CURTIS, WB3AIQ

Here's the complete inside story on what it takes to put your own repeater on the air for better two-way radio.

The hottest things going in ham radio today are repeaters. With 3000 on the air and the building of hundreds more underway, the "machines" dominate amateur activities.

But hams aren't the only people with repeaters on the air. There's an exciting new kind of CB being enjoyed by a small group of citizens banders operating repeaters near 450 MHz in the radio spectrum. That compares with the better-known 27 MHz CB rigs popularized by truckers.

Telephone companies use repeaters so mobile phone users can make calls from their cars. Police departments across the country have networks of repeaters to keep mobile and foot patrolmen in contact with base stations. Newspapers, wire services and tv networks have repeaters so reporters in the field can get in touch with editors.

How they work

Repeaters are very useful radio devices which are simple to understand and build. They are placed atop high buildings, hills or mountains so they can hear weak signals over a wide territory and retransmit those signals to listeners in the same territory. Since repeaters used by police, fire departments, ambulances, telephone companies, CBers and



Duplexers are machined metal tubes, or "cavities," which allow use of a single antenna for transmitter and receiver.

hams are electronically similar, let's use ham repeaters to see how they work:

A repeater is nothing more than a super-sensitive receiver, hooked to a transmitter, retransmitting weak signals strongly over a wide coverage area. Hams call their repeaters *machines* and there's hardly a spot in America where you are not in range of some repeater. And more are going on the air each month.

Repeaters, as automated amateur radio stations, include a transmitter,

frequency while accepting a signal a few kilohertz away makes the duplexer a very delicate, carefully-tuned instrument.

Hams operate repeaters in six frequency bands: 29.5-29.7 MHz (10 meters); 52-54 MHz (6 meters); 146-148 MHz (2 meters); 222-225 MHz (1¼ meters); 442-450 MHz (70 cm); and near 1215 MHz. Nearly 3,000 machines are on the air with the majority on two meters and the second largest number at 450 MHz. Quite a few are on 220 MHz but a

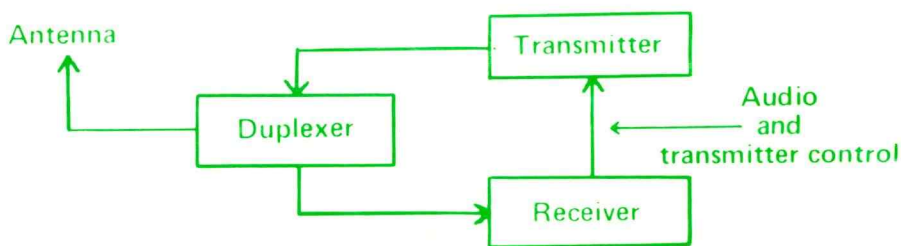

receiver and antenna. The difference between a ham's manually-operated home station and a remote repeater on a high hill somewhere, is the repeater's transmitter must be able to put out power to the antenna even as the receiver takes in signals from the same antenna. At first it seems like magic, but there's a way to do it. Use a *duplexer*.

Machine shop art

Duplexers, or isolation cavities, are \$500 sets of large metal tubes, crafted by machinists in such a way as to reject one radio frequency and accept another. Hook a set of four or six such tube cavities into the feed line from the antenna and they will allow incoming signals to pass along into the receiver section of the repeater while blocking from the receiver the signal going out from the transmitter.

A couple of things are obvious:

- You can't talk and listen on the exact same frequency at the same time so a repeater's receiver is offset on the radio dial a bit from its transmitter frequency.
- Being able to filter out a signal on one

tiny fraction operate on 10 meters, six meters and 1215 MHz.

Channelized operation

The two-meter ham band between 146-148 MHz has been subdivided by common agreement among hams into some 80 specific frequencies, called *channels*, separated by 15 kHz. A repeater's transmitter usually is off-set 600 kHz from its receive frequency.

A typical two-meter machine is built to receive narrow-band frequency-modulation (NBFM) signals, deviating plus or minus 5 kHz. Suppose you want to operate on the pair of two-meter repeater frequencies, .34/.94? You would build a machine which receives signals on 146.34 MHz and retransmits them on 146.94 MHz.

Two-meter machines between 146-147 MHz repeat 600 kHz higher while 147-148 MHz machines repeat 600 kHz lower.

A .01/.61 machine hears on 146.01 and retransmits on 146.61. A .99/.39 machine listens for signals on 147.99 and repeats them on 147.39 MHz. (The frequency on which the repeater listens is listed first

Vhf engineering

PRICES EFFECTIVE
JAN. 15, 1977

THE WORLD'S MOST COMPLETE LINE OF VHF-FM KITS AND EQUIPMENT

RX28C	28-35 MHz FM receiver with 2 pole 10.7 MHz crystal filter	\$ 64.95
RX28C W/T	same as above—wired & tested.	117.95
RX50C Kit	30-60 MHz rcvr w/2 pole 10.7 MHz crystal filter	64.95
RX50C W/T	same as above—wired & tested	117.95
RX144C Kit	140-170 MHz rcvr w/2 pole 10.7 MHz crystal filter	74.95
RX114C W/T	same as above—wired & tested	119.95
RX220C Kit	210-240 MHz rcvr w/2 pole 10.7 MHz crystal filter	74.95
RX220C W/T	same as above—wired & tested	117.95
RX432C Kit	432 MHz rcvr w/2 pole 10.7 MHz crystal filter	84.95
RX432C W/T	same as above—wired & tested	129.95

RECEIVERS

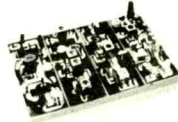

RXCF	accessory filter for above receiver kits gives 70 dB adjacent channel rejection	8.95
RF28 Kit	10 mtr RF front end 10.7 MHz out	13.50
RF50 Kit	6 mtr RF front end 10.7 MHz out	13.50
RF144D Kit	2 mtr RF front end 10.7 MHz out	18.50
RF220D Kit	220 MHz RF front end 10.7 MHz out	18.50
RF432 Kit	432 MHz RF front end 10.7 MHz out	29.50
IF 10.7F Kit	10.7 MHz IF module includes 2 pole crystal filter	29.50
FM455 Kit	455 KHz IF stage plus FM detector	18.50
AS2 Kit	audio and squelch board	16.00

TX50	transmitter exciter, 1 watt, 6 mtr	44.95
TX50 W/T	same as above—wired & tested	64.95
TX144B Kit	transmitter exciter—1 watt—2 mtrs	34.95
TX144B W/T	same as above—wired & tested.	59.95
TX220B Kit	transmitter exciter—1 watt—220 MHz	34.95

TRANSMITTERS



TX220B W/T	same as above—wired & tested	59.95
TX432B Kit	transmitter exciter 432 MHz	49.95
TX432B W/T	same as above—wired & tested	79.95
TX150 Kit	300 milliwatt, 2 mtr transmitter	24.95
TX150 W/T	same as above—wired & tested	39.95

PA2501H Kit	2 mtr power amp—kit 1w in—25w out with solid state switching, case, connectors	64.95
PA4010H Kit	2 mtr power amp—10w in—40w out—relay switching	64.95
PA50/25 Kit	6 mtr power amp, 1w in, 25w out, less case, connectors & switching	54.95
PA144/15 Kit	2 mtr power amp—1w in—15w out—less case, connectors and switching	44.95
PA144/25 Kit	same as PA144/15 kit but 25w	54.95
PA220/15 Kit	similar to PA144/15 for 220 MHz	44.95
PA432/10 Kit	power amp—similar to PA144/15 except 10w and 432 MHz	54.95
PA140/10 W/T	10w in—140w out—2 mtr amp	219.95
PA140/30 W/T	30w in—140w out—2 mtr amp	189.95

POWER AMPLIFIERS



Blue Line	RF power amp, wired & tested, emission—CW-FM-SSB/AM			
	Model	BAND	Power Input	Power Output
BLC 10/70		144 MHz	10W	149.95
BLC 2/70		144 MHz	2W	70W 169.95
BLC 10/150		144 MHz	10W	150W 259.95
BLC 30/150		144 MHz	30W	150W 239.95
BLD 2/60		220 MHz	2W	60W 164.95
BLD 10/60		220 MHz	10W	60W 159.95
BLD 10/120		220 MHz	10W	120W 259.95
BLE 10/40		420 MHz	10W	40W 179.95
BLE 2/40		420 MHz	2W	40W 179.95
BLE 30/80		420 MHz	30W	80W 259.95
BLE 10/80		420 MHz	10W	80W 289.95

PS15C Kit	15 amp—12 volt regulated power supply w/case, w/fold-back current limiting and overvoltage protection	94.95
PS15C W/T	same as above—wired & tested.	124.95
PS25M Kit	25 amp—12 volt regulated power supply w/case, w/fold-back current limiting and ovp, with meter	154.95
PS 25M W/T	same as above—wired & tested.	179.95

POWER SUPPLIES

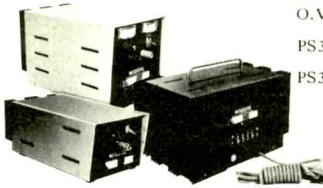

O.V.P.	adds over voltage protection to your power supplies, 15 VDC max.	12.95
PS3A Kit	12 volt—power supply regulator card with fold-back current limiting	10.95
PS3012 W/T	new commercial duty 30 amp 12 VDC regulated power supply w/case, w/fold-back current limiting and overvoltage protection	249.95

RPT50 Kit	repeater—6 meter	499.95
RPT50	repeater—6 meter, wired & tested	799.95
RPT144 Kit	repeater—2 mtr—15w—complete (less crystals)	499.95
RPT220 Kit	repeater—220 MHz—15w—complete (less crystals)	499.95
RPT432 Kit	repeater—10 watt—432 MHz (less crystals)	579.95
RPT144 W/T	repeater—15 watt—2 mtr	799.95
RPT220 W/T	repeater—15 watt—220 MHz	799.95
RPT432 W/T	repeater—10 watt—432 MHz	849.95

REPEATERS



DPLA50	6 mtr close spaced duplexer	575.95
DPLA144	2 mtr, 600 KHz spaced duplexer, wired and tuned to frequency	379.95
DPLA220	220 MHz duplexer, wired and tuned to frequency	379.95
DPLA432	rack mount duplexer	319.95
DSC-U	double shielded duplexer cables with PL259 connectors (pr.)	25.00
DSC-N	same as above with type N connectors (pr.)	25.00

TRX50 Kit	Complete 6 mtr FM transceiver kit, 20w out, 10 channel scan with case (less mike and crystals)	244.95
TRX144 Kit	same as above, but 2 mtr & 15w out	234.95
TRX220 Kit	same as above except for 220 MHz	234.95
TRX432 Kit	same as above except 10 watt and 432MHz	254.95
TRC-1	transceiver case only	29.95
TRC-2	transceiver case and accessories	49.95

TRANSCEVERS



OTHER PRODUCTS BY VHF ENGINEERING

CD1 Kit	10 channel receive xtal deck w/diode switching	\$ 7.95
CD2 Kit	10 channel xmit deck w/switch and trimmers	15.50
CD3 Kit	UHF version of CD1 deck, needed for 432 multi-channel operation carrier operated relay	13.50
COR2 Kit	carrier operated relay	22.75
SC3 Kit	10 channel auto-scan adapter for RX with priority	19.95
Crystals	we stock most repeater and simplex pairs from 146.0-147.0 (each)	5.00
CWID Kit	159 bit, field programmable, code identifier with built-in squelch tail and ID timers	39.95
CWID	wired and tested, not programmed	54.95
CWID	wired and tested, programmed	59.95
MIC 1	2,000 ohm dynamic mike with P.T.T. and coil cord	12.95
TS1 W/T	tone squelch decoder	59.95
TS1 W/T	installed in repeater, including interface accessories	89.95
TD3 Kit	2 tone decoder	35.95
TD3 W/T	same as above—wired & tested	59.95
HL144 W/T	4 pole helical resonator, wired & tested, swept tuned to 144 MHz band	29.95
HL220 W/T	same as above tuned to 220 MHz band	29.95
HL432 W/T	same as above tuned to 432 MHz band	29.95

SYN II Kit	2 mtr synthesizer, transmit offsets programmable from 100 KHz—10MHz, (Mars offsets with optional adapters)	169.95
SYN II W/T	same as above—wired & tested.	239.95
SYN 220 Kit	same as SYN II Kit except 220-225 MHz	169.95
SYN 220 W/T	same as above—wired & tested	239.95

SYNTHESIZERS



Vhf engineering

DIVISION OF BROWNIAN ELECTRONICS CORP.

BOX S / 320 WATER ST. / BINGHAMTON, N.Y. 13901 / Phone 607-723-9574

Prices and specifications subject to change without notice. Export prices slightly higher. 502 3100 1 78

CIRCLE 17 ON READER SERVICE CARD

MARCH 1978

when referring to a pair of frequencies.)

Alligator vs. rabbit

A *balanced* repeater is one which receives signals from approximately the same area it can transmit back to successfully. A machine which hears weak signals from distances greater than it can talk back to is labeled a *rabbit* as if its ears were bigger than its mouth.

One which transmits farther than it can receive is an *alligator* with large mouth and small ears. To achieve balance, use one common antenna for transmitting and receiving. (Some cheap-and-easy unbalanced systems use two antennas, often with the receive antenna elevated 30 feet above the transmit antenna.)

In a one-antenna system, signals come down the coaxial cable from the antenna and into the duplexer. Coax from the duplexer takes those signals on into the repeater's receiver where they are changed from radio-frequency (RF) energy to audio frequencies (AF). That audio is fed to the input of the transmitter section for retransmitting.

Repeater transmitters remain shut off until a signal is heard by the receiver section. As a signal arrives at the receiver section, it triggers a carrier-operated relay (COR) which turns on the transmitter. When the distant ham stops transmitting to the repeater, and his signal disappears from the receiver input, the COR allows the transmitter to drop off the air.

A time-out timer prevents the transmitter from being held on the air more than a predetermined time, usually three minutes.

IDers

Ham stations must be identified by call letters when transmitting. Automatic stations, such as repeaters, are no different. An identifier transmits either International Morse code or tape-recorded voice to give a repeater's call sign periodically. Most identify every three minutes.

The transmitter repeats the received audio by sending new modulated RF out through the duplexer to the antenna. The duplexer isolates the receiver from signals on the transmitter frequency.

A repeater is a complex device, finely-tuned and heavy-duty in operation. It must be built of components capable of surviving continual operation for months on end without rest.

Repeater transmitters must be clean of *garbage* from wide sidebands which would give extra interference to the receiver section listening 600 kHz away. And receiver sections must be narrow in the width of the band they hear so they don't lock up on, or be de-sensitized by, their own transmitter sections.

It's very delicate. All parts of the sys-

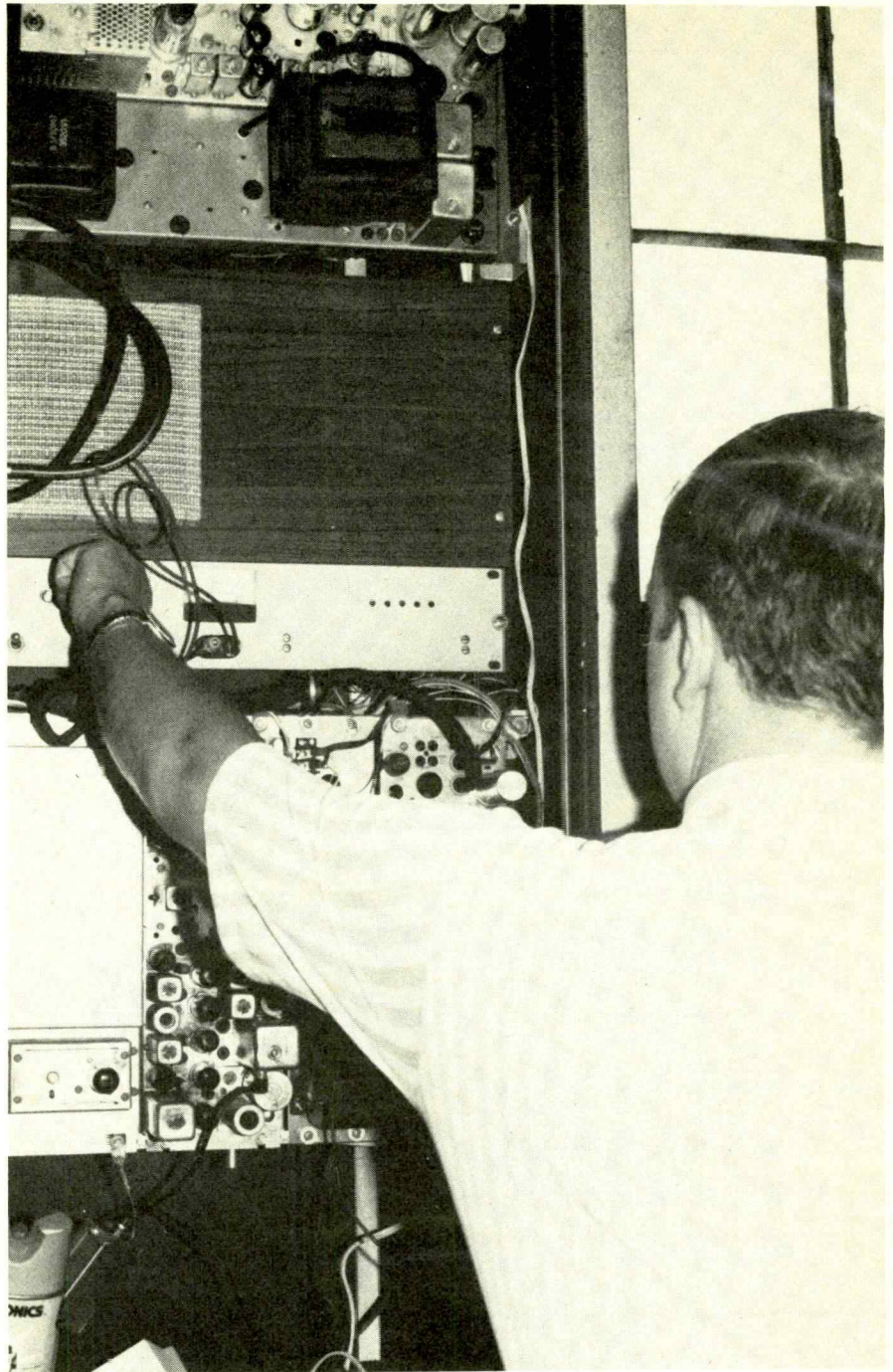

Hams from the Horseshoe Radio Club at Altoona, like others in localities across the U.S., pitch in free time to build and maintain this repeater station. WR3AIZ is in a shed at a ski resort on the second highest peak in Pennsylvania.

tem must operate properly, on time and as planned. If something gets out of tune or breaks down, the system dies.

Autopatch

One popular accessory often added to repeaters is *autopatch*. It's a device which hooks the sound from the repeater receiver into a regular telephone line so hams can make telephone calls from their cars or while walking with hand-held portable two-way radios.

The autopatch equipment, when installed in a repeater, listens for a special tone which the amateur radio operator can transmit to the repeater when he

wants to make a phone call. When the tone arrives at the repeater, electronic switches turn on the telephone and allow the ham to dial a number. Dialing is done with a tone-generating pad similar to that found in home telephones. Hams have mounted tone pads on their two-way portable and mobile radios so they can dial calls.

Through the repeater, hams can be heard by the party they are calling and they hear replies in a normal two-way telephone call fashion. For an exciting account of how it works, see the article *Ham Autopatch* in this issue of *Modern Electronics*. 

ME photo: Mary Patton

BY RON COGAN

With computers in everything from washing machines to cassette tape decks, how long before they're in cars?

Remember those trips when a quick, accurate check of your mileage would have come in handy? Or perhaps some instant data that could show how your pedal pressure was affecting fuel consumption, then quickly update these readings to guide you along the path to better mileage? And then, after a peek at the distance you've travelled, and the amount of fuel consumed, you could tell what time it is.

Rather farfetched? Until recently, yes; but with the introduction of SpaceKom's *Autocomp*, imagination becomes reality—bringing with it the age of automotive computers and a sign of things to come. And of utmost importance to cost-conscious motorists, the price tag of this package is well within reason (approximately \$120 retail).

Basically, the *Autocomp* is a multi-function instrument that provides invaluable data on your engine's performance instantly, at the touch of a button, as you drive. By providing this instantaneous feedback in the form of miles-per-gallon, you can determine when your vehicle is operating most efficiently, how to improve your driving habits, and when your engine is in need of servicing.

Save fuel

The instrument's readout module contains a custom microprocessor that is programmed to measure speed and fuel flow of your vehicle. In addition, an internal clock provides a readout of hours and minutes. By counting pulses from the spinning ball flowsensor and speedsensor and performing the appropriate division, accurate miles per gallon readings are obtained. The microprocessor stores this data so the amount of fuel used, the average miles-per-gallon attained, and the distance traveled can be computed.

The heart of this system is the Fairchild F8 microprocessor, which controls and processes all functions displayed on the four-digit LED readout. A photocell senses ambient light to automatically dim the readouts at night, while a special power supply doubles the input voltage so that 12-volts is maintained to



New car computer tells instant miles per gallon, average mpg, time of day, elapsed time, distance traveled and fuel used.

the processor with as little as 7-volts real input. Standby power is always supplied to the F8 so the memory stays intact and correct time is always displayed (typically to within one minute per month).

Each monitoring function the *Autocomp* offers may be viewed by depressing the proper pushbutton on the unit's faceplate. With the exception of the time-of-day readout, this information is updated on the display every three seconds—an especially critical feature when monitoring the instant miles-per-gallon mode. These functions can be reset by simultaneously depressing the "average mpg" and "hour set" buttons. The quartz crystal clock can be reset to "0" by depressing the three right-hand pushbuttons simultaneously; this will provide an elapsed-time readout that's handy on long trips.

Information at your fingertips

This system comes with three easy-to-install components—a speedsensor, flowsensor, and computer readout module. The module mounts in the passenger compartment of your vehicle with brackets supplied, or you may

mount it in-dash if you prefer (a cutting template is provided). The speedsensor is installed in-line on the speedometer cable, usually at the transmission. Simply unscrew the cable fitting, attach the speedsensor to the transmission, and reconnect the speedometer cable to the speedsensor fitting. Finally, the flowsensor is introduced into your fuel line by splicing it either before or after the fuel pump. Electrical hookups are easy using the five color-coded wires, and all connectors, clips, and mounting hardware is supplied.

Although the *Autocomp* doesn't qualify as the end-all in mobile electronics (technology is advancing too rapidly to hang that tag on it), it is an important automotive innovation that can help improve your driving habits, save fuel, and provide valuable time and trip data. And when you consider just how cost-conscious most of us are with our vehicles nowadays—that's saying quite a mouthful! Additional information: SpaceKom, Inc., 212 E. Gutierrez St., Santa Barbara, CA 93101. 

Ron investigates away-from-home electronics on the West Coast.

CPI's ULTRA CP-2000 & BC-2000 COMBO

finest, most complete, full performance CB communi- cations system *EVER!*



The exceptional, solid-QSO record of this superb, U.S.-made base station system is attributable to the score of improved operational functions all under full control of the knowledgeable operator.

CP-2000B Base Station

- SSB w/USB/LSB, 12W output p.e.p., AM, 4W output.
- 40 channels w/digital readout.
- Manual RF gain control with automatic override. PIN diode attenuator.
- Advanced design RF pre-amp gives 13db signal boost. Exceptionally low, 1.5db noise figure.
- Cross/inter modulation reduced to negligible levels (-85db). Power JFET mixer makes it possible.
- Unequalled adjacent channel rejection (an unprecedented -80db) 8 pole crystal filter does this great job.
- Noise blanker, an exclusive CPI design, has its own tuned RF noise sampling circuit, switches IN/OUT.
- Also, automatic noise limiter with switch.
- Full range clarifier $\pm 1.5\text{kHz}$
- Brilliant audio! Full 4 watts at less than 3% total harmonic distortion (THD)
- Automatic gain control w/107dbm range effectively handles "blasting" by strong, nearby locals.

- Super strong, high average talk power without "bleedover"... functions automatically w/CPI exclusive speech compressor.
- Front panel MIC gain control.
- Built-in FET mic. pre amplifier.
- Full modulation at varying speech levels with automatic level control (ALC)
- 115VAC and 13.6VDC operation.

BC-2000 Base Console

- Operates w/CP-2000B or any CB radio
- 7 digit frequency counter w/3PPM (0.0003%) accuracy.
- Switchable to 6 figure digital clock. 12 or 24 hour operation.

- JFET RF pre-amplifier w/13db gain. 1.5db noise figure. IN/OUT switch.
- Built-in antenna tuner matches to 3:1 VSWR. Handles up to 400W.
- Built-in TVI filter gives more than 50db harmonic suppression. Handles 400 watts.
- Antenna switch allows choice of two separate antennas. LED indicator shows antenna in use.
- 115VAC and 13.6VDC operation.

CP-2000B . . . 599.95

BC-2000 . . . 249.95

At your dealer. Write for brochure



**COMMUNICATIONS
POWER, INC.**

Canada: E. S. Gould Marketing Co., Ltd.
109 Montee de Liesse, Montreal, Quebec, Canada, H4T 1S9

Australia: CPI Australia Pty, Ltd.
100 William St., Sydney, Aust. 2011. Telephone: 357-2022. Telex: AA 23381

for the experimenter!

INTERNATIONAL CRYSTALS & KITS
 OSCILLATORS • RF MIXER • RF AMPLIFIER • POWER AMPLIFIER

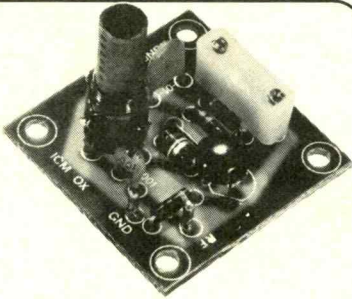

OX OSCILLATOR

Crystal controlled transistor type. 3 to 20 MHz, OX-Lo, Cat. No. 035100. 20 to 60 MHz, OX-Hi, Cat. No. 035101
 Specify when ordering.

\$4.95 ea.

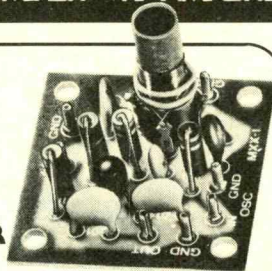

MXX-1 TRANSISTOR RF MIXER

A single tuned circuit intended for signal conversion in the 30 to 170 MHz range. Harmonics of the OX or OF-1 oscillator are used for injection in the 60 to 179 MHz range. 3 to 20 MHz, Lo Kit, Cat. No. 035105. 20 to 170 MHz, Hi Kit, Cat. No. 035106
 Specify when ordering.

\$5.50 ea.

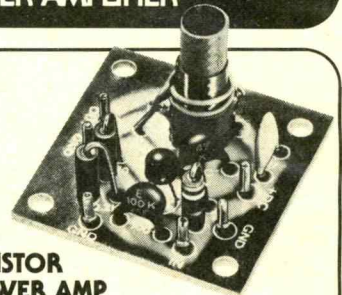

PAX-1 TRANSISTOR RF POWER AMP

A single tuned output amplifier designed to follow the OX or OF-1 oscillator. Outputs up to 200 mw, depending on frequency and voltage. Amplifier can be amplitude modulated. 3 to 30 MHz, Cat. No. 035104
 Specify when ordering.

\$5.75 ea.

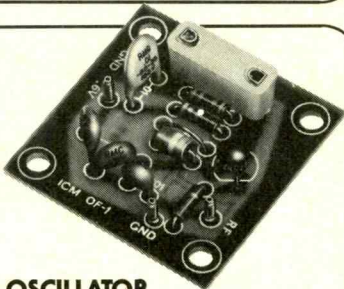

OF-1 OSCILLATOR

Resistor/capacitor circuit provides osc over a range of freq with the desired crystal. 2 to 22 MHz, OF-1 LO, Cat. No. 035108. 18 to 60 MHz, OF-1 HI, Cat. No. 035109
 Specify when ordering.

\$4.25 ea.

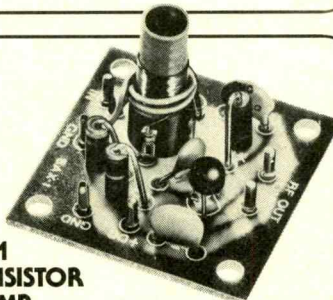

SAX-1 TRANSISTOR RF AMP

A small signal amplifier to drive the MXX-1 Mixer. Single tuned input and link output. 3 to 20 MHz, Lo Kit, Cat. No. 035102. 20 to 170 MHz, Hi Kit, Cat. No. 035103.
 Specify when ordering.

\$5.50 ea.

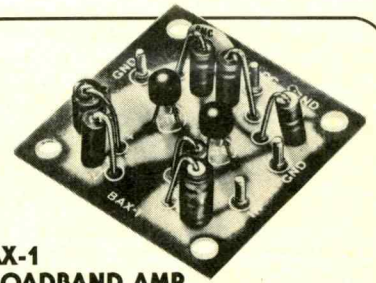

BAX-1 BROADBAND AMP

General purpose amplifier which may be used as a tuned or untuned unit in RF and audio applications. 20 Hz to 150 MHz with 6 to 30 db gain. Cat No. 035107
 Specify when ordering

\$5.75 ea.

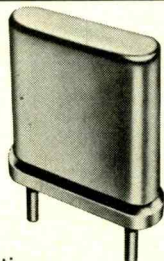

.02% Calibration Tolerance
EXPERIMENTER CRYSTALS
 (HC 6/U Holder)

Cat. No.	Specifications	
031080	3 to 20 MHz — for use in OX OSC Lo	\$5.95 ea.
	Specify when ordering	
031081	20 to 60 MHz — For use in OX OSC Hi	\$5.95 ea.
	Specify when ordering	
031300	3 to 20 MHz — For use in OF-1L OSC	\$4.75 ea.
	Specify when ordering	
031310	20 to 60 MHz — For use in OF-1H OSC	\$4.75 ea.
	Specify when ordering.	

Shipping and postage (inside U.S., Canada and Mexico only) will be prepaid by International. Prices quoted for U.S., Canada and Mexico orders only. Orders for shipment to other countries will be quoted on request. Address orders to:
 M/S Dept., P.O. Box 32497,
 Oklahoma City, Oklahoma 73132.

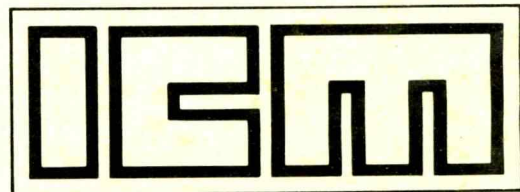

International Crystal Mfg. Co., Inc.

10 North Lee
 Oklahoma City, Oklahoma 73102



Knock, Knock Who's there? FCC FCC who? FCC strike force Oh no!

by Bob Margolin
Assistant Editor

It was a cold and windy winter Saturday. "King Kong" was getting ready for some hot CB action:

"Let's see, 27.850 looks good. Turn on the linear. Hello skipland. CQ DX. Come on skipland, you got your King Kong here, come on!" But, instead of skipland, King Kong heard the front doorbell ring. "Damn!"

"Yeah, what do you want?"

"Hello. I'm Jack Smith and this is John Jones. We're with the Federal Communications Commission, and we'd like to inspect your station."

The moment of truth that every CBer who bends the rules dreads had arrived for King Kong. Uncle Charlie, as CBers refer to the FCC, nailed him while breaking just about every rule in the book. But how did they find him, and why?

King Kong was nailed by one of Charlie's five Special Enforcement Facility (SEF) strike forces, each responsible for a region of the country. The SEF force was sweeping King Kong's home town because of a large number of complaints about CB operation Charlie had been receiving from the area. Some were from irate citizens complaining about television interference (TVI). Others were from CBers who were unhappy about bleed-over and channel hogging.

FCC responds to complaints

Because of the large number of TVI complaints received by the FCC, individual responses are impractical. Instead, the FCC sends out form letters offering suggested cures. While the recipients of these form letters may feel the FCC is uncon-



Most CBers picture the FCC using vans like this in their CB enforcement effort. Actually, these vans are used to monitor microwave transmissions such as those made by the telephone company and other common carriers. The SEF engineers use ordinary four-door sedans.

cerned, Charlie really does care. And when the number of complaints indicates a real problem area, SEF drops by for a friendly visit.

On Monday of that week, regional SEF engineers had loaded into four non-descript four-door sedans and headed up the freeway. Most CBers still picture the strike force as riding around town in Econoline vans with a dozen antennas hanging on the sides and a direction

finder mounted on the roof. The area was then divided into four sections with each two-man car assigned to one section. Jack Smith and John Jones drew the section where King Kong lived.

By Wednesday they had monitored King Kong breaking several FCC rules.

"This guy sounds like a winner, Jack. He's out of band, working skip, must be running at least a full kilowatt. Let's get him."

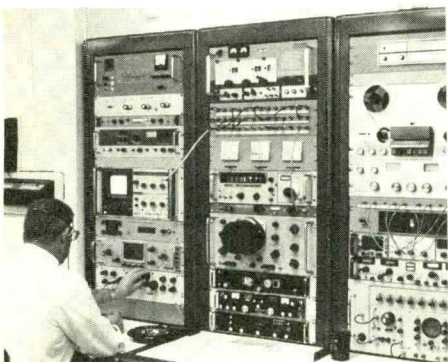

Although FCC monitoring stations are seldom used in blanket CB enforcement, they are a great help to the SEF in nailing down some hard-nosed characters.

finding loop sticking out of the roof. But, these days Charlie drives around in ordinary looking cars with hidden antennas.

About five hours later the force checked into a local motel and began casual monitoring of the band. They were more interested in learning the operating patterns of the area than in tracking down who was doing what. By the next morning they had a pretty good idea what activities held sway at which

Where's the culprit

In the old days, hidden transmitters were run down using a method known as triangulation. Triangulating a station involves taking three direction bearings and tracing them on a map. At the point where the three bearings cross, you should find the transmitter. It is slow, not all that accurate, and requires a lot of maps if you do it as often as the FCC.

Today, the strike force uses a much faster method. Each car is equipped with special direction finding equipment that indicates whether the transmitter is ahead or behind the car, and whether it is to the left or the right.

"The signal is behind us on my side, Jack. Hang a right at the next corner. Okay, he's in front of us on my side; keep heading down this street. There, he just fell behind us. Hang another right. Okay, he's out front again on my side. Hang another right at this corner. He's right in front of us now. Slow down, he's on your side. Just fell behind us. It must be that brick house. Turn around up ahead and I'll get the house number."

That's all it took to find King Kong. But King Kong wouldn't learn about it

for a few days yet. That's the way the force works. The first five days are spent in getting to its target, learning the operating patterns of the area, and tracking down the bad apples. By the time anyone learns they're in town, they've already made up their pink ticket list.

Get the worst offenders

Because of the number of violations and the limited time each SEF force has in any given area, they go after the worst offenders first: out-of-band HFer operations, linear amplifiers, and deliberate communications beyond the 150 mile limit. Then, if there's time, anything else they can spot.

Saturday and Sunday are reserved for station inspections. Although it may not seem like it, inspections are PR tools used to educate the wayward CBER in proper operating practices and procedures.

"Let me see your ID cards," King

FCC fines

Section 510 of the Communications Act of 1934, as amended, authorizes the Commission to levy monetary forfeitures for Citizens Band (CB) rule violations to a maximum of \$100 per violation. Currently, CB licensees who violate the Rules for the first time are issued forfeitures in the amount of \$50 per violation. In order to achieve increased compliance with the CB Rules, the amount of the initial forfeiture has been increased for the more serious violations.

Forfeitures are assessed as follows:

- Use of power in excess of authorized (Section 95.613) ..\$100
- Use of a frequency not authorized for use by CB stations (Section 95.455)\$100
- "Skip" communications (i.e., communicating or attempting to communicate over 150 miles) (Section 95.501(b))\$75
- Operating with an overheight antenna (Section 95.437) ..\$75
- Failure to identify transmissions by assigned call sign (Section 95.471(c))\$50
- Repeated failure to reply to official Commission correspondence (Section 1.89)\$50

No change is being made with respect to requests for reduction or cancellation of the forfeiture. Such requests will continue to be reviewed on a case-to-case basis.

When a forfeiture has been issued and violations again occur, the Commission will either issue a second forfeiture at \$100 per violation or, when appropriate, will initiate license revocation proceedings.

Forfeitures for Citizens Band (CB) rule violations other than those listed above will be assessed in amounts up to \$100 for each violation. Examples of such violations are transmission of sound effects, music or whistling and the use of unauthorized transmitting equipment.

Kong said as he took a closer look at the cards and badges offered by Smith and Jones. "I don't know about this. Would you mind if I called your office first?"

"Not at all, sir."

Since they didn't mind his calling, King Kong figured they were okay and let them in. After all, he figured, they probably had search warrants anyway. In truth, SEF engineers hardly ever carry warrants. That's because they have more than enough proof from their monitoring activities to back up the citations they're planning to hand out. So they don't really need to see the station.

Once inside his radio shack, Jack Smith began an informal interview while his partner examined the radio equipment, making frequency and power measurements.

"May I please see your CB radio license, sir?" Smith asked.

Where's your license

It was very lucky for King Kong that he did have a valid CB license. Operating a CB, or any radio transmitter other than toy walkie-talkies, without a valid license is a violation of Title 47 of the U.S. Code, and punishable by as much as a \$10,000 fine and one year in prison.

"You were observed operating your station on a frequency other than one of the 40 authorized channels, contacting stations more than 150 miles distant, and using excessive power. Is there anything you'd like to tell me before I file my report?"

King Kong was nailed and he knew it. He had nothing to say. Smith informed him of the fines that he could expect for his violations of the rules.

"Do you want the money now?" King Kong asked.

"No sir. No FCC agent may collect fines in the field. You'll receive instructions about making payment in the mail in two or three weeks.

"Are you going to take my radios?"

"No sir. We are not empowered to confiscate private property. If we needed your equipment as evidence, we'd bring along a U.S. marshal, who would impound it. But that won't be necessary today."

And so that was that. The SEF engineers left town, and King Kong quit working skip in the HFer's band.

About three weeks later, there was the envelope from Charlie's Violations Enforcement Branch (VEB). Inside was FCC Form 793L, listing his violations and the corresponding fines, and a cover letter explaining what to do. First, he could simply pay the fines by sending a check or money order to the VEB in Washington, DC.

He could, if he chose, appeal the fines by writing a letter setting forth his position to the VEB, or he could request an

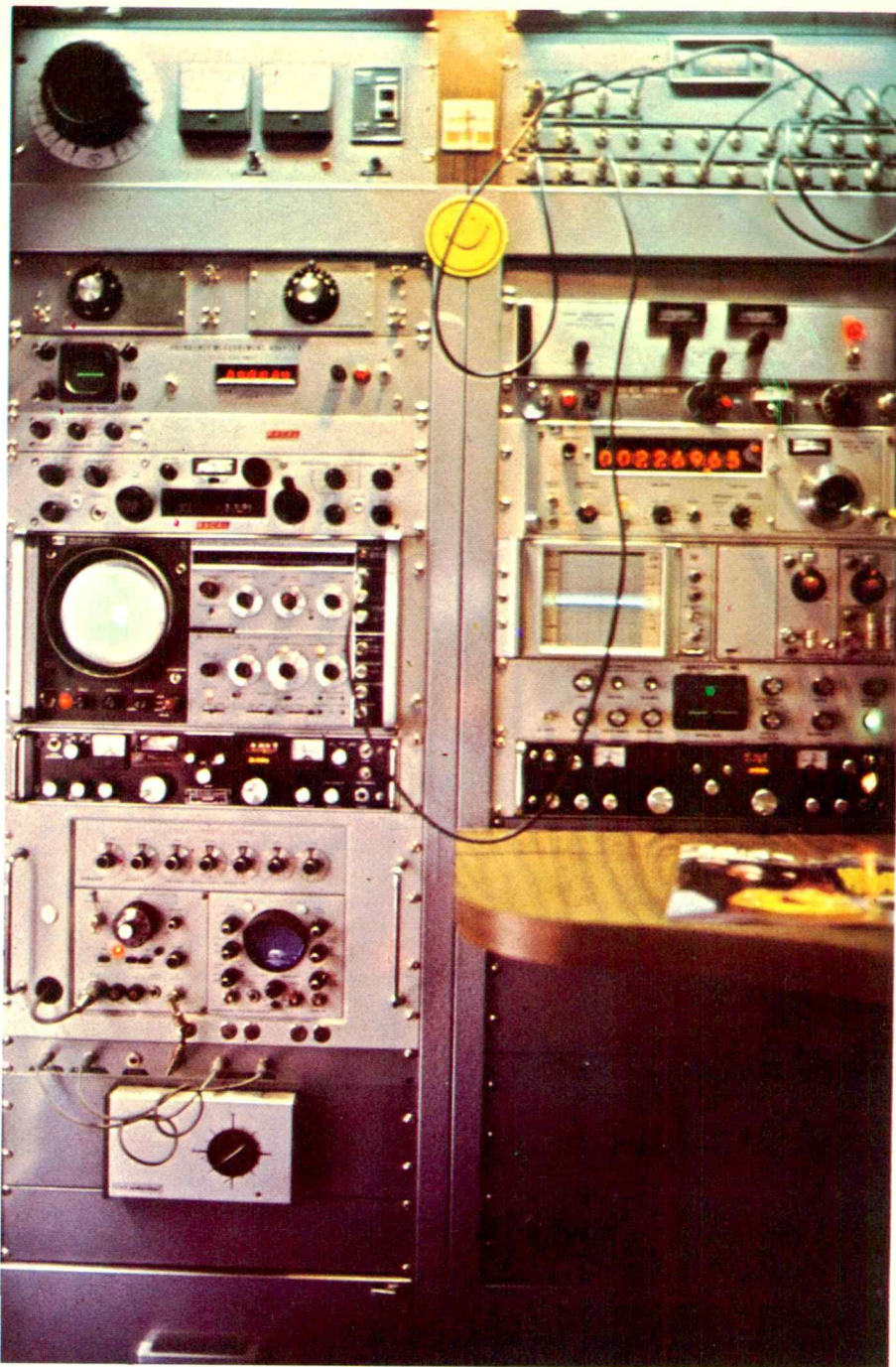

At first glance, this seems to be nothing more than a close-up of the equipment used at the monitoring station pictured at the far left. Actually, it's a close-up of the equipment you'll find inside the monitoring van pictured on page 28. As you can see, the monitoring vans have nearly as much equipment as do the monitoring stations. With this gear, FCC field engineers can accurately measure a signal's frequency and analyze its composition to determine the kind and percentage of modulation.

interview at the district FCC office closest to where he lived.

King Kong thought the fines were too high for what he had done, and decided to appeal. He thought he could explain his side better in person so he requested an interview.

Stiff fines

The VEB, upon receiving his request for an interview, took the violations package it received from the SEF engineers and forwarded it to the district field office where King Kong wanted to be interviewed. The office contacted

King Kong and an appointment was arranged.

Although it meant he would have to miss a day's work, it would be worth it. He would have a chance to tell them a thing or two. Actually, King Kong discovered, the field interview was just that—an interview.

The field office staff would talk with him, explain things, answer questions, but beyond typing up a report of the interview, they did not become involved in the case. It would be up to Washington. So the violations package, along with a report of the interview, was sent



This FCC van, caught here in the middle of a winter snow storm in Denver, Colorado, is used to monitor the short wave spectrum, including the CB band, by field engineers operating out of local offices. These local enforcement efforts are aimed at individual operators while the SEF effort is geared to policing entire geographical areas.

to the Violations Division of the Field Operations Bureau.

Appeal denied

The Violations Division's role at this stage of the appeal process was to make sure the violations were well substantiated, and all the paperwork was correct. Once satisfied all was in order, the package was sent to the Legal, Advisory and Enforcement Division (LA&E) of the Safety and Special Radio Services Bureau.

At LA&E, the entire package was very carefully evaluated. The extenuating circumstances claimed by King Kong were examined in light of the evidence. If any of the data supplied by King Kong were questioned, he would have been asked to supply additional substantiating evidence. But, in this case, the evidence spoke for itself. King Kong's appeal to reduce the fines was denied.

Shortly thereafter, he received notification that the original fine stood. He could, if he thought he had been unfairly treated by LA&E, refuse to pay. In that case, the matter would be turned over to the Justice department for prosecution in Federal court. That seemed a bit much, so he paid the fine.

King Kong had been relatively easy to track down because he transmitted for several minutes at a time. But what about the jammer who spends his life dropping a carrier for a few seconds every minute or so. The direction finding equipment the SEF engineers use is just not fast enough to catch the hit and run jammer.

Pinpoints in less than a second

Interference caused by short bursts of radio energy is not limited to just the CB band. It plagues the entire radio spec-

trum. In most non-CB cases, though, the cause is usually unintentional—a malfunctioning automated translator or beacon, or a telemetry unit out of adjustment. But the interference caused is just as real. And so the FCC has developed a new generation of monitoring and direction finding equipment.

One recent innovation is a "super-snooper" that can provide a very accurate direction bearing in just one-tenth of a second. That's right, in the time it takes you to key your mic as fast as you can, Charlie knows in which direction you are. If you keyed it just once each minute, for only a second or two, in just a matter of minutes, Charlie would be sitting outside your home writing up that pink ticket for you.

In the past, the FCC has not been very aggressive in policing the CB band. But now that the use of linears and sliders is getting out of hand, things are changing. The SEF strike forces, and new sophisticated direction finding equipment is proof that Charlie means business.



FCC Form 793-L May 1977		NOTICE OF VIOLATION		FEDERAL COMMUNICATIONS COMMISSION													
NOTICE OF APPARENT LIABILITY TO MONETARY FORFEITURE				P. O. Box 250													
This Notice must be responded to within 30 DAYS from its date of mailing. Use enclosed Reply Form 793-R and follow the instructions on that form.				Columbia, Maryland 21045													
CERTIFIED MAIL NO. <u>000001</u>				Mailing Date <u>Dec. 25, 1980</u> Call Sign <u>KAAA 0000</u> <small>(Class D Citizens radio station)</small> Violation Date <u>Dec. 1, 1980</u> Frequency(s) used: <u>27.395 & 27.450</u> MHz TOTAL APPARENT LIABILITY \$ <u>450.00</u>													
RETURN RECEIPT REQUESTED																	
L I C E N S E	John Doe 1000 ABC Street Anywhere, USA 00001																
This is to notify you that the above reference radio station was operated as indicated in willful violation of the Rules marked below. It appears, therefore, that you are liable to a monetary forfeiture, as shown below, for each of the violation "Categories" indicated in parenthesis following the items marked in the box below, under Section 510 of the Communications Act of 1934, as amended, the maximum amount of forfeiture liability being \$500. The reference to "Category" correlates with pertinent provisions of Section 1.80(c) of the Commission's Rules, which implements Section 510.																	
<table style="width: 100%; border-collapse: collapse;"> <tr> <td style="width: 5%; text-align: center;"><input checked="" type="checkbox"/></td> <td style="width: 95%;">Section 95.501(b) - Communications over 150 miles (Category 9) (\$ 75.00) Denver Colorado; 7:42 p.m.; 27.395 MHz</td> </tr> <tr> <td style="text-align: center;"><input checked="" type="checkbox"/></td> <td>Section 95.471(c) - Failure to identify by call sign. (Category 2) (\$ 50.00) "No Name"; 7:43 p.m.; 27.395 MHz; 7:52 p.m.; 27.450 MHz</td> </tr> <tr> <td style="text-align: center;"><input checked="" type="checkbox"/></td> <td>Section 95.455(a) - Use of frequency not authorized for Class D stations. (Category 4) (\$100.00) 7:52 p.m.; 27.450 MHz</td> </tr> <tr> <td style="text-align: center;"><input checked="" type="checkbox"/></td> <td>Section 95.437(a) - Overheight antenna. (Category 11) (\$ 75.00) Directional antenna; 100' over-height</td> </tr> <tr> <td style="text-align: center;"><input checked="" type="checkbox"/></td> <td>Section 95.613(b) - Power in excess of 4 watts. (Category 8) (\$100.00) Yaesu FT-101EEEE measured 150 watts output</td> </tr> <tr> <td style="text-align: center;"><input checked="" type="checkbox"/></td> <td>Section 1.89 - Repeated failure to reply to Commission Notices. (Category 12) (\$ 50.00) Form 762K issued October 1, 1980</td> </tr> </table>						<input checked="" type="checkbox"/>	Section 95.501(b) - Communications over 150 miles (Category 9) (\$ 75.00) Denver Colorado; 7:42 p.m.; 27.395 MHz	<input checked="" type="checkbox"/>	Section 95.471(c) - Failure to identify by call sign. (Category 2) (\$ 50.00) "No Name"; 7:43 p.m.; 27.395 MHz; 7:52 p.m.; 27.450 MHz	<input checked="" type="checkbox"/>	Section 95.455(a) - Use of frequency not authorized for Class D stations. (Category 4) (\$100.00) 7:52 p.m.; 27.450 MHz	<input checked="" type="checkbox"/>	Section 95.437(a) - Overheight antenna. (Category 11) (\$ 75.00) Directional antenna; 100' over-height	<input checked="" type="checkbox"/>	Section 95.613(b) - Power in excess of 4 watts. (Category 8) (\$100.00) Yaesu FT-101EEEE measured 150 watts output	<input checked="" type="checkbox"/>	Section 1.89 - Repeated failure to reply to Commission Notices. (Category 12) (\$ 50.00) Form 762K issued October 1, 1980
<input checked="" type="checkbox"/>	Section 95.501(b) - Communications over 150 miles (Category 9) (\$ 75.00) Denver Colorado; 7:42 p.m.; 27.395 MHz																
<input checked="" type="checkbox"/>	Section 95.471(c) - Failure to identify by call sign. (Category 2) (\$ 50.00) "No Name"; 7:43 p.m.; 27.395 MHz; 7:52 p.m.; 27.450 MHz																
<input checked="" type="checkbox"/>	Section 95.455(a) - Use of frequency not authorized for Class D stations. (Category 4) (\$100.00) 7:52 p.m.; 27.450 MHz																
<input checked="" type="checkbox"/>	Section 95.437(a) - Overheight antenna. (Category 11) (\$ 75.00) Directional antenna; 100' over-height																
<input checked="" type="checkbox"/>	Section 95.613(b) - Power in excess of 4 watts. (Category 8) (\$100.00) Yaesu FT-101EEEE measured 150 watts output																
<input checked="" type="checkbox"/>	Section 1.89 - Repeated failure to reply to Commission Notices. (Category 12) (\$ 50.00) Form 762K issued October 1, 1980																
Other violations observed:																	
Signature <u>Vincent S. Galbraith</u>		Title <u>Supervisor, SEF-LR</u>															
<small>Refer to other side for important statement.</small>																	
<small>The knowing and willful making of any false statement in reply to this NOTICE is punishable by fine or imprisonment under Title 18, United States Code, Section 1001.</small>																	
<small>(All previous editions of this form are canceled.) (See Reverse Side)</small>																	

Jan King: the man who builds OSCAR satellites

Amateur radio operators have built and sent seven sophisticated communications satellites into Earth orbit. Two more are about to be launched from the U.S. and, according to leaks from behind the Iron Curtain, Russian hams are about to send up their own birds. Here's the unusual story of how recent ham satellites have been built.

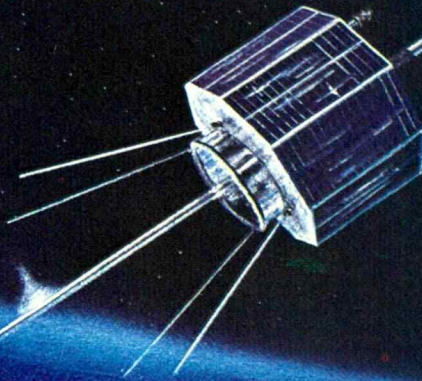

by Gerald R. Patton, WA3VUP
Contributing Editor

Fifteen years! That's how long ham radio operators have had satellites orbiting Earth. And that's not much less time than the U.S. and U.S.S.R. governments have had birds in space.

It was 12:42 p.m., Dec. 12, 1961, when a Thor-Agena rocket lifted on a pillar of flame from Vandenberg, CA, carrying the first 10-pound ham satellite aboard as ballast.

OSCARs, Orbital Satellites Carrying Amateur Radio, are built by amateur radio operators working evenings, weekends and spare moments in their basements, garages and attics. So far, seven of these sophisticated satellites have flown and two more will be in orbit soon.

Hams around the world have contributed to machining, wiring, soldering, bolting and testing OSCAR satellites. A handful of key amateurs have been instrumental in ramrodding the construction projects to completion. Among them, Jan King, 30, operator of amateur station W3GEY in Maryland, has been a leading builder of ham satellites.

Modern Electronics asked contributing editor Randy Patton, himself operator of amateur radio station WA3VUP, to track down King at Goddard Space Flight Center near Washington, DC, where he is employed by NASA. In an exclusive interview, Jan told Randy what it's like to build satellites in

his own home-birds which are destined to go where most men never visit—what a satellite looks like close up, how it's built, how it gets into space.

Randy explored the future of ham radio as a space-science hobby with Jan, who is a member of the board of directors and vice-president for engineering of AMSAT, the Radio Amateur's Satellite Corporation which oversees ham missions in space.

Jan was graduated in 1968 from Oakland University in Michigan with a bachelor of science (BS) degree in physics. Later he received a masters degree in electrical engineering from Catholic University, Washington, DC.

ME: Jan, how did you first get involved in amateur satellites?

JK: When I was going to school in Pontiac, Michigan, I became quite interested in OSCAR 3 at that time. Through my exposure there, and through writing computer programs to do tracking and plotting, I became involved with the program.

After that, when I graduated from college, I ended up going with NASA in Washington, DC, at the time that AMSAT was being formed.

ME: What do you do at NASA?

JK: I'm presently with the communications and navigation division at the Goddard Space Flight Center in Greenbelt, Maryland.

ME: Who started the OSCAR program?

JK: The original OSCAR guys (Project OSCAR) are located in northern California, and they have also produced some of the hardware for the upcoming launch (OSCAR 8 or AO-D). AMSAT was formed in 1965 in the Washington, DC, area.

ME: Okay, now, the first OSCAR that AMSAT was involved with was OSCAR...

JK: Five. The Australians built it at the University of Melbourne. It sat around for a number of years before a launch vehicle could be found for it. We picked it up when we were formed and decided to make it our first project since the spacecraft existed and would presumably require a minimum effort to get it going. We did a lot of refurbishing to the satellite, though.

ME: Where was this work done?

JK: That one spent most of its time at Goddard in a small room that wasn't being used at the time, a storage room. It was really a humble beginning. The satellite was quite a mess when we got it. It had spiders in it and all kinds of things.

ME: Then you might say it had some bugs in it?

JK: Real live ones!

ME: Where was it launched from?

JK: All the satellites from OSCAR 5

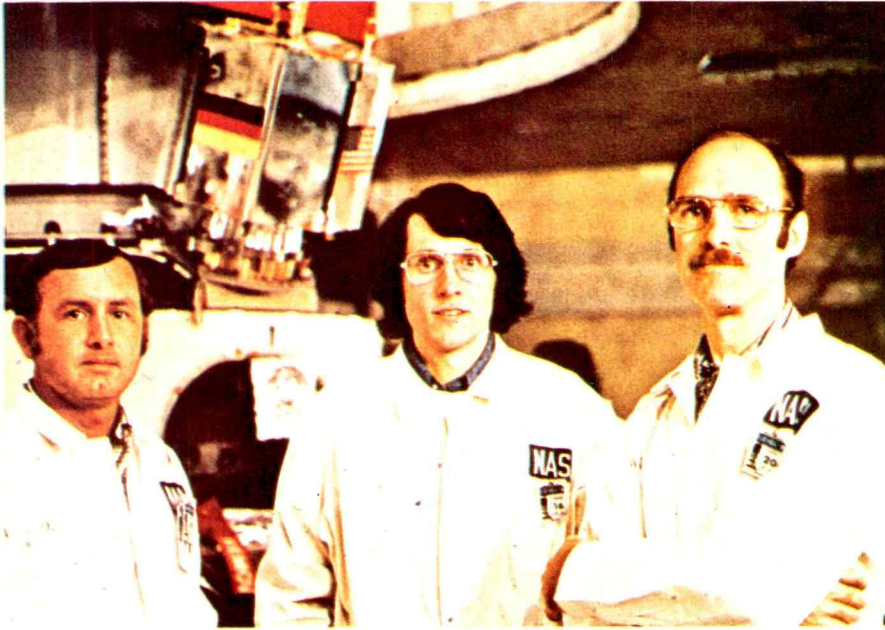

Jan King, W3GEY, is at center, with W6OAL, left, and WA4DGU, right.

on were launched by NASA rather than the Air Force, and they were launched from Vandenberg Air Force Base, which NASA calls the Western Test Range.

ME: How did you transport the satellite to the launch site?

JK: By aircraft. We contacted the airline to let them know ahead of time. We

'Somehow, what you create is more than the sum total of the parts you put into it; it takes on a life of its own.'

didn't want it to go in the cargo bay because we were a little concerned about the vibration environment there. It wasn't too much of a problem to carry it in the passenger area, but when you tell people you want to bring a satellite on board it tends to create some confusion.

ME: Was this a pretty big box?

JK: No, actually OSCAR 5 itself was only about 12" by 17" by 6", about the size of four shoe boxes. I took the spacecraft out and was met by a number of amateurs.

We had a lot of support from the people in the Los Angeles area who met us there and took us to the Western Test Range and so on. Bill Stewart, K6HV, was the guy who helped me on that particular trip. We did some work on the craft down there to get it finally ready for launch.

ME: AMSAT is doing a great deal with very little money. We're curious to know what NASA thinks about what

you're able to do with the limited money you have available.

JK: If you look at it from the professional standpoint, it's really crazy to think of a spacecraft being built for, say, \$100,000 in round numbers. You know, that's three orders of magnitude less than a spacecraft system costs them. They're used to paying \$100-million for the craft plus the ground stations that support it. So they really can't even relate to that number, which would be about the cost of a major sub-system, like the power system, of their spacecraft.

ME: How do you arrange for NASA to carry out the launch?

JK: Well, amateur radio sort of falls into the same general category as apple pie and motherhood. It's a good thing to them, and to that extent they've never turned us down in way of support.

Naturally, they don't want to see it get out of line in perspective with other things. These satellites are, of course, a secondary payload, or piggyback, to the primary launch vehicle, and we've spent a lot of time preparing ourselves

'Lo and behold, we found it won't fit in a standard station wagon or through a typical house door.'

for the necessary meetings wherein we have to explain exactly what we're doing to the NASA people, justify our technical competence, and so forth. You see, they sometimes tend to put the brand "amateur" on you before realizing you have the technical degree, are a

professional person, and also work in the aerospace field. So, they're surprised when you tell them that you've taken these skills and applied them to a different area.

ME: Are there other NASA people involved with AMSAT?

JK: Dick Daniels, WA4DGU, who built all of the Mode A transponder, is a

'It's really crazy to think of a spacecraft being built for, say, \$100,000.'

NASA headquarters fellow who has also built most of AO-D. He's not only been responsible for pushing the proposals through headquarters, but he also deals with the paperwork coordination between NASA and the FCC.

ME: Right now, you're working on AO-D and Phase III, right?

JK: Yes. This is the first time we've really tried to build two satellites at the same time. The reason for this has to do with program continuity.

The first five satellites were short-lived and were fundamental in getting the whole program concept visualized and in learning the basic skills necessary.

The Phase II satellites, OSCARs 6, 7, and AO-D, brought satellite work into the everyday experience of amateurs, but they still are not the kind of satellites that will provide real communications viability to amateur radio. In other words, they won't entice all amateurs into using satellites as a method of communications.

The Phase III satellites will provide a

'Amateur radio sort of falls into the same general category as apple pie and motherhood.'

capability that never existed before: amateur communications by satellite for many hours a day. It will really extend amateur radio. But, it takes a long, long time to develop this Phase III type of satellite. So, we're replacing OSCAR 6 with another Phase II satellite in order that we don't have a long gap where we may not have a satellite at all, because that's pretty fatal to trying to raise money. Trying to develop Phase III at the same time is probably the biggest challenge the organization has ever had.

ME: Where were the satellites after OSCAR 5 actually built?

JK: OSCAR 6 was built in my home in Lanham, Maryland, and so was OSCAR 7. AO-D is being built in Dick Daniel's

basement, but this may be the last of the basement satellites.

We have approached Goddard to do a cooperative educational program where they will provide us a facility at Goddard at the visitors' center, where we will show people how we go about building these satellites. We need that facility very badly for Phase III.

The Germans developed the prototype structure for Phase III. Lo and behold, we found it won't fit in a standard station wagon or through a typical house door, so it immediately became clear that it was time to grow into a new facility.

ME: What's it like to actually build a

'It sat around for a number of years before a launch vehicle could be found for it. The satellite was quite a mess. It had spiders in it and all kinds of things.'

satellite and watch it being launched into space?

JK: I doubt if anybody, unless they've been into this, really can even comprehend the amount of work it is to get one of these satellites up there. Anything else you can fix, but everything you put in a satellite is special because once you let go of that piece of hardware, you're never going to see it again. And, you have to be on schedule because the launch doesn't wait.

So, when you've finally got one of these things built, OSCAR 7 particularly for me, you turn around and look at it, and you think, "My God, this is really something." Somehow, what you create there is more than the sum total of the

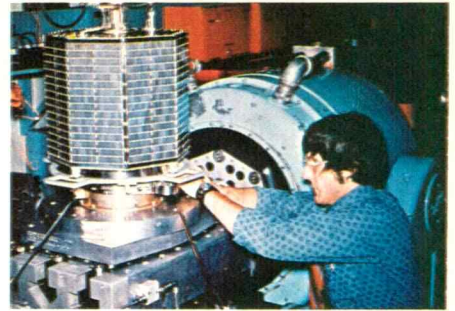
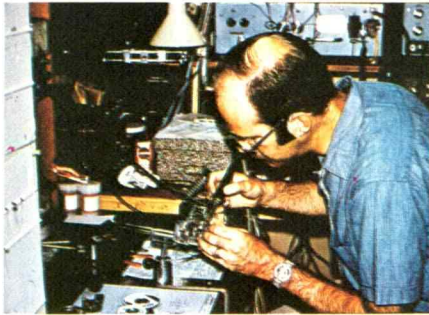

Operators of amateur radio stations K3JTE, K6JSG, W5CAY, DJ4ZC, K6HIJ, VK3ZPI, and W3GEY, top left, all worked on OSCAR. Jan King, W3GEY, top right, prepares OSCAR 7 for vibration tests. Ham operator WA4DGU, bottom left, wires a transponder into OSCAR. The satellite listens for signals in the two-meter amateur radio band and the transponder repeats them in the 10-meter band.

parts you put into it; it takes on a life of its own.

They're quite pretty, by the way. With the solar cells on the side and the mirror bright surface finishes, it's really quite an amazing machine to have created.

When you put it on the gantry, on the

'This may be the last of the basement satellites.'

launch vehicle, and finally close the door on the thing and seal it up for the last time, somehow just watching it disappear is quite incredible. Knowing what's gone into that little package from people all over the world, both in parts and many, many late hours of work, and knowing that thousands of people

will be using it... Well, it's hard to really put the feeling into words.

ME: What's the best thing about the OSCAR program in your mind?

JK: I'm excited by the concept that an individual can be involved actively in the space program, can experience what it's like to hear a satellite, communicate through a satellite, learn about telemetry and about controlling satellites remotely; in effect, to be as much up there in space as you possibly can be down here on earth!

ME: What are your thoughts about the upcoming Russian amateur satellite?

JK: I guess we consider the Russian spacecraft to be highly flattering, because not only does it help us tremendously in that it's going to be perfect for the educational program, but also because they've chosen a compatible frequency plan which is adjacent to

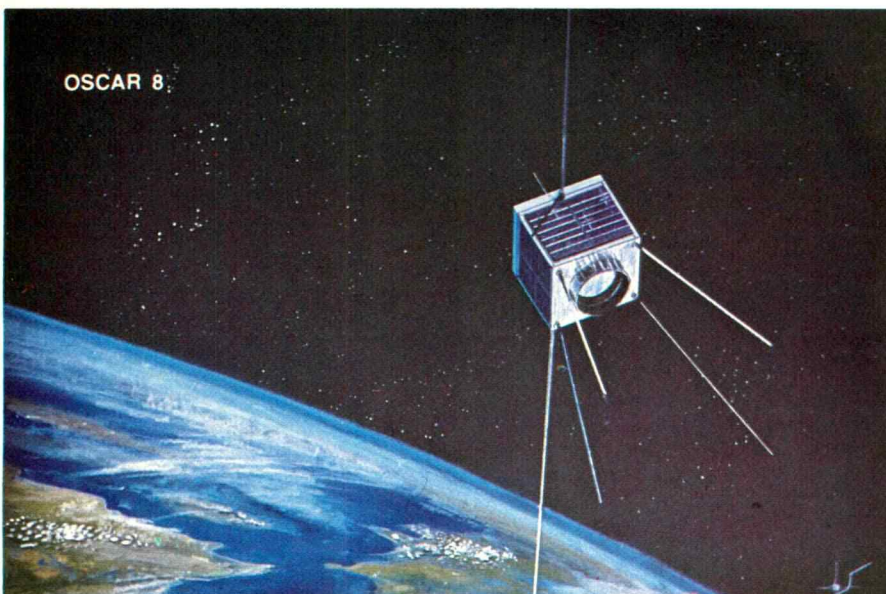

'OSCAR 5, itself, was only about the size of four shoe boxes.'

ours. There were virtually no communications between them and us.

Once, during the Apollo-Soyuz flight, a Russian communications engineer who happened to be a ham came over, and we got a chance to meet him and talk for about 20 minutes. I think he got the general drift of the OSCAR program, and this was the only direct contact we had about amateur satellites.

ME: Let me ask you a question that really has nothing to do directly with amateur satellites. The movie *Star Wars* has been playing now for over 19 weeks. Do you think a movie like this will have

You gotta shop around.

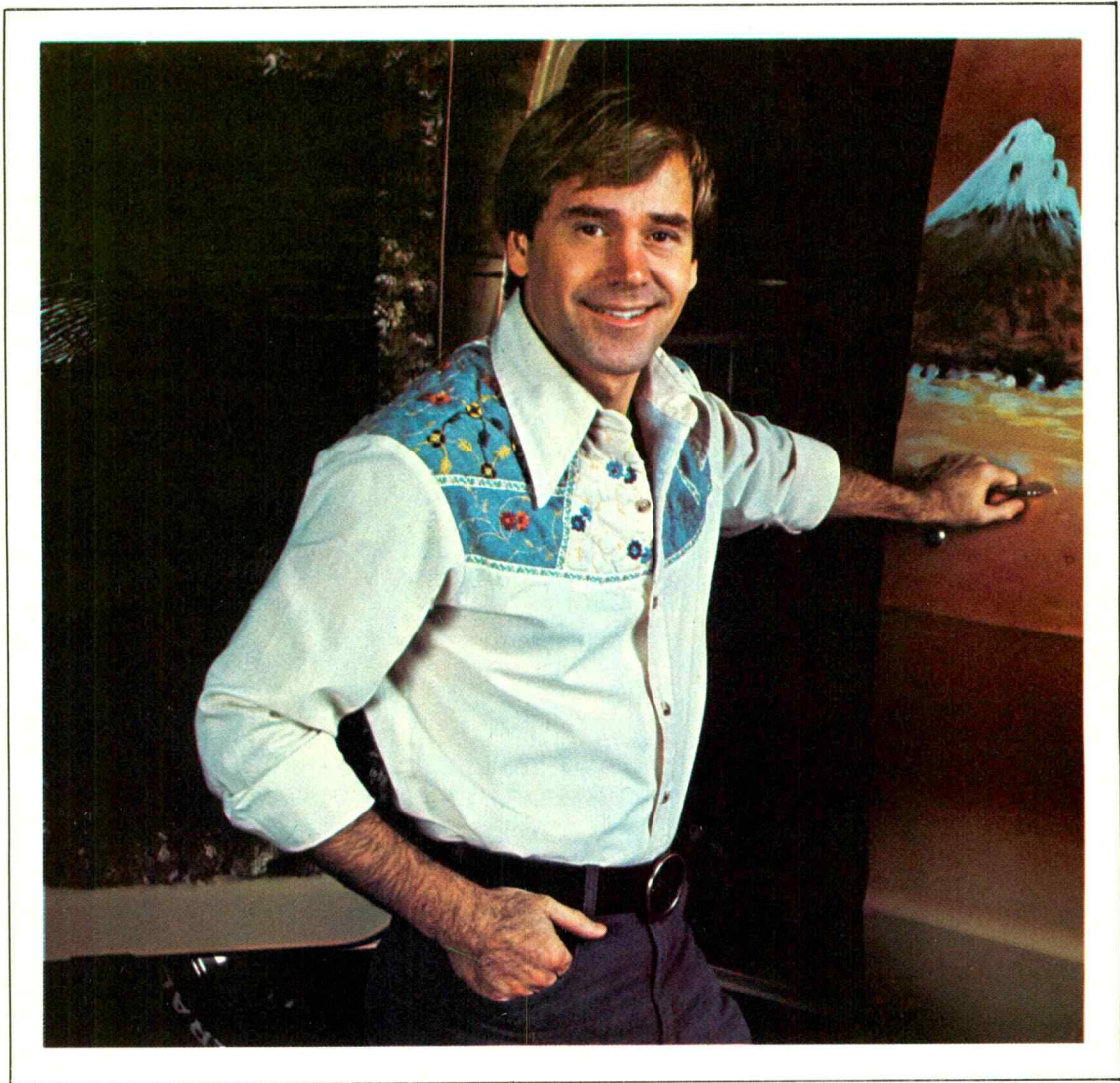

**When you do, you'll probably pick CIE.
You can't afford to settle for
less when it comes to something like
electronics training that could
affect your whole life.**

When you shop around for tires, you look for a bargain. After all, if it's the same brand, better price — why not save money?

Education's different. There's no such thing as "same brand." No two schools are alike. And, once you've made your choice, the training you get stays with you for the rest of your life.

So, shop around for your training. Not for the bargain. For the best. Thorough, professional training to help give you pride and confidence.

* * *

If you talked to some of our graduates, chances are you'd find a lot of them shopped around for their training. They pretty much knew what was available. And they picked CIE as number one.

Why you should shop around yourself.

We hope you'll shop around. Because, frankly, CIE isn't for everyone.

There are other options for the hobbyist. If you're the ambitious type — with serious career goals in electronics — take a close look at what we've planned for you at CIE.

What you should look for first.

Part of what makes electronics so interesting is it's based on scientific discoveries — on ideas! So the first thing to look for is a program that starts with ideas and builds on them!

That's what happens with CIE's Auto-Programmed® Lessons. Each lesson takes one or two principles and helps you master them — before you start using them!

How practical is the training?

This is the next big important question. After all, your career will be built on what you can do — and on how well you do it.

Here are ways some of CIE's troubleshooting programs help you get your "hands-on" training . . .

With CIE's Experimental Electronics Laboratory . . .

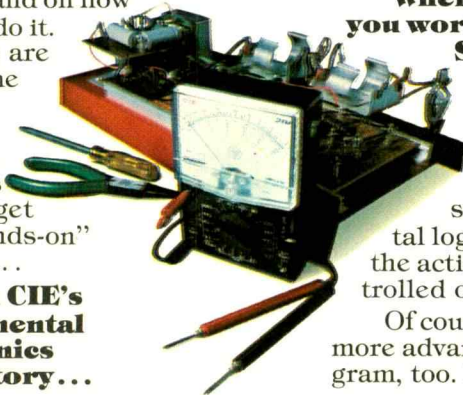

you learn and review the basics — perform dozens of experiments. Plus, you use a 3-in-1 precision Multimeter to learn testing, checking, analyzing!



When you build your own 5 MHz Triggered-Sweep, Solid-State Oscilloscope you take your first real professional step. You use it as a doctor uses an X-ray machine — to "read" waveform patterns . . . lock them in . . . study, understand and interpret them!

When you get your Zenith 19-inch Diagonal Solid-State Color TV you

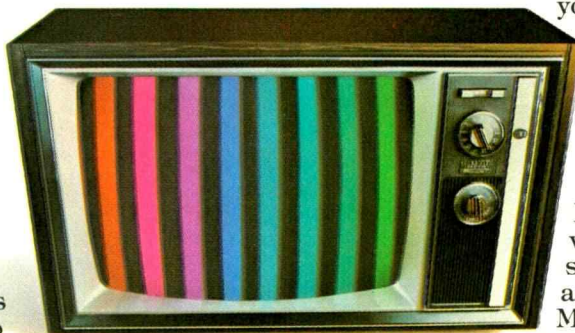

Pattern simulated.

apply your new skills to some real on-the-job-type troubleshooting! You learn to trace signal flow . . . locate malfunctions . . . restore perfect operating standards — just as with any sophisticated electronics equipment!



When you work with a completely Solid-State Color Bar Generator — actually a TV signal transmitter — you study up to ten different patterns on your TV screen . . . explore digital logic circuits . . . observe the action of a crystal-controlled oscillator!

Of course, CIE offers a more advanced training program, too. But the main point is

simply this:

All this training takes effort. But you'll enjoy it. And it's a real plus for a troubleshooting career!

Do you prepare for your FCC License?

Avoid regrets later. Check this out before you enroll in any program.

For some troubleshooting jobs, you must have your FCC License. For others, employers often consider it a mark in your favor. Either way, it's government-certified proof of specific knowledge and skills!

More than half of CIE's courses prepare you for the government-administered FCC License exam. In continuing surveys, nearly 4 out of 5 CIE graduates who take the exam get their Licenses!

Shop around . . . but send for CIE's free school catalog first!

Mail the card. If it's gone, cut out and mail the coupon. If you prefer to write, mention the name and date of this magazine. We'll send you a copy of CIE's FREE school catalog — plus a complete package of independent home study information! For your convenience, we'll try to have a representative contact you to answer your questions. Mail the card or coupon — or write: CIE, 1776 East 17th St., Cleveland, OH 44114.

CIE Cleveland Institute of Electronics, Inc.

1776 East 17th Street, Cleveland, Ohio 44114
Accredited Member National Home Study Council

YES . . . I'm shopping around for the **right** kind of career training in electronics troubleshooting — and CIE sounds well worth looking into. Please send me my FREE CIE school catalog — including details about troubleshooting courses — plus my FREE package of home study information! MO-03

Print Name _____

Address _____ Apt. _____

City _____

State _____ Zip _____

Age _____ Phone _____

(area code)

Check box for G. I. Bill information:

Veteran Active Duty

Mail today!

a beneficial fallout for the space program?

JK: First, I think *Star Wars* has a lot to say about the fact that people haven't been producing movies that people were interested in going to for a long time. I'm really impressed with the technology amassed in the film; the battle scene was a whole new dimension in filmmaking.

But, I see kind of a dangerous thing happening with *Star Wars*, *Star Trek*, and so on. People who are non-technically oriented may jump into the field thinking that these shows represent science and then find that it's not really what they're interested in, because they may really be looking more for the adventure in these shows.

I think there's a lot more to be said for a movie like *2001*, and I believe the OSCAR program is more aligned with trying to create a good excitement for students which will couple them towards an engineering career. It's supposed to excite in them a desire to learn more about mathematics, more about

physics, and about areas of science which will cause them to develop further skills.

An example of this is doing orbit calculations using computers. I did this as a high school senior and thought it was the greatest thing in the world. Now, they're doing it in tenth grade. This kind

'They sometimes tend to put the brand amateur on you before realizing you have a technical degree, are a professional person and also work in the aerospace field.'

of thing is much more positive than something that's not real.

ME: It seems, though, that, as a nation, we lost momentum in the manned space program and that we let a team who accomplished a great deal deteriorate or at least be held inactive. If

Star Wars re-awakens some kind of yearning in people who are the age to appreciate it and who, hopefully, will be voting and having some kind of input into where the money's going to be spent, it would really accomplish a purpose that maybe wasn't intended.

JK: Nationally, I'd like to see anything that would create that kind of interest again. In a lot of ways, if you're a true space buff... well, I saw *Star Wars* three times, and I thought it was fantastic; my kid saw it four times. Things like the space program do seem to have a tendency to go through a burst mode, or else it'll be like a pendulum where every other generation will sort of re-discover an interest in it.

The problem, of course, is that these things tend to get more and more expensive. Each time you go to a farther planet, it costs more, and sometimes by a lot of money. And, our solar system is just about the limit until physics comes up with a way to travel faster than the speed of light, because it's just too damn far to the next star! 

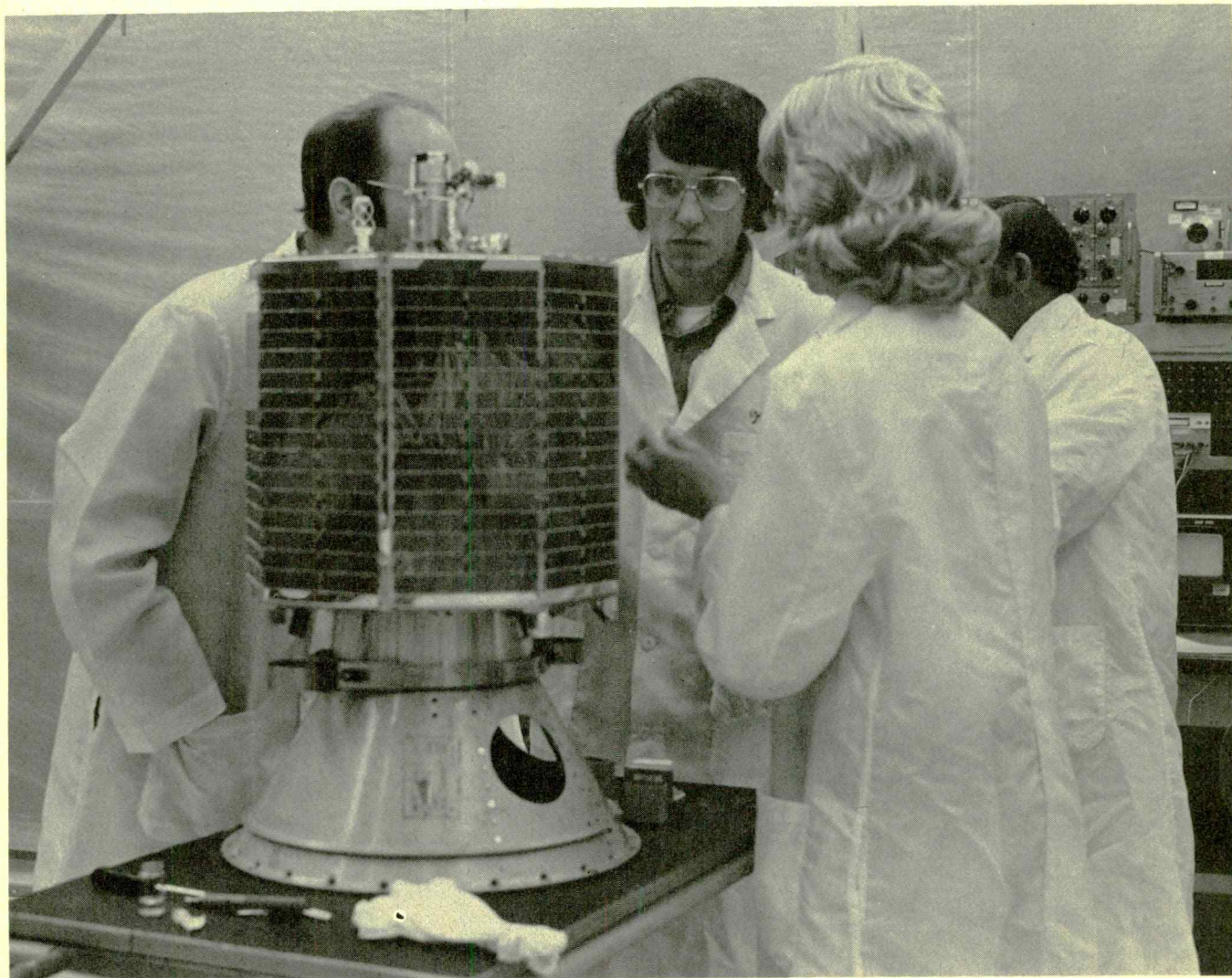

Jan King, W3GEY, confers with other NASA employees in making last minute checks on OSCAR 7.

I'M SERIOUS

"I'm serious about a lot of things. The clothes I wear, the car I drive...the Citizens Band radio I operate. For some people, buying a Browning CB radio may seem an extravagance...but I'll never settle for less than Browning performance!"

Serious CBers have relied upon the name Browning since Citizens Band first began. If CB means more to you than fun and games, check out Browning...**seriously!**

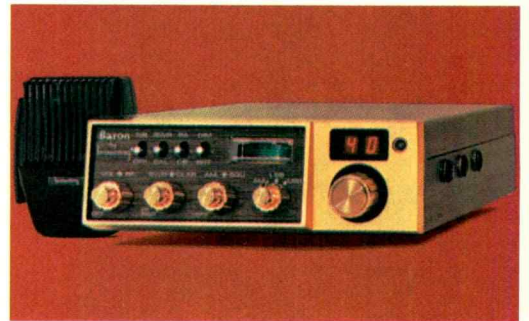

browning
bringing people together

Browning Laboratories, Inc., Laconia, New Hampshire 03246

In Canada: Paco Electronics, Ltd., Montreal, Quebec

CIRCLE 35 ON READER SERVICE CARD

Videogames roundup: the best and most fun

by Bob Margolin
Assistant Editor

One of the biggest happenings, if not *the* biggest, in home entertainment during 1973 was the announcement by Magnavox of its Odyssey video game. With its introduction, you could, for the first time, use your tv set for something other than watching tv programs received off the air.

You and a friendly opponent actually could play electronic tennis across the face of the tv screen, each of you controlling the position of your racquet. And when you positioned your racquet in front of the bouncing ball, it actually rebounded back towards your opponent.

In those early days of video games, the only things the game put on your screen were the two racquets and the ball. The field was on a plastic overlay, and you had to keep your own score.

On-screen playing field

As the technology improved, so did the video games. Soon after their introduction, the playing field appeared on-screen. Then came automatic scoring with the numbers displayed at the touch of a switch. More recently, a running score appeared on screen.

But that was only the beginning. All the video games then available were pre-programmed by the manufacturer to produce a handful of tennis derived games. In computer parlance, these were dedicated games.

The real breakthrough came with the introduction of the programmable game. Programmables, as the name implies, let you change the games that can be played. This is usually done by simply changing a plug-in cartridge, very similar in appearance to an eight-track tape cartridge.

Programmable games

Not only can you change the number of activities produced by your video game, you also can greatly increase the complexity of activity. Rather than being limited to variations of tennis, you can engage in races, wage war, even pilot star ships.

Programmable games now are offered by APF, Atari, Fairchild, RCA and



Both the Sears Video Arcade, shown above, and the Atari Video Computer System offer over 150 different video game variations. The number and complexity of games offered in these and similar programmables is possible because of plug-in program cartridges, each containing all the circuitry needed to produce the games provided.

Sears, with others just over the horizon. All come with between two and five games built-in, or with a plug-in cartridge offering up to 27 games.

The number of games offered in each cartridge depends on the complexity of the program required. The Fairchild Videocart-5 cartridge contains just one game—*Space War*. The Atari Video Olympics cartridge, on the other hand, contains 50 pong-derived ball game variations. The total number of games offered for each programmable unit also varies widely. Sears and Atari, for example, catalog over 150 game variations. However, Coleco currently offers

just 14 game variations with its programmable Telstar Arcade.

Tennis Anyone?

Even the most sophisticated video games still offer the games that started the whole thing—ping pong, tennis and hockey. But they're not the same games you played four or five years ago. In those days, you and your opponent moved a single paddle up and down the screen attempting to position it in front of a slowly moving dot.

Today, tennis and all its variations are available with paddles that can be moved in any direction to any position

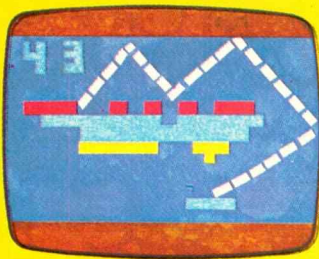

Breakaway

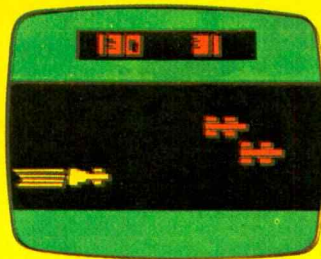

Road Race

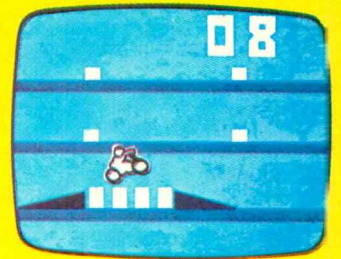

Stunt Cycle

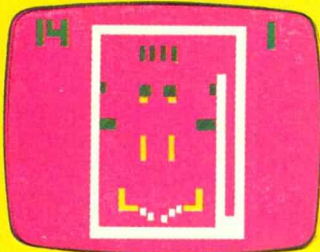

Pinball

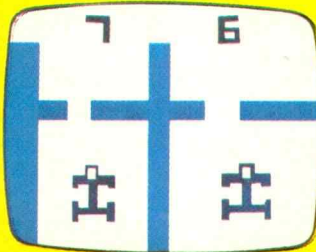

Street Racer

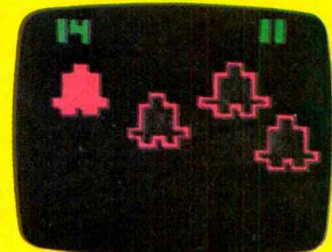

Shooting Gallery

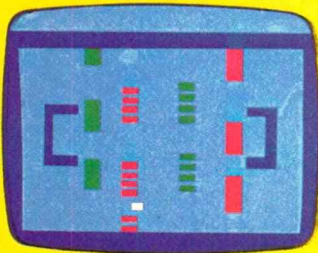

Soccer



Anti-Aircraft

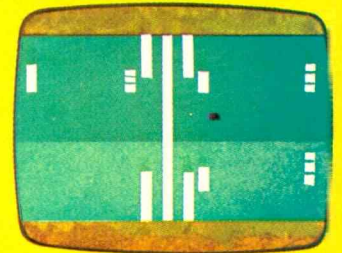

Super Pong

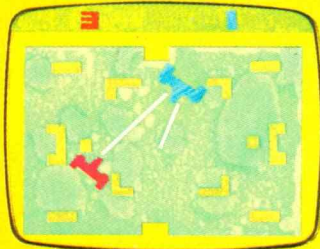

Combat

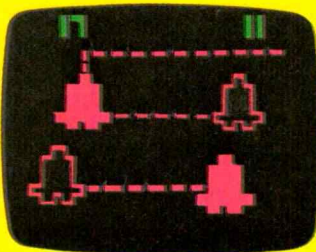

Shoot the Bear

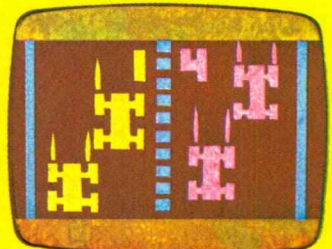

Speedway IV

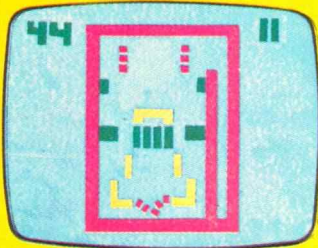

Deluxe Pinball

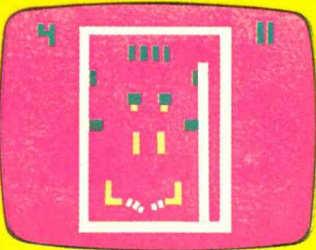

Bonus Pinball

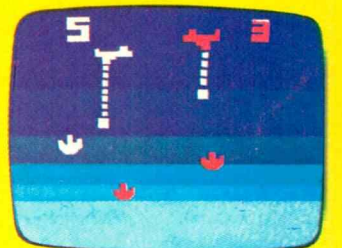

Air Sea Battle

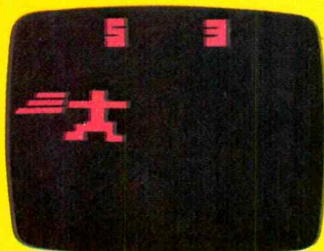

Quick Draw

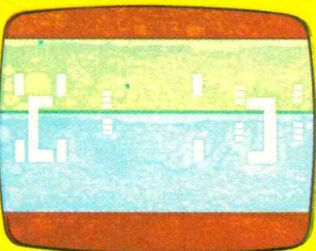

Hyper Pong

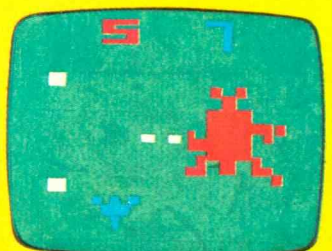

Starship



RCA's Studio II programmable video game uses a calculator-like keyboard to control the action.

on the screen. You even can change the angle at which the paddle hits the dot. If you're a better player than your opponent, you can give him a sporting chance by reducing the size of your paddle. If your opponent is your equal, you can speed up the dot to make it a real challenge.

Some of the hockey games available also give you independent control of both the forward and the goalie. The Fairchild version, for example, lets you use your controller to move your forward over the entire playing surface, changing the angle of your shots, while at the same time sliding your goalie back and forth across the goal crease to defend against your opponent's shots.

Probably the most complex of all the pong-derived ball games is the Fairchild *Baseball* game. As your batter stands at the plate, waiting to swing his bat at your command, your opponent is using his controller to move his outfield to the left and right. Using the same controller, he will command his pitcher to release the ball. Once it's in flight, he can change its speed and course.

So there you stand, at the plate, waiting for the pitch. Will it be a fastball or a change of pace? Will it seem to be right over the plate, only to suddenly curve to the left or right? Or will it be a ball? There you stand, at the plate, with the count three and two, men on first and third, waiting for your opponent to pitch the \$@#%&* ball. Oh well, that's what makes baseball so interesting.

In a galaxy far, far away

As exciting and enjoyable as all the ball games are, the real action is deep in space, or in a live mine field in the Black Forest. These are the scenes where the various combat games are played—Space War, Combat, Tank, Air-Sea Battle and the others.

Although the scene differs from one combat game to the next, the object in all of them is the same. Using your controller, you must maneuver your vehicle, be it tank, ship, or starcruiser, around obstacles and mines until you can get a shot at your opponent, who is trying to get a shot at you.

Some combat games have invisible vehicles that show themselves only

when they fire. Other games are handicapped by providing each player with a limited number of cannon shells or laser blasts. Some award your opponent points when you hit a mine, others just disable your vehicle for a short period—usually enough time for your opponent to get off a shot or two. Many of the combat games provide visual effects such as tanks that spin when hit, or space ships that seem to explode. Some have realistic sound effects as well.

Road racing

Other action games include variations of road racing. The object is to drive your car through the field of other racers without hitting anyone. One of the more complex racing games is Fairchild's *Drag Strip*, which can be played by one or two players. What makes this game so complex is the many functions of the controller. Not only does it act as a gear shift—it's a four-speed H pattern shifter—it also serves as the throttle and clutch.

You and your opponent settle down, your cars at the line. You shift into low gear, and rev up the engine. The Christmas Tree starting lights are counting down. Four, three, two, one, GO! You pop the clutch and... Oh no, you redlined. Too many revs. Those high RPMs blew the engine. Oh well. But wait, your opponent is still at the line, too. What happened? He stalled out, that's what happened. While you had too many RPMs, he had too few. When he popped his clutch, the engine just quit.

Not all video game programs provide

action games. There also is a good selection of numbers, card, and logic games available. Fairchild's *Mindreader* is one of the better numbers games. In *Mindreader*, you have either 20 guesses or your choice of two, five, 10 or 20 minutes to determine your choice of a three-four- or five-digit mystery number selected at random by the game.

Each time you make a guess, the number you've chosen appears on screen. Next to it there can be one, two, or more *H* and or *T* symbols appearing. An *H* means that a digit you've selected is correct and in its proper location in the number. A *T* means the digit is correct, but in the wrong location. Using these clues, you can logically track down the mystery number in just a few moves—if you're good. You can play this one against yourself, or against any number of players.

The universal card game is blackjack, or 21 as it is known in some parts of the country. Though the video display differs from one game to the next, all work on the same principle. You and your opponent bet against each other and the house as cards are dealt from a freshly shuffled deck. The object is, of course, to come as close to 21 as you can without going over.

Which way out?

There's another class of video games that have motion, but which do not involve hitting a moving target as do the ball and combat games. These are the maze games. All are built around the object of getting from one end of a maze to the other as quickly as possible. Some

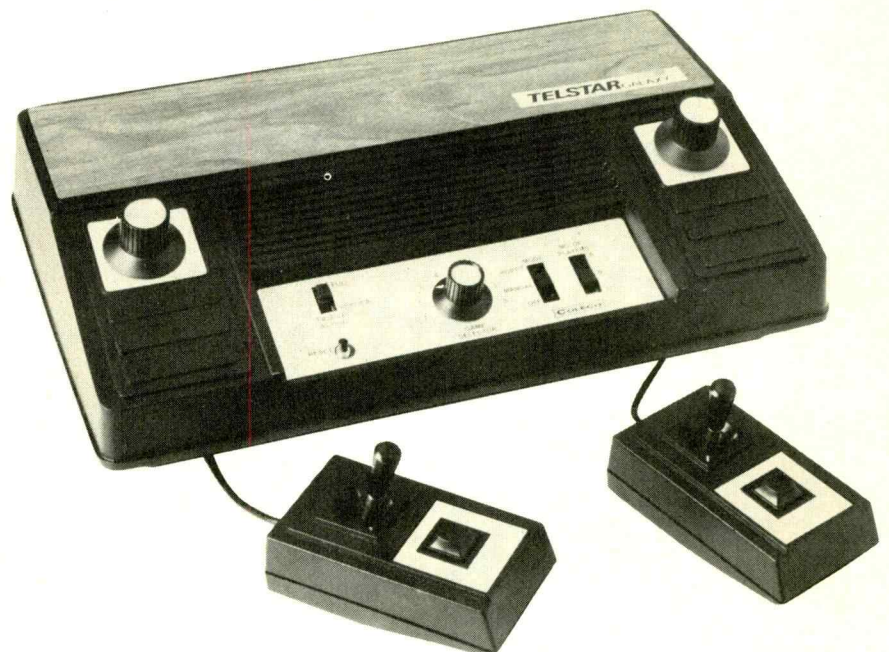

Coleco's Telstar Galaxy dedicated video game lets two or four players compete in tennis, hockey, handball, soccer, basketball and football. Built-in variations give you a total of 48 different games, all in full color on color tv sets.



The APF TV Fun Model 402 provides not only two and four player versions of tennis, hockey, handball and hockey, but also includes two shooting gallery games as well. The target pistol control contains a photosensitive pickup that scores a hit if you've aimed on-target at the moving light spot on your tv screen.

maze games are designed for two players, others can be played by one person against the game program.

The Fairchild maze games have two interesting variations. One, called *Cat and Mouse*, pits you against the cat which is coming towards you from the exit of the maze. You have to find a way to get by the cat to win. The only advantage you have is that the cat doesn't know how to get through the maze either, so it tries every passageway until it finds the right one. The other variation is *Jail Break*, in which the maze is hidden behind a solid cross-hatch pattern. So, not only do you have to find your way out, you have to find the maze itself.

Atari has another approach to the maze game. Called *Trapped*, the object is for you to build a wall around your opponent before he builds one around you. Your escape from his wall is made slightly easier by virtue of your ability to erase any walls you've built. And you can disappear off one side of the screen only to reappear from another side, building your wall as you go.

How much is one and one?

Since video games are built around digital microprocessors that aren't much different from those in calculators, it's only natural to use them for math games as well. Atari's *Basic Math* offers eight math game variations.

In four, you select a number and function—addition, subtraction, multiplication or division. The game then selects another number. You must then find the solution before time runs out. The other four are essentially the same, except after you select the function, the game chooses both numbers.

In the Fairchild version, you can program the game to provide you randomly selected problems in either addition or subtraction. Once the problem is pre-

sented, you solve it. If your first answer is wrong, you get a second chance. If you're still wrong, the game presents the correct answer. Both the Atari and the Fairchild math games can be played alone, pitting you against the game, or by several players.

When either game is played by more than one person, scoring is done on the basis of fewest wrong answers or shortest time to solution. However, each

player must solve his own problem, since only one player can participate at a time.

RCA has taken a different approach with its *Addition* game. Here two players, using their own keyboards, work against time to be the first to solve the same problem. The first one to correctly solve the problem locks out his opponent and wins the point.

Regardless of which math game you have, your video game can be used to help improve your family's math skills. Combined with games of logic, such as *Mindreader* and the various maze games, the math games turn your video game into a home education center. And because of its unique method of presenting mathematics and logic, it is an educational tool your family will want to use.

Is dedication all that bad?

Dedicated games, though lacking in the versatility of the programmables, offer a big price advantage, and provide a lot of action, too. Some dedicated units are very simple, offering two or three tennis-type games for as little as \$20. Of course, these low-end games are so limited in action you're likely to lose interest in them after just a few hours of use.

Not all dedicated games are simple. The Coleco Telstar Combat game, for



The Coleco Telstar Arcade, although offering the fewest games of any programmable set, gives you greater feel for the game by providing realistic control action. Instead of turning a rotary control, or moving a joystick, you steer your racecar with a real steering wheel, and shift gears with a separate shift lever.

example, offers four variations of the basic tank game. In *Robot Battle*, *Night Battle*, *Combat* and *Camouflage*, you maneuver your vehicle through a field of obstacles and mines to get a shot at your opponent. The built-in programming lets you move your vehicle at different speeds and angles all over the field. The game comes complete with realistic sound effects.

Coleco also offers three games with a built-in shooting gallery, complete with

program or the program contained in plug-in cartridge produces the tv picture information which is applied to the tv transmitter, just as a tv camera provides the picture for a tv station. By setting a switch, pushing a button, or inserting a cartridge, you select the tv picture you want.

Built-in computer

The action in the game, be it a moving ball or set of numbers, is provided by



The Magnavox Odyssey 3000 is a descendant of the world's first home entertainment video game. It offers tennis, hockey, smash and practice games with adjustable paddle size for handicapping, and adjustable spin for the advanced player.

pistol. Inside the pistol is a photosensitive pickup. If your pistol is aimed correctly when you squeeze the trigger, the pickup will sense the target on your tv screen and you'll score a point.

The number and complexity of games built into dedicated units depends on selling price. Low cost units have only a few, simple games. Expensive games, selling between \$80 and \$100, offer more complexity and greater numbers. The Telstar Galaxy, for example, offers a total of 48 game combinations, built around six basic games—basketball, football, handball, hockey, soccer and tennis.

The more expensive dedicated games also offer the sophistication of the programmables in the game action. Most let you select ball speed. Some let you angle your shots. Others let you alter the size of the paddles to handicap the game.

All video games, both programmable and dedicated, are very low power television transmitters. They generate the same kind of signal that your local tv station does. The signal produced by the game is applied by cable through an adapter to the antenna terminals of your tv set, which treats it just as any other tv signal would be treated.

Because your video game is a tv transmitter, there's a real danger that some of the video game's signal may be picked up by other tv sets in the neighborhood. And while you may be having a lot of fun playing space war, your neighbor may not appreciate the game as much, especially if it's interfering with the program he's watching.

The FCC, in an attempt to prevent this kind of problem, requires all video games to meet certain standards it has set. So, make sure your game is FCC approved.

In your video game, the dedicated

the built-in microprocessor. In some games, all the variables in the game are programmed in by the manufacturer. In others, you can select ball speed, paddle size and angle, and other variables. Once these variables are programmed, the game begins.

The action of your playing piece is controlled by a hand operated controller. Each manufacturer has its own ideas about how a controller should function. Some manufacturers, such as Coleco, provide separate controllers for the different kinds of games in the unit. Others, such as Fairchild, have settled on a single, multi-function controller. All controllers, though, fall into three basic categories: keyboard, rotary control and joystick.

Keyboard controllers are just like keyboards found on pocket calculators. APF and RCA use keyboards, though APF also provides a rotary control. Keyboards don't have the feel of the other controls—you punch a button to speed up your race car rather than turn up the speed. But, keyboards do add a scientific air to the game because you get the feeling that your programming a big computer.

Joysticks are more fun

Rotary controls are like the volume controls on your radio and tv sets. Turning the control knob to the left moves your playing piece to the left; turning to the right moves it to the right. While you'll get the feel of the road using rotary controls, they can only provide limited action—left or right, up or down, slower or faster.

Joysticks are by far the most versatile and realistic-feeling controls. Simple joysticks provide full 360 degree control of your playing piece. That means you can move your piece not only left and right, and up and down, but also at any

angle you want. Some combine other functions as well. Many combine both joystick and rotary control in a single unit. This allows you to control both speed and direction.

Fairchild's controller is probably the most complex of all the controllers. Not only can you move the joystick in any direction, but you also can twist it left or right and push it down or pull it up. It takes a little getting used to but once you've mastered it, you like the added versatility.

Color me blue

About half the games available today provide color displays on your tv set, if it is a color set. Naturally, the color games cost more. Generally, dedicated games with color displays cost over \$40. All programmable games, with the exception only of RCA's Studio II, are in color.

There has been some concern expressed about possible damage to the tv screen resulting from extensive use of video games. The cause of the damage, if there is any, is the continuous display of stationary, bright, playing field boundary lines. After extended use, a shadow may appear on your tv screen where these playing field lines appear. Though the facts are not yet in, you'd be wise to turn down the brightness and contrast of your set when using your video game.

Some games won't work well with certain model tv sets. Problems include rolling or tearing pictures, and ghosting. Many times, the situation can be corrected by carefully adjusting the vertical or horizontal hold controls, and manually adjusting the fine tuning. However, make sure you can exchange the video game you buy for another make or model, just in case your set is incompatible.

Who makes what?

Any listing of video games is bound to be incomplete because of the changing market. Nevertheless, here's a list of video games available from the leading manufacturers.

Manufacturers are listed in alphabeti-



The Sear's Hockey-Tennis II gives you and your opponent a choice of tennis, handball and hockey, with adjustable paddle size to handicap the match. There's also a one-player practice game to sharpen your skills.

Send today for the
NEW WINTER '78
HEATHKIT CATALOG

FREE



The world's largest selection of fun-to-build electronic kits plus value-packed Heath-recommended assembled products. Heathkit products are world-famous for their easy step-by-step instructions, top performance and professional specifications.

MAIL COUPON BELOW FOR YOUR FREE COPY!

Select from nearly 400 unique electronic kits for the student, hobbyist and experimenter including:

- TEST & SERVICE INSTRUMENTS ■ PERSONAL COMPUTERS
- ELECTRONICS COURSES ■ AMATEUR RADIO
- COLOR TV ■ HI-FI COMPONENTS ■ HOME PRODUCTS
- MARINE, AUTO & AIRCRAFT ACCESSORIES

FREE

Send for your Heathkit Mail Order Catalog today! It's filled with large, clear illustrations and complete descriptions of unique products you can build and service yourself!



You can get a FREE retail catalog by redeeming this coupon in person at any of the 50 Heathkit Electronic Centers (Units of Schlumberger Products Corporation) in major markets coast-to-coast, where Heathkit products are sold, displayed, and serviced. (Retail prices on some products may be slightly higher.) Check the white pages of your telephone books for the Heathkit Electronic Center nearest you.

HEATH Schlumberger	Heath Company, Dept. 378-380 Benton Harbor, Michigan 49022
Please send me my FREE Heathkit mail order Catalog. I am not on your mailing list.	
Name _____	
Address _____	
City _____	State _____
CL-649	Zip _____



Atari's Video Pinball is one of the most popular dedicated video game. Built-in flipper control buttons on the console sides give you the feel of a real pinball game.

cal order. In the brief description of each game that follows, you'll find the maximum number of players, the type of controls used, a list of the games included, special features, whether the display is in black and white (B&W) or color, power requirements and price.

Dedicated games

APF Electronics, 444 Madison Ave, New York, NY 10022

■ **Model 405**—2 Players; remote rotary controls. Tennis, hockey, handball and squash, in three degrees of difficulty, in B&W. 6 C batteries or optional ac adapter required.

■ **Model 442**—Deluxe version of Model 405.

■ **Model 444**—4 players; 2 console mounted and 2 remote rotary controls. Tennis, hockey, handball and squash, with 8 variations, in B&W. 6 C batteries or optional ac adapter required.

■ **Model 402**—4 players; 2 console mounted and 2 remote rotary controls plus shooting gallery pistol. Tennis, hockey and handball in singles and doubles versions plus target shooting and skeet. Ball games in color, shooting games in B&W. 6 C batteries or optional ac adapter required.

■ **Model 500**—2 players; remote rotary controls. 20 space war games including Phantom War, Space Phasor and Phantom Phasor, with guided missiles, slow and fast moving asteroids and phantom spaceships, in color. 6 C batteries or optional ac adapter required.

Atari Inc, 1265 Borregas Ave., P.O. Box 9027, Sunnyvale, CA 94086.

■ **Video Pinball**—1 player; console mounted rotary control and 2 pinball flipper buttons. Breakout, 4 variations each of 2 pinball, 2 paddle pinball and 2 rebound games, all in color. 6 C batteries or optional ac adapter required. \$90.

■ **Ultra Pong**—4 players; 4 remote rotary controls. Ultra pong singles and

doubles in 32 variations, all in color. 4 C batteries or optional ac adapter required. \$53.

■ **Stunt Cycle**—1 player; handlebar grips mounted on console. Stunt Cycle, Drag Race, Motocross and Enduro. AC adapter built-in. \$73.

Coleco Industries, Inc., 945 Assylum Ave., Hartford, CT 06105.

■ **Telstar Alpha**—2 players; console mounted rotary controls. Tennis, hockey, handball and Jai-Alai in B&W. 6 C batteries required.

■ **Telstar Regent**—2 players; remote rotary controls. Otherwise similar to Alpha model.

■ **Telstar Colormatic**—Color version of the Regent Model.

■ **Telstar Galaxy**—4 players; 2 console mounted rotary controls, 2 remote joystick controls. Tennis, hockey, handball, soccer, basketball and football in color. Total of 48 game variations. AC adapter included.

■ **Telstar Ranger**—2 players; remote rotary controls and remote pistol. Tennis, hockey, handball, Jai-Alai, target shooting and skeet B&W. 6 C batteries required.

■ **Telstar Ranger Colormatic**—color version of Telstar Ranger (shooting games in B&W).

■ **Telstar Gemini**—1 player; remote pistol and 2 console mounted pinball flipper buttons. 2 versions each of bonus pinball and deluxe pinball, shoot the bear and shooting gallery. Pinball games in color, shooting games in B&W. AC adapter included.

■ **Telstar Combat**—2 players; console mounted dual lever controls. Combat, night battle, robot battle and camouflage in B&W. 6 C batteries required.

Magnavox, 1700 Magnavox Way, Fort Wayne, IN 46804.

■ **Odyssey 2000**—2 player; console mounted rotary controls. Tennis, hockey, smash and practice, each with 2



Atari's Ultra Pong is claimed to be the ultimate extension of the original ping pong video game. Two or four players can compete in 32 game variations.

skill levels and 3 sound effects, in B&W. 6 C batteries or optional ac adapter required. \$40.

■ **Odyssey 3000**—2 players; remote rotary controls. Tennis, hockey, smash and practice with paddle size and deflection angle controls in color. 6 C batteries required. \$40.

■ **Odyssey 4000**—2 players; remote joystick controls. Tennis, hockey, smash, gridball, basketball, soccer and practice for basketball and smash in color. 6 C batteries or optional ac adapter required. \$70.

Radio Shack, Fort Worth, TX 76102.

■ **Model 60-3056**—2 player; remote lever controls. Tennis, handball, hockey and practice with paddle size, ball speed and slice controls, in B&W. 6 C batteries or optional ac adapter required. \$40.

■ **Model 60-3055**—2 players; remote slide controls. Tennis, handball and hockey, with adjustable paddle size, in color. AC adapter built-in. \$60.

■ **Model 60-3057**—4 players; 2 console

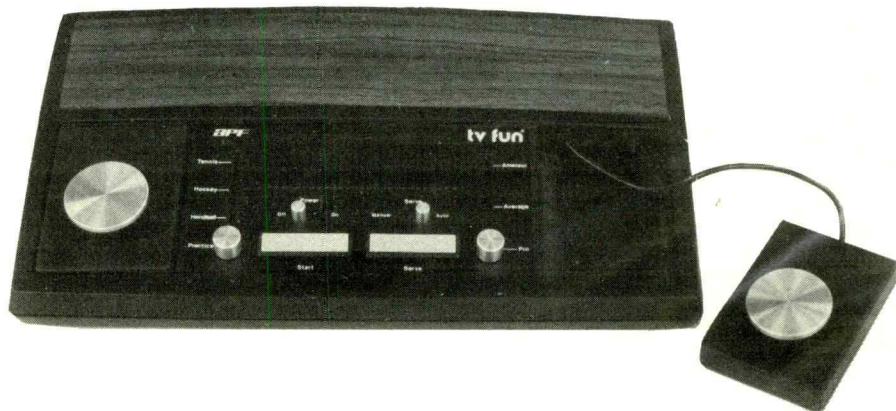

APF's Model 405 offers tennis, hockey, football, squash and handball, each with three levels of difficulty that keep pace with increasing skills.

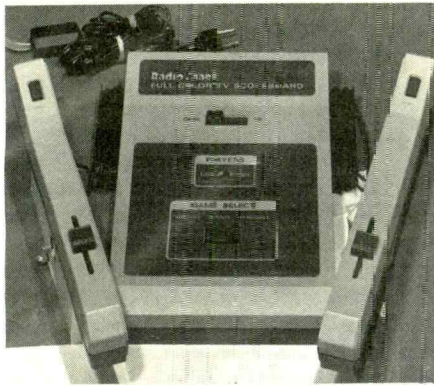

The Radio Shack Model 60-3055 TV Scoreboard uses unique slide action controls for tennis, handball and hockey games.

mounted and 2 remote slide controls and shooting gallery pistol with rifle attachment. Tennis, hockey, squash, skeet and moving target in color. 6 C batteries or optional ac adapter required. \$80.

Sears, Roebuck and Company, Sears Tower, Chicago, IL 60684.

■ *Tennis-Catch*—2 players; console mounted rotary controls. Tennis, catch and handball, without scoring, in B&W. 4 AA batteries or ac adapter required. \$20.

■ *Hockey-Tennis II*—2 players; remote

rotary controls. Tennis, handball, hockey and practice, with adjustable paddle size, in B&W. 4 C batteries or ac adapter required. \$30.

■ *Pong-Sports II*—2 players; remote rotary controls. 4 versions of tennis, 4 versions of pong, and 8 versions of hockey in color. 4 C batteries or optional ac adapter required. \$40.

■ *Pong-Sports IV*—4 player version of Pong-Sports II with 4 remote rotary controls. \$50.

■ *Tank*—2 player; remote joystick controls. Tanks have 3 forward and reverse speeds, exploding mines and barriers in B&W. Built-in ac adapter. \$60.

■ *Pinball-Breakaway*—1 player; pinball flipper buttons and rotary control mounted on console. Pinball, pin paddle, breakout, basketball, with 2 variations, in color. 6 C batteries or optional ac adapter required. \$80.

■ *Motorcross Sports Center IV*—4 players; console mounted handbar grip controls for cycle games, 4 remote rotary controls for ball games. Stunt cycle, drag race, moto-cross and enduro cycle games. 17 variations of tennis, hockey and pong. All games in color. Built-in ac adapter. \$85.

■ *Speedway IV*—4 players; 4 remote rotary controls. Indy-type auto race for one or two players, tennis and hockey in

color. 6 C batteries or optional ac adapter required. \$100.

Programmable games

Atari Inc., 1265 Borregas Ave., P.O. Box 9027, Sunnyvale, CA 94086

■ *Video Computer System*—comes with 4 interchangeable controls; 2 remote rotary controls and 2 remote joystick controls. Comes with Combat program cartridge containing 27 combat games. Other cartridges available include 27-game Street Racer, 50-game Video Olympics, 27-game Air-Sea Battle, 8-game Basic Math, 17-game Star Ship, Blackjack, 14-game Surround and 14-game Indy 500. All games in color. Built-in ac adapter. Console, \$200. Programs, \$20-40.

Coleco Industries, Inc., 945 Assylum Ave., Hartford, CT 06105.

■ *Telstar Arcade*—2 players; 3 sets of controls, console mounted steering wheel and shift lever, 2 console mounted rotary controls, and remote shooting gallery pistol. Comes with 3-game cartridge containing Road Race, Quick Draw and tennis. Other cartridges available include 6-game pinball and shooting gallery program, and 8-game tennis, hockey, handball and shooting gallery program. AC adapter included. Console, \$125. Programs, \$20.

Fairchild Consumer Products, 4001 Miranda Avenue, Palo Alto, CA 94304.

■ *Channel F*—2 players; 2 remote joystick controls. Comes with tennis and hockey built-in. Other programs include 4-game tic-tac-toe, 2-game desert fox, blackjack, space war, 2-game math quiz, 2-game Mindreader, baseball, 4-game maze, drag race, and Spitfire, most with 1 or more variations. All games in color. AC adapter included. Console, \$170. Programs, \$20.

Sears, Roebuck and Company, Sears Tower, Chicago, IL 60684.

■ *Video Arcade*—2 players; 2 remote joystick controls. 2 additional remote rotary controls available for 4 player capability. Similar to Atari Video Computer System. Console, \$180. Programs, \$20-40.

RCA Distributor and Special Products Division, Deptford, NJ 08096.

■ *Studio II*—2 players; 2 console mounted 10-digit keyboards. Comes with 5 games built-in: Freeway, bowling, addition, doodle and patterns. Cartridges available include TV Arcade I space war game, TV Arcade II with 3 numbers games, TV Arcade III tennis, squash game with adjustable paddle size, TV School House with quizzes in math, history and geography, and TV Baseball. All games in B&W. AC adapter included. Console, \$150. Programs, \$15-20.



The Atari Stunt Cycle video game has handlebar grip controls that give you the feel of a real motorcycle. The Stunt Cycle game lets you work your way up from jumping across eight busses to a mind-boggling 32-bus leap. Drag racing, Motocross and Enduro racing games are also included. All games are in color on color tv sets.

What's in a microcomputer?

Look inside your home computer and you'll find a heck of a lot more than one 8080 integrated-circuit chip. Here's a fast rundown on what's in your black box.

by Pete Stark
Contributing Editor

They call them "the computer on a chip." So, when you see an advertisement in a leading catalog for a "100 percent Prime 8080A 8-Bit Microcomputer Chip" at \$17.95 you might be tempted to think that with this integrated circuit and a power supply you will have a complete computer. Unfortunately, it's not that simple.

To make a complete computer with the 8080A or other popular microprocessors you will need quite a few other integrated circuits. Although several manufacturers have in the last few months developed microprocessor IC's which can work almost by themselves, they usually can be used only for special and limited applications. More IC's still have to be added for most uses.

Let's take a look at what we need besides "the chip." Figure 1 shows the typical pin connections for common microprocessor integrated circuits. As the name implies, the microprocessor IC is not a complete computer—it is just the processor portion of a computer system. The processor, or the *Central Processing Unit* (CPU), includes the arithmetic and logic circuits which perform calculations for the computer, as well as the control circuits which govern its operation. It acts as the central controller to which the computer's memory and all input and output devices are connected.

Running pulse

Like all IC's, the microprocessor requires a source of power. Modern microprocessors require only a well-regulated source of +5 volts. The CMOS processors such as Intersil's IM6100 or RCA's Cosmac may require just a few milliamperes, while others may require several hundred milliamperes. Older processors may require 12 volts or other voltages in addition to the +5 volts. The choice of +5 volts, of course, is to make the microprocessors compatible with standard TTL IC's.

Also required is a continuously running pulse signal, called the *clock*, which regulates the internal timing of the

entire system. The clock oscillator which generates the clock pulses may be either inside the microprocessor IC or outside. If it is inside, then an external resistor-capacitor circuit or crystal is connected to two of the IC pins to regulate the exact clock frequency. External clock oscillators also use R-C or crystal circuits to generate a pulse wave of a constant frequency. Since crystals are more accurate than R-C circuits, they are more common except in very simple (and inexpensive) systems. Some micropro-

cessors has arrowheads on both ends, while the one-directional address bus has only one arrowhead.

Eight bits

The computer's memory is used to store numbers, usually written as binary numbers using only ones and zeroes. Each of these binary digits is called a *bit*, and each number stored in memory has a fixed number of bits. The most common number length today is eight bits. Since the data bus is used to carry these numbers to and from the memory, it too has eight wires. The eight-bit numbers stored in memory can represent one of three things—numbers used in calculations, letters or punctuation marks coded into binary form, and instructions.

Each number stored in memory is in a separate memory location. The traditional way of describing the organization of a computer memory is to visualize it as a row of post office boxes, each big enough to contain exactly one number and each having an *address*. In most microprocessors, the address is a binary number having 16 bits. Since it is carried over the address bus, the bus also generally has 16 wires.

Memories come in two types—RAM and ROM. The letters RAM stand for Random Access Memory, although Read-Write Memory might have been a better choice. It's a memory which can be written into—meaning that numbers may be put into it by the microprocessor. It also can be read from—meaning that its contents can be sent to the microprocessor. Such a RAM memory can be used to hold instructions and data, as well as intermediate results and answers to problems run by the computer.

The letters ROM stand for Read Only Memory, meaning that numbers can be read out of the memory by the microprocessor but not written. Such a memory can store instructions or long-term data but not results of calculations. At some point, of course, something had to be written into the ROM to be read, but in this case the writing occurs during the manufacture or installation of the ROM.

The set of instructions stored in memory for doing some particular problem is

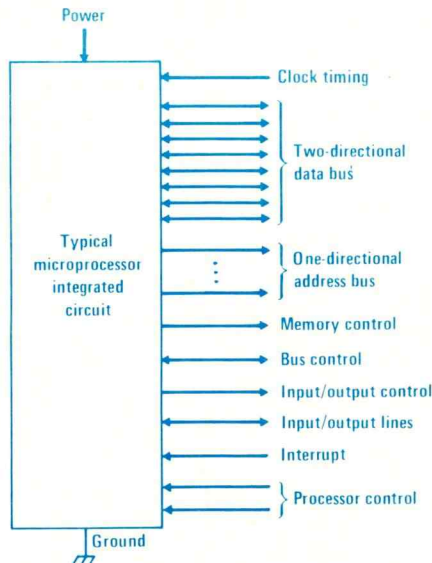

Figure 1 Typical microprocessor connections

cessors require two clock signals of the same frequency but carefully staggered so that they alternate pulses on two lines. This is called a two-phase clock and, in some cases, requires the use of several IC's just to generate the proper clock signals.

The data bus and address bus communicate with memory and input-output equipment. Figure 2 shows the connections to a typical computer memory. The term *bus* describes a group of wires which carry several related signals all at one time. For most systems, the data bus consists of eight wires and the address bus consists of sixteen. Rather than show the individual wires, however, most busses are shown as a thick bundle. The data bus, which carries data in both directions (not at the same time)

called a *program*. Programs can be stored in either RAM or ROM memory, depending on use. A program which is changed often or which is used only now and then would most likely be in RAM. On the other hand, a program which never changes and is run continuously would best be stored in ROM so it could not accidentally be erased in case of power failure or computer malfunction.

A good example might be the new computerized cash registers used by some of the national hamburger chains. Whenever the clerk pushes the button labelled double hamburger, for instance, the microprocessor inside follows a program stored in ROM to calculate the price and add it to the total. Even in such a system, though, some RAM is needed, both for data involved in one particular sale, as well as to keep totals for daily sales. In the case of the double hamburger, the RAM stores the total number of hamburgers ordered by the customer, total price for those hamburgers, and eventually total price for the entire order. At the end of the day, the RAM also contains somewhere inside the total number of double hamburgers ordered all day and other data needed to total up the day's sales.

Read or write

Several types of memory control lines are used. To keep diagrams simple, the various control lines have short abbreviated names such as R/W or VMA to indicate their function. The R/W line tells the memory whether to read or write. Since the same voltage levels used by TTL integrated circuits are used in most microprocessors, the R/W line takes on one of two voltages: 0 volts or +5 volts. In a typical system, placing the R/W line at +5 volts indicates the micro-

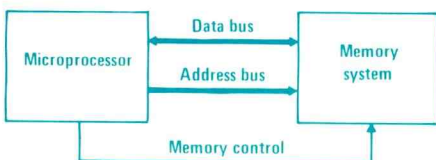

Figure 2 Connections to memory

processor wants to read from memory, while placing the line at 0 volts indicates it wants to write.

VMA stands for Valid Memory Address, a signal used by the microprocessor to tell the memory that an address has been placed on the address bus and is ready to be used. In addition to these, the memory also may get some timing signals from the microprocessor to indicate the precise instant when to read or write. Sometimes these signals have names such as *02* (which stands for *phase two of the clock* and doesn't mean much to the newcomer). Other times they may have specific names such as MEM SEL for MEMory SElect.

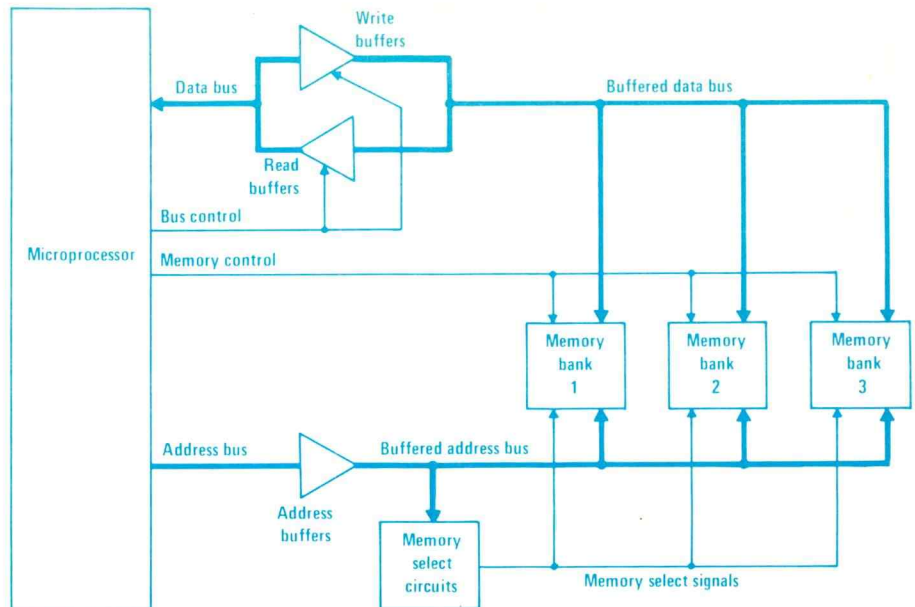

Figure 3 Memory connections in larger systems

At this point, let's pause and see just how all these signals work together. Suppose the microprocessor IC wants to read some number out of memory. The particular sequence of signals would work like this:

- The microprocessor sends out the binary address of the desired location, waits a short time to allow the memory circuits to receive it, and then sends the Valid Memory Address signal.
- At the same time, the microprocessor puts the R/W line at the correct voltage level to signify a read.
- A short time later, a clock pulse on the *02* or MEM SEL line appears, and the memory sends the appropriate memory contents to the processor on the data bus. At the end of the *02* or MEM SEL pulse, the processor accepts the number from the data bus.

Data bus

If the memory were just a single IC, then it might be possible to connect that IC directly to the microprocessor. In very simple systems that is exactly the case, since some memory integrated circuits have been designed to be directly compatible with certain microprocessors by connecting directly to the address and data busses and to the memory control lines. In larger systems this is not possible, however, for two reasons. First, to provide larger memory it often is necessary to provide many different memory integrated circuits, with each IC storing just part of the needed memory locations. Additional circuitry then is necessary to select the particular IC which contains the location addressed at any instant. The second reason is that to keep the processor IC small and to reduce its power requirements and heat output, it is necessary to take some short cuts. One of these is to design the

output amplifier circuits which feed the busses and other outputs in such a way that they can drive only a limited load. If more than just one or two external IC's need to be connected to any given output, then external amplifiers have to be added to provide enough power. The catch is that some of these, such as those on the data bus, have to amplify in both directions if the line they handle is also two-directional.

As a result, the memory often looks like Figure 3. To keep the diagram simple the memory is shown divided into only three sections, called banks. In an actual system, many memory banks might be used, possibly with some as RAM and some as ROM memory.

Both the data bus and the address bus have amplifiers inserted called *buffers*. Since the address bus is a one-directional bus, only a single set of buffers is needed. That portion of the bus which lies between the microprocessor and the buffers still is called the address bus, whereas the output of the buffers is called the *buffered address bus*. The data bus is also buffered; but since it is a two-directional bus, two sets of buffers are needed—write buffers for data going from the microprocessor to the memory to be written, and read buffers for data being read. To avoid feedback and oscillations, however, only one set of buffers can be turned on at any one time, and so a bus control output from the microprocessor is needed to switch off the set of buffers not being needed at any one time. In most systems, this bus control is handled by the R/W signal, but in some systems which permit several processors to connect to the same data bus (such as National Semiconductor's SC/MP microprocessor) other bus control inputs or outputs may be present.

The buffered address bus is split into two portions, one portion going to all

memory banks, the other portion going to memory select circuits which select one of the banks, depending on the actual address. Some microprocessor systems are even more complicated, since part or even all of the address may actually travel over the data bus. Instead of address buffers, a group of flip-flops and control circuits would be needed to catch the address as it is placed on the data bus for an instant, and retain the address for the entire time that it is needed by the memory, even after the data bus is used for other data transfers.

Input/output control signals are used on some microprocessors—those which have specific input and output instructions. This includes the Intel 8008 and 8080, the Intersil 6100, and others. In these units, specific instructions exist which output pulses on these input/output control lines. When a program is supposed to input data from a device such as a keyboard, or output to a device such as a printer, an input/output instruction is placed into the program. This generates a pulse which goes out to all input/output equipment. It is used in conjunction with the address lines, which select a particular input/output device, and the data bus, which carries the data being handled, to perform the input or output operation. Some of the more recent microprocessors such as

Motorola's 6800 do not use this idea. Rather than treat input/output equipment as a special case, the 6800 treats input/output equipment as if it was part of memory. In that case, the same memory control lines which control reading and writing of memory also control reading and writing to output or input devices.

IC Pins

Some microprocessors, especially those designed for use in small systems, have one or more input/output lines which may be one-directional or two-directional. These are pins on the microprocessor IC which can be set to either a high or low voltage by the program, or which can be connected to an external device and the voltage state on the line sensed under the control of the program. For very simple uses, these control lines may be all the input/output circuitry that is needed. For example, National Semiconductor's SC/MP microprocessor has seven such lines. In one simple application, this processor can be used as the central control in an electronic lock. The input/output lines are connected to several switches, lights, and a solenoid to unlock the door. Along with a ROM to hold the control program—no RAM is needed for such a simple use—the microprocessor monitors the switches. When a particular sequence of switch closures is detected, it opens the door.

Virtually every microprocessor has one or more interrupt inputs. The interrupt system is designed to allow external devices, such as input/output

devices, to interrupt a program being performed by the processor and switch to a different program. A simple example might be a computer which is normally used to handle bookkeeping for a small motel but which is also connected, via the interrupt inputs, to the motel's burglar alarm. Part of the burglar alarm might connect to the television set in each room. If, while the computer is processing the payroll, a guest decides to disconnect the tv set, then an interrupt immediately stops execution of the payroll program and forces the computer to switch to a burglar alarm program which alerts the operator to the room number, looks up the name and address of the guest occupying that room in the computer file, and alerts the police.

There are generally at least, two processor control connections, labelled halt and reset. The halt lead causes the processor to stop executing a program. When the halt signal is removed, the processor simply continues from wherever it had stopped. The reset signal is a bit different—it halts the program but also causes the microprocessor to start from the very beginning by erasing all internally stored results and starting a new program from a different starting point.

Let's put all this information together and see exactly what is required to make a complete system. First are data and address busses and their buffering, con-

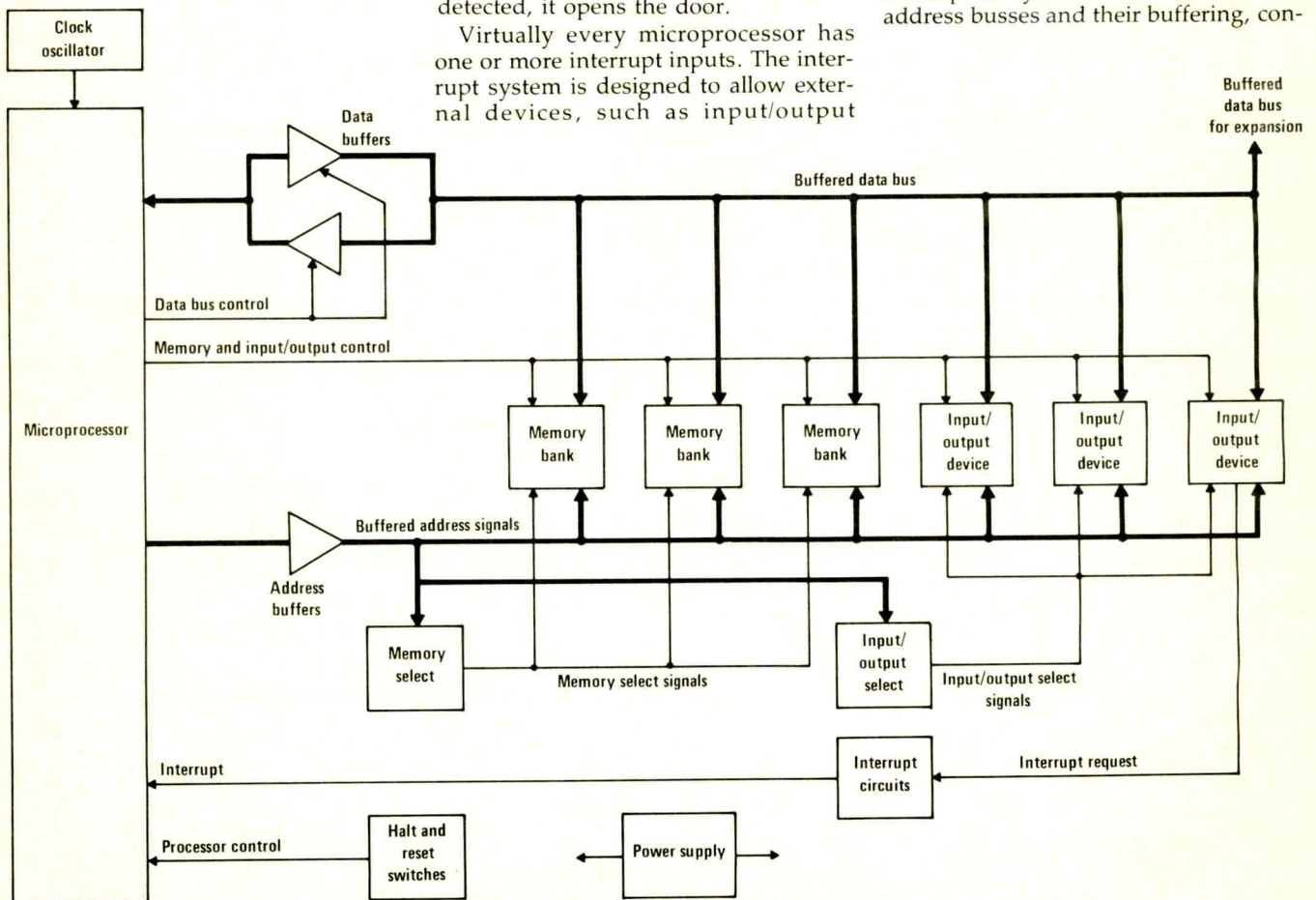

Figure 4 Typical complete computer system

necting the microprocessor integrated circuit to the memory and input/output devices. Memory select circuitry selects one of several memory banks, while input/output select circuitry selects one of several input and output devices. Some of the input/output devices may connect to the interrupt input through some additional interrupt circuitry. Finally, panel switches for reset and perhaps halt connect to the processor control inputs.

Wrapup

What is a means of entering the program into memory in the first place? The very first small computers solved this problem by adding a control panel. By means of switches and readout lights on the panel, it was possible to enter data into specific memory locations, check to see that it had been properly entered, and start and stop the computer. Such a control panel requires connection to both the address and data busses, some way of disconnecting the microprocessor from these busses so that the control panel can feed numbers directly into the memory without the microprocessor being involved, as well as connections to the processor, memory, and input/output control lines. This requires a substantial amount of circuitry.

A more recent approach has been to make at least one of the memory banks a ROM which is preprogrammed with a system program called a monitor. This monitor program allows an external device, such as a teleprinter or tv-type terminal, to enter data or output data from the system under monitor control, acting as a control panel but without all the circuitry a real panel would require. Some systems, such as the Heathkit H8, combine a monitor with a small control panel. The control panel contains just a series of pushbutton switches on a keyboard, and some light emitting diode readouts. The switches do not really do anything, as they simply connect to various combinations of wires on the data and address busses. Instead, the monitor does all the work by monitoring these switch closures and interpreting their meaning by means of a program.

Despite the need to make hundreds and hundreds of connections to interconnect the microprocessor with all the other integrated circuits needed to make a complete system, the recent progress in hobby and personal computers has made a thorough knowledge of just exactly how this is done and why quite unnecessary. Whereas 10 years ago the amateur computer builder had to build his system circuit by circuit, connection by connection, today's computer builder can buy preassembled components and even complete systems. Still, sometimes it is comforting to know just what is inside. There's a lot more than just a \$17.95 IC chip!

Basic building blocks for electronics projects: gates

Newcomers to electronics hear a lot about gates. But what the heck are they?

Thumbing through the pages of *Modern Electronics*, you'll find many small, inexpensive, and easy-to-build projects. The key ingredient in these "mini" projects, and the basic building block of even the world's largest computer, is the integrated circuit (IC) digital gate.

The digital gate in reality is nothing more than an educated "on-off" switch. You can get a better idea of what goes on inside an IC by looking at the diagram below. Here you'll see a simple relay circuit that

If you connected your relay control switches in series, as shown below, you would have to close all

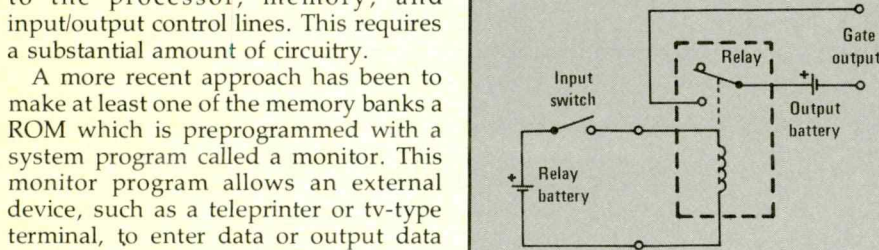
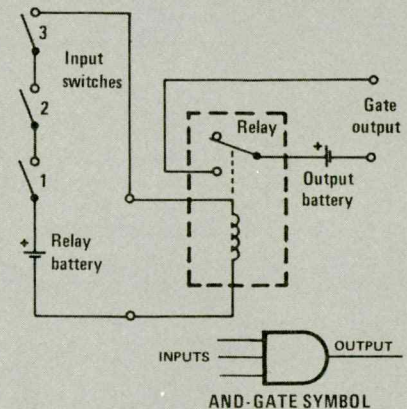

connects a battery to the output terminal when another battery is applied to the input.

Suppose you connected the relay battery through two or more switches as shown below. If you did, you could connect the battery

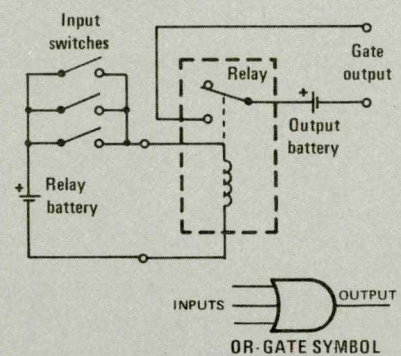

to the relay, energizing it, by closing any one of the switches. Since you can connect the output battery to the terminal by closing input switch one or input switch two or any other input switch, this kind of circuit is called an OR gate.

of them before the output battery would be connected to the terminal. Since you would have closed switch one and switch two and every other switch in the circuit, this kind of circuit is called an AND gate.

The OR and the AND gates described so far have no output unless the relay is energized by closing the appropriate switches. Sometimes, however, you need a gate that provides an output *except* when the relay is energized. This is done by adding a connection to the relay contacts, as shown below. Gates that provide *no* output when energized are called NOT gates. So an OR gate becomes a *not-or* gate, or simply NOR gate; AND gates become NAND gates. NAND and NOR gates are distinguished from

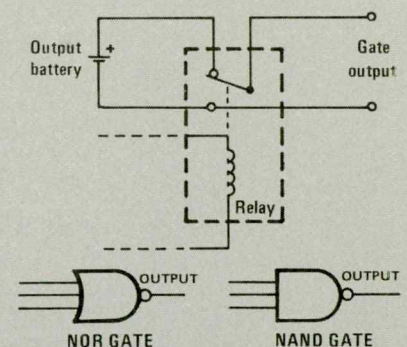

AND and OR gates by a small circle at the output end of the symbol in schematic diagrams. — Bob Margolin

Buyer's guide: 19 microcassette recorders

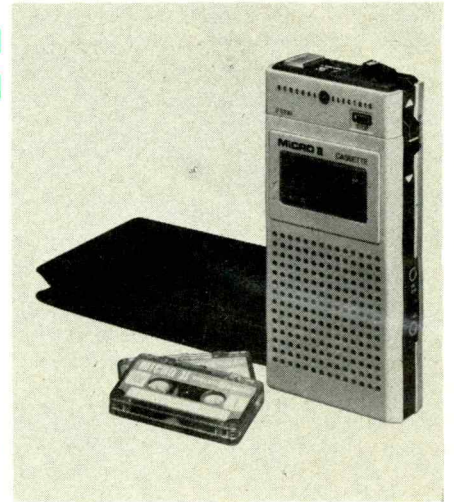

Some of these new, super-small tape recorders perform better than machines twice their size. Here's an up-to-the-minute buyer's guide with everything you ever wanted to know about the 19 best on the market right now.



Realistic model 14-814 Micro Miniset from Radio Shack has low-battery LED tattletale, weighs 12 ounces. Shirt-pocket General Electric model 3-5330 Micro II, top of this page, has one-button operation, end of tape signal.

by Gerald R. Patton
Contributing Editor

The age of miniaturization has arrived on the personal tape recorder scene, and it's benefiting businessmen, students, and all of us who find audio note-taking a real convenience, if not a necessity.

The typical miniature cassette (the term Microcassette, a registered trademark of Olympus Corporation of America, is perhaps more indicative of the actual physical size) is about one quarter of the size of a standard tape cassette and one-quarter inch thick. Sales of minicassette recorders, at first primarily to executives, got off to a slow start, but industry sales during 1977 are estimated to have exceeded one half million units, and sales are expected to increase to over one million per year as the market grows.

Minicassette recorders are being designed and manufactured for one (or both) of two different uses: dictation and general, or conference, recording. Dictation recorders are designed for close-up voice recording, and the sensitivity of the internal microphone delib-

erately is kept low to minimize recording unwanted background noise you might find onboard a plane or train. On the other hand, conference recorders have much higher sensitivity which records normal speaking voices from a distance of 20 feet or more.

Most of the units listed in the chart as "part of dictation system" also can be successfully used for distant recording by plugging in an external microphone. While these dictation recorders have companion desktop transcription equipment for secretarial use, they also func-



Pearlrecorder SD, opposite, has plug-in am, fm radio tuners and voice control. Courterport, above, has two speeds.



tion for both record and playback as independent units.

Two formats

Miniature cassettes are available in two basic formats depending upon the type of transport mechanism used in the recorder. The more sophisticated and expensive system is known as *capstan drive*. This system utilizes a rotating capstan, which extends through an opening in the cassette, and a pinch roller to press the tape against the capstan. The capstan rotates at a regulated speed, causing the tape to move across the heads of the machine at a constant speed. The standard speed for capstan drive is 15/16 inches per second (ips), although a few recorders are now available with a second, slower speed of 15/32 ips which doubles the record/playback time of the cassette. In the case of the Olympus Microcassette used in many of these machines, this increases the available time per cassette side to 60 minutes from 30 minutes.

The use of a standardized and constant speed makes this system ideal to use where the tape cassette may be played on a different machine than was used to record it, such as in tape correspondence. One thing to watch out for though, is that not all makes of capstan drive recorders use the same size cassette. Our chart shows the Sankyo and Grundig machines require special cassettes other than the Olympus type used by all the other capstan units.

Clever features

The simpler, less expensive format uses *spindle drive*. The cassette has holes for guide pins and, of course, in the center of the supply and take-up reels. An idler wheel turns against the rim of the spindle which engages the appropriate reel for the function desired. A small variation in tape speed across the machine heads is inherent in the system, since it is affected by the amount of tape wound on the drive reel at any given time. When the take-up reel of the cassette is empty, the speed starts out at about 1.22 ips and gradually increases to 1.84 ips as the reel is filled. The average tape speed is 1.53 ips, and the variation factor is fairly constant. This means that these cassettes can be interchanged between many of the spindle drive recorders with reasonable quality.

All spindle cassettes are interchangeable between different makes of equipment with spindle drive system. Recording time is 15 or 20 minutes per side, depending on tape thickness. Most cassettes are clearly marked. Keep in mind that capstan cassettes and spindle cassettes definitely are not interchangeable with each other.

Some cassettes are manufactured with foil at the end of the tape, which is

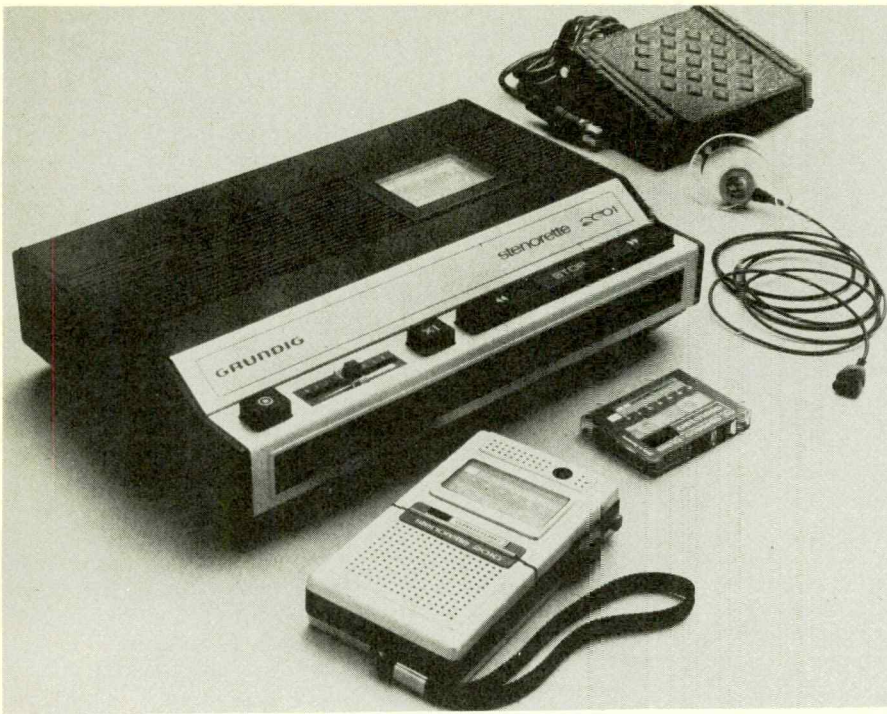

Grundig Stenorette 2010, bottom above, is pocket companion to desk model 2001. The 2010 weighs 10 ounces. It is part of business system.

used to trigger an end-of-tape (EOT) signal or shutoff in some recorders. This is a highly desirable feature, because the quiet operation of most of these recorders could lead you to continue talking long after the tape cassette has wound to an end.

All the capstan drive units have a quick fast forward mode for speeding ahead on the tape. Of the spindle drive machines, however, only the GE Micro II has this feature.

A record indicator in the form of a glowing light emitting diode is handy because you can see the unit is in record mode and can help to eliminate accidental erasures of previously-recorded cassettes.

A pause feature, whether a separate



Panasonic model RQ-170, right, has capstan drive, weighs 12 ounces.

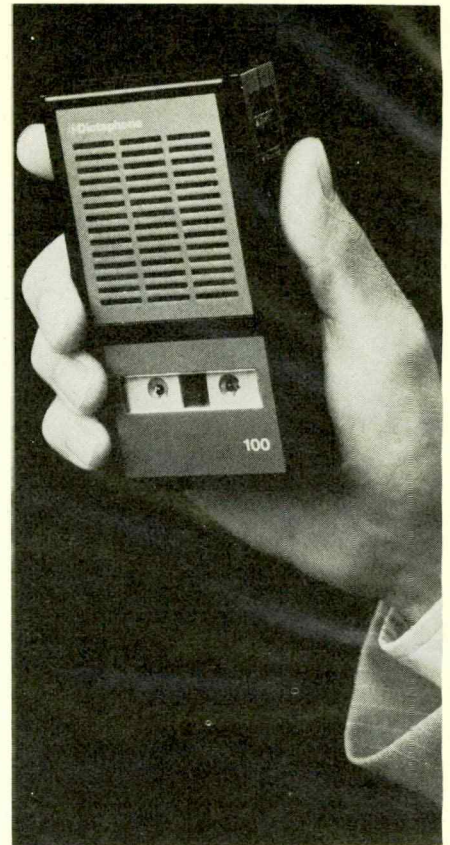

Dictaphone model 100, above, like Grundig, IBM, Lanier, Norelco and Sony recorders, are designed to be used as part of larger business-office dictation systems. But they can be used for leisure-time fun as well. Dictaphone has spindle drive, end of tape signal.

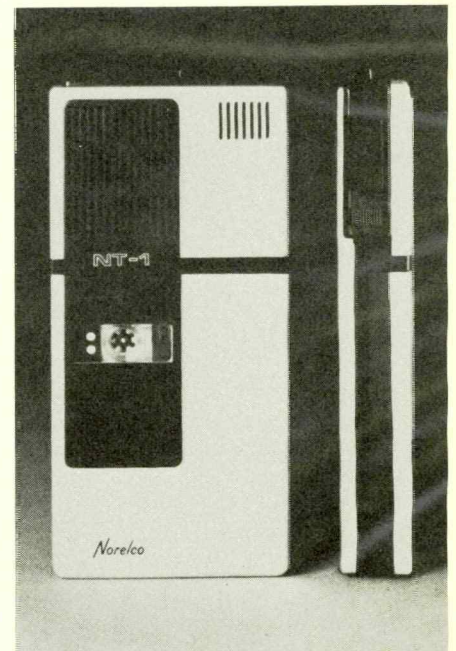
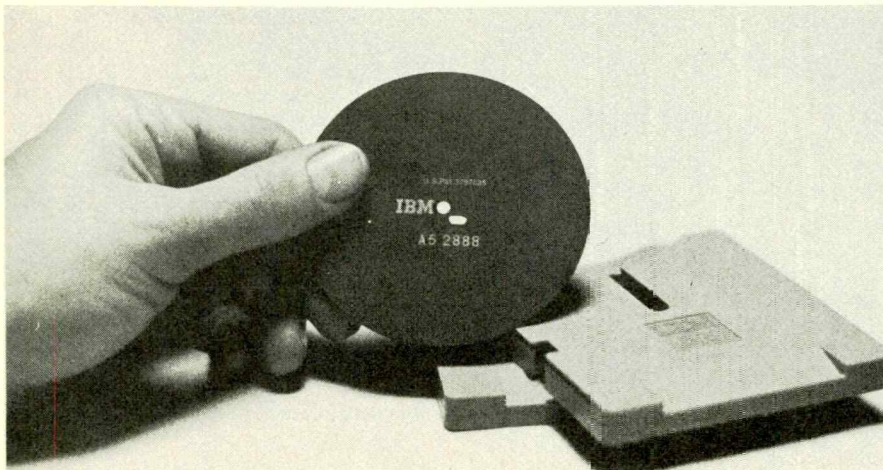

Side view, above right, tells how thin Norelco NT-1 recorder really is. Eight-ounce package includes spindle drive and end of tape signal. IBM, on the other hand, unlike recorders which use tiny cassette tapes, uses 3 1/4-inch magnetic disc, left.

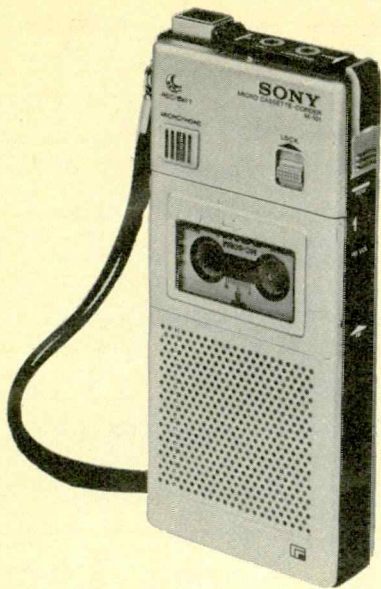

Sony model M-101 Micro Cassette-Corder, above, has capstan drive, ac adapter, weighs 13 ounces.

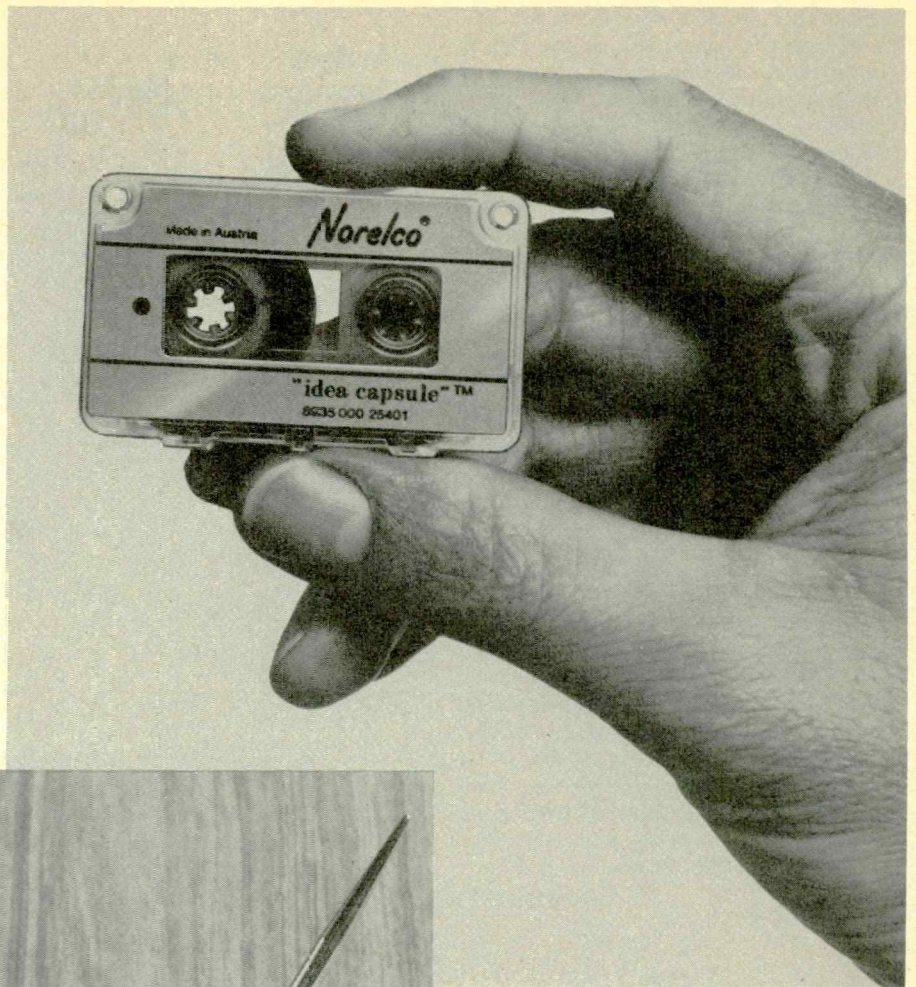

Tiny new cassettes of recording tape, such as Norelco's Idea Capsule, above, make micro recorders possible.



pause switch or included in one switch lets you conveniently stop the tape drive without disengaging the record mode. This makes it easy to collect your thoughts while in the process of recording dictation, or to stop the tape while your philosophy prof ponders a difficult question, and thereby avoid wasting precious recording time.

The power supply column of the chart indicates the number and type of batteries required for each machine and whether an ac adapter is available for home use. Many of the units that have ac adapters also can use Nicad batteries, which can be recharged using the same adapter.

Add-ons

Many units have extra accessories available, including external microphones, remote control switches, transcription pedals and car power adapters.

Unique among the units, however, as

Relative sizes of Grundig 2050 recorder and 30-minute tape, left, can be compared with desk pen.

far as variety of accessories and flexibility of use are concerned, is the Pearl-corder Model SD. In addition to many plug-in options (such as earphone, telephone pick-up, head set, foot switch, universal ac adapter, extension speaker with amplifier, remote control switch), several special accessory modules are designed to simply and quickly attach onto the bottom of the recorder.

Two different radio tuners are available, one for am and one for fm. With one of these tuners attached, you can play your favorite station through the recorder, and even record directly off the air if you wish. The fm tuner has a small, telescoping whip antenna which provides outstanding reception. The am tuner is equipped with a built-in antenna.

Sophisticated dictator

Two other add-on modules are an adapter with a remote control switch, and a voice operated system which causes the tape drive to start and stop as you speak or quit speaking into the recorder.

There is one unit listed in the chart which is an exception to the others both

Where to write for more information

Courterport
82-39 164th Street
Jamaica, NY 11432

Dictaphone Corp.
120 Old Post Road
Rye, NY 10580

General Electric
Audio Electronics Dept.
Syracuse, NY 13201

Grundig: NTI Business Corp.
23 Just Road
Fairfield, NJ 07006

IBM Corporation
Parson's Pond Drive
Franklin Lakes, NJ 07417

Lafayette Electronics
Box 500
Syosset, NY 11791

Lanier Business Products
1700 Chantilly Drive, N.E.
Atlanta, GA 30324

Norelco: Philips Business Systems, Inc.
175 Froelich Farm Blvd.
Woodbury, NY 11797

Panasonic Company
One Panasonic Way
Secaucus, NJ 07094

Pearlcorder: Olympus Corp. of America
2 Nevada Drive
New Hyde Park, NY 11040

J.C. Penney Company, Inc.
1301 Avenue of the Americas
New York, NY 10019

Realistic: Radio Shack
2617 West Seventh Street
Fort Worth, TX 76107

Sankyo Seiki (America) Inc.
149 Fifth Avenue
New York, NY 10010

Sony Corp. of America
9 West 57th Street
New York, NY 10019

Westminster: Montgomery Ward
535 West Chicago Avenue
Chicago, IL 60607

Technical specifications for microcassette recorders

MAKE/MODEL	PRICE CLASS	SIZE (INCHES)	WT. (OZ.)	RE-PAUSE CORD IND.	FEA- TURE	POWER SUPPLY	JACKS	COMMENTS
Courterport RAD-7	\$400	5 1/4 x 2 1/2 x 1 1/8	12	*	*	2-AA/ AC Adptr	Ear, mic	Capstan drive, two speed, many accs.
Courterport RAD-17	460	5 1/2 x 2 5/8 x 1 3/8	12	*	*	2-AA/Re/ AC Adptr	Ear, mic	Capstan drive, two speed, EOT shutoff, many accs.
Dictaphone 100	175	4 7/8 x 2 5/8 x 1 1/4				1-9V	Ear, mic	Spindle drive, EOT signal, part of dictation system
General Electric Micro II	75	5 3/8 x 2 1/2 x 1	10	*		1-9V/ AC Adptr	Ear, mic remote	Spindle drive, EOT signal Capstan drive, special cassette w/index, part of system
Grundig 2010	195	4 7/8 x 3 1/8 x 1	10	*	*	1-9V/Re/ AC Adptr	Ear, mic	Capstan drive, special cassette w/index, EOT signal, audio indexing, part of dictation system, many accs.
Grundig 2050	245	6 1/2 x 2 7/8 x 1 3/8	14	*	*	3-AA/Re/ AC Adptr	Ear, mic, remote	Capstan drive, special cassette w/index, EOT signal, audio indexing, part of dictation system, many accs. Uses 3 1/4" magnetic disc medium, compatible with IBM 6:5 dictation system, tone indexing, up to 2 1/2 hours
IBM #284	575	6 1/4 x 4 x 1 3/8	20			Re battery		
Lafayette	50	5 1/2 x 2 1/2 x 1 1/2	14			1-9V and 2-AA	Ear	Spindle drive
Lanier Microsette 60	220	5 1/2 x 2 1/2 x 1 1/8	13	*	*	2-AA	Ear, mic	Capstan drive, EOT signal, part of dictation system
Norelco NT-1	220	5 1/4 x 2 7/8 x 3/4	8	*	*	1-9V/ AC Adptr	Mic	Spindle drive, EOT signal, many accessories, part of system
Panasonic RQ-170S	140	5 3/8 x 2 5/8 x 1 1/4	12	*	*	2-AA/Re/ AC Adptr	Ear, mic	Capstan drive
Pearlcorder S	180	5 1/4 x 2 1/2 x 1 1/8	12	*	*	2-AA/ AC Adptr	Ear, mic	Capstan drive, EOT shutoff, many accs.
Pearlcorder SD	240	5 1/2 x 2 5/8 x 1 3/8	12	*	*	2-AA/Re/ AC Adptr	Ear, mic, accs.	Capstan drive, EOT shutoff, radio tuner modules, remote control, voice actuation, many accs.
Pearlcorder S-301	200	5 3/4 x 2 5/8	11.3	*	*	2-AA/ AC Adptr	Ear, mic, remote	Capstan drive, two speed, many accs.
JCPenney Co. 6505A	40	5 1/2 x 2 1/2 x 1 3/8	13			3-AA	Ear	Spindle drive, very good value
Realistic 14-814	60	5 3/8 x 2 1 1/8 x 1 1/8	12			1-9V/ AC Adptr	Ear, mic	Spindle drive, low battery indicator LED
Sankyo MTC-10	130	5 3/8 x 2 3/4 x 1	12	*	*	2-AA/ AC Adptr	Ear, mic, remote	Capstan drive, special one hour cassette, noise filter switch, many accs.
Sony M-101	200	5 1/4 x 2 5/8 x 1 1/8	13	*		2-AA/Re/ AC Adptr	Ear, mic	Capstan drive, part of dictation system
Mont. Ward Westminster	59	5 1/2 x 2 5/8 x 1 3/8	14			1-9V and 2-AA	Ear	Spindle drive

in terms of drive system and recording medium, and that is the IBM Model 284. This unit is designed strictly for dictation use and is fully compatible with the IBM 6:5 dictation system. It uses several 3¼-inch magnetic discs in a cartridge to provide up to 2½ hours of recording time. With it, you can record a tone signal at any point on a disc so that a rapid audio scan can reveal special instructions or priority dictation regardless of its location in the recording.

If you've been looking for a personal note-taker, a pocket dictation machine, or a tiny recorder for all-around convenience, check our chart for the unit that best suits your needs and budget. 



Spindle-drive J.C. Penney 6505A, below, \$40, was lowest price among 19 recorders. IBM 284, right, \$575, with mag disc instead of tape, was highest.



GILFER



"NORTH AMERICA'S SHORTWAVE MAIL ORDER PLACE"

One-Stop Armchair Shopping For All SWL Needs

*Receivers — Drake, Yaesu — special mods for better performance *Frequency Readouts *Receiving Antennas *Antenna Tuners *Frequency Calibrators *Log Books *FM or TV Guides *QSL Albums *AM Pattern Maps *ITU Publications *QSL Address Books *Confidential Frequency List *Clocks *All SWL Books

The New 1978 32nd Edition WORLD RADIO TV HANDBOOK Is Ready!

Listen to the world with this comprehensive directory of stations at your side. Best there is! Only \$11.95 ppd.



FREE SWL MINI-CATALOG GILFER SHORTWAVE

Dept. ME-3, Box 239, Park Ridge NJ 07656
CIRCLE 52 ON READER SERVICE CARD

ALDELCO ELECTRONICS COMPANY

NEW IMPROVED DIGITAL ALARM CLOCK KIT 
0.5 LED Display 12 hour format
Snooze Feature
Elapsed Timer
Simulated Wood Grain or Black Leather Cabinet \$24.95
12 or 24 Hour Clock Kit. Similar to above but without Alarm or Timer features Only \$23.95
Crystal Time Base Kit for 12 Volt DC use 4.95

COMBINATION FREQUENCY COUNTER & CLOCK 0.4" LED Display, .0001% accuracy. 12 or 24 hour Clock uses 8AA Nicad batteries (not supplied) \$99.95
Assembled Unit \$99.95
110 Volt AC Power Supply & Battery Charger 5.95

VOLTAGE REGULATORS		CLOCK CHIPS	
TO220 Package		5313	\$3.49
Positive	Negative	5314	3.95
\$1.00	\$1.25	5316	3.95
7805	7905	5375	3.95
7806	7906	CT7001	6.95
7808	7912		
7812	7915		
7815	7918		
LM309H	\$1.10		
LM309K	1.10		
LM723	.55		

LOGIC PROBE KIT	
DIGIPEAKE-A \$11.95	
POWER SUPPLY KITS	
Includes schematic	
5 Volt 6 Amp	\$17.95
+15 Volt & -15 Volt	\$16.95

MA 1003 National AUTO or BOAT CLOCK MODULE SPECIAL \$21.95
With Module Three Push Button Switches AND choice of Blue, Green, or Amber Filter.

WOW LOOK AT THIS JUMBO RED LEDS	AMATEUR TV CONVERTER
11 for \$1.00 Green, Yellow or Orange LEDS	Covers 420 to 450 AM TV BAND. Works on unused Commercial TV Channel
5 for \$1.00	KIT ONLY \$39.95
FND 70 CC 0.3" Display LED .49	ASSEMBLED \$49.95
FND 500 CC 0.5 Display LED .89	
CLOCK FILTERS 2 1/8 x 5 3/4"	BLINKY-FLASHER-TIMER KIT
Red, Blue, Green or Amber .60 ea	Includes 555, PC Board, Parts & Instruction \$2.50

WE STOCK COMPUTER, AMATEUR, AND ELECTRONIC BOOKS AND MAGAZINES. COME IN TO OUR STORE AND LOOK US OVER. YOU'LL BE PLEASANTLY SURPRISED.
Want our catalog in a hurry? Send us a first class stamp.
TAKE THE MEADOWBROOK PARKWAY TO BABYLON TURNPIKE EAST. PROCEED ¼ MILE SOUTH ON BABYLON TURNPIKE.

VARIABLE POWER SUPPLY KITS. 5 Amps 5-15 Volt DC \$6.95
add \$1.00 per kit shipping. 5 Amps 12-28 Volt DC 6.95

Visit Our Store, Hours 9:00 A.M. to 6:00 P.M. Mon. to Fri. Sat 9:00 A.M. to 2:00 P.M. Phone Orders accepted. Visa & Master Charge. Add 5% FOR SHIPPING. ORDERS UNDER \$10.00, add \$1.00. Foreign Orders add 15% shipping (Except Canada & Mexico) send Certified Check or Money Order in USA funds.

ALDELCO

2281 M Babylon Turnpike, Merrick, New York 11566
516 378 4555

CIRCLE 53 ON READER SERVICE CARD
MARCH 1978 53

BY CARMINE PRESTIA

Balancing the family checkbook, keeping track of the monthly budget, easy fare for the home computer.

What are you going to do with it?" was the first question my wife asked when I said, "I'm going to get a home computer." After my new Heathkit H-8 computer system arrived, I found out it might not be such a bad question.

Fortunately, answers are readily available if you just take a few minutes to think about it and use a little imagination. Playing games with a computer is one of the most popular and common uses around. However, to most people that really isn't a practical use, and I was going to have a lot of convincing to do!

One of the first ideas to come to mind was the family checkbook. In our case there are monthly statements to reconcile that require tallying the outstanding checks and deposits, computing a final balance and comparing it with the balance in my checkbook.

To make the chore easier and to put the new Heath H-8 to work, I designed a *program* that allows me to enter the data and then has the H-8 do all the computations and comparisons.

A program is a sequential set of instructions that tell the computer what to do. The checkbook program is written in "Extended Benton Harbor BASIC," a Heathkit version of the original Dartmouth BASIC computer language. Although very easy to use, BASIC (Beginner's All-Purpose Symbolic Instruction Code) is also extremely powerful, making program writing much simpler than with the more complex computer languages.

The program, called Checkbook, is stored on magnetic cassette tape and takes less than a minute to *load* into the H-8 from a regular cassette tape recorder/player, also purchased from Heathkit.

To start the program I enter the BASIC *command* RUN. The program then asks me to enter the checkbook balance and the bank's closing balance. It then goes to or *calls* two *subroutines*; one to enter and tally the outstanding checks and the other to do the same with the outstanding deposits. Then it

program

```
100 REM CHECKBOOK, VER. 1, 10/24/77, CWP
101 REM CHECKBOOK BALANCING PROGRAM THE MACHINE WILL
102 REM CALL FOR DATA FOR YOU TO ENTER WHENEVER YOU
103 REM REACH THE LAST CHECK OR DEPOSIT ENTER THE FLAG
104 REM NUMBER 00.00 THE MACHINE WILL THEN COMPUTE
105 REM THE BALANCE AND ADVISE YOU IF THE CHECKBOOK BALANCES
106 INPUT "THE BANK BALANCE IS ";B1:PRINT
110 INPUT "THE CHECKBOOK BALANCE IS ";B2
115 REM THE PROGRAM NOW CALLS A SUBROUTINE TO
116 REM ENTER THE OUTSTANDING CHECKS
120 GOSUB 200
125 REM THE MACHINE NOW CALLS ANOTHER SUBROUTINE
126 REM TO ENTER THE OUTSTANDING DEPOSITS
130 GOSUB 300
135 REM THE MACHINE NOW COMPUTES THE FINAL BALANCE
140 F1 = B1 + D1 - C1
145 PRINT:PRINT:PRINT:PRINT
146 PRINT "THE FINAL BALANCE IS",,F1
150 PRINT "THE CHECKBOOK BALANCE IS",,B2
151 PRINT
152 REM THE MACHINE NOW COMPARES THE BALANCES
155 IF F1 B2 THEN 170
160 PRINT "THE CHECKBOOK BALANCES!"
165 END
170 PRINT "THE CHECKBOOK DOES NOT BALANCE,"
175 PRINT "THERE IS SOMETHING WRONG !!!!!!"
180 END
200 INPUT "OUTSTANDING CHECK ";C2
205 IF C2 = 00.00 GOTO 220
210 C1 = C1 + C2
215 GOTO 200
220 RETURN
300 INPUT "OUTSTANDING DEPOSIT ";D2
305 IF D2 = 00.00 GOTO 320
310 D1 = D1 + D2
315 GOTO 300
320 RETURN
```

returns to the *main* program. Subroutines are smaller programs that perform a task that is needed repeatedly throughout the main program.

The main program figures out the final balance, then prints both the final balance and the checkbook balance. It makes a comparison between the two balances; and if they are the same, the computer prints, "The Checkbook Balances!" If the figures do not agree, the

machine prints, "There is something wrong, the checkbook does not balance!" Then I have to go back and find out where I subtracted wrong in the book.

A listing of my program is included for those who would like to try it. Of course, there may be other ways to program this problem (in addition some modifications might be necessary under different versions of BASIC). Part of the

challenge of program design is finding better ways to make the computer do the things you want it to do, the way you want them done.

This program is just that first step in the thousand mile journey. Coming soon will be a program to compute the heat loss factors of your home so that you can plan the most efficient and cost effective changes in your heating system or insulating properties.

Two for the price of one: here's another easy-to-understand program written in Basic language so you can try it out on your home computer.

BY PETE STARK

One of the many uses for a small, personal computer is in Computer Aided Instruction (CAI). A very popular concept about a dozen years ago, CAI never became widely used because of the high costs involved with the traditional computer approach. But now, with the aid of inexpensive small computers, computer aided teaching and drill may finally come into its own.

Teaching new concepts with the help of a computer is still an involved and difficult job. A trained educator with a talent for computer programming usually has to prepare a set of lessons which takes a student through the material to be learned in a slow and precise way. The time required to prepare these lessons is so large, that it's unlikely that a casual computer user or owner will even tackle it. The best we can hope for is that sometime in the near future prepared computer programs for teaching specific subjects will be available.

On the other hand, preparing the program for computer review and drill is fairly easy. This program is a short Basic program to take a youngster through some multiplication drill. The program makes up 10 different multiplication problems and asks the youngster to type in the answers. For each answer, the computer prints out a short message indicating whether the answer is right or wrong. After 10 tries, the computer prints out the youngster's score, along with a short message telling him how well he is doing.

Most of the program is easy to follow. Line 1 prints out the words MULTIPLICATION DRILL. Line 2 makes a number S equal to zero; S will be used to keep score by indicating the number of correct answers. It is initially set to zero because at the very beginning the youngster has not answered any questions correctly.

Lines 4 and 5 select two random numbers called A and B. Unless you are familiar with Basic, these two lines are a bit difficult to follow, so let us just assume that they work. Both A and B

will be numbers between 1 and 12, different for each problem. Line 6 then multiplies them to get the number P, which is the correct answer. But note that the computer doesn't yet print out the answer.

In line 7, the computer prints out the words WHAT IS, then the value of A followed by the word TIMES, and finally the value of B. This is followed by line 8, when the computer waits for the youngster to type in (or *input*) his guess G. If the guess is right, then line 9 tells the computer to go to line 12, which prints the word GOOD! On the other hand, if the guess is wrong, the computer continues from line 9 to line 10 and prints out WRONG. THE ANSWER IS followed by the real, correct product P.

Lines 3 and 14 work together to repeat this entire series of steps exactly 10 times. Each time the youngster answers correctly, line 13 adds 1 to the value of S, so that after 10 tries S is equal to the number of correct answers. Then line 15 prints out YOU GOT, the value of S,

program

```
0001 PRINT "MULTIPLICATION DRILL."
0002 LET S=0
0003 FOR I = 1 TO 10
0004 LET A = INT (12*RND(0)+1)
0005 LET B = INT (12*RND(0)+1)
0006 LET P = A*B
0007 PRINT "WHAT IS "; A; " TIMES "; B;
0008 INPUT G
0009 IF G=P THEN GO TO 12
0010 PRINT "WRONG. THE ANSWER IS "; P
0011 GOTO 14
0012 PRINT "GOOD!"
0013 LET S=S+1
0014 NEXT I
0015 PRINT "YOU GOT "; S; " RIGHT. ";
0016 IF S<5 THEN PRINT "THAT'S TERRIBLE!"
0017 IF S<10 THEN PRINT "YOU NEED MORE PRACTICE"
0018 IF S=10 THEN PRINT "FANTASTIC. YOU'RE AN EXPERT."
0019 PRINT "WANT TO TRY AGAIN? YES OR NO?"
0020 INPUT A$
0021 IF A$=" YES" THEN GO TO 2
0022 PRINT "OK, SEE YOU LATER."
0023 END
```

and the word RIGHT.

Lines 16 through 18 now examine the number of correct answers. If this number is less than five, line 16 instructs the computer to print the words THAT'S TERRIBLE! If the number is less than 10, then it prints YOU NEED MORE PRACTICE. Only if the number S is exactly equal to 10 does line 18 print FANTASTIC. YOU'RE AN EXPERT.

Finally, line 19 tells the computer to ask whether the youngster would like to try again with another 10 problems, and line 20 waits for an answer which the computer calls A\$. If the answer is YES, then line 21 tells the computer to go back to step 2 and run the program again. Otherwise, the computer is told to print OK, SEE YOU LATER, and the program ends at line 23.

The program could easily be changed to provide drill in addition or subtraction instead of multiplication just by changing line 1, and also by changing the * in line 6 (which means *times*) to either + or -.

What more could you ask in a do-nothing box?

by Jeffrey A. Sandler
Contributing Editor

It started years ago. Some guy invented an electronic gadget which did nothing but sit around and blink a light. Then somebody added an occasional beep to the blinking light. And so on. It all had to end somewhere. So, here's our idea of the ultimate do-nothing box.

If you've ever put together simple projects, you've probably found yourself wishing the circuit would do more.

No matter how many functions a project has or how well it performs, there's always one more thing you'd like

it to do. Well, here's your chance to design your own *do-nothing box*.

You can have it turn on and off lamps or LEDs at different times and for different periods. You can have it make different tones, sounded at different times for different periods. You can even use it to control motors to turn pin-wheels and other mobile displays.

The heart of the ultimate do-nothing box is a 4060 CMOS binary counter. As shown, it turns on 10 outputs once every second, two seconds, four seconds, eight seconds, 16 seconds, 32 seconds, 64 seconds, 128 seconds, 256 seconds and 512 seconds, respectively.

Blinking lights

You can design a very simple do-nothing box by simply connecting an

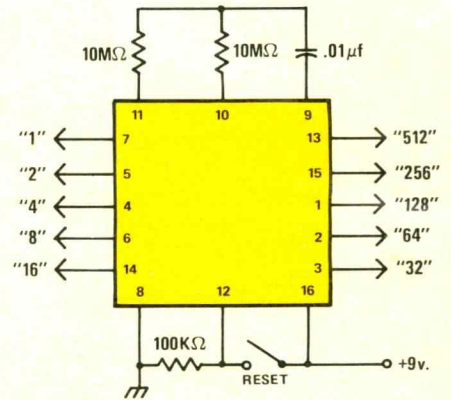
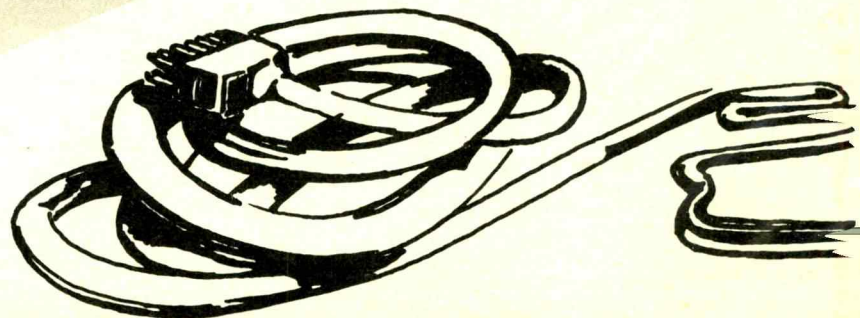
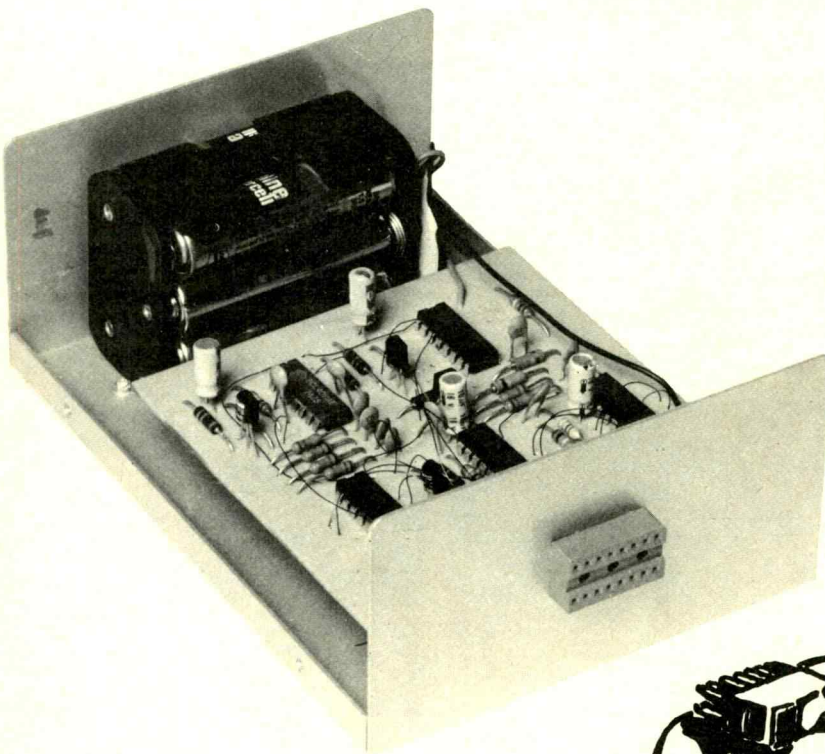

Figure 1 The heart of the ultimate do-nothing box is this self-oscillating 4060 CMOS ripple-carry binary counter, divider. Each succeeding output switches on and off at half the rate of the preceding output.

LED to each output through a buffer such as the 4050 CMOS. This will result in one LED turning on for about a half-second, then turning off for a half-second; a second LED turning on for a second, and off for a second; a third LED turning on for two seconds, and off for two seconds; and so on.

A more sophisticated lighting arrangement comes from driving the LED through a 4081 AND gate; one input of which is connected to the 1 output of the 4060, the other input connected to any other output. With this arrangement, the LED will blink at the half-second on, half-second off rate, but only some of the time.

For example, if the 4081 were connected to the 1 and 128 outputs of the 4060, the LED would blink at the half-second on-off rate for about one minute, then remain off for the next minute, and



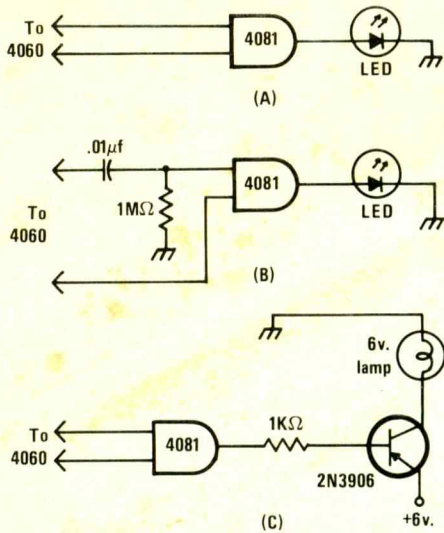

Figure 2 You can use your do-nothing box to control up to 90 combinations of blinking LEDs and lamps. LEDs can be connected (A) to remain on for a period of time equal to the shortest 4060 output, or (B) to flash at a rate equal to the rate of the 4060 output connected to the capacitor input. If you'd prefer, you can use incandescent lamps (C) with transistor drivers.

so on. You can have greater variety by connecting the 4081 gates to other combinations of 4060 outputs—4 and 64, for example. This gives you up to 90 blink rate/on-time combinations.

Power packs

Although LEDs draw very little current individually—some draw only 0.005 amps—the total can add up fast. 90 LEDs, for example, draw close to one-half ampere. So, if you want a battery-powered do-nothing box, you'll

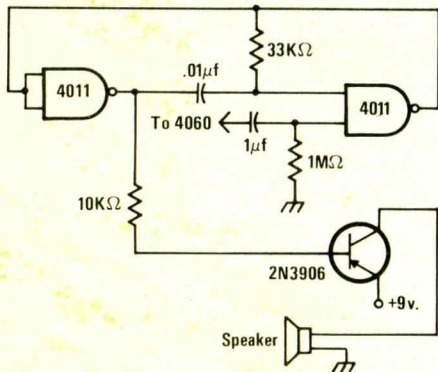

Figure 3 Your do-nothing box can be used to create a sound spectacular by generating hundreds of combinations of tone, on-time and time sequencing. The tone is controlled by the resistor and capacitor in the feedback network between the 4011 gates.

have to limit the number of LEDs you use.

There's nothing, however, to prevent you from using a power supply such as an HO gauge model train power pack, for power. With a power supply, you can use as many LEDs as you want. Or, you can replace them with incandescent lamps, which provide much greater light output.

With lamps, you illuminate colored translucent glass or plastic forms to animate free-form sculpture or other static displays. If you do use lamps, you'll have to include a transistor driver for each lamp in your circuit.

The 4060 timer also can be used to gate on and off various audio oscillators to produce a sound program of different tones, produced for varying lengths of time, during different time periods. The timing is accomplished in the same manner as you would use to obtain different combinations of LED or lamp on-off times.

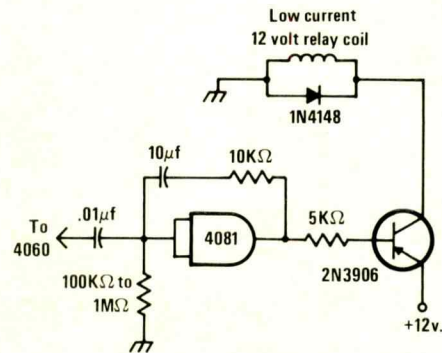
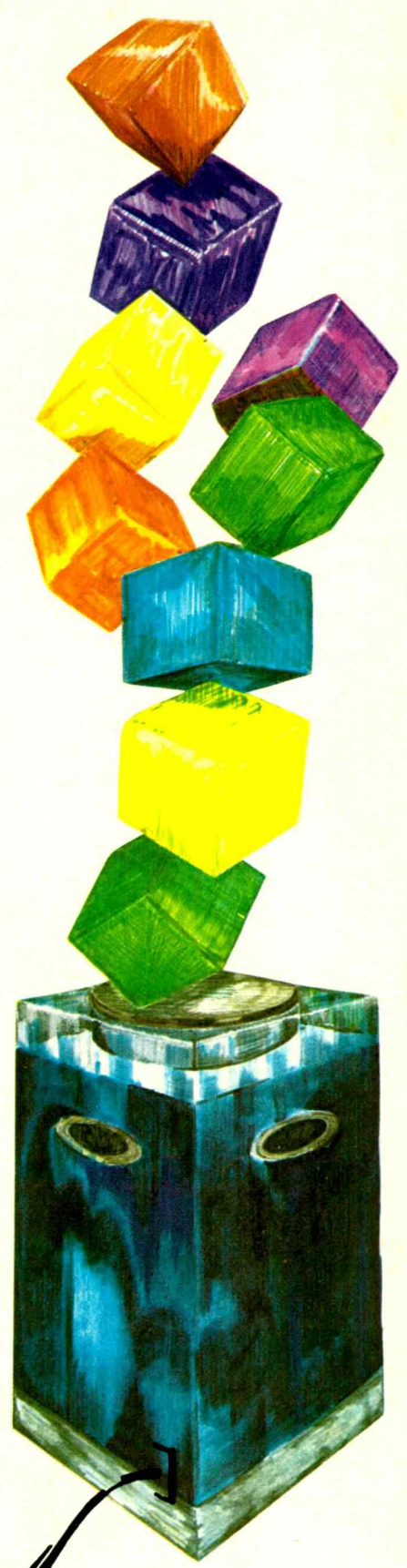

Figure 4 Small motors powering mobiles, pinwheels and other action displays can be controlled with your do-nothing box. The relay is actuated each time an on signal is received from the 4060. The time the relay remains closed is determined by the feedback capacitor and the resistor to ground. The values chosen *must* be at least 10 times greater than those of the input capacitor and feedback resistor.

The audio oscillator shown in figure 3 uses a pair of 4011 NAND gates and a PNP transistor, such as the 2N3906, to drive a small speaker. The resistor and capacitor in the input lead from the 4060 determine the length of time the oscillator produces a tone.

Using the values shown, the tone will sound for about one second. If you want to create a real sound show, you can connect the input lead of the 4011 gate to the output of a 4081 gate. This will, in effect, make your speakers *blink* with sound in the same manner as LEDs or lamps.



Please turn to page 93

HAM AUTOPATCH

OUR STORY UNFOLDS AS 'BUTCH' BARKER AND HIS DOG, RALPH, HUNT PHEASANT IN THE PENNSYLVANIA WOODS.

ART - HAROLD A. PERRY
TEXT - ANTHONY R. CURTIS

THIS IS THE LIFE, RALPH. A MAN AGAINST NATURE USING NOTHING BUT HIS HANDS & BRAINS.

PLUS A REMINGTON 30-30 AND A WILSON VHF FM 2-METER TRANSCEIVER.

WHOOWEE! LOOK AT THE SIZE OF THAT BIRD.

GOT 'EM! OK, NOW WE CAN GO HOME.

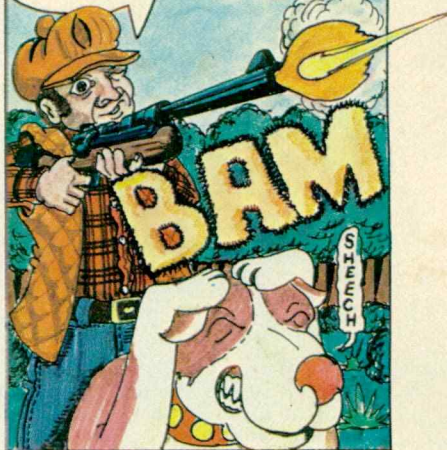

SNORT

TWO HOURS LATER

OMIGOSH! WE'RE LOST! OK, DON'T PANIC. PLAN ONE: RALPH, FIND OUR TRAIL BACK TO THE CAR.

WHIMPER

OK, NOW FOR PLAN TWO!

I'LL ACCESS AN AUTO-PATCH WITH MY TWO WAY RADIO, AND DIAL FOR THE RESCUE SERVICE.



BEEP
BOOP
WEEP

HHMMM

WAG
WAG
WAG
WAG

BUTCH'S RADIO SIGNAL IS PICKED UP BY A REPEATER STATION.

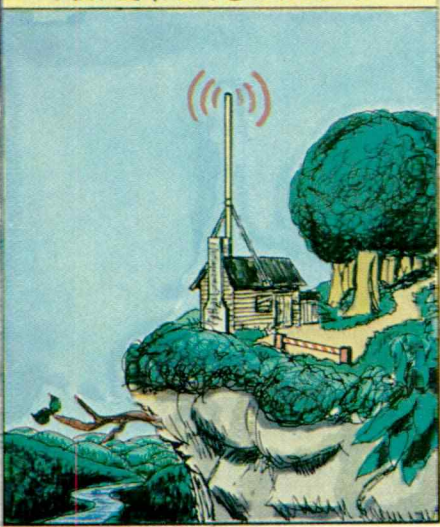

THE SIGNAL IS TRANSMITTED THROUGH THE 'RACK PANEL' AND THEN IS FED INTO THE PHONE LINES.

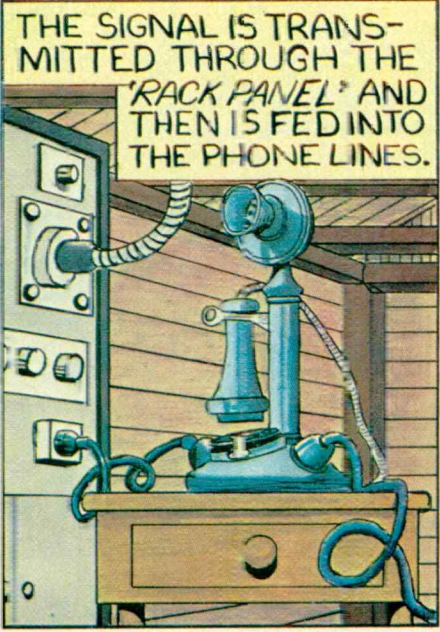

THE DISTRESS CALL THEN CONTINUES OVER NORMAL PHONE LINES TO THE CITY.

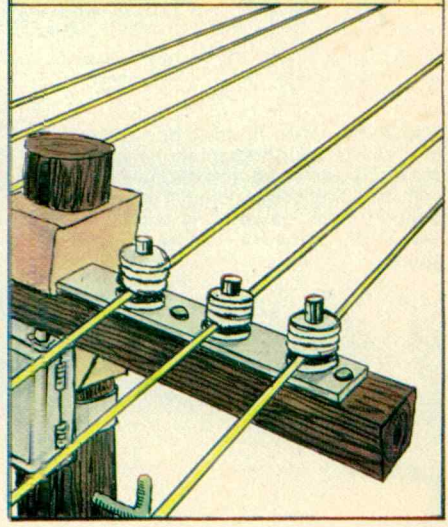

IN THE CITY, THE CALL IS ROUTED THROUGH THE PHONE COMPANY RELAYS

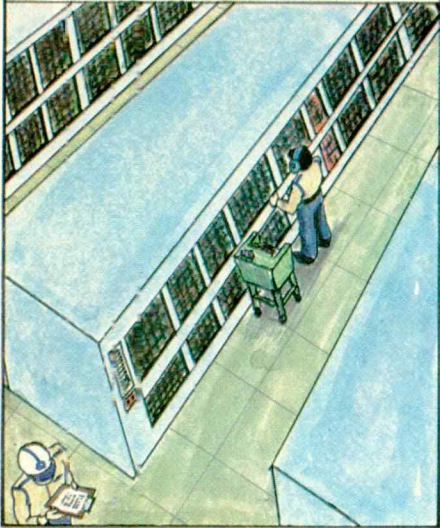

AT THE SPEED OF LIGHT THE CALL ARRIVES AT...

EMERGENCY RESCUE SER...



RESCUE 8 - HUNTER LOST IN WOODS, GRID REFERENCE DELTA ZERO NINER. CODE 7

WHERE'S THAT?

THAT'S THE WOODS BEHIND THE SHOPPING CENTER.



BACK AT THE WOODS

CLOMP CLOMP CRUNCH

UH-OH. THAT SOUNDS LIKE A BEAR TO ME.



OK RALPH, WE'LL MAKE A STAND, TOGETHER.

SOB



NOW CUT THAT OUT!

THANK GOD! IT'S THE RESCUE TEAM. YOU SAVED MY LIFE!!! I'LL BE ETERNALLY GRATEFUL.

EMBARRASSIN' AIN'T IT?

LICK LICK LICK



HI MURIEL? GUESS WHAT? WHILE I WAS HUNTING I GOT...

AFTER AN EVENTFUL DAY, BUTCH HEADS HOME UNHARMED, THANKS TO THE TECHNOLOGY OF HAM AUTOPATCH.

HI ERNIE? BUTCH. Y'KNOW THAT NEW HAM RADIO I... I... -HEY! I NEVER SAW THIS ROAD BEFORE. OMIGOSH! UH-ERNIE DO YOU HAVE THE NUMBER OF THE HIGHWAY PATROL?



UH-COULD YOU TELL ME ABOUT IT LATER, HONEY JUST DON'T FORGET TO PICK UP A POUND OF CHOPPED CHUCK AND A SIX PACK OF BUD. BYE.

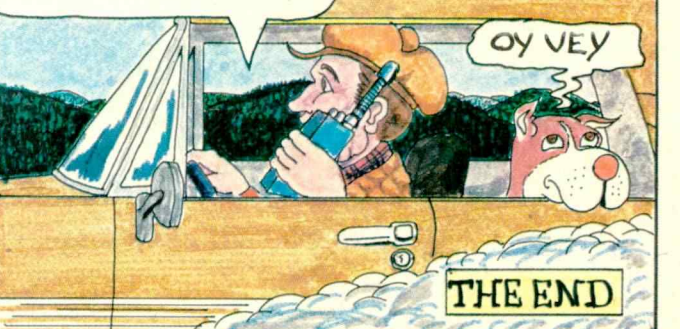

OY VEY

THE END

Electricity pumps: batteries and power supplies

Atoms are the key to **electricity**. Everything you can see or touch is made up of atoms. Atoms, in turn, are composed of subatomic particles.

Subatomic particles

An atom has a **nucleus** of particles, with other particles around it like planets around a sun. Particles in the core have positive charges + while those in orbit are negative. - Like magnets, similar particles push away from each other. Opposite charges attract each other. The negative particles are **electrons**.

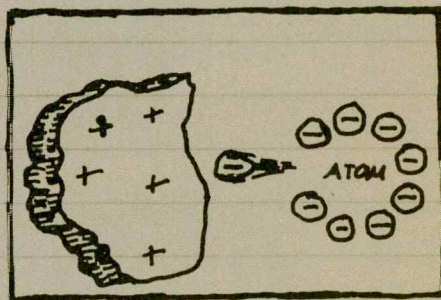

Silver, copper and other metals have electrons which can easily be jilted away from the nucleus. If something knocks an electron off a copper atom, for instance, the copper atom then is more positive than negative. It is unbalanced, hungry for a replacement electron. If it is near a balanced neutral atom, it will strip an electron from the neutral atom. It will pull that electron across open space to satisfy itself. We call such a flow of electrons: **electricity**.

Ⓐ -----> Ⓐ

Electricity is the flow of electrons.

Atoms which give up electrons easily are **conductors**. Those which hang on tight to electrons are **insulators**.

Here's how to see electricity :

- I. Hang metal foil from dry thread.
- II. Rub end of plastic comb on wool cloth to build up extra electrons in comb. Bring comb end near metal foil. The foil will move away from comb.
- III. Electrons in foil, having moved away from the electrons in the comb, have a + charge in the edge of the foil nearest the comb. So, the now-positive edge of the foil is attracted toward the negatively - charged comb.

Electrons flow through a wire like water through a pipe. If pumps produce water pressure, how do we pressure electrons to flow in a wire?

Volts

It takes a strong pressure, called electromotive force, or *emf* for short, to make electrons flow.

Emf usually is referred to as **voltage**. We measure it in volts. The more volts, the more electrons will flow.

Amps

The flow of electrons is called current. The more volts, the more current that flows.

We measure water flowing in a pipe in gallons. We measure current flowing in an electrical circuit in amperes, or **amps** for short.

Electricity pumps

A pump sucks water from a reservoir in your town and sends it through pipes to your house. The reservoir and pump are your source of water. Similarly, our electrical circuits require a **source** of electrons to flow and a **pump** to move them along.

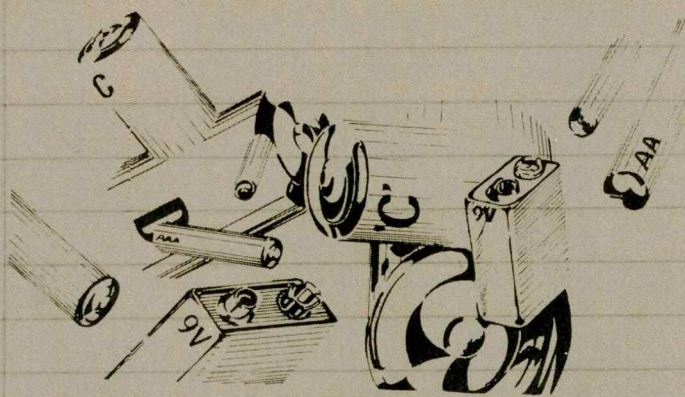

Batteries

A **battery** is a source of electrons and a pump at the same time. It provides:

- electrons to flow (current)
- pressure to move it along (voltage)

Plus and minus

A battery has a plus (+) and a minus (-) connection. Electrons flow between them when you hook a **circuit** or path between them. Here's how we use a schematic diagram to symbolize a battery and other parts of a simple electronic circuit:

Battery symbols

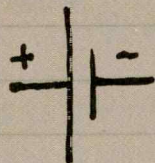

single-cell battery

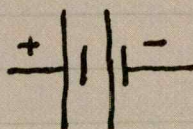

multiple-cell battery

Power supply: man-made battery

As users of electricity, we don't always have to use batteries. Power companies sell electricity, that they generate and send through wires to your house. We tap into that source at a wall plug outlet.

110 Volts

Power company electricity is standardized at 110 volts. How can you use that to power up a CB radio designed to run on 12 volts from a car battery?

Easy! Build a power supply to step 110 volts down to 12 volts. Here's the schematic of an easy-to-build power supply:

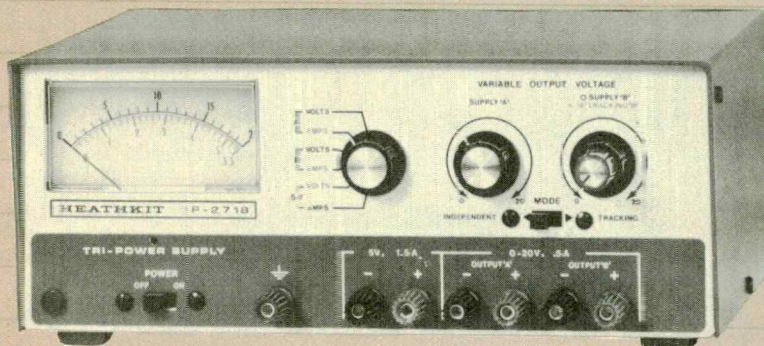
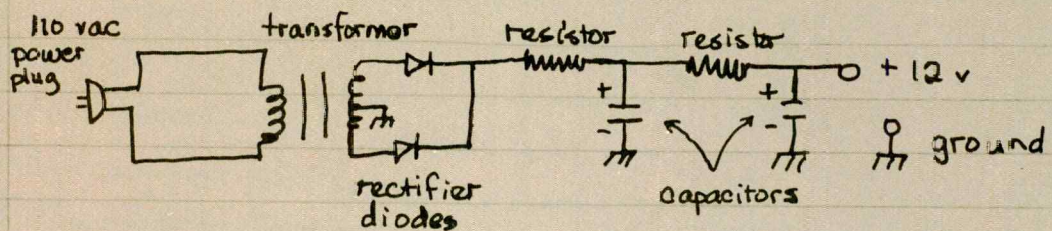
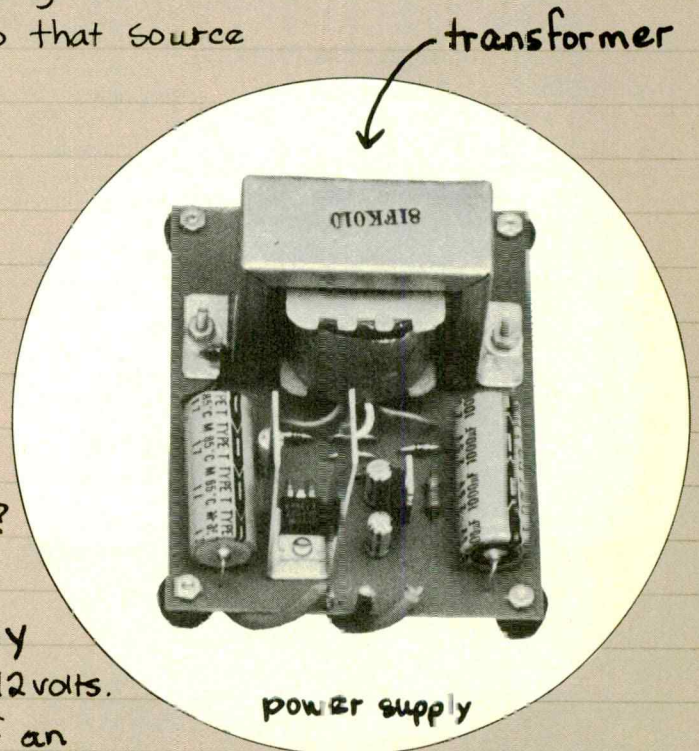

Example of a ready-made power supply you might buy at your radio store.

Home study: get a ham ticket and talk to the world

Lots of schools and courses let you study on your own schedule at home for an amateur radio operator's license.

by Gerald R. Patton, WA3VUP
Contributing Editor

Licensed *amateur radio operator!* It seemed like an impossible dream to me when I was only 12 years old and just starting junior high school. Long before then, I had been bitten by the "bug": a

fascination with electronics and gadgets of all types and descriptions.

A friend and I had read and heard about amateur radio operators talking all over the world and being involved in public service communications. More than that, we had also been exposed to the business use of Citizens Band radio by our families and friends (this was long before CB was well known by the general public).

We decided to visit a meeting of a local ham organization, the Horseshoe Radio Club (named for the famous Horseshoe Curve in the Pennsylvania Railroad tracks just outside the city of Altoona). We met in person some of the

people who were really doing these things we had read about, and who generously took time to explain how we could become ham operators.

Clarence "Scotty" Scott, K3GIH, volunteered to be our "Elmer," a person who takes the time and trouble to help a newcomer qualify for an amateur license, especially with learning to send and receive the International Morse Code, which is a requirement for every class of ham radio license.

By virtue of his assistance, we both became fairly proficient with the code at a speed of five words per minute, which was then and still is the required speed for the beginner's ticket in amateur radio, the Novice license.

The best laid plans

However, at about this same time, the pressure of our academic work in school was getting heavier, and we both became involved in what was to become about seven years of service in the Civil Air Patrol, where we learned about military communications procedures while assigned as radio operators during many practice, and all-too-many real, search and rescue missions for downed aircraft and lost persons.

Due to the school work, my interest in C.A.P., and perhaps any number of other reasons, my pursuit of that coveted ham radio license came to a halt. I didn't know it then, but my interest in amateur radio was not to re-surface until ten years had gone by.

High school, college, and C.A.P. were now things that existed only in my past. I was working in my home town in central Pennsylvania, and my friend was now an Air Force officer stationed in North Dakota. We found that our time was even more limited than it had been in our high school days.

However, the bite of the "bug" had been permanent, and we both had a desire to communicate with each other by some means aside from long-delayed letters or costly telephone calls. We had again become prime candidates to enter the world of amateur radio.

My original Elmer was still ready and willing to help, even after ten long years. To my surprise, I found that my code copying ability came back to me very quickly, and I was ready for the Novice exam after just a few practice sessions. Scotty served as volunteer examiner for my code test and sent to the Federal Communications Commis-



ME art: Chuck McVicker

sion for the written portion of the exam. For the Novice license, this consists of only 20 basic multiple choice questions covering elementary radio theory and applicable rules and regulations.

License at last!

Not long thereafter, just in time for Christmas of 1973, I received an envelope from the FCC containing my Novice amateur radio license, WN3VUP. Shortly after that, my friend Jack in North Dakota also received his Novice license. Naturally, this was very exciting for us, but we were both totally biased toward voice communications based upon our previous experience, and the Novice license permits code, or cw (for continuous wave), operation only. It quickly became obvious: we had to advance farther up the amateur licensing ladder!

We each had to prepare for the higher class exams more-or-less on our own. There weren't any courses being offered here at that time, such as some radio clubs sponsor through adult education programs, etc. I anticipated that I might have more of a problem with learning the necessary theory for the written exam than with increasing my code speed to the 13 wpm required for the General class license, which would open the door to long-range voice communications.

I found that there are two basic approaches that are used to prepare for

Privileges for each class of amateur radio license					
	NOVICE	TECHNICIAN	GENERAL	ADVANCED	EXTRA
CODE REQUIREMENT:	5 wpm	5 wpm	13 wpm	13 wpm	20 wpm
WRITTEN EXAM:	Elementary theory and regulations	Same, plus general theory and regulations	Same as for Technician	Same, plus intermediate radio theory	Same, plus advanced techniques
EXAMINER:	Volunteer examiner, General class or higher	FCC*	FCC*	FCC*	FCC*
LICENSE TERM:	2 years, not renewable	5 years, renewable	5 years, renewable	5 years, renewable	5 years, renewable
PRIVILEGES:	CW only 250 watts Sub-bands on 80, 40, 15, and 10 meters	Novice, plus other modes on 50.1-54 MHz 145-148 MHz and above 220 MHz	All bands, excluding sub-bands reserved for Advanced and Extra	All bands, excluding sub-bands reserved for Extra	All amateur Privileges

*Except in certain cases of prolonged physical disability, where FCC will designate an examiner close to applicant.

that you can develop a real understanding of the subject. There are a few problems attached to this method, though. One, it takes longer; two, you can be overwhelmed by the somewhat complex nature of electronics and its associated mathematics unless the material is presented just right; and three, you might get bogged down trying to grasp some technical detail that you are not even required to learn in order to qualify for an amateur license.

A special course

I opted for the second method and enrolled in a home study program offered by the National Radio Institute (NRI) and designed specifically for amateur license exam preparation.

Actually, NRI offers three of these courses. Their Basic Amateur Radio course, which is aimed at the Novice, Technician, and General licenses, consists of 35 "bite-size" texts, two reference books, a code record graduated to 15 wpm, and three training kits: a code practice oscillator, a 3-band elementary receiver, and a 15-watt crystal-controlled transmitter.

The Advanced course is directed toward the Advanced and Amateur Extra class licenses with 30 texts and a code record for increasing speed to 25 wpm. I took the Complete Amateur Radio course, which starts with the basics and leads you to the theory level required for the Amateur Extra license.

With this background, I have since reached my goal by obtaining the Advanced class license. By the way, some very good news about these NRI courses comes at the bottom line: the tuition fees are extremely reasonable!

At this point, you may be wondering about Jack. Yes, he also has progressed to the Advanced class license, but he now lives only about 50 miles away, and we communicate by amateur radio regu-

larly through one of several mountain-top repeater stations using two-meter fm.

The first step

There are several fine home study programs available to help you earn a Novice license in a minimum of time. ME sister publication *CQ Magazine* has teamed up with Ameco Publishing to offer an excellent Novice training package. Another beginner package, *Tune in the World with Ham Radio*, is from the American Radio Relay League (ARRL) and consists of a 60-minute cassette tape to assist you in learning the code and a book which explains basic radio theory, regulations, and gives a preview of many of the exciting different phases of the hobby.

Heathkit recently introduced a new programmed instruction Novice license course. For under \$30, this course includes a text, two cassette tapes, operating aids, and even a code practice oscillator kit complete with telegraph key. Here's something else: Heath guarantees you'll pass the Novice exam after completing this program or your payment for the course material will be refunded!

Other helpful materials include the *ARRL License Manual* and various publications available from Ameco and Radio Shack.

Reaching the top

The amateur radio licensing structure is like a very unusual ladder because you can climb to the top with one giant step! I went up the ladder from Novice to Advanced step-by-step, but it's entirely permissible for you to walk into an FCC field office with no license and walk out having qualified for the Amateur Extra license. With motivation and the right preparation using materials such as these, you can get the amateur license of your choice just as I did. 

Where to write for more information

AMECO PUBLISHING CORP.
275 Hillside Avenue
Williston Park, New York 11596

AMERICAN RADIO RELAY LEAGUE (ARRL)
225 Main Street
Newington, Connecticut 06111

CQ MAGAZINE
14 Vanderventer Avenue
Port Washington, New York 11050

HEATH COMPANY
Benton Harbor
Michigan 49022

NATIONAL RADIO INSTITUTE (NRI)
3939 Wisconsin Avenue
Washington, D.C. 20016

RADIO SHACK
2617 West Seventh Street
Fort Worth, Texas 76107

the written exams. One of these is to attempt to memorize sample questions and answers and then hope that the actual test questions will be close to the ones you memorized!

The other is to begin a more overall, comprehensive study of electronics so

5 projects for a spring weekend

Build this multi-stage timer, scope calibrator, temperature indicator, flood alarm and power failure detector this weekend.

by Jeffrey A. Sandler
Contributing Editor

1 Multi-stage timer

Here's a nifty multi-stage timer you can use to time up to five sequential periods each ranging from a few seconds to 15 minutes or more. The circuit has just two ICs, five LEDs and a handful of common resistor and capacitor values. The whole project costs under \$10.

Each time period is indicated by different LEDs, which light in sequence.

The period each LED stays on depends on the values of $10R$ and $10C$, each of which must be at least 10 times greater than the values of R and C . So, if R is 1000 ohms, $10R$ must be at least 10,000 ohms. And if C is .01 μF , then $10C$ must be at least .1 μF .

As a rough guide, the value of $10R$ in ohms multiplied by the value of $10C$ in farads will give you the time in seconds its LED is on. You can add a variable resistor, shown in dashed line in the diagram, to fine tune the time period.

The timer is turned on by bridging the gap in the touchplate with your finger. Once on, the first LED will light for the predetermined time period. When the

first LED goes out, the second LED lights for its time period, and so on until the last LED lights. If you want the sequence to repeat, you can add a feedback line from the output stage back to the input through the spare 4009/4049 inverter and a diode, as shown in dashed line in the lower diagram. With this line installed, the first LED will light when the fifth LED goes out, and the entire sequence repeats until the line is opened.

Although parts layout is not critical, some care should be taken to keep wiring between components as short as possible, with a minimum of crossovers.

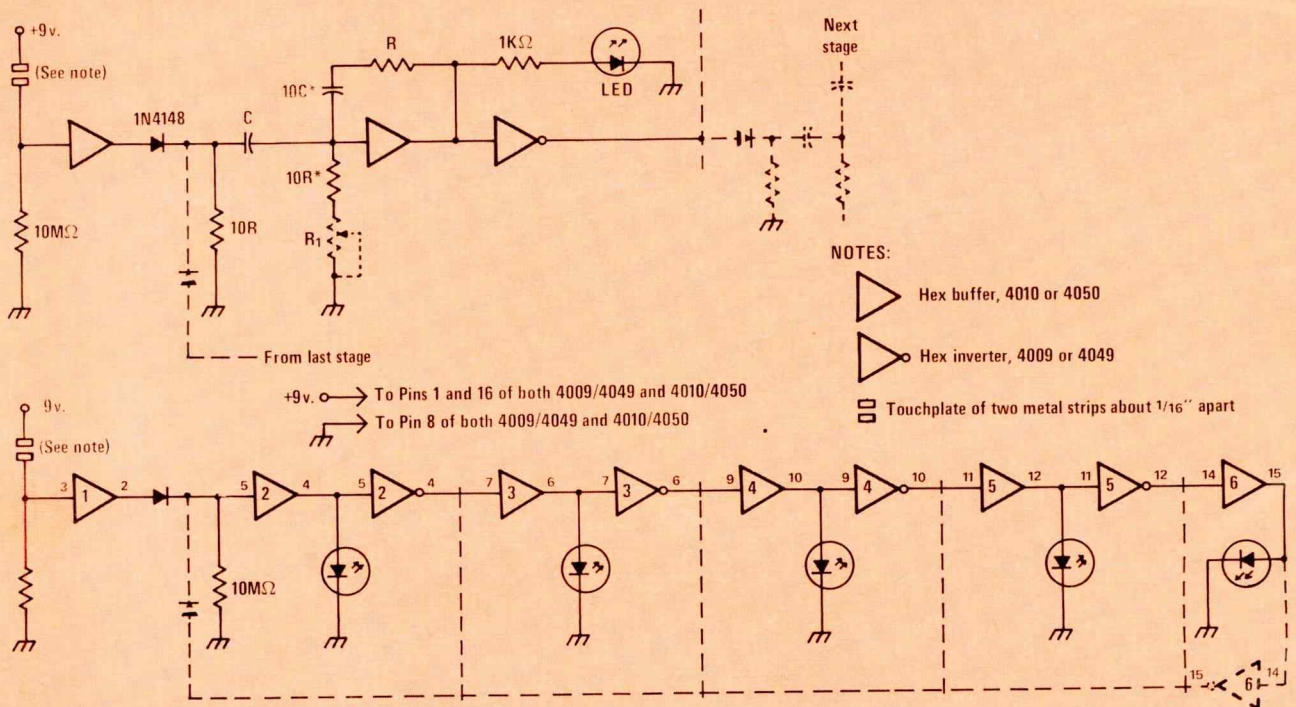

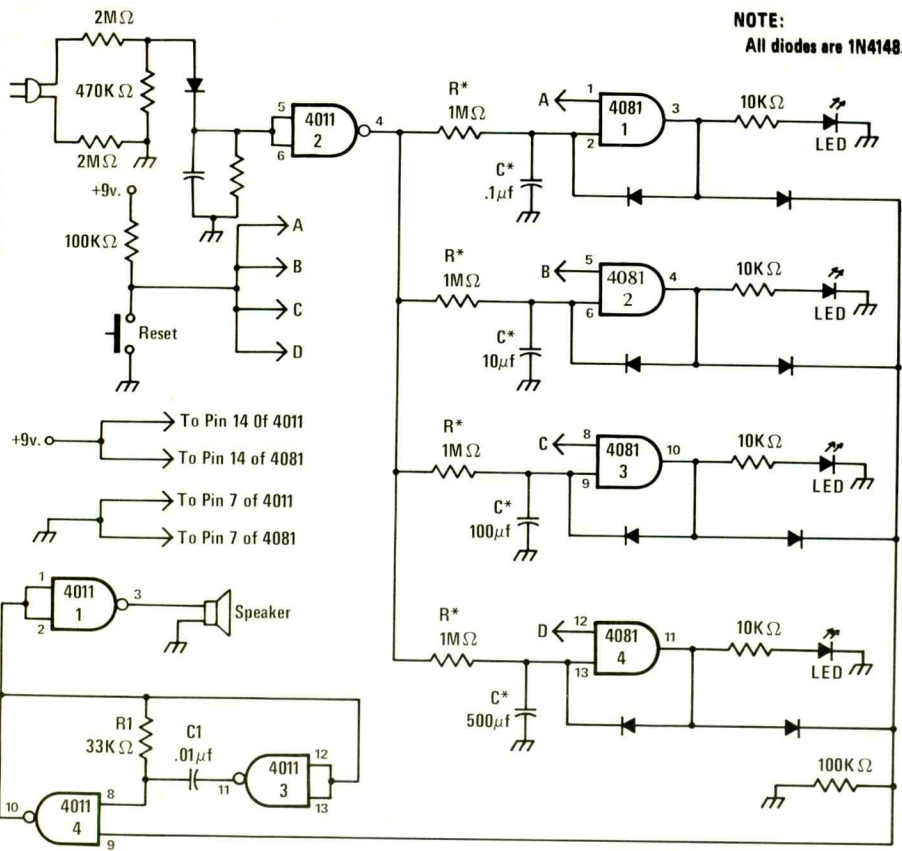

NOTE:
All diodes are 1N4148.

2 Power failure detector

Ever come home and find all your digital clocks reading "eights" leaving you wondering how long the juice was off? Well this inexpensive circuit can give you a good idea. All you have to do is connect it to any outlet.

When the power fails, an alarm will sound and from one to four LEDs will light, depending on how long the outage lasts.

You can select the time required for each LED to light by carefully choosing the values of each R^*C^* pair. The values given here are for 1 second, 10 seconds, 100 seconds, and 500 seconds. The tone of the alarm is determined by R_1C_1 .

Current drain is quite low when the alarm is off. A single 9-volt battery should last a year.

After a power failure has occurred, you can reset the alarm by momentarily depressing the pushbutton "reset" switch.

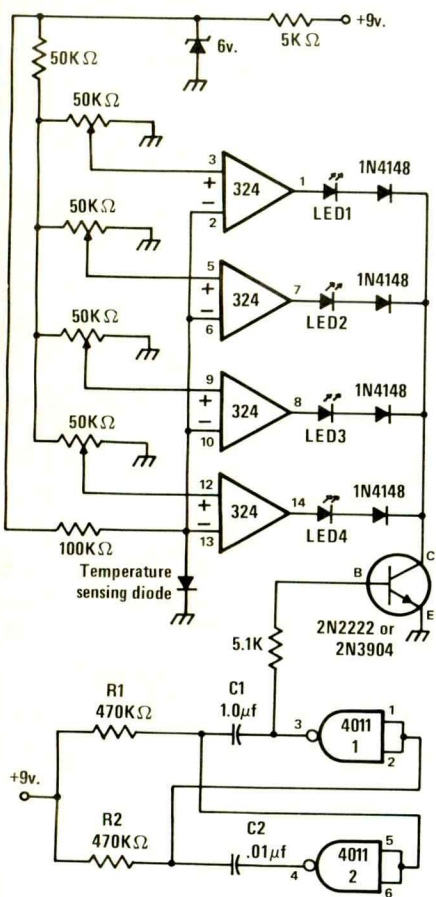

3 Temperature indicator

This inexpensive temperature indicator is easy to build, and at the same time, makes an interesting conversation piece. Temperature is indicated by a flashing LED. The circuit shown provides four temperature ranges, but you easily can add another 324 integrated circuit and associated components to provide a total of eight.

Each amplifier segment of the 324 monitors the voltage across a temperature sensing diode, and compares it to a preset voltage. When the diode voltages rise above the preset level, the amplifier output swings positive, turning on the associated LED.

The temperature at which each LED is turned on depends on the setting of the associated variable resistor. To calibrate

the setting, you'll have to use a standard thermometer. Although it is possible to set the amplifiers to turn on the LEDs over a range of a few degrees, it is more practical to set them for at least five degree steps, with 10 degree steps preferable.

The LEDs, when turned on, blink at a rate determined by the value of R_1 and C_1 . The values given provide a flash rate of about one-half second. Blinking the LEDs conserves battery power. However, if you power the circuit from a dc power supply, you may prefer to have the LEDs remain on, rather than blink. All you need to do is connect the cathodes of the LEDs directly to ground. Removing the oscillator and transistor circuits will not otherwise affect the operation of the temperature indicator.

Use of a dc power supply will be necessary if you expand the circuit by adding a second 324 integrated circuit. The total current drain will then be near a tenth of an ampere when all the LEDs are on.

The temperature sensing diode can be any silicon diode. However, germanium diodes will not work in this circuit. If you do expand the circuit to include a second 324, use the 2N2222 or 2N2222A transistor. The 2N3904 current handling capability will be marginal at best.

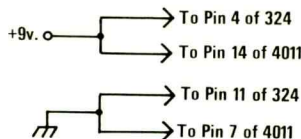

4 Flood alarm

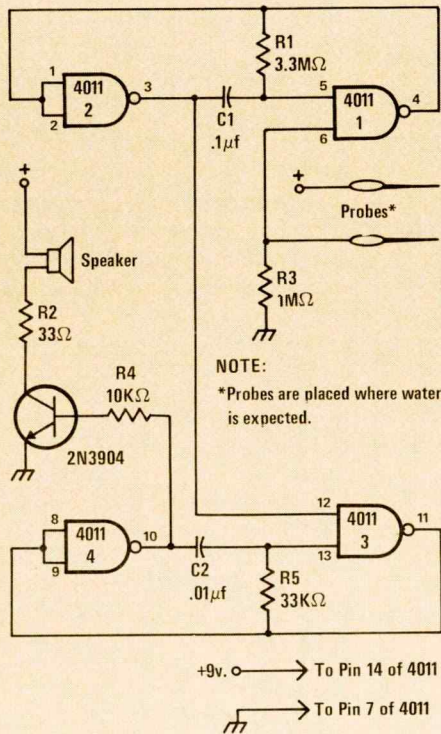

If you're worried about a flooded basement, or your swimming pool overflowing, you'll really like this inexpensive flood alarm.

The alarm is built around two audio oscillators, each using two NAND gates. The detection oscillator, shown at the top of the schematic, is gated on by a pair of remote probes, which you locate in the area you want to protect. One of the probes is connected to the battery supply, the other to the input of one of the gates. When water flows between the probes, the detection oscillator is gated on.

The alarm oscillator, shown at the bottom of the schematic, is similar in design and is gated on by the output of the detection oscillator. The values given produce an audio tone of about 3000 Hz. The detection oscillator gates this audio tone at a rate of about 3 Hz. The result is a unique pulsating note, sure to draw your attention. You can change the audio tone by changing the values of R5 and C2, and the bleep speed by changing the values of R1 and C1.

You can use any small eight-ohm speaker to sound the alarm. The 2N3904 can be replaced by any similar NPN transistor.

The circuit will work from any six to 12-volt supply—a standard nine-volt transistor battery is ideal. Current drain in the off condition is negligible, so battery life should be well over a year.

5 Scope calibrator

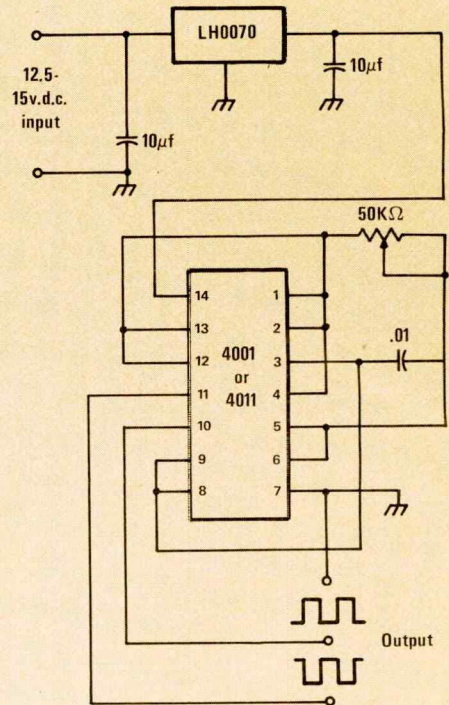

Many oscilloscopes, designed primarily to display waveforms, provide only relative amplitude measurements. These scopes easily can be used to measure amplitude with the addition of this handy scope calibrator.

The heart of the calibrator is an LH0070 integrated circuit voltage regulator. Operating from any 12.5 to 15-volt dc source, the LH0070 produces exactly 10 volts. This 10-volt output is applied to a 4001 or 4011 CMOS quad gate, connected to produce square wave output. Because CMOS logic has no voltage offsets, the square wave output swings between zero and the 10-volt output of the LH0070.

The frequency of the square wave produced by the 4001/4011 flip-flop circuit is determined by the .01 μF capacitor and the setting of the 50,000 ohm variable resistor. The switching rate of the CMOS logic is fast enough to provide a square wave with reasonably sharp corners.

Two outputs are provided, on the inverse of the other. The arrangement can prove very useful for setting gain on inverting amplifiers when using a dual-trace scope.

Calibrating your scope with this calibrator is very easy. Just connect one of the outputs to the vertical input of the scope, and adjust the vertical sensitivity to a convenient measurement standard—one division of trace deflection, for example. In this case, a waveform deflecting 3-1/2 divisions would have a peak-to-peak amplitude of 35 volts.

Frequency counters: hot new CB add-ons

Ever get lousy signal reports on your CB rig? Maybe the box is transmitting off frequency, not right on channel. There's a new wave of handy-dandy testers which tell exactly where you are in the radio spectrum. And they work well for hams and other two-way radio people, too.

by J. L. Genevicz

First you had to buy and install new crystals when you wanted new channels in your CB. Then, after you invested in a 23-channel set for your car, it got bumped off channel by the potholes in the public roads. Whether putting in new crystals or tweaking the 23-channel job back onto frequency, you had to fork out a bundle to a service shop for a reading on their frequency counter.

Here's good news: you won't have to haul the CB to a radio repair station anymore to pay a technician for a

reading on his \$2000 tester. Buy yourself an inexpensive *frequency counter* and check your own radio every day if you like.

Prices have tumbled on superaccurate digital frequency counters so you can have your very own. What cost in the thousands just a few years ago now can be had for under \$100.

Get on channel

Here's what you get for the money:

■ An extremely accurate reading of the frequency at which you are transmitting so you know you are putting out a signal correctly at the center of each CB channel. For instance, if you are using channel 1, the red LEDs in your counter will read 26.965 megahertz (MHz). Or, the reading of the popular trucker's channel, 19, is 27.185 MHz.

■ Indication that your CB is transmitting power. Counters work by sampling a tiny bit of the actual radio-frequency (rf) energy radiated from your transmitter.

■ A top-notch shop tool if you plan to make extra income repairing CBs on the side. Get a second-class FCC ticket and you'll find that a frequency counter will be the first piece of test equipment you'll need.

There are many models on the market, from a \$90 unit by Digitrex, 4412 Fernlee, Royal Oak, MI 48073, to the best-available \$529 model IM-4130 by Heath Co., Benton Harbor, MI. Another under-\$100 device is model CT-40 from Telco, 44 Sea Cliff Ave., Glen Cove, NY 11542.

To use one of these CB add-ons, hold it near your transmitter coax or antenna. It should pick up signals from the air, as you transmit, and flash the frequency on its LED readout. Or use a special coax coupler, supplied with many counters, to hook it into the coax line. Don't hook the full-power output from your transmitter directly into the input of the counter. You'll burn up the counter!

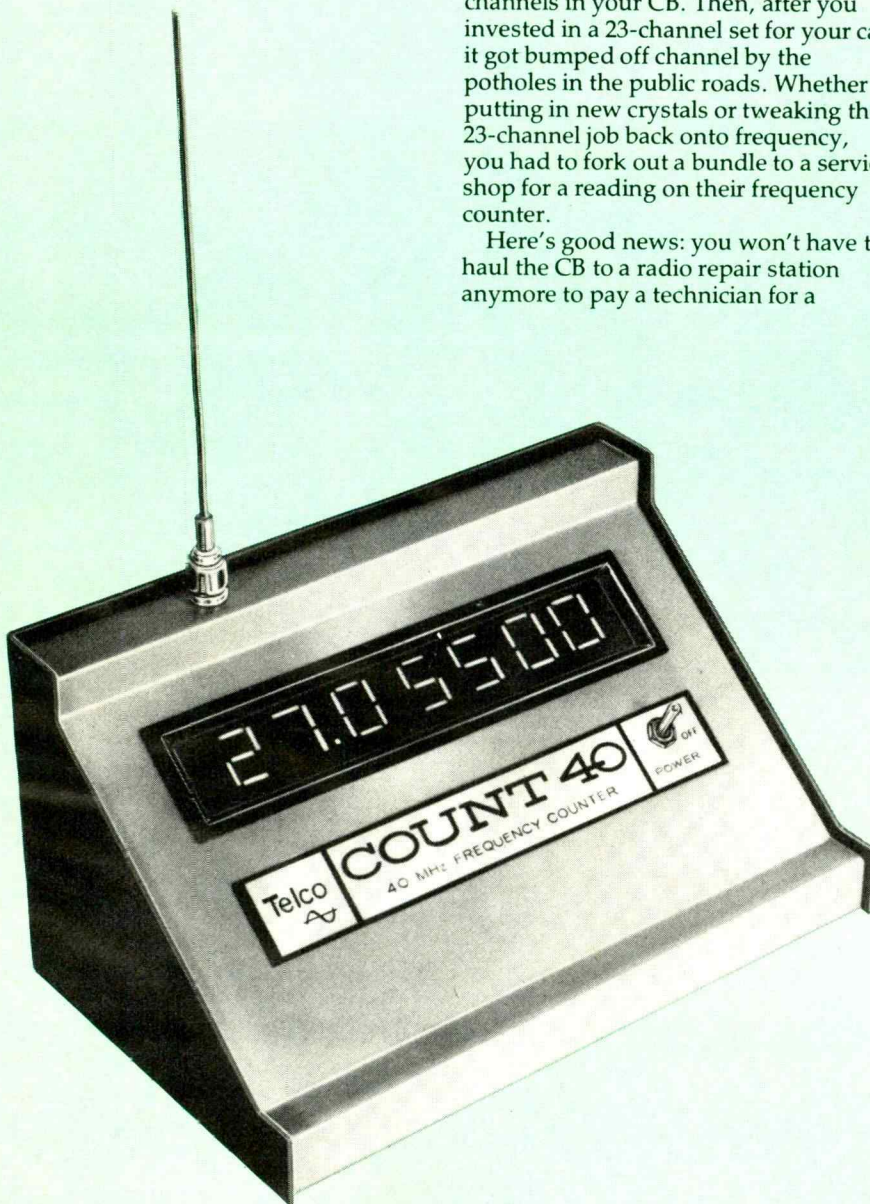

One example from many different styles of frequency counters available is the Count 40 by Telco. Display shows 27.055 MHz which is the frequency of CB channel 8.



Here's your key to

An unusual approach to dits and dahs makes for hours of building and code-sending fun in our \$17 project.

by Jeffrey A. Sandler
Contributing Editor



Dahditdahdit dahdahditdah—the sound of Morse code; the sound that keeps so many CBers from becoming amateur radio operators. Learning Morse code is really very easy. What's difficult is increasing the speed at which you can send and receive code. And this inexpensive, easy-to-build code practice oscillator is just the thing to make increasing your speed a lot easier.

The big difference between this oscillator and most others you've seen is its automatic keying capability. Just like the modern keyers used by today's active

hams, this gem will automatically send a string of dits or dahs for as long as you hold the *paddle* against the appropriate contact.

Learning the sound

The big advantage of using an automatic keyer to increase your speed is that it forces you to recognize the sound of each Morse character. It's no longer a matter of counting how many times you push down the key to form an H. With the keyer, you hold the paddle against the *dit* contact until you hear the sound

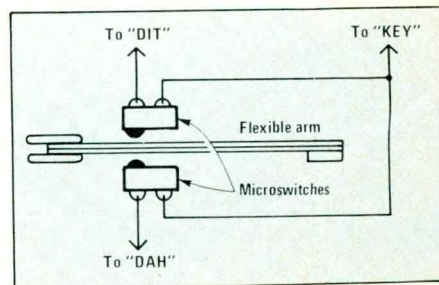

You can use a pair of microswitches, such as the Radio Shack 275-016 or 017 with their levers removed, and any flexible arm to make a simple keyer paddle.

learning the code

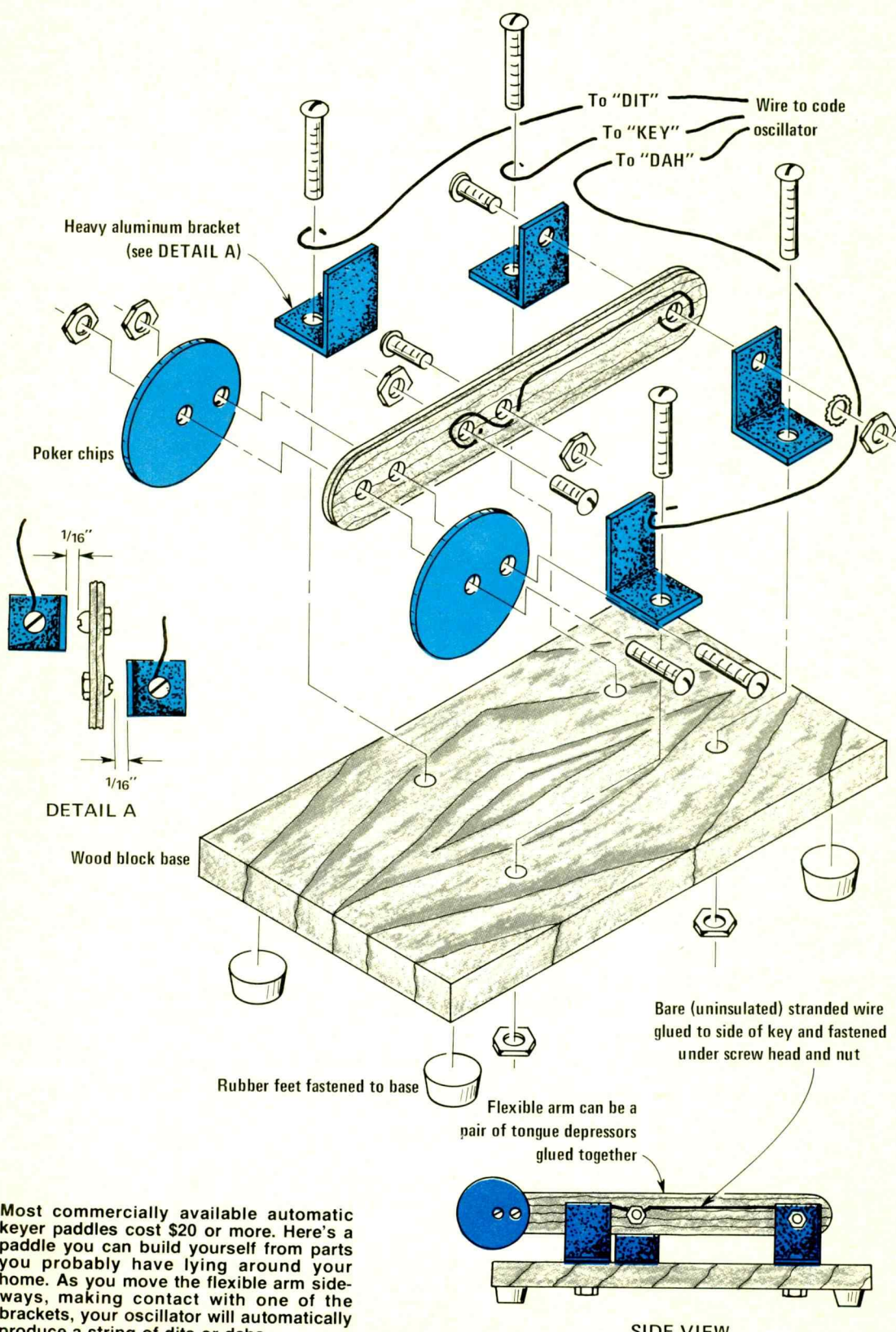

Most commercially available automatic keyer paddles cost \$20 or more. Here's a paddle you can build yourself from parts you probably have lying around your home. As you move the flexible arm sideways, making contact with one of the brackets, your oscillator will automatically produce a string of dits or dahs.

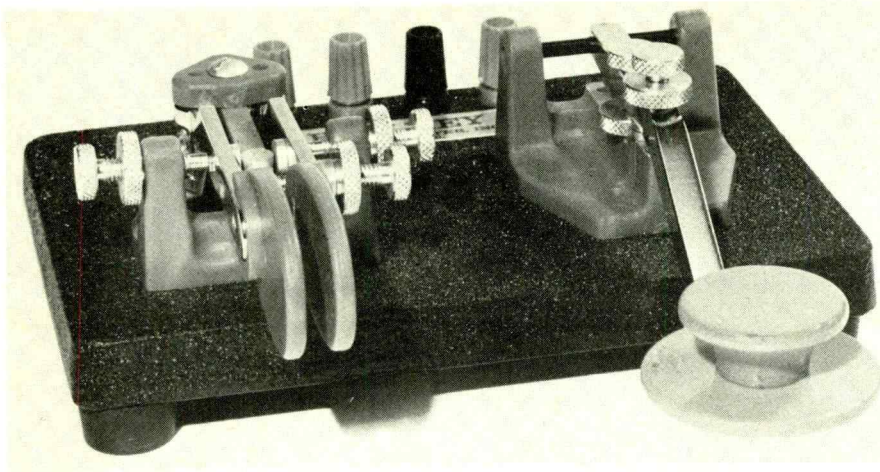

If you'd rather not build your own paddle key, you can buy manufactured keys from several sources you'll find advertised in *CQ*, *The Radio Amateur's Journal*, and other amateur radio magazines. Among them is this HK-4 Ham Key, which combines both a paddle and a straight key in a single unit, available from Ham Radio Center, 8340-42 Olive Blvd., St. Louis, MO 63132 for \$45.

of the letter H, then release the paddle. If you release it too soon, you'll have formed the letter I or S; if you hold it too long, you'll end up with the number 5. So, you have to learn the sound of each letter.

The circuit consists of two parts: the basic oscillator and the automatic keyer. The basic oscillator, shown above the dashed line in the diagram, can be used with a *straight* hand key if you'd like.

The automatic keyer is designed to be used with a sideways-moving keyer paddle. You can buy keyer paddles from several sources advertised in *CQ*, *The Radio Amateur's Journal* and other amateur radio magazines.

An easy paddle

An even simpler paddle can be made using non-electronic parts you can obtain from your local hardware and drug stores. The flexible arm can be made of any material handy, but a pair of tongue depressors glued together

should be flexible enough, yet rigid enough to hold its position between the contacts when not in use. The knobs can be made from poker chips. Electrical contact is made when one of the screw heads on the arm is pressed against the facing aluminum bracket. The paddle can be mounted on a block of wood, or any other non-conducting material handy.

The circuit shown contains a visual indicator in the form of an LED, which lights during the period a dit or dah is being sent. If you'd rather not include the LED, you can delete it and the associated transistor without affecting the remainder of the circuit.

Circuit layout is not critical. The finished oscillator can be mounted in a metal cabinet, such as the Radio Shack 270-260 wood grained box shown here, or in any convenient wood or plastic box you have handy.

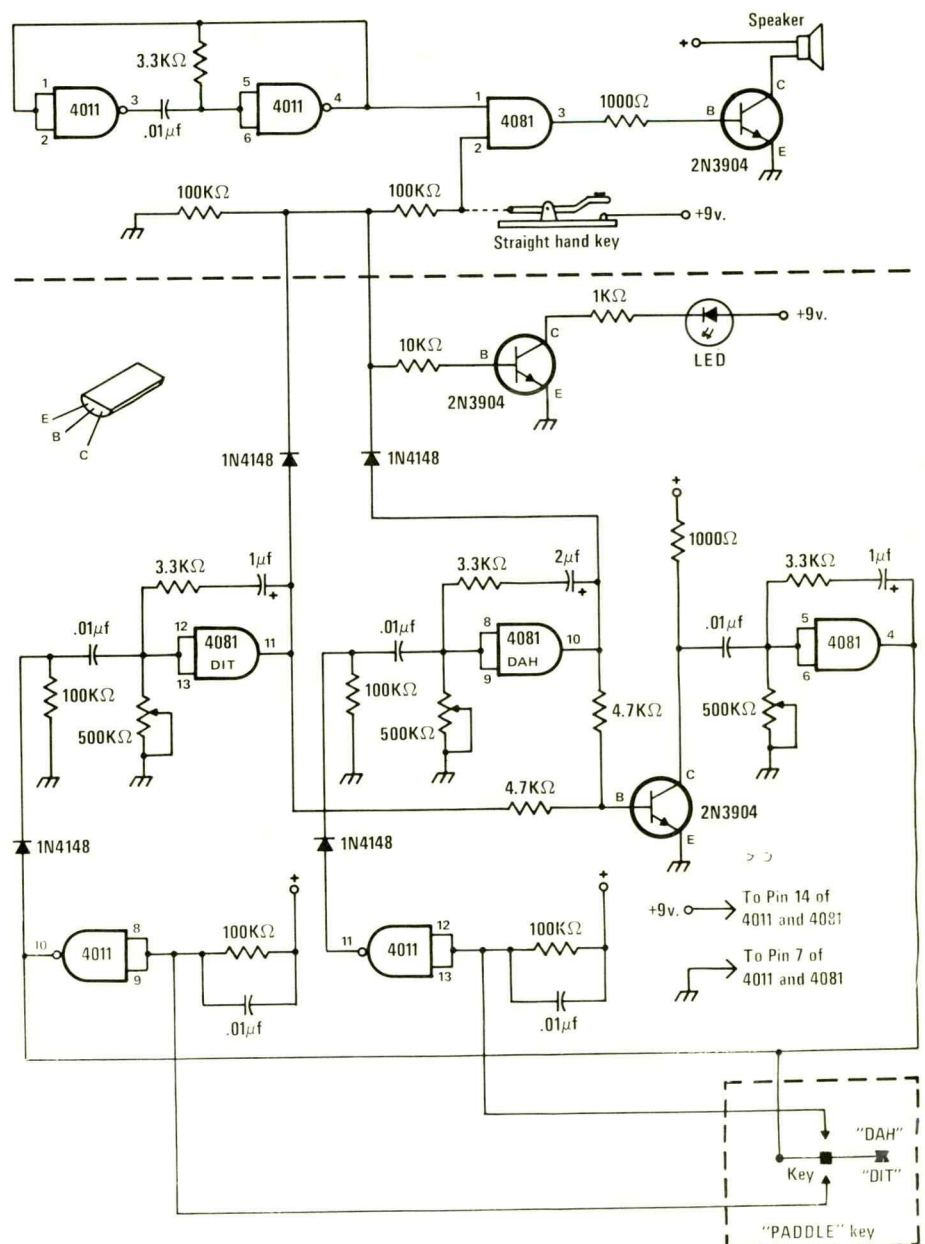

Parts list

Quantity	Description	Radio Shack No.
2	1000 ohm resistor	
2	3.3 k ohm resistor	
3	4.7 k ohm resistor	
1	10 k ohm resistor	
1	33 k ohm resistor	
6	100 k ohm resistor	
3	500 k ohm controls	271-210
6	.01 uF capacitor	272-131
2	1 uF tantalum cap	272-1406
1	2.2 uF tantalum cap	272-1407
4	1N4148 diodes	276-1122
2	2N3904 NPN transistor	276-1603
1	4011 NAND gate IC	276-2411
1	4081 AND gate IC	
1	Optional hand key	20-1084
1	LED	276-041
1	battery clip	270-325
1	9-volt transistor battery (alkaline preferred)	23-553
1	2-inch speaker	40-245

All resistors are 1/4-watt, composition type. All are available from Radio Shack's 271-1300 series. Radio Shack part numbers are provided because your local Radio Shack store probably will be your chief source of supply. However, all parts used in this project are readily available from the many firms advertising in this issue of *Modern Electronics*, usually at less cost—though with the usual mail-order delays.

Sometimes a lot of guesswork goes into your idea of what frequency you're transmitting on.

You know you're in the ball park but you really don't know what the score is.

Now you can put our new FC-76 in your line-up and have the capability of reading out your frequency right down to ± 100 Hz if you need it. (Or ± 1 kHz at the flip of a switch.)

On a big, bright 5-digit LED display anywhere between 5 kHz and 40 MHz.

The FC-76 also features an "Antenna" connector with two-position sensitivity switch for low signal levels down to 50 millivolts.

So you can use the counter as a sensitive test frequency meter, too. One that's good enough to calibrate receivers, realign transmitters, compare dial readings or wherever you need accurate frequency measurement.

And with built-in 117 VAC power supply plus 13.8 VDC

(positive or negative ground) binding posts the FC-76 is all ready for mobile or fixed station duty.

Now here's a score you can't beat: \$169.95. So why wait? Use your Swan credit card. Applications at your dealer or write:



SWAN
ELECTRONICS®

A subsidiary of Cubic Corporation
305 Airport Road, Oceanside, CA 92054
(714) 757-7525

(Price FOB Oceanside, CA)

OUR NEW FC-76 FREQUENCY COUNTER DOESN'T JUST GET YOU IN THE BALL PARK.

IT GIVES YOU THE SCORE.

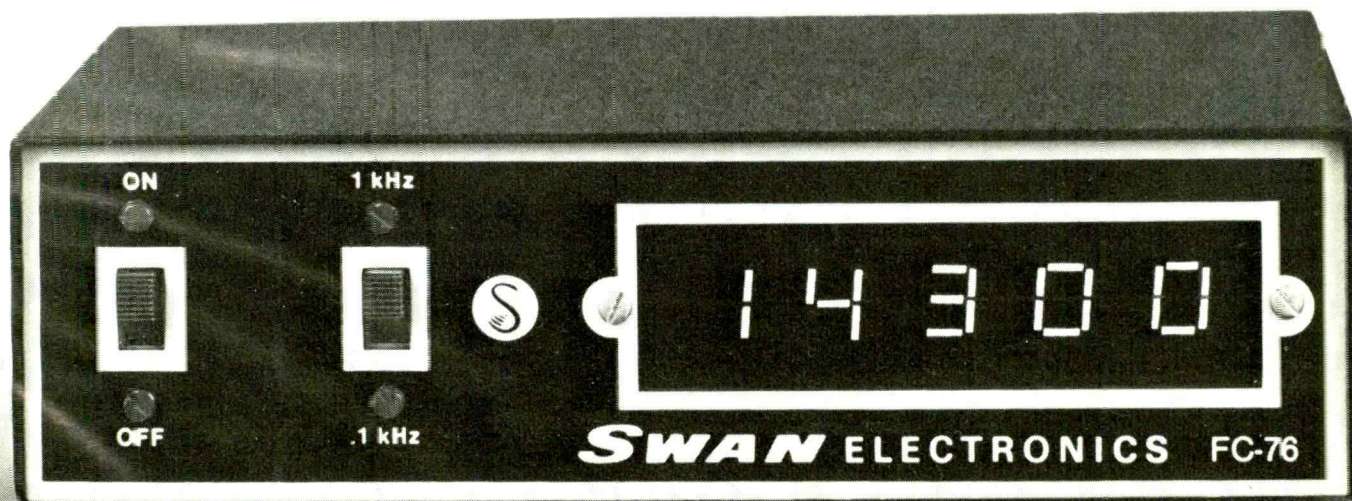

CAT beeps at burglars

Turn your back. Go around a corner. Somebody steals your car. Only this time a radio beeper goes off in your pocket. This may be the ultimate in auto burglar alarms.

by Ron Cogan
Contributing Editor

One of the more distasteful aspects of owning an automobile is the problem of keeping it in your possession. With automobile thefts rising consistently over the years and the spiraling cost of purchasing a car making ownership an expensive proposition, it's no wonder car theft is a worry for motorists everywhere.

To graphically illustrate this nationwide concern, take a few moments at your local electronics store or accessory shop and check out the myriad of alarm systems and anti-theft devices on the shelves. These components vary in design and application, but they are all marketed for one purpose—to keep your vehicle and its contents in your hands.

Unfortunately, many products look great on the shelf but fall short of expectations once they're installed and in use. Probably the number of hit-and-miss items designed for theft prevention out-

number truly functional ones, and only some thorough shopping around will set you on the right path.

Always on duty

Enter the CAT Security System from California Electronics Industries, 2005 S. Ritchey Ave., Santa Ana, CA 92705. Unlike most low-buck auto alarms found on discount store shelves, the CAT is a sophisticated security system to really protect your vehicle. It's on duty 24 hours a day without ever needing to be manually set. It operates with the ignition key.

The basic system components include a central alarm module containing the electronic brains, a trumpet speaker for blasting a high-low sound, pin switches, wiring harness, and various bits and pieces of installation hardware.

Some optional accessories include CEI's alarm pager, stand-by battery



First step is to locate an out-of-view mounting location for the alarm module, which we determined to be behind the dashboard in front of the passenger's seat. The wiring harness was located at this point and its wires routed to various locations as needed.

pack, reed switches, and pressure-sensitive floor mats.

The pager uses a one-watt class C citizens band (CB) transmitter operating on 26.975 MHz and a small receiver that clips to your belt or pocket. You are immediately signaled of a break-in up to a mile away. Even if you're out of range of the alarm's high-pitched warbler, you can personally keep tabs on your vehicle's security at all times—even while you're working in your 15th floor high-rise office.

A quick call to a security guard should net instant results in even the most crowded, expansive parking lot, since it's a simple matter to isolate the source of the distracting, 110 db sound.

This alarm can be heard approximately 200 feet away from the vehicle and will cease two minutes after the intruder leaves. The security system then resets itself and waits for the next attack.

Easy installation

Installing the CAT system is an easy step-by-step project that takes about three hours by following the instruction

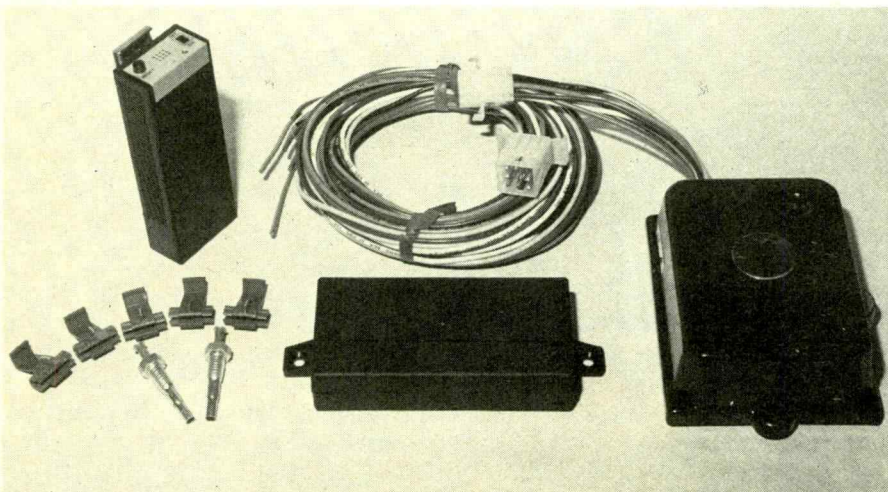

The CAT components used in our sample installation included a central alarm module, trumpet speaker (not shown), transmitter, pager-receiver, and mounting hardware. The transmitter and receiver are not a part of the basic system, but available as one of the many optional CAT accessories.

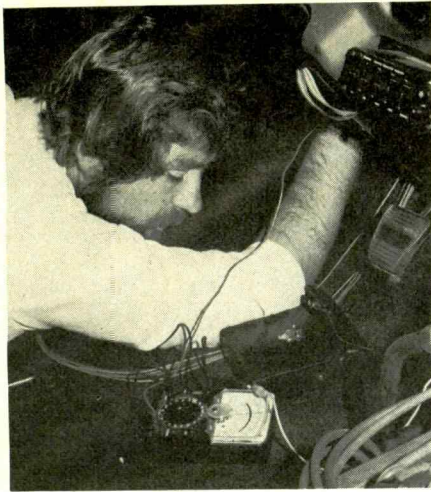

Three wires will have to be tapped into at the fuse block -- a wire that's always hot, one that is hot only with the key in the "on" or "accessory" position, and a ground. A test light or meter will prove handy here.

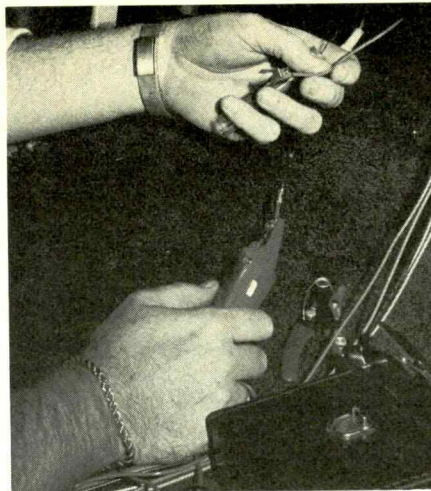

All connectors needed to install the system are included with the installation kit.

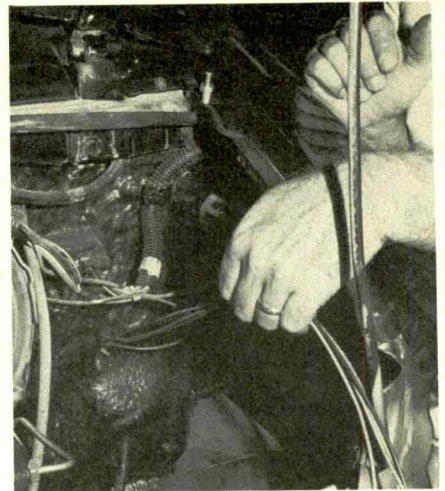

You will have to route several wires into the engine compartment, so try to find an access hole where stock wires have already been run through. If one isn't available, then drill a new hole to enable the wires to pass through.

manual. You'll need a power drill and assorted bits, crimping pliers, wire strippers, ratchet and sockets, soldering iron and solder, and several strips of Velcro fastening tape. A 12-volt test light or meter will help you locate various hot and ground wires, too.

Begin by locating a suitable mounting spot for the alarm module, preferably in an area hidden from view and out of the way of feet and legs. We found the ideal location in a Chevy van to be an accessible, yet out-of-view, area behind the dashboard in front of the passenger's seat.

A strip of Velcro glued on the back of the module and a second strip secured to the backside of the dash will hold the module securely in place.

Next, you should route wires from the module's wiring harness to various locations where you'll be splicing into

The trumpet speaker should be mounted against the sheetmetal inside the engine compartment and then connected to the system.

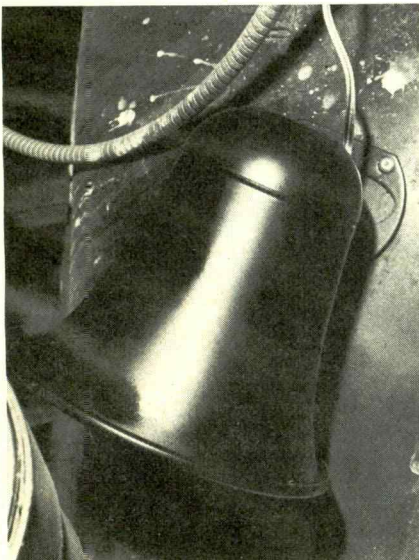

door pin switches, connecting to the trumpet speaker, and tapping into power sources.

Most of this wiring easily is hidden behind the dash, since the module is located there, too. Simply run wiring through the firewall to the spot you'll be mounting the trumpet speaker, down the firewall inside the cab to the fuse block, and behind kick panels to the front door jambs where the pin switches will be installed.

The easiest way to route wire to the engine compartment is to run it through an existing hole where other stock wires already have been routed, although you can drill a new access hole in the firewall if necessary.

Line the trumpet speaker up in the engine compartment so it's out of the way of all moving parts, then attach the

Bugging the hood and door jambs against intrusion comes next. Many vehicles have holes already drilled by the manufacturer for this purpose; if holes aren't present, then you'll have to drill all necessary holes as outlined in the installation manual. Screw the pin switches into the holes next.

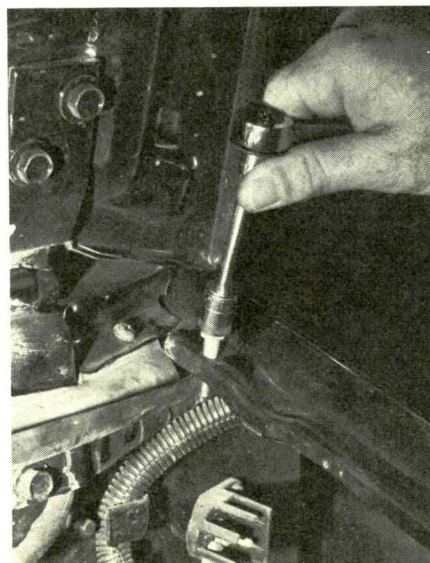

proper wires from the module to the speaker's leads. Insulated connectors are supplied for this purpose. Although the high-pitched sound will be heard regardless of the exact positioning of the trumpet speaker, you can increase the alarm's range by aiming the speaker's mouth at any hole or opening to the outside, like the vehicle's grille.

Once you've selected the mounting location, hold the trumpet speaker's base against the engine compartment's sheetmetal, drill the necessary mount-

Locate the pin switch wire running from the alarm module, then crimp on a connector. Splicing the hood's switch to the system's yellow wire will result in the alarm sounding some ten to fifteen seconds after a thief opens the hood. By splicing it to the green (panic switch) wire instead, the high-low sound will begin blasting immediately and then cease as soon as the hood is closed. Once the system is activated in this manner, though, the entry delay time will begin to expire and the system will sound until two minutes after the disturbance has ceased.

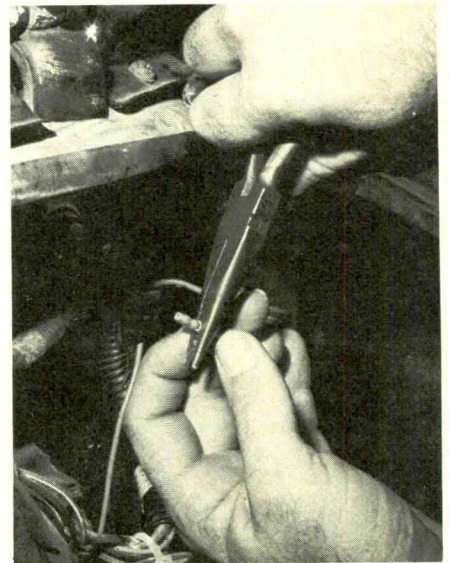

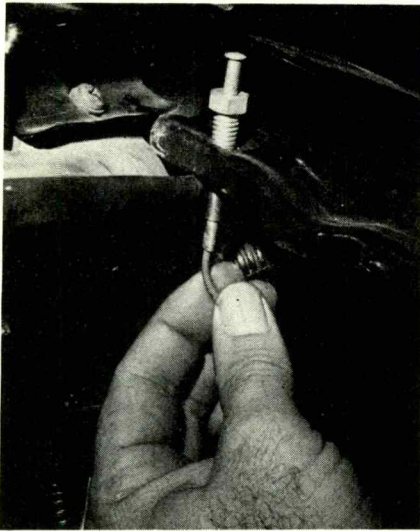

Insert the wire end into the pin switch and the hood is now bugged.

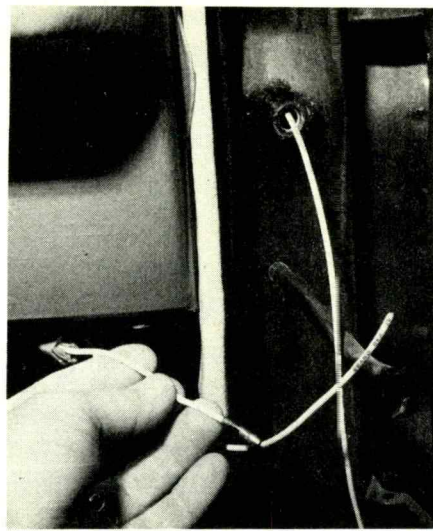

Door jambs are bugged in much the same way as the hood. Drill the hole, insert the proper wire through the hole, clip wire to switch, then screw the pin switch into place.

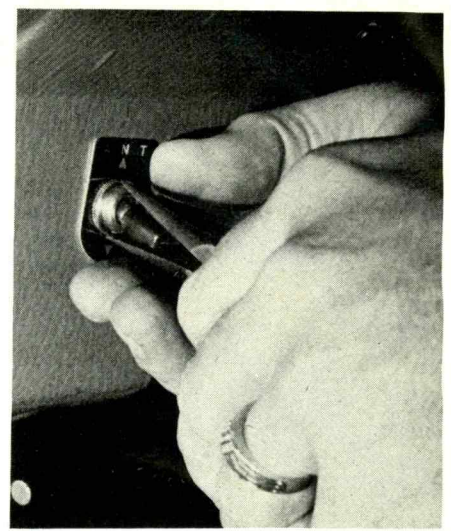

If your vehicle is equipped with a motorized antenna, then the security system can be wired so the antenna will be raised when an intrusion is detected. This will supply the raised antenna that the transmitter will need to send out its signal.

ing holes, and then secure it in place with pop rivets or sheet metal screws

Moving inside, drill holes at appropriate spots in the door jambs for pin switches. Feed the proper wire from the wiring harness through the hole, clip the wire to the pin switch, and then screw the switch securely into the door jamb. This procedure should be followed at every door jamb.

You also can "bug" the hood by adding a pin switch there. Splice the power and ground wires following the instructions, and the basic security system is now installed and functional.

Now comes the trick part. To install the pager you need to place a Y connector in your radio's antenna wire so the

transmitter and radio can both use the antenna. If your vehicle, like our van, has a power antenna, the system can be wired so the antenna raises when the security system detects an intrusion.

You can leave the antenna in the down position to protect against antenna vandalism while you're away, yet still provide the transmitter with an antenna when it needs one.

The big test

Once the installation is completed, it's time to test the system. Turn the ignition key to the *off* position and allow a minute for the system to arm itself. Then open one of the doors that has been bugged.

A pre-set entry delay time will expire, and then the alarm will sound continuously until two minutes after the door is shut. The shortest entry time possible is best.

Seconds after the audible alarm sounds, the transmitter will be activated

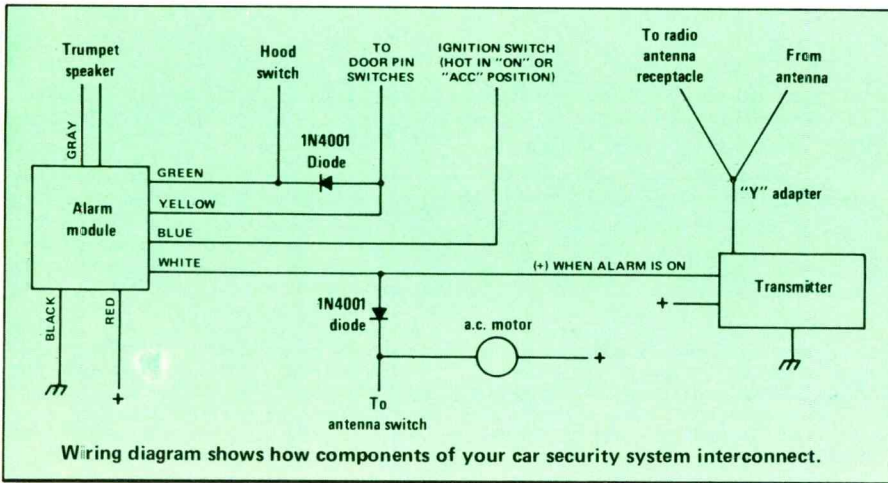

Remove the antenna's control switch from the dash and tie in the wire from the transmitter with a connector.

A Diode was added in the system to prevent the alarm from being activated when the vehicle owner is in the car and raising the antenna manually for radio reception.

Unobtrusively snugged down to the fender, this power antenna is now ready to raise when a thief strikes.

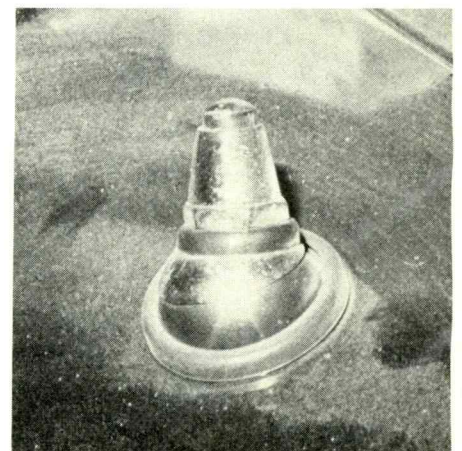
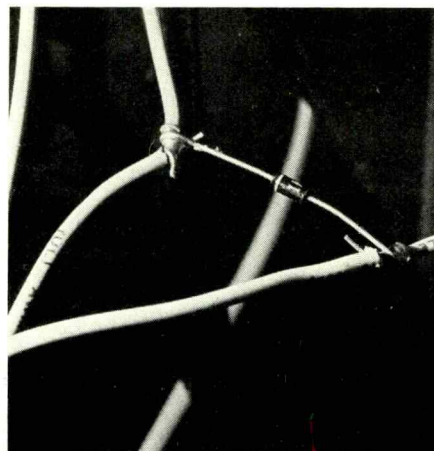

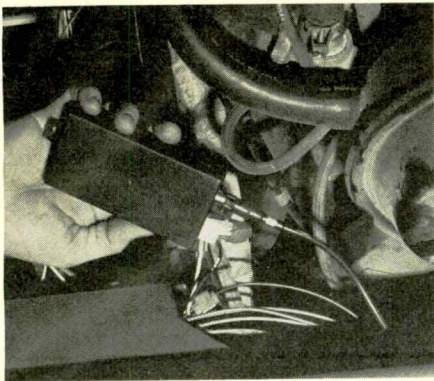

Introduce the transmitter into the system per the directions contained in the CAT's installation manual, then place it behind the dashboard. A "Y" connector is used so both the transmitter and radio can use the same antenna. This new 1-watt transmitter from California Electronics Industries far surpasses earlier 1-mW models, increasing its effective range from ¼ mile to approximately 1 full mile.

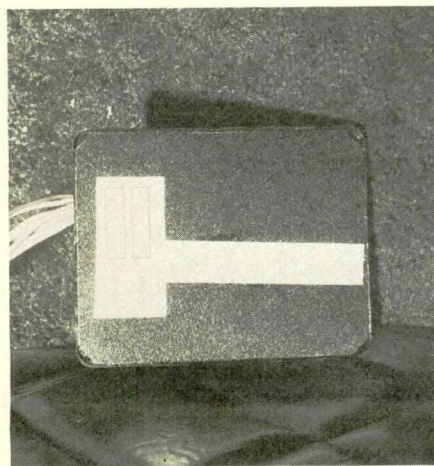

Readily-available Velcro fastening tape was glued to the back of the alarm module, while a matching piece was secured behind the dash. The module can then be pressed against the dashboard's Velcro and held securely in place.

and your pocket pager will begin beeping. This will continue to beep until the pager's reset button is pushed. However, this button does not deactivate the security system itself. Turn the key to the *on* position to switch the alarm off.

If the system is installed following our wiring diagram, it will work as follows. When you exit the vehicle, turn off the ignition and lock the doors as you would normally. The 60-second exit delay allows plenty of time for you to leave the vehicle, although you can remain inside as long as desired by leaving the key on *accessory* or *on*. When you return, unlock the door and turn the ignition to *on* before the entry delay time expires. The alarm then is deactivated before it has a chance to sound.

When a thief opens a door or jars the vehicle in any way (a motion detector is built into the system), the entry delay time expires, the warbler sounds, and the antenna raises. At this point the transmitter sends out its signal, and alerts you to the attempted theft. 

Solar flares erupting on the sun are about to disrupt and enhance two-way radio around the world.

by Judy Curtis
Contributing Editor

Gigantic black holes in space, ten times the size of Earth, with magnetic centers a thousand times stronger than our own planet's, are affecting worldwide radio communications. And conditions will get worse in the next two to four years.

The holes, in the surface of our own Sun, are *sunspots*. They first were uncovered by Galileo and other scientists in 1611. They were seen as clouds thought to be like our own clouds and not actually on the Sun's surface.

But, by the 1800s, it could be seen that the average number of spots peaked and dropped, peaked and dropped, in 11 year cycles. And it's only been in the 20th Century that researchers figured out the magnetic nature of the sunspots, formed by the movement of electrically-charged particles in the Sun.

Solar flares

It's not exactly the spots themselves which wreak havoc with Earth's radio signals. Rather, it's something which happens when the Sun's surface is pocked with spots—solar flares.

Flares are large explosions near sunspots. The explosions create violent, sudden release of magnetic energy. The amount of such energy released, if only we could capture and use it, would be strong enough to supply Earth's needs for 100,000 years. And that's the energy in *each* flare.

A flare lasts only minutes but can disturb Earth's magnetic field for days. When the 11-year sunspot cycle is at its height, three years from now, several flares will explode each day.

This release of magnetic energy in the Sun's environment produces many kinds of radiation: radio waves, gamma rays, X-rays, ultraviolet light and even visible light. Solar flares probably even affect radar and may cause power outages while they are disrupting radio communications.

Radio signals which travel in the shortwave portion of the radio spectrum, 3-30 MHz, travel several ways. First, they can travel by *ground wave* where they move line-of-sight across town or up the highway for short distances. Or they can move by *sky wave*.

Radio signals which travel up into the

sky bounce off the ionosphere and are reflected back to Earth at long distances away. In this fashion, signals can *skip* across the country or the world allowing you to talk much farther away than line-of-sight.

Charged ionosphere

The ionosphere, which is made up of charged particles called *ions*, at some times contains more ions than other times. When there are more ions, there's more chance for signals to be reflected back to Earth. The ionosphere becomes more charged with ions when there are explosions of magnetic energy in the sun or when there are large numbers of sunspots and solar flares. These explosions send out clouds of radiation, causing the Earth's ionosphere to hold an unusually large number of charged ions.

You might think it's a good result to have a radio's range increased but that depends on what kind of communications activity you're involved in. For instance marine SSB operators who have shortwave frequencies for high seas and long distance communications will benefit from increased communications range. Also some of their bands which are useful only during certain times of the day may become good around the clock.

Shortwave listeners, if they're not plagued by noise, will be able to hear many more stations and from longer distances away during sunspot activity.

Who suffers?

And ham operators who like to work countries on the other side of the world will have their range extended, too. Some bands will stay open all day and night when they usually can only be used half a day.

Who will suffer? Mainly CB operators, who need only short range, line-of-sight 150 mile communication radius, are going to suffer the most. When you want to reach your friend, one mile away, you may only be able to hear Katmandu or the drone of thousands of CB sets across the country coming in on your radio. 

Good grief! Now there's Rodney and Buster

First it was Mel in Modern Electronics first issue. Now it's Rodney and Buster and whole families of imaginative runabouts. Our resident expert takes a longer view of what robots are, ought to be, and may become.

by David L. Heiserman

If you have been thinking about building your own robot, you certainly aren't alone in the world. Countless thousands share that particular dream at one time or another.

Not many people carry their ideas beyond the dreaming stage, however. Some manage to make a few preliminary drawings, and others get as far as gathering some parts and assembling them. The job, however, usually falls by the wayside for one reason or another. The process of transforming an idea for a robot into reality poses two special problems. On the one hand, there are practical and immediate problems of having the right know-how, finding the necessary time and money, and taking full advantage of parts and materials available from today's technologies. Given a sufficient amount of motivation and some guidance, these problems are relatively easy to handle.

The second problem is more difficult to handle, however, because it requires taking a new, long-range philosophical view of robotics that runs counter to the mainstream of present-day thinking.

How to begin

The most common stumbling block to completing a robot project is a lack of technical know-how. But the fact that a would-be roboticist lacks the know-how and experience to finish the job is no reason to reject the idea of building a robot. If you feel you don't have the knowledge to carry out an ambitious robot project, start with plans for something simple. Begin something now, and let the machine evolve as your knowledge and experience grow. Talk with people who know more about electricity and electronics than you do, and you'll be surprised how easy it is to

Dave's latest book is Build Your Own Working Robot published by Tab Books, Blue Ridge Summit, PA 17214.

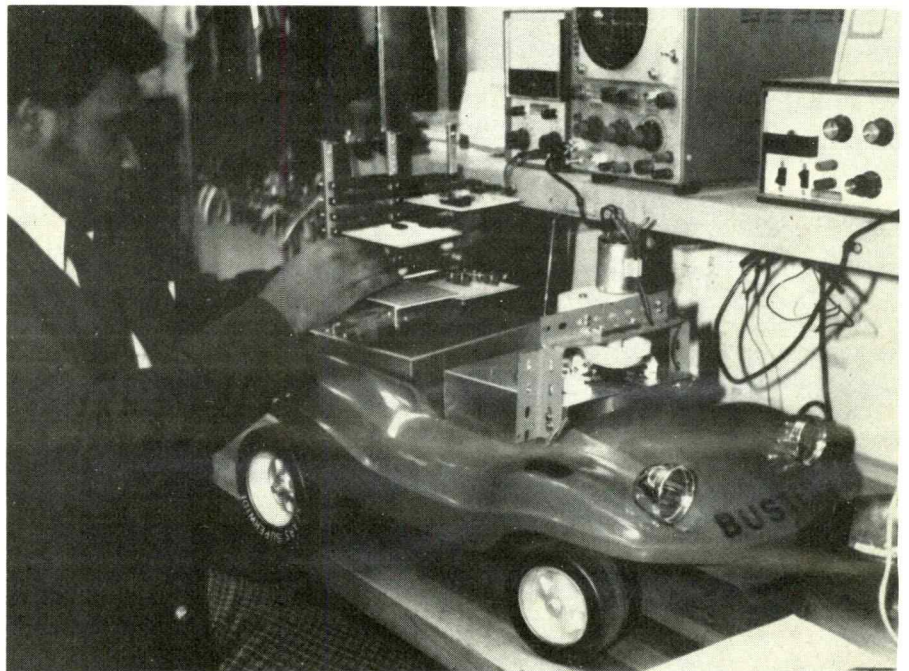

Buster, the Alpha-class robot, had its touch-sensing bumpers removed for this portrait. The bumpers are two-inch strips of aluminum parallel to the floor. Four bumpers, one along each side and front and back, extend some two inches from the mainframe and four inches from the floor.

interest someone into helping with a robot project.

Robots don't have to be expensive, either. Simply alter the design to fit your present budget. Start somewhere now, even if it means resurrecting parts from a junk box and scouting around local garage sales for bargains on electronic parts. Spread the cost over a longer period of time by building the machine piecemeal. Sometimes having to wait for the \$25 you need for making the next circuit gives you a chance to discover a novel way of doing the job for \$5.

Finally, reject the notion that the right kind of technology isn't available yet. Actually it has been technologically possible to build a working robot for more than 30 years. A good robot built during the 1940s might have been loaded with

heavy lead-acid batteries, carried hundreds of power-gobbling vacuum tubes and weighed more than 300 pounds—but it was entirely possible to build a robot in those days. It was possible back then, and it certainly is possible with today's advanced technology. It's just a matter of finding a clever way to apply the tools, materials and components at hand.

It can be done

All this adds up to the encouraging fact that a lack of know-how, experience, money and technological progress are not valid objections when it comes to building a real robot. Such things can be handicaps, but they don't make it impossible to get the job underway right now.

Some hobbyists manage to overcome the short range immediate problems and build robots that work more or less to their own satisfaction. But millions of people would like to build or own a genuine robot. The marketplace is primed and ready but nothing really significant is happening. Why not?

I think the product isn't right. The robots that exist today are mere shadows of what they could be. The world is primed for a major explosion in robot technology, but the people trying to light the fuse are, for the most part, using wet matches.

What is needed are dynamic, self-programming, general-purpose machines capable of setting and pursuing their own goals in the context of the world *as the machines, themselves, perceive it*. The film *Star Wars* portrays robots as free-will machines that are fully capable of dealing with a complex environment in meaningful ways. Now that's the kind of robot people really want, and that's the kind of robot you can start building right now.

Simple yet sophisticated

It is going to take some time and a lot of effort to evolve a machine as sophisticated as little Artoo-Detoo, but we must start somewhere that leads along a fruitful path; and I am convinced the starting point is a physically simple *living machine* I have dubbed an Alpha-Class robot.

An Alpha-Class robot is one whose responses are limited to basic reflex activity. One can include any number of sensory systems to sense light, sound, touch and so on, but the responses are purely reflexive and, for the most part, random.

My robot Buster includes the basic elements of an Alpha-Class robot. A newer robot that I am calling Rodney more clearly exemplifies the character of an Alpha-Class robot. Rodney's responses include feeding (recharging his own batteries) and a series of 16 different motion patterns such as spinning clockwise or counterclockwise, moving slowly forward or backward with a slight turn, running fast forward and so on.

Rodney's sensory system is limited to knowing when he has made contact with the feeder and sensing a stall condition when he is supposed to be moving. This machine responds to contact with the feeder by remaining motionless, absorbing energy as long as it is available. And he responds to a stall condition by going through a series of quasi-random spinning and turning motions that continue until the stall condition is cleared.

Alpha-Class robots might seem too simple to be of any real importance. Indeed they are simple little creatures, but they do not represent a trivial step in

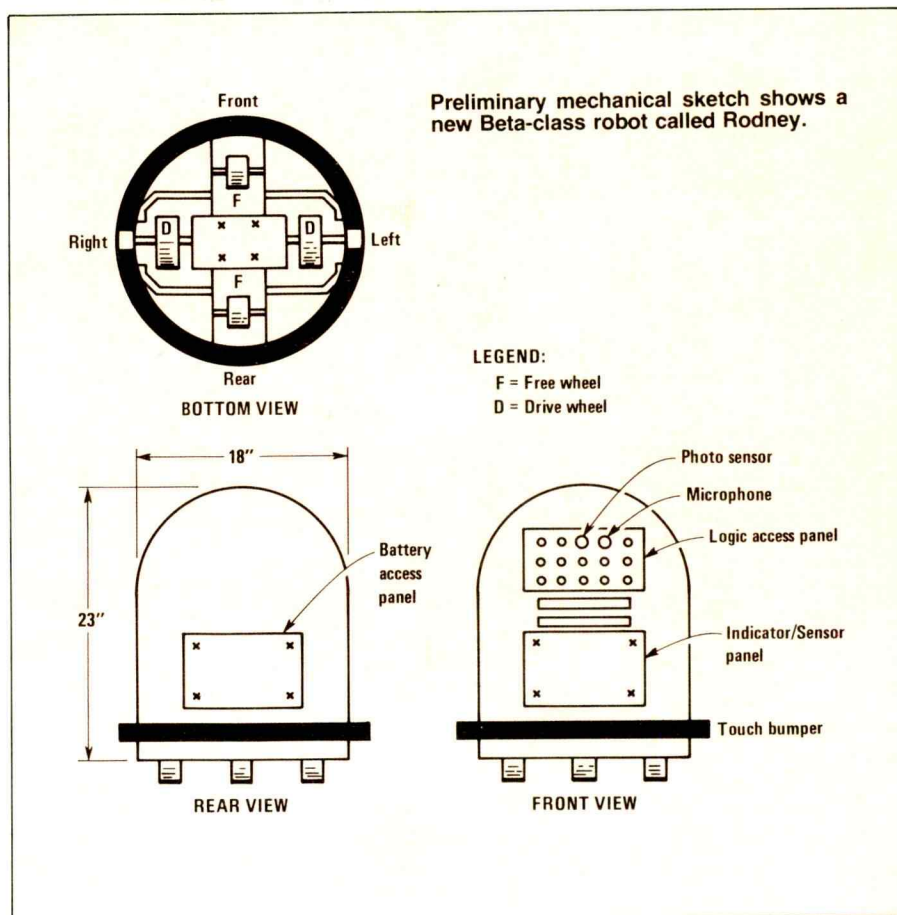

the evolution of real robots. They manage to survive quite well in a moderately complex environment just as their organic counterparts, one-celled creatures, have survived throughout earth's biological history.

Alpha-Class robots merely mark the starting point for the evolution of robot machines, however. A Beta-Class robot is slightly more intelligent than any Alpha-Class version. Beta robots have the same primitive reflex mechanisms, but they are also able to *remember* reflex responses that work best under a given set of circumstances. So whenever a Beta-Class robot manages to extricate itself from an undesirable environmental condition via a set of random responses, it remembers the one response that worked, and then uses it immediately whenever the same situation arises again. The responses are purely reflexive and random the first time around, but they become more rational as the machine gains experience with the world around it.

The number of sensory elements and motor responses can be extended indefinitely, but as long as the robot must encounter a given situation at least one time before learning and remembering the correct response, it remains a Beta-Class robot.

A Gamma-Class robot includes the reflex and memory features of the two lower-order machines, but it also has the ability to *generalize whatever it learns*

through direct experience. Once a Gamma-Class robot meets and solves a particular problem, it not only remembers the solution, but generalizes that solution to a variety of similar situations not yet encountered. Such a robot need not encounter every possible situation before discovering what it is supposed to do; rather, it generalizes its first-hand responses, thereby making it possible to deal with the unexpected elements of its life more effectively.

To get a clearer impression of how a Gamma-Class robot learns and thinks, suppose its initial successful response to a bright flashing light is to attack it and knock it over. The machine generalizes that particular aggressive response to a wide range of different environmental situations involving bright flashing lights in particular and, perhaps, any sort of light in general. It is impossible to say how deep this experience will penetrate the robot's view of his world. To be sure, this particular machine will exhibit elements of aggressive behavior that might even extend to situations other than those directly related to bright flashing lights.

Alter its response

Now suppose the human experimenter sees these elements of aggressive behavior as being somewhat undesirable or inappropriate from a human perspective. If that is the case, the experimenter can attempt to alter the

response, perhaps by flashing a light in the robot's eyes while speaking to it in soft tones. If the robot has learned to respond in a positive fashion to soft-spoken tones, the experimenter can alter much of what the machine deems as a threat from flashing lights. But whether or not the machine again will attack bright lights when the experimenter isn't present is something that can be determined only by careful experiment.

One further refinement that is entirely possible today is extending the Gamma-Class robot's level of self-awareness to the point where it can *evaluate* the responses it is learning. This Delta-Class robot assigns a certain confidence level to the responses it deems appropriate under certain environmental conditions. The solution to a problem that is solved by first-hand experience takes on a rather high confidence level.

As in the case of a Gamma-Class robot, the machine generalizes its responses to first-hand solutions to similar conditions not yet encountered. This robot assigns a relatively low confidence level to these conditions.

Easily taught

So as the Delta-Class robot experiences events in its world, it evolves a hierarchy of responses having a high, medium and low level of confidence. The machine, however, does not like responses with a low confidence level to exist within itself, so it sets out to encourage those events that call for a test of its responses gained by inference or second-hand generalization.

The Delta-Class machine might not be wholly successful in its attempts to set up new environmental conditions, but it works at the job ceaselessly. It has a will of its own. It programs itself, setting goals aimed at enhancing its confidence in dealing with the world as it perceives it.

We are not trifling with mere gimmicks here. These are not toys or slave machines. We are dealing with the evolution of machine intelligence on a level and in terms that are rather unique today.

The practical significance of this approach is that such machines exhibit a level of behavior that is far out of proportion with the simplicity of their construction. None of these machines have to be very elaborate or expensive; but given the proper sensory and response mechanisms, they can be taught to perform a wide variety of practical tasks.

If you want to build a real robot, then, first construct a machine that fits the qualifications of a Delta- or Gamma-Class robot. Turn it loose in your home for a while, letting it learn its way around the world as it perceives it. Let it build up a personality of its own, and carefully study that personality as it develops. Then—and only then—are

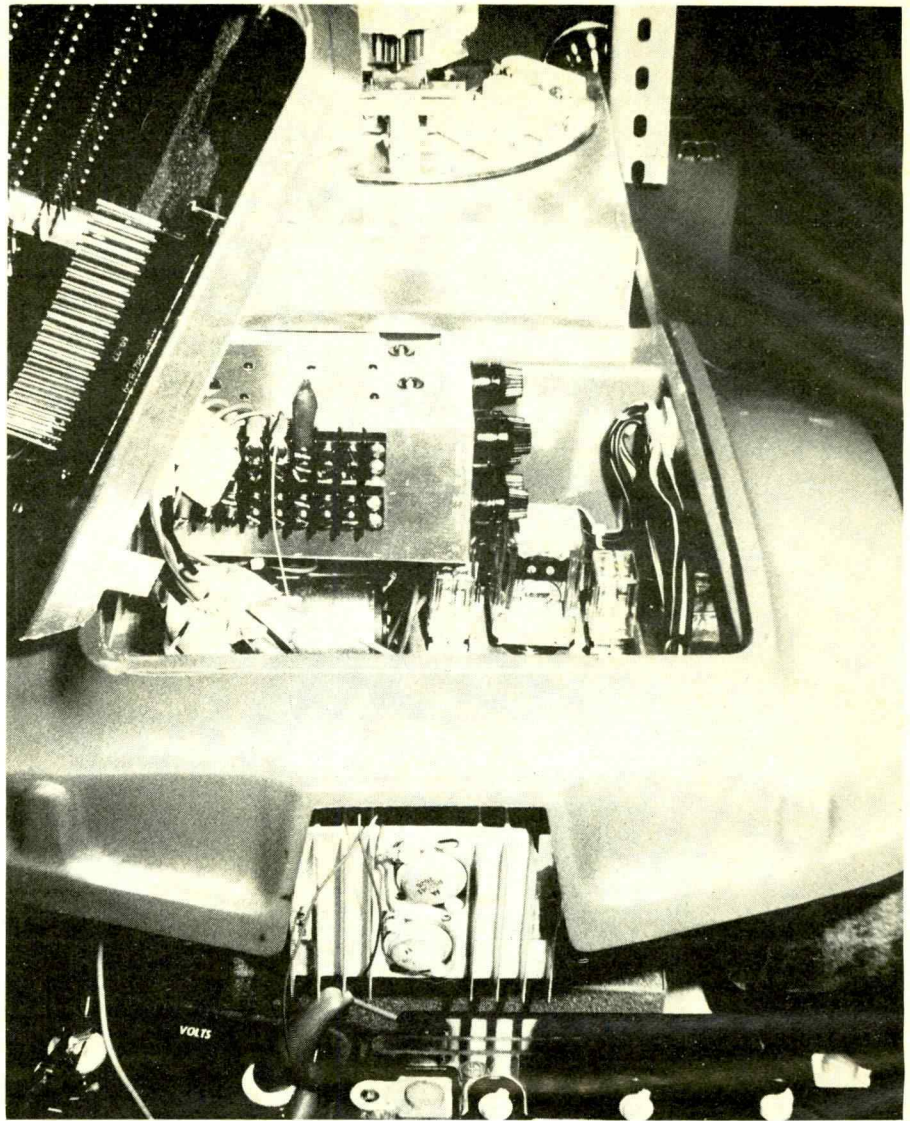

The internal power pack can be seen in this rear view of the Alpha-class robot, Buster, with logic rack removed.

you in a position to start modifying its behavior to suit your own needs.

Using this approach to building a robot, you will end up with a real robot. It will be a living machine that can, indeed, be taught to respect your commands. And if you are handling the situation properly, you will find that your commands do not have to be entirely specific. Give the robot a goal to achieve, convince it that the whole thing is worth the trouble, and then let the machine work out the exact procedure itself.

Bridging the gap

In a practical sense, approaching robotics with an emphasis on the evolution of artificial intelligence, offers the greater promise for success in the long run. The more traditional approach—building machines that can be externally programmed to perform specific sets of useful tasks—lacks the dynamic elements demanded by the science-fiction tradition of robotics. And what is even more damaging to the traditional

approach is the simple fact that the cost and complexity of traditionally designed machines is directly proportional to the number of different tasks it can perform.

Finally, this emphasis on the evolution of artificial intelligence leads to some special insight into human intelligence and behavior. Intelligent robots are a breed of machine that stands far apart from anything ever developed through the scientific and technological efforts of mankind. Exactly what we can learn about ourselves from the machines described here remains to be seen; but there is a promise of new insight in the fields of psychiatry, social behavior, learning, problem solving and practical, everyday human psychology.

Why should we be content to settle for anything less than the most challenging approach to robotics? We have nothing to lose and everything to gain by viewing robots as creatures that bridge the gap in intelligent behavior between the highest-order living non-human creature and man, himself. 



WE DON'T KNOW OF ANOTHER TRANSCEIVER OFFERING ALL THESE FEATURES AS STANDARD EQUIPMENT

- Hybrid digital frequency presentation . . . built-in
- AC and DC VDC power supplies . . . built-in
- CW filter . . . built-in
- High performance noise-blanker . . . built-in
- VOX and semi-break in CW keying . . . built-in
- Speaker . . . built-in
- Cooling fan . . . built-in
- Microphone . . . included

When you buy the Tempo 2020 you don't have to spend a bundle on accessories . . . just hook up to a power source and an antenna and you're on the air. A truly fine transceiver at a modest price.

The Tempo 2020 features a phase lock-loop (PLL) oscillator circuit that minimizes unwanted spurious responses. It is an advanced solid-state unit with only 3 tubes, including 2 rugged 6146-B final amplifier tubes. It covers all bands 80 through 10 meters, USB, LSB, CW and AM. Additional features worth noting is the 2020's crystal calibrator and WWV receiving capability, dual RIT control, fixed channel crystal control on two available positions, RF attenuator, adjustable ALC action, phone patch in and out jacks, separate PTT jack for foot switch, extraordinary receiver sensitivity (.3u S/N 10 db) and oscillator stability (100 Hz 30 min. after warm-up).

The **TEMPO 2020** \$759.00
Model 8120 external speaker \$29.95
Model 8010 remote VFO \$139.00

Send for descriptive information on the fine transceiver, or on the time proven Tempo ONE transceiver which continues to offer reliable, low cost performance. Both are available at select dealers throughout the U.S.

Henry Radio

11240 W. Olympic Blvd., Los Angeles, Calif. 90064 213/477-6701
 931 N. Euclid, Anaheim, Calif. 92801 714/772-9200
 Butler, Missouri 64730 816/679-3127

Selectivity: how a radio tells one signal from another

Selectivity is one measure of a good receiver, whether for CB, shortwave listening, ham, FM music or whatever. Here's an easy-to-understand explanation of what selectivity is all about and how to tell if you bought a good radio:

by George McCarthy

Have you ever wondered how your radio is able to select just one signal from among the millions that are being broadcast all over the world at any one moment? Or perhaps you have thought about what causes signals from adjacent CB channels to slop over onto the channel you are trying to use. What's inside your radio that determines how well it can tune in a particular signal, while rejecting others that are nearby?

That ability is generally referred to as a receiver's *selectivity*. We define selectivity as the ability to discriminate among many signals of varying strengths that are relatively close to the

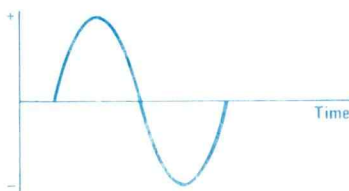

Figure 1 One complete cycle of alternating current. The number of times this occurs per second determines the frequency.

frequency of the station we want to hear. For ham and CB receivers it is one of the most important characteristics to look for. Of course, a good receiver also needs *sensitivity* to pick up weak signals, *frequency stability* so that it stays at the spot where it has been tuned, and resistance to *front end overload* where extremely strong signals cause the receiver's amplifying circuits to malfunction.

For the first two dozen years of the developing radio industry, receiver circuitry was fairly simple. Circuits responsible for selecting the received frequency were made up only of coils and capacitors. Tuning was accom-

plished either by varying the coil with taps or sliders, or by varying the capacitor mechanically by rotating it. The capacitor was *variable* in that a series of rotating plates could be moved to intersect a series of stationary plates, much like an egg slicer. You've seen such a variable capacitor if you've ever peeked inside a radio.

After the simple crystal sets using only a coil with sliders on it, came vacuum tube sets which had more tuned circuits. Each set of coil and capacitor allowed the receiver to tune sharper and pick out a particular signal from the group of signals in some portion of the frequency spectrum.

A problem developed as more and more stations came on the air. The first signals were all in Morse Code (cw) sent by spark gap transmitters, which transmitted very broad code signals that took up a lot of space. A *broad* signal occupies more space on the frequency spectrum than is necessary for the transmission it is sending.

A look at the spectrum

In general terms, *frequency* describes the number of times some particular event takes place. When we use the term to describe events in the audio and radio ranges, we are referring to *cycles*. A cycle describes a waveform that goes through changes consisting of rising to a maximum in one direction falling to zero and then rising to a maximum in the opposite direction and falling again to zero. Think of the 60 cycle per second alternating current of the electric energy supplied to your home.

All alternating cycles have a certain frequency. This is only a way of saying how often they complete one cycle on a time scale of one second. If the power from a Hi-Fi amplifier moves the speaker cone back and forth 40 times a second, we will hear a very low pitched sound. If the same amplifier moves the cone of a tweeter speaker back and forth

15,000 times a second, we will hear a very high pitched tone.

These alternating cycles don't stop at the end of our audio range. As they alternate more rapidly they move into that portion of the frequency spectrum we know as supersonic—beyond our hearing, but within the range of most animals.

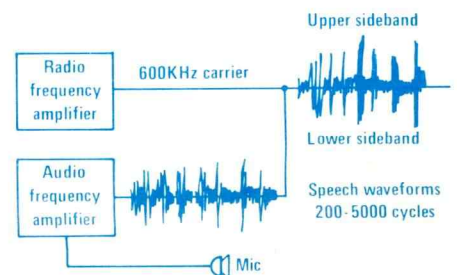

Figure 2 When the steady radio frequency carrier at 600 kHz is modulated by audio tones up to 5,000 cycles, two sidebands are produced. They are identical. The upper sideband is the sum of the carrier and the audio, 600-605 kHz. The lower sideband is the difference between carrier and audio, 595-600 kHz. A total space of 10 kHz is required for the fully-modulated am signal from 595-605 kHz.

In terms of the entire frequency spectrum we are still talking about very low frequencies since the high end of the frequency spectrum describes cycles that are occurring at the rate of 300,000,000 per second! The spectrum has been divided up into *bands* to describe certain segments. Each band within the total radio frequency spectrum has transmission characteristics which are unique. We will deal mainly with the *shortwave* bands and how your receiver functions at these frequencies.

To picture a band, think of the horizontal axis on a graph. Fortunately, many radio dials are made in just this fashion, with the lowest frequency on the left and gradations or numbers, ris-

ing to the highest frequency on the right. It is a scale that most of you have seen, so it will be easy to relate to it.

Obviously the vast range of the spectrum would be cumbersome to describe if the single standard of cycles per second were used. Multipliers are used that have universal acceptance. Kilocycles means 1,000 cycles.

So, for more than 50 years frequency was described in the radio field as kilocycles and megacycles and everyone understood what was meant. The general public knew just where their favorite stations were on the am broadcast band by tuning to a certain number of kilocycles. The term was changed to honor the German physicist Heinrich Hertz, who first proved the existence of radio waves in his laboratory. Now it is known as kilohertz and megahertz. Of course, the whole idea of radio waves was postulated by the English physicist, James Maxwell, 30 years before Hertz proved it, so we could have been faced with "kilomaxwells."

Now we hear music

In time those old spark gap code transmitters gave way to tube amplifiers, which transmitted narrow code signals and took up much less space in the spectrum. Then a new development came along. The radio *carrier* which had been only turned off and on to send Morse Code was now being *modulated* by having an audio signal superimposed on the radio signal. Voice and music could now be transmitted over the radio!

The very process of modulation created additional radio frequencies besides the one used to transmit the carrier. Although the audio range runs up to a high of 20 kHz, most tones of the human voice are within the 5 kHz range, and many musical tones are within that limit. In short, it's perfectly adequate to transmit audio signals only within the range of 200 to 5,000 Hz on the am broadcast band. At least 10 kHz of room was needed for both the sidebands that were generated by the modulation process.

The U.S. broadcast band for am stations covers the frequency spectrum from 550 kHz to 1650 kHz. That's only 1100 kHz of room to hold all the stations in the country! If we allow some room between stations, so they don't interfere with each other, that would allow only five dozen or so stations to broadcast at the same time.

Fortunately, the range on this band is quite limited most of the time, and station frequencies are allocated based on the region or area to be served by a particular station.

How about the ability of receivers to discriminate between stations on this band? Some old TRF receivers didn't do too badly, as long as they weren't too

close to a powerful station. After all, their job was to select a station that was 10 kHz wide on a band that was only 550 to 1650 wide. As a ratio or percentage, that 10 kHz was pretty low when compared to the received frequency. Let's look at it this way. If there is a station on 600 kHz and another station on 620 kHz, they are 20 kHz apart. Even with those 5 kHz sidebands, the separation is still 10 kHz between the "edges" of the two signals. All the receiver must do is be able to discriminate between the two frequencies, and yet be wide enough to allow both of those sidebands to come on through, be amplified, detected and come out of the speaker.

If we compare the 10 kHz separation to the total frequency involved, 600 kHz, we are looking at a selection ratio of 1 to 60, not too tough a job. What happens when we tune the radio to the *high* end of the broadcast band? Now we find ourselves discriminating between two stations separated by the same distance. Only now the ratio has increased to 10 kHz out of 1600 kHz, or a ratio of 1 to 160, a much tougher job of selection.

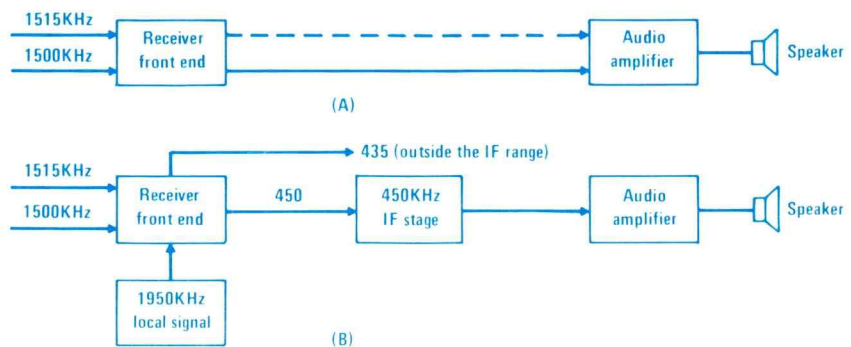

Figure 3 In tuned radio frequency (TRF) receiver A, the difference between the two signals is only 15 kHz out of 1500 kHz, a ratio of 100:1. In the superheterodyne circuit B, the local signal has been used to beat with the incoming signals. The dif-

ference produces two signals, one at 450 kHz and one at 435 kHz. The 15 kHz difference is now out of 450 kHz, a ratio of 30:1. The signal at 1515 kHz will fall outside the bandpass of the i.f. stage and not be amplified.

The sum and the difference

The same thing can be done in the radio frequency range. Each signal you want to hear is being transmitted on a certain frequency. If you generate within your receiver another signal that is separated from the received signal, they will *beat* together just like those two piano notes. And they will produce two new frequencies, the *sum* and the *difference* between the transmitted frequency and your own internal frequency. Now you can choose to deal only with the beat or *heterodyne* frequency that represents the difference between the received signal and your own local signal.

You see, the higher we go in frequency, the less the signal width there is in relation to the received frequency. In spite of putting several tuned circuits in the amplifying section of the receiver, the gate through which signals will come is still quite broad in relation to one signal. Unless some modification is made, it is likely that such a receiver will simply receive several stations at the same time. Now you see why kids' walkie-talkies supposed to work on channel 14 seem to pick up signals from channels 10 through 18 with no trouble at all. It is basically a TRF receiver. Operating in the 27 MHz band and trying to select a signal 8 kHz wide and reject others is an impossibility! The selection ratio now is about 3.3 million to 1—and the gate for such a receiver is wide enough to let in signals many kHz away.

Let's take an example from our am broadcast receiver to see how the heterodyne principle works. In our TRF receiver if we wanted to hear a station at 1500 kHz, we tuned the set to that frequency. If there was another strong station at 1515 kHz, it was likely that we would hear it, too, or at least the top part of its lower sideband. In fact, we could pick up the beat of the music being played just from the interference peaks, the squawk squawk sounds of voice or music peaks.

Suppose we had an *internal* signal being generated inside our receiver that was tuned to 1,950 kHz. That's going to beat or heterodyne with the incoming signal. It will produce two new frequencies, one at 3,450 being the sum of the two, and one at 450 kHz, being the difference between the two.

Now, suppose we had some *fixed tuned* circuits tuned to 450 kHz. They would pick up that 450 kHz signal and treat it just as if it were the original signal being transmitted. That's right! The entire signal would come on through, carrier frequency and both sidebands. Only the entire bit would have been transferred to this *intermediate frequency*, known as the IF stage. We've now got that 10 kHz wide signal back down to a ratio of 1 to 45. That's a lot better than a ratio of 1 to 150.

Is there anything else that happened? Remember that interfering signal up at 1515 kHz? It's going to have to beat with our local signal also. But the difference between 1515 kHz and 1950 kHz is 435 kHz. Our IF stages are tuned to 450 kHz and that heterodyne signal from the station at 1515 kHz is 15 kHz away. And that's 15 kHz out of only 450, not out of 1500. As a ratio of frequency, the interfering signal is 30 to 1 instead of 100 to 1.

Remember the lower in frequency we go, the fewer number of kilohertz that can be accommodated in a tuned circuit. It's not difficult to construct a tuned circuit at 450 kHz that is only 10 or 15 kHz wide. To obtain the same width at much higher frequencies is much more difficult.

The superheterodyne principle is used universally in all radio receivers, even in that tiny transistor job you can stick in your pocket. It provides for excellent selectivity even on fairly crowded bands—such as the top part of the am broadcast band.

Not quite solved

So the problem with receiver selectivity was solved, right? Wrong. What was good enough down on the am broadcast band, simply wouldn't do the trick when we got up to those shortwave frequencies. And, don't forget, the stations on the broadcast band sit sedately on their assigned frequencies and don't try to elbow each other out of the way. Such a benign condition hardly exists in the assigned shortwave broadcasting bands, where there's intense competition for air space. And if that's bad, how about the crowded ham bands, or, even worse, those CB channels?

So far we've been talking about selectivity as if only one dimension mattered, the width of the frequency response of the IF stage. Unfortunately, we must concern ourselves with another dimension that is shown on the vertical scale because it is not enough to have selectivity if the rejection characteristic can be overcome by very strong signals that are close to the desired frequency. Our IF selection process must incorporate circuitry that *filters* out unwanted signals, even extremely strong ones. Thus it will look on a chart much more like a win-

dow than just a simple width of frequency.

It is very important to get a handle on the concept of filter depth as well as width. Basically, any device that allows certain frequencies to pass through, while rejecting other frequencies is a *filter*. Many of you already are familiar with the hi-pass filter which you put on your tv set to let high frequencies pass

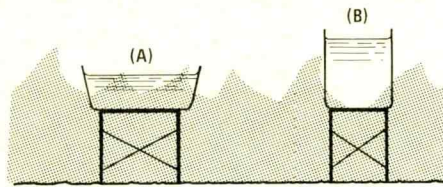

Figure 4 Two aqueducts carry an equal amount of water across the surface of a lake. A has lower, sloping sides and is more likely to have lake waves slop over into it. B is more immune to wave action. A bandpass filter with steep sides, likewise, is less prone to strong, nearby signals.

through, while discriminating against frequencies lower than the tv spectrum that might contain interfering signals. Or, perhaps you put a lo-pass filter on your ham or CB set to prevent high frequency signals from getting out and into someone's tv set.

Another type of filter is called a *band-pass filter*. This filter allows a specific band of frequencies to pass through it, while rejecting all frequencies above and below the specific band. This type of filter, installed in the IF stage of your ham, CB or communications grade receiver allows the kind of selectivity

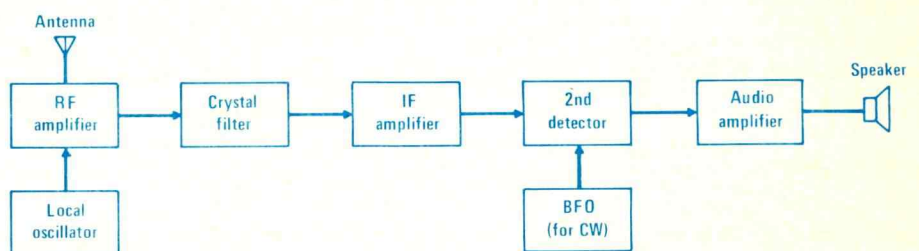

Figure 5 The superheterodyne receiver uses a local oscillator to produce a signal to beat against the incoming signal and produce an intermediate signal at a different frequency which then is sent through a crystal bandpass filter which passes only a narrow band of frequencies,

needed to pick out that one signal from many. Think of it like a "window" in your receiver.

The process of tuning your radio involves sliding this window along a radio frequency band if you have continuous tuning, or placing the window in the middle of a certain channel, if you tune by switching. If you have a *slider* in your CB radio, it allows you to shift the window back and forth a bit, in order to let the desired signal through.

The width of a band-pass filter is usually described in kiloHertz. On the horizontal scale of a graph it shows the frequencies that will be passed through by the filter. You might think of it in terms of a raised aqueduct with the radio frequencies as the water moving on through. Just how wide the band-pass filter should be depends on the specific job it must do.

Band-pass filters for use in the IF stage can be made to be very narrow, less than 500 Hz, or fairly broad, say 10 or 12 kHz. To copy a code (cw) signal, we need only pass through a very small increment of frequencies—just enough to create the tone we need to hear to decode those *dits* and *dahs*. In this case it's best to have a very narrow filter, say only 500 Hertz wide, to let us discriminate between very close together signals.

Telephone quality

When we need to copy the sounds of the human voice with enough clarity to understand what is being said, the filter must be much broader. In tests many years ago, the Bell Telephone Laboratory found that 90 percent of intelligibility is contained between 400 and 2700 Hertz and 95 percent within 200 to 3000 Hz. That was an important finding because in any crowded frequency spectrum there is no purpose in using any more room than necessary.

Your telephone transmits and receives only within these boundaries. The expression telephone quality is commonly used in the communications business to describe voice response

rejecting all others. To copy International Morse code, for instance, another local oscillator is needed. It is a beat frequency oscillator (BFO) which is offset just enough in frequency to produce a beat note with the carrier coming in through the i.f. amplifier.

characteristics which are entirely readable, but lacking the fullness of the human voice in an unfiltered environment.

Even if the voice frequency response were fairly restricted, say the typical 4 kHz in CB equipment, the modulation process is going to create those sidebands, the sum and difference of the carrier frequency, which will occupy a space a little greater than 8 kHz. For an am receiver to properly detect and

amplify that signal so it will come out of the speaker in about the same way it left the transmitter, the band-pass filter must be able to pass the entire signal through—all 8 kHz of it.

If, however, the signal being transmitted were of the single sideband variety (SSB) only *one* sideband is needed to pass through the filter in order to come out of the speaker in the same way it left the transmitter. Obviously, the filter needs only to be half as wide, 4 kHz in this case.

The width of the band-pass filter depends largely on the job it does. If we try to run a voice signal through the cw filter, so many of the voice frequencies are rejected by the filter that we can't make any intelligence out of the sounds we hear.

For many years filters were made up of coil and capacitor combinations contained in IF transformers operating in the frequency range of 200 to 500 kHz. The use of *crystal filters* became predominant when really good selectivity was needed because they have the characteristic of being sharper than the coil-capacitor types.

It is this sharpness that is directly related to the depth of the filter. Thinking of the analogy we made of a filter to a raised aqueduct or canal, we can see that the slope of the sides is an important determination in the volume of water that can be passed through in relation to the width of the canal or aqueduct. The steeper the sides of the aqueduct or canal, the higher it will be off of the bottom point. If we visualize such an aqueduct running along the surface of a lake, it is clear that waves from the lake will have less chance of sloping over into the aqueduct if the sides are high than if it were a wide aqueduct with gently sloping sides.

Keeping strong signals out

That's just the way it is with a band-pass filter. Only in this case the waves are radio signals from nearby frequencies. There are two important considerations involved in their ability to slop over into our filter. One is the height of the wave (strength of signal) and the other is the distance away from the aqueduct (number of kilohertz away from center frequency).

How can we measure the height of our filter's walls? Perhaps the best way would be to figure what strength a signal would need to get over the wall. We can do this in two ways. We can use the ratios of received radio voltage that would be needed to scale the wall in relation to the center frequency of the filter, showing just how much of an increase is required to make it over as the wall moves away from the middle or center frequency. Or we can use the power ratio of decibels (db) which will indicate the increase in power necessary

to scale the wall at different frequency points. We will plot both the voltage (actually microvolts or millionths of a volt) and decibels at a zero level at the bottom of our aqueduct—the center frequency of our band-pass filter.

Figure 6 shows the typical selectivity curve (slope of sides) of a very superior band-pass filter. This is the shape of the window that your receiver will place at various points in the radio frequency band. If it is a steep-sided window as shown for this filter, it will present quite an obstacle to any signal that is not within its pass band. It would take a tremendous wave very close at hand to slop over this type of wall.

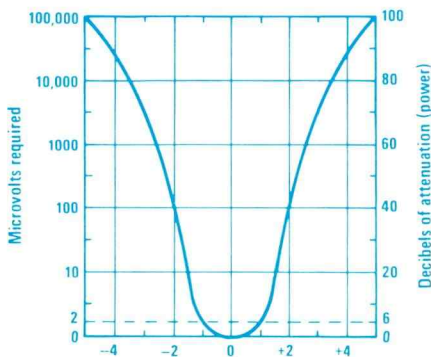

Figure 6 The curve of a very sharp band-pass filter. Too sharp for am, it would have to be used for single-sideband reception. At the 60 db point a signal would have to be a million times stronger than one at the center to be heard, although it would be only 2500 cycles away in frequency.

Just what kind of power ratios are we talking about when we think of the filter in Figure 6 as operating inside a radio receiver? Looking at the chart, we can see that the width of the filter at the 6 db point is 2.5 kHz. This is the point at which the width of a filter is normally first measured. It means that a signal four times as strong as one right in the middle of the band-pass will go through the filter, passing 2.5 kHz of frequency spectrum. The next point commonly measured is at 60 dbs. This is a power ratio one million times as strong as the zero db point in the middle of the filter. It would take a signal that strong only 2.5 kHz on either side of the center to get through at the same level as a signal right on center! That's a pass band of 5 kHz, only twice as wide as the window down at the 6 db point. In filter design this is known as the *shape factor* which represents the bandwidth at 6 db divided into the bandwidth at 60 db. The shape factor of the filter shown in Figure 6 is 2:1, a very, very sharp filter curve. If you look at the 80 db point, you can see that the width is 7.5 kHz, but 80 dbs is a power ratio of 100 million compared to that zero db point in the middle. That means that the signal of only 2 microvolts that goes through the filter

easily, must be increased to 10,000 microvolts to make it through the filter only 3.75 kHz away from the center frequency.

Ideal Filter

What is an ideal band-pass filter to give you the best window for your needs? It should be wide enough to pass through all the frequencies you want to hear. Its rejection of unwanted frequencies should be as great as possible, so that signals on either side (high or low) of the one you want to hear will not interfere.

That's a pretty tall order for any receiver. Of course, that Hi-Fi fm receiver must have a very wide filter to pass all of those audio tones through. Your am CB radio will have a filter that is really put to the test, considering the sheer number of stations on adjacent channels, not to mention those that are running illegal power. In fact, the best band-pass filter in the world can't stop signals that are inside of its pass band. Such is the case with splatter that occurs from mis-used or mis-adjusted ham or CB transmitters that put out spurious signals up and down the band many kilohertz away from where they are supposed to be.

The band-pass filter is really the heart of any good receiver. In selecting a radio receiver for shortwave reception, CB or ham use, it is probably the single most important characteristic you should look for.

It would have been possible to make the band-pass filters much sharper for CB am radios if the frequency tolerance specifications required by the FCC of radio manufacturers had been tighter. The plus or minus .005 percent from center channel frequency actually allows two sets to be as much as 2.7 kHz apart from each other, and yet still meet specs. Add that figure to the eight kHz needed to accommodate both am sidebands and you begin to see that the six db point on a good CB filter has to be about 10 kHz wide to allow all possible signals on the channel to come through.

Very few manufacturers give their selectivity information in a manner that can be accurately related to typical filter curves. Knowing that a 2:1 shape factor is difficult and expensive to obtain, we can be fairly sure that very few manufacturers would even come close to it. But even a 2:1 factor would mean a bandwidth of 20 kHz at 60 db for our am filter.

The majority of CB channels are spaced every 10 kHz, right next to each other! So, even with a really good filter, part of the pass band will be in adjacent channels. A very strong, or very local, signal can easily force its way through the window and out of your loudspeaker. 

Build this easy tag-along PA

A tiny amplifier, a mini microphone and a loudspeaker. Put 'em together and you've got your own inexpensive carry-around public address system.

by Fred Blechman

If you, or your club or organization, sometimes need a voice amplifier for large rooms, small auditoriums or outdoor gatherings, you can build the basic mini-PA for under \$25, not including the microphone. It uses two six-volt lan-

dle. The maximum slightly over one watt output is loud enough to boost your voice to be heard by groups of some 100 people, especially if you're competing with background air-conditioning or traffic noises.

couldn't find any microphone that would allow me to advance the volume control all the way without overloading it.

The microphone input from jack J1 is reduced by potentiometer R1 and fed to the input of the unmodified BN-9 amplifier. The output of the BN-9 goes to the speaker that is already built into the cabinet specified in the parts list. Phono jack J2 and terminal screws TS1 and TS2 are also provided in this cabinet, in case you want to connect an external eight ohm speaker to operate in parallel with the cabinet speaker, for greater sound coverage. Switch S1 allows the batteries to power the amplifier.

Meter M and dropping resistor R2 are optional, and are used to monitor battery voltage under load. A full-scale meter reading, using the meter specified in the parts list, is approximately 12 volts, with half-scale at about nine volts. When the meter needle drops below this point, be prepared to change the batteries soon, since distortion will start to become noticeable below about eight volts. The battery drain is about 100 milliamperes at 12 volts at typical voice levels (about 10 milliamps when not speaking). This will give you approximately 50 hours of voice use until the batteries are down to eight volts, for an operating cost of under 10 cents an hour.

Ready to build

The unit I built uses a microphone permanently wired into the circuit. I quickly found that this was not a good idea, since I needed to add brackets to the back of the unit to hold the microphone and its cable. Messy! Instead, I later added the microphone jack shown in the schematic, and I now can use *any* microphone leaving the back of the unit uncluttered. By using a standard one-quarter inch phone jack for the microphone input, the unit will accept many microphones directly, and most others



Fran Vitano shows how the home-made portable PA, built into a small speaker cabinet works. Although not the equal of commercial PA systems, it will save wear and tear on your voice when you address more than a handful of people. A chrome cabinet door handle available from any hardware store, adds to the portability.

tern batteries and a small kit amplifier, and is built into a pre-assembled bookshelf cabinet that comes complete with a five-inch speaker. It weighs less than seven pounds, including batteries, and can be used anywhere with an external microphone. It even has a carrying han-

The heart of the unit is a Ramsey Electronics BN-9 *Super-Snoop amplifier* that sells in kit form for \$4.95. It uses an LM380 integrated circuit linear amplifier and a transistor pre-amp stage for very high sensitivity (gain is almost 3000). The amplifier is so sensitive that I

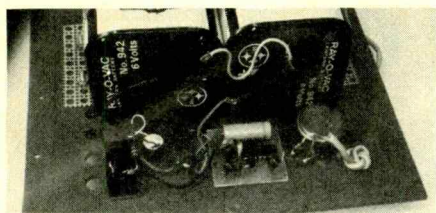

The amplifier board, batteries and other parts can be mounted directly on the speaker cabinet's rear panel.

with the optional adapter in the parts list.

The layout I used has a particular advantage—all the new parts are mounted on the cabinet's rear panel, which is easily removed. Only two wires go from the rear panel to the speaker, and they have clip ends for easy connection to the speaker terminals.

A bracket, made from decorative punched aluminum sheet, holds the batteries against the panel with four screws and nuts. Two small right-angle brackets are used as shelves for the batteries to rest on.

The BN-9 amplifier kit is assembled according to the instructions that come with it, with no modifications. Since a printed circuit board is included, it only takes about 20 minutes to assemble the

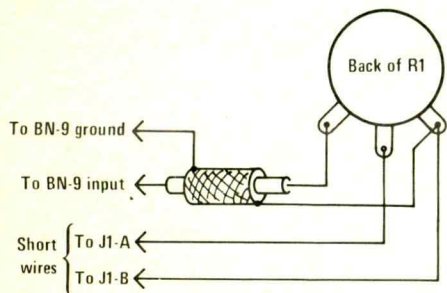

The wires from the volume control, R1, to microphone jack must be kept as short as possible. Use shielded wire to the amplifier board.

BN-9. It is held to the back panel with double-sided foam tape, commonly found in hardware stores. The drawing shows how to wire the potentiometer to the amplifier and jack so that clockwise rotation of the pot will increase the volume. Place the jack close to R1, and use regular wire to connect them; but use shielded wire (or two wires twisted together) between the pot and the input to the amplifier. Otherwise, there's a chance of inducing hum through this

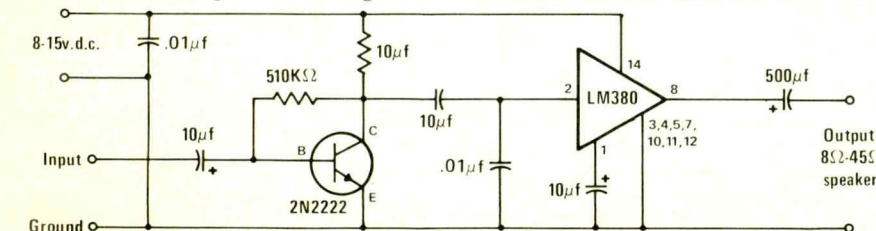

If you're into making your own printed circuit boards, or prefer to hand wire, here's the diagram of the BN-9 amplifier. If you're not experienced at scratch building, you'll be wise to use the Ramsey Electronics kit.

short, but high-impedance, connection.

Use lantern cell batteries with binding posts rather than spring terminals. Wire the batteries in series with a short piece of wire, positive terminal of one battery to the negative terminal of the other battery. Then wire the remaining positive terminal to the amplifier positive input. The remaining negative battery terminal goes to either terminal of the switch. The other switch terminal is wired to the amplifier ground connection.

A typical hardware store cabinet handle is added by drilling holes in the top of the cabinet. For best balance, place the handle slightly toward the rear of the cabinet, instead of dead-center, since the rear-mounted batteries make the unit heavier in the back.

Now you're ready to test the mini-PA. Turn on the switch. After about five seconds the speaker will hiss slightly. This is normal, and reminds you the unit is on—so you won't need a pilot light. The hiss should not be affected by the setting of the volume control. Now, turn the volume control setting all the way counter-clockwise and plug in a microphone. A 600 ohm dynamic or electret microphone will sound the best, but practically any microphone will work. A crystal mic will have lots of gain but sounds tinny. Radio Shack's 33-1034 pencil type dynamic mic (\$5.99) sounds fair, but their more expensive 33-1050 electret mike (\$17.95) sounds much better. Try all the microphones you have available, and use the one that sounds best. In all cases, when you advance the volume control past a certain point, you'll get feedback howl. This can be eliminated in several ways: reduce the volume control setting slightly; move the microphone farther from the mini-PA speaker; use a cardioid or noise-cancelling directional microphone.

Many microphones have on-off switches using additional wires in the mic cable. Don't try to turn the amplifier on and off with this switch, since the amplifier is so sensitive the microphone leads will pick up the power fluctuations in the power leads of the mic cable and you'll get distortion. Use a separate panel power switch instead.

Possible substitutions

The only critical part is the BN-9 amplifier. Any eight-ohm speaker able to handle at least one watt can be used.

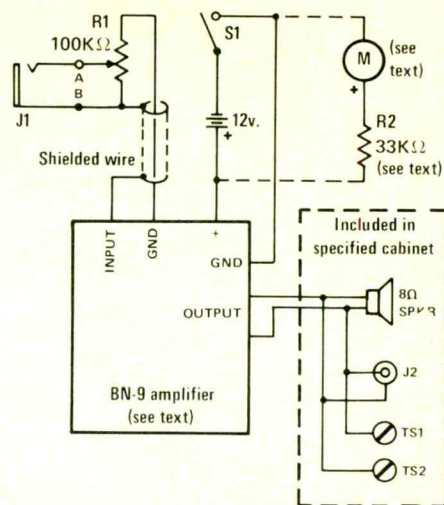

This portable PA really contains only a handful of parts. The battery-check meter is optional. J1 can be eliminated if you wire your microphone permanently into the PA circuit.

You can build your own cabinet. Six or eight D cell batteries can be used as a power supply, or you can plug the unit into your car cigarette lighter for 12 volts. The switch and potentiometer may be almost any type, but avoid sub-miniature sizes. Any milliammeter will work, but the value of resistor R2 would have to be changed to show full-scale at maximum battery voltage.

Parts List

BN-9 Super Snoop Amplifier Kit (\$4.95)
 Ramsey Electronics, P.O. Box 4072
 Rochester, NY 14610. Add 75¢ for orders under \$10. NY residents add 7% tax)

R1—100K potentiometer (Radio Shack 271-092 99¢)

S1—SPST panel switch (Radio Shack 275-602 79¢)

Minimus-3 Cabinet and Speaker (Radio Shack 40-913 \$10.95)

Knob—for potentiometer (Radio Shack 274-407 2 for 99¢)

Batteries—two six-volt lantern cells (Radio Shack 23-066 \$2.39 each)

Microphone—your preference

Miscellaneous—Carrying handle, double-stick foam tape, scrap sheet metal, screws, nuts, wire.

Optional Parts

M—500 uA sub-mini panel meter (\$1.20 Formula International, Inc., 12603 Crenshaw Blvd., Hawthorne, CA 90250. Minimum order is \$10. Write for catalog)

R2—33K 1/4W carbon resistor (Radio Shack 271-1300-33K 5 for 39¢)

J1—1/4" phone jack, open circuit (Radio Shack 274-260 59¢)

Adapter—1/8" miniature phone jack to 1/4" phone plug (Radio Shack 274-325 99¢)

The mini-PA won't substitute for a professional public address system, but it will allow you to have an inexpensive, portable amplifier that will save your voice while providing pleasant listening for your audience.

Make a relative jump ruler

Tired of counting lines to find the next byte of a relative-jump instruction for your computer? Here's an easy-to-make ruler to cut confusion and turn machine-language programming into more fun, from the Journal of Semiconductor Progress, Fairchild Camera and Instrument Corporation.

by John S. MacDougall

Machine language programming of a microprocessor like the F8, 6800, 6502 or Z-80 requires tedious hex arithmetic or counting of lines to determine the second byte of a relative jump instruction. For the novice, this is a confusing task; for the expert it becomes a tiresome chore. The confusion and tedium of relative jump calculations can be reduced with the simple and easy-to-make relative jump ruler shown in the illustration.

The figure illustrates a relative jump ruler (designed for the F8) in use on a coding sheet. Notice that the ruler has two columns of figures to allow both forward and backward jumps. This covers about 80% of the actual cases. For the remaining 20%, hex arithmetic must be used or additional columns added to the ruler. These are used by dropping backward (or forward) three hexades, for example, and then using the extra columns to calculate the jump.

The coding sheet illustrated contains an actual program (the jump to location 16D is 05). Naturally, the coding sheet and the ruler must have the same line spacing. The back side of the ruler can be used for important, but easily forgotten, pieces of information relating to I/O ports and sense digits. 

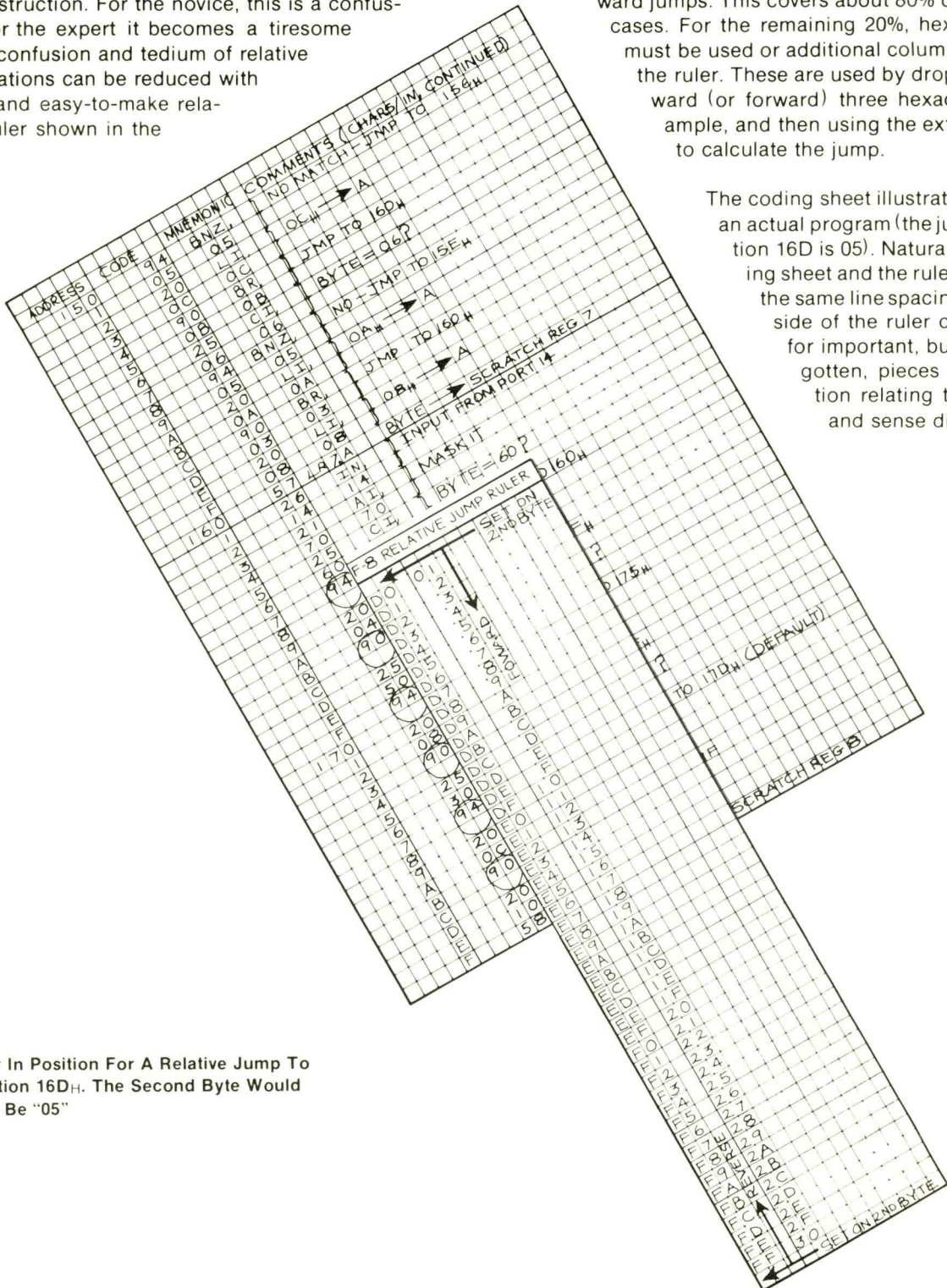

Ruler In Position For A Relative Jump To Location 16D_H. The Second Byte Would Thus Be "05"

**Answers to Puzzle
from Modern Electronics'
February issue**

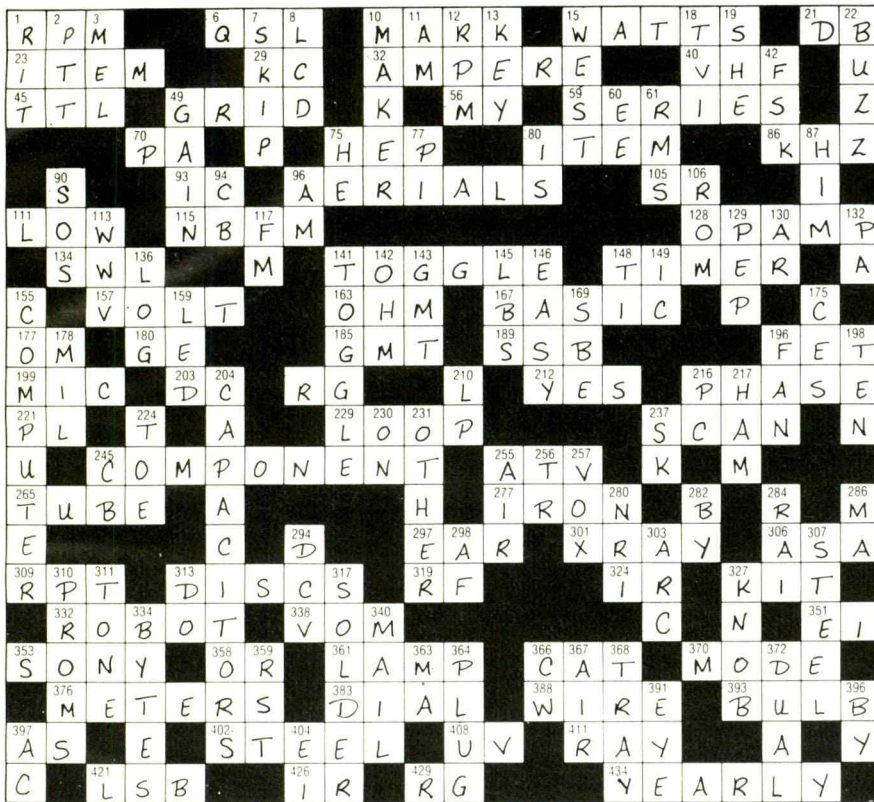

**ATTENTION ALL MAGAZINE
RETAILERS**

Cowan Publishing Corp. is pleased to announce a Retail Display Plan available to all retailers interested in earning a display allowance on MODERN ELECTRONICS Magazine.

To obtain details and a copy of the formal contract, please write to Fawcett Marketing Services, a Division of CBS Publications, Inc., Fawcett Place, Greenwich, Connecticut 06830. Under the Retail Display Plan, in consideration of your acceptance and fulfillment of the terms of the formal contract to be sent to you upon your request, you will receive a display allowance of 15c per copy sold by you. This plan will become effective with all issues of MODERN ELECTRONICS Magazine delivered to you subsequent to the date your written acceptance of the formal Retail Display Agreement is received and accepted by our company. This offer is valid in the U.S. and Canada only.

**WE'RE FIGHTING
FOR YOUR LIFE**

**Eat Less
Saturated
Fat**

American Heart
Association 

**GET YOUR HAM RADIO
LICENSE THE EASY WAY**

**The Fun Way, The Quickest Way
with the CQ/S9 learning program**

The publishers of S9 and CQ Magazines have collaborated with Ameco to bring out the best ham radio training program ever offered. Just a few minutes a night, for just a few weeks will bring you the joys and rewards of being a fully licensed radio amateur.

This complete novice package includes a 1 hour code cassette course, a 32 page code instruction book, and an easy-to-use theory book with sample FCC exam questions.

All for just \$6.95.

The best training program on the market at the very best price. Order today.

Order from Circulation Department

Cowan Publishing Corp.

**14 Vanderventer Avenue
Port Washington, N.Y. 11050**

**Complete
Package...\$6.95**

Would you believe

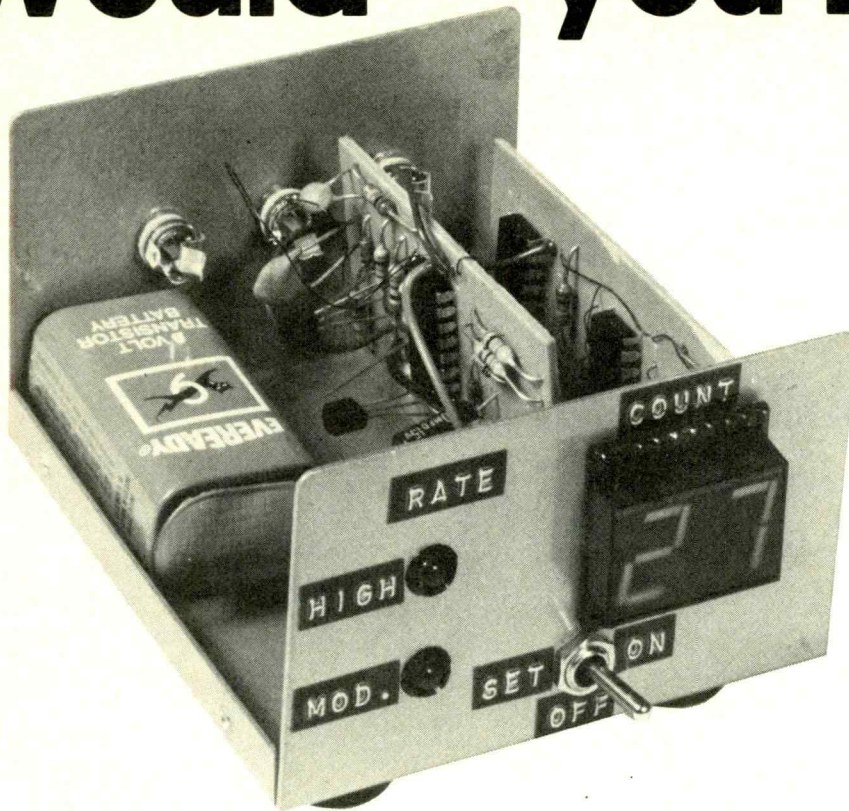

anywhere. The rest of the circuit is contained in a small box that can be left on your bookcase, end table, or desk. The box used here is a Radio Shack two-piece cabinet 270-251, but any box will do.

All electronics are contained on two printed circuit boards mounted in the box. If you chose a larger cabinet, you can combine the two boards into one larger board. If you're not yet into making your own printed circuit boards, you can use perboard and push-in terminals, such as Radio Shack 276-1394/5/6 and 270-1392.

The raindrop detector probe is a specialized version of the touchplate described in Clinic circuits in this issue. Instead of bridging a gap with a finger,

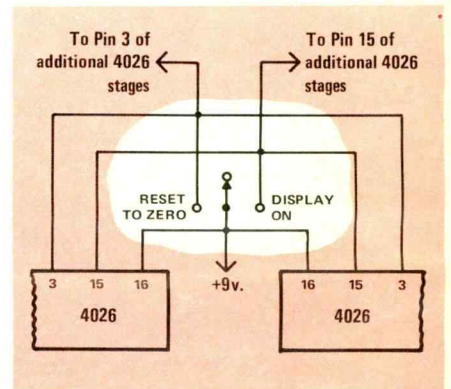

You can use separate display on and reset switches, as shown in the project diagram, or a single pole, center off, double throw switch as shown above.

the gap is bridged by the falling raindrop. Each time a raindrop strikes one of the gaps in the probe, a specially shaped pulse is generated in the counter circuitry. This pulse is fed into a pair of rate detectors, each preset to start at moderate and high rates by built-in variable resistors.

Measure the rate

If the rate at which raindrops strike the gaps in the detector probe is relatively low—less than the preset levels—neither LED lights. When the rate increases beyond the lower preset level, the first LED lights indicating a moderate rate of rainfall. When the rate increases beyond the second preset level, both LEDs light, indicating a relatively heavy rainfall.

The rate detectors are equipped with latch switches. When these switches are

Have you ever awakened on a bright, sunny morning wondering if it had rained during the night? Was the rainfall light, moderate, or heavy? Had more rain fallen than during a downpour a week before? Here's a low-cost week-end project that lets you know if it

rained, relatively how much rain fell, and at what rate.

The circuit consists of a raindrop detector probe, an audio alarm circuit, two rate detectors, and a digital counter. The raindrop detector, which is fashioned from a metal comb, can be located

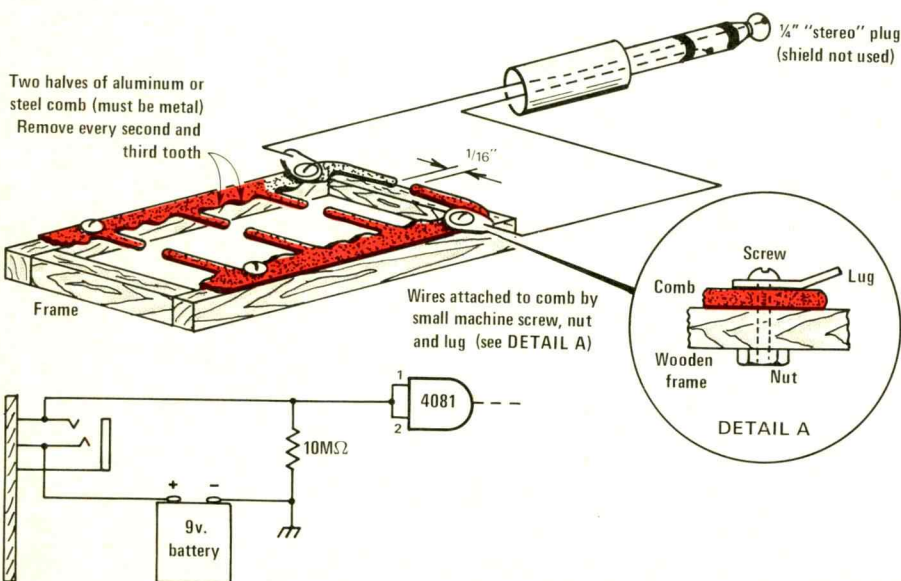

The raindrop detector probe is made from a metal comb fastened to a wooden frame with machine screws and nuts. Connections to the probe is made by wires soldered to lugs, as shown. The probe can be wired directly to the electronics box, or you can use a three-circuit stereo plug and jack.

a raindrop counter?

by Jeffrey A. Sandler
Contributing Editor

closed, the LEDs stay on until the switches are opened. So, the unit can be used to record rainfall rates during the night, or during periods when you're out of town. However, if the switches are left open, the LEDs provide an instantaneous indication of relative rainfall rates.

Counting the drops

The actual number of raindrops striking the gaps on the detector probe is provided by a two-digit counter and LED readout. You can expand the counter to as many digits as you wish by adding additional IC counters and LED readouts.

The counters used in this version of the unit are 4026 CMOS ICs, which directly drive most 0.1 and 0.2-inch displays, and even a few larger displays. However, if you'd like to use very large displays, you'll have to add transistor drivers between the 4026 and the LED readouts. 2N2222 work well.

In addition to providing a visual display, your raindrop counter also provides a click sound each time a raindrop strikes the gaps in the detector probe—much like the sound made by a Geiger counter. The speaker can be mounted in

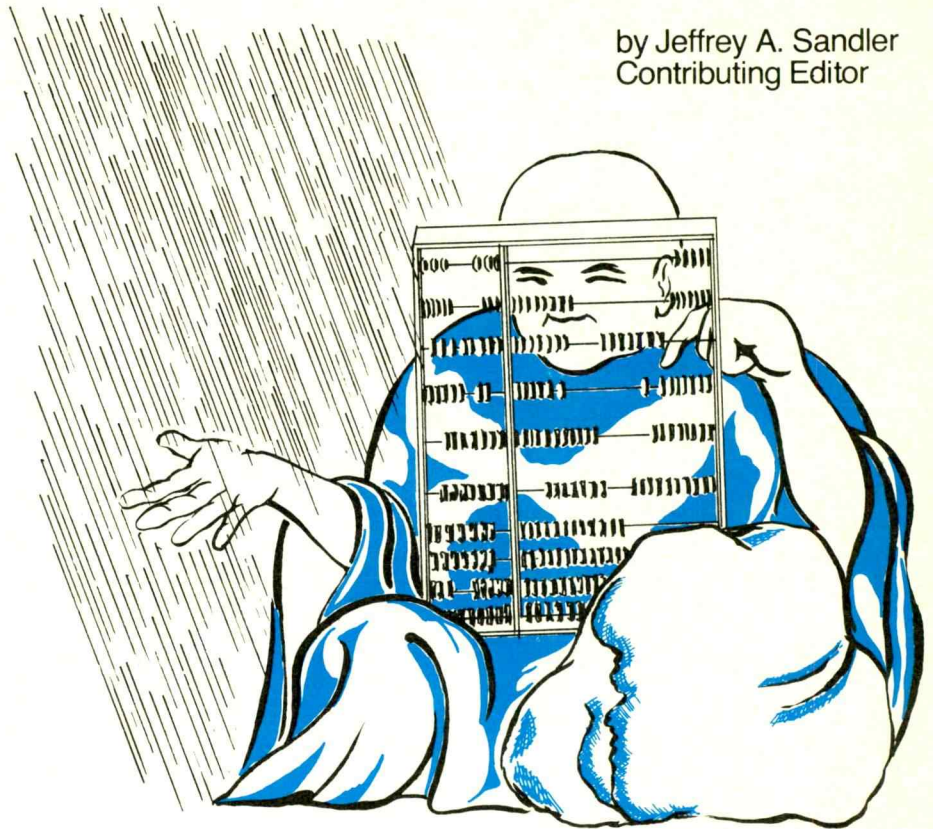

the same cabinet as the electronics, or at some other convenient location. In this version, the speaker is remote and con-

nected to the electronics by a cable using a miniature phone connector (Radio Shack 274-286).

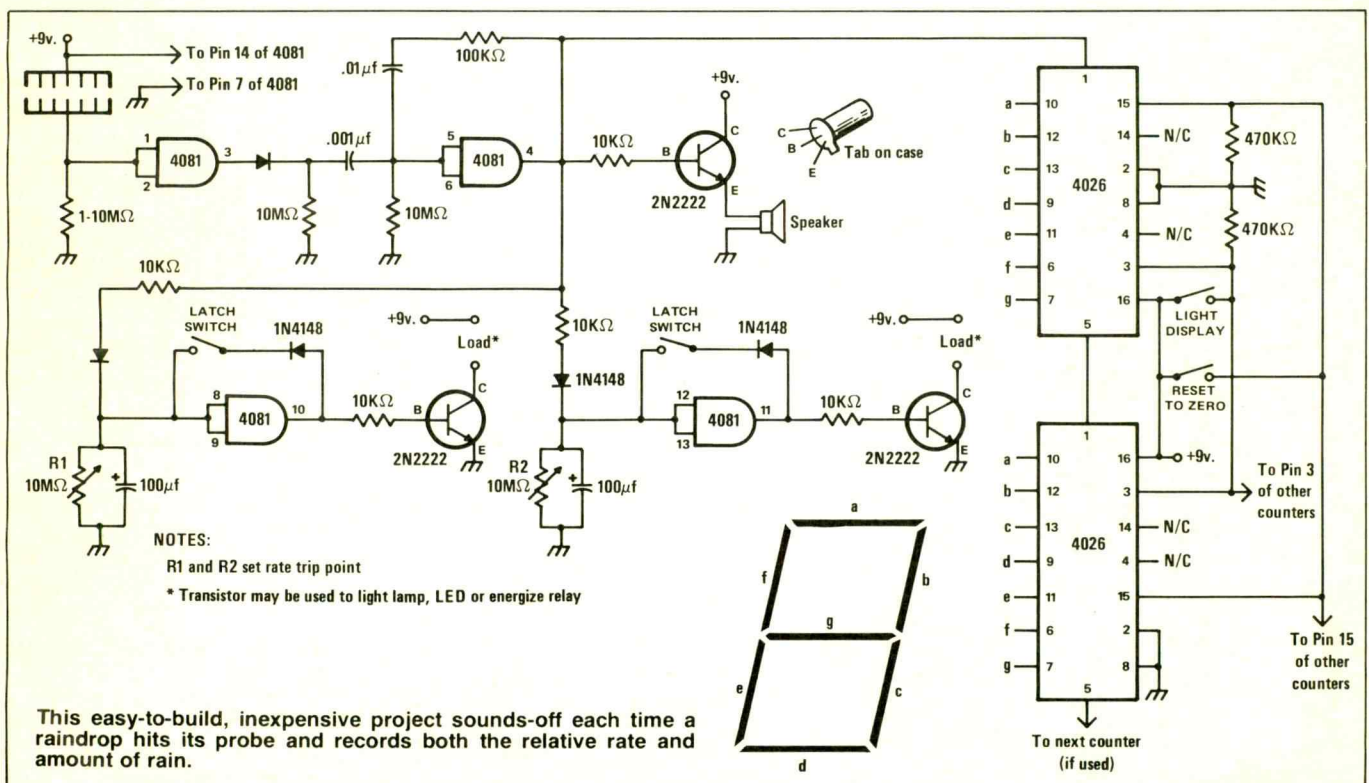

5

great reasons

why YOU should

subscribe to **CB RADIO**

(if you aren't already doing so!)

AMERICA'S OLDEST AND LARGEST CB MAGAZINE

S9

- 1** You'll save a bundle. Newsstand copies are \$1.50 each, or \$18 for a year's supply. Your subscription costs only \$12 – that's 33% off!
- 2** You'll get S9 earlier. Subscriber copies will reach you as much as two or three weeks ahead of newsstand or store copies.
- 3** You'll be sure of getting your copy. Many times S9 is sold out before you can find it. Your subscription is like an insurance policy of fun reading.
- 4** You'll get a bonus. Right on! A 24 page copy of the FCC Part 95 CB regulations. The Commission charges \$1.25 for a copy, and it's a must for every CBER.
- 5** You'll make our editor very happy. And there's nothing more important than having a happy Tomcat (that is, if you're going to keep a Tomcat on the premises, as we do.)

So, indulge yourself. S9 is the CB magazine that doesn't quit when it comes to giving CBERs all the scoop on what's happening out in the CB world. Do it now! Today! Before you forget!! After all, spreading joy is what CB's all about, now, isn't it?

CB RADIO/S9

14 Vanderventer Avenue
Port Washington, New York 11050

Please include my FREE copy of FCC Part 95 CB Regulations

Name _____ Call _____

Address _____

City _____ State _____ Zip _____

Signature _____

Here's my \$12 for a 1 year sub,
..... \$20 for 2 years. This is a new
sub, or a renewal.



Interbank No.	Exp. Date	Mo.	Year

BankAmericard Mastercharge

ME

Note: Allow 8 weeks for delivery of first issue.

RAA 8700 Computer/Controller

**The Answer For...
Student
Hobbyist
Manufacturer**

8700 Processor: 6503 MPU. Wear free "Active Keyboard", Micro-Diagnostic.[®] Extensive documentation, Fully Socketed.

Piebug Monitor: Relative address calculator, Pointer High-low, User Subroutines, Back-step key.

Cassette Interface: Load & Dump by file #, Tape motion control, Positive indication of operation.

Applications systems from \$90 (10 unit quantity)
Development systems from \$149 (single unit)

TELL ME MORE I want to see for myself that the 8700 is The Answer.

- Please send documentation and price lists. \$10 enclosed. name: _____
- I don't need documentation please send price lists. address: _____
- Please send FREE CATALOG. city: _____ state: _____ zip: _____

RAA
ELECTRONICS DEPT. 2-E • 1020 W. Wilshire Blvd. • Oklahoma City, OK 73116 (405) 843-9626

CIRCLE 92 ON READER SERVICE CARD

wire wrapping

ok[®] center ok[®]

NEW HOBBY WRAP MODEL BW 630

Battery wire wrapping tool
\$34.95
Batteries not included
COMPLETE WITH BIT AND SLEEVE

STRIP/WRAP/UNWRAP MODEL WSU-30

\$6.95*

DIP IC INSERTION TOOL WITH PIN STRAIGHTENER

MODEL INS-1416
\$3.49*

WIRE DISPENSER MODEL WD-30-B

REFILLABLE **\$3.95***

*MIN. ORDER \$25., SHIPPING CHARGE \$1., N.Y. CITY-STATE RESIDENTS ADD TAX

OK MACHINE & TOOL CORPORATION
3455 CONNER ST., BRONX, N.Y. 10475
(212) 994-6600 Telex 125091

CIRCLE 93 ON READER SERVICE CARD

Ultimate do-nothing box

Continued from page 57

You also can use your do-nothing box to control other electrically operated

devices. Here too, the time period during which the controlled device is turned on depends on how the relay circuit is connected to the 4060. You could, for example, replace an incande-

cent lamp with a sensitive relay coil. Or, if you prefer, you can make self-timing relay drivers that are turned on by an output from the 400, as shown in figure 4.

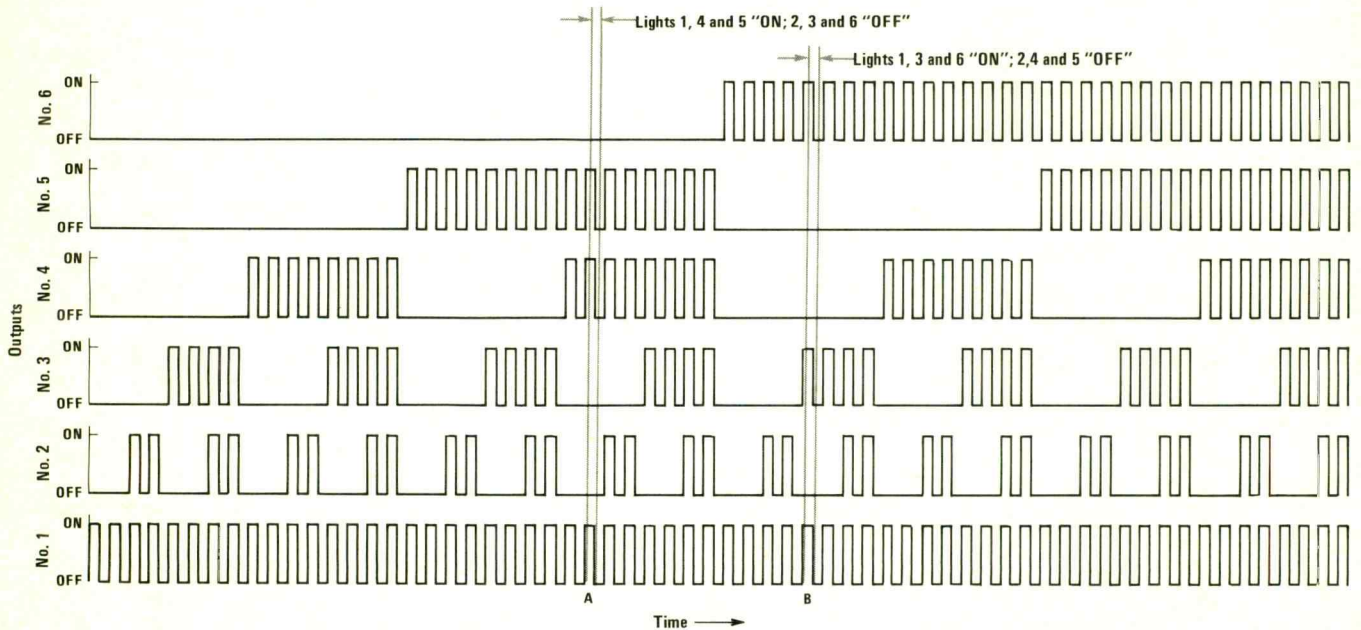

Figure 5 This partial timing diagram shows how the various combinations of on and off times are obtained. The six LEDs are driven by AND gates, one input of each gate being connected to the 1 output of the 4060. The other gate input for LED one is

also connected to the 1 output; LED two, to the 2 output; LED three, to the 4 output. Others are connected in turn to the 8, 16 and 32 outputs. You can determine which LEDs will be on by drawing a vertical line through the 1 on-time pulse. If any other

LED shows an on pulse, that LED will be lit. At point A, for example, LEDs one, four and five are on. At point B, however, LEDs one, three and six are on.

Pocket CB

New integrated circuit technology and a major electronic breakthrough brings you the world's smallest citizens band transceiver.



The PocketCom measures approximately 3/4" x 1 1/2" x 5 1/2" and easily fits into your shirt pocket. The unit can be used as a personal communications link for business or pleasure.

Scientists have produced a personal communications system so small that it can easily fit in your pocket. It's called the PocketCom and it replaces larger units that cost considerably more.

MANY PERSONAL USES

An executive can now talk with anybody in his office, his factory or job site. The housewife can find her children at a busy shopping center. The motorist can signal for help in an emergency. The salesman, the construction foreman, the traveler, the sportsman, the hobbyist—everybody can use the PocketCom.

LONG RANGE COMMUNICATIONS

The PocketCom's range is limited only by its 100 milliwatt power and the number of metal objects between units or from a few blocks in the city to several miles on a lake. Its receiver is so sensitive, that signals several miles away can be picked up from stronger citizens band base or mobile stations.

VERY SIMPLE OPERATION

To use the PocketCom simply turn it on, extend the antenna, press a button to transmit, and release it to listen. And no FCC license is required to operate it. The PocketCom has two Channels—channel 14 and an optional second channel. To use the second channel, plug in one of the 22 other citizens band crystals and slide the channel selector to the second position. Crystals for the second channel cost \$7.95 and can only be ordered after receipt of your unit.



The PocketCom components are equivalent to 112 transistors whereas most comparable units contain only twelve.

A MAJOR BREAKTHROUGH

The PocketCom's small size results from a breakthrough in the solid state device that made the pocket calculator a reality. Scientists took 112 transistors, integrated them on a micro silicon wafer and produced the world's first transceiver linear integrated circuit. This major breakthrough not only reduced the size of radio components but improved their dependability and performance.

BEEP-TONE PAGING SYSTEM

You can page another PocketCom user, within close range, by simply pressing the PocketCom's call button which produces a beep tone on the other unit if it has been left in the standby mode. In the standby mode the unit is silent and can be kept on for weeks without draining the batteries.

SUPERIOR FEATURES

Just check the advanced PocketCom features now possible through this new circuit breakthrough: 1) Incoming signals are amplified several million times compared to only 100,000 times on comparable conventional systems. 2) Even with a 60 decibel difference in signal strength, the unit's automatic gain control will bring up each incoming signal to a maximum uniform level. 3) A high squelch sensitivity (0.7 microvolts) permits noiseless operation without squelching weak signals.

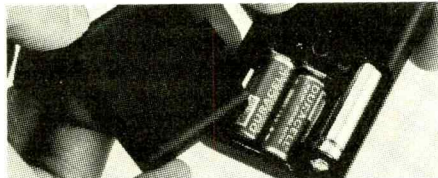

EXTRA LONG BATTERY LIFE

The PocketCom has a light-emitting diode low-battery indicator that tells you when your 'N' cell batteries require replacement. The integrated circuit requires such low power that the two batteries, with average use, will last weeks without running down.



The PocketCom can be used as a pager, an intercom, a telephone or even a security device.

MULTIPLEX INTERCOM

Many businesses can use the PocketCom as a multiplex intercom. Each employee carries a unit tuned to a different channel. A citizens band base station with 23 channels is used to page each PocketCom. The results: an inexpensive and flexible multiplex intercom system for large construction sites, factories, offices, or farms.

NATIONAL SERVICE

The PocketCom is manufactured exclusively for JS&A and is the unit currently used on the hit TV show, Charlie's Angels. JS&A is America's largest supplier of space-age products—further assurance that your modest investment is well protected. The PocketCom should give you years of trouble-free service, however, should service ever be required, simply slip your 5 ounce PocketCom into its handy mailer and send it to our prompt national service-by-mail center.

GIVE IT A REAL WORKOUT

Remember the first time you saw a pocket calculator? It probably seemed unbelievable. The PocketCom may also seem unbelievable so we give you the opportunity to personally examine one without obligation. Order only two units on a trial basis. Then really test them. Test the range, the sensitivity, the convenience. Test them under your everyday conditions and compare the PocketCom with larger units.

After you are absolutely convinced that the PocketCom is indeed that advanced product breakthrough, order your additional units, crystals or accessories on a priority basis as one of our established customers. If, however, the PocketCom does not suit your particular requirements perfectly, then return your units within ten days after receipt for a prompt and courteous refund. You cannot lose. Here is your opportunity to test an advanced space-age product at absolutely no risk.

A COMPLETE PACKAGE

Each PocketCom comes complete with mercury batteries, high performance Channel 14 crystals for one channel, complete instructions, and a 90 day parts and labor warranty. To order by mail, simply mail your check for \$19.95 per unit (or \$39.95 for two) plus \$2.50 per order for postage, insurance and handling to the address shown below. (Illinois residents add 5% sales tax). But don't delay.

Personal communications is the future of communications. Join the revolution. Order your PocketComs at no obligation today.

NEW LOW PRICE!

Credit Card Buyers Call Toll-Free

\$19.95
per unit

*Sold originally for \$40 per unit.

JS&A NATIONAL SALES GROUP

Dept. SN One JS&A Plaza
Northbrook, Ill. 60062 (312) 564-9000
CALL TOLL-FREE... 800 323-6400
In Illinois call... (312) 498-6900
© JS&A Group, Inc., 1977

7400N TTL

SN7400N	16	SN7472N	39	SN74160N	125
SN7401N	18	SN7473N	39	SN74161N	125
SN7402N	20	SN7474N	35	SN74162N	185
SN7403N	20	SN7475N	50	SN74163N	99
SN7404N	20	SN7476N	35	SN74164N	99
SN7405N	20	SN7477N	5.00	SN74165N	99
SN7406N	35	SN7478N	50	SN74166N	125
SN7407N	35	SN7479N	99	SN74167N	3.25
SN7408N	20	SN7480N	70	SN74170N	2.10
SN7409N	25	SN7481N	60	SN74172N	6.00
SN7410N	20	SN7482N	29	SN74173N	1.50
SN7411N	30	SN7483N	3.50	SN74174N	1.25
SN7412N	35	SN7484N	2.49	SN74175N	99
SN7413N	69	SN7485N	45	SN74176N	79
SN7414N	20	SN7486N	7.9	SN74177N	79
SN7415N	35	SN7487N	49	SN74179N	2.49
SN7417N	35	SN7489N	49	SN74180N	99
SN7420N	20	SN7490N	2.49	SN74181N	2.49
SN7421N	39	SN7491N	79	SN74182N	99
SN7422N	49	SN7492N	79	SN74184N	1.95
SN7423N	37	SN7493N	1.00	SN74185N	1.95
SN7425N	29	SN74100N	1.25	SN74186N	15.00
SN7426N	29	SN74107N	39	SN74187N	6.00
SN7427N	37	SN74109N	9.95	SN74188N	9.95
SN7428N	42	SN74116N	1.95	SN74190N	1.70
SN7430N	25	SN74121N	39	SN74191N	1.25
SN7432N	25	SN74122N	39	SN74192N	89
SN7437N	35	SN74123N	50	SN74193N	89
SN7438N	35	SN74125N	60	SN74194N	1.25
SN7439N	25	SN74126N	60	SN74195N	7.75
SN7440N	21	SN74132N	1.25	SN74196N	1.00
SN7441N	89	SN74136N	95	SN74197N	1.00
SN7442N	69	SN74141N	1.15	SN74198N	1.75
SN7443N	75	SN74142N	2.95	SN74199N	1.75
SN7444N	75	SN74143N	3.25	SN74200N	5.59
SN7445N	75	SN74144N	3.00	SN74201N	2.25
SN7446N	89	SN74146N	1.15	SN74202N	1.75
SN7447N	89	SN74147N	2.35	SN74203N	1.75
SN7448N	89	SN74148N	2.00	SN74204N	6.00
SN7450N	25	SN74150N	1.25	SN74205N	6.00
SN7451N	25	SN74151N	89	SN74206N	6.00
SN7452N	25	SN74153N	89	SN74207N	7.75
SN7454N	25	SN74154N	1.25	SN74208N	7.75
SN7459A	25	SN74155N	89	SN74209N	2.25
SN7460N	25	SN74156N	89	SN74210N	2.25
SN7470N	45	SN74157N	89	SN74939N	2.25

BUGBOOK®

Continuing Education Series

BUGBOOK I and II \$17.00 per set
By Peter R. Reay, David G. Larnas, WB9ATJ

Sold as a set these two books outline over 90 experiments designed to teach the reader all he will need to know about TTL logic chips to use them in conjunction with microprocessor systems. You'll learn about the basic concepts of digital electronics including gates, flip-flops, latches, buses, decoders, multiplexers, demultiplexers, LED displays, RAM's, ROM's, and much, much more.

BUGBOOK III \$5.00
By Peter R. Reay, David G. Larnas, WB9ATJ

This volume will introduce you to the ubiquitous UART chip — that all important interface between data terminals, etc., and your microprocessor. It also covers current loops, and the RS 232C interface standard. Particularly recommended for any RTTY enthusiast!

THE 555 TIMER APPLICATIONS \$6.95
SOURCEBOOK WITH EXPERIMENTS
By Howard M. Berlin

This book shows you what the 555 timer is and how to use it. Included are over 1000 various design techniques, equations and graphs to create "ready-to-go" generators, power supplies, measurement and control circuits, party games, circuits for the home and automobile, photography, music and Analog Radio!

INSTRUCTOR'S MANUAL \$3.00
Necessary for instruction of Bugbook I and II. Answers questions regarding experiments, suggestions for further reading, philosophy of authors approach to digital electronics. A must for self-teaching individuals.

OP AMP MANUAL \$9.00
An experiment guide to application of operational amplifiers. Over 25 experiments on all phases of Op Amps.

DEBUG \$5.00
8086 interactive debugger. A program for entering, debugging and storing assembly language programs.

COMPLETE MANUAL FOR DIGITAL CLOCKS by John Weiss and John Brooks
Familiarizes technician or hobbyist with basic theories behind digital clocks. Includes trouble shooting guides, basic characteristics of clocks, soldering techniques, clock component data sheets and construction tips. \$3.95

CMOS — DESIGNERS PRIMER AND HANDBOOK \$6.00
Starts at basic structure of CMOS devices through integration into MSI.

8086 interactive debugger A program for entering, debugging and storing assembly language programs. \$5.00

DISCRETE LEDs

125° dia.				185° dia.				200° dia.				190° dia.					
XC209	Red	5/81	XC111	Red	10/51	XC209	Green	4/51	XC111	Green	4/51	XC209	Orange	4/51	XC111	Orange	4/51
XC209	Green	4/51	XC209	Orange	4/51	XC209	Yellow	4/51	XC111	Yellow	4/51	XC209	Yellow	4/51	XC111	Yellow	4/51
XC209	Yellow	4/51	XC209	Clear	4/51	XC209	Clear	4/51	XC111	Clear	4/51	XC209	Clear	4/51	XC111	Clear	4/51

DISCRETE LEDs \$5.00
8086 interactive debugger. A program for entering, debugging and storing assembly language programs. \$5.00

DISPLAY LEDs

TYPE	POLARITY	HT	PRICE	TYPE	POLARITY	HT	PRICE
MAN 1	Common Anode-red	270	2.95	MAN 6630	Common Anode-orange	560	1.25
MAN 2	5 x 7 Dot Matrix-red	300	4.95	MAN 6640	Common Cathode-orange-D	560	1.25
MAN 3	Common Cathode-red	125	3.99	MAN 6650	Common Cathode-orange-D	560	1.25
MAN 4	Common Cathode-red	187	1.95	MAN 6660	Common Cathode-orange	560	1.25
MAN 5	Common Cathode-red	270	1.25	MAN 6670	Common Cathode-orange	560	1.25
MAN 6	Common Cathode-red	270	1.95	MAN 6710	Common Anode-red-D	560	1.25
MAN 7	Common Anode-green	270	1.95	MAN 6720	Common Anode-red-D	560	1.25
MAN 8	Common Anode-green	300	1.00	MAN 6730	Common Cathode-red-D	560	1.25
MAN 9	Common Anode-red	300	1.25	MAN 6740	Common Cathode-red-D	560	1.25
MAN 10	Common Anode-red	300	1.25	MAN 6750	Common Cathode-red-D	560	1.25
MAN 11	Common Anode-red	300	1.25	MAN 6760	Common Anode-red	560	1.25
MAN 12	Common Anode-red	300	1.25	MAN 6770	Common Anode-red	560	1.25
MAN 13	Common Anode-red	300	1.25	MAN 6780	Common Cathode-red	560	1.25
MAN 14	Common Anode-red	300	1.00	MAN 6790	Common Cathode-red	560	1.25
MAN 15	Common Anode-red	300	1.00	MAN 6800	Common Cathode-red	560	1.25
MAN 16	Common Anode-red	300	1.00	MAN 6810	Common Cathode-red	560	1.25
MAN 17	Common Anode-red	300	1.00	MAN 6820	Common Cathode-red	560	1.25
MAN 18	Common Anode-red	300	1.00	MAN 6830	Common Anode-orange	560	1.25
MAN 19	Common Anode-red	300	1.00	MAN 6840	Common Cathode-orange	560	1.25
MAN 20	Common Anode-red	300	1.00	MAN 6850	Common Cathode-orange	560	1.25
MAN 21	Common Anode-red	300	1.00	MAN 6860	Common Cathode-orange	560	1.25
MAN 22	Common Anode-red	300	1.00	MAN 6870	Common Cathode-orange	560	1.25
MAN 23	Common Anode-red	300	1.00	MAN 6880	Common Cathode-orange	560	1.25
MAN 24	Common Anode-red	300	1.00	MAN 6890	Common Cathode-orange	560	1.25
MAN 25	Common Anode-red	300	1.00	MAN 6900	Common Cathode-orange	560	1.25
MAN 26	Common Anode-red	300	1.00	MAN 6910	Common Cathode-orange	560	1.25
MAN 27	Common Anode-red	300	1.00	MAN 6920	Common Cathode-orange	560	1.25
MAN 28	Common Anode-red	300	1.00	MAN 6930	Common Cathode-orange	560	1.25
MAN 29	Common Anode-red	300	1.00	MAN 6940	Common Cathode-orange	560	1.25
MAN 30	Common Anode-red	300	1.00	MAN 6950	Common Cathode-orange	560	1.25
MAN 31	Common Anode-red	300	1.00	MAN 6960	Common Cathode-orange	560	1.25
MAN 32	Common Anode-red	300	1.00	MAN 6970	Common Cathode-orange	560	1.25
MAN 33	Common Anode-red	300	1.00	MAN 6980	Common Cathode-orange	560	1.25
MAN 34	Common Anode-red	300	1.00	MAN 6990	Common Cathode-orange	560	1.25
MAN 35	Common Anode-red	300	1.00	MAN 7000	Common Cathode-orange	560	1.25
MAN 36	Common Anode-red	300	1.00	MAN 7010	Common Cathode-orange	560	1.25
MAN 37	Common Anode-red	300	1.00	MAN 7020	Common Cathode-orange	560	1.25
MAN 38	Common Anode-red	300	1.00	MAN 7030	Common Cathode-orange	560	1.25
MAN 39	Common Anode-red	300	1.00	MAN 7040	Common Cathode-orange	560	1.25
MAN 40	Common Anode-red	300	1.00	MAN 7050	Common Cathode-orange	560	1.25
MAN 41	Common Anode-red	300	1.00	MAN 7060	Common Cathode-orange	560	1.25
MAN 42	Common Anode-red	300	1.00	MAN 7070	Common Cathode-orange	560	1.25
MAN 43	Common Anode-red	300	1.00	MAN 7080	Common Cathode-orange	560	1.25
MAN 44	Common Anode-red	300	1.00	MAN 7090	Common Cathode-orange	560	1.25
MAN 45	Common Anode-red	300	1.00	MAN 7100	Common Cathode-orange	560	1.25

RCA LINEAR

CA3013	2.15	CA3082	2.00
CA3023	2.56	CA3086	1.60
CA3035	2.48	CA3086	1.60
CA3039	1.35	CA3091	3.75
CA3046	1.30	CA3091	3.75
CA3053	1.50	CA3102	1.95
CA3059	3.25	CA3121	2.15
CA3060	3.25	CA3130	2.30
CA3080	8.65	CA3140	1.25
CA3081	2.00	CA3141	1.25
CA3090	1.75	CA3142	1.25

XR-2206K Kit \$19.95

WAVEFORM GENERATOR

XR-200 \$8.40
XR-2206CP 5.50
XR-2207CP 3.85

XR-2206KA Kit \$14.95

XR-556CP \$1.49
XR-556CP 1.85
XR-556CP 1.85
XR-556CP 3.20
XR-556CP 4.80

MISCELLANEOUS

XR-2211CP \$6.70
XR-4136 2.00
XR-210 5.20

PHASE LOCKED LOOPS

XR-2211CP \$6.70
XR-4136 2.00
XR-210 5.20

IC SOLID STATE — LOW PROFILE (TIN) SOCKETS

8 pin	1-24	25-49	50-100	1-24	25-49	50-100
14 pin	1-17	16	15	24 pin	3-38	37
16 pin	20	19	18	28 pin	45	44
18 pin	22	21	20	36 pin	50	59
22 pin	37	36	35	40 pin	63	62
14 pin	27	25	24	28 pin	59	90
16 pin	30	27	25	36 pin	1-39	1-26
18 pin	33	32	30	36 pin	1-59	1-45
18 pin	49	47	45	40 pin	1-75	1-59
8 pin	30	27	24	24 pin	70	63
14 pin	35	32	29	28 pin	1-10	1-90
16 pin	38	35	32	36 pin	1-15	1-140
18 pin	52	47	43	40 pin	1-75	1-59

WIRE WRAP SOCKETS (GOLD) LEVEL #3

8 pin	\$40	38	35	22 pin	95	85	75
10 pin	45	41	2	22 pin	110	95	85
14 pin	39	38	37	28 pin	1-40	1-25	1-10
16 pin	43	42	41	36 pin	1-59	1-45	1-30
18 pin	75	68	62	40 pin	1-75	1-59	1-40

50 PCS. RESISTOR ASSORTMENTS \$1.75 PER ASS'T.

ASS'T. 1	5 ea.	10 OHM	12 OHM	15 OHM	18 OHM	22 OHM	27 OHM	33 OHM	39 OHM	47 OHM	56 OHM	1/4 WATT 5% - 50 PCS.	
ASS'T. 2	5 ea.	180 OHM	82 OHM	100 OHM	120 OHM	150 OHM	180 OHM	220 OHM	270 OHM	330 OHM	390 OHM	1/4 WATT 5% - 50 PCS.	
ASS'T. 3	5 ea.	470 OHM	560 OHM	680 OHM	820 OHM	1K	1K	1.2K	1.5K	1.8K	2.2K	2.7K	1/4 WATT 5% - 50 PCS.
ASS'T. 4	5 ea.	3.3K	3.9K	4.7K	5.6K	6.8K	8.2K	10K	12K	15K	18K	1/4 WATT 5% - 50 PCS.	
ASS'T. 5	5 ea.	22K	27K	33K	39K	47K	56K	68K	82K	100K	120K	1/4 WATT 5% - 50 PCS.	
ASS'T. 6	5 ea.	390K	470K	560K	680K	820K	330K	330K	330K	330K	330K	1/4 WATT 5% - 50 PCS.	
ASS'T. 7	5 ea.	2.7M	3M	3.3M	3.9M	4.7M	5.6M	6.8M	8.2M	10M	12M	1/4 WATT 5% - 50 PCS.	
ASS'T. 8R	Includes Resistor Assortments 1-7 (350 PCS.)											\$9.95 ea.	

James Electronics

1021-A HOWARD AVE., SAN CARLOS, CA 94070
PHONE ORDERS WELCOME — (415) 592-8097
All Advertisements Good Thru December

1978 CATALOG NOW AVAILABLE

HOBBY-WRAP TOOL - BW-630

Battery Operated (Size C)
Weights ONLY 11 Ounces
Wraps 30 AWG Wire onto Standard DIP Sockets (.025 inch)
Complete with built-in bit and sleeve

\$34.95 (batteries not included)

WIRE-WRAP KIT - WK-2-W

WRAP • STRIP • UNWRAP

- Tool for 30 AWG Wire
- Roll of 50 Ft. White or Blue 30 AWG Wire
- 50 pcs. each 1", 2", 3" & 4" lengths — pre-stripped wire.

\$11.95

WIRE WRAP TOOL WSU-30

WRAP • STRIP • UNWRAP - \$5.95

WIRE WRAP WIRE - 30 AWG

25 ft. min. \$1.25 50 ft. \$1.95 100 ft. \$2.95 1000 ft. \$15.00
SPECIFY COLOR — White - Yellow - Red - Green - Blue - Black

WIRE DISPENSER — WD-30

- 50 ft. roll 30 AWG KYNAR wire wrap wire **\$3.45 ea.**
- Cuts wire to desired length
- Strips 1" of insulation **Specify — Blue-Yellow-White-Red**

REPLACEMENT DISPENSER SPOOLS FOR WD 30

Specify blue, yellow, white or red **\$1.98/spool**

DIP IC INSERTION TOOL WITH PIN STRAIGHTENER

Inserts both 14 and 16 pin packages. Pin Straightener built into handle.
Model INS-1416 **\$3.49/ea.**

HP 5082-7400 SERIES — MULTI-DIGIT

10 or more

- 1/2" bit • Common Cathode Red 2 Digit \$.79 .69
- 3-5 volts @ 5 mils/second 3 Digit .89 .79
- 7 segment Monolithic 4 Digit .99 .89
- Dip Package 5 Digit 1.19 .99

TV GAME CHIP SET — \$9.95

Includes AY-3-8500-1 Chip and 2.010 mhz crystal
(2.010 crystal — \$1.95 ea./AY-3-8500-1 Chip — \$8.95 ea.)

ZENERS — DIODES — RECTIFIERS

TYPE	VOLTS V	PRICE	TYPICAL VOLTS V	PRICE
1N746	3.3	400mm	4.1/0	1N4005 800 PIV 1 AMP 10/10
1N751A	5.1	400m	4.1/0	1N4006 800 PIV 1 AMP 10/10
1N752	5.6	400mm	4.1/0	1N4007 1000 PIV 1 AMP 10/10
1N753	6.2	400mm	4.1/0	1N4008 500 PIV 1 AMP 10/10
1N754</				

news check ^{me}

STOP THE PRESSES: LAST MINUTE NEWS JUST IN TO MODERN ELECTRONICS

BY ANTHONY R. CURTIS

IS AUSTRALIA'S NEW CB BAND A portent of the future for America? It is in the UHF portion of the radio spectrum near 470 MHz. CBers there will not be able to renew 27 MHz licenses. To stay on the air they'll have to switch to 470. A new CB band for the U.S. has been discussed for 900 MHz. Such a UHF CB band, with fm radios, would give hi-fi quality modulation and less interference from distant stations you don't want.

A PORTABLE DESKTOP FLIGHT SIMULATOR for students, weighing under 50 pounds with a built-in computer, is out from Analog Training Computers Inc., West Long Branch, NJ. The \$5900 panel is realistic, simulating turbulence, wind conditions. Pilot moves change panel meters just as they would in a real flight.

SHORTWAVE LISTENERS, HAMS AND professional two-way radiomen are getting headaches listening to a mysterious Russian "woodpecker" signal blanketing their part of the radio spectrum. Governments have protested to the USSR to no avail. Now, word is European professional shortwave communicators have threatened to boycott messages to and from Russian ships. The woodpecker is an intermittent irritating sound which interferes with worldwide two-way communications.

THERE'S A REAL ELECTRONIC SPECTACLE in the making for 1980 when NBC tv telecasts the Olympic games from Moscow. As much as \$100 million will change hands for the network's exclusive rights to the telecast. Tons of the world's best gear will be sent to the city to cover many sites.

49 MHZ RADIO CLUB IS A new organization boosting the 49.820-49.9 MHz license-free CB walkie-talkie band set up by the FCC to get those kiddie toys away from 27 MHz where they were interfering with adult base and mobile stations. 49 MHz gear is limited to a maximum of 0.10 watts of transmitter power and antennas up to only about one yardstick in length. The club is for public-service, emergency work.

RADIO AMATEUR SATELLITE CORPORATION, the international club of hams interested in building and operating orbiting space communications satellites, is placing its latest OSCAR 8 satellite in orbit right now, according to plans. A super-sophisticated new series of birds known as Phase III satellites is set for launch next year. The first Phase III may be launched piggyback with other NASA satellites in late 1979. A second Phase III satellite is a possibility for late 1980 or early 1981. (See an interview with Jan King, one of the builders of OSCAR satellites, on page 29 of this issue of Modern Electronics. A detailed study of how the high-flying ham stations work is coming in our April issue.)

Colt CB. Pure thoroughbred.

Colt 1978. Coming down the stretch with a pure bred line of high performance 40-channel AM, AM single sideband and base station transceivers.

Taking the lead with over eight years of innovative electronics engineering and computer technology. Supported by a network of qualified service centers throughout North America.

Finishing first with an unconditional guarantee to meet or exceed published specifications by any industry accepted testing standard.

U.S.A.: Colt Communications, Inc.
5725 N. Central Ave., Chicago, Illinois 60646
Canada: Coltron International,
430 Flint Road, Downsview, Ontario, M3J2J6
Japan: Colt (Far East) LTD.,
Konan, P.O. Box 18, Yokohama, Japan



Colt CB.
Ride with a winner.

CIRCLE 98 ON READER SERVICE CARD

Only three receivers in the world give you master control of the entire music spectrum.

JVC believes that when you buy a full performance stereo receiver you should be able to get full performance from it. Without having to buy expensive add-on accessories.

That's why one of the very special features built into JVC's three new top-of-the-line receivers (JR-S300 II, JR-S400 II, JR-S600 II) is our exclusive SEA five-zone graphic equalizer system. It totally eclipses the capability of conventional bass/midrange/treble tone controls of other receivers. With SEA you're in complete command of every segment of the musical spectrum—from gut bucket bass to coloratura highs. SEA also permits you to custom tailor the sound to the acoustics of any room, and to compensate for the shortcomings of other components in your system.

And if you're a recording buff, you'll appreciate another exclusive JVC professional touch. You can switch the SEA equalizer section in to the tape recorder circuit for simultaneous equalization while you're recording.

While these unique features alone set JVC's pace-setting receivers apart from the common herd, we're further insuring top performance with a solid combination of additional features.

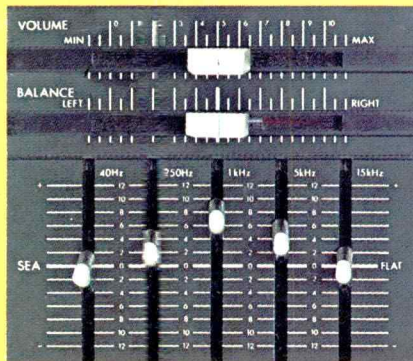

Exclusive 5-zone SEA graphic equalizer system for better performance from components and listening room.

JVC

We build in what the others leave out.

And all the power you'll ever need to drive your favorite speakers.

So it's up to you. Which do you prefer? A JVC professional receiver with a built-in SEA graphic equalizer. Or one that leaves it out.

JVC America Company, Division of US JVC Corp., 58-75 Queens Midtown Expressway, Maspeth, N.Y. 11378 (212) 476-8300. Canada: JVC Electronics of Canada, Ltd., Scarborough, Ont.

For your nearest JVC dealer, call toll-free (outside N.Y.) 800-221-7502.

	S600 II	S400 II	S300 II
RMS power/channel, 8 ohms, 20Hz to 20,000Hz	120 W.	80 W.	50 W.
Total harmonic distortion	0.08%	0.08%	0.1%
Approx. retail value	\$650.	\$530.	\$400.

