

ANTENNAE
 By Greenleaf W. Pickard
 NEW EIFFEL TOWER PLANT
 By A. C. Marlowe
 ELECTRO MAGNET FOR BATTERIES
 By H. W. Secor
 CONCERNING STORAGE BATTERIES
 By C. C. Whittaker
 THE MAGNETOSCOPE
 A HANDY SWITCH
 By H. Gernsback
 PARIS LETTER
 A PERIKON DETECTOR
 By Lewis W. Klopfer
 WIRELESS RECORDER
 By Clarence W. Winchell
 FIRST AEROPHONE AUTOMOBILE
 A MODERN STATIC MACHINE

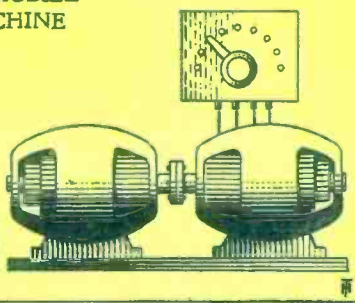
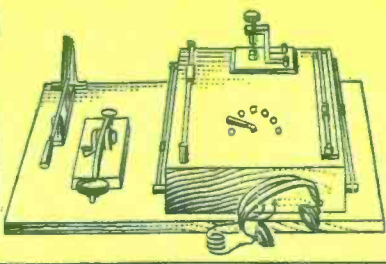
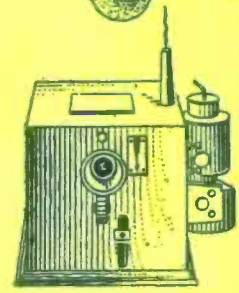

"THE ELECTRICAL MAGAZINE FOR EVERYBODY"

Copyright 1909, by MODERN ELECTRICS PUBLICATION.

N. S. E.

MODERN ELECTRICS

The "ELECTRO"-LYTIC BARE POINT DETECTOR (PATENT PENDING)

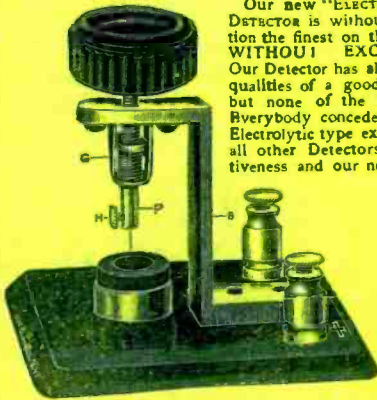

Our new "ELECTRO"-LYTIC DETECTOR is without a question the finest on the market WITHOUT EXCEPTION. Our Detector has all the good qualities of a good Detector but none of the bad ones. Everybody concedes that the Electrolytic type excels by far all other Detectors in sensitiveness and our new type—already adopted by two of the leading wireless companies—is without doubt the same of perfection. Please

bear in mind that our new Detector has been designed for *hard commercial work*, it is not an amateur contrivance. Here are a few points: Hard rubber base $\frac{1}{2}$ in. thick, hard rubber thumbnut 1 in. diameter, graphite-carbon cup moulded in brass cup (under hydraulic pressure,) heavy cast brass standard, etc. The most important part is that the 1-10,000 inch Wollaston wire does not need to be soldered, as in all other Detectors, a screw holds it in a unique manner. The last 1-16 inch piece of wire is utilized, new wires inserted in 10 seconds, etc. By means of an ingenious plunger movement, the fine wire is raised and lowered with greatest precision—less than 1-10,000 inch at a time. The wire cannot turn in a circle, (as wires do, directly attached to thumb screws,) it can only move *up or down*, not sideways, etc. This has been found to be of tremendous importance. ALL METAL PARTS ARE HEAVILY SILVER PLATED, as we found that silverplate is not attacked by fumes of the acid. We also furnish bottle to hold acid, and one pipette to fill acid in cup.

Introduction price, \$1.50 By mail extra 12 cents
Write for new Pamphlet on this Detector.
Electro Importing Co., 86-Z W. Broadway, New York

Just From The Press OPERATORS' WIRELESS TELEGRAPH AND TELEPHONE HAND-BOOK

BY VICTOR H. LAUGHTER



UP-TO-DATE and most complete treatise on the subject yet published. Gives the historical work of early investigators on up to the present day. Describes in detail the construction of an experimental wireless set. How to wind spark coil and dimensions of all size coils. The tuning of a wireless station is fully explained with points on the construction of the various instruments.

A special chapter on the study of wireless telegraphy is given and the rules of the Naval stations with all codes, abbreviations, etc., and

other matter interesting to one who takes up this study. The most difficult points have been explained in non-technical language and can be understood by the layman. Wireless telephony is given several chapters and all the systems in use are shown with photographs and drawings. By some practical work and a close study of this treatise one can soon master all the details of wireless telegraphy.

Sold by booksellers generally or sent postpaid to any address upon receipt of price.

12mo., Cloth, 200 Pages Fully Illustrated, and with Six additional Full-Page Half-tone Illustrations Showing the Installation of "Wireless" on the U. S. War Ships and Ocean Liners - \$1.00

FREDERICK J. DRAKE & CO., Publishers
FISHER BUILDING - CHICAGO, ILL.
Send for Catalog FREE.

NEW ENGLAND GETS FIRST SERVICE



RESIDENTS of Portland, Me., Old Orchard, Me., Saco, Me., Biddeford, Me., Dover, N. H., Portsmouth, N. H., Exeter, N. H., Haverhill, Mass., Lawrence, Mass., Lowell, Mass., Boston, Mass., and adjacent points, are now communicating by wire at rates so low and service so accurate and prompt that they are wondering at their former patience with exorbitant rates and inadequate service.

☞ New lines will be opened as rapidly as physical and financial conditions permit until every city in the United States will be sending—

25-word TELEGRAMS, any distance, for 25c.
50-word TELEPOSTS, any distance, for 25c.
100-word TELETAPES, any distance, for 25c.
10-word TELECARDS, any distance, for 10c.

☞ An interesting illustrated booklet has been prepared, describing in detail the invention, its operation, its economy, its rapidity and its accuracy. Mailed without cost to anyone asking for Booklet No. 359.

TELEPOST COMPANY 225 Fifth Ave., New York



WE MANUFACTURE MOULDED AND SPECIAL RUBBER GOODS OF EVERY DESCRIPTION AND CAN FURNISH ANY SPECIAL RUBBER ARTICLE TO YOUR SATISFACTION.

NEW YORK BELTING & PACKING CO. LTD.
91-93 CHAMBERS STREET,
NEW YORK

Send for our large Catalogue "M" containing 94 pages, with useful information.

When writing please mention "Modern Electrics."

"Modern Electrics" guarantees the reliability of its advertisers.

When writing please mention "Modern Electrics."

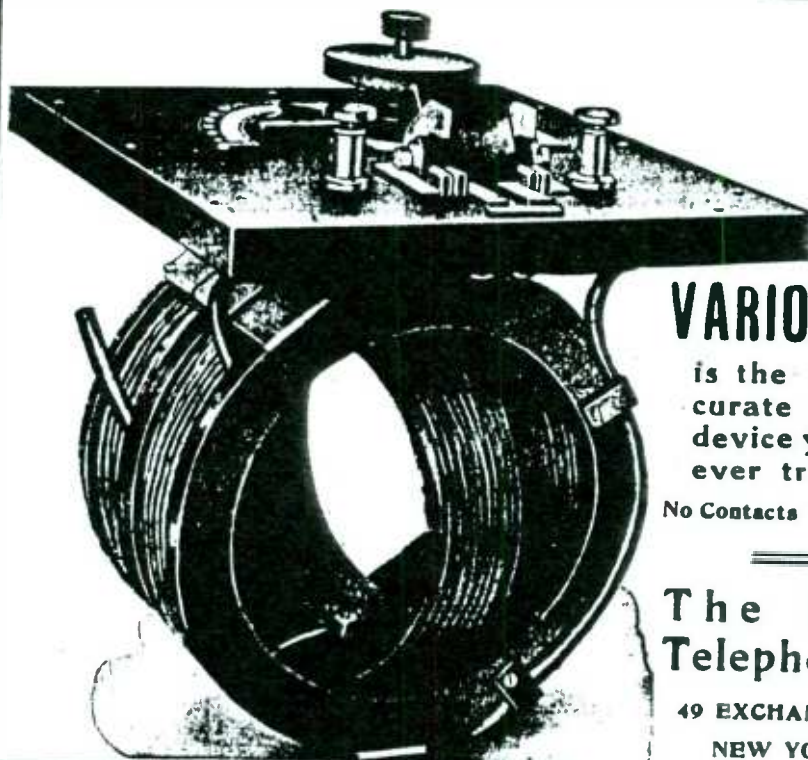

THE
"R-J"

VARIOMETER

is the most accurate tuning device you have ever tried

No Contacts Low Prices

The Radio Telephone Co.

49 EXCHANGE PLACE
NEW YORK CITY

When writing please mention "Modern Electric."

Patent What You Invent

THIS BOOK

Giving full information in Patent Matters, and two others telling what to invent and a history of successful inventions

MAILED FREE

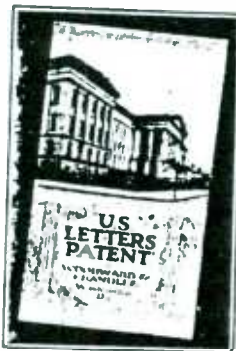

Send Us a Sketch

of an invention for our opinion as to patentability which will be rendered without charge. If we believe it to be new, we will issue a contract under which

WE REFUND ALL FEES IF WE FAIL TO OBTAIN A PATENT : : :

We Advertise Patents of Our Clients For Sale in Prominent Dailies At Our Expense

CONSCIENTIOUS SERVICE

WRITE FOR OUR BOOKS

WOODWARD & CHANDLEE

Registered Attorneys

1268 F Street, Washington, D. C.

When writing please mention "Modern Electric."

The First Annual Official Wireless Blue Book

The only book of this kind in existence. It contains the location, call letters, wave length, power, etc., of

972 Wireless Stations in the United States and Canada

U. S. Atlantic and Inland Stations	90
" Pacific Shore Stations	60
" Navy Stations	51
" Army Stations	50
" Revenue Cutters Stations	22
" Navy Vessels Stations	185
Hawaii Stations	7
Merchant Vessels in the Atlantic, Pacific & Great Lakes	350
Canadian Stations	39
Cuban Stations	3
U. S. Amateur Stations	115
Total	972

If you have a wireless station this book will be invaluable to you. When receiving messages you will know at once where from they originate. NO MORE GUESSWORK as heretofore. The Wireless Blue Book creates a new interest in wireless as it enables every experimenter to accurately estimate the range of his outfit.

It took four months to compile the data of the Blue book and it is warranted to be correct in every respect. YOU CANNOT AFFORD TO BE WITHOUT IT.

 **PRICE, 10c BY MAIL.**

Cash or stamps (only U. S., no foreign ones) taken

Modern Electrics Publication,

84 W. Broadway, New York

ROYAL STORAGE BATTERY

STYLE B-3 6 Volts, 60 Ampere Hours

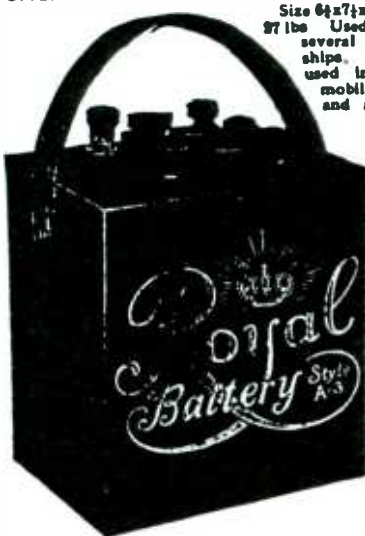

Size 6 1/2 x 7 1/2 x 7 in. Weight 37 lbs. Used on board of several U. S. Battleships. Same type used in the Oldsmobile, Pullman and a number of other high-class automobiles for ignition and lighting. Six plates in each cell, 3 positives and 3 negatives. 16 plates in one battery.

Through a fortunate deal with the makers, we have purchased several hundred of these batteries, all in perfect condition except that they are of the 1908 style. As the makers have brought out

a new 1909 type they did not wish to keep the 1908 type in stock and we bought the whole block. If you wish to know more about this wonderful ROYAL BATTERY, send 2c stamp and we will send you a 20 page book entitled: "Treatise on Storage Batteries." The type B-3, exactly as cut, only wider and bigger. Lists at \$7 Dollars (see book.)

Our PRICE NOW, to M. E. Readers ONLY \$4.00. This is a chance of a lifetime. We can ship at once; two styles. One Enamel steel case, the other treated wood case. Fine rubber-belting handle, patent gas vent, etc. etc. Speak quick, only about 25 left.

ELECTRO IMPORTING CO., 86x W. Broadway, N.Y.

When writing please mention "Modern Electrics."

The Three Best Books

WIRELESS TELEGRAPHY. By R. P. Howgrave-Graham. Including History of Principles; Generation of Electric Waves, Practical Radiotelegraphy, transmitting and receiving apparatus. 160 pages, profusely illustrated, 12mo. cloth \$1.00.

MAKING WIRELESS OUTFITS. By Newton Harrison. A concise and simple explanation on the construction and use of simple and inexpensive Wireless Equipments. Fully illustrated, 12mo. cloth. 50c.

WIRELESS TELEPHONE CONSTRUCTION. By Newton Harrison. The latest work on the subject, practically written and fully illustrated, paper price, 25c

SEND FOR OUR NEW LIST OF OVER 50 TITLES OF PRACTICAL BOOKS

Books mailed postpaid on receipt of price

Spon & Chamberlain
Publishers of TECHNICAL BOOKS
123-G LIBERTY STREET
NEW YORK

When writing please mention "Modern Electrics."

MODERN ELECTRICS

Vol. II.

JUNE, 1909.

No. 3

Antennae

By GREENLEAF W. PICKARD.*

While it is true that the early systems of wireless communication, depending upon conductive or inductive effects, used conducting structures that might be called the equivalents of certain forms of modern antennae, it does not appear that the antenna, as a radiating and receiving element of a



Dolbear's Antenna and Wireless

wireless system employing electrical waves, came into existence before 1880.

It was this year that Prof. A. E. Dolbear, of Tufts College, Mass., commenced his experiments with wireless communication. At first employing apparatus of small dimensions and power, he gradually increased his range until satisfactory signals were obtained over distances approximating a mile. For this distance, which to-day seems to us absurdly small, his sending and receiving antennae consisted respectively of a hundred foot wire, held aloof by a kite, and a large tin roof. As is even the case to-day in some minor installations, his transmitter consisted of a large induction coil, one terminal of the secondary being connected to the antenna, and the other to the ground.

While it has been frequently stated that Dolbear's system did not radiate true electrical waves, but was simply an electrostatic induction system, the writer has definite proof to the contrary. He has been honored by Prof. Dolbear's acquaintance for the past ten years, and has had frequent opportunity to examine and test much of the original apparatus used in these

* Paper read before the Wireless Institute of New York.

early tests. As a result, he has no hesitation in stating that true electrical waves were radiated and received. Although the present paper is not the place for a detailed discussion of the Dolbear system, the writer considers that the invention of the antenna may safely be ascribed to Dolbear. An account of his experiments was published in 1881 in the *Scientific American*, and on March 24, 1882, he applied for U. S. patent on his system of wireless telegraphy and telephony, which issued October 5, 1886.

Edison's U. S. patent of December 29, 1891, shows a vertical wire terminating in an elevated capacity area, and ground connection, while Sir William Preece, in experiments conducted in England in the early 80's, used conducting structures that much resembled certain modern forms of looped antennae. Edison's system, however was confessedly one depending upon electrostatic induction, while in the

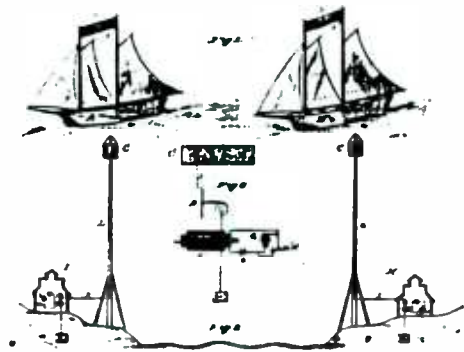

Edison's Wireless System

experiments of Preece a combination of magnetic induction and earth currents was employed, so that their structures cannot be considered as antennae in the modern sense of the word.

Interesting as has been the development of the antenna, starting from the simple vertical wire of Dolbear, it is

not the intention of the writer to present the historical side. Within the limits of this paper he feels it wise to confine himself strictly to the antennae of to-day, with perhaps a prophetic word as to the future.

To-day we find in almost universal use some form of the vertical wire antenna of Dolbear. Disguised as this may be by conductor multiplication, and departures from the vertical in the shape of spreading and converging fans of wire strands, it yet remains essentially a simple electrical conductor, reaching away from the earth's surface into free space; the link between the telegraphic apparatus and the electrical waves.

It is the function of an antenna both to convert an electrical current into electrical waves, and to regenerate a portion of the energy in a passing wave into electrical current. All



Edison's Antenna

forms of antenna are in this regard reversible, although it is frequently the custom to convert, as by change in connection, the radiating antenna into one of another type for purposes of receiving.

A more detailed analysis will show us, however, that the conductor or conductors composing the antenna is merely a means for guiding an electrical current, or moving electrical charge. Electrical waves are not radiated directly from the conductors of the antenna.

An electrically charged body, or, more simply, a charge of electricity, is always surrounded by what is termed an electrostatic field. We do not know what this field is, but it is our working hypothesis that such a field is simply a state of strain in the ether. We picture this strain as lying along certain lines, called lines of force,

which link portions of the electrical charge with other electrical charges, which may be distributed on surrounding conducting objects as so-called induced charges.

If an electrical charge is moved, or varied in any way, a corresponding change in its electrostatic field takes place. If the intensity of the charge falls to zero, we say that the field collapses, or draws in on the conductor carrying the charge. This, however, is true only of the space in the more or less immediate vicinity of the varying charge. At a certain distance, depending upon the suddenness with which the charge varies, the lines of force are no longer able to collapse on the conductor, but are broken or nipped off, as closed lines of force. It is these detached loops of ether stress that form the electrical waves.

It is somewhat difficult to form a clear mental picture of the electrostatic field in the vicinity of a varying or moving electrical charge, and the electrical wave formation at its boundary. Perhaps the best way is to imagine an electrical charge at a considerable elevation above the earth's surface. This is shown in Figure 1., with the electrostatic field indicated by the four lines of force. If this charge were slowly lowered toward the earth, the lines of force would simply shorten, until, as the charge reached the earth, they would entirely disappear. There would be but little radiation of electrical waves in this case. But now imagine that the charge fell to earth with very great velocity, in fact, that of light itself. The field still collapses as the charge nears the earth, but as the speed with which the lines of force can collapse, or shorten, is now merely that of the moving charge, the outside, longer lines of force cannot follow the motion of the charge, although the inner shorter lines are able to do so. This is shown in Figure 2, where the charge has fallen half way to earth. The inner pair of lines of force are collapsing as rapidly as the charge falls, but the outer pair, owing to their greater length, are becoming curiously distorted. In Figure 3 the charge has reached the earth, and the inner pair of lines have entirely disappeared, but the outer pair are left standing, their in-

ner ends having been carried down to the earth by the movement of the charge. These figures are really cross sections of the wave formation. In Figure 3, the standing loops of other strain really form a circular ripple around the place where the charge fell, and have already begun to move outward in all directions.

These figures have been purposely slightly exaggerated in vertical dimen-

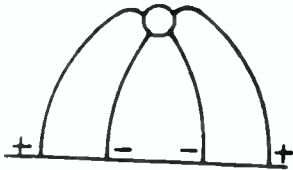

-FIG. 1-

sion, in order to make the formation of the wave a little clearer. As a matter of fact, the wave could not start quite so near the line of fall of the charge as is here indicated.

As these waves can only start at the boundary of that portion of the field capable of entirely collapsing on the conductor carrying the varying or falling charge, it is apparent that the waves are not radiated directly from the antenna, but rather from points considerably outside. Radiation really takes place from an imaginary shell, surrounding the antenna, and distant from it perhaps a matter of miles. If electrical waves of the length employed in wireless communication were as visible to our eyes as those of light, a radiating antenna would look like a vast elipsoidal shaft of light, from hundreds of feet to even miles in diameter, and considerably higher than the antenna itself. Within this shaft exist simply collapsing and expanding lines of force, that is to say, merely a varying electrostatic field. Without this space, we have also a varying field, but this is in the form of electrical waves, spreading outwards as a series of ever widening ripples.

To radiate a large amount of energy as electrical waves, a large radiating surface is required. To better appreciate the reason for this, an accoustical analogy may be of assistance. We are all familiar with the fact that to efficiently radiate sound waves, the vibrating body must have considerable surface. The sound of a violin string

does not proceed directly from the small area of the vibrating string, but rather from the broad surfaces of the violin body, to which the vibration of the string has been communicated. So it is with the wireless antenna. This does not directly radiate electrical waves, but communicates its electrical vibrations to the field of force surrounding it, whose wide surfaces act as the sounding board, or link between the electrical vibration on the antenna and the ether.

Considering the earth's surface immediately surrounding the wireless station as flat, it is at once obvious that the further away from the earth we place a charge, the wider will be its electrostatic field, and the larger the radiating surface. If we could imagine ourselves in the happy state of freedom from all limitation, financial and otherwise, and wished to construct an antenna capable of radiating very powerful electrical waves, we would naturally make it in the form of a very high vertical conductor. But, unfortunately, questions of cost, and, finally, engineering difficulties in construction, soon limit man's vertical excursions. It does not seem likely that we shall soon have vertical conductors much in excess of a thousand feet, unless upheld by such temporary supports as kites, or, perhaps, aeroplanes or dirigible balloons.

The new station shortly to be erect-

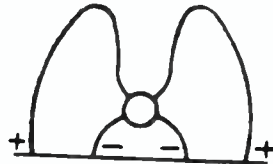

-FIG. 2-

ed at Washington is a good example of the importance of vertical dimension. This station will probably be the most powerful station in the United States, perhaps in the world. The antenna will be upheld by a cement shaft, 650 feet high; the highest wireless structure in the world, with the exception of the Eiffel Tower antenna. And, owing to the fact that the Eiffel Tower itself is not insulated from earth, this antenna is not as efficient as its length would indicate.

The next best thing we can do is

to spread out horizontally, after we have attained our limit in vertical dimension. While this is by no means as good as increase in height, it does give a materially larger field, and consequently a larger radiating surface.

For what may be well termed an "all around" antenna, that is to say,

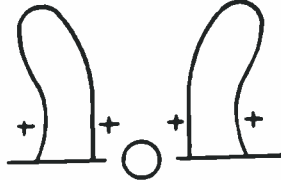

-FIG 3-

one capable of sending and receiving equally in all directions, the so-called "umbrella" or pyramidal type is undoubtedly the best. This the writer has verified by actual radiation measurement of antennae of the same height, but of different shapes. This form lends itself well to erection on a single cell support, or mast. The ribs of the umbrella are simply wires converging to a point at the top, and stayed out in a wide ring around the mast, the lower ends coming near the earth, and being drawn in by nearly horizontal wires to the station at the base of the mast. This form is shown in Figure 4.

It not infrequently happens that we are limited not only in the matter of vertical dimension, but in certain horizontal dimensions as well. And, in addition, we often have available two neighboring elevated points of support. Under these conditions, the best form is the "T" antenna, stretching from



-FIG 4-

mast to mast, with its vertical portion depending from the middle of the horizontal part. A typical "T" antenna is shown in Figure 5.

On shipboard our available horizontal dimensions run "fore" and "aft,"

and it is necessarily in this direction that the horizontal spread of the antenna must lie. The writer, although considering the "T" antenna the second best form, wishes to point out that it is not perfect. It is slightly directional, that is to say, radiates and receives best in its own plane, so that on shipboard better sending and receiving can be done "fore and aft" than "abeam." Unless the "T" antenna has much greater horizontal than vertical length, this directional effect is not serious, and often escapes observation. The writer has found by measurement, however, that the directional effect is always present in this type.

A third form of antenna is the "L," or, more accurately speaking, the inverted "L" type, differing only from the "T" antenna in that the vertical portion depends from one end of the horizontal, rather than from the middle. This is shown in Figure 6. Unfortunately, this type is in too common use on shipboard, and at other stations

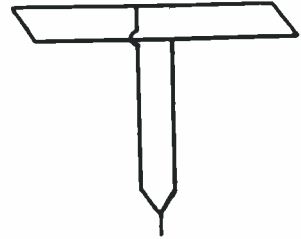

-FIG 5-

where its directional radiation and receiving properties are disadvantageous. With this type, radiation is strongest in the direction opposite to that to which the free end points, and receiving is best from a station lying in the direction of maximum radiation. For example, if an "L" antenna is erected on a vessel, with the vertical portion and wireless station aft, both sending and receiving will be at their best for stations lying astern.

It may be safely said that any departure from horizontal symmetry in a radiating or receiving antenna will cause it to become directional. And, as above stated, directional antenna are only permissible in certain well defined cases. The large Marconi stations at Glace Bay, Nova Scotia, and Clifden, Ireland, are perhaps the best examples of the properly used "L" antenna. These stations were built only

to communicate with each other, and five antennae of approximately 200 feet in height, and 1,000 feet horizontal. At the eastern station, Clifden, the antenna runs nearly due east from the transmitting instruments, while at the western station, Glace Bay, the an-

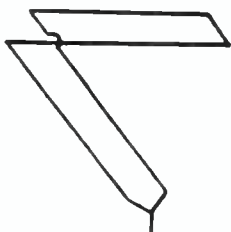

-FIG. 6-

tenna runs west, so that the free ends of the antennae point away from each other, thereby securing the maximum radiation and reception.

Without entering into the detailed explanation of this directional effect, it may be remarked that it is most apparent when receiving. In sending, after the wave has spread radially for a hundred wave lengths or so, inequalities in the distribution of wave energy begin to disappear, and at very great distances, as Fleming has pointed out from theoretical considerations, and as the writer has to some extent proven by measurement, the intensity of the wave is sensibly the same in all directions. It seems that however much the wave is distorted from the hemispherical shape at the start, it eventually smoothes itself out and returns to this form, although the distortion may recognizably persist for many hundred wave-lengths. In receiving, the

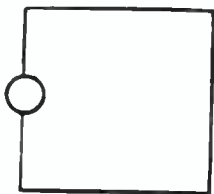

-FIG. 7-

directional effect is the same, regardless of the distance.

Another very commonly used antenna is the loop form, with two legs, or sides, grounded through different

values of inductance. This may be constructed in outward similarity to any of the preceding types, and its efficiency, directional and other properties depend upon the same considerations. In fact, the loop antenna operates in precisely the same way as does an ordinary "open" antenna, so far as the receipt of energy from a passing wave is concerned. After the energy has been captured by the antenna, the loop behaves in a very different manner from the ordinary antenna, but this is a matter coming under the head of receiving circuits rather than antennae, and so cannot be here taken up. Either the "T" or "L" antennae of Figures 4 and 5 may be made into loop antennae by simply bringing the two vertical leads down to the receiving instruments separately, instead of joining them as shown in the figures.

A fourth form of antenna, depending upon a distinctly different principle than the open antenna with ground connection, is the writer's ungrounded loop. This is essentially a simple closed circuit, in the form of a loop of wire enclosing a large area, erected in a vertical plane. Its operation depends upon the magnetic lines of force in the passing waves, rather than on the electrostatic component utilized by all other types. This is shown in Fig. 7.

An electrical wave has two components, one, the electrostatic, which has already been mentioned; the other, the magnetic. The magnetic component is everywhere at right angles with the electrostatic lines, the magnetic lines forming closed horizontal rings about the transmitting antenna. When a closed circuit in the form of a loop of wire in a vertical plane is placed at right angles to these magnetic lines of force, it is threaded thereby, and an electromotive force is set up in the circuit, resulting in a current flow around the loop. Essentially, its operation is that of a closed loop of wire in a dynamo armature, threaded by the magnetic flux from the polepieces. With the ungrounded loop antenna, the passing waves form the equivalent of pole pieces as they move past the loop, the magnetic lines first threading the loop in one direction, then ceasing, then threading the loop again in the opposite direction, and so on until the wave train has passed.

(To be Continued)

New Eiffel Tower Plant

By A. C. MARLOWE.

Paris Correspondent MODERN ELECTRICS

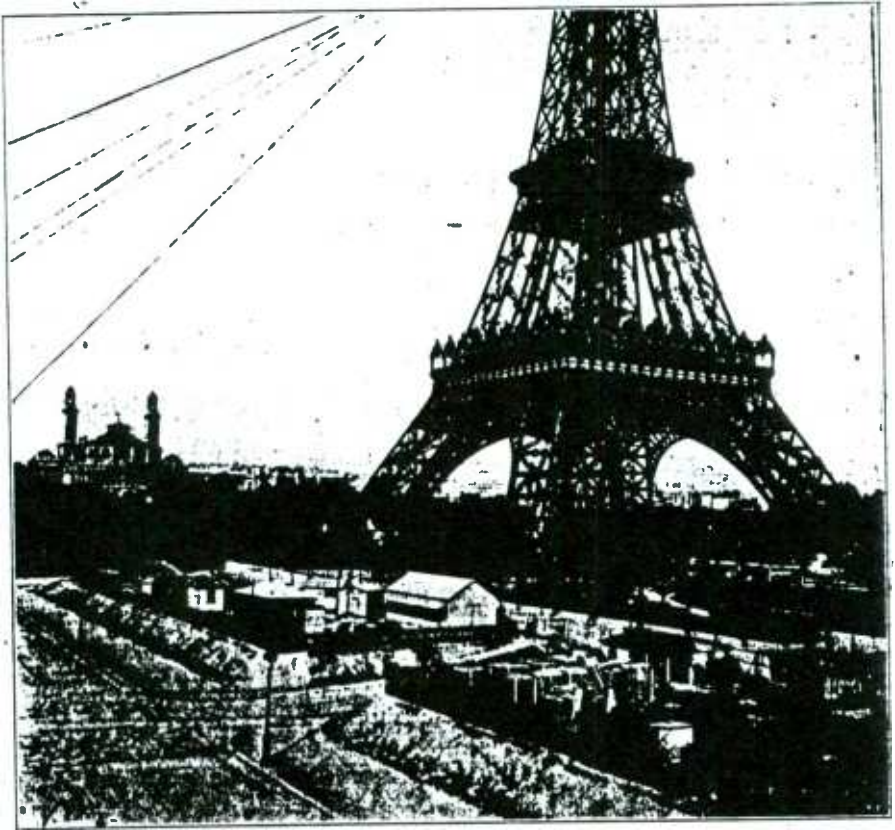

For some years past it was desired to increase the capacity of the plant at the Eiffel Tower, but it is only within the last few months that the work of building the new station has been actually carried out. What is desired in the present case is to provide a high power station which will be in keeping with the great height of the tower, 984 feet, so that the proper advantages can be secured. This is far from being the case with the small station which is now in use. It was only intended as a temporary plant at the time when it was installed some years ago, and as it has hardly over 15 horse power, the full advantage of a tower of this height are far from being realized. The plan of building a high power station which would use at least 100 horse power could not be realized for a long period, owing to the various difficulties which arose in official circles, and it was only during the last year that it was defin-

itely decided to erect the new plant.

Wireless matters in France are entirely under the control of the State, owing to a decision which was made some years ago. Some of the coast stations belong to the navy department, while the remainder of the coast plants and the interior stations are controlled by the War Department, including the Tower plant. Capt. Ferrié, one of the leading military wireless engineers, and a corps of efficient officers and aides, have charge of the present plant at the Tower, and the new plant is being erected according to Capt. Ferrié's plans. During the last summer a definite agreement was made between the War Department and the city of Paris, so that the new station could be built, and the work was commenced during the latter part of the year. It has been carried out during the winter, and the station building is now nearing completion. Nothing will be lacking to

make it a model station, and it will be by far the largest in Europe as regards the range. No doubt we will see some unusual results as to the distance to be covered, as this is the first time that we have the present conditions of high power and an aerial of such a great height.

It was decided to build the new station entirely underground, and this was done for two main reasons, the first of these being that the explosive report which is made by the sparks coming from such high power apparatus can be heard for a considerable distance from the station, and an outsider who is familiar with reading messages by ear can easily take the messages in this way. It is, of course, quite necessary that the messages sent and received by the Government should be kept secret, and in time of war this would naturally be quite important. By placing the station underground, the noise of the spark cannot be heard in the neighborhood of the station, and this difficulty will therefore be overcome. Another reason is that the noise of the spark explosion can be heard in the dwelling houses which border the Champ de Mars, and this would be quite objectionable, especially as the plant is operated during the night. For these two reasons it was decided to build the tower station underground. It is situated about 450 feet from the centre of the tower, and occupies a rectangular space of about 70 by 80 feet. Reinforced concrete was chosen for building the station. The accompanying photograph shows the appearance of the station in the present stage of the work, with the roofing completed. By the time the present account appears, there will be nothing visible above ground but the small central area which serves for admitting daylight and for the passage of the aerial wire.

As soon as the preliminary matters were settled, the work of construction was promptly commenced, as the War Department wished to use the new station with its increased range at the earliest possible date in order to be able to connect in the proper manner with the other stations in France which are situated on the coast, and also to allow the smaller plants to connect with Paris. This cannot always be done at present in the case of the posts which lie at some distance off, such as in the

Mediterranean region, and in Algeria and Tunisia, but when the increased range is secured by the aerial system, this will allow these posts to connect with Paris in turn. The aerial wires are to be laid out on a much more extensive scale than was adopted for the old plant.

As regards the plan of the underground station, we will mention some of the leading points, but the information as to these features is somewhat limited, at least at the present time, owing to the fact that it is impossible for anyone outside the military corps to visit the construction work. We are able to say, however, that the station is disposed so as to provide a series of chambers which surround a central area or small court, so that the latter will admit light to the different rooms and at the same time the principal aerial cable can be brought down through the middle space, where it will

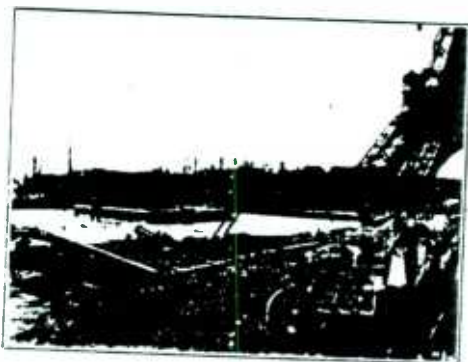

be connected to a large ground plate, this to be buried in the ground in the middle of the court. The surface of the ground plate is about 600 square meters. The various rooms which surround the court will be laid out to suit the requirements of the plant, both for the apparatus needed for the high power station and the accommodations for the personnel. Some of the rooms will be fitted out for the machines and storage batteries, others for the space telegraphy apparatus of different kinds. Provision will also be made for aerophony experiments, which will be one of the interesting features. As regards the apparatus to be used in the station, we expect to give as full an account as can be obtained, during the succeeding period of the work, as at present the station building is not completed. It is quite probable that the type of

electrolytic detector which is designed by Capt. Ferrié with telephone receiver will continue to be used in connection with the new apparatus, as it has given very good results in the old plant during the last year. The capacity of the new apparatus will be somewhere near 100 horse power, which will be much above what is used in the old station, as this does not exceed 15 horse power. The other part of the underground space will be fitted out for the personnel of the plant as well as for storerooms, etc. There will be employed about 20 persons, officers and men of the army corps, and suitable lodgings will be provided for these, kitchen, etc.

While the tower has a great advantage on account of its height, it is not so favorably disposed as to the placing of the aerial, seeing that it does not lie in the centre of an extended area and for this reason it is not possible to bring down the aerial wires around the tower on all sides in what is known as the "umbrella" form, such as we find in many stations of large size on

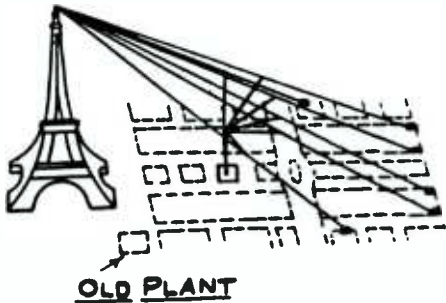

M.E.

the continent, the Nauen plant in Germany, for instance. In fact, the tower is situated on the relatively narrow tract of the Champ de Mars, and the width has been still further reduced within a recent period, by building houses on a portion of it. The tower lies at one end of the area and not far from the Seine, so that for this reason it is not possible to bring down the wires in a circle around the base of the tower. They can only be brought down on one side, and thus within a comparatively limited area. In order to give the greatest spread possible for the aerial cables, they are anchored in masonry columns which are situated at the farther end of the park, and here will be located four

pillars of this kind. Two additional pillars are to be placed at the sides and somewhat nearer the tower, as will be observed in the drawing, making six pillars in all. A 5-millimeter steel cable is used for the aerial. As the cables have a considerable weight, the proper means must be used for fixing them at the upper platform of the tower, and at the same time for insulating them properly. A good insulation is needed in this case, seeing that there will be a very high voltage on the aerial wire, and at the top of the tower this is estimated at 1 million volts. The best way of carrying this out is to use a separate insulator for each of the six cables, and in this way we can obtain the proper insulation without putting a too severe strain upon any one of the insulators. It would not be practicable to support all the cables from a single insulator, as the strain upon this would be too great. Each of the cables will be anchored at the ground in a separate column which will be built of masonry and at some height above the ground, so that the ends of the cables will be well out of reach, thus avoiding any danger to the public. The columns will be surrounded by an iron fencing for the same reason. A series of lighter cross-wires will connect the different aerial cables in order to form a network, after the usual methods. From each cable there will descend a wire, and all the six wires are connected together at a point lying directly above the underground plant, allowing a single wire to descend into the station.

As this is the first time that a tower of 300 meters has been used for an aerial telegraphy station, it will not be possible to predict the results which are to be obtained from it in the way of distance, but this will certainly be greater than what is covered by the existing plants. The first experiments to be carried out when the station is completed will be to send messages to America, and this will be very easily done. Messages are to be sent to the station which is already erected in New York for this purpose. As to the distance which can be covered, it has been thought that messages can be sent nearly around the globe. At any rate, we may expect some unusual results. The Tower plant will occupy

(Continued on Page 101.)

First Aerophone Automobile

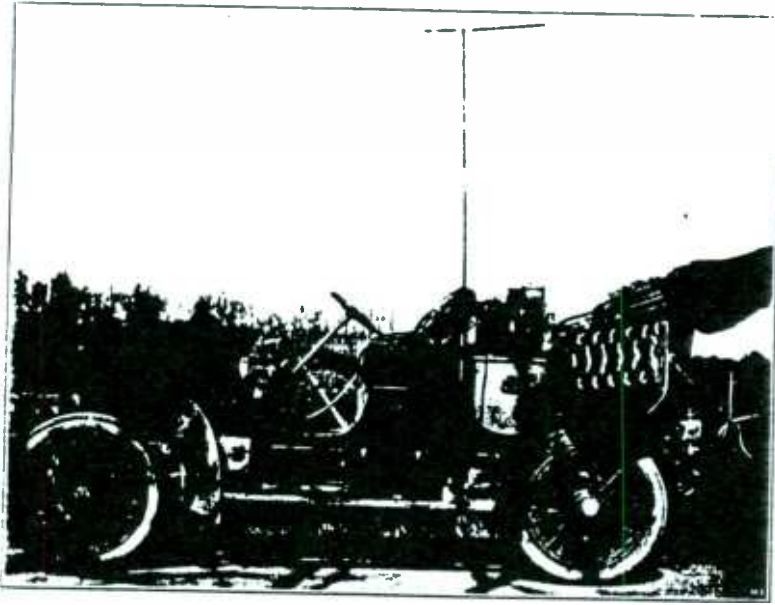

The Radio Telephone Co. has recently performed some interesting experiments in Aerophony between a running automobile and a stationary plant. A short mast about 10 feet high was used as Antenna, while the "ground" was made by trailing a metallic net behind the automobile. The experiment was an entire success. Speech was transmitted both ways up to two miles. The voice at all times could be made out distinctly.

A Powerful Electro-Magnet For Batteries

BY H. W. SECOR.

The writer was once called upon to make an electro-magnet, to be used on dry batteries, for lifting purposes. The magnet proved so efficient that he has given the data on same for the benefit of MODERN ELECTRICS' readers, who might wish to make one.

Get a piece of 9-16 inch round, soft wrought iron bar, long enough to bend to the shape shown in illustration, making the cores and yoke. The armature is a piece of wrought iron also.

Make two sheet iron sleeves, No. 24 gauge, 4½ inches long, which will just fit over the iron cores. Four fibre washers for spool ends, are made and held in place on the iron sleeves, by means of the 4 brass washers shown, 1-32 inch thick, soldered to the sleeve ends. Taper off the pole faces 1-32 inch all around, leaving a magnetic contact face ½ inch diameter.

The magnet spools should now be covered with 2 layers paper (4 mil.) between the spool ends, shellac, place in lathe, and proceed to wind on in

even layers 14 layers, No. 22 B. & S. S. C. C. magnet wire. Place spools on magnet cores as shown, and connect them in series, so that the resultant magnetic poles will be N. & S. This may be easily tested with a compass.

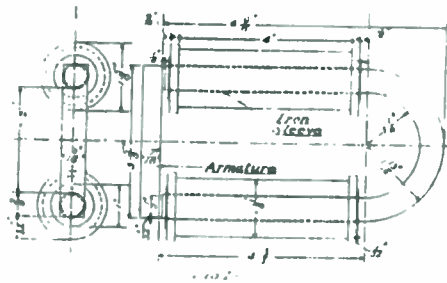

The two pole faces should attract opposite ends of the compass needles.

In an actual test on 10 dry cells (15 volts) the magnet took 0.95 ampere, and developed a lifting power of 50 lbs. Of course, the strength will vary with the number of cells used.



A Magazine devoted entirely to the
Electrical Arts.

PUBLISHED MONTHLY BY

Modern Electrics Publication
NEW YORK CITY, N. Y.

H. GERNSBACK, EDITOR.

Subscription Price: For U S. and Mexico
\$1.00 per year, payable in advance.

New York City and Canada, \$1.25.

Foreign Countries, \$1.50 in Gold.

Stamps in payment for subscriptions *not*
accepted.

Checks on out of town Banks cannot be
accepted unless the usual exchange is
added.

SINGLE COPY, 10 CENTS.

Forms close the 20th of the month pre-
ceding date of publication. Advertising
rates on application.

The Editor will be pleased to receive
original contributions of timely interest
pertaining to the electrical and the affil-
iated arts. Articles with good drawings and
clear photographs especially desired. If
accepted, such articles will be paid for on
publication, at regular rates. No manu-
scripts will be returned unless return postage
is enclosed.

Address all communications to:
MODERN ELECTRICS PUBLICATION
84 West Broadway, New York, N. Y.

Chicago Office: 113 Dearborn Street

Paris Office: 136 Rue d'Assas.

Brussels Office: 23 Rue Henri Nass.

Copyright, 1909, by MODERN ELEC-
TRICS PUBLICATION.

Entered as Second Class matter March 31, 1908, at
the New York Post Office, under the Act of Con-
gress of March 3, 1879.

Vol. II. JUNE 1909. No. 3

EDITORIAL.

This is a talk on advertising, and
should be carefully read by every read-
er who has the welfare of MODERN
ELECTRICS at heart.

Did it ever occur to you when you
send your subscription to us, for which
you pay one dollar, that it costs us ac-

tually over \$1.25 to get up 12 single
issues? In other words, on each sub-
scription we sell, we lose 25 cents.
The printing of each single number
costs us over 6 cents. Then comes the
expense of cuts, photographs, mailing
expense, honorary of the many articles,
salaries paid to foreign correspondents,
office expenses and a hundred smaller
items, each adding to the cost.

Our large news stand circulation is
still more unprofitable, as we must sell
each copy for 5 cents to the news com-
pany handling the magazine. We lose
about 6 cents on each copy we sell.

We, therefore, must rely on our ad-
vertising pages to cover our expenses,
the same as every magazine. There is
not a paper printed which could exist
without its advertising. No matter
how good or how well gotten up a
magazine is, it must rely on its adver-
tising pages or perish.

If you are a good observer the
fact cannot escape your eyes that
usually the magazines carrying a great
amount of advertising present their
readers with an abundance of text mat-
ter, as they can well afford to do so.

On the other hand, the large amount
of advertising obtained was solely due
to the reader's efforts to help the mag-
azine, as the magazine has helped and
instructed the reader. We wish to im-
press the important fact on every
reader that there is something equally
as important about a magazine than
merely perusing its text pages. There
is such a thing as duties of the reader
towards his magazine.

If you buy a wireless outfit you do
not buy it for the sole purpose of look-
ing at it, but *you wish to bring out its
best points.* It is your duty to bring
out its best points, and you knew this
before you bought it. By buying the
outfit you assumed a certain obligation
towards same, as it were.

The same with your magazine. You
wish to bring out its best points, nat-
urally. You assume a certain obliga-
tion towards it, as soon as you start
reading it. Like the wireless outfit, it
will not "go" without your co-opera-
tion and without your assistance. You
must help and co-operate if you wish
to see this magazine to be the greatest
of its kind.

Consider the advertiser for a second.
He buys a page which is worth thirty-

five dollars, or smaller space at a proportionate figure. Like yourself, he has no money to throw away. *His advertising must pay him*, or else he is forced to seek a publication whose readers are known to take as much interest in the advertising section as in the text.

The reader should always bear in mind when perusing advertisements that the advertiser displaying only one or two articles, usually makes or handles probably a great many more, and while the reader will not always need the few advertised articles, he would unquestionably find what he really needed in the catalogue or literature, procured from the advertiser.

There are advertisements which very likely do not interest you at all. However, if you really knew what the advertiser had to say you would quite likely change your mind.

Most advertisements are like a theater curtain. You may not particularly like the curtain, but once it is raised you forget the curtain, and your interest is centred on the stage.

The same with the average "ad." It usually hides a good catalogue, and it is your duty to possess it.

As this magazine *absolutely guarantees* the reliability of its advertisers, every reader is fully protected. It is impossible for any one to lose money sent to advertisers, as MODERN ELECTRICS makes good every time.

There are several cases on record where this magazine has refunded money to readers who sent money to advertisers who became bankrupt during the panic last year.

Most readers would be astonished to know how much advertising is refused right along from unreliable persons or for "scheme ads," etc.

You never see in the advertising section patent medicine advertisements, "electrical" hair combs and other impossible schemes, which only serve to extract money from credulous readers.

If you see a doubtful advertisement in this magazine you may rest assured that it is not doubtful at all upon investigation. Each will stand the "acid test." If you do not believe some of the statements made, do not discredit the advertisement, but let the advertiser "show you." He will be only too glad to do so.

And, before all, do not fail to get all the catalogs and literature you see advertised. You will need them when you least expect it, and before all you will save money.

And then, when sending your order maybe weeks or months later, do not fail to say that you became acquainted with the advertiser through MODERN ELECTRICS. It will pay you, him—and us.

TO DESTROY BATTLESHIPS WITH MAGNETS.

Naval Constructor Hollman, of the German Navy, has patented a device to destroy battleships of the Dreadnought class. Compared with this newest engine of war the Zeppelin dirigible airship, which aims, among other things, to drop explosives on an enemy's ships and towns, seems harmless.

Hollman's device is an enormous electro magnet capable of being charged up to 20,000 volts. With such a magnet, he says, he can attract by magnetic attraction any battleship within a radius of seven miles. He believes that a magnet can be made powerful enough to attract a whole fleet of warships and draw them into shallow water, where they will run aground and be at the mercy of heavy artillery ashore.

Hollman declares most seriously that the amount of metal in the battleships of to-day will only intensify the force of his magnets. Anchors and the ship's engines will be powerless, he says, against the magnet's attractive force.

The magnet, or a battery of them, should be established, according to the ideas of Naval Constructor Hollman, at the mouth of a river or in some favorable submerged position along the coast where the enemy could not readily detect it.

The rest is easy. Along comes a hostile fleet to blockade a port or bombard a town or even steam up the river. The moment the ships get within magnet-range the operator in charge of the station turns on the power and the ships are drawn to the shore, to be captured or demolished.

There are electro magnets in several of the German shipyards capable of lifting a dead weight of 50,000 pounds. The Hollman magnet is designed to lift a battleship.

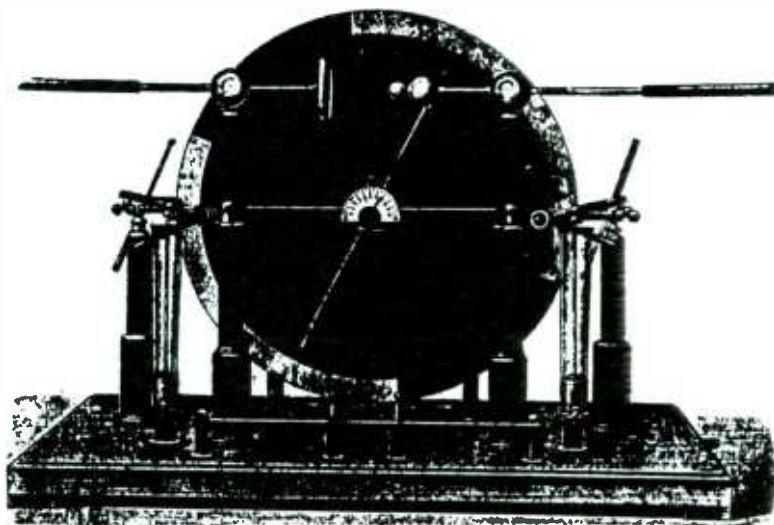

A Modern Static Machine

BY OUR BERLIN CORRESPONDENT.

The present engraving shows one of the latest large static machines, furnishing—contrary to other like machines—pure “direct current,” in “continuous sparks,” the same as a spark coil.

The middle plate is fixed while there is a rotating plate at each side, rotating in opposite directions to each other.

These machines are made especially for X-Ray work, for which direct current is required.

The large size machine gives a spark 200 millimeters (11 inches) long and a tension of 135,000 volts. A current of 500-600 micro-amperes is furnished. The diameter of the rotating plates is 55 centimeters (21½ inches) 1-6 h. p. is used to operate the machine.

CONSTRUCTION OF SMALL SWITCHBOARDS.

It is annoying to have to unscrew a small laboratory switchboard in order to wire it for a new instrument or to test a circuit, but this can be easily avoided, and a neater appearing job can be had by hinging the switchboard to the wall. The hinges are attached to one side of the board and all the wires of the board are led to this side, where they are bunched and a piece of “Circular Loom” slipped over them. In this way they do not interfere with the swinging of the board. A small hook and screw-eye are used to hold the other side of the board to the wall. By swinging the board out, all the wiring is exposed to view, and any instrument may be installed, or any circuit tested, without the inconvenience of taking down the board.

J. M. WALSH.

NOVEL ELECTRIC SAFE ALARM.

A very effective alarm for a safe is made as follows: An arc carbon is hung from a spiral spring in such way that it bears very lightly upon the end of a screw with a platinum point. A battery and galvanometer are connected through the contact and with an adjustable resistance in circuit. We adjust the latter so that the galvanometer needle comes to zero, and lies in the middle between two contact points without touching them. Should the carbon contact be disturbed, the needle comes against one of the contacts, and this is made to ring a bell at a distance. Should the wire be cut, the result is the same, as the circuit is opened. If the two outside wires are connected together so as to short circuit the device, this action cuts out the resistance and the needle comes against the second contact, owing to the increased current.

Concerning Storage Batteries

By C. C. WHITTAKER.

An accumulator, storage, or secondary battery is a battery in which chemical and *not* electrical energy is stored. The process of charging with an electric current is merely changing the state of aggregation of the chemicals contained in the cell. After a cell has been discharged the chemicals therein are inactive. It now remains for the electric current from some outside source to decompose the inactive substance and to reunite the products of decomposition so as to make them chemically active with reference to each other. This process is called "charging" the cell. Before proceeding with the way that this is accomplished we will consider the make-up of the cell.

The lead-lead storage battery has an odd number of plates, usually one more negative than positive. This brings a negative plate at each end of a series of plates, as in Fig. 1.

The negative plate consists of a lead "grid" or framework, in the interstices of which is placed a paste made of litharge (oxide of lead) and sulphuric acid. The positive plate is filled with the red lead. On forming the litharge of the negative plate changes to metallic "gray" lead; that of the positive plate changes to peroxide of lead.

Gray lead, or "sponge" lead, as its name implies, is of a slate color and is easily scored with the finger nail. It is an allotropic form of metallic lead and may be reduced to the latter state by heat.

The positive plate, now containing the peroxide, has a velvety, chocolate-brown appearance and is very hard. Only a bright surface on either of these grids will be affected by the sulphuric acid, because, in its action with lead, it forms an insoluble sulphate coating which protects the grid from further reaction.

The electrolyte, or solution, consists of one part of chemically pure sulphuric acid, H_2SO_4 , diluted with five parts of distilled water. The acid should always be poured into the water. The specific gravity of the electrolyte of the cell when charged should be between 1200° and 1250° .

When either sponge lead or peroxide of lead is in the presence of sulphuric

acid, there is a reaction between the two, provided the circuit is closed, by which both the sponge lead and the peroxide are changed to sulphates. These reactions are represented below:

(Negative plate) —

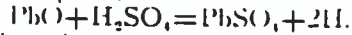

(Positive plate) —

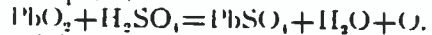

By adding these equations we obtain the equation of charging and discharging.

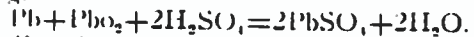

For charging, the equation is read toward the left; for discharging it is read

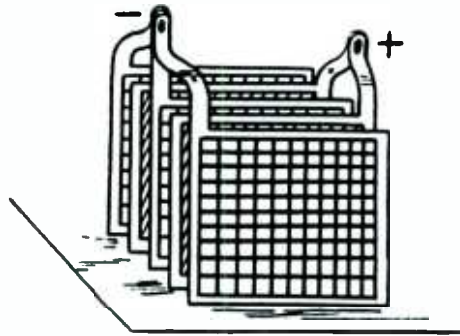

M.E. -FIG 1-

toward the right.

From this equation it will be seen that part of the sulphuric acid is decomposed, going to make lead sulphate and water. This water dilutes the electrolyte and thereby reduces its specific gravity.

Lead sulphate is a white powder of extremely low conductivity. Should much of this be formed, the internal resistance of the cell would be greatly augmented and thereby lower its efficiency. There is also another serious trouble which arises from lead sulphate. This chemical requires much more space per unit weight than either gray lead or peroxide of lead; accordingly, if much of this is formed, and more especially if formed quickly, "buckling" of the plates results. If this proceeds far enough it may cause an internal short circuit or may cause the active material to become loosened from its grid, technically called "shedding."

Buckling results when the cell is discharged too quickly, when it is over discharged or overcharged. When the voltage drops below 1.8 it is a sign that the cell needs recharging. This should be a danger signal which should always be heeded.

Fig. 2 represents the charge and discharge of a cell diagrammatically. The time of charge and discharge is plotted along the horizontal axis; the voltage along the vertical axis.

Charging, except when forming the plates, begins at about 2 volts; then rises to 2.3. At this point gas is evolved. The voltage remains nearly constant now for several hours, when it begins to rise rapidly till it reaches 2.5 volts and sometimes 2.8. On opening the charging circuit the voltage rapidly falls to 2.2. On beginning the discharge it falls to 2.05. In about a quarter of an hour, the voltage is down to 2. Here it remains nearly constant till it reaches 1.9, when it begins to fall suddenly. At this point

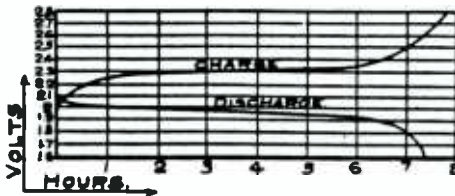

-FIG. 2-

M. E.

the cell should be recharged.

The "formation" of the cell takes considerably longer than for an ordinary recharge. The time varies between 35 and 45 hours. The current used for forming, and likewise for recharging, should be about 10 per cent. higher in voltage than the subsequent output of the cell. From 8 to 10 amperes are allowed per square foot of surface on the positive plates. More than this will not hasten the reduction of the lead oxide but will be wasted in decomposing the water in the cell. This phenomenon is technically known as "boiling."

After the cell is first formed, it should be half discharged and then recharged for three or four times. It does not attain its maximum efficiency until this has been repeated about twelve or fourteen times.

Ordinary recharging takes about ten hours. When the cell is charged to its full capacity, the electrolyte assumes a

milky appearance, due to the oxygen liberated at the positive plate. This shows that this plate has absorbed as much oxygen as it is capable of. Toward the end of the charging process, the voltage may be increased to 15 per cent. or 20 per cent.

The ampere hour capacity of a cell may be roughly calculated from the amount of active material upon the plates. For one ampere hour, to be discharged in eight or ten hours, .53 ounce of active material is needed on each plate if the cell is made up of two plates; half this quantity is needed on each plate if the cell is made up of four plates, etc. For a five hour discharge rate, .6 ounce is allowed; for a three hour rate, .7 ounce; for a one hour rate, 1 ounce.

The storage cell requires constant care. The specific gravity of the electrolyte is continually fluctuating on account of evaporation and chemical action. More water and acid must be added if the surface of the solution is less than one-half inch above to top of the plates. Failure to do this will result in injury to the plates.

CARBON MELTED AT LAST?

An Italian scientist, M. de la Rosa, finds that the singing arc under some conditions has a higher temperature than the ordinary arc. In a paper presented to the Academie des Sciences, he describes his experiments upon the fusion of carbon at this high heat, and by placing powdered carbon in the arc he claims to have melted it and even to have obtained minute crystals which he hopes to prove are of the same nature as the diamond, should he produce enough of them to make a conclusive test.

W. A. O. A.



The Wireless Association of America, headed by America's foremost wireless men, has only one purpose: the advancement of "wireless."

If you are not a member as yet, do not fail to read the announcement in the January issue. *No fees to be paid.*

Send today for free membership card. Join the Association. It is the most powerful wireless organization in the U. S. It will guard your interest when occasion arises.

The Magnetoscope

This is a new French article, and is used to measure comparatively the magnetic strength of magnets of same size and of same dimensions.

This instrument will be used widely by manufacturers who use large quantities of magnets, and who desire to produce absolutely uniform goods.

The instrument is furthermore used to verify the conservation or the loss of the magnetic strength, after a first reading has been taken.

This instrument is not electric; it is, in fact, very simple, having nothing but a spring, hand and soft iron movable armature.

The magnetoscope is placed between the two poles of a magnet, as our engraving shows. It will be seen that the dial containing the numbers does not move, but when grasping the rim of the instrument, the mechanism bearing the hand, will turn in either direction.

At a certain point there will be rupture. the hand returning abrupt-

ly to zero. This is occasioned by the counteracting effect of the spring, which at that point overcomes the magnetic attraction of the magnet.

The number obtained at point of

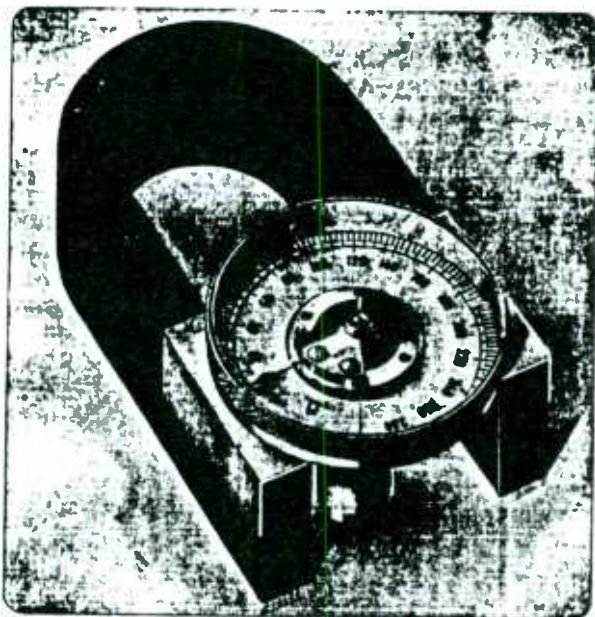

rupture is carefully noted and inscribed on the magnet for later reference.

YOUNGEST WIRELESS OPERATOR.

When the Mallory line steamer Nueces came in she brought with her the youngest operator who ever worked the wireless telegraph on shipboard. He is Master Raymond Caldwell, of Tampa, Fla., who was working in the place of the regular operator.

Young Caldwell is 15 years old.

When the Nueces reached Tampa a couple of weeks ago the regular operator became ill. There was no person to take his place and the company appealed to young Caldwell to make the trip. It was his first voyage and he was sick the last three days. He has enjoyed the experience, but says he prefers a good job on land to one on the ocean deep. He hopes the sea will smooth down for the return trip.

WIRELESS VS. WIRE TELEGRAPH.

The French Government is taking measures to provide for cases where the telegraph should fail, as for instance, during the recent strike of the employes, as it is feared that similar troubles may occur in the future. Wireless messages will be sent in such cases, and a good system is now being organized for the purpose. This will be completed before the 1st of June, as at this time there are some disturbances to be expected. The idea is to send war vessels provided with apparatus and have a vessel stationed at each of the principal ports on the channel, the Atlantic and the Mediterranean, so that the whole country, with Paris as a centre, will be covered in this way.

Correspondence

H. Gernsback, Editor,
New York City.

Dear Sir:

I am enclosing herewith the diagram of looped aerial connections that I am now using. I at first used the circuit outlined in a recent issue of MODERN ELECTRICS, but found it was too hard to handle on account of the variable condenser which had to be very carefully adjusted to get any good results.

This method of connecting is used by the United Wireless Company in most of their stations, and I think it is about the best yet. My aerial at the present time is but 28 feet above the ground and but 6 feet above the roof of the house.

I have heard all the large stations in the vicinity and all the stations in and about New York. Cape Henlopen, Atlantic City, Fire Island, Washington, D. C. (Q. I.) and other commercial stations.

It is comparatively easy to construct the tuning coils in this set, but extreme care must be taken with the condenser,

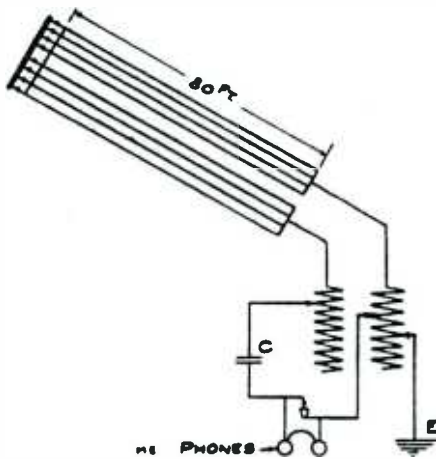

I experimented a long while before I found the correct capacity. There should be 180 square inches in the two plates. The rolled type is the best to use, though fair results can be had with other types.

My aerial is of No. 20 Galvanized Iron Wire, seven strands (four on one tuner and three on the other) and is just 80 feet long.

My headphones are of the single pole type wound to the resistance of 3,000 ohms. I use the Silicon Detec-

tor, as I found that the above tuner works best with it.

Hoping that it will be of interest to some of the readers of MODERN ELECTRICS. I am,

Yours truly,

E. L. McCaskey.

Darby, Pa., May 22, 1909.

H. Gernsback, Editor.

Dear Sir:

A short time ago I performed an unusual and interesting experiment. It was in the evening, I desired to construct an indoor wireless outfit, but the spark coil was not in working order, so I decided to try a static machine instead. The sending and receiving stations were on tables about twelve feet apart. The aerials were of No. 16 bare copper wire, about eighteen inches long, and the ground was a single No. 24 copper wire. The sending station consisted of a Holtz static machine and the receiving station of a detector, battery, and telegraph sounder. I had no good receiver. The detector was the one described on page 352 of MODERN ELECTRICS. The sounder worked a few times, but the metal parts became so heavily charged that it would not move. I kept the static machine running, and soon noticed something peculiar in the air. The sparking between the balls stopped and the atmosphere of the room became heavily charged with electricity. As I stood by the sending aerial I could feel the electrical action working strongly in my hair; there were two people with me, and the action was felt in the farthest parts of the room. All the iron-work nearby was so heavily charged that one could get a spark by holding out his hand towards it. The spark thus received made a snapping noise, but gave no shock. I tried to readjust the sounder, but it would do nothing but give me sparks.

The experiment was repeated a few nights later, but the result was the same. I then tried to use a Levdén jar for sending, but when charged and connected to ground and aerial it would give no heavy spark, as usual, but a stream of small sparks would pass between the ball and the discharger.

I remain, yours very respectfully,

H. L. CARVER.

Marion, Iowa, April 19, 1909.

A Handy Switch

BY H. GERNSBACK.

The writer was once called upon to devise a small automobile switch which should do the following:

Turn on the electric headlights, then headlights and sidelights, then sidelights and tail-light, all lights together, or else each set of lights independently from all others.

The problem was not as easy as it looked and after several trials the writer constructed the switch as shown in illustration.

L represents the switch arm which, at the free end is widened contrary to usually switch arms. Three recesses are formed (see separate sketch) which engage with the switch points.

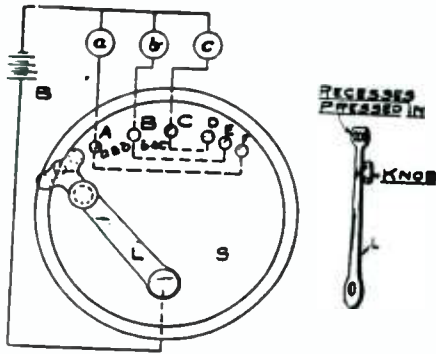

M.E.

Points A, B, C, are spaced evenly and are just far enough apart that the two end recesses of the switch arm cover either A and B or B and C. C, D, E and F are spaced in such a way that the recesses of the switch arm will either cover C, D and E, or D, E and F.

Connections are made as shown.

If the center of switch arm is at point A, the light a (or lights) will light. If the arm covers points A and B, lights a and b light. At B only b alone lights. Over B and C, b and c will light. At C, light c only lights. At E, a, b, c, or all lights are connected.

When used as automobile switch, a represented the headlights; b, sidelights; c, tail-light.

This switch will prove very handy for wireless work and for other purposes as well.

Any experimenter can make it with-

out much trouble. The switch arm, L, is made of a stiff piece of brass strip. The recesses are formed by means of a blunt iron or steel point. The base, S, may be of wood or hard rubber. Switch points are obtained from any house carrying experimenter's supplies, at trifling cost.

Connections should be made from the back, of course.

LIGHTNING DETECTOR.

The other day while experimenting with my wireless outfit I found that I could hear lightning flashes about 10 miles distant far better without a detector than with one. First I connected one dry cell in series with detector and telephone receiver (75 ohms) but could only faintly hear the flashes, then I used detector without battery with a little better result. Lastly, I used telephone receiver alone connected with aerial and ground, and could hear every flash plainly.

I wish some readers would try the same experiment, using a tuning coil. I think better results might be obtained.

ROBERT F. ADAMS.

NEW EIFFEL TOWER PLANT

(Continued from Page 94)

a leading position among the European stations, and not only will it be able to connect with all the posts on the continent, but many of these latter will now be brought within range so as to signal to Paris, which cannot be done with the present aerial. The wave-length which is to be given by the station will probably be in the neighborhood of 6,000 feet.

W. A. O. A.

The Wireless Association of America, headed by America's foremost wireless men, has only one purpose: the advancement of "wireless."

If you are not a member as yet, do not fail to read the announcement in the January issue. *No fees to be paid.*

Send today for free membership card. Join the Association.



“Via Wireless”



Courtesy N. Y. Times.

Paris Letter

RECENT AEROPHONE WORK.

Some interesting experiments in aerophone work were carried out not long since between the Eiffel Tower and a plant which is located at Melun, some 30 miles distant. This is not the first time that the aerophone has been made to work between these two points. Dr. De Forest had successful results in this case during his visit to Paris, and during a recent period two officers, Lieutenants Jeance and Colin, were able to cover the distance with apparatus designed by them. However, the apparatus which they used was designed on the Poulsen principle. In the most recent experiments between Paris and Melun, they used an apparatus which is said to be designed on a new principle, departing from the methods usually employed for aerophone work. The principle of the new apparatus is kept secret. An official test was carried out in which the Minister of the Marine was stationed at Melun and received the message. These were very clear and distinct, and there are no outside noises heard in the receiver to

interfere with the sounds of the voice. The results from the new apparatus are very encouraging, and further experiments are to be carried out in the near future.

PARIS - AMERICA WIRELESS NOW.

Not long since, the Eiffel Tower plant succeeded in making connection with the station at Glace Bay, Canada, and was thus able to send messages for the first time across the Atlantic, at a distance of over 3,000 miles. This was carried out with the present low-power plant, as the new station has not yet been completed. Messages could be caught which were being sent from Glace Bay to Cliffden, in Ireland, these two posts being 2,500 miles apart. The present results were obtained by Capt. Ferrié.

TIME BY WIRELESS TO SEA.

Some time ago the question came up at Paris of transmitting the time to vessels at sea by wireless, and it was decided to carry this out, as it would be a great benefit to the marine.

Accordingly measures are being taken to install an apparatus of a special design upon the Tower. Signals will be sent at midnight so as to indicate the hour. The war vessels of the fleet as well as other vessels equipped with wireless posts will receive the time each day in this way. The Paris Observatory will transmit the time to the tower by telegraph. Parliament has recently voted a credit for the purpose of establishing the system.

NEW FRENCH BATTERY.

Among the recent French electrical patents is a primary battery which utilizes scrap iron. It is patented by V. Jeanty (No. 391,322). The battery is claimed to give a steady voltage for a considerable time. The cathode consists of iron scrap which fills a compartment, in which is a copper wire which acts as a conductor. A double sulphate of iron and ammonia forms the cathode liquid. For the anode there is used a porous vessel containing a carbon electrode. When the battery works, the iron combines with the sulphuric acid of the salt in order to form sulphate of iron. Ammonia is thus given off, and it acts to decompose the sulphate of iron, thus regenerating the sulphate of ammonia. The iron is precipitated in the form of oxide. Owing to this effect, the liquid of the cathode remains constant and does not need to be renewed. In the porous cup with the carbon anode is placed strong sulphuric acid with a little bromine, and the latter serves as a depolarizer. Hydrobromic acid is formed, but this is acted upon by the sulphuric acid so as to set free the bromine, and the sulphuric acid is reduced to sulphurous acid. The battery thus works for a long time without removal of the liquid.

NEW MULTIPLEX TELEGRAPHY.

Experiments have been carried on with Prof. Mercadier's system of multiple telegraphy between Paris and Marseilles, a distance of over 500 miles, with good results. The principle of vibratory currents is employed. On the same line there are placed a number of vibratory transmitters and at the other end a like number of receivers. The transmitter is composed of a tuning fork, which is made to vibrate by an electromagnet and it sends a

pulsatory current into the line. For the receiver there is used what is known as a "mono-telephone," consisting of a metal disc of some thickness which is substituted for the usual diaphragm, and it is held fixed in such way that it will only vibrate and give a musical note when a current of a certain frequency is received, corresponding to the pitch of the tuning fork at the other end. We thus have a selective system. Fork No. 1 acts together with mono-telephone No. 1; fork No. 2 with mono-telephone No. 2, and so on. All the currents from the forks can pass over the line without interfering, and are selected out by the mono-telephone. To make the signals, we use a key in the circuit of each fork so as to make Morse signals, and these are read by ear in the mono-telephone. From 12 to 18 messages can be sent over the line at the same time, and these do not interfere with each other, seeing that the mono-telephone is only sensitive to the pulsatory current coming from one particular tuning fork. A double line is needed in this case, but Prof. Mercadier stated to the writer that he was making tests with the aid of the Government between Paris and Lyons with a view of using a single line wire and a ground connection. In practice the mono-telephones are mounted so as to work as relays and to close a local circuit. This is done by causing the strong vibration of the disc to produce a mechanical action, and to push up the end of a lever which rests upon it, thus breaking contact between the disc and the lever.

STERILIZING MILK BY ELECTRICITY.

Some interesting experiments are being made at the Paris University by Prof. Henry with the mercury vapor lamp in quartz tube. While a glass tube cuts off ultra-violet rays, the quartz allows them to pass, and these rays have a high intensity. He succeeds in sterilizing milk by treating it with the rays for a short time. The effect of the rays is remarkable in many ways. Cancer upon animals can be cured by a few exposures to the rays. A most practical result is that of sterilizing water, and the action of the rays is very efficient in destroying the microbes.

Wireless Department

A Perikon Detector

By LEWIS W. KLOPPER.

Of the many detectors that have been invented and are being invented daily, few have found so much favor as the perikon. Many of the Government and commercial stations are using the perikon type now. This is due to its simplicity of adjustment, construction and operation.

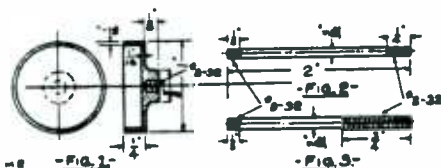

It consists primarily of two metallic elements having a variable contact with each other. Its action is twofold: with a battery in circuit it is like a coherer, while without a battery the action is thermo-electric.

This detector also proves the ideal one for the experimenter. Several private stations about Washington, D. C., are able to hear the large 35 K. W. station at Key West, Fla., very clearly by use of this detector, a distance of about nine hundred miles.

To make this detector, two brass cups, as shown in Fig. 1, must be turned. These are to hold the elements. A hole

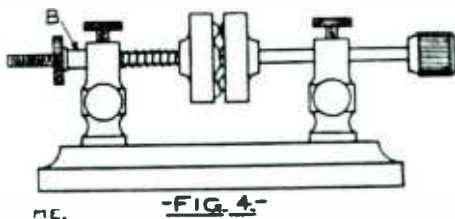

is drilled in the back of each and tapped with an 8/32 thread to receive the end of the rods, Figs. 1, 2, 3. The rods are threaded, as shown.

A base of some hard wood is made, dimensions 4 inches long, 3 inches wide, 1/2 inch thick. Holes for the binding posts are made in the middle of the base, 3/4 inch from either end. The posts

should be of the double type. The holes through which the rods pass will have to be reamed out a little in order that the rods may fit. The points of the thumb screws on the top of the post will need to be filed off flat that the necessary purchase may be obtained on the rods.

The minerals used are zincite and copper pyrites. They are to be obtained from supply houses at small expense. The cups should be filled with melted solder and the crystals pressed into this

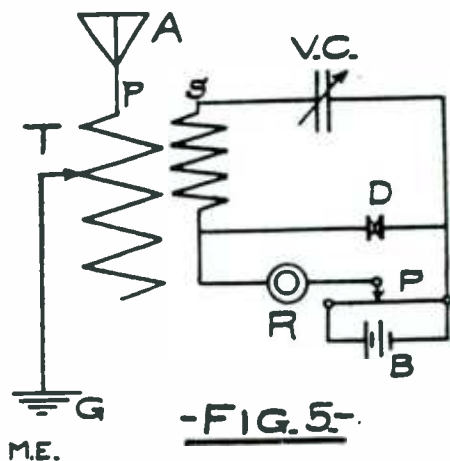

while it is hot. About five pieces should be put in each cup, all of one kind being placed in the same cup. A rubber handle is placed on one end of one rod after the cup has been placed onto the other end. The other rod is mounted with the other cup and the adjustment screw and spring, to vary the contact between the elements. A small piece of brass tubing B acts as a bushing between the thumbnut and binding post.

The finished instrument should appear as in Fig. 4. To get the best results two thousand ohm phones should be used. The connections are made as in Fig. 5. The detector is at its best when sounds from a buzzer are heard the loudest. When once adjusted this detector gives

excellent results. For long distances one dry cell and a potentiometer must be used to furnish the current. Two dia-

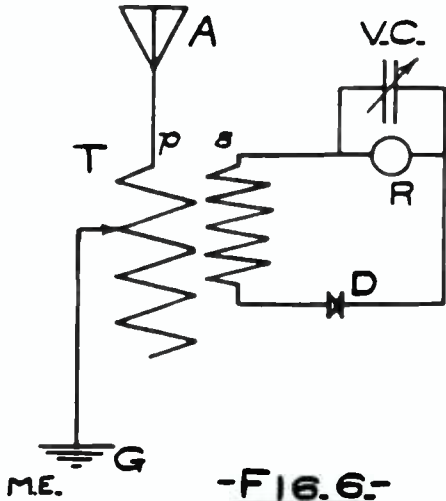

-FIG. 6-

grams are given for connections, and either gives good results.

NO WIRELESS DANGER.

LONDON.—William Marconi has sent an interesting letter to The London Times with reference to various statements in the English medical press dealing with "certain noxious physical effects alleged to be produced upon wireless telegraphic operators in the course of their employment."

Mr. Marconi declares that his own experience supplies no evidence whatever in support of the report "of a medical officer in the French Navy, who is pleased to attribute to the practice of wireless telegraphy the occurrence within his observation of various cases of conjunctivitis, keratitis, corneal ulceration, leukoma, functional cardiac, and other formidable-sounding maladies, and continues:

"During the 12 years or so of our operations we have had to deal with no single case of compensation for any injury of this origin, nor, so far as I can ascertain, has any such injury been suffered. Speaking for myself, I may remark that my own good health has never been better than during the often extended periods when I have been exposed for many hours daily to the conditions now challenged, and in the constant neighborhood of electrical discharges at our transatlantic station: which, I believe, are the most powerful in the world."

"I observe that at least one daily newspaper seems to have pressed the reports to which I have alluded into the service of a further theory that electric waves as used in wireless telegraphy may be harmful not only to the operators, but to the world at large. This suggestion is a very familiar one to me, but hitherto, I confess, it has reached me only through the letters of the insane persons who occasionally besiege me with accusations and threats in respect to the tortures which they imagine me to be continually and of malice aforethought inflicting upon them by the practice of wireless telegraphy."

A SIMPLE HOME MADE BATTERY.

A simple battery may be made by procuring two plates of carbon eight by four and 1/4 inch thick. Also a zinc plate of the same size. The zinc plate is placed between the carbon plates and separated from them by 3/8 inch. The two carbon plates are connected together. A clamp may be made by using two pieces of paraffined wood or other acid proof and insulating material. Each seven inches long, four inches square and two pieces seven inches long, 1 by 3/8 inches. The two 1 inch pieces are placed on the outside

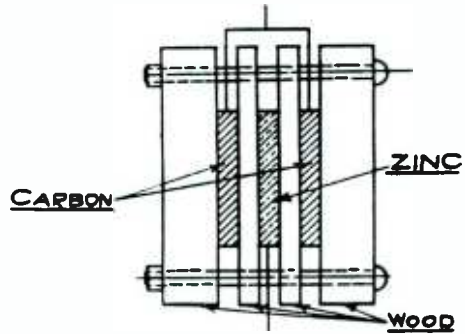

M.E. -FIG. 1-

and the plates are fastened in between. Four-inch bolts will hold these together. A glass jar six by eight inches is used. The solution is made of dissolved sodium bichromate with a gallon of water, and adding slowly a pound of strong sulphuric acid. When it begins to get weak add a little more acid. The plates should never be left in the solution unless in use.

Contributed by
GEORGE C. EDMINSTER.

Wireless Recorder

By CLARENCE W. WINCHELL.

There are, at present, many amateurs who give up experimenting because they could not read the signals. Because of this reason their instruments were discarded, but if they rescue a few of the useless instruments they may, with little work, make a recorder. The standard ink writer on the American market is out of reach of nearly every amateur experimenter.

If you pick out some of the old instruments, such as the coherer, decoherer, choke coils, tuner, relay, motor, brass pieces, telegraph sounder and the dry cells that are now used to run the little motor which is in danger of burning out most of the required material is at hand. Then repair to the tool kit for solder and the wood working tools. Get a tin baking powder can and your neces-

piece of rather heavy wire or brass strip, which may be soldered or screwed to one side of the armature of the sounder. One end of the support should have a rub-



A-BASE D-BEARINGS
B-BRASS ROD E-RUBBER BANDS
C-CYLINDER F-PULLEY

M.E. -FIG. 2-

ber stopper fastened to it; if a wire is used, it may be wound around the stopper.

For the pen a glass tube may be drawn but I have used an old thermometer. I removed the mercury by breaking the

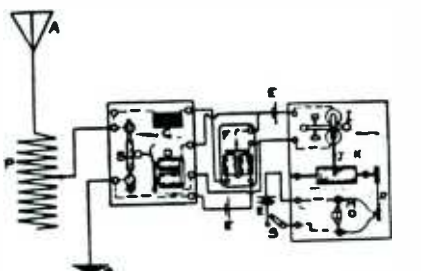

A-AERIAL E-BATTERY K-PEN J-GROUND
B-CONDENSER F-RELAY L-CYLINDER S-SWITCH
C-CHOKER COIL I-SOUNDER M-MOTOR P-TUNING COIL
D-DECOHERER J-ARM

-FIG. 1-

sities are complete.

First prepare a base on which you will mount the motor, cylinder and sounder. Get a long brass bolt and a nut to fit. File the nut thin if you are not going to tap a brass standard. Solder the bolt to the *exact* center of the lid of the can and solder the smooth rod to the bottom. Then solder the nut to a brass standard. Looking at the illustration will give you a good idea how this is accomplished. The pulley wheel may be soldered onto the smooth rod. A hole should be drilled in a brass standard just large enough to allow the smooth rod to slide into it. It is the bearing for the rod while the nut is the bearing of the other rod or bolt.

The light pen support is made of a

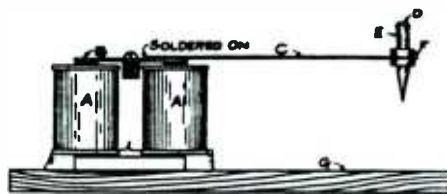

A-SOUNDER MAGNETS D-CORK
B-ARMATURE E-PEN
C-LIGHT ROD F-RUBBER CORK
G-BASE.

-FIG. 3-

tip of the bulb. I then broke the tube farther up, ground it to a point and filled it with *red* ink. I pushed the stem through the stopper and bent the wire so that it brought the bottom of the tube about one-sixteenth of an inch above the paper on the cylinder. The paper is held in place by two rubber bands. When the paper is filled it is removed and a new one replaced with it. The sounder should be set rather heavily.

With a little patience one will be able to learn to read by watching the pen and hearing the sounder.

COLLEGE COURSE IN WIRELESS.

Columbus, O., May 13.—Engineers in wireless telegraphy will be trained in the engineering department at Ohio State University. The first class will start with the third term in the next college year.

How to Make a Headband

By C. W. WEBBER.

There is a very important part of the wireless station which seems to have been overlooked by the "how to make" magazines; it is a telephone receiver headband.

I will suppose that the reader has a telephone receiver of the watch case type and describe the band itself.

Procure from a hardware dealer a piece of "strap" hard brass, 1 foot long, 1 inch wide and 1-16 inch thick; also a piece of "strip" brass 6 inches long, 1/4 inch wide and 1/16 inch thick.

Bore a hole with a 1/8 inch drill, 1/2 inch from one end of the long piece and bend an inch of this end up at right angles as Fig. 1 a.

In the middle of the small piece of brass bore a hole with a No. 29 drill. Also bore a like hole 1/4 inch from each end. Tap each hole 8-32 and bend as Fig. 1 b. Screw an 8-32 machine screw 3/16 inch long into each of the end holes and by passing a like screw through the hole in a Fig. 1 bolt this piece loosely to the top of b.

Now we come to the receiver. Bore a 1/8 inch hole in the opposite sides of the case, so that the screws d, e, Fig. 1 b, will fit in nicely and let the receiver swing between the two arms of b, as in Fig. 2 a.

The headband is completed by bending the long strip in Fig. 1 to fit the head. This should be done after the other work is finished, so that it will fit perfectly.

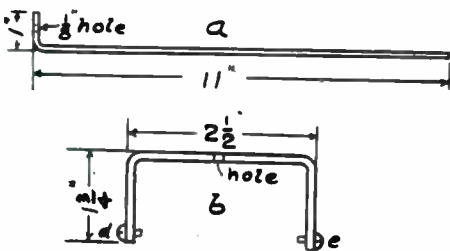

M. E. -FIG. 1-

Any extra length may now be cut off. When completed it will appear something as in Fig. 2 b.

This band has the advantage of having a universal joint, so that it will fit closely to the ear. The writer has used a

headband of this kind for some time and likes it better than other ones he has tried.

If two receivers are used, the head-piece may be made longer and the second receiver put on in the same manner as the first. A second piece put on the top of the headpiece at c, Fig. 2, at right

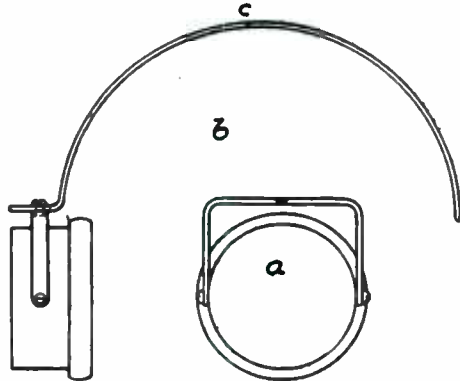

M. E. -FIG. 2-

angles with it bent to fit the head will improve the band when used with two receivers.

WIRELESS DEFEATS STRIKE.

In the recent postal crisis the disaffected Government employes controlled the ordinary means of communication, and could have stopped or altered every Government message sent over the wires and have sent their own instructions. Instead, in fact, M. Faure practically sent the strike order to the provinces over the Government wires through the telephone into which he spoke from the tribune of public hall.

It appears that the Government had sent elaborate sealed instructions to the postal and military centres through the country to be opened in case of a strike. When the moment would come he had only to send a word or two from Eiffel Tower in all directions to "open envelope."

It was the unexpected preparations which met them on every hand that puzzled and frightened the strikers and defeated them. They had forgotten that the Government had means of communication they could not cut.

Signal Service Telegraph

S. R. MONTCALM

Sometimes the practical man or the amateur wants a rugged, portable, cheap, telegraph, capable of working over a long line of none too well erected and insulated wire. In such case he can do no better than adopt the system said to be used, with modifications, by the Signal Service.

For each station he will need a buzzer, the larger the better, enough batteries to operate the buzzer, a telephone receiver, a key, and a two-point switch. The set is wired as shown in the accompanying diagram. When the key is closed the buzzer operates, and small sparks are formed between the vibrating contacts. If the fingers be placed across the binding posts a shock will be felt, for when the circuit is broken the "kick" or self-inductance of the magnetic coils sets up a momentary current, sometimes having a potential of several hundred volts.

This is sent into the line when the key is pressed, and produces a buzzing in the telephone receiver, short for dot, long for a dash.

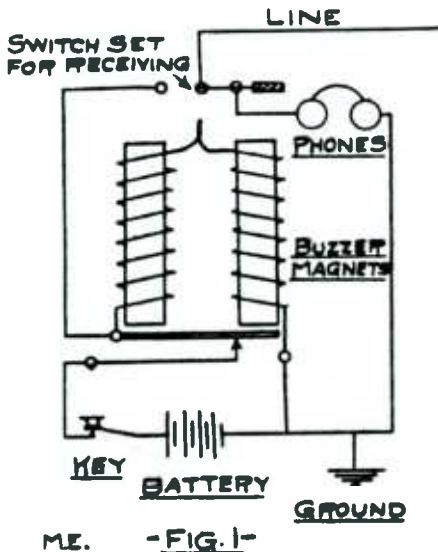

While the better the insulation the better the results, and the less battery required, good insulation is not absolutely necessary. The writer has worked a line over two miles in length, the

wire being in several pieces, not very good joints, and the line simply stapled to trees.

Figure two shows an arrangement using a gas engine coil, of the make and break type, in series with the buzzer. The kick of the coil is greater than that of the buzzer, but it burns

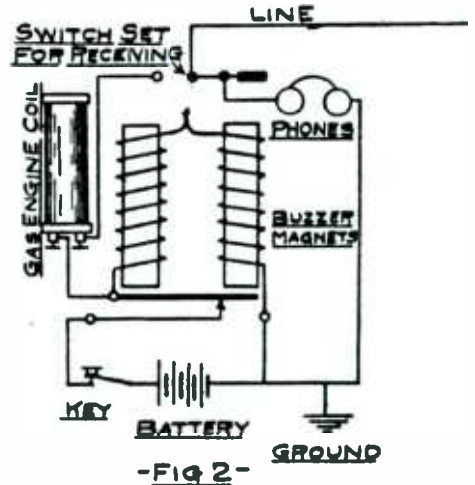

ME.

the buzzer, contacts faster and takes more battery, so it should not be used unless absolutely necessary.

By using a good sized coil, several miles can be telegraphed by placing the two leads to two railroad rails, if there are no trains near and not too many switches to connect the rails together.

It is understood, of course, that the two point switch must be placed on the proper point for sending, and for receiving.

A SENSITIVE GALVANOMETER.

By J. CARLTON PAULMIER.

The galvanometer here described is remarkably sensitive, and may be constructed by any one in a few minutes. The materials required are as follows: A good compass, a pair of electro-magnets, a small bar magnet and a piece of oak for the base. Almost any kind of electro-magnets will do, and the higher resistance they are wound to the more sensitive the instrument will be. A pair of 80 ohm

ringer coils will do very well for ordinary work.

Fasten the coils near the center of the oak base. In front of the coils place the compass, so that the needle will be level with, and as close as possible to the coil of the magnets. At the other end of the magnet coils place the bar magnet. Both the bar magnet and the compass should be movable, so as to allow of adjusting the instrument.

To use the galvanometer, the needle must first be adjusted to balance between the electro-magnets. This is done by moving the bar magnet slightly one way or the other. With the bar magnet in the right position both coils of the magnet are of the same polarity, and the needle is balanced between them. Now the slightest current

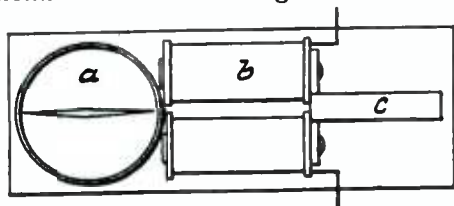

through the coils will change the polarity and thus swing the needle one way or the other.

In the cut "a" is the compass; "b" the electro-magnets, and "c" the bar magnet.

NEW IDEA IN TELEPHONE CABLES.

M. Devaux-Charbonnel, a prominent telephone authority of Paris, finds some rather curious results as to the use of underground telephone cables. Paris is connected with some of the leading cities, such as London and Berlin, and subscribers within the city can make connection at these distances, but outside of a certain range, such as Rome or Madrid, the telephone cannot be used. However, as these latter cities can be reached from telephones placed in the suburbs of Paris, the fault is evidently in the underground cables, and subscribers' lines inside of town. There are six miles of cables, and about the same distance for the subscribers' lines from the central exchange, making 12 miles in all. He shows that this distance is equivalent to 500 miles of overhead line, for a 1 millimeter wire, as regards the sound in the telephone, or 300 miles for a 5 millimeter wire. The fault can be remedied by using Pupin

cables, but he proposes a method which may be more satisfactory. This is to lessen the static capacity of the cable by using a thicker insulation between the wires. A double thickness will give but half the capacity, and such a cable can be easily manufactured.

Book Review

MAKING WIRELESS OUTFITS. By Newton Harrison, E. E. Published by Spon & Chamberlain; 12 mo.; 61 pages. Profusely interested. Price, 25 cents.

This little book will be welcomed by most wireless experimenters, amateurs and the layman. It is written in simple language, the author's point of view being to initiate the young reader in the wonders of wireless in general.

WIRELESS TELEPHONE CONSTRUCTION. By Newton Harrison, E. E. Published by Spon & Chamberlain; 12 mo. Well illustrated; 74 pages. Price, 25 cents.

This little volume, the same as the other book by Mr. Harrison, is a review of the new art, showing in concise and clear language how the experimenter can, with little trouble, construct wireless telephone outfits.

While Mr. Harrison could give more details as to the construction of some apparatus, the book is well gotten up, and will undoubtedly be welcomed by those interested in wireless.

OPERATOR'S WIRELESS TELEGRAPH AND TELEPHONE HAND-BOOK. By Victor H. Laughter. Published by F. J. Drake. 12 mo.; cloth; 200 pages; profusely illustrated. Price, \$1.00.

The author of this book is a practical man, who, having dealt for years with wireless experimenters, found it not very difficult to get up a valuable book.

While there is no abundance of new or hitherto untreated matter, the author, thanks to his experience, has confined himself in general to treat the matter from the experimenter's standpoint.

Aerophony has been well taken care of, and an abundance of practical advice is given. The Wireless Codes, also important abbreviations used in transmitting aerograms, are included. The book will undoubtedly be of great help to the beginner in wireless.

WIRELESS "TELE-MECHANICS."

By OUR PARIS CORRESPONDENT

I had occasion to pay a visit to Dr. Branly's laboratory, and he showed me a new apparatus which he had devised. This he uses in connection with his "tele-mechanic" system for operating mechanism at a distance by waves. This apparatus now includes three distinct features, first the device for securing the wave control, of a torpedo for instance, second an apparatus for protecting the system against the influence of accidental waves from outside sources which would interfere with the control waves sent from the station, and lastly, the new device which protects the apparatus against the effect of a continuous series of sparks, such as would be sent by the enemy in time of war. In this latter case he uses a



Revolver Fired Wirelessly from a Distance
of 100 Miles.

special solenoid device by which the sending station is warned of the effect on the torpedo, for instance, of the continuous waves, so that the operator can stop the mechanism and prevent the outside waves from operating the device in a way which is not desired. Such disturbances will, therefore, not have any hurtful effect on the apparatus but it is evident that the latter must be stopped as long as the continuous waves are being sent, as the wave-control could not be carried on at the same time.

**FIRST WIRELESS
NEW YORK TO CHICAGO.**

Chicago.—The first wireless press message ever transmitted between New York and Chicago was received here May 3d. It was sent by the New York Times to the Chicago Tribune from the United Wireless station in the tower of the Waldorf-Astoria Hotel, New York, and was received at that company's station in the tower of the Auditorium Annex here.

The first attempts made were to reach New York from Chicago. The sending apparatus was not strong enough to reach the Eastern city. Then New York was called on to send to Chicago. A few minutes later the operator in the Auditorium caught the signals from New York and the message from The Times addressed to the Tribune was received.

It was a difficult matter to send the first message to the Chicago Tribune, owing to the constant interruptions from shipping reports along the coast. Many attempts were made to get the Chicago station to answer, and it was only after hours of patient endeavor that communication was established. Nevertheless, when the stations got in touch with one another, the message was filed and in twenty minutes it had gone.

"SINGING" WIRELESS.

BERLIN.—"Singing sparks" is the name given to an improved wireless system just perfected by the German Telefunken Wireless Telegraphy Company. Messrs. Slaby and Arco, the chief engineers of the company, have invented a device which, it is claimed, will entirely obviate the uncertainties with which other wireless systems have had to contend.

The new method consists in sending out the vibrations which form the messages as pure musical tones, which are capable of being heard by the receiver, no matter how they are tuned. It is declared that by means of this device it will be possible for the first time since the wireless telegraphy was established to maintain communication by this means in spite of the most violent atmospheric disturbances.

Wireless Association of America

Amateur Defense of Interference

After reading many a treatise on wireless interference on the part of the amateurs, I have seen very little in the defense of the amateurs; especially by their own writings.

To begin with, and as has been stated by the Government operators, their apparatus is three years behind time. The amateur, taking advantage of scientific discoveries, either makes or buys all up-to-date apparatus, with the aid of which he may tune out stations not wanted. The Government has been offered time and again up-to-date apparatus which the wireless companies proved would eliminate interference down to one or three per cent. Still these offers have been refused, and of course Government stations, with their old style apparatus, continue to be interfered with by the amateurs. Most all experienced amateurs and commercial wireless companies generally respect the army or navy stations when they are receiving important messages. The experienced amateurs claim that the interference is generally caused by carelessness of the Government operators or by inexperienced amateurs. Some of these amateurs, when told to "get out" by the navy operators, stay out for a time, but the average, after waiting half an hour, generally gets impatient and starts sending again. I hear more forcible conversations take place between them. The navy or army operators sometimes press down their keys for several minutes and drown out all sending which is being done in that range. Here the amateur steps in and says that if the Government operators cannot overcome amateur interference what will become of them in time of war when high powered stations of the enemy put the naval apparatus out of commission by simply holding down their (the enemy's) keys?

Besides doing mischief, the amateurs have many times been of benefit to the large stations when the apparatus was out of working order and have received and sent messages for them. At the time of the Republic disaster, most all amateurs will admit that they greatly hindered the work of receiving messages during the rescue. This caused the large wireless companies and the naval

stations, who want a law prohibiting the use of the ether by the amateurs, to make a series of attacks on the amateurs. Then, after a short time, they had another occasion to make another series of attacks, when the Hall and the Dimock collided. They claimed that the amateurs prevented the Hall from sending messages for help. As far as I can find out, the operator of the Hall sent out but one message, which was received in good order by the naval stations. I have learned lately, though, from a reliable source, that the operator at one of the naval stations was sending out weather signals without regard to the C. Q. D. call. I think that before restrictions be made on the part of the amateur, the stations of the navy should be equipped with up-to-date apparatus and thoroughly tested on the question of amateur interference.

JOHN CROCKFORD

ASSOCIATION BUTTONS

Quite a few members of the W. A. O. A. have asked us if we could not furnish a higher grade button than the one regularly furnished now, which is only plated. We have taken up the matter with the manufacturer and are now prepared to furnish the association button in solid gold at cost (\$2.00). The lettering and background is gold, while the background of the lettering is navy blue hard enamel. Flashes of post are hard, bright red enamel. It is the prettiest button ever made.

W. A. O. A.



The Wireless Association of America was founded solely to advance wireless. IT IS NOT A MONEY MAKING ORGANIZATION. Congress threatens to pass a law to license all wireless stations. The W. A. O. A. already has over 2,000 members—the largest wireless organization in the world. When the time for action arrives, the thousands of members will exert a powerful pressure to oppose the "wireless license" bill. This is one of the purposes of the W. A. O. A. There are more

Wireless Telegraph Contest

Our Wireless Station and our Laboratory Contest will be continued every month until further notice. The best photograph for each contest is awarded a monthly prize of Three (\$3) Dollars. If you have a good, clear photograph send it at once; you are doing yourself an injustice if you don't. If you have a wireless station or a laboratory (no matter how small) have a photograph taken of it by all means. Photographs not used will be returned in 30 days.

This competition is open freely to all who may desire to compete, without charge or consideration of any kind. Prospective contestants need not be subscribers for (the publication) in order to be entitled to compete for the prizes offered.

FIRST PRIZE THREE DOLLARS.

Enclosed find a flashlight of my wireless station, which is one of the many located in and about Los Angeles.

In the photo on the large table are the sending instruments and on the small one the receiving instruments.

THE SENDING INSTRUMENTS.

At the extreme right of the large table is seen the variable condenser, which was made of eight 8x10 photographic plates with tin foil on each side; connections were made with spring contacts by means of which any number of plates can be cut in or out. At the right of the variable condenser are two induction coils, one on the top of the other. The primaries and secondaries are connected together in series and, using only one vibrator, gives about a two-inch spark.*

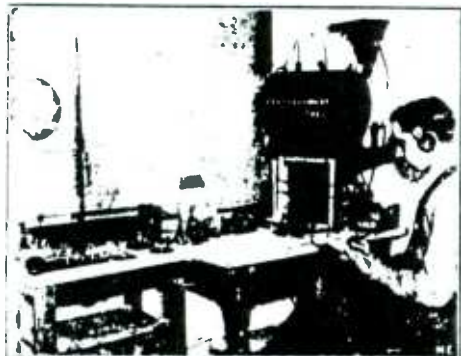

Underneath on the first shelf of the small table are about thirty batteries, from which I get my power for the telegraph-telephone line, and also the induction coils, to which they are connected by a snap switch seen in front of the coils.

On top of the variable condenser are seen the helix and spark-gap. The helix was made according to the directions given in MODERN ELECTRICS; the spark-gap was made from two pencil battery zines.

Directly in front of the variable condenser is seen the D. P. D. T. switch, and key. At the rear of the table is a three-point switch, which is used for cutting

* It is strange that this simple arrangement has not been tried before by experimenters. EDITOR.

in either of two aerials: one a looped aerial, about seventy-five feet high and about four hundred feet long, strung from the tops of two tall eucalyptus trees; it is used for what I call my long distance work; the other, about sixty feet high and about seventy-five feet long, for local work.

At the left of the large table are located an ordinary sounder, key, and switches; these are separate from the wireless instruments, and are connected by wire with several friends. By means of switches the telegraph is cut out and a complete telephone set is cut in, of which the transmitter and receiver are seen at the extreme left of the small table.

RECEIVING INSTRUMENTS.

At the rear of the small table is shown the receiving tuning coil, which was made of about five hundred turns of No. 18 insulated wire wound on a wooden cylinder, with insulation taken off on top of contacts. By means of either aerial and this tuning coil, my wave length ranges from about twenty-five meters to one thousand meters.

In front of the tuning coil are: A condenser, battery, switches, an E. I. Co's potentiometer, and E. I. Co's "Electro"-lytic detector, and a detector stand that was patterned by myself and in which I generally use silicon or iron pyrites. Through the use of the switches either detector can be cut in.

I use high resistance double-head receivers which are seen on my head. With this set I am able to send about fifteen miles. By the use of the electrolytic detector I can receive from stations hundreds of miles off. I am always experimenting and making improvements on my station and expect to be able in a short time to receive from Honolulu and other far-distant stations.

The other day, while using my wireless instruments, I made the acquaintance "wirelessly," through the ether, of one who was an absolute stranger to me. On meeting him I learned that he belongs to W. A. O. A., of which I am a member.

A good many instruments were made by myself with the aid of the directions and diagrams given in MODERN ELECTRICS, and I realize that I owe much of my success to MODERN ELECTRICS, which I always keep for reference.

Los Angeles, Cal. M. H. DODD.

HONORABLE MENTION.

Enclosed find a picture of the Wireless Station of the Broadway High School of this city. This station was first built in 1905 and has been in charge

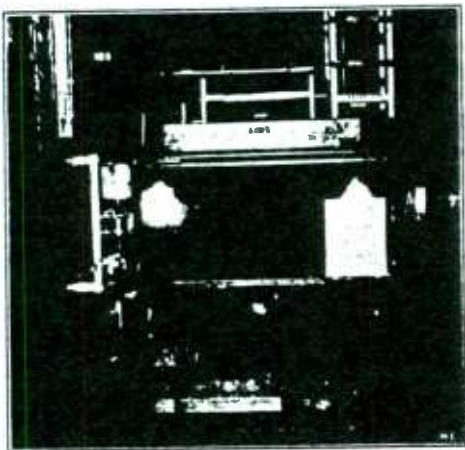

of a different boy each year since, every one has added something to it and also derived a great deal of pleasure and experience from its operation. I have had it in charge for the last year. Supplies for its improvement and operation are furnished by the Physics Department.

A six-inch "Knott" induction coil is used for sending but it is used as an alternating current transformer, about three-quarters of a kilowatt being consumed in it. Find the electrolytic detector quite satisfactory as regards sensitivity, but the silicon is less delicate and liable to get out of order in our experience. Have caught Frisco, Mare Island Navy Yard and San Diego at different times and all the stations on Puget Sound are always audible. The Navy Yard at Bremerton and the commercial station at Tacoma, Wash., can easily pick us up.

We have a "Science Club" in the school and engage engineers and professional men to speak at our meetings. MODERN ELECTRICS is a favorite among the members.

EARL C. SHERMAN,
Seattle, Washington.

HONORABLE MENTION.

Enclosed please find photo of my wireless station for the wireless contest.

I am 16 years old, and have been experimenting with wireless telegraphy a little over a month. I have learned all I know about it from experience. MODERN ELECTRICS, and an E. I. Co.'s catalogue, as I have never read a book on the subject, and have never seen a wireless station except my chum's, which was put up after mine.

At the right are the sending instruments, composed of a strap key, Morse key, E. I. Co.'s 1/4 inch coil, glass plate condenser, and sending helix made of No. 6 copper wire.

At the left are the receiving instruments, composed of variable condenser "Electro" Lytic detector, potentiometer, tuning coil and E. I. Co.'s 1,000 ohm single phone. The tuning coil has a capacity of 720 meters. The potentiometer is made as per directions in August MODERN ELECTRICS. The variable condenser is of the slide plate type, and is essential for tuning out unwanted stations and static electricity in the air.

I have made most of the instruments, and although I have had them but a

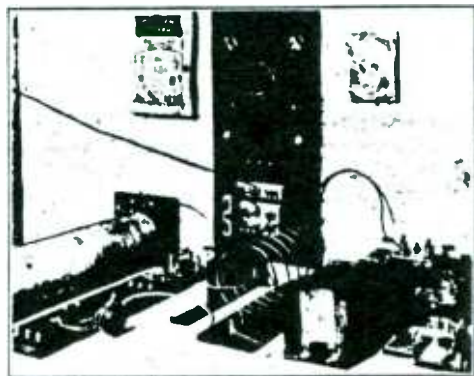

short time I have had very good success with them.

Ore. PAUL H. LEWIS.

HONORABLE MENTION.

Please find enclosed a picture of my wireless station. I made all my instruments except the telephone receivers, which are of the 100 ohm type. The whole outfit costing me only one dollar and a half, the induction coil having been given me, broken down.

In front of the tuning coil, which

has 2 sliders and a wave length of 600 metres may be seen the electrolytic detector with a bicycle tire jiffy tool, which makes a fine screw for the Wollaston wire. At the right of the tuner is the adjustable condenser of fairly large capacity; at the other side of this is the sending key, and behind the tuner is the potentiometer. At the left of the table is a double throw switch with a swing of 35 degrees, with 3 points at the bottom and 2 at the top, this switch takes the place of an anchor gap. On the stool is my loose-coupled tuner, which I have just finished.

My transmitting instruments consist of 3 Leyden jars, sending helix, made of zinc strips wound on wooden pegs. Over this is the hot-wire meter and zinc spark gaps. The jar at the right of the table is a Wehnelt-Cadwell interrupter as described in the December issue of MODERN ELECTRICS. I use this in series with my coil and the A. C. current.

My aerial consists of 5 wires, 3 to one tree, 55 feet high, and 2 to another, about 60 feet high, from my attic window.



I began experimenting with wireless last winter, and have had good success, much of which is due to the instructions given in MODERN ELECTRICS.

Massachusetts. FRANCIS DUNMORE.

HONORABLE MENTION.

Please find enclosed a flashlight "photo" of my small wireless plant at Nantucket.



This station was in operation last summer, and will be in order this summer also.

The aerial is of 6 strands of No. 14 bare wire (phosphor bronze) each strand 130 feet long and $4\frac{1}{2}$ feet apart, run from the ridge pole of one house to the ridge pole of our house. This antenna has enormous capacity.

The receiving set is comprised of an oscillation transformer, variable, primary and sliding secondary.

Condenser and a silicon detector. Across the secondary of the transformer is a .001 microfarad variable condenser in a box. I also have a simple electrolytic set, detector and phone which I used on the more powerful sets.

The sending is a 2 inch spark coil, a 14-inch helix, wound with No. 14 bare stranded wire, condenser and gap.

I am able to receive about 100 miles in daylight and transmit about 25 miles. At my home here in Somerville I have a really good set.

A 48-foot pole on top of our house, which is on a hill, a 4 strand loop antenna, each strand 160 feet long.

A "Perikon" detector and 2,000 ohm

head set, also a complete weeding out set. So I can work small amateur sets without the slightest bother from the Navy Yard or B. N. station (2 K. W.)

I have a 1 K. W. transformer operating on 110 V. A. C. lighting circuit.

I can send about 75 miles over water, and can receive over 300 miles.

I think that the MODERN ELECTRICS is the real article on wireless, and I have already got several other young men interested in it.

As soon as I get a photo of my 1 K. W. set I'll send it along.

ED. P. CROCKER.

Somerville, Mass.

HONORABLE MENTION.

Enclosed please find a photograph of my wireless set.

On the right is a one inch spark coil, on top of which is a zinc spark gap. I run the coil with nine dry batteries, using an adjustable condenser, consisting of two Leyden jars, and operating it with a telegraph key. With this apparatus I get a very good fat spark, and can be heard by one of my friends who has a wireless set, and who lives about a mile from me.

On the left is my receiving set, consisting of an electrolytic detector, silicon detector, a tuning coil, a potentiometer,

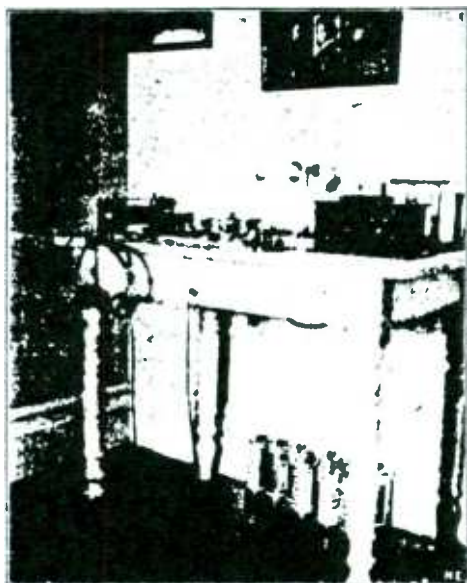

and two 1,000 ohm telephone receivers, with necessary head band. With this set I receive messages from all over the city, and from incoming steamers.

For beginners, I recommend the silicon detector, as it is very simple, and will give good results.

My aerial consists of four bare copper wires, each thirty feet in length, extending from a thirty foot pole (well insulated) and joined to a chimney from which it is also well insulated.

I wish to thank MODERN ELECTRICS for many valuable hints which I have obtained from reading that magazine.

JAMES WHITE.

New York City, N. Y.

HONORABLE MENTION.

Enclosed you will find a photograph

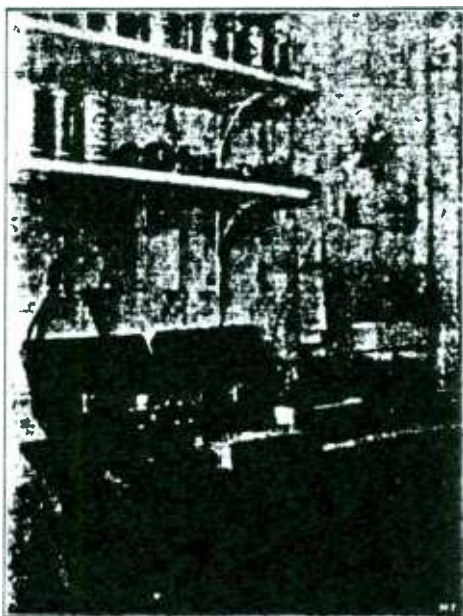

of my tuned wireless telegraph set, which is located at my residence. I use a carborundum detector with which I get very good results. My aerials are made up of two strands of No. 12 bare copper wire and suspended from a ten-story building next door to my house, having a total length of 110 feet.

My instruments, which were all made by me except the telephone receivers, which I bought and which are wound for 1,500 ohms each, are capable of receiving messages from a distance of 150 miles. I have forty-eight dry batteries connected in six series—multiple for the operation of the one inch spark coil, which you will see on the right. I wish to thank MODERN ELECTRICS for its valuable information.

New York.

PETER TESTOR.

HONORABLE MENTION.

Enclosed find a photograph of my wireless station. All the apparatus, excepting the spark coil has been constructed by myself. In back of the batteries is the fixed condenser for receiving, and near it is a variable one not seen in the picture. Next to it the other way is the variable sending condenser, 13 plates, and 30 square inches on a plate. Beside this is the Caldwell-Wehnelt interrupter described in one of the issues of MODERN ELECTRICS. With this interrupter my coil, which is a 1-inch E. I. Co.'s, gives a $1\frac{1}{2}$ inch spark, about a quarter of an inch in diameter, and which flames up in the middle to about $\frac{3}{4}$ inch high. The sending helix consists of eight turns No. 6 brass wire, and is 17 inches in diameter. Among the receiving instruments is an electrolytic detector; double slide tuning coil, 250 turns No. 26 enameled wire and 3 inches in diameter; 75 ohm telephone receiver and a microphone detector.

The aerial is a 4 strand type, 20 feet long and 18 inches apart. It is 30 feet high and 45 feet from my instruments.

In the construction of my instruments, and many other electrical appliances I find MODERN ELECTRICS indispensable, and I thank my lucky stars that I was one of the lucky ones

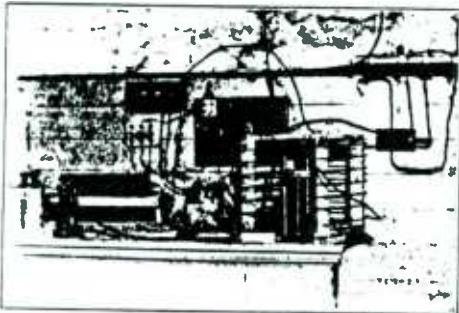

to have been able to get MODERN ELECTRICS from the start.

Minnesota.

JOE B. PARSONS.

HONORABLE MENTION.

Please find enclosed photograph of my wireless station, which has a range of about five miles. To the front of the table may be seen the tuning coil and back of it four one pint Leyden jars. The induction coil, though it does not give more than $1\frac{1}{4}$ inch spark, is very powerful, being wound with 4 lbs. No. 30 wire on the secondary and No. 14

on the primary. In front of the coil is the key, the sounder being on the same base. On the floor is the interrupter, being of Wehnelt Caldwell type, which was made from description in MODERN ELECTRICS. Before getting this inter-

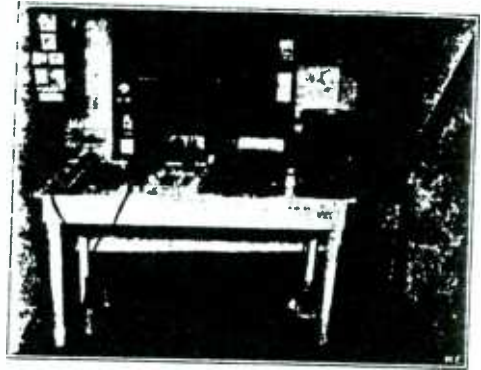

rupter, the vibrator on the coil used to stick, owing to the number of batteries used, but since getting this interrupter, the coil has given good results.

The receiving set is on the left side of the table. The electrolytic detector is used in series with a "Rheostat regulator" and 75 ohm telephone receiver. I am constructing a potentiometer to be used in place of the rheostat. The coherer, call bell, sounder and 150 ohm relay are only used for calling, but may be switched out and the detector thrown in to receive.

The air wire on my roof is about 60 ft. high and is run between two poles 18 feet apart. The air wire itself, being about 18 ft. by 5 ft., is composed of twelve No. 14 hard drawn copper wires.

The Fessenden receiving and De Forest sending systems are used. I now send and receive regularly from my two friends in Lewis Place and on Bayard avenue. I have received much valuable information pertaining to wireless telegraphy from MODERN ELECTRICS.

CARLISLE OTTOFY.

St. Louis, Mo.

HONORABLE MENTION.

I enclose photo of my laboratory, of which the following is a description: In the upper right hand part of the picture is a wall bracket. Above the copy of MODERN ELECTRICS is a switchboard which I made myself. On the floor you can see some sal-ammoniac cells, and also a storage battery. On the table at the right is an E. I. Co.'s auto co-

herer, to its left is a D. P. D. T. switch. The box with the 3 binding posts on the outside is my coil, it gives a 1 1/4 inch spark. To the left of that is an E. I. Co.'s zinc spark gap, and also one of their keys. A small E. I. Co.'s "New Departure" motor is toward the front in the center of the table. Behind it is a tabular flashlight and the 9 point switch which is seen right behind the flashlight regulates a rheostat. I also have a dynamo. It generates 4 1/2 volts. On the back is a shafting which is run by an Edison motor, the top of which can be seen just above the spark coil. An E. I. Co.'s fixed condenser and large size tuning coil are behind me on the table. My aerial is composed of 4 phosphor bronze wires on 3 1/2 foot spreaders. My success at receiving has been very good.

MODERN ELECTRICS is a great help to me, and it is the best electrical magazine I know of.

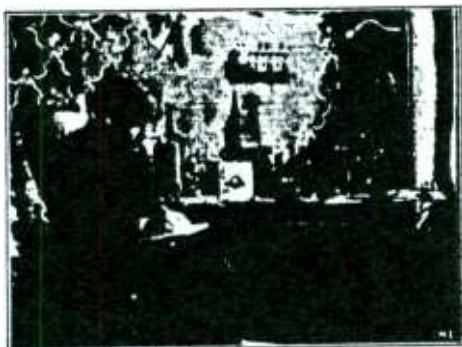

MONROE JACOBS.
New York City, N. Y.

HONORABLE MENTION.

Enclosed find photo of my wireless station, which consists of the following: Lower right hand corner is set of Leyden jars. The spark coil, which is of the open core transformer type, and of 1/2 K. W. capacity, sets on Leyden jars with the sending tuning coil above it. The large jar next to the Leyden jars is a water cooled electrolytic interrupter, in front of the interrupter is the key, and to the left an electrolytic detector; to the left on the wall is an "E. I. Co." tuning coil and adjustable condenser used for receiving; in the center on the wall is the change-over switch. The Massie connections

are used for both sending and receiving and give excellent results.

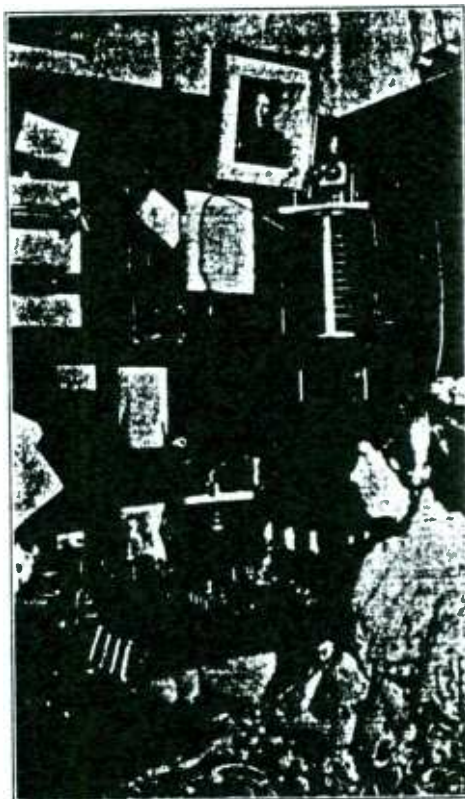

On lower left side is a typewriter used for copying messages.

I am in constant communication with all stations in Butte and vicinity.

D. D. PHELAN.

Butte, Mont.

"C. Q. D." MEDALS.

Novel medals of silver and gold bearing the letters "C. Q. D." and a reproduction in relief of the White Star liner Republic, which sank after collision with the steamer Florida off Nantucket last winter, are being struck off at the expense of the passengers of the ill-fated liner and of the steamer Baltic, which brought the Republic's passengers to New York.

The gold medals will be presented to Captains Sealsby of the Republic, Ransom of the Baltic and Ruspini of the Florida, and to Purser Barker and Wireless Operator "Jack" Binns of the Republic. The silver medals will be given to members of the crews of the three steamers, in recognition of their gallantry.

Electrical Patents for the Month

921,161 SOUND TRANSMITTER AND RECEIVER. **ARTHUR J. BLISS,** Boston, Mass., assignor to Submarine Signal Company, Waterville, Me., a Corporation of Maine. Filed Apr. 12, 1908. Serial No. 104,208.

1. An electric sound transmitter and a reception sound receiver, arranged in relation to the diaphragm of the receiver to form sound vibrations thereon.

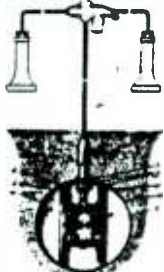

921,162 TRANSMITTING APPARATUS. **WALTER BRAD WASH,** Jersey City, N. J., assignor to International Telegraph Construction Company, a Corporation of New York. Filed Apr. 8, 1907. Serial No. 307,354.

1. In transmitting apparatus, the combination with a circuit including a source of energy, of a high frequency oscillating current, separated conductors immersed in electrolytic liquid common to both circuits, and a signaling instrument.

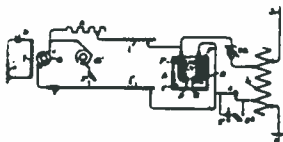

921,204 ANIMAL TRAP. **MARION D. COLE,** Tynon Valley, Ohio. Filed Nov. 6, 1908. Serial No. 481,175.

1. An animal trap comprising a receptacle for gas composed of a charged electric circuit for causing the ignition of the explosive, and a normally open circuit-closer operable to the closed position by a force applied to the receptacle for the explosive.



921,206 TRANSMITTING APPARATUS. **WALTER BRAD WASH,** Jersey City, N. J. Filed Aug. 26, 1907. Serial No. 309,514.

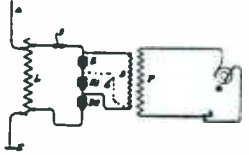

1. In combination, a closed oscillation circuit enclosing the primary of a transformer connected in series with each other and in series with inductance, a charging source, and a circuit connected from said charging source to the terminals of less than the whole number of equations in said oscillation circuit.

921,207 TELEPHONE. **BRUCE HAMILTON,** Philadelphia, Pa. Filed Jan. 12, 1908. Serial No. 371,201.



1. In an apparatus of the character described, the combination with a transmitter and an arm, said arm and transmitter constituting a body adapted to enclose the body between them, and a receiver supported by said transmitter and arm.

921,277 KLYSTRONIC ANIMAL KRYPTOGRAPH. **EDWARD S. ANDERSON,** Washington, Pa. Filed July 27, 1908. Serial No. 545,326.

1. An electric animal kryptograph comprising a body and formed in series insulated from each other, said series forming the terminals of an electric circuit closed circuit for supporting a cover at the highest part of said body portion.

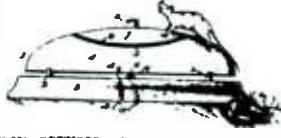

921,281 RECEIVER FOR ELECTROMAGNETIC WAVES. **WILLIAM A. FROSTENBERG,** Washington, D. C. Filed Apr. 2, 1908. Serial No. 312,072.



1. A receiver having in combination an electrostatic and an electrode in contact therewith means for maintaining a constant pressure between said parts whereby the pressure of gas in the air is varied by the flow of electric currents and the resulting motion gives a signal.

2. A receiver having in combination an electrostatic and a small electrode in contact with the electrostatic, means for maintaining a constant pressure between them and means whereby varying the pressure on the electrode by an induced oscillation produces a signal.

921,282 SENSITIVE IMPROVEMENT. **WILLIAM S. VAN ALLEN,** New York, Ohio, assignor to Allen-Chalmers Company, a Corporation of New Jersey, and The Bellows Electric Manufacturing Company, a Corporation of Ohio. Filed Sept. 28, 1908. Serial No. 328,087.

1. In a measuring instrument, a pair of stationary receptacles, each having a movable wall, a tube in common contact with both receptacles, the receptacles and tube being held fixed, each receptacle containing a fluid which may expand into the tube and whose capacity of expansion due to temperature changes the same amount as the fluid in the other receptacle, and means for applying force or pressure to at least one of said receptacles so as to move a fluid movement in one direction throughout the length of the tube, whereby the value of said force or pressure may be measured directly by the extent of fluid movement in the tube.

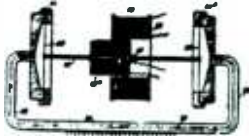

921,283 ELECTRIC GAS IGNITER. **WILLIAM D. BRADLEY,** Birmingham, Miss. Filed Mar. 2, 1908. Serial No. 418,647.

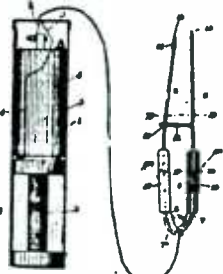

1. In an electric igniter comprising a pair of handles of insulating material, a spring rigidly connecting said handles at one end, conducting rods drive into the other ends of said handles, and thereby insulated from each other, the said rods having recessive spring contacts at their free ends and one of said rods having a laterally extendible guide loop and the other rod having a groove member constructed of insulating material and worked in said loop, substantially as described.

921,285 WIRELESS TELEGRAPH. **WILLIAM S. VAN ALLEN,** New York, Ohio, assignor to The Brown Heating Machinery Company, Cleveland, Ohio. Filed Aug. 2, 1908. Serial No. 329,000.

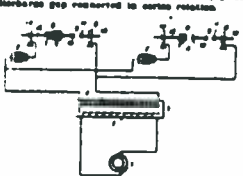

1. The combination of a source of alternating or pulsating current, a condenser, a single spark gap and a steel discharge gap connected in series, wherein:



1. A method of building up an insulating portion or core of a condenser bank for a spark or wireless telegraph, consisting of first spreading over a lower surface of work a bed of heretofore plastic material which temporary retaining means, consisting of a bed of solid material, which portion, on completion of treatment, and filling the interstices between the same with sand or the granular matter to snug their tops, and thereafter, after the interstices with sand or the granular matter, in layers, using the insulating portion of surface of said bed to bring up to the requisite diameter, all substantially as above and described.

921,276 HAIR DRYING APPARATUS. **WILLIAM A. BRUCE,** New York, N. Y. Filed May 27, 1908. Serial No. 484,000.



1. A hair drying apparatus, comprising a tube open at both ends, the front end being arranged for engagement with the nose of the wearer's head so, that the hair extended within the tube, a non-conducting material within the rear end of the tube is covered, and a cylinder of electric lamp to the bottom of the said receiver.

921,284 METHOD OF PREVENTING CORROSION OF METALS IMMERSED IN LIQUIDS. **WILLIAM S. VAN ALLEN,** St. Kilda, Victoria, Australia. Filed June 12, 1907. Serial No. 378,330.

The method of preventing the corrosion and decomposition of metallic parts and other suitable surfaces of other material or in contact with sea water and whereby the same constantly exposed, placed up in immersion and connected in parallel and continuous a positive electrode, consisting in placing additional iron means in contact with the water in proximity to the metal parts to be protected and insulating said iron means from said parts except through the sea water, and connecting said

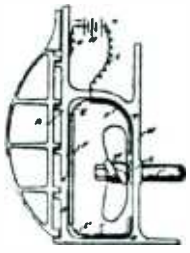

metal means in parallel and to the positive pole of an auxiliary source of electrical energy having a higher E. M. F. than that caused by the difference of electric potential between the various metals immersed in the structure to be protected, and insulating the negative pole of said source of energy said metal to be protected, constituting the negative electrode.



Queries and questions pertaining to the electrical arts addressed to this department will be published free of charge. Only answers to inquiries of general interest will be published here for the benefit of all readers. Common questions will be promptly answered by mail.

On account of the large amount of inquiries received, it may not be possible to print all the answers in any one issue, as each has to take its turn. Correspondents should bear this in mind when writing, as all questions will be answered either by mail or in this department.

If a quick reply is wanted by mail, a charge of 15 cents is made for each question. Special information requiring a large amount of calculation and labor cannot be furnished without remuneration. THE ORACLE has no fixed rate for such work, but will inform the correspondent promptly as to the charges involved.

Name and address must always be given in all letters. When writing only one side of question sheet must be used; not more than three questions answered at one time. No attention paid to letters not observing above rules.

If you want anything electrical and don't know where to get it, THE ORACLE will give you such information free.

MYSTERIOUS JARS.

(220.) B. NICOL, Texas, asks:
1.—Is it possible that a weak solution of salammoniac and water will crack a glass jar? I have been making some batteries and have used common fruit jars, but I find that half of them have cracks in the bottom of the jars which allows the solution to seep out?

A. 1.—No. You must have accidentally set the jars down too hard or put hot solution in them.

1,000 OHM RECEIVER.

(222.) ADOLPH TURZNIK, Wis., writes:
1.—Can watch case receivers be wound to a resistance of 1,000 ohms with No. 40 enameled wire?

A. 1.—No; you must use 1 1-2 mil. (No. 50) wire for this purpose.

2.—Where can enameled No. 40 wire, and mil, and mil and 1-2 wire be obtained.

A. 2.—Electro Importing Co., 86 West Broadway, N. Y.

SENDING APPARATUS.

(223.) RICHARD BAKER, Pa., asks:
1.—What accessory sending apparatus and what description of aerial will give best results with an E. I. Co.'s 1-inch spark coil, and what will be maximum range if electrolytic detector is employed for receiving?

A. 1.—Zinc spark gap, adjustable condenser, sending Helix. With an aerial 75 feet high you should be able to cover a distance of three to five miles.

2.—Under the same conditions, what will be the maximum range of a 1 1-2 inch coil?

A. 2.—Six to eight miles.

3.—Of a 2-inch coil?

A. 3.—About 10 to 15 miles.

TUNER.

(224.) LOMJL HAYES, Cincinnati, O., writes:

1.—State the amount of wire on the Electro-Tuner, and diameter of same.

A. 1.—About 900 feet. Diameter, 6 inches.

2.—Would a 150 ohm Polarized relay be more sensitive than a 300 ohm Standard relay?

A.—Yes, considerably more.

BATTERIES.

(225.) JOSEPH M. WALSH, Pa., asks:

1.—Please let me know as to whether or not Carbon Cylinder Batteries are suitable for running a 1-2 in. spark coil, for use in wireless telegraphy, and for general laboratory work. If they are not, would you please recommend a good, cheap and easily renewed battery for the above work?

A. 1.—Carbon cylinder batteries are not suitable for any closed circuit work. You should use some form of Edison primary battery or storage battery for this purpose.

LIGHTNING ARRESTER.

(226.) ALVIN W. ADAMS, Wis., asks:

1.—Will a combined fuse block and carbon lightning arrester protect the instruments and the building against lightning when used on a telegraph line of 300 feet in length, if not, what kind of an arrester do you advise?

A. 1.—Yes.

2.—Is it possible to electro-plate with several dry batteries, if so, how many batteries are required to copper plate, and what kinds of solutions to use?

A. 2.—Copper sulphate solution should be used for copper plating. This is sometimes varied by an addition of a small percentage of sulphuric acid. You cannot use dry cells, however. Use Edison primary batteries.

SPARK COIL.

(227.) ARTHUR W. LARSEN, Minn, writes:

1.—When I connect one terminal of my secondary to the aerial and bring the ground wire close to the other terminal, quite a powerful spark leaps the gap. Does this indicate poor insulation of my aerial?

A. 1.—No.

2.—Which is the better to use for the secondary of a 4-inch spark coil, for wireless work—No. 30, No. 34, or No. 36 wire?

A. 2.—No. 30 B. & S. gauge S. S. C.

3.—Would S. C. C. wire do if run through shellac and if the sections are well soaked in paraffin?

A. 3.—No, we do not think the insulation is sufficient for use for such a powerful coil.

4.—Can the transformer described in October issue of MODERN ELECTRICS be used for wireless? If so, how far will it send a message?

A. 1.—No, you must use what is known as a high tension transformer. See article on 250 Watt Transformer, April issue.

KITE AERIAL.

(228.) H. N. JACOBY, Nebr., asks:

1.—Are there any stations that I could receive from in cities as per enclosed list, with a 200-foot aerial, Tuning Coils, Electrolytic Detector, variable condensers, Potentiometer, 2,000 ohm phones?

A. 1.—There are stations in several of the cities mentioned, and with a 200-foot aerial you should have no difficulty in receiving from any of them. With such an aerial and with the instruments mentioned you should be able to receive almost any distance, providing you have a good ground.

2.—Would it be possible to elevate an aerial by kites sufficient to receive 500 miles for tests?

A. 2.—Yes.

SENDING DISTANCE.

(229.) J. R., Jersey City, N. J., writes:

1.—How far would a 1½-inch spark-coil, with the necessary Leyden jars, transmit distinct messages under favorable conditions with the following receiving outfit? Aerials 40 feet high, silicon detector, tuning-coil, 1,000 ohm receiver.

A. 1.—Three to five miles.

TWO-INCH COIL.

(230.) HAROLD KLECKER, Appleton, Minn., writes:

Will you kindly tell me how much No. 34 and 36 D. C. C. magnet wire is required to construct a two-inch induction coil?

A. 1.—About 2½ pounds No. 36, or about 3 pounds No. 34.

HUMMING AERIAL.

(231.) FRANK W. HARTH, East New York, N. Y., asks:

I am having considerable trouble with my aerial caused by loud humming sounds which can be heard plainly almost a block

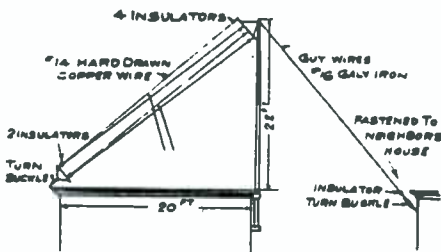

- FIG. A -

away. The pole is of galvanized iron pipe about 30 feet long, the top of which is about 60 feet from the ground. Is there any method or contrivance I could use to stop this nuisance?

A.—At the point where your pole is supported you should put a soft rubber sleeve around same and all guy wires should be fastened with a similar soft rubber sleeve around them at the point of contact. This

will take up the vibration which causes the

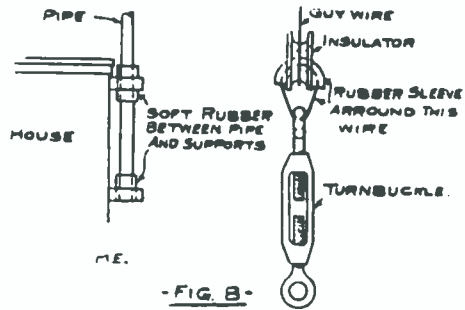

- FIG. B -

loud humming sound.

TELEGRAPH KEY.

(232.) HARRY PARKS, New Orleans, La., writes:

1.—Is silver good for the contacts in a telegraph key?

A. 1.—Yes, silver will do, but platinum is of course better and lasts longer.

2.—I have an antenna 50 feet high, 25 feet long. With a silicon detector, tuning coil, condenser, 1000 ohm receiver and good ground, how far will I be able to receive?

A. 2.—From 200 to 300 miles.

GROUND.

(233.) LAWRENCE S. CRAMER, N. Y., asks:

1.—Would an iron rod about 4 feet long driven in the bottom of a cellar which is about 4½ feet below the surface of the ground, make a good ground for station?

A. 1.—Iron rod would make a fairly good ground, but if you have a water pipe we think this considerably better.

2.—Will a 2 wire aerial 50 feet in height and 50 feet in length be satisfactory if I use an "electrolytic detector," tuning coil, potentiometer, fixed condenser and 1000 ohm receiver?

A. 2.—Yes, but we would suggest using a 4 wire aerial.

3.—Could I receive 250 miles with the same outfit except for a 1000 ohm receiver I would use a 75 ohm receiver?

A. 3.—Signals received would not be loud as when using 1000 ohm receiver. With the outfit in question you could work the distance of 250 miles if you use the lower resistance receiver.

DIRECTIONAL AERIAL.

(235.) HAROLD PARKER, Indiana, asks:

1.—Would it be practical to put my aerial on a barn 40 feet high and 200 feet distant from the house?

A. 1.—Yes

2.—Would I need a tuning coil?

A. 2.—You would do a great deal better work with a tuning coil.

3.—Please describe the method used by De Forest to project Hertzian waves in the desired direction for selective communication.

A. 3.—You will find this described on page 61 of the May issue, article on the "Directive Control of Electric Waves," by M. A. Deviny.

RECEIVING QUERIES.

(234.) RALPH L. SMITH, Maine, asks:

1.—Would this arrangement work 20 to 25 miles?

A. 1.—Yes

- 2.—Can it be tuned?
 A. 2.—To a slight degree.
 3.—Would it work without R No. 2?
 A. 3.—Probably better.
 4.—Would it work without P?

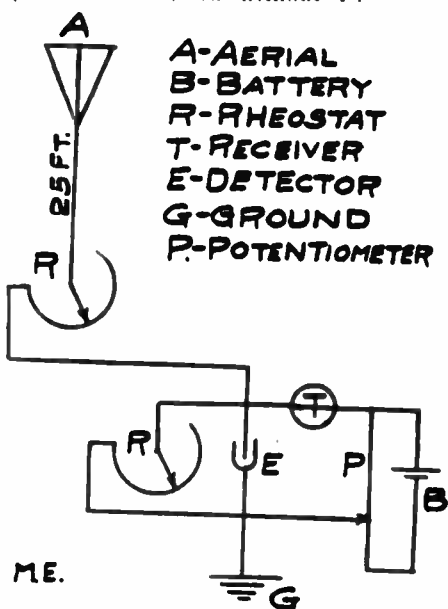

- A. 4.—Not so well.
 5.—Would it work the same distance if an auto-coherer was submitted for the detector?
 A. 5.—Signals will not be received as loud with the auto coherer as with the electrolytic detector.

CONDENSERS FOR 2-INCH COIL.

(235.) HAL HILL, Chicago, Ill., writes:

- 1.—How far can I receive with diagram

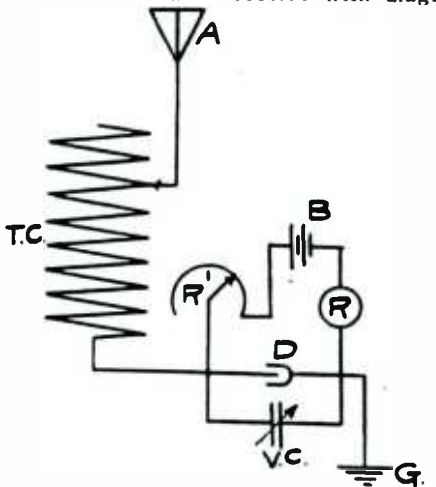

- shown? Aerial 50 feet high.
 A. 1.—150 to 200 miles.

- 2.—How many condensers are needed for 2-inch coil in sending?

A. 2.—It depends entirely upon the size of the condensers used. We have found one set of E. I. Co's adjustable condensers to be of the required capacity for use with a 2-inch coil.

TUNING COIL.

(237.) CLYDE DAVIS, Kansas, writes:

- 1.—Would annunciator wire No. 20 do to make a tuning coil and if I would use 4-pound would I have a tuning coil that would take in most stations?

A. 1.—Yes.

- 2.—If I would take 2 "Telim" auto-coherers and connect them together using one 75-ohm telephone receiver, would this receive messages any farther than when using one?

A. 2.—Yes, it increases range about 25 per cent.

- 3.—Would it be a good plan to put the aerial in a tree, cutting away the lumber around close to it and insulating it good?

A. 3.—This might be done, but enough play must be allowed, else the wires will sever in a storm.

ARC LIGHT INTERFERENCE.

(238.) LEO TROOSTWYK, Connecticut, asks:

- 1.—I am greatly interested in wireless and am constructing my own station. My an-

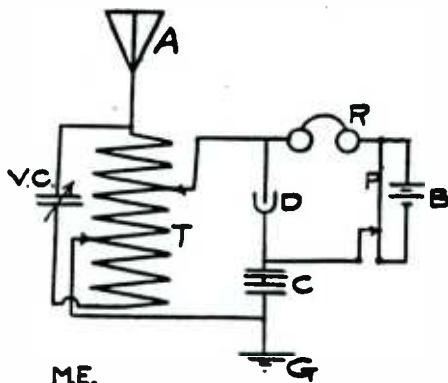

tenna is suspended over four houses, but my two wires on the antenna run parallel with the high tension current city wires. There is also an arc lamp about 50 feet from the antenna and as a result I am much disturbed by the buzz from the arc. How can this be overcome?

A. 1.—It is difficult to get rid entirely of the noise of the arc. Double slide tuner connected as per diagram will take care of the buzz and also the induction from the electric wire, but you will still hear the breaks in the arc and the heavy static splashes. We also suggest you use a variable condenser shunted around tuner. See page 67, May issue.

ANTENNA WIRE.

(239.) EDWARD L. LONG, New York, asks:

- 1.—What kind of wire will I have to use from the antenna to station?

A. 1.—Same as used on the antenna.

- 2.—Will you kindly tell me how to make a tuning coil to work on a one to two-mile line.

A. 2.—A very good tuning coil was described in our July, 1908, issue.

LOOP ANTENNA.

(240.) GEO. D. HENDERSON, Illinois, writes:

1.—Explain the loop antenna of the De Forest system.

A. 1.—It is theoretically claimed that when using the loop antenna stronger signals may be received for the reason that the oscillations are received on a continuous loop embracing both the antenna and detector. They are thus able to surge back and forth with more freedom and greater power than when the closed circuit is simply at the base of the antenna. We are unable to find that this has ever been demonstrated practically.

2.—How far will a 7-inch spark coil, secondary wound with No. 32 wire, transmit wireless messages using tuned circuits?

A. 2.—Approximately 75 to 100 miles.

3.—Where can I get fibre tubing for induction coil?

A. 3.—Bartlett & Co., 57 Warren street, New York City.

92-MILE COIL.

(241.) CHAS. A. AKERS, Iowa, writes:

1.—Do you think that we can work a wireless distance of 92 miles with coils wound with 15 pounds of No. 32 wire wound in many sections?

A. 1.—We should presume so if you have properly tuned circuits.

2.—Would telephone receivers of 300 ohms resistance do?

A. 2.—Hardly; use 2000 ohm double head phones.

3.—Could we do it with an aerial of 60 feet providing that the country was comparatively level?

A. 3.—Yes, but we suggest to use one 75-foot length.

4.—Could we work it for this distance with a coherer and polarized relay?

A. 4.—No.

IRON WIRE AERIAL.

(242.) C. B. ELLIOT, Massachusetts, asks:

1.—Why can't iron wire be used for an aerial?

A. 1.—Iron wire may be used for aeriels but not with as good results as copper or aluminum. A number of reasons are assigned to this. The principle one being on account of the antagonizing magnetic effects of the iron.

2.—What does it mean by "loose coupled" instruments?

A. 2.—Inductively coupled.

3.—How does the potentiometer work in wireless systems?

A. 3.—Potentiometer varies the potential impressed upon the detector without putting resistance directly in the circuit. (See article in August issue.)

RECEIVING DISTANCES.

(243.) REGINALD OVERTON, New York City, writes:

1.—How far can I send with following: 1-inch coil, sending condensers and aerial on top of a house which is 70 feet?

A. 1.—Two miles. The shorter distance being accounted for the fact that you are located in the city.

2.—How far can I receive with the following: 75 ohm receivers, auto-coherer carburendum and electrolytic detectors, rheostate regulator, tuning coil, condensers, 520 met wave length?

A. 2.—Probably about 100 miles with auto coherer, 250 miles with carburendum, 100 miles with electrolytic detector.

TELEPHONE RECEIVER.

(244.) C. MUEHLICHEN, New York, asks:

1.—Can I use a tin can 7 inches in diameter, 12 inches long as a drum for a receiving tuning coil if well insulated?

A. 1.—No, we would not advise it. Tuning coils should not be wound over any metal.

2.—How many ohms resistance will a telephone receiver have if wound with about 1,400 turns of inclosed wire?

A. 2.—We presume that the telephone receiver in question is a standard and that same will have upon the magnets about 500 feet of wire. Wire enclosed is No. 36 and 400 feet of same would have a resistance of approximately 75 to 100 ohms.

RECORDER FOR DETECTORS.

(245.) AMOS K. HOBBY, New York, says:

1.—While reading a book on wireless sometime ago, I read a statement to the effect that the electrolytic or any type of detector other than filing could not be used on some lines, because, although far more sensitive, no permanent record could be made of messages. Now, I have thought of a method by which a record can be obtained from these detectors, and what I want to know is, is this method of any value to any company or person who would pay for it if of value, and if so, can you suggest some?

A. 1.—We would suggest that you write the manager of the Wireless Association of America giving full details of your arrangement and he will pass on same and advise you whether the idea is of any value. This, we think, would be the best method for you, as there is no possibility of your idea being stolen and there is no cost to you.

STORAGE BATTERY QUERY.

(246.) JUAN V. GREY, Mexico, asks:

1.—What is the easiest method to calculate the loss of energy in conductors for certain distances?

A. 1.—We refer you to our excellent book lessons in Practical Electricity by Swope, which we shall send you on receipt of \$1. This will give you all the information.

2.—How powerful a motor must I have to charge a storage battery of 110 volts, discharging at the three hour rate?

A. 2.—It is very hard for us to answer this question, as you failed to give us the ampere hour capacity of the storage cells. Please furnish this information.

DETECTORS.

(247.) J. K. MATSUO, Seattle, Wash., writes:

1.—If I send you the subscriptions for two years, could you send me a free premium of Auto-coherer, complete, postpaid?

- A. 1.—Yes.
 2.—Which is the best detector for money? Price and address of dealer?
 A. 2.—The electrolytic detector in our opinion is more sensitive in general work than any other one. We refer you to the advertisers of this magazine from whom you can procure such instruments.
 3.—What is Micro-phone detector?
 A. 3.—This has been described in the March issue.
 4.—Which is the best receiving tuning coil?
 A. 4.—We consider a double slide tuner, as, for instance, the ones manufactured by the Electro Importing Co., New York, most satisfactory.
 5.—What is best book to study wireless telegraphy?
 A. 5.—Maver's Wireless Telegraphy, which we shall send you on receipt of \$2.20.
 6.—What is Fixed condenser No. 10,000 in catalogue of E. I. Co.?
 A. 6.—Fixed condenser is usually used in the ground circuit and the condenser in question which you described is made by having two condensers of small capacity in series.

1/2-INCH COIL SENDS 2 MILES.
 (248.) CARL H. BRUBAKER, Pennsylvania, writes:

In the May issue you said you could send one-half mile with a 1/2-inch coil. Last Saturday a friend and I went across the Susquehanna River with a portable outfit, consisting of a tuner, battery and molybdenite detector made by myself and 1,500 ohm phones another young man sent from his home in Columbia. The distance in a straight line is about 1 3/4 to 2 miles. The sending coil was an E. I. Co. 1/2-inch coil. The antenna had three wires about 10 feet long stretched between 2 stacks and one end fastened to a tree, the other end one of us had to hold up. We were highly elated because of such a small coil and rudely constructed aerial working such a distance. The three of us all have good stations at home.

A. The policy of the ORACLE is to tell readers what can be reasonably expected under ALL circumstances, with coils, detectors, etc. Usually the answer given is meant for transmission over land. Over water—as in your case—the distance is always double and often three times as great as that over land. The "Oracle's" answers are ALWAYS conservative, never exaggerated, and it is always better to understate than to overstate distances in wireless work.

A green wrapper on MODERN ELECTRICS means your subscription has expired. You want to know what's going on in Electrics, don't you? Send in your sub. before you forget it.

Did you not write us some time ago for a binder to bind M. E.? It's out now: 50 cents each. Send for it before the supply is exhausted.

Cure Yourself

Right at Home With

Vibration



Health is waiting for you! Perfect, abounding, glowing health—such health as you have not known for years, perhaps. And without the aid of doctors, drugs or medicines! No matter what ails you; no matter even if your case has been pronounced incurable—don't give up hope! Vibration, the marvel of the 20th century, has cured uncounted thousands of people who thought they were hopeless invalids.

THE WHITE CROSS ELECTRIC VIBRATOR

is the greatest boon that suffering humanity has ever known. It gives life and health, strength and beauty to all. It sends the good red blood leaping and coursing through your veins, puts new life into diseased muscles and nerves. It shakes the disease right out of your system.

The White Cross Electric Vibrator is the only instrument in the world which enables you to make use of the three great natural forces, Vibration, Faradic and Galvanic Electricity—right in your own home! It is a perfect Massage Vibrator and Medical Battery combined for less than the usual price of either.

VIBRATING CHAIR FREE With a simple attachment you can transform any chair into a perfect Vibrating Chair. You can take Vibratory treatments and Swedish Movements right in your own home, that physicians and sanitariums charge \$1 to \$3 a piece for.



CURES THESE DISEASES:

- | | | |
|-------------|------------------|-----------------|
| Head Ache | Asthma | Heart Trouble |
| Colic | Neuritis | Deafness |
| Insomnia | Ears | Stomach Trouble |
| Indigestion | Weak Eyes | Shin Disease |
| Weakness | Nervous Debility | Scaly Disease |
| Rheumatism | Constipation | Lumbago |

All these and dozens of other chronic and acute diseases can be instantly relieved by Vibration and Electricity.

Valuable Book Given Away

Send us your name and address on the attached coupon at once and we will mail you a copy of the famous book, "Health and Beauty," absolutely free and postpaid. Tells how to prevent and cure disease and how to be healthy, hearty, happy and beautiful in a natural way. No matter how well you are now, you need this book. It has saved thousands of lives—it may save yours. No obligations—just your name and address.

SIGN THE COUPON

Get the free book at once. Let us tell you about our liberal Free Trial Offer. Get our special 90 day introductory discount. Learn how you and all your loved ones can get well without drugs or doctors. Remember, no obligations, just name and address. Get the free book today.

Lindstrom,
Smith Co.,
Dept 218x
251 La Salle St.,
CHICAGO, ILL.

Without obligations on me, please send me free your free book "Health and Beauty," Special Reduced Price Offer and Complete Catalog.

Name.....
 Address.....
 Dep 512x

When writing please mention "Modern Electrics."

CLASSIFIED ADVERTISEMENTS.

Advertisements in this column 2 cents a word, no display of any kind. Payable in advance, stamps not accepted. Count 7 words per line. Minimum, 2 lines. Heavy face type 4 cents a word. Minimum, 3 lines.

Advertisements under "Wireless" 5 cents a word. Minimum, 4 lines. Wireless books and blueprints not listed under "Wireless" 2 cents a word.

Advertisements for the July issue must be in our hands by June 25.

ELECTRICAL APPARATUS.

STUDY ELECTRICITY AT HOME—A complete electrical course at home, containing 30-page detail book, 220-page text-book, 200 experiments and over 100 pieces of apparatus. Price, complete, only \$5.60. Catalogue "M. E. S." explains this and other remarkable offers. Thomas M. St. John, 848 Ninth Ave., New York.

When writing please mention "Modern Electric."

ELECTRICAL BOOKS, BLUEPRINTS, ETC. WIRELESS CODES. Send 10c. for blue print showing Morse, Continental and Navy Codes. A. C. Austin, Jr., Hasbrouck Heights, N. J.

When writing please mention "Modern Electric."

INSTRUCTIONS IN WIRELESS TELEGRAPHY, 25 CENTS. Tells you how to make your own spark coils, relay, coherer-decoherer, tapping key, etc. Complete instructions, no red tape. Electrical Experimenters' Supply House, Dept. A., 622 Wells street, Chicago, dealers and manufacturers of wireless apparatus and electrical novelties. Send 6 cents postage for illustrated catalog.

When writing please mention "Modern Electric."

HOW TO BUILD A WIRELESS TELEGRAPH. Directions and blueprints, 25 cents. Miller Electric Co., Syracuse, N. Y.

When writing please mention "Modern Electric."

WIRELESS EXPERIMENTERS! If you construct your instruments according to our set of ten blueprints of tuned transmitting and receiving circuits you can transmit and receive the longest possible distances. 25 cents. Four wireless telephone blueprints, 15 cents. Electrolytic Detector blueprint, 15 cents. Imperial Wireless Co., 5215 Penn avenue, Pittsburg, Pa.

When writing please mention "Modern Electric."

? WIRELESS ?

Of course we have it. Coherers, Detectors, Auto Coherers, Rheostats, Static Machines, in fact all the Electrical "knick-knacks" you have been looking for. All apparatus carried in stock in St. Louis. Why pay freight and expressage to get goods from the East? Come and look over our stock. **HANCE ELECTRIC CO., Olive Street, St. Louis, Mo.**

When writing please mention "Modern Electric."

A CHOICE STOCK and the finest assortment of Wireless Telegraph supplies for the experimenter and the amateur in Philadelphia. We can save you money on all these goods and shall be only too pleased to demonstrate and explain you the philosophy and working of the apparatus' tuners, detectors, condensers, high resistance phones, coherers, etc. J. Elliott Shaw, 639 Arch St., Philadelphia, Pa.

When writing please mention "Modern Electric."

WIRELESS. New England wireless amateurs can obtain high grade wireless goods from me. All supplies kept in stock. All material guaranteed. Send 2-cent stamp for printed matter on New Detector. Springfield Wireless & Morse Institute, Room 31, 176 Main street, Walker Building, Springfield, Mass.

When writing please mention "Modern Electric."

YOU BET

We have all up to date wireless supplies. We carry more wireless goods for the amateur than any other house on the Coast. Why pay express and freight, when you can get the goods right here at right prices? Detectors, Tuners, Condensers, Spark Coils from 1-2 to 4 inch spark, oscillators, coherers, lamps, static machines, in fact, anything electrical you want. Call or write. It will pay you. **PAUL NEILER ELECTRIC WORKS, Market St. San Francisco, Cal.**

When writing please mention "Modern Electric."

1000-OHM WIRELESS RECEIVERS SENT on trial, \$1.75 each. New wireless detector, the best yet, \$3.50. Send stamp for descriptive circulars. Alden Wireless Co., Campello, Mass.

When writing please mention "Modern Electric."

SPECIAL PRICES.—1,000-ohm wireless receiver, double pole, special thin diaphragm, \$1.75. Wireless telephone for amateurs, blueprint showing connections, 30c. Morse, Continental and Navy Codes, 10c. W. M. F. receiving condenser, 30c. Waterhouse Bros., 5 Main street, Bourne, Mass.

When writing please mention "Modern Electric."

WANTED.—Coherers to test in connection with my combination wireless receiving instrument. U. S. patent 391,461. Who makes the best? State price when writing. J. E. Ostrander, Staatsburg, N. Y.

When writing please mention "Modern Electric."

JUST OUT.—New wireless receiver set \$4.00. Large line of wireless supplies. Send 2 cents for catalogue. Miller Electric Co., Syracuse, N. Y.

When writing please mention "Modern Electric."

WIRELESS BARGAINS. Zincite and Copper Pyrites, 50c per set. Brass Cups silver plated for mounting crystals with solder, 10c each. No. 36 M. S. C. IRON wire for Marconi Magnetic Detector, 50c per ounce. No. 50 (1 1/2 mil) S. M. covered copper wire for high resistance phones, 10c for spool containing exactly 1000 ohms. Wollaston wire, .0005, 15c. .0001, 25c; silicon fused, large piece 15c. Molybdenite, more sensitive than silicon 10c large piece. Graphite carbon cup for electrolytic detector, 20c. Selenium metal in sticks for selenium cells, large piece, 25c. Stamp for 120 page catalog. Electro Importing Co., 862 West Broadway, N. Y. City.

When writing please mention "Modern Electric."

FOR SALE.

TO EXCHANGE. Gramophone, Cycle Engine Castings, Lathe, Books, Libraries, for Camera, Wireless Coil Electric Goods, Colt Revolver. James Mosser, Flat 2, 641 W. Erie street, Chicago.

When writing please mention "Modern Electric."

FOR SALE.—A 500 Watt 20,000 volt transformer, for \$22.50, and other wireless instruments. Fred Ford, 334 Lake street, Los Angeles, Cal.

When writing please mention "Modern Electric."

FOR SALE.—One kilowatt transformer, closed core type. Size ten by ten by six inches. Primary can be connected in series or parallel, as desired. Price, forty dollars. F. W. Huntington, Jr., 2629 Pacific avenue, San Francisco, Cal.

When writing please mention "Modern Electric."

WANTED.—A I. H. P. Gasoline Engine, 8 light Dynamo. Wm. Huth, 340 Lombard street, San Francisco.

When writing please mention "Modern Electric."

FOR SALE.—One small generator, 6 volts, 6 amp., good condition, price \$3.00, cost \$7.00. Frank Cross, 3917 Millin street, Pittsburg, Pa.

When writing please mention "Modern Electric."

40-WATT DYNAMO. Delivers alternating and direct current, 8 volt, 5 amperes. Price \$3.50. Walter Voskil, Cedar Grove, Wis.

When writing please mention "Modern Electric."

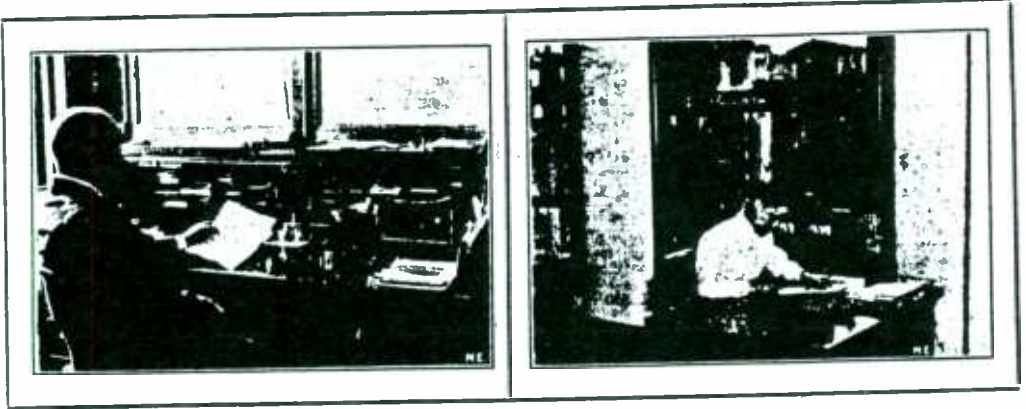

PRESIDENT OF LARGE CORPORATION DICTATING TO STENOGRAPHER IN ANOTHER ROOM.

HOW THE PRESIDENT SAVES AN HOUR EVERY DAY

By W. W. GRIFFITH

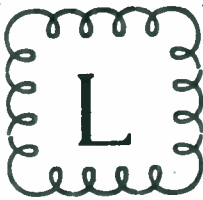

LIKE most other men with Hurry as their gad-fly, I sometimes hear of astonishing things that I mean to look into, but which "business" drives out of my mind before I have the opportunity to investigate.

But when I was told at luncheon the other day that the active President of a great corporation had installed a system whereby he could instantly and directly issue a general order to all the heads of departments throughout the building, at one time without leaving his room, I remembered to have heard about that wizard-like performance before, and determined to follow the lead at once, before I could lose it again. Fortunately I was acquainted with the President, and I found him not only willing but rather pleased to show me the operation of the wonderful saver of time and annoyance.

Just under the pigeon-holes of his desk, out of the way of everything and almost out of sight, was set an innocent looking box not more than 11 inches long and 6 inches high; a row of small levers ran along the lower part of it, above which were two orifices that might remind one of a pair of exaggerated eyes.

"Demonstration number one," said the President, and reaching over he pulled down several levers; "Buzz," went the instrument and several "buzzes" answered. "Now I

know," said he, "that my heads of departments are at their end of the wire and I'm going to issue a general order about deliveries," which he did in a low tone of voice at a distance of at least 6 feet from the box, and rather away from it than toward it. "Is that understood, Mr. Evans, Mr. White, etc?" and he went down the line of names. Imagine my astonishment when "Yes, sir, O. K.," came from the box, as each name was called in tones clearly audible in every part of the private office (about 15 feet square). It was almost uncanny.

"You see," he said, "instead of sending a boy and bringing them to my office from distances of 100 to 700 feet and on different floors, I can issue a general order and have it acknowledged in 10 seconds."

"Demonstration number two will show you how the private office can be secluded even from my stenographer who used to be its most constant invader," continued the President, as he pressed another lever; instantly the box said, "Yes, sir, ready"—walking to the extreme end of the office he dictated a letter in a tone of voice scarcely above a whisper and, mind you, without connection with or apparent regard for the location of the box—talking into the air. "Read that back, please," and out of the instrument came the text of the letter word for word clearly understandable and distinct to both of us.

"This feature is particularly desirable," he

said, "when I have a number of gentlemen in the office and want to dictate an agreement or a letter. It saves the time for them and for me which would be required for her to come to the office and depart; I get her instantly and when through dictating I shut off and we are immediately ready to resume our conference."

"The third demonstration will show you how secret communication is assured. We will assume that you are a salesman and have quoted me a price on a large quantity of oil. I press my bookkeeper's lever," suiting the action to the word, "and ask 'What did we pay for that last supply of oil?' Now I take this receiver off the hook; that automatically causes the instrument to act like an ordinary telephone—I get the information and you have heard nothing. Further and entire secrecy is assured by the fact that no matter how many lines are opened on the other end (or substitution), nothing can be heard unless I switch them on here (at the master-station). No central is necessary—the intercommunicating and cutting out system is evidently perfect in its arrangement and is entirely governed by my pressing the lever."

"Here is also an interesting test that I have tried. We will suppose that clerk No. 1 has laid the blame for an error on clerk No. 2, I connect up both clerks without either knowing that the other is on the wire: then I say to clerk No. 2, 'Clerk No. 1 says that you are at fault in this case' and state the reason. Clerk No. 2 gives his side and if it is not correct Clerk No. 1 breaks in and tells him so. They then argue it and I hear both sides without taking them away from their desks or having them invade my office for the discussion.

"It is quite a detective in its way and beside giving me much inside information I figure that it saves me perhaps as much as one to two hours a day which is obviously a great consideration.

"Our Secretary, Treasurer, General Manager and Superintendent all have Master Stations and we communicate with each other constantly without leaving our desks and without the bother of either talking into a mouth-piece or holding a receiver to the ear."

"Does it ever get out of order?" I asked.

"Ours has not as yet and it has been installed six months." was the reply. "It is put in on a rental basis and The National Dictograph Company guarantees all maintenance and perfect working order."

By the way, the name of this little Wizard of modern business is the Dictograph, but that name hardly expresses its capabilities as demonstrated to me, and in fact it would be hard to find a name that would.

I have just learned of another very interesting and practical service which the Dictograph rendered. A certain financial institution of large interests, through being checkmated in several important moves, was convinced that some of its employees were not only "leaking" but playing with the other side.

Suspicious actions led the officers of the Institution to believe that one room was consistently used for conferences by the employees in question — in this room they proceeded to install a Dictograph, setting it in the wall and covering it with wall paper so as to make it entirely invisible.

The conspirators (so to speak) met, their discussion, word for word, was heard by the Company officials some distance away, and the graft of the traitors as well as the embarrassment (financial and otherwise) of the Institution, came to an immediate ending.

Further investigation gives me the information that while the National Dictograph Company is a young concern, its instruments are now installed in some of the largest and most conservative Banks, Trust and Life Insurance Companies and Industrial Corporations in New York, Chicago, and other large cities.

The purpose of the Company, now that the practicability and usefulness of the Dictograph has been proved by actual rentals to great Corporations, is to take immediate steps toward making it universally known and used.

It would seem that every business man would conserve his best interests by writing to the Sterling Debenture Corporation, Brunswick Building, Madison Square, New York, for Booklet No. "N. 359," which gives full information about the Dictograph, its purposes, its rentals, installations and plans for the future.

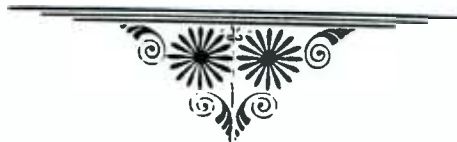

Magnet Wire

At fabulous low prices. Ask for quotation on size, style and quantity desired. S. M. COHN & CO., 83 Fulton Street NEW YORK CITY

When writing please mention "Modern Electrica."

The Inventor's Universal Educator

TELLS ALL ABOUT PATENTS, HOW TO SECURE THEM. HAS 600 MECHANICAL MOVEMENTS, also 50 PERPETUAL MOTIONS

Every inventor should have a copy. Price \$1.00 by mail.

—ADDRESS—

F. G. DIETERICH, Ourey Bldg., Washington, D. C.

When writing please mention "Modern Electrica."

PATENTS That Protect and Pay

WATSON E. COLEMAN,

Registered Patent Attorney.

Advice and Book Free; Highest References; Best Service

612 P Street, N. W. WASHINGTON, D. C.

When writing please mention "Modern Electrica."

6 x 12 inch **ELECTROPHORUS** and 21 articles. A few rubs gives stunning 8-inch spark to hand, 8-inch to metal conductor. Charges Leyden Jar, Lifts and holds up 8-in. 40 oz. tin pie plate. Price \$1.25 Prepaid. **INDUCTION COIL EXPERIMENTAL APPARATUS**, 21 articles, prepaid, \$1.25. Stamp for catalogue.

THE HERTZIAN ELEC. CO.
1024 Flatbush Ave., Brooklyn, N. Y.

When writing please mention "Modern Electrica."

Premium Catalog

containing over 600 electrical articles anyone of which you may acquire for NOTHING, simply by getting us new subscribers will be sent you on receipt of 2c stamp.

MODERN ELECTRICS PUBLICATION
24 West Broadway, New York

When writing please mention "Modern Electrica."



GROBET SWISS FILES

And Other High Grade Tools

Are shown in our catalog. Send your name and address on postal and mention this paper and we will send free our catalog.

MONTGOMERY & CO.,
108 Fulton Street, New York City

When writing please mention "Modern Electrica."

SEND US YOUR NAME AND ADDRESS so as to be at the head of the list to receive our new **STORAGE BATTERY CATALOGUE** now in blossom. Just the thing for the wireless experimenter. A new low priced complete storage battery of any capacity. We have almost anything you can wish for and a few specials you can get nowhere else. Send the stamps today and state just what you are most interested in. Storage batteries and storage battery work is our specialty.

ELECTRICAL MAINTENANCE AND REPAIR CO.
200-202 Manay St., Newark, N. J.

When writing please mention "Modern Electrica."

WIRELESS GOODS

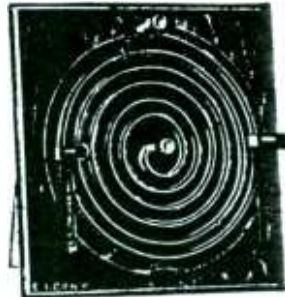

SENDING HELIX

Sending HELIX

(Inductance)
AS CUT
\$2.00



POTENTIOMETER

POTENTIOMETER

NON-INDUCTIVE, as cut, with two Resistance Rods, 300 and 500 Ohms.

\$1.50

Only house in Washington, D. C. carrying a COMPLETE line of Wireless experimental apparatus in stock. Come and look over our stock and judge for yourself. Will gladly demonstrate all goods.

JOHN C. RAU, Electrical Supplies
526 12th St. N. W. Washington, D. C.

All information free and good treatment assured.

When writing please mention "Modern Electrica."

Electric Light Fixtures

For Residence, Boat and Camping.

We construct special designs to order. We manufacture all specialties of metal goods in quantities only. Write us your requirements. We issue no catalogue.

Gothberg Manufacturing Co.
112 Duane Street, New York City

When writing please mention "Modern Electrica."

All You Need is the Idea

We design and manufacture Mechanical and Electrical Instruments and Apparatus of precision for all purposes.

MULLER & JABLONSKY
Electrical Instrument Makers
62 CORTLANDT STREET NEW YORK
EXPERIMENTAL AND MODEL WORK
SPECIAL MACHINERY, TOOL AND FIXTURES

When writing please mention "Modern Electrica."

TELEGRAPHY TAUGHT

in the shortest possible time.

The Omnigraph Automatic Transmitter combined with standard key and sounder. Sends you telegraph messages at any speed just as an expert operator would. 5 styles \$2 up; circular free.



Omnigraph Mfg. Co.
89 1/2 Cortlandt St., New York

When writing please mention "Modern Electrica."

Wireless Communication

NOW is the time to engage in the study of the new art of wireless. The demand for trained wireless operators is growing constantly. The recent government action has increased the demand 100 per cent. Salary of trained operators ranges from \$15.00 to \$40.00 per week.

The American Wireless Institute

is the only universally recognized school in the world for the teaching of this art.

Applications Now On File For 100 Expert Operators

Come in and be one of the first to take a position in this new field that offers promotion, good salaries and boundless opportunities. Descriptive matter free on request.

Address Nearest Office

27 WILLIAM STREET
New York, N. Y.



UNIVERSITY BUILDING
Detroit, Mich.

WIRELESS

affords you more genuine pleasure than anything you have known yet. We have the goods—the best made—right in stock. We wish to cater especially to wireless folks in and around Chicago. Our prices are right, our goods still better. Come and look over our stock and judge for yourself.

Send us postage for our great Catalog

ANDERSON SPECIALTY CO.

68 & 70 La Salle Street - Chicago, Ill.

When writing please mention "Modern Electrician"



We Ship on Approval

without a cent deposit, prepay the freight and allow 10 DAYS FREE TRIAL on every bicycle. IT ONLY COSTS one cent to learn our unheard of prices and marvelous offers on highest grade top models.

FACTORY PRICES Do not buy a bicycle or a pair of tires from anyone at any price until you write for our new large Art Catalog and learn our wonderful proposition on the best sample bicycle going to your town.

RIDER AGENTS everywhere are making big money exhibiting and selling our bicycles. We sell cheaper than any other factory.

Tires, Coaster-Brakes, single wheels, parts, repairs and accessories at such small prices. Do Not Wait! Write today for our latest special offer.

MEAD CYCLE CO. Dept. C. 219. CHICAGO

When writing please mention "Modern Electrician"

DON'T BUY WIRELESS GOODS!

Until you see our INSIDE PRICES. We make tuning coils, potentiometers, etc., and sell directly to you. Our prices can't be beat. Send for list.

CHICAGO WIRELESS SUPPLY CO.
52 B Auditorium Bldg., Chicago

When writing please mention "Modern Electrician"

B O O K S

We carry the best book assortment in this country. Our specialty is to publish electrical books—just what you are looking for. Here are a few: **Storage Batteries**, by A. E. Watson. Ph. U.E.E. Theory, Construction and Use. Price postpaid, cloth, \$1.50.

How to Make a 1-Kilowatt Dynamo, by A. E. Watson. Profusely illustrated. Price postpaid \$1. **The Gas Engine**, How to Make and Use It, by P. B. Warwick, including discussion on gasoline engines. Price, cloth, postpaid 75 cents.

A B C of Wireless Telegraphy, by E. Trevert. An excellent book for the amateur. Price postpaid \$1.00

New Experimental Electricity, by E. Trevert. A book every experimenter should possess. Price postpaid \$1.00.

X-Rays for Everybody, by E. Trevert. Unquestionably the best book printed for the amateur and experimenter. Price postpaid 50 cents.

These are only a few books from our large assortment. Send for free list containing over 70 best electrical books in existence.

M. Bubier Publishing Co., Lynn, Mass.

S K O O B

When writing please mention "Modern Electrician"

METAL E. KONIGSLOW STAMPING & TOOL WORKS. CLEVELAND, O. **STAMPING**
DIE MAKERS. HARDWARE SPECIALTIES.

PRICE
\$1.50
AND UP

STAR SAFETY RAZOR

Reputation from accomplished facts and not promises has carried the Star Safety Razor through thirty successful years. The expense of large advertising space prohibits going into detail in regard to the Star Safety Razor. You get value in this article and are not paying for the advertisement. Men who have used this Razor for many years, and who have also tried numerous thin blade Safety Razors, state that **THERE IS BUT ONE SAFETY RAZOR** that gives entire satisfaction—and **THAT IS THE "STAR."**
Catalogue sent upon request.
KAMPFE BROTHERS, 28 Rensselaer St., New York.

When writing please mention "Modern Electrics."

JUST OUT

Anything Electrical

A 3c stamp will secure OUR NEW BIG CATALOG. Positively the largest and most comprehensive electric catalog of its kind published. 25 pages to wireless goods alone. Wireless outfits from \$10.35 to \$250.00 and upwards.

J. J. DUCK, 432 St. Clair St. Toledo, O.

When writing please mention "Modern Electrics."

WIRELESS TELEGRAPHY

Taught quickly by Correspondence. Positions secured. I make a specialty of qualifying ambitious young men and women for **RAILROAD, COMMERCIAL** and **WIRELESS TELEGRAPHY**. Send 10 Cents for Codes and Full Information.

CHARLES ELLIS
1720 2d Avenue, New York, N. Y.

When writing please mention "Modern Electrics."

.. TRANSFORMER ..

250 watt 10,000 volt transformer for use in wireless telegraphy. Special price delivered to any part of U. S., \$30.00. Will send up to fifty miles. Speaking arcs, transformers, etc. supplied for use in wireless telephony. Drawings and plans furnished. Send for descriptive matter.

VICTOR H. LAUGHTER
BYHALIA, MISS.

When writing please mention "Modern Electrics."

Wireless Telegraphy

Taught Quickly by Correspondence.

Positions secured.

BOSTON SCHOOL OF TELEGRAPHY

18A Boylston St., Boston, Mass.

The largest and best Telegraph School in New England. We make a specialty of qualifying ambitious young men and women for **Railroad, Commercial, Brokerage and Wireless Telegraph** service. Send 10c postage cash or stamps for free wireless telegraphic book. With this we furnish **FREE OF CHARGE** two handsome Telegraph codes, mounted on fine cardboard, one showing the Wireless Telegr. code, the other Morse code. Size 6 x 6 inches.

When writing please mention "Modern Electrics."



TYPEWRITER Sacrifice Sale

Greatest bargains ever offered, **UNDERWOODS, OLIVERS, REMINGTONS, SMITHS** (all makes) rebuilt \$15. to \$38, worth double; sent subject to examination and trial. Send for "Bargain List"

Consolidated Typewriter Exchange

245 BROADWAY, NEW YORK

Old reliable. Established 27 years on Broadway. Don't miss this chance to get a good typewriter at half price. Write immediately.

When writing please mention "Modern Electrics."

FREE--Two Books:
61 Page
"Inventor's Guide"
AND
41 Page
"Proof of Fortunes in Patents—
What and How to Invent."
Trade-Marks, Copyrights
Prints, Labels, Registered.
ADVICE FREE.
Correspondence Solicited.

PROTECT YOUR IDEA! Patents That Pay

SPECIAL OFFER: Send sketches or model and description of invention for **FREE SEARCH** of Patent Office Records and Report as to patentability. You will save **TIME and MONEY.**

EXPERT--PROMPT SERVICES.
E. E. VROOMAN,

HIGHEST REFERENCES
Registered Patent Attorney
Patent Lawyer (Patent Litigation)
**1109 F STREET,
WASHINGTON, D. C.**

REFERENCES:
American National Bank,
Washington, D. C.
Little Giant Hay Press Co.,
Dallas, Texas.
Gray Lithograph Co.,
New York City, N. Y.
Farmers Mfg Co.,
Norfolk, Va.
New Era Mfg Co.,
Fairfield, Iowa.
The Parry Stationery Co.,
Oklahoma City Okla.
Bell Show Print Co.,
Seymour, Ia.

When writing please mention "Modern Electrics."

No. 602 "Ulery" Pocket Knife Tool Kit

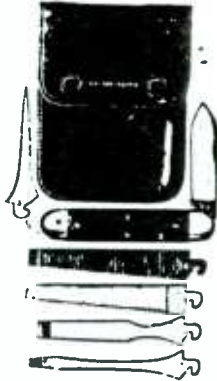

Made in America.
 Every one has use for a Knife, Reamer, File, Saw, Chisel or Screw Driver. This outfit is practical, yet so small, being contained in a Leather Pocket Book 4 1/2 x 3 1/2 inches, is, by carrying it in your pocket, always at hand for immediate use, whether Camping, Boating, Teaming, Driving, in the Shop, Factory, Office, Store, Warehouse, Automobile, on the Farm Bicycle or around the Home

Any Tool firmly attached or detached to the Pocket Knife in a second.

Sent Post Paid on receipt of price \$2.25.

Use it five days and if not satisfactory return it and we will refund your money.

U. J. ULERY CO.
 25 V Warren St., New York, N. Y.

When writing please mention "Modern Electric."

Wireless Experimenters

Magnet wire single silk in sizes from Nos. 29 to 40 at greatly reduced prices wound on spools in quantities desired.

Secondary windings of any size wound to any specification, prices on application. Have a lot of condensers suitable to be used with 1 and 2 inch spark coils, while they last 50c each. I also carry everything in wireless. Send 2c stamp for catalog.

Spark coil for sale giving 36 inch spark on A. C. and 24 inch on D. C. Very finely finished in Mahogany wood with first class condenser. Heavy platinum contacts suitable for wireless or X-Ray work. Price complete \$450.00. For photographs and particulars apply to

M. TANENBAUM, 728A Broadway, Brooklyn, N. Y.

When writing please mention "Modern Electric."

INDUCTION COILS OUR SPECIALTY

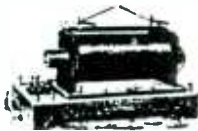

All sizes from 1 in. to 20 in. Spark Testing Instruments, Telegraph Apparatus, Experimental Work of all kinds.

Footo, Pierson & Co.
 160 Duane St., New York

When writing please mention "Modern Electric."

Send For Our Latest List on

WIRELESS APPARATUS

Double Slide Tuning Coil \$4.00

Detectors \$3.50 to \$5.50

Receiving Condensers \$1.00

Head Receivers all Resistance, 100-ohm to 6,000 \$2.70 to \$10.00

Every Instrument Guaranteed

FLETCHER-STANLEY CO.

32 & 34 Frankfort St., New York

When writing please mention "Modern Electric."

ELECTRICITY
 Practically and Individually Taught

Our pupils actually handle the tools and machinery. Instructors stand beside them, directing, criticizing and showing them how to work.

Day and evening sessions.
 Call and inspect our school and equipment or write for Prospectus.

New York Electrical School
 391 West 17th St., New York.

When writing please mention "Modern Electric."

MR. WIRELESS EXPERIMENTER

To be perfectly frank do you personally prefer your instruments to look good as well as work good.

(Or do you enjoy ruining the neat appearance of your outfit, with troublesome acid that will not only hurt the highly polished wood surfaces, but also stain hard rubber and corrode all metal parts, no matter how plated.

We believe that you prefer a clean and efficient detector—one that can be set up in a second; that requires no battery nor potentiometer and that will not wear out, burn out, or be thrown out.

Therefore we offer

The IMPROVED SILICON DETECTOR

and guarantee it the most reliable and efficient type sold for experimental use, send for circular.

THE WIRELESS EQUIPMENT CO.
 West Arlington, Md.

When writing please mention "Modern Electric."

ACCURATE COMPACT INEXPENSIVE

Voltmeters, Ammeters and Volt-Ammeters

Send for Complete Catalogue of PORTABLE and SWITCHBOARD PATTERNS



L. M. PINOLET
 82 CORTLANDT ST., NEW YORK

When writing please mention "Modern Electric."

Here, Cigaret-Smokers

Roll A Cigaret in 8 Seconds

The "Kwick-Roller" is a marvel. Rolls a perfectly formed cigarette that never unravels, quicker than by hand, and Makes Better Cigarets Than You Can Buy



Gives better "draw," a sweeter smoke and more compact "roll." Carry it in your vest-pocket; no tobacco waste; used for any tobacco, with any paper. It's a luxury. Tell your friends about it. Send us the name of your dealer and 25c in stamps or coin and we'll send you one quick. To Dealers—You can make more money selling a "Kwick-Roller" and one sack of tobacco than selling several boxes of ready-made cigarettes. Write for our liberal offer.

SIGARET ROLLER WORKS
 40-42 Quincy Street Chicago, Ill.

When writing please mention "Modern Electric."

Wireless Apparatus

1/2 K. W. Mounted in Mahogany Cabinet \$75.00
Oscillation Transformer alone . . . 15.00

These transmitting sets mounted or unmounted, in sizes of 1/2 K. W. upwards are fully equal to commercial installations of similar rating.

Of their many exclusive features, one fact stands out pre-eminent—that fact is absolute reliability.

An illustrated catalog descriptive of wireless apparatus of distinctive merit will be mailed on request.

CLAPP - EASTHAM CO.

730 Boylston St., Boston, Mass.

HENRY MORTICE, 24 East 21st Street
Representative for New York City

WAGNER ELECTRIC MFG. CO.
McKay Bldg., Portland, Ore.
Western Representative

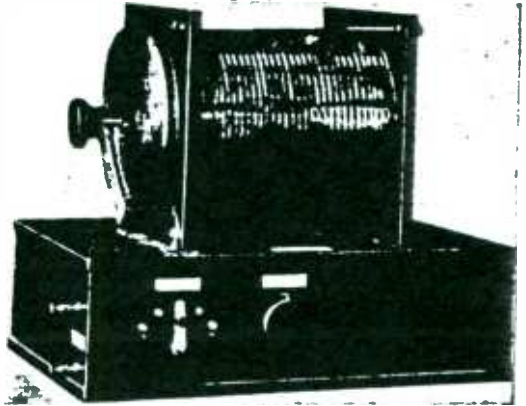

Type A. C. C. Transmitting Set.

When writing please mention "Modern Electrics"

Faucet WATER MOTORS



Complete with every \$2.50 wheel, buff wheel, pulley to run sewing and washing machine, polish. In some cities where we have no agents, and where the water pressure is good, a sample motor will be given free; apply at once if you want to make some extra money, or if you can devote your whole time, liberal salary and commission will be paid.

ALCOHOL STOVES, LAMPS AND FLAT IRONS.

ENGINEERS WANTED to send for catalog of indicators, Reducing Wheels, Planimeters. Address, LIPPINCOTT M. S. CO., 52 Columbia St.,

Newark, :: :: New Jersey

When writing please mention "Modern Electrics."

The Schoen Printing Co.

Magazines
Printers Catalogues
Stationery, etc.

13 Vandewater Street. NEW YORK

When writing please mention "Modern Electrics."



SPECIAL. Rheostat that will give you service and resistance, will regulate your current gradually and not in jumps; is very accurate. Little heating, coil air cooled. Has no concealed parts, will not get out of order. Can be used for 1 to 110 volts. Buy one and regulate the speed of your small motors. Dim down your incandescent lamps 2 to 110 volts. Fine as an inductor.

Use in wireless work for tuning. This rheostat is the best on the market; resistance coil will not rust, break or bend under a constant load of 2 Amperes. Resistance 10 Ohms. Maximum capacity 2 Amperes. Price 80 cents. By mail extra, 4 cents. Send 2 cents for our catalogues with latest discount sheet.

KETTEMAN ELECTRIC CO., 23d St., Toledo, Ohio.

When writing please mention "Modern Electrics."

60 YEARS' EXPERIENCE
PATENTS
TRADE MARKS
DESIGNS
COPYRIGHTS & C.

Anyone sending a sketch and description may quickly ascertain our opinion free whether an invention is probably patentable. Communications strictly confidential. HANDBOOK on Patents sent free. Oldest agency for securing patents. Patents taken through Munn & Co. receive special notice, without charge, in the

Scientific American.

A handsomely illustrated weekly. Largest circulation of any scientific journal. Terms, \$3 a year; four months, \$1. Sold by all newsdealers.

MUNN & Co., 367 Broadway, New York
Branch Office, 625 F St., Washington, D. C.

When writing please mention "Modern Electrics."

"C. Q. D." We are sounding a general call to inform all

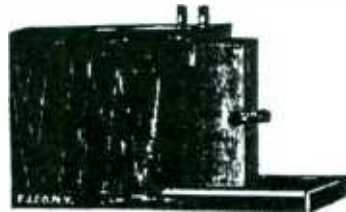

Wireless experimenters and amateurs located

in and around Cleveland, to come and look over our new stock of Wireless Goods.

All goods for the Wireless experimenter carried in stock. Satisfaction and good treatment assured. Send for our new Wireless catalog.

ERNER ELECTRIC CO.

122a E. St. Clair Ave. - Cleveland, O.

When writing please mention "Modern Electrics."

A Book Worth Having—it's FREE



A book packed full of new ideas in labor-saving "YANKEE TOOLS" for all classes of Mechanics. Tools that appeal to any man, no matter what his profession or calling. The book is the embodiment of Yankee ingenuity and invention, illustrated with photographic reproductions of the Tools in use.

A postal brings it if you say "Modern Electrics" Your dealer sells "YANKEE TOOLS"

NORTH BROS. MFG. CO.

Philadelphia, Pa.

When writing please mention "Modern Electrics."



Detector Stand \$1.00

Wireless Goods

of every description. We carry a larger stock of Detectors, Tuning Coils, Potentiometers, Spark Gaps, Telephone Receivers, Condensers, etc., than any other house in Chicago.

Our prices are right, our goods of the highest precision.

Send for our Wireless Catalog TO-DAY

Central Electric Co.

26-4a 5th AVENUE - CHICAGO, ILL.

When writing please mention "Modern Electrics."



GLOBE

The Best Low Price Dry Cell Made

Price in lots of 12 or more

13½ CENTS EACH

No extra charge for Fahnestock Connections

If you are carrying on experiments in which wet or dry cells have to be used our battery catalogue will prove of interest. Sent free to all who mention this publication.

**NATIONAL
CARBON
COMPANY,**

Cleveland, Ohio



When writing please mention "Modern Electrics."

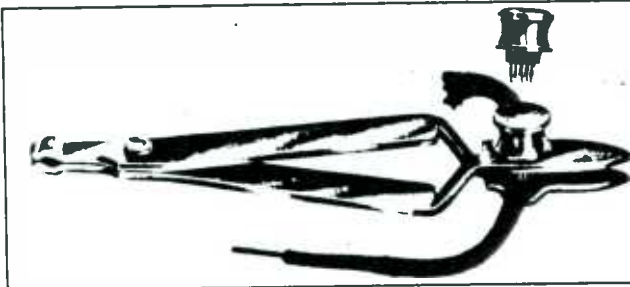

Williams Test Clamps

will pay you a fine profit in saving of labor and material. They save skinning—they save re-taping—they save time—they save the wire. This clamp is particularly to be recommended for Wireless Work in connection with sending inductances, etc. The needle part is then not used, only the jaws. Will firmly grip round wires (see groove) or flat strip by means of flat jaws. Does away with harmful sparking and increases your efficiency. Send 75 cents for a set (two) postpaid, on 30 days' trial. Your money back if you want it.

THE WILLIAMS TEST CLAMP CO.
416 Prospect Ave. S. E. Cleveland, O.

For sale in Canada by W. J. KONKUS,
64 York St., Toronto

When writing please mention "Modern Electrics."



ADJUSTABLE ZINC SPARK GAP

This Spark Gap, ever since its introduction last year, has found much favor among wireless people. This Gap is a marvel of simplicity and must be seen in action to be appreciated. It has heavy zinc plugs, $\frac{1}{8}$ -inch thick, which makes it possible to use the Gap up to a $\frac{1}{2}$ -K.W. transformer. Size of base: $4\frac{1}{2} \times 8\frac{1}{4}$ in. Finely polished hard rubber pillars, binding posts and thumb screw (1 inch in diameter). Metal arch is of cast brass $\frac{1}{8}$ -inch thick, finely lacquered. The adjustment is extremely accurate. Gap is to be adjusted while IN OPERATION.

No. 9820a—Zinc Spark Gap patents pending as described.

\$1.00

BY MAIL, EXTRA 12 CENTS.

Electro Importing Co., 86-n West Broadway, New York

**THIS IS THE WONDERFUL
RED STYLO
INK PENCIL**

Impossible to leak, even if carried upside down. Writes like a pencil. Has a platinum-iridium feed wire and we therefore guarantee each and every pencil. Order one now.

Over 3 Million of these Pencils now in use.

All editorials and text matter of MODERN ELECTRICS are written with

**Red Stylo
Ink
Pencils**

To introduce this marvelous ink pencil to readers of MODERN ELECTRICS we will send One sample pre-paid for \$1.00. Regular price strictly \$2.00. Dealers and Agents write for interesting proposition. We also make electric flash lights, batteries, the famous Universal dry cells, electric scarf pins, Alladin electric gas lighters, electric magic lanterns; also the marvelous dry alcohol (in chunks) Universal flaming cigar lighter, sample sent by mail for 50c., etc. CATALOGUE FREE.

Universal Novelty Co.
165 W. 29th St., New York, N. Y.

When writing please mention "Modern Electric."

PATENTS
TRADEMARKS AND COPYRIGHTS
SECURED OR FEE RETURNED

Send model or sketch and description of your invention for free search of the U. S. Patent Office records.

Our Four Books mailed Free to any address. Send for these books; the finest publications ever issued for free distribution.

HOW TO OBTAIN A PATENT
Our Illustrated eighty page Guide Book is an invaluable book of reference for inventors and contains 100 mechanical movements illustrated and described.

PORTUNES IN PATENTS
Tells how to invent for profit and gives history of successful inventions. Also list of Patent buyers.

WHAT TO INVENT
Contains a valuable list of inventions Wanted and suggestions concerning profitable fields of inventions. Also information regarding prizes offered for inventions, among which is a

PRIZE OF ONE MILLION DOLLARS
offered for one invention and \$10,000 for others.

PATENTS THAT PAY
Contains fac-similes of unsolicited letters from our clients who have built up profitable enterprises founded upon patents procured by us. Also endorsements from prominent inventors, manufacturers, Senators, Congressmen, Governors, etc.

WE ADVERTISE OUR CLIENT'S INVENTIONS FREE in a list of Sunday Newspapers with two million circulation and in the *World's Progress*. Sample Copy Free. Electrical Case a Specialty.

VICTOR J. EVANS & CO.
(Formerly Evans, Wilkens & Co.)
Main Offices, 200 "F" Street, N. W.
WASHINGTON, D. C.

When writing please mention "Modern Electric."

MURDOCK WIRELESS APPARATUS

Style Amtuning Coil
Double Slide. Special Friction Contacts.
Enamel Wire Winding.
All Metal Parts are Nickel Plated.
Coil Ends made from Hard Rubber Composition.

PRICE \$4.00

Head Receivers, all resistances, 100-ohms to 6000-ohms \$2.70 to \$10.00.
Detector Condensers \$3.50 to \$5.50.
Receiving Condensers \$1.00.

Send for our latest list.

WM. J. MURDOCK & CO., : : 40 Carter Street, Chelsea, Mass.

Winners at

THE GERNSBACK ELECTROLYTIC INTERRUPTER (PATENTS PENDING)

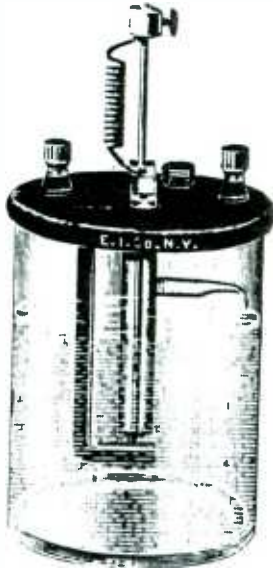

No. 8000

This interrupter is connected in series with any ordinary spark coil and the 110 V or 220 V, direct or alternating lighting current supply. No resistance or condenser is used, except a key or switch to break the current in the usual manner. The vibrator of the coil must be screwed up tight as it should not vibrate. The glass vessel is filled with the solution and as soon as the key is depressed you will get the surprise of your life. You don't get a thin, meagre spark, as with batteries, but A HEAVY FLAME ¼ INCH THICK. That this is the ideal thing for Wireless is unnecessary to mention. The spark obtained of a 1 inch coil, connected to a big sending condenser and a zinc spark gap with zinc ½ INCH THICK will crash in the gap with such a tremendous noise that it will take your breath away. AND THE SPARK FILLS THE GAP. These are PLAIN FACTS. Our usual guarantee backs them. By way of proving our statement look at the two photo's taken by Mr. Gernsback. The first one shows the full spark of a 2-inch coil run by a 6 V 60 A. II. storage battery. Exposure 1½ seconds. The second shows the FLAME of the same coil with a 110 V current and the new interrupter. Exposure 1½ seconds. The flame shoots upward, as the great amount of heat raises the discharge. You cannot appreciate the work you are able to do with this wonderful interrupter till you see it in operation. Not alone do you get a better and a heavier spark, but it is also from 15% to 25% LONGER, all depending on the construction of the coil. And that is not all. The output of the coil is increased at least 60%. That means that you can send at least 60% further with the Gernsback interrupter. This will be better understood by mentioning that two No. 14 copper wires, connected to a 1-inch coil and separated ¼ inch will fuse within 5 to 10 seconds.

The Gernsback interrupter starts with 50 volts. A metal rod of especial alloy goes through the cover, down in the glass tube. This tube at its lower end has a peculiar aperture in which the point of the rod fits. The tube at the upper end has a screw top which screws in the cover. In operation the metal rod wears itself away to a perfect point. The rod itself is fed down by gravity. Very little metal is used up; it takes about 60 hours constant work to consume one inch of the rod. New rods are supplied at a trifling cost. The hard rubber composition top has all metal parts IMBEDDED in it

(Patented). No metal exposed whatsoever. Therefore NO KORROSION as is usually experienced in other interrupters. The interrupter heats up very little, even when working for hours. The path between the two electrodes is only ¼ inch and the amount of solution heated at a time therefore is necessarily slight. This interrupter will find thousands of friends and is especially recommended for wireless and X-ray work. When used for the former it may be stated that it produces an extremely high sound in the distant receiver, which is much easier to read than the low sound produced with the old spring vibrator giving only from 150 to 200 vibrations per second, against 5000 to 7000 per second with the electrolytic interrupter.

The interrupter is to be used in connection with ordinary spark coils from ¼ inch up to 12 inch spark length. Two coils (or more), may be connected in series and if the secondaries are connected in series, too, the length of the resulting spark is as long as the sparks of the two coils put together. Therefore two 2 inch coils will give a 4 inch spark, and so on.

Every instrument is fully guaranteed to be all we claim for it. Mr. Gernsback would not allow his name put to it if he had not implicit faith in it. It is a guarantee by itself.

The Gernsback Interrupter (patents pending) No. 8000, as described, size 10½x5 inches. Weight, without solution, 2 lbs. INTRODUCTION PRICE \$2.50
Send for descriptive circular.



No. 1



No. 2

THE "ELECTRO" ANTENNA SWITCH

This switch has been brought out in pursuance to a great many calls we have had in the past for such a switch. As illustration shows this is a three-pole, double throw switch. As will be seen the end prongs are at an angle of 140 degrees and the construction of this switch is unlike any other. By referring to the diagram below it will be seen that when the switch is thrown for receiving the primary of the coil is disconnected. If accidentally the sending key should be touched it will be impossible to damage the receiving instruments, as the coil can under no circumstances operate. The diagram shown below is standard, but of course many other connections can be devised by the experimenter. All metal parts are pure copper.

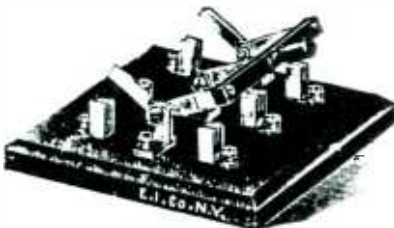

No. 8100

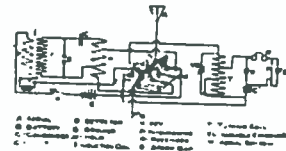

Hard rubber handle is provided as switch handle. This switch will stand the discharge of a 4 inch coil without jumping across. It can be used in connection with a transformer up to 5 K. W. All copper parts are almost an eighth of an inch thick. Binding post is provided at each pole of the switch and new connectors are provided which makes the unscrewing of wires impossible.

The switch can be screwed down on any table or on the wall. Size of base 7 x 7 inches, height over all 3½ inches, when lever is down; when lever is up, height is 5 inches. Weight 1¼ pounds. This switch is built thoroughly all the way through, best material used and construction is right. There is at the present no quicker wireless throw switch on the market. We shall refund your money if it is not absolutely satisfactory.

No. 8100. "Electro" Antenna Switch, as described, price.....\$1.50

a Glance

We have been building spark coils for the last 6 years. It is on record that we have sold more coils than any other concern in the U. S. to experimenters and amateurs. In fact, our coils have helped much to give us the national reputation as "The Experimenter's House."

We have had such a large demand of late for a REAL wireless coil, to be used for wireless only, that we have put our best efforts towards building such a coil. We leave you to be our judge if we succeeded.

The "Electro" 1/2 K. W. Transformer-Coil

(100 MILE WIRELESS COIL.)

is a radical departure from ordinary coil building. It possesses all the good points of a good coil, but none of its bad ones.

The average experimenter when buying a coil nowadays buys a cat in a bag. The coil is sealed entirely and if it should break down it must go back to the factory. Neither does the owner know what is inside the coil—he must take the maker's word for it—which is sometimes not satisfactory.

Our coil is NOT SEALED IN, and is still better insulated than a sealed in coil, where most of the time you get only 1/4 of the weight in wire and 3/4 weight in sealing wax.

Our new Departure is centered in our

BLOCK-SECONDARIES

(see cut). These secondaries are wound with NO. 30 B. & S. ENAMELED WIRE. This means, on account of getting 3 times as many ampere turns into a given space, that our secondaries are 3 times as efficient as other ones, and that they take up one-third as much room. Size of secondary, 3 1/4 x 2 3/4 x 3 1/2 inches.

You marvel that such a small coil could give such an enormous output. The enameled wire explains the mystery. After the secondary coils have been wound they are placed in a square form which is filled with molten paraffine. When cold, a square block-coil is obtained, which exposes no wire except the 2 end pieces.

We form our secondaries square so they can not roll. We guarantee that the wire is No. 30 B. & S. Each secondary weighs 2 3/4 lbs and gives a 3/4-inch spark. The primary is another marvel. We use again enameled wire, No. 14 B. & S., and consequently get just 3 times as much wire on the core, as if we used the common D. C. C. wire, used now almost entirely on inferior coils. The result is of course that our new primary is just 3 times as efficient as other ones.

We are willing to prove that our primary gives a 25 per cent longer spark on the secondary as with the old type.

A hard rubber insulating tube is slipped over the primary. Then the two block secondaries are slipped on, and the whole is placed in the coil box, which has been treated with an insulating compound.

All coils fit perfectly close and snug and the box is arranged in such a way that the secondaries can not move, but are always 1/4 inch apart.

Connections are made and the cover is screwed down. Thus this marvel of simplicity is always ready to be inspected and to be taken apart, when occasion arises, for new experiments, etc., etc.

Four top rubber binding posts are provided, so that one secondary may be used at a time, both in series, both in parallel and for other important experiments.

As there is no vibrator nor condenser to this coil, it must of course be used with an electrolytic interrupter or independent vibrator, or running it from 110-220 Alternating current.

The spark obtained is from 1 1/4 to 1 1/2 inches long, but 1/4 inch THICK. For wireless work it is the fat spark that counts, not the long, thin spark. You must radiate energy (amperage) from your antenna, not tension (voltage).

Our coil radiates energy—high amperage—and lots of it. Compared with the ordinary coil, ours as far as wireless transmission is concerned, will send further than the 8-inch coil wound with No. 36 B. & S. wire. And an 8-inch coil costs \$38.50!!

Size of box, 9 x 5 1/2 x 4 1/2 inches. Weight of complete coil 8 3/4 lbs.

No. 8050. Electro 1/2 K. W. Transformer-Coil, as described:



NO. 8050

INTRODUCTION PRICE \$7.00

- No. 8060. Same coil as above, but with fine vibrator and condenser, to work on 6 to 10 volts (100 Watts equal to 20 miles). Price \$10.00.
- No. 8070. Block-Secondaries wound with No. 30 Enameled wire, as described. Price.....each \$2.75
- No. 8071. Primary, with Enameled wire. Priceeach \$1.25
- No. 8072. Hard wood box. Priceeach \$0.50

We have so much confidence in our new coils that we will ship any one—or more—either No. 8050 or 8060, on receipt of \$1.00 deposit, with full privilege of inspection. Try the coil. If it is not all and everything we claim for it—if it does not suit you in any respect, return it to us at our expense. Can we do more?

You want a good Wireless coil, here is your chance. Order at once, first come, first served.

Our new ELECTRICAL CYCLOPEDIA CATALOG No. 6, containing 120 pages, valuable information, wireless diagrams, WIRELESS CODES, electrical photographs and the most complete assortment of wireless goods, apparatus, novelties, etc., etc., will be sent to you on receipt of 2 cents postage to cover cost of mailing.

Electro Importing Co., 86-z W. Broadway, New York

"Everything for the Experimenter."



PROMOTED!

☞ Don't worry about the boss not having his eye on you and noticing the improvement in your work. Remember he is human—he is on the lookout for good men. His success, and the firm's depends on his ability to select the right man.

☞ If you are a little better than the other man—if you know more about your work than he does, do you suppose the boss will pass you by and boost the other fellow?

☞ You wish you had a better job. You wish you knew more, then you could do more and earn more. Fill in the blank form below and let us tell you how these wishes can be realized.

FREE INFORMATION COUPON

American School of Correspondence:

Please send me free your Bulletin of engineering information and advise me how I can qualify for position marked "X."

- | | |
|---------------------------|---------------------------------------|
| Electrical Engineer | Telephone Engineer |
| Draftsman | Heating and Ventilating Engineer |
| Civil Engineer | Plumber |
| Mechanical Engineer | Architect |
| Stationary Engineer | Hydraulic Engineer |
| Structural Engineer | Textile Boss |
| Municipal Engineer | Sheet Metal Pattern Draftsman |
| Railroad Engineer | College Preparatory Course |
| Structural Draftsman | Sanitary Engineer |

NAME

ADDRESS

OCCUPATION

Mod. Elect. 6-09.

☞ Our advice, based upon the experience of our successful students and graduates will cost you nothing. It may start you right and change your whole future.

☞ The American School of Correspondence is an educational institution. We employ no agents or collectors. The merit of our work makes this unnecessary.

☞ Advice regarding the work you wish to take up and our complete Bulletin will be sent for the coupon. There's no obligation attached to this—mail it to-day.

WE HELP MEN HELP THEMSELVES

AMERICAN SCHOOL of CORRESPONDENCE
CHICAGO, U. S. A.

When writing please mention "Modern Electrics."

"Modern Electrics" guarantees the reliability of its advertisers.