

Electrical Communication



VOLUME 59 No 1/2 1985

THE TECHNICAL JOURNAL OF

ITT



Volume 59
Number 1/2 · 1985

Electrical Communication

Technical Journal Published Quarterly by ITT Corporation

Electrical Communication is the technical journal of the ITT System reporting the research, development, and production achievements of its affiliates worldwide. First published in 1922, Electrical Communication appears in four language editions distributed throughout the world. Contributions are invited from ITT engineers and scientists; summaries of papers should be sent to the English edition Editor for consideration.

Executive Editor, Brussels
Lester A. Gimpelson

Editor, Electrical Communication, Harlow
Michael Deason

Editor, Elektrisches Nachrichtenwesen, Stuttgart
Otto Grewe

Editor, Comunicaciones Eléctricas, Madrid
Antonio Soto

Editor, Revue des Télécommunications, Paris
Jean Pierre Dartois

Subscriptions cost \$ 20 (£ 13.00) per volume (4 issues)
Individual copies \$ 5 (£ 3.25).
Editorial and subscription enquiries should be addressed to the Editor, Electrical Communication, Great Eastern House, Edinburgh Way, Harlow, Essex, England, or Editors of other editions.
Published 17 December 1984.
© ITT Corporation, 1984.

Coden: ELCMAX 59 (1/2) 1-248 (1985)
ISSN: 0013-4252

System 12 Digital Exchange

This special double issue of *Electrical Communication* is devoted to ITT's revolutionary System 12* Digital Exchange, the world's fastest selling digital switching system.

A previous issue of the journal published in January 1982 (volume 56, no 2/3) described the modular distributed control architecture, switching network, component technology, software, operations and maintenance, and other key features in some detail. The present issue provides an up-to-date account of how the "future safe" architecture of System 12 has allowed new technologies to be introduced and modules for new services and applications to be developed while retaining the fundamental architecture. Particular emphasis is given to System 12's role in a future ISDN, including ISDN field trials and pilot services. Also included are details of experience with installing and operating the first System 12 exchanges to go into service.

New applications for the System 12 architecture, including wideband switching, a digital business communication system, a switch for the German satellite system, and cellular mobile radio switching systems, are discussed in some detail.

A full contents list for the issue – the largest in the journal's 62-year history – is given on pages 2 and 3.

* System 12 is an ITT trademark.

ITT

System 12 Digital Exchange

- 4 **Overview**
 - 6 **Market Status,**
J. Loeber
 - 12 **Integration and Field Experience,**
K. J. Hamer-Hodges, G. De Wachter, and H. Weisschuh
 - 20 **Review of the Fundamental Concepts,**
R. Van Malderen
 - 29 **Technological Enhancement,**
R. Cohen
 - 35 **Architecture for Change,**
R. H. Mauger
 - 43 **Analog Line Circuit,**
J. M. Danneels and A. Vandevelde
 - 48 **Analog and Digital Trunk Circuits,**
J. J. van Rij and P. Wöhr
 - 54 **Dual Switch Port,**
W. Frank, M. C. Rahier, D. Sallaerts, and D. C. Upp
 - 60 **Software,**
G. Becker, R. S. Chiapparoli, R. S. Schaaf, and C. Vander Straeten
 - 68 **Software Quality Assurance,**
J. Nenz
 - 74 **Traffic Overload Control,**
G. Morales Andrés and M. Villén Altamirano
 - 80 **Switching System Maintenance,**
M. Beyltjens and P. Van Houdt
 - 89 **ISDN Field Trials in the Belgian, Italian, and Spanish Networks,**
F. Haerens, B. Rossi, and J. M. Serrano
 - 98 **ISDN Pilot Service of the Deutsche Bundespost,**
D. Becker and H. May
 - 105 **ISDN Line Circuit**
R. Dierckx and J. R. Taeymans
 - 112 **Data Module Architecture Including Packet Operation,**
A. Chalet and R. Drignath
 - 120 **Configuration for ISDN Subscriber Equipment, Network Termination,
Digital Telephones, and Terminal Adapters,**
T. Israel, D. Klein, and S. Schmoll
-

Contents (continued)

- 127 **Transmission at 144 kbit s⁻¹ on Digital Subscriber Loops,**
L. Gasser and H. W. Renz
- 131 **Technique for Wideband ISDN Applications,**
S. R. Treves and D. C. Upp
- 137 **Switching for the German Satellite System,**
K. Nigge, K. Rothenhöfer, and P. Wöhr
- 145 **Acilia International Toll Exchange,**
M. Della Bruna and F. Minuti
- 154 **Aarhus Local-Transit Exchange,**
J. A. Broux, P. Erlandsson, and E. Rishøj
- 159 **Toll Exchanges for the German Network,**
M. Langenbach-Belz
- 166 **Collado-Villalba Digital Island,**
A. Campos Flores and M. Fernandez Moreno
- 174 **Application of the Remote Subscriber Unit in the Norwegian Network,**
S. Husby and B. Vinge
- 179 **ITT 5630 Business Communication System,**
A. Bessler, M. E. Edelmann, and L. Lichtenberg
- 188 **Network 2000 Evolution in the United States,**
R. E. Pickett
- 195 **Role of the Digital Adjunct in Network Enhancement,**
J. E. Cox and R. E. Pickett
- 200 **Digital Network Planning**
P. A. Caballero, F. J. de los Rios, and F. Casali
- 207 **Containerized Exchange,**
D. Ardizzone and L. Peli
- 212 **Cellular Mobile Radio Applications,**
G. Adams, M. Böhm, and K.-D. Eckert
- 220 **Telecommunication Networks beyond ISDN Transport,**
L. A. Gimpelson and S. R. Treves
- 228 **Future Direction,**
B. J. Fontaine
- 235 **Contributors to this Issue**
- 241 **Abbreviations in this Issue**
- 243 **This Issue in Brief**
-

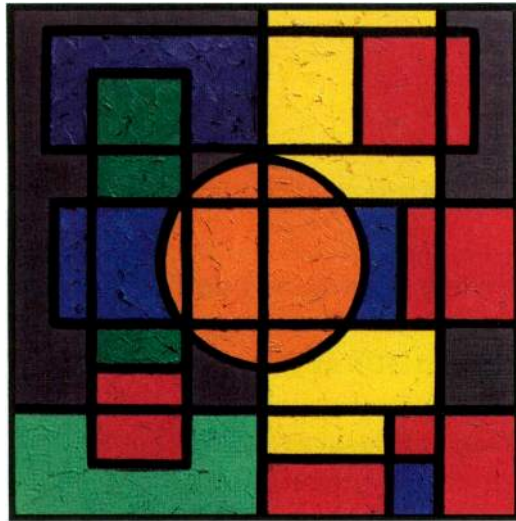

The strength of System 12 lies in the versatility of its architecture: terminals equipped with their own control are able to communicate through the digital switching network. This structure allows fully modular hardware and software to be used, which in turn ensures the flexibility necessary to build exchanges of all types and sizes, to introduce new services, and to benefit from advanced technologies.

Overview

When the previous special issue of *Electrical Communication* devoted to ITT's System 12 Digital Exchange was published three years ago, the system with its revolutionary distributed control architecture was on the verge of full scale implementation. In the intervening years, the early promise of this fourth-generation architecture has been fully proved by field experience with more than 25 exchanges in eight countries, and awards totaling well over 11 million equivalent lines in 19 countries.

The essence of System 12's "future safe" design is that it can adapt easily to take advantage of advances in technology and add new services, accommodating change on an incremental basis. Exchanges in operation or undergoing field trials, installation experience, and negotiations with administrations worldwide have generated new ideas as to how System 12 can be used and further enhanced, and helped clarify future needs as the ISDN concept is gradually implemented in the world's telecommunication networks. Thus the past few years has seen a number of changes of detail and the development of new modules for a continuously expanding range of applications. This evolution has, of course, been accomplished without changes to the basic distributed control architecture. It is indeed remarkable that such a fundamentally new architecture should have accomplished so much so rapidly.

Today, several System 12 exchanges have been operating for more than two years during which time they have demonstrated an excellent overall performance, including high availabilities (over 0.9999 in the Deutsche Bundespost exchanges). Throughout this period exchange performance has demonstrated the impressive fault resistance of the distributed control architecture. However, the field experience has resulted in some fine tuning of the system, which has taken advantage of the built-in hardware and software modularity.

One area for enhancement has been the provision of new features and capabilities, including CCITT No 7 common channel signaling, digital operator positions, remote subscriber units, a new network service center, and extended man-machine communication facilities to make operation even easier. Packet switching capability has also been added, and a wideband capability based on switching multiple associated 64 kbit s⁻¹ channels (up to 2.048 Mbit s⁻¹) has undergone successful tests in the laboratory. This ability to realize a wideband ISDN using the existing network puts System 12 in the forefront of network evolution.

Naturally, advantage has been taken of advances in VLSI technologies as they have become available. VLSI circuits are more widely used, there are fewer hybrid circuits, high voltage integrated circuits have replaced relays, and a new 256 kbyte RAM has been introduced. The results have been improved performance, lower power consumption and heat generation, and reductions in packaging volume. An analog line rack can now handle 1024 lines with eight lines per analog line circuit board. Consequently System 12 exchanges now make even better use of exchange floor space.

Initially System 12 was aimed at local, toll, rural, combined local/toll, and local tandem applications; at the same time the evolution to an ISDN was a basic design consideration.

An ISDN field trial based on System 12 has been successfully demonstrated in Italy, and similar trials and pilot services are imminent in several countries. Telecommunication administrations and ITT are gaining valuable experience with ISDN through these trials.

New applications are rapidly coming into existence with the development of cellular mobile radio systems, a satellite switching system, and a business communication system (digital PABX) based on the System 12 architecture and making extensive use of common hardware and software. In addition, in the United States System 12 is being developed as a series of digital adjuncts to analog exchanges to provide functions and services that are difficult to add to existing conventional exchanges. One such adjunct under development is the signal transfer point, a high speed switch for CCITT No 7 common channel signaling, which will open up new revenue opportunities for telephone administrations that wish to introduce sophisticated services such as automatic calling party screening.

System 12 technology is so effective that it opens up opportunities in areas far removed from traditional switching applications. An example from a current project is the development of powerful local area networks that can grow to full PBXs. One can envisage this technology being applied to support distributed voice and data communication needs such as exist in banking, factory, or hotel environments.

Already System 12 is being adapted to the specifications of 19 different countries, including the United States where market conditions are very different from those in most other countries. The modular nature of the System 12 architecture enables such adaptations to be carried out by development teams located all over the world — from Taiwan (China) to North America to Europe, with new teams planned in countries such as Turkey. System 12 is truly an international switch designed for international markets. In competitive international tenders, telecommunication administrations generally view System 12 as the most technically advanced switching system among the alternatives.

The articles in this special double issue of *Electrical Communication* look at all aspects of System 12 today, ranging from hardware and software evolution, through field experience, ISDN, new features and facilities, to new applications and finally to the future direction of System 12 which has still unrealized potential, a potential that ITT is dedicated to tapping for the benefit of telecommunication users and industry worldwide.



C. Rivet
Vice President
ITT Europe, Brussels

System 12

Market Status

The innovative features of ITT's System 12 Digital Exchange have ensured its rapid acceptance by telephone administrations throughout the world. The validity of the distributed control concept has already been proved in trials and acceptance tests, and System 12 exchanges are now carrying live traffic in several countries. ISDN field trials are demonstrating that the exchange concepts are as applicable to non-voice services as to telephony.

J. Loeber

ITT Europe Telecommunications and Electronics, Brussels, Belgium

Introduction

Outside the United States, ITT is the largest supplier of telecommunication equipment in the world, especially in the field of public switching. In particular ITT is the major supplier of public switching equipment to European administrations. During 1983 alone the corporation installed exchanges with approximately 3 000 000 lines and 250 000 trunks. Over the years, ITT has installed some 64 million lines and 4 million trunks of exchange equipment.

The corporation's latest public switching system, the System 12 Digital Exchange, has completed its design phase and

become a fully proven system which is rapidly gaining international acceptance. Indeed, awards for System 12 equipment have already exceeded 11 million equivalent lines*, just three years after the first exchange of its kind (Brecht in Belgium) started tests with the Belgian administration. It is fair to say that System 12 is the fastest selling digital switching system on the market.

System 12 Development

System 12 development, the largest project ever undertaken by ITT, required the coordination of all available switching resources within the corporation. Early studies indicated that the development of a digital exchange based on the architecture of traditional analog systems with centralized stored program control would provide an easy but shortlived solution. Instead ITT made a conscious decision to look for a longer term solution that would be able to take full advantage of anticipated evolution in technology to provide the new telecommunication networks and services that subscribers were beginning to demand. The result is the System 12 concept of distributed control and modular hardware.

Because the System 12 architecture is radically different from that of its predecessors, it has required major new hardware developments, including the

View of a typical System 12 exchange with the cabinet doors removed.



* As of November 1984.



Building housing the Seinajoki System 12 digital exchange in Finland.

design and production of several complex custom VLSI devices. In addition, new software concepts have been necessary to take full advantage of the power of the distributed control architecture.

Figure 1 shows the six principal ITT Design Houses involved in the project, which is coordinated by the ITC (International Telecommunications Center) in Brussels. The ITC and these ITT Units together comprise about 2000 full time engineers and support staff working on System 12. Country adaptations and other specific system developments are handled by the other units shown in Figure 1.

- Regie van Telegrafie en Telefonie (RTT), Belgium
- Deutsche Bundespost, Germany
- Società Italiana per l'Esercizio Telefonico pa (SIP), Italy
- Azienda Statale Servizi Telefonici (ASST), Italy
- Compañía Telefonica Nacional de España (CTNE), Spain
- Norwegian Telephone Administration (NTA), Norway

System 12 Success in the World

The promise contained in System 12's fresh architectural approach has been recognized by the world's telecommunication community, which is why System 12 has been so successful over the past few years.

Western Europe

In Western Europe alone, the following telephone administrations have ordered System 12 for digitizing their national public networks as the first step towards realizing a full ISDN capable of carrying both voice and non-voice services:

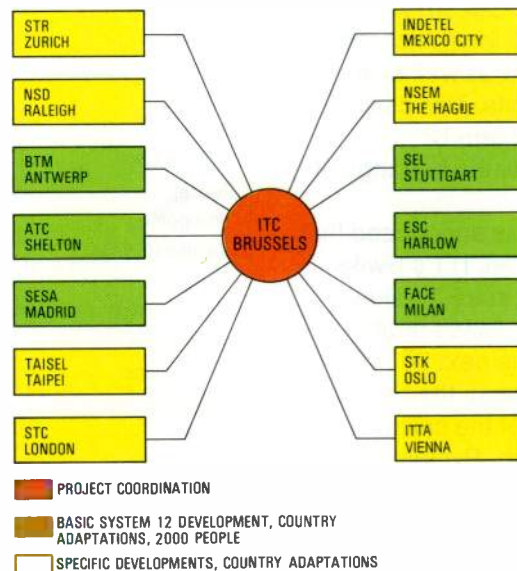

Figure 1 ITT units involved in the System 12 development – the largest project ever undertaken by the corporation.

- Swiss PTT
- Jydsk Telefon A/S, Denmark
- Finnish PTT
- Kuopio Telephone Company, Finland
- Kankaanpaa Telephone Company, Finland.

The Federal Republic of Germany, Norway, and Switzerland were typical of the strong competition among suppliers of digital switching equipment.

In Germany, following a system selection process which may be unique in its scope and complexity, System 12 was selected as one of two standard systems adopted by the Deutsche Bundespost. Considering the administration's long standing tradition of using a single standard switching system, this decision demonstrates the Bundespost's faith in the architecture and performance of System 12.

In Norway, the NTA selected System 12 as the only system to meet their needs for digital switching (560 000 equivalent** lines) in the public telephone network between 1985 and 1988. Previously, ITT supplied only half the equipment for the Norwegian network.

The NTA's selection criteria included both *technology* and *overall economy*. The NTA highlighted other advantages of System 12, including its flexibility with respect to the introduction of new services and new technology, and its advanced operations and maintenance features. In November 1983, the Norwegian government officially ratified the NTA's decision and increased the total System 12 order to 700 000 equivalent lines covering the entire spectrum of exchange sizes and hierarchical levels. The range covers from large toll exchanges (e.g. Oekern with 12 000 toll trunks) to small local exchanges (several hundreds of lines), as well as about 250 remote subscriber units. This clearly demonstrates that the System 12 architecture is able to cover the full range of switching applications.

In December 1983 it was announced that Standard Telefon und Radio, ITT's Swiss affiliate, would participate in a \$3 billion programme to digitize the Swiss public switching network over the next 20 to 25 years. Announcing the award, the Swiss PTT stated that, in terms of the criteria set down by the administration, System 12



Large local System 12 exchange installed in Wuppertal for the Deutsche Bundespost.

came first as a result of its advanced technology and its ease of integration into existing telephone networks. The first two orders for exchanges under this programme have already been received.

International Markets

System 12 has also become the leading product outside Western Europe, with

Table 1 – System 12 awards list (October 1984)

	Equivalent lines	Exchanges
Belgium	1 115 080	149
Mexico	580 214	350
Germany	453 610	51
Denmark	97 860	29
Italy	112 680	35
Finland	27 860	19
Spain	1 126 110	212
Venezuela	143 000	20
Nepal	23 750	18
Philippines	8 000	4
Taiwan (China)	121 920	3*
Norway	700 000	458
People's Republic of China	2 372 000	325
Yugoslavia	570 000	75
Switzerland	19 840	2
United States	19 600	2
Chile	3 600	1
Turkey	3 400 000	350
Colombia	16 000	2
TOTAL	10 911 124	2 105

** The total number of equivalent lines is given by adding the number of lines to twice the number of trunks.

* Includes local field trial exchange.

awards from countries as widely separated as Mexico, the People's Republic of China, Yugoslavia, and Turkey.

Mexico: In Mexico, Telmex has selected System 12 to meet 75% of their public digital switching needs (578 000 equivalent lines) between 1982 and 1987. Initially BTM (Bell Telephone Manufacturing Company) will supply this equipment, but subsequently will transfer equipment manufacture to Indetel, the ITT affiliate in Mexico.

People's Republic of China: Over the past few years suppliers of digital switching equipment have been making vigorous attempts to gain a foothold in the country with the largest population on earth. System 12 was recently selected for a major contract by the China National Postal and Telecommunications Industry Corporation. The contract includes the direct supply by BTM of 100 000 equivalent lines together with the further supply of components for the local assembly of System 12 exchanges. In addition the award covers the transfer of technology to China and the construction of a factory which at the end of a five-year period will achieve a yearly output of 300 000 System 12 lines.

Taiwan, China: The System 12 proposal for two 30 000 trunk digital toll exchanges was the lowest tender. The official award was given to ITT in November 1983, and the exchanges are already being manufactured.

Yugoslavia: In November 1983, BTM and ISKRA, Yugoslavia's main telecommunication manufacturer, signed an agreement for the introduction of System 12 into the national network. BTM will provide equipment and technology leading to the production of 570 000 equivalent lines over a period of five years.

Turkey: System 12's most recent success has been a major award from the Turkish PTT for a total of 3.4 million lines over a 10-year period. More than 100 000 equivalent lines will be manufactured by BTM; the remainder will be manufactured locally in Turkey, with BTM being responsible for transferring the necessary technological knowhow. Turkish Government officials stated that one of the reasons for selecting System 12 was that it is more technically advanced than the products offered by competitors.

Current Status

Awards for System 12 equipment have been received from 19 countries totaling over 11 million equivalent lines — in excess of 2 100 exchanges. Table 1 shows the System 12 awards list (as of October 1984) which clearly demonstrates that System 12 can cover the entire application range. Indeed it includes every conceivable type of exchange configuration, ranging from very small rural systems to very large toll exchanges. Also included are several international gateway and transit exchanges.

The System 12 digital operator position completes the application range. It can be used either as a stand-alone operator position subsystem, or fully integrated in a System 12 exchange. Several awards for both configurations have been received from the administrations in five countries — Belgium, Italy, Nepal, People's Republic of China, and Switzerland.

International System 12 toll exchange of Acilia in Italy, the first installation for the international application.



Operating System 12 Exchanges

The large number of lines already ordered has led to the need for the rapid and simultaneous introduction of System 12 in several countries. Exchanges have already been installed, tested, and handed over to administrations in eight countries (Figure 2).

The various signaling interfaces, billing schemes, and other features required for

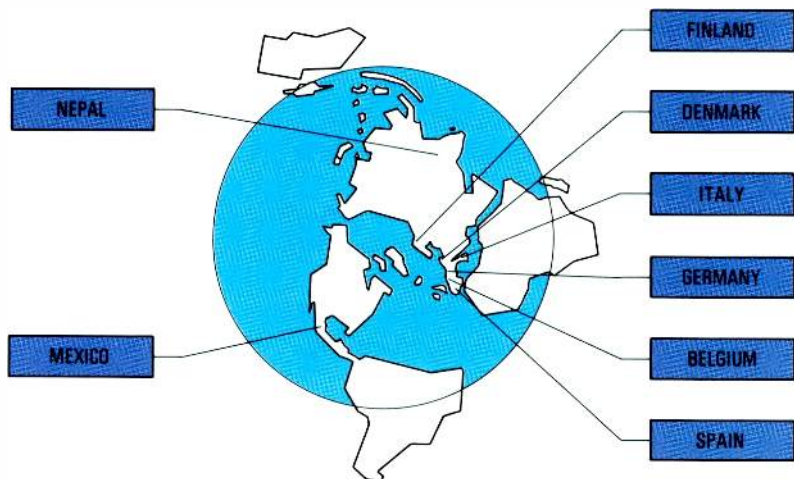

Figure 2
Countries in which there are installed System 12 digital exchanges.

these applications demanded significant country specific adaptations. System modularity and ease of adaptation are crucial to the successful introduction in so many different environments.

System 12 Technology Transfer

Today System 12 is the top ranking digital switching system in the world and has been adopted as the universal product by the telecommunication manufacturing units within ITT. Currently the system is being manufactured at BTM, FACE-Standard, Standard Elektrik Lorenz, and Standard Eléctrica.

System 12 hardware integration is straightforward as an exchange typically contains only around 35 types of printed board. The comparable figure for other digital systems generally exceeds 150. This feature, together with ITT's long experience in the transfer of technology, will allow

System 12 to be manufactured throughout the world. Already System 12 technology is being transferred to several countries for local manufacture (Figure 3).

System 12 ISDN Application

ITT is well advanced in the development of ISDN features for its digital switching system. Close cooperation between ITT and the telephone administrations in Italy, Belgium, Germany, and Spain has been going on for a considerable time in order to define and implement ISDN field trials involving System 12.

In Italy, Belgium, and Spain these field trials have already been defined in detail. The System 12 ISDN field trial in Italy was successfully initiated on the occasion of the International Switching Symposium held in Florence in May 1984. The trial in Belgium is scheduled to start soon and, together with the Italian trial, will last until about mid 1985. Agreement has been reached with CTNE to start the Spanish field trial in mid 1985. ISDN subscriber loop operation, including digital voice, fast facsimile, and both circuit- and packet-switched data calls, will be demonstrated on System 12 exchanges which have already been installed and operational in their respective networks.

System 12 ISDN pilot installations will go into service in Germany during 1986, with the full series production and introduction of ISDN exchanges in the network planned to start in 1988.

Adaptation of System 12 for the United States market is also well underway. As part of the introduction of System 12 into North America, ITT is working with the Southern

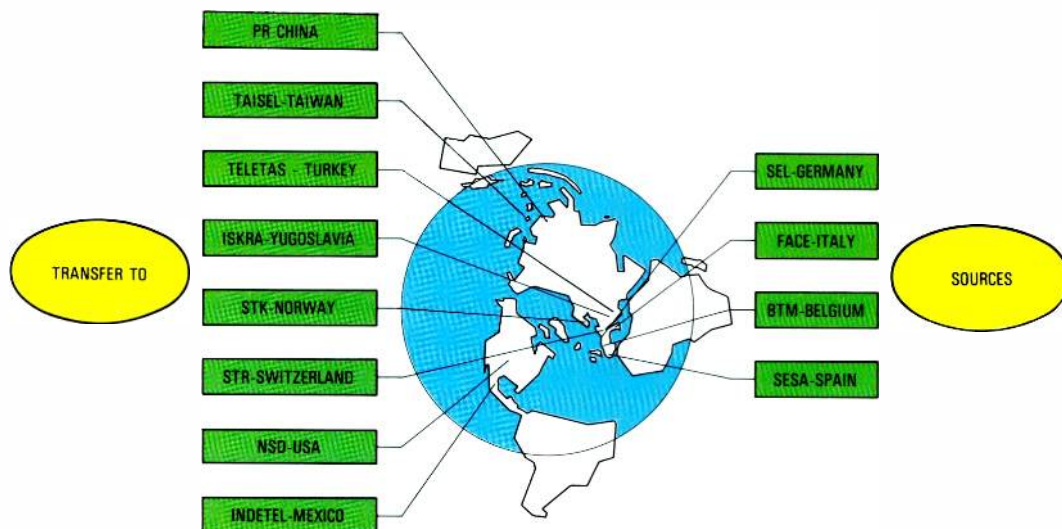

Figure 3
Transfer of System 12 technology to countries throughout the world.



Exchange building in Salamanca which houses Spain's first System 12 digital exchange. The capacity of the exchange is 10000 subscriber lines.

New England Telephone Company. This application is for a telemetry field trial, covering both analog and digital subscriber loops, in which a System 12 exchange will act as a *digital adjunct* to an existing stored program control analog exchange.

Outlook for Digital Switching

Over the years the development of digital communications systems has become an increasingly expensive undertaking. Reasons for this phenomenon include the huge R&D investments required to build up and maintain skilled software staff and a state-of-the-art custom VLSI design capability, as well as the increasing trend in system complexity needed to provide features such as common channel

signaling, complex interfaces (e.g. access to packet networks), advanced subscriber features, and the sophisticated operations and maintenance features expected by administrations. Implementation of the ISDN will reinforce this trend.

In order to keep pace with present developments in digital switching alone, a company has to spend around \$100 million yearly on R&D. Assuming 10% of the sales figure can safely be spent on R&D, minimum sales of about \$1 billion are required in switching alone.

ITT is well above this figure — many others are not. This problem is affecting several companies, leading to a reduction in the number of digital switching products, possible mergers of companies or projects, and cancellation of other projects. The systems that survive will be characterized by an extensive content of state-of-the-art (V)LSI components, sophisticated software, and high volume production. This will be the only way to achieve high reliability at reasonable cost. Administrations should seriously consider these aspects before selecting a particular system.

Conclusions

Development of System 12 required a major investment of ITT's R&D resources. Within the corporation there has always been a firm belief that the System 12 architecture, built on the foundations of distributed control and VLSI technology, is essential to a new generation of switching equipment. The significant success of System 12 over the past few years is now confirming this belief. The introduction of System 12 for telephony is in full swing. The next major step, the addition of ISDN capability, will prove the soundness of its concept beyond doubt.

System 12

Integration and Field Experience

Experience with installing and operating more than 20 System 12 digital exchanges has proved the basic advantages of a distributed control architecture. Target values for parameters such as call effectiveness, service availability, and hardware failures have been rapidly met, and in some cases exceeded by wide margins.

K. J. Hamer-Hodges

International Telecommunications Center,
Brussels, Belgium

G. De Wachter

Bell Telephone Manufacturing Company,
Antwerp, Belgium

H. Weisschuh

Standard Elektrik Lorenz AG, Stuttgart,
Federal Republic of Germany

Introduction

By the end of October 1984, System 12 exchanges had been installed in the networks of Belgium, Denmark, Finland, Germany, Italy, Mexico, Nepal, and Spain (Table 1). In addition, well over 11 million equivalent lines had been ordered by 17 administrations on four continents¹.

When evaluating the experience gained during System 12 integration on laboratory test beds and with field installations, it is

important to realize that System 12 is not merely an upgrade of an existing system concept but has an entirely new switching architecture (Figure 1) that takes advantage of two fundamental changes in the telecommunication and technological environment. First, digital switching and transmission are of increasing importance; in future digitized voice will be treated simply as one of many forms of data. Second, advances in LSI and VLSI technologies now make it possible to distribute many of the functions in a switching system.

Because the concept of System 12 is completely new, the field experience must not only prove the exchange's ability to treat calls in accordance with classical standards, but also that all aspects of this new architecture are fundamentally sound^{2,3}.

Although only about seven years have elapsed since the concept was suggested, and just five years since firm proposals were patented, a configuration with more than 600 intercommunicating distributed control elements (microprocessors) has already been installed and accepted by the administration. Exchanges carrying live traffic in several networks have proved that this high number of control elements can communicate and interwork reliably. The largest size exchange based on a 4-stage digital switching network would have about 6000 control elements.

System 12 exchange at Namur. This was one of the first System 12 exchanges to carry live traffic.

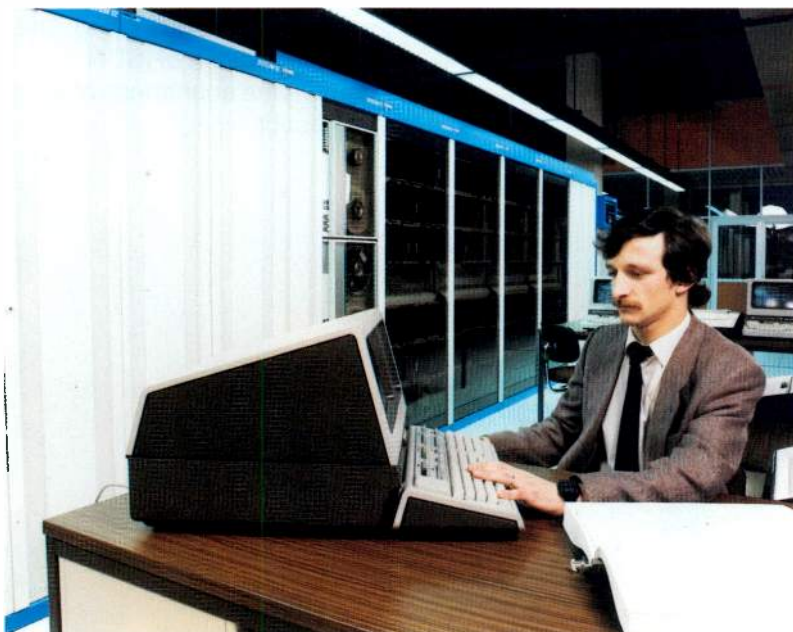

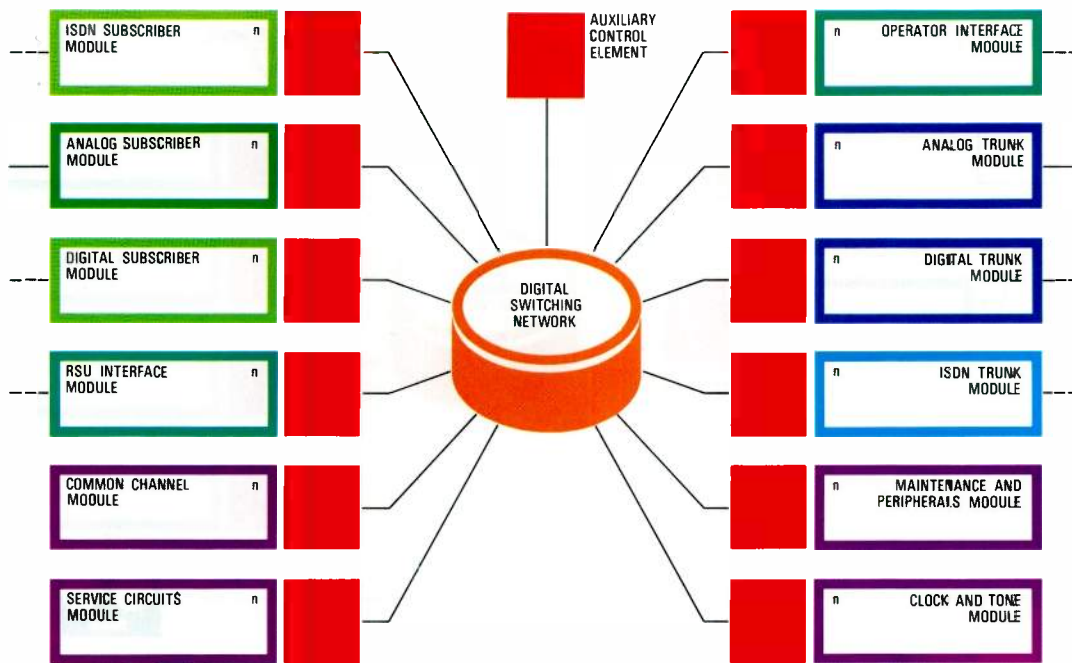

Figure 1
System 12 distributed control architecture.

System 12 Integration Experience

Before System 12 was installed in the field, valuable information on system behavior was obtained from integration studies on test beds in ITT laboratories. Integration of the basic software building blocks – finite message machines and system support machines – into a system is accomplished in three stages: local integration, master integration, and system testing.

Subsystems consisting of logically connected modules are tested during local integration in order to validate the subsystem functions and exercise all internal interfaces. Next, the various subsystems are assembled step-by-step and the new configuration is tested at each stage during master integration. This is done on a laboratory prototype using the control element software for a particular market segment. Finally, the complete system is tested as an exchange using the currently released software on a hardware configuration that meets the exchange requirements. System testing, as this is called, aims to verify that all functions are available and that the exchange meets the performance requirements.

Tools for Integration Testing

Integration testing is supported by the program test control element and its associated terminal (Figure 2), which is able to access other control elements in the configuration under test via the digital switching network. This dedicated control element provides password controlled

access for display and modification of memory locations in the control element under test (target control element in

Table 1 – Installed System 12 exchanges as of October 1984

Exchange	Size		Number of processors	Number of racks
	Lines	Trunks		
Brecht, Belgium	960		41	9
Stuttgart, Germany		3800	197	27
Heilbronn, Germany		800	56	12
Namur, Belgium	1920		60	11
Wuppertal, Germany	4000		119	20
Hueckeswagen, Germany	1200		54	11
Bologna, Italy	3780	540	40	20
	1080T			
Salamanca, Spain	10000	798A 30D	200	34
Corregidora, Mexico	3000		101	15
San Juan, Mexico	2000	1477A 2177D	236	27
Borda, Mexico	2000	4580A 270D	270	39
Acilia, Italy		12390	570	
Aarhus, Denmark	4020	12720	621	64
Torsted, Denmark	8160		191	24
Horsens, Denmark		5070	226	26
Seinaejoki, Finland		1500	96	12
Katmandu, Nepal	5000		141	25
Jambes, Belgium	1000		37	7
Antwerp, Belgium	660		40	9
Birgunj, Nepal	2000	281	78	18
Lugo container, Italy	960	90D	32	5
Roma, Mexico	2000	2789	200	25
Mayo, Mexico	2000	450	82	13
Popocatepetl, Mexico	2000	2959	205	25
Bolzano, Italy	7860	570		27
	720T			

A - analog trunks D - digital trunks T - two-party lines

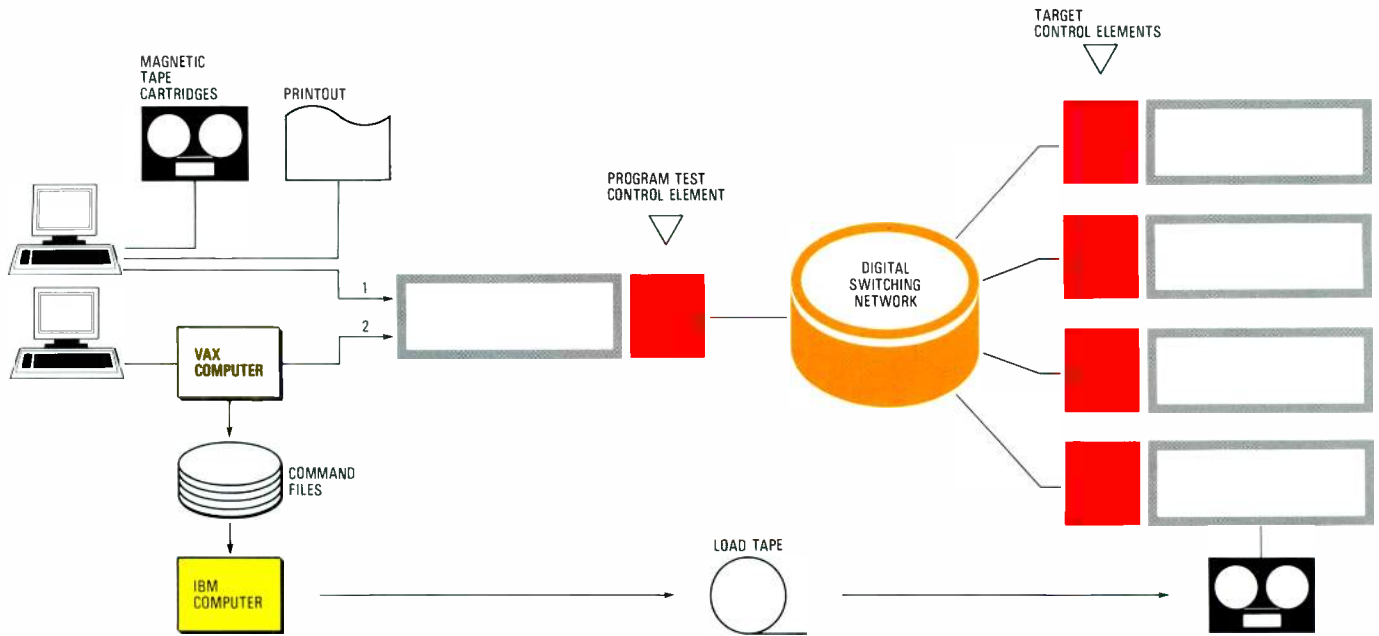

Figure 2 Program test interface.

Figure 2), as well as for break point setting (i. e. interrupting programs executing in other control elements) in order to retrieve test and status information.

The program test control element allows four modes of message tracing: FMM (finite message machine) basis, process basis, message basis, or transaction basis. In addition it provides control element restart and reload controls for test initialization. Other features include user-defined macro facilities for test automation, and a host interface for configuration management and patch control.

Information from the Error Handler

Throughout system integration testing, built-in automatic error treatment reporting obtains valuable information from the error handler. The error handler supervises control element initialization sequences following an error, and sends the internal state of the FMM that reported the fault, together with other relevant information such as terminal identity, over the digital switching network for display or printout at the man-machine communication terminal. The location of software errors and their correction has proved to be relatively fast.

Figures 3 and 4 show the results of load tests in the laboratory on models of the exchanges for the Deutsche Bundespost. The curves show how rapidly stabilization was achieved.

System test engineers have observed that fully distributed control provides a more tolerant environment for a given level of program quality than central control

systems, primarily because the impact of an error is limited to a single control element. The many other system control elements continue to operate normally, providing information that facilitates fault tracing and system testing. As a result, subsystem testing and system testing are able to proceed in parallel.

If a problem occurs in a subsystem, that subsystem can be independently restarted without aborting the testing of other subsystems executing in other control units.

Built-in Test Facilities

Integration and operation are supported by two built-in test features. The first is a ROM-based control element self-test program that is activated whenever a hardware interrupt or software error is detected. With the aid of this program, faulty control

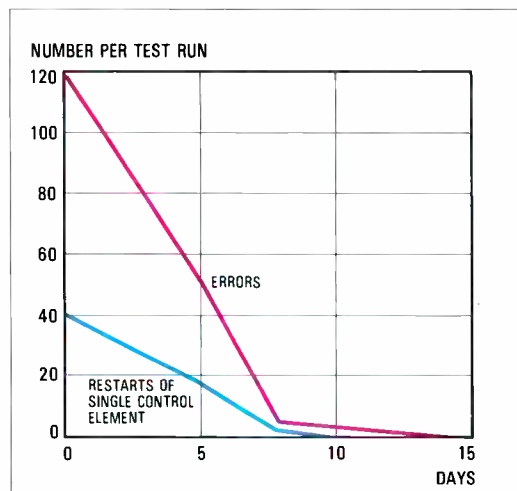

Figure 3 System integration testing showing the numbers of errors and single control element restarts during the first two weeks of operation of the laboratory models.

elements are taken out of service and recovery actions are started.

This so-called fast test is supported by the second built-in facility: a set of three LEDs per control element which indicate the immediate status of that control element, including the identity of faulty hardware. Control elements also use these three LED indicators to show the status of the operational processor, as well as the fault status. During normal operation, their flash rate indicates the instantaneous processor load. In a fully distributed exchange, these lights have proved useful indicators of exchange status and behavior, comparable to the audible indications given by electromechanical exchanges.

Reconfiguration Flexibility

The flexibility and relocatability of FMMs have been clearly demonstrated during integration and testing. It is possible to test each set of FMMs constituting a subsystem within a single control element before the FMMs in the set are distributed, together with other FMMs, between the many control elements in larger system configurations. This approach enables the performance requirements for a particular exchange to be met in the optimum way.

Multiservice Configurations

One of the major features of the distributed System 12 architecture is that it has been designed to handle both voice and non-voice services in an ISDN. The switching network handles both digitized voice and data in exactly the same way. One of the first successful demonstrations of a small scale ISDN was given by ITT on their stand at Telecom 83 in Geneva where a System 12 exchange was used to handle a range of services including digital telephony, facsimile, teletex, and videotex.

A number of ITT units are establishing ISDN field trials in cooperation with local administrations^{4,5}. The first of these trials at the Bologna System 12 exchange in Italy was demonstrated to delegates who attended ISS 84 in Florence in May 1984. Successful implementation of these ISDN models has proved that System 12 can indeed meet the challenge of handling both voice and non-voice services.

Capacity and Overload Capabilities

No problems have been encountered in building and testing both large and small System 12 configurations. The design is

such that the largest configurations are little more complex than the small ones.

Overload tests are an excellent example of this important point. The capacity of each control element is fixed irrespective of exchange size. Overload tests are therefore a case of successively focusing traffic at individual microprocessors. For example, stress tests of the trunk resource manager ACE under overload conditions for the Stuttgart exchange were carried out by focusing traffic from other call handling control elements onto the trunk resource manager under test. The results verified the correct functioning of the built-in overload prevention mechanism.

Large configurations require multiple trunk resource managers, each managing a

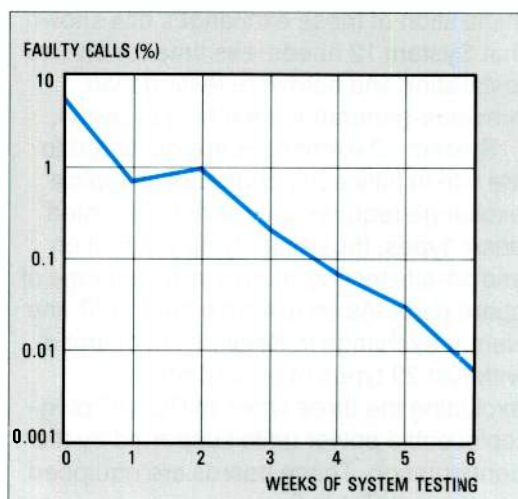

Figure 4
System integration testing showing how rapidly the percentage of faulty calls declined during the first six weeks of operation.

subset of the total exchange (e. g. Stuttgart toll exchange has four resource manager pairs; the large Aarhus exchange in Denmark has 5 pairs); the behavior of any one under load is no different from its behavior in the test configuration.

Each functional control element has likewise been tested under stress conditions in quite small, manageable configurations. The mechanisms of the generic kernel and the distribution tables are unchanged. Only the configuration data needs to be adjusted for the different field configurations.

System 12 Installation Experience

System 12 exchanges, including local, transit, combined local-toll, and international toll exchanges, have now been installed in

Table 2 — Generic hardware circuit boards in a 1920-line System 12 exchange

Functional circuits	Generic board types	Quantity of boards	% total
Digital switching network	1	32	4.7
Analog subscriber lines	2	352	51.6
Digital trunks	2	8	1.2
Control elements	3	202	29.6
Transmission test equipment	3	9	1.3
Clock and network synchronization equipment	4	27	4.0
Peripheral interface equipment	4	10	1.5
Exchange call services	5	18	2.6
Exchange alarms and display	5	24	3.5
Total	29	682	100

eight countries: Belgium, Denmark, Finland, Germany, Italy, Mexico, Nepal, and Spain (Table 1). Experience gained from the installation of these exchanges has shown that System 12 needs less time for on-site installation and hardware testing than previous-generation switching systems.

System 12 exchanges are delivered to the site in fully equipped racks. A typical exchange requires only about 35 printed board types, thus simplifying production and on-site testing, as well as the storage of spare parts. As an example, the 1920-line Namur exchange in Belgium is equipped with just 29 types of printed board, excluding the three types of DC-DC plug-replaceable power units supported by the configuration. These boards are equipped as shown in Table 2.

Each rack is tested as a stand-alone functional unit prior to shipment. Once on site the racks are easily maneuvered into position. The cables, which are fitted with connectors during production, are then quickly installed.

Field Experience

Excellent performance results have been achieved with System 12 exchanges in the field. The results discussed here have been obtained from exchanges listed in Table 1. As some exchanges have been commissioned for more than two years, while others have been operating for only a few months, the results collected to date are quite varied. More attention has therefore been given to exchanges that have been in service for some time in order to provide more relevant figures covering exchange operation over a significant period.

Distributed Processor Behavior: Individual Restarts and Reloads

One of the most interesting aspects to be observed in the field is how well a distributed processor system and the associated distributed software perform their tasks. Because ultimately an error leads to the restart or reload of an individual processor, this performance has been measured (Figure 5). The results were obtained during 1982 and 1983.

The design goals for the mean times between reloads and restarts of individual processors have been significantly exceeded. Moreover a mean time between restarts of 2000 hours per control element is now regarded as readily achievable. Indeed, the Heilbronn exchange in Germany has operated for several months without a reload of any of its 56 equipped microprocessors. The large Aarhus exchange in Denmark was observed to have a mean time between restarts of 1870 hours and a mean time between reloads of 6390 hours. The exchange at Birgunj in Nepal has exhibited even better values, namely 2750 and 16200 hours respectively. At such low levels, both reloads and restarts have a negligible impact on the overall system availability.

Any restart or reload in a fully distributed system relates only to individual control elements and therefore has little impact on overall exchange performance. The need to restart or reload more than an individual control element has proved to be such an infrequent event that meaningful projections of the mean time between such occurrences cannot be made. Consequently the time and effort required for exchanges to achieve acceptable service levels have been less than anticipated. Every field configuration confirms that distributed processing relaxes critical concerns regarding the mean time between failures of subsystems.

System Behavior: System Restarts and Reloads

The global behavior of the system is in the end more important than the behavior of individual processors. It is therefore of particular interest to note that the system reload facility has been used infrequently for recovery reasons and that the design of the system makes no use of any global system restart facility in order to synchronize data or purge corrupted data.

Digital Switching Network Behavior

The digital switching network has proved its high traffic handling capacity and to date

Figure 5
Meantime between individual reloads and restarts. The design objectives were for a mean time between individual reloads of 1700 hours, and between individual restarts of 600 hours.

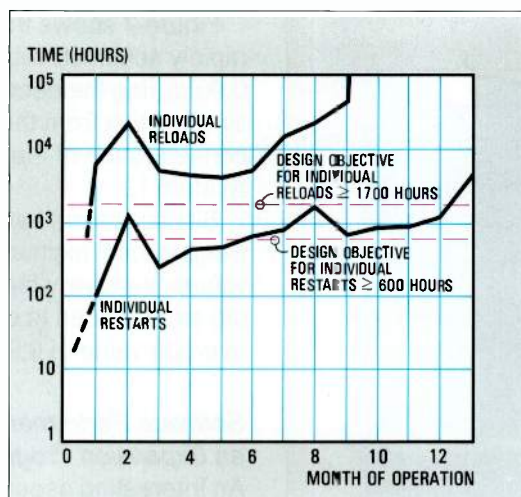
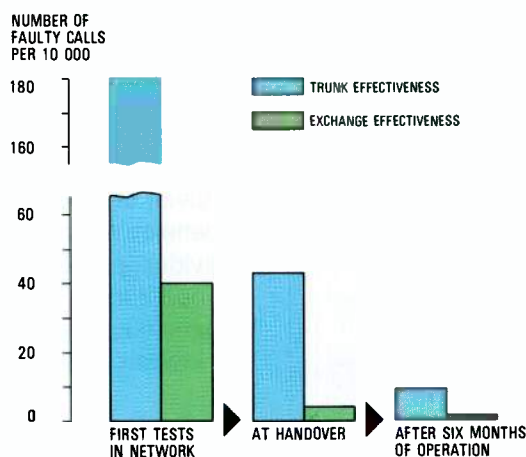

Figure 6
Trunk effectiveness and exchange effectiveness of the Namur local exchange. The lower the effectiveness, the better the exchange performance.



there has been no observed blocking. Additionally, it has effectively prevented the propagation of errors within the system. This inbuilt protection is inherent to end-controlled networks and full distribution. The error isolation performance of the digital switch has been demonstrated by the control element restart and reload results from the exchanges currently in operation.

Call Effectiveness

Call effectiveness is a measure of the failure rate of call attempts and established calls caused by switching or trunk connection failures (hardware or software). Call effectiveness has two components. Trunk effectiveness considers calls processed by the exchange under consideration together with other exchanges in the network that handle the calls and the trunks that carry the calls. Exchange effectiveness only considers processing in the exchange itself.

Figure 6 shows the exchange and trunk effectivenesses for the Namur System 12 local exchange in Belgium. The exchange

effectiveness relates to the Namur exchange alone. It reflects the lost call rate for both local calls and calls incoming from or outgoing to the network, but only considers failures within the exchange itself. It shows how efficiently the software and hardware treat calls.

Trunk effectiveness was measured by generating outgoing calls at the Namur exchange and looping them back via another exchange in the Belgian network.

At the time the Namur exchange was connected into the public network for testing, the call effectiveness had not achieved its specified value, particularly with respect to trunk effectiveness (see Figure 6). As trunk effectiveness is only concerned with trunk calls, it appeared that incoming or outgoing network calls were more prone to failure than local calls. Improvements were therefore made to the trunking interface and the corresponding trunk call software. As a result, by the time the exchange was handed over, call effectiveness was acceptable to the Belgian administration. Subsequent investigations indicated that modifications were needed to other parts of the network.

After six months of operation, trunk and exchange effectiveness had been reduced well below the initial targets established by the Belgian administration (one-fifth and one-eighth of the target values, respectively). Also, the performance of the System 12 exchange was better than that of the semielectronic stored program control exchange used in the tests for trunk effectiveness. Recently call effectiveness for the exchange has reached 0.5×10^{-4} .

Service Availability

Service availability is a measure of the time that service is available to each subscriber. Figure 7 shows the service availability for the first four exchanges delivered to the Deutsche Bundespost⁶. The requirements of the German administration specified that the first exchange integrated into the network was to achieve a service availability of 0.99908 in the first six months after handover. (This corresponds to a nonavailability of a termination circuit of four hours in six months.) The average annual long term service availability after stabilization was specified as 0.99977. (This corresponds to a nonavailability of a termination circuit for two hours in 12 months.)

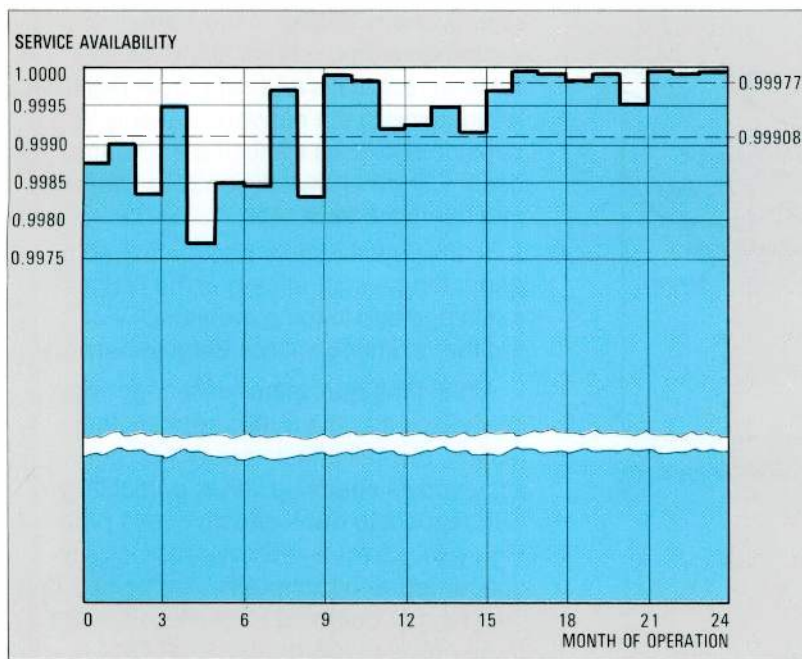

Figure 7
Service availability of the Deutsche Bundespost exchanges.

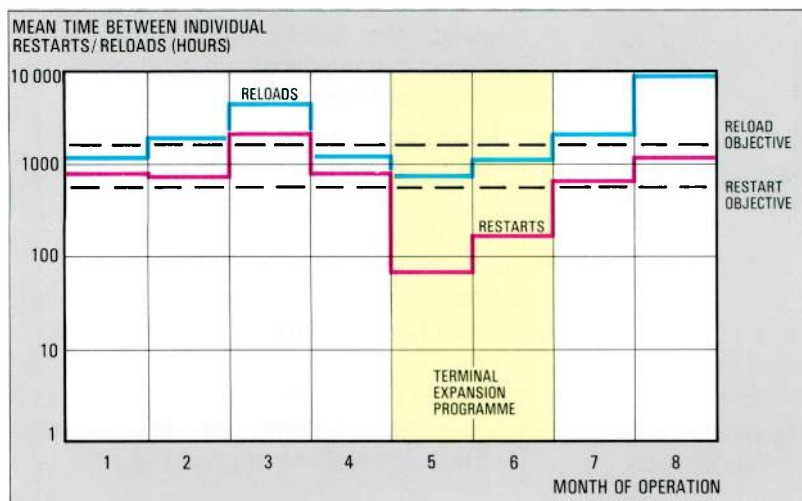

Figure 8
The effect of a terminal expansion programme on the service availability of an exchange in Mexico.

Figure 9
Total number of hardware failures in the four German trial exchanges (a) in an analog environment, and (b) in a digital environment.

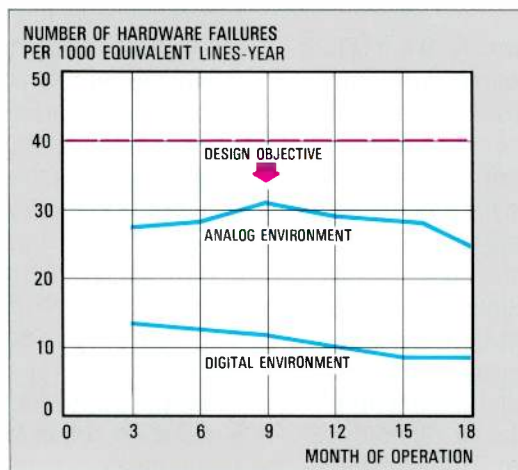

Figure 7 shows that stabilization was rapidly achieved with a grade of service of 0.99 during the second month. The high availabilities from the outset are a consequence of the distributed structure of System 12.

Similar results have been achieved at the Belgian local exchange in Namur. Start-up values were very high (0.9999); the largest dip experienced to date is 0.9991, with an average value of 0.99989.

Software Performance over an Expansion Programme

An interesting aspect of exchange performance is the system behavior under substantially increased engineering manipulations as a result of interventions when additional line or trunk terminals and modules are put into service, when the network configuration is changed, or when the system is extended.

Figure 8 shows a first case example of the behavior of System 12 during a tenfold expansion programme in the field in Mexico. Individual processor reloads and restarts did occur more frequently during the expansion phase, but rapidly improved on the low target levels.

Hardware Failures

System 12 hardware is characterized by the excellent reliability of the main VLSI components compared with the calculated values. Table 3 shows the failure rates of key VLSI components in the two German toll exchanges after 17 months of operation. The failure rate is measured in FITs (failure in time), which gives the failure rate per hour for 10^9 modules. The values show that the failure rate is much better than predicted.

Figure 9 shows the early hardware failure distribution for the four German exchanges. The number of trunks and subscriber circuits of all four exchanges are normalized to equivalent lines, assuming that one trunk is equivalent to 2.5 subscriber line circuits.

The ability of System 12 to reconfigure in order to replace a faulty control element automatically by a standby control element has led to some alarms being downgraded. This is possible because the faulty control element can be replaced automatically in a much shorter time than the mean time to repair by a technician, so such failures no longer result in urgent alarms. Consequently, maintenance can be deferred thereby reducing the number of urgent service calls.

Table 3 — Actual and predicted failures of System 12 LSI components

LSI component	Number of components	Reported failures (17 months)	Measured failure rate (FITs)	Predicted failure rate (FITs)
Switch port	3392	1	24	195
Terminal port	1265	1	63	160
64 K dynamic RAM	15796	3	15	600
Microprocessor	253	0	—	300

Conclusions

Field experience over the past two or more years has proved the soundness of the distributed control architecture used in the System 12 Digital Exchange. These early results are very encouraging and show a remarkably better performance for System 12 in its first years than previous generation exchanges in their start-up period. The evolution of System 12

described elsewhere in this issue^{7, 8} will ensure even better results in the future.

References

- 1 J. Loeber: System 12: Market Status: *Electrical Communication*, 1985, volume 59, no 1/2, pp 6–11 (this issue).
- 2 ITT 1240 Digital Exchange: *Special Issue of Electrical Communication*, 1981, volume 56, no 2/3.
- 3 R. Van Malderen: System 12: Review of the Fundamental Concepts: *Electrical Communication*, 1985, volume 59, no 1/2, pp 20–28 (this issue).
- 4 F. Haerens, B. Rossi, and J. M. Serrano: System 12: ISDN Field Trials in the Belgian, Italian, and Spanish Networks: *Electrical Communication*, 1985, volume 59, no 1/2, pp 89–97 (this issue).
- 5 D. Becker and H. May: System 12: ISDN Pilot Service of the Deutsche Bundespost: *Electrical Communication*, 1985, volume 59, no 1/2, pp 98–104 (this issue).
- 6 M. Langenbach-Belz: System 12: Toll Exchanges for the German Network: *Electrical Communication*, 1985, volume 59, no 1/2, pp 159–165 (this issue).
- 7 R. Cohen: System 12: Technological Enhancement: *Electrical Communication*, 1985, volume 59, no 1/2, pp 29–34 (this issue).
- 8 R. H. Mauger: System 12: Architecture for Change: *Electrical Communication*, 1985, volume 59, no 1/2, pp 35–42 (this issue).

System 12

Review of the Fundamental Concepts

The modular distributed control architecture of System 12 depends on microelectronics for its effective implementation. Full use of VLSI technology has made it possible to implement a flexible architecture that is suitable for use in small to very large exchanges, and can handle both voice and non-voice services.

R. Van Malderen

ITT Europe Telecommunications and Electronics, Brussels, Belgium

Introduction

Digital technology is rapidly being introduced into today's telecommunication networks as a result of the wide availability of digital microelectronic circuits. In turn, this trend is leading to the integration of voice and various data services in a single digital telecommunication network – the integrated services digital network, or ISDN.

The current telecommunication revolution makes it essential to design a digital switching system architecture that

will be able to handle the complex user interfaces and greatly increased call handling capacity required in an ISDN environment characterized by the carrying of many data calls of short duration, with a mix of circuit and packet switching. At the same time, effective use must be made of VLSI technology by adopting a highly uniform and repetitive architecture so that advantage can be taken of high volume production of the main VLSI components.

By the second half of the 1970s ITT engineers had realized the profound

Figure 1
System 12 architecture showing the intelligent terminal modules and the digital switching network.

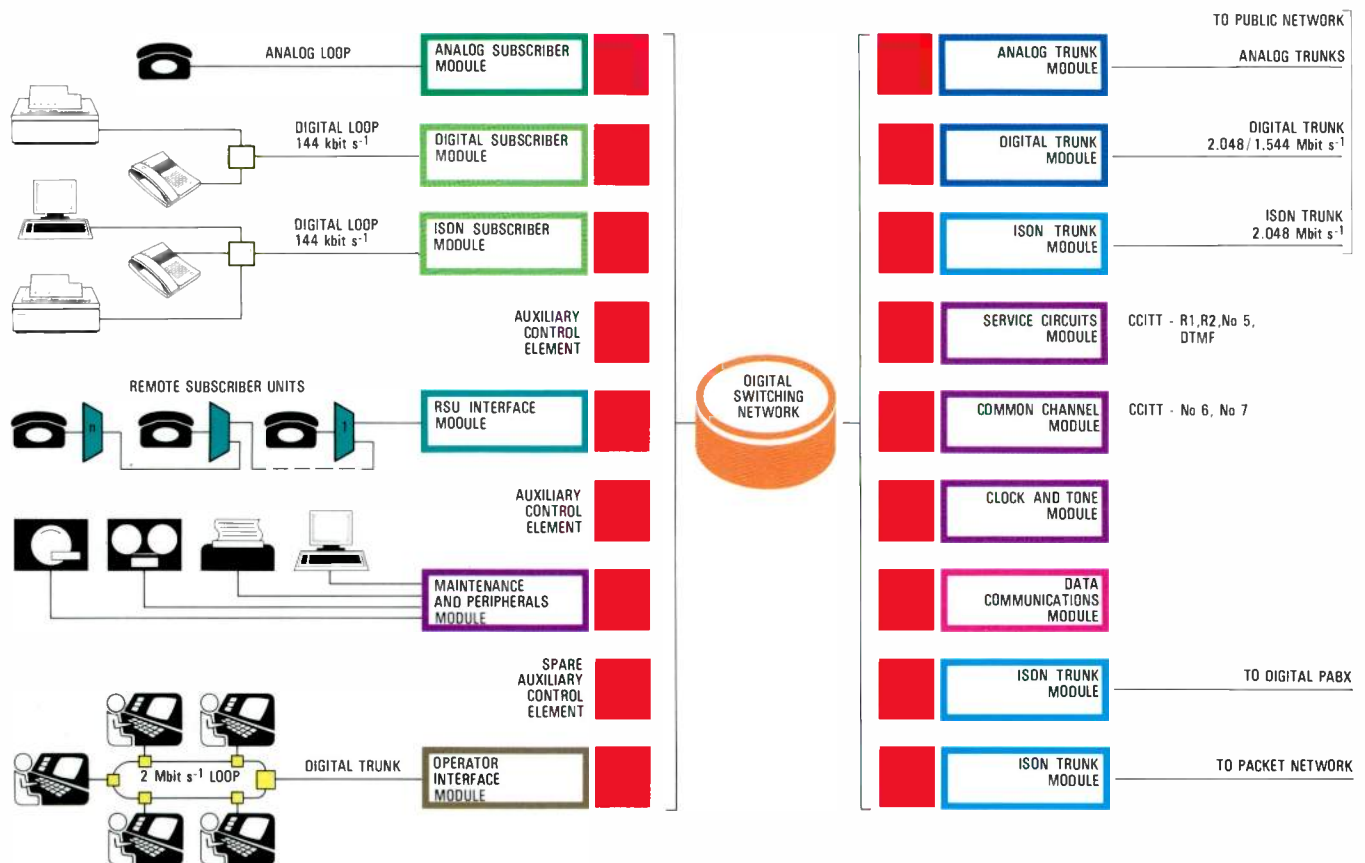
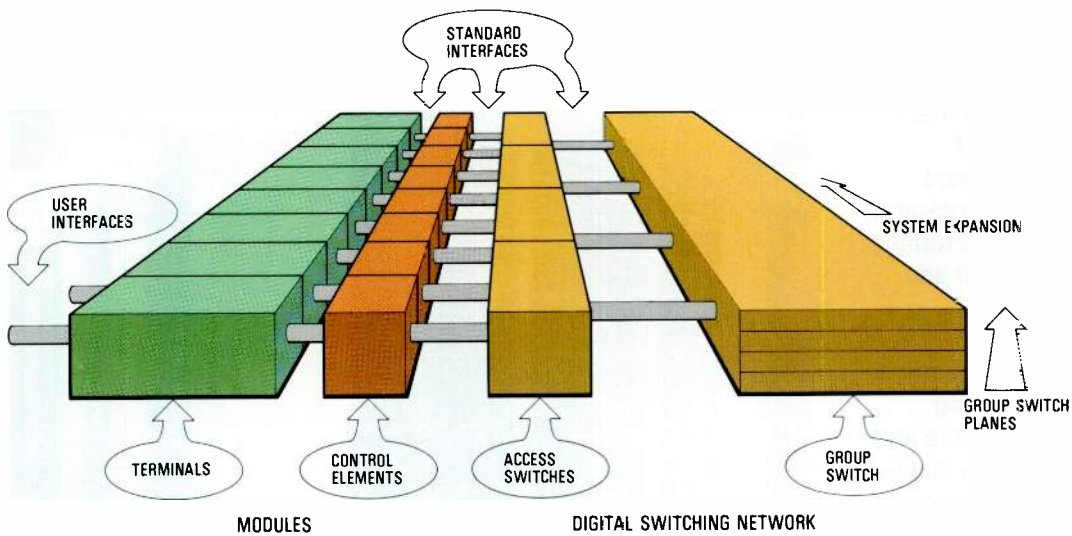

Figure 2
System 12 hardware levels.



consequences of implementing an ISDN and the potential of VLSI in this context. System 12 was conceived with a fully distributed control architecture both to prepare for the transition to an ISDN and to ensure effective use of VLSI technology.

System Architecture

Figure 1 illustrates the distributed control architecture of the System 12 Digital Exchange. At the highest level the system consists of a digital switching network connected by a standard interface to a series of modules. Figure 2 looks at the architecture in more detail, revealing the two module levels (terminal hardware and standard TCE) and the two digital switching network levels (access switches and group switch). The interfaces between the four levels in the architecture are standard throughout System 12.

Control elements establish digital paths through the switching network to interconnect the terminal modules. A digital path consists of a 16-bit timeslot with a repetition rate of 8000 Hz. Eight bits are available in each timeslot for external users, resulting in a 64 kbit s^{-1} digital path for user traffic. This can be increased to $n \times 64 \text{ kbit s}^{-1}$ by using multiple paths¹.

The digital switching network is end controlled: in-timeslot commands allow paths to be established between terminal modules without a central network map and path search mechanism. In principle, this characteristic allows the four stages depicted in Figure 2 to be expanded indefinitely.

Dimensioning of the group switch is determined by two parameters: system size and switched traffic. System size grows with the number of access switches, which in turn determines whether one, two, or three group switching stages are required. This range meets all size requirements in real networks. The second parameter, switched traffic, then determines the number of planes in the group switch: two, three, or four planes are provided.

Figure 3 shows the generic diagram of a module. The TCE consists of three basic hardware blocks: microprocessor, memory, and terminal interface. The microprocessor runs on programs stored in the memory.

The terminal interface connects the module to the digital switching network via two bothway 32-channel PCM links. Since each timeslot contains 16 bits and the repetition rate for a 32-timeslot frame is 8000Hz, the links run at $4.096 \text{ Mbit s}^{-1}$. Thirty of the 32 channels are available to

Figure 3
Generic System 12 module.

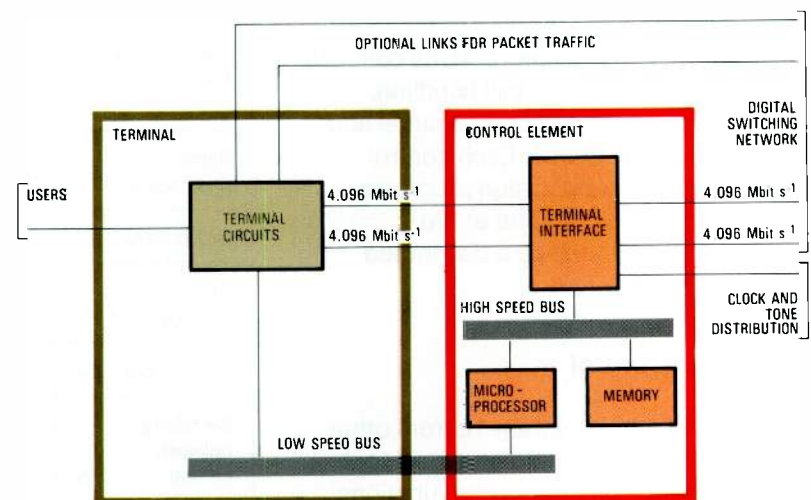

user traffic (PCM voice or data). Two similar bothway PCM links connect the terminal interface to the terminal.

An incoming-only link to the terminal interface provides for up to 32 PCM encoded tone or voice announcement sources which are located in the clock and tone module. Finally, the terminal interface is connected to the microprocessor and memory via a high speed bus. The microprocessor can establish a unidirectional digital path from the terminal interface through the digital switching network to a second terminal interface and microprocessor, which can in turn establish a path back to the first microprocessor. These two paths can then be used to transmit messages between the TCEs.

The microprocessor can also establish digital paths between any channels of the incoming and outgoing PCM links connected to the terminal interface. This allows user traffic to or from the terminal to be switched to the digital switching network. Bothway traffic between two users requires two unidirectional paths to be set up through the digital switching network.

The hardware in the terminal depends on the module type and may contain user-specific interfaces. As an example, two further 4.096 Mbit s⁻¹ PCM links connect the digital switching network to the terminal of modules handling user packet traffic². A digital switching network path is then established on a per packet basis directly from the terminal.

Information can be transferred between the terminal and the TCE either via the PCM links or via a low speed bus. One or both methods are used depending on the type of module.

It should be stressed that in System 12 the digital switching network is used for all communication between the distributed control elements as well as for circuit- and packet-switched user traffic.

The software in the various TCEs consists of the operating system, call handling, telephonic support, and maintenance and administrative programs. Each control element contains application programs specific to the module. The entire configuration operates as a distributed software system.

Distributed Control

What distinguishes System 12 from other digital switches is its fully distributed control of the following call processing functions:



System 12 exchange equipment in the 10 000-line Salamanca exchange in Spain.

Signal processing (F1) deals with the conversion of telephonic signals to and from the outside world.

Call control (F2) keeps track of the state of the call. When an incoming telephonic signal is received, call control determines the necessary call state transitions and generates the outgoing telephonic signals.

Resource management (F3) manages the telephonic resources. It keeps track of idle/busy status (e.g. for trunks or service circuits) and selects and assigns idle devices to calls upon request.

Translations (F4) deal with digit analysis, routing, etc.

Table 1 – Assignment of call processing functions

Call processing functions	Terminal control elements L1	Auxiliary control elements L2	Digital switching network
Signal processing F1	X	X	
Call control F2		X	
Resource management F3		X	
Translations F4	X	X	
Switching network control F5			X

Switching network control (F5) maintains a memory map (idle/busy status of network links) and provides path search, path setup, and path clear-down mechanisms. It also ensures that no conflicts occur between paths for different calls.

In System 12 none of the above functions is handled by a single computing element.

System 12 Call Processing

System 12 call processing is divided into three basic levels:

- TCEs (L1) associated with each terminal.
- ACEs not associated with a terminal (L2); ACEs are software assignable to a particular function. A spare ACE may easily replace the function of a failed unit.
- Digital switching network.

Table 1 shows how call processing functions are assigned to these three

control levels. Each level can be expanded as required so that no bottlenecks can occur in the call handling capacity at any level when the system grows or the number of call attempts increases. In particular, the switching network control function is dispersed throughout the network.

Digital Switching Network

Figure 4 shows the digital switching network³. The basic building block is the DSE (digital switching element) – essentially a small switching network with 16 input and 16 output ports. Each port is a PCM link similar to those between the modules and the access switches, that is it has 32 channels with 16 bits per channel, running serially at 4.096 Mbit s⁻¹. In total a DSE has 512 incoming and 512 outgoing channels. In-channel commands originating from

Figure 4
Digital switching network.

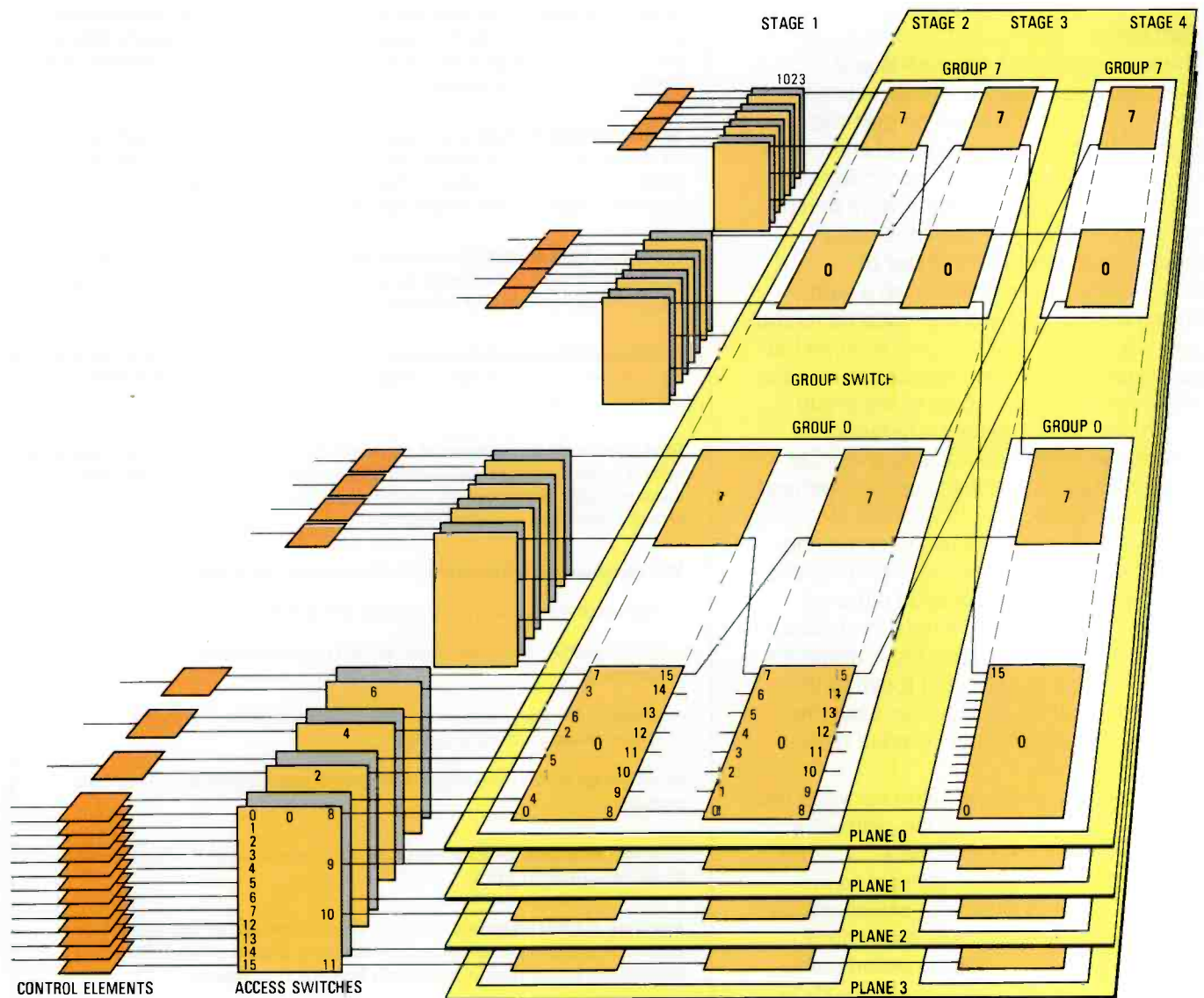

control elements allow a path to be established from any incoming to any outgoing channel in a DSE.

The DSE printed board is built up of a single type of VLSI known as the switch port⁴. The entire switching network is built up by interconnecting DSEs.

In its full-size configuration the group switch consists of four planes, each with three switching stages, connected as shown in Figure 4. The access switches, which are paired, are also constructed from DSEs. For reliability, each control element is connected to each access switch in a pair, and each access switch is connected to all the equipped planes.

A three-stage group switch allows up to 512 access switch pairs to be connected. At this size and using four planes in the group switch the network is able to switch a traffic of well over 30 000 erlangs, making it suitable for use in local exchanges with more than 100 000 lines or toll exchanges with over 60 000 trunks.

Path Setup

The digital switching network is end controlled. To establish a unidirectional folded path from an incoming port and channel to an outgoing port and channel, a series of 16-bit in-channel commands are injected into the incoming network port by the originating control element via its terminal interface. The number of commands needed to establish a path equals the number of DSEs to be traversed (i. e. 1, 3, 5, or 7) depending on whether the path is reflected in an access switch or in the first, second, or third stage of the group switch. The time separation between successive commands equals one PCM frame (125 μ s); each successive command is acted on by the next DSE along the path being established. A variety of command types exist, but in normal call handling the outgoing DSE port is selected either at random (up to the point where the folded path is reflected) or is directed towards the terminating control element (beyond the point of reflection). In the latter case the channel is selected at random but path delay is minimized.

Establishing a bothway path between two control elements requires the path setup procedure to be executed twice, once for each direction. Because of the random nature of the individual DSE select actions, paths for the two directions are entirely independent. As several unrelated path setup actions may start simultaneously at

Table 2 — System modules

Analog subscriber module interfaces up to 128 analog subscriber lines. Each subscriber line interface contains the necessary BORSCHT functions including a codec per line. Exceptional software control flexibility is provided with respect to audio gain, balance impedance setting, polarity reversal, sending of metering pulses, etc.

ISDN subscriber module interfaces with 144 kbit s⁻¹ ISDN subscriber loops (CCITT). It can handle both circuit- and packet-switched traffic.

Digital subscriber module interfaces with 144 kbit s⁻¹ digital subscriber loops in a similar way to the ISDN subscriber module, but its functions are limited to circuit-switched voice and data services.

Remote subscriber unit interface module: a pair of such modules interfaces with a set of remote subscriber units in a multidrop arrangement over one or two digital trunks (2.048 Mbit s⁻¹). Each remote subscriber unit in the multidrop configuration can handle up to about 500 lines, with the total multidrop arrangement able to handle 1 000 subscriber lines.

Analog trunk module interfaces with up to 36 analog trunks. It interfaces with only 32 trunks when equipped with optional equipment for CCITT No 5 supervisory signaling and echo suppression.

Digital trunk module interfaces with a 2.048 Mbit s⁻¹ (32-channel) or 1.544 Mbit s⁻¹ (24-channel) digital trunk. Optional digital equipment is available for CCITT No 5 supervisory signaling and echo suppression.

ISDN trunk module interfaces with a digital trunk facility which handles circuit- and packet-switched calls. This digital trunk connects the exchange to either a second digital exchange in the public network, an existing packet network, or a digital PABX with ISDN features.

Service circuits module provides a set of 32 multifrequency senders-receivers for a range of signaling schemes, including CCITT R1, R2, No 5, and dual-tone multifrequency. An alternative configuration provides for a combination of 16 senders-receivers and a digital conference bridge.

Clock and tone module provides the necessary clock signals and digital tone sources for the entire exchange. An exchange is always equipped with a pair of clock and tone modules for reliability.

Common channel module provides functional levels 2 and 3 for CCITT No 6 and No 7 signaling. One common channel module can handle up to 16 common channel data links.

Data communications module provides subscriber service functions belonging to layer 4 and upward as defined in the ISO reference model for open systems interconnection. Examples are videotex databanks, telemetry data collection, protocol converters, and electronic mail.

Maintenance and peripherals module provides three major functions;

- man-machine interface (VDU, printer) and bulk data storage (disk, tape)
- coordination of maintenance and system recovery actions under fault conditions
- control of software loading from the bulk storage to the distributed microprocessors in the exchange.

An exchange is always equipped with a pair of maintenance and peripherals modules.

Operator interface module interfaces to a cluster of up to 15 digital operator positions via a digital trunk.

Auxiliary control elements — control elements without an associated terminal — provide a variety of system functions. Should an auxiliary control element fail, it is replaced automatically from a pool of spares.

Figure 5
System 12 software
structure based on the
virtual machine
concept.

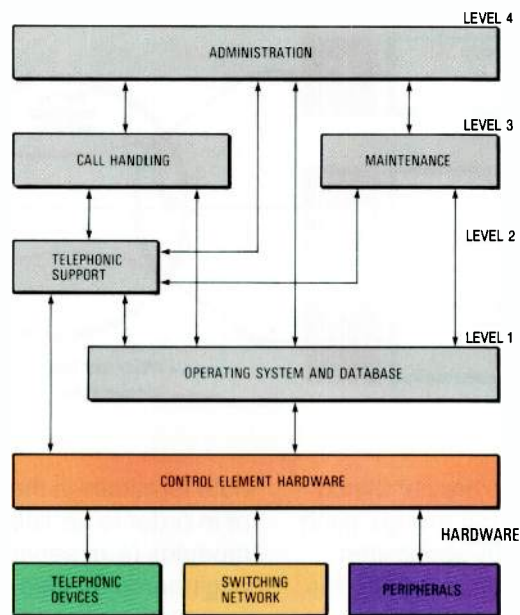

various inlet ports without utilizing any central control mechanism, the network overload problems inherent in centralized control systems do not occur.

System Modules

The range of System 12 module types is open ended. The distributed control architecture and consistent use of standard interfaces makes it possible to add new modules as necessary without a major impact on the existing modules. Some commonly used types are shown in Figure 1. Each module type is briefly described in Table 2.

Software Structure

To a company with a world presence like ITT, it is important that the System 12 Digital Exchange should be flexible so that it can be used in different applications (e. g. local, local-toll, tandem) and meet the needs of administrations throughout the world. The software structure was designed to achieve this flexibility through a high degree of modularity with independence between software modules, as well as through the use of appropriate programming languages (e. g. problem-oriented languages, CHILL).

Virtual Machines

The System 12 software is organized in a number of hierarchical levels using the virtual machine concept by which software and hardware implementation details at the

lower levels are hidden from the higher ones. Figure 5 shows these levels and their functions.

The entire set of software functions is distributed over the various control elements in the system. The actual software implementation is based on a distributed operating system and database control system, finite message machines, and system support machines.

Finite message machines (FMMs): The complete set of System 12 application programs is divided into modules, known as FMMs, which communicate via standard messages. Depending on whether communicating FMMs are located in the same or different control elements, message transfer is either internal to the control element or between two different control elements via the switching network. The allocation of FMMs to particular control elements within an exchange configuration is determined on the basis of economy and performance.

System support machines (SSMs): The most frequently used software functions are implemented as SSMs; these consist of one or more procedures which may be invoked by a procedure call from an FMM or the operating system.

Database control system: Optimum performance of the distributed control requires a distributed database. The database control system within each control element handles access to and updating of data. It hides the physical location of data from the FMMs to increase software flexibility.

Operating system: An operating system in every control element supports execution of the application programs. Specific operating system functions include message handling between FMMs, process scheduling, and access to peripheral units.

Copies of all system programs and data are provided on disk ready for reload if required.

Call Setup Procedure

Figure 6 shows the modules and ACEs involved in setting up a local call between subscriber A and subscriber B. It is assumed that subscriber A has a dual-tone multifrequency telephone subset, so a service circuits module is included to detect the tone pairs generated by this subset.

The main software functions and data types associated with local call setup are distributed between the control elements.

Figure 6
Call setup procedure.

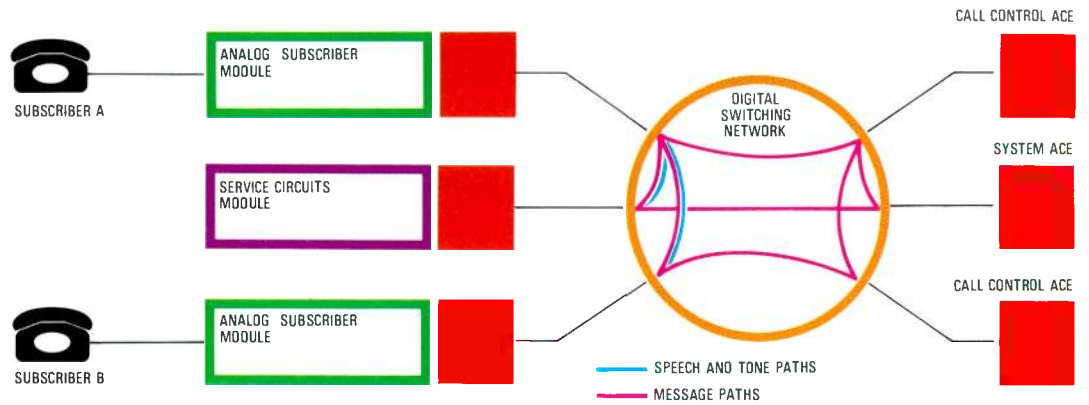

Analog subscriber modules are combined into small groups (e.g. six per group), each of which is semipermanently associated with a call control ACE. In Figure 6, TCE 1 is associated with ACE 1 and TCE 2 with ACE 2. However, no such association exists for TCE 3. Signaling functions are spread over TCEs 1, 2, and 3 and ACEs 1 and 2. Call control is provided in ACEs 1 and 2, but is only active in the originating side of the call (ACE 1 in the example). Resource management (i.e. selection of a dual-tone multifrequency receiver in the example) is handled by ACE 3.

Data and programs for translations are assigned as follows:

TCEs 1 and 2: class of line

ACE 1: originating class of service

ACE 3: digit analysis, directory to equipment number translation, terminating class of service.

The various call handling phases (i.e. digit reception, ringing, conversation, disconnect) are all triggered by telephonic events (i.e. seizure, reception of individual digits, answer, disconnect signal) which cause software processes to be activated in the control elements and messages to be exchanged between control elements⁵.

System Availability

Several redundancy techniques are used to achieve high system availability. At least two planes are equipped in the digital switching network and the access switches are paired. There are a multiplicity of network paths.

Certain types of module, such as the analog and digital subscriber modules, are paired in a dual control arrangement which allows one TCE to take over the control of

both terminals in the event of a TCE failure, or in order to update the software. Some modules (e.g. service circuits module) are engineered on an $n + m$ basis, while others (e.g. clock and tone module) are duplicated. High system availability for ACEs is achieved through automatic replacement by spare ACEs. In the case of a few critical functions, active-standby ACE pairs are used.

Equipment Practice

A single size of printed board is used throughout. Equipment racks are 2.10 m high, 0.90 m wide, and 0.45 m deep and contain seven subracks plus a top rack unit.



Main standard components of the System 12 equipment practice.

Each subrack can house up to 32 printed boards. Most connections within a subrack are provided by printed wiring backplanes, although wirewrapping is used in a few exceptional cases. Subracks in the same or different racks are connected by plug-in cables. Aluminum doors form the front and back of each rack. Interrack and main distribution frame cabling either run underneath a raised floor or, if preferred, via an overhead cable grid.

Packing density is very high; a typical analog subscriber line rack houses 1024 line interface circuits. Figure 7 shows the number of racks and the required floorspace for a typical 10240 line exchange. Under average ambient conditions System 12 racks are convection cooled.

Fundamental Advantages of System 12

Open-Ended Control Capacity

The fully distributed architecture of System 12 allows both the switched traffic capacity (in erlangs) and the call capacity to grow with the size of the exchange. Call capacity may be engineered as required. This allows large size systems to be realized and avoids the need for multi-unit configurations to build a single exchange (i.e. it avoids double switching and splitting of trunk groups).

Fail Safe System

System 12 is based on multiple intelligent terminal modules each containing a microprocessor-based control element. The handling of a call involves only a few of the many control elements making the system extremely resistant to large scale failures. Total system outage is virtually impossible, as has been shown by experience with the exchanges in service⁶.

One System for the Entire Range

In a distributed control system, the number of peripheral circuits and control elements, and the size of the switching network grow linearly with the required exchange size. The entire spectrum of exchange sizes, from small to very large, is covered by a single system.

ISDN Evolution

Two crucial features will allow System 12 to evolve gracefully into the ISDN era:

First, the ISDN will require new interfaces with the external environment, additional to

those for traditional telephony. System 12 modules all contain their own control element and the handling of calls originating from a particular module involves only a few other control elements. This makes it feasible to have different module and control element types, containing software adapted to particular types of user. In this way conventional telephony subscriber modules can coexist with ISDN subscriber modules in the same System 12 exchange with little interaction except for the ability to set up voice calls between both. It is expected that ISDN traffic will substantially increase the number of call attempts to be handled. Independence between module types

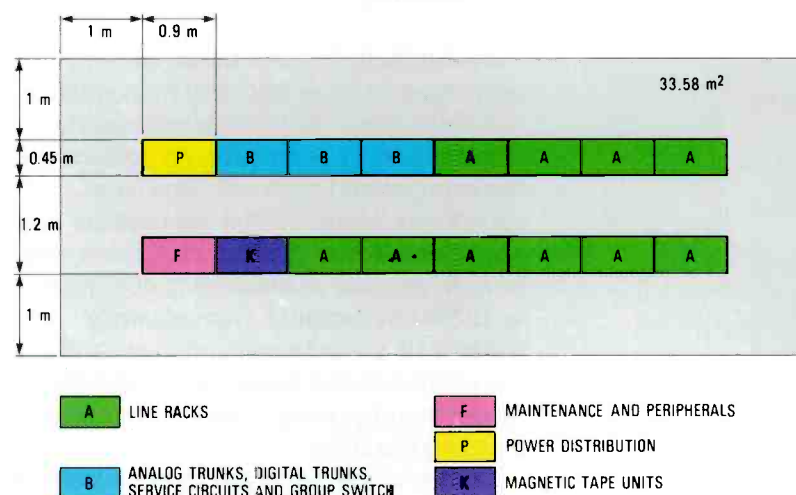

Figure 7
Typical floor plan for a
10240-line System 12
exchange.

allows modules and their control elements to be dimensioned according to the required call capacity.

Second, ISDN services will represent a mix of circuit- and packet-switched traffic. The digital switching network used in System 12 does not rely on centralized path search and path setup mechanisms. Instead, the end-controlled network allows many paths from different ports to be set up simultaneously. This mode of operation enables individual packets to be sent through the network. The digital switching network thus appears as the ideal switching vehicle for an ISDN, truly integrating circuit and packet switching into a single network.

Technology

The method of fully distributed control implemented in System 12 results in a very uniform structure for both the modules and the digital switching network. In fact the switching network consists essentially of a large assembly of just one basic type of integrated circuit.

This uniform structure provides the potential for making wide use of a few LSI types, as well as simplifying the introduction of more advanced LSI and VLSI components in the future. Uniformity has also resulted in a very low number of printed board types being used in the system. A typical System 12 exchange today uses only about 35 board types.

In addition, just eight types of board represent over 80% of the boards equipped in a typical exchange consisting of 35 board types. This has several advantages with respect to testing procedures, spare stock, training and local manufacture.

Conclusions

Fully distributed control allows System 12 exchanges to grow smoothly from small to very large sizes. As the control capacity increases with system size, no bottlenecks are encountered even with very large exchanges. Moreover the call capacity is an engineerable quantity and the system may be dimensioned as required to operate in an ISDN environment. Consequently System 12 is a universal switch covering the entire size and hierarchical application range, thereby giving unequalled network planning flexibility.

Control of the digital switching network is fully distributed throughout the network, allowing both circuit and packet switching. Thus System 12 is also a universal switch in a second sense in that it truly integrates circuit and packet switching in a single

system, making it ideal for application in a future ISDN.

From a technological viewpoint, the uniform structure enables it to accept new components with improved performance or of smaller size, lower power, higher reliability, and greater complexity (VLSI) without affecting the basic architecture⁷. The System 12 architecture and technology make it ideally prepared to stay in step with telecommunications as it evolves over the next decades.

References

- 1 S. R. Treves and D. C. Upp: System 12: Technique for Wideband ISDN Applications: *Electrical Communication*, 1985, volume 59, no 1/2, pp 131–136 (this issue).
- 2 A. Chalet and R. Drignath: System 12: Data Module Architecture Including Packet Operation: *Electrical Communication*, 1985, volume 59, no 1/2, pp 112–119 (this issue).
- 3 J. M. Cotton, K. Giesken, A. Lawrence, and D. C. Upp: ITT 1240 Digital Exchange: Digital Switching Network: *Electrical Communication*, 1981, volume 56, no 2/3, pp 148–160.
- 4 W. Frank, M. C. Rahier, D. Sallaerts, and D. C. Upp: System 12: Dual Switch Port: *Electrical Communication*, 1985, volume 59, no 1/2, pp 54–59 (this issue).
- 5 M. Van Brussel and A. Campos Flores: ITT 1240 Digital Exchange: Application to the Local Network: *Electrical Communication*, 1981, volume 56, no 2/3, pp 218–234.
- 6 K. J. Hamer-Hodges, G. De Wachter, and H. Weisschuh: System 12: Integration and Field Experience: *Electrical Communication*, 1985, volume 59, no 1/2, pp 12–19 (this issue).
- 7 R. H. Mauger: System 12: Architecture for Change: *Electrical Communication*, 1985, volume 59 no 1/2, pp 35–42 (this issue).

System 12

Technological Enhancement

Over the past few years technological advances and new services have been implemented within the System 12 distributed control architecture, proving that it is truly "future safe". In addition, use of the System 12 architecture has been extended from telephone switching to other applications, including a digital business communication system.

R. Cohen

International Telecommunications Center,
Brussels, Belgium

Introduction

During the 1970s, and particularly during the latter half of the decade, ITT undertook many studies and development projects to determine the best strategy for developing a digital switching system. One of the crucial questions to be answered was whether or not a new digital switching system should be based on the successful METACONTA* stored program controlled analog switching system. In view of the considerable progress in semiconductor technology since the Metaconta system had been developed, and taking into account the continuing rapid advance in the technology, it was concluded that the time was right for another significant leap forward in switching, comparable with those from step-by-step to register controlled systems and to stored

program controlled systems with central control.

When this decision was taken in 1979, it was decided to base the system architecture of System 12 not on the available semiconductor technology, but on the technology that it was anticipated would be available at the time production started.

The rapid progress in semiconductor technology, computer science, and telecommunication service requirements adversely affects the product lifetime of a telecommunication system unless that system can readily take advantage of such changes. Therefore a conscious decision was taken that System 12 must be "future safe". To achieve this System 12 has been designed with a revolutionary distributed control architecture which allows new technologies, new features, and new applications to be implemented with very little impact on the equipment already in place in exchanges. As the articles in this issue of *Electrical Communication* show, experience has proved that this major goal has been achieved.

Since the first System 12 exchanges were installed towards the end of 1981 in Belgium and the Federal Republic of Germany, many telephone administrations have decided to introduce System 12 in their networks. They have chosen System 12 largely because of its ability to exploit future advances in semiconductor technology and its potential to carry both voice and non-voice services in future ISDNs and wideband ISDNs.

An important feature of System 12 is that it is future safe. The architecture, which is based on modular hardware and software, provides the flexibility to introduce advanced technologies, new features, and new applications with the minimum impact on existing equipment.

SYSTEM 12 ARCHITECTURE

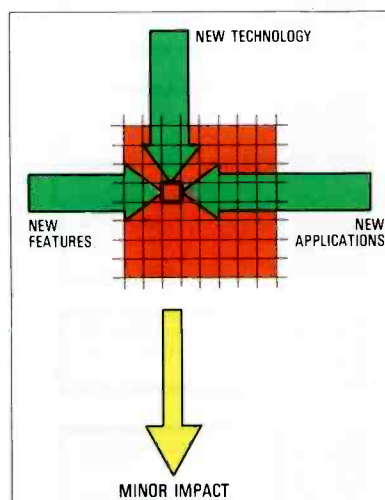

CONVENTIONAL ARCHITECTURES

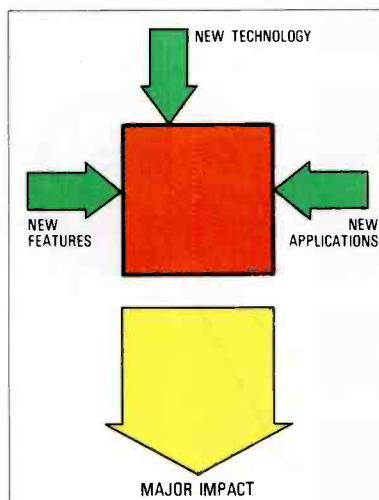

* A trademark of ITT System

Discussions with administrations covering their detailed requirements and anticipated future network evolution, together with the continuing rapid progress in semiconductor technology, led to the setting up of a number of evolutionary development projects during 1982 and 1983. This article highlights the main areas which have been affected by the evolutionary development programme and overviews the main new areas of application for System 12. More details are given by other articles in this issue. Further evolutionary developments will depend on future progress in technology, and on new feature and service requirements.

Objectives of the Evolutionary Development Programme

Evolution of System 12 had to be defined so that it maintained compatibility with the existing design and did not compromise the system's flexibility to evolve further to meet new needs. In contrast to other digital switching systems, this was not a problem as a major feature of the modular System 12 architecture is that it allows easy system evolution. One of the most important areas of investigation was that of new telephone administration requirements, primarily relating to the implementation of an ISDN. In addition, feedback from exchange installation and operation, and from manufacturing and engineering, was

channeled to the planners of the evolutionary development programmes.

Definition of the evolutionary development also took into account advances in semiconductor technology, and looked closely at the benefits of enhancement in relation to the required R & D effort.

The result was the setting up of development projects covering the following areas:

- technology and system hardware
- software and software tools
- new services
- new System 12 based products.

Progress in the first two areas is determined by advances in semiconductor technology and programming techniques.

Administration and user requirements and CCITT recommendations are guiding factors for further development in the other two areas.

Technology and System Hardware

Figure 1 is a block diagram of a System 12 exchange showing the basic components: digital switching network with built-in distributed control for path search and setup, microprocessor-based terminal modules, and auxiliary control elements.

Various terminal modules have undergone evolutionary design (e. g. analog

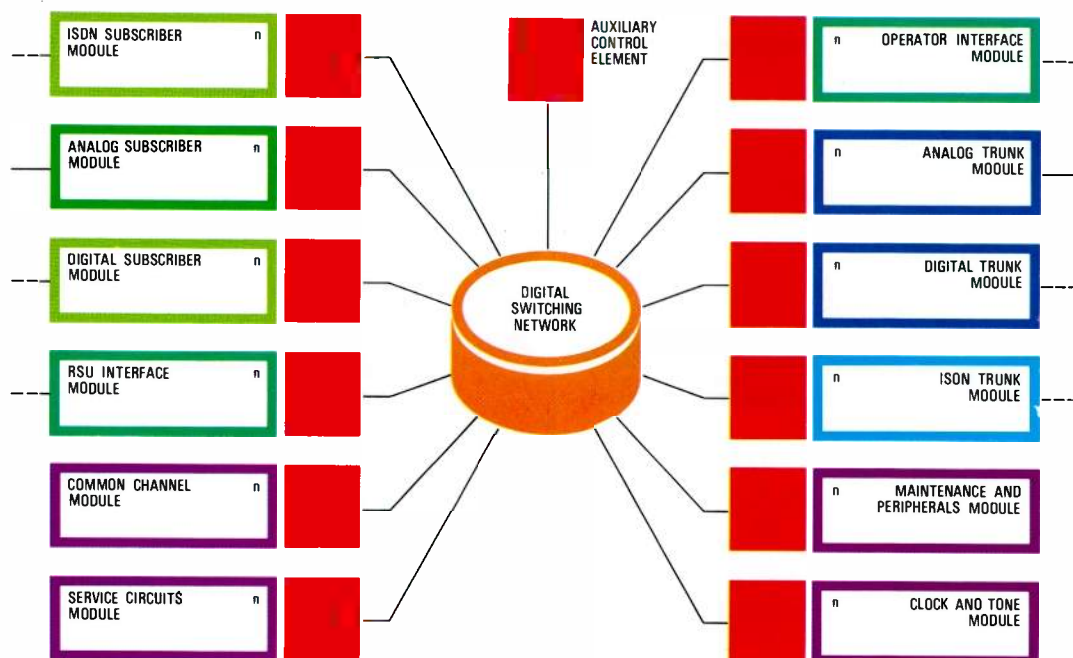

Figure 1
System 12 exchange architecture.

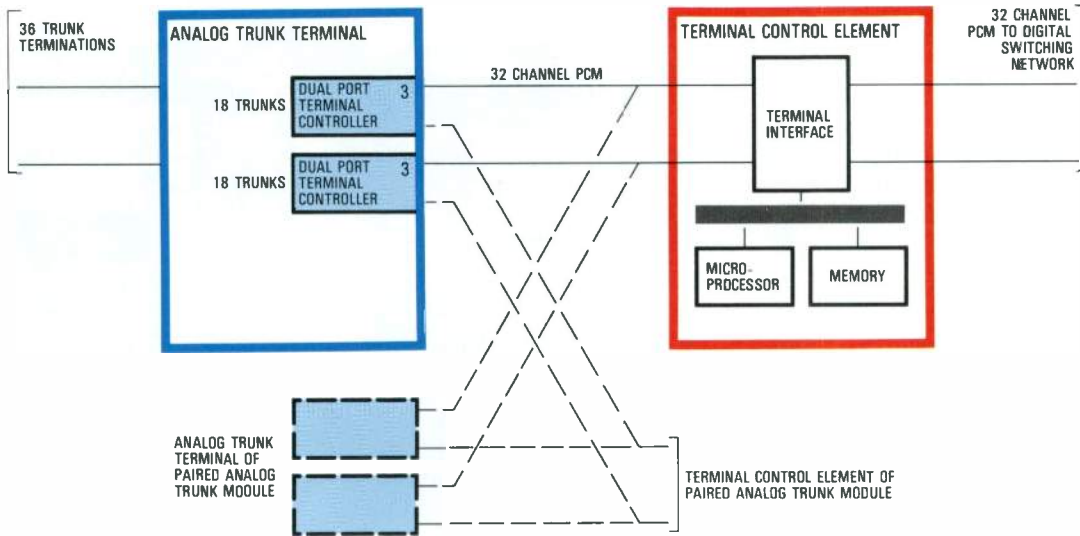

Figure 2
Analog trunk module.

subscriber module, analog and digital trunk modules). Compatibility with previous module versions has been ensured by maintaining the standard interface to the digital switching network.

Applying this line circuit technology, eight line circuits or six trunk circuits can now be assembled on one standard System 12 printed board, increasing the packing density to 1 024 lines per rack.

Analog Line and Trunk Circuits

Priority was given to enhancing the line and trunk circuits because of their major impact on the entire system.

To reduce the power and space requirements, and to increase reliability, a number of new custom VLSI circuits have been developed¹. Three of these integrated circuits are constructed using 3 μm CMOS technology. The functions of these CMOS devices are:

- digital signal processing: high speed sampling (1 MHz), analog/digital conversion, digital filtering, digital level adjustment, and digital balancing
- transcoding of the linearly coded output from the digital signal processor to A- or μ -law code for a group of lines (eight) or trunks (six)
- control and multiplexing for a group of lines (eight) or trunks (six).

The other two new VLSI circuits use TRIMOS (triac metal oxide semiconductor) technology and BIMOS technology, a combination of bipolar and CMOS technology¹. TRIMOS technology is used to realize a circuit with 300 V high voltage solid state switches; this replaces the miniature relays used in previous analog line and trunk circuits. BIMOS technology is used in a line interface circuit which provides line feeding, supervision, and the 2-/4-wire hybrid function.

Control of Terminal Circuits

A serial interface, the dual port terminal controller which is implemented as a custom VLSI device, is used to control groups of terminal circuits in one module from the TCE via channel 16 of the 32-channel PCM link, as shown in Figure 2 for the analog trunk module. This makes it possible to configure subscriber or trunk modules in pairs, so that in the event of a TCE fault, the working TCE can take control of both terminals. A further advantage of this arrangement is that software reloads and TCE maintenance can be performed without disrupting service^{2, 3, 4}. Module pairing also provides redundancy for certain classes of

High voltage switch for ringing and test access constructed in 300 V TRIMOS technology and 15 V CMOS technology.

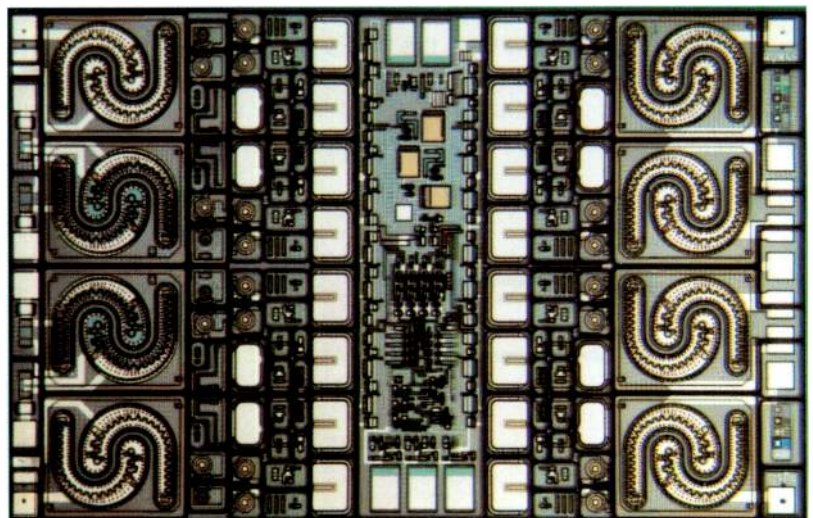

hardware fault, thereby enhancing the service availability.

Processor Memory

Although the 64 kbit RAM used so far is well suited to System 12, the new 256 kbit RAM that is now available allows more efficient packaging. More importantly, it allows TCEs to be equipped with sufficient memory for them to perform call control in addition to terminal control – yet another step towards greater functional distribution in System 12. In this implementation, the subscriber and trunk modules represent “mini-exchanges” which are supported by other types of module (e.g. service circuits module, maintenance and peripherals module), and by the system ACEs for functions such as signaling, call routing, and call charging. This concept is also used in ISDN modules⁵.

Software and Software Tools

The structure of the System 12 software and its implementation were designed to complement the distributed architecture of System 12. Specifically, the principles of modularity and clearly defined and controlled message interfaces have been rigorously maintained.

The software concepts of System 12 are described elsewhere in this issue⁶; the support tools have been described previously⁷. However, two software areas are particularly important in relation to evolutionary development: software allocation and software packaging for exchanges for a particular market segment.

Software Allocation

When it was decided to implement call control in the TCEs, it was known that this could be achieved quite easily by relocating the call handling software from the ACEs to the TCEs, as indicated in Figure 3. This was possible because from the outset it had been a design objective, now fully realized,

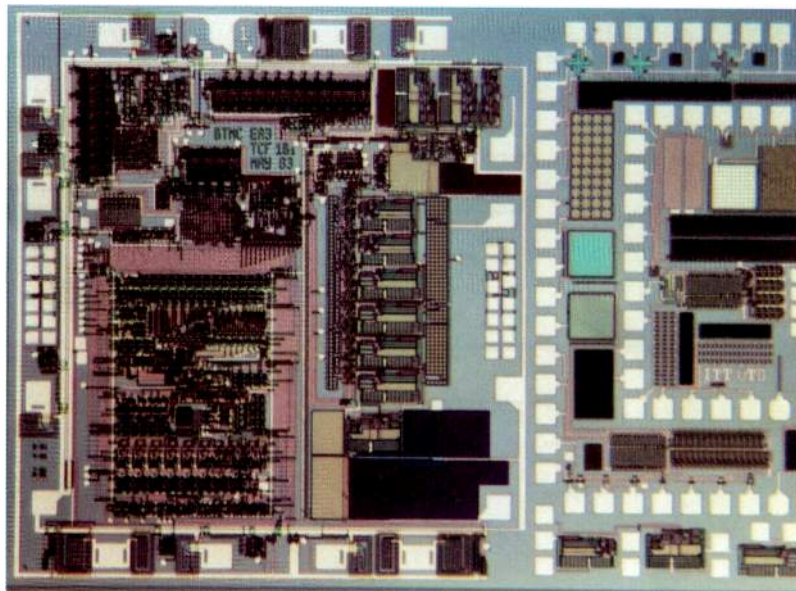

Linear to A- μ -law converter and remote metering circuit for use in the transcoder. It is fabricated in 3 μ m ISO-CMOS technology.

that software should be freely allocatable or relocatable. This characteristic is used when defining the software packages for the exchanges of a certain market segment.

Free allocation and relocation of software are the results of using a modular design based on FMMs (finite message machines) which communicate by defined sets of messages which are transferred in the same way regardless of whether two communicating FMMs are in the same or different processors. In the first case transfer takes place internally within one processor; in the second case transfer takes place via the digital switching network.

Following the relocation of call control software from an ACE to the TCE, some messages will continue to be transferred through the digital switching network, while others become internal messages.

Software Packaging for Market Segments

In order to minimize the effort required to prepare the system load tapes for individual exchanges, it is important to use the same software allocation in exchanges with the same feature requirements as they exist in

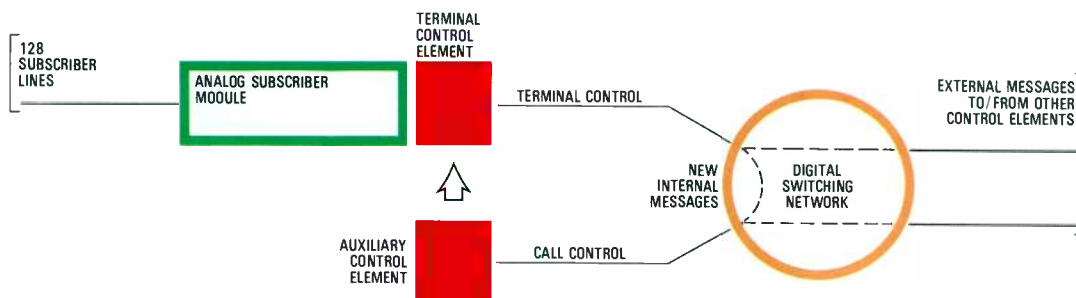

Figure 3 Principle of relocating call control software from an ACE to a TCE.

one market segment. To achieve this, the software for each type of control element required in a market segment is defined and tested. These processes are performed both for the resident software (generic load segment), which is permanently located in the memory of a control element, and the overlay software (generic overlay segment), which can be loaded from disk to the memory of a control element. Both types of software consist of FMMs and system support machines. Following definition of the generic load segments and generic overlay segments for one market segment, these software packages are integrated and tested to ensure high quality (i. e. freedom from bugs).

Software tools are available to support the development and manufacture of software for an individual exchange. They are used to produce system load tapes with pretested software packages of high quality⁶.

New Services

At present, most of the standard telephonic services have been developed and are already in service. Evolutionary development concentrates on services for which new CCITT recommendations are available, or nearly finalized.

The most important area concerns the ISDN, for which modules have been and are being developed; they will initially be used in field trials in Belgium, Italy, Spain, and Germany^{8,9}. Services to be provided in the trials include circuit-switched digital telephony, facsimile, and packet-switched teletex on the B and D channels. Custom VLSIs are under development for these modules.

ISDN subscriber and trunk modules are connected to the digital switching network via the standard interface (Figure 1). The messages defined for interprocessor communication are compatible with those used in modules which were initially implemented for telephony⁵.

Experience gained from the field trials will be used to develop product versions of the ISDN modules.

A further design enhancement relates to the wideband ISDN. Whereas many switching systems cannot easily provide $n \times 64 \text{ kbit s}^{-1}$ paths with mutual timeslot integrity, System 12 can provide such paths. To achieve this, the spare bandwidth of the System 12 digital switching network is used to transmit a multiframe identifier which

allows the receiving trunk module to re-establish timeslot integrity with the transmitting end. This will be implemented in a wideband subscriber module¹⁰.

System 12 Based Products and Extended System 12 Applications

The System 12 solutions – modular hardware, distributed control, programming techniques, programs, and software tools – can also be of great value for the development of other products, and for extended System 12 applications which were not part of the initial design. The most important new applications are:

- Network service center; this System 12 based configuration can be used in a network to concentrate the operations and maintenance functions (e. g. man-machine communication, charge recording, network management) for a number of System 12 exchanges at a single location¹¹.
- ITT 5630 business communication system, a digital PABX which covers the size range from 60 to 10 000 extension lines¹².
- System 12 application for switching in the German satellite system DFS¹³.
- System 12 application in cellular mobile radio systems¹⁴.
- System 12 as a digital adjunct used to extend the operating life of an existing analog exchange. This approach is being used in the North American telecommunication network^{15,16}.

In most of these and similar applications, it is the modularity of System 12 that has allowed new terminal modules and new or modified software to be added without changing the system architecture. This is a clear demonstration of the future safe characteristic of System 12.

Conclusions

The enhancements made to System 12 since its inception show how straightforward it is to add new services and implement new technologies as they become available. The concepts of standard interfaces and distributed control ensure that all enhancements are fully compatible with the previous design and that System 12 remains flexible for future enhancements.

The need for further evolution will be determined by new requirements and by the continuing progress in semiconductor technology, as well as the speed with which administrations implement the ISDN concept. ITT will meet this challenge to ensure low cost of ownership and a long product lifetime for System 12.

References

- 1 R. Chea, W. Cochran, J. Danneels, and P. Wöhr: System 12 Line Circuit Technology: *Proceedings of the International Switching System*, Florence, 7–11 May 1984, volume 3, session 32A, paper 3.
- 2 R. H. Mauger: System 12: Architecture for Change: *Electrical Communication*, 1985, volume 59, no 1/2, pp 35–42 (this issue).
- 3 J. M. Danneels and A. Vandevelde: System 12: Analog Line Circuit: *Electrical Communication*, 1985, volume 59, no 1/2, pp 43–47 (this issue).
- 4 J. J. Van Rij and P. Wöhr: Analog and Digital Trunk Circuits: *Electrical Communication*, 1985, volume 59, no 1/2, pp 48–53 (this issue).
- 5 A. Chalet and R. Drignath: System 12: Data Module Architecture Including Packet Operation: *Electrical Communication*, 1985, volume 59, no 1/2, pp 112–119 (this issue).
- 6 G. Becker, R. S. Chiapparoli, R. S. Schaaf, and C. Vander Straeten: System 12: Software: *Electrical Communication*, 1985, volume 59, no 1/2, pp 60–67 (this issue).
- 7 C. G. Denenberg and J. H. Newey: ITT 1240 Digital Exchange: Product Support Systems: *Electrical Communication*, 1981, volume 56, no 2/3, pp 274–282.
- 8 F. Haerens, B. Rossi, and J. M. Serrano: System 12: ISDN Field Trials in the Belgian, Italian, and Spanish Networks: *Electrical Communication*, 1985, volume 59, no 1/2, pp 89–97 (this issue).
- 9 D. Becker and H. May: System 12: ISDN Pilot Service of the Deutsche Bundespost: *Electrical Communication*, 1985, volume 59, no 1/2, pp 98–104 (this issue).
- 10 S. R. Treves and D. C. Upp: System 12: Technique for Wideband ISDN Applications: *Electrical Communication*, 1985, volume 59, no 1/2, pp 131–136 (this issue).
- 11 J. Van Walle and F. Peeters: Centralized Operation, Maintenance, and Call Charge Recording: *Proceedings of the International Switching Symposium*, Florence, 7–11 May 1984, session 43B, paper 3.
- 12 A. Bessler, M. E. Edelmann, and L. Lichtenberg: System 12: ITT 5630 Business Communication System: *Electrical Communication*, 1985, volume 59, no 1/2, pp 179–187 (this issue).
- 13 K. Nigge, K. Rothenhöfer, and P. Wöhr: Switching for the German Satellite System: *Electrical Communication*, 1985, volume 59, no 1/2, pp 137–144 (this issue).
- 14 G. Adams, M. Böhm, and K.-D. Eckert: System 12: Cellular Mobile Radio Applications: *Electrical Communication*, 1985, volume 59, no 1/2, pp 212–219 (this issue).
- 15 J. Cox and R. E. Pickett: Role of the Digital Adjunct in Network Enhancement: *Electrical Communication*, 1985, volume 59, no 1/2, pp 195–199 (this issue).
- 16 R. E. Pickett: Network 2000 Evolution in the United States: *Electrical Communication*, 1985, volume 59, no 1/2, pp 188–194 (this issue).

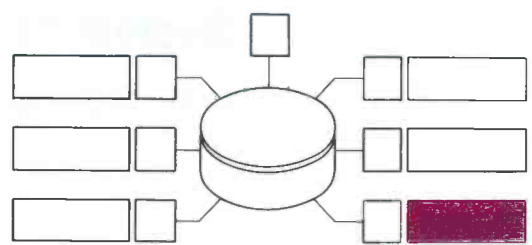
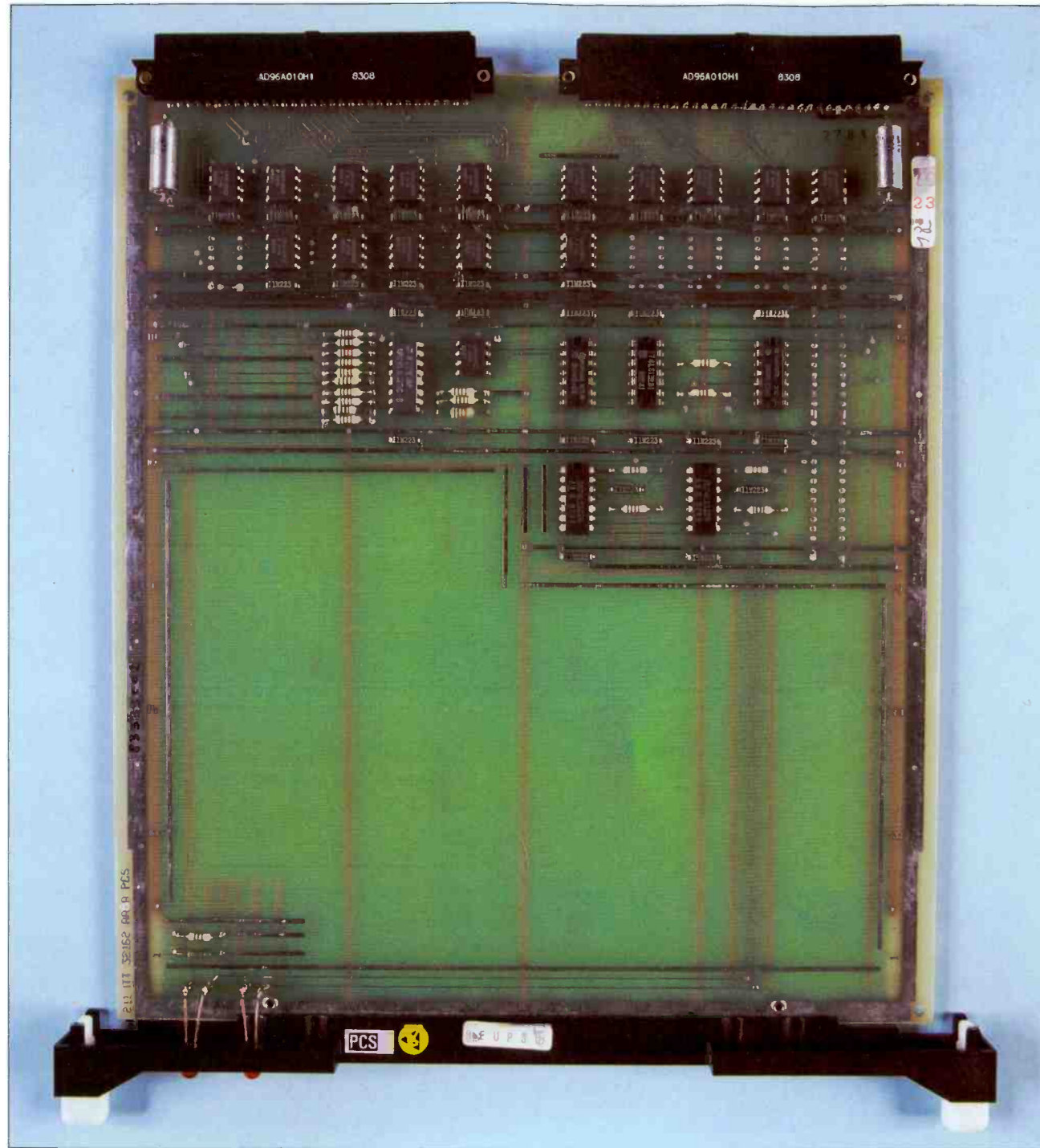

System 12
Clock and Tone Board

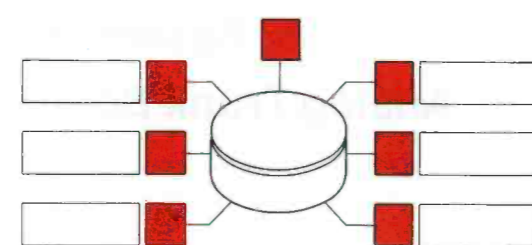
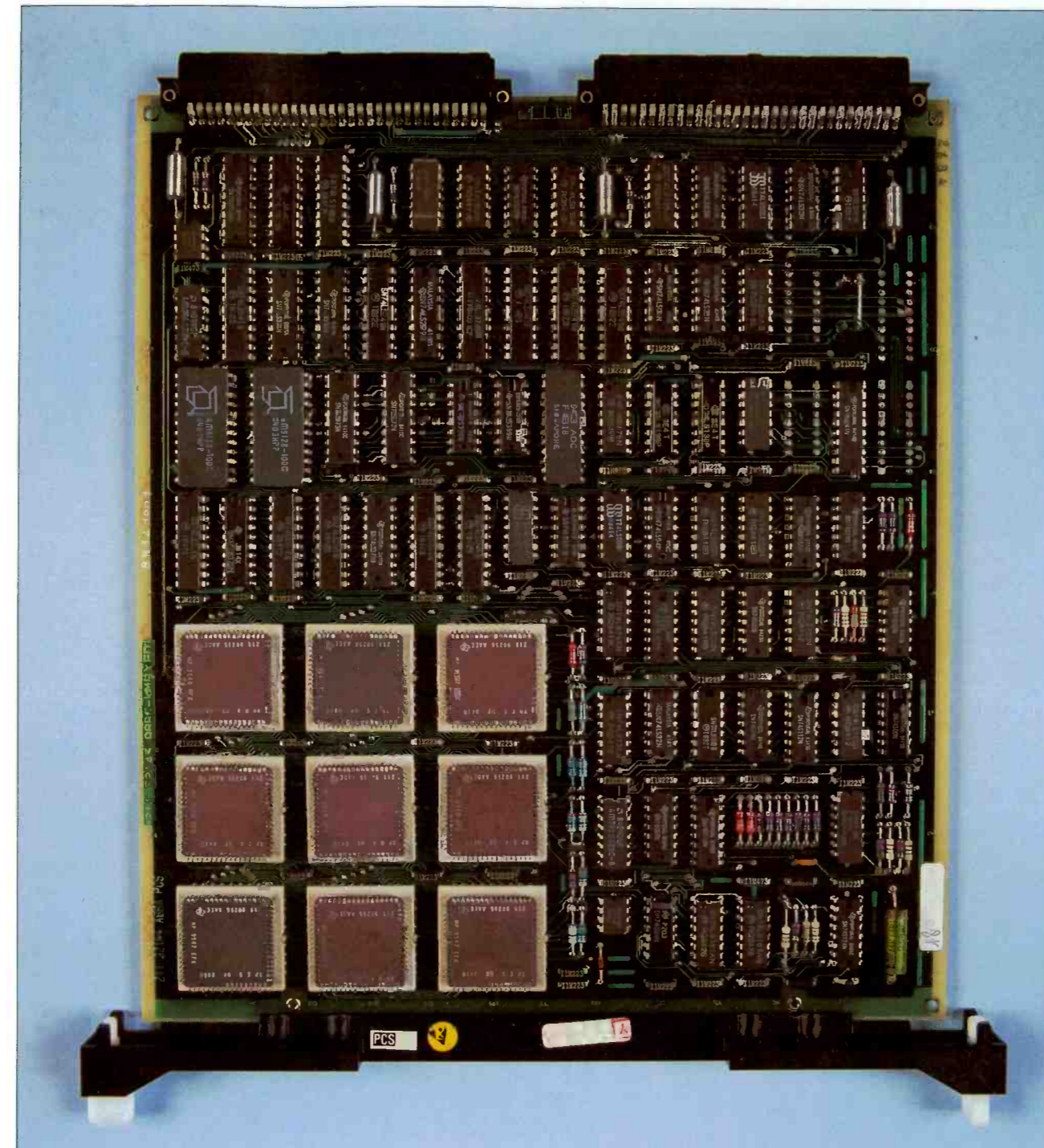

System 12
Terminal Interface Board

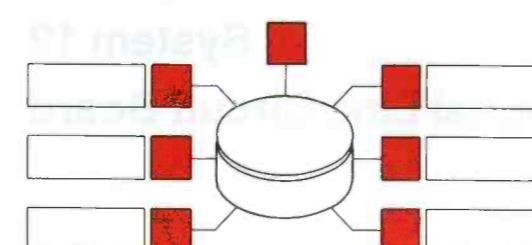
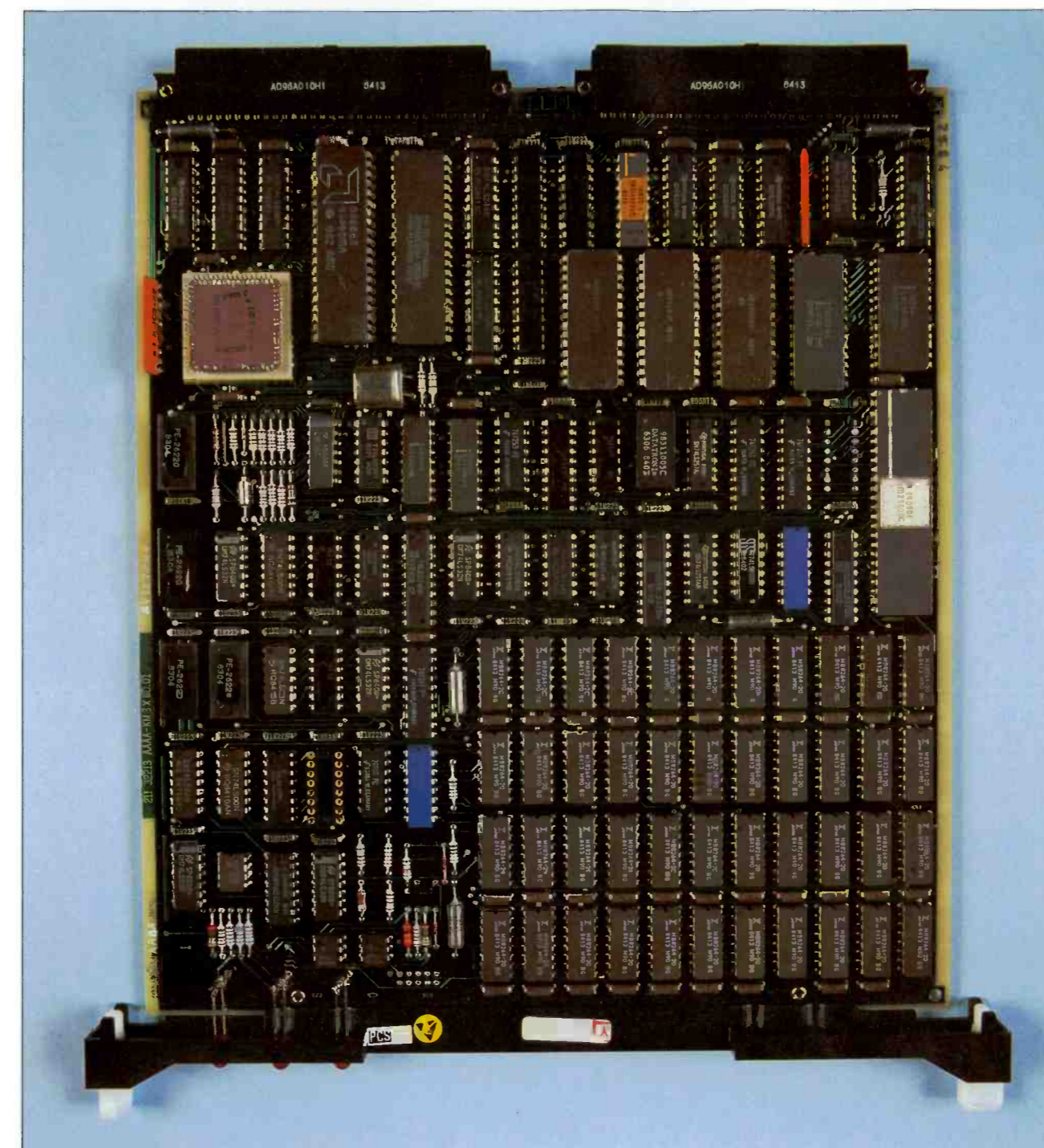

System 12
Microprocessor Board

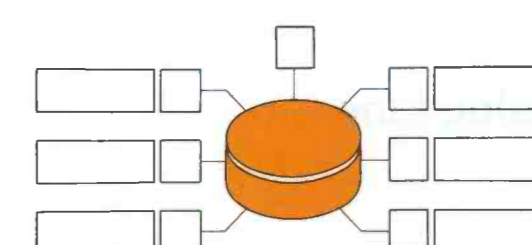
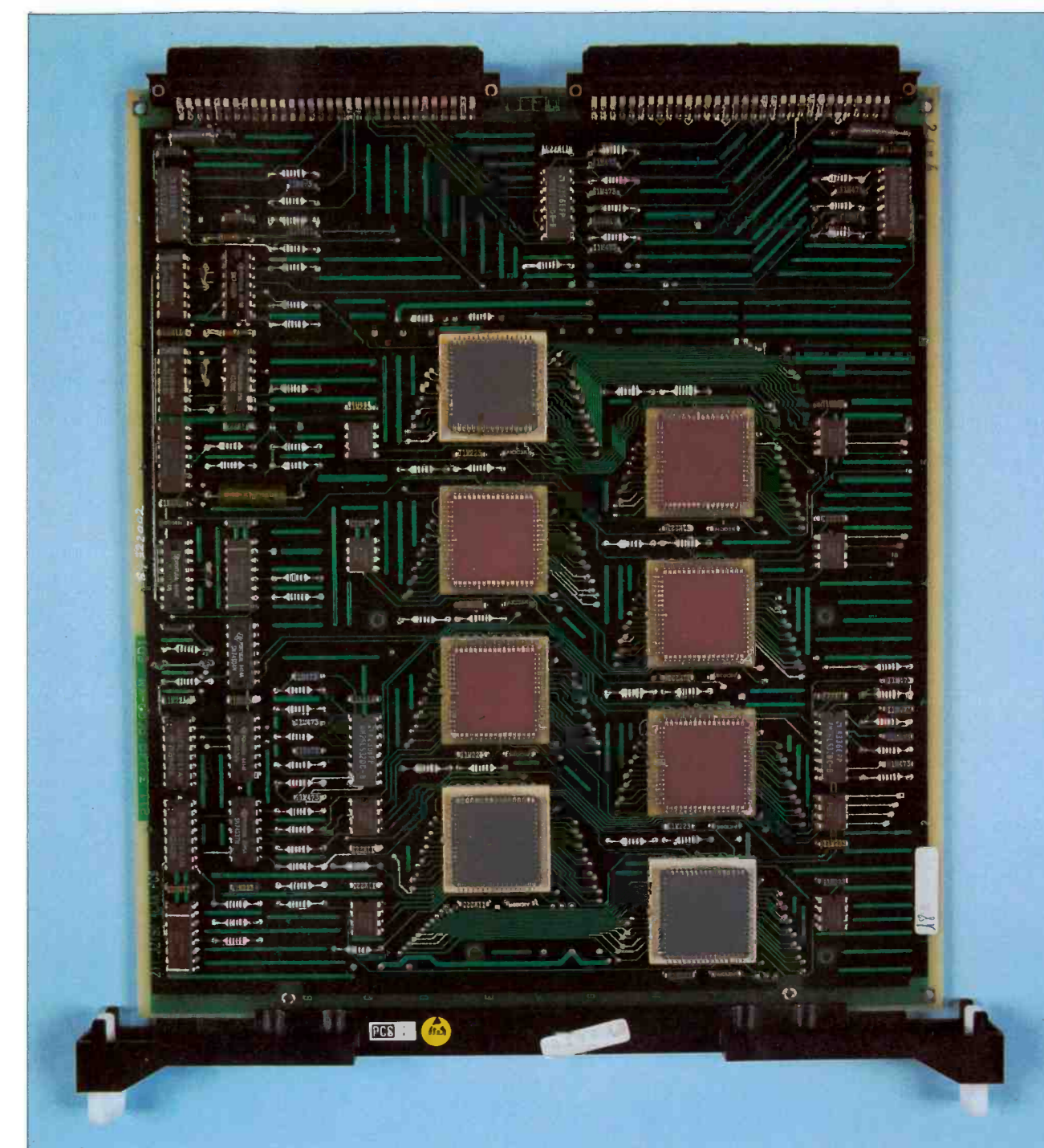

System 12
Digital Switching Element Board

**A Selection of Printed Boards
Used in System 12 Exchanges**

System 12

Architecture for Change

The System 12 distributed control architecture was conceived at a time when major changes in the world's telecommunication networks were inevitable, and were likely to occur with increasing rapidity for many years. The architecture has already proved its ability to cope with change as System 12 evolves to meet new requirements.

R. H. Mauger

International Telecommunications Center,
Brussels, Belgium

Introduction

When development of System 12 was started in the late 1970s, ITT recognized that the 1980s would herald the start of a period of rapid change in the world's telecommunications networks — change which would continue until at least the end of the century driven by rapid advances in VLSI technology and increasing subscriber demands for more sophisticated services. Thus one of the primary objectives when developing System 12 was to design an architecture that would be future safe, that is, which would allow evolution in technology and services without fundamental architectural changes. Indeed, so basic was this objective considered to be that System 12 was not designed around the component technology available at the start of development, but around the VLSI technology that ITT forecast would become available by the time development was complete.

The result was the by now well known System 12 distributed control architecture with its extensive modularity, standard interfaces, and intelligent digital switching network — an architecture designed for change. New modules can be developed to provide additional services, or modules can be redesigned to take advantage of advanced VLSI technology, and connected to the system via the standard interfaces without affecting the operation of the rest of the exchange.

The architectural concepts have already proved themselves by allowing the analog subscriber and digital trunk modules to be enhanced to take advantage of more cost-

effective custom design VLSI circuits. The digital switching network has also benefited from the availability of 3 μ m VLSI technology with the development of a new custom design dual switch port. In addition, several new modules have been developed for use with the future ISDN, including an ISDN subscriber module, digital trunk module, and ISDN trunk module.

As well as these specific hardware changes, a number of more general evolutionary changes were established for System 12. The most important of these are:

- Increasing the number of lines per rack to 1024 by using CMOS technology. This has maintained System 12's leading position in terms of exchange floor space and heat dissipation.
- Higher availability using a paired (dual control) configuration for some modules to meet the requirements of operating companies in the United States that specify much higher line and trunk availabilities than those recommended by CCITT.
- Provision of advanced digital switching capabilities for ISDN (packet switching and digital wideband switching). Although CCITT has not yet produced full recommendations for the services supported by these features, the long lead time for new custom VLSI circuits made it essential to develop the necessary infrastructure for both packet switching and digital wideband switching. The generic nature of the hardware ensures that it will not be outdated by future CCITT recommendations.

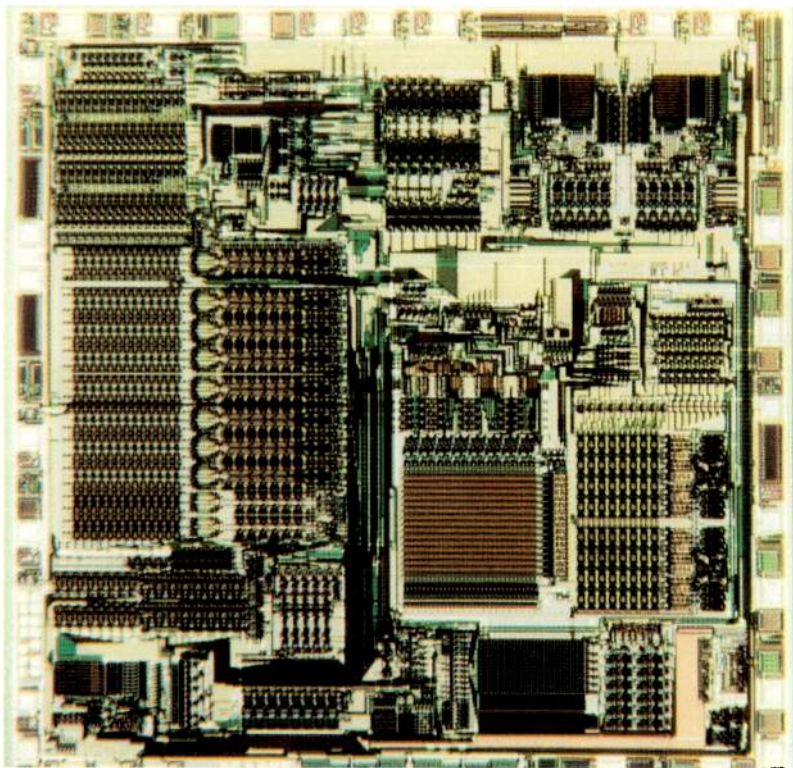

Dual processor terminal controller used in the System 12 line circuit. This 3 μm ISO-CMOS device incorporates 23000 transistors.

The digital distributed control architecture has allowed all these objectives to be met without any major system redesign, fully justifying ITT's confidence that System 12 is "future safe".

Technical Strategy

The three programmes outlined above are highly synergistic and together have led to three main enhancements to System 12: pairing of some types of module in a dual control configuration, simplification of the control structure, and the development of a multipurpose digital terminal chip set for specific System 12 terminals.

Figure 1 Dual control arrangement of an analog subscriber module pair.

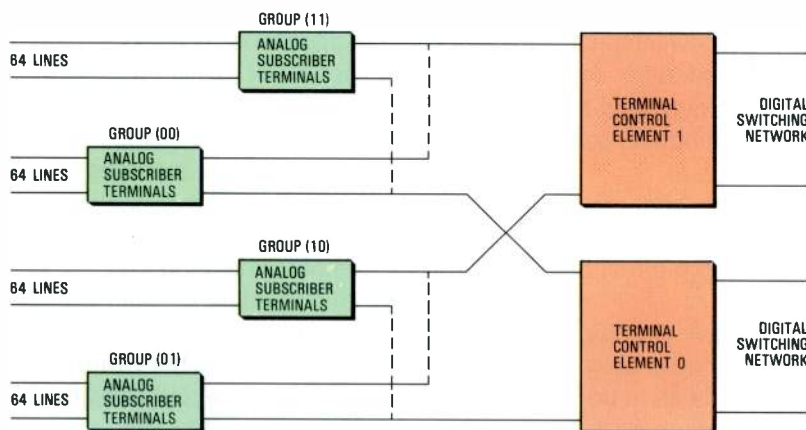

The programme for increasing the line density to 1024 lines per rack required a substantial reduction in the number of control elements for a given number of lines. This has been achieved by pairing some types of module in a dual control configuration. In this configuration, two new VLSI circuits perform some of the control functions of the line and trunk boards, thereby reducing the TCE load per call and eliminating any reliability problems. As a result it has been possible to increase the number of lines controlled by a TCE from 60 to 128, or 256 in failure mode. In addition the simplified control structure allows the number of ACEs in the 1024-line rack to be reduced.

Dual Control Pairing

This feature allows certain types of module (e.g. line and trunk modules) to be paired so that each terminal is connected to both TCEs in the pair. In normal operation each terminal is controlled by its assigned TCE. However, in the event of a TCE fault, control can be transferred smoothly to the other TCE a line at a time.

Control can also be transferred at the request of a man-machine command, for example to allow maintenance to be performed or software to be updated without affecting service. In this case, stable calls are allowed to complete before control of the line or trunk is transferred to the other TCE in the pair.

Figure 1 shows how pairing has been applied to the analog subscriber module. The lines are divided into four 64-line groups. Traffic from each group is concentrated onto a 30-channel 4.096 Mbit s⁻¹ serial standard interface in the normal operational mode. In the "crossover" mode, two 64-line groups are concentrated onto a single 30-channel interface as indicated by the dashed lines. Usually a TCE controls 128 lines (i.e. two groups), but in the crossover mode all 256 lines are controlled by the same TCE.

Realization

Module pairing is supported by two new VLSI chips: a DPTC (dual processor terminal controller) and an OBCI (on-board controller interface).

The DPTC is used in analog line and trunk terminals, as well as in miscellaneous devices such as the ring and alarm boards which operate on the basis of scan and drive

points. The OBCI interfaces directly to an on-board controller which may be one of a wide range of commercial microprocessors. The device allows any type of intelligent terminal (i.e. a microprocessor-based System 12 terminal such as an ISDN line circuit or digital trunk circuit) to be connected to the system.

DPTCs and OBCIs are equipped with two $4.096 \text{ Mbit s}^{-1}$ System 12 serial standard interfaces for connection to the two TCEs in a dual control pair. Each serial interface is connected as a bus arrangement of up to 32 DPTCs and/or OBCIs which can operate compatibly on the same bus.

Figure 1 illustrates the principle of dual control. The DPTCs and OBCIs are controlled by packets, typically in channel 16 (optionally on other channels for the OBCI). The DPTC supports scan and drive commands addressed to the connected devices and autonomously detects changes in an 8-bit scan byte (mismatch processing). OBCI time switching operations can be controlled directly by TCE commands; in addition, control packets can be sent to or received from the on-board controller for the control of attached intelligent terminals.

Transfer of Control

Referring again to Figure 1, in normal operation line groups 11 and 10 are controlled by TCE 1 and line groups 00 and 01 by TCE 0. This assignment is determined by the TCE software; it is not known to the line groups. The DPTC and the on-board controller can distinguish between assigned and nonassigned terminals, where assigned means related to one of the two TCEs for control purposes. If a signal is received from a nonassigned terminal it is sent to both TCEs, whereas if the terminal is assigned then only the designated TCE receives the signal.

In call handling operations a line or trunk is nonassigned if it is idle, and assigned to a particular TCE if it is engaged in a call or is part of a leased line. When a software package in the two TCEs has to be upgraded, the procedure is as follows. First a message is sent to TCE 1 to instruct it to handle all new calls, and another message to TCE 0 to instruct it not to handle any new calls. The first message of a new call is sent to both TCEs; in this condition TCE 1 accepts all such messages and assigns all the associated lines to itself.

Any message relating to a line still associated with TCE 0 is sent to TCE 0

which continues to control the release phase of that call until control of the line has been transferred to the other TCE. After a *wait traffic clear* period, typically five minutes, any leased lines are transferred to TCE 1, freeing TCE 0 to load the new software.

When the new software has been loaded, TCE 0 is instructed to handle all new calls and the same procedure is used to free TCE 1 for loading with the new software. Finally, as soon as TCE 1 has been reloaded, both TCEs are instructed to return to the normal control configuration.

On-board controller interface for line and trunk circuits. Constructed in $3 \mu\text{m}$ NMOS technology, this device includes 50000 transistors.

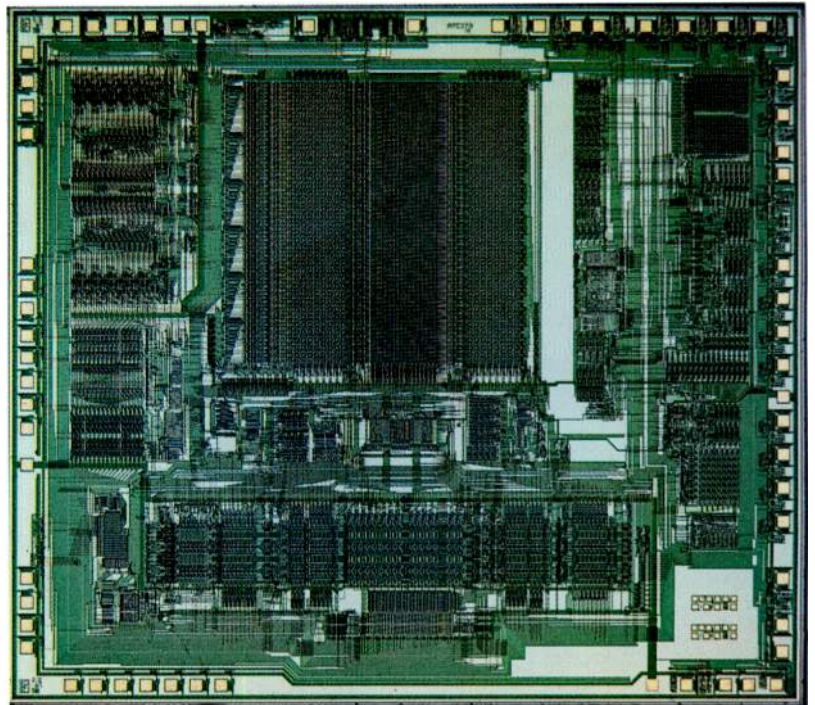

If control is transferred because of a hardware failure, lines are transferred immediately without a wait traffic clear period.

Serial Control of DPTC Group

As indicated in Figure 1, 64 lines are controlled as a single group. Figure 2 illustrates the operation of the eight DPTCs serving this group. Control of a group of DPTCs is a continuous serial process. The packet launched from the TCE is serially processed by all the DPTCs, which may respond in any of three ways:

- with an "echo" for common control information
- with the contents of a register
- with a series of mismatch reports.

Figure 2
Serial control of a DPTC group.
MMI - mismatch indication.

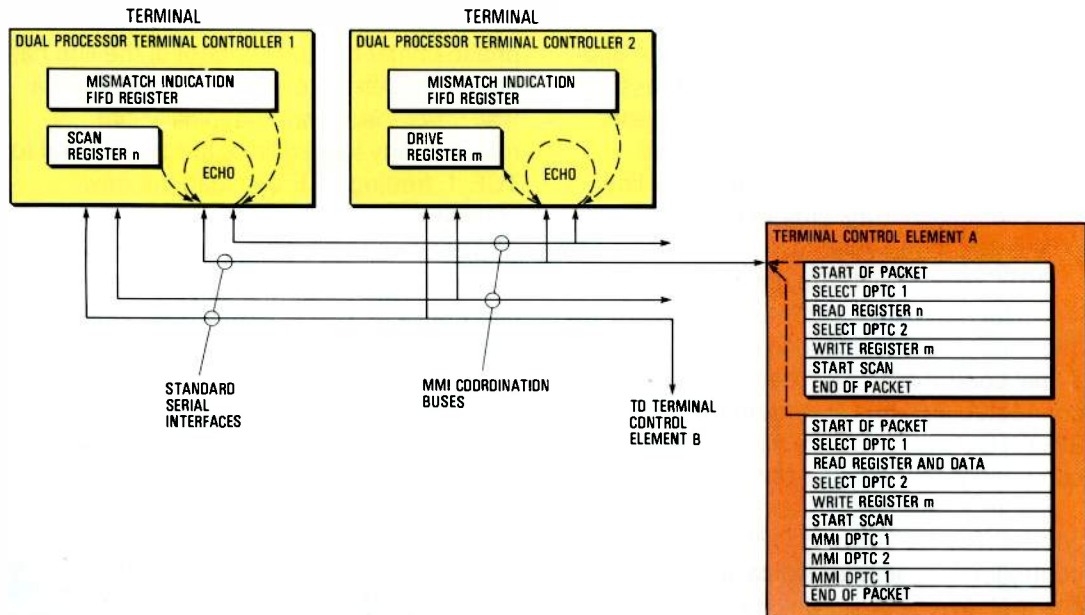

Consider the packet structure shown in Figure 2. The *start of packet* word initiates a transaction and initializes all DPTCs to a control operation mode. All DPTCs then echo the *start of packet* to the originating TCE where it prepares the TCE to receive the return packet.

Select DPTC 1 is detected by the addressed DPTC but echoed by all so that it is received in the reply packet.

Read register n is addressed to the selected DPTC. All DPTCs echo the command with the exception of the addressed DPTC which overwrites the data area with the contents of scan register *n*.

Select DPTC 2 and *write register m* similarly cause the drive register of DPTC 2 to be updated.

Start scan initiates the collection of mismatch indication reports which are held in FIFO (first-in/first-out) memory in each DPTC. All DPTCs in the control group are interconnected by a mismatch indication coordination bus which nominates each DPTC in turn for the delivery of a mismatch indication report to ensure equal treatment of all lines in the group.

End of packet is generated automatically when either all FIFOs are empty or the reply packet reaches the maximum size of 32 words, thereby terminating the serial control operation.

Packet Transfers Using the OBCI

The OBCI supports an extensive command set which may be used flexibly in a wide

range of applications. It is not possible in this article to describe the full potential of the device.

A typical example of communication between a TCE and an on-board controller is illustrated in Figure 3 which shows the contents of the send and receive packets for both directions of transfer. Transfers through an OBCI between a TCE and an on-board controller are controlled by a command register. In the transfer shown in Figure 3, the packet in the TCE may be launched on any channel, although typically channel 16 is used.

Select OBCI 1 selects a particular OBCI and a free internal command register, and links the command register with the channel on which the command was received. Subsequent commands are addressed to the linked command register.

Assign DMA channel selects a free DMA (direct memory access) channel on the interface to the on-board controller and links it to the command register. Subsequent *data* words are transferred serially into the command register and then transferred in parallel to the on-board controller memory. Because of the serial-to-parallel conversion, a *no operation* command is required following the *data* words.

End of packet clears the command register and terminates the DMA transfer with an interrupt to the on-board controller. The DMA channel remains busy until cleared by an on-board controller interrupt routine which changes the address to point to the

memory space for the next packet to be reviewed.

Transfer in the opposite direction from controller to TCE operates similarly, as follows:

Select OBCI: although there is a one-to-one relation between the controller and its interface, this command is still necessary as the OBCI has the same functional operation on all its ports. The command links a command register to the selected DMA channel.

Assign channel selects a channel towards the TCE. The command may be addressed specifically to channel 16 or may select any channel.

Start of packet is recognized by the TCE and a packet area is created in the packet RAM. Subsequent *data* words are transferred to the packet RAM.

End of packet terminates the transfer in both OBCI and TCE. The command register in the OBCI is then cleared and the on-board controller receives an interrupt. In the TCE the content of the packet RAM is delivered to the software in the same way as for other System 12 developments.

Simplified Control Structure

The commercial availability of 256 kbit dynamic RAM VLSI chips has led to the development of a processor with 1 Mbyte of memory on a single printed board. This has enabled the System 12 call handling control structure to be simplified. The previous structure consisted of two levels: the TCE level, which dealt with device handling and signaling, and the ACE level, which was devoted to call handling. Development of the new 1 Mbyte processor board has now allowed these two control levels to be integrated in the TCE.

The main objective of the change is to extend the application of distributed control in the areas of call handling, resource management, fault and error handling, and exchange maintenance.

The flexibility of the finite message machine concept allows the System 12 software to be distributed largely by selecting existing software modules when building the software package for a control element rather than by redesign. This flexibility has allowed the simplified control structure to be introduced without affecting the ability to provide feature enhancements to existing exchanges with the two-level control structure.

Call Handling

Call handling is currently performed by ACEs which typically serve 480 lines or 120 trunks. The main advantage of distributing this function to the TCEs that serve the lines and trunks is that it reduces the design and regression testing effort required when engineering System 12 for new markets as less control element software needs to be modified.

Resource Management

The management of resources (e.g. lines, trunks, multifrequency receivers and senders) is not fully distributed in present exchanges. In particular, the busy/free status of all such circuits is held in ACEs that provide the resource management function as well as in the TCE that handles the particular terminal. This is not a problem in most exchanges, but development of the international exchange configuration¹, with the provision of extensive alternative routing, required a change of strategy in which the resource management function is guided by the busy/free indicators of trunk groups and routes, and the busy/free status

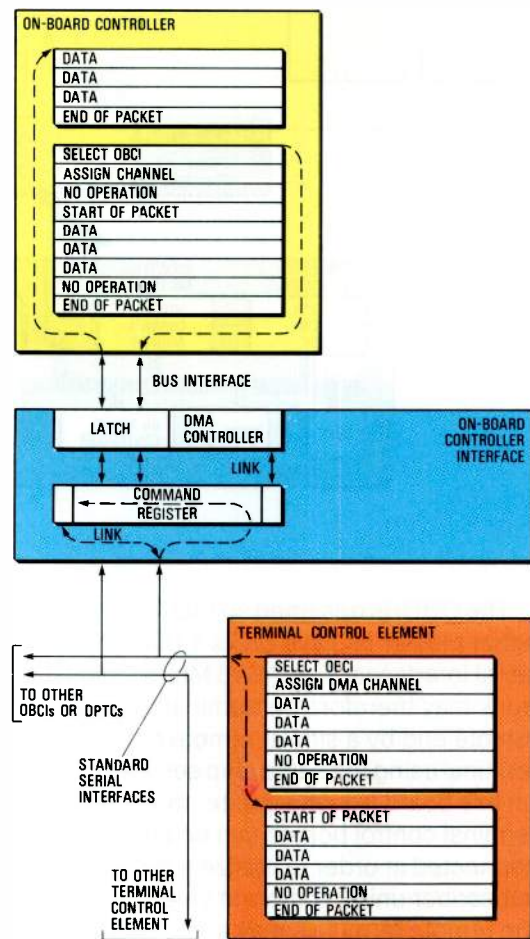

Figure 3
Packet transfers using
the OBCI.

of the individual terminal is handled exclusively by the associated TCE.

The simplified control structure allows this improved strategy to be applied cost-effectively to all exchange types.

Fault and Error Handling

These functions are largely centralized in currently installed exchanges. The remarkable stability of System 12 in operational exchanges allows central operation without difficulty. At early stages of system integration, however, centralization caused some problems. The functions have now been redesigned on a distributed basis. This has substantially reduced overall system interactions between control elements, thereby allowing software integration testing of each control element to proceed independently.

Maintenance of Exchange Terminals

The OBCI supports a wide range of intelligent terminals which are being designed to be self testing. Built-in self testing and diagnostics together with the simplified control structure make System 12 modules fully responsible for the maintenance of their terminals without the need for any centralized maintenance and peripherals module to overlay additional test programs.

Multipurpose Digital Terminal Chip Set

This set of VLSI chips has a variety of applications. An important objective of the development was to allow pairing of System 12 digital subscriber and trunk modules. Other major objectives were to support remote subscriber unit capability for analog and digital subscriber lines (Figure 4), packet switching on ISDN lines and CCITT No 7 or X.75 trunks, and digital wideband switching ($n \times 64 \text{ kbit s}^{-1}$ up to $2.048 \text{ Mbit s}^{-1}$).

The chip set comprises elements for support at layers 1, 2, and 3 of the OIS model, and control.

Layer 1 support: this includes digital trunk logic for interfacing with $2.048 \text{ Mbit s}^{-1}$ digital trunks. A U-interface circuit provides echo cancellation for 144 kbit s^{-1} ISDN line transmission and an ISDN line interface. Finally the multichannel aligner is an alignment circuit for digital wideband switching.

Layer 2 support consists of a commercial HDLC (high level data link controller) which supports CCITT No 7 common channel signaling and CCITT X.25 links, an ISDN link controller to support the D-channel and E-channel protocols, and B-channel packet switching service.

Layer 3 support: the OBCI provides a control and switching interface between a control element and an intelligent System 12 terminal.

Control is based on a commercial microprocessor.

Basic Application

The general principles of the multipurpose digital terminal architecture are shown in Figure 4. Specific applications are discussed elsewhere in this issue^{2,3}. The application shown in Figure 4 for the digital trunk terminal has three main features: HDLC signaling protocol, wideband switching, and a $2.048 \text{ Mbit s}^{-1}$ digital trunk interface.

Figure 4
Application of the multipurpose digital terminal architecture for remote subscribers.

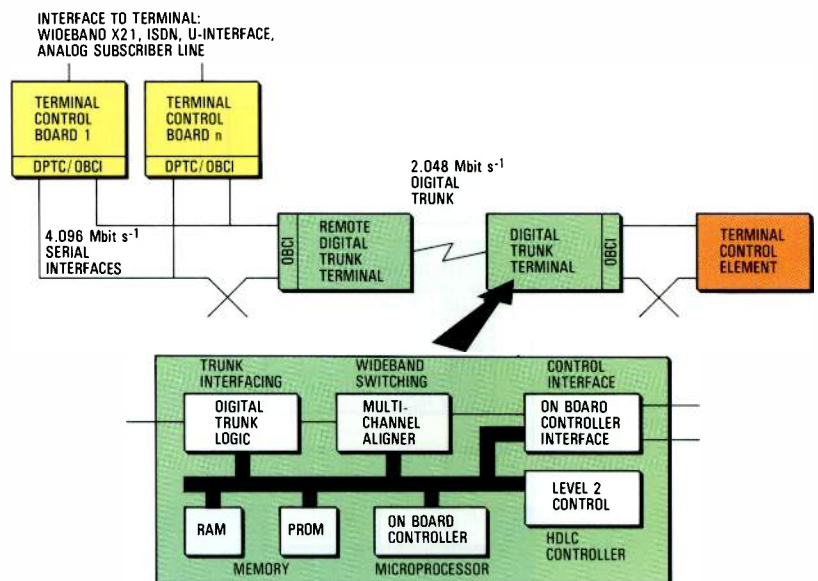

The OBCI is designed so that it can act as either master or slave on its $4.096 \text{ Mbit s}^{-1}$ serial interfaces. The $2.048 \text{ Mbit s}^{-1}$ digital trunk may therefore be terminated at its remote end by a similar remote digital trunk terminal using the same chip set. The OBCI on this board is in the master mode so that terminal control boards can be directly connected in order to realize a remote subscriber unit. In different configurations the remote terminals may be:

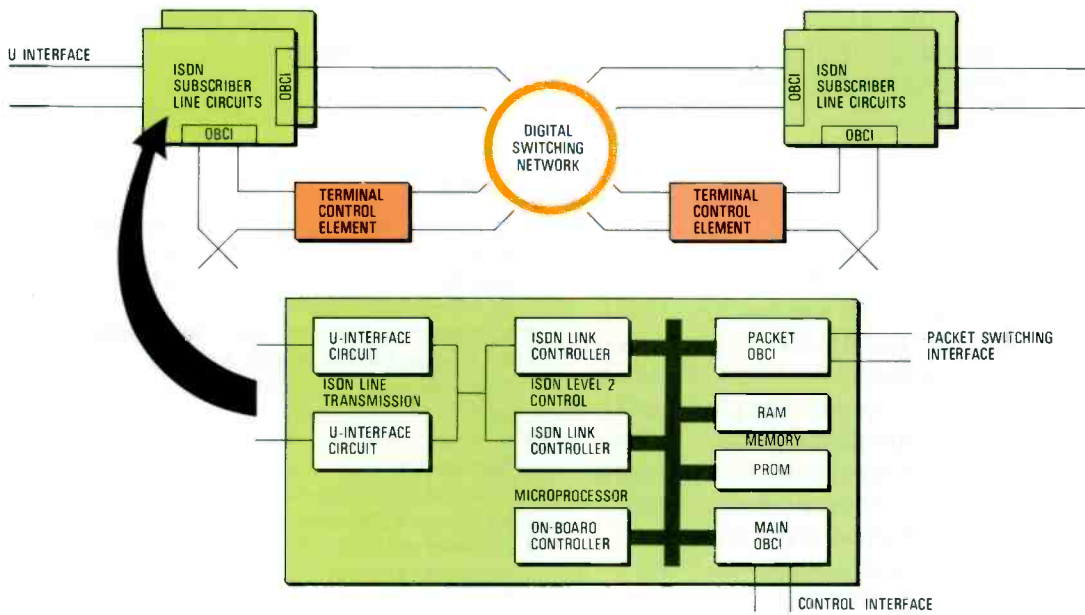

Figure 5
Application of chip set for ISDN subscribers with packet switching.

- wideband: CCITT X.21 with n 64 kbit s⁻¹ channels (where n is between 2 and 32)
- ISDN subscriber: U-interface
- analog subscriber lines.

virtual calls onto the same ISDN subscriber or trunk line.

Signaling over the digital trunk connection can use a reduced form of CCITT No 7 common channel signaling, a special purpose HDLC protocol, or channel associated signaling, depending on the particular application.

Packet Switching

The application of the multipurpose digital terminal chip set in the ISDN subscriber module is outlined in Figure 5. The implementation of ISDN subscriber modules to support packet switching is described elsewhere⁴.

The System 12 digital switching network is, in essence, a packet switch since message communication between control elements is directly based on packet switching principles. In order to provide a packet switching capability to external users, the ISDN line circuit controllers are given direct access to the switching network by an OBCI operating in a special packet mode.

Virtual calls are processed in the same way as circuit switched calls during the setup phase, but once established each ISDN line circuit controller is able to set up a path across the network to deliver a packet to its destination. This mode of operation allows statistical multiplexing of different

Wideband Switching

The principles of wideband switching are illustrated in Figure 6. Individual 64 kbit s⁻¹ paths across the digital switching network experience a variable time delay which may amount to a dispersion of a number of frames between the paths making up a wideband connection. However, the internal paths of the digital switching network operate at 128 kbit s⁻¹, with 16 bits per frame to transport each external 8-bit byte. A frame reference can therefore be inserted at the input to the switch which can be used at the output to control a variable time delay to realign the channels. This view is purely

Figure 6
Principle of wideband switching.

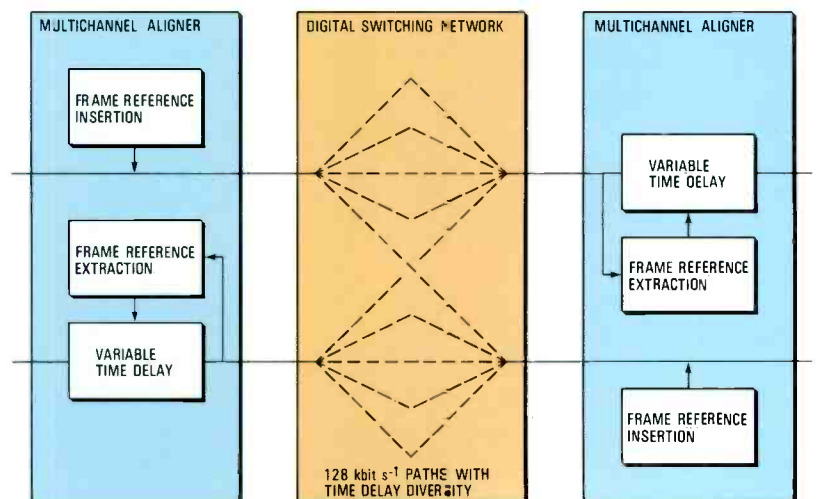

functional; further details are given in a companion paper⁵. The feature has already been demonstrated in an exchange environment.

Conclusions

One of the main claims made for System 12 when it was launched was that it is "future safe", meaning that it is able to evolve and use new technology to the full and to provide the full range of new services promised by future ISDNs. Experience to date has fully confirmed these expectations. In particular the System 12 architecture has allowed evolution in the following areas without major changes: dual control, 1024-line equipment racks, ISDN subscriber access, packet switching, wideband switching, and remote subscriber units.

The simplicity and elegance of the solutions outlined in this article illustrate that

"future safe" is no longer a vague concept but an established fact.

References

- 1 M. Della Bruna and F. Minuti: System 12: Acilia International Toll Exchange: *Electrical Communication*, 1985, volume 59, no 1/2, pp 145–153 (this issue).
- 2 K. Nigge, K. Rothenhöfer, and P. Wöhr: Switching for the German Satellite System: *Electrical Communication*, 1985, volume 59, no 1/2, pp 137–144 (this issue).
- 3 S. Husby and B. Vinge: System 12: Application of the Remote Subscriber Unit in the Norwegian Network: *Electrical Communication*, 1985, volume 59, no 1/2, pp 174–178 (this issue).
- 4 A. Chalet and R. Drignath: System 12: Data Module Architecture Including Packet Operation: *Electrical Communication*, 1985, volume 59, no 1/2, pp 112–119 (this issue).
- 5 S. R. Treves and D. C. Upp: System 12: Technique for Wideband ISDN Applications: *Electrical Communication*, 1985, volume 59, no 1/2, pp 131–136 (this issue).

System 12

Analog Line Circuit

A number of different LSI technologies have been used to produce the integrated circuit chips for the System 12 analog line circuit. The result is a standard device that can meet a wide range of administration requirements. Eight line circuits can be mounted on a printed board, enabling 1 024 circuits to be housed in a single line rack.

J. Danneels

A. Vandeveld

Bell Telephone Manufacturing Company,
Antwerp, Belgium

Introduction

Advances made over the past three years in high voltage technology, complex processing techniques, and design aids for LSI circuits have been used in designing the System 12 analog line circuit. The result is a line circuit which makes wide use of the latest integrated circuits to achieve high performance, flexibility, small size, and low power consumption.

Considerable effort has been expended within ITT to define and develop technologies that can meet the specific telecommunication system requirements (e.g. metering tone level) of the analog

line circuit. This has led to three main advanced technologies being used:

- high voltage technology using dielectric isolation
- 70 V bipolar and 15 V CMOS combined processing
- 3 μm CMOS technology for low voltage digital and analog circuits.

These technologies have been used in the line circuit design so that it is fully electronic with solid state switches. Excellent transmission performance has been achieved by using digital hybrid techniques.

The line circuit functions are provided by a small number of LSI circuits. These so-called BORSCHT functions – battery feed, overvoltage protection, ringing, supervision, coding and decoding (codec function), hybrid for 2-wire to 4-wire conversion, and testing – are fundamental to any digital exchange. In addition the line circuit provides a range of telephony features that are able to meet the requirements of administrations throughout the world.

The line circuit meets or exceeds the recommendations on transmission and noise performance for digital terminals as specified in CCITT Recommendations G.712 and Q.517.

Design Approach

In order to fulfill the wide range of requirements encountered in countries throughout the world, the design allows

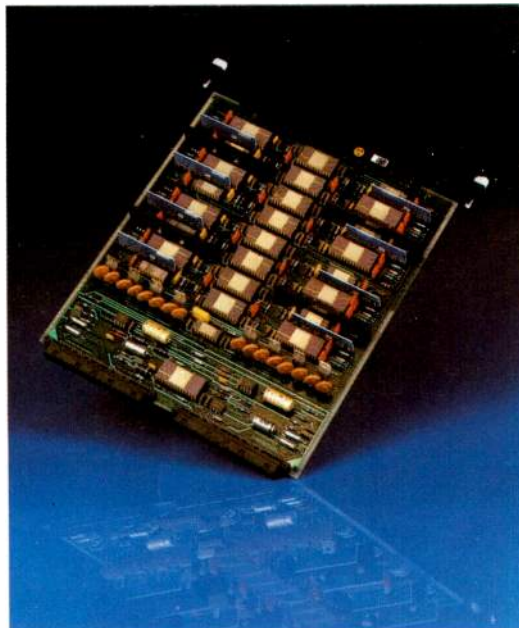

Analog line circuit board.

Figure 1
Block schematic of the System 12 analog line circuit.

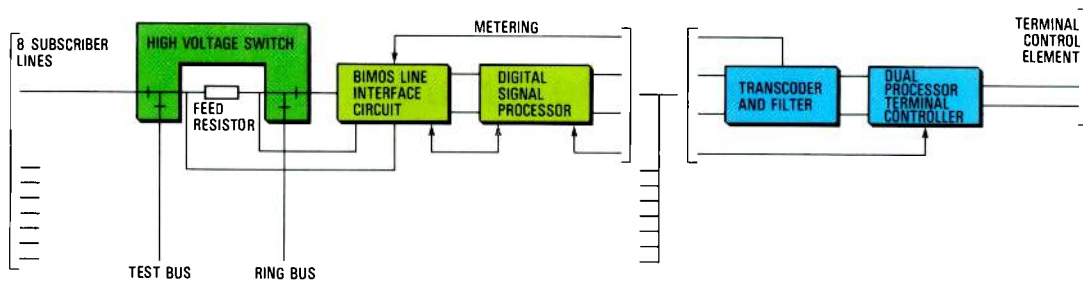

considerable flexibility in choosing important parameters. Both AC and DC feedback loops are used so that various impedance requirements and DC feed characteristics can be realized either by a simple choice of components or under software control. Transmission levels are settable by software in coarse and fine steps. Similarly, hit-timing (debouncing time) on hook switch detection is software selectable, enabling it to be set to meet various telephony requirements. In addition, the terminal balance networks can be chosen to meet particular needs.

Analog Line Circuit

Figure 1 is a block diagram of the analog line circuit; it emphasizes the serial bus approach for sharing transmission and control over several lines. Each analog line circuit consists of three functional units; in addition, two common units are equipped per eight line circuits (i.e. on each line circuit board). The functional units for each line circuit are:

- High voltage solid state switch unit which provides access to the ringing and test bus.
- BLIC (BIMOS line interface circuit), which controls the DC loop gain thereby determining the synthesized DC feed resistance. It also controls the AC loop gain and thus the AC impedance of the line circuit.
- Digital signal processor which controls the gain, terminal balance return loss,

filters, and codec functions. As digital techniques are inherently precise and stable, the design requirements on the analog functions can be relaxed.

The two functional units per eight line circuits are:

- Transcoder and filter, which includes the metering tone function as well as the transcoding function. Transformation from the linear coding in the digital signal processor to the required μ - or A-law encoding is performed on a time-shared basis.
- DPTC (dual processor terminal controller) which provides the PCM bus interface and control functions.

A feed resistor is provided per speech wire for AC and DC impedance synthesis and for subscriber line supervision. The voltage drop across these feed resistors is continuously controlled by the BLIC. The AC and DC feedback loops for impedance synthesis are within the BLIC, separating the DC and AC loops. The feed resistor and the resistive dividers for line supervision are realized as a thick film hybrid circuit to achieve the required accuracy and stability.

Functions and Technology

High Voltage Switch

This integrated circuit connects the subscriber line to the ringing bus, test bus, or line circuit. In addition it can connect the test bus to the line circuit and isolate the subscriber line.

The major functional parts of this 8-switch device are shown in Figure 2. A CMOS logic decoder sets the appropriate switch configuration in the various ring, talk, and test states from a 3-bit logical input. This can come either from a TTL or CMOS interface with no direct ground through-connection. Capacitive coupling in the converter ensures full galvanic isolation. The decoder output is

Figure 2
Major functional parts of the high-voltage switch device.

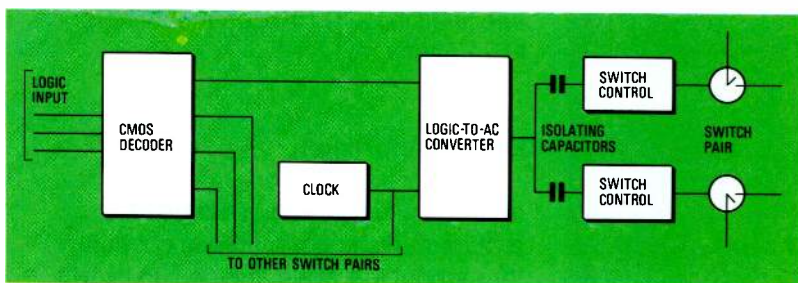

converted into a 1 MHz AC signal which is further transformed into a gate control voltage for the switching device. One completely floating control is provided for each switch.

The high voltage switches are of the TRIMOS type. Initially they exhibit an MOS characteristic, but at a certain current level they switch to a TRIAC characteristic. These switches have a characteristic with a resistance of $6000\ \Omega$ when the voltage between the terminals is less than 0.8 V. Above this voltage (i.e. in the on state) the dynamic resistance falls to only $10\ \Omega$.

In the off state, the switch leakage is a few tens of nanoamperes. Switching from the low ohmic on-state to the high ohmic off-state is possible even when the DC current has to be interrupted. The maximum interruptible current is 250 mA for the ringing switches and 150 mA for the other switches.

BIMOS Line Interface Circuit

The BLIC provides both constant-current feeding and constant-voltage feeding for the subscriber line. AC and DC impedance synthesis loops are designed into the BLIC, which also provides for battery reversal and the control necessary to connect both speech wires to the battery.

All line supervision is done in the BLIC: loop or ground start, ground detection on both speech wires, ring trip, dial pulses, and overcurrent. The BLIC also allows for 12 or 16 kHz metering tone injection, 2-wire to 4-wire conversion, and software driven output signals for off-board functions (e.g. c-wire drive/scan).

Various integrated circuit technologies are used in the BLIC. Conventional bipolar circuitry is used in conjunction with CMOS analog building blocks. Standard static CMOS gates interface with dynamic CMOS logic and bipolar level shifters and dedicated input/output structures. Pure analog signal processing goes hand in hand with sampled data techniques such as switched capacitor structures for the gain and filter stages. All these techniques are necessary to minimize chip size and the number of external components. The result is a chip with an area of $30\ \text{mm}^2$ containing an equivalent of 22 operational amplifiers, 10 comparators, and 200 gates.

Digital Signal Processor

The digital signal processor incorporates a rudimentary analog transhybrid circuit to

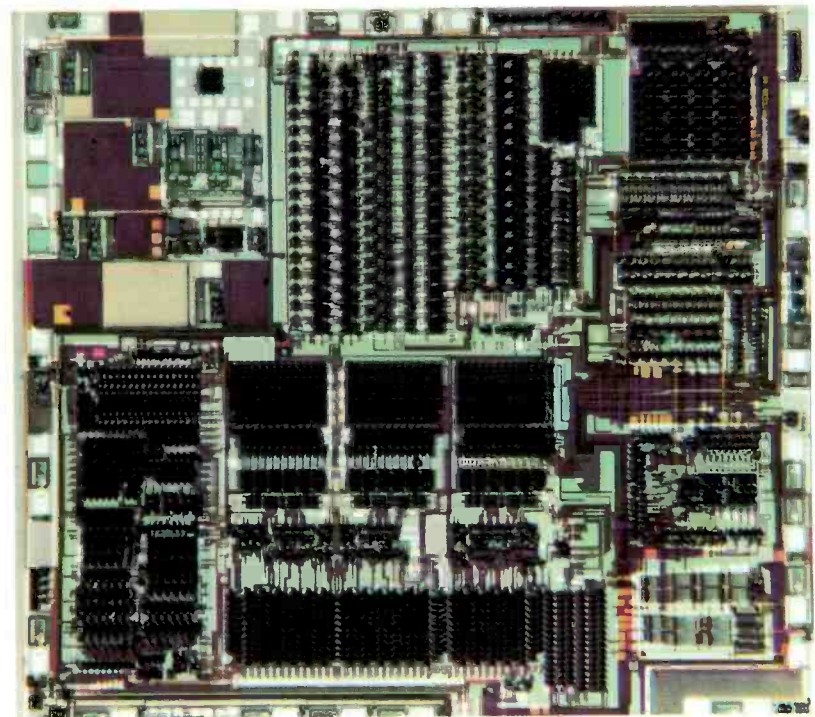
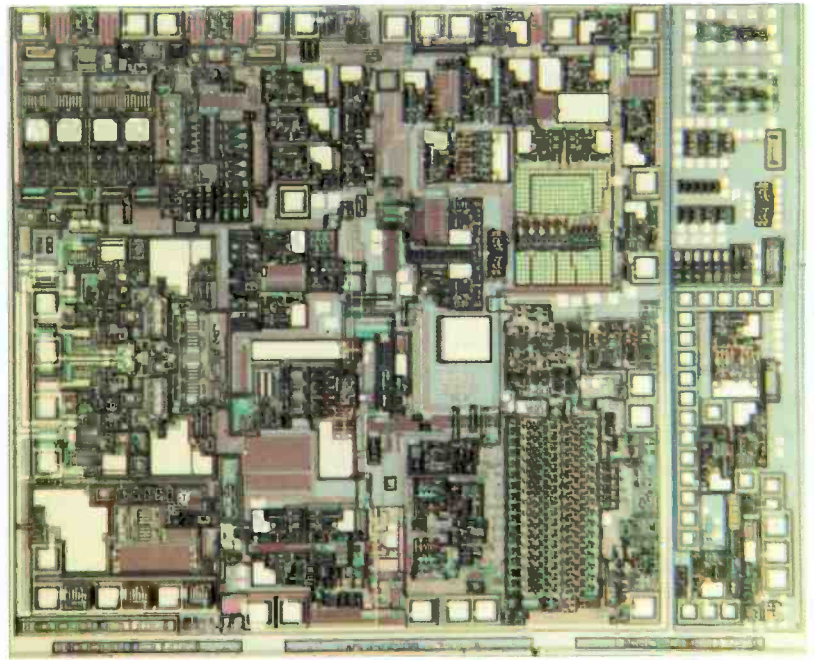

Two LSI chips used in the analog line circuit: BIMOS line interface circuit (top), and digital signal processor.

assure a nominal terminal balance return loss for normal terminations even when the digital hybrid is not active. The hybrid has coefficients that are software selectable; they are set to match customer-defined networks or, as an important alternative, they can be determined by automatic line impedance measurements. Auto-selection allows the terminal balance return loss of the connected line to be customized.

In addition, the digital signal processor contains simple analog filters for analog-to-digital and digital-to-analog conversion.

Digital filters supply the transmission characteristics defined for PCM systems. The processor also provides digital control of loss in both the transmit and receive directions. The loss is set by software selection of the coefficients.

Other important functions of the digital signal processor are the transfer of line control information and the debouncing of line status bits, such as hook switch, ring trip, and overcurrent detection.

The complete integrated circuit, which is realized in $3\ \mu\text{m}$ CMOS n -well technology, measures just 5.3 by 5.8 mm. With a power supply of 10 V for analog functions and 5 V for digital functions, the power consumption is about 135 mW at the full clock frequency of 4 MHz and 40 mW in the power down mode.

Transcoder and Filter

The transcoder and filter converts the linear coded $4\ \text{Mbit s}^{-1}$ output from the digital signal processor to A- or μ -law 8-bit PCM code, as required. The linear code is transmitted in two's complement format, with all bits inverted in order to fill all the idle channel bits with logical high (i.e. "1") obtained by using a pull-up resistor in the transmit direction, which represents "silence". The first three bits of the linear code are the sign and two sign extensions; the last bit is used for rounding only.

The PCM interface has 32 channels each with eight bits. The companding law is selected by means of a strap. For the A-law, all even bits are inverted, while for the μ -law all bits except the sign are inverted. Transcoding of all 32 channels, in both the receive and transmit directions, is performed every $125\ \mu\text{s}$.

In telephone communication, a frequently used charging method is to inject a signal containing a 12 or 16 kHz sinewave burst onto the line. This is then detected by a meter at the telephone set. Because line attenuation is high at these frequencies, the metering level has to be quite high relative to the speech level. Injection of the signal burst must not cause any audible clicks. As such high levels complicate the design of the metering path, the generation and shaping of metering signals is relegated to a common point in the transcoder and filter.

To achieve low power consumption and minimize chip area, all the transcoder and filter circuitry is implemented in fully dynamic CMOS technology. The chip, which has a total area of $9.7\ \text{mm}^2$, is housed in a 16-pin dual-in-line ceramic package.

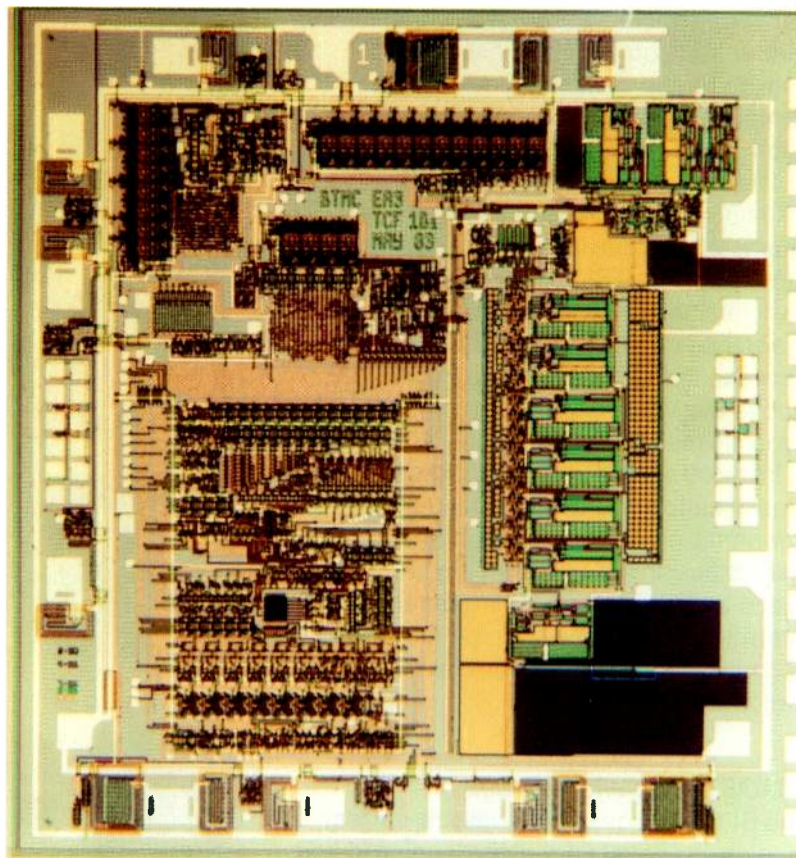

Transcoder and filter chip used in the analog line circuit.

Dual Processor Terminal Controller

The DPTC acts as the interface between the line circuit and the associated TCE, and thus to the System 12 digital switching network. The DPTC provides access to two PCM links. One of these links is connected to the TCE associated with the terminal, while the other is connected to the TCE of a "paired terminal". In the event of a TCE failure, or in order to load new software, one TCE can take over control of the line circuits associated with both terminals in the pair.

Each 4 MHz PCM stream consists of 32 channels of 16 bits at the standard 8 kHz frame rate. Channel 0 normally contains synchronization code and channel 16 command information. System 12 is designed so that the TCE (associated with 128 lines) can insert commands into channel 16 and receive line circuit information on the returned channel 16.

High speed parallel processing and highly efficient data handling are reflected in an internal multibus architecture. An analog phase locked loop circuit derives the 4 MHz local timing from the asynchronous exchange clocks. Additional dedicated logic was designed into the DPTC to enhance its testability in accordance with ITT's philosophy of "design for testability".

The DPTC contains a 1 kbit dynamic RAM which stores 8-byte control packets on a per-line basis.

A static switching RAM is efficiently addressed in an associative way by a channel number and a port address to set up simplex or duplex links from any serial port channel to any other serial port channel. The associative key of the switching RAM is controlled by the DPTC. A fully optimized dynamic channel allocation scheme (on a per-line basis) minimizes delay through the circuit.

The 22000-transistor DPTC chip is implemented on a 35 mm² silicon area in an advanced two-layer polysilicon, 3 μm *n*-well CMOS technology. The power consumption is only 150 mW.

Line Circuit Board

The high functional integration achieved by using LSIs and the low number of discrete components per line circuit have enabled eight line circuits to be mounted on a standard System 12 board. As a result of the low power consumption per line and the efficient airflow resulting from the low blocking by the components, 1024 line circuits can be housed in a System 12 line rack. The feature set built into the integrated circuits makes it possible to cover different

administration requirements using a single type of analog line circuit board.

Conclusions

Maximum advantage has been taken of technological advances to develop a System 12 analog line circuit that is cost effective, compact, reliable, and has a low power consumption. The generic design and versatility of adaptation to meet various specifications mean that the System 12 analog line circuit is able to satisfy the requirements of administrations worldwide.

Bibliography

- 1 J. M. Danneels, L. Van den Bossche, and L. A. Bienstmann: Monolithic 70 V Bipolar Linedriver IC for PCM SLIC: *Institute of Electrical and Electronics Engineers Journal of Solid State Circuits*, June 1983, volume SC-18, no 3.
- 2 R. Chea: Subscriber Line Interface Circuit with Impedance Synthesizer: *US Patent*, No 4387273, 7 June, 1983.
- 3 R. Chea: Subscriber Line Interface Circuit Utilizing Impedance Synthesizer and Shared Voltage Source for Loop Current Regulation Control: *US Patent*, No 4317963, 3 March, 1983.
- 4 The DSP functions are covered by multiple patents. B.P. Agrawal, K. Shenoj, and L. Chu: *US Patent Nos* 4270026, 4270027, 4272648, and 4302631.
- 5 R. Chea, S. Das, D. C. Upp, J. Cornu, J. Danneels, and J. Taeymans: Telephone Line Circuit and System: *US Patent No* 4456991.

System 12

Analog and Digital Trunk Circuits

The analog and digital trunk circuits are fundamental to any digital switching system. In System 12 these circuits have been designed to be generic so that only a few types of printed board are needed to perform all the functions necessary for interfacing with the wide range of existing trunks.

J. J. van Rij

Nederlandsche Standard Electric Mij BV,
The Hague, Netherlands

P. Wöhr

Standard Elektrik Lorenz AG, Stuttgart,
Federal Republic of Germany

Introduction

Trunk circuits provide the interface between exchanges and all types of transmission media, making them an important part of any switching system in terms of both functions and performance. In a telecommunication network they are used in concentrators and local, toll, and international exchanges. The primary function of the trunk circuits is to interface a switching system to various types of transmission equipment which may use analog low frequency, frequency multiplex, and digital time division multiplex techniques. Because they have to adapt the speech channel and handle interexchange signaling (and line signaling in particular), numerous variants are required for use in existing networks.

An important design objective for System 12 was to meet all the various interface requirements using the minimum of different hardware and software. The modular structure and distributed control architecture of System 12 made it possible to meet all requirements using just two types of trunk module: the analog trunk module and the digital trunk module^{1 to 4}.

As with other important modules, the trunk modules operate in a paired configuration which allows one TCE to take over control of both terminals in the pair in the event of a TCE failure. Two new custom VLSI circuits are being used in the trunk modules for interfacing the trunk circuits with the TCEs in paired modules: the dual

processor terminal controller (used in the analog trunk module) and on-board controller interface (used in the digital trunk module)^{5, 6}.

The analog trunk circuit makes extensive use of custom VLSIs developed for the analog subscriber line circuit⁷. The digital trunk circuit uses an on-board microprocessor and allocated firmware, giving considerable flexibility in adapting the trunk circuit to interface with various signaling systems simply by changing the firmware. As a result of preprocessing being performed by the firmware-driven on-board controller, the software-firmware interface is more standardized, thereby minimizing software development for adaptation to different signaling systems.

Analog Trunk Circuit

The task of the analog trunk circuit is to interface the System 12 digital switching network with the predominantly analog telephone network environment. In practice, therefore, it must work with a wide variety of analog trunk types in terms of traffic handling, incoming and outgoing interexchange signaling, trunk supervision, and analog-to-digital conversion.

To meet these diverse requirements the System 12 analog trunk module can be equipped with trunk circuit boards for 4-wire E & M incoming or outgoing trunks, 2-wire outgoing trunks with loop disconnect, and 2-wire incoming trunks with battery

reversal. These trunk circuits realize and control the telephony, transmission, and interface functions and requirements. Telephony functions consist of battery feeding, line signaling, line signaling control, and interregister signaling. Transmission functions and requirements cover transmit and receive levels, exchange impedance, different losses, frequency attenuation, delay, noise, intermodulation, and distortion. Interface functions include the interface to the digital switching network, transmission interface, digital speech interface, signaling interface, and test interface.

An analog trunk module consists of six trunk circuit printed boards, each equipped with six trunk circuits. A module can be configured with 4-wire trunk circuits, 2-wire outgoing trunk circuits, 2-wire incoming trunk circuits, or a combination of the last two.

Special Signaling Requirements

The signaling function can be divided into two main parts. Line signaling defines the status of the physical line and controls the signals on the line, while interregister signaling covers the interchange of register information between exchanges.

Line signaling is defined as layer 1 of the communication protocol between exchanges. It provides the scan function for signal detection and the drive function for signal generation (see Table 1). Line signaling can be realized as continuous

signaling or in noncontinuous or impulsive forms.

Interregister signaling can be multifrequency or decadic signaling; the latter uses the same components and hybrids as the line signaling. Both signaling principles work in two directions; forward in the direction of the connection setup and backward in the other direction.

The System 12 trunk types are based on continuous signaling (CCITT R2) and a basic set of decadic signaling principles.

Implementation

Trunk circuits are designed using hybrids to meet the transmission requirements. Local adaptation only requires the design of a new hybrid which can then be assembled onto the corresponding printed board.

Figure 1 shows the configuration of the analog trunk circuit which consists of a trunk part and a common part. The transmission interface provides impedance matching, signal level adjustment, and pad insertion to adjust insertion loss in accordance with transmission plan requirements. Software selectable pads are inserted in both directions.

A transformer is provided in the transmission interface for overload protection and for use in phantom circuits with 4-wire trunks. In the case of 2-wire trunks, 2-/4-wire conversion is needed to realize a 4-wire information stream. Analog-to-digital and digital-to-analog conversion are performed by the digital signal processor. The transcoder and filter converts the linear coded output of the digital signal processor to A- or μ -law 8-bit PCM code. The interface is constructed using one digital signal processor per trunk and an integrated circuit transcoder and filter for each trunk printed board (six trunks).

In the transmit direction, analog-to-digital conversion is performed by the sigma-delta modulator. The output goes to the decimation filter which attenuates out-of-band noise and reduces the data rate from 1024 kwords s^{-1} (each one bit long) to 32 kwords s^{-1} (each 16 bits long). Next the decimation filter output goes to the transmit digital filter which carries out spectral shaping and reduces the data rate to 8 kwords s^{-1} (each 21 bits long). Transmit gain control then compensates for gain tolerance in the analog front end and adjusts the signal levels. Gain control reduces the signal word length from 21 bits to 13 bits.

In the receive direction, a reverse process takes place via the receive gain control,

Table 1 — Line signaling functions for different analog trunk types

Trunk type	Line signaling	
	Scan function	Drive function
E & M trunk (bothway)	detection on E lead detection of group-carrier control signal persistency	generation on M lead trunk blocking following a fault or for maintenance splitting function for in-band tones
Outgoing trunk	polarity detection (normal feed, reserve feed, no feed) persistency	loop signaling with loop resistance (low-ohmic, high-ohmic, open)
Incoming trunk	loop detection with loop currents persistency	line feed polarity reversal with/without click suppression blocking function

Figure 1
Analog trunk circuit showing the basic building blocks of the analog trunk board (right) and the functions of the digital signal processor (below).

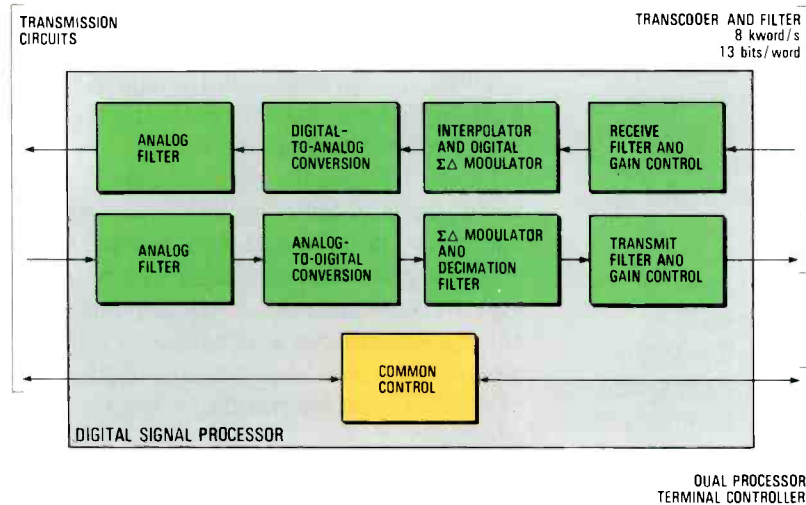
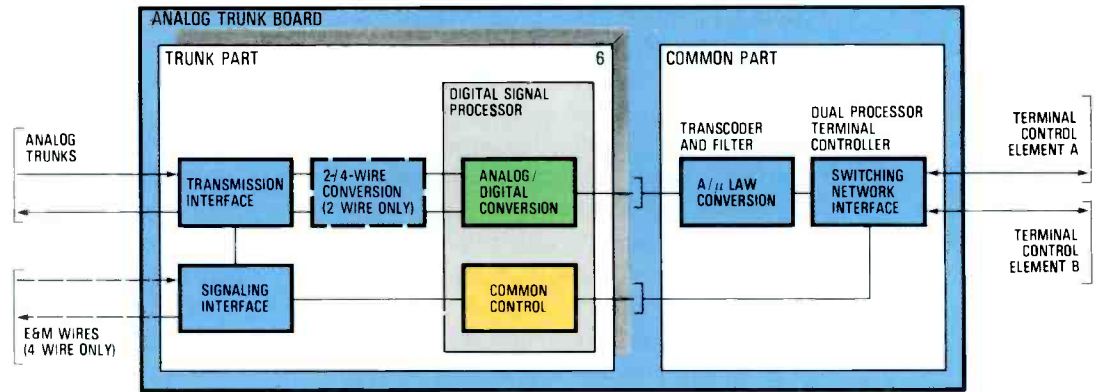

receive digital filter, and interpolator. The digital signal processor also includes a digital hybrid which allows the customer-defined balance networks for 2-wire trunks to be set under software control. In addition, the digital signal processor sets the gain in both the transmit and receive directions. The transcoder translates the 8-bit A- or μ -law PCM of the speech channel into 13-bit linear PCM.

The signaling interface detects and generates signals for the communication protocol. In the case of E & M trunks it scans and drives the E & M wires directly.

Figure 2
Basic configuration of an analog trunk terminal.

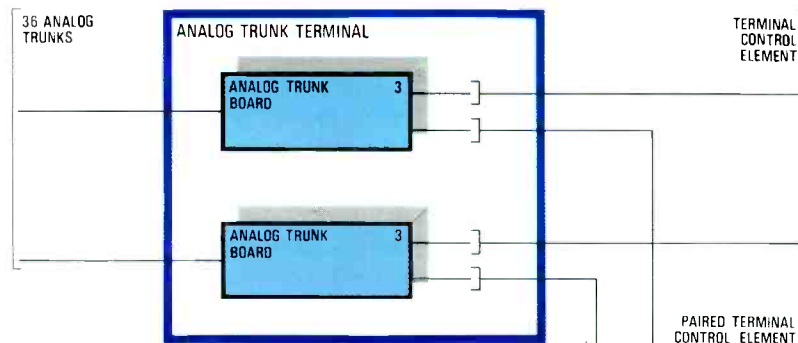

Modules for 2-wire trunks incorporate a connection via the test access bus to the test access unit. In the modules equipped for 4-wire trunks, loop test facilities are integrated in both the transmission interface for the speech wires and in the signaling interface for the E & M wires. In-channel signaling is also implemented for centralized trunk testing.

An analog trunk module consists of six printed boards, each of which serves six trunks, together with the standard TCE configuration used for all System 12 modules (Figure 2). The dual processor terminal controller is connected by a 4 Mbit s^{-1} PCM link to the microprocessor in each TCE of the paired module configuration. All functions are controlled by software using a virtual hardware concept. The device handler system support machine is defined in such a way that it hides the hardware configuration from the programs on a higher level.

The system support machine in the TCE handles a mixture of the three analog trunk types described earlier. Signaling logic is structured in the same way and can support different signaling types at the same time in one program. The performance of the hybrids and the modular software structure minimize customer design engineering.

Digital Trunk Circuit

The System 12 digital trunk circuit connects 2048 kbit s^{-1} 32-channel PCM links to the digital switching network. Thus it must, above all, provide a 32-channel PCM interface that meets CCITT Recommendations in the G. 700 and Q. 500 series, with the exception of the requirements that apply to the switching system itself.

In common with the analog trunk modules, each digital trunk module is paired with a similar module in the standard System 12 architecture so that, in the event of a TCE failure, the remaining TCE can take over control of both terminals.

Functions of the digital trunk terminal include the handling of channel associated signaling in channel 16 (mismatch reporting to the associated TCE and signal sending according to instructions from the TCE), and the handling of CCITT No 7 common channel signaling at level 2. In addition the on-board processor and associated firmware help to perform self-testing of the digital trunk terminal after power-on and at the request of the software.

Implementation

The digital trunk circuit (Figure 3) is constructed on a single printed board. Two custom VLSIs (on-board controller interface and digital trunk logic) and a microprocessor (on-board controller) are the key components of the digital trunk circuit.

Digital trunk logic: This block performs a wide range of functions such as HDB3 conversion, frame synchronization and supervision, jitter and slip control, frame alignment buffer control, and CAS (channel associated signaling) channel 16 multiframe buffer control. It also carries out alarm handling and alarm signaling, as well as in-channel signaling for trunk testing. The digital trunk logic is realized as a semi-custom VLSI circuit using standard cell design.

On-board controller interface: This custom VLSI circuit carries out software controlled channel allocation to and from TCE links and software controlled switching of one PCM channel to the high level data link controller for CCITT No 7 common channel signaling. In addition it provides direct memory access control for message transfer from TCE to RAM, and vice versa, and supervises the TCE links.

Frame alignment RAM: This buffer provides storage for two frames to control frame slips

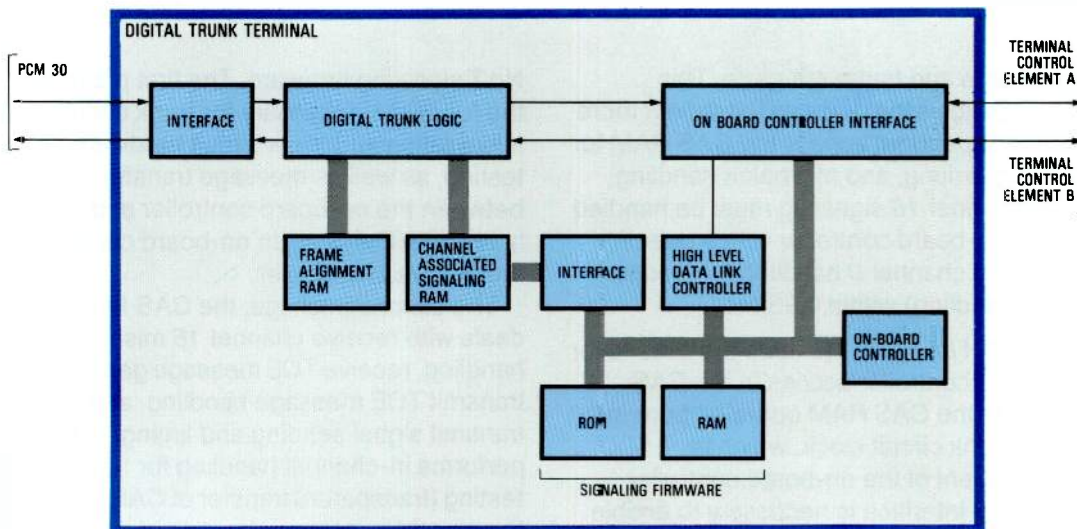

Figure 3
Block schematic of the new digital trunk circuit which occupies a single System 12 printed board.

Memory chips (RAM and ROM or EPROM) are allocated to the on-board controller for program and data storage, and to the digital trunk logic as a frame alignment buffer and channel associated signaling buffer.

Hardware Functions

The functions of the various hardware blocks shown in Figure 3 are as follows:

2 Mbit s⁻¹ interface: Provides the interface to the transmission equipment, including clock extraction from the incoming signal.

(in conjunction with the slip control logic of the digital trunk logic) in cases where there is too large a deviation between the phases of the incoming bit stream and the exchange clock.

CAS RAM: Buffers CAS information in channel 16 in the receive and transmit directions, as well as information in the odd and even frames in channel 0. Access to and from the 2048 kbit s⁻¹ PCM link to other exchanges is provided under the control of the digital trunk logic in accordance with the

Digital trunk circuit printed board.

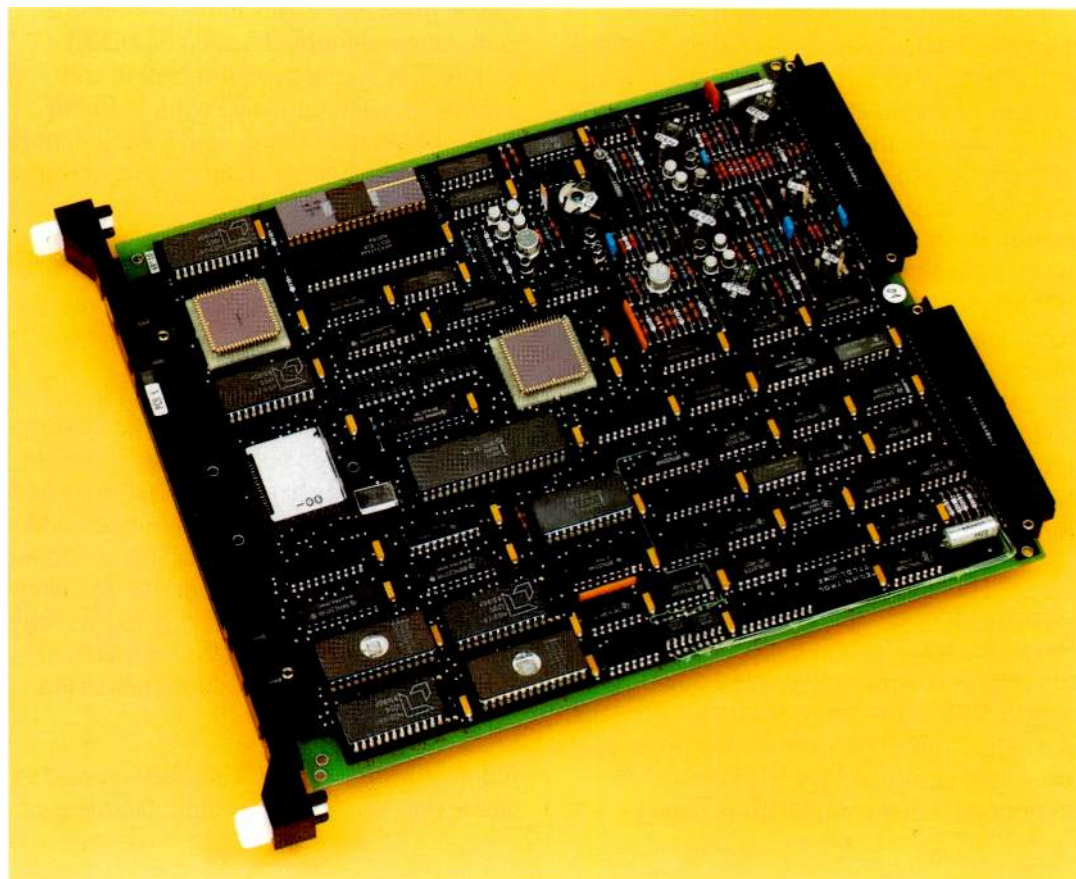

multiframe and frame structure. This method allows the on-board controller more time-independent access the CAS RAM for reading, writing, and mismatch handling. CAS channel 16 signaling must be handled by the on-board controller with a rate of 2 ms, and channel 0 handling (particularly alarm handling) within 0.25 ms.

CAS RAM interface provides the circuits for on-board controller access to the CAS RAM. As the CAS RAM operates from the digital trunk circuit clock, which is independent of the on-board controller clock, the interface is necessary to enable the on-board controller to access the CAS RAM with the correct phases.

High level data link controller: This controller handles part of the CCITT No 7 signaling system level 2, such as indicating the arrival of messages. It communicates with the on-board controller to transfer data to/from the on-board controller. Thus the high level data link controller provides physical access for a PCM channel carrying CCITT No 7 common channel signaling.

Firmware

Three firmware packages contain the general firmware, CAS firmware, and CCITT

No 7 signaling firmware. The first provides the functions necessary for trunk circuit initialization and trunk circuit hardware testing, as well as message transfer between the on-board controller and TCE. In addition it acts as an on-board controller monitor and scheduler.

The second package, the CAS firmware, deals with receive channel 16 mismatch handling, receive TCE message generation, transmit TCE message handling, and transmit signal sending and timing. It also performs in-channel handling for trunk testing (transparent transfer of CAS through the switching network for individual channels).

Third, the CCITT No 7 signaling firmware carries out level 2 handling in cooperation with the high level data link controller, as well as message translation and transfer from TCE to the allocated PCM channel, and vice versa.

Conclusions

The analog and digital trunk circuits have both demonstrated how advances in integrated circuit technology can be

incorporated into the System 12 design without any change in the overall system.

Development of the analog trunk circuit required only a limited effort in view of the common usage of custom designed VLSIs in lines and trunks. The new analog trunk circuit described here occupies a single printed board, with six boards being equipped in an analog trunk module.

The digital trunk circuit connects 2048 kbit s^{-1} 32-channel PCM links to the System 12 digital switching network. By make use of the latest VLSI technology it has been possible to construct the new digital trunk circuit on a single printed board rather than the two required previously. The same hardware is used for both CAS and CCITT No 7 common channel signaling – only the firmware is different. The chosen design approach allows signaling functions to be extended for future digital trunk circuits.

References

- 1 F. Alvarez Casas and F. Casali: ITT 1240 Digital Exchange: Network Planning and Application: *Electrical Communication*, 1981, volume 56, no 2/3, pp 302–314.
- 2 P. Haerle and M. della Bruna: ITT 1240 Digital Exchange: Application to the Toll Network: *Electrical Communication*, 1981, volume 56, no 2/3, pp 235–247.
- 3 R. Bonami, J. M. Cotton, and J. N. Denenberg: ITT 1240 Digital Exchange: Architecture: *Electrical Communication*, 1981, volume 56, no 2/3, pp 126–134.
- 4 J. M. Danneels and A. Vandevelde: System 12: Analog Line Circuit: *Electrical Communication*, 1985, volume 59, no 1/2, pp 43–47 (this issue).
- 5 R. H. Mauger: System 12: Architecture for Change: *Electrical Communication*, 1985, volume 59, no 1/2, pp 35–42 (this issue).
- 6 R. H. Mauger and P. Wöhr: Impact of Advanced Component Technology on HW/SW Interface for Function in a Digital Switching System: *Proceedings of the International Switching Symposium*, 7–11 May 1984, Florence, paper 41A2.
- 7 R. Chea, W. Cochran, J. Danneels, and P. Wöhr: System 12 Line Circuit Technology: *Proceedings of the International Switching Symposium*, 7–11 May 1984, Florence, paper 32A3.

System 12

Dual Switch Port

Advantage has been taken of the latest VLSI technology to integrate two System 12 switch ports onto a single chip. At the same time new features have been added and the device testability enhanced. The new digital switching element, which is based on this dual switch port, remains fully compatible with the previous version.

W. Frank

Standard Elektrik Lorenz AG, Stuttgart,
Federal Republic of Germany

M. C. Rahier

D. Sallaerts
Bell Telephone Manufacturing Company,
Antwerp, Belgium

D. C. Upp

ITT Advanced Technology Center, Shelton,
Connecticut, United States of America

Introduction

The manufacture of electronic systems becomes more cost-effective and performance is improved as the integration level of the semiconductor chips is increased. Reasons for this include the

Microphotograph of the new dual switch port VLSI chip which incorporates around 20000 transistors.

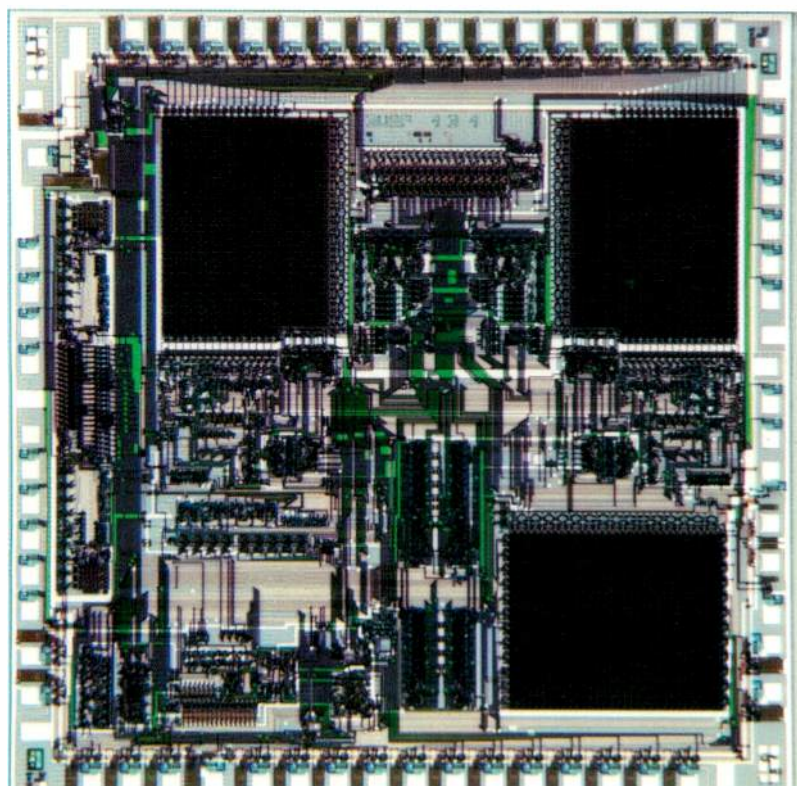

lower number of parts, the need to interconnect fewer devices, and the smaller area required for mounting the integrated circuits. Increases in integration level are made possible by continuous evolution of semiconductor technology towards smaller feature sizes. Hence, it is worthwhile investigating whether existing LSI components can be further integrated.

Such a study has been performed on the switching element of the System 12 Digital Exchange¹. As a typical 10000-line exchange based on the present technology has 3168 switch ports, significant advantages can be expected from halving the number of devices. With this in mind, a dual switch port has been developed.

Switching Element Functions

Figure 1 shows the structure of the switching element with 16 ports connected by a common time division multiplex bus. Each switch port has a bidirectional PCM interface for an incoming and an outgoing 4096 kbit s⁻¹ serial bit stream with 32 channels of 16 bits per frame. A clock circuit selects one of the two 8192 kHz system clock signals (A or B) and provides the ports with 8192 kHz, 4096 kHz, and a local frame reference (8 kHz) for its internal bus operations and outgoing links.

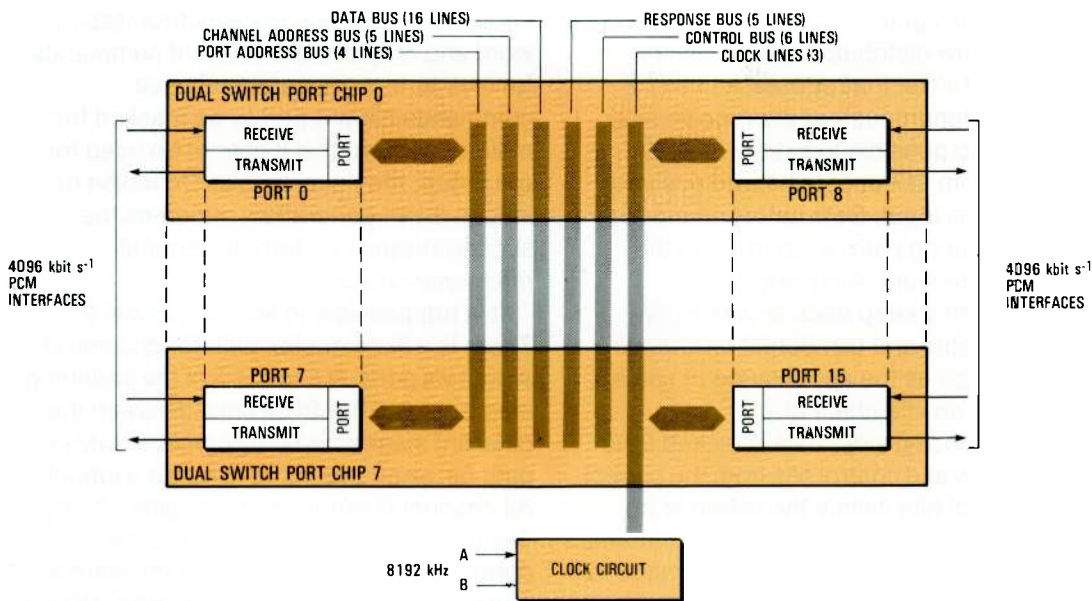

Figure 1
Switching element structure.

Incoming PCM signals have an arbitrary phase relation to the switch port clock, one reason being the physical length of the PCM link. Hence it is first necessary to acquire bit synchronization and frame alignment. Bit synchronization is achieved by detecting the transients ($1 \rightarrow 0$ and $0 \rightarrow 1$) in the incoming PCM bit stream.

Frame alignment is based on the detection of a synchronization pattern in channel 0 of the incoming PCM link. If no synchronization word is detected, a *loss of synchronization* alarm message is launched on the outgoing PCM links of switch ports N and $N+8$. As soon as a synchronization word is detected within the serial bitstream, the beginning of the frame (channel 0) is known.

The following channels are converted to a 16-bit parallel word. The two most significant bits characterize the word format as being idle, select command, spata (speech or data), or escape. When the protocol bits indicate idle, no further operation is performed: the channel is simply not used. When the protocol bits designate the word as being a select command, appropriate action is taken to set up a path. If no free channel is available for setting up a path, a NACK (no acknowledgment) message is sent back to the adjacent port of the preceding switching element. Sending this NACK message back to the source clears the existing path.

If the protocol bits indicate that the word has spata (speech or data) format, then action is taken to transmit that word over the existing path using two switch ports and the TDM bus. Each receive side of the switch

ports has access to the TDM bus during a fixed bus cycle per channel time of $3.9 \mu\text{s}$ (32 times per frame). A bus cycle is split into four phases P , D , W , and R (Figure 2), each with a timeslot of 244 ns. The bus cycles at ports 0 to 15 are staggered by one timeslot to avoid overlapping on the TDM bus.

During phase P a port address is sent from a receive side of the dual switch port on the port bus. Each transmit side compares this address with its own port identity to check whether it should process the information on the active buses in phase P and phase D . Subsequently the information is processed by the selected transmit side in phase W ; an acknowledgment may be returned during phase R . The port identity, which is determined by external strap inputs of the dual switch port, defines the timeslot assignment to each receive side (Figure 2).

Figure 2
Timing in the System 12 digital switching element.

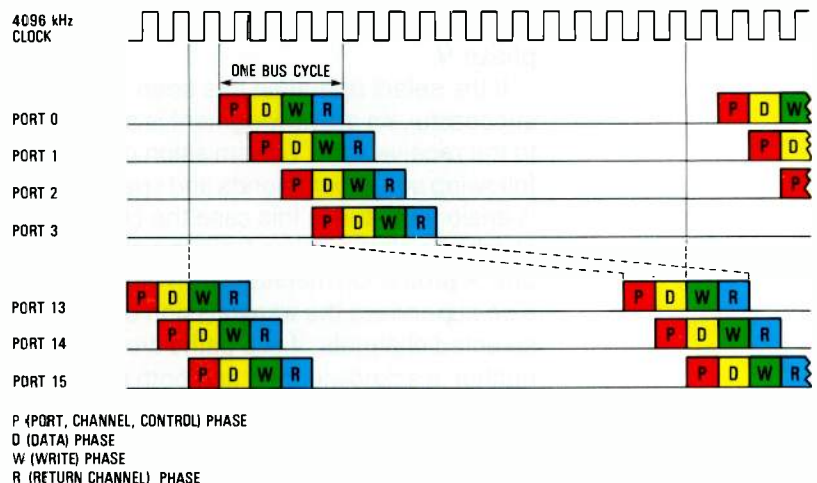

Some intelligence is built into the switch ports to allow distributed control via the serial PCM links. Port addresses can be chosen autonomously at the receive side, but it is also possible to extract the port address from select commands received via the serial input. Both selection modes are used during path setup through the switching network. All receive sides independently keep track of their PCM channel status and can detect erroneous actions, such as the appearance of spata protocol in an idle channel.

At the transmit side, data is picked from the data bus and control bits from the control bus. Control bits dictate the action to be performed. In the case of a select command, a channel is assigned and a check made to determine whether it is free. The channel

separately; it carries the synchronization word and may contain different commands for maintenance purposes. These commands allow a port to be masked for maintenance so that it cannot be used for call setup; they may be used to inhibit or invoke alarm generation, suppress the synchronization pattern, or request maintenance status.

It is not possible to select channel 0. There is a fixed duplex path for channel 0 words via ports N and $N+8$ of the switching elements and the PCM links between the different stages. Such a complete duplex path between two TCEs is called a tunnel. All channel 0 words are propagated along this tunnel towards a TCE where the commands are generated and the alarms and responses interpreted. Channel 16 also has a special function: it carries NACK information to the adjacent port of the preceding stage of the switching network and so, stage by stage, back to the TCE.

Figure 3
Block schematic of the receive side of the dual switch port.

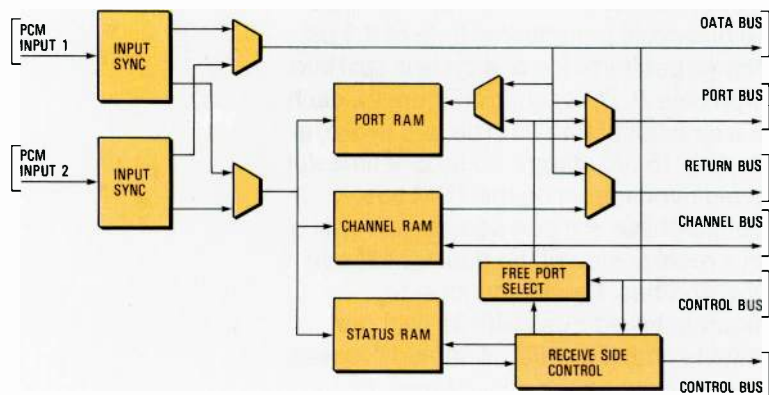

is determined by the type of select command. If it is a free select, a channel number is chosen by the transmit side. In the case of a specific select command, the channel number is put on the channel bus by the originating receive side, and the transmit side selects this channel. In both cases, the address of the selected channel is returned to the receive side during phase R .

If the select operation has been successful, an acknowledgment is sent back to the receive side. Transmission of the following select commands and spata words is analogous, but in this case the channel number is always taken from the channel bus. A protection mechanism in the transmit side supervises the transmission on selected channels: if two paths cross, neither is acknowledged and both paths are cleared down. Another function of the transmit side is to process the contents of channel 0. This channel is handled

Dual Switch Port Structure

The block schematics of both the single and dual switch ports are very similar as the two versions are functionally equivalent. The major functional aspects of this device are explained below, and the differences from the single switch port are highlighted.

Receive Side

Figure 3 is a block diagram of the receive side of the dual switch port. Two PCM input streams are, after synchronization and serial-to-parallel conversion, interleaved on an internal bus (eight clock periods each). The content of the internal bus can be interpreted as idle, data, or command. If it is data, the 16-bit word is placed on the TDM bus, together with a 4-bit port address (stored in the port RAM) and a 5-bit channel address (stored in the channel RAM). These addresses determine the destination of the data word. In addition, an appropriate control word is sent on the bus.

When a path setup command is detected, the 16-bit word is processed by the receive control part. The select code is interpreted, and if port and channel addresses are given they are extracted from the corresponding fields in the select command. It is also possible for the port address to be freely chosen by the receive side hardware using the free port select circuits that keep track of the availability of all the transmit ports on one switching element. The chosen port

and channel addresses are put on the respective buses together with a control word. The port address is also stored in the port RAM for use during the transmission of subsequent spata words. The channel RAM is loaded with the address as it is returned from the destination transmit side. The function of the status RAM is to keep track of PCM channel status changes on the PCM input line.

While there is no functional difference between the receive sides of the single and dual switch ports (i.e. all commands are interpreted and executed in exactly the same way), there is a significant implementation difference arising from the fact that receive side operations can be executed in seven clock cycles, although 16 clock cycles are available. Thus it is possible to treat two receive side channels within the 16 available clock cycles, allowing the two receive sides of the dual switch port to be multiplexed onto one internal bus. So that the processing time for both receive sides is identical, the 16 clock cycles are split into two groups of eight. As one receive side is processed eight clock cycles later than the other, their bus cycles (P , D , W , R) must be separated by eight clock cycles. This is one reason for grouping the switch ports with identities N and $N+8$ into one dual switch port. The strap for the most significant bit of the port address can thus be omitted or be replaced by an internal signal that distinguishes port N from port $N+8$.

Not all parts of the receive sides may or can be multiplexed. The input synchronization circuits must be completely independent as there is no relation between the PCM signals. All the RAM section has to be separate for the same reason. The other parts of the receive sides are common to both.

As a result several hundred transistors have been saved, thereby reducing power consumption and chip area (approximately 3 mm^2).

Transmit Side

A block diagram of the transmit side is shown in Figure 4. Both transmit sides of a dual switch port are identical. Each transmit side has an address (which differs by 8) that is used to detect whether or not it is to process data on the TDM bus. If the port number on the port bus equals the address of a specific transmit side, data on the buses is accepted. Data on the control bus is evaluated to determine the action to be

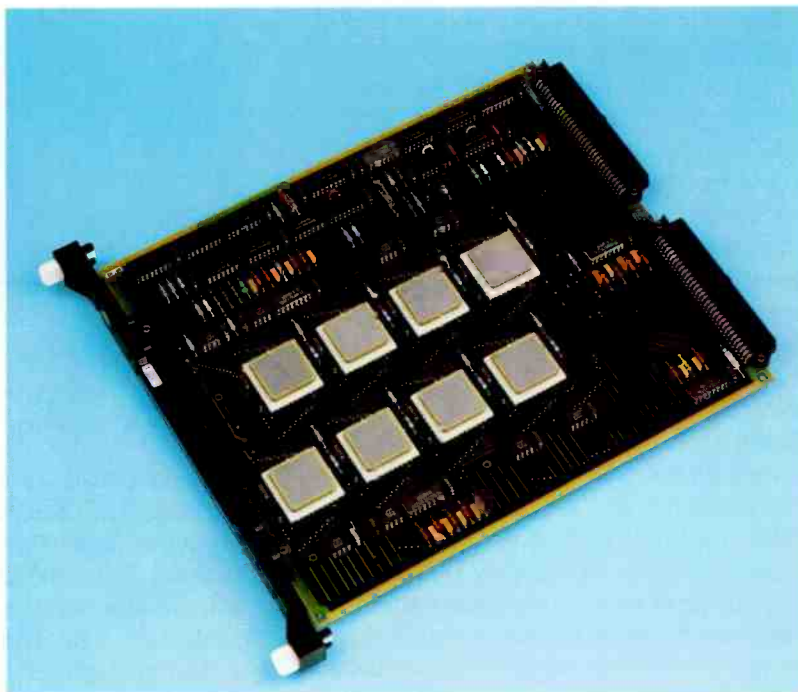

New System 12 digital switching element printed board based on the dual switch port.

taken. If a select command is to be executed, the status RAM is updated and a channel is chosen. This can be done by free search or it can be a specific channel, in which case it is determined by the channel address on the channel bus. In both cases, the channel address is returned to the initiating receive side via the response bus.

Selection of a free channel is performed by a first free select circuit which keeps a stack of three channels that can be chosen for path setup. The stack is updated so as to minimize delay between acceptance of the channel from the TDM bus and outputting of the data via the PCM link. If a spata word is taken from the TDM bus, it is stored in the data RAM at a location defined by the channel address on the channel bus. Channels are read sequentially from the data RAM and output serially on the PCM line.

Figure 4 Block schematic of the transmit side of the dual switch port.

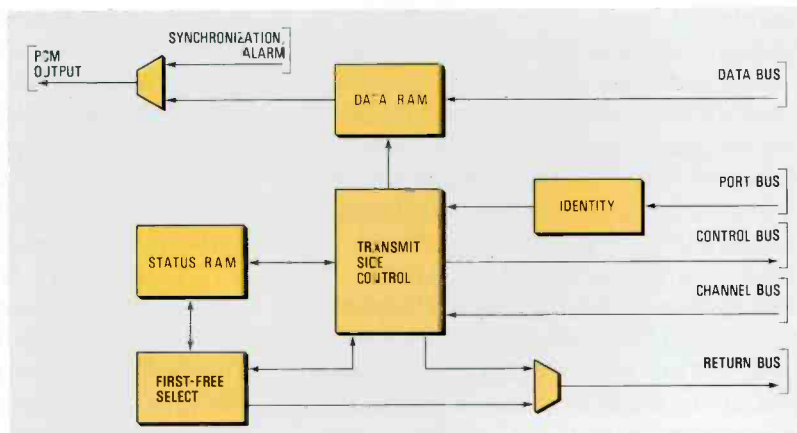

Transmit control checks whether two paths are crossing, whether path search is ended by a NACK, or whether a channel is cleared. It also launches alarms (loss of synchronization, write activity error), executes channel 0 commands, and inserts the synchronization code. Should the adjacent receive side (i.e. the side accepting the PCM bitstream) lose synchronization, information from the data RAM is suppressed. Only protocol bits and the synchronization pattern in channel 0 are sent. This ensures correct synchronization by the adjacent receive side.

As both transmit sides can be addressed independently by data coming from the TDM bus, they can be involved in different processes at the same time. This makes it impossible to share a significant amount of hardware between the two transmit sides. However, some savings have been possible in the so-called bypath circuit: as switch ports N and $N+8$ are on the same chip, there is no need to provide an external bypath connection. Parallel-to-serial conversion has also been omitted as the bypath bits are more easily exchanged directly between the switch ports.

Compared with the single switch port, the command set has been enhanced with the clock interrogate command for channel 0. This allows the software to check whether both system clocks in a specific switching element are operational or faulty, and which one is currently selected. Also a *power on reset* circuit has been included. After power-up, all dual switch ports in a switching element are in a state that does not allow them to accept path select commands or send any alarms before they have been correctly initialized by the system software.

With the exception of the above changes, there is no functional difference between the transmit sides of the dual and single switch ports.

Testability Logic

Testing increasingly complex VLSI circuits is a real challenge. Dedicated circuitry has therefore been included on the dual switch port to enhance circuit testability. It consists of a set of 16 shift registers which can be connected to the switch port circuits under hardware control. It is then possible to access internal points that could not otherwise be monitored. Four of these test registers are provided in each of the receive sides, and four in each of the transmit sides. Data can be shifted in these registers and subsequently written to a specific location.

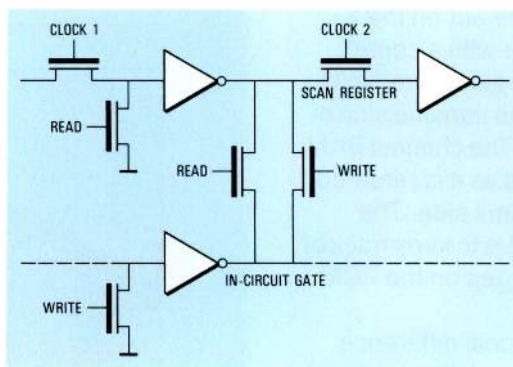

Figure 5
Typical hardware circuit included on the chip to improve testability of the dual switch port.

A typical circuit is shown in Figure 5. On the other hand it is possible to retrieve data from that same location, and shift it out for analysis. Data shifted in and the test register used for the test can be independently controlled. A third set of test inputs (read and write) makes it possible to choose when a specific test action is to be performed.

Data can be exchanged between the test logic and the circuit by connecting the in-circuit gate and the shift register gate together in a wired AND configuration. Simultaneously, the gate that is to be written is forced to logic 1 condition as its input is tied to ground. The additional hardware occupies about 5% of the total chip area. Seven additional input/output connections are necessary to make use of all test registers. When the VLSI device is mounted on the printed board, the test registers are not used: the testability circuit is disabled and in a low power state. An additional test feature is the possibility of communication between ports N and $N+8$ without using the input/output structures.

Dual Switch Port Characteristics

The dual switch port VLSI circuit is realized in $3\ \mu\text{m}$ single polysilicon NMOS technology. Die size is $6.08\ \text{mm} \times 6.16\ \text{mm}$, giving an area of about $37\ \text{mm}^2$. There are around 20 000 transistors in the complete circuit, including those provided to improve testability. The devices operate on a single 5 V supply in contrast to the single switch port chip which needs three supplies (+5 V, +12 V, and -3 V). The +12 V was mainly used to power the input/output circuitry while the -3 V was for substrate biasing. The dual switch port dissipates about 650 mW, with a maximum of 900 mW. It is packaged in a 68-pin leadless chip carrier.

New Switching Element Printed Board

The reduction from 16 single ports to eight dual switch ports in a switching element has considerably simplified the layout of the new printed board which has been developed in a four-layer technology. Lines of the common TDM bus are much shorter, thus reducing the capacitive load. Power dissipation of the board has been reduced by a factor of about 1.7.

The 68-pin leadless chip carrier, which replaces the 64-pin leaded chip carrier, uses a new chip carrier interconnection element called a *pin frame*. This injection-molded glass-reinforced polyester frame with embedded interconnection pins^{2,3,4} enables leadless ceramic chip carriers to be reliably, simply, and inexpensively attached to standard glass epoxy printed boards.

The new switching element printed board with dual switch ports is fully compatible (upward compatible) with the present switching element printed board, and can therefore be used to replace the earlier type. The additional clock interrogate command can be used in switching

networks equipped with the new switching element.

Conclusions

A dual switch port VLSI circuit has been developed in 3 μm NMOS technology which performs the same functions as the single switch port, provides new features, and enhances testability. A new switching element printed board for System 12 has been constructed using this dual switch port.

References

- 1 J. M. Cotton, K. Giesken, A. Lawrence, and D. C. Upp: ITT 1240 Digital Exchange: Digital Switching Network: *Electrical Communication*, 1981, volume 56, no 2/3, pp 148–160.
- 2 W. Hartl: "Pin Frame" Provides Economic Alternative to Surface- and Socket-mounting of Leadless Chip Carrier.
- 3 J. Lyman: Low-cost Plastic Frame Reliably Mates Leadless Chip Carrier and Printed-circuit Board: *Electronics*, December 15, 1983, pp 50–51.
- 4 W. Hartl: Chip Carrier Socket Provides Integral Soldered Connections: *Electronic Packaging and Production*, March 1984, pp 140–141.

System 12

Software

Many of the major features of the System 12 Digital Exchange depend entirely on the software which must support the distributed hardware architecture and allow changes to be introduced without major disruption. The concepts of virtual machines, finite message machines, and system support machines have made it possible to achieve these goals. In addition, a distributed database has been designed.

G. Becker

Standard Elektrik Lorenz AG, Stuttgart,
Federal Republic of Germany

R. S. Chiapparoli

R. Schaaf

ITT Advanced Technology Center, Shelton,
Connecticut, United States of America

C. Vander Straeten

Bell Telephone Manufacturing Company,
Antwerp, Belgium

Introduction

In System 12, as in many telecommunication products, programming represents the major part of the development and maintenance effort. If this activity is to meet the needs of administrations and the manufacturer, a number of basic requirements must be satisfied: software development and maintenance must be cost-effective, the product should be easily

adaptable to changing requirements, and naturally the logic should be correct and complete in terms of both functionality and performance. These objectives can only be achieved if the product is developed on a sound conceptual basis.

The structure of the System 12 software, which is based primarily on the virtual machine concept, software building blocks, and leading edge programming techniques for database management, has made it possible to meet all these objectives.

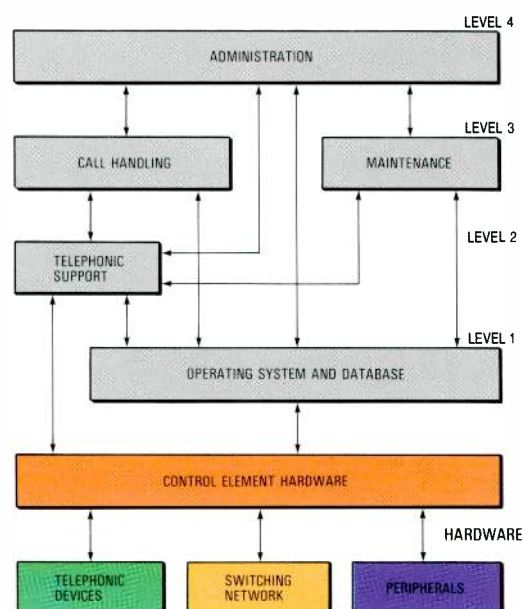

Figure 1
Structuring of software functions according to the virtual machine concept.

Virtual Machine Concept

Virtual machines are a well known software design technique that makes it possible to structure the functions of a system in such a way that programs on higher levels do not need to know how functions are implemented on lower levels.

Logical View of Virtual Machine Concept

The structuring of functions into a nesting of several levels of virtual machines was applied early in the System 12 software design. Figure 1 shows the arrangement of System 12 software into virtual machines.

Closest to the hardware is level 1 software such as the operating system,

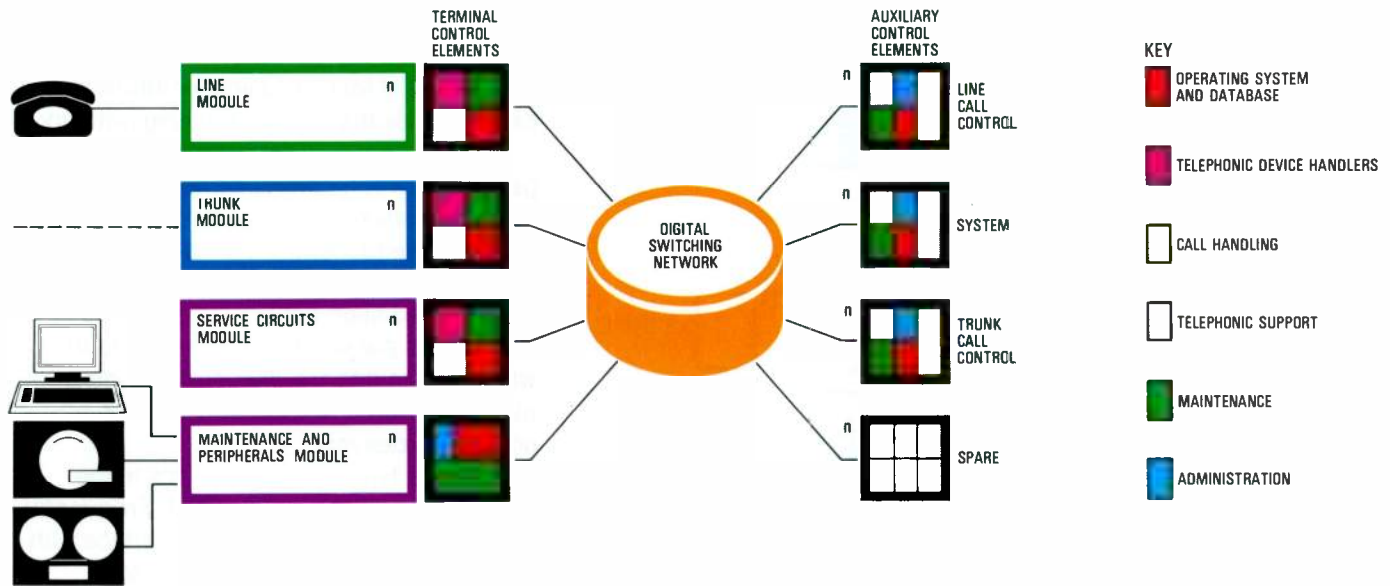

Figure 2
Typical allocation of software functions to control elements. It should be noted that the figure shows a particular exchange configuration.

network handler, device handlers, and database. Level 2 supports primitive telephonic functions, including conversion of signals into telephonic messages and vice versa, trunk resource management, and charging functions. Application functions such as call handling are performed at level 3; a virtual machine is allocated to execute telephonic functions directly. Call handling functions on level 3 generate data for administration. The administration programs on level 4 work only on this data, and are thus completely separate from the call handling programs.

Implementation of this concept restricts the influence of hardware changes to small areas of the virtual machine. This is of great importance for switching systems, since technological advances in the semiconductor industry result in frequent changes. The operating system and network handler isolate the application FMMs (finite message machines) from most nontelephonic hardware properties. Thus, for example, changes to processor hardware only require the level 1 programs to be modified, and do not affect the application programs.

During development, these levels of problem definition are converted into CHILL programs and packaged into FMMs with the aid of an interface context library that ensures the communication standards of System 12. As levels 2 to 4 are transparent to physical machine properties, FMMs at these levels can be freely allocated between the many microprocessor-based control elements of System 12's distributed design, taking into consideration both performance and economy.

Physical View of Virtual Machine Concept

Figure 2 shows the various types of control element, together with their resident software functions. In System 12, not only the call handling functions are distributed, but also major parts of the maintenance, administration, operating system, network handler, and database software.

The flexibility of the FMM concept allows software to be allocated in various ways to suit the requirements of particular exchange configurations. Furthermore, during detailed design and coding it is unnecessary for designers to know how the software will ultimately be allocated. This information is only needed when the software package is being produced for a particular exchange type in terms of size and market requirements. For example, in a small exchange functions can be concentrated in a few types of control element. In contrast, in a large exchange these functions can be distributed over a greater number of control element types in order to meet the performance requirements in the optimal way.

Building Blocks for System 12 Software

Figure 3 shows the three types of physical building block for the software: operating system, FMMs for the application programs, and SSMs (system support machines) to support the FMMs. Communication between FMMs is by messages; all other communication within the system is by procedure calls to the SSMs and the operating system.

Figure 3
Software building blocks.

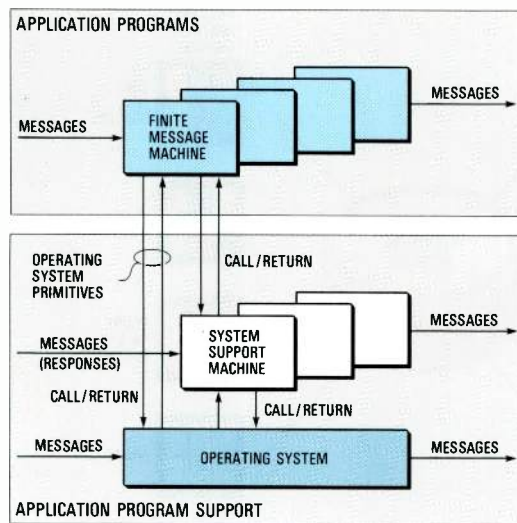

The operating system provides basic support for executing the application programs by performing such functions as intermodule communication, process scheduling and timing, access to peripheral units, and autonomous recovery.

FMMs are based on a concept that ensures a highly modular, flexible, and well-structured software design. Each FMM is defined as a unique entity: this means that the internal structure of a particular FMM need not be known to designers of other FMMs. The interface between an FMM and the rest of the software system is defined by a set of messages received and sent. The functional behavior of each FMM is defined completely by the sequence of messages it receives, and the messages that it sends in response (Figure 4).

The FMM concept allows software functions to be distributed over a large number of control elements. As already explained, this distribution can be fixed as late as during the building of the software package for a specific exchange. At this time a set of distribution tables is populated which map the selected layout of software components in the exchange.

The sending of messages between FMMs is controlled by a message handler, which is part of the operating system. It resides in all

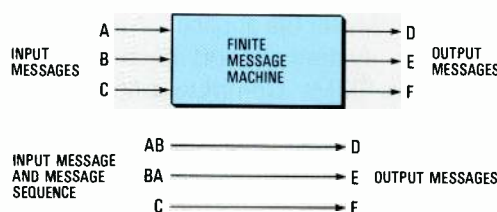

Figure 4
Finite message machine concept.

control elements of the distributed control system. Each control element is equipped with a serial 4 MHz data link for information exchange via the digital switching network.

Figure 5 shows how messages are passed between control elements. The message handler consults its message routing table to identify the destination of a message. If the message routing table indicates a distant control element, the message is passed to the network handler which routes it to the destination control element where the message handler completes delivery.

The third type of building block in the System 12 software is the SSM. Frequently used software modules which interface with hardware are implemented as SSMs (Figure 6). An SSM consists of one or more procedures which are invoked by procedure calls. For example, the following procedures may be contained within one SSM: interface procedures, clock-driven and interrupt-driven procedures, and event handlers. SSM procedures can share common data which is accessed via monitors that ensure controlled access to the data. These procedures are called by a mechanism, supported by the operating system, using software interrupts. Thus SSMs need not be linked off-line to the FMMs that call them.

Operating System

Whereas FMMs are defined to be driven by messages and represent a process definition, SSMs represent implementation-defined built-in routines to support hardware-related control functions. The System 12 operating system supports this modularity by providing an environment in which FMMs and SSMs can coexist and by providing mechanisms that enable the system to be driven through messages.

The System 12 operating system is a distributed real-time multitasking system. Each control element is considered as a self-contained unit, and therefore contains basically the same operating system, which provides the following features:

- support for the concurrent operation of many instances of process (FMM) definitions running in the same control element
- mechanism to allow concurrent process instances to communicate via messages (including transfer to a remote control element where necessary)

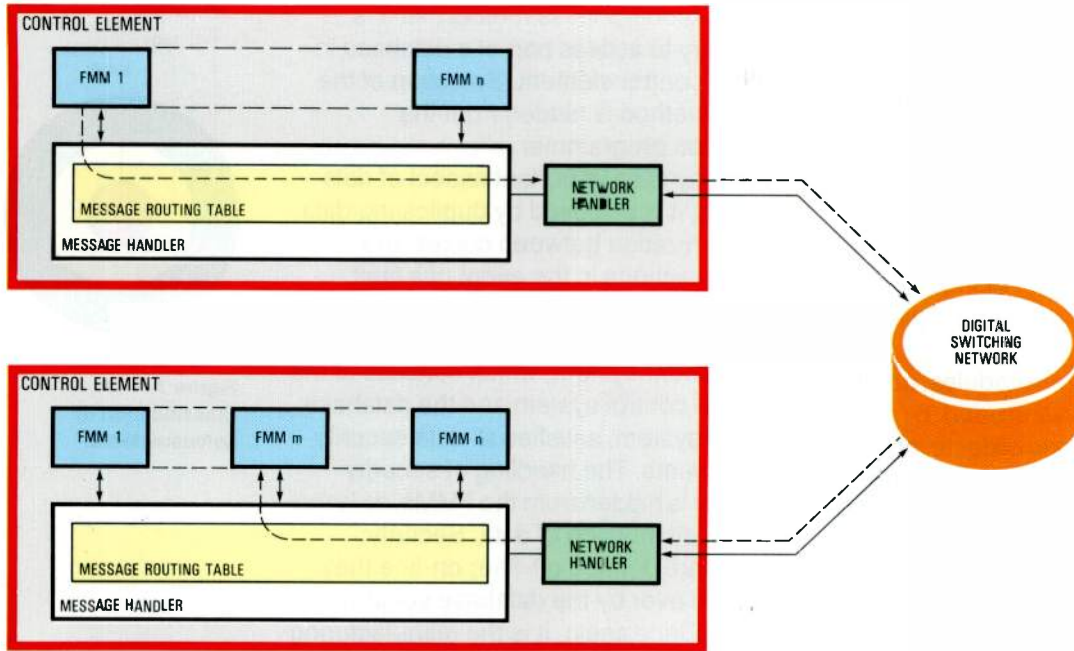

Figure 5
Passage of messages
between control
elements.

- range of timing facilities
- miscellaneous support functions, such as report of real-time usage, management of sanity timer, memory management, and recovery from hardware and software faults.

System 12 is a completely distributed system from a hardware viewpoint. Its use of an intelligent digital switching network and microprocessor-based terminal modules has been the key to building a powerful distributed system. Each terminal module includes a terminal control element (consisting of a terminal interface, microprocessor, and memory) which controls the terminal hardware. This approach has resulted in a flexible and expandable network.

The System 12 operating system has taken advantage of the distributed architecture by providing a mechanism which conforms to the needs of the specialized terminal hardware, whether it be telephone lines and trunks, ISDN, input/output, or just simple data reference control elements.

The operating system can configure itself at build time and run time to provide the features necessary to support user application programs and system hardware features. This approach eliminates unnecessary storage of code and data in control elements and supports only those features specific to the included user application code. Thus it differs from centralized design which builds operating systems with all the features in one software

package. The System 12 approach is designed to allow the system to change and conform to future product lines without burdening all control elements with all past and future features.

The operating system is packaged in the same way as user applications (FMMs and SSMS). Software modules for operating system support functions and the terminal interface subsystem are present in all control elements.

Operating system support includes the following facilities:

- message handler which routes the user communication
- process manager which provides the scheduling algorithms

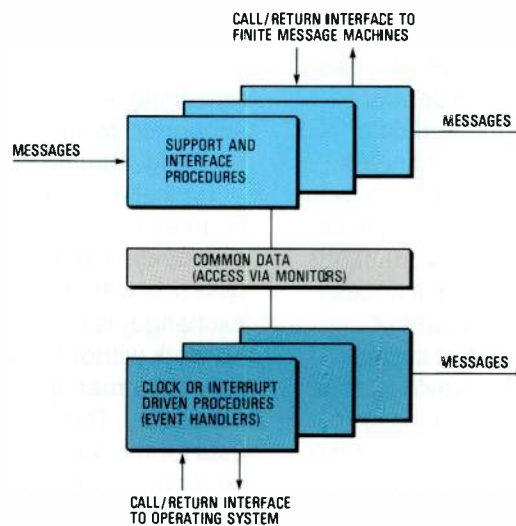

Figure 6
Basic structure of a
system support
machine.

- buffer manager which provides the resource allocation scheme
- time services which provide the system timing mechanism
- overlay manager which supervises nonresident user application software.

The terminal interface subsystem provides the basic mechanism for interfacing the control element with the intelligent digital switching network.

In contrast to these kernel modules, other software modules are only included in particular control elements in order to meet, for example, specific hardware needs and overload control features.

A method for allowing software modules to be added or removed is required in the kernel. The method for implementing user level FMMs and SSMs is via the FMM and SSM control blocks, which describe all relevant attributes of the module to the operating system. Using this method, the kernel is informed of the software modules within a processor. This method is also used for the removable parts of the operating system.

Data Handling

As the distributed control principle leads to data being distributed to the various control elements, a distributed relational database and a corresponding database control system have been developed for System 12. Each control element contains a section of the database, and a database control system which controls access to and updating of data. To ensure flexibility and prevent the same data from being stored in more than one control element, the database control system hides the physical location and implementation details of the data from the programmer who need not know at coding time which control element will house the requested data.

An FMM in a control element handles communication with the database (i.e. with all sections of the database, residing in all control elements) using simple commands such as *get* and *modify*. Database access mechanisms also reside in all control elements. The database control system supports these requests by providing local or global access to data. Local access means that data can be accessed from the database section that resides in the same control element as the requesting control

system; global access means that it is necessary to access part of a database in another control element. Selection of the access method is hidden from the application programmer.

Security is an important aspect of data handling; it is achieved by duplicating data. Synchronization between copies and recovery actions in the event of a fault should be integral to the data handling system. The System 12 database management system, which consists of the database control system and the database security system, satisfies all data security requirements. The handling of security functions is hidden from the FMMs, as is the physical distribution of data. Security aspects are defined off-line; on-line they are taken over by the database security system. Once again, it is the manufacturing process that identifies security levels in the distribution tables.

Classification of Software Items

System 12 software packages are designed to be as generic as possible. The basic package is the system kernel, which is identical in all applications (Figure 7). The components of the system kernel are the operating system with network handler, database management system, maintenance system, input/output system, man-machine communication system, and other components that cause the hardware and system kernel to act as a fault-tolerant, real-time, extendable multiprocessing and multiprocessor machine.

The next software package in the hierarchy is the shell which consists of the telephonic device handlers. These programs are written so that they all have a standard interface to the surrounding application programs which constitute the remaining software packages. Functions supported by these packages include call handling, administration, and charging.

Typically, customer design engineering is linked to the shell and the application programs. If an exchange of a particular type (i.e. with the same logic as a previous exchange) is to be installed again in a given network without any change in features, only customer application engineering is necessary. This is limited to the provision of data for the specific application, and integration of the data into the existing software system.

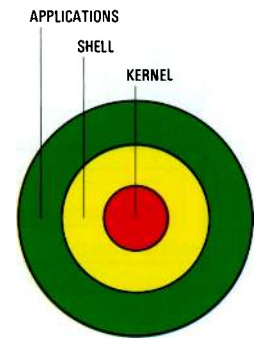

Figure 7
Classification of software items.

System 12 Data Design

A relational database is used in System 12. Data is represented by relations, each of which is a two-dimensional organization of interrelated data items. This results in data independence (i.e. separation between the user's logical view of data and its physical representation), flexibility (relational operations permit different treatment of data depending on user needs), and clarity.

As shown in Figure 8, logical and physical data models are used during design. The logical data model describes the logical structure of System 12 data: it contains the data submodel definitions for FMMs and SSMs that use the database, the access rights models, and the virtual and real relation definitions.

The physical data model describes the physical layout and attributes of each relation. Furthermore, it defines the control element in which each physical relation has to appear, resulting in the definition of the data load segments for each processor.

Data development consists of two main steps: data specification and data design. Inputs to the data specification process are the functional specifications, system requirements, programmers' and designers' ideas, and database designers' know-how. During specification, the database designer supports the program designer in identifying data items and analyzing relationships (functional dependencies). The data dictionary is consulted for existing data items, and new data item descriptions are inserted; if necessary, the required modes for each data item are described. Finally, a data population document is created which describes the population rules.

Inputs required for data design include the previous release of the logical and physical data model, data mode definitions (in the CHILL sense), data item descriptions, population documents, and the definition of the software build for an application (e.g. an exchange type). During this process, conflicting data requirements are identified and resolved. Data submodels and access right models are defined, as well as physical relations and their distribution between the control elements. Data population documents are reviewed, and the final data population algorithms are defined. Finally, new versions of the logical and physical data models are created. These two data models together with data mode definitions form the so-called

metadatabase which is used as an input for production of the system load tape for a series of exchanges with the same characteristics (e.g. size, market segment).

Data design involves two teams of designers with different skills: program designers (who understand the functions to be performed by FMMs and SSMs, and their implementation), and data designers (who have specific knowledge about the contents of existing metadatabases, the database management system, and the tools used to produce the system load tapes).

Software Production and Manufacture

The System 12 product lifecycle is supported by an integrated set of systems to support engineering activities. Most of these support systems currently run on IBM 370 and compatible mainframes under the MVS (multiple virtual storage) operating system.

Generation of a system load tape for a System 12 exchange relies heavily on some of these support systems, as shown in Figure 9.

Two categories of processes may be distinguished:

- Software production processes, which create components that are common to all exchanges of the same type. These may be further classified into the

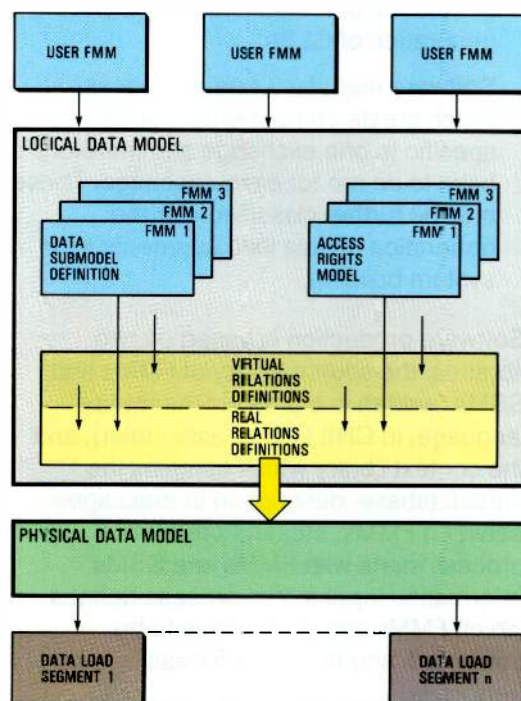

Figure 8
Logical and physical data model.

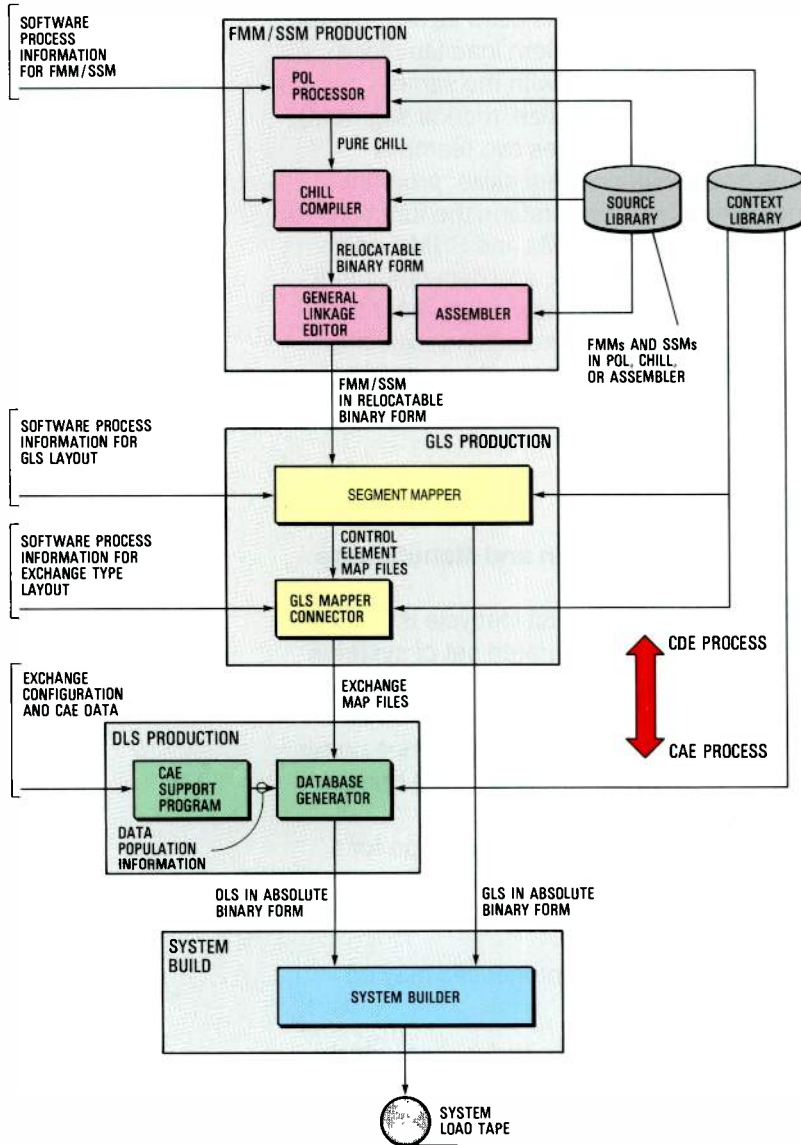

Figure 9
Software production and manufacture.
CAE - customer application engineering
CDE - customer design engineering
DLS - data load segment
POL - problem-oriented language.

generation of FMMs and SSMs, and the generation of GLSs.

- Software manufacturing processes, which create components that are specific to one exchange and therefore have to be run for each exchange. These may be further classified into the generation of data load segments and system building.

Software production is based on two libraries, the source library of FMMs and SSMs (written in a problem-oriented language, in CHILL, or in assembler), and the context library which contains the metadatabase, description of messages between FMMs, etc. The production process starts with FMMs and SSMs. Information input to this process defines which FMMs and SSMs have to be translated, and how the process is to be performed.

Depending on the type of source program, different translators are activated. The problem-oriented language processors translate source programs coded in problem-oriented languages into pure CHILL statements; the CHILL compiler translates CHILL statements into an intermediate relocatable binary object format and assembler language.

After the FMMs and SSMs have been produced, a general linkage editor is used to make the FMMs and SSMs available in relocatable object format so that they can be used to produce GLSs. A GLS consists of all the FMMs and SSMs that are to be loaded into a particular type of control element (several control elements in an exchange will execute the same logic). This layout of a control element type is input to the segment mapper which takes the relevant FMMs and SSMs and combines them to form GLSs in absolute binary object format.

In a second stage, a customer design engineering map generator is activated to process information about a particular application (e.g. exchange type). It also adds reference information about all the control element types that form the specific application to the information contained in the control element map files. All components described above, the context, the exchange configuration data, and the customer application engineering data for a specific application, represent the input to the software manufacturing process, and in particular the production process for the data load segments. Together with the exchange configuration and other typical exchange-related data, this input is processed by a customer application engineering support system and a database generator, which then output the data load segments in absolute binary object form.

In the final stage, the system builder combines the GLSs and data load segments on a system load tape which is then ready to be loaded into a System 12 exchange. It should be emphasized that for customer application engineering (i.e. producing a system load tape for an existing exchange), only the data load segment production process and the system builder have to be applied; GLS production is required only once for each exchange type, and FMM and SSM production only once per FMM and SSM translation. The entire generation process and the associated tools have been designed to minimize the need for manual input and interference. Within each process, input and output information is automatically

validated, thereby ensuring that high quality system load tapes can be shipped to the laboratories or to the exchange sites.

Conclusions

The advanced software structuring techniques applied to System 12 offer a number of advantages with regard to easy extension, high system reliability, and nearly unlimited control capacity. Development and manufacture of the software are both supported by powerful engineering systems. All this has ensured that the functional and performance objectives of System 12 have already been achieved in many field applications. Experience in the field has also proved the high system reliability, flexibility, and future safety of the System 12 design.

Bibliography

- 1 L. Katzschner and F. Van den Brande: ITT 1240 Digital Exchange: Software Concepts and Implementation: *Electrical Communication*, 1981, volume 56, no 2/3, pp 173–183.
- 2 R. Arranz, R. Conroy, and L. Katzschner: Structure of the Software for Switching Systems with Distributed Control: *Proceedings of the International Switching Symposium*, 21–25 September 1981, Montreal, session 41A, paper 3.
- 3 R. Cohen, K. Hamer-Hodges, G. De Wachter, and H. Weisschuh: System 12: Integration and Field Experience: *Proceedings of the International Switching Symposium*, 7–11 May 1984, Florence, session 32A, paper 1.
- 4 K. J. Hamer-Hodges, G. De Wachter, and H. Weisschuh: System 12: Integration and Field Experience: *Electrical Communication*, 1985, volume 59, no 1/2, pp 12–19 (this issue).
- 5 G. Becker, C. Kammire, C. Vander Straeten, and R. Schaaf: System 12 Programming Aspects: *Proceedings of the International Switching Symposium*, 7–11 May 1984, Florence, session 32A, paper 4.

System 12

Software Quality Assurance

At the outset of the System 12 development, software quality assurance measures were identified as essential to the realization of good quality software and high programming productivity. The main objectives were to prevent defects during design, then to identify any remaining faults and remove them at the earliest possible development phase.

J. Nenz

Standard Elektrik Lorenz AG, Berlin,
Federal Republic of Germany

Introduction

Modern telecommunication products, such as the System 12 Digital Exchange, must meet stringent performance and reliability objectives in order to achieve the high equipment standards demanded by most telecommunication administrations.

As software development represents more than half the total development effort for a complex telecommunication system, it is essential to define and implement measures that help ensure that the finished software will meet all the quality targets. The discipline which provides these methods, procedures, tools, and organizational recommendations is termed SWQA (software quality assurance).

A comprehensive SWQA programme was considered as mandatory from the outset of the System 12 development, and SWQA methods and techniques have played an important part in achieving a high quality product.

Characteristics of Software Quality

Software quality can be defined as the sum of all the characteristics and attributes of software products and processes and their qualification to satisfy user requirements and expectations. Reliability, effectiveness, and user friendliness are examples of these characteristics. It has to be emphasized that these characteristics refer not only to the product attributes but also to all aspects that may influence the quality of the final product in a given project environment. Thus all

technological aspects of software product development (e.g. methods, tools, concepts) and all management aspects (e.g. planning, coordination, control) must be checked to see whether they contribute to quality.

The quality characteristics that are relevant to a software product can be derived from the product requirement specification. It is then possible to use quality metrics (measurement systems for quality characteristics) to define the testable quality targets for each characteristic. Only when clear target values or definitions have been produced for both the product and development processes is it possible to plan, control, and evaluate product quality throughout the software lifecycle.

Elements of Software Quality Assurance

After the quality targets have been defined in detail, measures by which to achieve these targets must be selected. SWQA offers the technical and organizational methods that are necessary to achieve the specified product quality targets economically. These measures can be subdivided into five main activities:

Software quality planning defines the product quality characteristics, quality targets, and acceptance criteria; it also defines all SWQA activities to be performed, including resource planning and SWQA milestones.

Software quality construction covers the definition and implementation of a quality-

oriented development concept and defect prevention techniques, and ensures that software engineering methods and tools are applied, and project standards are adhered to.

Software quality control includes the implementation, coordination, and supervision of SWQA activities, the acceptance of phase products, the reporting of software product quality status, and the initiation of compensating measures should product quality be at risk (e.g. as a result of high defect rates, poor performance, or low availability of product components, or of the system as a whole in operation).

Software quality testing is concerned with the testing of design phase products (requirement reviews, design inspection, code inspection, etc); with test planning, test specification, and test performance; and with project and process audits.

Software quality evaluation permanently supervises the quality status of software products and software development processes, provides defect measurement and quality cost analysis, and evaluates the applied tools, methods, and concepts.

During System 12 development it was shown that the only way to achieve the required product quality in the most cost-effective and controlled way was to combine activities from all five areas. SWQA activities are chosen according to the product quality targets; together they constitute the project

SWQA programme, and are specified in the SWQA plan for the project.

The relationship between the quality system of a company, its SWQA standards, and the project SWQA plan and programme is shown in Figure 1.

Software Quality Planning

Product quality is a major objective of software development, so a plan must be carefully drawn up on how to proceed from the quality targets specified during the project definition phase to a final product which satisfies these requirements.

The SWQA plan defines this process and all the SWQA activities necessary to reach the goal. It contains clear instructions as to which activities have to be carried out in which development phase and refers to the underlying procedures (tools) and guidelines set out in (project or company) standards. The plan also clearly specifies which team is responsible for SWQA and which other functions have to participate. In addition the SWQA plan includes acceptance criteria that must be met by phase products before they are released to software configuration management, enabling the next development phase to be started.

Table 1 outlines an SWQA plan similar to that being used for System 12 development.

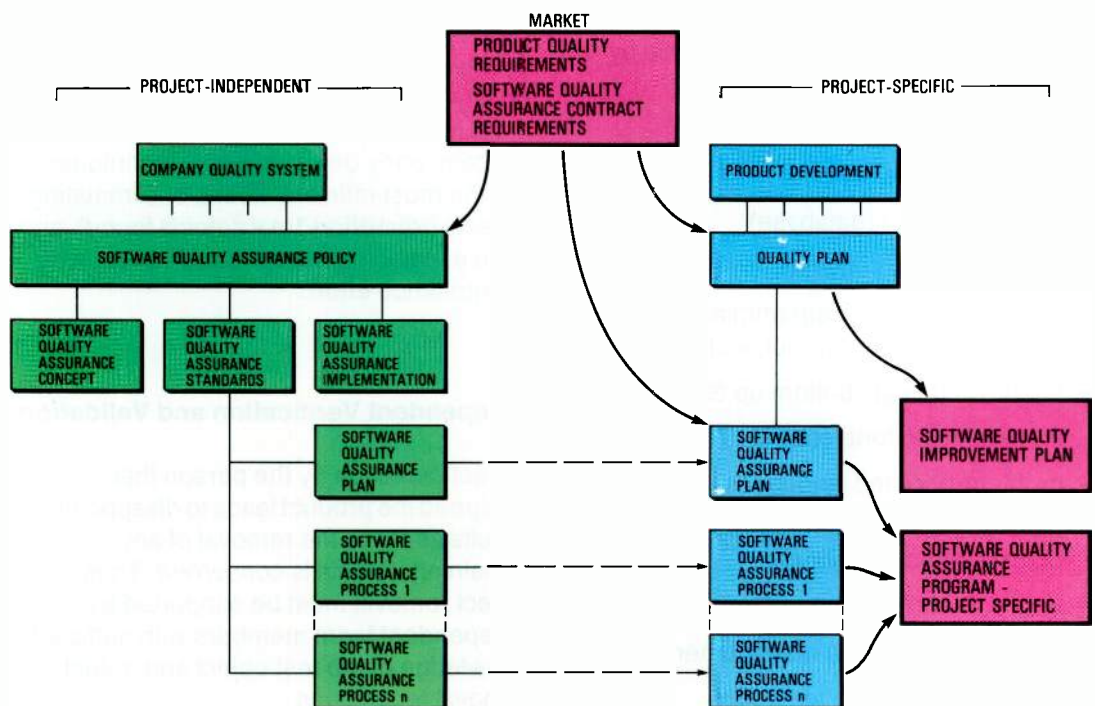

Figure 1
SWQA system and associated interfaces.

Table 1 – Outline of SWQA plan

<p>Introduction</p> <p>Objectives Scope References to project plan, company quality system, etc.</p> <p>Requirements</p> <p>Prerequisites for SWQA Priority quality characteristics Definition of quality targets/acceptance criteria.</p> <p>Activities</p> <p>SWQA activities within project SWQA standards/methods (reference only) SWQA tools to be used (reference only).</p> <p>Organization</p> <p>SWQA within project organization structure Allocating responsibilities for SWQA activities Interfaces to other functions Effort estimation Reporting.</p>

“Do it right the first time” has been a slogan used by ITT in campaigns to enforce and maintain hardware quality, but it is equally relevant for software development and a valid recommendation for all participants in software development projects.

Early Defect Detection and Correction

Defects are inadvertently introduced into software products in all development phases and during all activities. This is particularly true of the earlier phases of software development, with some 60% of all defects being design defects.

Traditionally defects have remained until testing started when they were detected in the first or a subsequent test phase, or even at the customers’ sites. This certainly is not an efficient way to remove defects; SWQA offers more advanced and more cost-effective methods. If it is not possible to avoid a defect by prevention techniques, the second-best method is to detect that defect as early as possible and remove it immediately after the relevant design phase has been completed.

All reviews, design inspections, and code inspections come within this category. Basically, these procedures define immediate inspection of development products (i.e. design documentation) by independent project team members after the author has released the product as complete. The main purpose of these activities is to avoid remaining defects causing a “defect avalanche” which would require more testing, increase project costs, cause delays and, inevitably, lead to product quality problems.

As many published SWQA experiences indicate, early defect removal techniques are the most efficient means of eliminating defects (total effort/total defects found), and have a major impact on reducing test and maintenance effort.

Independent Verification and Validation

Defect detection by the person that designed the product leads to disappointing results as far as the removal of any remaining defects is concerned. Thus defect removal must be supported by independent team members with sufficient knowledge of the test object and defect removal techniques.

Built-in Quality

From the start of the System 12 project it was recognized that the very high quality standards necessary in such a complex and sophisticated telecommunication product could not be achieved simply by using comprehensive defect removal techniques and other analytic and test-oriented SWQA methods throughout the development lifecycle. It was clear that quality had to be “designed-into” the product by selecting a quality-oriented software architecture. The System 12 software has achieved this by using, for example:

- finite message machine concept
- virtual machine concept
- data separation (database)
- reusable basic software.

In addition, modern programming practices have been used throughout, including:

- top down design/bottom up testing
- lifecycle milestone control
- problem-oriented languages
- development standards (programming practices and guidelines)
- host computer based documentation
- strong configuration management
- suitable design and test tools.

In the System 12 project, each development phase was followed by a verification and validation step (performed by independent members of the development team) in order to detect as many defects in each phase as possible and to carry out a formal acceptance for all phase products in all project phases. It also made it possible to evaluate and control product quality throughout the development cycle (Figure 2). Each design phase was followed by design inspection and an acceptance procedure for each product. Each test phase was followed by a comprehensive acceptance procedure in

maintainability and usability, and in revealing the interrelationships between quality attributes, means that software quality measurement is not yet a mature technique.

The main criterion for numeric evaluation and analysis of software quality is the number of defects found within the different software products during reviews, inspections, and tests. Simply counting the number of defects would be misleading so defects must be "weighted" according to their impact on the system. Only then can measures of different software components be compared and "error-prone" parts isolated. To obtain a clear indication as to

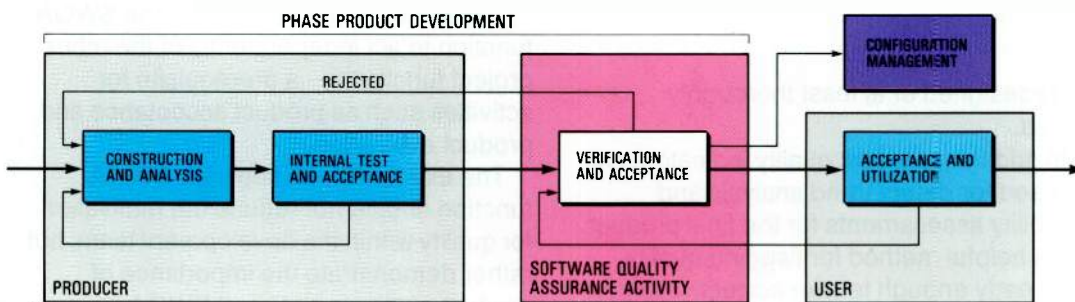

Figure 2
Acceptance and
release of phase
products.

which test coverage and documentation quality were checked.

The concept of separating the responsibilities for design and testing/acceptance – which is what independent verification and validation entails – has been extended in the System 12 development with the establishment of a new function for software/hardware integration and testing. This new function covers:

- acceptance of software design products
- integration of software and hardware items
- testing of software/hardware subsystems
- final system testing
- change control
- release of final product for installation.

This arrangement of responsibilities within a separate organization has major advantages.

Quality Measurement and Analysis

Problems inherent in defining metrics for quality characteristics such as

where improvements are necessary, many other defect characteristics should be collected and analyzed, including the type and source of a defect, the phase during which it was introduced, and the phase during which it was removed.

In large projects, defect measurement (recording, collection, and analysis) can only be successful if test personnel are supported by software tools that help them (indeed force them) to record defects. Only a complete set of defect data will lead to correct analysis results and to the necessary countermeasures.

The results of these measurements clearly indicate where defects are generated and how they could be avoided (or at least minimized), or in which phase of the software development cycle they were detected, and when they could have been detected. Thus the impact of defect measurement is threefold. First it leads to an analysis of the quality of the methods and tools used during design and how well they fulfill the requirement to support "building-in quality". Second it evaluates all defect removal techniques and the discipline and effectiveness with which they are applied. Third it provides an analysis of error prone parts of the software system which should

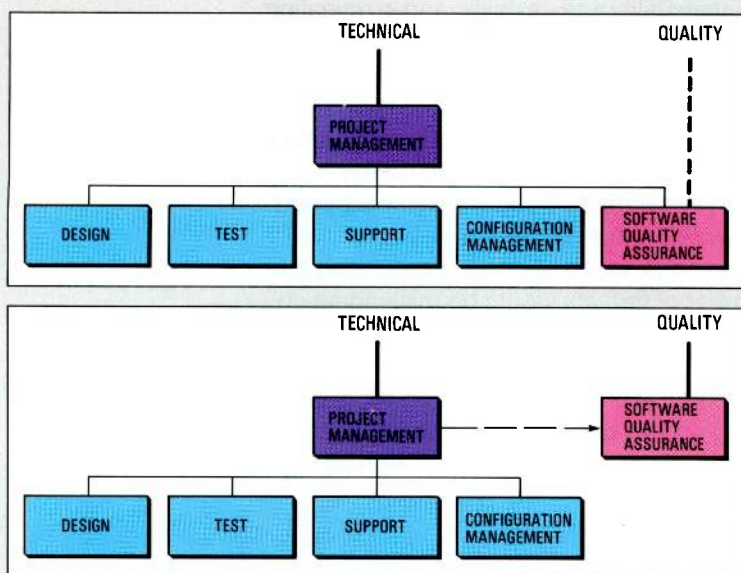

Figure 3
Alternative project organization structures involving SWQA. The top structure uses a project-specific SWQA function; the alternative uses a more independent SWQA function.

be redesigned or at least thoroughly tested.

In addition, product quality indicators can be used for defect trend analysis and reliability assessments for the final product. It is a helpful method for flagging quality risks early enough to take corrective action, thereby avoiding the penalties of high maintenance costs, customer dissatisfaction, and so on.

As yet there are only a few quality characteristics for which metrics exist and are useful for analysis and comparison. There is thus a wide field for investigation and research to provide more and better quality metrics, and to increase product quality visibility and the control of quality targets throughout the software lifecycle.

Organizational Aspects of SWQA

Not all SWQA activities need be performed by a separate SWQA function. As overall product quality is the responsibility of the project manager, he must decide how to organize SWQA (e.g. whether to allocate a project-specific SWQA function or to use the resources of an existing quality organization). Two possible organizational structures are shown in Figure 3. In general, using a project-specific SWQA function reporting to the project manager (upper structure) means a higher degree of acceptance of this function by the project team and greater familiarity of the SWQA personnel with the software products involved.

On the other hand, the lower proposal implies greater independence for SWQA

activities, possibly a broader knowledge for SWQA personnel as a result of their earlier involvement in other software projects, and the opportunity to share common SWQA resources and experience on more than one project. Nevertheless, by avoiding the possible disadvantages, both structures have proved effective during System 12 software development, and have been used in design centers in Europe and the United States of America. In most cases the SWQA function has been made responsible for tasks such as quality planning, quality control, and quality evaluation, while quality construction and quality testing have remained the responsibility of the project design or test function.

These two structures enable the SWQA function to act independently of the other project functions – a prerequisite for activities such as product acceptance and product evaluation.

The existence of a separate SWQA function should not reduce the motivation for quality within the development team, but rather demonstrate the importance of product quality targets and SWQA measures.

Software Quality and Software Productivity

In current software projects, more than 50% of the total development effort is spent on test activities. Defect detection and defect correction are the most important cost factors within software projects. Defect removal effort and the related costs depend on the quality of development products (i.e. poor quality in development products means poor productivity).

It has been shown by experience in ITT software projects (including the System 12 development) that the earlier defects are detected, the less expensive is their removal. Defect-removal activities during the design phase (e.g. design inspection) have considerably reduced overall testing effort in later project phases.

Conclusions

A comprehensive SWQA programme was initiated at the start of the System 12 development, and is still going on. This has produced much useful experience, and clearly shown the role SWQA should have

in future software projects, how it should be organized, and which SWQA activities can contribute to the success of a project.

As it is a relatively new discipline, SWQA will be continually improved by more research and practical experience with new methods and tools. In particular, the following areas are receiving such attention:

- defect prevention techniques
- software quality measurement
- support tools for SWQA.

Improvements in these areas will ensure that future software projects benefit even more from the systematic application of SWQA techniques.

Bibliography

- 1 E. H. Bersoff et al: Software Configuration Management: Prentice Hall, 1980.
- 2 B. W. Boehm: Characteristics of Software Quality: TRW Series of Software Technology 1, North Holland, 1978.
- 3 B. W. Boehm: Proceeding of the TRW Symposium on Reliable, Cost Effective, Secure Software: TRW Software Series, Report TRW-SS-74-14, 1974.
- 4 B. W. Boehm: Software Engineering Ergonomics: Prentice Hall, 1981.
- 5 R. Dunn: Quality Assurance for Computer Software: McGraw-Hill Book Company, 1982.
- 6 G. Myers: Software Reliability – Principles and Practises: Wiley Interscience Publication, 1976.
- 7 D. Freedmann and G. M. Weinberg: Ethnotechnical Review Handbook: Ethnotech Inc, 1979.

System 12

Traffic Overload Control

System 12 overload control ensures a high throughput with a good grade of service for accepted calls under even severe overload conditions. The control mechanism is based on a distributed structure which can cope with overloads in a network of processors.

G. Morales Andrés
M. Villén Altamirano

Standard Eléctrica Research Center,
Madrid, Spain

Introduction

The System 12 Digital Exchange has good traffic handling characteristics as a result of its distributed control architecture and intelligent digital switching network. The virtually nonblocking switching network provides paths for both speech traffic and interprocessor communication. It maintains a negligible blocking probability under normal, overload, and unbalanced traffic conditions¹.

The exchange control has fully distributed hardware, with well structured software. The distributed hardware, based on microprocessors, allows a linear relation between the traffic to be handled and the required equipment. Thus, the exchange control can be tailored, according to the exchange size and traffic, to provide the required capacity to handle calls under normal and high load conditions.

The software is structured in separate modules, each of which performs a specific function, with standard interfaces between them. This approach provides considerable flexibility for adapting each module to administration requirements. Network management, traffic measurement, and overload control are provided by three separate modules which benefit from this flexibility. As an example, this allows the network management module to be adapted to the network management philosophy of the surrounding network.

The traffic measurement module consists of data collection and report generation parts. Data collection is distributed over the different processors. At this level events of statistical interest are gathered and counters are updated. The report generation part

requests information from data collection, and produces output reports in response to operator requests. As a result of its organization, the measurement module is very flexible making it possible to run user-defined traffic measurements.

The purpose of the overload control module is to ensure that in the event of a severe overload, the exchange maintains a high throughput with a good grade of service for accepted calls.

Overload controls for previous stored program control systems had to cope with overloads in a centralized configuration^{2,3}. In the present case, a new design of overload control was necessary in view of the distributed structure of System 12. This new overload control has to deal with overload in a network of processors, in which focused overload can affect only a few processors. Accordingly, the overload control also has a distributed structure in which the detection mechanisms and the actions taken are divided between the appropriate processors.

Overload Control Objectives

The effect of a severe overload in an exchange which is not designed to cope with it is a fall in the throughput, measured as the number of calls correctly handled with an acceptable grade of service. Reasons for this reduced throughput include:

- delays which are greater than those corresponding to the minimum grade of service

- waste of system resources as a result of the loss of calls after partial treatment by the system; loss of calls may be caused by insufficient memory, mistreatment of calls, or premature on-hooks and timeouts because of excessive delay.

The System 12 Digital Exchange is designed to cope with severe overload without incurring these problems. This objective has been achieved as a result of the system structure and an efficient overload control mechanism which is designed to maintain system throughput under *any* overload condition and to handle calls according to specified priorities.

Overload Control Strategy

The overload control strategy takes into account the distributed structure of System 12. Accordingly, each processor has its own overload detection and reaction mechanisms which depend on the type of processor^{4,5}. Three types of processor can be distinguished from the overload viewpoint:

- Call control processors are associated with a group of terminals (lines or trunks); they have overall control of calls generated by or terminated at these terminals.
- System processors, which work as a pool with load and/or function sharing, provide facilities for the entire exchange. They are requested to perform specific functions on a per-call basis (e.g. prefix analysis or trunk resource management).
- Service processors, each of which controls a specific group of service circuits: pushbutton receivers or multifrequency senders/receivers.

When a call is being set up, two call control processors, one in the originating side and the other in the terminating side, have overall control. One or two service processors are used if the call needs service circuits, and system processors are invoked as necessary to perform specific functions.

In this context, the overload detection and reaction mechanisms are implemented in the following way. Each processor has its own detection mechanism, which is common to them all, that enables it to provide an indication of its overload status. The actions taken depend on the type of processor: when a call control processor or a service processor is overloaded, the

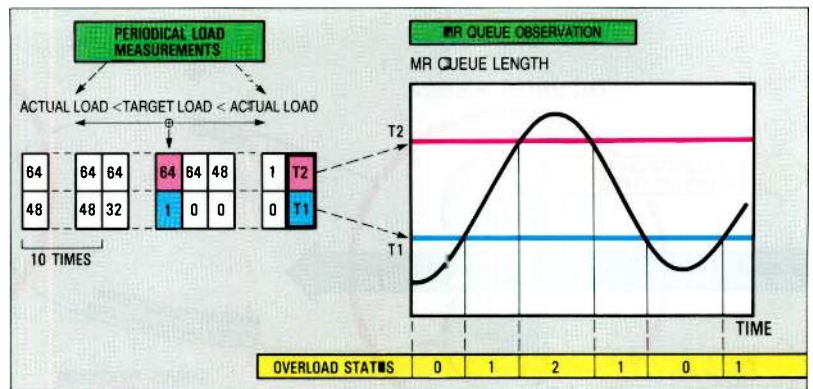

Figure 1
Overload detection.
MR - message ready.

processor itself takes the necessary corrective action. However, when a system processor is overloaded, this fact is communicated to the processors that are sending load messages to it so that they can take the necessary actions.

Overload Detection

Each processor has an overload status indicator. In addition to level 0 (no overload), two overload levels (levels 1 and 2) have been defined so that controls can be applied according to traffic priorities.

The overload status is determined by comparing the length of the queue of messages waiting for processing (message ready queue) with two thresholds T1 and T2 (see right hand side of Figure 1). These threshold values are dynamically updated to ensure that the processor load during overload is equal to a target load for any overload condition. The target load is such that the throughput and response time requirements are satisfied during overload.

Actual processor load during a period of one second is compared to the target load. The result determines the increase or decrease of the threshold values by moving a cursor in a table, as indicated to the left hand side of Figure 1. If the load during this period was greater than the target load, the cursor moves one step to the right pointing to a pair of lower threshold values; the cursor moves to the left if the load during this period was smaller than the target load. In this way, the values are automatically tuned to the appropriate value, ensuring that the processors work at the target load, regardless of the level and type of overload. Consequently the throughput and grade of service are always optimum.

In normal traffic conditions, the cursor is at the left of the table, pointing to the higher threshold values. As well as being repeated

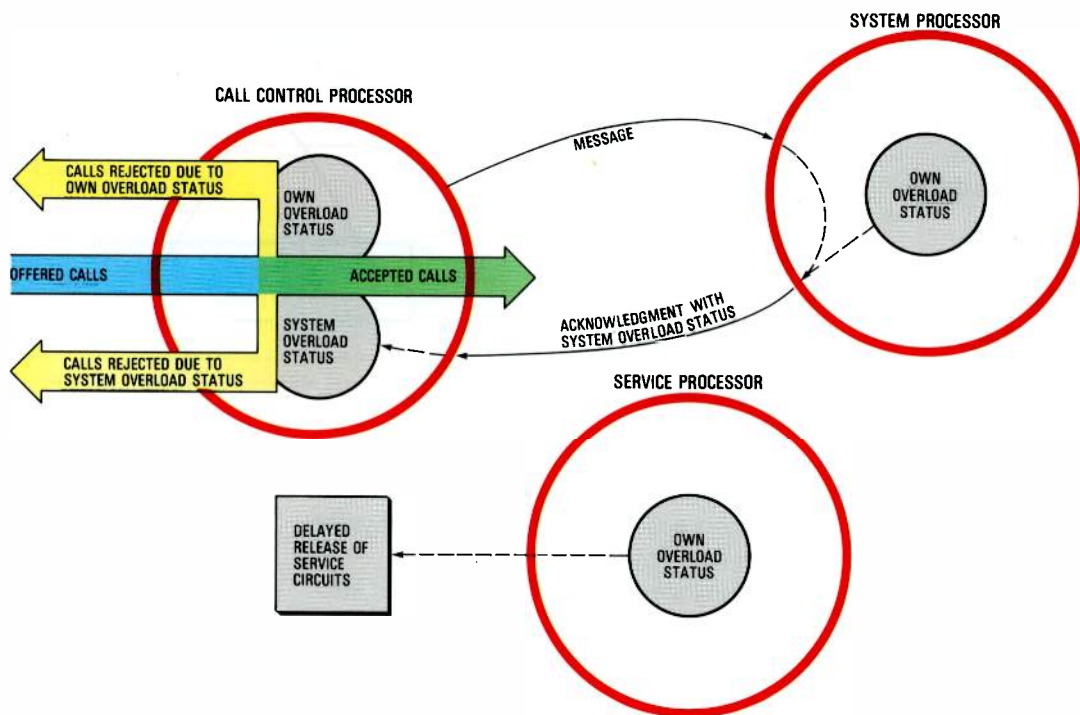

Figure 2
Overload control actions.

ten times, these high values provide "inertia" before the overload status is set at level 1 or 2, thereby preventing overload control actions being initiated by transitory peaks during normal traffic conditions.

Overload Control Actions

Processor overload actions depend on the processor type. Figure 2 shows the actions taken by each processor when an overload is detected.

Call Control Processors

When a call control processor is overloaded, it initiates the necessary defensive actions. Calls that the processor has just started to treat (i.e. for which the process control block of the signaling control finite message machine has yet to be created) are rejected. Rejection priorities depend on the type of call and which side of the call (originating or terminating side) is being handled by this processor. In particular, if the processor overload status is level 1, all originating side calls (i.e. calls for which the calling terminal is controlled by this processor) are rejected, as are terminating side line-to-trunk calls. In the event of a level 2 overload, all calls are rejected.

At the request of an administration, certain lines or trunks can be defined as high priority. Calls on these lines or trunks are never rejected.

The principle used for assigning the level at which a call is rejected is to give priority to

calls that have already been treated by other processors in the exchange (terminating side calls) or by other exchanges (trunk-to-line or trunk-to-trunk calls), and to calls on high priority lines or trunks.

When a call is rejected, any resources which it was using are released, and a "message" is sent to the corresponding line or trunk in accordance with administration requirements (e.g. recorded announcement, special tone or congestion tone, parking of the line, etc). The processing time spent in call rejection has been minimized in order to maintain throughput even when overload is severe and many calls have to be rejected.

System Processors

The overload status of a system processor is communicated via the message acknowledgment packet to the processors that are sending messages to it. These processors then take the corresponding actions. No action must be taken by the overloaded system processor because (in contrast to the call control processor) the processing time needed to reject a call is similar to the processing time needed to treat a call, so overload control would be ineffective.

Two principles have been followed in defining what actions must be taken when a system processor is overloaded:

- if a call is to be rejected, this must be done as early as possible to minimize wasted processing time

- only calls that would use the overloaded system processor must be rejected to avoid an unnecessary decrease in throughput in the case of focused overload.

To achieve this, system processors are classified into two types according to the actions to be taken during an overload. The types are assigned according to the exchange configuration.

Type 1 is assigned to a system processor when it only treats part of the calls of the exchange (e.g. a processor with only trunk resource manager functions which is not used by line-to-line or trunk-to-line calls). When an acknowledgment packet informs a processor that a type 1 system processor is overloaded, the processor rejects a call when the *first* message of that call is going to be sent to the overloaded processor. Thus, only calls which would use the overloaded system processor are rejected.

Type 2 is assigned to a system processor when it treats all or most of the calls in an exchange, or if the processor belongs to a load sharing pool and the whole pool treats all or most calls in the exchange. Typically, type 2 processors are those with several system functions. When a processor is informed that any type 2 system processor is overloaded it rejects calls at the beginning (i.e. when the process control block of the signaling control finite message machine is going to be created in the call control processor which treats the originating side).

In both cases, only line-to-line and line-to-trunk calls are rejected if the overload status is 1; all types of call are rejected if the overload status is 2. Calls from high priority lines or trunks are never rejected.

When a system processor is overloaded, the overload control actions mean that it may not be sent normal messages; under these circumstances it does not send out acknowledgment packets containing information on the current overload status. To avoid possible deadlock when a processor has rejected a certain number of calls because of a system processor overload, without in the meantime having received an acknowledgment from the system processor, the former sends a "probe packet" to the latter. This packet generates an acknowledgment and avoids deadlock without producing a significant load in the overloaded system processor.

Service Processors

The number of service circuits assigned to a service processor during dimensioning

can prevent overload of the service processor, since the number of service circuits limits the number of calls per unit time which it has to handle. However, if the service circuits are overdimensioned, they may not limit the number of calls sufficiently and overload of the service processor is possible. As this circumstance may occur because service circuits are equipped in multiples of 16 or as a result of the average holding time of the service circuits being shorter than was foreseen when the exchange was dimensioned (e.g. following a change in the network or in the call mix), overload control has been provided for the service processors.

When a service processor is overloaded, the control actions delay release of the service circuits. If the service processor is overloaded when a service circuit is going to be released, the service circuit is kept busy for a certain timeout. When the timeout expires, it is restarted if the processor is still overloaded. Delaying the release of the service circuit does not affect the call which was using it, but prevents a new seizure of this circuit during the timeout, reducing the call rate offered to the service processor.

This control action is taken for pushbutton receivers when the overload status is 1 or 2, and for multifrequency senders/receivers only when the overload status is 2.

Overload Control Performance

A time-true multiprocessor simulation model was built⁶ to give traffic support to the development of the overload control system. The model was used as a basic tool for designing the overload control, tuning its related parameters, and evaluating its performance.

An exhaustive study of overload control performance, involving a large number of simulation runs, has been carried out covering a wide variety of overload situations:

- Different traffic levels, ranging from normal loads to extreme overload situations.
- Various overload patterns: general and focused overloads, and overloads caused by excessive traffic demand or fault situations.
- Different exchange sizes and control configurations (i.e. different distributions of system functions among the system processors).

- Various dimensioning situations: exchanges in which the capacity of all the processors is balanced, and exchanges in which the capacity is limited by some processors which act as bottlenecks in the event of overload.

These studies have shown that all overload situations are controlled by the mechanisms used for System 12. Under normal load conditions, the overload control does not affect call handling (i.e. normal traffic variations never cause the overload control to be activated and calls rejected).

Under normal conditions the processors work at a load of 0.6 erlang, including the fixed overhead of 0.15 erlang. Even under overloads as high as 40%, practically all calls are accepted and correctly handled, satisfying the grade of service specified for high load situations.

Under more severe overload situations, the throughput corresponding to a 40% overload is practically maintained in most cases. Although in a few special cases the

circuits have been overdimensioned so that they do not limit the load offered to the call control and system processors.

Each call requests three different system processors for its treatment. These are termed A, B, and C according to the order in which the first message is sent to each one.

Four traffic levels were investigated corresponding to normal load, and 45%, 100%, and 190% of general overload. Figure 3 shows how each processor reacts in the four cases. Under normal load situations, a processor does not reject any calls and thus the final throughput (red column) is equal to the total number of offered calls (brown column). Under a 45% overload, only a few line-to-line and line-to-trunk calls are rejected because of the originating call control processor.

In severe overload cases, 100% and 190% overloads, calls are rejected by different processors, resulting in a final throughput which, in both cases, is practically equal to the case for a 45% overload. The originating call control processor and system processor A appear to be the main bottlenecks, since they are the first ones to treat the call and therefore act as a filter for the other processors. As a result of the selective rejection of calls, the throughput of trunk-to-line and trunk-to-trunk calls (lower "gray" area of columns in Figure 3), which have been assigned a higher priority, increases when the number of offered calls increases.

As an example of the grade of service obtained, Figure 4 shows the averages and distributions of the dial tone and ringing tone sending delays (distribution for 100% overload has been omitted for clarity). Again, the response time is practically the same for 45%, 100%, and 190% overloads.

Conclusions

The System 12 overload control has a distributed structure which matches the distributed architecture of the system. Dynamic updating of the thresholds on which the overload control is based ensures that the system can adapt to each specific overload situation. The selective rejection of calls allows calls to be handled according to priority.

Simulations have proved that the overload control mechanisms ensure a high system throughput with a good grade of service for accepted calls under all overload situations.

Figure 3
Results of four simulation runs: total offered calls, calls rejected due to each processor, and final throughput.

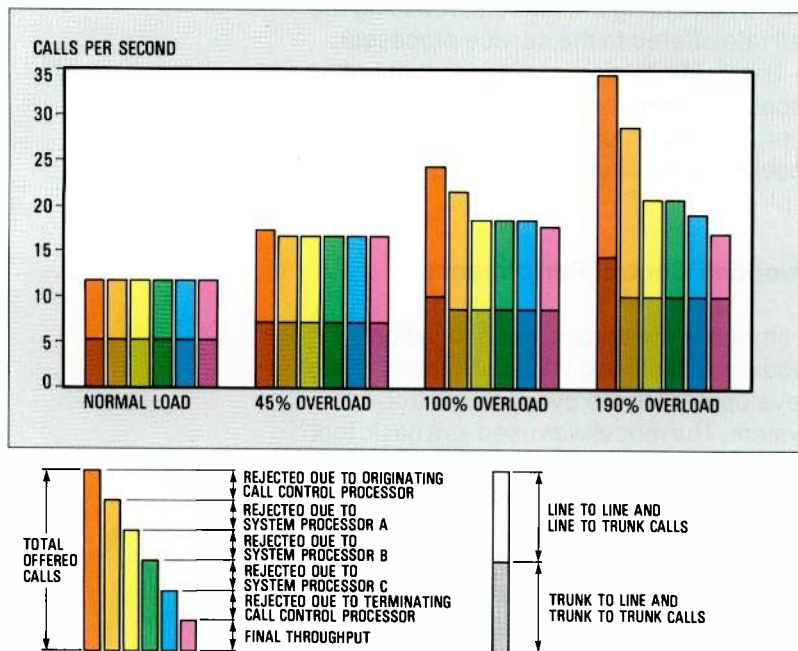

throughput may be lower, it is always significantly higher than that corresponding to normal load conditions. All accepted calls are correctly handled with a grade of service, in terms of response times, corresponding to a 40% overload.

Consider, as a typical example, the case of a medium size local exchange in which all the call control processors and system processors work under normal conditions at a load of 0.6 erlang, so that the capacity of all the processors is balanced. The service

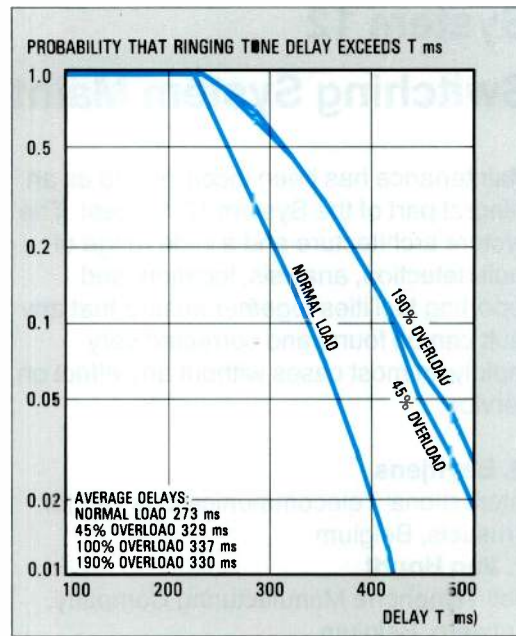
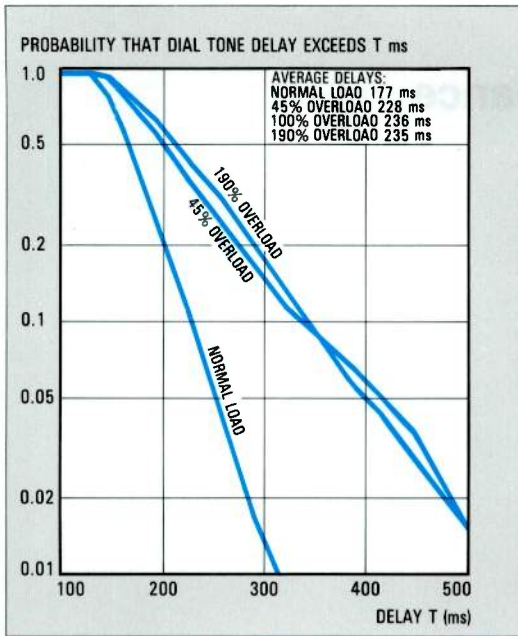

Figure 4
 Dial tone sending delay (left) and ringing tone sending delay (right).
 The distribution for 100% overload has been omitted for clarity.

References

- 1 J. R. de los Mozos Marques and A. Buchheister: ITT 1240 Digital Exchange: Traffic Handling Capacity: *Electrical Communication*, 1981, volume 56, no 2/3, pp 207-217.
- 2 J. A. Garcia Higuera and C. Diaz Berzosa: Progressive Method of Overload Control for Processors: *Proceedings of the 9th International Teletraffic Congress*, Torremolinos, October, 1979.
- 3 P. Somoza and A. Guerrero: Dynamic Processor Overload Control for SPC Switching Systems: *Electrical Communication*, 1980, volume 55, no 1, pp 37-44.
- 4 R. Bonami, J. M. Cotton, and J. N. Denenberg: ITT 1240 Digital Exchange: Architecture: *Electrical Communication*, 1981, volume 56, no 2/3, pp 126-134.
- 5 R. H. Mauger: System 12: Architecture for Change: *Electrical Communication*, 1985, volume 59, no 1/2, pp 35-42 (this issue).
- 6 L. Bermejo: ITT 1240 Control Unit: Multinode Simulation Study: *CISE Report*, code 82-TM-33.06, March 1982.

System 12

Switching System Maintenance

Maintenance has been incorporated as an integral part of the System 12 concept. The system architecture and a wide range of fault detection, analysis, location, and reporting facilities together ensure that any fault can be found and corrected very rapidly, in most cases without any effect on service.

M. Beyltjens

International Telecommunications Center,
Brussels, Belgium

P. Van Houdt

Bell Telephone Manufacturing Company,
Antwerp, Belgium

Introduction

Field experience over the past two years has shown the basic System 12 maintenance concepts to be viable and effective. Nevertheless, enhancements have been introduced that further improve performance, extend and standardize interfaces to cover the full range of System 12 applications, and make system behavior more reliable by the rigid application of defensive programming techniques.

Control elements are now informed of a change in the configuration (control element switchover from standby to active, replacement by a spare control element) by broadcasting over the tone bus, thereby ensuring that all control elements operate with the same information at all times.

Handshaking mechanisms and timers have been introduced to ensure that maintenance actions can be completed should a further fault occur that would otherwise affect completion of the maintenance action. Completion codes and error codes, which are generated by device handlers in response to maintenance requests, have been extended to improve maintenance reactions and provide more-detailed fault reports.

Recent enhancements to System 12 have helped to achieve this goal¹. Line and trunk TCEs with 1 Mbyte of memory allow more maintenance functions to be moved to the lowest level (where most faults are detected), thus reducing the processor load

of the maintenance and peripherals module and making the centralized maintenance software transparent to the addition of new hardware modules or to further changes in technology. In conjunction with enhancements to the maintenance and peripherals module hardware (e.g. introduction of dual port memory and an input/output processor), this has speeded up fault reaction and location, and made them independent of exchange size.

Maintenance Concepts

Fault Detection and Reporting

Fault detection circuits, tailored to the particular equipment, have been introduced at the lowest level. Failure of a fault detection circuit only affects this equipment. Error analysis can be done partly at the lower level, simplifying error reporting and requiring less processing power. Hardware fault conditions are also detected by continuously monitoring alarm point voltages.

Routine tests check functions that are not monitored on-line or by alarm supervision, or when the detection delay would adversely affect the grade of service. Routine tests are scheduled automatically and run on equipment which is in service without disturbing traffic.

All software modules have built-in checks that report any malfunction. These include simple CHILL run-time checks, operating system checks, timers, validity checks, and



audit tests. Audit tests, which are scheduled in the same way as routine tests, ensure data consistency throughout the system.

Control Element Redundancy

High exchange availability and effectiveness of service have been achieved because a fault is generally restricted to one of a large number of small and reliable control elements. Standard commercial microprocessors and memory enhanced with error detection and correction codes are sufficient to meet the fault detection and reliability objectives.

Control element redundancy ensures that the unavailability of one of the many control elements has only a minimal effect on exchange operation. The choice of redundancy scheme (e.g. duplex operation, pooling, sparing, and crossover) depends on the criticality and nature of the control element function.

Duplex control elements operate in an active/standby mode. Up-to-date status information is kept in the standby control element so that it can take over immediately should the active control element fail. Overall maintenance, loading, and input/output control are provided by duplex

control elements that do not have any call control functions.

Some system functions (e.g. trunk selection) are located in duplex control elements, while others (e.g. directory number translation) are located in a pool of control elements. In both cases, spare hardware is provided which can take over the functions of any of the system ACEs whether they are working in a duplex or pooled configuration. This reduces to a few seconds the period when control element duplication or complete pooling is not available.

Subscriber and trunk modules are equipped in a paired configuration. During normal operation each TCE handles its own terminal. However, in the event of a TCE fault, the working TCE takes over control of both terminals and handles their traffic until the faulty TCE has been repaired. This feature is known as crossover.

All control elements communicate via the digital switching network in exactly the same way by sending data messages. A message routing table in each control element lists the network addresses of all control elements in the configuration, including the standby and spare control elements. When maintenance reassigns a

Maintenance was considered as an integral part of the System 12 concept. As a result faults can be located and corrected very quickly, usually without affecting service.

control element, these tables can be updated simply by swapping entries so that messages will be routed to the newly assigned control element.

Security Block Concept

The division of an exchange into call handling functional units is not always appropriate for maintenance functions. Another division, based on maintenance requirements, has resulted in the security block concept. A security block is a group of hardware circuits which is chosen so that if one function within the block fails, the remaining functions cannot be used by the exchange. Thus the whole group (security block) can be taken out of service without any further effect on call processing.

Security blocks are arranged in a hierarchical structure in a similar way to functional units. If a security block which is responsible for blocks in a lower level is taken out of service, the lower level blocks are also automatically disabled. Each security block consists of replaceable items or parts thereof (e.g. printed boards or plug-in units such as DC/DC converters).

Repair Block Concept

A repair block is defined as the smallest number of security blocks that must be taken out of service during the short period of actual replacement (repair) to ensure that the faulty replaceable item is correctly repaired without endangering other security blocks within the repair block.

The actual repair is initiated by a man-machine communication request to take the repair block out of service. If necessary, a waiting period is allowed for traffic to clear in security blocks within the repair block that are not affected by the fault. When this time has elapsed, the repair request is confirmed

and maintenance personnel are allowed to replace the faulty item and to give the end-of-repair order. The repaired security block is then requalified by rerunning the diagnostic test that detected the fault to ensure that the correct replaceable item has been fitted and that the security block is functioning correctly.

After successful requalification, the security block and all the blocks that it controls are reinitialized. Successful reinitialization is confirmed by a teleprinter printout and removal of the alarms. If it is not successful, a further fault message is printed out and the system alarms remain active. The same strategy is used when extending the exchange hardware.

The repair strategy is greatly assisted by several basic System 12 attributes. In most cases repair is simply a matter of plugging in new printed boards or other plug-in units. This is straightforward because there are only about 40 types of replaceable item, and most exchange equipment consists of only a few types (e.g. eight types constitute 85% of all replaceable items). To simplify maintenance even further, several exchanges can be supervised from a single maintenance center.

These features enable an administration to use less-experienced staff for exchange maintenance, and also minimize the stocking of spare parts.

Exchange Defense

The security block concept makes it possible to adopt a straightforward defense mechanism that can be applied throughout the system. This requires error analysis to locate all fault reports and alarms down to the security block level. Security blocks are then taken out of service by defense to avoid propagating the effects of the fault.

Figure 1 Division of the System 12 maintenance subsystem into functional areas and subareas.

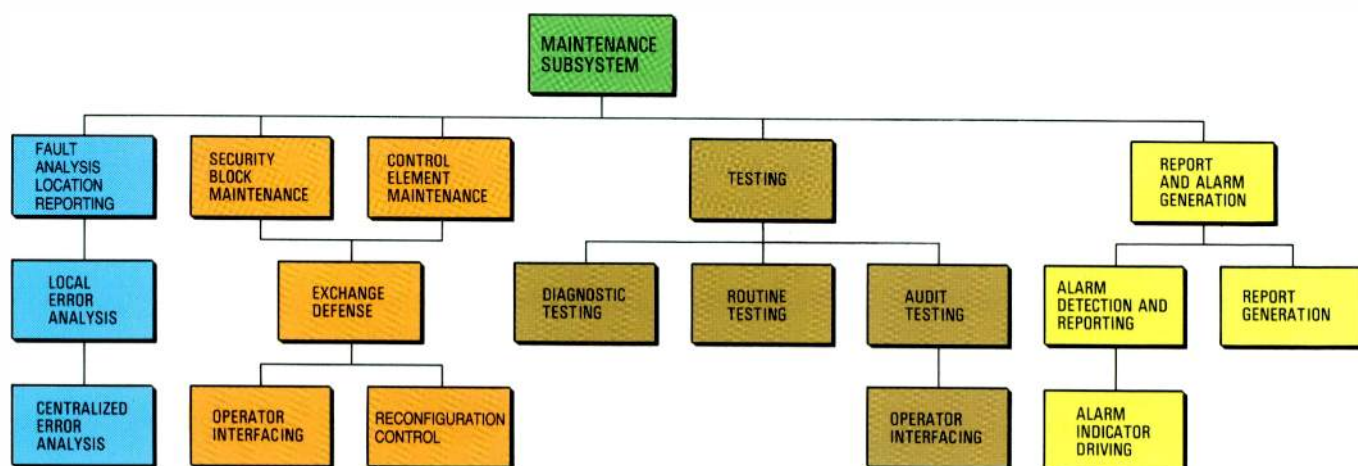

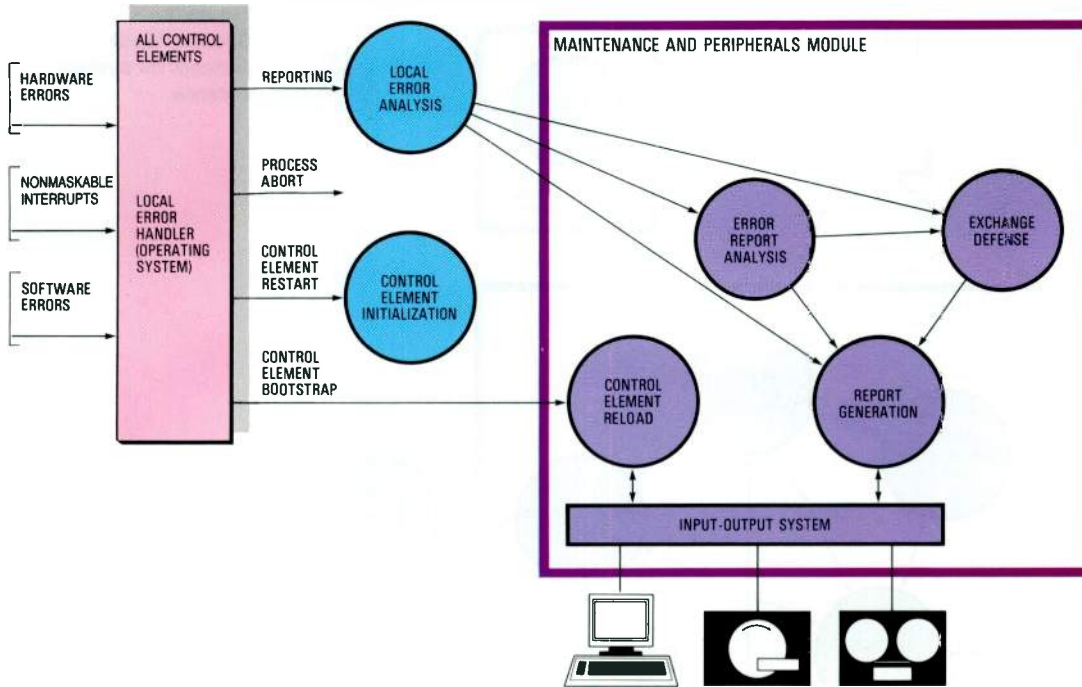

Figure 2
Principles of fault analysis, location, and reporting in a System 12 exchange.

Crucial security blocks are automatically replaced by spare security blocks.

A diagnostic test is executed to locate the faulty replaceable items within the suspect security block. In 80% of cases, replacement of one replaceable item will suffice; in all other cases between two and five replaceable items are affected. Removing security blocks from service automatically generates an action report and an associated alarm.

Exchange Alarms and Fault Reports

Three alarm reporting methods are provided. Primary alarm indicators (e.g. alarm bell, master alarm panel) alert maintenance personnel. Secondary indicators, such as teleprinter reports, VDU information, and rack and row alarm lamps, give more detailed fault information (urgency of alarm, faulty replaceable items, location of replaceable item) and direct maintenance personnel to the fault. Tertiary indicators, such as fuse indicators or LEDs on printed boards, indicate special conditions and/or the faulty board to maintenance staff.

The alarm system allows up to eight alarm categories to be specified, with up to 32 alarm indicators on the master panel. Assignment of alarm conditions to alarm category and alarm indicators is data driven.

Exchange Implementation

The maintenance subsystem is subdivided into five functional areas and a number of

subareas (Figure 1). The functions of each area are as follows:

Fault Analysis, Location, and Reporting (Figure 2)

Software faults are detected by the programs within each control element, whereas hardware faults in the terminals are detected (mainly by device handlers) when the device is used (e.g. during call setup).

Some faults require immediate defensive actions, others require central error analysis, and still others require alarms (audible, visual) to be triggered and/or a report to be printed out.

All detected faults are reported to the local error handler, which provides a standard user interface. Depending on the fault category, the local error handler may simply report the error (e.g. recoverable software faults or transient hardware errors) to the local error analysis program, or may initiate the abortion of a software process (e.g. as a result of a blocked process audit). In the case of more serious faults, the local error handler may start emergency recovery procedures — reinitialization and restart of the control element (e.g. for unrecoverable software faults, sanity time-out, abortion of a critical software process) or may force the control element into bootstrap; this results in a reload request being sent to the maintenance and peripherals module (e.g. for double memory parity errors, incorrect checksum, too many restarts).

Local error analysis results in action on four levels:

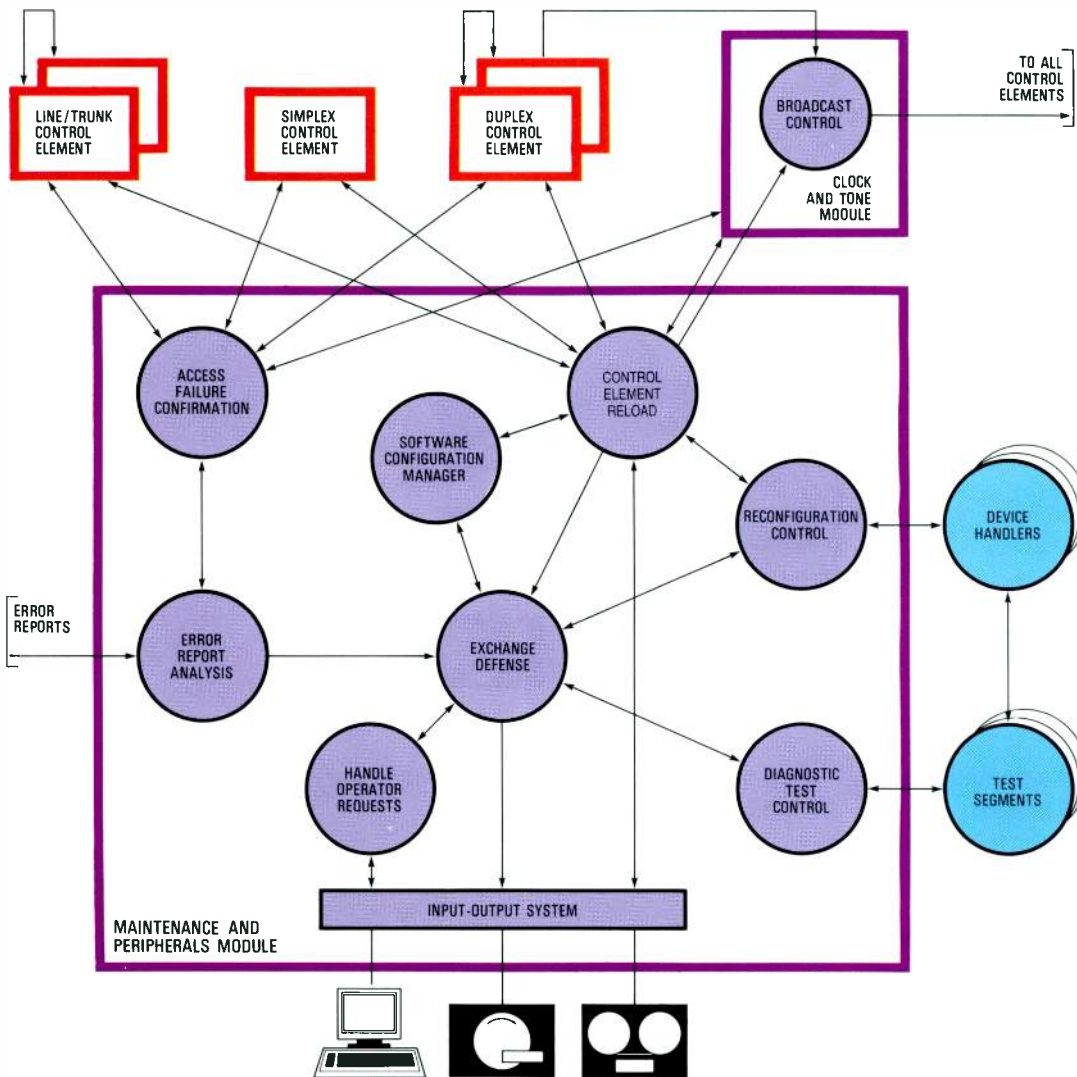

Figure 3 Security block concept for system defense.

- Certain faults are sent directly to the report generator module for output on a VDU or storage in historical files.
- Counters are provided for some noncritical faults. The counters can be polled by the TCE of the maintenance and peripherals module element; central error analysis is then performed based on the information received from the various control elements.
- Local error analysis identifies the affected security block in the case of some critical faults. This information is passed to the maintenance control element which initiates exchange defense actions.
- If fault correlation has to be performed, errors are first routed to a centralized *error report analysis* software module which locates each fault down to the security block level, validates the fault (e.g. probe tests), keeps statistical counters relating to certain errors, and determines the level of recovery action (e.g. verify or disable).

Security Block Defense (Figure 3)

The security block identified by the error analysis is normally taken out of service to avoid propagating the effects of a fault. System redundancy ensures that this does not significantly degrade exchange operation.

Coordination and validation of action requests resolves problems of concurrency between simultaneous verification requests and/or actions requested by a maintenance operator. Disabling of security blocks starts from the lowest level in the hierarchy.

In order to hide specific hardware-related actions from the defense programs, a set of reconfiguration modules is provided for all telephonic, digital network, computer peripheral, and system security blocks. Standard interfaces between these reconfiguration modules and device handlers facilitate the addition of device handlers developed for new devices.

As soon as the faulty security block has been disabled, a diagnostic test is executed to confirm the fault and locate the faulty

replaceable item. If the fault is confirmed, the security block remains disabled, an action report identifies the physical coordinates of the replaceable item, and an alarm is generated. However, if the diagnostic does not confirm the fault, the security block is initialized and put back into service. Initialization of security blocks starts at the highest level in the hierarchy. A loop counter is incremented each time a security block is returned to service following an unconfirmed fault. If this counter reaches a preset threshold, the security block remains disabled and an alarm is generated.

All defense functions that are executed automatically can also be requested by an operator. A special interface module between exchange defense and the input/output system translates the operator input into action requests, takes care of sequencing if several security blocks are involved, and translates requests on replaceable items into actions on security blocks. To protect the system against inadvertent operator error, some requests require confirmation by the operator after the system has issued a warning (e.g. grade of service is endangered).

Fault reporting, security block defense, and alarm chain all operate reliably even in the event of a fault in the reporting control element and/or maintenance control element. Critical faults are repeated until acknowledged by a maintenance action. The defense chain is secured by repetition of the "trigger" condition, while internal audits ensure that no action is left incomplete so that security blocks will always end up in a defined state. The alarm chain is secured by an audit of the defense status against alarm record information.

Control Element Defense (Figure 3)

Although the above defense principles apply to control elements as they are security blocks, their tasks impose additional requirements. Control element defense includes:

- control element restart
- control element crossover
- control element switchover
- control element takeover
- control element bootstrap
- periodic access check.

Control element restart. After the operating system has been initialized, all software

modules are sequentially initialized. Initialization is left to each software module. For example, device handlers initialize the devices they control. As a result, stable calls (calls in the conversation phase) are not affected. Restart is a self-contained recovery action which is, in most cases, initiated autonomously by the control element.

Control element crossover. This recovery mechanism is used for the TCEs associated with subscriber and trunk modules. The TCEs in a module pair continuously supervise each other. In the event of a TCE failure, the working TCE autonomously takes over control of both terminals. When a repaired TCE comes back on line, it takes back control of its associated terminal. Exchange defense is not involved (except when the action is requested by an operator) and is not informed of a crossover action. The operating system ensures that messages are always routed to the TCE which is in control of the terminals.

Control element switchover. This changes the active/standby role of a control element pair. Switchover is done autonomously on restart of the active member of the pair or on reception of rerouted messages by the standby member that cannot be forwarded (i.e. inability to communicate with the active member of the pair). Switchover of active/standby status of a control element requires notification to all other control elements so that they may update their message routing table. The recovering control element informs the *broadcast control software module* (in the clock and tone module) so that up-to-date message routing information can be distributed to all control elements over the tone bus.

Control element takeover. Spare control elements are provided for duplex system ACEs or system ACEs operating as a member of a pool. As soon as the sanity timer alarm indication is received for such a control element and the reload attempt fails, the software configuration manager selects a spare control element which is preloaded with a software package matching that of the failing control element. The spare is then switched into the configuration, and the maintenance software updates the message routing table so that the control element can assume a functional role. The selected control element is then loaded with the data required to perform its function, after which it performs a restart.

Figure 4
Routine and audit tests.

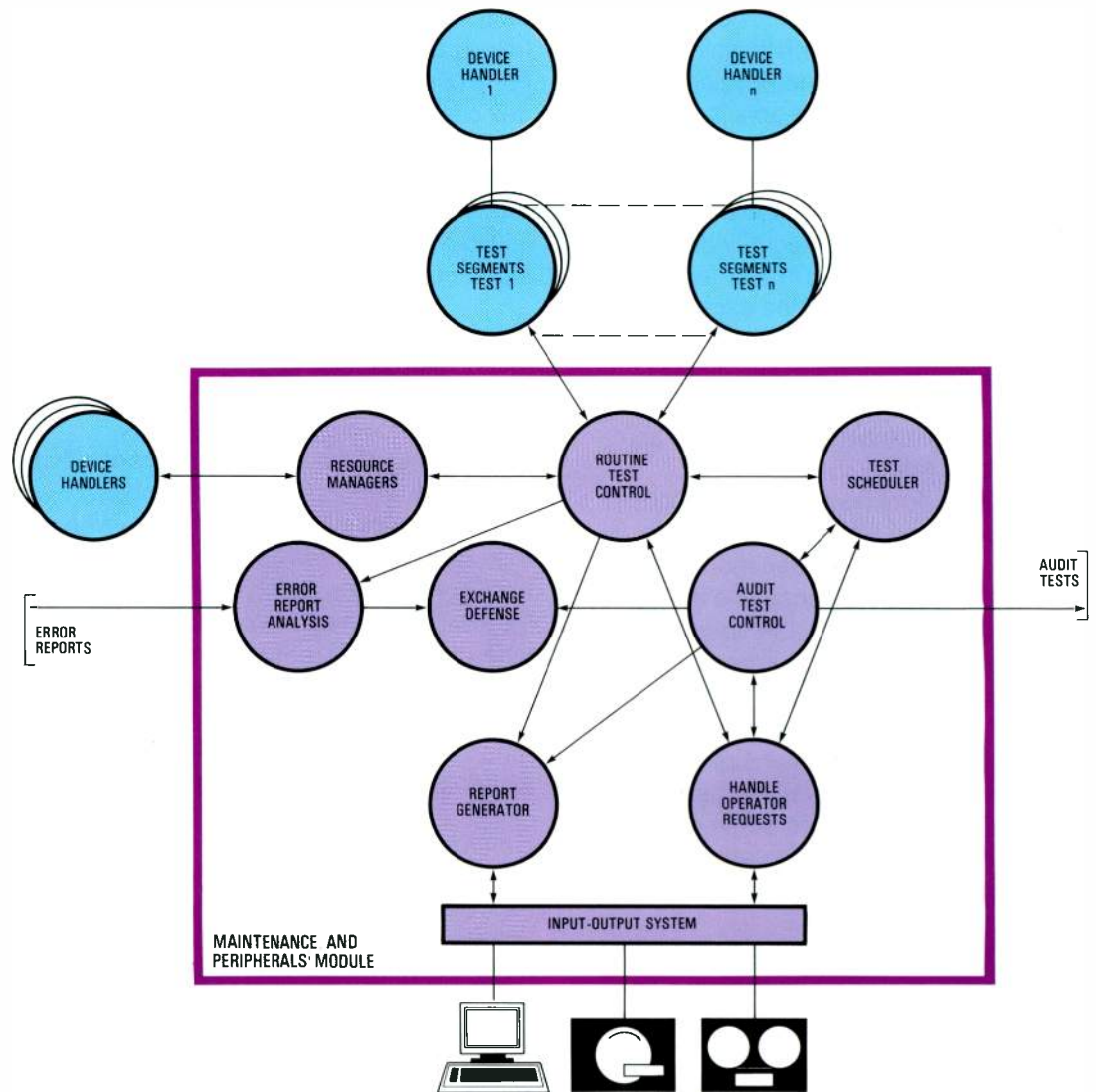

Control element bootstrap. This is the most severe recovery action: the control element is completely reloaded from disk. Before loading, a fast test is executed by a program in read-only memory to check that the control element is still working correctly. The decision to bootstrap can be made locally by the control element itself, or the action can be triggered by exchange defense. In both cases loading is carried out under the control of the maintenance and peripherals module on receipt of a *reload bid message* from the involved control element. This recovery chain operates reliably even in the event of a fault in the maintenance and peripherals control element. Failure to reload a booting control element within five minutes always results in the reload bid being repeated, so that the action may complete on the next attempt.

Periodic access check. This function provides a watchdog mechanism by systematically and frequently probing all

control elements. Failure to answer is promptly reported to the error report analysis software module so that recovery can be started.

A control element may be forced into the bootstrap condition by exchange defense for software maintenance (i. e. patching or software replacement to correct, enhance, or extend the software). This is achieved gracefully by triggering a partial reload, thereby skipping execution of the fast test. Partial reload ends with a control element restart while preserving stable calls.

Tests (Figure 4)

An extensive set of test modules ensures that any equipment failure or system data inconsistency is rapidly detected and located. The test strategy is based on maximum flexibility. All tests can be triggered automatically when a fault is detected, scheduled automatically, or requested by an operator. Where appropriate,

tests are functionally subdivided into test segments which are loaded consecutively during a test to minimize memory requirements. It is possible to speed up testing by specifying only one or a few test segments if it is only necessary to test a few equipment functions.

Tests can be split into three categories, each with its own control mechanism:

- diagnostic tests
- routine tests
- audit tests.

Control software modules initiate loading and sequencing of the test segments, allocate resources, and compile detailed fault reports. Special hardware devices (e.g. test access unit, trunk test module) are allocated by resource managers as necessary.

All output reports are sent to the report generator where they can be printed, displayed on a VDU, or recorded on a historical file on disk.

Diagnostic test control is part of the defense chain because diagnostic tests can only be carried out on security blocks that are out of service. Routine test control and audit test control interface with exchange defense either directly or via the error report analysis software module to trigger a *verify* action.

Report and Alarm Generation (Figure 5)

All maintenance reports are routed via a central module, the report generator, which allocates input/output devices to error report types and logs test results in historical files. An operator interface allows the allocation of input/output devices to be changed and historical files to be displayed. Action reports are routed from the report generator to the alarm control module where they are tagged with an indication of the urgency of the alarm associated with the defense action before being passed to the input/output system.

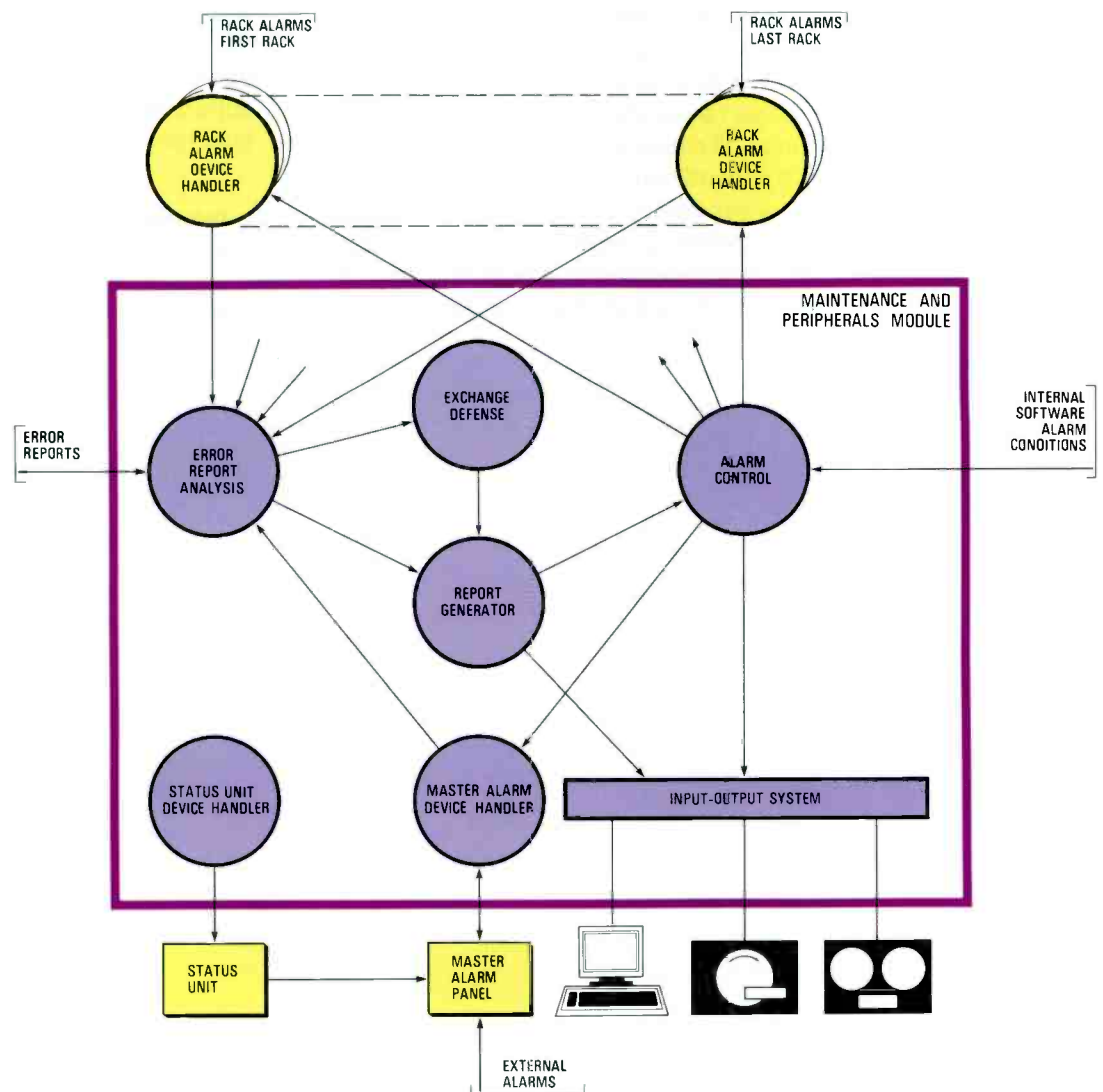

Figure 5
Report and alarm generation.

Main alarm panel for System 12 maintenance.



Alarm points are continuously supervised by fast scanning which is always performed by two control elements per rack. Any alarm transition (on-off/off-on) is reported to the local error handler. Normal fault analysis is then performed which may result in defensive actions on control elements or security blocks; this in turn leads to action reports being generated. All alarm reports are routed through an alarm control module which maintains alarm records (i.e. reasons why an alarm indicator is on), issues orders to drive rack and master alarm indicators, and provides mechanisms for alarm level escalation (e.g. several nonurgent alarms leading to an urgent alarm).

Again alarm reporting operates reliably under all circumstances. The hardware alarm condition is repeated periodically by the alarm device handlers until it is recorded by software. Consistency between alarm indicators and alarm records is guaranteed at all times by auditing alarm records

whenever an alarm is reported. Alarm records are kept on disk so that they can survive any control element fault.

To recover from a complete maintenance and peripherals module failure, an external sanity checking device "status unit" is connected to it via its high speed cluster bus. If the status unit device is not accessed during a preset period, a special dual failure alarm is generated on the master alarm panel and all other alarms are inhibited.

Conclusions

The maintenance subsystem provides the high standards of quality, reliability, and flexibility which are a feature of System 12. Full advantage has been taken of the distributed modular architecture to ensure that System 12 is much less susceptible to the effects of faults than previous telephone switching systems, while at the same time reducing overall complexity.

Simple central control element mechanisms that communicate through the standard System 12 interfaces provide an adequate means for efficient exchange operation, thereby simplifying day-to-day supervision with minimal manual intervention.

Reference

- 1 R. H. Mauger: System 12: Architecture for Change: *Electrical Communication*, 1985, volume 59, no 1/2, pp 35 – 42 (this issue).

System 12

ISDN Field Trials in the Belgian, Italian, and Spanish Networks

Field trials of the System 12 ISDN configuration in a number of countries are proving the ability of the distributed control architecture to cope with the integration of services. At the same time valuable experience is being gained which will help ITT and the participating administrations to implement commercial ISDNs at the earliest possible date.

F. Haerens

Bell Telephone Manufacturing Company,
Antwerp, Belgium

B. Rossi

FACE Research Center, Milan, Italy

J. M. Serrano

Standard Eléctrica SA, Madrid, Spain

Introduction

It is almost universally accepted that future progress in telecommunication will be based on the evolution of the present predominantly analog telephone network to an integrated digital network, which will itself evolve into an integrated services digital network able to carry both voice and non-voice services with equal ease. This evolution is based on improvements in digital technology and advances in VLSI devices. As explained elsewhere in this issue, ITT's System 12 Digital Exchange takes advantage of these trends, thereby enabling it to meet the needs of a future ISDN. System 12 facilitates the integration of existing and new services as it handles all types of digitally encoded information (e.g. digital speech, data) in exactly the same way. Consequently System 12 makes it possible to move directly from the present telephone network to an ISDN where this is more appropriate than evolution through an integrated digital network.

Although there has been considerable discussion of the ISDN in the world's telecommunication community, and CCITT are discussing standards for its implementation, very little has yet been done to prove its feasibility. ITT, as a leading proponent of the ISDN, has therefore undertaken to set up ISDN field trials in cooperation with a number of European

telecommunication administrations. The objectives are to prove that an ISDN can be realized in the near future, to demonstrate that the System 12 Digital Exchange is well suited to the implementation of an ISDN, and to gain field experience on which to base the installation of national ISDNs. Field trials are already underway or being planned in the Federal Republic of Germany¹, Belgium, Italy, and Spain.

Objectives of the Field Trials

Three ITT associates in Belgium, Italy, and Spain have jointly developed a field trial configuration, based on the System 12 Digital Exchange, which will be implemented in cooperation with the telephone administrations in these countries. Even before the trials begin, it is important for ITT to cooperate with these administrations to agree on specifications for the standardization of interfaces, protocols, and services. This is necessary both with individual administrations on a national level, and internationally within CCITT. An initial objective of the field trials will therefore be to evaluate these standards and see how they might need to be modified for use in a real ISDN. At the same time, the field trial will enable administrations to gain experience in applying international standards to their national networks.

A second objective will be to demonstrate that System 12 can implement service enhancements, add new services, and incorporate advanced technology without modification to the basic structure.

Third, the field trials will stimulate demand for new services and facilities by demonstrating to potential subscribers the range of services that is possible using digital connections.

The results of the field trials will be fed back to the System 12 design centers so that they can evaluate how well the exchanges have performed while carrying live traffic in an ISDN. Any small changes that are necessary will then be implemented so that final design and manufacture of the various custom VLSI devices can be carried out in preparation for the widescale implementation of ISDNs in national networks.

ISDN Field Trials

Belgium

In Belgium, the RTT (Regie van Telegrafie en Telefonie) and BTM (Bell Telephone Manufacturing Company) have jointly planned an ISDN field trial which will be used to try out the integration of voice and data services, such as analog and digital telephony, teletex, facsimile, and videotex. By the end of 1984 the trial will demonstrate circuit- and packet-switched call handling functions in the Marie-Henriette local exchange at Namur. Subsequently both the Marie-Henriette exchange and the Brecht exchange in Antwerp will be used to demonstrate ISDN circuit- and packet-switched connections to the Belgian CCITT No 7 common channel signaling network and to the Belgian packet-switching network via X.75 links.

Italy

The Italian telephone operating company SIP (Societa Italiana per l'Esercizio Telefonico) and the FACE Research Center have jointly planned the present ISDN field trial model of Bologna Pallone. The trial

covers the integration of voice and data using services such as telephony, teletex, facsimile, videotex, and personal computers, all handled by the System 12 ISDN exchange at Bologna which was installed by FACE. This is an enhancement to the Bologna System 12 exchange.

Spain

A joint working group from the telephone administration CTNE (Compañia Telefonica Nacional de España) and Standard Eléctrica has agreed to set up an ISDN field trial based on the Diana System 12 exchange. This exchange will integrate the analog telephone service with digital voice, teletex, facsimile group 3, and personal computers. It includes circuit switching for local, incoming, and outgoing calls, and packet switching for local calls. The trial is scheduled to start in July 1985.

Extension of this initial trial to cover other services and connection to IBERPAC, the Spanish packet-switching network, is currently under discussion between CTNE and Standard Eléctrica. In parallel, studies are underway to determine the optimum strategy for introducing ISDN into the Spanish network.

Digitization of the Subscriber Loop

At present, when a telephone subscriber is connected to a digital exchange, the analog voice signal must be converted into digital form before it can be switched through the exchange. In many types of exchange this analog-digital conversion is performed by providing a codec (coder-decoder) for each subscriber line. However, if this codec is transferred to the subscriber's premises and a digital transmission system installed between subscriber and exchange, the subscriber line can be digitized, making it possible to transfer digitized speech and any kind of data over one or more 64 kbit s⁻¹ channels. CCITT is recommending a 144 kbit s⁻¹ basic access consisting of two 64 kbit s⁻¹ B channels and a 16 kbit s⁻¹ D channel as the highest rate that can be

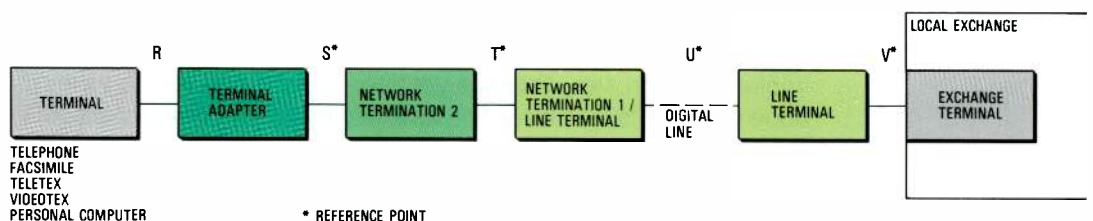

Figure 1
Reference configuration for access to ISDN.

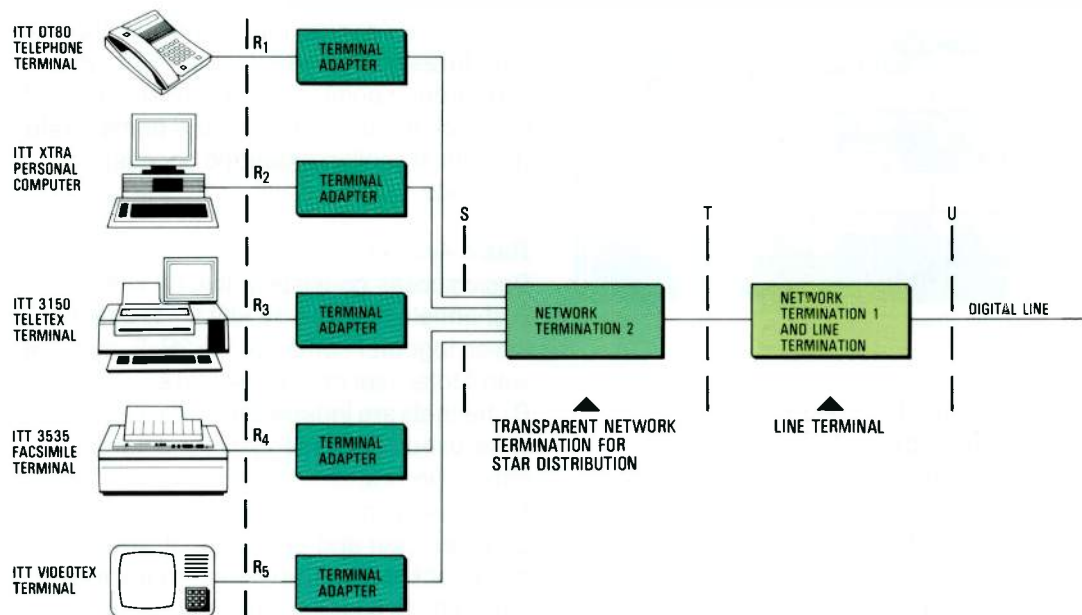

Figure 2
Block diagram of the
end-user installation.

achieved over the standard telephone wire pairs which are already in use in subscribers' offices and homes.

Two main transmission techniques are being evaluated; namely the burst (or ping pong) method and the digital hybrid with echo canceling. The latter has proved to have the better performance and is likely to become the recommended solution, although it is not intended to issue international standards for the transmission system between subscriber and exchange (at the U reference point).

All the ISDN field trials discussed here use an auto-adaptive digital hybrid with echo cancellation. In cooperation with their national administrations, FACE and BTM have carried out extensive studies of this technique. The results have shown that the performance, in terms of distance, quality of transmission, bit error rate, and recovery of synchronization, is excellent. As a consequence, a VLSI version is already being designed.

Transmission over the digital subscriber loop uses the two 64 kbit s^{-1} B channels and one 16 kbit s^{-1} D channel recommended by CCITT. The adopted 3B/2T code allows the overall speed on the loop to be reduced to $104 \text{ ksymbol s}^{-1}$ ($96 \text{ ksymbol s}^{-1}$ carry information; the other 8 ksymbol s^{-1} are for housekeeping and synchronization).

Interfaces

Figure 1 shows the basic reference configuration for access to the ISDN. The S, T, U, and V reference points

(indicated by CCITT) separate the functions located in the terminals, terminal adapters, and network terminations NT 1 and NT 2. These functional groupings are defined in relation to the layered structure of the OSI reference model.

The R interface between the terminal and the terminal adapter is not considered as a reference point as the adapter is an interim solution to interface off-the-shelf terminals to an ISDN. In the final stage, when all recommendations have been finalized, the terminal adapter will migrate to the ISDN terminal which will then interface with the outside world via the S interface reference point.

Network termination NT 1 contains the functions belonging to layer 1 (physical), that is, the line transmission functions, timing, and layer 1 multiplexing. Network termination NT 2 includes the functions related to layers 2 and 3 of the OSI reference model; NT 2 is also able to control a local area network. It is possible for only some NT 2 functions to be present (e.g. only layer 2), or none at all. In the latter case, the network termination is termed "transparent". The local area network can be of the ring, star, or bus type; it will serve a number of different terminals irrespective of the degree of intelligence of the network termination.

Figure 2 shows the end-user installation implemented in the field trial models. Each digital subscriber will have several terminals connected via a terminal adapter to the transparent network termination. The main function of the terminal adapters is to translate the terminal interfaces (R_1 , R_2 , R_3 ,

Figure 3
Full use of address field A.

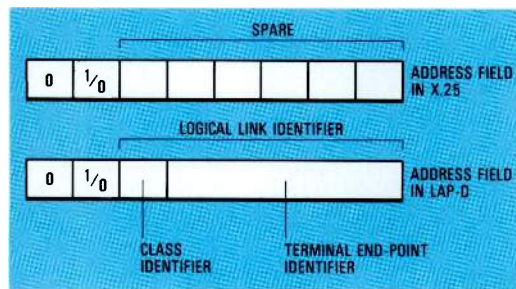

R₄, and R₅) into the common standard S interface. Both the S and T interfaces have been implemented in a way that does not necessarily meet present or future standard CCITT interfaces. To enable development to start, it was agreed to freeze the specification in November 1982, taking the state of the art at that time as a working basis.

The line terminal at the exchange side and the NT 1/line terminal at the user premises provide the same transmission functions to the digital line. While the NT 1/line terminal will be integrated physically in NT 2 (when the custom VLSI circuit has been developed), the most economical solution will probably be to amalgamate both the exchange terminal and line terminal functions into an integrated digital line circuit, so that there will be no physical interface at the V reference point. The physical interface T will always be available irrespective of whether the transmission system is integrated in the terminal or NT 2.

Different physical interfaces and channel structures may be used for the S, T, and U reference points; the two most important ones are the basic access and primary rate (previously called extended access) channels.

Basic Access

Basic access consists of two 64 kbit s⁻¹ B channels and one 16 kbit s⁻¹ D channel which together comprise the 2B-D interface with a total user rate of 144 kbit s⁻¹. The two B channels are independent, enabling them to be used simultaneously for different connections and different services. The D channel carries signaling information between user and exchange; it can also carry packet data (*p*-type information) and telemetry (*t*-type information).

Several other functions have to be performed across the S interface: bit timing, octet timing, power feeding, activation and deactivation, request and permission to access the D channel, and request and permission to busy one of the B channels.

While B channels are assigned to a terminal throughout the call (i.e. they are handled in a circuit-switched mode), the D channel is shared by all active terminals (i.e. it is handled in a packet-switched mode). Thus an arbitration mechanism is necessary to grant access to the D channels without conflict (i.e. contention resolution at layer 7). A mechanism based on carrier sensing has recently been chosen by CCITT: the field trials use a similar approach based on a demand/acknowledgment algorithm.

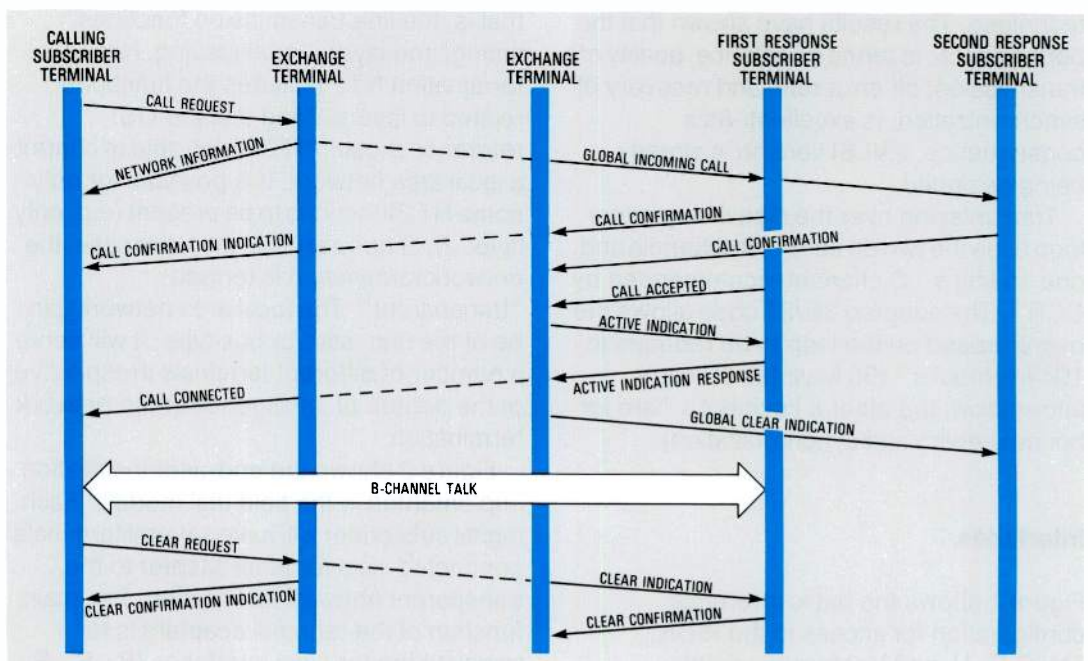
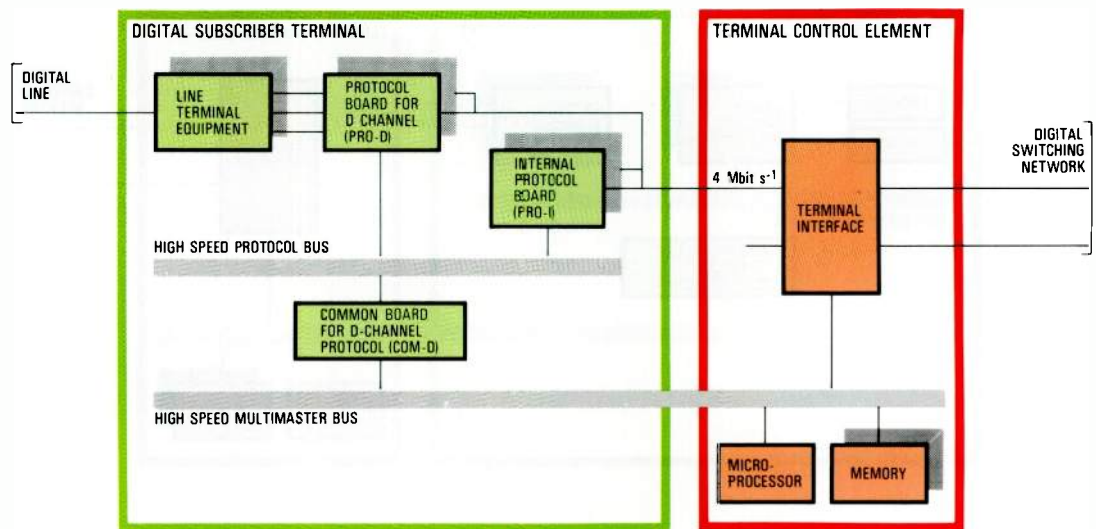

Figure 4
Example of telephone setup and clearing procedures.

Figure 5
Digital subscriber
module used in the
ISDN field trials.



Signaling

All signaling information between the user and the network is carried over the D channel, the signaling functions being structured in accordance with the OSI layered reference model (up to the network layer):

- Layer 1 functions, as already described.
- Layer 2 of the D channel line access protocol (LAP-D) is based on LAP-B of CCITT Recommendation X.25 and extended with the procedures required for ISDN application. The most important difference, shown in Figure 3, is the full use of address field A. Extension of the field A is a result of the point-to-multipoint working of ISDN (X.25 is point-to-point only).

The logical link identifier defined in the layer 2 address field consists of a terminal end-point identifier which determines the physical end point (e.g. a specific terminal out of the ones which are equipped), and a class identifier which distinguishes between line access protocols with different characteristics (e.g. one protocol for *s*-type information and one for *p*-type information).

Layer 3 procedures are also based upon X.25 procedures using messages such as *call request* and *call connected*. As can be seen in Figure 4, the layer 3 procedure is extended with other messages, such as *network information* and an *active indication*, which contain additional parameters and different service indications.

The protocol implemented in the field trials addresses all the basic principles discussed within the international

standardization bodies. At present the protocol is being designed to cope fully with CCITT Recommendations Q.920 and Q.930, and to comply with the requirements of wideband switching.

Exchange Modules

New services can easily be added to a System 12 digital exchange by equipping modules dedicated to the services to be implemented. The ISDN exchanges used for the field trials incorporate two important new modules, the digital subscriber module and the packet switching module. The integration of ISDN features raised two main problems; handling of the digital subscriber loops (and their LAP-D protocol) and handling of CCITT X.25 packet terminals.

Digital Subscriber Module

The digital subscriber module (Figure 5) directly interfaces with the 144 kbit s^{-1} digital lines. Each digital line (two B channels and one D channel) is supported by one PRO-D (protocol board D) which has the primary function of separating the D channel from the B channels, as they are handled differently.

The main features of the digital subscriber module are:

- Layer 1 functions are fully handled by the line terminal.
- Layer 2 functions of the D-channel protocol are handled by the PRO-D board; they include dynamic multiplexing and demultiplexing of D-channel data calls, error recovery and retransmission,

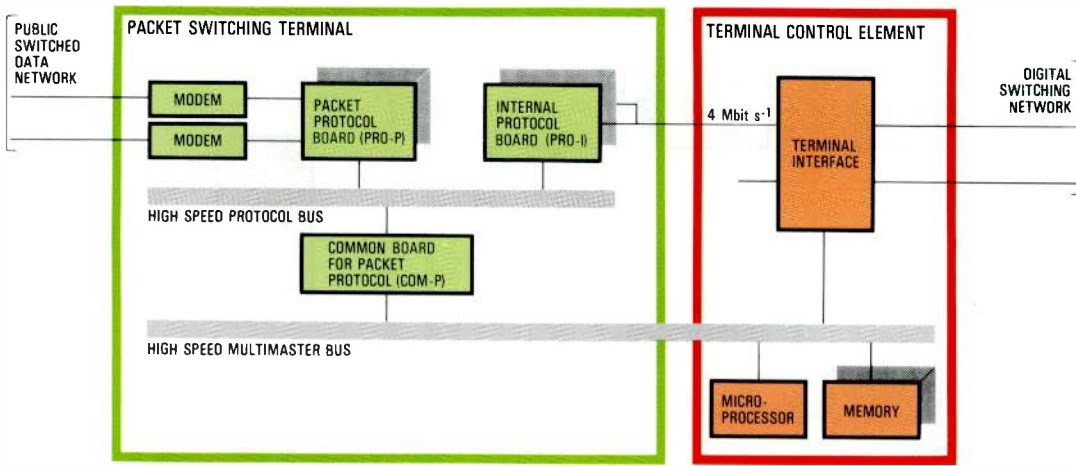

Figure 6
Packet switching module used in the ISDN field trials.

and point-to-multipoint procedure for multiterminal configurations.

- Channel mapping of the B channels onto internal timeslots by the PRO-D board. Apart from this mapping, B channels are handled fully transparently.
- Common board COM-D acts as a functional switch for information on the D channel; s-type information (i.e. layer 3 signaling information) is forwarded to the terminal control element for further processing, while p-type information (i.e. packet data information) is sent to the destination module via PRO-I (protocol board – internal).
- Layer 2 functions of the internal protocol (e.g. multiplexing and demultiplexing of data and signaling on the internal links) are handled by PRO-I.
- Layer 3 functions (e.g. call control) for telephony and other circuit-switched services are handled by the terminal control element.

Packet Switching Module

The packet switching module has been developed to handle X.25 terminals; it can

be considered as a gateway between the ISDN and a packet-switched data network. Development of this module has been divided into two stages; the first, which is implemented in the field trials, only provides local packet switching functions. The second stage will see the provision of a connection (using the X.75 protocol) to dedicated packet-switched networks.

Hardware for the digital subscriber module and the packet switching module is the same (i.e. the PRO-I, PRO-D, PRO-P, and COM boards are identical). The different functions performed by these boards depend upon the firmware loaded in the read-only memory.

Figure 6 is a block diagram of the packet switching module. Its main functions are:

- Layer 2 functions of the internal protocol (e.g. multiplexing and demultiplexing of data and signaling on the internal links) and layer 2 functions of the X.25 protocol are handled by the PRO-I board.
- Layer 3 functions for terminals with an X.25 interface, such as teletex terminals, are handled by the terminal control element.

Figure 7
System 12 ISDN configuration used in the ISDN field trials.

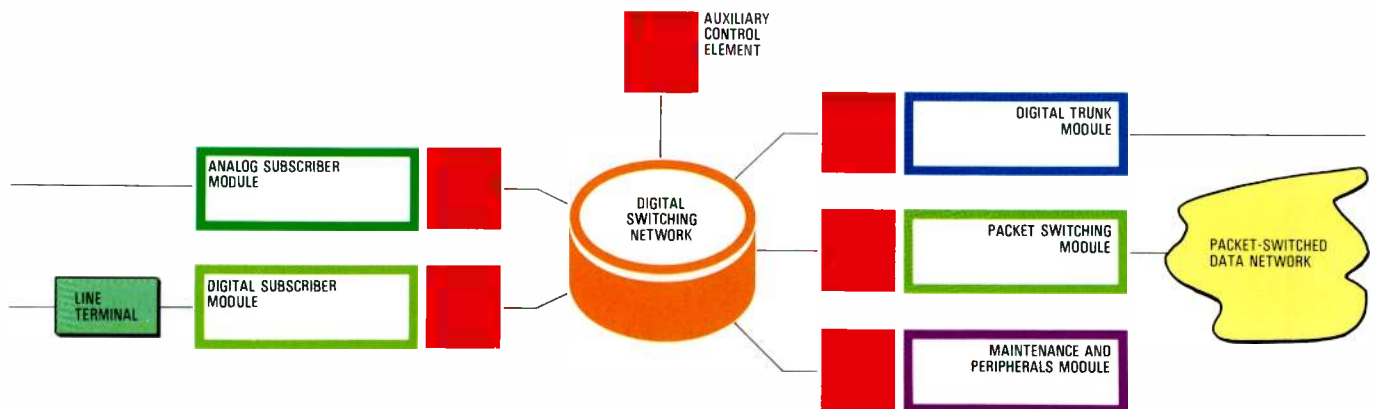

ISDN field trial configuration of the System 12 Digital Exchange at the Bologna exchange in Italy. From top to bottom the photographs show: System 12 digital exchange; digital telephone subset and terminal adapter; and a typical subscriber installation (ITT 3150 teletex terminal, ITT 3535 facsimile terminal, and digital subset).

- Rate adaptation for low speed terminals and packet call charging is performed by the terminal control element.

Field Trial Configuration

The three field trials will be based on modifications to the communication hub designed jointly by FACE, BTM, and SESA. The first of these trials, also believed to be the world's first ISDN field trial, was demonstrated during the 1984 International Switching Symposium at Florence. The integration bed was the System 12 Digital Exchange installed in Bologna for SIP.

Figure 7 shows the ISDN configuration of the field trial exchanges. Four digital subscribers are connected to two digital subscriber modules. Each subscriber will have a number of terminals available, which will be connected via a terminal adapter to the network termination.

The following terminals are being used in the ISDN field trials:

- Cyrrus DT80* digital telephone subset
- ITT 3150 teletex terminal with X.25 interface and 2.4 kbit s^{-1} net user bit rate
- ITT 3535 facsimile terminal with V.24/V.25 interface and 9.6 kbit s^{-1} net user bit rate
- ITT XTRA* personal computer with RS 232C interface and 9.6 kbit s^{-1} net user bit rate.

The digital telephone can be used to make both local and long-distance calls to the analog network.

In the first phase of the field trial only local connections are possible for the teletex and data terminals. Teletex connections are possible with B and D channels as well as interconnections between B and D channels. In this case the packet switching module provides local packet switching and rate adaptation between the channels. This is necessary because the B channel is circuit switched and its 64 kbit s^{-1} bandwidth is fully allocated to one active terminal. The D channel is packet



* A trademark of ITT System

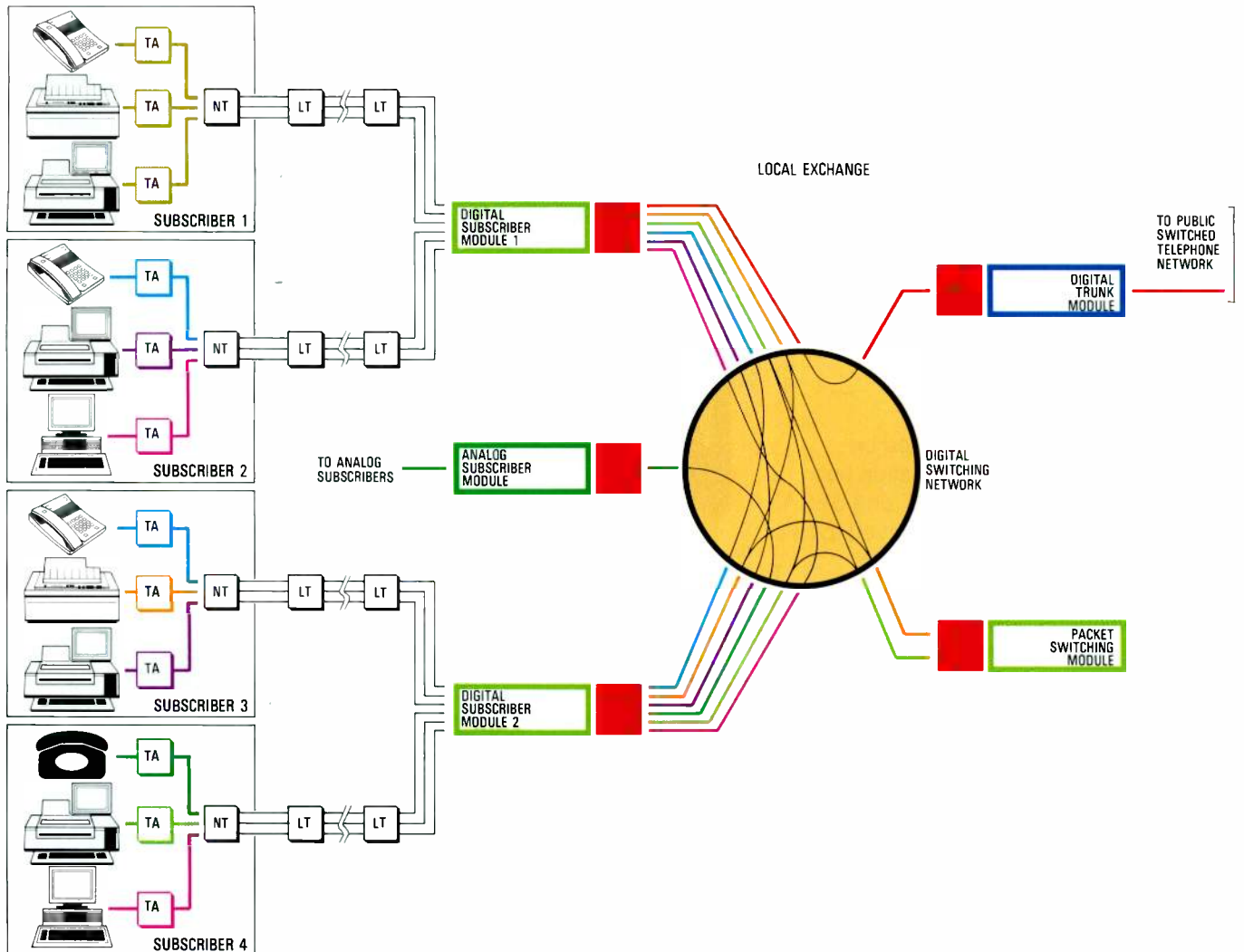

Figure 8
Call scenarios demonstrated using the field trial configuration at Bologna.
 LT - line termination
 NT - network termination
 TA - terminal adapter.

switched and its 16 kbit s⁻¹ bandwidth is shared between a number of terminals.

The digital telephone, facsimile terminal, and personal computer are all circuit switched, so they access either of the two B channels, depending on availability. Simultaneous operation of two terminals over the same B channel is not allowed, but two B channels can be engaged at the same time by two different terminals of any type. Signaling for all terminals is always carried on the D channel.

The teletex terminal is packet switched, and therefore needs to be connected to the packet switching module for layer 3 (call control) function handling. Connection via a B channel requires the terminal to start a hot-line access procedure on the D channel (according to the LAP-D protocol) to obtain access to the packet switching module: once the link has been established, the terminal is transparently connected via the terminal adapter to the packet switching module.

Both signaling and data are handled on the D channel in full accordance with the

ISDN protocol. Once the link to the packet switching module has been established, the terminal is connected to the module via the terminal adapter and the digital subscriber module which performs the link layer control functions (i.e. multiplexing and demultiplexing).

Types of Call

The basic ISDN concepts described in this article were demonstrated during the Bologna field trial. A number of non-voice calls were placed over the digital subscriber loop and handled by the System 12 ISDN exchange, illustrating the feasibility of setting up a number of simultaneous calls over the same telephone pair. Figure 8 shows the types of call that were demonstrated within the framework of the field trial:

1. *Digital telephone to digital telephone call between subscribers 2 and 3. In both cases the digital telephone seizes one available B channel.*

2. *Outgoing call* from subscriber 1 who is accessing the external world. The digital telephone again seizes one available B channel.
3. *Facsimile call* between subscriber 1 and subscriber 3: at both ends of the connection the facsimile terminal uses the B channel which is not already engaged in calls 1 and 2.
4. *Incoming call* from analog subscriber to subscriber 4: again the digital telephone can seize one available B channel.
5. *Personal computer to personal computer call* between subscribers 2 and 4. The two personal computers can only seize the B channel which is not engaged in calls 4 and 1.
6. *Teletex to teletex call* between subscribers 1 and 4.
7. *Teletex to teletex call* between subscribers 2 and 3.

Calls 6 and 7 are packet-switched calls: on the digital local loop the related data is carried on the D channel while switching is performed by the packet switching module.

For clarity, all teletex terminals are shown as being active on the D channel. However, this does not need to be the case; a packet terminal can use either the B channel or the D channel. The use of the B channel by a packet terminal would prevent other terminals using the B-channel resource. Instead the D channel can be accessed by other packet terminals by exploiting logical channel multiplexing techniques. The dynamic algorithm used for channel

allocation is implemented within the exchange in order to optimize the use of the resources (i.e. the channels) on the local loop.

The Future

The second stage of the ISDN field trial model will feature access to dedicated packet-switched networks and the CCITT No 7 common channel signaling network, as well as integration of the videotex service.

Conclusions

Planning and implementation of ISDN field trials based on System 12 exchanges are giving ITT and the cooperating administrations valuable experience which will be used in the realization of full-scale national ISDNs. Future extension of the trials to include access to dedicated packet-switching networks and the CCITT No 7 common channel signaling network are further major steps in ISDN evolution.

Already ISDN field trials have proved the effectiveness of the System 12 architecture for switching voice and non-voice services in an ISDN environment.

Reference

- 1 D. Becker and H. May: System 12: ISDN Pilot Service of the Deutsche Bundespost: *Electrical Communication*, 1985, volume 59, no 1/2, pp 98–104 (this issue).

System 12

ISDN Pilot Service of the Deutsche Bundespost

As a major step towards the implementation of a full ISDN, the Deutsche Bundespost and German telecommunication suppliers will realize a pilot service to gain experience with the new technology and its facilities. One of the trials will be based around a System 12 digital exchange equipped with digital multiservice modules and common channel signaling modules.

D. Becker

H. May

Standard Elektrik Lorenz AG, Stuttgart,
Federal Republic of Germany

Introduction

Over the past five years the Deutsche Bundespost has drawn up comprehensive plans for digitizing the German telephone network, including digital subscriber line field trials¹, introduction of the System 12 Digital Exchange, and evolution to an ISDN. In the case of the ISDN, the Bundespost decided to introduce a pilot service to enable themselves, their suppliers, and potential users to gain experience with the offered features before the introduction of a full scale ISDN. Comprehensive specifications were drawn up during the first half of 1983, and by the end of the year the Bundespost had issued a request for proposals for the pilot service.

Pilot Service Concept

As a result of the success of System 12 in the Bundespost's digital exchange trials,

SEL (Standard Elektrik Lorenz) was one of only two companies asked to submit proposals for a pilot service. The company will be involved in the ISDN pilot service project in Stuttgart; the other will be carried out in Mannheim. Each pilot service will be equipped with 400 ISDN basic accesses. The objective of the Deutsche Bundespost is to gain technical and operational experience, as well as information for standardization of the components and protocols which will be used for digital switching and transmission within an ISDN. Figure 1 illustrates these components and protocols.

The pilot service is scheduled to start by December 1986. During the following two years, additional transmission and terminal equipment from various suppliers will be connected to the pilot exchanges to check their compatibility; common channel signaling modules will also be added. From 1988 on, ISDN equipment will be regularly introduced into the Bundespost's network

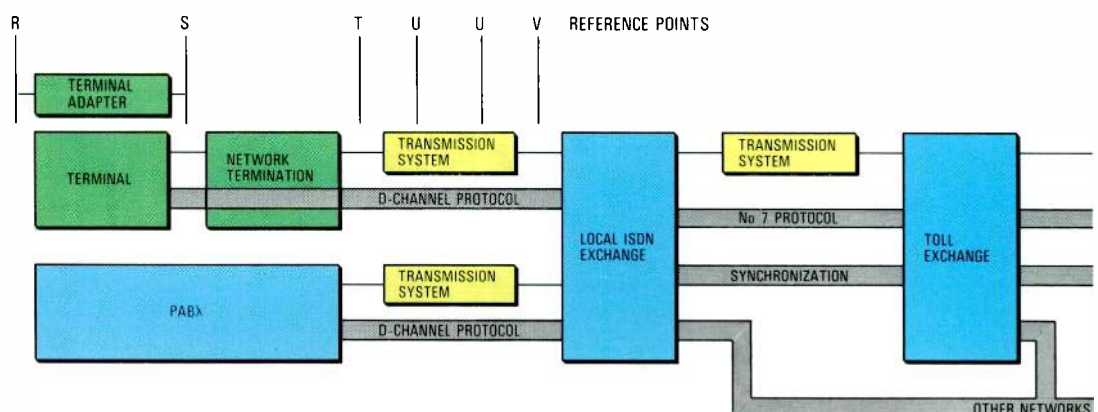

Figure 1
Components and protocols to be tested in the ISDN pilot service.

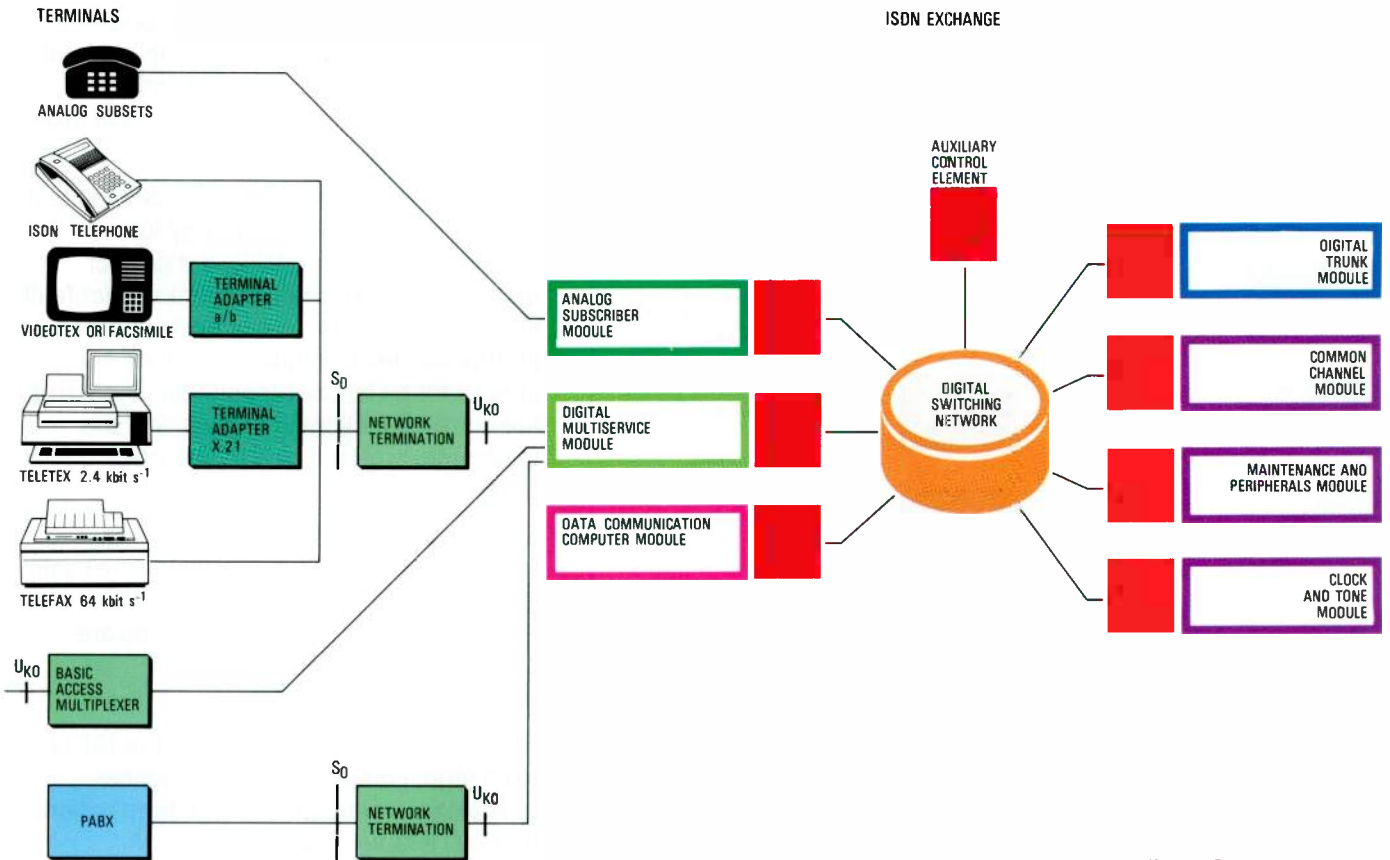

Figure 2
Configuration of the Deutsche Bundespost's ISDN pilot service based on the local configuration of the System 12 Digital Exchange.

so that within a few years the ISDN will be available throughout Germany².

Figure 2 shows the equipment to be developed for the pilot scheme. Services to be provided are telephony, facsimile at 64 kbit s⁻¹, and bearer services via an S interface. Terminal adapters will be provided for CCITT X.21 and for an analog interface. In addition, the services and facilities listed in Table 1 will be realized.

Pilot Service Specification

An important objective of both the Bundespost and the German telecommunication suppliers in defining the pilot service was to follow the latest international standards as closely as possible, especially those from CCITT Study Groups VII, XI, and XVIII. The specification phase from January to June 1983 extended the available CCITT proposals with selected options. In a second phase between November 1983 and June 1984 these documents were brought into line with the latest CCITT standards. As a result of this close compliance with international standards, it will be possible to use most of the equipment developed for

the pilot service for the full ISDN service without significant rework.

The specifications covered the following main areas (see Figure 3):

S₀ interface (subscriber interface) allows for a passive bus or a star configuration using 4-wire copper cable; it complies fully with CCITT Recommendation I.430. Up to eight terminals can be connected to the bus.

Table 1 — ISDN services and facilities in the pilot service

Multiservice operation
Change of service during a connection
Change of device during a connection
Abbreviated dialing
Diversion services
Call waiting
Barring service
Do-not-disturb service
Direct in-dialing
Alarm call
Display of call charge during the connection
Textual information via the D channel (e.g. network blocked, subscriber busy)
General announcements
Malicious call identification
Display of called number

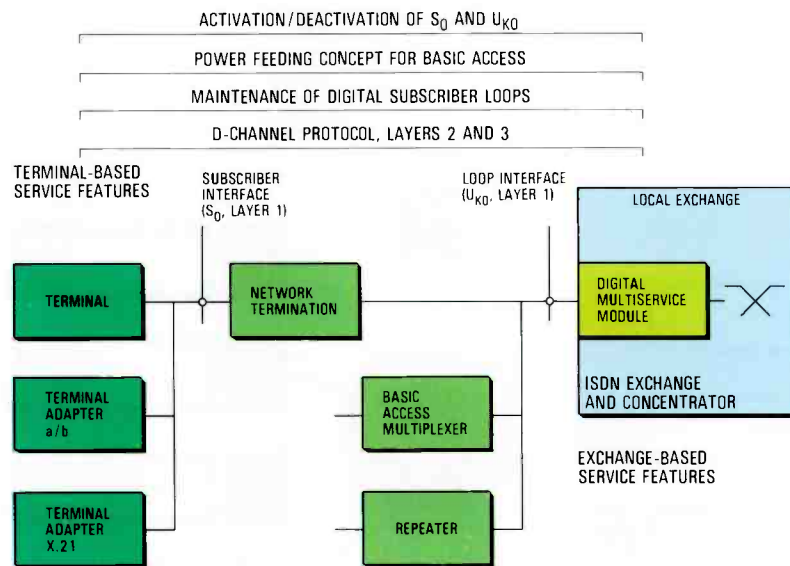

Figure 3
German Bundespost
ISDN pilot service
specifications.

U_{k0} interface (exchange interface) includes the physical and logical parameters of layer 1 for the subscriber loop. Duplex transmission of two B and one D channels is provided for on standard copper pair with 2-wire echo compensation. The MMS43 line code (4B/3T block code) is used with a symbol rate of 120 kbaud, data rate of 144 kbit s^{-1} , 11 kbaud synchronization, and 1 kbaud maintenance channels. The maximum repeater-free length is 4.2 km with 0.4 mm wires and 8 km with 0.6 mm wires.

D-channel protocol fully meets CCITT Recommendations I.441 and I.451. The *multiple frame mode* has been selected for layer 2 because of its advantages over the newly introduced *single frame mode*. In layer 3, the functional protocol will be used because it is applicable to all types of terminal. The stimulus option included in the CCITT recommendations will not be realized in the pilot service. In addition to current CCITT recommendations, the Bundespost specification includes a detailed description of service features and associated procedure scenarios.

Activation/deactivation is based on CCITT Recommendation I.430, which has been extended with respect to the loop activation scenarios. Activation can be started by either the terminal or exchange, whereas deactivation is always initiated by the exchange.

Power feeding is specified for normal and emergency operation. In normal operation, the network termination is fed from the exchange and the S bus is powered with 4 W by a mains-supplied converter for feeding up to four telephones. In an

emergency (mains breakdown), one predetermined telephone is supplied from the local exchange via the network termination. Non-voice terminals have to be powered from the local mains.

Maintenance specification provides the test loop definition and test strategy for supervising the availability and correct operation of outside equipment and for fault location. In addition to loop tests at different interfaces, tests include code violation checks for bit failure recognition, checks of the correct functioning of layer 2 of the D-channel protocol, and loop current measurements.

Service features specifications cover terminal-based features, including the basic ISDN services and facilities listed in Table 1. Procedural details of these features are given in the D-channel protocol specification.

Equipment specifications cover the ISDN exchange, concentrator, basic access multiplexer, repeater, network termination, terminal adapters, and terminals. All specifications are based on CCITT recommendations, together with additional Deutsche Bundespost requirements (e.g. for overvoltage protection, electromagnetic interference).

The above specifications cover all aspects of the planned pilot service. In the meantime, specifications for additional ISDN equipment are being prepared:

- new telephone and telematic terminals
- network interworking unit between the ISDN and the circuit-switched Datex network
- service interworking units for teletex and telefax services.

The availability of all these specifications guarantees stable and reliable conditions for users, the Deutsche Bundespost, and telecommunication suppliers.

ISDN Configuration

Figure 2 illustrates the equipment that will be provided by SEL for the pilot service in Stuttgart. The configuration is based on a System 12 local exchange with the standard modules for analog telephone subscribers with the addition of a DMM (digital multiservice module) for ISDN subscribers. Transmission equipment and both voice

and non-voice terminals for ISDN subscribers will also be tested. SEL will provide digital ISDN DIGITEL* telephones and facsimile terminals with an S interface. The digital telephone is an important link between the subscriber and many service features in the exchange. The use of the D channel and a display makes it possible for subscribers to use the advanced ISDN features in a user-friendly way.

The facsimile terminal, which operates at 64 kbit s^{-1} , complies with CCITT recommendations on facsimile group 4. The transmission time for an A4 page is less than 10 s, clearly demonstrating the advantages over group 2 and group 3 facsimile terminals with their transmission times of several minutes. However, as many group 2 and 3 facsimile terminals, as well as other low speed terminals, are in general use, terminal adapters³ will be provided to allow them to operate at a basic access. A terminal adapter with an X.21 interface and a terminal adapter with an analog a/b-wire interface will be included in the pilot service.

The network termination provides the necessary adaptation between the 2-wire U interface and the 4-wire S interface³. The latter supports a passive bus with D channel contention resolution to which terminals are connected.

Figure 2 shows a PABX operating at the S-bus interface to verify the PABX-related D-channel protocol elements. An ITT 5630 business communication system will be used for the pilot installation. For the introduction of a full ISDN, a 2 Mbit s^{-1} primary rate access is planned to enable large PABXs to be connected to the local ISDN exchange.

A basic access multiplexer will carry 12 basic accesses for remote subscribers to the local ISDN exchange. This multiplexer is connected to a special line board in the DMM via a standard 2 Mbit s^{-1} interface. Such multiplexers will be used to connect ISDN subscribers from exchange areas with analog exchanges to remotely located central ISDN exchanges, enabling administrations to achieve area coverage of ISDN within a few years.

Link Between Subscriber and Exchange

One of the basic principles of ISDN is the digital transmission of two B channels for

user data or speech and one D channel for signaling information. These channels are provided up to the terminals via the S bus. The D-channel protocol is structured in three layers in accordance with the OSI reference model: layer 1 as the physical base, layer 2 for the data link, and layer 3 for network information (Table 2). All the functions relating to these layers have to be performed by the DMM and the terminals. Physical layer 1 includes frame structure and line signal parameters, as well as additional information for loop activation/deactivation, synchronization, and so on.

Data link layer 2 is structured in HDLC format of variable length. The start and end of each frame are marked by a flag, a fixed 8-bit sequence. The 16-bit address field indicates the type of information in the information field (e.g. signaling message, packet data) and contains the terminal's layer 2 address. The control field includes HDLC commands, such as synchronous-asynchronous balanced mode, and sequence numbers for the multiple frame mode. A frame check sequence is used to detect transmission errors.

Network information for call setup, disconnection, activation of features, and so on, is carried in the layer 2 information field. As a functional protocol is used, several commands, acknowledgments, and user data (e.g. called number) have to be processed.

Table 2 – ISDN protocol architecture

Layer	D channel	B channels (circuit switched)
3	Layer 3 address Service identifier Subaddress Network messages	
2	HDLC procedures Layer 2 address Information type	
1	16 kbit s^{-1} Activation, maintenance, synchronization	$2 \times 64 \text{ kbit s}^{-1}$

Figure 4 shows conceptually how these functions will be realized. The physical layer is provided by two custom (V)LSI circuits: the SIC (S-interface circuit) and the UIC (U-interface circuit). The UIC is an echo canceler for 2-wire loop transmission between the exchange and the network

* A trademark of ITT System

Figure 4
Basic ISDN access structure and related (V)LSI chips.

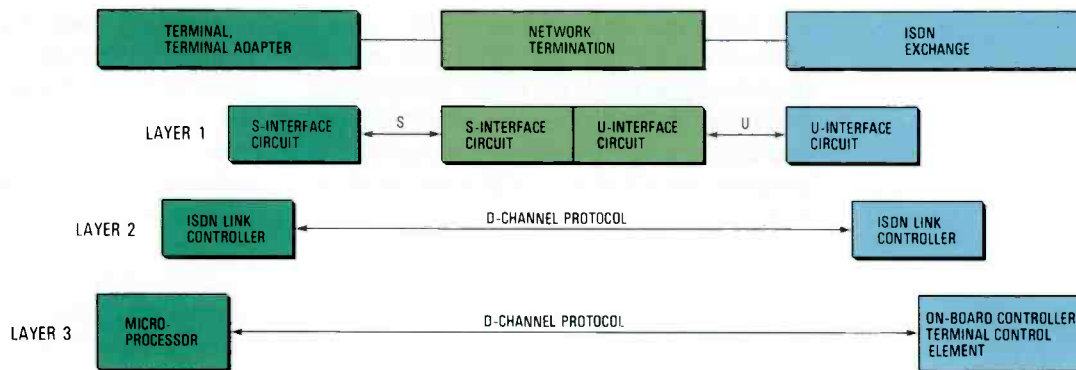

termination^{4,5}. It is used in both the DMM and the network termination. The SIC for the 4-wire subscriber interface is part of the network termination as well as of each terminal.

Basic layer 2 functions are provided by a third custom LSI circuit, the ILC (ISDN link controller), which handles HDLC formatting, the address field, frame check sequence, etc. The ILC is used in components which handle layers 2 and 3 of the D-channel protocol (i.e. in the DMM and in each terminal).

The ILC has an interface to the SIC and to a microprocessor which controls the higher functions of layer 2 and transmits and receives network information via direct memory access. Similarly the microprocessors in the exchange and in each subscriber terminal control all layer 3 functions.

System 12 local exchange (Figure 2). The connection to existing toll exchanges is provided by the digital trunk module. Subscribers with analog telephones communicate with the system via the analog subscriber module. Standard System 12 modules, such as the maintenance and peripherals module (for man-machine communication, testing, maintenance, etc), the clock and tone module, and the auxiliary control elements are all standard parts of local ISDN exchanges.

One of the major advantages of System 12 is that all these modules interface with the digital switching network via a standard terminal control element, enabling new modules (such as the DMM) to be introduced easily without affecting those already in operation.

After the ISDN user part of the CCITT No 7 common channel signaling system has been introduced, the link to other ISDN exchanges will be handled by a common channel module. Tests on this module and the related protocols are planned for a later phase in the pilot service. As an option a data communication computer module can

System 12 Local Exchange

An ISDN local exchange is realized simply by introducing a DMM in a standard

Figure 5
Hardware structure of the System 12 digital multiservice module.

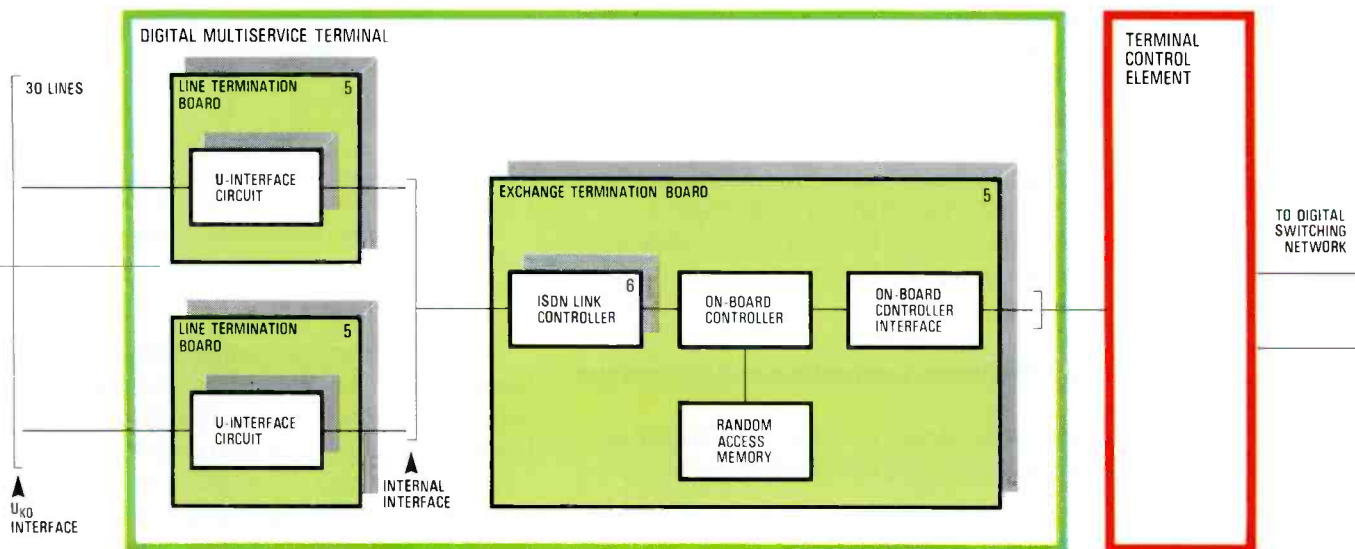

be included to provide additional services, such as improved videotex⁶.

Digital Multiservice Module

The DMM is a new System 12 module for ISDN subscribers. The structure of the DMM for the pilot service is shown in Figure 5. In principle it is similar to the digital subscriber module⁷. The DMM supplies up to 30 subscribers with a basic access via the U-interface. Eleven DMMs will be installed to connect 320 ISDN subscribers in the pilot service.

The line termination printed boards are digital line circuits that perform layer 1 functions⁴ such as:

- full duplex transmission with echo cancellation
- line feeding
- activation/deactivation of the basic access
- maintenance.

Each line termination printed board serves three lines. Key components of these boards are the UIC VLSI circuits⁵.

Two line termination boards are allocated to one exchange termination board via an internal interface. The main functions of the exchange termination are:

- interfacing with the line termination and terminal control element
- performing layer 2 procedures
- transferring layer 3 information to and from the terminal control element.

The key LSI circuits in the exchange termination are the ILCs and the OBCI (on-board controller interface). The ILC performs part of the layer 2 procedures, while the OBCI provides the interface with the terminal control element. An on-board controller, consisting of a 16-bit microprocessor with random access memory and read-only memory for data and firmware, is the front end control unit. This configuration is similar to that described elsewhere in this issue⁷ except that there is no packet switching support as this is not required for the ISDN pilot service.

The main tasks of the on-board controller are to perform the remaining layer 2 functions, control hardware devices such as the ILC, and carry out digital line testing and communication with the terminal control element.



The ISDN pilot service will include both facsimile and teletex terminals.

The terminal control element is the standard System 12 interface to the digital switching network. Its main functions⁶ include:

- message handling for transfer to and from other modules via the digital switching network
- processing layer 3 of the D-channel protocol
- allocation of B channels and the administration of subscriber data
- processing of charging data and information
- line testing control.

Further functions, such as call control, are tasks of the ISDN auxiliary control element. All the exchange functions for call handling, maintenance, man-machine communication, database administration, and so on, can be accessed by the DMM in exactly the same way as by other System 12 modules.

The DMM can be enhanced to an ISDN subscriber module, which handles packet-switched data, by adding a second on-board controller interface and further software and firmware, and by using more of the ILC features which support packet switching⁷.

Conclusions

The German ISDN pilot service is being set up to test ISDN equipment and services, and to provide experience for the full scale implementation of an ISDN in Germany. SEL will provide a complete ISDN system, including a System 12 digital local exchange, the necessary transmission equipment, and voice and non-voice terminals.

A chip set has been defined for this system related to the layers of the signaling protocol and based on the CCITT interface concept; it is currently being implemented.

The addition of a DMM to a System 12 local exchange provides subscribers with access to a range of ISDN features. A common channel signaling module allows interexchange communication based on the CCITT No 7 ISDN user part.

References

- 1 D. Becker, L. Gasser, and F. Kaderali: Digital Subscriber Loops – Concept, Realization and Field Experience of Digital Customer Access: *International Switching Symposium 1981*, Montreal, Canada.
- 2 H. Schön: ISDN – A Challenge for the Deutsche Bundespost: *International Switching Symposium 1984*, Florence, 7–11 May 1984.
- 3 T. Israel, D. Klein, and S. Schmoll: System 12: Configuration of ISDN Subscriber Equipment, Network Termination, Digital Telephones, and Terminal Adapters: *Electrical Communication*, 1985, volume 59, no 1/2, pp 120–126 (this issue).
- 4 L. Gasser and H. W. Renz: System 12: Transmission at 144 kbit s⁻¹ on Digital Subscriber Loops: *Electrical Communication*, 1985, volume 59, no 1/2, pp 127–130 (this issue).
- 5 R. Dierckx and J. R. Taeymans: System 12: ISDN Line Circuit: *Electrical Communication*, 1985, volume 59, no 1/2, pp 105–111 (this issue).
- 6 H.-J. Bergs, S. Nett, and M. Wizgall: Implementation of Services in an ISDN: *International Switching Symposium 1984*, Florence, 7 to 11 May 1984.
- 7 A. Chalet and R. Drignath: System 12: Data Module Architecture Including Packet Operation: *Electrical Communication*, 1985, volume 59, no 1/2, pp 112–119 (this issue).

System 12

ISDN Line Circuit

Development of the ISDN line circuit now makes it possible to realize the full potential of System 12 to handle voice and non-voice services. The new line circuit supports basic access on two 64 kbit s^{-1} B channels for voice or data, and a 16 kbit s^{-1} D channel for low speed data or signaling.

R. Dierckx
J. R. Taeymans

Bell Telephone Manufacturing Company
 Research Center, Antwerp, Belgium

Introduction

Introduction of the ISDN will be an important step in the direction of total communication. CCITT defines ISDN as a network, evolved from the integrated digital network for telephony, which supports a wide range of voice and non-voice services. Users will access the network via a limited range of standard multipurpose user interfaces. The next few years will see ISDN field trials and pilot services being implemented by several European and North American administrations to pave the way for the full scale introduction of ISDNs towards the end of this decade.

Integration of the System 12 Digital Exchange into an ISDN is straightforward as a result of the intelligent digital switching network and intelligent terminal controllers.

The System 12 ISDN line circuit is simply a new intelligent terminal controller featuring specialized line interfaces and protocol conversion hardware.

ISDN Line Circuit

The ISDN subscriber module¹ interfaces on one side with the digital subscriber lines and on the other side through its terminal control element to the digital switching network (Figure 1). This module supports the connection of a cluster of basic access ISDN subscriber lines, that is, 64 digital lines. One basic access is two 64 kbit s^{-1} B channels for voice or data and one 16 kbit s^{-1} D channel for low speed data or signaling.

Figure 1
Basic System 12
architecture including
the ISDN subscriber
module.

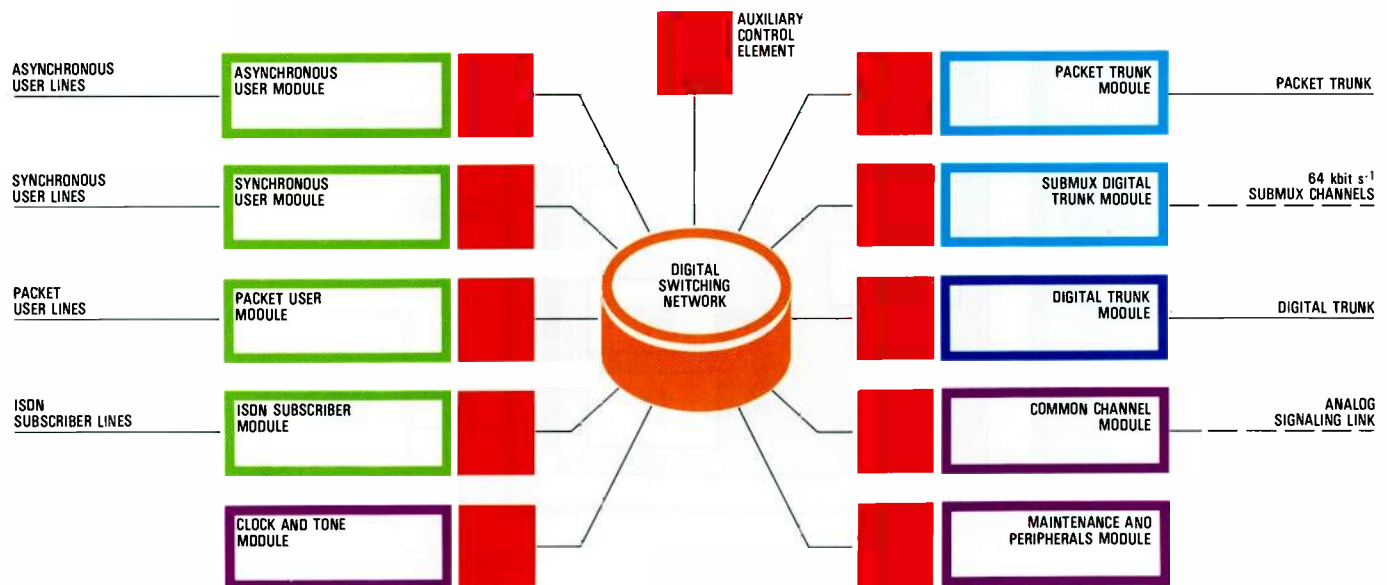

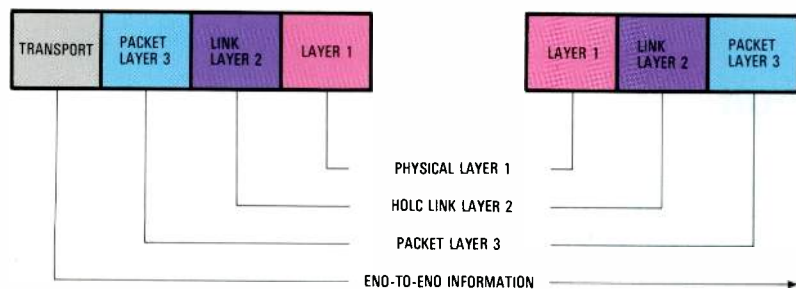

Figure 2
Protocol levels as proposed in the OSI model.

The ISDN subscriber module is able to process both packet- and circuit-switched data. Low speed packet data and signaling can be carried on the 16 kbit s⁻¹ D channel, while higher speed packet data uses either of the two 64 kbit s⁻¹ B channels. The configuration of the ISDN line circuit board differs slightly depending on whether or not the B channels are used for packet data. The case in which one B channel is used for packet data is considered here in more detail; the other channel is then used for transparent data, such as digitized voice.

The ISDN line circuit architecture is strongly influenced by the OSI model for a communication network. This model defines hierarchical communication interface levels in such a way that protocols to corresponding layers at each end of the connection are consistent and well defined (Figure 2).

The lowest level, or layer 1, is called the physical level in which the electrical and physical characteristics of the link are defined. This level requires a physical link over which data can be transported. The UIC (U-interface circuit) supports the layer 1 functions in an ISDN.

Figure 3
Block schematic of the ISDN subscriber module.

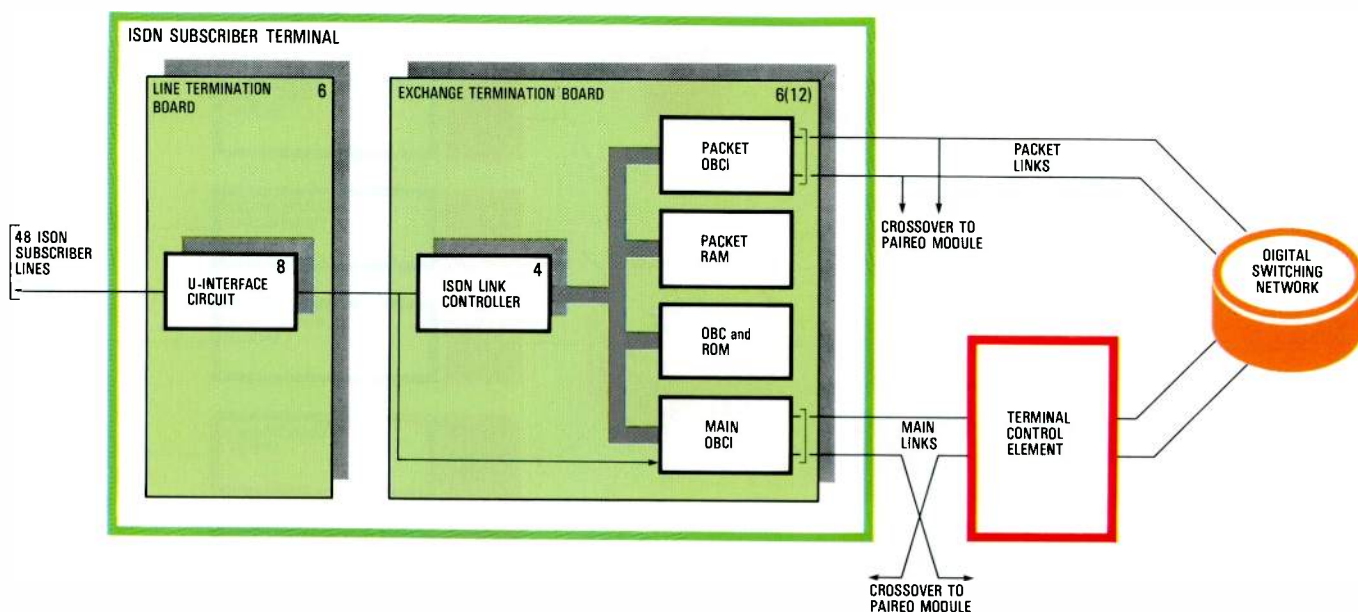

Layer 2, the link level, is concerned with establishing a reliable error-free link to the correct destination over the physical link (layer 1). The layer 2 protocols are based on HDLC protocols similar to the CCITT X.25 protocol for packet-switching systems and the CCITT No 7 common channel signaling protocol for interexchange signaling.

Once a reliable link has been set up supported by layers 1 and 2, the packet level or network control level (layer 3) is used to set up a call. Layer 2 and 3 functions are provided by the ILC (ISDN link controller), OBCI (on-board controller interface), and OBC (on-board controller)¹.

The configuration of the ISDN line circuit, which is part of the ISDN subscriber module, is shown in Figure 3. It is also used in the digital subscriber module¹. The line circuit realizes the interface between the U interface (i.e. subscriber line) and the digital switching network either directly or via the TCE. One line circuit module supports eight basic accesses; an ISDN subscriber cluster consists of six such line circuit modules, giving a total of 48 basic access connections.

The line circuit module consists of six functional blocks:

- Line termination or U-interface circuit which supports the layer 1 connection; this realizes the 2-/4-wire connection of the subscriber lines as well as bit and frame synchronization.
- On-board controller which supports layer 2 and layer 3 control functions for packet-switched data and signaling. The

OBC is a commercial 16-bit microprocessor.

- Main OBCI which supports the switching of B channels to and from the terminal control element.
- Packet OBCI which is used for data packet switching directly to and from the System 12 digital switching network.
- ISDN link controller which supports the HDLC control function. Together with the OBC and packet RAM it realizes all the layer 2 and layer 3 functions. The ILC is a custom VLSI circuit.
- Packet RAM which stores received packets and packets to be transmitted. It interfaces with the OBC, OBCI, and ILC under the control of the OBC.

The functions of the main and packet OBCIs are performed by the same custom VLSIs. Straps and software differentiate between the two interfaces.

U-Interface Circuit

The UIC is the custom VLSI device which supports the physical link (layer 1). Thus its function is to transport 144 kbit s^{-1} data over telephone lines originally installed to carry signals that were band limited up to, say, 4 kHz. Clearly this function is not straightforward. A bothway (full duplex) link must be provided on existing 2-wire lines. If 4-wire lines with sufficient bandwidth were available, the UIC function would be simple.

Setting up of the physical link requires the following functions:

- activation and deactivation of one end using layer 1 signals
- transmission and correct reception of a 144 kbit s^{-1} full duplex signal over 2-wire lines
- word and frame synchronization.

Full Duplex Transmission at 144 kbit s^{-1}

Two main problems arise when transmitting signals at a high bit rate. First, the received signal is attenuated by the line, in the worst case by as much as 46 dB relative to the transmit level. Second, because a 2-wire line is being used, a hybrid is necessary for 2-/4-wire conversion.

Imperfections in the hybrid cause some of the transmit signal to be injected back into the receive path. In the worst case the level of the returned signal can be as high as -6 dBm , while on long lines the wanted

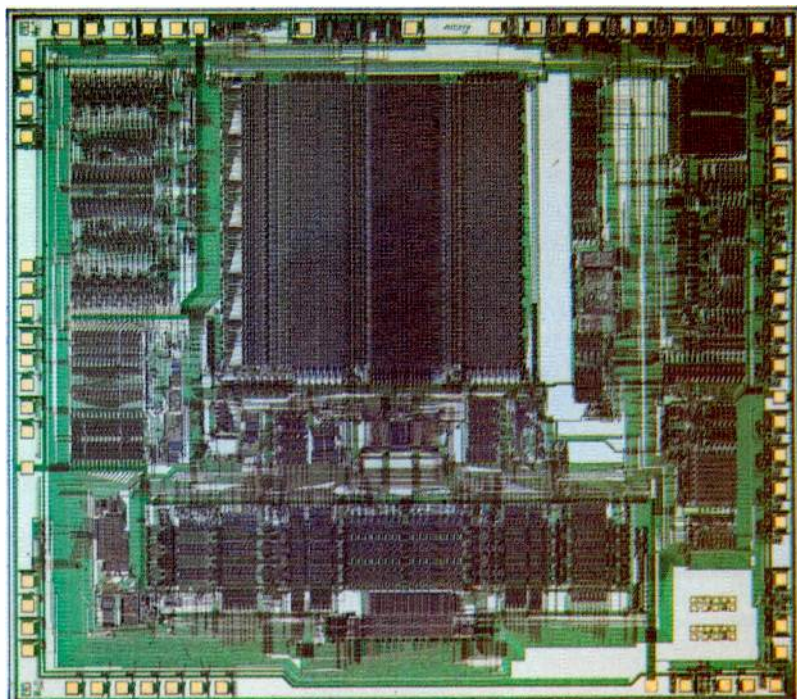

Microphotograph of the on-board controller VLSI circuit for the ISDN subscriber module.

signal may be 40 dB below the unwanted signal. The function of the UIC is to extract the wanted signal even under these unfavorable conditions. In achieving this, the UIC provides a reliable 144 kbit s^{-1} link using lines originally intended to carry no more than a speech signal.

Three methods are used to extract the wanted signal:

- adaptive echo cancellation
- adaptive equalization
- line coding.

It is assumed that both the hybrid leakage and the echo generated by the line (as a result of impedance mismatch) can be modeled by a linear function (Figure 4). In this case the echo can be simulated by a linear filter, enabling it to be subtracted from the actual echo in order to cancel it, yielding the wanted receive signal. Adaptive echo cancellation can be used for automatic

Figure 4 Modeling of hybrid leakage and line-generated echo by a linear function.

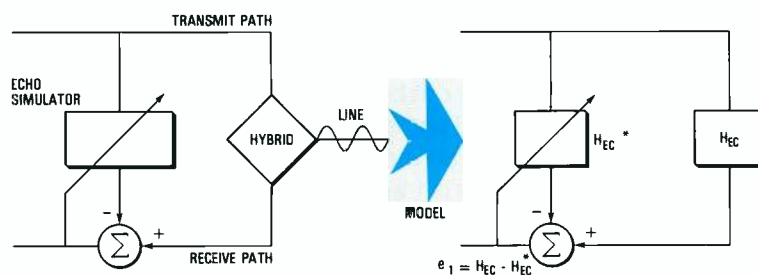

adjustment of the linear filter characteristic to minimize the influence of echo.

The filter can be implemented in several ways (e. g. analog or digital). A transversal digital filter was chosen in which the filter characteristic is defined by the coefficients of the transversal taps; the coefficients are adapted by a least-mean-square algorithm which minimizes the least mean square of the residual echo. Automatic updating of the coefficients is used: residual echo is correlated with its possible cause, and if there is any correlation the coefficients are adapted to minimize the echo.

The function of the equalizer can be compared to that of the echo canceler. Because of the low pass characteristic of the line, data transmitted at the high rate ($120 \text{ ksymbol s}^{-1}$) generates intersymbol interference. The decision as to which symbol has been received must not be influenced by data received before or after the decision point. Any such information must therefore be canceled to ensure that the signal received during a symbol cycle depends only on the symbol transmitted from the far end. This is again a matter of realizing an adaptive digital filter where the coefficients are updated automatically by the least-mean-square algorithm depending on the correlation between residual intersymbol interference and the possible cause of this interference.

In addition, the line coding scheme is designed to decrease the frequency band in which the power spectral density is important. The 4B/3T code, a modified mark-space 4/3 code, is used. For information transfer at 144 kbit s^{-1} the power spectral density function has a maximum at 30 kHz, thus reducing attenuation and intersymbol interference.

Word and Frame Synchronization

An important function of the UIC is the synchronization of both ends. First, bit synchronization is achieved to ensure that sampling is carried out at the optimum instant (i. e. maximum impulse response) in order to maximize the signal-to-noise ratio. Second, it is necessary to detect the position of the symbol sequence within the frame. A digital correlation phase locked loop has been used to carry out both tasks.

The principle of the digital correlation phase locked loop is based on the use of a synchronization word which is transmitted in each 1 ms frame. This enables the received signal to be continuously correlated with the synchronization word.

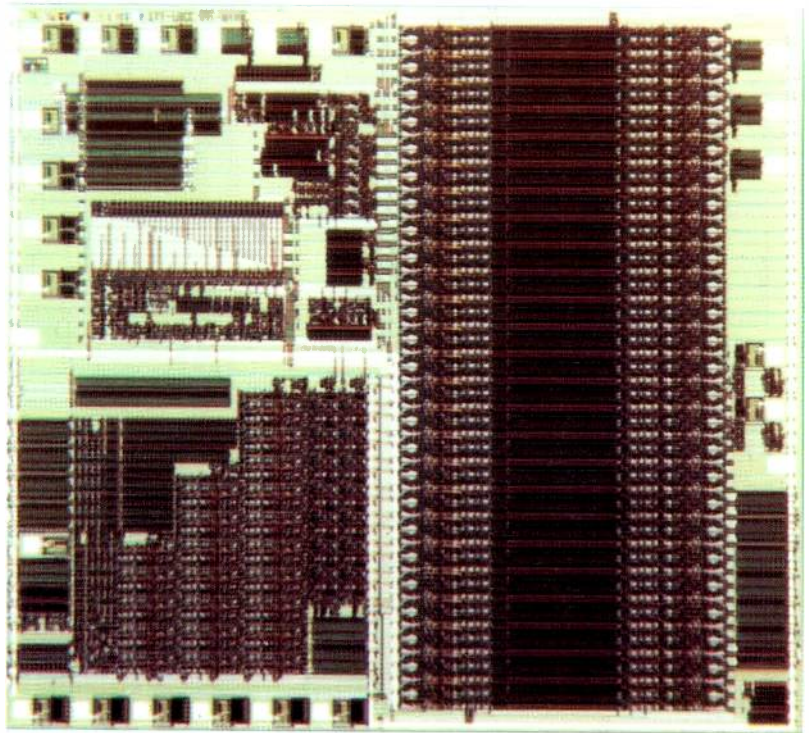

Microphotograph of the echo canceler part of the U-interface circuit chip set. This chip, which consists of 38 000 devices on an area 34 mm^2 , operates at a clock frequency of 15.36 MHz.

Although the received signal is attenuated, the maximum of the correlation function can still be sought. Thus detection of the precise instant at which the maximum of this correlation occurs defines the frame reference. In fact the same operation results in both frame and bit synchronization.

Correlation with the synchronization word has the same shape as a pulse response function (Figure 5). The optimum

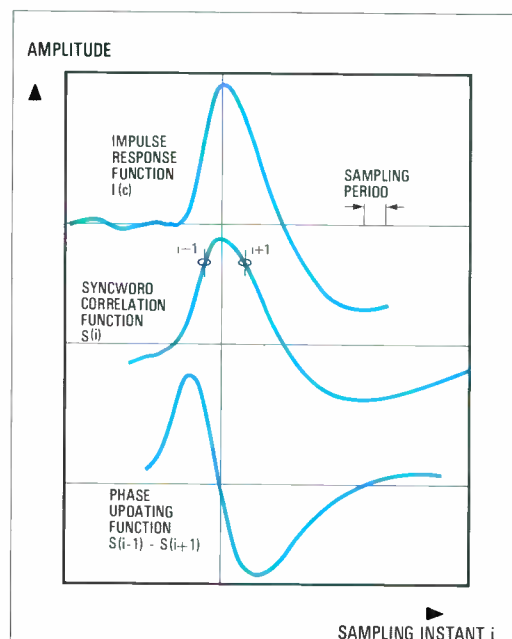

Figure 5 Operating principle of the digital correlation phase locked loop.

sampling moment is exactly at the maximum of the pulse. It is assumed that the pulse is symmetric, so that the signal level is the same one sample before and one sample after the maximum. If the levels are not the same, the difference between them can be used as a feedback control signal to adjust the sampling instant. Control is achieved by increasing or decreasing the 120 kHz symbol period by one 15 MHz clock cycle

influenced by each other, care must be taken to ensure reliable start up. Initially the echo canceler and equalizer coefficients and the sampling instant are not defined precisely; in the worst case, after 150 ms a reliable physical link is set up with a bit error rate of 10^{-6} .

The ISDN loop transmission method has been developed and verified in a field trial by SEL. It has been improved for the

Figure 6
Block schematic of the U-interface circuit.
AGC - automatic gain control
PE - precursive equalizer
S/S - serial-to-serial converter
TE - transversal equalizer.

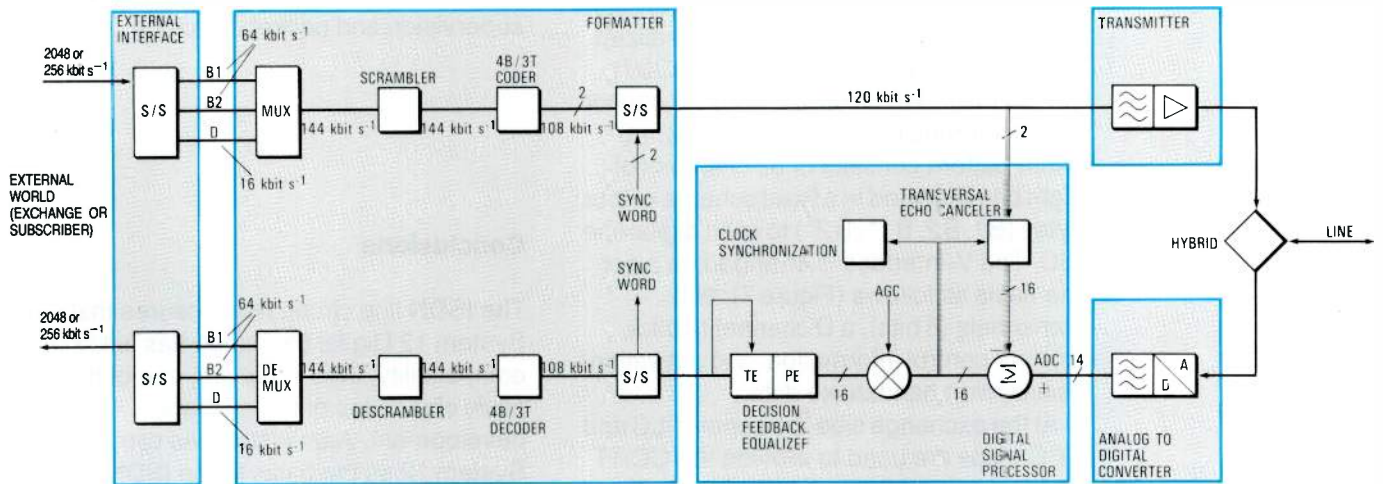

until the difference is zero. This effectively organizes frame and bit clock timing extraction.

Activation/Deactivation

The physical link must be activated and deactivated at layer 1. When no calls are in progress, the UICs are in the power down mode and no physical link exists for transporting data. As a result, a link must be set up by the layer 1 signals. Furthermore, as there is strict separation between the various levels, link deactivation must also be carried out by layer 1 signals.

In order to set up a link, a 7.5 kHz wake-up signal is transmitted by sending the appropriate bit pattern through the transmitter hardware. The 7.5 kHz detector is the only part of the UIC which is always powered up. After an appropriate delay this carrier is detected as wake-up information and acknowledged by sending back a 7.5 kHz signal which is recognized as an acknowledgment by the initializing end.

The two sides are now powered up and the layer 1 connection can be set up: echo must be canceled, the received signal equalized, and both ends synchronized. As these three functions are strongly

German ISDN pilot service and will be realized as the UIC using VLSI technology. Initially a multi-chip version will be developed. The echo canceler chip is a full custom design VLSI circuit developed at the BTM Research Center^{1,2}. Figure 6 shows the functional block diagram of this circuit. The characteristics of the field trial version of the chip are shown in Table 1.

V-Interface Supports ILC and OBCI Circuits

An ISDN subscriber module (Figure 3) provides all the hardware to support CCITT HDLC and interfacing to the System 12 distributed architecture.

Table 1 - Main characteristics of the UIC

Technology	3 μ m CMOS, <i>n</i> -well, double polysilicon, single metal
Transistor count	100000
Area	130 mm ²
Maximum clock rate	16 MHz
Power dissipation	350 mW
Pin count	24

Figure 7
Four-byte interface of the V-interface.

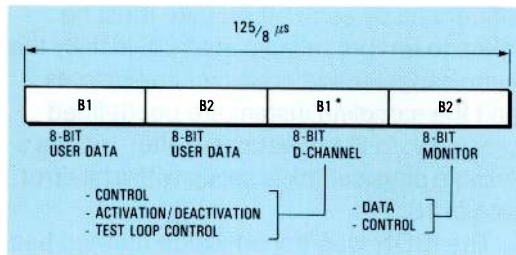

UICs interface with the System 12 exchange through a 2 Mbit s⁻¹ time division link. The connection is physically realized on four wires: two for data (*IN* and *OUT*), one for the 2.048 MHz bit clock, and one for frame referencing (8 kHz). Logically the frame pattern consists of 32 channels of eight bits allocated in a fixed scheme of four bytes (B1, B2, B1*, B2*) to each digital line UIC. The V-interface is arranged on a per line basis as follows (Figure 7): two B channels (8 bits), a D channel (2 bits), monitor control information, and activation/deactivation handshake data.

At the exchange side the generic ILC and OBC chips are used to provide the CCITT protocol and the System 12 interface. These two VLSI devices perform all layer 2 functions. The ILC carries out the serial processing (Table 2):

- generates an HDLC flag and transmits it on the line

- fetches data octets (address, control, and information fields) and transmits them; one 0 bit is inserted after each sequence of five contiguous 1 bits
- generates a cyclic redundancy check and processes it
- generates the end of packet flag.

The ILC also either generates special sequences such as abort and idle, or monitors them in the opposite direction.

The OBC software provides the layer 2 functions of the OSI model, such as link supervision and packet switching.

Conclusions

The ISDN line circuit now ensures that the System 12 Digital Exchange has full ISDN compatibility, thus achieving one of the basic objectives of the exchange development. Administrations can use System 12 as the basis for an ISDN to meet the increasing demand from users for a wide range of new voice and non-voice services. As reported elsewhere in this issue, ISDN field trials based on System 12 are already in progress or in the planning stage in many countries^{4,5}.

Table 2 – ISDN frame format

Direction of transmission	
Bits	←
	8 8 8 n 16 8
	Flag Address* Control Information Frame check Flag
	└──────────────────┘
	└──────────────────────────────────┘
	Packet level
	Link level
Flag	- Performs synchronization function using bit sequence 01111110.
Address	- Defines whether frames contain commands or responses and whether from data terminal equipment to data circuit terminating equipment, or vice versa.
*	Additionally the address field includes a protocol indicator which describes the service involved.
Control	- Defines type of frame: I frame – information transfer S frame – link supervisory U frame – additional link control functions. - Performs acknowledgment function by sending receive sequence number.
Frame check	- 16-bit polynomial code serving as error check on contents of frame.
Information	- Contains data and signaling that are independent of the bit sequence.

References

- 1 A. Chalet and R. Drignath: System 12: Data Module Architecture Including Packet Operation: *Electrical Communication*, 1985, volume 59, no 1/2, pp 112–119 (this issue).
- 2 R. Dierckx, P. Guebels, and P. Six: VLSI for the System 12 ISDN Line Termination: *Electrical Communication*, 1984, volume 58, no 4, pp 411–417.
- 3 L. Gasser and H. W. Renz: System 12: Transmission at 144 kbit s⁻¹ on Digital Subscriber Loops: *Electrical Communication*, 1985, volume 59, no 1/2, pp 127–130 (this issue).
- 4 F. Haerens, B. Rossi, and J. M. Serrano: System 12: ISDN Field Trials in the Belgian, Italian, and Spanish Networks: *Electrical Communication*, 1985, volume 59, no 1/2, pp 89–97 (this issue).
- 5 D. Becker and H. May: System 12: ISDN Pilot Service of the Deutsche Bundespost: *Electrical Communication*, 1985, volume 59, no 1/2, pp 98–104 (this issue).

System 12

Data Module Architecture

Including Packet Operation

A new family of System 12 modules provides for the full integration of ISDN voice and non-voice services, together with the distributed support of circuit switching and processed packet switching.

A. Chalet

International Telecommunications Center,
Brussels, Belgium

R. Drignath

Standard Elektrik Lorenz AG, Stuttgart,
Federal Republic of Germany

Introduction

The basic concept of an ISDN is to allow different telecommunication services to use the same network by sharing data transport functions, that is, layers 1 to 3 of the OSI model. These can be considered as *bearer services*. Upper OSI layers will differ and will be handled by terminals that are specific to each telecommunication service, and in some cases by intelligence integrated into the network.

The primary role of an ISDN is to provide a set of bearer services that will meet the needs of a broad range of telecommunication services. An ISDN achieves this by providing three main facilities:

- end-to-end digital network
- powerful subscriber signaling supported by the D-channel packet protocol
- support for both circuit-switched and packet-switched connections.

ISDN subscriber and trunk modules which support these key features are easily introduced into the distributed architecture of ITT's System 12 Digital Exchange. This enables the modules to take advantage of the System 12 intelligent digital switch which is equally capable of switching data packets and conventional circuit-switched connections. Thus System 12 offers a processed packet switching service, distributed over ISDN modules, without the need for expensive local or remote centralized packet switching resources.

System 12 Support for an ISDN

New Functions

Since its inception, the fully digital System 12 has been capable of switching basic 64 kbit s⁻¹ digital channels. As a result, support for digital subscriber loops and digital trunks is provided by the standard architecture; only layer 1 transmission equipment is affected.

Support for ISDN subscriber signaling, packetized on the D channel, is achieved by a new terminal circuit: the exchange termination in the subscriber modules.

Switching at 64 kbit s⁻¹ and ISDN signaling support are needed by the circuit-switched part of ISDN. The System 12 architecture can support both functions, as demonstrated by the Deutsche Bundespost's ISDN pilot service¹.

The third function needed for full ISDN support is processed packet switching.

Packet Switching

Two basic types of connection are planned within an ISDN to support *calls* (i. e. data transport between two parties over a switching network):

Circuit switching: Switching is only required at the start of a call, and results in the allocation of a synchronous duplex data path which can be used continuously and freely by both parties.

Packet switching: No synchronous path needs to be allocated between the two parties. Each party transmits data in the form of packets, which are individually

transported and delivered in sequence to the other party.

A circuit call monopolizes a channel, but several packet calls (or *virtual calls*) can share the same channel. In ISDN, packet calls can be carried on B or D channels, whereas circuit calls are restricted to B channels.

An ISDN exchange may handle packets in two ways: using transparent handling or processed handling.

In transparent handling the exchange does not "see" packets, but switches transparent circuits for them. Of course, not every exchange in the network acts in this

In the stable phase, each data packet is received and stored by the terminal module that controls the input line or trunk. The module switches the packet through the digital switching network³ to the terminal module controlling the line or trunk on which the packet will be output.

This mechanism implies two things. First, that ISDN terminal modules must be equipped with sufficient memory and intelligence to store and switch data packets; this should be in the terminal rather than the TCE. Second, that switching of packets through the digital switching network should bypass the TCE so that it is

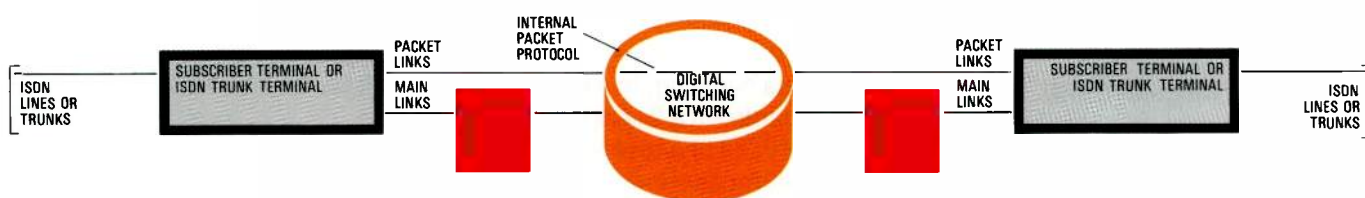

simple way. Also, as this method cannot be used on the D channels, it is only suitable for providing access to true packet switching networks or exchanges.

In processed handling, however, the exchange acts as a full packet switching node, making it the best method for implementation in an ISDN. System 12 exchanges equipped for processed packet switching will be able to interface with dedicated packet switching networks or even form an ISDN capable of supporting subscriber-to-subscriber packet switching. System 12 provides flexible support for processed packet switching, enabling each administration to choose the extent to which the service will be implemented.

Distributed Packet Switching in System 12

Two successive phases can be distinguished in the handling of a packet call:

- call setup phase
- stable call phase.

In the stable phase, data packets are handled by the terminals of the relevant System 12 modules² without involving any TCE or ACE processing. This is similar to the handling of circuit switching which also does not involve any TCE or ACE processing in the stable phase.

not overloaded: terminal modules are equipped with a direct connection to the digital switching network in addition to the standard connection through the TCE.

These principles are illustrated in Figure 1 which shows two ISDN line (or trunk) modules and their connections to the digital switching network. The TCE controls the module and handles circuit-switched calls via the main links, as in every non-ISDN System 12 configuration. In contrast, data packets are switched between ISDN modules over the digital switching network and the packet links using the internal packet protocol.

System 12 ISDN Modules

Figure 2 shows the System 12 modules that support ISDN bearer services.

ISDN Subscriber Module (ISM)

Each ISM controls 48 basic access (i. e. 2B + D) ISDN subscriber lines. It can process data packets and signaling on the D channels and, optionally, the X.25 packet protocol on B channels.

ISDN Trunk Module (ITM)

Each ITM controls a 2 Mbit s⁻¹ digital trunk with a 32 × 64 kbit s⁻¹ channel configuration. The ITM is able to process data and/or signaling packets on one of these channels.

Figure 1
Packet switching using a System 12 exchange in an ISDN showing the main and packet links between the ISDN subscriber module and the digital switching network.

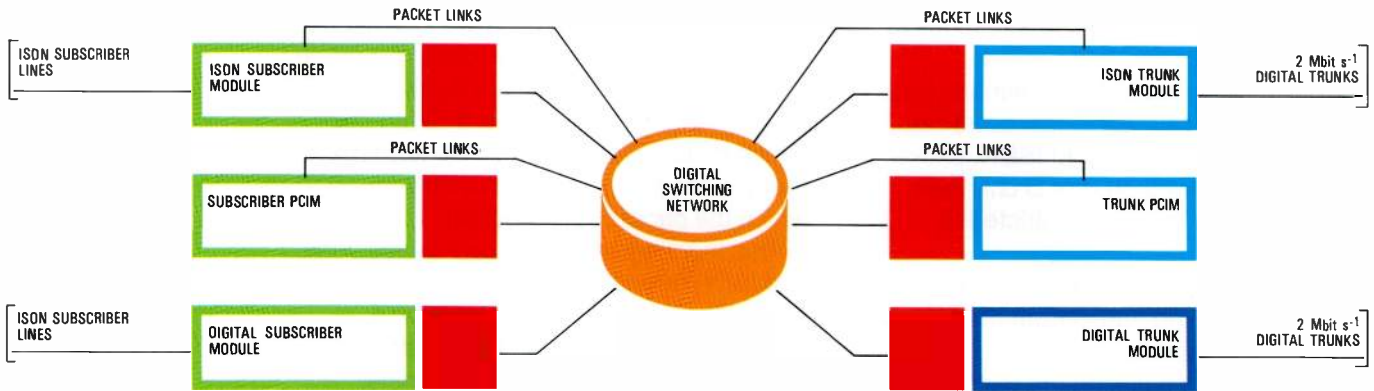

Figure 2
System 12 modules supporting ISDN bearer services.

Digital Subscriber Module

This is a subset of the ISM without the data packet processing capability. It is also known as a digital multiservice module.

Digital Trunk Module (DTM)

This is a subset of the ITM without data packet processing capability.

Packet Channel Interface Module (PCIM)

Each PCIM processes data and/or signaling packets on B channels that have been circuit switched to it through the digital switching network from ISDN terminal modules that cannot themselves process packets on these channels, either because they have no packet processing capability (digital subscriber and digital trunk modules), or because this capability is being used for other packet channels (ISDN subscriber and ISDN trunk modules).

ISDN Subscriber Module

ISM Architecture

The architecture of the ISM is shown in Figure 3. Line termination and exchange termination functions are implemented on different boards, connected by 2 Mbit s⁻¹ PCM links. Exchange termination boards are connected to two TCEs by two 4 Mbit s⁻¹ PCM links for signaling and the transfer of circuit-switched data; two additional 4 Mbit s⁻¹ links are provided for direct access to the digital switching network.

OSI layer 1 functions are supported by the line termination board, which includes the U-interface circuit for transmitting the subscriber line signal across the 2-wire subscriber line using the echo cancellation method⁴. This data signal consists of user data on two 64 kbit s⁻¹ B channels together with the signaling and packet data on the 16 kbit s⁻¹ D channel. One ISM, with six line

termination boards each equipped with eight U-interface circuits, supports 48 ISDN subscribers.

Each line termination board is connected to one or, in the case of B channel packet data handling, two exchange termination boards via a 2 Mbit s⁻¹ PCM link. The 32 PCM channels of this link can be used fully for data transfer between the exchange termination and line termination boards as the system is synchronized by an external clock line. Four PCM channels per basic access are used to transfer B and D channel data in addition to signals for activation and deactivation, monitoring, and maintenance.

OSI layer 2 and some layer 3 functions are supported by the exchange termination board, which is also called the DCPI (dual circuit/packet interface). The line activation/deactivation procedure and monitoring and maintenance of the basic accesses are controlled by the on-board controller, a commercial 16-bit microprocessor.

The processor bus is connected to several peripheral units:

- ISDN link controller: a VLSI circuit which supports the LAP-D procedure (CCITT Recommendations I.440 and I.441) for signaling and packet data transfer on the D channel, as well as the LAP-B procedure (CCITT X.25) for packet data transfer on the B channel. Two independent controllers can be assigned either to the D channels of two basic accesses (2 × LAP-D) or to the D and B channels of one basic access (LAP-D + LAP-B)
- On-board controller interface (OBCI): this VLSI circuit connects the on-board controller to the TCE and the digital switching network. Both OBCIs in the DCPI are identical; the main OBCI is used for circuit-switched calls while the packet OBCI is used for packet-switched data.

- Signaling information and packet data are stored in the on-board RAM while being processed by the on-board controller or the ISDN link controller.

The number of DCPIs equipped in an ISM depends on the number of ISDN subscribers sending packet data in a B channel. If the module does not have to process B channel packet data, each ISDN link controller supports two basic accesses and six DCPIs are required. However, if all 48 subscribers generate packet data on the B channel, 12 DCPIs are necessary.

Main OBCIs are connected to the appropriate TCEs by two 4 Mbit s^{-1} 32-channel PCM links, whereas packet OBCIs are connected to the digital switching network via two further 4 Mbit s^{-1} PCM links using an auxiliary electrical adaptation circuit which bypasses the TCE.

Circuit-Switching Support

Setup of a circuit-switched call is performed in three steps under the control of the on-board controller:

- activation of basic access (OSI layer 1; CCITT Recommendation I.430)
- establishment of a D channel LAP (OSI layer 2; CCITT Recommendations I.440 and I.441)
- signaling in the D channel and assignment of a B channel (OSI layer 3; CCITT Recommendations I.450 and I.451).

If the ISM is receiving the call from the digital switching network, the TCE selects

the on-board controller that is controlling the relevant basic access. However, in principle the first two steps are performed without involving the TCE.

Since basic access is in a power-down mode during the idle-state, layer 1 must first be activated by a command from the on-board controller. When the terminals and the exchange have been synchronized, the U-interface circuit confirms that the active state has been achieved by sending an indication signal to the on-board controller via the ISDN link controller.

Data transfer in the D channel is regulated by the D channel protocol in accord with CCITT Recommendations I.440/441 and I.450/451. Layer 2 provides HDLC frames for transporting layer 3 elements, which represent the actual signaling information exchanged between the subscriber and the ISM. The frame content is generated by the on-board controller and stored in the packet RAM. Subsequently, the ISDN link controller reads the data using direct memory access, formats the data, and sends it out via the U-interface circuit (see Figure 3). Frames received from the subscriber are processed by the link controller and stored in the packet RAM.

The establishment of a LAP corresponds with identification of the frame address assigned to the relevant terminal on the subscriber side. Specific frame addresses have to be assigned to the basic access terminals to distinguish the transferred frames, allowing more than one layer 2 connection at a time. The frame address consists of two parts:

Figure 3
Architecture of the System 12 ISDN subscriber module.

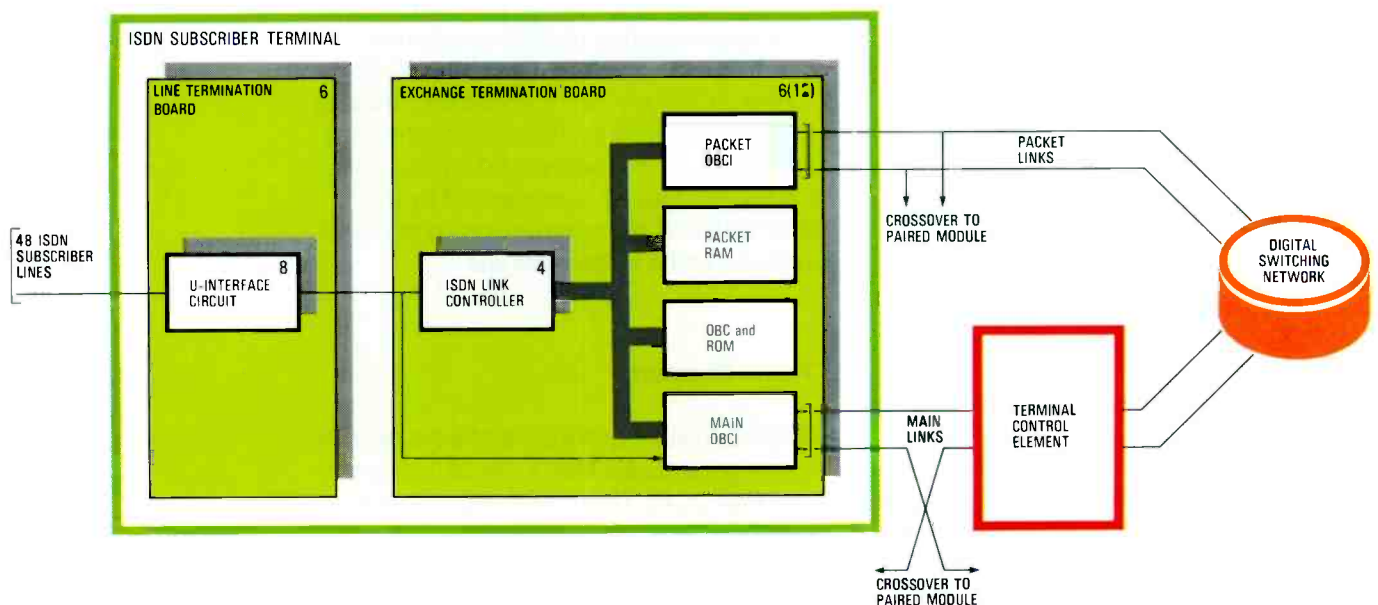

- service access point identifier
- terminal end point identifier.

The service access point identifier provides access to different protocol types within LAP-D (OSI layer 2 procedure for the D channel). This makes it possible to distinguish between signaling information (*s*-type) and packet data (*p*-type), for example. Using the terminal end point identifier it is possible to identify different terminals of one basic access using the same protocol type.

Layer 2 functions of the on-board controller are controlled by its basic access device handler⁵:

- administration of the states of the basic access (e.g. number and state of the different LAPs)
- address administration (e.g. terminal end point identifier allocation and supervision).

Sequence number counters in the ISDN link controllers at the terminal and exchange sides supervise the flow of HDLC frames.

In the last step, layer 3 functions are handled by the on-board controller and TCE cooperating to exchange messages across the 4 Mbit s⁻¹ PCM interface. Subscriber signaling data is sent to the TCE which handles the call in conjunction with the system ACE.

Finally, the TCE assigns a B channel to the relevant terminal. When the call is released, the LAP is cleared by resetting the sequence number counters enabling the counters to be used for a new LAP, possibly using another terminal end point identifier.

Packet Switching Support

Call Setup Phase

Packet-switching call setup also involves the first two circuit-switching steps. In the event of the D channel being used to transfer packet data, a D channel packet LAP is used. Packet transfer on the B channel requires an X.25 LAP to be established in the B channel (following step 3 in the previous section).

A layer 3 parameter known as the *call reference value* is required in order to set up several virtual calls based on one LAP. External call reference values are used between terminals and the exchange. In the case of calls originating from the terminals, the external call reference values are generated by the terminals and may be

ambiguous within one basic access. Thus specific call reference values have to be generated by the on-board controller used between the DCPIs. Two internal call references have to be allocated to transfer packets between two DCPIs. Additionally, a set of select commands³, for use in the stable call phase, is constructed in each of the two DCPIs using the physical address of the other one.

These parameters are established using the main link through the main OBCI and the TCEs (see Figure 1). In the stable call phase, this connection is no longer used.

Stable Call Phase

A specific packet path has to be switched through the digital switching network for every data packet to be sent from one DCPI to another (see Figure 1).

A packet received by DCPIa from the subscriber is handled as follows. The packet is received by the ISDN link controller (see Figure 3) on the D or B channel, processed at layer 2, and stored in the packet RAM. The related on-board controller processes the packet at layer 3 (i.e. it evaluates the external call reference value, generates an internal call reference, and adds digital switching network select commands for path switching to the front of the packet and select commands for path release at the end of the packet).

The DCPIa on-board controller sends the data packet and the select commands through the packet OBCI to the digital switching network. Flow control through the digital switching network is carried out by the internal packet protocol. Next the packet is received by DCPIb and stored in its packet RAM. Finally an acknowledgment is sent from the DCPIb on-board controller to the DCPIa on-board controller which then erases the packet from its packet RAM.

The DCPIb on-board controller provides the packet with the external call reference necessary for the addressed subscriber. Finally, the packet is processed by the DCPIb ISDN link controller on layer 2 and sent out to the subscriber line.

Trunk Support

The DCPI concept is also applied to the ITM which controls a 2 Mbit s⁻¹ trunk using only one ITM DCPI. This differs slightly from the ISM DCPI in that only one ISDN link controller is used and an on-board layer 1 trunk interface is added. An ITM can circuit

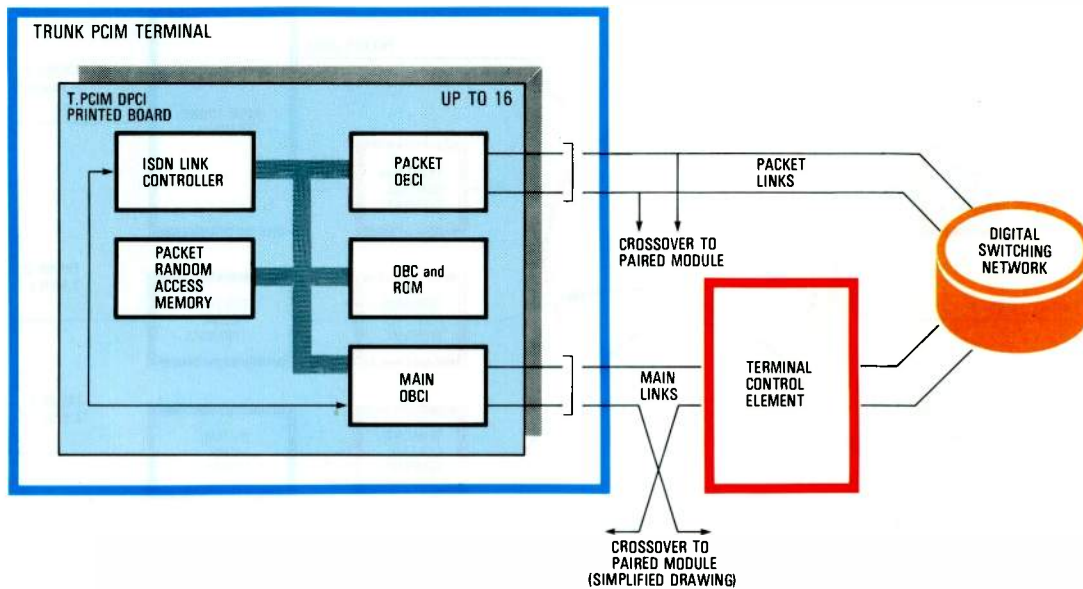

Figure 4
Architecture of the trunk packet channel interface module.

switch any of the 32 channels (except channel 0) through its main OBCI, and can also process packets on one of these channels. A variety of protocols can be supported, including LAP-D, CCITT No 7, and X.75. Thus the ITM can process both data and signaling packets. Unless the packets have to be handled by the TCE, which may be the case for some signaling packets, the ITM uses the internal packet protocol to switch them over the digital switching network via the packet OBCI.

PCIM Functions

In some cases packets must be processed on a channel for which there is no available DCPI in the controlling terminal module:

- subscriber B channel connected to a digital subscriber module, or to an ISM without B channel packet processing capability, or with this capability already used by other channels
- trunk channel connected to a DTM or to an ITM that is already processing packets on another channel.

A PCIM is a cluster of DCPIs for use in such cases. There are two types: trunk PCIM (or T.PCIM) for trunk channels, and subscriber PCIM (S.PCIM) for subscriber B channels.

Figure 4 illustrates a trunk PCIM which is identical to an ITM DCPI except that there is no layer 1 trunk interface. The packet trunk channel is circuit switched from the terminal module to one of the trunk PCIM DCPIs via the main links through the digital switching network. The trunk PCIM processes packets in exactly the same way as an ITM

DCPI, switching them to other DCPIs via its packet links and the digital switching network using the internal packet protocol.

In a similar way, a subscriber PCIM is a cluster of DCPIs which are identical to the ISM DCPIs except that there is no 2 Mbit s⁻¹ connection to any line termination board.

As an example, Figure 5 shows a trunk PCIM handling packet trunk channels connected to two DTMs. Assume that the System 12 exchange in Figure 5 has to process packets on a channel of the 2 Mbit s⁻¹ trunk A, controlled by a DTM. The DTM switches channel a through the digital switching network to a trunk PCIM DCPI that can process the packets. All arrows in Figure 5 refer to packet traffic that the DTM receives from trunk A on channel a.

Various cases are possible, three of which are illustrated. In case 1, a packet from channel a has to be switched to channel b of trunk B, which is also connected to a DTM. Channel b is also circuit switched to another trunk PCIM DCPI. The internal packet protocol connection p1 is used to switch the packet from trunk PCIM DCPIa to trunk PCIM DCPIb in the same trunk PCIM. This procedure also applies when channels a and b are handled by different PCIMs.

In case 2, the packet from channel a has to be switched to channel c on trunk C, controlled and processed by the ITM. Internal packet protocol connection p2 is used to switch the packet from trunk PCIM DCPIa to an ITM DCPI. This procedure also applies to case 3 in which a packet is switched by internal packet protocol connection p3 to a subscriber line connected to an ISM DCPI.

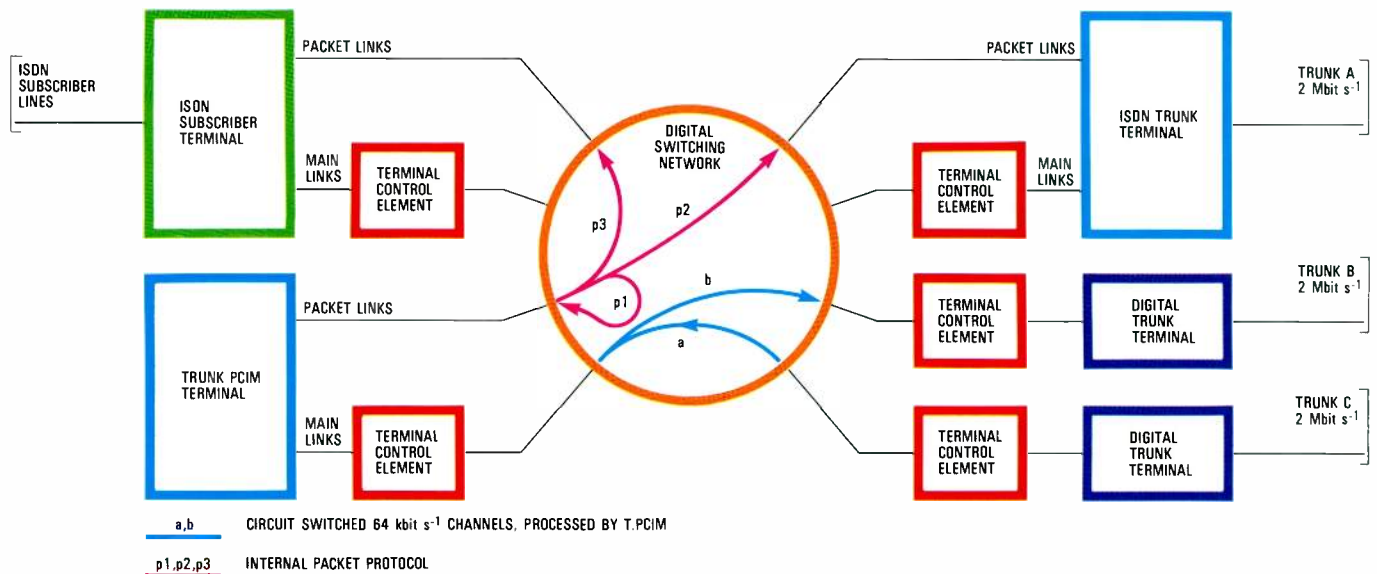

Figure 5
Channel support by the trunk packet channel interface module.

Other Applications of the Architecture

The flexibility of the DCPI architecture makes it possible to build System 12 modules for a wide range of applications, including:

Primary rate access. 30B+D or 30B+E channel configurations can be supported by an ITM, an ITM and a trunk PCIM, or a DTM and a trunk PCIM combination. This will be used for connecting ISDN remote subscriber units or ISDN PABXs.

Access to packet networks. CCITT X.75 links may be connected to System 12 modules supporting them at layer 1 and circuit switching them to an appropriate PCIM for layer 2 and layer 3 processing.

CCITT No 7 signaling system. Trunk PCIMs can handle signaling point and signaling transfer point traffic on any channel of trunks connected to ITMs or DTMs.

Internal Packet Protocol

The internal packet protocol is the protocol (OSI layers 1, 2, and 3) used between DCPIs to switch packets (subscriber data or CCITT No 7 signaling messages) through the digital switching network. An internal packet protocol connection is set up for each virtual call processed by the exchange. Packet routing is fully dynamic within the System 12 digital switching network. Externally on the ISDN trunks, call routing is dynamic, but packet routing within a call is static and is changed only when abnormal conditions are met (e.g. congestion or trunk failure). Under all normal ISDN traffic

conditions, this achieves a more effective performance/cost ratio than systematic dynamic routing per packet.

The protocol looks like a simplified X.25 protocol and essentially relies on *positive acknowledgment* of frames that have been successfully transmitted across the digital switching network: unacknowledged frames must be retransmitted after time-out. A standard 16-bit CCITT cyclic redundancy checking mechanism ensures frame integrity.

Switching of a DCPI-DCPI path for a packet through their packet OBCIs and the digital switching network takes about 2 ms. A DCPI may handle several hundred virtual calls and may, at a given instant, transmit or receive up to 16 packets to or from other DCPIs. For example, a System 12 exchange with 10000 ISDN subscribers connected to ISMs could easily switch more than 25 Mbits⁻¹ of processed data packet traffic, if necessary, in addition to circuit switching for these subscribers and non-ISDN subscribers.

Conclusions

The System 12 ISDN module architecture is based on the intelligent digital switching network and an advanced distributed packet processing concept. Extensive use is made of new and powerful custom VLSIs (OBCI, ISDN link controller, and U-interface circuit), which are also used in ISDN subscriber equipment⁶ developed by ITT. The System 12 Digital Exchange provided by SEL for the ISDN pilot service in Germany¹ is based on a subset of this new ISDN module architecture.

Experience gained with the ISDN field trials in Belgium and Italy⁷ is being integrated into the development of the full ISDN module family, including processed packet switching and CCITT No 7 signaling handling.

References

- 1 D. Becker and H. May: System 12: ISDN Pilot Service of the Deutsche Bundespost: *Electrical Communication*, 1985, volume 59, no 1/2, pp 98–104 (this issue).
- 2 R. Bonami, J. M. Cotton, and J. N. Denenberg: ITT 1240 Digital Exchange: Architecture: *Electrical Communication*, 1981, volume 56, no 2/3, pp 126–134.
- 3 J. M. Cotton, K. Giesken, A. Lawrence, and D. C. Upp: ITT 1240 Digital Exchange: Digital Switching Network: *Electrical Communication*, 1981, volume 56, no 2/3, pp 148–160.
- 4 R. Dierckx and J. R. Taeymans: System 12: ISDN Line Circuit: *Electrical Communication*, 1985, volume 59, no 1/2, pp 105–111 (this issue).
- 5 H. J. Bergs, S. Nett, and M. Wizgall: Implementation of Services in an ISDN: *Proceedings of the International Switching Symposium 1984*, Florence, 7–11 May, 1984.
- 6 T. Israel, D. Klein, and S. Schmolli: System 12: Configuration for ISDN Subscriber Equipment, Network Termination, Digital Telephones, and Terminal Adapters: *Electrical Communication*, 1985, volume 59, no 1/2, pp 120–126 (this issue).
- 7 F. Haerens, B. Rossi, and J. M. Serrano: System 12: ISDN Field Trials in the Belgian, Italian, and Spanish Networks: *Electrical Communication*, 1985, volume 59, no 1/2, pp 89–97 (this issue).

System 12

Configuration for ISDN Subscriber Equipment, Network Termination, Digital Telephones, and Terminal Adapters

When the ISDN reaches subscribers' premises, new wiring configurations based on the standard S_0 interface will be necessary to enable several terminals to be connected to one subscriber line with more than one terminal active at any time. Network terminations will connect terminals for ISDN services to the exchange over relatively long distances, and terminal adapters will be introduced for terminals that were not designed for ISDN operation.

T. Israel
D. Klein
S. Schmoll

Standard Elektrik Lorenz AG, Stuttgart,
Federal Republic of Germany

Introduction

The rapid development of integrated circuits and the use of modern transmission methods make it possible to develop new terminals for the ISDN and connect them together at a subscriber's premises using special configurations. In this way it is possible to meet present and future subscriber demands for new services, efficiency, flexibility, reliability, and economy¹.

Figure 1 shows the basic configuration at the subscriber's premises. The network termination connects the subscriber's cable (to which the terminals are connected) to the subscriber line (U_{K0} interface) which is the connecting link to the digital exchange.

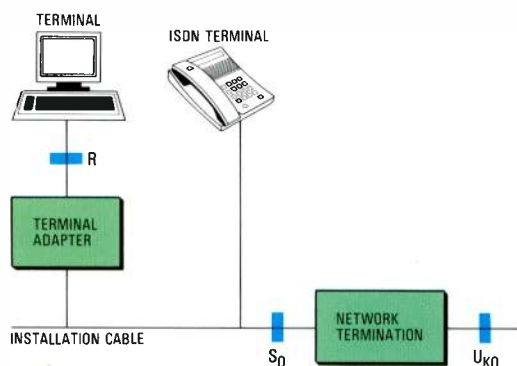

Figure 1
Basic wiring configuration for the introduction of ISDN terminals at subscribers' premises.

The standard subscriber interface S_0 of the network termination is the border of the public network and of the administration's responsibility. Terminals developed for the analog telephone network or circuit- or packet-switched data networks are modified for ISDN operation by terminal adapters.

The main requirements that the wiring configuration must meet are:

- connection of more than one terminal for different services (voice, text, data, facsimile, video) to one subscriber line
- simultaneous operation of several terminals
- selective calling of a terminal for a required service
- transmission over a long distance with an attenuation of 6 dB at the S_0 interface (point-to-point operation), and 40 dB at the U_{K0} interface between subscriber and exchange.

Configurations

Terminals can be connected to the S_0 interface using various 4-wire configurations. The existing subscriber's installation can be retained if it uses twisted pair cables with a capacitance of 40 to

120 nF km⁻¹ terminated at both ends with resistors of about 100 Ω.

The simplest configuration is point-to-point operation (Figure 2a) with only one terminal connected to the S₀ interface. This configuration is used whenever the terminal and the network termination are some distance apart because an attenuation of 6 dB is allowed, corresponding to about 1 km of cable. Furthermore, point-to-point operation is needed for an intelligent network termination which is capable of switching B channels for different terminals within the subscriber's installation.

A more complex type of point-to-point operation is the active bus (Figure 2b) in which bus expanders are inserted in the cable. One terminal can be connected at each bus expander, which decouples the terminal from the cable and controls access to the network termination when two or more terminals want to communicate with it simultaneously. Terminals can be a considerable distance from the network termination because signals are regenerated in the bus expanders.

A favorable configuration is the short passive bus (Figure 2c) which allows up to eight terminals to be connected at random points along the cable using connecting cords up to 10 m in length. The distance between the terminal and network termination is limited to between 100 and 150 m by the round trip delay of the pulses which must not exceed 2.7 μs with the maximum number of terminals connected. This prevents inadmissible overlapping of pulses from terminals located near the network termination and at the remote end of the bus. Access control to the D channel is necessary to ensure orderly access to the network termination.

A variation of the short passive bus is the extended passive bus (Figure 2d) in which terminals are grouped at the far end of the cable, thus forming a short passive bus which is connected to the network termination over an intermediate distance. The differential round trip delay between the clustered terminals is restricted to 0.25 μs, corresponding to a distance of 25 to 50 m. The distance between the terminals and the network termination is limited by the permissible attenuation of 6 dB.

User – Network Interface and Interface Integrated Circuit

The interfaces between the installation cable and the network termination, and

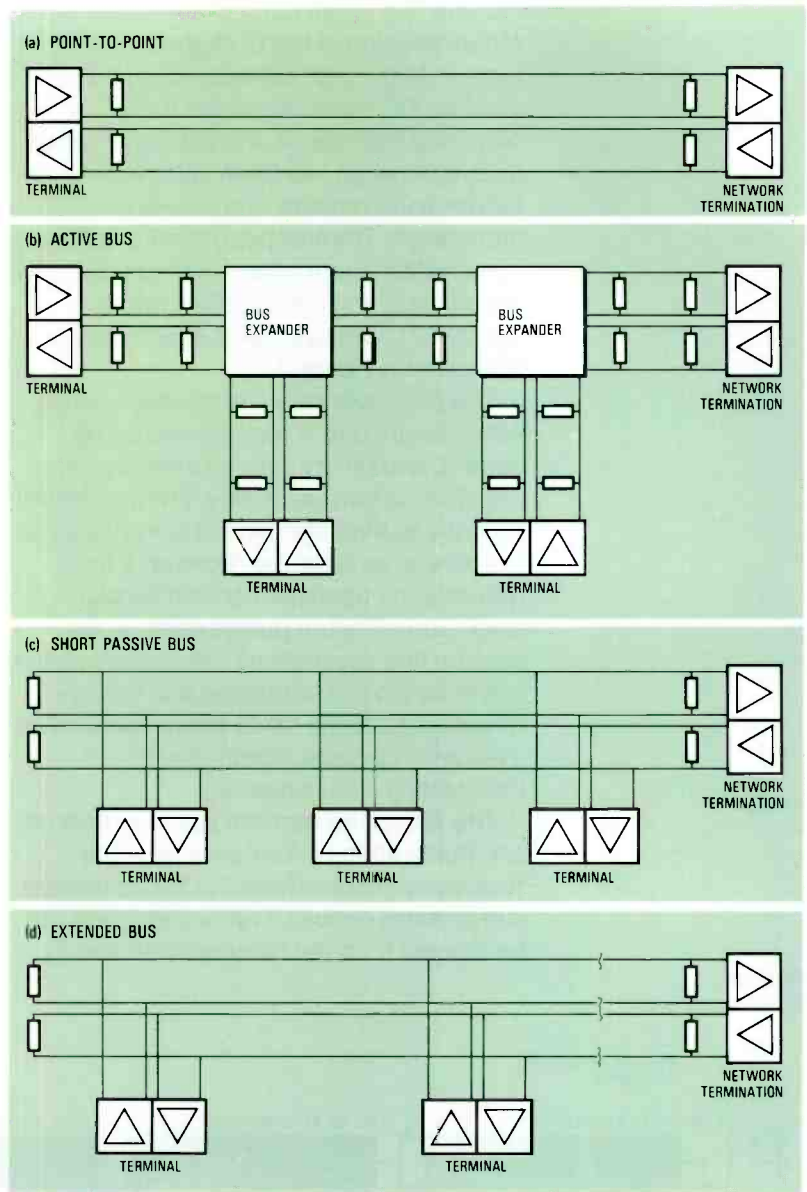

Figure 2
Wiring configurations.
 (a) point-to-point,
 (b) active bus,
 (c) short passive bus,
 and (d) extended bus.

between the installation cable and the terminals are based on the user – network interface circuit SIC (S-interface circuit). This integrated circuit, which is mounted in a 24-pin dual-in-line package, is realized in CMOS (complementary metal oxide semiconductor) technology to minimize power consumption while meeting the stringent requirements. The SIC transmits a 192 kbit s⁻¹ signal grouped into frames of 48 bits, 36 of which are information bits (two successive octets of each of the two B channels, and four bits of the D channel). This leaves 12 bits per frame for signals added by the SIC. In the direction from terminal to network termination, four bits are used for framing (F and F_A, each with balancing bit L) and eight bits L for DC balancing of the four B-channel octets and the four D-channel bits. In the opposite direction, four bits (F with balancing bit L, F_A, and N) are again used for framing; a further

four bits E form an echo channel for retransmission of the D-channel bits received from the terminals, one bit L is used for DC balancing of the frame contents, and one bit A is set to "1" when bit synchronism has been achieved between the terminal and network termination. The final two bits S1 and S2 are reserved for spare information which is not yet defined, and are therefore set to logical "0". The two frame structures are illustrated in Figure 3.

The pseudoternary line code is used in which binary one is represented by no current, and binary zero by a positive or negative current alternately. The transmitter must act as a voltage-limited current source to present, as does the receiver, a high termination impedance so that no high amplitude reflected pulses occur in the passive bus application. The output current has to be limited so that the bus voltage never exceeds 1.6 times the nominal value even when several terminals are transmitting simultaneously.

The SIC in the terminal has to extract bit and frame timing information from the received signal and feed it to the transmitter and terminal circuits. Frame alignment can be derived from the framing bits F and F_A

necessary only when point-to-point or extended passive bus operation is used, because in these modes the delay can be as much as six bits. Passive bus operation with a short delay uses fixed timing with the received signal being sampled approximately 4.5 μs from the rising edge.

If point-to-multipoint operation is used (short passive or extended bus), allowing up to eight terminals to be connected to one network termination receiver, the SIC must control access to the D channel. In this access control procedure, D-channel bits received at the SIC in the network termination are retransmitted with a delay of 8 or 10 bits in the D echo channel so that the terminal receives the D echo bits prior to transmitting the next bit.

SICs in the terminals monitor the D echo channel and start transmitting at the request of higher layers in the OSI structure only if the SIC has counted a predefined number of consecutive logical 1s, indicating that the D channel is free. The number of 1s to be counted depends on the message priority; it may be 8 or 10 in the idle condition. On finding that the D channel is free, the SIC starts transmitting the terminal's assigned address which is superimposed on the addresses of other terminals when they

Figure 3 Frame structure.

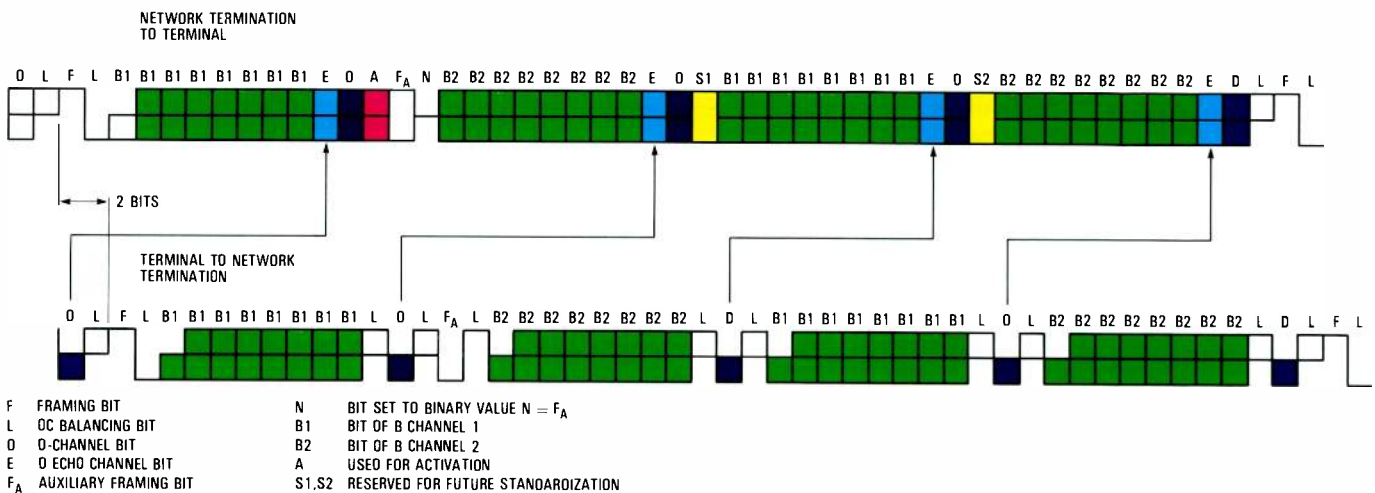

(Figure 3) which form code violations with two successive logical 0s of the same polarity and mark the frame delimitations. The transmitted frame is delayed by two bits with respect to the received frame.

The network clock supplies the SIC in the network termination with an exact bit timing signal. The transmitter must be synchronized to this clock. Extraction of the timing signal from the received signal is

attempt to gain access simultaneously. When a logical 1 and a logical 0 are superimposed, a logical 0 results at the network termination receiver. As long as the received bits in the D echo channel are the same as the transmitted D-channel bits, the SIC continues transmitting. However, if there is a difference between the D echo channel and the D channel, the SIC immediately ceases transmission.

This procedure gives access to the terminal with the best address (i.e. the address with the largest number of successive 0s). To ensure that access is shared fairly, a terminal must lower its priority when it has finished transmitting; this means that it has to count an additional logical 1 in the D echo channel prior to transmission to give terminals with unfavorable addresses but with messages of the same priority a chance to gain access. As soon as the D channel is free, the normal priority is again assigned to the terminals.

The SIC is connected to the installation cable by balanced transformers, making it possible to feed power from the network termination to the terminals through the phantom circuit of the cable. A nominal supply of 4 W at 40 V is derived from the local mains. However, in the event of mains failure, the voltage in the phantom circuit is inverted and a reduced power of 420 mW is taken from the exchange battery to enable a preselected terminal to maintain at least the basic telephony functions.

Network Termination

The network termination connects the subscriber installation to the subscriber line. The transmission of information and signaling is transparent. It is possible to include switching functions in a network termination so that it can act as a PABX.

The subscriber installation cable is connected to the network termination via the SIC, which provides transmission functions to and from the terminals.

Connection to the subscriber line is via the UIC (U_{K0}-interface circuit)² which realizes the transmission function to the local ISDN exchange. A digital two-wire transmission procedure with echo cancellation and a 4B3T code is used on the subscriber line, allowing the subscriber to be a long way from the exchange (≥ 40 dB).

The SIC and UIC are connected via the internal module interface, over which data is transmitted at 256 kbit s⁻¹. Data is grouped into four octets; the first two are reserved for the two B channels, the third is unused, while the fourth contains two D-channel bits, four bits for the transmission of commands and messages between the S₀ and U_{K0} interfaces, and two unused bits.

In addition to the SIC and UIC, the network termination includes a transformer to terminate the subscriber line.

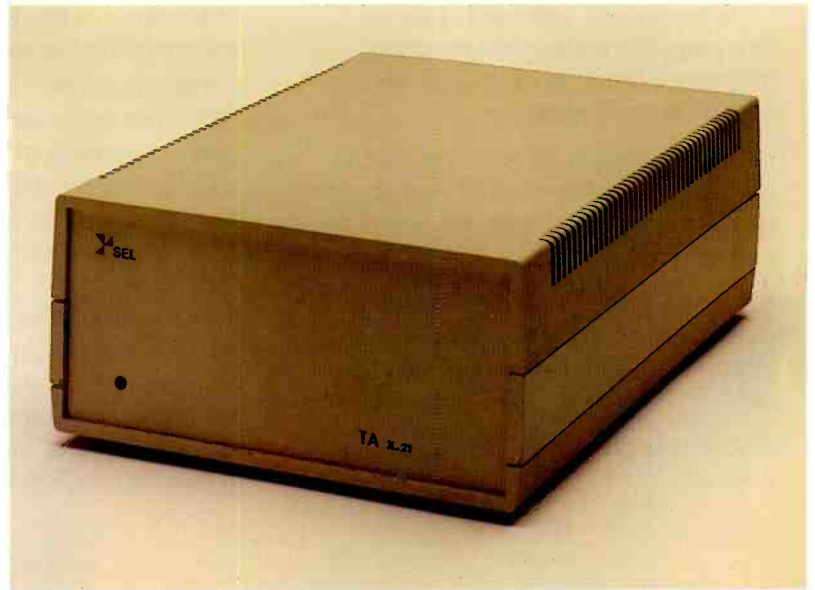

Terminal adapter for terminals that do not conform to ISDN requirements.

DIGITEL* Digital Telephones

Digitel subsets are designed for connection to an ISDN. Separation of the data and speech channels makes it possible to send signaling information to and receive it from the exchange without disturbing transmission in the speech channels.

The signaling protocol requires the administration of call states within the subset, so all telephony features are implemented in firmware. This enables user guidance to be provided (e.g. display of messages relating to programming and operating the subset) so that inexperienced users can operate the subset easily.

The modular firmware structure minimizes any modifications that might be necessary following the Deutsche Bundespost's ISDN pilot service or standardization by CEPT and CCITT. The subset design concept allows models with additional features to be produced simply by adding hardware and software modules. Subsets can be equipped with a 2-wire U interface or a 4-wire S interface.

The main features of the Digitel subset which will be used in the ISDN pilot service are:

- 4-wire S₀ interface with S₀ bus contention capabilities
- HDLC LAP-D signaling
- pushbutton dialing
- alphanumeric liquid crystal display for indicating called party, calling party,

* A trademark of ITT System

stored numbers, activated features, charging information, call progress messages from the exchange, and user guidance messages

- dialing facilities such as single-button dialing (up to 14 numbers), repeat last number, on-hook dialing, off-line dialing, and hot line
- function keys for activating exchange features, such as camp on busy, charging information, and accept reverse charge call
- loudspeaking facilities with volume control

outgoing calls and bus-contention resolution for the terminal on the S_0 bus.

The ISDN link controller consists of an HDLC controller which supports the basic layer 2 functions of the D-channel protocol and performs multiplexing and demultiplexing for the B and D channels. It is the interface between the microprocessor and the SIC.

The microprocessor system consists of the microprocessor, program memory, data memory with battery to store repertory and programmed features, and peripheral interface circuits. Its primary functions are to generate signaling bits and to decode

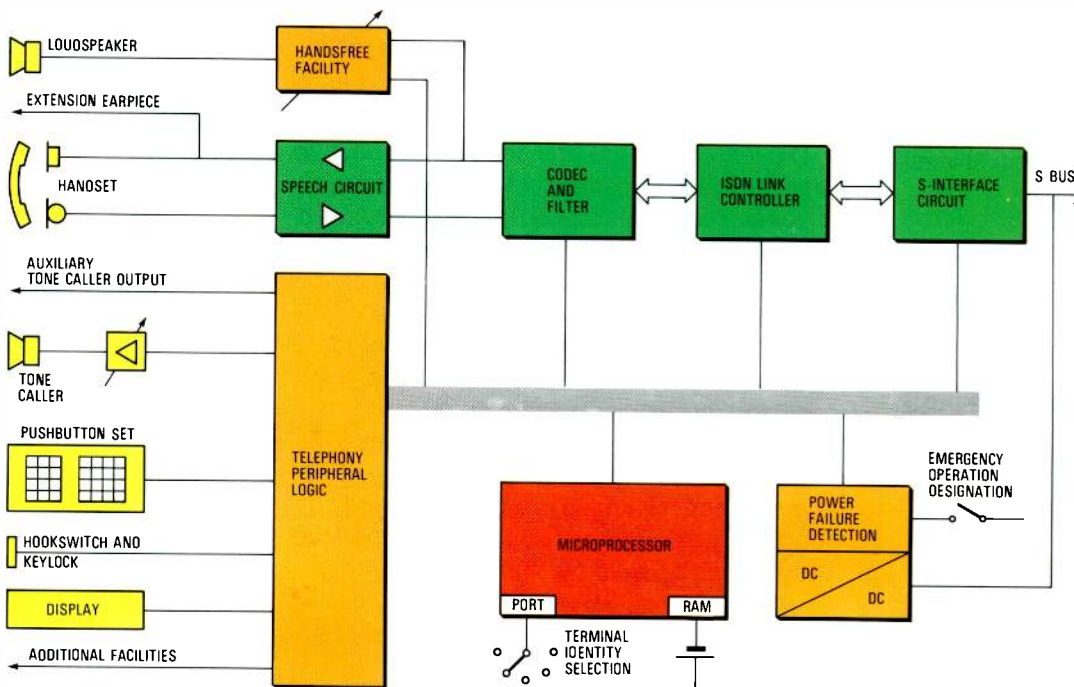

Figure 4 Digitel hardware architecture.

- key-switch for programming functions, outgoing call restriction/barring, and hot line enable
- tone caller with tone and volume control via pushbuttons
- additional facilities such as earphones and second tone caller; abbreviated dialing devices can be connected via a special serial interface.

received signaling in layers 2 and 3, handle user features, control the telephony peripheral hardware (e.g. alphanumeric display), control the keyboard, and generate ringing tones.

The telephony peripheral logic consists of the keyboard decoder, tone caller volume control, power down activation logic, and switching of loudspeaking and other facilities.

The alphanumeric liquid crystal display consists of memory, character generator, multiplexer, and driver. The display, which is directly controlled by the microprocessor, shows the status of the call, number dialed, number called, charging information, and other information.

The main functional hardware blocks of the Digitel subset are shown in Figure 4. The SIC realizes the electrical and transmission interface to the S_0 bus. It also provides the system clocks, and supports the activation/deactivation procedures on incoming and

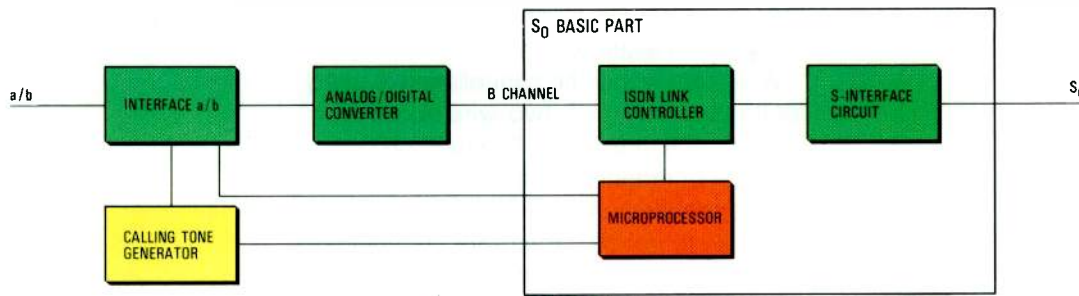

Figure 5
Block diagram of the terminal adapter *a/b*.

The analog speech circuit matches the electrical characteristics of the handset to the codec and filter, and feeds back the sidetone signal from the microphone amplifier to the transducer. The codec and filter performs analog-to-digital and digital-to-analog conversion of speech. Coding and decoding are based on the A-law principle. The digital speech data patterns are presented to and received unscrambled from the ISDN link controller in words of eight bits.

To facilitate line powering of the Digital subset, all LSI and VLSI components are realized in CMOS technology.

Terminal Adapters

Terminals that do not conform to ISDN requirements (i.e. terminals for an analog telephone network or a switched data network) can be connected via terminal adapters. These circuits adapt the bit rate to 64 kbit s⁻¹ and convert signaling information into D-channel protocol messages.

A variety of terminals are connected to the analog telephone network, such as facsimile machines, data terminals with modems, and telephone answering machines. They have different bit rates and are not able to insert a special service indicator when they are connected to the ISDN via analog trunks, making it difficult to select a suitable bit rate in the gateway between the analog telephone network and the ISDN. A terminal adapter *a/b* (Figure 5)

has been developed which operates using the same voice frequency signals as are transmitted over analog networks without regard to service or bit rate. A codec is used for bit rate adaptation. Pulse dialing information is received by a subscriber line interface circuit and converted to the D-channel protocol by a microprocessor and the ISDN link controller. The interface to the ISDN port is again provided by the SIC.

Adaptation of terminals connected to the circuit-switched data network is performed by the X.21 terminal adapter in accordance with CCITT Recommendation X.30 (Figure 6). The part that converts X.21 signaling to the D-channel protocol is the same as for the terminal adapter *a/b*, and is also common to the Digital subset.

Adaptation for the bit rates of 0.6, 2.4, 4.8, and 9.6 kbit s⁻¹ is carried out in two stages. First the rates are increased to 8 or 16 kbit s⁻¹ by inserting 48 information bits in a frame of 80 bits, which multiplies the bit rate by a factor 5/3. The remaining difference from 8 kbit s⁻¹ is made up by repeating the information bits eight times at 0.6 kbit s⁻¹ and twice at 2.4 kbit s⁻¹. The spare 32 bits in the 80-bit frame are used as follows: 17 bits for the frame alignment pattern, 7 bits for information related to the user rate, and 6 bits for status information on the X.21 interface. The final two bits, which are reserved for future use, are set to 0.

To adapt the intermediate bit rates of 8 and 16 kbit s⁻¹ to 64 kbit s⁻¹, the next stage is to insert seven or three 0 bits,

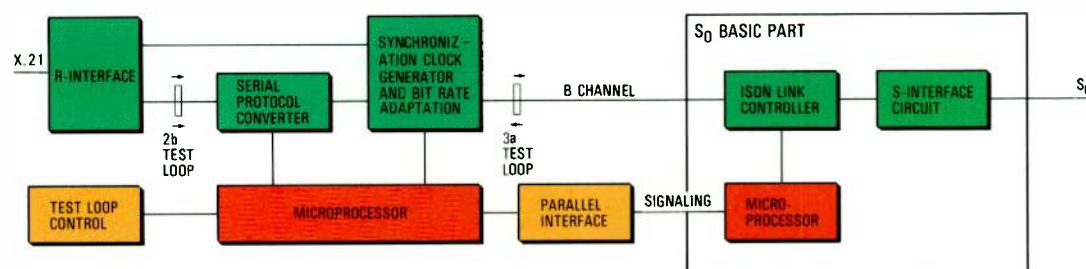

Figure 6
Block schematic of the X.21 terminal adapter.

respectively, after each bit of the intermediate data bits.

Conclusions

When the ISDN is introduced into subscribers' premises, new wiring configurations based on CCITT Recommendation I.430 will be necessary which allow several terminals to be connected to one subscriber line and to be active simultaneously. It will be possible to send calls directly to preselected terminals. The installation consists of a four-wire line with which it is possible to build a bus and which is terminated by a network termination. A variety of new terminals for different services (e.g. voice, data,

facsimile, and video) may be connected to this new installation.

A system with echo cancellation is used for transmission over two-wire subscriber lines in both directions. The method ensures operation on a subscriber line with an attenuation of 40 dB. Existing terminals which were not designed with the standard ISDN interface can be modified for operation in the ISDN by terminal adapters.

References

- 1 K. H. Rosenbrock: Mögliche Integration von Fernmeldediensten im digitalen Fernsprechnetz der Deutschen Bundespost – ISDN: *Zeitschrift für das Post- und Fernmeldewesen*, 1982, volume 34, no 9, pp 3–10.
- 2 L. Gasser and H. W. Renz: System 12: Transmission at 144 kbit s⁻¹ on Digital Subscriber Loops: *Electrical Communication*, 1985, volume 59, no 1/2, pp 127–130 (this issue).

System 12

Transmission at 144 kbit s⁻¹ on Digital Subscriber Loops

Implementation of the 144 kbit s⁻¹ data rate on existing subscriber lines is a challenge for both system and VLSI designers. A new transmission system has been designed which offers the high performance needed for use on all types of lines in the local networks of administrations worldwide.

L. Gasser

H. W. Renz

Standard Elektrik Lorenz AG, Stuttgart,
Federal Republic of Germany

Introduction

CCITT has recommended a 144 kbit s⁻¹ data rate on subscriber lines for customer access to the ISDN (basic access). This rate covers two 64 kbit s⁻¹ B channels for speech and data transmission, and a 16 kbit s⁻¹ D channel for signaling and low speed data or telemetry. In addition, auxiliary channels are provided to carry synchronization and maintenance information on the loop. The introduction of transmission systems that can support these channels will bring a new range of technology to the subscriber plant.

Digital subscriber loops will primarily support voice and data communication, albeit more flexibly and at much higher speeds than present analog subscriber lines. However, in the slightly longer term they are expected to provide a range of new features (e. g. display of calling and called numbers, message storage, message handling and transfer, user guidance).

While the quality of voice and data transmission over analog lines depends on line attenuation, distortion, noise, and return loss in the voice band, the quality of a digital loop will depend on the bit error rate of the line over the entire transmission band (which is quite different from the voice band). As far as the operation of a transmission system over existing cable plant is concerned, it should be kept in mind that analog and digital systems will coexist in the same physical cable for a long transition period.

Extensive measurements and field trials of subscriber line networks in Germany¹,

Belgium, and Italy have been used to develop a broadly applicable duplex transmission system. Two main areas are of interest with regard to transmission performance on the subscriber line. First, its characteristics in the frequency and time domains, including line impedance, near and far end crosstalk, and line attenuation. Second, its behavior in terms of noise counts per unit time in the transmission band, noise pulses and noise bursts on the line (occurring either simultaneously or at different times) caused by dialing, ringing, meter pulsing, or data or telex transmission (or any combination of these) on adjacent lines.

During field trials the most attractive options – the time separation (or ping-pong) and echo cancellation methods – were compared². The results show that the echo cancellation method offers the best characteristics with respect to line length, noise immunity, and tolerance to analog and digital transmission within the same cable bundle. A disadvantage is that this method requires more functions and hardware, but it could be designed to be applicable to all lines in the subscriber networks of different administrations. The echo cancellation method has several major advantages. The line code (i.e. the center frequency of its power density spectrum) can be chosen so that the attenuation of the maximum line length to be bridged by the system is kept below 40 dB. Also, a wide range of line diameters, chains of sections with different diameters, mismatch, and bridged taps can be covered. Finally the bandwidth can be

less than half that required for the ping-pong method, resulting in improved noise immunity.

System Requirements

According to the ISDN terminology of CCITT, the functional blocks terminating the subscriber line are the LT (line termination) located at the exchange side and NT 1 (network termination 1) at the subscriber end of the line; both are connected to the two-wire subscriber line at the U interface. The transmission system itself is terminated by the V interface on the exchange side and by the T interface on the network termination side (see Figure 1). The major requirement for a transmission system for subscriber line applications is to make the maximum use of local cable plant without restricting system performance. This can be achieved by a system that ensures a high transmission quality even on poor lines.

CCITT Recommendation G.281 defines the following error performance objectives for international connections:

- speech transmission: bit error rate of better than 10⁻⁶ for 90% of the transmission time
- data transmission: error free time of 92% or better.

The subscriber section is only allowed to contribute between 20 and 25% of these impairments.

The problems to be solved by system designers relate primarily to achieving the required transmission performance in the face of conditions in local networks which were not designed for data transmission. More specifically, the major problems are:

- Large differences in line lengths. Although line lengths do not vary much in Europe, system design should allow for networks where there are considerable differences, such as the United States. During the transition to an ISDN, it should be possible to use long lines where there are insufficient ISDN exchanges.
- Variations in cable size and construction. Cable types, line diameters, and diameters of chained sections must meet administration regulations. Diameters of 0.4, 0.5, 0.6, and 0.8 mm are common. Copper cables are used throughout, except in the United Kingdom where some aluminum cables are also used.

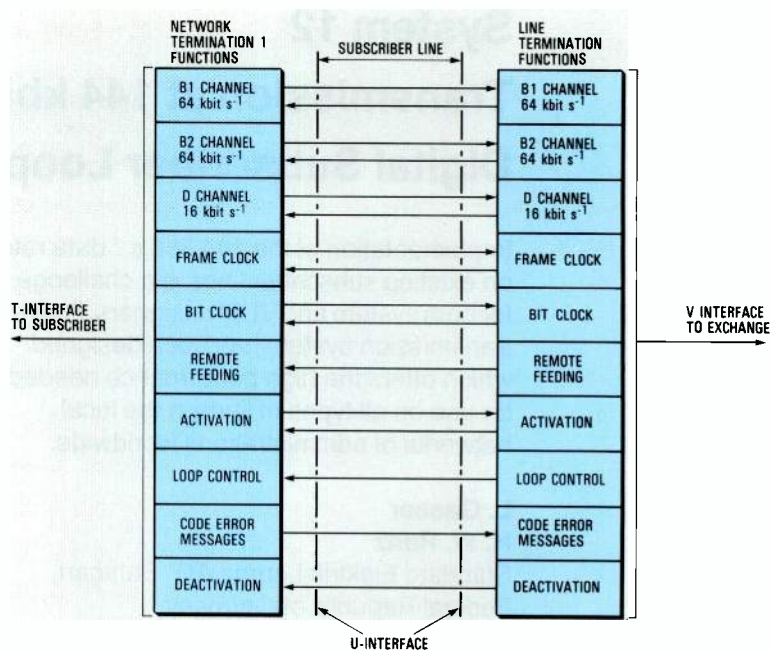

Figure 1
Functions of the transmission system between the line termination and network termination 1.

- Crosstalk from adjacent lines carrying 144 kbit s⁻¹ digital signals, as well as between lines carrying mixed analog and digital signals, which will be the case during the long transition to fully digital networks.
- Impairment by conventional data, telex, or telemetry signals transmitted in the same bundle.
- Impairment of digital subscriber lines by broadcast transmission (e.g. speech and music) on the same subscriber line, as is common in some European countries (e.g. Switzerland and Italy).
- Impairment of digital subscriber lines by mains power cables, radio interference, or electromagnetic radiation.

In addition to the performance requirements for the subscriber line networks, further user and administration demands have to be met, such as the need for reduced maintenance. Although the U interface of the ISDN basic access will not be specified by CCITT (and will consequently remain a national responsibility), some essential features are determined indirectly by the V- and T-interface recommendations.

Figure 1 summarizes the functions required to satisfy the basic access features. First, an activation/deactivation procedure minimizes power consumption by allowing the system to be in power down mode when not in use. The procedure permits rapid seizure and release of the transmission path.

Second, frame and bit synchronization must be provided in addition to the two B channels and the D channel. The master clock, which is supplied by the exchange, is transmitted via synchronization information from the line termination to network termination 1, and thence to the terminal equipment. In network termination 1 the clock is looped back to the line termination. Transmission must be independent of the bit sequence.

Third, in the event of a local power failure it must be possible to feed one pre-designated telephone subset from the exchange in order to provide basic telephony functions.

Fourth, maintenance of the basic access is performed by connecting test loops: special commands, generated by maintenance routines within the exchange, initiate the switching of test loops in the line termination, network termination 1, and, if required, in following functional blocks. Test patterns are transmitted through the loops either on request or in low traffic periods to locate hardware faults.

Finally, the basic access transmission system is continuously supervised by counting code violations while the equipment is active.

System Description

The stringent system requirements would result in bulky hardware if conventional circuitry (e.g. discrete components, hybrids) were to be used. Therefore the transmission method and system parameters were chosen to allow digital signal processing to be used, enabling full advantage to be taken of modern VLSI technology. The main system features are summarized in Table 1.

Figure 2 is a block diagram of the VLSI circuit conceived for the line termination and network termination 1 functions.

The activation procedure is initiated by exchanging 7.5 kHz wake-up and acknowledge signals between the line termination and network termination 1. After recognizing these signals, the controller starts the synchronization procedure. The external interface then generates a bit stream, which is sent via the scrambler and encoder to the multiplexer. Unscrambled information (e.g. synchronization word and service information) is added. The ternary information is then transferred to the line via

Table 1 — Main characteristics of the transmission system for digital subscriber loops

Analog to digital conversion by a pulse density modulator followed by a digital conversion filter
Sampling rate of once per symbol
Digital-to-analog conversion and pulse shaping at the transmit side
Digital signal processing for all functions, including timing recovery
Frame and bit clock recovery using a Barker synchronization word
Evaluation of the sampling instant by a digital phase-locked loop
4B/3T coding and decoding (MMS43)
Scrambling and descrambling using a polynomial of the 23rd degree (CCITT Recommendation V.29)
Symbol rate on the line of 120 kbaud, ternary
Frame contains 120 ternary intervals, corresponding to a 1 ms frame length
Synchronization word consists of 11 (ternary) bits, unscrambled
Service information (e.g. loop commands, code error messages) is transmitted by one ternary interval, unscrambled
Unscrambled information is differently located within the frame for the two transmission directions on the line to avoid degrading echo cancellation
Adaptive echo cancellation includes a transversal filter structure
Adaptive decision feedback equalization
Automatic gain control
Fast return to operation after line seizure as a result of data storage during power down
Activation and deactivation are controlled by handshake procedures using special sequences of signals
Maintenance loop control and code violation detection.

the transmit filter and digital-to-analog converter. Synchronization proceeds with the exchange of signals between the line termination and network termination 1. After these signals have been recognized the line is released for user data.

The signal received from the far end has an echo signal (i.e. the transmit signal reflected at the imperfect hybrid and by inhomogeneities in the subscriber line) superimposed on it at the receiver input. This echo signal can be much larger than the signal from the far end. The sum of both signals at the receiver input is scanned by the analog-to-digital converter. The scanning rate is 15.36 MHz at the input and 120 kHz after down-sampling. After filtering at the input, timing information is extracted

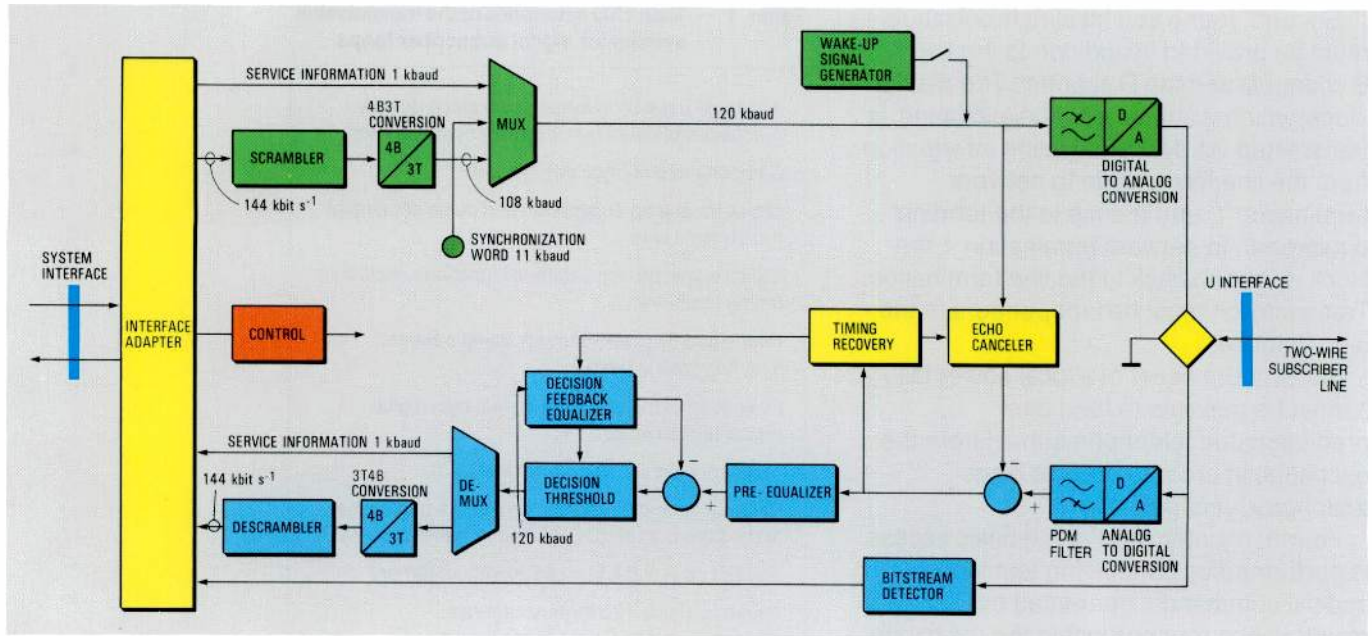

Figure 2
Block diagram of the line termination/network termination VLSI circuit.

by correlation with the Barker synchronization word. The echo canceler eliminates the unwanted echo signal.

To ensure setting up is achieved under all conditions, the three important adaptive loops (i.e. clock recovery, equalization, and echo suppression) are independent of each other, thereby avoiding any risk of mutual interference. The equalizer (adaptive pre-equalizer and decision feedback post-equalizer) has adequate initial convergence. The control signal for updating the equalizer is derived from the decision signal at the output of the logic threshold.

The ternary transmit signal is used as a reference for the echo canceler while the updating criterion is the mean square error at the receive side.

Echo canceler performance must be excellent with respect to echo suppression, and quantizing and updating noise. More than 60 dB echo suppression is necessary to achieve the required performance.

After the receive signal has passed the decision threshold in the decision feedback equalization circuit, the demultiplexer extracts service information and the decoder converts the ternary bitstream to binary. Finally, the descrambler recovers the information in the binary sequence, which is required by the following functional blocks in the transmission system.

Information is then passed via a terminating buffer through the system interface to the functional units.

Status and Outlook

Design of a 144 kbit s⁻¹ transmission system for use on digital subscriber loops has been completed. Test results on a hardware emulator and computer simulations have shown that the expected performance has been largely achieved. Several transmission system emulators have been delivered to ITT companies for use by administrations in ISDN field trials in Italy, Belgium, Spain, and Australia.

The VLSI design is in progress, and the finished device should be available for use in the Deutsche Bundespost's ISDN pilot project which will go into service in 1986.

References

- 1 B. Aschrafi, P. Meschat, and K. Széchényi: Field Trial Results of a Comparison of Time Separation, Echo Compensation and Four Wire Transmission on Digital Subscriber Loops: *International Symposium on Subscriber Loops and Services*, 20–24 September 1982, Toronto, p 181.
- 2 D. Becker, L. Gasser, and F. Kaderali: Digital Subscriber Loops Concept, Realization and Field Experience of Digital Customer Access: *International Switching Symposium*, 1981, Montreal, Section 24c, paper 2.

System 12

Technique for Wideband ISDN Applications

New services planned for ISDNs will require wideband signals to be switched by telephone exchanges. Using a simple mechanism and a new hardware subsystem, the System 12 Digital Exchange is able to carry services with bandwidths of $N \times 64 \text{ kbit s}^{-1}$ up to a maximum of 1920 kbit s^{-1} .

S. R. Treves

FACE, Milan, Italy

D. C. Upp

ITT Advanced Technology Center, Shelton, Connecticut, United States of America

Introduction

Certain telecommunication services, such as high quality audio, compressed video, and computer-to-computer data transfer, require bit rates in excess of the 64 kbit s^{-1} digital telephone bit rate. Switched paths with bit rates that are a multiple of 64 kbit s^{-1} will be used to provide these services. Conventional ISDN mechanisms can be used for bit rates up to 64 kbit s^{-1} , but new mechanisms are required for higher rate services. Two higher bit rate categories are considered: wideband and broadband. Wideband ISDN services are defined here as using bit rates of $N \times 64 \text{ kbit s}^{-1}$ ($2 \leq N \leq 30$) up to the maximum of 1920 kbit s^{-1} . Services at rates above this are classified as broadband. A new technique presented in this paper will allow System 12 to offer switched wideband services.

Requirements

CCITT has defined a set of ISDN channel rates in Recommendations I.412 and I.431 for ISDN user/network physical interfaces:

D channel: primarily for carrying signaling information for circuit switching by the ISDN at 16 kbit s^{-1} in the basic channel structure (2B + D) and at 64 kbit s^{-1} in the primary rate structure (1544 kbit s^{-1} for North America or 2048 kbit s^{-1} for Europe).

B channel: 64 kbit s^{-1} channel carrying user information: provides access to communication modes within the ISDN, including circuit-switched voice or data and packet-switched data.

H0 channel: rate of 384 kbit s^{-1} circuit switched.

H1 channel: rates of 1536 kbit s^{-1} for North America and 1920 kbit s^{-1} for Europe, circuit switched.

In addition a double H0 channel has been proposed for high resolution facsimile, carrying circuit-switched data at 768 kbit s^{-1} . In general, any bit rate which is a multiple of 64 kbit s^{-1} may be required for one service or another.

The main requirement if System 12 is to provide wideband ISDN services is that it must be able to switch B, $N \times B$, H0, $N \times H0$, and H1 channels through the existing digital switching network. Wideband service will be provided as a transparent circuit-switched channel at the selected bit rate from subscriber to subscriber; it will be established on a per-call or continuous service basis. The basic wideband switching mechanism must be programmable to provide any bit rate from 64 kbit s^{-1} to 1920 kbit s^{-1} in 64 kbit s^{-1} increments. Both point-to-point and point-to-multipoint services will be required, and the switched service will have to be provided in both local and transit exchanges.

Wideband signals will be carried between exchanges on a number of associated

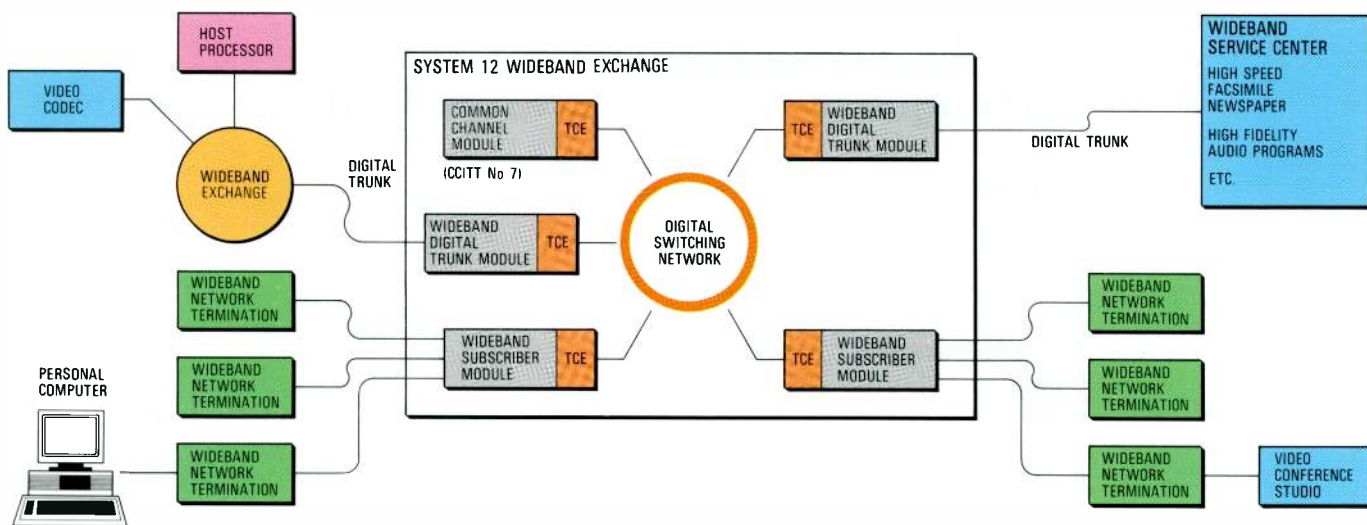

Figure 1 Wideband network based on the System 12 Digital Exchange.

channels on a digital trunk. Subscriber connections in local exchanges may range from wire pairs for relatively low rate services to coaxial cable or optical fiber for higher rate services. In either case, the probable wideband ISDN structure will include a D channel in addition to the B, H₀, or H₁ channels.

To establish a wideband call, signaling information will be conveyed by D-channel messages between subscriber equipment and the exchange. Wideband trunk connections will be established in accordance with the CCITT No 7 signaling channel using a new expanded user part. The format and content of these signaling procedures have yet to be decided, but the new information to be conveyed is principally the number of channels to be associated in the route.

Time Skew Problem

In order to deliver a wideband signal from a source to one or more destinations requires a transmission path to be set up through one or more exchanges, as shown in Figure 1. Digital trunks are used for transmission, giving an available bit rate of 1920 kbit s⁻¹ (30 channels) on CEPT format lines, and 1536 kbit s⁻¹ (24 channels) on North American T1 lines. Since the maximum value of *N* is 30 for a wideband ISDN, it is assumed that all associated channels of a wideband word are carried on the same digital trunk. Were this not true, different signal channels would experience varying transmission delays, a problem not addressed by the mechanism being considered. As long as all the channels are

carried on one digital trunk, no time skew is introduced in transmission.

However, compensation must be provided for the time skew which is introduced by unequal transit delays among the *N* paths through the digital switching network. This skew problem is illustrated in Figure 2 which shows a simple case of two associated paths (*N* = 2). At the source, words consisting of a high byte *H* and low byte *L* enter the switch. The consecutive words have bytes

$$\dots, H_{n-1}: L_{n-1}: H_n: L_n: H_{n+1}: L_{n+1}, \dots$$

Low bytes pass through the switch on path *P1* with delay *T1*, while high bytes are switched over path *P2* with delay *T2*. If the delays are equal, the associated high and low bytes *H_n* and *L_n* come out in the correct sequence, and the wideband path is *coherent*. However, if *T1* is longer than *T2* by one frame, for example, *H_{n-1}* and *L_n* are incorrectly reassembled and the path is *incoherent*. Clearly, incoherent paths are of no use so a technique must be found to compensate for the differing transit delays of *N* independently established paths.

Figure 2 Illustration of the problem of skew for two linked paths.

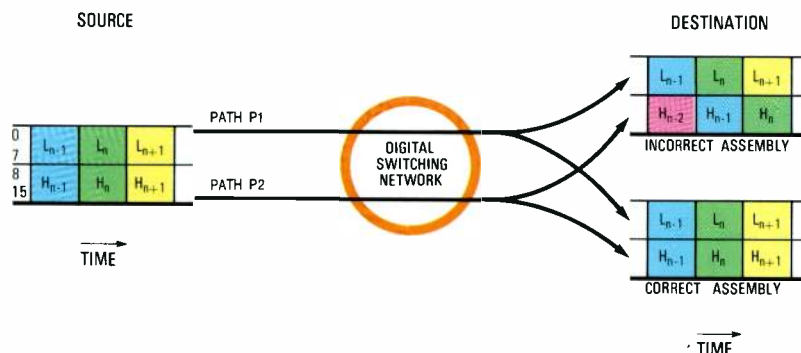

Wideband Switching Mechanism

A wideband signal consists of frames of N bytes, a frame occurring once every $125 \mu\text{s}$. The technique used to remove time skew and allow wideband switching is to add a common frame identifier at the switch input to each of the N channels to be associated in a wideband path, and then use this frame identifier at the switch output to resolve skew. This can be achieved very simply in System 12.

The System 12 wideband environment shown in Figure 3 is made up of the digital switching network and wideband subscriber modules; the latter consist of TCEs and one

identifier. N channels are then established through the switch, each carrying data plus the frame identifier. Their different delays are resolved using an array of RAM and CAM (content addressable memory) sections.

The operation of CAM is shown in Figure 4. The CAM structure is an array of R rows of associative cells, each C bits wide. There are two operating modes: normal RAM-like write or read of rows, and associative read. During a write operation, data to be written into a row of cells is placed on the *data* lines. One row is selected by decoding the write address. Strobe signals (not shown in Figure 4) then cause the

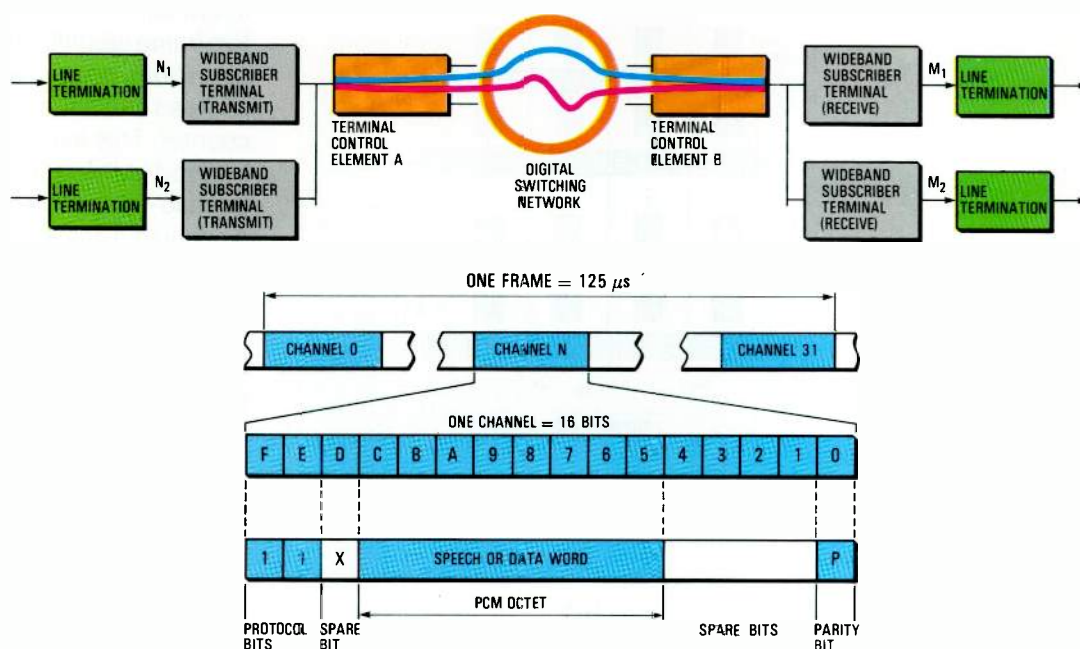

Figure 3
Connection of two wideband subscriber terminals through the System 12 digital switching network.

or more wideband subscriber terminals. The sending terminal adds a frame identifier signal which is used by the receive terminal to remove any skew. Multiple paths are established through the digital switching network between wideband subscriber modules using conventional System 12 methods. Five spare bit positions in the System 12 format words are used to carry a modulo-32 frame identification count which is indexed once per frame. The current value of this count is inserted into these bits on all N associated channels.

One wideband subscriber module can include from one ($N = 30$) to 15 ($N = 2$) wideband subscriber terminations so long as no more than 30 channels are linked by one module. In this case, all channels of all paths are tagged with the same frame

contents of the *data* lines to be loaded into the selected row. A read operation is similar, with the contents of a selected row being output onto the *data* lines.

Within each CAM cell there is effectively a section of exclusive OR circuit designed so that an R -bit magnitude comparator circuit is formed when R cells are interconnected as a row. During the associative read operation, an *associative address* is placed on the *data* lines. The value of this address is compared simultaneously with the contents of each of the C rows of cells. If the associative address and the contents of a row are equal, the comparator for that row gives an active *equal* output. This mechanism allows a fast parallel search for the location(s) of a particular address value.

Deskewing uses N pairs of 12×8 RAM

Figure 4
Operation of content
addressable memory
(a) write, and
(b) associative read.

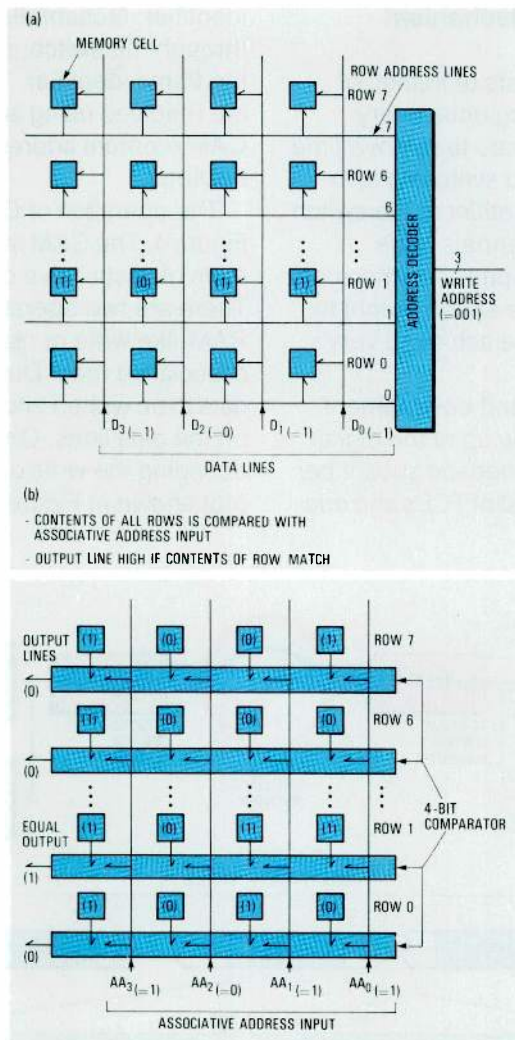

and 12×5 CAM segments plus control circuitry, as illustrated in Figure 5 for the case of $N=2$. The two memory segments are arranged so that the write address for RAM and CAM comes from the same source — a local 4-bit frame counter. During the associative read operation, the 12 equal outputs of the CAM rows form the 12 row select inputs to fetch bytes from the RAM. In the context of our operation, only one equal will be active at a time.

During normal operation two paths are established through the network: path X into one CAM/RAM, path Y into the other. By controlling path setup it is possible to ensure that the high byte goes into the first pair, and the low byte into the second. Thirteen bits are of interest: eight channel information bits are written into RAM, and five frame identifier bits into CAM. Two write operations occur every frame, both at an address indicated by the local frame counter. This independent counter is indexed at the start of each frame in a modulo-12 cycle. Thus the two CAM/RAM pairs hold a stack of the last 12 frames of channel data and the associated frame identifiers. All that is then required to reassemble the output correctly is to pull out the associated byte pairs from RAM with the aid of a 5-bit output frame counter F_0 ; this contains the number of the current frame to be read, and is indexed once per frame during channel 0.

The output frame number F_0 of the next frame to be read is presented as an associative address to both CAMs. Within the CAMs, the output of the comparator in the row with contents equal to F_0 becomes active and in turn selects the RAM contents associated with frame F_0 and forwards them to the RAM output. This occurs simultaneously in both CAM/RAM pairs. Thus the two RAM outputs retrieved are the high and low bytes associated with frame F_0 .

The sizes of the memory and counter fields are determined by the System 12 switch parameters. The length of the memory segments must be greater than or equal to the maximum skew so that deskew can be achieved even in the worst case. The length of the multiframe counter cycle must be twice the memory length so that no possible ambiguity can be introduced. In the System 12 digital switching network, including TCEs and on-board controller interfaces, a theoretical maximum delay of under 12 frames can occur. Since all user-controlled paths are established by using

Figure 5
Normal operation of
the frame aligner.

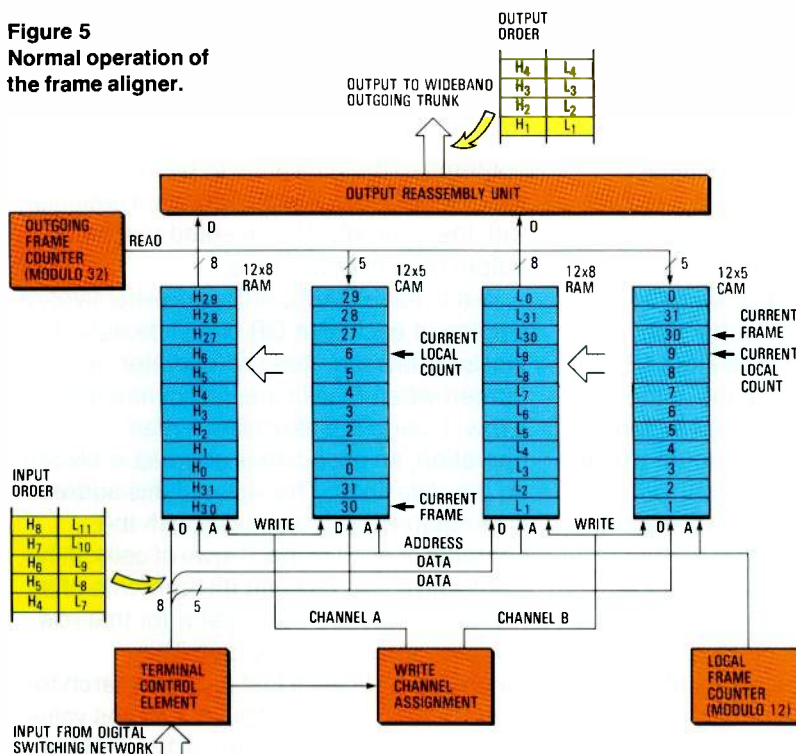

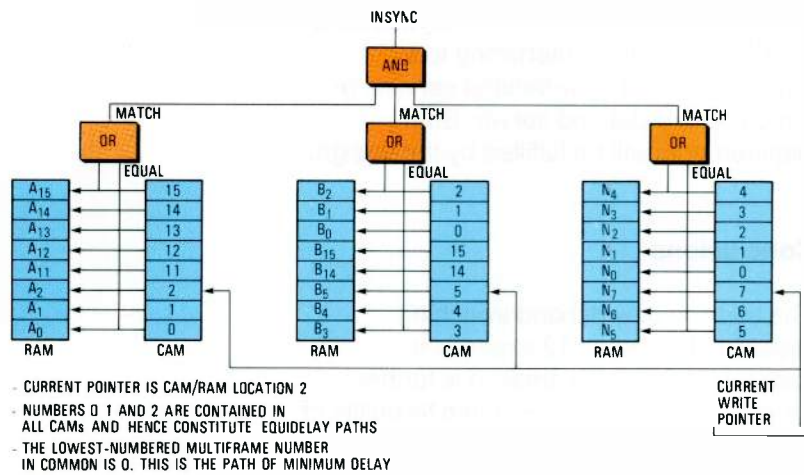

Figure 6
Search operation.
Current pointer is CAM/RAM location 2. Numbers 0, 1, and 2 are contained in all CAMs, and therefore constitute equidelay paths. The lowest numbered multiframe number in common is 0; this is the path of minimum delay.

the first free select mechanism of the switchport, this delay almost never occurs.

The minimum delay of slightly less than one frame is only achievable by careful clock synchronization between switch elements or by the chance occurrence of such synchronization. Thus, the maximum differential delay between any two paths is less than twelve frames worst-case. Hence, a CAM/RAM length of 12 and a frame count cycle of at least 24 are required. A cycle of 32 is used.

A synchronization procedure must be carried out before the normal operating mode can be accessed. This synchronization procedure searches for the simultaneous appearance of a frame number in all N CAMs. A circuit associated with the CAM helps in the search. Each of the comparator *equal* outputs of the CAM is fed into an OR gate, the output of which is termed *match* (Figure 6). *Match active* indicates that one comparator *equal* output is active, showing that the contents of some row is equal to the associative address input number. All N *match* outputs are ANDed to form a signal *INSYNC*. If this output is active, it indicates that frame numbers equal to the current output frame counter state are present in all N CAMs.

Search is initiated by fixing the value of the output frame counter (say 1), and holding it there until synchronization has

Figure 7
Experimental setup for demonstrating the feasibility of wideband ISDN operation in System 12.

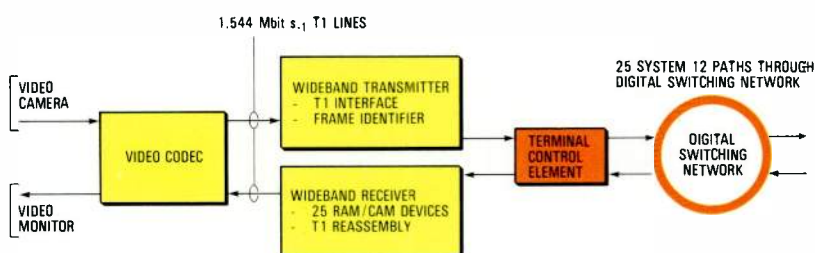

been achieved. Once per frame an associative read of all N CAM/RAM segments is performed and the state of *INSYNC* checked. When *INSYNC active* is first observed, the synchronization procedure is complete. To maintain synchronization, the output frame counter is indexed once per frame during channel 0. If an error occurs and *INSYNC* becomes inactive, hardware mechanisms automatically initiate resynchronization without software intervention. The maximum time required to achieve synchronization after path setup is 24 frames. Since path setup in System 12 takes a few tens of milliseconds, the three milliseconds required for synchronization is insignificant.

The method of search, looking at a fixed number until the time of first occurrence of that number in all CAMs, also minimizes the transit delay of the N -link path through the network.

Current Status and Plans

A feasibility model of this mechanism has been built. Figure 7 illustrates the transparent switching of a 1544 kbit s^{-1} compressed video signal. The output of a color video camera is fed into a codec, the output of which is a 1544 kbit s^{-1} signal, which in turn is fed to a prototype wideband transmitter where the frame identifier is added. Twenty-five paths are established through the switch to the wideband receiver (the 25th channel carries the 193rd bit).

Deskewing is carried out in the wideband receiver by 25 frame alignment module medium scale integration devices. The output is reconstructed as a 1544 kbit s^{-1} channel, passed to the codec for decoding, and then sent to a color monitor to complete the video path.

The frame alignment module device is a custom integrated circuit fabricated for this model; it contains an 8×8 RAM and 8×4 CAM interconnected as already described. It is fabricated in $3.5 \mu\text{m}$ NMOS technology, and packaged in a 24-pin dual-in-line package. No attempt was made to include all the required control on the chip in this initial phase. Consequently, the device is quite universal in application, but requires substantial support circuitry to perform all the wideband receiver functions.

A versatile, cost-effective wideband switching module requires all 30 CAM/RAM pairs and their associated control circuitry to

be built as a single custom VLSI circuit. The control requirement is that any of the 30 channels can be a single channel, any can be wideband, and that any combination of channels can be involved simultaneously in one or more paths. This is completely general, but still reasonable in implementation. Such a device should become available in 1986.

Correctly designed, the device can function in two places in the network. First, it can be equipped as an option on a digital trunk board to allow wideband trunk switching. Second, appropriate design will

enable it to be incorporated into a wideband subscriber module, interfacing to a subscriber needing wideband service, or directly to a wideband server. Both requirements will be fulfilled by the design.

Conclusions

The addition of wideband switching capability to System 12 expands its applicability into new areas. It is further proof of the inherent power and flexibility of the underlying architecture.

Switching for the German Satellite System

The Deutsche Bundespost is planning to install a satellite communication system to provide new high speed data services. Switching in this network will be based on a small stand-alone exchange, which may be one of the first exchanges to handle ISDN services on a nationwide basis.

K. Nigge
K. Rothenhöfer
P. Wöhr

Standard Elektrik Lorenz AG, Stuttgart,
Federal Republic of Germany

Introduction

A consortium of four German telecommunication companies is developing a nationwide satellite communication system for the Deutsche Bundespost which will provide new services, mainly for high speed data, including wideband switching. This satellite system – known as DFS (Deutsche Fernmelde-Satelliten-System) – will also be used for the distribution of television programs and for digital long distance transmission. The coverage area is shown in Figure 1.

Apart from the satellite, the project includes 32 ground stations and an

operations and maintenance center. In the longer term it is envisaged that the system will be extended to 100 stations.

Following field trials using existing satellite capacity, scheduled for the early part of 1986, the satellite system will go into public service early in 1988, after the launch by Ariane in 1987. Initially the system will operate as a separate network serving a group of subscribers requiring high speed data connections and PABX tie lines. However, this situation is likely to change with the introduction of an ISDN in Germany in the near future. In addition, being a national satellite system it can be used to bridge a temporary shortage in trunk connections and in general to interconnect (temporarily or permanently) any public communication service.

To meet these requirements, the terrestrial switching system must have the flexibility to introduce new features as they become available and to grow in small increments. A further advantage would be the availability of a containerized version. The system which is being supplied by SEL for the Deutsche Bundespost public switching network, meets these requirements and also makes it possible to use common operations and maintenance facilities. The installation for the DFS system will have a wideband switching capability.

Ground Station

Data traffic is switched digitally by the ground stations; the satellite simply acts as a digital transmission medium which receives data from one station and sends it transparently

Figure 1
Coverage area of the satellite for the DFS system at an orbit position of 23.5° east.

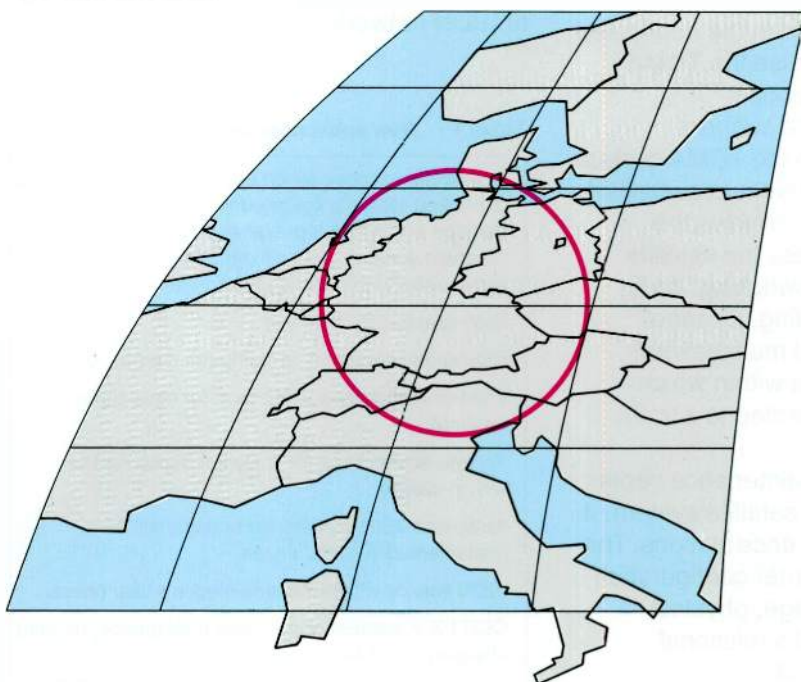
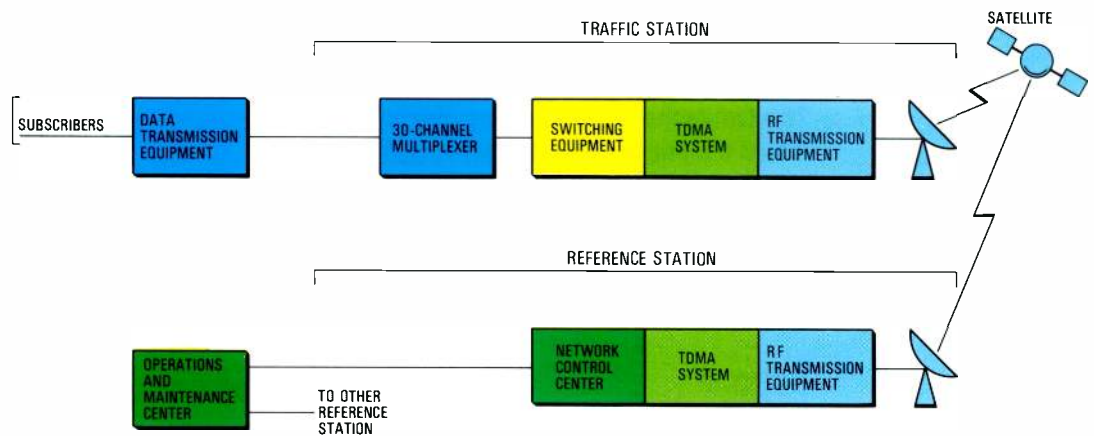

Figure 2
Ground stations for the new Deutsche Bundespost satellite system showing the difference between traffic stations and reference stations.



to other stations. Data is only accepted by the ground station to which it is addressed.

Figure 2 is a block diagram of the ground stations, of which there are two types: traffic stations to which subscribers are connected, and reference stations to which the operations and maintenance center is connected. In the first stage of the project there will be 30 traffic stations, two reference stations, and one operations and maintenance center. The satellite capacity (two transponders) will allow for up to 625 simultaneous 64 kbit s⁻¹ duplex interconnections.

Each ground station consists of a 3.5 m antenna (12/14 GHz), radio frequency/intermediate frequency equipment, and the TDMA (time division multiple access) system which provides access to the satellite transmission channels, operating in the *demand assigned channel allocation* mode (i. e. quasidynamic satellite channel allocation to the ground stations depending on the traffic volume).

Network control centers in the duplicated reference stations supervise the TDMA systems in the traffic stations.

Although it is feasible to connect terrestrial links directly to the TDMA system in the traffic stations (but without signaling), an ANPE (switching unit) enables the terrestrial system to access the satellite system by adapting the switching, traffic concentration, and signaling. Channel access units (30-channel multiplexers) extend the coverage area within which subscribers can be connected to a traffic station.

One operations and maintenance center is provided for the entire satellite system; it is connected to both reference stations. The center uses a dual computer configuration with redundant data storage, physical Ethernet connection, and a relational database system (ORACLE).

Standard Elektrik Lorenz's participation in the satellite system project covers the terrestrial switching equipment (ANPE and channel access units), operations and maintenance center, data transmission equipment (single channel and wideband), and the tracking, telemetry, and command subsystem which is part of the "space segment". This article concentrates on switching for the satellite system, that is, on the ANPE and channel access unit.

Characteristics and Switching Requirements

New services provided by DFS include the subscriber features given in Table 1. Subscribers can access most of these services by self-dialing or reservation. However, in the future there may be an interconnection between the DFS network and the public switching network (telephony or ISDN network).

Table 1 – New subscriber features

<p>Reservation service which allows the automatic setup of booked calls at a specified time and for a specified duration with a maximum delay of one minute; the reserved duration can be extended or shortened within certain limits during the connection.</p> <p>High speed data switching.</p> <p>High speed computer-to-computer connections.</p> <p>Point-to-multipoint service (e.g. for newspaper printing).</p> <p>Tie-line connections for analog or digital PABXs with in-dialing.</p> <p>Audio and video conference facilities will be implemented in a later phase.</p> <p>ISDN service will be implemented in a later phase.</p> <p>CCITT X.2 features (e.g. closed user groups, reverse charging, point-to-multipoint).</p>
--

Table 2 shows the data rate switching that must be provided to implement the new services, together with the signaling systems that must be handled and the administration and operations features of the satellite system. Internal traffic (both single-channel and wideband connections) is handled by the ANPE.

Switching in the DFS network is based on a number of local exchanges (30 in the first phase), represented by the ANPE and channel access units in the traffic stations, which are connected to a nodal switch represented by the TDMA in the traffic stations and the satellite.

ANPE System Configuration

Figure 3 illustrates the switching equipment of the traffic stations. All single-channel data subscribers, representing a 72 kbit s^{-1} interface (8 kbit s^{-1} for CCITT X.21 signaling), and the PABX tielines are connected to the channel access units, whereas wideband users are connected directly to the ANPE via 2 Mbit s^{-1} links (CEPT format). Similar 2 Mbit s^{-1} links using channel associated signaling and the CEPT format connect the ANPE and channel access units. The ANPE is connected to the TDMA system via 2 Mbit s^{-1} links using common channel signaling (reduced CCITT No 7).

Compared with exchanges in the public switching network, the ANPE is rather small with a maximum planned configuration of 17 terrestrial 2 Mbit s^{-1} links and six 2 Mbit s^{-1} trunks to the TDMA system. The 30 exchanges to be installed in the first phase will use nine terrestrial links and three trunks. However, the Deutsche Bundespost has specified that further network extension must be possible.

The ANPE (Figure 4) is a small stand-alone exchange which can be realized in a single rack, making it cost-effective for use in a container. It is built from standard digital switching equipment hardware and software modules, making extensive use of

Table 2 — Main features of switching for the German satellite system

Data rate switching
Single 64 kbit s^{-1} channel.
Wideband with N channels of 64 kbit s^{-1} ($N = 2$ to 30); at present the Bundespost has chosen N as 2, 4, 8, 12, 24, and 30.
2 Mbit s^{-1} for reservation service only. Structured and quasi-unstructured — likely to be switched by the ANPE at a later phase; at present it bypasses the ANPE and is connected directly to the TDMA.
8 Mbit s^{-1} for reservation service only; this will be connected directly to the TDMA in a later phase.
Signaling systems
IKZ 50 signaling for use with PABXs with in-dialing; this is a national signaling type.
CCITT X.21 signaling for all data subscribers connected to the ANPE and channel access unit for single channel user (64 kbit s^{-1}) and wideband terminals.
Reduced CCITT No 7 common channel signaling for internal satellite system signaling (ANPE-ANPE, ANPE-operations and maintenance center).
Administration and operations features
All traffic stations are unattended.
All traffic stations are supervised centrally by the operations and maintenance center via the satellite; a reduced set of supervisory features is available via terrestrial connections.
Local and remote man-machine communication from the operations and maintenance center.
Remote control of the adaptation function of N (used by the wideband terminal) in data terminal transmission equipment.

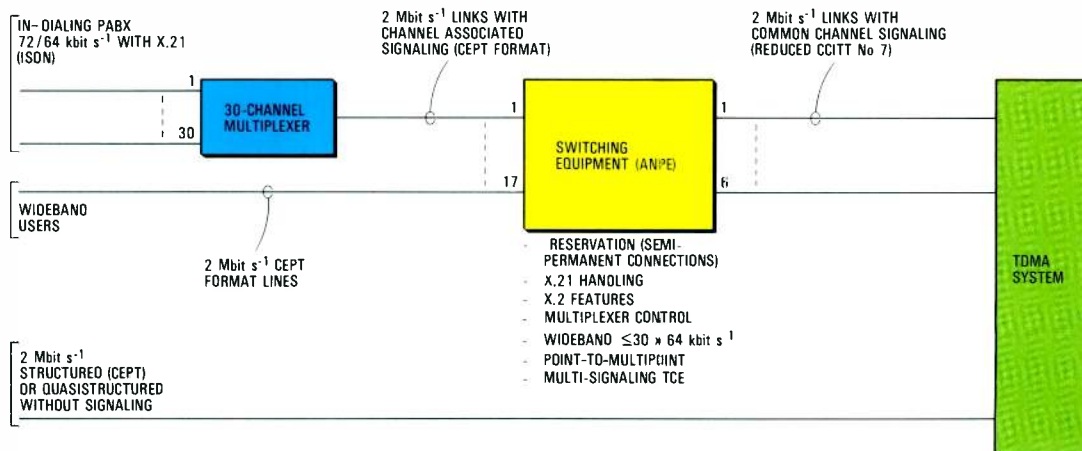

Figure 3
Connection configuration and main switching requirements for the traffic stations.

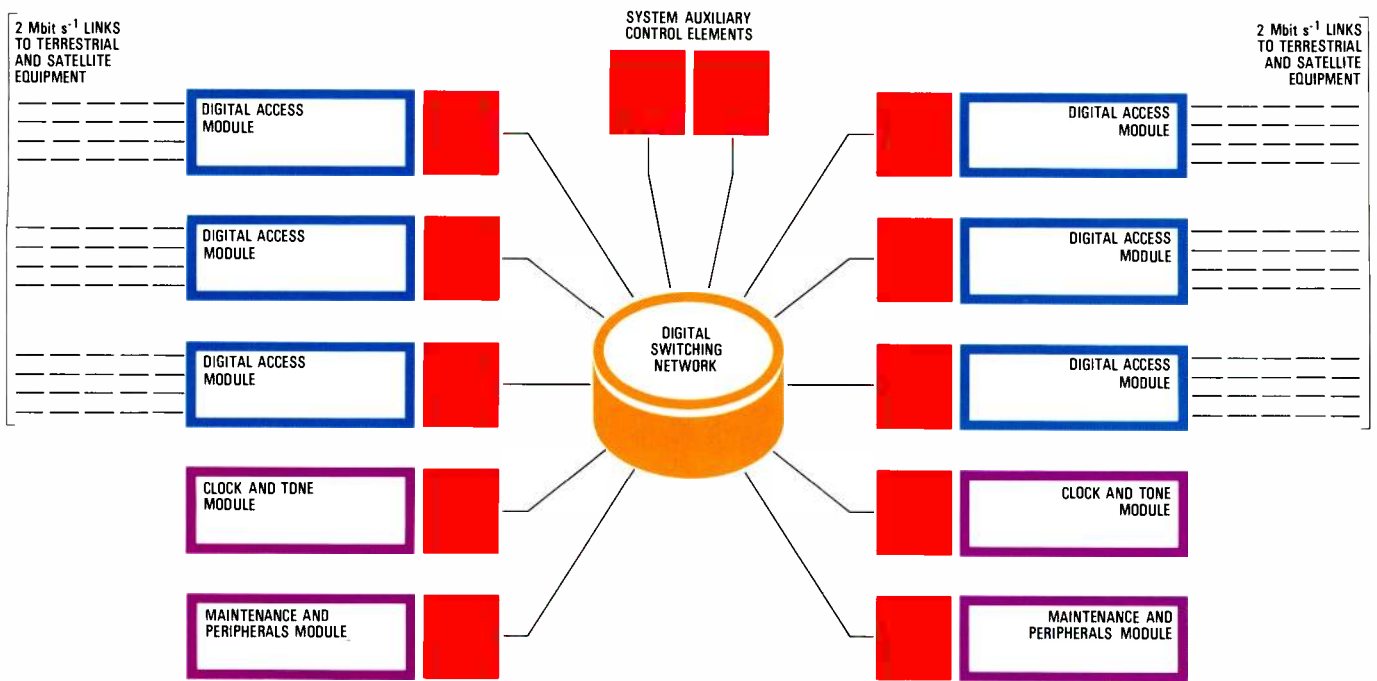
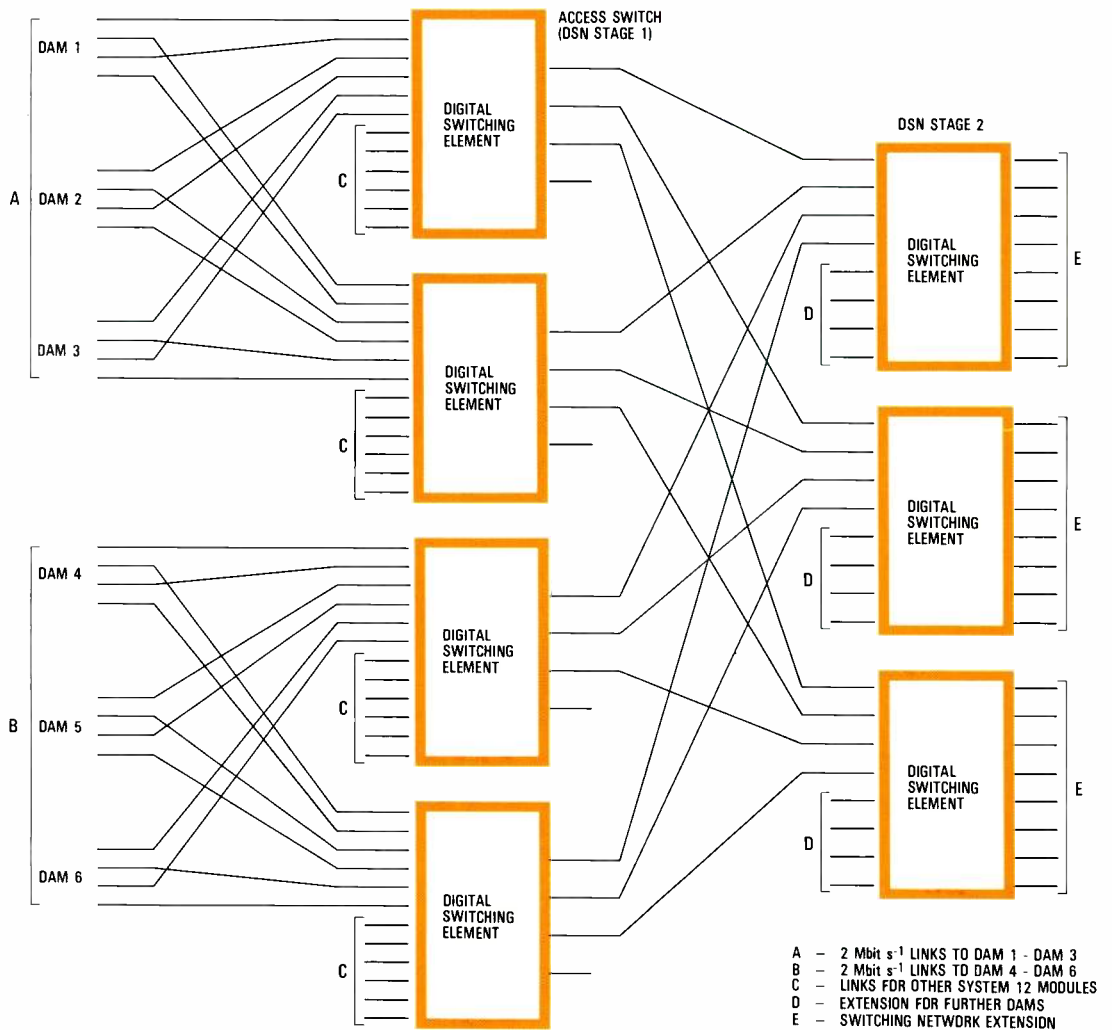

Figure 4
Configuration of the ANPE which is essentially a small stand-alone exchange based on existing switching modules.



256 k × 1-bit memory chips, with a few modifications to meet the DFS requirements.

ANPE Building Blocks

Digital Access Module

The DAM (digital access module) interfaces with the 32-channel, 2048 kbit s⁻¹ PCM trunks. The DAM consists of TCEs and digital trunk circuits¹ as for the digital trunk module, except that more than two trunk circuits can be connected to and handled by two TCEs.

The number of trunk circuits controlled by one TCE is traffic dependent. Traffic concentration is necessary, particularly for the interconnection of multiplexers and data terminals. Traffic and wideband requirements for the DFS application resulted in a configuration with four trunk circuits per DAM. Thus three DAMs are required for the first phase and six DAMs for the planned exchange size of 23 trunk circuits. A digital trunk circuit variant is used in the DAM to meet the DFS requirements.

Digital Trunk Circuit

As well as the standard features, the modified digital trunk circuit has several facilities that will be implemented for the first time in the DFS system (see Table 3). Figure 5 is a block diagram of the circuit which incorporates new DTRL (digital trunk logic) to handle the additional facilities. Also more RAM had to be added to the DTRL both to ensure the frame sequence integrity of wideband connections and to receive CCITT X.21 signaling information. Frame RAM stores two PCM frames for frame

Table 3 — Main characteristics of the digital trunk circuit

<p>Exchange features</p> <p>32-channel PCM, 2048 kbit s⁻¹ interface according to CCITT Recommendations G.700 and Q.500 series</p> <p>Channel associated signaling</p> <p>CCITT No 7 point-to-point signaling</p> <p>Hardware self test.</p> <p>Satellite system features</p> <p>Sharing of a TCE by two digital trunk circuits</p> <p>Control of wideband connections (frame, channel, and bit sequence integrity handling)</p> <p>CCITT X.21 signaling for data service.</p>
--

alignment at the receive side, and 16 frames at the transmit side to control frame sequence integrity. CCITT X.21 RAM buffers up to eight X.21 receive messages, each with a maximum length of 512 bytes. The basic functions are controlled by the same firmware as in the standard digital trunk circuit.

The procedure used to ensure frame, channel, and bit sequence integrity for wideband connections is as follows. The PCM channels to be used for wideband connections are assigned by software. When the assignment register in the DTRL is set, the status of a 5-bit multiframe counter is added to the incoming 64 kbit s⁻¹ speech or data information and transferred via the switching network to the connected outgoing trunk. The digital switching network transmits 16 bits per channel: two protocol bits, eight speech or data bits, five multiframe status bits, and one parity bit.

Path search and setup are accomplished in the usual way for all N channels in the wideband connection. The original frame

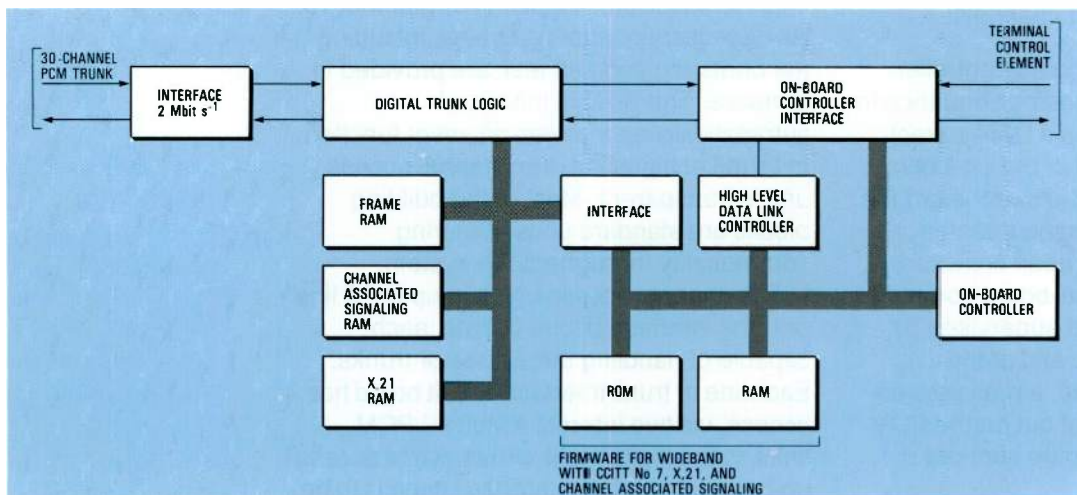

Figure 5
Digital trunk circuit based on the standard circuit but with new digital trunk logic.

and channel sequence can be lost at the outgoing side of the network as a result of the free path search mechanism which causes different delays and channel allocations. Channel sequence integrity is software controlled. Channels are rearranged in the on-board controller interface. Frame sequence integrity is controlled by hardware and firmware. The DTRL cyclically stores 16 frames of 16 bits per channel in the frame RAM. The on-board controller reads the multiframe status information in one frame area of the frame RAM for all channels included in the connection. The status information is then analyzed to determine which channel has the longest delay and what the delays should be on the other channels to ensure frame sequence integrity. Delays are calculated in multiples of frames and the result is written into the frame RAM. The DTRL first calculates the address of the channel to be transmitted (channel number + status of multiframe counter + delay factor) and then reads and inserts the speech or data information into the outgoing bit stream. This procedure minimizes the delay for wideband connections.

The procedure for handling CCITT X.21 signaling messages is as follows:

Signal reception: PCM channels used for data connections with X.21 signaling have to be assigned by software. To activate signal reception, the address of a free X.21 RAM area is assigned to the PCM channel. The DTRL supervises the incoming bitstream and routes it to the memory as soon as useful information is received. The on-board controller then reads and sends the information to the TCE for software processing. Dummy information within the bitstream is suppressed by the DTRL. Signaling information can be received simultaneously from eight channels.

Signal transmission: on-board controller firmware prepares the transmit sequence in the associated RAM. Then a DMA (direct memory access) channel of the on-board controller interface must be switched to the used PCM channel. Message transfer can start when the DTRL has been activated, and is controlled by the on-board controller interface. The bitstream is supervised by the DTRL; as soon as the end of the signaling block is detected, a preassigned constant bit pattern is sent out on the PCM trunk. Four messages can be sent out simultaneously.

System Auxiliary Control Element

This duplicated module consists of a control element with 1 Mbyte of memory.

Maintenance and Peripherals Module

The duplicated maintenance and peripherals module is essentially the standard module² with a few modifications. The differences are that there are fewer man-machine communication interfaces and no tape system; two 5¼ inch disks³ and associated interfaces will be provided in the switching equipment rack. Also the functions of the display logic, lamp driver, and dual-failure monitor have been combined on a single printed board.

Digital Switching Network and Switching Element

In view of the number of links between the modules and the digital switching network⁴, four digital switching elements will be equipped for the access switches, and three switching elements in stage 1 of the group switch (digital switching network stage 2) during the first phase with three DAMs. A fourth digital switching element (not shown in Figure 4) might be required in stage 1 of the group switch when the system is extended to six DAMs.

Channel Access Unit

This unit is a multiplexer for connecting up to 30 data lines with a transmission rate of 72 kbit s⁻¹ and CCITT X.21 signaling or up to 30 analog bothway trunks for PABXs with direct in-dialing and IKZ signaling (Figure 6). Each line or trunk is assigned to a specific channel in the PCM link.

The on-board controller in the digital trunk circuit controls the channel access unit with the support of the ANPE using channel associated signaling on channel 16. All necessary control programs, including the bootstrap and self test, are provided in firmware. The RAM is initialized automatically by a power-on-reset function. In terms of signaling, the channel access unit is transparent. Most of the building blocks are standard units, ensuring commonality throughout the system.

The channel access unit has up to 10 line or trunk interface circuit boards, each capable of handling three lines or trunks. Each line or trunk interface circuit board has access, via two internal 4 Mbit s⁻¹ PCM links, to the digital trunk circuit. A test access unit enables the trunk interface circuits to be

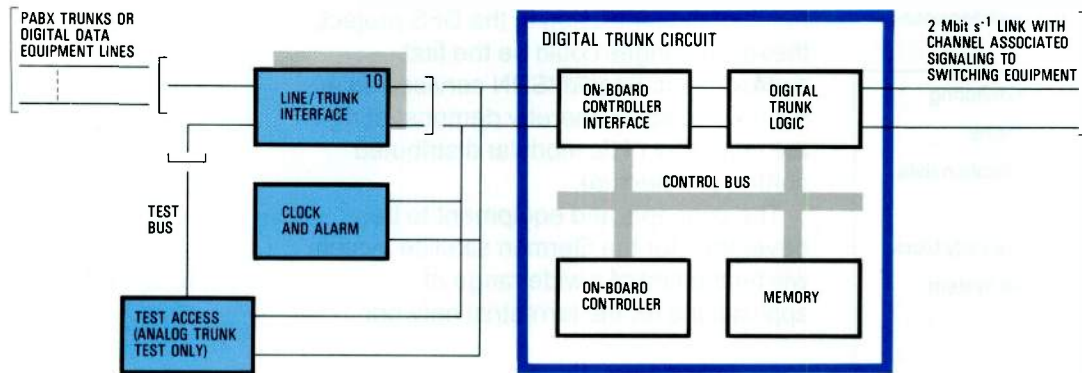

Figure 6
Block schematic of the channel access unit (30-channel multiplexer).

tested. A combined clock and alarm circuit board provides local timing, synchronized with the PCM signal from the ANPE, and transfers alarm information to the ANPE.

ANPE – A New Application of the Existing Software

The software used for switching in the ANPE is based on existing software and is therefore already available for the generic features. The ANPE provides sufficient control element redundancy and further distribution of call handling functions from the trunk ACE to TCEs. Intelligence in telephone terminals has been increased by assigning signaling and path setup functions for speech and data traffic to the digital trunk terminal.

The increased intelligence of the digital trunk circuit is achieved by making extensive use of an on-board controller with its interface, and VLSI circuits. The VLSIs in the digital trunk circuit receive and send X.21 register signals (digits, facility control information) and perform the level 1 and level 2 functions of CCITT No 7 signaling.

Call Handling Features

Two types of call have to be handled: dialed calls and reserved calls. Reserved calls differ from dialed calls with respect to the setup procedure, grade-of-service during setup, and security during the stable phase. The subscriber requests the reservation operator at the operations and maintenance center to book a reserved call at a given time for a specified duration. A reserved connection is set up automatically by the ANPE at the requested time using reserved capacity in areas where blocking could occur.

In the case of PABX connections, the reserved call results in a tie-line being established between two PABXs. During

the reservation time, the DFS system ensures signaling transparency between the two PABXs involved.

Administration Features

Charging will be based on detailed billing – there will be no meter counting. Call records will be collected in the ANPE and transferred to the operations and maintenance center in blocks. The ANPE maintains call records for 24 hours as a backup.

Date and time of day for the ANPE are initialized centrally and distributed to the ANPE partly as a CCITT No 7 message (high order part) and partly as dynamic in-channel information (low order part).

Operation of the ANPE

The ANPE is essentially a small stand-alone exchange connected to an operations and maintenance center which can remotely initiate all man-machine communication commands possible in the ANPE (i.e. activate all operations and maintenance functions), as listed in Table 4.

CCITT No 7 Signaling System

CCITT No 7 signaling is used for interexchange communication in the network. The user parts to be implemented are:

- Telephone user part for all IKZ oriented call handling.
- Data user part for all CCITT X.21 call handling.
- Operations and maintenance user part which will support remote man-machine communication, call specification data transfer, file transfer, disk initialization, and backup tape generation. As at the start there will be 30 ANPEs in the network, disk initialization will be speeded up by simultaneously initializing all ANPE disks using the broadcasting facilities of the satellite system.

Table 4 — ANPE operations and maintenance facilities

Centralized traffic supervision and monitoring
Initiation of network management actions
Centralized collection of all call specification data
Centralized alarm reporting
Initiate initialization and disabling of security block
Initialize all ANPE disks in the satellite system network with new software package
Collect backup data from the ANPE
Collect detailed billing information and provide data to the Deutsche Bundespost charging center.

Conclusions

Switching of high speed data links for the German satellite system, including wideband connections, has been achieved economically using small stand-alone exchanges based on the same digital switching system that SEL is supplying to the Bundespost for the public network. As a

result of their inclusion in the DFS project, these exchanges could be the first exchanges to handle ISDN services on a nationwide scale, thereby demonstrating the versatility of its modular distributed control architecture.

The concepts and equipment to be developed for the German satellite system will be the first of a wide range of applications for the terrestrial network.

References

- 1 J. J. Van Rij and P. Wöhr: System 12: Analog and Digital Trunk Circuits: *Electrical Communication*, 1985, volume 59, no 1/2, pp 48–53 (this issue).
- 2 R. H. Mauger: System 12: Architecture for Change: *Electrical Communication*, 1985, volume 59, no 1/2, pp 35–42 (this issue).
- 3 A. Bessler, M. E. Edelmann, and L. Lichtenberg: System 12: ITT 5630 Business Communication System: *Electrical Communication*, 1985, volume 59, no 1/2, pp 178–187 (this issue).
- 4 W. Frank, M. C. Rahier, D. Sallaerts, and D. C. Upp: System 12: Dual Switch Port: *Electrical Communication*, 1985, volume 59, no 1/2, pp 54–59 (this issue).

System 12

Acilia International Toll Exchange

Although the basic System 12 architecture allows any type of exchange to be easily configured, a number of requirements are specific to international toll exchanges. Thus development of the Acilia exchange for Italcable involved the design of modules for the international application. The exchange has now been successfully handed over and is undergoing acceptance testing.

M. Della Bruna

Industrie FACE Standard SpA, Milan, Italy

F. Minuti

Italcable, Rome, Italy

Introduction

The key position of an international toll exchange in the worldwide network imposes special requirements on a switching system. In particular, the exchange must guarantee high performance in terms of operation, maintenance, availability, and flexibility. It is important that the exchange should be capable of performing complex functions, while at the same time ensuring that new services and technologies can be added cost-effectively. ITT's System 12 Digital Exchange is able to meet these stringent requirements as a result of its ISDN oriented approach based on a modular distributed

control architecture. This architecture allows new features to be added as they are required without the need to install any additional processing power in advance.

The international toll exchange at Acilia, the site of Italcable's Rome operating center, is the world's first very large application of a distributed control system. It is based on the addition of international features to the standard System 12 architecture.

Structure of the Italcable Network

Italcable, the recognized private operating agency responsible for all intercontinental telecommunication services in Italy, has considerably increased its switching and transmission capabilities to cope with increases in intercontinental telephone traffic. Today Italcable's telephone network connects Italy directly with about 80 countries using more than 2200 international circuits. All international traffic is routed through three centers at Acilia (in Rome), Milan, and Palermo (Figure 1). These centers are connected by a national network. National and international trunks are distributed between these centers according to two main criteria: location of the center and traffic interest (countries to which the traffic is to be routed).

A center which is not connected directly to a particular country can route traffic to that country via one of the other centers. This facility can also be used for overflow traffic. Suitable controls are implemented to avoid network loops.

The Italcable operating center at Acilia.



Figure 1
Italcable's network of International toll exchanges.

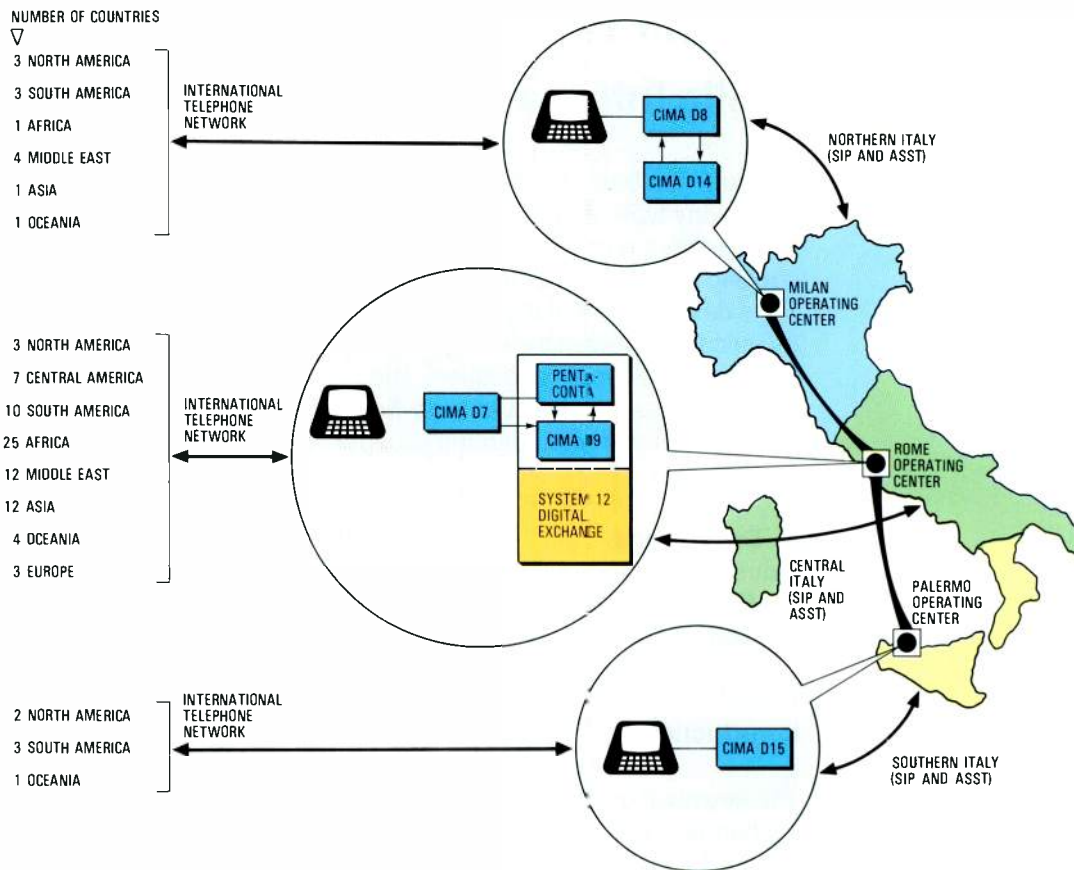

To improve call routing and service quality, Italcable has implemented a network management center which meets all relevant CCITT recommendations¹. This center is based on two main systems: GTAI (an Italian acronym for management of transit traffic between Italcable exchanges) developed by Italcable, and ITSS (Italcable telephone service supervision) designed by FACE.

Because of its size, performance, and traffic handling capability, the System 12 exchange at Acilia is of importance to the whole Italcable network, and will become increasingly so in the future as it gradually replaces the existing Pentaconta and CIMA D9 exchanges. The new exchange will enhance the network maintenance strategy

by physically and logically integrating international features (e.g. echo suppression, large conferences, in-band signaling system handling), and by providing a powerful trunk testing subsystem (or 12ST).

Moreover, the ability of System 12 to manage the operator service using the sophisticated digital operator position (which will be introduced at Acilia in the second half of 1985) and to handle ISDN services will ensure that it plays an increasing role in the Italcable network.

Requirements for an International Toll Exchange

The working scenario of an international toll exchange differs greatly from other transit or local nodes in a telephone network. At the top of the hierarchy of a national network, an international exchange exemplifies the telecommunication services of the country. Thus such an exchange must provide a wide variety of services and special facilities.

To ensure that the Acilia System 12 exchange would offer all the necessary services and facilities, the requirements were analyzed jointly by Italcable and FACE

Table 1 — Signaling systems at the Acilia Exchange

Channel associated	National	Out-of-band decadic Out-of-band multifrequency code 2V/V (2 channels per direction) CCITT No 1
	International	CCITT R.2 (analog/digital) CCITT No 5
Common channel	National	CCITT No 7 (analog/digital)
	International	CCITT No 6 (including signaling CCITT No 7 transfer point function)

experts, and detailed specifications on features, traffic, and service performance were prepared in order to:

- Ensure correct interworking between national and international networks handling various associated and common channel signaling systems (Table 1).
- Analyze digits, and provide the ability to understand, add, or delete digits for special services (Table 2).
- Provide routing capability and flexibility, taking into account the characteristics of international traffic and the possibility of overflow between Italcable exchanges based on GTAI information (Table 2).
- Enable or disable echo suppressors on the basis of signaling information, or at the request of an operator (Table 2).
- Provide special services such as conference calls, data calls, and semipermanent connections, under operator or subscriber control (Table 3).
- Provide extensive data collection and measurement facilities to support call charging, network planning, quality of service observations, and network management functions (Table 3).
- Initiate network management actions and controls, either automatically (on receipt of appropriate signals from colocated or remote network management centers) or manually, in order to reduce or eliminate the possibility of blocking (Table 3).
- Provide administration and maintenance facilities that can deal flexibly with network extensions, changes in national or international environments, and faults and alarms (Table 3).
- Ensure the easy addition of functions and services during the transition to an ISDN.

These requirements will be met in two operational phases.

Hardware and Equipment

The general characteristics of the Acilia exchange and the new equipment needed to meet the identified requirements were described in a previous issue of *Electrical Communication*². The present article considers practical details of the Acilia configuration, and emphasizes specific features of the international toll application.

The Acilia international toll exchange is based on the standard System 12

Table 2 — Telephonic requirements for the Acilia Exchange

Numbering	National plan International plan Special services
Routing	Up to 12-digit analysis Up to 16 alternative routes per direction Up to 8 trunk groups per route Various traffic restrictions Variable on { Time basis (e. g. on Sunday) Operator request Network management control Service basis
Charging	On outgoing traffic } for both On call basis } automatic and For special services } semiautomatic With duplicated files } traffic
Recorded announcements	Some nonblocking messages Predefined message duration Message broadcasting More than one language Programmable iteration of messages
Echo suppressor control	Operator request Signaling information
Network synchronization	National International

Table 3 — Present services and facilities

Administration	Man-machine communication handling Data collection Measurement reports (automatic/on demand) Statistics Exchange configuration management Exchange size/function extensions
Maintenance	Alarm and fault detection Alarm reporting (different priorities) Routine tests Fault isolation Graceful degradation
Automatic patching	Semipermanent connection handling Echo suppressor disabling by operator
Network management	Processing of collected data Overload control Traffic disabling/enabling actions Interconnection with network maintenance centers
Operator position	Language assistance Manual calls Operator controlled conference calls Datel service
Trunk testing	National procedures (MCA-DRA) automatic International ATME-2 Test desk interface and manual tests Test terminations Timed signals measurements Measurement on digital trunks Result handling and reporting

architecture. The digital switching network consists of access switches and three group switch stages with the full complement of four planes to meet all the requirements for a large exchange of this type. Table 4 shows the trunks associated with the various signaling systems.

All the hardware modules can be grouped into 12 types²:

- maintenance and peripherals module
- clock and tone module
- service circuits module
- common channel module
- operator interface module (to be added in the second phase)
- auxiliary control elements
- digital trunk module for international application
- analog trunk module for international application
- recorded announcement module
- conference service module (to be installed in the second phase)
- trunk testing module
- administration and peripheral module.

The first six types are standard System 12 modules. The second six, which were developed by FACE for the international

Table 4 — Acilia trunks and signaling systems

Trunks			Signaling system
Incoming	Outgoing	Bothway	
2130 analog	3750 analog		multifrequency code/decadic
		660 analog	CCITT R2
		240 analog 240 digital	CCITT R2 + DES
		2790 analog 60 digital	CCITT No 5 + DES
		900 analog	CCITT No 6 + DES
		120 analog 600 digital	CCITT No 7
		420 digital	CCITT No 7 + DES
210 digital	210 digital		Two channels per direction
		60 analog	Manual lines (CCITT No 1)

DES - digital echo suppressor.

application, connect with the digital switching network in exactly the same way as all other modules.

Only 62 types of printed board are used in the Acilia exchange — many fewer than in equivalent international exchanges. About 7450 boards were installed and tested in the first phase of the Acilia project; a further



The System 12 Digital Exchange room at Acilia.

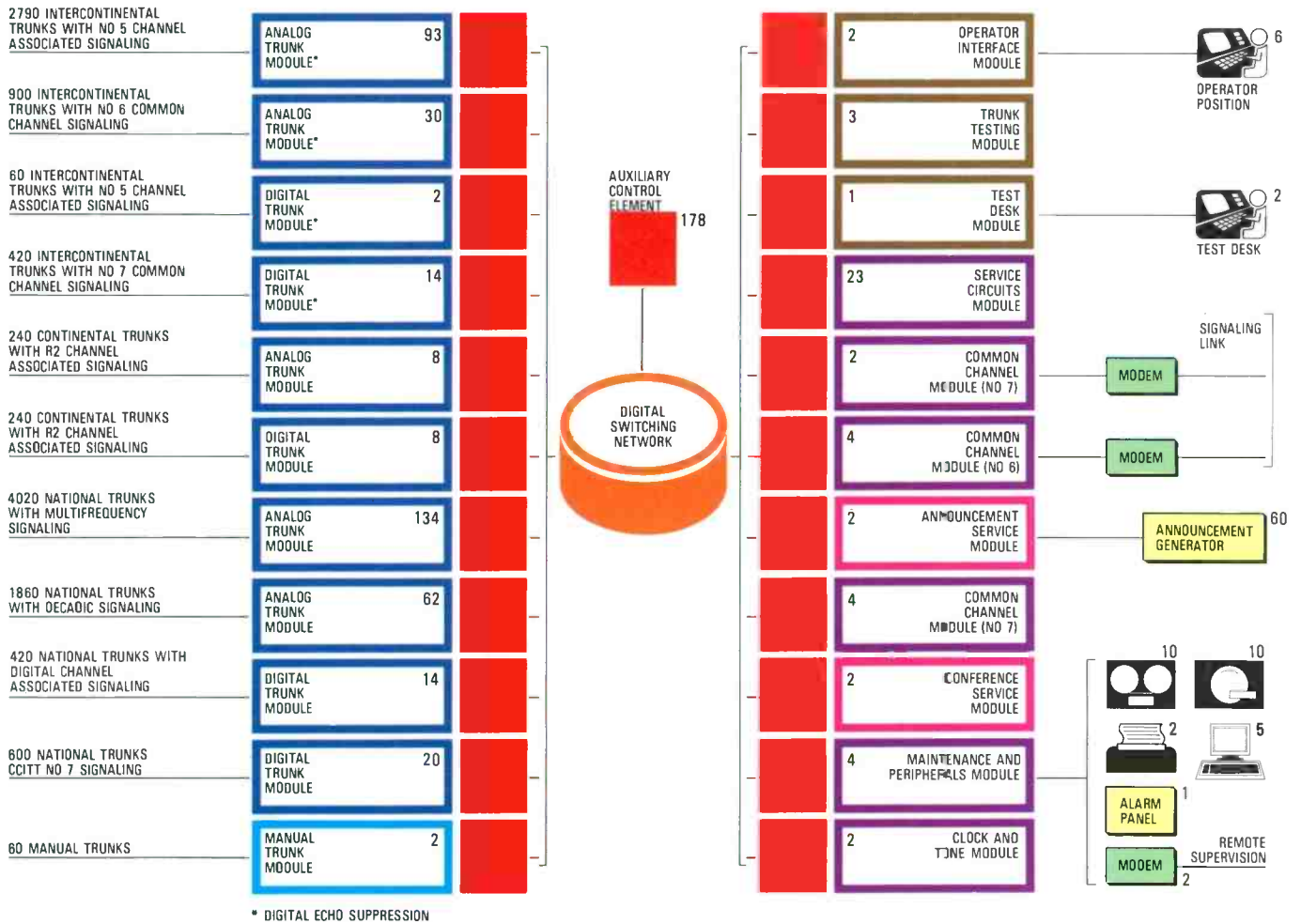

Figure 2
Junction diagram of the System 12 international toll exchange of Acilia.

Digital echo suppressor printed boards developed by FACE Sud for the System 12 international toll exchange application.

600 boards will be added in the second phase.

About 4 300 of the boards already installed are dedicated to international functions, including the interface for digital and analog trunks; echo suppression for long distance calls; international in-band (CCITT No 5) signaling; analog and digital trunk testing; test desk for trunk testing; analog recorded announcements; large international and national conference calls; and speech detection for manual tone-on/tone-off signaling systems.

The number of hardware modules (463) and racks (116), and the exchange layout can be derived from Figures 2 and 3. Table 5 lists the rack types shown in the floor layout.

Table 6 summarizes the performance of the digital trunk testing unit; the features of the digital echo suppressor, digital interface for CCITT No 5 signaling, and the conference mixer have been described previously in *Electrical Communication*². In addition to the modules, the Acilia exchange includes: 5 video display units; 10 magnetic tape units; 10 disk units; 7 printers; 2 line printers; a master alarm panel; 2 test desks; 6 operator positions plus 2 line terminal

units; 16 modems for analog common channel links; 5 power racks and 900 DC/DC converters; all the required cabling; main distribution frame; and a digital access frame. Equipment for the CCITT No 7 signaling system interface, conference service module, and operator positions will be added in the second phase.

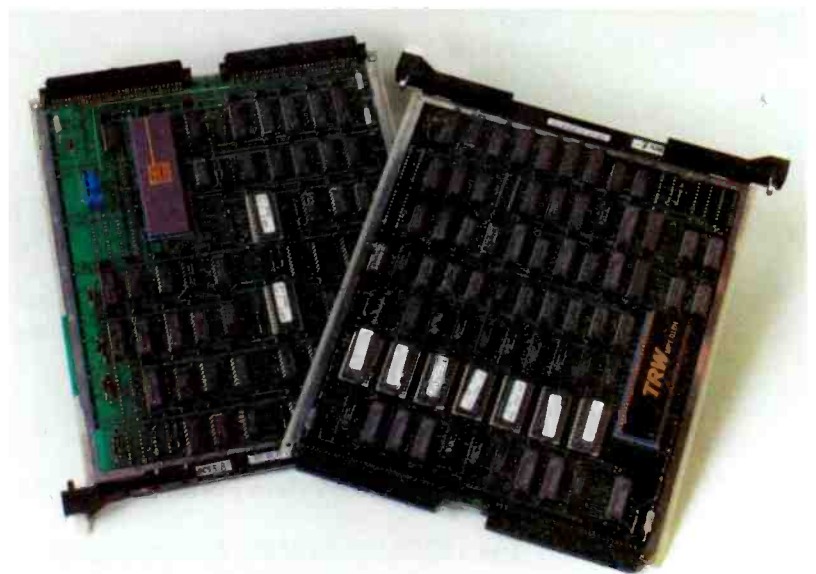
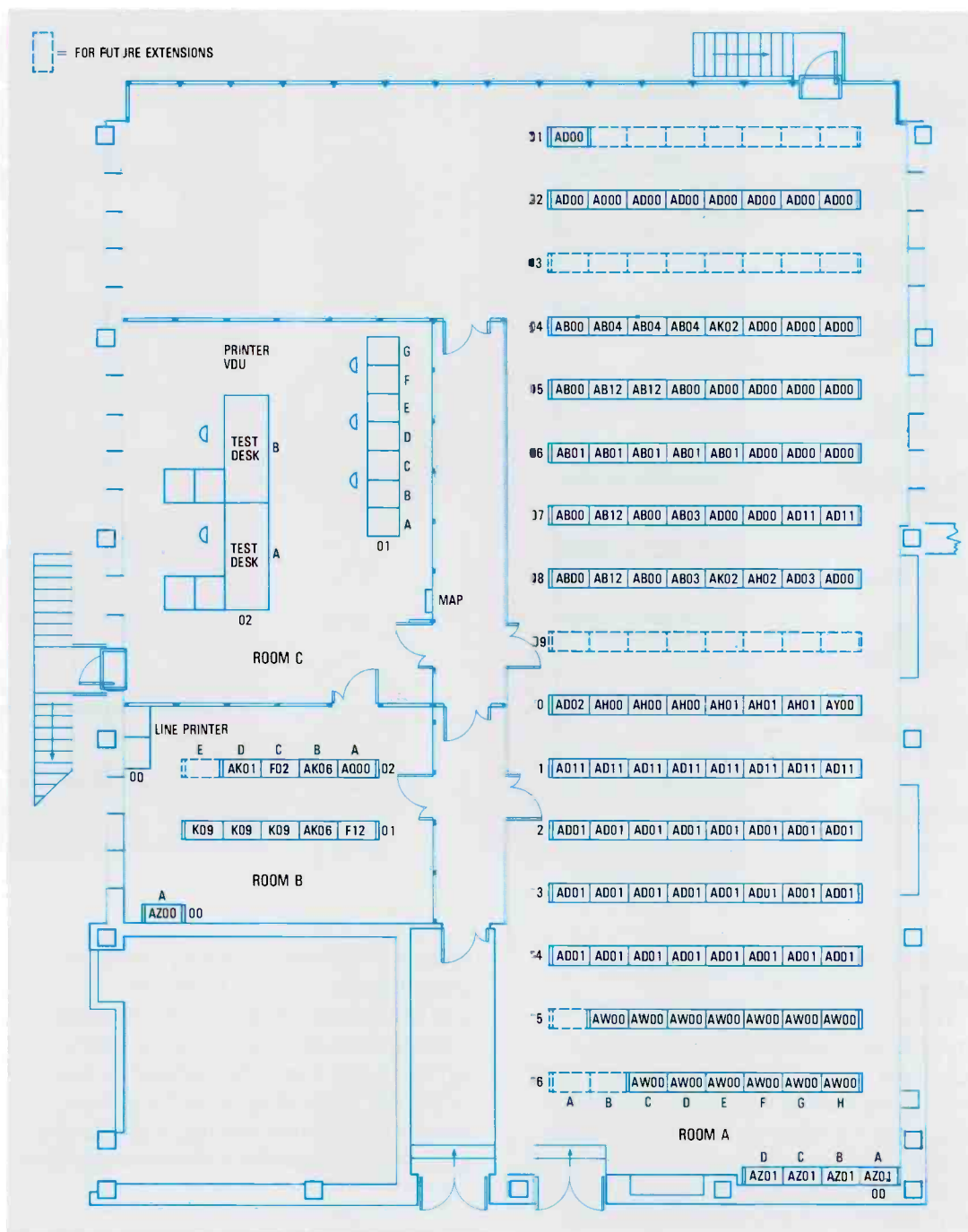

Figure 3
Floor plan of the Acilia exchange.



The new facilities (echo suppressors, signaling interface, conferencing, trunk testing, etc) are all integrated in the system, and are thus covered by its advanced maintenance strategy. This new hardware, which meets all relevant CCITT recommendations, continuously supervises all the functions during service, and controls loop closure for out-of-service routine functional tests.

Software and System Performance

The 12390 trunks of the Acilia exchange can handle an offered traffic of about

4500 erlang for a total of 162000 busy hour call attempts while meeting the relevant CCITT recommendation for response time and grade of service. Even if the load exceeds the predetermined thresholds, any degradation takes place gradually.

The System 12 software³ used at the Acilia exchange is divided into two categories:

- software kernel (i. e. the set of basic programs that supports the generic software of any System 12 exchange)
- application software (i. e. the set of software subsystems that is added to the kernel to perform exchange functions).

The main software subsystems implemented at Acilia are:

- call handling
- input/output
- maintenance
- billing
- trunk testing (or 12ST)
- operator subsystem, including Datel and conferencing services

- administration plus GTAI interface
- special services subsystems (e. g. for handling recorded announcements, semipermanent connections, recall service, malicious calls, etc).

The following areas of the software in particular were affected by the requirements of the international application: call handling, administration, maintenance, billing, type and number of operator commands, diagnostics, trunk testing and operator subsystems, and peripherals handling and input/output subsystem.

Call handling had to be enhanced to meet the requirements listed in Tables 1 and 2. In particular, seven analog and four digital signaling systems were required for channel associated and common channel applications, for both short and long distance calls with echo.

Italcable requested a major effort in the administration field to tailor the system for different management levels as a result of the large amount of data to be collected and the various types of report required. The new strategy, which requires four layers of reporting, was specifically defined for key Italcable personnel.

System maintenance and defense were also subject to stringent requirements (Table 3), and modifications were required to the standard software package to implement a newly organized security block structure on the basis of the new hardware units. Moreover an enhancement was necessary to cope with Italcable's alarm strategy (e. g. dedicated printer and special requirements for alarm display).

Trunk testing is one of the new features designed for the international application; in addition to the features listed in Table 6, it makes it possible to split any circuit into two sides (trunk side and exchange side), and to perform measurements on both sides from the test desk.

The operator subsystem will include language assistance, Datel service, and conference calls for up to 30 parties, as well as the supervision of manual trunks using special digital speech detector units.

Software for the administration and peripherals module, which is based on the hardware of the maintenance and peripherals module, was developed to increase the number of peripheral devices the exchange can handle for billing and measurement purposes. The disk units used in the Acilia exchange each have a 70 Mbyte capacity to support this capability.

Table 5 – Rack types used in the Acilia exchange

Number	Rack type	Equipment
1	AB00	120 analog trunks; group switch 1/2
2	AB01	120 analog trunks; group switch 3
3	AB03	2 service circuit modules; 2 No 6 common channel modules; group switch 1/2
4	AB04	2 service circuit modules; 2 No 7 common channel modules; group switch 1/2
5	AB12	4 service circuit modules; group switch 1/2/3
6	AD00	240 analog trunks
7	AD01	120 analog trunks (No 5 with DES)
8	AD02	60 analog trunks; 2 conference circuit modules
9	AD03	180 analog trunks; 60 digital announcement channels
10	AD11	120 analog trunks (No 6 with DES)
11	AH00	360 digital trunks or operator interface trunks
12	AH01	240 digital trunks with DES
13	AH02	60 digital trunks (No 5 with DES)
14	F02	2 maintenance and peripherals modules; 2 clock and tone modules; 4 disk units
15	FI2	2 administration and peripherals modules; 2 disk units
16	AK01	recorded announcement machines
17	AK02	modems for analog No 6 and No 7 signaling
18	AK06	peripherals (tapes, formatters, and disks)
19	K09	peripherals (tapes)
20	AQ00	trunk testing and test desk interface
21	AW00	main distribution frame
22	AY00	digital access frame
23	AZ01	DC power distribution
24	AZ00	AC power distribution

Note: racks 1 to 13 and rack 20 also house access switches.

Table 6 – Major characteristics of the digital trunk testing equipment

Transmission quality of the speech and signaling path verification, System 12 internal tests execution, self testing by means of looping
Handling of up to 30 simultaneous testing channels (sending or receiving)
Digital generation of tones and multifrequency codes in the total speech band (± 4 Hz accuracy) with a wide range of levels (0.5 dB steps)
Digital detection and measurement of tones and noise levels including psophometrically weighted noise with or without time assignment speech interpolation band stop filters
Full compliance with relevant CCITT recommendations (e. g. Recommendation 0.22 ATME-2)
Timed signals measurements and measurements on digital links (bit error rate, line error rate)
Direct and indirect trunk testing operations by means of automatic procedures, semiautomatic routines, operator controlled external instruments
Flexibility to meet, under software control, any national and international testing procedure using an automatic programmable test plan or from a test desk (network and exchange maintenance operators).

Table 7 summarizes the software content of the Acilia exchange. The finite message machine organization has generated a set of well structured software programs with a high degree of modularity, flexibility, and transparency, as a result of the care taken during the top level design phase, the use of standard interfaces, and well defined and generalized message interchange.

Implementation of the virtual machine concept ensures that System 12 will be virtually unaffected by technological evolution of hardware and software. Increasingly, System 12 software is taking advantage of support tools that have been developed to improve the efficiency of coding, production, manufacture, and management, thereby significantly enhancing software quality.

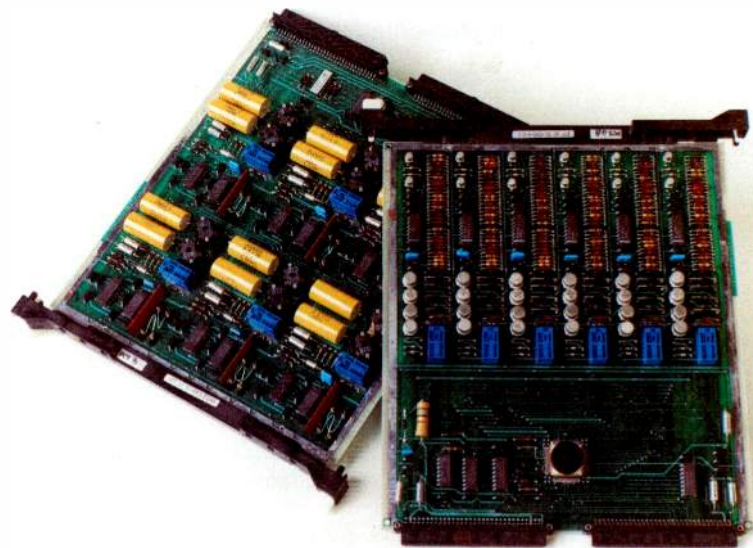

Digital trunk interface printed boards for the Acilia international toll exchange.

Special Services and Network Evolution

Trends indicate that telephone communication will continue to produce more traffic and revenue than other telecommunication services for many years. However, the increasing interest of both subscribers and administrations in non-voice services (e.g. value added and ISDN services) indicates that this situation is changing. System 12 allows new bearer services (e.g. digital transparency, wideband communication, packet switching) and new teleservices (e.g. teletex, videotext, protocol conversion) to be added as they are needed by the administration.

Figure 4 depicts the strategy that will be adopted for adding new features and services to the Acilia exchange. These capabilities will be tested in an ISDN experiment on the Acilia exchange being planned jointly by Italcable and FACE.

The existence of a sophisticated digital exchange together with new digital transmission media and technologies (optical fiber cables, speech interpolation devices, satellite systems) will allow Italcable to extend the System 12 maintenance strategy to the entire network. This will, for example, allow analysis of the end-to-end supervision and overflow control bits on the digital links connecting Acilia to the Italian earth station of Telespazio at Fucino, for the management of satellite circuits using time division multiple access/digital speech interpolation techniques.

All these ideas are being examined in detail on the basis of planned evolution of the Italcable network and the System 12 Digital Exchange⁴. In particular, a suitable approach seems to be the digital adjunct concept⁵ in which System 12 exchanges provide advanced services while retaining an existing exchange that has not yet completed its economic operating life.

However, the most important increase in services will result from the addition of ISDN facilities^{6,7}. The international exchange of Acilia will then allow the Italian gateway to be connected to national and international packet- and circuit-switched communication networks.

Table 7 — Content of the software package of the Acilia international toll exchange

Software areas	Finite message machines	System support machines	Statements (000s)	
			Total	FACE design
Operating system nucleus	7	—	20	—
Database control system	—	1	6	—
Network handler	9	—	—	—
Disk unit	20	—	20	—
Operator request job	25	—	30	12
Input/output subsystem	31	1	30	—
Administration*	10	—	21	21
Call handling	38	13	40	40
Defense	24	—	35	2.5
Diagnostics	86	—	85	8.5
Digital operator positions	54	7	58	15
Trunk testing subsystem	6	1	15	15
Total	310	23	360	114

* Including the handling of transit traffic between Italcable exchanges.

Conclusions

Successful implementation of the System 12 international toll exchange at Acilia has shown that the equipment performs well and meets the requirements of Italcable. Development of this new System 12 application has involved the definition and implementation of equipment and facilities for new services, as well as call control and supervision. It has also led to a more detailed definition and implementation of basic building blocks and interfaces (e.g. international trunk interface, trunk and network testing, and conferencing).

Figure 4
Italcable's strategy for increasing the services offered by the System 12 Digital Exchange at Acilia.

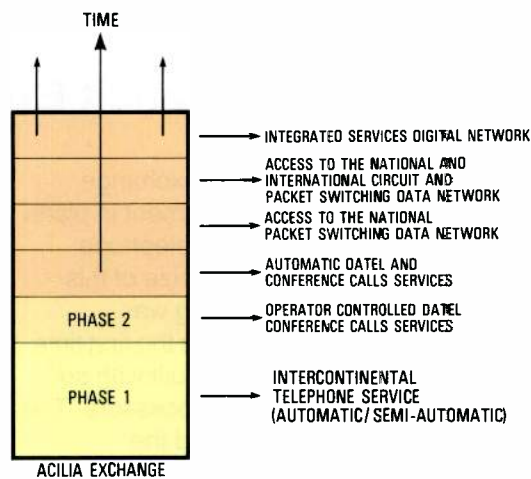

References

- 1 A. Di Benedetto and M. Ketmaier: Network Management in Italcable: Present Situation and Perspectives: *Telecom 83*, Geneva, November 1983.
- 2 P. Haerle and M. Della Bruna: Application to the Toll Network: *Electrical Communication*, 1981, volume 56, no 2/3, pp 235-247.
- 3 G. Becker, R. S. Chiapparoli, R. S. Schaaf, and C. Vander Straeten: System 12: Software: *Electrical Communication*, 1985, volume 59, no 1/2, pp 60-67 (this issue).
- 4 R. H. Mauger: System 12: Architecture for Change: *Electrical Communication*, 1985, volume 59, no 1/2, pp 35-42 (this issue).
- 5 J. Cox and R. E. Pickett: System 12: Role of the Digital Adjunct in Network Enhancement: *Electrical Communication*, 1985, volume 59, no 1/2, pp 195-199 (this issue).
- 6 F. Haerens, B. Rossi, and J. M. Serrano: System 12: ISDN Field Trials in the Belgian, Italian, and Spanish Networks: *Electrical Communication*, 1985, volume 59, no 1/2, pp 89-97 (this issue).
- 7 S. R. Treves and D. C. Upp: System 12: Technique for Wideband ISDN Applications: *Electrical Communication*, 1985, volume 59, no 1/2, pp 131-136 (this issue).

System 12

Aarhus Local-Transit Exchange

The System 12 local-transit exchange located in Aarhus is a key element in plans to digitize the entire Jutland telephone network. In view of the large size of this exchange, acceptance testing was particularly important as it was the first time that an exchange had been built with so many intercommunicating processors. The test results have again proved the effectiveness of the System 12 concept.

J. A. Broux

Bell Telephone Manufacturing Company,
Antwerp, Belgium

P. Erlandsson

Standard Electric Kirk A/S, Horsens,
Denmark

E. Rishøj

Jydsk Telefon A/S, Aarhus, Denmark

Introduction

In the autumn of 1979, JTAS (Jydsk Telefon-Aktieselskab) evaluated the economic viability of introducing digital switching into its telephone network. The studies showed that digital switching would be very attractive compared to the existing electromechanical systems, particularly for transit exchanges. Specifically the studies highlighted the overall cost-effectiveness of

digital switching equipment, including reduced operating and exchange building costs, in an environment with an already high penetration of digital transmission. Consequently, JTAS was one of the first telephone operating companies in the world to decide that from 1983 onwards all newly installed switching equipment would be fully digital. JTAS placed orders in 1980 and 1981 for 250 000 lines to be installed and commissioned between 1983 and 1988.

The new digital equipment will make it possible for JTAS to offer subscribers a variety of subscriber controlled services at reasonable rates. In the longer term subscribers will benefit from an integrated voice and data communication network, including data transmission, cable television, telefax, and other new services.

JTAS is cooperating with the three other Danish operating companies – P&T (the central PTT), Copenhagen Telefon Aktieselskab, and Fyns Kommunal Telefonselskab – to expand the overall Danish telecommunication network.

System 12 Aarhus MC Exchange

The first stage of JTAS's network plans involves digitizing the high growth rate transit exchanges in the main city areas: Aarhus, Aalborg, Holstebro, Horsens, and Kolding. At the same time, considerable investment is being put into the digital



View of a System 12 cabinet with the doors removed showing some of the printed boards in the Aarhus exchange.

transmission network linking the exchanges. In most cases the digital exchange equipment will partially replace electromechanical transit exchanges to provide digital "cores" for future expansion. The much smaller floorspace requirement of digital systems is a major asset for this application. When electromechanical equipment is freed as a result of conversion it is being reused to handle traffic growth in secondary switching areas. However, reuse will soon cease as such exchanges are gradually replaced by fully digital exchanges.

A typical example of the present evolution in the Jutland telephone network is the Aarhus main transit exchange. Aarhus, with its 250 000 inhabitants and 120 000 subscribers, is Jutland's largest city. Today 14 local exchanges are operating in Aarhus, the largest of which serves 30 000 subscribers. In addition to the local exchanges, the switching complex of Aarhus includes two toll exchanges. The older of these, taken into service in 1953, processes traffic from distant areas coming into Aarhus. It also handles about 150 operator positions located in the Aarhus building. The newer toll exchange, taken into service in 1964, processes outgoing traffic from Aarhus to distant areas.

The System 12 Aarhus exchange is a combined local-transit exchange providing the following functions:

- Transit point for traffic incoming from the long distance network to Aarhus.
- Transit point for traffic outgoing from Aarhus to the long distance network.
- Transit point for all traffic in the Aarhus area which is not carried on direct routes between local exchanges in the city.
- Connection point for digital concentrators, PABXs, and digital local exchanges.
- Parent exchange for existing rural satellite exchanges with digital transmission.
- Local exchange to cater for high traffic volume subscribers in the city center. Low traffic subscribers will be connected to other exchanges.

Figure 1 shows the Jutland telephone network. The digital exchanges installed in Jutland are as follows:

Aarhus (System 12): combined local-transit exchange with 12 720 trunks and 4020 subscriber lines.

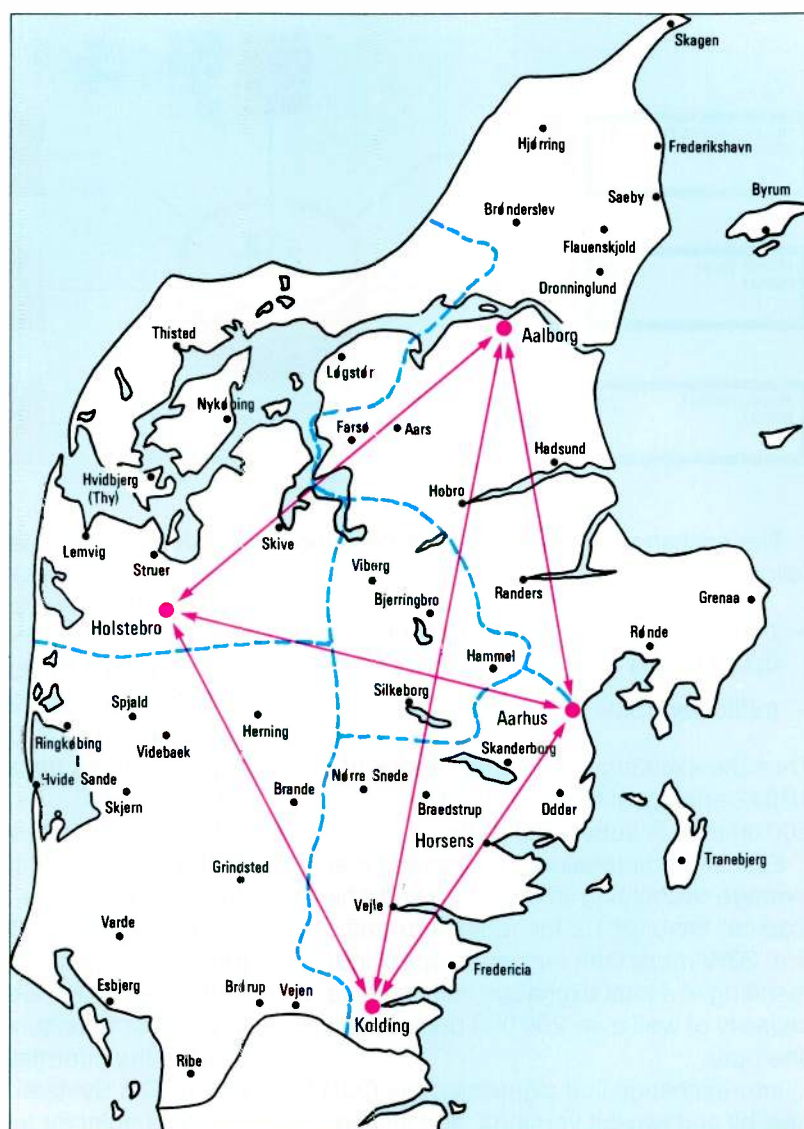

Horsens (System 12): transit exchange with 5010 trunks.

Tyrsted (System 12): local exchange in the Horsens area with 8 160 lines.

Aalborg: combined local-transit exchange with 9 000 trunks and 10 000 lines.

Kolding: transit exchange with 9 000 trunks.

Holstebro: transit exchange with 6 000 trunks.

Two more System 12 local exchanges are presently being installed in the Aarhus area: Lisbjerg with 2 400 lines, and Hasselager with 4 800 lines. These exchanges will be installed and tested by JTAS with BTM (Bell Telephone Manufacturing Company) acting as consultants.

System 12 Aarhus MC Technical Details

The System 12 Aarhus MC is the largest digital exchange in Jutland. It is also ITT's biggest System 12 installation to date.

Figure 1
The Jutland telephone switching network.

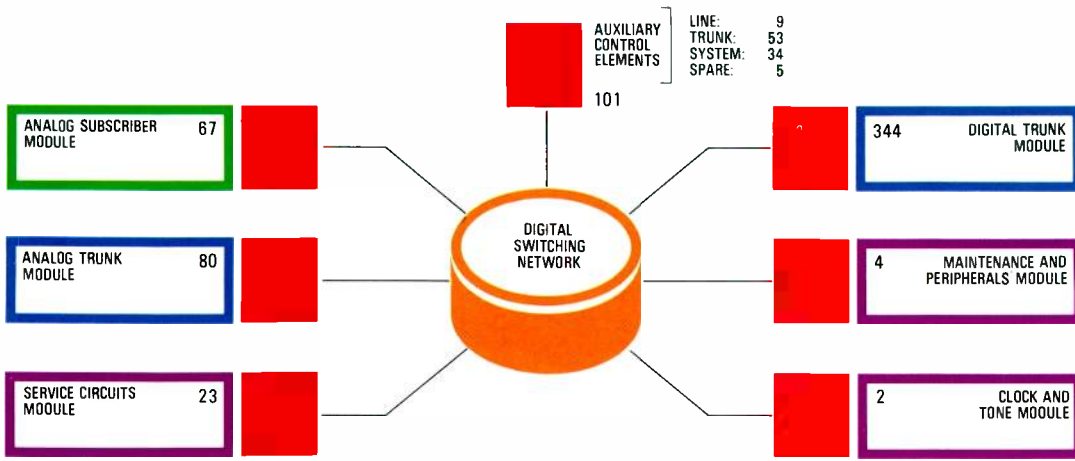

Figure 2 Schematic of the Aarhus System 12 Digital Exchange.

The exchange is designed to process the following traffic:

- bothway traffic per subscriber line: 0.125 erlang
- traffic per trunk: 0.85 erlang.

Thus the exchange can handle a total of 10812 erlangs of transit traffic and 500 erlangs of subscriber traffic.

Exchange dimensioning is based on an average call holding time of 100 s and a high load call factor of 1.2 for subscriber traffic (i.e. 20% more than maximum specified), resulting in a total exchange call handling capacity of well over 200 000 busy-hour call attempts.

Interexchange line signaling uses CCITT one-bit and two-bit versions, and analog in-band (3000 Hz) and out-band (3825 Hz) pulse signaling. CCITT R2 is used for

register signaling, while special signaling is provided for rural satellite exchanges.

Given the high penetration of digital transmission (30-channel multiplex and higher order 140 Mbit s⁻¹ multiplex links), 10320 of Aarhus' 12720 trunks are of the digital type. The 2400 analog trunks are expected to be replaced gradually in the future.

Subscribers connected to System 12 exchanges benefit from modern subscriber controlled services.

The charging system uses Carlsson-type periodic pulse metering. Two counters, on duplicated disks, are provided for each subscriber to ensure security. These provide the information needed for bulk billing. The System 12 exchange acts as a charging point for toll calls originating in the Aarhus area; it incorporates provisions for dividing revenues among the operating

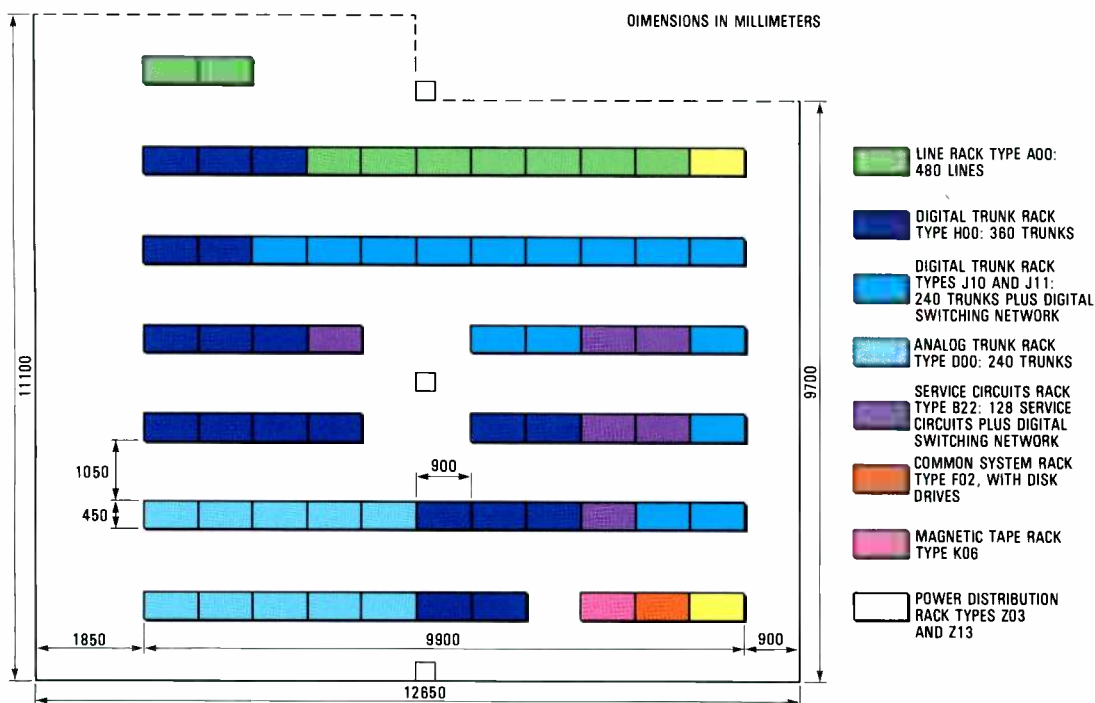

Figure 3 Floorplan of System 12 Aarhus MC exchange.

companies where calls are made between different network areas.

The System 12 Aarhus MC exchange is of an exceptionally large size (Figure 2). It incorporates 621 microprocessor-based control elements, including five spare ACEs for automatic on-line replacement of a faulty unit.

Exchange equipment is housed in 63 standard System 12 cabinets in an exchange room with 125 m² of floorspace. A simplified floorplan is shown in Figure 3. A raised floor is used for all exchange cabling.

Three visual display units and three teleprinters are used for man-machine communication. They are located in a separate supervision room together with the general alarm supervision panel.

No difficulties relating to the large size of the exchange were encountered during testing and commissioning. Similarly there were no problems with transmission delays or electromagnetic interference. This experience, together with the excellent results of the transmission measurements carried out by JTAS, has proved the soundness of the System 12 design.

Commissioning Experience

Initially JTAS planned an acceptance test period of seven weeks: one week for stability testing and six weeks for further functional testing. It was soon clear that this was too optimistic for a first System 12 exchange in Denmark. Although JTAS maintenance personnel had received extensive theoretical and hands-on training at BTM in Antwerp, they needed memory refreshment and further familiarization with the equipment before they could start effective acceptance testing.

The first stability test conceived by JTAS consisted of a 72-hour performance test followed immediately by a heat test of seven hours in a controlled environment at 35°C. During both periods stringent individual quantitative performance criteria were imposed. Automatic call generators set up calls on the subscriber lines in a double loop-around mode at a rate of 35 000 calls per hour. With this load the line TCEs and the line ACEs were loaded at up to 1.6 times the maximum guaranteed load. In addition to this internal traffic, JTAS used automatic call generators to set up external traffic in the following ways:

- calls originating in System 12 and terminating in other exchanges in the local and long distance networks

- calls originating in exchanges in the local and long distance networks and terminating in System 12
- long distance calls using the Aarhus exchange as a transit exchange.

JTAS also established 30 permanent connections through System 12 for the duration of the test. Some of these connections were purely internal in System 12, while others terminated in distant exchanges.

Altogether well over 3 000 000 calls were generated during the 72-hour test. Various parameters were observed in the course of the test: alarms, hardware faults, processor restarts and reloads, all aspects of charging in connection with the test traffic, grade of service for all types of call, traffic measurements relating to the test traffic, fault reports, and so on. No service

System 12 local-transit exchange installed at Aarhus.



interruption was allowed, although normal maintenance could be applied.

The first stability test was unsuccessful because of an excessive number of ACE restarts and reloads. In addition, JTAS had some comments on the charging performance in traffic conditions. The reason for the difficulties soon became clear. Whereas all System 12 functions had previously been successfully tested using a limited number of test lines from JTAS and individual test calls, JTAS and BTM learned that there is a considerable difference between test calls and test traffic. For the final test of a first exchange, substantial test traffic is essential. The exchange was handed over to BTM for one week to sort out the problems in real traffic conditions. The stability test was then rerun with complete success.

Table 1 summarizes the main requirements and the results achieved. These show that the Aarhus System 12 exchange met all the requirements with good performance margins.

It is worth noting that the heat test at 35°C did not significantly affect operation of the System 12 exchange. Consequently it was not repeated during the second stability test.

Upon completion of the functional tests and after final updating of the exchange data, the System 12 Aarhus exchange was cut over in October 1984.

JTAS's Future Plans

JTAS is at present actively planning future evolution of the Jutland network in three main ways:

International traffic. In the future, the Aarhus System 12 exchange might be used to handle international traffic to and from the other Scandinavian countries.

Synchronization. In collaboration with the other Danish operating companies, JTAS is planning to implement a nationwide synchronized data transmission network. This plan uses the Aarhus exchange as the primary master for the entire Jutland area. It will, in turn, act as a slave to the Copenhagen exchange where a caesium

Table 1 — Results of the 72-hour performance test

Test	Requirement (72 hours)	Result (72 hours)
System down time	Nil	Nil
Grade of service: internal traffic	0.5%	0.12%
Grade of service: total traffic	1.5%	0.45%
Hardware failures	5	1
System ACE duplex failures	0	0
ACE restarts	56	5
TCE restarts	82	19
ACE reloads	17	5
TCE reloads	30	2
Charging errors	None	None

clock will be installed. In preparation for implementing this plan, all System 12 exchanges installed in Jutland are equipped with external synchronization interfaces. Tests between System 12 exchanges and between other digital exchanges and System 12 have proved that the unsynchronized mode of operation is perfectly satisfactory for interexchange signaling and voice traffic.

CCITT No 7 signaling. During the five-year plan from 1985 to 1989, a CCITT No 7 common channel signaling system network will be implemented in Jutland based around the principal signaling transfer points: Aarhus MC, Aalborg, Kolding, and Holstebro. These exchanges will be connected in a mesh network (Figure 1).

Conclusions

The Aarhus MC local-transit exchange has been handed over to and accepted by JTAS. As of the beginning of November 1984, some 4000 trunks were in service, with the connection of subscribers scheduled to start towards the end of the month. Experience with the exchange has proved the soundness of the System 12 concept of fully distributed control in large exchanges.

The ease with which the architecture allows new features and services to be added will be very beneficial in implementing JTAS's future plans for the Jutland network.

System 12

Toll Exchanges for the German Network

The first step in the Deutsche Bundespost's long-term strategy for digitizing its telephone network was to evaluate commercially available digital switching systems under live traffic conditions. Operational experience with two System 12 toll exchanges, which were cut over in Heilbronn and Stuttgart during 1982, has resulted in System 12 exchanges being ordered for the German network.

M. Langenbach-Belz

Standard Elektrik Lorenz AG, Stuttgart,
Federal Republic of Germany

Introduction

When it became clear in the mid 1970s that future expansion of the telephone network would be achieved most effectively and economically by introducing digital exchanges and transmission, the Deutsche Bundespost started to plan for digitization of the German telephone network. The first stage in this plan was a one-year presentation (planned for 1982/83) in which three telecommunication companies were asked to install and run digital toll exchanges to demonstrate their performance and features. This implied that the Bundespost would depart from its previous strategy of having a single make of switching system in the German network.

Standard Elektrik Lorenz (SEL) offered the toll configuration of the System 12

Digital Exchange^{1,2} for the toll application, and installed two presentation exchanges in Heilbronn and Stuttgart.

Operational experience during this phase, in which the exchanges carried live traffic, was evaluated by the Bundespost before a decision was made as to which system or systems should be installed in the network starting in 1985³. As a result of the performance of System 12 during the presentation year, the Deutsche Bundespost decided to introduce this advanced distributed control digital exchange into the German network.

Six months later the Bundespost established a similar programme for the introduction of digital local exchanges. Again SEL successfully offered System 12, this time in the local configuration.

System 12 large toll exchange installed in Stuttgart for the Deutsche Bundespost.



Deutsche Bundespost Requirements

The major requirement set by the Bundespost was that the presentation exchanges should provide the full range of services offered by the existing network, and at least the present service quality. In this way, subscribers would not receive an inferior service during the presentation period. Additional features were specified for optional implementation, in order to indicate the range of facilities that could be included in production exchanges. No demonstration of future more advanced features was required.

The presentation specification called for each supplier to install two toll exchanges of

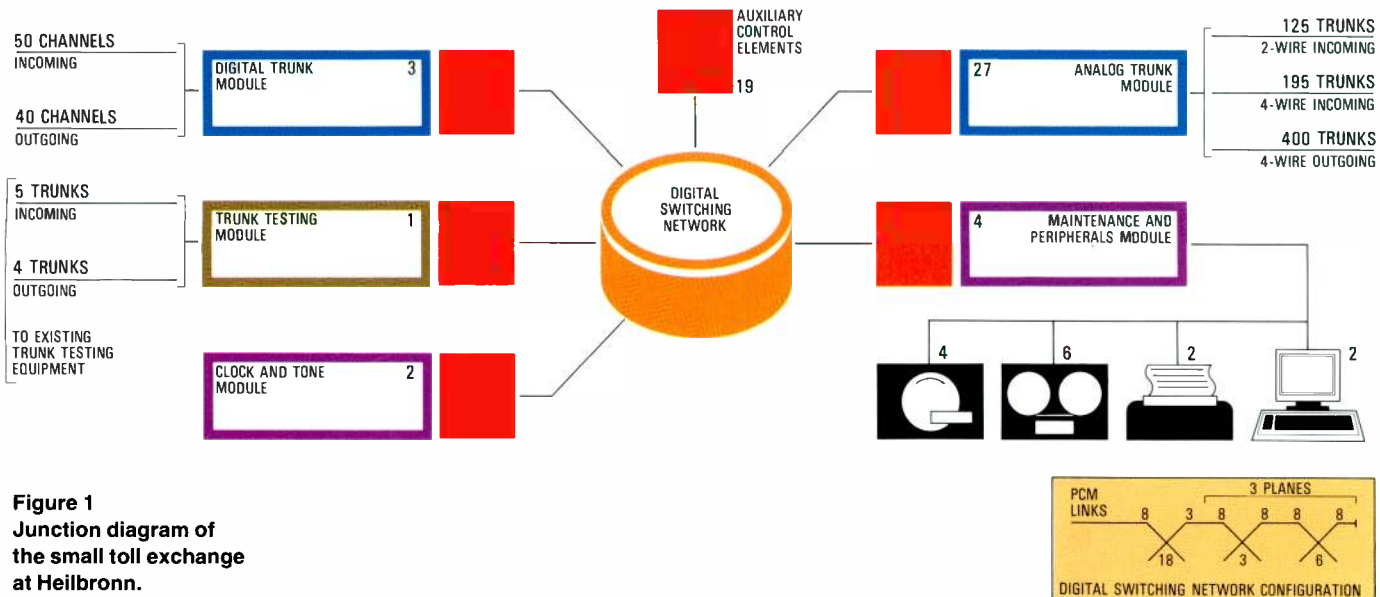

Figure 1
Junction diagram of
the small toll exchange
at Heilbronn.

different sizes; a small exchange with 800 trunks and a large exchange with 3800 trunks. These are typical of the toll exchange sizes in the German network. In this way the Bundespost would be able to evaluate how exchange performance depended on the size of the installation and, in particular, whether different system versions were necessary. The unique distributed control architecture of System 12 ensured that both sizes of exchange could be realized using the same basic configuration, the only differences being in the amount of hardware and software required.

The smaller of the two System 12 exchanges is located at Heilbronn, 30 km north of Stuttgart. This functions as a nodal exchange, the lowest level of toll exchange

within the network hierarchy. The larger exchange is installed in Stuttgart where it is functioning as a combined nodal and main exchange, the next higher toll exchange level in the hierarchy. Each exchange has taken over the functions of one-third of an existing electromechanical analog exchange within the network.

The Bundespost drew up comprehensive specifications for the toll exchanges in the following areas:

- Network requirements, covering introduction into the existing network and utilization of existing devices (e.g. for network tests).
- General functional requirements, covering interfaces to test equipment and a few other general aspects.

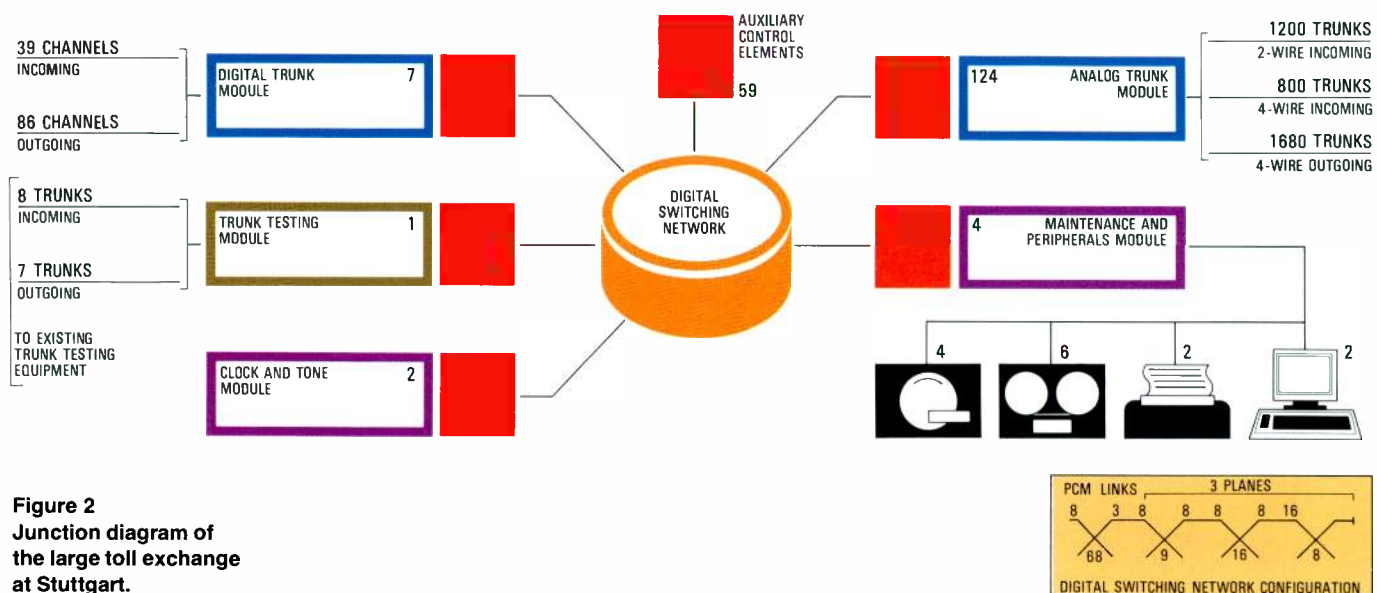

Figure 2
Junction diagram of
the large toll exchange
at Stuttgart.

- Technical requirements, covering aspects such as traffic handling capabilities of the control and switching network, clock supply, interface to the network (signaling system, transmission aspects, electrical requirements), and reliability.
- Operational requirements, covering supervision and alarm reporting, testing and measurements, gathering of operational and planning data, and documentation.
- Software requirements, including security, flexibility, and maintenance.

Particular aspects of these specifications dealt with the use of the IKZ 50 decadic signaling system, and automatic changing of alternate routing and charging data according to the time of day, day of the week, and public holidays.

As far as operation, maintenance, and testing were concerned, existing equipment was to be used for trunk testing and measurement. Operation and maintenance input/output devices (visual display unit and printer) were to be provided both within the exchange room and at a remote location. Also, at times when the exchange was unattended it had to be possible to forward alarm signals to the remote location.

Configuration of System 12 Toll Exchanges

The junction diagrams in Figures 1 and 2 show the numbers and types of module used in the small and large toll exchanges, respectively. Typical rack layouts for both exchanges are shown in Figure 3.

As can be seen from the junction diagram of the larger exchange, it incorporates 197 processors (one per module) and was the first operational exchange to have such a large number of processors. However, since then System 12 digital exchanges with more than 600 processors have been successfully installed⁴.

The equipment layout of the 3800-trunk exchange at Stuttgart has achieved space savings of at least 65% compared with the analog exchange which it replaces in this specific case with a 95% analog environment. In a fully digital environment, even greater space savings can be achieved. This reduction in required space will on its own solve practically all the Bundespost's space problems for anticipated exchange extensions over the next 20 years.

Figure 4 shows the floorplan of the smaller 800-trunk exchange.

An important factor for maintenance (spare parts stocking and maintenance activities) is the low number of printed board types used in System 12 exchanges. Only 30 different types of board are needed for a complete exchange – a dramatic reduction compared with former processor controlled systems which generally required several

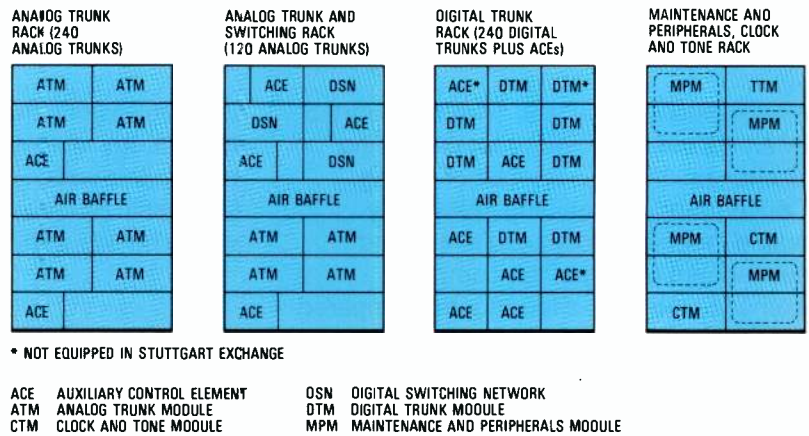

Figure 3
Layouts of some typical racks for the System 12 toll configuration.

hundred board types. Indeed this number is much smaller than in other digital exchanges, which may require more than 30 board types in the central control alone.

The exchange software consists of about 210000 source statements, the majority of which are written in CHILL, the CCITT high level language for telecommunication systems. The percentage of the software devoted to the various exchange functions is given in Table 1. The individual software modules of the different subsystems are not allocated to specific control elements but are distributed (and replicated) flexibly over the many control elements in the system.

Toll Exchange Implementation

A completely new system concept frequently leads to new (and sometimes unexpected) problems for design and test engineers. However, this risk is minimized by the System 12 concept as its modularity and distributed control make it possible to use many new procedures during design, testing, and system integration that were not feasible in previous systems.

In particular, the simple, clearly defined interfaces allow hardware and software modules to be tested independently and, to

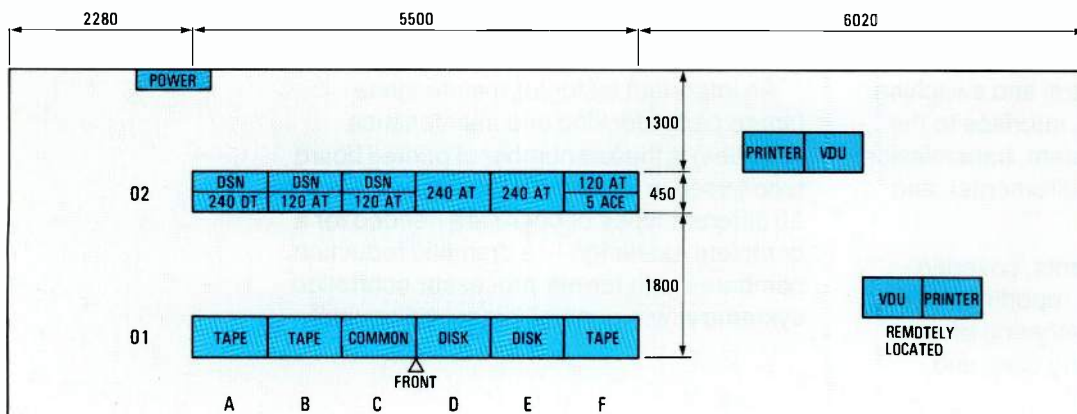

Figure 4
 Floorplan of the small exchange with 800 trunks in a 90% analog environment.
 AT - analog trunks
 DSN - digital switching network
 DT - digital trunk.
 Dimensions are in millimeters.

a large extent, in parallel. This is supported by an effective procedure for controlling all changes made as a result of testing. Consequently, combining individually tested modules into an exchange, and subsequent testing of the complete exchange took only a few months compared with perhaps a year or more for previous systems.

In addition to equipping a variety of small test stations in the laboratory, SEL installed copies of the two Bundespost toll exchanges in the laboratory for system testing. These copies were identical to the actual exchanges with regard to rack layout, numbers and types of modules, number of control elements, and exchange data. Only the number of trunks within the modules was underequipped. This arrangement allowed a wide range of tests to be carried out with the full support (in terms of manpower, skills, and tools) of a well equipped laboratory. The system load tapes were identical for the laboratory prototypes and the Bundespost exchanges and could therefore be taken directly from the prototypes. Consequently, only regression testing had to be performed on site, requiring the minimum of staff.

Also, any problems encountered on site could be investigated in detail quickly and

effectively within the laboratory. Normally this strategy enabled corrections to be made within a day, or a few days at most. As a result, SEL was able to carry out system testing on site within eight weeks.

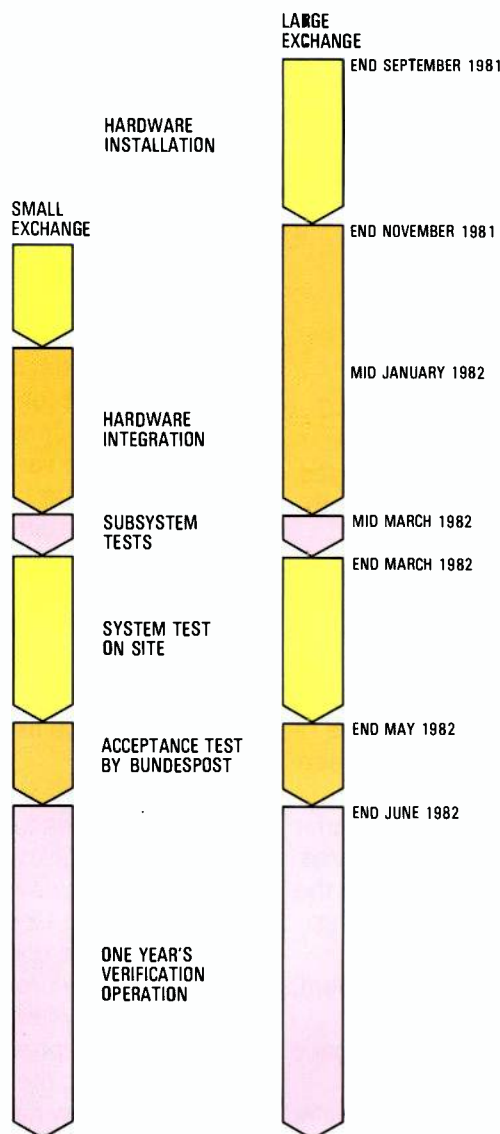

Figure 5
 Installation and testing schedule for the two System 12 toll presentation exchanges for the Deutsche Bundespost.

Table 1 — Percentage of software devoted to various exchange functions

Software subsystem	Percentage of total source statements
Operating system	26
Database	15
Input/output	10
Call handling	15
Administration	12
Maintenance	22

Figure 5 shows the schedule for on-site activities. The relatively long time for hardware installation and testing (although much shorter than for previous systems) was a result of testing the hardware and the connections to other exchanges stringently as it was the first time such a large new system had been installed. It also ensured that subsequent software and systems tests were not affected by hardware problems. Since this initial installation, test times have been appreciably reduced.

After the exchanges had been handed over, a team of engineers from the Deutsche Bundespost thoroughly tested both exchanges for a period of one month prior to acceptance. This team had received prior training at SEL on the operation and maintenance of System 12 exchanges using a training exchange with the same configuration as the Heilbronn exchange. From the software point of view the two toll exchanges only differ in the data area, not in the program area, so Bundespost personnel were able to familiarize themselves with the working of the System 12 toll configuration at the same time as SEL engineers were undertaking on-site testing.

After the one month of acceptance tests by the Bundespost, both exchanges were cut into full service with live traffic. In most cases problems that occurred during the first six months of the presentation period were overcome within a few days as they could be reproduced and corrected on the test exchanges in the SEL laboratories.

Field Experience

Both the Heilbronn and Stuttgart toll exchanges were put into full service with live traffic in July 1982, since when they have been operated exclusively by Bundespost personnel. Prior to cutover, an effective fault reporting and correction procedure was agreed between the Bundespost and SEL. Important experience was gained during operation of these System 12 toll exchanges within the German network — the first practical experience with a digital toll exchange based on a distributed control architecture.

Operations and maintenance personnel were able to take over the running of the exchange within a matter of days. On the occasions that faults occurred, the exchange's built-in test and diagnostic capabilities and indicators rapidly identified the source of the fault (hardware and



View of the large 3800-trunk System 12 toll exchange with the cabinet doors removed.

software). As soon as software faults could be reproduced in the laboratory, a correction was normally available within a few days.

The presentation period showed that there were no important discrepancies between the behavior of the smaller exchange with 56 processors and the larger exchange with 197 processors. No basic system concept faults manifested themselves, and System 12's inherent advantage of eliminating total system breakdown was thoroughly proved.

The traffic handling capability proved to be as good as predicted, even during periods of extremely high traffic. As an example, about twice the usual number of busy hour call attempts was handled without any problems during New Year's Eve 1983/84.

Table 2 summarizes some of the main hardware fault statistics for both exchanges.

Table 2 — Hardware fault statistics

Printed boards	Total number installed	Faulty boards June 82–Dec 83	Failure rate	
			measured ($10^{-6}/h$)	predicted ($10^{-6}/h$)
Switch	212	3	1.3	8.9
Memory	359	7	1.4	28
Processor	253	9	2.6	3.1
PCM multiplexer	152	1	0.5	1.7
4-wire outgoing trunk	694	106	10.9	4.0
Digital trunk	10	4	21.5	2.0



Small 800-trunk System 12 exchange in Heilbronn.

This table shows that the basic System 12 printed boards proved more reliable than predicted. However, some other boards which were subject to customer design adaptation proved to be somewhat less reliable than anticipated. The cause was traced to component problems: considerable improvements have been made in this area for the production exchanges.

The complete system behavior, including hardware and software, can be expressed by the service availability figure which gives

a measure of the time that service is available to each trunk circuit. The service availability of the two toll exchanges is shown in Figure 6. More detailed information on field experience can be found elsewhere^{3, 5, 6}.

As a consequence of the future-oriented system architecture and the excellent results of the one year's presentation operation within a real network, the Deutsche Bundespost made the decision to introduce System 12 digital exchanges.

Future Application in the German Network

The first production exchanges to be supplied under the contract with the Deutsche Bundespost will be installed at the beginning of 1985. They will differ from the presentation exchanges in a number of details. First, no more analog trunks will be connected — only digital trunks (around 75%). Second, trunk testing devices will be integrated into the exchange; no separate conventional trunk testing equipment will be provided. Third, CCITT No 7 common channel signaling will be introduced following pilot projects planned for the middle of 1986. Finally, Service 130 will be introduced; using this service, the called subscriber has to pay the charges after the calling subscriber has dialed the first digits 130.

In addition to the toll exchanges, SEL is to supply System 12 local exchanges, again starting in 1985, and international toll exchanges.

Conclusions

The two toll exchanges installed in Heilbronn and Stuttgart for the Deutsche Bundespost were the first practical applications of the toll exchange configuration to carry live traffic in a real telephone network. The results have proved the benefits of a distributed control architecture based on many individual interworking processors communicating via the switching network. In the case of the Stuttgart exchange, 197 processors were involved, but exchanges with more than 600 processors have since been installed elsewhere in Europe.

The architecture and design principles have been followed not only at the top level of design activities, but right down to the

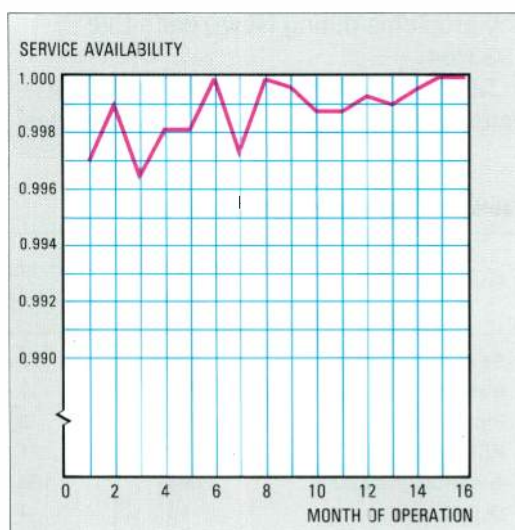
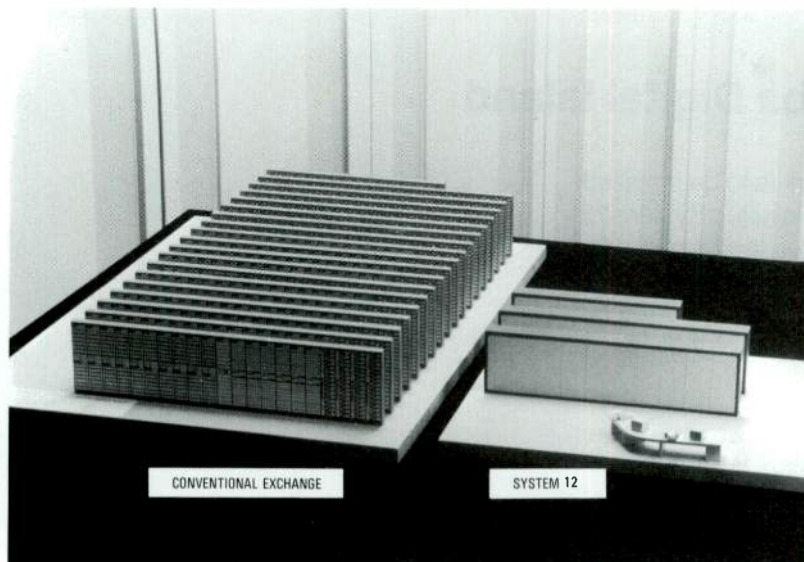

Figure 6 Service availability of the two toll exchanges following crossover.



Models illustrating the very large floor space savings in System 12 exchanges compared with equivalent conventional analog stored program control exchanges.

lowest level of implementation. This discipline helped considerably during the design and test stages, as well as during operation with live traffic.

The two System 12 toll exchanges have formed the basis for further applications and have confirmed the strategy for future System 12 activities, which will eventually

lead to the introduction of an integrated services digital network⁷.

References

- 1 M. Langenbach-Belz, A. Melis, and H. Verhille: ITT 1240 Digital Exchange: An Introduction: *Electrical Communication*, 1981, volume 56, no 2/3, pp 114 – 125.
- 2 P. Haerle and M. della Bruna: ITT 1240 Digital Exchange: Application to the Toll Network: *Electrical Communication*, 1981, volume 56, no 2/3, pp 235 – 247.
- 3 R. W. Slabon and J. Haag: Presentation of Digital Switching Systems to the Deutsche Bundespost Network – Presentation Method and Experiences: *XI International Switching Symposium*, Florence, May 1984, Paper 24 B1.
- 4 J. A. Broux, P. Erlandsson, and E. Rishøj: System 12: Aarhus Local-Transit Exchange: *Electrical Communication*, 1985, volume 59, no 1/2, pp 154 – 158 (this issue).
- 5 K. J. Hamer-Hodges, G. De Wachter, and H. Weisschuh: System 12: Integration and Field Experience: *Electrical Communication*, 1985, volume 59, no 1/2, pp 12 – 19 (this issue).
- 6 J. Dutt: Field Experience with System 12: *4th International Conference on Reliability and Maintainability*, Lannion, May 1984.
- 7 D. Becker and H. May: System 12: ISDN Pilot Service of the Deutsche Bundespost: *Electrical Communication*, 1985, volume 59, no 1/2, pp 98 – 104 (this issue).

System 12

Collado-Villalba Digital Island

A fully digital rural network is to be installed at Collado-Villalba in Spain using System 12 rural equipment. It features the System 12 network service center for centralized operations and maintenance, supported by CCITT No 7 common channel signaling.

A. Campos Flores
M. Fernandez Moreno
Standard Eléctrica SA, Madrid, Spain

Introduction

The application of System 12 in rural areas is attractive for a number of reasons. The modular distributed control configuration allows cost-effective implementation of small exchanges, while offering the full range of services enjoyed by subscribers connected to large urban exchanges. In addition, it ensures that new services can be introduced; this is facilitated by the use of CCITT No 7 common channel signaling.

System 12 also offers a number of advantages in the area of operations and maintenance of rural networks based on equipment commonality, the small number of printed board types, the software concepts, and so on. These have now been further enhanced by the development of the NSC (network service center) concept which allows the administration, operation, and maintenance of an area to be centralized at the minimum cost. This is possible because only a small amount of additional equipment is required to provide these services (e.g. alarm supervision,

subscriber administration, charging), and all NSC related functions are realized using System 12 modules and CCITT No 7 common channel signaling over the same digital links as telephone traffic.

Advantage is being taken of all these features in the application of System 12 to the rural area of Collado-Villalba in Spain.

System 12 Application to the Collado-Villalba Network

The Collado-Villalba digital island is one of the first applications of System 12 in a rural network. It consists of a cluster of digital exchanges and RSUs (remote subscriber units) connected by digital transmission systems to form a fully integrated digital "star-like" network. This is centered on the digital local-transit exchange located at Collado-Villalba.

Initially the digital network will be superimposed on the existing analog network, thereby looking like a "digital island". As shown in Figure 1, the first phase of the network, which is scheduled to be cut over in 1985, consists of:

- Local-transit digital exchange initially equipped with 2400 lines and 2800 trunks (analog and digital). This will provide trunk access and transit functions for the analog and digital exchanges in the primary area; it is the only interface between the analog and digital primary networks. The exchange configuration also integrates the NSC functions for administration and operations and maintenance of the entire digital island.
- Four small local independent exchanges with initial capacities ranging from 1000 to 1500 lines.

Figure 1
Collado-Villalba digital island showing the configuration with four System 12 local exchanges, two remote subscriber units, and a local-transit exchange.

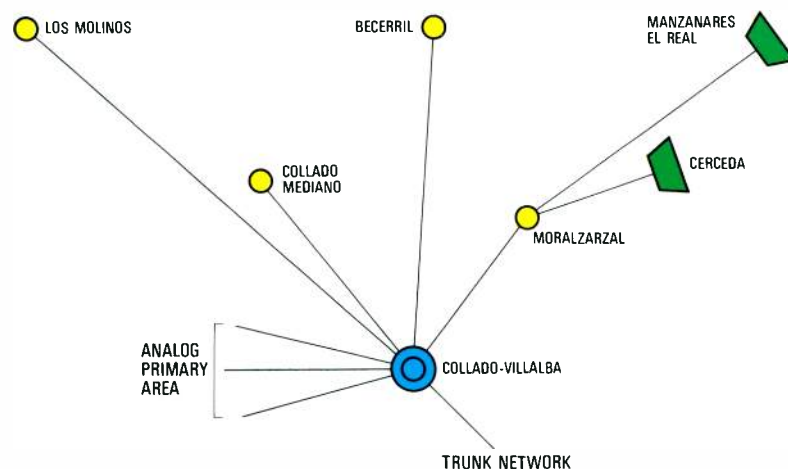
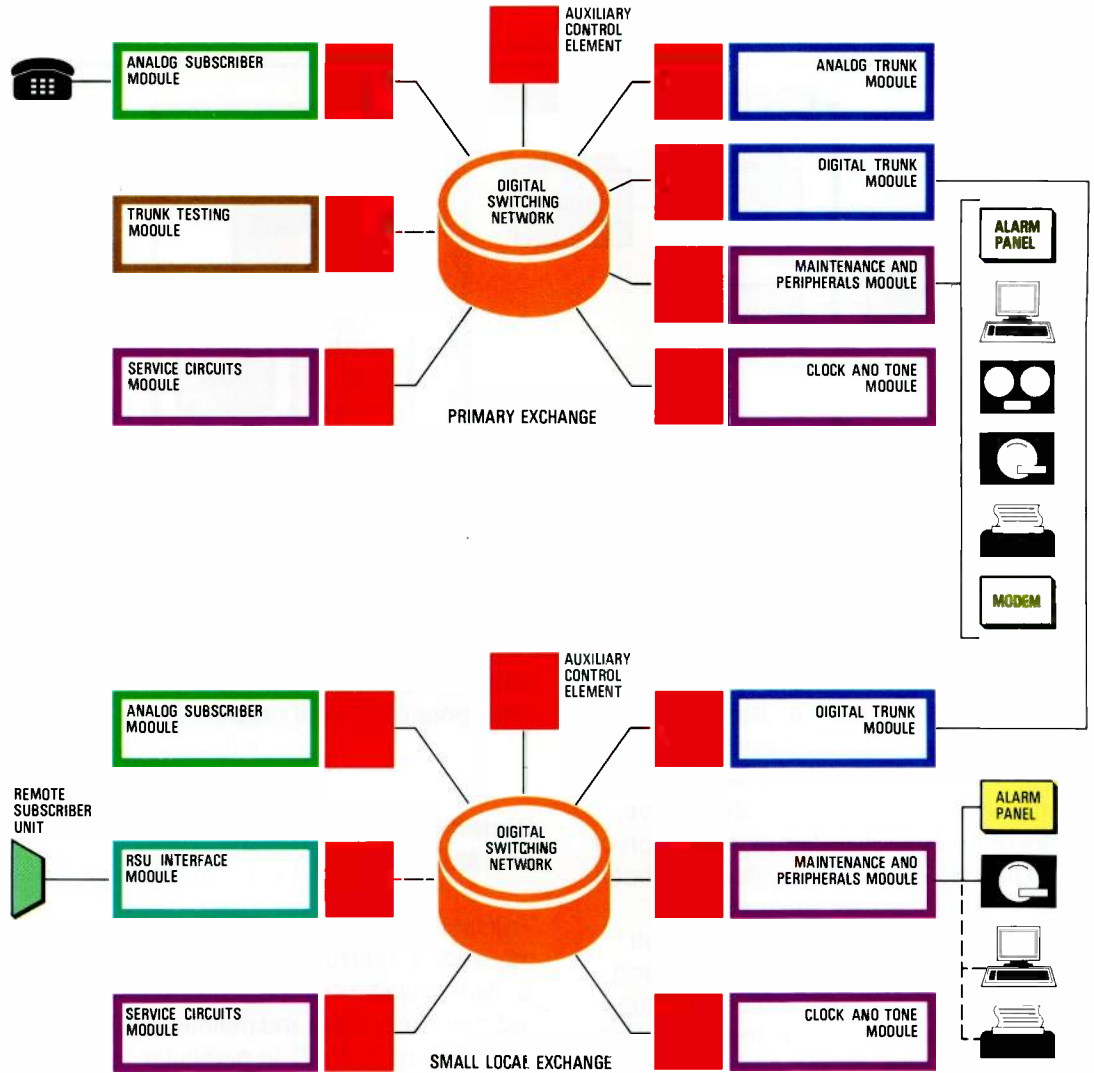

Figure 2
Configuration for the initial installation phase of the Collado-Villalba project showing the connection of the System 12 local-transit exchange and a small System 12 local exchange.



- Two 120-line RSUs dependent on one of the small exchanges.

An area such as Collado-Villalba shows the ability of System 12 to meet the different requirements of rural networks. A single system concept with full commonality of software and hardware building blocks is used for the local-transit and small local independent exchanges, as well as for the RSUs. At the same time the modular distributed architecture of System 12 makes it possible to select the most appropriate numbers and types of modules to reduce the start-up cost of small exchanges, and allows for unrestricted extension of exchanges in size and features simply by adding generic modules^{1, 2}.

Figure 2 shows the modules required for the initial configurations of the local-transit and small local exchanges. The RSU (Figure 3) has a similar configuration to a System 12 analog subscriber module, except that it can accommodate 120 subscribers and is connected via a

digital trunk to a RIM (RSU interface module) in the exchange using common channel signaling^{2, 3}.

Subscriber services and facilities are the same for all exchanges, including the RSU which shares those of its parent exchange. In particular, facilities include detailed billing capabilities and multifrequency receivers for pushbutton dialing. Similarly, comprehensive System 12 administration, operation, and maintenance facilities are available throughout the digital island.

The introduction of System 12 exchanges also provides all the economic and operating advantages of a digital network, particularly when used in conjunction with digital transmission as is the case throughout the Collado-Villalba digital island and on some of the routes to connected analog exchanges.

Other important new features of the Collado-Villalba digital island are the use of CCITT No 7 common channel signaling³, master-slave synchronization, and a network service center.

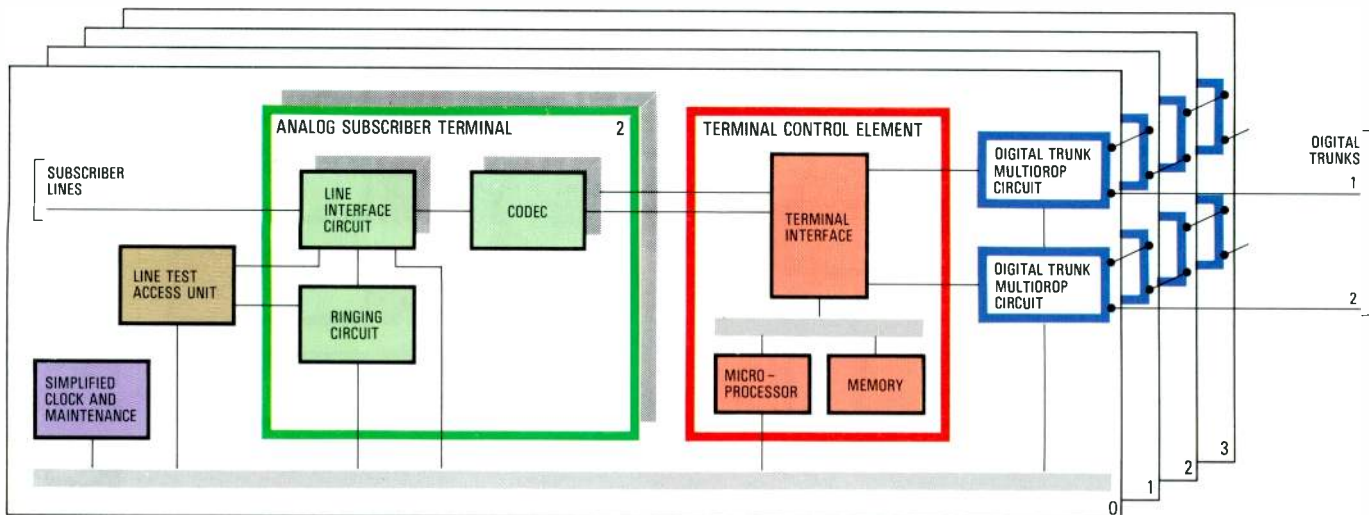

Figure 3
System 12 remote subscriber unit.

CCITT No 7 Common Channel Signaling

The message transfer part provides basic support for a wide range of present and future applications, such as trunk signaling for national application, telephonic user part, and a new OMUP (operations and maintenance user part). A cost-effective variant of the System 12 implementation of the CCITT No 7 signaling system has been designed for rural area applications by merging level 2 and level 3 distribution functions (to the telephonic user part and OMUP) in a digital trunk module. Because of its position in the network, the System 12 local-transit exchange provides for the interworking of CCITT No 7 common channel signaling with conventional signaling systems used on analog or digital trunks.

in the Collado-Villalba digital island. As a result the NSC offers a genuinely cost-effective approach to the operation and maintenance of rural networks.

Digital Island Operations and Maintenance

The fact that a single switching system can be used to realize all elements in the Collado-Villalba network considerably reduces operations and maintenance costs. The System 12 NSC, in particular, is ideal for this type of rural application, although not limited to them (Figure 4).

Figure 4
Functional partitioning of the network service center and connected exchanges.
MMC - man-machine communication.

Master-Slave Synchronization

Highly stable oscillators in the local-transit exchange send reference signals over the digital transmission links to the local clocks in the small exchanges, thereby reducing the requirement for stable local references. The clock and tone module for small exchanges can incorporate either a standard System 12 central clock or a simplified one. RSUs are also synchronized to their parent exchange.

Network Service Center

This System 12 configuration provides full centralization of operations and maintenance. The associated equipment (computer peripherals, control elements, signaling terminals) can be configured in a stand-alone center, colocated with a System 12 exchange or, in rural applications, even shared with an exchange in an integrated configuration as is the case

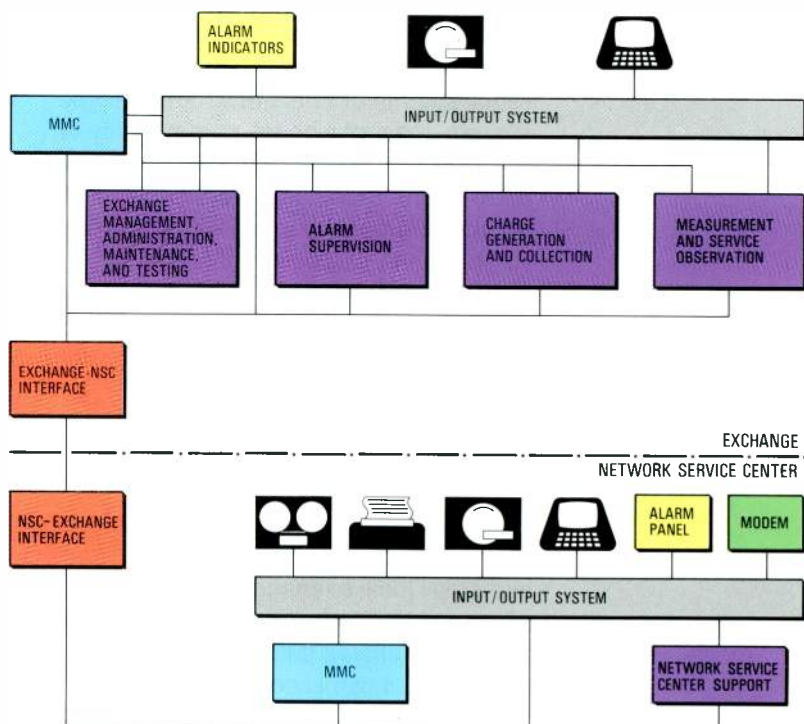

In the Collado-Villalba digital island, the NSC provides centralized operations and maintenance for the area from the local-transit exchange, enabling the unattended exchanges to be remotely supervised, controlled, operated, and administered⁴.

The System 12 NSC offers comprehensive operations and maintenance center facilities, including remote access to system dependent functions that are usually only available on-site. Table 1 indicates the key NSC features used in the Collado-Villalba rural area. However, the center can be extended to provide additional features such as an interface to electronic data processing centers for call billing, and network management. Present features include:

- Handling of centralized charge recording on transportable mass memory (magnetic tape) for further data processing at a billing center.
- Alarm reporting and display.
- Handling of measurements and service observation data that will be centrally displayed, recorded for further analysis, or concentrated for transfer over a data link to a specialized traffic data processing center.
- Centralized remote man-machine communication terminals, visual display units, printers, etc, shared by all exchanges in the digital island.

Remote operation of the exchanges does not preclude local operation during maintenance visits.

RSUs are considered as a remote part of the local exchange to which they are connected. Consequently, the NSC provides administration and maintenance support for RSUs through the parent exchanges. In addition, local maintenance at an RSU is supported by a remote man-machine communication terminal which is functionally part of the parent exchange but can be connected to the RSU.

System 12 Operations and Maintenance User Part

NSC functions are based on the transfer of messages and raw or formatted data files to and from the connected exchanges. This capability has been built around the CCITT No 7 signaling system by defining a special System 12 OMUP which interfaces with the message transfer part of CCITT No 7 in the

same way as the telephonic user part or data user part (i.e. as a level 4 user).

The OMUP itself is structured in layers, as shown in Figure 5.

Transaction Handler

The transaction handler provides common support for all OMUP (sub)users in the

Table 1 — Major functions of the System 12 network service center

<p>Charge data collection and administration</p> <p>Centralized charge recording on magnetic tape</p> <ul style="list-style-type: none"> - bulk metering - detailed billing - management of tape recording <p>Display of requested reports</p> <ul style="list-style-type: none"> - individual meter counters - charging statistics <p>Change of charging data</p> <ul style="list-style-type: none"> - tariff, scales, zone, etc - types of calls to be detailed <p>Measurements and service observation</p> <p>Centralized recording on a magnetic tape and/or display of measurement and service observation data</p> <ul style="list-style-type: none"> - traffic observation - single line observation - call sampling - on-line occupancy - load and overload measurement <p>Concentration of traffic data to data processing center</p> <p>Exchange management</p> <p>Subscriber administration</p> <p>Routing administration</p> <p>Service circuits administration</p> <p>Control administration</p> <p>CCITT No 7 links administration</p> <p>Maintenance</p> <p>Display repair items or security blocks status</p> <p>Initiate and display results of diagnostics</p> <p>Transfer security files</p> <p>Transfer actual exchange data</p> <p>Alarm supervision function</p> <p>Centralized display of alarms on a panel</p> <p>Fault report printing</p> <p>Transfer of history files</p> <p>Display of pending alarms per exchange</p> <p>Testing</p> <p>Initiate and display subscriber line and trunk test results</p> <p>Network service center management</p> <p>Assign/deassign exchanges</p> <p>Enter operator requests</p> <p>Report results of operations</p> <p>Measure performance</p> <p>Change NSC semipermanent data.</p>

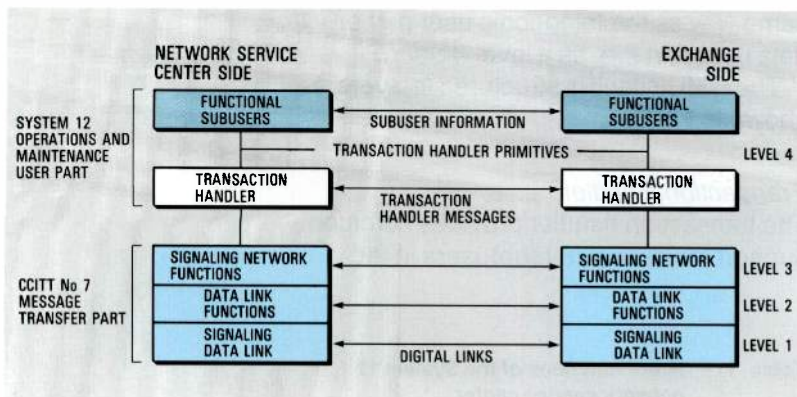

Figure 5
System 12 operations and maintenance user part and CCITT No 7 signaling system network as used in the Collado-Villalba digital island.

Collado-Villalba area based on a well defined set of primitives in line with CCITT Q series draft recommendations. It is designed to meet forecast data link usage and allow for a future increase in the number of users.

The transaction handler is the level between the CCITT No 7 message transfer part and functional (sub)users. At the request of a user, the transaction handler can set up a logical connection, or transaction, between peer users cooperating in a given function (e.g. charge transfer), and located at two connected points in the CCITT No 7 network, either directly or via signaling transfer points. For a given connection, the transaction handler performs the following functions:

- set up and release of logical connections, and assignment of the transaction number
- end-to-end control

- sequencing of messages
- retransmission in the event of an incorrect message sequence
- flow control of OMUP messages
- distribution of the load between the data links
- handling of routing label to message transfer part (CCITT Recommendation Q.704) and level 4 header (Figure 6)
- sending and receiving of packetized user data
- segmentation and reassembly of user data blocks of up to 2 kbytes (e.g. file records) into shorter CCITT No 7 message signal units.

A set of messages is defined between peer transaction handlers; this set consists of messages conveying user information and those needed for end-to-end control, fault recovery, etc, which form the class 4 transaction handler protocols.

Functional Subusers

The application level of the OMUP consists of up to 16 specialized subusers. Functional subusers are implemented by a set of modules, as described below:

OMUP subusers: the application level is, in general, not symmetrical so there are two different peer subusers for each function, one located in the NSC (NSC OMUP subuser; NOS) and the other in the connected exchange (exchange OMUP subuser; EOS). Dedicated protocols are defined between peer subusers which are

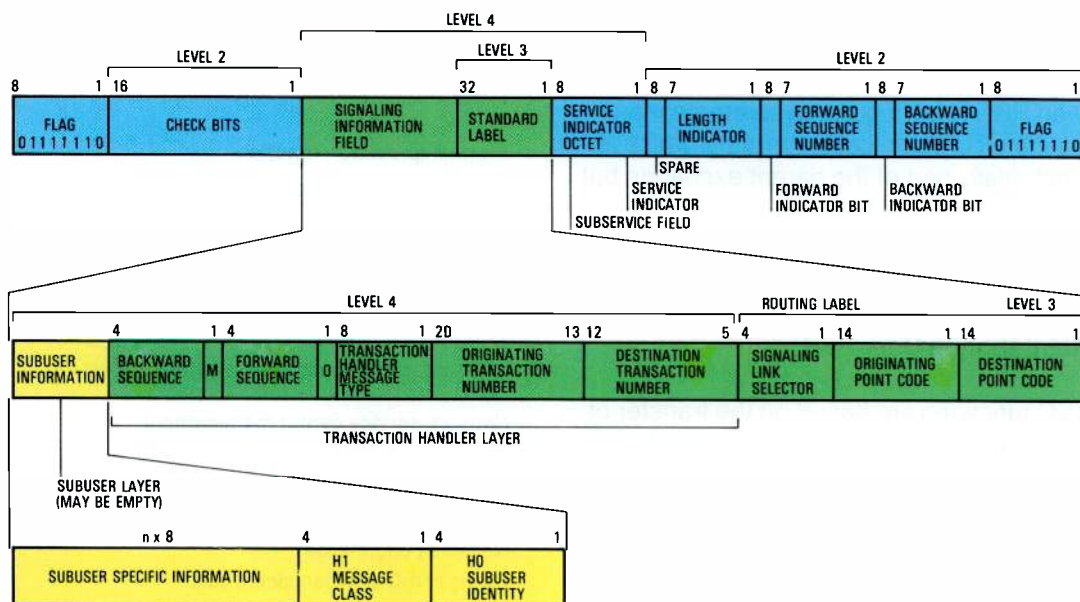

Figure 6
Format of the message signal unit in the operations and maintenance user part.

sufficient for their functions. They are supported by formatted application level messages, to which the transaction handler is transparent. Functions performed by OMUP subusers are:

- requesting transaction handler to set up and release transactions, including addressing information
- message exchange using the formats defined for the specific protocol with its peer subuser
- interface to exchange and NSC functions
- transfer of files and data messages
- specific actions to cover normal and abnormal cases: close files, release transaction, report, etc.

OMUP copy utility: the transfer of files from exchanges to the NSC, and in some cases in the reverse direction, is a routine function which is common to most subusers. This function interfaces with the transaction handler using the primitives defined for sending and receiving data blocks (file records) and with the System 12 general input/output by means of a generic interface for file handling (open, close, read, write, etc). It has been implemented by an OMUP copy utility which can transfer files on behalf and under the control of exchange and NSC OMUP subusers. File identities and access rights are controlled by subusers who pass this information to the OMUP copy utility when requesting a file transfer job. Completion information relating to the requested copy job is returned to the subusers enabling them to proceed with the task (e.g. report to operator, close transaction).

OMUP scheduler: this centralized NSC function manages the NSC and its man-machine interface (Table 1), and controls subuser activities (e.g. transfer of one file at a time for a subuser). It also schedules subuser operations, either at the operator's request (immediate, delayed, periodic on a calendar basis), or remotely requested from connected exchanges (e.g. when a buffer is full).

These scheduling functions increase the security of file transfer, improve data flow, and enhance operational flexibility.

Operation of Functional Subusers

The four functional subusers of the Collado-Villalba digital island operate as follows:

Charge Transfer

Charge data, both bulk metering and detailed billing, is stored at local exchanges and duplicated in nonvolatile mass memory. The OMUP scheduler and NOS charge initiate the transfer of a predefined charge

Remote subscriber unit rack for 120 lines, including power supplies, battery backup supply, main distribution frame and all other equipment necessary to make it a self-contained unit.



data file from one of the connected exchanges. First a transaction is initiated from NOS to EOS charge. The latter obtains access rights to a locally generated file containing formatted charging data, and initiates the transfer with the support of copy utilities at both ends (Figure 7).

After the charge data has been correctly transferred, it is recorded on duplicated magnetic tape drives at the NSC. A pair of tapes can be generated for each remote exchange or one pair for all exchanges. A report on the transfer operation is then output, and the operator is informed of any

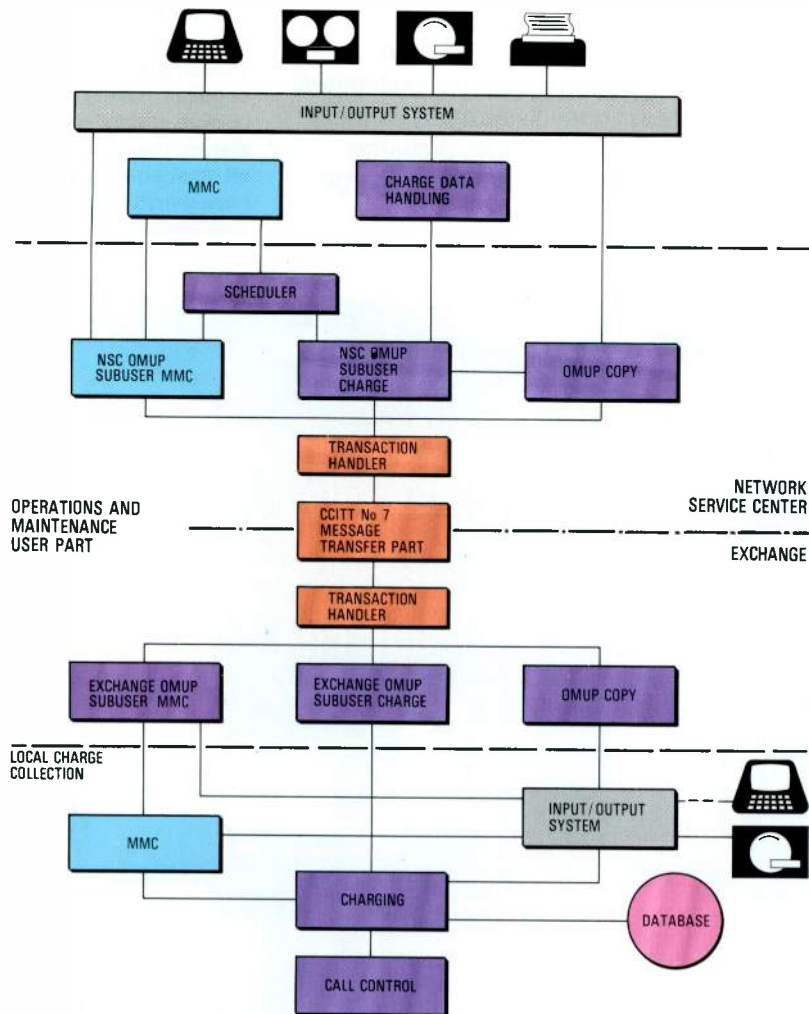

Figure 7
Charge data collection and administration in a System 12 network service center.

incident that requires his intervention at the NSC.

Predefined files can be logically identified by subusers. As data is formatted according to administration requirements (Compañía Telefonica Nacional de España in the present case), a system independent protocol is available for charge transfer.

Measurement and Service Observation Transfer

Measurement results and service observation data are locally stored in the exchanges. As in the case of charge transfer, NOS and EOS measurement and service observation collaborate to transfer predefined files to the NSC so that they can be centrally output to magnetic tape or sent to a traffic recording center for further analysis. A system independent protocol is provided by the OMUP for measurement and service observation transfer.

Man-Machine Communication Transfer

This subuser has three main functions. First to transfer predefined reports generated by

an exchange to the NSC man-machine communication terminals (monologue output). Reports are grouped functionally (alarms, observation results, etc) so that the EOS/NOS man-machine communication can distribute them to dedicated terminals. This facility includes distribution to different CCITT No 7 destination points, allowing for future specialized NSCs. Second the subuser distributes jobs requested by the NSC operator to a specific exchange where the job is to be carried out (dialogue mode). Operator requested jobs can be entered from several terminals, possibly located at different signaling points. Third it transfers files of system dependent data, identified by operator jobs entered to the OMUP scheduler. The first two functions can be made system independent as the transfers are in ASCII code; man-machine communication language translation and function execution are performed by the destination exchanges. This allows a remote terminal mode of operation.

Alarm Transfer

Any alarm generated at a remote exchange is transferred to the NSC using the EOS/ NOS alarm protocols. This allows maintenance personnel at the NSC to receive data on remote alarms, including the identity of the originating exchange, associated category, class, etc (Figure 8). Alarms transferred to the NSC are independent of, and in addition to, the standard System 12 man-machine messages. They are in fact the alarm indications that are normally displayed on the local alarm panel which have, in this instance, been transferred for remote display on a fault panel at the NSC.

Functional Organization of NSC

The System 12 OMUP implementation allows functional specialization of NSCs. Functional partitioning, such as that shown in Table 1, can be provided. Specialized NSCs can be organized by distributing functional subusers and their associated man-machine communication subuser to different CCITT No 7 signaling points, although this is not the case at Collado-Villalba where a single NSC provides all functions. Figures 7 and 8 show examples of ways in which functions can be distributed among different NSCs.

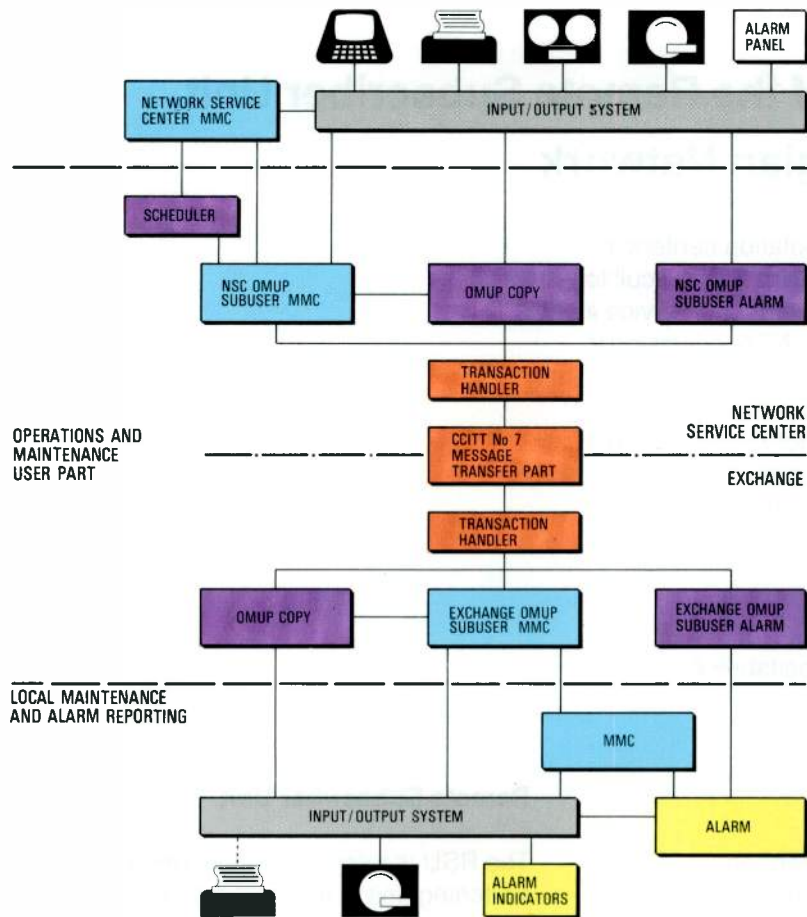

Figure 8
Network service
center maintenance
and alarm supervision.

Conclusions

The advent of new digital technologies is making it economically attractive to provide subscribers connected to rural networks with modern services. At the same time administrations benefit from more efficient methods of operating, maintaining, and administering the exchanges and the rural network.

The distributed architecture of the System 12 Digital Exchange makes it easy to incorporate such features. The network service center provided for the Collado-Villalba area in Spain shows how CCITT No 7 common channel signaling can be used with System 12 to support a range of new functions.

References

- 1 F. Alvarez Casas and F. Casali: ITT 1240 Digital Exchange: Network Planning and Application: *Electrical Communication*, 1981, volume 56, no 2/3, pp 302-314.
- 2 M. Van Brussel and A. Campos Flores: ITT 1240 Digital Exchange: Application to the Local Network: *Electrical Communication*, 1981, volume 56, no 2/3, pp 218-234.
- 3 B. Rossi and F. Haerens: ITT 1240 Digital Exchange: Implementation of CCITT No 7 Common Channel Signaling: *Electrical Communication*, 1981, volume 56, no 2/3, pp 264-273.
- 4 E. Bertoli, H. Neufeldt, and M. Smouts: ITT 1240 Digital Exchange: Operations and Maintenance: *Electrical Communication*, 1981, volume 56, no 2/3, pp 184-197.

System 12

Application of the Remote Subscriber Unit in the Norwegian Network

The scattered small population centers in Norway have traditionally made it difficult to supply a cost-effective telephone service in rural areas. However, the NTA's decision to install System 12 has made it possible to overcome this problem by making extensive use of the remote subscriber unit which can economically provide a full-feature telephone service to very small numbers of subscribers.

S. Husby
B. Vinge

Standard Telefon og Kabelfabrik A/S,
 Oslo, Norway

Introduction

The NTA (Norwegian Telephone Administration) has ordered approximately 700 000 lines of System 12 equipment, representing some 458 exchanges. Because of Norway's geography with long valleys, long coastline, small islands, and scattered small population centers, the average exchange has about 300 lines. Consequently, the System 12 RSU (remote subscriber unit) will play an important part in Norway's new digital network.

The severe Norwegian environment with its low and high temperatures, high humidity, and salty atmosphere near the coast, sets stringent requirements on the equipment.

Remote Subscriber Unit

The RSU is a small line-concentrating switching unit at the lowest level in the System 12 hierarchy. Fully dependent on the parent exchange for control and supervision (Figure 1), it provides line interface circuits for up to 480 subscriber lines and is connected to the parent exchange via one or two RSU digital trunk circuits (30 or 60 channels). There is full availability between all subscriber lines and all 60 channels. One RSU trunk circuit can take control of all subscriber lines if the other fails or there is a transmission failure. The RSU offers the same facilities as the medium/large exchange configuration.

The capability of providing up to eight

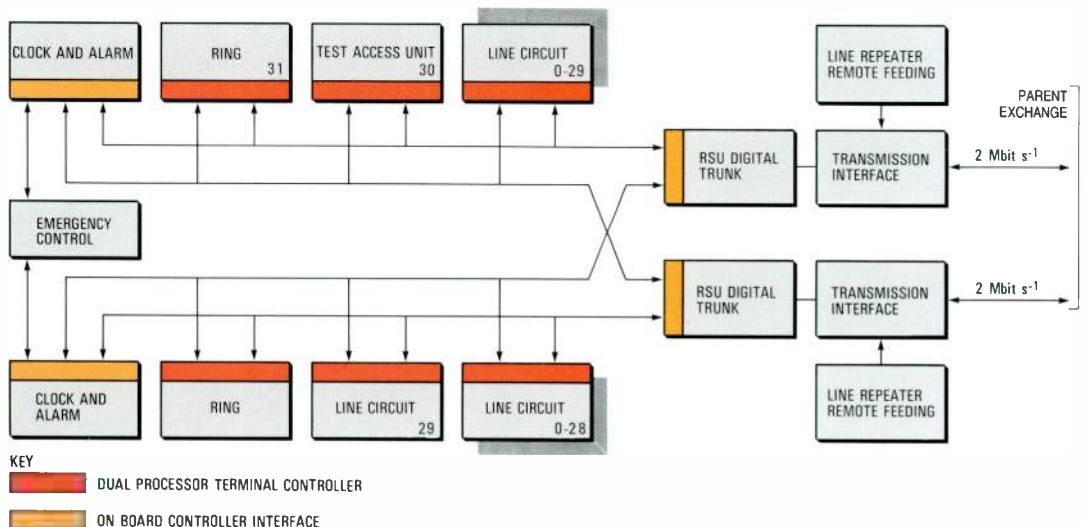

Figure 1
 Block diagram of RSU and its connection to the host System 12 exchange showing the various printed boards.

RSUs in a multidrop configuration is an important feature for the Norwegian network (Figure 2). The host exchange uses a polling technique to control which RSU is to send its status over channel 16, and which speech channel is to be connected to the subscribers. A maximum of 1000 subscribers can be connected in a multidrop configuration. In Norway, the typical bothway traffic for subscribers in rural areas is 0.06 erlang, giving a total traffic of 60 erlangs which is higher than can be carried on 60 channels with a reasonable grade of service. This implies that traffic rather than the maximum number of subscribers is the limiting factor.

In the event of a transmission link failure, a relay on the line transmission interface board connects the outgoing and return bitstreams, thereby disconnecting the faulty link. Failure of the RSU actuates a second relay which bypasses the RSU.

The RSU digital trunk circuit has the same structure as the standard System 12 digital trunk circuit. Firmware in the RSU digital trunk circuit carries out the necessary packing/unpacking of messages into a reduced CCITT No 7 signaling system format that will be used for signaling between the RSU and parent exchange.

There is no TCE in the RSU; a TCE in the parent exchange also serves the RSU, making it unnecessary to download software to the RSU. The TCE performs the standard functions for System 12 digital trunk circuits, control of the CCITT No 7 mechanism, and line handling.

Automatic maintenance and operation are controlled from the parent exchange. A portable man-machine communication terminal can be connected to the RSU, but the commands are transmitted to the parent exchange where the man-machine communication software is located.

A subscriber line test access unit in the RSU enables the administration to remotely test subscriber lines connected to the RSU.

Two transmission interface boards will be developed for Norway. One will be used for feeding the repeaters. The other will include circuits for the transmission interface to the cable, as well as relays to disconnect faulty links and bypass the RSU. The RSU digital trunk circuit complies with CCITT Recommendation G. 703. In the event of a total transmission or trunk failure, an optional RSU facility (emergency control circuit) enables local subscribers to be connected to the Nordic mobile telephone network.

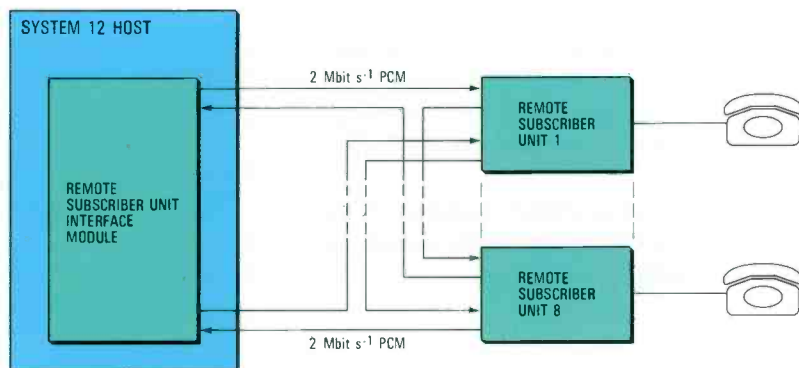
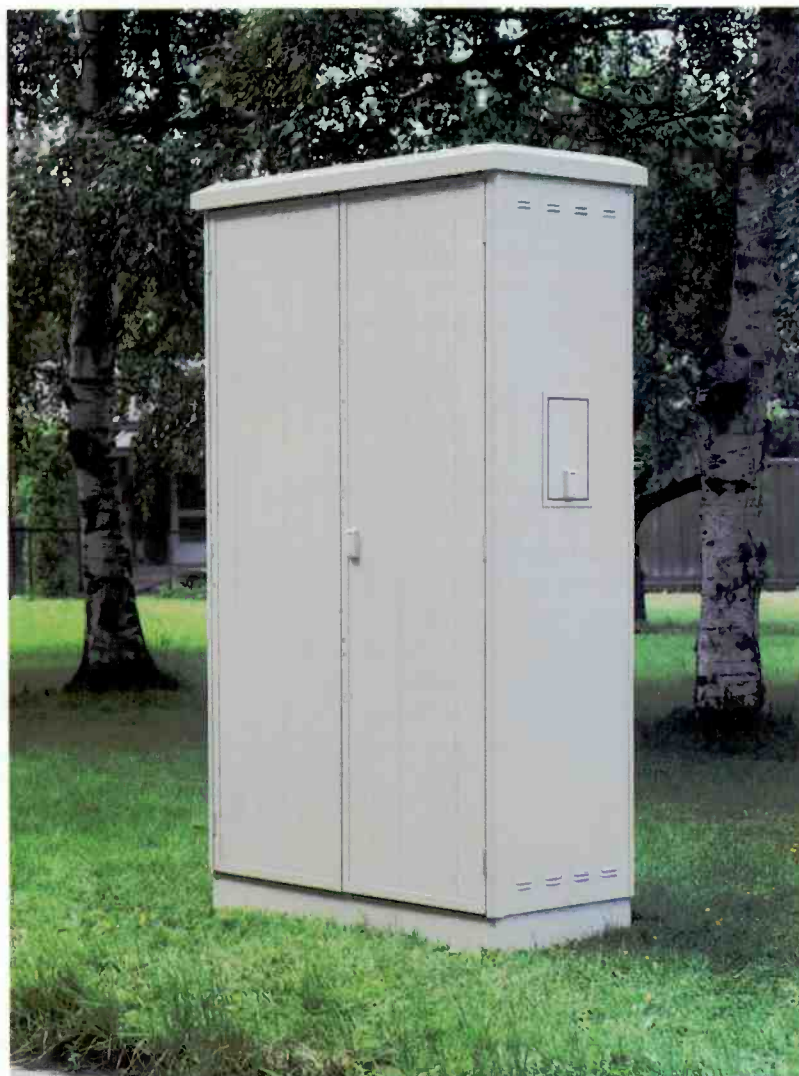

Figure 2
RSUs connected in a multidrop configuration.

System Configurations

RSUs for Norway will be equipped in three configurations, as shown in Figure 3. The smallest, which serves 80 subscribers, can be housed in a single cabinet complete with rectifier, battery, and main distribution frame. Either an indoor or outdoor cabinet can be used. Next is an intermediate configuration which serves 240 subscribers; again it is housed in one

Outdoor version of the System 12 RSU.



cabinet (indoor or outdoor version) complete with rectifier, battery, and main distribution frame. At the top end, a configuration of two RSUs (960 lines) can be housed in a single standard System 12 rack.

These sizes have been selected on the basis of the existing population structure and anticipated growth rates.

Rural Network

The Norwegian telephone network is today based on a 5-level hierarchy with exchanges connected in a star/mesh configuration (Figure 4). The RSU will normally be connected to the lowest level or to the group switching center.

In rural areas of Norway, community centers are usually small and scattered with fair distances between them. Traffic within these centers is usually low. As high labor costs and difficult ground conditions make cable laying expensive, cabling costs are an important factor in network planning. The RSUs will be connected to the parent exchange using either a multidrop or star configuration, or a combination of these. The chosen configuration will depend on geographical conditions, community center sizes, and existing or planned transmission networks.

The multidrop configuration is particularly suitable where community centers are situated along a line or in a circle, as is the case in long valleys or groups of islands.

Urban Pair Gain

The RSU also offers a cost-effective method of saving pairs in the urban network, particularly in suburbs where most subscribers generate low traffic. The administration is trying to restrict the introduction of new cables, not only for cost reasons, but also to avoid disruption of road traffic during installation. The NTA has ordered RSUs for use in the suburbs of Oslo.

Operations and Maintenance

Small exchanges in Norway are always unattended. The distance between them and the maintenance centers is usually large, and it is sometimes hard to reach exchanges because of difficult geographical

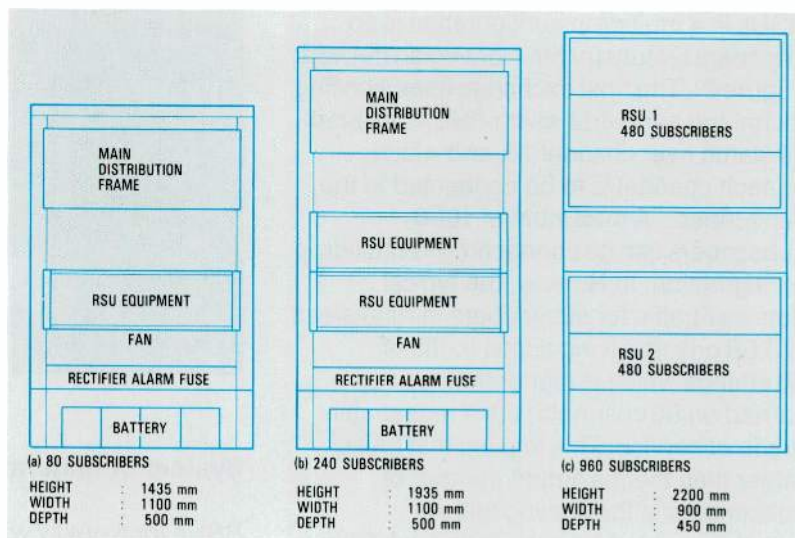

Figure 3
The three main RSU equipment configurations. From left to right these serve 80 subscribers, 240 subscribers, and 960 subscribers.

or climatic conditions. This places stringent requirements on the reliability of switching equipment, and on operations and maintenance facilities. The cost-effectiveness of System 12, and specifically of small exchanges and RSUs, is based on the comprehensive facilities it provides for centralizing operations and maintenance.

The NSC (network service center) is a powerful means of providing centralized operations and maintenance facilities for a System 12 network (Figure 5). The NSC is an integrated part of an exchange, although its location can depend on the network configuration, local operations and maintenance organization, and the siting of support centers. All exchanges connected to an NSC are completely independent and all functions may be performed by the local exchange. The basic principle is that all

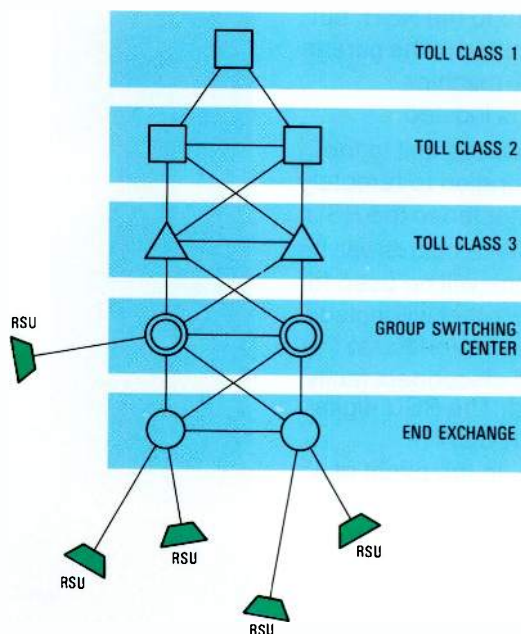

Figure 4
Structure of the Norwegian telephone network which is based on a 5-level hierarchy with exchanges connected in a star/mesh configuration.

software remains in the individual exchanges, but peripheral devices such as VDUs, printers, cartridges, and tapes can be located at the NSC to reduce the amount of equipment and allow remote supervision and operation. CCITT No 7 common channel signaling is used between the NSC and exchanges via a defined operation and maintenance user part.

The basic NSC functions are:

- centralized man-machine communication
- centralized mass memory for data storage (e.g. charging functions, measurement reports, and editing functions)
- reception, logging, and display of alarm messages on printers and/or VDUs.

Climatic Conditions

Norway frequently has high summer temperatures and the effect of 24 hours sunshine during a day in the northern regions implies that special attention must be paid to thermal management of the outdoor cabinets and containerized exchanges. In wintertime, extremely low temperatures and low humidities can be reached inland. Near the coast humidity is high and there are large concentrations of salt in the atmosphere in spring and autumn. This environment makes it essential to use rigid, well designed equipment and high quality materials.

The outdoor cabinets and the containers therefore use aluminum as the base material, either as extruded profiles in loadbearing structures or as skin plates. Careful selection of the surface treatment ensures an almost maintenance-free housing.

Handling and Transportation

Exchanges are completely tested in the factory before shipment. All racks are shipped fully equipped in special crates. Equipment is primarily transported by road and sea, although air shipment is also possible. Because of Norway's long coastline with its many fjords and islands, transportation by sea will also be used. Thus loading and unloading of crates may be necessary in a hostile environment.

Transport by helicopter may be required to the most remote rural locations. Roads in

rural areas can be difficult to negotiate in springtime when the ground is thawing, so there are generally weight restrictions on road traffic. The weight and design of the equipment and packaging are therefore important issues.

Equipment Practice

Indoor Cabinets

The RSUs are particularly cost-effective as they are fully tested in the factory and are quickly and easily installed in almost any location. In addition they offer virtually maintenance-free operation.

The indoor cabinet can be installed in existing premises in the local community. Changes to the subscriber side of exchanges are rare in these areas. Batteries

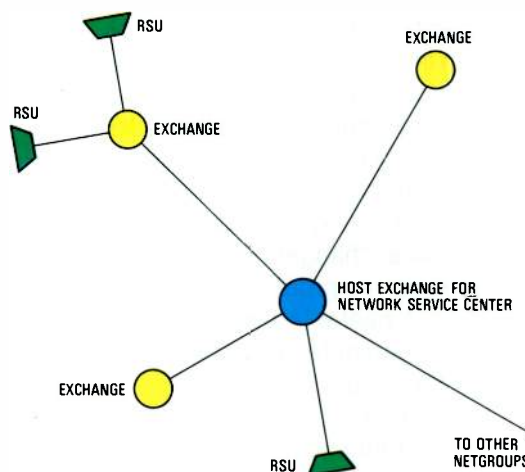

Figure 5
Typical network
service center
network.

are hermetically sealed and maintenance-free, helping to keep maintenance and inspection at a low level.

Standard System 12 equipment practice is used for all sizes of RSU. The lower range "single cabinet" RSUs (below 240 subscribers) include the main distribution frame, battery, and rectifier as an integral part of the cabinet.

Outdoor Cabinet

The outdoor cabinet contains the same equipment as the indoor version, but the equipment practice is integrated with the cabinet construction. The design makes extensive use of interlocking extruded aluminum profiles to minimize corrosion and provide effective weatherproofing. Locks, hinges, and general fasteners are only accessible from within the cabinet to reduce the risk of vandalism.

Figure 6
Principle of heat transfer in the outdoor cabinet.

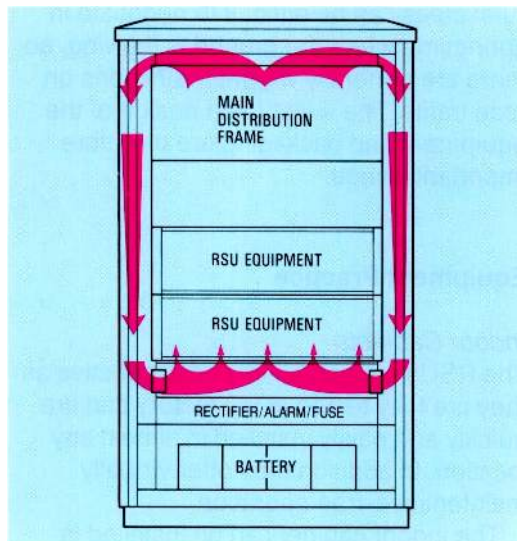

To ensure that equipment in the cabinets operates within the specified temperature range, an environmental control unit is incorporated which blows cooling air through the subracks when the temperature exceeds the preset value. Warm air at the top of the cabinet is sucked through the side channels and recirculated through the subrack. The sides of the cabinet, which are of tubular extruded construction, act as heat sinks/heat exchangers (Figure 6). The outer skin gives protection from the sun's radiation. A heater is also included because in some areas of Norway temperatures can fall to -50°C during winter.

The outdoor cabinet can be mounted on various foundations ranging from concrete or steel bases to wooden poles. The mounting height depends on local conditions, such as the depth of snow or floodwater.

Container Versions

All containers are delivered fully equipped and tested; they include all the necessary entries for connecting the exchange to the existing network and local power supply. The mechanical design is based on the principles that were used successfully for the METACONTA* rural containers.

* A trademark of ITT System

The design uses thermally insulated panels made from a closed cell structural foam core with aluminum plates bonded to both sides. These provide an optimum compromise between strength, weight, and thermal insulation. Doors and openings for cables, etc. are sealed to ensure that ambient conditions within the container are maintained well within the specified limits. All materials and finishes are self-extinguishing and protected against attack from insects, and bacterial and fungal growth. All outside dimensions are to ISO standards, as with ordinary freight containers, and corners are equipped with ISO corner fittings to simplify handling.

In Norway the containers are normally transported by container side-loading trucks, as they have proved the simplest and safest.

Site preparation is normally limited to laying down corner slabs of concrete or logs of wood to spread the load from the four corner pillars of the container.

The standard single-phase mains voltage in Norway is 230 V AC. The mains supply cable is connected directly to the fusebox inside the container. Each container is equipped with battery and rectifiers dimensioned for 960 subscribers. The air conditioning system is powered by the 230 V AC system and is designed for the extreme temperatures (-50 to $+35^{\circ}\text{C}$) encountered in Norway during the year. Diesel generators may be provided in areas that are prone to frequent or lengthy power cuts.

Conclusions

Special attention has been given to the design of a reliable, cost-effective communication system for the small widespread communities in the rural areas of Norway. The flexibility of the System 12 small exchanges and remote subscriber units, and the network service center concept, make them particularly suitable for use in Norway with its topology, climate and network configurations. Consequently the remote subscriber unit will play an important part in the NTA's plans for a Norwegian digital telecommunication network.

System 12

ITT 5630 Business Communication System

The ITT 5630 business communication system makes extensive use of the concepts, hardware, and software of System 12 to provide a versatile, cost-effective digital PABX which can handle both voice and non-voice services.

A. Bessler

M. Edlmann

L. Lichtenberg

Standard Elektrik Lorenz AG, Stuttgart,
Federal Republic of Germany

Introduction

New private communication systems must offer more than just a basic voice service if they are to meet the increasingly sophisticated demands of today's users. At the same time a new system must work with a wide spectrum of existing subsets and interfaces, and with existing public exchanges.

System design of the ITT 5630 BCS (business communication system) is based on the premise that any new PABX should use digital technology, and be able to interface with digital terminals, non-voice terminals, and a future ISDN. Only in this way will the system be able to evolve to provide the full range of services and features required by a future ISDN business communication system:

- transparent 64 kbit s⁻¹ end-to-end transmission between subscriber terminals
- full 144 kbit s⁻¹ basic access on two B channels (64 kbit s⁻¹) and one D channel (16 kbit s⁻¹) for signaling
- access to various communication services via the standard ISDN subscriber interface
- capability of integrating wideband services with bit rates from 64 kbit s⁻¹ up to 2.048 Mbit s⁻¹.

The flexibility and modularity necessary to provide these features could not be achieved by the evolution of an existing stored program control exchange. Studies showed that only an advanced system and control architecture, high level programming languages, and VLSI microprocessor and memory components, could provide the required flexibility and modularity. As new digital public switching systems must meet similar requirements, from an architectural viewpoint there are only minor differences between public and private switching equipment.

It became clear from these studies that the proven System 12 technology would form an ideal basis for a digital private business communication system.

Main Requirements

The ITT 5630 BCS has been designed as an office communication system suitable for use throughout the world. In order to attain this demanding objective, the system has to meet the national regulations of PTTs in

The sophisticated operator console developed for the ITT 5630 BCS. Its comprehensive facilities help operators to provide a full and effective service.



many countries, as well as the recommendations of the international standardization organizations. Naturally it also has to fulfill the needs of many different types of businesses and the specific requirements of individual organizations.

PTT Requirements

PTTs issue a wide range of regulations covering such areas as system sizes and extension stages, expansion rules, traffic requirements, grade-of-service, and network interfaces. The distributed control architecture and modular design of the ITT 5630 BCS give the flexibility that is necessary to meet the requirements of PTTs in most countries.

The ITT 5630 BCS covers the entire range from 60 to 10 000 extension lines. It has been designed to carry traffic of up to 0.2 erlang per extension line, but flexible partitioning allows for even higher traffic values. Similarly, while a normal system will be configured for 10% exchange lines, any value up to 25% is feasible.

Signaling and transmission requirements for all types of analog connection are well defined. However, a variety of interfaces are necessary to meet these diverse regulations. In contrast, recommendations for digital transmission and signaling are only now being drawn up. When recommendations have been finalized, new hardware and signaling protocol interfaces will be required.

The ITT 5630 BCS has been designed around functional system interfaces which allow peripheral interface boards to be added to meet new requirements, without modifying the basic hardware and software.

Market Requirements

Potential users cover the entire range of business operations, including banks, hotels, city administrations, hospitals, and factories. To meet the needs of such organizations, the ITT 5630 BCS offers more than 600 voice, administration, and maintenance features. Various networking techniques are also possible, such as remote extensions (distributed system installation), main/satellite technique (interworking of two or more systems where one is the master and the others are slaves), and large network groups including tandem operation (interworking of two or more systems on a national or international basis using the customer's own network). Consequently each organization can select

the features that meet its own communication requirements.

The system is able to interface with all existing analog subsets, as well as with a variety of digital terminals ranging from simple subsets up to a full 144 kbit s⁻¹ ISDN multifunction terminal. In addition, many text and data terminals with different protocols can be connected and supported by new service modules for non-voice applications. Interfaces and signaling protocols to various public and private networks are also required, including interfaces to mainframe computers.

Each user has individual requirements concerning system size, trunk bundles, traffic, subsets and terminals, features, and future enhancements. The ITT 5630 BCS can be tailored to provide a communication focal point that exactly meets the user's needs and can grow as his requirements evolve.

Operational Requirements

System definition paid particular attention to reliability, administration, and maintenance. The wide range of system administration features can be used easily and effectively. A sophisticated testing and maintenance concept ensures high system reliability; integrated diagnostic programs continuously supervise system performance. Administration and maintenance terminals can be provided locally or can be sited in a remote service center.

Design Objectives

Extensive studies of user and administration requirements, technological trends, and the future evolution of services resulted in the following main design objectives:

- cost-effective over the entire size range from 60 to 10 000 extension lines
- no cost penalty for voice communication only
- extensive range of features
- flexibility between periphery and system kernel so that new peripheral interface circuits can be connected without affecting the system kernel software
- connection of text and data terminals such as facsimile, textfax, and teletex
- ISDN capability on subscriber and public exchange side

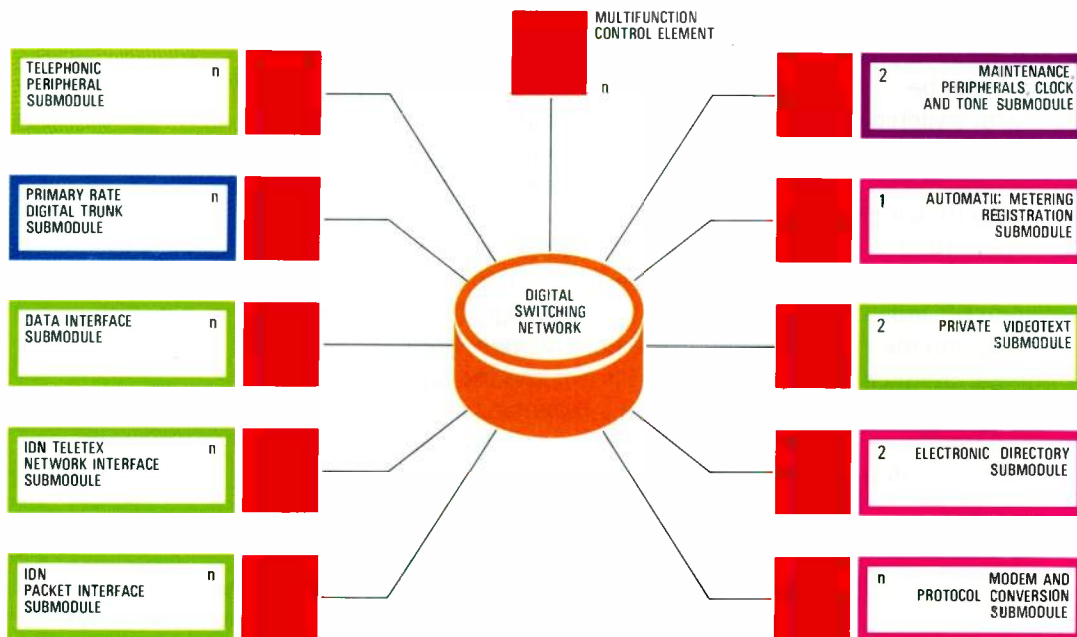

Figure 1
Architecture of the ITT 5630 BCS which is based on the modular, distributed control principles used in System 12.

- integration of value added services, such as private videotex and message handling
- connection of service modules (servers) to extend the usability of terminals by providing protocol conversion, electronic directory, database, and so on.

Design Considerations

Fully distributed control, as implemented in System 12, meets all the above requirements, in particular those relating to system size, growth steps, modularity, and flexibility.

A common technology for different applications, such as local and toll public exchanges, ISDN, the German satellite system DFS, and the ITT 5630 BCS allows high quantity production of VLSI devices, common printed boards, and the equipment practice. Additionally there is a considerable carry over of software statements by using the public system kernel software for private applications. Finally, the same software development tools and production system can be used.

However, there are differences between public and private switching which require modifications to the System 12 design used for public exchanges, although not to the fundamental architecture. For example, the wide variety of telephonic peripheral interfaces requires modifications in the peripheral area, and an operator subsystem must be designed.

System Architecture

The ITT 5630 BCS is based on the System 12 digital switching network, a virtually nonblocking switch with transparent 64 kbit s^{-1} channels (Figure 1). The basic voice system will be the core of a future office communication system for use in medium and large businesses. In addition to the digital switching network and MFCEs (multifunction control elements) it consists of four submodules:

- telephonic peripheral submodule
- primary rate digital trunk submodule
- maintenance, peripherals, clock and tone submodule
- automatic metering registration submodule.

Peripheral circuits for ISDN and non-voice (low speed) applications will be located in the telephonic peripheral submodule. All submodules and the MFCEs are connected via two PCM links over the digital switching network.

A 3-level control hierarchy is used with on-board controllers, TPCEs (telephonic peripheral control elements), and MFCEs. Larger systems require an additional control level to provide central functions (e.g. resource management) for the 600 extension line modules. Signaling and control between the telephonic peripheral boards, TPCEs, and MFCEs utilize semipermanent channels through the digital switching network.

The digital switching network has a maximum of three stages (access switches and two group switch stages); it can be extended simply by adding digital switching elements. In addition there is a switching stage in each terminal interface and in the OBCI (on-board controller interface), which connects all active telephonic peripherals on the associated board onto two PCM links.

In configurations with between 60 and 600 extensions, each submodule and the MFCE is connected via its terminal interface and via two PCM links to the common access switches (Figure 2). Switched connections and the control path are either

submodule controller, and a DC/DC or AC/DC converter which provides all the required voltages (Figure 4). In practice the submodule will be equipped with mixed telephonic peripherals (e.g. 120 analog line circuits, 12 analog trunks, two analog tie-lines, eight dual tone multifrequency receivers, and one operator access unit or a conference circuit with up to 30 ports).

A universal standard signaling interface between the telephonic peripheral submodule controller and the on-board controller of the telephonic peripheral printed board allows the boards to be plugged into any of the 24 reserved

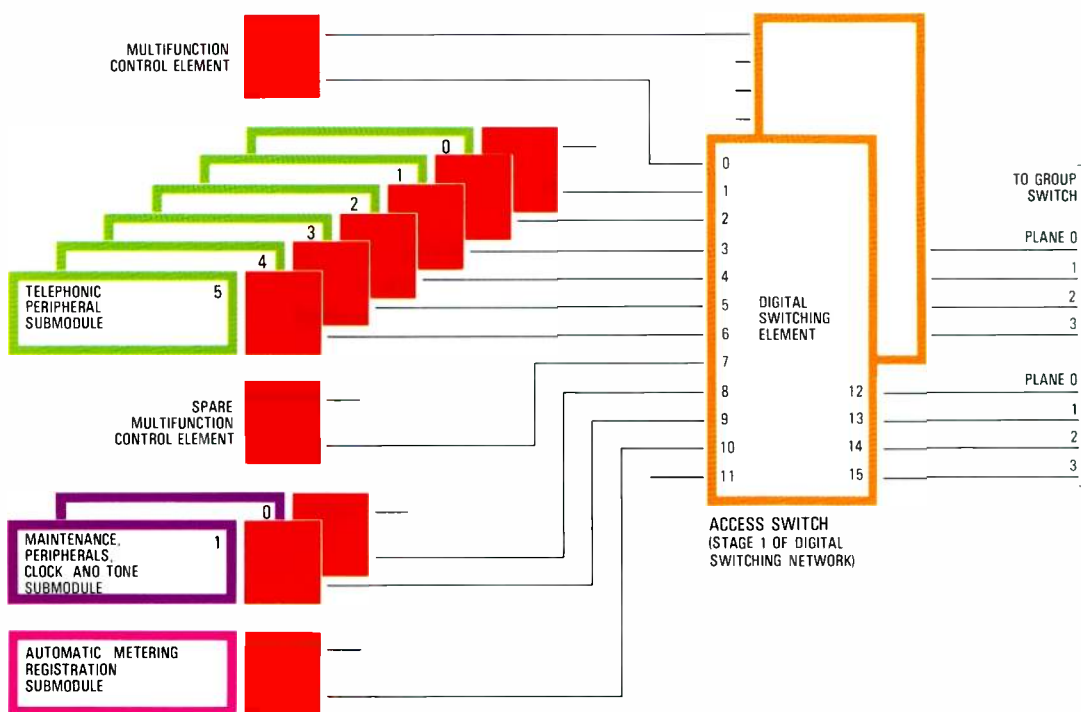

Figure 2
Structure of a system for up to 600 lines. The digital switching network consists only of access switches.

folded in a terminal interface for connections within a submodule, or in the access switch for connections between submodules.

Larger systems with up to 10000 extension lines also require group switch stages to connect all 600 extension line modules (Figure 3). In this case, paths are folded in the terminal interfaces, access switches, or group switch stages.

Telephonic Peripheral Submodule

This submodule includes all the telephonic peripherals (line circuits, trunks, tie-lines, dual tone multifrequency receivers, operator access unit, etc), a terminal interface, the telephonic peripheral

positions in the corresponding subrack.

This interface is independent of the telephonic peripherals and provides a structure which allows new telephonic peripherals to be added for future country applications, or to interface with digital line circuits and trunks.

Signal and device handling have been allocated to two controllers: the on-board controller handles signaling, while the telephonic peripheral submodule controller deals with device handling.

Multifunction Control Element

In the case of a 600-line system, the main task of the MFCE is to control call setup,

* ONLY MODULE 0 IS EQUIPPED WITH MAINTENANCE, PERIPHERALS, CLOCK AND TONE SUBMODULES AND AUTOMATIC METERING REGISTRATION SUBMODULE.

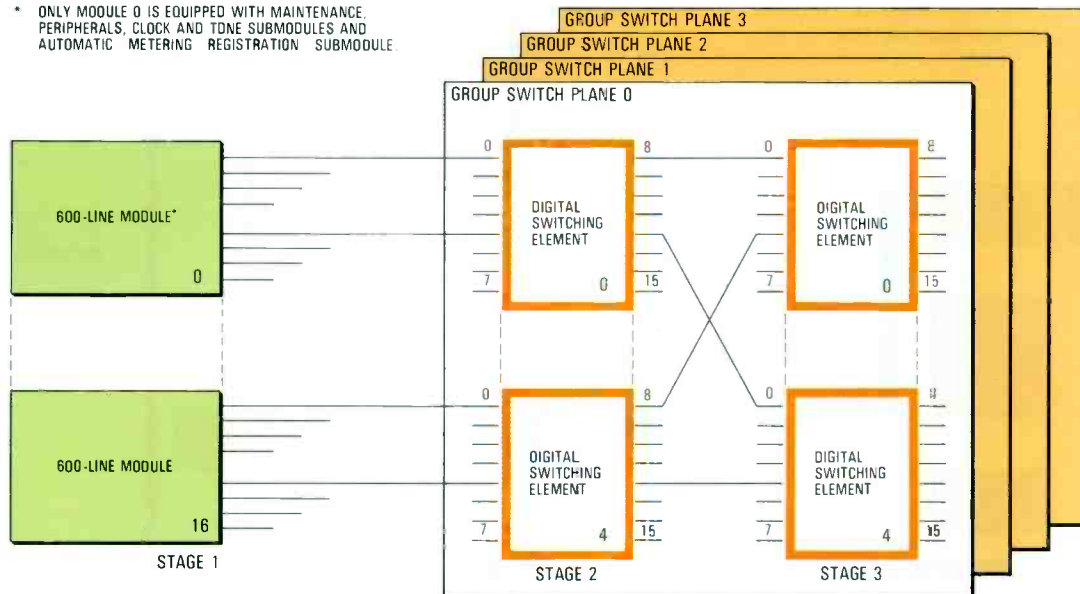

Figure 3
Structure of a large ITT 5630 with up to 10000 lines. Up to two group switching stages may be necessary in the digital switching network.

termination, and release. Call control includes feature control software for all ITT 5630 BCS facilities. Device handling functions are performed in the TPCEs.

The ITT 5630 software allows additional call service functions to be flexibly allocated. Examples are the handling of central resources (e.g. trunk pools, tie-line pools, central operator distribution, and translation tables for user manipulations, such as the digit or function buttons of intelligent digital subsets) in the MFCE of a 600-extension line module. In contrast, larger systems use dedicated control elements to provide these call service functions.

Systems with more than 600 lines are equipped with one MFCE for each 600 lines. To further enhance reliability, a single spare MFCE or a spare pool of MFCEs may be provided.

Maintenance, Peripherals, Clock and Tone Submodule

This submodule, which is based on the System 12 maintenance and peripherals module, provides the following functions:

- maintenance functions to detect, analyze, report, and react to faults
- start-up functions to initialize all control elements in the system, in particular the loading of programs and data into memory from the disk via the terminal interface and digital switching network
- detection of and defense against overload conditions to avoid system breakdown
- administration functions such as changes to telephonic data (e.g. class of service), call recording, and traffic measurements

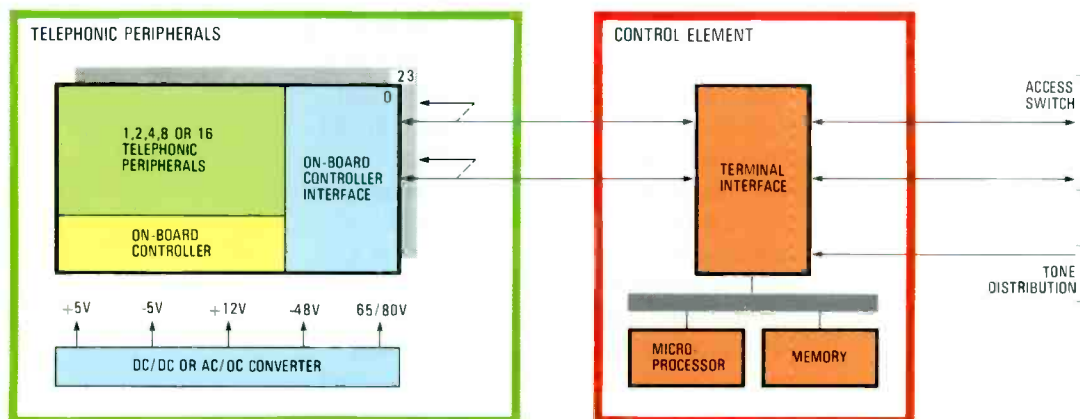

Figure 4
Block schematic of the telephonic peripheral submodule showing its similarity with System 12 modules.

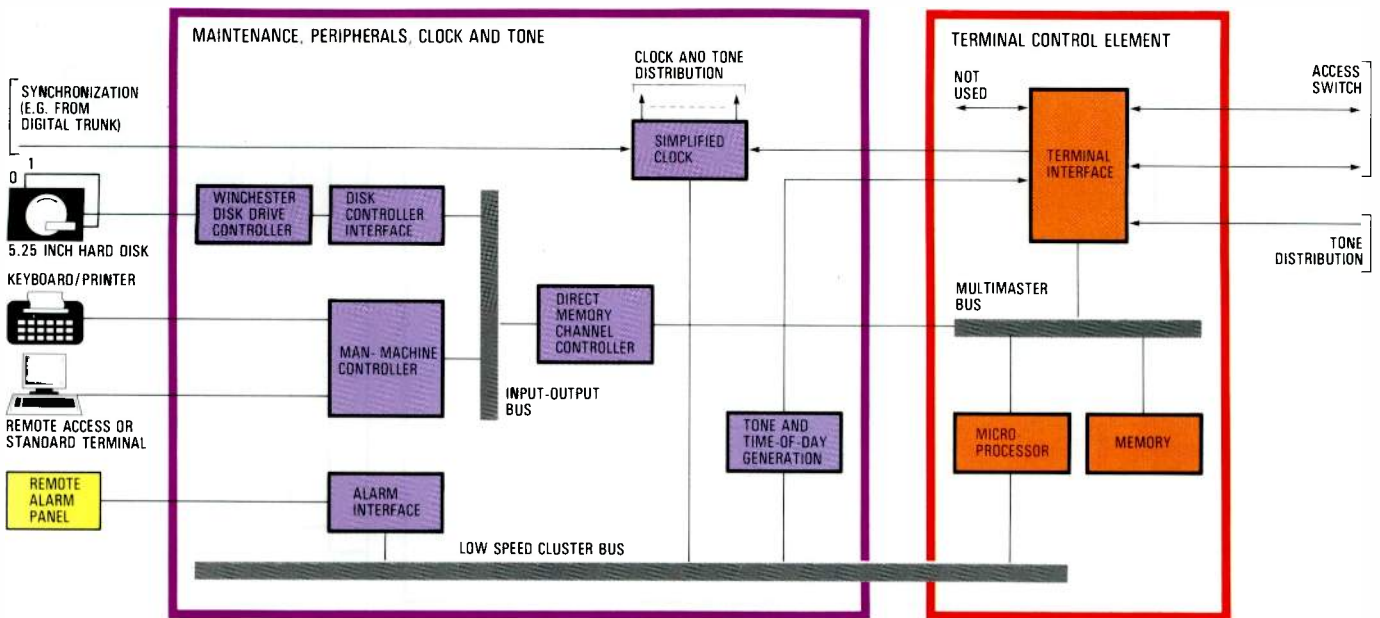

Figure 5
Block schematic of the maintenance, peripherals, clock and tone submodule for the ITT 5630.

- clock, tone, and time-of-day generation
- alarm reporting, including control of the remote alarm panel.

All these functions are controlled by a single microprocessor with a 2 Mbyte dynamic RAM and a terminal interface to connect the maintenance, peripherals, clock and tone submodule to the digital switching network (Figure 5).

Software Structure

The modular software concept ensures transparency, reliability, future expansion capability, and maintainability. The advanced System 12 software structuring techniques are used, including finite message machines, virtual machines, and generic interfaces. In addition, full use has been made of the flexible System 12 software tool set which supports structured programming (e.g. high level language) and provides extensive test facilities.

These sophisticated software techniques require abundant control capacity. Consequently the ITT 5630 BCS application software uses all the facilities of the system virtual machine which consists of the fully distributed System 12 software architecture and the underlying generic system software kernel.

Generic System Software Kernel

The use of mixed telephonic submodules, the application of an on-board controller with its associated interface, and the

inclusion of an Intel 80286 based control element required minor modifications to key software modules in common system kernel areas, such as the operating system, network handler, and database management system currently used in System 12.

Internal Communication

Communication between terminals and the controlling telephonic device handlers is via packets on channel 16. This packet-based internal cluster communication via the PCM system is the key to handling digital devices. The implication is that all packets must be routed to/from the appropriate terminals. In addition, the cluster side telephonic device handlers must be supported in a similar way to message interchange. Consequently a new software module called the cluster handler has been introduced and coupled to the restructured network handler as part of the replaceable kernel module concept.

Microprocessor Implementation

The requirements for extended addressing and performance are a consequence of the objective of implementing all application programs in a single MFCE in small BCSs, rather than using numerous control elements. There may be a need to address at least 4 Mbytes of on-line memory controlled by one MFCE, and there is a need for improved performance relative to the Intel 8086 based control element.

The Intel 80286 microprocessor was chosen to ensure compatibility, or at least the minimum of generic software kernel and

tool set modifications. No additional improvement in the protection of user dynamic data was necessary. The ITT 5630 BCS software relies on the System 12 protection mechanism. Only the descriptor table based extended addressing capability of the Intel 80286 is used.

CHILL software is unaffected at the source level, but recompilation may be necessary to ensure object code compatibility. Software context is not affected; the same data model and software component description library can be used regardless of the target machine. As a result, many standard System 12 finite message machines can be reused.

In the case of software written in assembler (for a number of modules within the generic software kernel), differences between code written for the 8086 and for the 80286 target machine must be minimized. There is an unconditional restriction on applying 80286 specific instructions. The instruction superset of the

80286 is only used in the bootstrap and loader software, and in a special operating system nucleus module. This module is treated as a replaceable generic software module; it is mainly a collection of primitives for virtual-to-real address translation and deletion of segment descriptions.

All modifications to the database management system source modules are tailored to the handling of a new absolute binary format based on 24-bit addresses. There are requirements for the System 12 standard tool set to support the extended instruction set of the 80286 and its extended addressing mechanism and extended addressing capabilities. The CHILL 2 compiler will be used for 80286 applications; only minor changes were necessary to the code generator part of this tool and to its runtime package. The CHILL 2 compiler will be generic for 8086- and 80286-based applications.

The System 12 standard relocatable assembler will be enhanced to a full 80286 standard relocatable assembler with the capability to handle all 80286 instructions as well as structure templates and operand references to manipulate descriptors during run time. Production tools for generic load and data segments are affected in those areas where they reflect the hardware architecture of the target machine. The major point of concern is to create a 24-bit absolute address for load addresses in the header of the core image record and all types of generic load segment located descriptors. Analog adaptations will be made for the database generator.

In the longer term, more extensive use will be made of the on-board architectural features of the 80286 processor (e.g. task switching and use of call gates).

ITT 5630 BCS Application Software Structure

The ITT 5630 BCS application software is modeled as a hierarchical arrangement of virtual machines (Figure 6). The various subsystems have clearly assigned tasks.

The *signaling subsystem* is supported by the on-board controller, which acts as a slave for all device handlers performing tasks such as line signal generation or line signal interpretation. It only performs device specific telephonic functions, and does not consider the state of the call (e.g. the line circuit signaling software does not reflect an enquiry state of an outgoing trunk call). As a

Cabinet housing an ITT 5630 BCS; it is only 1850 mm high and houses up to six subracks. The equipment practice is the same as used in System 12. The top subrack interfaces with the house wiring and also incorporates the protection circuits.

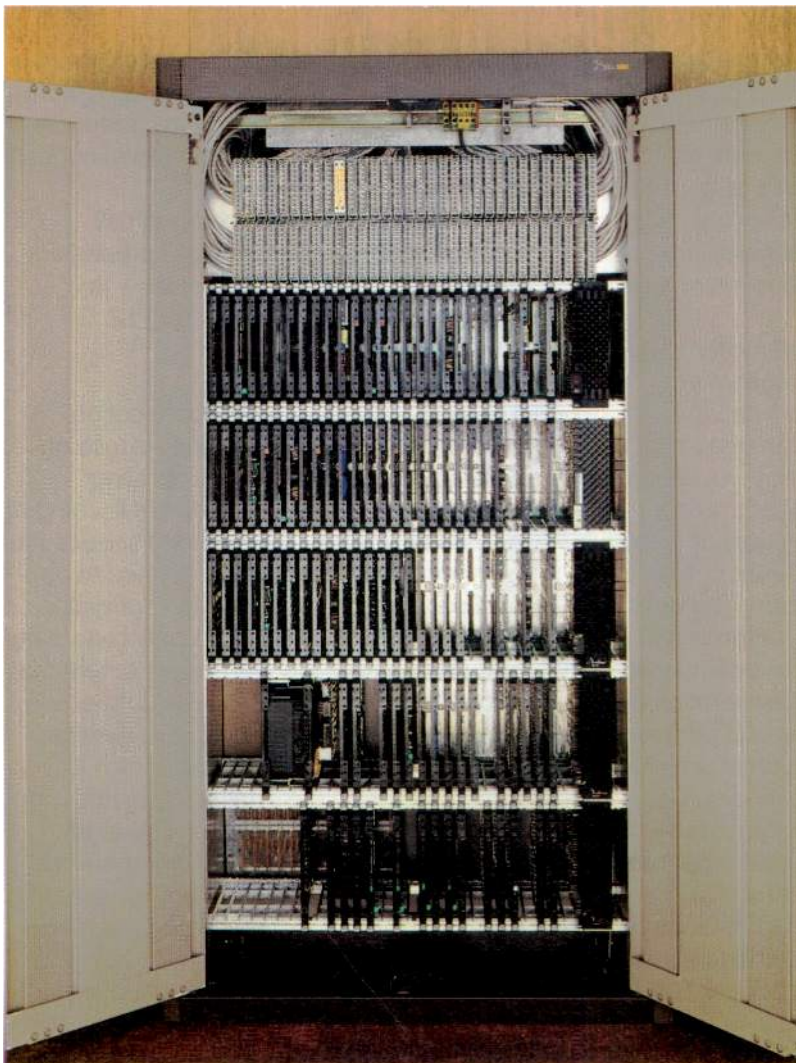
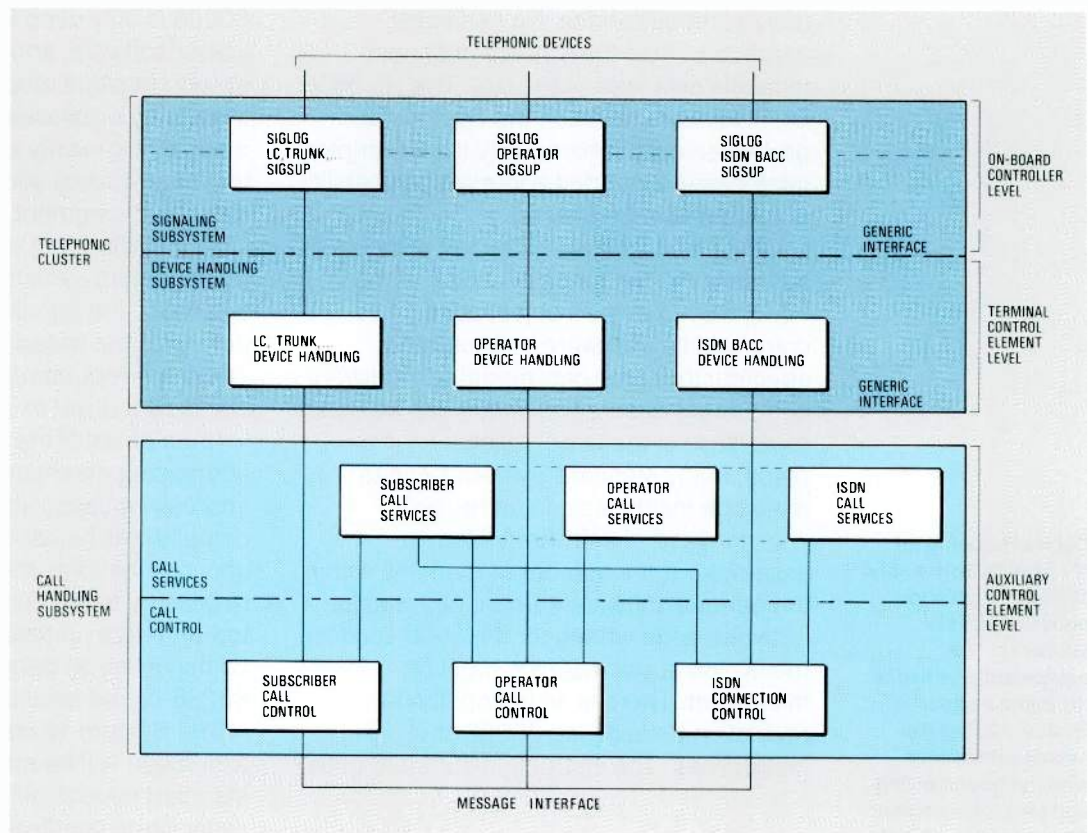

Figure 6
Structure of the application software showing the various building blocks, or subsystems.

- LC** - line circuit
- BACC** - basic access connection control
- SIGLOG** - signaling logic
- SIGSUP** - signaling support.



result, synchronization of signaling and call states is unnecessary. The signaling subsystem has a functional interface only to the device handling subsystem, which consists of signaling events (e.g. on/off hook, digits) and commands (e.g. ringing) for signal generation. The signaling subsystem data model contains no user or exchange variable data.

The *device handling subsystem*, which is located in the TPCE, represents an additional logical level between the signaling subsystem on the one hand, and the call handling subsystem, maintenance and administration control on the other. This subsystem includes all the device handlers necessary to control all classes of device in the mixed telephonic cluster. The device handlers' task is to handle the device specific part of call processing and to deal with maintenance and administration of individual devices or groups of devices.

The *call handling subsystem* is divided into call control and call services. Call control is subdivided into three parts; subscriber call control, operator call control, and ISDN connection control. The differences between these functions do not make it feasible to use a generic approach. However, all call controls access common call services. Call controls include sequence control for the many call setup

and release functions. Call services provide all call related data translations and handle interworking with the telephonic resource manager. They also deal with the major part of the exchange data model.

The principle of partitioning all call controls in three phases — call preparation, call completion, and call release — is basically the same as in System 12.

ISDN Connection Control

The basic part of the ISDN connection control handles the setup and release of calls supporting D-channel signaling functions for transparent circuit switching of non-voice services on B channels. Because eight mixed devices are connected to one basic access, the addressing information used for conventional voice-only calls is no longer sufficient; there is a need for terminal subaddressing. To keep ISDN connection control as generic as possible, a service indicator has been introduced which is transferred from the originating to the terminating basic access handler as an additional parameter for decoding the real terminal address which cannot be identified from the dialed number assigned to the entire basic access.

Compatibility checks are subsequently performed by the device handling subsystem. If the connection is permitted

(e.g. in the case of a peer-to-peer connection), a *service-in-use* message is sent from the basic access handler to the connection control which itself requests call services to store this status in the database. A later invocation of an incompatible service is canceled by evaluating the service-in-use parameter. All connections to protocol converters, integrated store-and-forward subsystems, gateway links, data editing and browsing functions, and so on, are established by the ISDN connection control.

Conclusions

The ITT 5630 BCS is a powerful digital PABX which uses intelligent peripheral units in a flexible, modular architecture to cover the full size range from 60 to 10000 extension lines.

The architecture, which is based on the proven software and hardware used for the System 12 Digital Exchange, allows the

ITT 5630 BCS to evolve from a sophisticated voice system into an office communication center capable of handling a wide range of voice services and ISDN services.

Bibliography

- 1 M. Langenbach-Belz, A. Melis, and H. Verhille: ITT 1240 Digital Exchange: An Introduction: *Electrical Communication*, 1981, volume 56, no 2/3, pp 114–125.
- 2 J. M. Cotton, K. Giesken, A. Lawrence, and D. C. Upp: ITT 1240 Digital Exchange: Digital Switching Network: *Electrical Communication*, 1981, volume 56, no 2/3, pp 148–160.
- 3 S. Das, K. Strunk, and F. Verstraete: ITT 1240 Digital Exchange: Hardware Description: *Electrical Communication*, 1981, volume 56, no 2/3, pp 135–147.
- 4 L. Katschner and F. Van den Brande: ITT 1240 Digital Exchange: Software Concepts and Implementation: *Electrical Communication*, 1981, volume 56, no 2/3, pp 173–183.
- 5 H. Schiemann, L. Van Laere, and F. Leysens: ITT 1240 Digital Exchange: Equipment Practice: *Electrical Communication*, 1981, volume 56, no 2/3, pp 283–292.

System 12

Network 2000 Evolution in the United States

Evolution of the North American telecommunication network to a future ISDN will proceed differently from that in Europe as a result of government deregulation and competitive pressures. Also the existing network differs from its European counterpart. The Network 2000 concept based on System 12 offers a logical and economic evolution path that allows US telecommunication users to take advantage of ISDN services before full implementation.

R. E. Pickett

ITT Telecom, Raleigh, United States of America

Introduction

The objectives of the international and North American telecommunication communities are similar – the creation of a compatible multiservice access and transport network to handle mixed voice and data transmission and switching. However, it has become clear that for a number of reasons the implementation of a North American ISDN will include several “pre-ISDN” arrangements and will evolve into a modified ISDN involving many networks that will be provided and controlled separately.

Gradual government deregulation of the telephone industry means that competitive pressures are leading to the introduction of innovative services and systems that will meet the growing user demands for more sophisticated communication facilities. Major corporations and institutions with wide ranging communication needs and sufficient resources to meet them are establishing their own networks to reduce overall costs and tighten control of their communication business. These factors will give the ISDN in the United States a different personality from its international counterpart.

Concurrently with CCITT planning of the ISDN, meetings have been held in the US between carriers, manufacturers, and potential users to consider the different approaches necessary to implement an equivalent service in the US under the existing competitive conditions. Several

years ago it became clear that the competitive services offered and the considerable influence of market demands would result in near-term ISDN-like networks evolving long before an integrated network could be defined or implemented. While the planning bodies in the US telecommunication industry support CCITT efforts to define universal ISDN standards, near-term network configurations and services in the US will not fit the ISDN designation. This modification of the ISDN has been referred to by ITT Telecom as the United States digital network, or USDN.

Network Differences

Of course, each country has differences which may affect implementation of the ISDN or the services that will be provided. In the US these differences significantly affect both the near-term and final configurations of the resulting national networks. One major difference is simply scale and its implications in terms of network distances, routes and translations, and the embedded cost of stored program control (including digital) tandem and local exchanges that are already in place. Most of these exchanges are relatively new and do not have ISDN capability.

The Federal Government has encouraged competition between long haul carriers, and several independent operators are providing efficient circuit-switched and packet-switched services over terrestrial

and satellite networks. Subscriber equipment (e.g. subsets, telex and facsimile equipment) is also highly competitive and the services and features offered vary widely. Local telephone companies are independently owned and obliged by law to provide subscribers with equal access to any carrier or service provider. In addition, major industrial or commercial users have the right to set up and operate their own networks should they deem it advisable for service or economic reasons. There are several federal and industry efforts to establish a standards setting process, but with no single organization to control what is being implemented, a universal ISDN will not evolve in the US.

Network Standards

In the US there is no single standard or agency responsible for setting standards and no means of enforcing compliance with any standards. As the major operator of the long distance network, AT&T publishes guidelines and recommendations which are generally followed by telecommunication companies and manufacturers. However, with competition and deregulation increasing, "standards" which are viewed as constraining development are abrogated. Carriers and service providers, whose success depends on meeting customer needs quickly, will not wait for a standards setting organization to optimize the design parameters or even the network concepts. As in any competitive arena there will be several specialized "niche" providers competing with general purpose networks for portions of the market.

Network Trends

Primarily as a result of Federal deregulation, a growing number of specialized common carriers are offering specific services (e.g. satellite circuits, packet transmission, direct digital services). These carriers are now permitted to bypass the local exchange and terminate their network circuits at the user's premises. To counter this, conventional telephone carriers are offering pre-ISDN arrangements, such as local area data transport and circuit-switched digital capability which can be provided by modifying existing systems. Even digital subscriber loops with less than full ISDN capability are being devised in the interest of early implementation.

In the business environment, local area networks are being implemented with wide variations in protocols, services, and capabilities. Some are expected to interface directly with the nationwide networks.

Local area network signaling primarily uses direct in-band signaling over individual trunks. However, AT&T has implemented an extensive common channel signaling network (based upon CCITT No 6) between most toll-tandem exchanges. More recently the company has begun implementing a digital common channel signaling system (based upon CCITT No 7). Most local exchanges have no common channel signaling capability, although No 6 can be added to many and No 7 is an option on some. Several competitive (i.e. non AT&T) transmission networks have evolved, providing voice and data services. As most of these specialized common carriers have no common channel signaling capability, signaling network compatibility is a problem.

Service Trends

The demands of the business world have instigated many new services which then migrate to the residential subscriber. Conversely, some services (e.g. entertainment, home computers, videotex) have their origins in the residential market and then migrate to the business world. The large increase in data needs is beginning to influence both business and residential subscribers in the use of videotex, teletext, home computer database access, transport services, etc.

Local common channel signaling and the special services it can bring by making the calling party number available on each terminating call are expected to be in growing demand. Custom calling features will become ubiquitous (i.e. available to everyone on a pay-as-you-use basis), and usage is expected to increase. Costs will decrease primarily by eliminating the engineering cost normally associated with providing nonroutine capabilities or circuit parameters (special services). At some stage the demand for services at the cost associated with that level of demand reaches a critical point and the market increases dramatically as a result of decreasing costs, which in turn increases the market demand, and so on. When this happens, an ISDN-like capability must be available or "bypass" entrepreneurs will find other ways of satisfying the demand.

System 12 Local and Tandem Exchanges

While System 12 can meet the requirements of administrations and operating companies worldwide, modules were not designed initially to meet US requirements for local exchanges (e.g. companding, multiplexing) or for toll exchanges (24-channel system). Now, however, the development of modules for these applications is at an advanced stage.

Although both the local and toll applications represent a major part of ITT's Network 2000 product line, introduction is not urgent. Most telephone companies in the US have a virtual moratorium on major capital outlays during the next few years of reorganization, except for revenue producing capabilities or items that reduce costs. Because of this anomaly, a programme has been established to introduce System 12 products to the US before local and toll exchanges are available.

Network 2000

Many of the advanced technology capabilities inherent in the System 12 system design can be used to upgrade existing switching and transmission equipment to avoid wholesale replacement of undepreciated capital equipment. System 12 has several major attributes that make digital adjuncts, as they are called, economically and technically attractive. The use of fully distributed functional processing allows users to start economically with small exchanges and enlarge them incrementally to very large exchanges. The distributed functional nodes can take advantage of centralized administration, maintenance, and operations support. The intelligent digital switching network routes traffic according to intelligence contained in the call data, thereby avoiding demands on external control mechanisms and making it transparent to all types of traffic.

The control structure consists of a combination of software and the hardware on which it runs. In this terminal-oriented control structure each terminal acts as a self-contained functional module that only handles the service for which it was designed. Another advantage is the availability of auxiliary control elements (incorporating a microprocessor and

memory) which can be accessed on demand.

These hardware and software modules are currently being offered in the United States as adjuncts to existing systems to provide new services under ITT's Network 2000 concept.

Digital Adjunct

Most end exchanges in service in the US were designed before present and future needs were evident. Thus, depending somewhat on the design vintage, most systems cannot add the sophisticated capabilities now being dictated by federal laws: customer selection of interexchange carriers (equal access), competition by non-telecommunication services directly to the end user (bypass), or customer demand for sophisticated local data access and transport connections.

Continual revision and retrofitting of existing hardware and software in an attempt to upgrade a switching system designed for conventional local telephone service are difficult to justify economically. This is especially true for analog exchanges.

The digital adjunct concept allows an existing local exchange to continue to provide local switching for conventional analog loops; more sophisticated equipment is installed on an integrated basis (i.e. using the same exchange codes, trunk routing, and line numbering) to provide new services and facilities.

The digital adjunct shares some operational features with the existing exchange, rather than acting as a stand-alone collocated switch. It may be closely coupled (e.g. with the ITT 1210), interfaced at the common channel signaling ports, coupled at a PCM trunk port, or use other system interfaces such as PBX trunks or remote subscriber line concentrator facilities.

Capabilities most logically available with the digital adjunct include:

- business line access services
- common channel signaling
- telemetry
- multitenant services (shared PBX)
- business communication features
- addition of operators and PBX attendants for inward and outward call assistance
- facilities management

- equal access provisions
- enhanced network management.

Many other facilities are inherent in the System 12 digital adjunct approach.

Business Line Access Services

Figure 1 illustrates a host exchange with a Network 2000 business line access service enhancement. Multiservice loops, providing a sophisticated ISDN type service for business customers, are interfaced via System 12 modules which route the traffic type to appropriate networks. Loops may be digital of the 2B + D type, or advanced analog loops with inherent data-over-voice capability. For conventional telephone use these lines are electronically switched to the telephone services port and routed into the host exchange for normal completion. Various exchange architectures are available which may provide common directory number lists, foreign exchange connection, or other features.

Data-only lines are groomed (i.e. isolated and reformed into dedicated trunk groups) by the digital adjunct and routed to the appropriate facilities, facilities management switch, packet network, or other network access point. Figure 1 also shows special service terminations, the assignment of which can be automated by the business line unit. Loop conditioning and facilities testing under software control provide added operational advantages and reduce costs.

Special service lines are connected to the host exchange via the business line access digital cross-connect capability which

enables semipermanent 64 kbit s⁻¹ digital circuits to be interconnected via external commands on an "automated main distribution frame" basis. All special service lines are groomed by the digital adjunct into the appropriate channels from the exchange. Digital adjuncts physically located in an exchange may also terminate a number of remote adjuncts located in high rise buildings, industrial parks, shopping precincts, and so on, serving clusters of business lines.

Of course, as the digital adjunct expands and the need for new conventional analog voice lines diminishes, it will become practical to upgrade the digital adjunct into a full end exchange, providing an effective method for discontinuing expansion of an exchange by the addition of like equipment. This is particularly justified where the existing exchange is of obsolete design, or to avoid adding new extensions to a depreciated system.

Common Channel Signaling Network

Figure 2 illustrates another application of the Network 2000 digital adjunct. Extending common channel signaling to the local exchange level in the US presents a peculiar problem. Since any new common channel signaling arrangement must be optimized for future digital networks, only a CCITT No 7 based system should be considered. Unfortunately, only a very few new local exchanges have a CCITT No 7 option, although many have a CCIS (US version of CCITT No 6) option. Still more have no common channel signaling capability and cannot be provided with one without

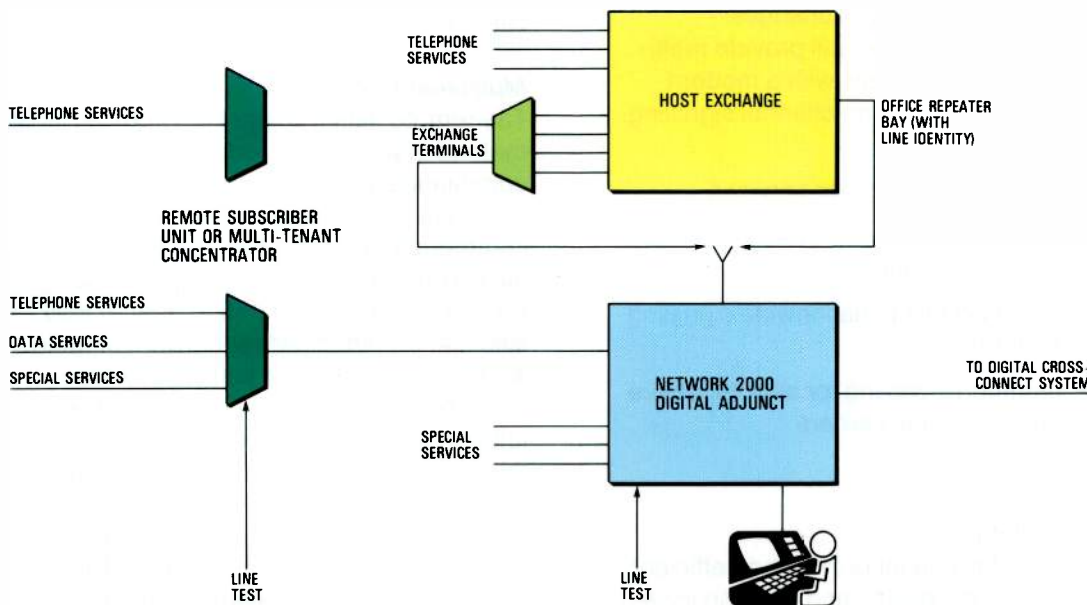

Figure 1
Application of the digital adjunct to provide a Network 2000 business line access service enhancement.

extensive redesign or replacement of major system elements (e.g. the central processor).

By utilizing the Network 2000 digital adjunct with its CCITT No 6 to No 7 conversion capability, a network based upon No 7 signaling becomes economically feasible. Exchanges equipped with No 7 signaling will interface directly with the signaling transfer points; exchanges which can be equipped with No 6 options will interface via a No 6 to No 7 conversion

telemetry data. Figure 3 illustrates such an arrangement in which the telemetry function is bridged onto the cable pair both at the station and at the exchange. Telemetry packets extracted from the loop by the digital adjunct are sent to host computers in CCITT X.25 format. This system collects data required for reading utility meters (e.g. gas, water), "pay-as-you-view" meters for broadcasting services, and media-alert alarm type signaling (i.e. mass response to radio and television advertising and

Figure 2
Use of CCITT No 7 common channel signaling in the US network based on the digital adjunct which offers No 6 to No 7 signaling system conversion.

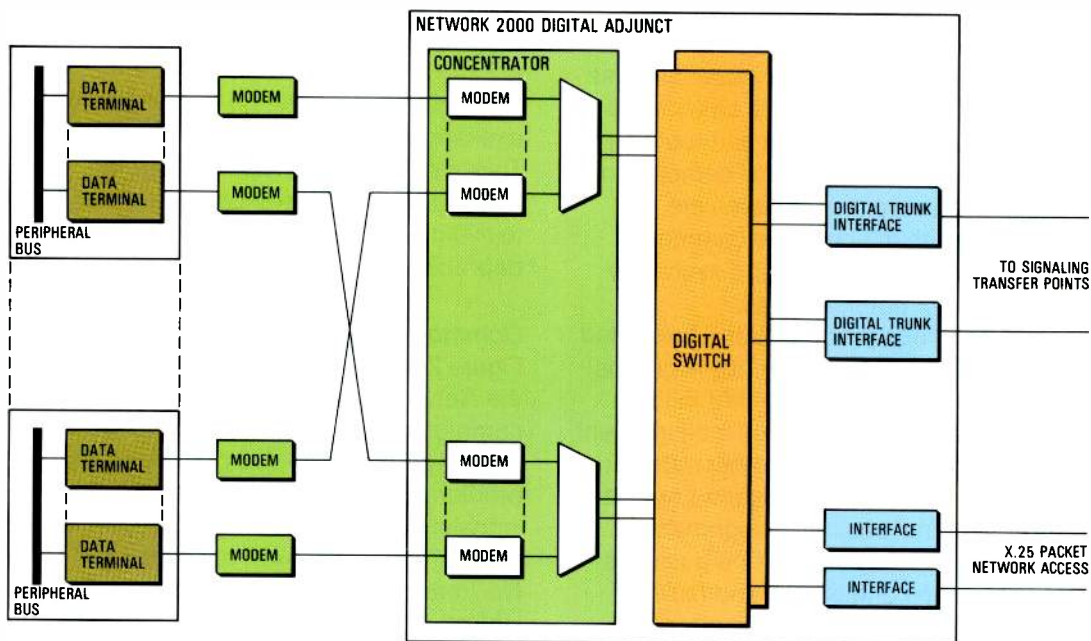

module. All others will utilize limited common channel capabilities, as available. The modular distributed concept of Network 2000 makes it economic to use common channel signaling even in very small or temporary exchanges.

This arrangement will provide multi-exchange local areas with a modern expandable common channel signaling network for:

- local area subscriber services
- improved network signaling to reduce call routing times
- direct access to nationwide signaling features
- common signaling for all competitive interexchange carriers
- packet switching.

Telemetry

The digital adjunct provides an efficient means of accessing and carrying local

announcements). In addition, the system can be used to control power load shedding, and for similar applications. The same system can be used in conjunction with full ISDN digital loops with telemetry data being carried on the D channel.

Multitenant Service

The remote digital adjunct provides an ideal method of providing modern communication service to a multitenant office building, shopping center, or other commercial complex. Figure 4 illustrates such a unit connected to the host exchange via a PCM wire line or optical fiber. It may also feature direct packet network or radio access. The exchange can serve as the traffic control point for a communication teleport (centralized communication terminal providing access to a major city) which offers facilities administration, bandwidth allocation, route selection, network administration, and so on. The implementation of common channel

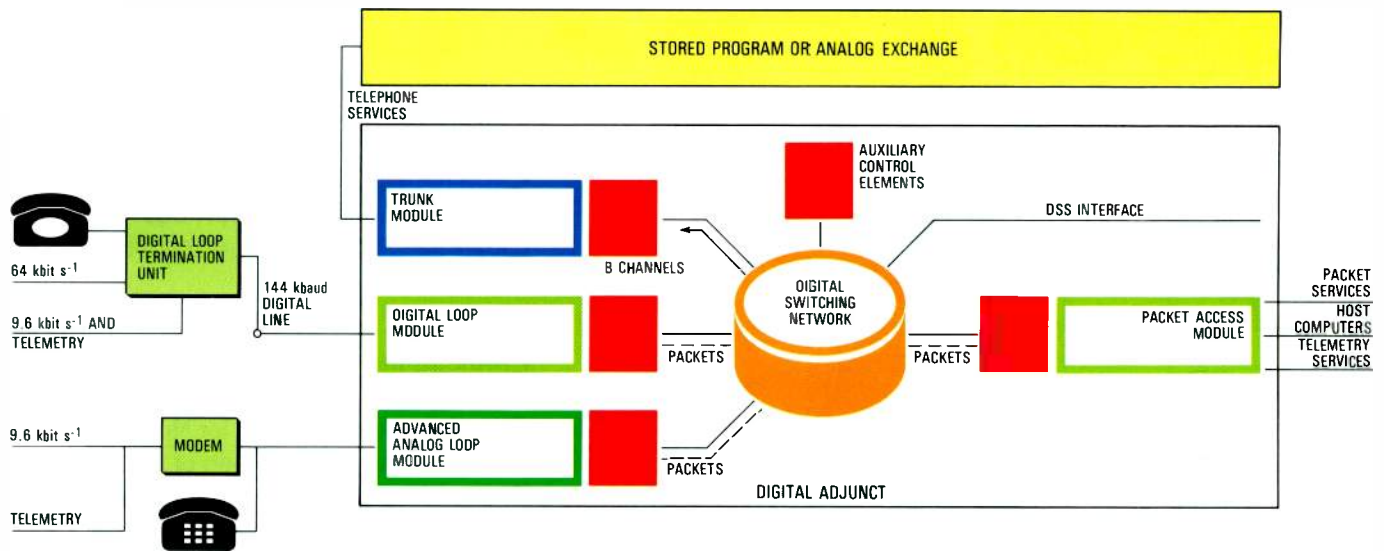

Figure 3
Access to and transport of local telemetry data using the Network 2000 digital adjunct.

signaling gives it advantages over small specialized exchanges in terms of signaling efficiency, response time, reliability, and maintenance.

Local multiservice loops can serve existing PBX trunk terminations, providing enhanced data capabilities. Because data circuits can address each other in a full packet network configuration, a local area network can be configured using conventional twisted pair "house" wiring in combination with PBX voice and data facilities.

Business Communication

In the US there is considerable turmoil and uncertainty concerning regulatory restrictions, tariffs, and operating responsibilities for providing business services (i.e. centrex, PBXs, keysets).

Special purpose local area networks are being deployed with virtually no agreement on an interconnection protocol. Various exchange bypass schemes are being implemented, and voice and data PBXs and other devices are becoming available with no unified long-term plan.

Figure 5 illustrates how the Network 2000 digital adjunct can be applied to this problem. The flexibility of the System 12 architecture allows current implementation with the minimum risk of obsolescence or need for major reconfiguration or retrofitting.

Economics

No matter how attractive it may seem to add modern capabilities to a network by sophisticated digital adjuncts, the final

Figure 4
Implementation of modern communication services in a multitenant business environment based on the digital adjunct concept.

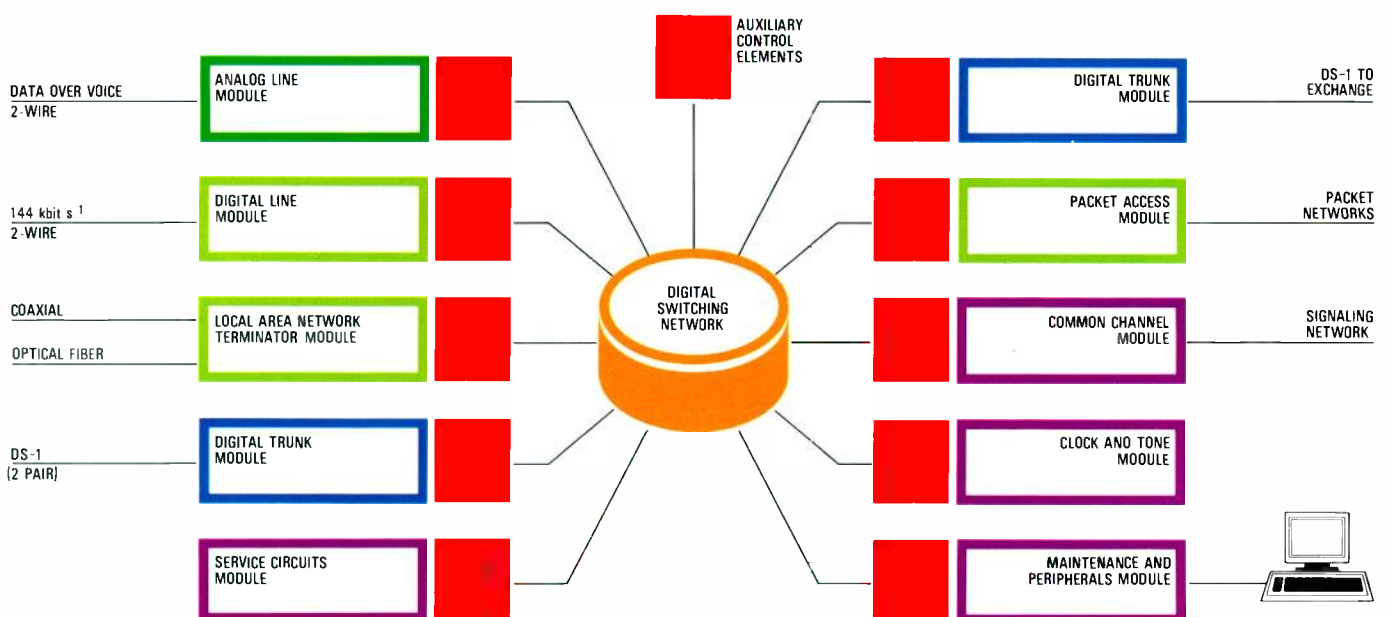

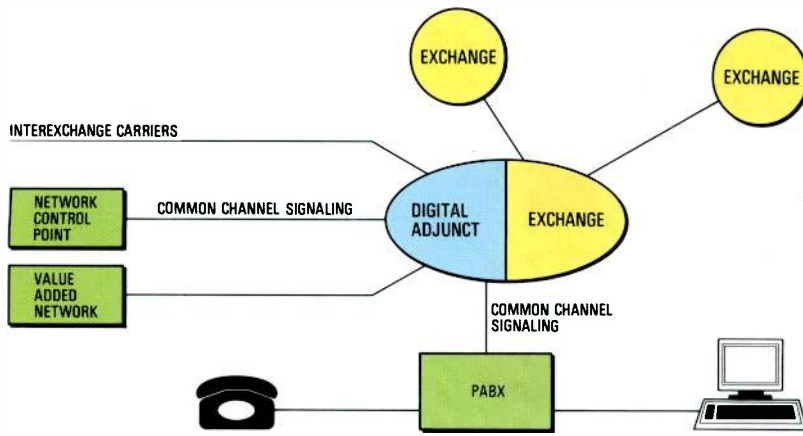

Figure 5
Realization of a comprehensive business communication system utilizing the digital adjunct.

decision will be determined by economic considerations. When compared with modification of an existing exchange for a single specific capability, the digital adjunct may not always show a first cost advantage. However, adding the Network 2000 digital adjunct is an investment in the future and an insurance against repeated retrofitting in the existing system. It removes the risk from long term network changes, technology advances, and service demands, while offering a pronounced

reduction in the overall lifecycle cost of ownership.

The digital adjunct approach is very attractive economically when adequate consideration is given to lifecycle costs, future network requirements, economics of optimum routing, future services capabilities, and exchange "capping" strategy.

Conclusions

The implementation plan for Network 2000 and the orderly introduction of the System 12 product line are dictated by the current industry environment, the customers' and telecommunication companies' needs, and the availability of US adaptations.

The inherent characteristics of the System 12 architecture ensure that it is equally logical to begin implementation of an advanced system from either the local exchange or the network side. In the US, ITT has chosen to start with network implementation, followed by switching exchanges.

System 12

Role of the Digital Adjunct in Network Enhancement

During the long transition to a future ISDN, network economics will make it essential to make the maximum use of existing analog plant. The digital adjunct concept in which new services are provided by an advanced switching system associated with an existing analog exchange allows this objective to be achieved, and enables new services to be tried out without major new investment.

J. E. Cox

ITT Advanced Technology Center, Shelton,
Connecticut, United States of America

R. E. Pickett

ITT Telecommunications Corporation,
Raleigh, North Carolina,
United States of America

Introduction

In most countries of the world there is a large investment in undepreciated communication network plant which will require various degrees of modification before it can become part of a future ISDN. Replacement of this plant is economically out of the question even for the most affluent countries. Thus telephone administrations and operating companies are choosing ways of upgrading existing plant, and deciding which parts should be replaced within their budgetary constraints.

At the same time administrations and operating companies are experiencing pressure from users to introduce new services. Some of this service demand could be turned into near-term revenue if interim solutions were to be employed. The extra revenue earned would then help to pay for new ISDN plant. While there is a risk that interim solutions could be incompatible with future standards, the time that is necessary to agree on worldwide standards increases the potential investment in such solutions. However, administrations cannot be sure that interim solutions and modifications to existing plant will be compatible with future standards when they are promulgated.

In some parts of the world, notably the United States, competition and the threat of

total bypassing of traditional communication networks (e.g. using networks intended initially for entertainment) place strong pressures on telephone companies to develop attractive new services using existing plant (i.e. interim solutions).

Against this background, telephone administrations and operating companies are seeking compromise solutions whereby a reasonably safe investment can be made now to generate near-term revenue by satisfying some of the unmet demands of business subscribers without creating further pressures from residential subscribers. Digital adjuncts to the analog plant based on advanced digital switching systems such as System 12, can ameliorate these difficult planning decisions.

Background

To meet the future requirements of truly integrated service networks, local network nodal points, including local exchanges, must offer the features shown in Figure 1. Within a given node, administrations have a wide choice as to how services are to be switched and administered.

ITT's Network 2000 concept has been designed to provide comprehensive switching, administration, and maintenance facilities for all the services shown in

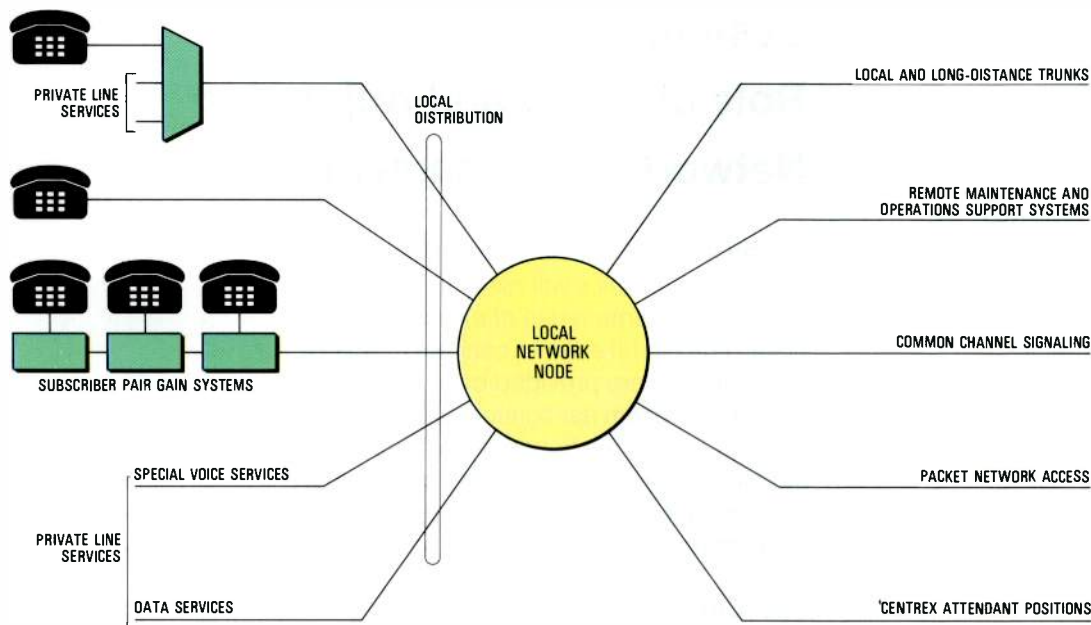

Figure 1
Service attributes of
the local network
node.

Figure 1. The ability of System 12 to act as a multiservice network node has been designed into the architecture by developing traffic serving units for each service and providing a nonblocking switch to interconnect them. Using this approach, the System 12 architecture permits individual services or a range of services to be provided economically even by small installations, thus allowing new services to be introduced without the large investment that would be necessary with common control switching equipment.

Except where a new network is being introduced, exchange equipment, line, and trunk plant is already in place for existing services. Administrations may elect to implement new services on completely separate facilities, or two or more services may be provided by a single exchange. Irrespective of the exchange type, economics tend to force *all* services to use existing subscriber line plant. Hence the integrated use of line plant has become a major focus of ISDN. Economic analyses also point strongly in favor of common utilization of trunk plant, although the penalties associated with using separate trunk bundles are not as great as those for using separate line plant for each service.

Systems designed to switch many types of service (with different holding times, traffic profiles, calling rates, and features) should preferably have a modular distributed control architecture that allows the range of features, traffic parameters, and exchange size (numbers of lines and trunks) to be chosen independently for the

application. In the case of exchange architectures based on a central processor, all three variables depend on common resources such as processor throughput, memory, and switch capacity.

Independence of these variables in distributed control architectures allows planning engineers to add near-term service enhancements without the risk that future undefined service changes will invalidate the economics of the initial plans.

A second valuable attribute of distributed control switching architectures is that they allow a small exchange to be installed initially and then grow smoothly to a large size, if required. This extension range is much greater than the typical range provided by central control systems. The ability to grow (and shrink) economically, should forecasts prove inaccurate, provides an additional degree of assurance to the planner.

Digital Adjuncts

The term "digital adjunct" describes a device or collection of devices which add to the capability of an existing network entity (such as a telephone exchange) in such a way that it appears to the outside world as an enhancement to that exchange.

Using this narrow definition, a device which could terminate a digital loop on an analog host exchange would be within the definition of a digital adjunct. The problem with this approach is that it can only implement services that can be provided by

the analog host. Generally this restriction will limit the digital loop to some form of telephone service, thus eliminating the possibility of raising new revenue from data services. Also, when the analog host exchange is replaced, any investment in this type of digital adjunct is discarded.

To be of practical use, a digital adjunct must offer the planner all the following facilities:

- ability to terminate existing services on a host exchange at an acceptable increase in cost per line
- revenue generation from new services while continuing to support existing services on the host exchange
- introduction of new services with a small initial investment
- smooth growth in small increments over a wide size range
- multiservice capability
- reuse of equipment when the time comes to retire the host exchange from service
- operation as an adjunct to the host for some lines and as a host in its own right to other lines
- operation as a remote switching device to extend the power and range of the host (e.g. to serve a number of tenants in high rise buildings and industrial estates).

The Network 2000 digital adjunct takes advantage of the System 12 distributed control switching architecture to meet these requirements. When acting as an adjunct it is invisible to the network because it appears to be part of the host exchange. However, by assigning a network office code to the adjunct in the numbering plan, the adjunct becomes a stand-alone network node colocated with the host. At the same time, the adjunct can continue to connect some lines to the host to receive call processing under the host's office code. This is important as it avoids unnecessary directory number changes.

Figure 2 shows the architectural implementation of the digital adjunct principle in Network 2000. The basic digital adjunct always consists of a kernel which includes a minimal switching network, clock and tone distribution, power, and alarms. The operations and maintenance user part of the CCITT No 7 common channel signaling system is used for communication with remote maintenance and administration centers. Modular service

terminations can be added to this kernel and the switching network expanded to provide the terminations, processing power, and features required by the offered services.

Typical Nodal Point Enhancements

The digital adjunct concept can be applied simultaneously to revenue enhancement and cost reduction. Figure 3 shows the concept applied to revenue enhancement of an existing analog SPC (stored program control) telephone exchange. Revenue growth can be achieved by adding new types of line terminating devices (local and remote) that provide integrated digital services over the existing loops. As lines on the analog SPC switch (usually business lines) are transferred to terminations on the adjunct, they free terminations on the host to meet residential growth.

The exchange interface connection between the digital adjunct and the analog SPC exchange allows the transferred business lines to continue to receive their telephone services from the analog SPC host. At the same time, non-voice traffic (e.g. packet data, facsimile) carried on the loop is switched by the adjunct to the appropriate digital channels for private lines and/or access to overlay packet networks. Figure 3 shows this kind of revenue growth. The common channel signaling unit provides access to the CCITT No 7 common channel user parts, such as the ISDN user part, operations and maintenance user part, billing user part, and signaling connection control part.

Figure 2
Implementation of a digital adjunct based on the Network 2000 concept.

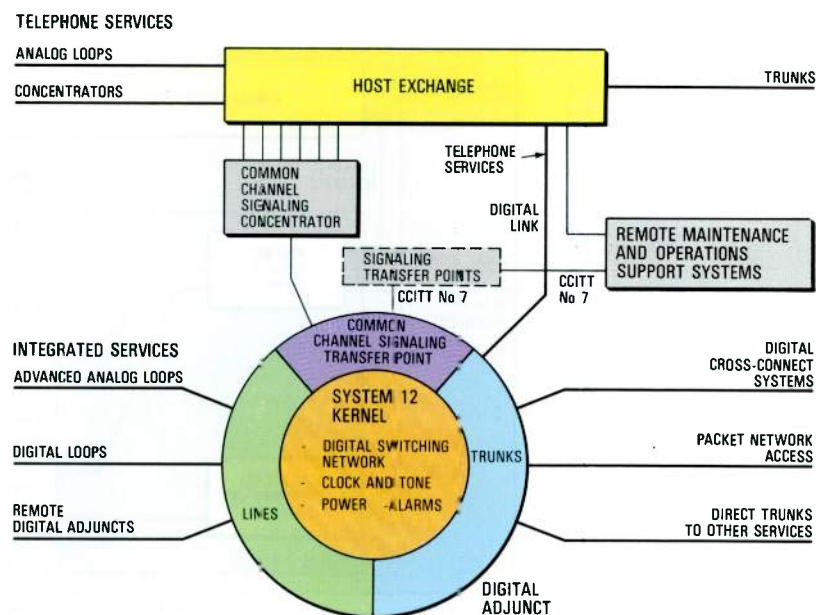

A second method of revenue growth, which is more applicable to residential lines, is to add functionality to the analog lines that remain connected to the analog SPC exchange. This is shown in Figure 3 by the local access communication system connections to existing analog loops. In this way a low duty cycle, packetized data service can be supplied to residential subscribers over existing wire loops. Residential data services of this type allow for periodic polling and pick-up of short data packets (e.g. scheduled polling four times per hour plus on demand polling within one minute of the request). The packets are then formatted into CCITT X.25 or CCITT No 7 user part packets for transmission to host computers via packet switching networks.

A two-way data service is possible by depositing a packet on the subscriber line during the polling sequence. Thus the digital adjunct can bring new service functions to all lines served by the host exchange. The packet service unit and the common channel unit also play their parts in this type of revenue enhancement.

Figure 3 also shows the extension of these revenue growth concepts to subscribers that are distant from the exchange or where they are in large enough clusters to warrant the use of multiplexed digital transmission to the main exchange. These are referred to in Figure 3 as carrier serving areas. In addition to serving existing pair gain carrier systems, the digital adjunct may act as a transmission hub to similar adjuncts placed at or close to subscriber

premises (e.g. to serve multiple tenants in an office complex).

Looking to the future, economical terminations combining low bit rate voice (32 kbit s^{-1} or 48 kbit s^{-1}) and a standard ISDN D channel within a 56 or 64 kbit s^{-1} envelope will provide another potential source of new revenue. Functions of the digital adjunct include directing the voice and data channels to their desired destinations, and conversion from low bit rate to full rate PCM channels when desired.

The implementation of a digital adjunct using ITT System 12 technology is depicted in Figure 4. The simplest application of such an adjunct employs only digital trunk modules, auxiliary control elements, and the common channel module for CCITT No 7 signaling. The common channel module provides for remote control and maintenance of the adjunct in addition to performing a limited (up to seven ports, duplicated) signal transfer point function for associated channel signaling, ISDN user part transport, and packet switching access to remote databases.

The digital trunks are used to segregate and collect the individual channels between the subscriber pair gain remote and central exchange terminals, and allow for administration and processing of non-switched (dedicated) channels without manual intervention. This "electronic mainframe" or cross-connect device function also permits sophisticated remote maintenance and diagnostics of existing subscriber pair gain terminals, thereby lowering the cost of ownership.

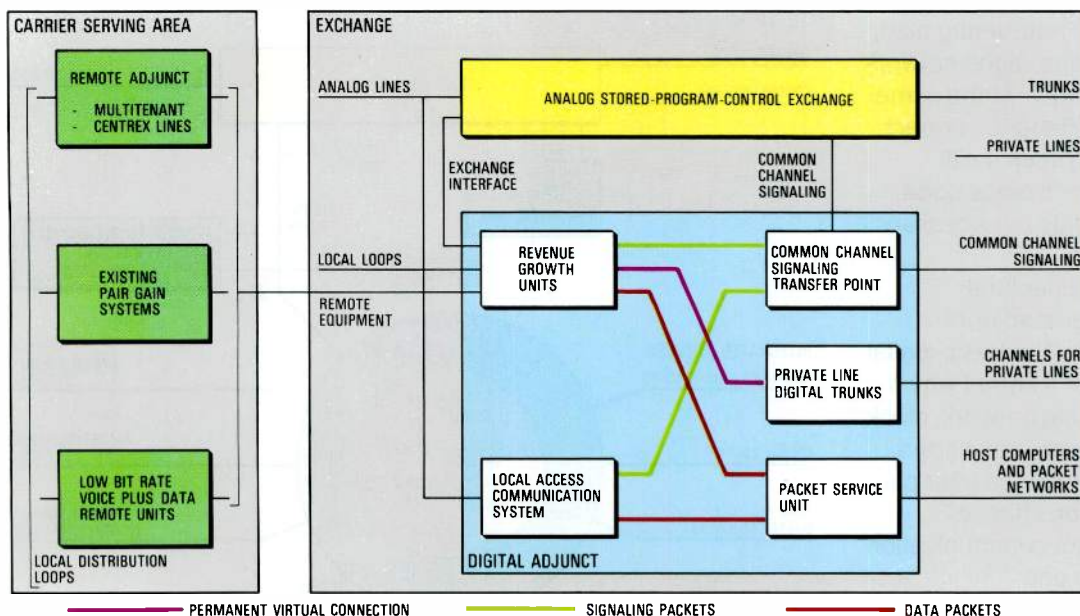

Figure 3
Application of a digital adjunct to an existing analog SPC exchange illustrating the possibilities for revenue enhancement.

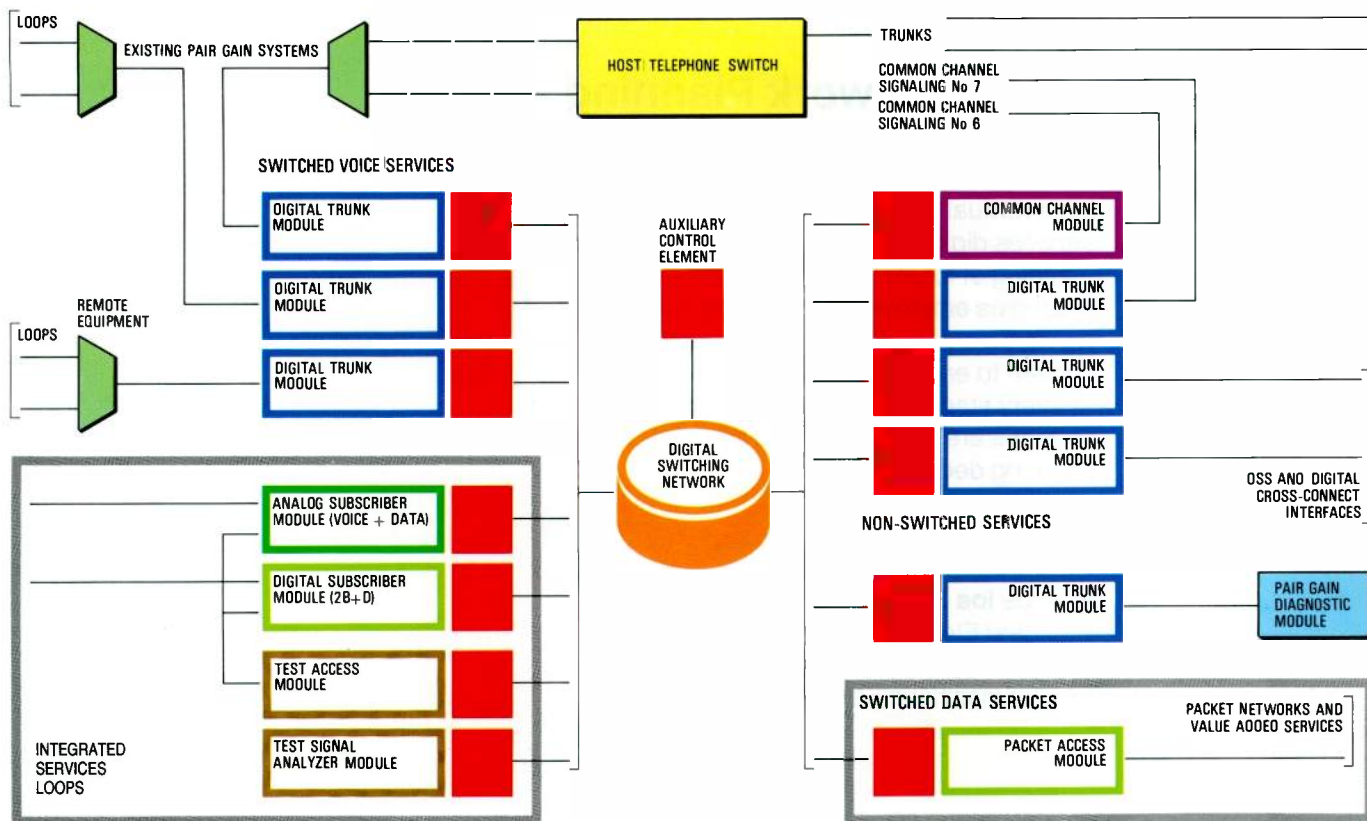

Figure 4
Implementation of a digital adjunct based on standard System 12 modules.
 OSS - operations support systems.

This simple application can be expanded by adding advanced digital (ISDN) and analog (voice plus data over voice) line circuit modules as shown in Figure 4. Packet access modules can also be added to route the data channels to packet switching networks.

The digital adjunct uses the same hardware modules as are used in System 12 (e.g. the same digital trunk modules and control elements). Thus such an adjunct may be readily expanded into a replacement for the analog SPC exchange. However, by then the presence of the digital adjunct has extended the useful life of the analog exchange as a result of offering new

services to subscribers that need them, while ensuring that subscribers needing only the telephone service continue to receive a low cost, high quality service.

Conclusions

There is a need for gradual transition to a future ISDN. The digital adjunct concept, based on a modular distributed control digital exchange architecture, makes it possible to start up new services very economically without extensive modification or premature retirement of useful analog plant.

System 12

Digital Network Planning

Digitization of the telephone network and the eventual evolution to an integrated services digital network are reflected in the planning of future telephone networks. The strategies employed in extending such networks and adding new features must be chosen to ensure that costs are minimized at every stage, and that future network changes are not constrained by today's planning decisions.

P. A. Caballero

F. J. de los Rios

Standard Eléctrica SA, Madrid, Spain

F. Casali

FACE Finanziaria SpA, Milan, Italy

Introduction

Telephone networks are subject to continuous change as they are extended to meet increased demand and as new equipment replaces old to improve performance and provide new features.

The multiplicity of network design solutions and the high investment involved make it necessary to ensure that any plan for network extension or improvement offers an optimal solution. The long life of telephone equipment and the constraints imposed by the existing network oblige planners to verify the correctness of today's decisions based on the medium- and long-term consequences.

System 12 and Network Planning

Essentially the objective of network planning is to determine the optimum evolution of the network for a given type of equipment. Looking at the problem from another angle leads to the question: what characteristics should the equipment have if it is to allow optimum network evolution? This viewpoint has been central to the development of System 12 which was designed as an integral network element.

From the earliest days of System 12, network planning studies were carried out

in parallel to the design work^{1 to 4}. Results were passed on to the development teams to enable them to assess how well the design was achieving its network objectives. The outcome was the unique System 12 distributed control architecture which allows optimal network evolution towards an integrated digital network, and subsequently to an ISDN.

The major requirements that the network planning studies imposed on the design were:

- decisions taken today must constrain tomorrow's actions as little as possible
- errors that are inherent in all forecasting should have minimal effect and not lead to major economic penalties
- single system for all applications – local, toll, and rural
- system should cover the full range of needs with an installed cost that increases linearly with capacity
- system modularity allowing equipment installation to be closely related to actual network needs
- system architecture suitable for any existing network environment without changes to the existing structure.

The System 12 Digital Exchange achieves all these objectives.

Evolution Towards the Integrated Digital Network

The introduction of digital systems means new planning aspects must be considered. Three are particularly important:

Optimal digital network structure: Digital equipment is characterized by performance and cost parameters that differ from those of analog equipment, so the optimal structure of a digital network will also differ.

Analog to digital transition: Existing networks are based primarily on analog technology, although in a few cases the first steps have been taken towards digitization. However, both technologies will coexist in the network for a long time, during which optimal design of the mixed analog/digital network will involve the interconnection of both subnetworks.

Introduction of non-voice-services: This will probably overlap the introduction of an integrated digital network. The suitability of digital switches and plant facilities to operate in an ISDN is of primary importance for the future of a public telephone network^{5, 6}.

The first two of these planning problems are analyzed separately for multi-exchange urban networks, long distance networks, and rural networks as each has its own characteristics.

Multi-exchange Urban Networks

Traditionally three aspects of multi-exchange networks have been distinguished during planning: determination of the optimal basic configuration (Figure 1), optimization of the junction network, and optimal design of the subscriber network.

Optimal Basic Configuration

This configuration is achieved by defining the number of terminal exchanges, their locations, and their service areas so as to minimize the cost of expanding the network to meet the forecast demand⁷. The main factors are the subscriber and junction networks, power supply equipment, exchange buildings, and land requirements. The subscriber network favors increasing the number of buildings; the other factors favor decreasing the number.

The introduction of an integrated digital network leads to a much wider range of exchange capacities, lower building space

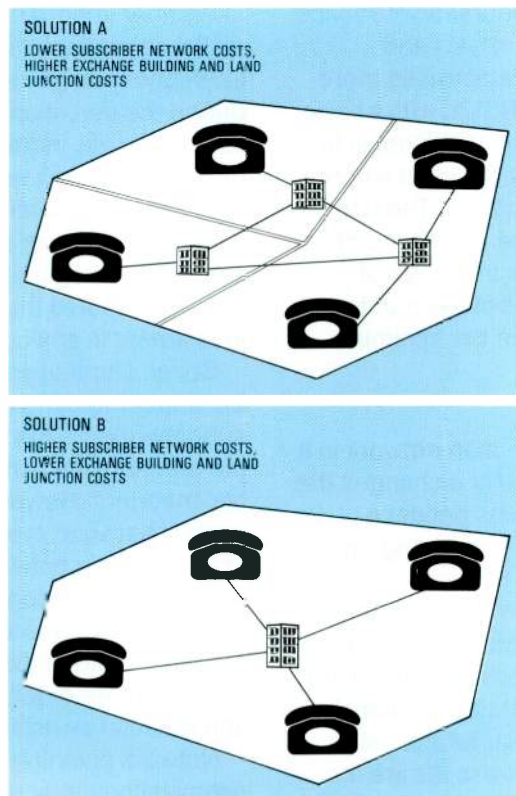
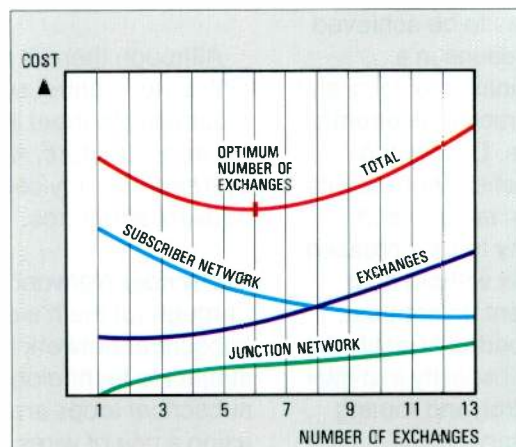

Figure 1
Urban network configuration.

requirements, junction network savings, and different cost parameters. The combined effect of these factors, together with the influences of the existing network, switching systems, and buildings, and the rate of growth of demand, varies from case to case. The general tendency is to reduce the need for new buildings and exchanges (Figure 2).

Remote subscriber units (RSUs) may affect the optimal network configuration. The role of these units depends on their size. Large RSUs (concentrators with 1000 lines or more) can be used to replace independent exchanges when an inadequate system architecture imposes high "getting started" costs. Their use



generally affects the configuration of service areas and makes traffic analysis and planning and maintenance activities more difficult. The role of small RSUs, with a basic module capacity of around 100 lines, is to reduce the cost of subscriber plant when connecting distant subscribers. The use of these small RSUs cuts the optimal number of exchanges and flattens the curve of network cost as a function of the number of exchanges in the region of the minimum.

Junction Network

Digitization affects the junction network in a number of ways. In particular it changes the cost parameter relationships between tandem and direct routes depending on whether the terminal and tandem exchanges are analog or digital, and on the penetration of digital transmission. Figure 3 illustrates the four cases normally found in a mixed network. It shows that the optimal transit capacities are similar for the "all analog" and "all digital" areas, as are the cost parameter relationships. However, the mixed case calls for higher transit exchange capacities as it corresponds to smaller values of the cost relationship⁸. Thus it is important to study the evolution of transit requirements during the transition period rather than base the transit capacities on short-term needs.

Modularity of the digital junctors and the use of bothway junctors⁹ must also be considered. Modularity restricts the sizes of routes to multiples of 30 (or 24) circuits when the network is being optimized. This is important because the size of the module corresponds to traffic capacities of the same order of magnitude as many traffic flows in a multi-exchange area. The use of bothway junctors alleviates the effect of this rigid modularity, and makes it possible to split the channels in the module between the two directions.

The wider range of capacities of digital systems allows economies to be achieved by combining several functions in a switching unit. The combination of local and tandem functions is of particular economic interest in urban networks. Distributed control is particularly beneficial because its incremental growth allows tandem and terminal switching capacity to be increased to achieve any desired mix without cost penalties for rearrangement. In contrast, high traffic volumes are needed to justify the addition of new switching capacity in digital systems with central control, and routing changes could be necessary.

Another important factor is that analog/digital converters will be required to interconnect digital and analog exchanges during the transition period. The number of converters will increase in the early stages of digitization, but will decline as digital exchanges predominate, and then disappear when an all digital network is achieved. An optimal plan for network evolution should therefore reduce investment in analog/digital conversion.

Several strategies have been proposed for interconnecting digital and analog subnetworks¹⁰. The overlay strategy has the primary goal of minimizing the number of converters. However, it pays an important penalty because it requires transit switching of all the traffic between analog and digital subnetworks. In contrast the integration of subnetworks leads to a better distribution of resources during the transition period, but requires more detailed network planning and modular switching systems.

Network planning studies show that an optimization study should be carried out specifically for each mixed network, and that the optimum solution will not, in general, correspond to any pure typical strategy. Severe penalties may be incurred if a dogmatic strategy is used irrespective of the characteristics of a particular case.

Figure 3
Junction network cost analysis.

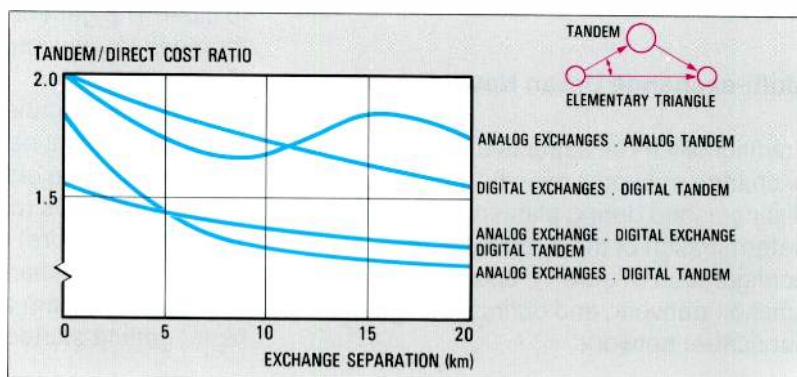

Although there is no universal solution, distributed control systems can pragmatically meet any case-related optimal network structure, whereas central control systems are only cost-effective in overlay network structures.

Subscriber Network

Throughout the history of telephony, the subscriber network has been the area least subject to technological advances. Most subscriber loops are voice frequency loops using a pair of wires as in the early years of

telephony. Now, however, digitization is changing the concept of subscriber plant.

Digital RSUs carry traffic from connected subscribers over PCM transmission systems to the exchange, thereby reducing the cost of subscriber plant. Small RSUs bring digitization closer to the subscriber. The resulting shorter subscriber loops simplify the subscriber network and, therefore, its engineering, maintenance, and operation. These considerations illustrate the attractiveness of the small RSU solution. Nevertheless, the maximum benefit will only be obtained when new methods, criteria, and practices have been established.

Long Distance Network

In analog networks, limitations on exchange switching capacity frequently make it necessary for two or more exchanges to work in parallel, thereby duplicating routes, doubling switching equipment, and so on. One of the most significant factors in digitizing the long distance network is the high switching capacities of advanced digital systems which allow the network to be simplified. Moreover, in principle there is no restriction on combining several functions (primary, secondary, etc) in a single unit, something which may imply a significant economy.

A second aspect is how digitization affects the optimum structure of the long distance network¹¹. Digitization represents an opportunity to analyze the optimum network structure. Generally, the result is fewer network levels as there is frequently a mismatch between the network structure and traffic demand because the present structure is commonly based on a network which was constrained by the use of direct control switching equipment. In these circumstances, the network structure would need revision even without digitization.

Rural Networks

In rural networks where demand is dispersed and low, the cost per installed line is high. For this reason, such networks include a variety of equipment and technologies designed to reduce this high cost. Early digital systems were unable to provide a single approach to the problem. In contrast, System 12 offers a unification of technology for rural areas and,

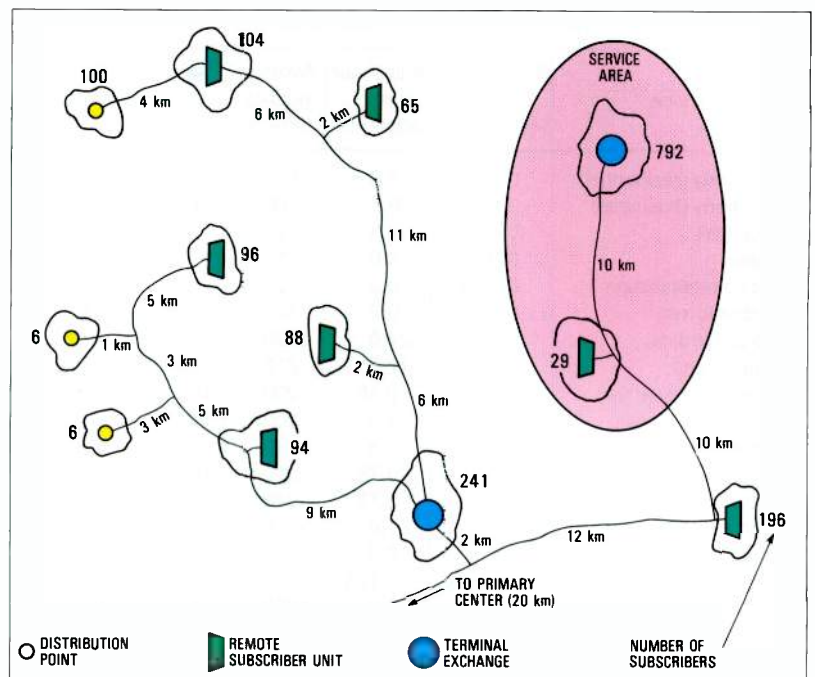

Figure 4
A branch of a primary network.

consequently, a reduction in operations and maintenance costs. In particular, System 12 uses the same elements for the rural network – small exchanges and RSUs – as in urban areas.

System 12 also offers an effective solution for serving small, dispersed groups of subscribers by connecting up to eight RSUs on one path (multidrop configuration). These RSUs share a transmission link (one or two 30-channel PCM systems) to the parent exchange. Figure 4 shows a branch of a primary network.

Switching Equipment Extension

An interesting aspect of digitization is the way in which digital switching equipment should be introduced into a network in which analog switching equipment neither is technically obsolete, nor has reached the end of its service life. This is the case in a network based on stored program control analog exchanges, or even crossbar exchanges. When an exchange requires relief in this situation, the options are:

- extend analog
- freeze analog and install digital equipment to meet the new demand
- replace analog by digital, and meet both existing and new demand with digital equipment.

There are no general rules on which to base such a decision, but extension of an analog exchange is difficult to justify economically

Table 1 – Envisaged traffic parameters for non-voice services

Service	Busy period traffic (erlang/line)	Busy hour call attempts	Average holding time (s)	Trans per call	Average trans holding time (s)
Telephony (residential)	0.10	3.0	120	1.0	120
Telephony (business)	0.20	6.7	108	1.0	108
Voice mail	0.01	0.3	120	1.0	120
Teletex	0.01	5.0	50	1.5	33.3
Text communication	0.0006	0.3	20	1.5	13.3
Electronic mail	0.007	0.2	120	1.0	120
Interactive data	0.30	27.0	30	3.0	10
Transactions	0.33	17.0	212	2.5	84.8
Videotex (residential)	0.03	0.45	200	11.5	17.4
Videotex (business)	0.20	3.6	200	11.5	17.4
Facsimile	0.01	0.3	120	1.0	120
Word processing	0.25	3.75	240	12.0	20
Data processing	0.25	3.75	240	12.0	20
Telemetry	2.7×10^{-6}	1.0	0.01	1.0	0.01
Telemedicine (central)	0.4	6.0	240	4.0	60
Telemedicine (peripheral)	0.002	0.125	60	1.0	60
Videoconference	0.5	1.0	1800	1.0	1800
Video games	0.0008	1.0	3	2.5	1.2
Telesurveillance	2.7×10^{-5}	10.0	0.01	1.0	0.01

Trans - transaction

if, during the study period, a digital exchange would have to be installed because the analog exchange has reached its maximum capacity. The decision as to whether to keep an analog exchange in service at its present capacity or to remove it depends primarily on the cost of digital equipment, installed capacity, operations and maintenance costs, and the cost of money.

Evolution to an ISDN

This is the third major problem for today's network planners. The transition from the present analog telephone network to a full ISDN will differ from one country to another¹². The type, speed of introduction, and penetration of new services will depend on a wide variety of factors. One important consideration will be whether these or similar services are already being provided on the telephone or other networks, and how they have been implemented.

In general the transition is expected to take 15 to 20 years so that equipment being installed today will be expected to handle non-voice services during its service life. Thus, the network structures now being proposed must pave the way to an ISDN.

The penetration of non-voice services is expected to increase rapidly (5% of telephone subscribers in 1994 and 40% in 2000 are considered reasonable figures). Although the traffic volumes will not affect

the optimal structure for telephony, they will affect routing and network dimensioning. Possible traffic values and characteristics envisaged for non-voice services are given in Table 1.

The provision of non-voice facilities will require service provisioning centers (videotex, data and word processing) and servers (electronic and voice mail); the siting of these centers could cause traffic imbalances.

If the evolution to an ISDN is not considered during network planning it could severely affect the future provision of services. In the near future when non-voice traffic is very low, an ill-advised choice of switching equipment could lead to a prohibitive cost per switched unit for non-voice traffic, thereby discouraging the introduction of new services. Subsequently, when non-voice traffic becomes important, it might prove impossible to provide the services and meet increased traffic demand – possibly as a result of short sighted routing decisions. This would make it difficult to achieve the goal of an ISDN.

It is important to choose a switching system with a modular processing capacity so that incremental growth can be achieved without software or hardware rearrangement. The advantages of processing modularity are even more evident if optical fiber subscriber loops for wideband ISDN services are likely to be introduced within the next 20 years.

Figure 5 shows the architecture of System 12. Planning for the introduction of non-voice services is considered of prime importance in ITT. An analytical method developed for ISDN planning¹³ has been tested in real networks^{14, 15}.

Computer Planning Aids

The increasing sizes and complexities of telecommunication networks make it imperative to utilize adequate computer-based planning tools such as those developed at the Research Center of Standard Eléctrica. Figure 6 shows the relationship between the planning problems and the main computer tools developed to solve them:

- WIRÉDIG determines the optimal number, locations, and service areas of the exchanges for an urban network in which analog and digital exchanges coexist.

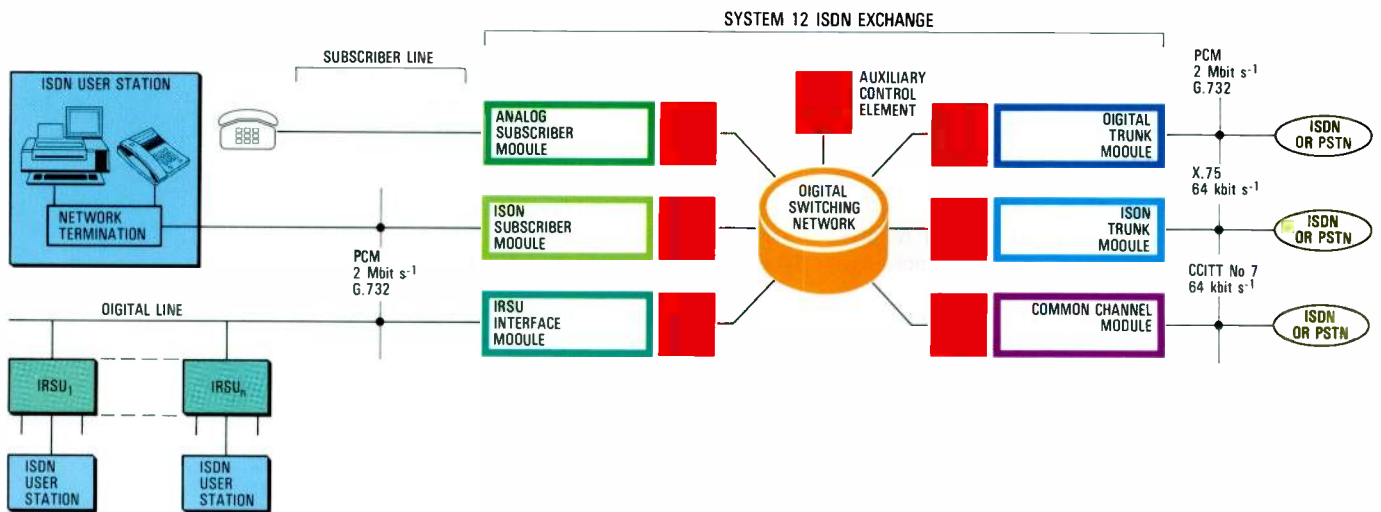
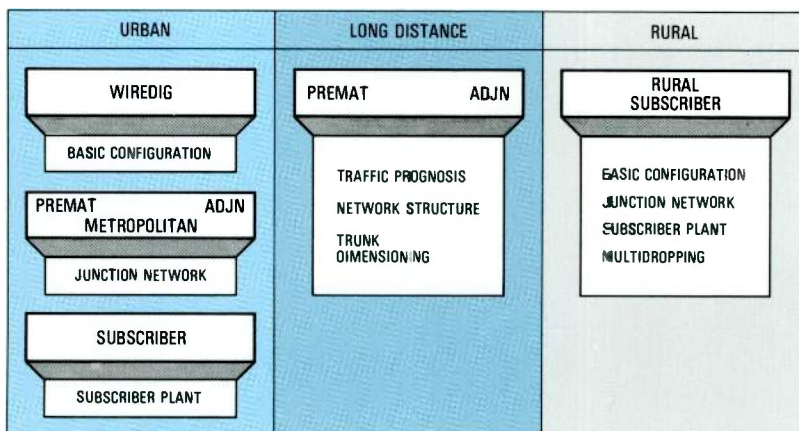

Figure 5
Future oriented architecture of the System 12 Digital Exchange.
 IRSU - ISDN remote subscriber unit

- PREMAT calculates the future traffic matrix between areas based on a forecast of global traffic growth.
- ADJN (analog/digital junction networks) optimizes the route sizes of a junction (or trunk) network based on traffic demand, equipment costs, routing laws, and grade of service.
- METROPOLITAN solves the physical aspects of the junction network including voice frequency and digital transmission on cables. It is being expanded to include fiber optics.
- SUBSCRIBER determines optimal expansion schedules for sections of the subscriber plant including both cables and infrastructures¹⁶.
- RURAL optimizes a rural network in three switching levels (primary center, terminal exchanges, and RSUs). Both switching and transmission are simultaneously optimized¹⁷.

Ancillary programs are available to aid forecasting, cost parameter calculations, network costing, and so on.

Figure 6
Computer aids developed at the Standard Eléctrica Research Center to help in network planning



All the above programs are specific in the sense that they treat a particular planning problem, but are generic in the sense that they can be used in every environment of equipment types, administration policies, or network strategies. The environment, including restrictions imposed by the existing network, is easily specified to the computer programs through specific input data.

Conclusions

Rapid technological evolution is forcing major changes in telecommunication. The separate networks which today support specific services, will be replaced by an ISDN that is able to provide a variety of services.

The wide range of options available to network planners makes it necessary to use advanced planning methodologies and tools for network analysis and system development. Planning is simpler if it can be based on a switching system that offers a full range of applications and modular extension. Also the distribution of intelligence towards the subscribers provides a sound basis for evolution to an ISDN.

References

- 1 L. Mack and G. Robin: Economic Comparison of the Evolution of Analog SPC and PCM-IST Telephone Networks: *Electrical Communication*, 1977, volume 52, no 1, pp 28-36.
- 2 F. Gomez Alamillo, I. Menéndez de Lurca, and C. Tirado Montero: Network Planning, Analysis of Digital Switching in the Spanish Network: *Electrical Communication*, 1979, volume 54, no 3, pp 237-244.
- 3 F. Alvarez Casas, R. Kelso, and C. Tirado Montero: Network Planning for the Introduction of Digital

- Switching Systems with Distributed Control: *International Switching Symposium 1981*, Montreal, Canada.
- 4 F. Álvarez Casas and F. Casali: ITT 1240 Digital Exchange: Network Planning and Application: *Electrical Communication*, 1981, volume 56, no 2/3, pp 302–314.
 - 5 E. Lera and E. A. Smith: Treatment of Some Important Aspects of Data Network Planning: *Ninth International Teletraffic Congress*, Torremolinos, 1979.
 - 6 E. A. Smith, W. A. G. Walsh, and M. J. Willson: Impact of Non-Voice Services on Network Evolution: *Electrical Communication*, 1981, volume 56, no 1, pp 17–30.
 - 7 P. A. Caballero, F. J. de los Rios, and I. Puebla: Planning the Structure of Analog/Digital Urban Networks and Optimizing Computer Aid: *2nd Middle East Electronic Communications Show and Conference*, Bahrain, 1981.
 - 8 M. de Miguel and F. J. de los Rios: Some Aspects of the Dimensioning and Optimization of Digital Networks in Both-Way Circuits: *10th International Teletraffic Congress*, Montreal, Canada, 1983.
 - 9 P. A. Caballero and J. M. Silva: Effects of Digitalization of the Optimum Structure of Junction Networks: *10th International Teletraffic Congress*, Montreal, Canada, 1983.
 - 10 G. Robin and S. R. Treves: Pragmatic Introduction of Digital Switching and Transmission in Existing Networks: *Institute of Electrical and Electronic Engineers Transactions on Communications*, 1979, volume COM-27, no 7.
 - 11 V. Navarro, P. Santana, and C. Tirado: Economic Evaluation of Parameters that Influence the Configuration of Mixed Analog/Digital Long Distance Networks: *Second International Network Planning Symposium*, Brighton, United Kingdom, 1983.
 - 12 L. A. Gimpelson: Introduction of Digital Technology into the Communications Networks of Developing Countries: *5th World Congress of Engineers and Architects*, Tel-Aviv, Israel, 16–21 December 1979.
 - 13 E. Lera and F. Casali: Analytical Method for Cross-Sectional Planning of Integrated Services Digital Networks: *Second International Network Planning Symposium*, Brighton, United Kingdom, 1983.
 - 14 F. Casali and S. R. Treves: Planning the Addition of Non-Voice Services in a Telephone Developed Area: *Second International Network Planning Symposium*, Brighton, United Kingdom, 1983.
 - 15 F. Casali and E. Lera: Pragmatic Planning for the Introduction of Non-Voice Services in Existing Analog/Digital Networks: *Fourth World Telecommunication Forum*, Geneva, 1983.
 - 16 F. J. de los Rios, P. A. Caballero, and J. M. Silva: A New Method for the Optimization of Outside Plant Provisioning Based on Branch and Bound Techniques: *Colloque International sur la Planification des Réseaux de Télécommunications*, Paris, 1980.
 - 17 F. J. de los Rios and C. Mayoral: Optimizing the Basic Structure of Digital Telephone Networks in Rural Areas: *Second International Network Planning Symposium*, Brighton, United Kingdom, 1983.

System 12

Containerized Exchange

Frequently the provision of a conventional exchange building is not feasible because of building restrictions or the need for the exchange to be cut over very rapidly. The System 12 containerized exchange overcomes these problems, enabling an unattended, stand-alone exchange to be installed and operating within a few days.

D. Ardizzone

L. Peli

Industrie FACE Standard SpA, Milan, Italy

Introduction

Generally telephone switching equipment is housed in an exchange building in which each type of equipment is accommodated in a separate room. Thus usually there are rooms for the main distribution frame, power plant, generating set, battery switching equipment, and transmission equipment, as well as for offices.

Clearly the work needed to build such an exchange from scratch, and to install, test, and cut over the telephone switching equipment, takes a considerable time. Sometimes this is unacceptable, or there is insufficient space in which to build a full telephone exchange.

Cases in which another solution must be found include the following:

- Only 50 m² or so of space is available for switching equipment and other plant.
- There are difficulties in obtaining building permission from the local authority.
- A small unattended exchange is required in a remote location, in which case the cost of a traditional exchange building is unwarranted.
- An exchange is required only temporarily, for example, during major exhibitions or to allow major modifications to be made to the main exchange. In such cases the temporary exchange must be cut over very rapidly, and the need for medium voltage transformers, power rooms, etc, must be kept to a minimum.
- In an emergency, such as extensive flooding or a severe earthquake, a temporary exchange could considerably

facilitate rescue work and subsequent relief operations. Under these conditions an exchange must be fully operational very rapidly.

It is now possible to meet all these varying needs using a single solution: the System 12 containerized exchange. In addition to the switching equipment, the containerized exchange includes the power plant, battery plant, environmental control devices, and main distribution frame. Thus installation is simply a matter of transporting the exchange to the site, and connecting it to the local power line and the telephone network; it is then fully operational.

System 12 Container

The containerized System 12 exchange is based on a 6 m (20 foot) long shelter which houses all the equipment necessary to serve 2000 subscriber lines. A prototype exchange has been delivered to the Italian telephone administration SIP, and is successfully carrying live traffic for 1000 lines.

The construction of the container was largely determined by the particular requirements of SIP, but the arrangement is suited to other applications. The shelter, which houses a 2000-line stand-alone System 12 Digital Exchange, meets the requirements of the relevant ISO 668 standard, size 1 CC (i. e. it is 6 m long and 2.49 m wide), as shown in Figure 1. At the request of SIP, the height has been increased from the 2.6 m specified by ISO to 3.25 m, making it possible to accommodate some customer-provided or

customer designated equipment (V-SEP* slim racks, main distribution frame, etc). In spite of this height increase, none of the System 12 equipment is higher than 2.6 m so that should the SIP height requirement be dropped at any time, it will be possible to install a 2000-line System 12 exchange in a standard ISO shelter without modification. The exchange will then offer full handling and transportation compatibility with ISO freight containers.

The outer walls of the shelter are ruggedly constructed in steel. Polyurethane foam is sprayed onto the inner surfaces to provide good thermal insulation. After curing the foam is machined flat and melamine sheets

operations cannot access the switching areas and make unauthorized changes).

The compartments at each end of the shelter house the batteries and the main distribution frame. All the System 12 switching equipment is located in the central compartment, together with the power plant and associated non-switching equipment (i. e. transmission and auxiliary).

Type of Containerized Exchange

The telephone network in which the System 12 containerized exchanges will be used in Italy consists of analog subscriber

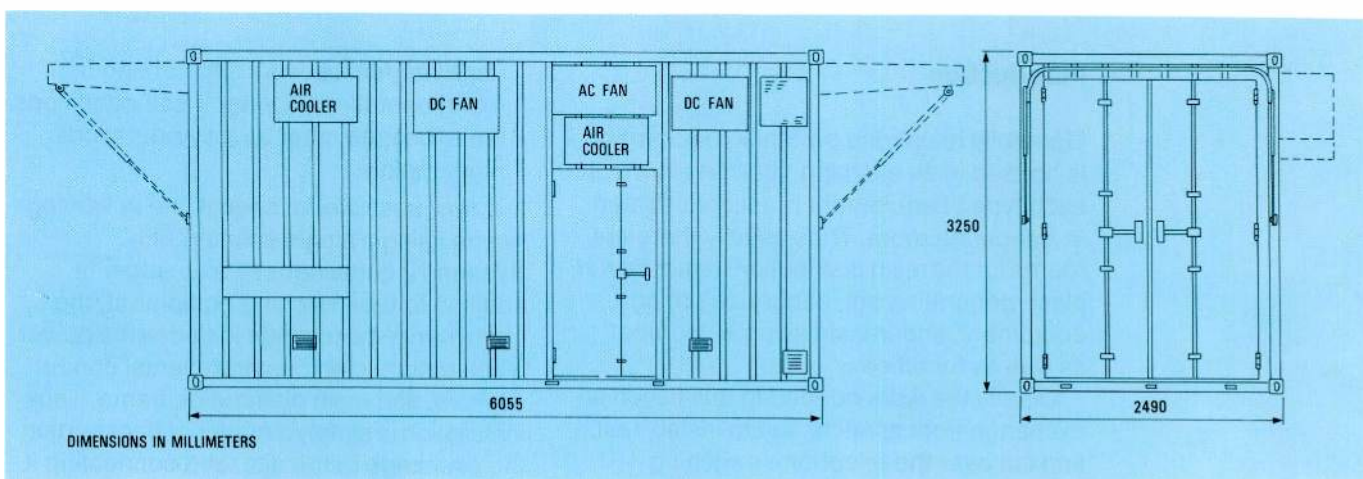

Figure 1
Dimensions of the
System 12 container.
The length and width
meet ISO standards,
but the height has
been increased at the
request of SIP.

bonded to it to form the inner walls. The outer walls are protected by a phosphate treatment followed by the application and curing of a layer of primer and two layers of white acrylic paint which helps reflect heat and significantly contributes to overall thermal and energy management.

The internal floor is of fabric/vinyl, except in the battery compartment where stainless steel is used to prevent damage from spilt acid. Omega-shaped rails in the floor, walls, and ceiling allow easy and versatile fixing of all equipment.

The usable internal space is divided into three independent compartments, all accessible from outside and lockable by padlocks with different keys. This ensures that maintenance personnel do not have access to equipment which they are not sufficiently skilled to work on (e. g. personnel carrying out jumpering

lines and 2 Mbit s⁻¹ digital trunks. The containerized exchange designed for this network environment is therefore a stand-alone exchange with 1 920 analog subscriber lines and 180 digital trunks. It has been dimensioned to handle a traffic of 0.15 erlang per subscriber and 0.8 erlang per trunk. All the facilities, services, and options offered by an exchange housed in a conventional building are offered by the containerized version. Thus it is equipped with line termination modules, digital trunk modules, service circuits modules, digital switching network, and maintenance and peripheral modules. Mass memory is provided by hard disks and magnetic tape units; as an option the latter can be located at a remote administration center with a modem and data link to the containerized exchange. Man-machine communication devices (VDU and printer) are not part of the containerized exchange, where they would mostly be unused. Two folding desks are provided to support portable units which

* A trademark of ITT System

can be plugged into the sockets provided for this purpose.

The System 12 equipment in the main compartment is arranged in two suites positioned back to back (Figure 2). One suite is fixed and accommodates the bulk of the cables from the main distribution frame, running on an overhead cable grating. When fully equipped it will consist of four line racks. In the version supplied to SIP, which has only 1000 lines and 90 digital trunks at present, the fixed suite consists of just two line racks and one mass memory rack (two magnetic tape units and two hard disks). The mass memory rack uses exactly the same equipment practice as all other System 12 racks.

The second suite consists of three racks which house the trunks, digital switching network, and maintenance and peripherals modules. This suite is suspended from an overhead iron beam using a bearing system with roller slides. It can therefore be moved easily by hand, creating a gangway wide enough to allow maintenance work to be carried out from the front or rear of the racks without undue restriction of movement (usable working space is never less than 0.6 m). All the rack equipment is constructed using the standard System 12 equipment practice.

Power Plant and Batteries

The power plant is, in common with the rest of the system, housed in a standard System 12 rack. It is divided into two parts. One part contains six (the equipment



Maintenance of the System 12 containerized exchange is facilitated by wide gangways which allow easy access to the equipment.

provision is for up to nine) 20 kHz self-controlled switching rectifiers with a nominal output power rating of 2 kW each. The other distributes the mains supply to the rectifiers, collects their outputs, and distributes the direct current to the batteries and the equipment; it also enables the equipment to be connected to an external emergency DC generating set.

Rectifiers can easily be plugged into or unplugged from the front of the equipment, enabling a faulty unit to be rapidly replaced. Subsequently it can be repaired in a maintenance center. Rectifiers are connected to the batteries and to the System 12 equipment in full floating mode.

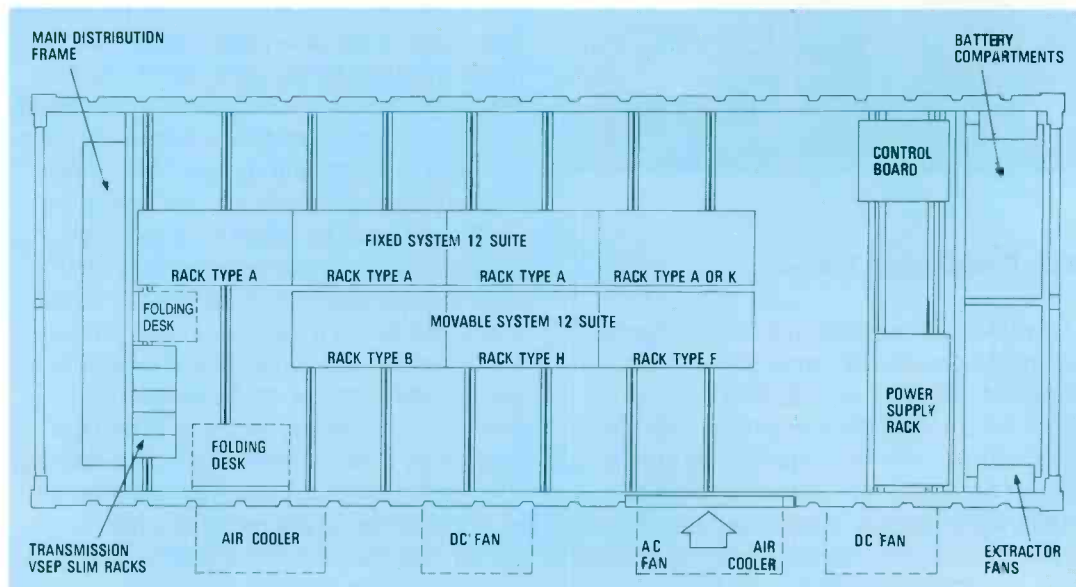

Figure 2 Floorplan of a System 12 containerized exchange developed for SIP.

The power distribution part of the suite is equipped with all the fuses, meters, and circuit breakers necessary to perform its functions. In this section all repair and maintenance work is carried out from the front, so access is not required to the rear of the power plant. An important advantage of this modular solution based on independent self-controlled rectifiers is that it allows the redundancy normally provided in telecommunication plant to be reduced to one (or more) extra rectifier(s), instead of duplicating the entire power plant.

In the battery compartment a steel scaffold can hold up to three 48 V, 1 000 AH batteries which enable the containerized exchange delivered to SIP to operate for 25 hours in the event of mains failure. Two sealed explosion-proof fans ventilate the battery compartment.

from the System 12 line circuits are terminated on the line blocks (one line module per block). A jumper pair between a protecting block and a line block then connects any subscriber to the relevant subscriber circuit. Equipment positions are available for other blocks to meet specific user needs.

The main distribution frame compartment is also equipped with a test subset to enable personnel installing the jumper leads to test the jumpering and outside plant network without entering the switching compartment. The main distribution frame was specified by SIP; however, any wall-mounted main distribution frame can be installed in the same way.

Environmental Control of the Interior

Control of the ambient conditions inside a container is important for correct equipment operation. The environmental control system is not only designed to ensure comfortable working conditions for maintenance personnel, but also to ensure that the temperature and humidity inside the shelter are within the wide operating limits of the System 12 equipment, however extreme the weather is outside. As the present container is used in Italy, the air conditioning equipment is designed to provide the required operating conditions for outside temperatures ranging from -20 to $+40^{\circ}\text{C}$. The basic concept is to blow outside air into the shelter whenever it is cold enough to cool the interior, and run air coolers only when necessary. This method saves energy and improves reliability by reducing the duty cycle of the coolers. As a result, all the air control units can be simple independent window blocks which are easily installed by plugging them into their openings and connecting them to the cables from the control board. Consequently they are easy to install and replace in the field without interfering with system operation. Faulty units can be taken back to a well equipped maintenance center for repair.

An AC fan sucks in outside air through filters and blows it into the shelter with a slight positive pressure, thereby helping to prevent the external environment from entering through any air gaps. When the outside air is too warm for effective cooling, the system switches to a window-mounted air conditioner. In the event of a mains failure, two DC fans can still change the inside air 50 times per hour.

Modular power plant integrated into a System 12 rack.



Main Distribution Frame

The wall-mounted main distribution frame can be equipped with up to 33 protecting blocks of 100 pairs, and 32 line blocks of 60 pairs (for a 1 920-line container). Outside plant cables from the subscriber subsets are connected to the protecting blocks where lightning and overcurrent protectors prevent damage to the electronic equipment from external disturbances. The line cables

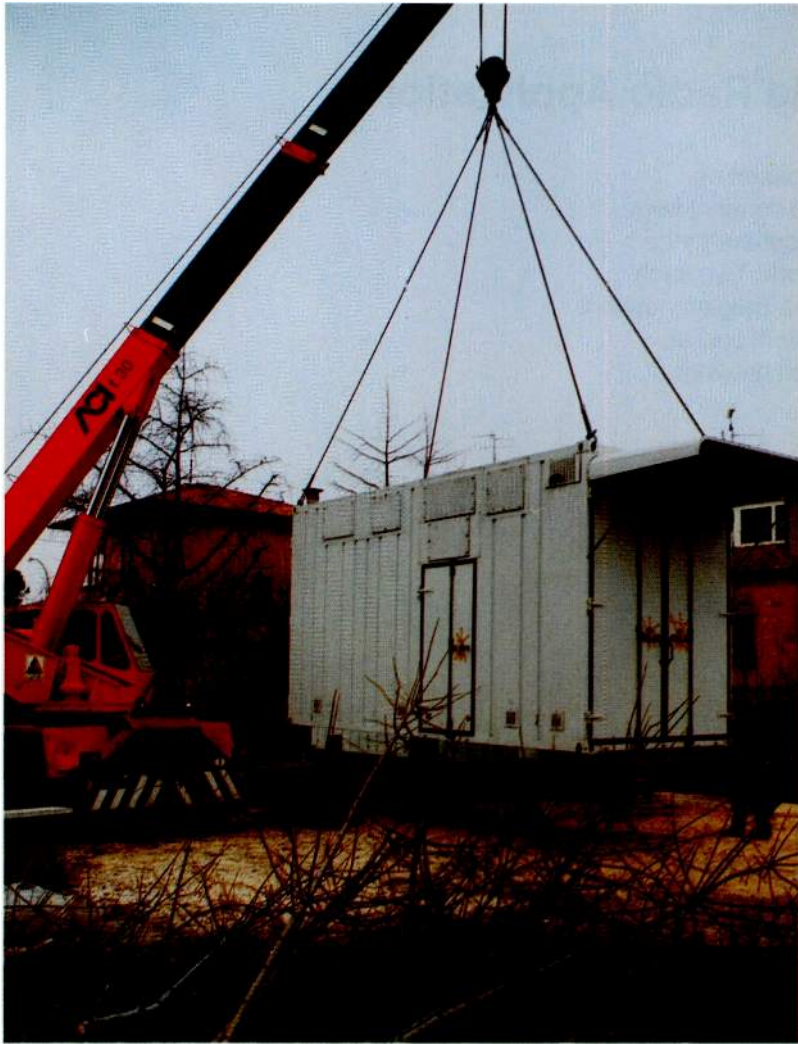

Installation of the System 12 container on-site. The only preparation necessary is the construction of a concrete base or, as shown here, four pillars.

All units are duplicated, except for the AC fan which is backed up by DC blowers. Thermostats and pressure switches control the operation of the air conditioning system and ensure that it is working correctly. Should a unit fail, the spare takes over and an alarm is generated.

Transport and Installation

The key advantage of a containerized exchange is that almost all manufacturing

and installation work can be completed in the factory, thereby minimizing the effort and time needed to cut over the exchange on site. This has economic advantages and is particularly useful when the exchange must be installed and operating in a very short time (e.g. during emergency relief operations). The container is assembled, cabled, and fully tested in the factory, then prepared for shipment. The moving suite is secured and the air conditioning units removed and separately packed and shipped. The openings left in the walls are closed by weatherproof covers.

When it arrives at its destination, the exchange can go into service in a very short time. Preparation of the site can be as little as providing a concrete platform or just four pillars. A power cable is all that is needed to get the exchange operating. The air cooling devices are simply plugged in and connected. Batteries are placed in the scaffold, interconnected, and filled with electrolyte. The exchange is then switched on.

After a short retest to ensure that no faults have occurred during transportation, the exchange is ready to be connected to the outside cable plant and for jumpering to be carried out. It is now an autonomous, unattended, stand-alone exchange.

Conclusions

The System 12 containerized digital exchange offers a unique solution to many problems: the provision of an exchange for a short period only, rapid introduction of an exchange, lack of building space, and economic restrictions. It is even possible to have mobile exchanges that offer the full range of System 12 features. The containerized exchange developed for SIP in Italy has demonstrated all the advantages offered by this approach.

System 12

Cellular Mobile Radio Applications

Cellular radio networks based on System 12 will be able to connect large numbers of mobile subscribers to the existing telephone network. Two such systems are scheduled: a Belgian network based on the Nordic system and an all-digital Franco-German network.

G. Adams

Bell Telephone Manufacturing Company,
Antwerp, Belgium

M. Böhm

K.-D. Eckert

Standard Elektrik Lorenz AG, Stuttgart,
Federal Republic of Germany

Introduction

Mobile telephones are quickly becoming a mass market. Systems are already operating successfully using radio transmission in the 450 MHz band from a network of base stations. New frequencies that have been allocated in the 860 to 960 MHz band now offer further scope for cellular mobile radio systems.

System 12 is ideally suited to the provision of switching centers to connect the mobile radio telephone network to the existing PSTN. System 12 equipment can also provide the control intelligence needed at each of the radio base stations.

This paper deals with the application of System 12 to the new Belgian telephone system based on the 450 MHz Nordic FDMA (frequency division multiple access) approach, which utilizes analog speech transmission, and the new Franco-German proposal CD900, which utilizes digital speech and data transmission based upon TDMA (time division multiple access). In both applications, System 12 architecture and technology is meeting the different requirements of the countries involved. Advanced technology and modular software for decentralized processing have coped easily with the demands of mobile radio. In fact, the merits of System 12, together with those of TDMA radio transmission, have been instrumental in the German administration's intention to procure a fully digital 900 MHz mobile telephone system.

Basic Cellular System Properties

A cellular radio network consists of one or more control centers, based on a telephone exchange, which are connected on one side to the telephone network, and on the other to radio stations distributed over the area to be covered. Each radio station provides as many channels as required for the expected traffic. Their service areas overlap each other, so that a mobile subscriber can be switched from one station to another without service interruption. The cellular radio system registers the area where each mobile subscriber resides so that it can provide full subscriber services at all times. Existing cellular radio systems differ from each other in the following respects:

- the maximum size to which the system can grow
- the structure of the network between control centers and base stations, and the integration of this network into the public telephone network
- the distribution of "intelligence" between the switching center, base station, and mobile subscriber equipment
- the transmission frequency, modulation technique, and signaling protocol used for the radio path
- the services offered to the subscriber.

The same basic structure is used for both analog and digital cellular mobile radio

Figure 1
Basic structure of a cellular mobile radio system.

PSTN - public switched telephone network.

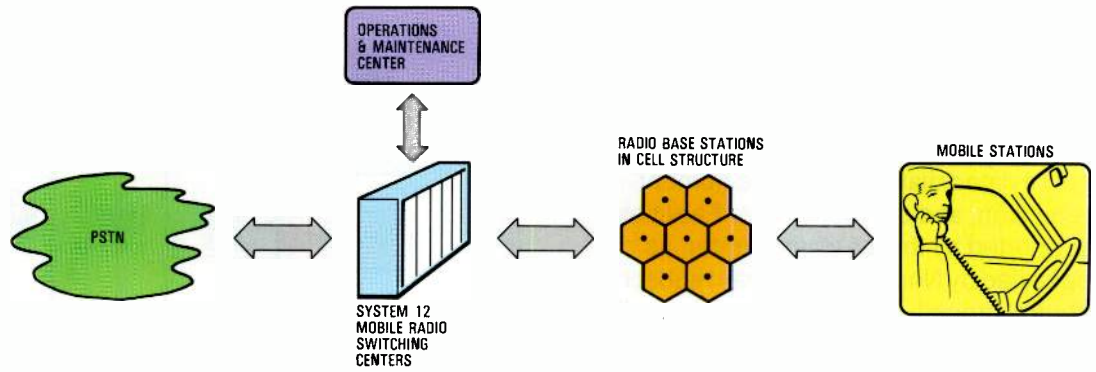

systems, as shown in Figure 1. Subscriber unit, base station, and switching center are the main elements of each system. The transmission lines that are used to link the base stations and exchanges belong to the system but are often already installed and provided by the local administrations.

System 12 Application to the Nordic Cellular Mobile Radio System

The Nordic system was created in and for the four Scandinavian countries where it has been operational since 1980. When the Nordic system was adopted by the administrations of Belgium, the Netherlands, and Luxembourg, the decision was taken to develop a cellular radio switching center based on System 12 (Figure 2). This switching center will be fully digital, including the 1200 baud modems. The system operates at

450 MHz, providing 222 channels using narrowband frequency modulation. Also, a 900 MHz version with 1 000 channels has been defined.

The basic system has a calling channel for each base station and a set of traffic channels. Idle mobile sets scan for and lock onto a calling channel. Calls are sent out on all calling radio channels in the traffic area where the mobile subscriber is expected to be. The addressed subscriber's set acknowledges the call in the return direction, following which the mobile telephone exchange commands switchover to an idle traffic channel at the same base station. Message communication is resumed on this channel and ringing starts, cadenced by the exchange. When the called subscriber off-hooks, a final exchange of messages sets up the voice path.

After seizure acknowledgment and an identification sequence, requested by the switching center, information signaling takes place on the relevant traffic channel. As soon as a call reaches voice conditions, a supervision circuit in the base station measures the signal noise. A 4 kHz tone is added to speech in the outgoing direction at the base station. The mobile set extracts this tone from the speech and returns it for signal-to-noise measurements. As soon as the signal-to-noise ratio, as detected in the base station, drops below a preset limit the base station requests the switching center to provide further call processing.

In addition, the signal strength level is monitored by the base station using a receiver which can be tuned to each of the channels used by the mobile transmitters. When the signal level is below a certain limit, the six nearest base stations are commanded to measure the signal level. The resulting data enables the exchange to select the appropriate actions, such as increasing the power, switching to a new base station, or disconnecting the call.

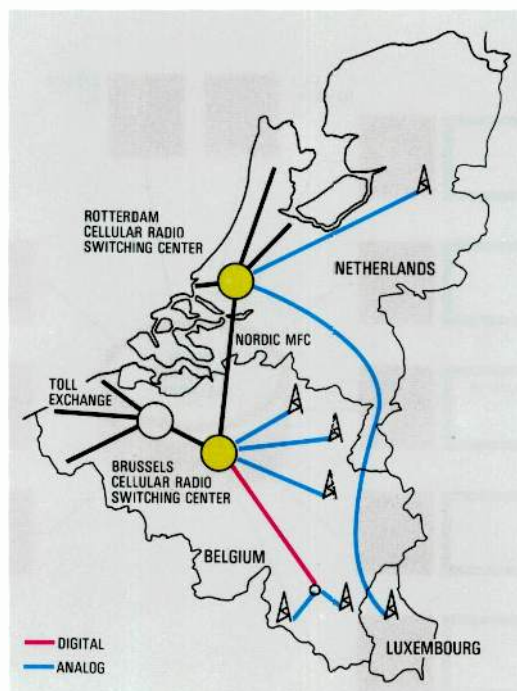

Figure 2
Nordic cellular mobile radio system for Belgium, the Netherlands, and Luxembourg which will use switching centers based on System 12.

When a mobile set leaves a radio area while it is idle, an automatic roaming update call is made by the set to inform the switching center of its new location.

Facilities handled by the mobile set are: abbreviated dialing, automatic number repetition, and call restrictions. Facilities supported by the switching center, as specified by Nordic, are standard subscriber control procedures, mobile coinboxes (for use in public transport), and priority mobile subscribers. In addition, System 12 generic subscriber facilities may be added to meet an administration's requirements. Signaling between the mobile set and the exchange, and between the base station and the exchange, is based on a 1200 baud modem using 1200 and 1800 Hz tones to represent 0s and 1s, respectively.

The control network consists of one layer of cellular radio switching centers, integrated into the telephone network and interconnected with multifrequency code (R2) signaling connections for exchanging subscriber information.

System 12 Application

The environment of the System 12 cellular radio switching center is fully digital. A standard analog-digital converter is provided at the base station (Figure 3). A signal strength measurement receiver is equipped in each base station and a dedicated 1200 baud signaling channel is used to control the radio equipment.

The digital trunk between the switching center and the conversion point is a

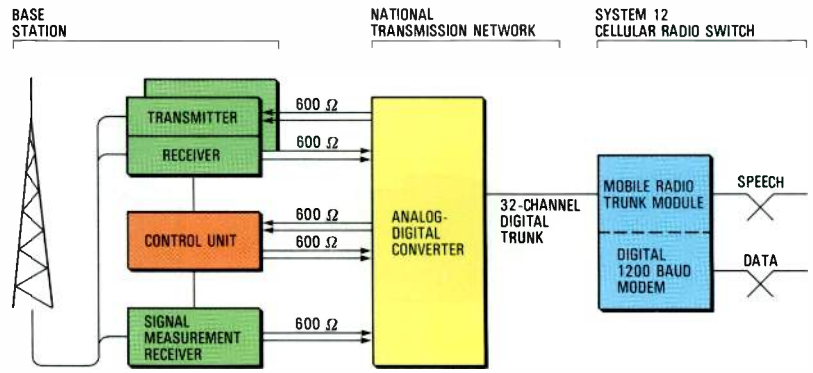

Figure 3
Interface between the System 12 cellular radio mobile telephone exchange and the base stations via an analog-digital converter.

standard circuit. In the switching center (Figure 4), the digital trunk is terminated by a standard 32-channel digital trunk circuit, extended with a digital modem pair for 1200 baud signaling with the base stations and mobile stations (one digital modem is the equivalent of 30 analog modems). This module has additional front-end processing power to handle the first level protocol and error correction of 1200 baud messages. These messages enter the terminal control element in a ready-to-use format: naked (without redundant information) Nordic defined signaling frames.

The TCE converts these messages to standard System 12 messages and vice versa. A new software module contains all new system functions. In addition, the call handling is modified to support specific signal sequences required between the mobile subscriber and the switching center.

The trunk module can handle 30 channels, which can be calling channels, traffic channels, and information channels

Figure 4
Schematic of the System 12 cellular radio switching center showing the new terminal modules.

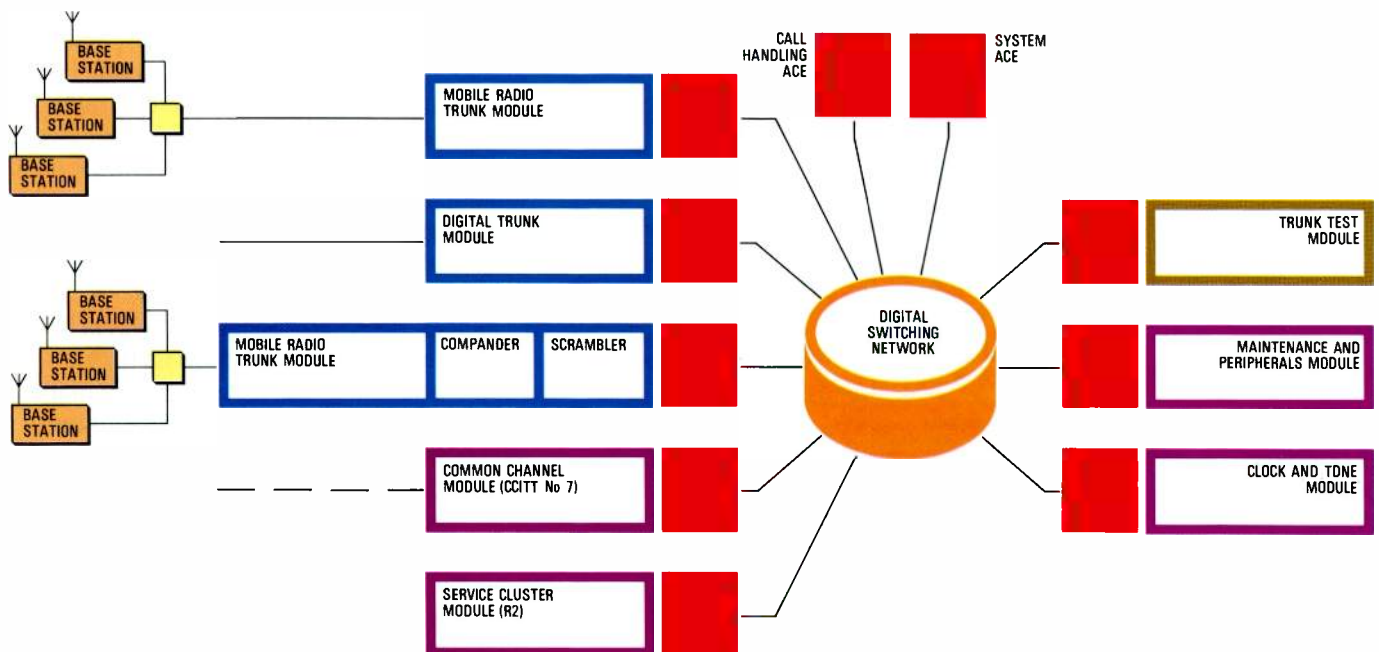

belonging to one or more base stations. The actual assignment is under software control.

System 12 software is required for two new modules: the new mobile radio trunk module handling the trunks equipped with modems, and the mobile telephone system function. In addition, the ACEs and service circuits module have been adapted to support the special call scenarios needed (Figure 5). The trunk TCE incorporates a device handler, signaling logic, and a local charging generator.

Call control functions have been adapted to support typical cellular radio procedures, such as the treatment of new line and register signals. In contrast to ordinary local exchanges, subscriber data relating to originating line classes cannot be distributed over the system. Therefore an interface is introduced to a centralized subscriber register, which is distributed over a number of control elements (one pair per N thousand subscribers). A new type of call control is introduced for call switchover

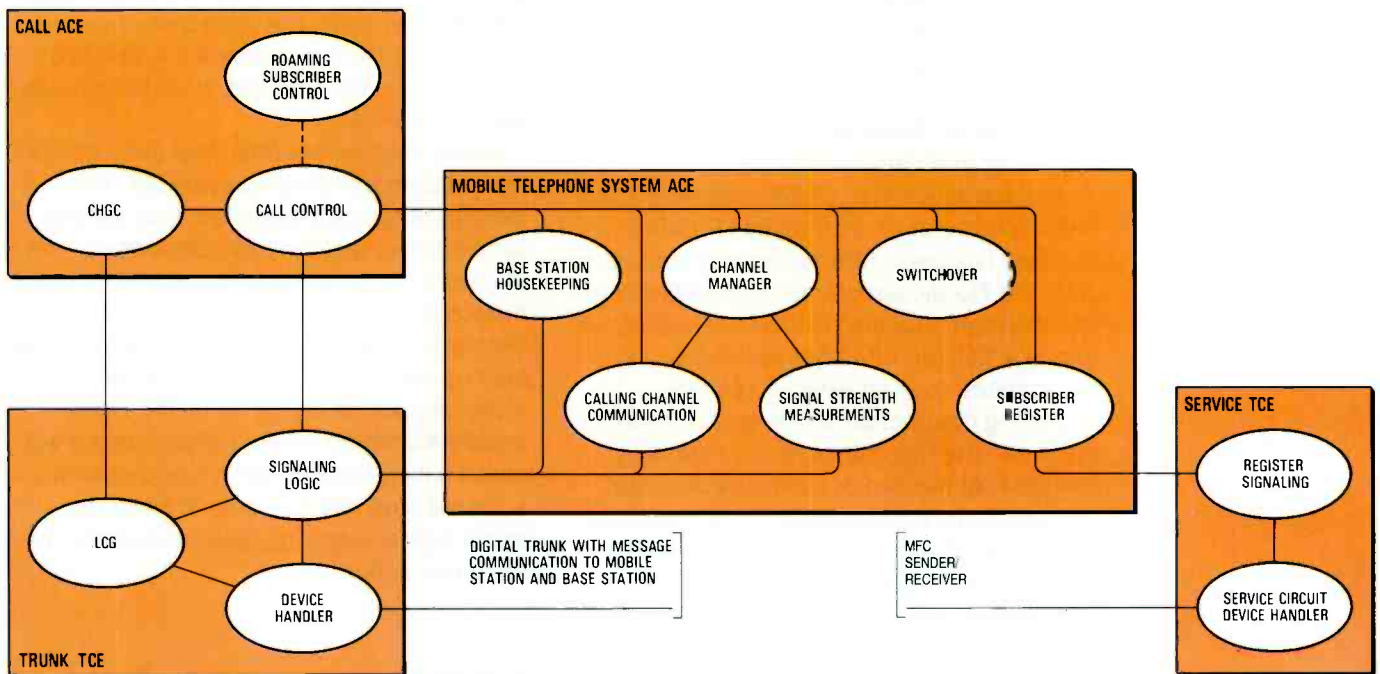

Figure 5
Cellular radio system software organization.
CHGC - charge generation control
LCG - local charge generator
MFC - multifrequency code.

The signaling logic interfaces with the hardware using naked Nordic messages exchanged over the high speed cluster bus and directly into and from memory. Channel associated signaling bits are also handled in this way.

The interface between the signaling logic and call handling is in accordance with the generic System 12 interface between call control and signaling control. There is no signaling control in the call ACE; this function is included in the signaling logic. A new interface has been created between signaling and the mobile telephone system functions for the treatment of non-call related messages such as transmitter on/off control, testing, and measurement. The device handler and local charge generator are typical generic System 12 functions. Standard System 12 modules are also used in the call ACE.

from one base station to another; its implementation has some similarities with a three-party call.

The roaming updating call control is combined with the subscriber control function because both are required to modify semipermanent subscriber data. For a subscriber controlled call the modified data concerns subscriber features; for a roaming call the data concerns the location of the subscriber.

The following functions are grouped in the system ACE for cellular radio:

- Subscriber register containing all relevant semipermanent subscriber related data.
- Channel manager which assigns radio channels for different applications.
- Base station housekeeping to support maintenance and operational tasks related to the external equipment.

- Calling channel communication function which handles call-related signaling upon assignment and switchover to a traffic channel.
- Signal strength measurement function responsible for signal evaluation by the measuring receiver.

The charging system and other call handling support remain unmodified.

The call scenarios for mobile telephones differ from a normal call scenario in the additional message interfaces to the new system functions, and in the specific signals which do not exist in ordinary telephone signaling systems. These additional messages flow between the call control and mobile telephone system ACE functions, and between these ACE functions and the signaling modules.

For the data link application between two switching centers, a modified MFC-R 2 module has been introduced, in accordance with the Nordic specification. It differs from the standard module in the use of packets of digits which are often not call related but transmitted over an existing register signaling connection which serves a call between the two cellular radio switching centers. At the end of normal information signaling, the equipment is not released but used to exchange subscriber information on "guests" or "roamers". When no traffic is available to carry this kind of information, dummy calls may be generated.

The first application of the System 12 Nordic cellular application in Belgium will have 45 base stations and 5000 mobile subscribers; it is planned to grow to 245 base stations and 50 000 mobile subscribers.

The maximum size of a System 12 cellular radio switching center is not limited by its structure but by the cost of the cable network. Above this limit, a second switching center should be introduced. It is feasible to connect base stations of both the 450 and 900 MHz network to the same switching center. It is also feasible to mix the System 12 cellular radio switching center with modules serving other applications (e.g. local, toll, tandem, and digital operator position); the System 12 call handling ensures interworking between a variety of line, trunk, and operator terminals.

The maintenance functions provided by the System 12 switching center are primarily intended to maintain the switching system. Two sets of operator requested jobs are provided for the administration. One

handles all subscriber related data, the other all semipermanent data relating to the base stations and related digital trunks.

Several counters have been added which give information on roaming, call switchover, and other typical events related to cellular radio. All other operations and maintenance features are generic to System 12.

Project Status

The first field tests are scheduled for August 1985, while the system should be in operational service in April 1986. The present status of the design is that almost all software functions are coded and module testing is underway. In addition, detailed design of the modem and trunk boards has been completed.

In the next few months, test assemblies and models will become available. The Belgian telephone administration will use simulators to test the base stations off-line. These will generate and decode 1200 baud messages as defined by Nordic. The simulators will allow the radio network to be built up without the need to have the switching center on the air all the time. Initially switching center factory testing will utilize a loop back function together with a software stub which is able to simulate some typical signaling patterns handled by the base station.

System 12 Application to the Digital CD900 Cellular Mobile Radio System

The German S900 requirements for a new cellular mobile radio were aimed at a more-than-one-million subscriber network for the Federal Republic of Germany to be opened in 1987. A recent agreement between the German and French governments covered the installation of a joint Franco-German digital mobile radio system in 1988. The Franco-German CD900 consortium headed by SEL has put in a strong tender for this system.

The CD900 Network

The CD900 anticipates about 500 to 700 cells and base stations for the Federal Republic of Germany. Each cell provides 60 speech and three control channels of 16 kbit s^{-1} each. For heavy traffic the cell size is small, for low traffic it is large. About 30 base stations, on average, are connected to a System 12 cellular radio switching center by a 2 Mbit s^{-1} 30-channel PCM

multidrop connection. CD900 is a TDMA system offering attractive economic and functional advantages over current analog systems for high subscriber capacities.

The CD900 network is shown in Figure 6. The switching centers are basically System 12 exchanges, which are connected to digital transmission lines of the PCM 30 type provided by the German PTT. In order to minimize costs while subscriber numbers are still low, CD900 features a multidrop approach, or busline structure. This allows a number of base stations to be fed by the same PCM 30 line.

speech channel; in contrast the CD900 as a TDMA system uses only one broadband frequency channel for all speech channels. Thus a considerable equipment reduction is possible, plus the benefits of digitization and extensive use of VLSI components.

CD900 Transmission

CD900 base station transmissions are coded differently and thus can be discriminated from each other. Groups of 6 bits each of 16 kbit s^{-1} digitized speech are transformed into specific faster codebit groups of 32 "chips". Coding of such a new

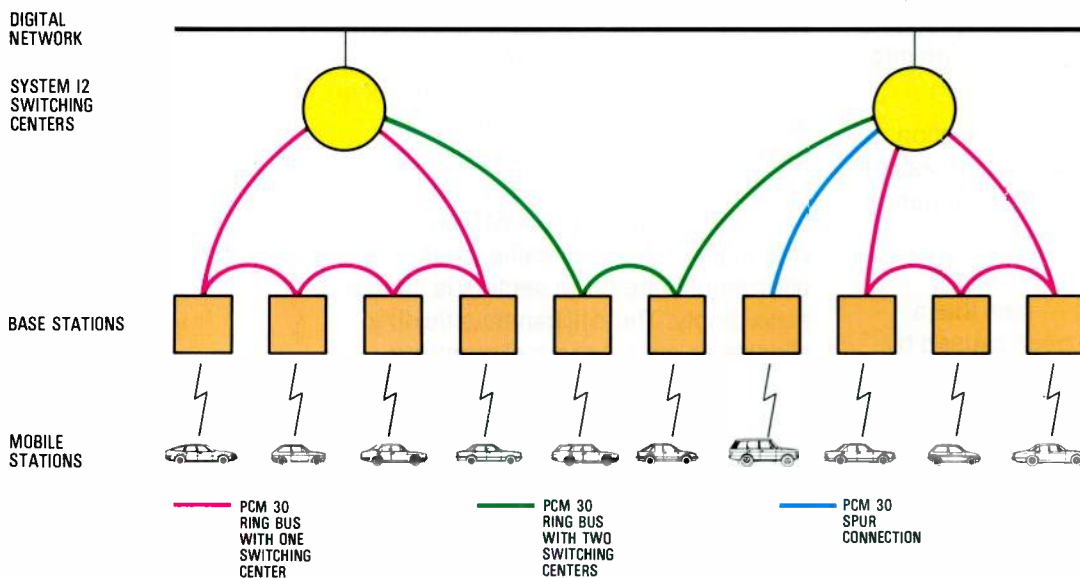

Figure 6
CD900 network structure showing the base stations and the switching centers which are based on System 12.

As the system approaches subscriber saturation, each base station needs two dedicated PCM30 lines in a multiplexed star network configuration.

CD900 Broadband Digital Radio Transmission

The CD900 system utilizes new radio transmission principles between base stations and subscriber units:

- Digital TDMA as opposed to analog FDMA.
- One fixed carrier frequency for all subscribers (co-channel principle).
- Several megahertz bandwidth of common frequency channel (4 MHz as opposed to 20 kHz for FDMA systems).
- Utilization of multipath effects to improve transmission.

FDMA systems use one specially tuned narrowband frequency channel for each

group is specific for a speech bit group and a base station. The ratio of code bits (chips) per group to speech bits per group is called the spreading factor. It results in a bandwidth increase, which improves the channel quality. Two code bit groups are modulated on the carrier frequency using quadrature phase shift keying. This method conserves bandwidth, and is a common technique for digital radio links. It is thus possible to transmit 12 speech bits using only 32 different, orthogonal codes (5 bits + sign equals 6 bits).

Detection and processing of the transmitted signals is achieved by correlation. Digitized received patterns are compared simultaneously with the known 32 stored code patterns. Only one of the 32 correlations provides the maximum correlation peak, which allows the speech bit group belonging to this code pattern to be identified. Actual speech bits are not transmitted.

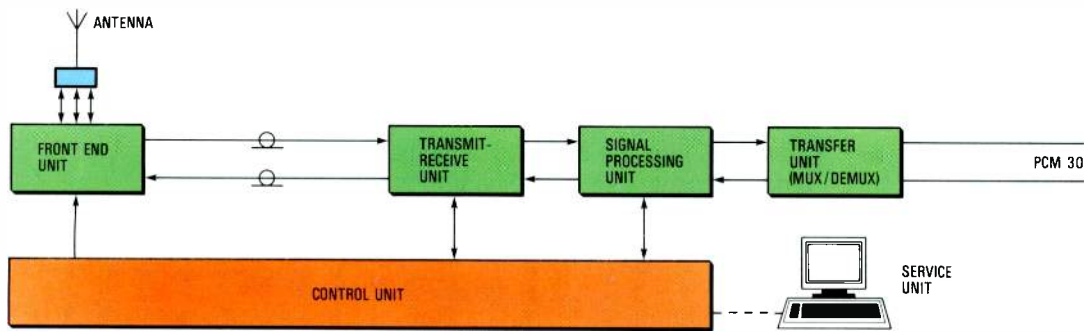

Figure 7
CD900 base station.

This method involves a very high bit transmission safety (i.e. a low bit error rate) for the following reasons:

- More redundancy by spectrum spreading due to speech bit group conversion into code bit groups of the same length.
- Utilization of a deterministic detection process (one out of 32 codes) instead of a stochastic one (a speech bit sequence is unpredictable).
- Neutralization of code bit errors by orthogonal codes. This means that a decreasing correlation peak caused by code bit errors can still be distinguished from neighboring correlators' peaks resulting from zero code cross correlation (when one code gives maximum correlation, all others provide zero).

The new digital transmission method of the CD900 has another important advantage: each correlator provides peaks not only from signals received directly, but also from multipath signals, which arrive delayed. This feature, which cannot be provided by FDMA systems, is used to stabilize and improve a link.

Simple Base Station with a Single Transmitter/Receiver

The CD900 base station is very simple. It comprises a combined transmitter/receiver for 60 speech channels (16 kbit s⁻¹) in the 7R equipment practice required by the Deutsche Bundespost. In addition, the base station contains two control racks. These control racks contain hardware derived from System 12. Putting more "intelligence" from the cellular radio switching centers into the base stations by these control racks reduces control traffic load on the PCM 30 lines and leads to simpler switching centers.

Figure 7 shows the block diagram of a CD900 base station, which features sequentially fed 3-directional antennas.

The Flexible Cell

The intelligence of each base station is required not least because of a CD900 special feature shown in Figure 8. Each base station serves a cell which comprises three sectors (A, B, C). The sectors are served sequentially via the 3-directional antennas. When there is equal traffic distribution in the three sectors, 20 speech channels and one control channel are allocated to each sector. When there is unequally distributed traffic, channel allocation to the three sectors is changed accordingly. The cell can thus flexibly allocate its sector channel numbers.

The term "cellular radio" particularly addresses high capacity mobile telephone systems with many small cells, as opposed to the large cells of conventional low capacity systems. Each cell is supplied by a base station, which transmits with only low power. Thus it is possible to reuse, at certain distances, the channels of a specific base station for other base stations. Nowhere do two cells with the same letter – representing a given speech channel group – touch each other. Thus there is no mutual interference.

Each CD900 cell provides 60 speech channels, independent of size. For high traffic areas the cells are small, for low traffic

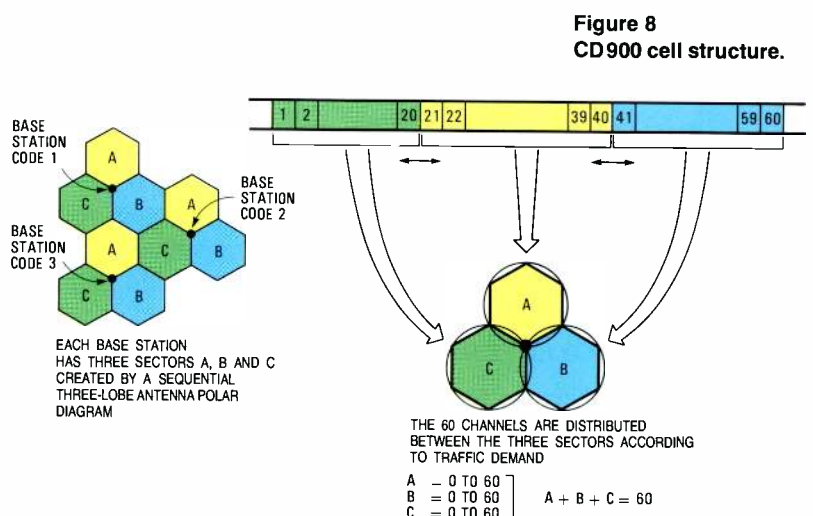

Figure 8
CD900 cell structure.

areas they are large. Capacity increase of a CD900 system is achieved simply and economically by cell division. For instance, transmitter range is reduced by half. The resulting coverage gaps are filled by new base stations each providing 60 channels. The system capacity for a given area is thus increased by four. A further reduction in transmitter range by half multiplies system capacity for the area by 16.

Conclusions

The first field tests for the Nordic-based system are scheduled for August 1985, and the system should be in operational service in April 1986. The CD900 system is to be opened 36 months after contract award, which is expected in late 1984 or early 1985. Initially the Deutsche Bundespost will install the digital mobile radio system in the four

most highly industrialized areas of the Federal Republic.

The development of System 12 cellular radio switching centers demonstrates the flexibility of the system in adapting to new requirements. The amount of new software needed represents only a fraction of the available software base for System 12.

The switching center designed for the 450 MHz version can, with minor modifications, be used for the Nordic 900 MHz version.

The switching center developed for the Franco-German digital CD900 system shares all basic functional units with that of the analog Nordic-based system for Belgium, the Netherlands, and Luxembourg. Peripheral equipment, however, has to be adapted to the requirements of the national customers.

As a product family, the System 12 cellular radio switching center is expected to be the basis of a variety of future mobile telephone applications, in addition to the two applications discussed in this paper.

System 12

Telecommunication Networks

Beyond ISDN Transport

Modern communication systems have already transformed the world in which we live, but their future impact is likely to be even greater. They will become an integral part of the home, office, and factory, offering facilities such as home entertainment, teleconferencing, and even computer-aided manufacture. The versatile architecture of System 12 lends itself readily to the implementation of these features.

L. A. Gimpelson

ITT Europe Inc, Brussels, Belgium

S. R. Treves

FACE, Milan, Italy

Introduction

A major evolution is taking place in both the communication and computer fields, aided by the availability of improved VLSI and fiber optic technologies and recent advances in programming.

In the communication field, the analog telephone network is evolving into an integrated digital network in which digital techniques are being used for both transmission and switching. This integrated digital network has the basic capability to support voice and non-voice services in an ISDN. Three bit-rate categories can be identified for signal transmission. The basic

ISDN supports bit rates of up to 64 kbit s^{-1} . For higher bit rates of up to 2048 kbit s^{-1} , a wideband ISDN will be used. Substantially beyond this – up to 140 Mbit s^{-1} – a broadband ISDN becomes necessary.

In the computer field, VLSI and software evolution have led to the migration of processing power from large centralized mainframes to powerful distributed systems, such as exchanges with fully distributed control.

The ISDN has far greater potential than signal delivery. Markedly decreasing transmission and processing costs are leading to a race between the addition of intelligence at subscribers' premises using personal computers and the use of network resources (i. e. centrally supplied value-added services, networking functions, processing, and storage).

Major international standards have been issued (Table 1) for both voice and non-voice services in an ISDN environment to ensure convenient, economic interworking. Of paramount importance is the OSI model for network architectures, which has recently been standardized through an ISO-CCITT agreement.

Impact of the OSI Architecture

The OSI architecture assures person-to-person, person-to-process, and process-

Table 1 – Major international standards for ISDN: 1984 status

Application area	Standard	Source
Network architecture	Open system interconnection model X.200, ISO 7498	ISO-CCITT
Integrated services digital network	I-series recommendations	CCITT
Local area networks	IEEE 802: – CSMA/CD – token bus and ring	Xerox and others IEEE, IBM
Image communication	Group 4 facsimile (T.5)	CCITT
Message handling	X.400 series	CCITT

CSMA - carrier sense multiple access
CD - collision detection

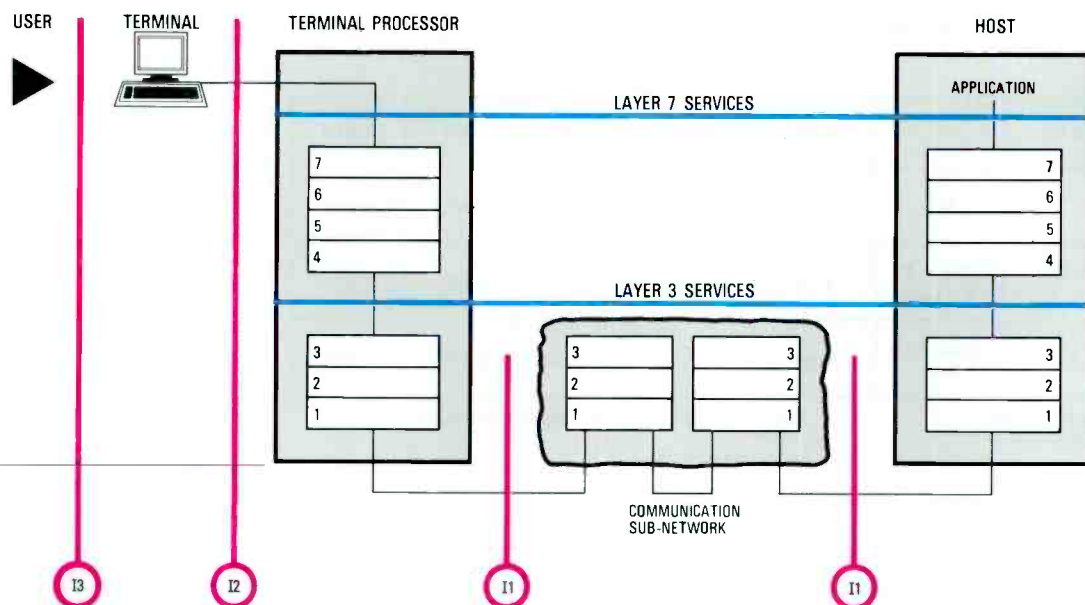

Figure 1
Possible boundaries
between public and
private services in an
OSI environment.

to-process communication using different carriers and hardware and software developed by different manufacturers. According to OSI, a *service* is a set of communication capabilities which is defined by a standard protocol and functions.

Two broad categories of services are considered:

Bearer services provide facilities for transmitting signals between user-network interfaces involving functions at OSI layers 1, 2, and 3 (e.g. 64 kbit s⁻¹ circuit-switched transparent service or packet-switched service).

Teleservices provide all the facilities, including terminal equipment functions, for communication between users in accordance with the protocols that have been agreed by administrations.

In an OSI environment the boundaries between public and private operating agencies may be located at various points in the network. Figure 1 shows three possibilities. The first is that of a private organization operating its own fully private service (e.g. a private database) using interface I1. Next is the case of a public organization operating a hybrid public-private service (e.g. packet assembly/disassembly function) using interface I2; in this case the public organization operates an application service, but the user terminals are privately owned. In the final case, a public organization operates a full public service (e.g. public electronic mail boxes) using interface I3; both the terminals

and services are provided, owned, and run by the public organization.

In addition, different customer* entities can be connected at different ISDN reference points: these entities include terminals, network terminations, systems (e.g. local area networks and PABXs), and private networks. From a functional viewpoint, it is possible to consider nesting (interconnecting) different local area networks into a private voice and data business communication; similarly different business communication systems could be nested into the public communication network.

Table 2 lists the standard protocols defined by CCITT to support major telecommunication services. In spite of the significant effort expended over the past few years on defining these standards, the majority still need further study. Thus telecommunication systems architectures must be adaptable to meet as yet undefined standards and implement future services.

Tariffs will significantly affect the evolution of non-voice services. Today, in an analog environment, voice traffic is generally far less expensive than data traffic. In an ISDN environment, circuit-switched data and voice traffic will be transported on the same 64 kbit s⁻¹ channels, and therefore at about the same cost. Thus local administrations will be able to offer lower tariffs for data traffic, thereby encouraging the rapid spread of telematic services.

* Customer can mean a network operator, or an individual subscriber with a PABX, keyset, or just a line.

Table 2 — Telecommunication services and CCITT protocols

(a) Bearer services

Layer 3	CCITT signaling	V.25	NS	X.20	X.21, X.25	X.25	I.451	X.213
Layer 2			NS		X.75 subset	X.25	I.441	X.212
Layer 1	CCITT signaling	V.24 V.28	V.24, X.21 X.21 bis	X.D.	X.21 X.21 bis	X.21 X.21 bis	I.430	X.211
Network	Man	Host	Leased lines	Telex	CSPDN	PSPDN	ISDN	OSI
	PSTN							

PSTN - public switched telephone network
 CSPDN - circuit-switched public data network
 PSPDN - packet-switched public data network.

(b) Teleservices

Layer 7	People		T.60	People	X.400:410	NS	
Layer 6	People	T.100	T.61	T.30	NS	NS	X.216
Layer 5	People	Not yet applicable	T.62	People	NS	NS	X.215
Layer 4	People	Not yet applicable	T.70	T.30	NS	NS	X.214
Teleservice	Telephony	Videotex	Teletex	Facsimile	Message handling system	Telemetry	OSI

NS - not standardized (vendor/user specific)

Bearer Services

Bearer services are described by a number of attributes, which can be grouped into three categories:

Information transfer attributes characterize the network capabilities for transferring information. They include the information transfer mode (circuit or packet), the type of information that can be transferred (unrestricted digital information, speech, video, etc), the communication configuration (point-to-point, multipoint), and the way in which communication is established (on demand, reserved, permanent).

Access attributes describe the means by which network functions and facilities are accessed; they include the access channel and rate (D channel, B channel) and the access protocol.

General attributes deal with the service in general. They include quality of service, interworking with other systems, and operational and commercial attributes.

These attributes impose three main requirements on the digital exchanges that

provide bearer services. First the architecture must support different modes of information transfer (circuit, packet, and message switching). Second, it must support different traffic patterns. Voice calls are characterized by a relatively tight cluster of values around 1 BHCA (busy hour call attempt) and 0.1 erlang per line; in contrast, non-voice calls may require 10 to 100 BHCA and approach 1 erlang per line. Third, the exchange must offer different bandwidths for the wide range of services that will be available in an ISDN. Particularly important is the availability of a subscriber controlled bandwidth feature ("dial-a-bandwidth") implemented by appropriate signaling on the D channel.

ISDNs based on the System 12 digital exchange meet all these requirements. As shown in Figure 2, analog, digital, and wideband subscriber lines can access, through a System 12 digital switching network, different types of telecommunication network, including the public telephone network, circuit-switched public data network, packet-switched public data network, ISDN, and wideband public switched network. System 12 exchanges will function as fully capable nodes in circuit- and packet-switched networks.

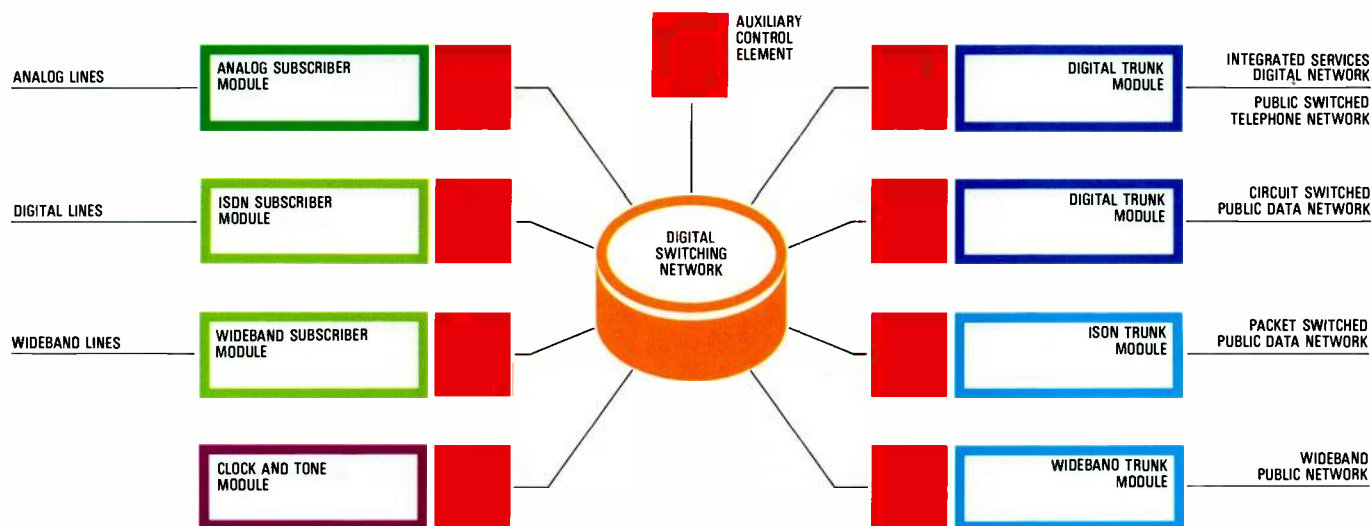

Figure 2
System 12 support for bearer services.

Teleservices

Teleservices enable users to communicate by means of terminals, network functions, and (possibly) functions provided by dedicated centers. Table 3 classifies teleservices according to the type of information to be carried (voice, data, video, text).

The System 12 architecture (Figure 3) is capable of supporting networking services (i. e. OSI layer 6 services related to the interworking of different services) and teleservices. Networking services ensure compatibility between different makes of terminals and computers by providing data format, protocol, and speed conversion. Thus users of different services can be interconnected (e. g. videotex/telex, videotex/teletex, telex/teletex), as well as different terminals and networks.

Different categories of teleservice (OSI layer 7) can be implemented through functionally different modules. Possibilities include:

Management and job transfer services module consists of four functional components: job submission, which issues the request for jobs to be done; job processing, which carries out the job; job monitoring, which advises on the progress of jobs; and manipulation submission, which controls job transfer and management.

Virtual terminal service module provides terminal access to a user process located in a remote host resource. The virtual terminal approach introduces, through a local mapping function, an abstraction (model) of the functions commonly found in terminal access methods and then uses this abstraction to define a set of communication services to support a distributed terminal service.

File service module is used to transfer, access, and manage information stored in or moved between open systems as files. The file transfer, access, and management services allow data to be added to or

Table 3 – Main teleservices

Media	Teleservice	Function
Voice	Voice mail	Store and forward
	Voice information service	
	Voice broadcast service	{ Voice recognition { Voice synthesized answering
	Voice ordering service	
Voice databases	{ Directory { Airlines information { Train reservation	
Video	Videoconferencing	
	Videophone	
Data	Graphics transfer	
	Television programmes	
Data	Database services	Videotex Professional databases (e. g. medical, press, layers) Industrial databases
	Telemetry	Gas, water, electric meter reading service Remote surveillance (e. g. medical alert, security alarm) Energy management
Text	Telex	
	Electronic mail	
		Text mail Electronic bulletin board News Appointments and calendars

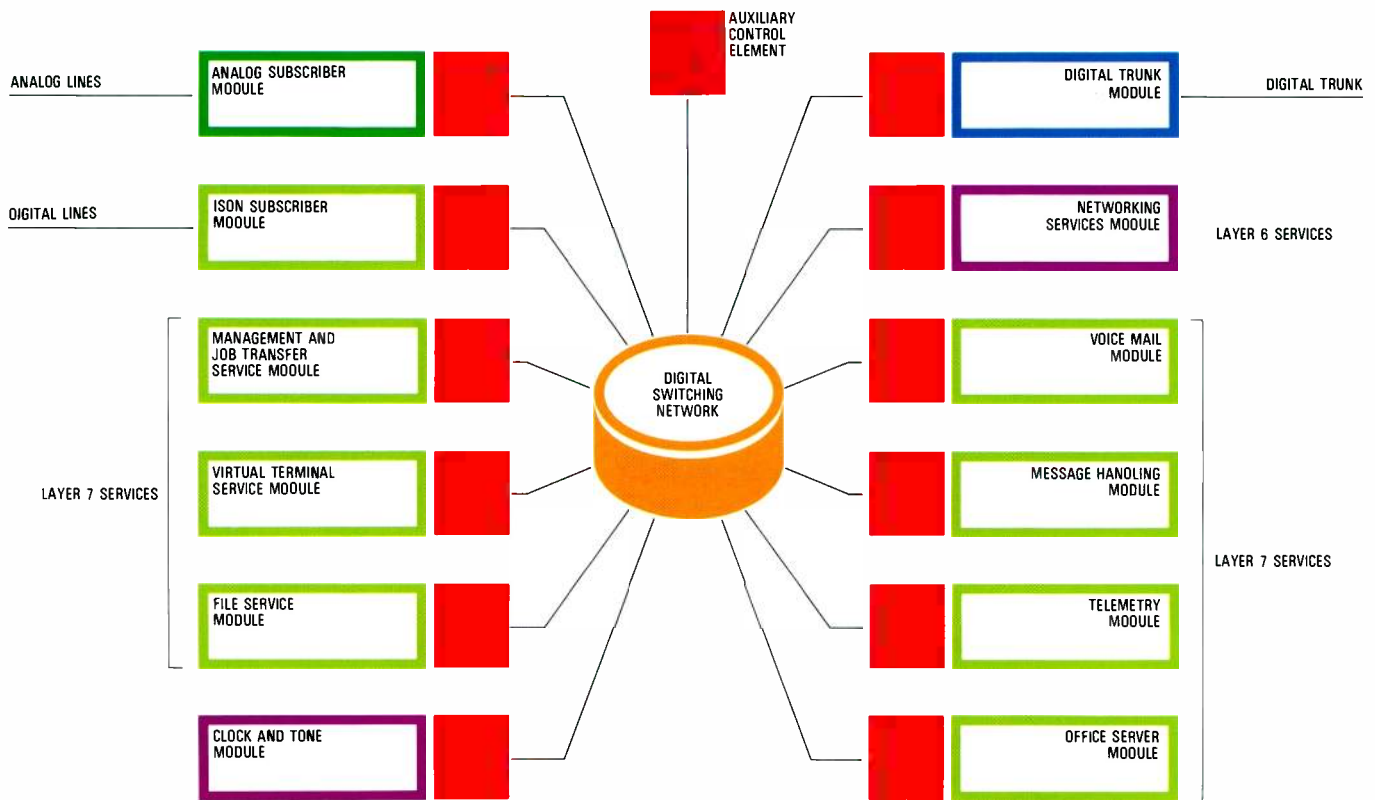

Figure 3
System 12 support for teleservices.

removed from a database and the description of the data to be maintained without knowing how the filing system is implemented.

Office server module mainly provides users with word processing, file management, agenda, and calendar management facilities.

Telemetry module uses the existing subscriber line; sensors and actuators are connected to the network termination at the subscriber site. Alarm signals from sensors at the subscriber site are fed to the existing telephone line via fibers and transmitted via the D channel to the exchange where the signal is routed to the telemetry module. There it can be collected, stored, preprocessed, and distributed to various supervision centers, if required.

Message-handling module. A user (person or computer application) can send an addressed message to a centralized database located in the message-handling module; the module stores the message and automatically distributes it to the addressee.

Voice mail module makes it possible for a subscriber to send voice messages rather than text messages. These are stored in audio compressed digital form and then retransmitted to the addressee at his request.

Communication and Computers

The communication and computer industries are converging in their technologies, architectures, and applications in the home, the office, and the factory. In all these areas the underlying technology that adds value is communication. In fact, the use of computer systems with their high processing power would be severely limited were it not for the services and flexibility provided by communication networks.

In the home, the main requirements are for intelligent telephones, information services, personal computers, utility telemetering, security systems, and home entertainment (high quality audio programmes and films). As a result, residential subscribers will require a variety of voice and non-voice services, initially operating at bit rates of up to 144 kbit s^{-1} , and subsequently with bit rates suitable for full motion video for color television programmes and interactive television.

The major facilities required in the office include electronic mail, teleconferencing, information processing, workstations, and speech driven equipment. Business subscribers will therefore initially require voice, text, and data services supported by an ISDN exchange that integrates LAN and PABX functions. Subsequently they will

require videoconferencing and videophone. Scenarios for residential and business subscribers in the wideband ISDN and broadband ISDN environments are shown in Figure 4.

Factory requirements are somewhat different and include computer-aided design, computer-aided manufacturing, material requirements planning, robotics, workstations, and security systems. A

Figure 4
Scenarios for wideband ISDN and broadband ISDN environments for (a) residential subscribers, and (b) business subscribers.
BISDN - broadband ISDN
WISDN - wideband ISDN.

(a) RESIDENTIAL SUBSCRIBERS

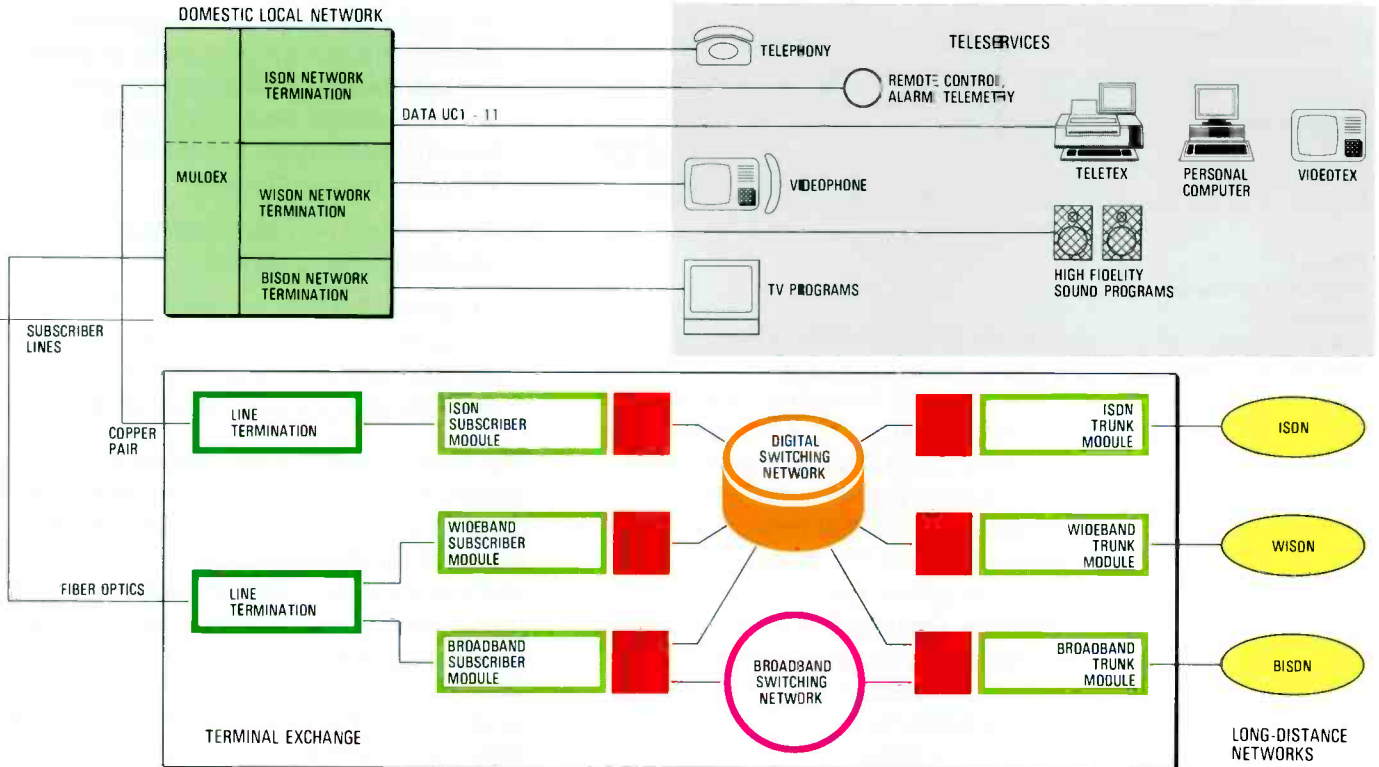

(b) BUSINESS SUBSCRIBERS

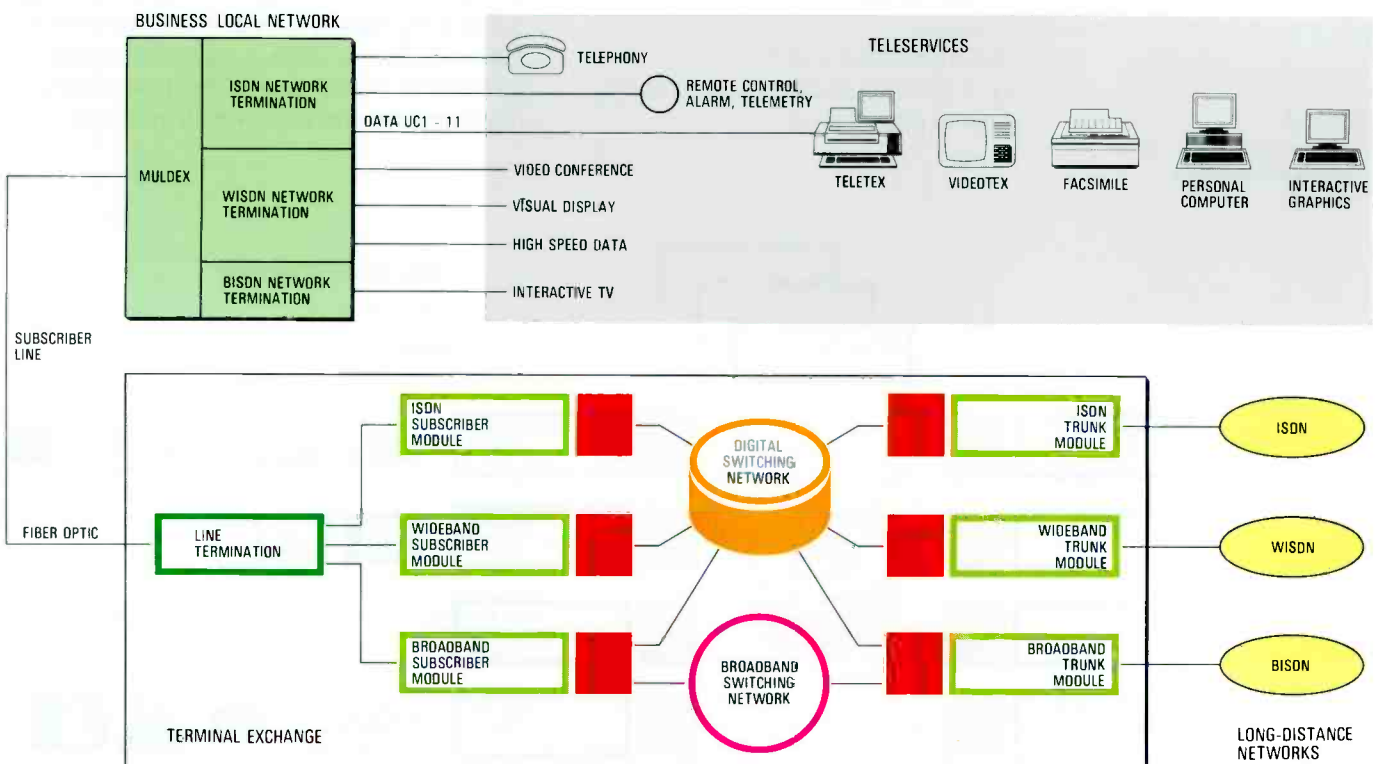

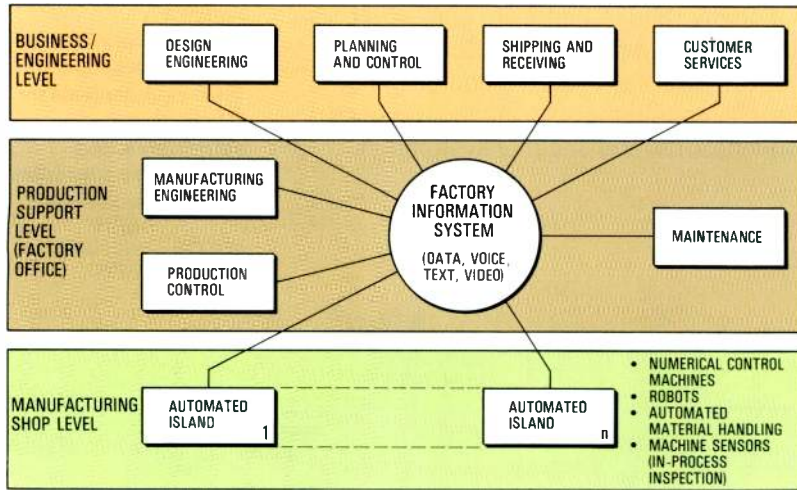

Figure 5
Integrated business-engineering-manufacturing information system.

major change in the factory environment is the users' need to integrate existing stand-alone equipment through an overall factory information system (Figure 5) capable of integrating the exchange of data, voice, text, and video between the different departments located at the business and engineering level, the factory office level, and the shop floor level.

All these opportunities for products, services and systems in the home, business, and factory environments naturally lead to System 12 applications as a result of its architectural advantages. The architecture, with its multiplicity of processor-controlled modules interconnected through a digital switching network, can be considered as a distributed data processor. In comparison with the traditional mainframe architecture, a System 12 distributed data processor has the following advantages:

- Smooth expansion from a small initial installation to the final size, which can be very large.
- Independence between the number of termination devices, traffic capacity between termination devices, and feature content of termination devices.
- Increased reliability, and therefore availability, of the processing complex because there are a multiplicity of paths through the digital switching network between control elements (instead of bus implementation) and the terminal modules are independent.
- Ability to add new applications without affecting existing services.
- Increased flexibility regarding "unbundling" of software packages and communication between dissimilar software designs in the terminal devices.

The basic software of the System 12 distributed data processor consists of four parts. The operating system administers processes and resources. The communication system between processes runs on one or several processors; it uses peripherals such as disks, tapes, and an operator console. A database management system is provided for the administration of data records on background storage, and finally offline utilities are included for software generation.

The application of System 12 to a computer-based integrated manufacturing system in a factory environment is shown in Figure 6. This system uses both existing System 12 modules (e.g. ISDN modules, maintenance and peripherals modules,

Figure 6
Fully integrated factory automation system.

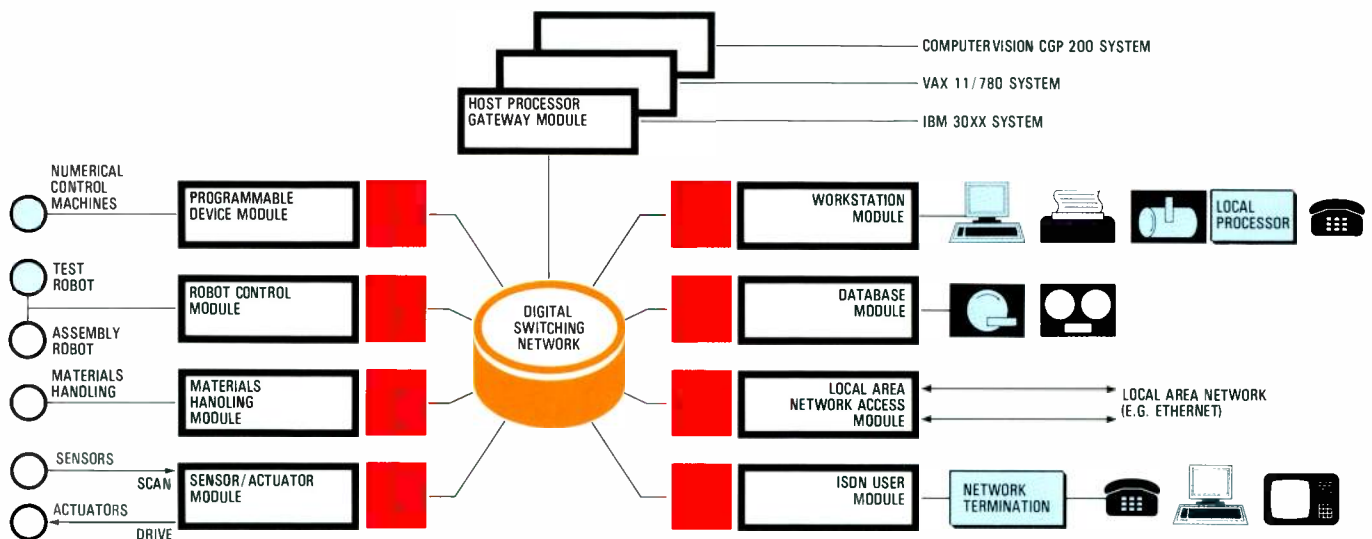

clock and tone module, auxiliary control elements) and new System 12 modules designed specifically for the factory application. New modules include a host processor gateway module, workstation module, sensor/actuator module, robot control module, and materials handling module.

Implementation of a fully integrated and automated factory system can be realized in a series of evolutionary steps. First the existing subsystems (mainly mainframes and workstations) can be interconnected. Second the system can be enhanced by adding a data management system to automate work at the engineering/business level and at the office level. Finally process

control of the production lines can be incorporated.

Conclusions

The System 12 architecture has proved to be expandable from switching applications into a total system that provides information processing and storage in addition to communication. As a result it can be used to realize a truly "open communication and control system" in OSI terms. Specifically, it is open in relation to new facilities, new services, and new applications. Above all it is equally applicable to both private and public environments.

System 12

Future Direction

System 12 has the ability to survive change so that unlike conventional switching systems it does not rapidly become obsolete. The introduction of advanced technologies, wideband and broadband switching, integrated factory and office systems, and special services overlay networks are some of the ways in which System 12 can be used as we approach the information society of the 21st century.

B. J. Fontaine

ITT Europe Inc, Brussels, Belgium

Introduction

Mankind's ascent from primitivism to an advanced civilization is based on a unique ability to adapt to changes in his environment, whether those changes are in climate, needs, or other circumstances. In turn this adaptability is founded on another unique faculty of mankind — the ability to gather information and apply it to the solving of problems. Each new stage of civilization has been characterized by major steps in our understanding of the world in which we live, and the consequent development of new technologies to help sustain the growth of mankind.

Despite the dramatic changes of the industrial revolution, which totally altered working practices and society, technological evolution was taking place at a snail's pace compared to current advances in every field of technology. By 1800, man's sum total of knowledge was doubling every 50 years. By 1950 it was doubling every ten years, and by 1970 every five years. Today it is estimated that the world's total knowledge base is doubling every two or three years.

The key to this rapid expansion of knowledge during the 20th century lies in the fields of communication, which has provided man with the means of sending many types of information around the globe, and computing, which allows information to be processed rapidly and accurately. Man soon harnessed these technologies to fulfill his expanding expectations. The result was a global telephone network and a proliferation of specialized data networks capable of linking one or more parts of an organization that needed to use the stored data. For some years this situation was

acceptable as computing was a specialist skill that required many years of training, so that relatively few people needed to transmit data on even a national scale. Today, however, the situation is again changing rapidly with the introduction of powerful microcomputers into most offices and the need for a wide range of new telecommunication services, such as high speed facsimile and videotex, and the setting up of massive databases in many parts of the world.

The next stage — which brings us to the threshold of what has become known as the information revolution — is to provide wider access to these services and databases by setting up a "universal" communication network to replace the many diverse networks already in place. System 12 was designed as an integral part of this revolution. Its ability to carry voice and data services (both narrowband and wideband) on a common switching network allows users to select the most appropriate mode of communication for their needs rather than forcing them to choose a less than optimum solution. This concept, which System 12 was designed to support, is that of the integrated services digital network or ISDN.

At present only in its infancy, the ISDN is expected to permeate the world's telecommunication networks over the next two decades. By the year 2000 the present telephone network will be totally transformed providing everyone with easy and reliable access to an unsurpassed wealth of information and services. The result could be a dramatic increase in the literacy of mankind and a many fold increase in his total store of knowledge.

System 12 and the Information Revolution

This issue of *Electrical Communication* has clearly demonstrated that the ISDN is not a distant dream, but is a near reality with field trials and pilot services underway in some countries and many more at an advanced planning stage. Current thinking is that the transition from the present essentially analog telephone network to the ISDN will require two decades or more, taking us well into the 21st century. History has shown that such estimates are frequently on the conservative side, and recent experience has borne this out. It was anticipated that in view of the large investment in existing transmission plant the introduction of fiber optic transmission systems would be slow despite their clear advantages. In practice the rate of installation has exceeded the most optimistic forecasts, and is continuing to accelerate.

System 12 was created for the ISDN and to help bring the realization of an ISDN closer. The first step — the simultaneous carrying of voice and narrowband non-voice (data) services — has already been demonstrated in trials. In the next stage, wideband data services, that is services that

require bandwidths of up to 1920 kbit s^{-1} , will be carried. Already the Deutsche Bundespost is planning a nationwide satellite system in which System 12 exchanges will be used to switch data at this rate. Beyond the implementation of a wideband ISDN looms the promise of a broadband ISDN capable of switching data at rates of up to 140 Mbit s^{-1} .

As the information revolution gathers pace there will be a need for new services, new ways of disseminating and processing information that cannot yet be foreseen. Perhaps the major advantage of System 12 is that it has been designed for just this situation. New modules for new services can be designed and connected to a System 12 exchange in the same way and as easily as existing modules. There is no penalty for late implementation of a new service, and any additional processing power that may be required is added incrementally with the modules. The constraints associated with central control of telecommunication switching systems have been eliminated.

It has already been indicated that System 12 allows much wider access to and distribution of information than has been possible hitherto. However, the unique

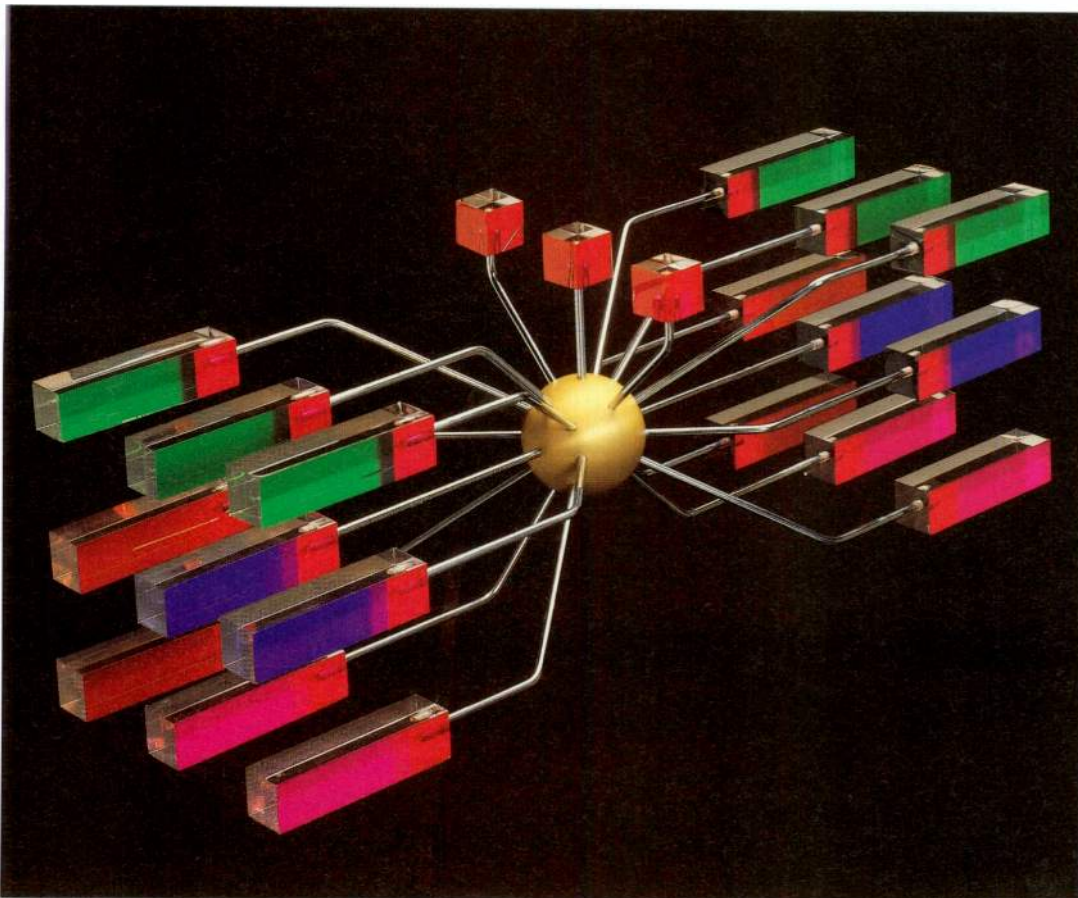

The modular System 12 architecture provides the flexibility that is necessary to allow its use in a wide range of new applications. These are not restricted to telecommunication, but include integrated systems for banking and factory automation.

System 12 architecture can be used in many other applications. Rapid advances in technology in all spheres has led to the development of many terminals and devices capable of performing a multitude of specialized tasks. Unfortunately few of these devices are able to communicate effectively with one another, so if the information output from one system needs to be input to another it is frequently necessary to transfer the information manually. System 12 now makes it possible to overcome these limitations by acting as a communications hub for such devices. In this way it is possible to produce specialized systems for banking or factory automation, to name just two examples currently being studied.

One thing that should be emphasized in this context is the versatility of the System 12 architecture to meet a wide range of applications. In the field of public telephone switching, System 12 will use distributed control; indeed, ITT anticipates that control will be further distributed to the

subscribers' premises in the future so that eventually there will be a microprocessor per subscriber line. However, the modular System 12 architecture with its standard interfaces is also well suited to other applications as discussed later in this article. In each case the System 12 architecture allows an appropriate solution to be realized.

Technological Advances

One of the main achievements of System 12 is that it can take advantage of improved technologies as they become available. Examples of current changes driven by improvements in VLSI technology can be found elsewhere in this issue^{1 to 5}.

Such recent developments as single-chip 32-bit microprocessors and 1 Mbit memory are already affecting System 12 development. In the longer term, further changes will take place based on continuing reductions in the feature size of VLSI circuits and the advent of new integrated circuit technologies. Present trends indicate that over the next decade feature sizes will be reduced from 1 μm , which represents the present edge of technology, to perhaps 0.1 μm . This will mean that instead of being able to package one million transistors on a chip, as has already been done in the laboratory, it will become practicable to pack well over 10 million transistors on a chip (Figure 1). Over the same period the processing speed of microprocessors is likely to increase from around 1 million instructions per second to in excess of 10 million instructions per second (Figure 2).

Evolution in these areas will be used by System 12 in three main ways. First to reduce equipment size, power consumption, and heat generation, and to improve system performance and reliability. This will enable administrations to make even better use of exchange floor space, and to reduce operations and maintenance costs, thereby cutting the overall lifecycle cost of ownership. Second, the higher functional complexities of VLSI circuits will make it possible to provide new services and facilities. On-board testing and diagnosis could be greatly improved, systems based on speech recognition and synthesis could be used routinely instead of being laboratory showpieces, and systems could include computer-aided instruction to help users to make optimum use of the available facilities. Third, VLSI circuits with millions of transistors operating at millions

Figure 1
Reducing integrated circuit feature size and increasing chip complexity.

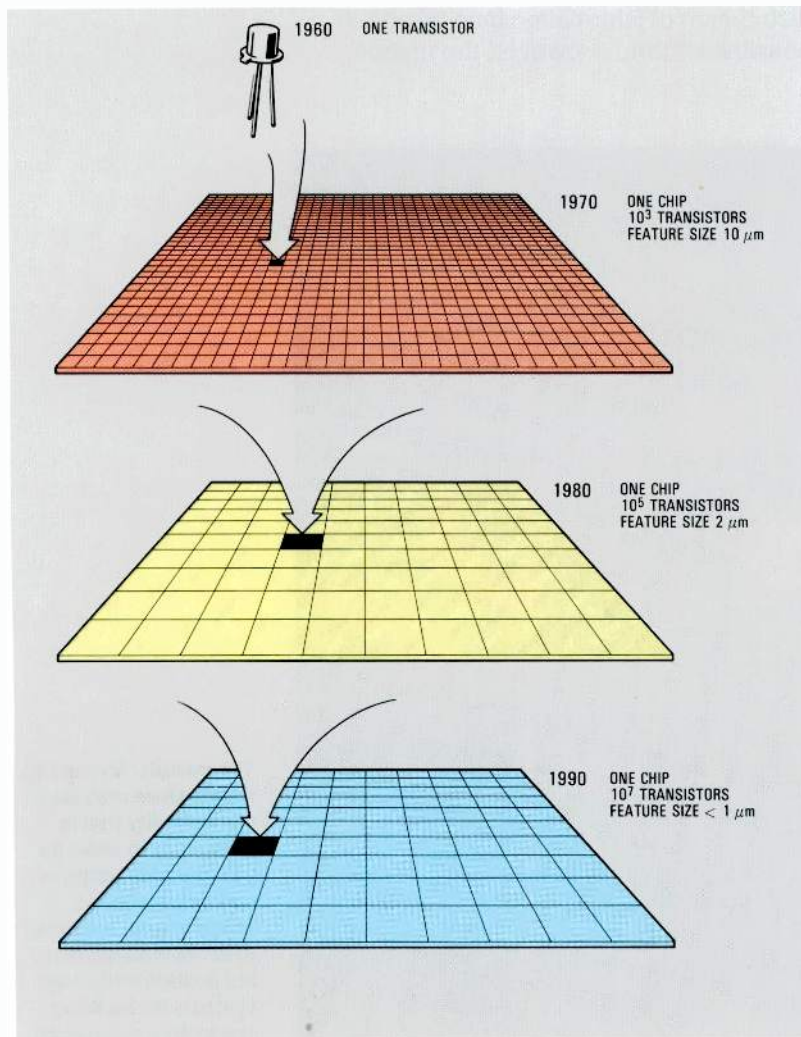

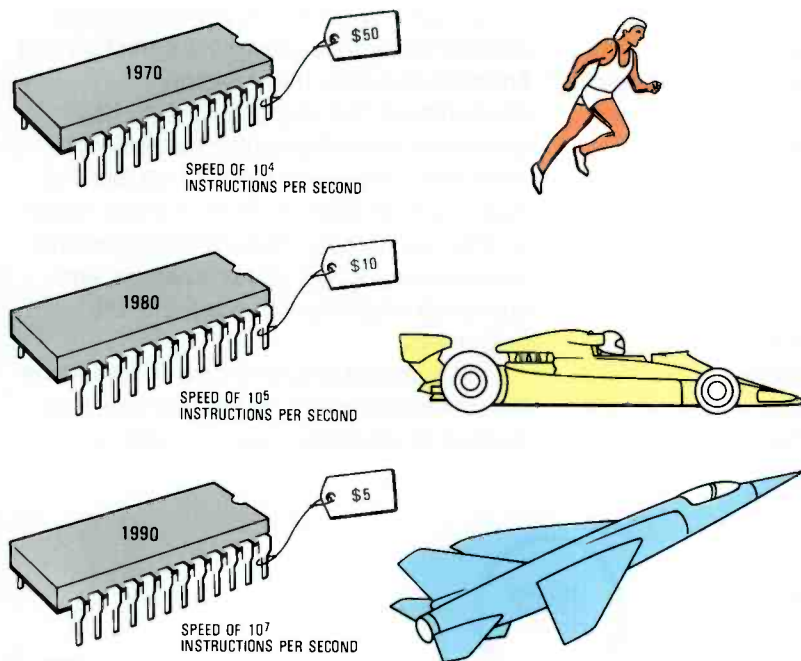

Figure 2
Increasing processing
speed over two
decades.

of instructions per second will allow new hardware and software architectures to be conceived and implemented. Today's microprocessors are based on the principles of the Von Neumann machine. New processing architectures such as associative arrays and systolic arrays hold out the promise of performance improvements of 50 or 100 times compared with current architectures, as well as being fault tolerant and especially suited to tasks such as signal processing. Again, the System 12 architecture will readily allow advantage to be taken of these major improvements in processing technology as they become available.

These technological advances will all result in changes to System 12 hardware and even software. Exactly how and when is difficult to predict, but change there will be. At present 1024 analog line circuits can be accommodated in a single System 12 rack. Next we may have 4000 lines, or 10000 lines, or . . . , who knows? Some crystal ball gazers are even predicting that the next century will see entire "systems on a chip".

One general way in which ITT is dedicated to using technological advance in System 12 is to improve human factors engineering. Today many advantages of modern office systems, for example, are being wasted because they are not easy to use. In the parlance of human factors engineers, they are not "user friendly". All of us who have struggled with a complex new piece of software on an office microcomputer will understand this

problem. However, it is a problem that has arisen as much as a result of technological limitations as from the inability of some software designers to see the need for ease of use and constant feedback of information to the user. Now the technological constraints are being lifted as a consequence of the availability of more complex, higher speed VLSI circuits, enabling software designers to implement the latest results of research into human factors. Not only will future systems be more powerful, but ITT is dedicated to designing them so that they are easier to use. Were this not the case it would prove impossible to harness the power of new systems to help us in our everyday tasks and the information revolution would founder.

New Applications for System 12

Not only is System 12 future safe in terms of technology and services, it is also "application safe" in that it can be utilized for both telecommunication and non-telecommunication applications. Several future applications for System 12 have been discussed in this special issue of *Electrical Communication*, including wideband switching in the German satellite system⁶, digital cellular mobile radio systems⁷, and a digital business communication system (digital PABX)⁸.

System 12 allows businesses to integrate the diverse communication networks that have grown up as a result of individual departments, divisions, or subsidiaries "going their own way" in order to fulfill specific requirements as and when necessary. Many organizations have long realized this as a far from desirable state of affairs, but there has been no clear path to solving the problem. Today System 12 can offer a cost-effective solution to corporate communications as it has the ability to carry both voice and non-voice services. Also there are considerable advantages in private networks using the same equipment as the public network. The business user is able to choose the most economic implementation for his network. In areas of high usage or where there are specific business-related requirements the user can install a private network based on System 12, but where usage is relatively low and only public ISDN services are required, he can choose to interface directly with the public System 12 network in order to access those

services. Conversely, administrations can utilize their extensive knowledge of communications to extend their equipment and service offerings into areas at present largely covered by corporate networks.

Broadband Switching

Although the wideband ISDN with its ability to carry services with bandwidths of up to 1920 kbit s^{-1} is adequate for many applications, there will be an increasing need for higher speed services operating at bit rates of up to 140 Mbit s^{-1} . This is the field of the broadband ISDN which will open up a

Two such applications currently being studied in depth are factory automation and financial services. In the factory environment, the use of a System 12 communications hub could revolutionize manufacturing ideas, opening up exciting new business opportunities. It could result in improved quality, reductions in the time lag between design and production, and improved relations with suppliers and customers.

One example of such a system appears in the preceding article. In another example System 12 could be used to create an

Figure 3
Integration of a future broadband switch with System 12.

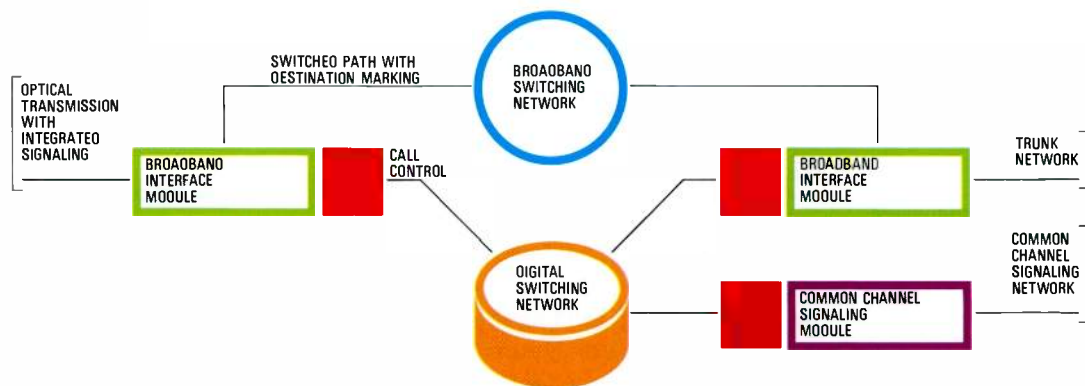

whole wealth of advanced services. The System 12 digital switching network is unable to carry such high rate data, but a broadband digital switching network which can handle these rates is already under development. This new switch will be served by existing System 12 modules such as the maintenance and peripherals module and the clock and tone module, while new broadband modules will be developed based on the standard architecture. Figure 3 shows how broadband switching could be integrated within System 12.

Factory and Financial Business Applications

System 12 goes far beyond being simply a sophisticated and cost-effective communications network. It can act as the hub of a complete business system that allows all the various functions in a business to interwork effectively. The fundamental concept is that System 12 integrates the switching and transport functions with the processing functions, enabling information to be located and accessed, transported at the appropriate time to the location where it is to be processed, the results to be transferred to the next process, and so on.

integrated computer-aided design and manufacturing system. By utilizing common information for many different functions from design to testing, materials ordering, manufacture, invoicing, and despatch it is possible for an industry to provide a better product and an improved service to the customer.

In the financial services field, banks have been among the biggest investors in computers and advanced communication equipment over the past two decades. Large mainframes have been required to process the huge amounts of data that banks have to deal with every working day, much of which has to be transported physically to data processing centers. Now there is an alternative. System 12 makes it possible to integrate mainframe computing with communications facilities, as illustrated in Figure 4. Another approach enables System 12 to be used to realize a banking system based on distributed data processing and distributed databases with their advantages of incremental extension, increased reliability, and greater flexibility. No longer will it be necessary to transfer all data physically to a large data processing center. Instead most of the processing can be done locally; only the data that is required

Figure 4
Integration of mainframe computing and communication based on a System 12 installation with wideband and broadband switching capabilities.

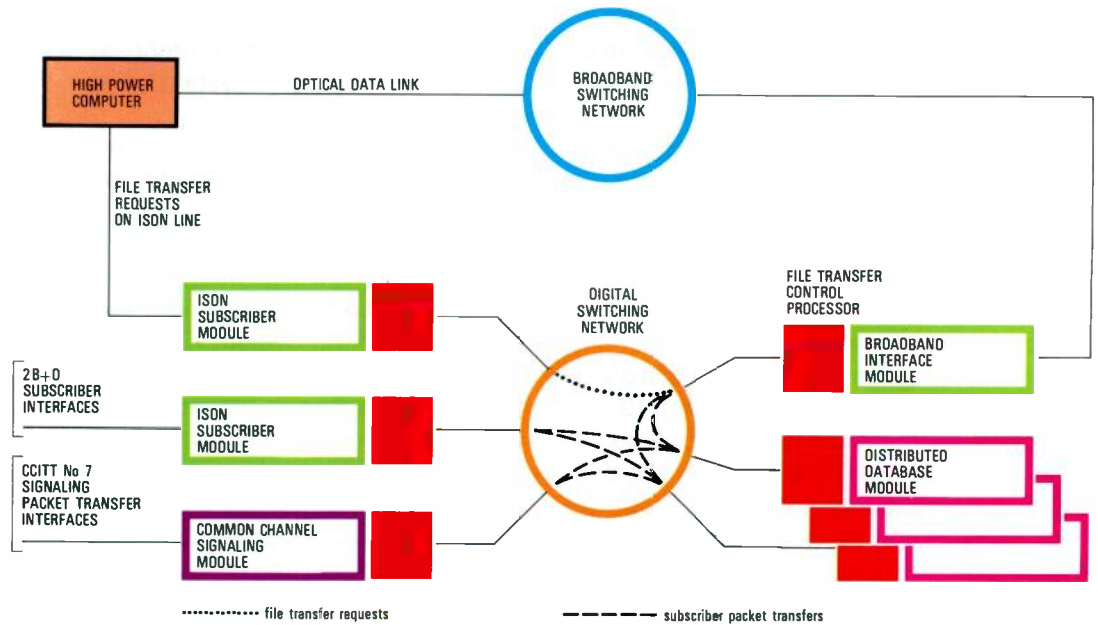

elsewhere need then be distributed over the network. Another advantage of this approach is that it opens up a whole range of new services, enabling banks to offer to each customer a range of services carefully tailored to his needs.

Whatever the application, System 12 offers two approaches. The first, which will perhaps be used extensively in the near future, is to connect existing equipment via a System 12 module which can provide the necessary protocol, speed, and format conversions to enable otherwise incompatible equipment to work together. The second approach involves developing specialized System 12 modules for the

tasks to be performed by the overall system. These modules could be developed either by ITT or by a third party who can easily connect his equipment to the System 12 hub via the standard interfaces.

Special Service Overlay

One of the major problems inherent in providing ISDN services to all subscribers connected to all exchanges, within a reasonable timeframe, is the enormous investment in existing electromechanical and stored program control switching systems, many of which have been installed in the past five to ten years and therefore have a long service life ahead of them. This

Figure 5
Special services overlay configuration which could be used to provide subscribers with new services while preserving the investment in existing analog exchanges.

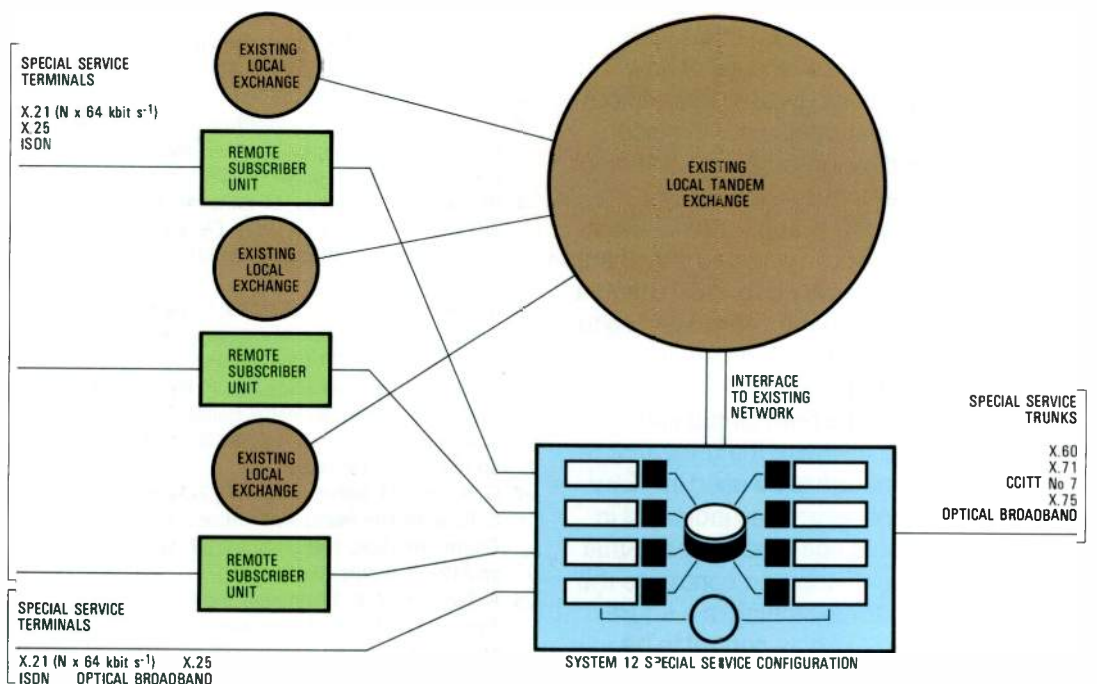

undepreciated plant cannot be written off lightly, but the expectation is that as the new services become available subscribers will want to be able to use them and administrations will wish to provide them to increase revenue. It is of little comfort to know that a wealth of ISDN services is available if the local administration cannot connect them into your home or business.

One approach being studied to overcome this obstacle is known as the special services overlay, as illustrated in Figure 5. In this case a special service System 12 configuration interfaces with the existing network and provides the new services that the old network is unable to handle. This is a cost-effective approach as it allows existing exchanges to be used to handle voice traffic until they reach the limits of their capacities or come to the end of their service lives.

This approach allows subscribers to take early advantage of new services, while at the same time administrations benefit from increased revenues from the new services without having to scrap undepreciated plant.

Conclusions

The potential of System 12 is enormous. So far ITT has only just begun to study in detail a few of its many applications in public networks, business, industry, and service organizations. As this article concludes the special issue on System 12 it is worth recounting a few of the features of System 12 that have resulted in such a wide range of applications.

First it is future safe. The modular architecture with its standard interfaces makes it easy to take advantage of new technology and to add new services without affecting the equipment already in place. This is supported by incremental addition of processing power for new services.

Second System 12 is application safe. It is equally capable of carrying and switching voice and non-voice services; it can handle narrowband and wideband information up to 1920 kbit s⁻¹ in an ISDN; it will provide support for a future broadband switching network; it can handle both circuit and packet switching. All these features ensure that it is flexible enough to be used in a very wide range of applications, as indicated in this article. It should again be stressed that although ITT sees distributed control as the correct approach for switching in a future ISDN, and indeed expects control to be further distributed to subscriber terminals,

System 12 can also provide central control facilities where these are appropriate — another example of the system being application safe.

Third it is not only a communication network but a system capable of integrating the operations of many businesses and industries at many levels. A user may need simply to rationalize his many disparate communication networks which have grown up over the years: System 12 offers an effective means of achieving this aim. On the other hand, he may wish to integrate the complete operation of a factory: again System 12 offers an effective solution.

The System 12 development has resulted in a new modular switching architecture, new VLSI devices, and a new equipment practice. In the software area some 1.5 million lines of code have been written for software tools, state-of-the-art programming techniques and new standards and procedures have been developed, new high level language (CHILL) compilers have been built, and a complete infrastructure has been introduced for software manufacture and configuration management. Together these form an unparalleled foundation on which to base the development of new applications. At the same time they ensure a long future for System 12 — a future that will help to fuel the information revolution as we approach the twenty-first century.

References

- 1 R. Cohen: System 12: Technological Enhancement: *Electrical Communication*, 1985, volume 59, no 1/2, pp 29–34 (this issue).
- 2 R. H. Mauger: System 12: Architecture for Change: *Electrical Communication*, 1985, volume 59, no 1/2, pp 35–42 (this issue).
- 3 J. Danneels and A. Vandevelde: System 12: Analog Line Circuit: *Electrical Communication*, 1985, volume 59, no 1/2, pp 43–47 (this issue).
- 4 W. Frank, M. C. Rahier, D. Sallaerts, and D. C. Upp: System 12: Dual Switch Port: *Electrical Communication*, 1985, volume 59, no 1/2, pp 54–59 (this issue).
- 5 R. Dierckx and J. R. Taeymans: System 12: ISDN Line Circuit: *Electrical Communication*, 1985, volume 59, no 1/2, pp 105–111 (this issue).
- 6 K. Nigge, K. Rothenhöfer, and P. Wöhr: System 12: Switching for the German Satellite System: *Electrical Communication*, 1985, volume 59, no 1/2, pp 137–144 (this issue).
- 7 G. Adams, M. Böhm, and K.-D. Eckert: System 12: Cellular Mobile Radio Applications: *Electrical Communication*, 1985, volume 59, no 1/2, pp 212–219 (this issue).
- 8 A. Bessler, M. E. Edelmann, and L. Lichtenberg: System 12: ITT 5630 Business Communication System: *Electrical Communication*, 1985, volume 59, no 1/2, pp 179–187 (this issue).

Contributors to This Issue

G. Adams was born in Mortsel, Belgium, in 1946. He studied at the University of Leuven where he graduated in 1971. Two years later he joined BTM as a METACONTA* 10C software design engineer, then in 1976 he became involved in the design of call handling software for the Metaconta 10CN exchange. Since 1980 Mr Adams has been a system engineer involved in System 12.

Domenico Ardizzone was born in Milan in 1946. He studied mechanical engineering at the Technical Institute of Varese, where he was awarded a diploma, and advanced mechanical technologies at an advanced engineering school in Milan where he received his degree. Between 1967 and 1970, he worked on power generation, and pipeline and pumping stations. Mr Ardizzone then joined FACE where he has worked on both electromechanical switching equipment and, more recently, the development and introduction of System 12. He is at present involved in product engineering in the FACE Switching Division.

Dietrich Becker was born in Frankfurt/Main in 1935. He studied communication engineering at the Technical University of Darmstadt, and then worked as an assistant at the University where he was awarded a Dr-Ing degree in 1966. He then joined SEL where he has held a number of posts in the central laboratory, and also in the Research Center where he was manager of the Systems Division. In 1982, Dr Becker took over as manager of systems engineering in the research and development department; his responsibilities include ISDN and data communication.

George Becker was born in 1932. In 1958, he received a Dipl-Ing in electrical engineering from the Technische Hochschule in Darmstadt. After working at AEG on hardware development, he joined SEL in 1960. He worked for three years on general software development before joining the Switching Division where he has been involved in the development of software for SPC switching systems, including Metaconta 10C, EWS, and System 12. In 1972, Mr Becker became manager of the software department, and in 1979 was made System 12 software manager with responsibility for System 12 software development at SEL.

Alfons Bessler was born in Stuttgart, West Germany, in 1936. He studied telecommunication at the Technical High School in Esslingen, graduating in 1962, and then joined SEL. After working on the HE 60 quasi-electronic public exchange system, and spending some time at ITT companies in the USA, he joined the development team for the HERKOMAT* PABX. In 1971 Mr Bessler became head of project management for PABX development. Then, in 1978 he took charge of PABX hardware and software development; since 1982 he has been the design center manager for SEL's new digital business communication systems.

Marcel Beyltjens was born in Antwerp, Belgium, in 1946. He graduated in electronic engineering at the Technical High School of Antwerp in 1967, then spent 10 years with Manufacture Belge de Lampes et de Matériel Electronique where he worked on microprograms for business computers. Later on his work included recovery aspects of a multiprocessor telephone exchange. In 1978, Mr Beyltjens joined the ITC in Brussels, where he was appointed manager for System 12 software top level design, responsible for the System 12 software architecture. He is now a member of the programming integration team as manager, product management.

Manfred Böhm was born in Schlewecke, Wolfenbüttel, in 1934. He studied telecommunication in Darmstadt and Berlin from 1954 to 1960. In 1960 he started work with Standard Elektrik Lorenz in the field of digital remote control, but soon changed to radio navigation systems, with special emphasis on digital signal processing. In 1977, Dr Böhm became director RD & E for navigation systems; since 1980 he has been director RD & E for radio and navigation systems.

Joseph A. Broux was born in Munsterbilzen, Belgium, in 1931 and graduated in electronic engineering at Liège University. He joined BTM in 1957 as a development engineer working in the field of electronic public switching systems. In 1972 he assumed system design responsibility for Metaconta 10C, later becoming product manager. In 1983 Mr Broux joined the System 12 development team as an implementation manager responsible for the System 12 project in Denmark.

P. A. Caballero was born in Cordoba, Spain, in 1943. He graduated as ingeniero electromecánico at the Escuela Técnica Superior del ICAI, Madrid, in 1966, then took a postgraduate course in automation at the Ecole National Supérieure de l'Aéronautique, Paris, where he was awarded the degrees of MSc and PhD. After working at the Centre d'Etudes et Recherches en Automisme, Paris, Dr Caballero joined the Research Center of Standard Eléctrica in Madrid. He is at present manager of the systems technology department at the Center, and is also a professor of graduate and postgraduate courses at the Escuela Técnica Superior del ICAI.

Augustin Campos Flores was born in Torrijos, Toledo, in 1944. He was awarded a Licenciado degree in physics from the University of Madrid in 1966, and joined Standard Eléctrica in 1969. Three years later he became involved in digital switching with the PCM-B project at LCT. Subsequently he returned to the Research Center of Standard Eléctrica, and was responsible for the PCM-B model installed in Madrid in 1977. After a period working on System 12 at the ATC, Shelton, he returned to SESA where he has been involved in the design of small System 12 exchanges and their remote operations and maintenance.

* A trademark of ITT System

F. Casali was born in Milan, Italy, in 1947. He studied physics at the University of Milan, graduating in 1971. From 1969 to 1974 he worked as a project leader in the electronic switching laboratory of Telettra. He then joined SECI as head of their development laboratory. In 1976 Mr Casali joined FACE where he is currently responsible for network planning studies.

Alain Chalet was born in Brussels in 1946. He graduated in 1969 from the Université Libre de Bruxelles as a civil engineer in mechanics and electronics, and the following year in applied mathematics and computer sciences from the Institut de Mathématiques Appliquées de Grenoble. He then joined Philips working on the development of operating systems, compilers, and telecommunication applications. In 1982, Mr Chalet joined the ITC where he is now manager for product system design, responsible for ISDN developments.

Richard S. Chiapparoli was born in Scranton, Pennsylvania, in 1949. He was awarded an AS in electrical engineering from Pennsylvania State University in 1969, a BS in electrical engineering from Spring Garden College in 1972, and an MS in electrical engineering from Stevens Institute of Technology in 1976. He worked at Bell Laboratories developing the traffic service position system before joining ITT's Advanced Technology Center in 1979. Mr Chiapparoli has been involved in the device handler, database, network handler, and operating system areas of System 12. As manager of System 12 software development, he is responsible for System 12 generic software development at the ATC.

Roger Cohen was born in 1935. He graduated with the degree of Licencié ès Sciences at Paris University, and as an electrical engineer at the Ecole Supérieure d'Electricité de Paris. He joined ITT in 1964 following a period as supervisor at Northern Telecom. Prior to coming to Europe. Mr Cohen worked at the ITT-CM switching R&D laboratory, the Puerto Rico Telephone Company, and as a member of the ITT technical staff in New York and Brussels. He is now technical director, system design, for System 12 based at the ITC in Brussels.

John E. Cox holds an MS degree in computer science from Stevens Institute of Technology. He has held several engineering management positions in both design and operating capacities. At the Western Union Telegraph Company he was responsible for the domestic satellite and digital data switching programs. When he joined the ITT Advanced Technology Center he was responsible for initiating and guiding the development of System 12. Mr Cox is at present acting as director of customer systems engineering in the sales department of ITT Network Systems Division in Raleigh, North Carolina.

Johan M. Danneels was born in Aalter, Belgium, in 1949. He received an MS degree in electromechanical engineering and a PhD degree in electronics from the Catholic University, Leuven, in 1972 and 1976, respectively. In 1983 he obtained a master's degree in business administration from the Boston University, Brussels. Dr Danneels joined the Research Center of BTM in 1976 where he is now manager of the microelectronics laboratory.

M. Della Bruna was born in 1946 in Serino, Italy. In 1972 he graduated in electronic engineering at the Technical University of Naples where he was subsequently professor of electronic devices until 1978. In 1974 he joined the telecommunication division of Selenia SpA where he worked on hardware, software, and system design for digital communication and control equipment and computer networks. Dr Della Bruna joined the Design Center of FACE Sud in 1978 where he was hardware and system manager for the Acilia project. He is now the FACE Design Center Manager for System 12, responsible for coordinating the development of local, toll, and combined exchanges.

F. J. de los Rios was born at Reinosa, Spain, in 1940. He graduated at the Escuela Técnica Superior de Ingenieros de Telecomunicacion, Madrid, in 1964, then worked for two years on computer applications at NCR in Madrid. In 1966 he joined the Research Center of Standard Eléctrica where he has been involved in the application of computers to network planning and the planning and control of manufacturing activities. Mr de los Rios is currently manager of the development group in the systems technology department at the Research Center.

G. De Wachter was born at Lubumbashi, Zaire, in 1949. He graduated in 1971 as an electrical and electromechanical engineer at the University of Leuven. In 1972 he was awarded a degree in applied economics, and the following year he received an MBA from the University of Chicago. He then joined the data processing department of BTM where he worked on retrieval systems before being made responsible for the design of a control system for the laser trimming of hybrid microelectronic devices. Since 1977 Mr De Wachter has been involved with the software engineering of System 12, and more recently has provided technical assistance for System 12 marketing. He is at present head of the system design group for switching applications.

R. Dierckx was born in Wilrijk, Belgium, in 1956. He studied industrial engineering at the Catholic Industrial Highschool, Antwerp, where he was awarded a degree in 1978. Three years later he obtained a degree in electrical engineering from the Catholic University, Leuven. After military service, Mr Dierckx joined the Research Center of BTM where he has worked on feasibility studies relating to the implementation of VLSI circuits. He is also interested in VLSI architectures and digital signal processing.

Reiner Drignath was born in Braunschweig in 1950. He graduated in 1974 from the University of Stuttgart with a Dipl-Ing in electrical communication. From 1974 to 1982 he worked at the Institute for Telecommunication at the University of Stuttgart where he was awarded the degree of Dr-Ing in 1983. Dr Drignath joined SEL in 1982, where he is currently manager of ISDN system design.

K.-D. Eckert was born in 1932 in Blankenburg/Harz, Germany. He studied electrical communication engineering at the Technical University of Berlin, and in 1959 was awarded the degree of Dipl.-Ing. He joined SEL in 1965 to work in the fields of radio navigation and communication, with responsibility for the development of civil and military navigation aids, including the microwave landing system. Subsequently Mr Eckert became head of systems planning and advanced development group in SEL's radio navigation R & D department, responsible for the conception and development of the CD900 digital mobile radio system.

Manfred E. Edelmann obtained a degree in electrical and electronic engineering in 1966 from Badische Ingenieurschule, Karlsruhe. He joined SEL in 1960 where he worked as a laboratory engineer on international toll systems. From 1972 to 1975 he was responsible for testing the Herkomat III electronic PABX, then in 1976 became a project manager in charge of the development of a medium-size software controlled PABX. Since 1982 Mr Edelmann has been head of a software development department which is responsible for the ITT 5630 BCS application software.

Per Erlandsson was born in 1928 in Kumla, Sweden. He studied at the Royal Technical University in Stockholm, then in 1955 joined L. M. Ericsson where he worked in the department for telephone exchange exports. In 1963 he joined SRT in Stockholm where he participated in the development of the rural PENTACONTA* system PC32. When this system was transferred to BTM he moved with it to Antwerp. In 1971 he was seconded to SESA, Madrid, as manager for PCM32 PCC. Mr Erlandsson was transferred to SEK, Horsens, in 1979 to work as technical secretary to the technical director. He is at present closely involved in the introduction of System 12 in Denmark.

Miguel Fernandez Moreno was born in Madrid in 1939. He studied at Madrid University, graduating in 1960 as Ayudante de Ingeniero de Telecomunicación, and in 1966 as Ingeniero Superior de Telecomunicación. In 1956 he joined Standard Eléctrica where he worked in the Rotary and Pentaconta switching system engineering departments. Mr Moreno also worked in the traffic engineering group and the system engineering group at the Standard Eléctrica Research Center during development of the Metaconta system, as well as with the marketing directorate of the electronic switching department. At present he is manager of the Systems Engineering Division for System 12 in SESA.

Bernard J. Fontaine was born in 1939 at Valenciennes, France. He graduated from Lille University with a degree in applied mathematics, then joined ITT in Paris in 1963 working for the data systems group as a software engineer. After a three year assignment to BTM working on the development of Metaconta 10CX, he had several assignments in the technical departments at ITT headquarters in Brussels and New York. Mr Fontaine joined the ITC in 1976, and in 1979 became director, exports, at CGCT in Paris, returning to ITTE headquarters in 1982. He is currently product line manager for switching.

* A trademark of ITT System

Willi Frank was born in Germany in 1945. In 1968 he graduated in electrical engineering and in 1973 was awarded a Dipl.-Ing in telecommunication at the Technical University of Darmstadt. He then joined SEL as a development engineer, and was subsequently appointed group leader for the hardware design of digital exchanges, with responsibility for the System 12 digital switching network and the design of LSI/VLSI circuits. Mr Frank is at present head of the department for test program design. He is a member of the NTG.

Lorenz Gasser was born in Yugoslavia in 1927. From 1944 to 1950 he worked in a mine in the Soviet Union. Subsequently he was employed for three years in a power station in Württemberg. He then studied at the Staatliche Ingenieurschule, Frankfurt, and in 1956 graduated as a telecommunication engineer. Mr Gasser subsequently joined SEL where he has been engaged in the development of transmission and switching technologies. He is at present head of the laboratory for transmission and advanced development in the private communications group.

Lester A. Gimpelson received BS, MS, and EE degrees in electrical engineering from the Massachusetts Institute of Technology where he held the position of instructor. He was a supervisor at Bell Telephone Laboratories before joining ITT New York in 1968. Mr Gimpelson transferred to ITT Europe in 1973 where he is now technical director, telecommunications systems, at ITT Europe's headquarters in Brussels. He is also executive editor of ITT's technical journal, *Electrical Communication*.

Frans Haerens was born in 1941 in Zwevegen, Belgium. He graduated in electrotechnical and electronic engineering in 1962, and two years later joined BTM as a computer design engineer for Metaconta 10C exchanges. Subsequently he participated in the hardware and software design of telephone and data systems including the PCM-B exchange, System 12, and packet switching developments. Mr Haerens is now responsible within the BTM System 12 design center for processor, peripherals, and LSI design. His main system responsibility is for the ITT contribution to the CCITT No 7 common channel signaling development.

K. J. Hamer-Hodges was born in England in 1945. He was awarded a CNA degree from Portsmouth Polytechnic in 1967. He has 15 years international experience in the field of telecommunication switching, gained from computer controlled switching products developed in the United Kingdom and the USA, and is recorded as an inventor of the System 12 digital switching system. In 1982/83 Mr Hamer-Hodges was responsible for the integration and system test of the first System 12 toll exchanges. He currently works at the ITC in Brussels on the coordination of System 12 generic program products for ITT worldwide.

Steiner Husby was born in Spydeberg, Norway, in 1941. After spending three years with the Royal Norwegian Air Force working on aircraft systems and radio link communication, he graduated as an electrical

engineer from the Göteborgs Tekniska Institut in 1964. Mr Husby then joined the STK Tele Division where he has since been involved in several multinational development projects within ITT in France, England, and Norway. He is now manager for technical support and CAD/CAM within the division.

Timothy Israel was born in Batavia, Indonesia, in 1947. He studied at the College of Electronics Engineering in Hilversum, Netherlands, where he received a degree in 1971. Two years later he joined SEL where he worked on hardware and software development of electronic switching systems and key systems. In 1982 Mr Israel became head of the digital telephone development group responsible for ISDN telephone activities.

Dagobert Klein was born in Stuttgart in 1937. After studying telecommunication at the University of Stuttgart and receiving the Dipl-Ing degree, he joined SEL. In 1972 he became a leader of the network laboratory for transmission products and today is head of development for transmission over the local network and data transmission.

Manfred Langenbach-Belz was born in Frankfurt in 1944. He graduated in 1968 from the University of Stuttgart with the degree of Dipl-Ing in electrical communication. From 1969 until 1974 he worked at the Institute for Switching and Data Techniques at the University of Stuttgart. His main interests were PCM techniques, simulation, telecommunication theory, and queuing theory applied to computers and communication networks. In 1973 he graduated as a Dr-Ing. The next year Dr Langenbach-Belz joined SEL where he worked on the development of SPC systems before becoming manager of the System 12 Design Center at SEL. He is a member of the NTG.

Leo Lichtenberg was born in Cologne, West Germany, in 1942. He studied electronics and telecommunication at the Staatliche Ingenieurschule in Cologne and graduated in 1967. He joined SEL in the same year, working on the development of PABXs. Following a period in the USA where he participated in the development of ITT's first stored program control PABX, he was made responsible for the peripheral control functions of the Unimat 4080 development. Since 1979 he has participated in an ITT study group for the next generation PABX systems. Mr Lichtenberg is currently head of the system design department and system design manager for the ITT 5630 BCS.

Jan Loeber was born in Germany, but moved to the United States when 10 years old. He studied physics at university, graduating with an MB degree. He spent two years with IBM, then two years as a lieutenant in the army before being assigned to the Pentagon. After a period as a systems analyst in the United States civil service, he joined the Security National Bank, becoming vice president, management information systems development. Mr Loeber then became head of finance industry marketing for AT & T, where he held a number of posts including director of product management for

PABXs and Centrex, and finally that of executive director for all AT & T PABXs and processors. Jan Loeber then joined ITT, and recently moved to ITT Europe as a vice president and director of market and product management for telecommunications and electronics.

R. H. Mauger was born in Castleford, England, in 1943 and graduated in electrical engineering from London University. He worked with Plessey for nine years, ending as system design manager of the Ptarmigan tactical communication system for the British Army. After three years with Philips in Holland, Mr Mauger joined the ITC in Brussels where he has been system design manager for System 12 since 1979, with overall responsibility for the evolutionary development of System 12.

Herbert May was born in Jena in 1949. After studying at the Universities of Bochum and Stuttgart, he graduated in 1975. He then worked for the Institut für Elektrische Nachrichtentechnik at the University of Stuttgart as an assistant in the field of microelectronics. In 1981 he was awarded the degree of Dr-Ing for work on low temperature electronics. Dr May then joined SEL as manager for the development of digital subsets and key systems. He is at present design center manager responsible for ISDN development.

Fabio Minuti was born in Pontedera, Italy, in 1947. He graduated in electronic engineering in 1973 at the Technical University of Pisa. The following year he joined the technical department of Italcable where he worked in the telephone switching and signaling area on the system definition and installation of new telephone exchanges. He is also involved in a traffic engineering study of the Italcable network. Since 1981 Mr Minuti has been coordinator for the development, installation, and cutover of the System 12 international toll exchange of Acilia.

Guillermo Morales Andrés was born in Madrid, Spain, in 1946. He graduated as Ingeniero Superior de Telecomunicacion in 1969 from the Universidad Politécnica de Madrid, then joined the traffic studies group of the Standard Eléctrica Research Center. He has been project leader for dimensioning Pentaconta and System 12 exchanges. Mr Morales is at present manager of the studies group of the systems technology department.

Jürgen Nenz studied computer science at the Technical University of Karlsruhe where he was awarded the degree of Dipl-Inform in 1976. The same year he joined SEL, and was seconded to work on the ADX6100* software project at IDEC in the United Kingdom. On returning to SEL he was responsible for software support and maintenance during the market launch of this product. In 1980 Mr Nenz became software quality assurance manager in SEL's central quality department, and was also involved in developing System 12 software. He was appointed software development manager at SEL Berlin in 1983 with responsibility for developing software for the ISDN pilot project.

* A trademark of ITT System

K. Nigge was born in 1928. He studied electrical communication at the Technical University of Aachen and joined SEL in 1962 as development engineer for public switching. He has worked on digital switching at SEL from the very beginning. Mr Nigge is in charge of a department for special switching networks and is SEL design center manager for the German satellite system development.

Luigi Peli was born in 1931 and joined FACE in 1947. He has been closely involved in engineering activities, and was head of engineering for electromechanical switching. In 1968 he became involved in the introduction of electronic switching techniques, and has since participated in the design and development of systems such as Mini PCM, System B, Metaconta, and System 12. Mr Peli now holds the position of product engineering manager within the FACE Switching Division.

Robert E. Pickett graduated from the Carnegie Institute of Technology in 1950 with a degree in electrical engineering. Subsequently he held several systems engineering and marketing positions in the North Electric Company, now part of ITT. In particular he was responsible for the initiation and systems planning of the ITT 1210 digital switching system. Mr Pickett is at present director, advanced systems planning, at the ITT Network Systems Division in Raleigh. He also serves on a number of industry committees, technical panels, and advisory groups.

Michel C. Rahier was born in Namur, Belgium, in March 1953. He received a degree in electrical engineering and a PhD in microelectronics from the University of Leuven in 1976 and 1979, respectively. In 1980 he joined the ITT central laboratory research staff at Bell Telephone Manufacturing Company, Antwerp, where he has been active in the design of custom integrated circuits for telecommunication applications, including subscriber line circuit, switching network, and digital telephony. Dr Rahier is currently head of the VLSI design group at the BTM Advanced Research Center in Antwerp.

H. W. Renz was born in 1944 and studied electrical engineering at the University of Stuttgart. He was awarded the degree of Dr-Ing in 1977 with a thesis on miniature active thin film filters. The following year he joined SEL where he became head of the laboratory department responsible for active and passive filter design. Dr Renz is also engaged in the development of analog and digital transmission equipment, including components for an ISDN.

Ejner Rishøj was born in 1925 in Aarhus, Denmark. He joined JTAS in 1950 as a technician responsible for the installation and testing of crossbar exchanges. After further education and training he joined the company's central administration staff. He has participated in different national working parties to specify the requirements for new telephone switching systems in Denmark, in particular for System 12 exchanges. Mr Rishøj is now JTAS installation manager with responsibility for the introduction of System 12 in Jutland.

Bruno Rossi was born in Cuneo, Italy, in 1948 and graduated in electronics from Turin Polytechnic in 1973. The same year he joined FACE-Standard, and was seconded to work at STL in the United Kingdom. He returned to FACE in 1977 where he was responsible for the implementation of signaling and call control specifications for digital exchanges. Mr Rossi is now assistant to the director of the FACE Research Center with responsibility for a number of projects in the areas of ISDN, WISDN, PABX-LAN, and speech processing. He is also FACE's representative on CCITT study Groups VII, XI, and XVIII and the related national working groups.

K. Rothenhöfer was born in 1941 and studied communication and data processing techniques at the Technical University in Stuttgart. He joined SEL in 1967 as a hardware design engineer for private switching. Soon afterwards he changed to software design in which capacity he has been involved in software design for Metaconta 10C telex, EWS analog, and System 12. Currently he is in charge of a department designing software for the German satellite system.

Danny Sallaerts was born in Leuven, Belgium, in May 1957. He received an electronic engineering degree from the Catholic University, Leuven, in 1980. The following year he joined the microelectronics design group at BTM, Antwerp, where he is currently in charge of a VLSI project group. His main interests are in the design of digital communication circuits.

Robert S. Schaaf was educated at the Technological University of Delft, The Netherlands, where he received an MS in electrical engineering. During two years with Philips and 12 years with IBM, he held various product development and management positions in Europe and the USA, primarily relating to operating systems, communication architectures, and office products. Mr Schaaf joined ITT in 1980 as director of the Programming Technology Center, Stratford, then transferred to the ITC in Brussels as director for System 12 programming.

Siegfried Schmoll was born in Stuttgart in 1940. He received a Dipl-Ing degree from the University of Stuttgart in 1964, and then started work with SEL in the transmission system engineering group. Since 1972 he has been head of data transmission development and represents SEL in several CCITT study groups.

José M. Serrano Hernandez was born in Madrid, Spain, in 1946. He graduated from the ICAI Technical School in 1968 in industrial engineering. After working for the Spanish PTT on real-time applications for subscriber services, he joined Standard Eléctrica as a design engineer. Currently he is technically involved in ISDN activities at the Standard Eléctrica Research Center.

Jean R. Taeymans was born in 1949 in Antwerp. He studied electronic engineering at the University of Brussels where he was awarded a master's degree in 1971. He became involved in VLSI technology and design in 1976 when he joined the BTM Research Center, and was part of the design team for the System 12 line circuit. Mr Taeymans is at present head of the Research Center's VLSI feasibility and advanced design group, which is involved with both computer-aided design and gallium arsenide technology.

Sergio R. Treves was born in Torino, Italy, in 1936 and graduated at the Turin Polytechnic in 1960. He then joined ITT Federal Laboratories, following which he worked at CGCT on call charging and recording, and later at FACE-Standard on PCM transmission, electronic switching, and the CCITT No 6 system. He was project leader for an ITT PCM integrated switching and transmission system, before becoming scientific director of electronics at FACE-Standard. In 1977 he was appointed technical director of the FACE group. Mr Treves became a professor of electrical communication in 1968.

D. C. Upp was born in Columbus, Ohio, in 1941. He studied at the Ohio State University where he was awarded the degrees of BEE and MSEE in 1966 and 1967, respectively. In 1966 he joined the Ohio State Electro-Science Laboratory working on the development of satellite TDMA and active antenna array systems. Mr Upp joined North Electric in 1974 where he participated in the DSS development (now the ITT 1210); three years later he moved to the ATC where he has been responsible for digital LSI development for the ITT 1240 Digital Exchange.

Chris Vander Straeten was born in Ghent, Belgium, in 1946. He received the degree of civil engineer in electronics from Ghent University in 1970. After two years in teaching, he joined BTM where he became involved in software development for a PCM exchange. In 1975 he designed the architecture of a packet switching data communications system, and the following year took charge of software development for digital switching system local applications. Since the end of 1979 Mr Vander Straeten has been head of the generic System 12 software development group at BTM, as well as the BTM design center manager for System 12 software.

A. Vandeveld was born in Leuven, Belgium, in 1940. He was awarded an electronics engineering degree from the University of Leuven. In 1964 he joined BTM as a development engineer in the switching division. He has worked on the Metaconta 10C exchange as head of hardware development for toll and large local systems. From 1977 to 1981 Mr Vandeveld was responsible for system design of the Metaconta 10CN system. Since 1981 he has worked for the system design department on System 12 where he is involved primarily in the development of the System 12 analog line circuit.

P. Van Houdt was born in Mol, Belgium, in 1945. He graduated in electronic engineering from the Technical High School of Geel in 1969, then joined BTM as a software engineer in the Metaconta switching division. In 1973, Mr Van Houdt became responsible for the call processing software for all medium local Metaconta 10C exchanges. From 1977 to 1979 he was section head for all ITT 1600 processor-based generic operational software, and then joined the top level design team for System 12. He is now responsible for the maintenance subsystem in BTM's generic software design team for System 12.

Renaat Van Malderen was born in Brussels, Belgium, in 1935. He joined BTM in 1958 after graduating from the Hogere Technische School in Antwerp, Belgium, with a degree in electrical engineering. After several years working on fully electronic switching, he joined GTE in the United States where he continued to work on SPC switching system development. In 1969 he gained an MSEE from the Illinois Institute of Technology (Chicago), and subsequently received a PhD in applied science from the University of Ghent, Belgium, in 1976. In 1979 Dr Van Malderen joined the ITT Europe headquarters in Brussels where he is active in field support for digital switching.

J. J. van Rij was born in Oegstgeest, Netherlands, in 1948. He attended the Technological College in Haarlem, graduating in 1973. In the same year he joined SEL as a member of a design team working on the development of a digital switching network. In 1978 he moved to NSEM and was seconded to BTM in Antwerp for the development of the DPS 1500 packet switching system. Mr van Rij moved back to NSEM in 1981 where he is now responsible for development of the System 12 analog trunk module.

Manuel Villén Altamirano was born in Rute, Spain, in 1948. He graduated as Ingeniero Superior de Telecomunicacion in 1970 from the Universidad Politécnica de Madrid. The following year he joined the traffic studies group at the Standard Eléctrica Research Center where he has worked on traffic studies of Pentaconta and Metaconta systems. Mr Villén is in charge of traffic studies for System 12. He has taught mathematics and given a number of seminars on simulation to postgraduate students.

B. Vinge was born in Drammen, Norway, in 1943. He was awarded a BSc in electrical engineering from the University of Strathclyde, Glasgow, in 1968 and then joined STC as a switching development engineer working on the Pentaconta and Metaconta 11B systems. Mr Vinge joined STK in 1972 where he has worked on various switching development projects, primarily semi-electronic and processor controlled systems. He is currently responsible for the public switching technical department at STK.

H. Weisschuh was born in Germany in 1943. He studied electrical engineering at the University of Stuttgart. Between 1970 and 1977 he worked at the University's Institute of Switching and Data Techniques on the design of an experimental digital switching system. In 1977 he was awarded a Dr-Ing degree with a thesis on the software for this experimental system. Dr Weisschuh joined SEL in 1977 where he has since worked on the development and integration of System 12 software.

P. Wöhr is 54 years of age. After studying electrotechniques at FHT Esslingen, he joined SEL in 1955 and was involved and responsible for various hardware and software development projects. Mr Wöhr is a senior engineer and department manager for switching and transmission systems development at SEL. He is at present responsible for System 12 hardware development, including the digital trunk module.

Abbreviations in this Issue

A	- analog	DES	- digital echo suppressor
AA	- associative array	DFS	- Deutsches Fernmelde-Satelliten-System (German satellite system)
AC	- alternating current	DIP	- dual-in-line package
ACE	- auxiliary control element	DLS	- data load segment
ANM	- recorded announcement module	DMA	- direct memory access
ANPE	- switching unit for German satellite system (German acronym)	DMM	- digital multiservice module
APM	- administration and peripheral module	DPTC	- dual processor terminal controller
ARM	- access right model	DRAM	- dynamic random access memory
ASM	- analog subscriber module	DSE	- digital switching element
AT	- analog trunk	DSM	- digital subscriber module
ATC	- Advanced Technology Center, an ITT company	DSMD	- data submodel definition
ATM	- analog trunk module	DSN	- digital switching network
ATME	- automatic transmission measuring equipment	DT	- digital trunk
ASST	- Azienda Statale Servizi Telefonizi (Italian Telephone Administration)	DTKL	- digital trunk logic
		DTM	- digital trunk module
		DTMF	- dual tone multifrequency
		DTRA	- remote digital trunk
		DTRL	- digital trunk logic for the German Satellite System
BCS	- business communication system		
BHCA	- busy hour call attempts	ESC	- ITT Europe Engineering Support Centre, a British associate of ITT
BIMOS	- bipolar-MOS	EOS	- exchange OMUP subuser
BISDN	- broadband ISDN		
BLIC	- BIMOS line interface circuit	FACE	- FACE Finanziaria SpA, an Italian associate of ITT
BTM	- Bell Telephone Manufacturing Company, a Belgian associate of ITT	FAM	- frame alignment module
		FDMA	- frequency division multiple access
CAM	- content addressable memory	FIFO	- first-in/first-out
CAS	- channel associated signaling	FIT	- failure in time
CCITT	- International Telegraph and Telephone Consultative Committee	FMM	- finite message machine
CCM	- common channel module		
CD	- collision detection	GLS	- generic load segment
CEPT	- Conference of European Post and Telephone Administrations	GTAI	- management of transit traffic between Italcable exchanges (Italian acronym)
CHILL	- CCITT high level language for telephone switching		
CMOS	- complementary MOS	HDLC	- high level data link control
CPM	- computer peripherals module	HVX	- high voltage switch
CRC	- cyclic redundancy checking		
CSM	- conference service module	ILC	- ISDN link controller
CSMA	- carrier sense multiple access	INDETEL	- Industria de Telecomunicacion SA de CV, a Mexican associate of ITT
CSPDN	- circuit-switched public data network	IPP	- internal packet protocol
CTM	- clock and tone module	IRSU	- ISDN remote subscriber (switching?) unit
CTNE	- Compañia Telefonica Nacional de España (Spanish telephone administration)	ISDN	- integrated services digital network
		ISM	- ISDN subscriber module
D	- digital	ISO	- International Standardization Organization
DAM	- digital access module	ITC	- International Telecommunications Center, a Belgian Associate of ITT
DBCS	- database control system	ITM	- ISDN trunk module
DC	- direct current	ITSS	- Italcable telephone service supervision
DCC	- data communication computer		
DCM	- data communication module	JTAS	- Jydsk Telefon Aktieselskab (Danish operating company)
DCPI	- dual circuit/packet interface		
DEMUX	- demultiplex		

LAN	- local area network	SABM	- set asynchronous balanced mode
LAP	- line access protocol	SAPI	- service access point identifier
LED	- light emitting diode	SCM	- service circuits module
LSI	- large scale integration	SC/CCM	- service circuits and call control module
LT	- line termination	SEC	- small exchange configuration
LTF	- line transmission feed	SEK	- Standard Elektrisk Kirk A/S, a Danish associate of ITT
MCA	- multichannel aligner	SEL	- Standard Elektrik Lorenz AG, a German associate of ITT
MFCE	- multifunction control element	SE/MPM	- small exchange/maintenance and peripherals module
MMC	- man-machine communication	SESA	- Standard Eléctrica SA, a Spanish associate of ITT
MMI	- mismatch indication	SIC	- S-interface circuit
MOS	- metal oxide semiconductor	SIP	- Societa Italiana per l'Exercizio Telefonico pa (Italian telephone administration)
MPCT	- maintenance, peripherals, clock and tone submodule	SPATA	- speech or data
MPM	- maintenance and peripherals module	SPC	- stored program control
MLC	- medium-large exchange configuration	S.PCIM	- subscriber PCIM
MSI	- medium-scale integration	SRT	- Standard Radio & Telefon AB, a Swedish associate of ITT
MSO	- measurements and service observation	SSM	- system support machine
MUX	- multiplex	STC	- Standard Telephones and Cables plc
NACK	- no acknowledgment	STK	- Standard Telefon og Kabelfabrik A/S, a Norwegian associate of ITT
NOS	- NSC OMUP subuser	STR	- Standard Telephon und Radio AG, a Swiss associate of ITT
NMOS	- <i>n</i> -channel MOS	SWQA	- software quality assurance
NSC	- network service center	SYNC	- synchronization
NSD	- North Switching Division, a company of ITT	TAISEL	- Taiwan International Standard Electronics Limited, an associate of ITT
NSEM	- Nederlandsche Standard Electric Mij BV, a Netherlands associate of ITT	TA	- terminal adapter
NT	- network termination	TAU	- test access unit
NTA	- Norwegian Telephone Administration	TCE	- terminal control element
OBC	- on-board controller	TCF	- transcoder and filter
OBCI	- on-board controller interface	TDM	- time division multiplex
OIM	- operator interface module	TDMA	- time division multiple access
OMUP	- operations and maintenance user part	TEI	- terminal end point identifier
OSI	- open system interconnection	TH	- transaction handler
PABX	- private automatic branch exchange	TIM/A	- analog trunk module for international application
PBX	- private branch exchange	TIM/D	- digital trunk module for international application
PCIM	- packet channel interface module	T.PCIM	- trunk PCIM
PCM	- pulse code modulation	TRIMOS	- triac-MOS
PDM	- physical data model	TTL	- transistor-transistor logic
PROM	- programmable read-only memory	TTM	- trunk testing module
PSDN	- packet-switched data network	TUP	- telephone user part
PSPDN	- packet-switched public data network	TXGC	- transmit gain control
PSTN	- public switched telephone network	UIC	- U-interface circuit
PTIC	- China National Postal and Telecommunications Industry Corporation	VDU	- visual display unit
PTIM	- packet trunk interface module	VLSI	- very large scale integration
RAM	- random access memory	WISDN	- wideband ISDN
R&D	- research and development	WSM	- wideband subscriber module
RF	- radio frequency	WST	- wideband subscriber terminal
RIM	- remote subscriber unit interface module		
ROM	- read-only memory		
RSU	- remote subscriber unit		
RTT	- Regie van Telegrafie en Telefonie (Belgian telephone administration)		

This Issue in Brief

Loeber, J.

System 12: Market Status

Electrical Communication (1985), volume 59, no 1/2, pp 6–11

The innovative features of ITT's System 12 have ensured its rapid acceptance by telephone administrations throughout the world. The validity of the distributed control concept has already been proved in trials and acceptance tests, and System 12 exchanges are now carrying live traffic in eight countries. ISDN field trials are demonstrating that the exchange concepts are as applicable to non-voice services as to telephony. The author outlines the awards which have been received for System 12 equipment from administrations in 19 countries. Just three years after the first trial exchange was installed, these awards total over 10 million equivalent lines, making System 12 the world's fastest selling digital switching system.

Hamer-Hodges, K. J.; De Wachter, G.; Weisschuh, H.

System 12: Integration and Field Experience

Electrical Communication (1985), volume 59, no 1/2, pp 12–19

Already 25 System 12 digital exchanges have been installed in eight countries. The authors discuss the field experience which has been gained with those exchanges which have been in operation for six months to three years. Results to date are very encouraging, showing the basic advantages of the System 12 distributed control architecture. For example, system availability and call effectiveness have both proved better than the specifications, and the fault reaction of the system has always been limited to a small part of an exchange, clearly demonstrating the reliability of the architecture.

Van Malderen, R.

System 12: Review of the Fundamental Concepts

Electrical Communication (1985), volume 59, no 1/2, pp 20–28

System 12, the digital exchange developed by ITT, offers a number of revolutionary new features including fully distributed control, an intelligent digital switching network, and modular hardware and software. The author outlines the major features of System 12 ranging from the architecture, through the various system modules, to the software concepts. He also briefly describes the fundamental advantages of these concepts in terms of system expansion, evolution of features and technology, and flexibility to meet differing administration requirements. The article provides a review of System 12 as a basis for the following articles on system evolution, exchanges, and new applications.

Cohen, R.

System 12: Technological Enhancement

Electrical Communication (1985), volume 59, no 1/2, pp 29–34

Since the announcement of System 12 in 1981, evolutionary development projects in a number of areas have resulted in technological and service enhancements that will ensure that System 12 stays in the forefront of digital switching systems. In addition, System 12 has been used as the basis for a number of new applications ranging from a digital business communication system to switching for the German satellite system. The author provides an overview of the advances in technology, software, new services, and System 12 based products, which are being implemented. Taken together these demonstrate conclusively how the distributed architecture of System 12 enables the system to evolve, ensuring compatibility with the previous design and continued flexibility for future enhancement.

Mauger, R. H.

System 12: Architecture for Change

Electrical Communication (1985), volume 59, no 1/2, pp 35–42

Following completion of the initial system design of System 12 in 1980, an extensive programme of system evolution has been maintained. The objectives of this programme are to maintain the system at the state-of-the-art with regard to both VLSI technology and the requirements of ISDN. The author outlines the main successes of this programme which has resulted in a range of product developments and experiments that cover the whole scope of traditional and ISDN telecommunication system applications.

Danneels, J. M.; Vandeveld, A.

System 12: Analog Line Circuit

Electrical Communication (1985), volume 59, no 1/2, pp 43–47

The line circuits represent a substantial part of the total hardware of a digital local exchange, and are therefore a significant system component. Advances in LSI technology have made it possible to realize the analog line circuit as a number of integrated circuits, giving higher packing density and lower power consumption and heat generation, while meeting all the performance requirements. The authors describe the realization of the functions of the analog line circuit that enable it to meet the requirements of administrations worldwide.

van Rij, J. J.; Wöhr, P.

System 12: Analog and Digital Trunk Circuits

Electrical Communication (1985), volume 59, no 1/2, pp 48–53

Trunk circuits are of major importance in a digital switching system; they are the key to good interexchange operation, high speed, quality, and good network performance. The authors describe the features of the System 12 analog and digital trunk circuits, and outline how their performance has been further improved by implementing advances in VLSI technology. The analog trunks make considerable use of circuits developed for the analog line circuits. The digital trunk uses complex VLSI chips; on-board preprocessing is performed by a firmware driven microprocessor. The result is fewer VLSI components and wider usage of these components for the trunk circuits.

Frank, W.; Rahier, M. C.; Sallaerts, D.; Upp, D. C.

System 12: Dual Switch Port

Electrical Communication (1985), volume 59, no 1/2, pp 54–59

One of the achievements of the System 12 hardware design is that it allows full advantage to be taken of evolution and advances in semiconductor technology. The integration of more and more functions onto a single silicon chip reduces the number of components, decreases power consumption, and improves manufacturability. A first candidate for such an upgrade was the System 12 digital switching element. This has been enhanced by combining two individual switch ports into a single VLSI device, thus reducing the number of components. Although this dual switch port has several new features and improved testability, the digital switching element remains fully compatible with the earlier version.

Becker, G.; Chiapparoli, R. S.; Schaaf, R. S.; Vander Straeten, C.

System 12: Software

Electrical Communication (1985), volume 59, no 1/2, pp 60–67

Development of the software for System 12 involved meeting a number of requirements. The authors describe the principles used to produce functionally correct and complete software that is easy to adapt to changing requirements, while at the same time minimizing development and maintenance costs. These include three advanced software structuring techniques for achieving modularity: the concepts of virtual machines, finite message machines, and generic interfaces. Another major part of the software system is the relational database. These concepts are backed-up by comprehensive development rules and an impressive set of tools to support engineering activities.

Nenz, J.

System 12: Software Quality Assurance

Electrical Communication (1985), volume 59, no 1/2, pp 68–73

Modern switching systems, such as the System 12 Digital Exchange, are complex products with a large software content – generally representing more than 50% of the total development effort. Clearly software development has a major impact on how well such a product meets the specifications as well as on development costs. The author outlines the general principles of software quality assurance which were considered from the outset of the System 12 development, and discusses the defect prevention, detection, and removal measures which proved most effective in achieving the goals of providing a high quality software product and achieving improved programming productivity.

Morales Andrés, G.; Villén Altamirano, M.

System 12: Traffic Overload Control

Electrical Communication (1985), volume 59, no 1/2, pp 74–79

The System 12 Digital Exchange is able to handle overloads while maintaining a good performance. Overload control is provided for severe overloads to ensure a high throughput with a good grade of service for accepted calls under any traffic situation. The authors describe a design of overload control which takes into account the distributed structure of System 12. It has to cope with the overload of a network of processors, in which focused overload can affect a few processors at most. Accordingly, the overload control also has a distributed structure in which the detection mechanisms and the actions taken are spread among the appropriate processors. Simulation tests have proved the effectiveness of this approach.

Beyltjens, M.; Van Houdt, P.

System 12: Switching System Maintenance

Electrical Communication (1985), volume 59, no 1/2, pp 80–88

When introducing a totally new technology and architecture, maintenance facilities are among the key design considerations during development. The authors describe how maximum benefit has been taken of the advantages of digital technology and distributed control to realize a maintenance philosophy based on the rapid, reliable, and automatic detection of faults in the system, location and diagnosis of these faults, and the generation of alarms and detailed fault reports. When appropriate, an automatic recovery action is taken with minimal impact on live traffic.

Haerens, F.; Rossi, B.; Serrano, J. M.

System 12: ISDN Field Trials in the Belgian, Italian, and Spanish Networks

Electrical Communication (1985), volume 59, no 1/2, pp 89–97

The System 12 Digital Exchange was conceived as an integral part of a future ISDN, and thus incorporates many features that are well adapted to network evolution. ITT units in Belgium, Italy, and Spain have jointly developed an ISDN field trial configuration based on the System 12 Digital Exchange which will be implemented in these countries in cooperation with the local telephone administrations. The authors describe the common configuration for these field trials, and discuss the objectives of the trials.

Becker, D.; May, H.

System 12: ISDN Pilot Service of the Deutsche Bundespost

Electrical Communication (1985), volume 59, no 1/2, pp 98–104

The Deutsche Bundespost is planning an ISDN pilot service to give themselves, equipment suppliers, and potential users experience with the new facilities that will be provided. One of the two trials will be based on a local System 12 exchange enhanced with a digital multiservice module. In a later phase, a toll exchange will be included to test the ISDN user part of the CCITT No 7 common channel signaling system. The authors outline the basic standards with which the pilot service equipment must comply, and discuss the equipment that will be provided. They also consider some of the services to be included in the trial.

Dierckx, R.; Taeymans, J. R.

System 12: ISDN Line Circuit

Electrical Communication (1985), volume 59, no 1/2, pp 105–111

System 12 was conceived from the outset as the basis for switching both voice and non-voice services in an ISDN. The authors describe the design and implementation of the ISDN line circuit which, as part of the ISDN subscriber module, will make it possible to realize the full potential of System 12. The line circuit supports basic access on two 64 kbit s⁻¹ B channels for voice and data, as well as a 16 kbit s⁻¹ D channel for low speed data or signaling. The architecture meets the requirements of the OSI model for communication systems which defines hierarchical layers for the communication interfaces.

Chalet, A.; Drignath, R.

System 12: Data Module Architecture Including Packet Operation

Electrical Communication (1985), volume 59, no 1/2, pp 112–119

The modular structure of System 12 and its unique intelligent digital switch allow it to be easily enhanced to provide full support for ISDNs in countries throughout the world. One such enhancement to System 12 is the provision of processed packet switching in addition to circuit switching, thereby integrating all ISDN voice and non-voice services. The authors describe the new family of System 12 ISDN modules which supports these functions in a fully distributed manner, thereby avoiding the need for an expensive local or remote centralized packet switching resource.

Israel, T.; Klein, D.; Schmoll, S.

System 12: Configuration for ISDN Subscriber Equipment, Network Termination, Digital Telephones, and Terminal Adapters

Electrical Communication (1985), volume 59, no 1/2, pp 120–126

When ISDN is introduced into subscribers' premises, new wiring configurations based on the standard CCITT ISDN subscriber interface will be necessary to allow several active terminals to be connected simultaneously to one subscriber line. It will be possible to send calls directly to preselected terminals. The authors describe a configuration based on a four-wire line with which it is possible to build a bus and which is terminated by a network termination. A variety of new terminals for voice, data, facsimile, and video services may be connected to this new installation. A system with echo cancellation is used for transmission in both directions over two-wire subscriber lines. Existing terminals which are not able to work over the ISDN can be adapted to the ISDN by terminal adapters.

Gasser, L.; Renz, H. W.

System 12: Transmission at 144 kbit s⁻¹ on Digital Subscriber Loops

Electrical Communication (1985), volume 59, no 1/2, pp 127–130

CCITT has recommended that customer access to the ISDN should be based on a data rate of 144 kbit s⁻¹. To achieve this relatively high rate on existing subscriber lines, many of which were installed long before the widespread introduction of digital technology, is a challenge to system designers. The authors outline the problems involved in meeting the performance requirements on a wide range of line types, and describe a transmission system based on echo cancellation and digital signal processing. Hardware emulation and computer simulations have proved that the system has excellent performance. More extensive testing will be carried out in ISDN field trials in Belgium, Germany, Italy, and Spain. The system is currently being designed as a VLSI circuit.

Treves, S. R.; Upp, D. C.

System 12: Technique for Wideband ISDN Applications

Electrical Communication (1985), volume 59, no 1/2, pp 131–136

The System 12 Digital Exchange switches paths at a rate of 64 kbit s⁻¹. However, newly emerging services will require switched paths of greater bandwidth. This article describes a simple mechanism which uses the space bandwidth of the System 12 switching network and a newly designed hardware subsystem to produce coherent switched paths with a bandwidth of $n \times 64$ kbit s⁻¹. An experimental version has been demonstrated, and a custom VLSI implementation is now being designed.

Nigge, K.; Rothenhöfer, K.; Wöhr, P.

System 12: Switching for the German Satellite System

Electrical Communication (1985), volume 59, no 1/2, pp 137–144

The Deutsche Bundespost is planning to install a nationwide satellite communication system. Scheduled to go into service early in 1988, the system is designed primarily to provide new high-speed data services. The authors describe how existing units are being used to develop a small stand-alone exchange for switching these new single-channel and wideband data services. Part of the project covers the development of a multiplexer, again based on existing building blocks.

Della Bruna, M.; Minuti, F.

System 12: Acilia International Toll Exchange

Electrical Communication (1985), volume 59, no 1/2, pp 145–153

The key position of an international toll exchange in the global telephone network imposes special requirements on the system because of its high performance, complexity, size, flexibility, and availability. ITT's System 12 Digital Exchange meets these requirements as a result of its ISDN-oriented approach and modular architecture which allow the basic exchange configuration to be enhanced for the international application simply by adding new hardware and software modules. The Acilia project started in late 1980 and is now at an advanced stage; it has already been handed over, and FACE and Italcable are working together to complete the acceptance tests.

Broux, J. A.; Erlandsson, P.; Rishøj, E.

System 12: Aarhus Local-Transit Exchange

Electrical Communication (1985), volume 59, no 1/2, pp 154–158

As early as 1979, Jutland Telephone decided to start digitizing their telephone network. The System 12 telephone exchange of Aarhus, Jutland's main center and Denmark's second biggest town, is the key exchange in the company's plans. This article highlights the function of the System 12 Aarhus exchange within the framework of JTAS' overall digitization plans. The System 12 exchange of Aarhus is of special interest because of its exceptional size which makes it by far ITT's largest System 12 installation to date.

Langenbach-Belz, M.

System 12: Toll Exchanges for the German Network

Electrical Communication (1985), volume 59, no 1/2, pp 159–165

The Deutsche Bundespost decided in 1979 to establish a comprehensive programme for the introduction of digital exchanges into its network at the earliest possible opportunity. In the first stage of this programme, two System 12 toll exchanges were installed in the German network so that they could be evaluated during operation in a real network. The author surveys the requirements laid down by the Bundespost, the configuration of the System 12 toll exchanges, and the experience gained during installation and system and acceptance testing. He also discusses the field experience with both exchanges. As a result of this presentation programme, the System 12 Digital Exchange will be introduced into the German network.

Campos Flores, A.; Fernandez Moreno, M.

System 12: Collado-Villalba Digital Island

Electrical Communication (1985), volume 59, no 1/2, pp 166–173

System 12 has been used to realize a fully integrated digital rural star network centered at Collado-Villalba in Spain. The authors describe this application which covers switching nodes ranging from the main local-transit exchange down to 120-line remote subscriber units, parented by a 1000-line small exchange. In addition to the system commonality and the modern services and facilities offered by System 12, the Collado-Villalba network utilizes the CCITT No 7 common channel signaling system and a fully comprehensive network service center for area wide operations and maintenance. Network service center functions are supported by the CCITT No 7 operations and maintenance user part. Collado-Villalba is an example of the cost-effective application of advanced concepts to a rural network.

Husby, S.; Vinge, B.

System 12: Application of the Remote Subscriber Unit in the Norwegian Network

Electrical Communication (1985), volume 59, no 1/2, pp 174–178

As a result of Norway's geography with its long valleys and coastline, small islands, and scattered small population centers, the average size of a telephone exchange in the NTA network is around 300 lines. Thus in equipping the network with the System 12 Digital Exchange, considerable use will be made of the cost-effective remote subscriber unit. The authors describe how remote subscriber units will be used in the NTA network, and outline their features and construction, and in particular the techniques used to ensure that they operate reliably in the often severe Norwegian climate.

Bessler, A.; Edelmann, M. E.; Lichtenberg, L.

System 12: ITT 5630 Business Communication System

Electrical Communication (1985), volume 59, no 1/2, pp 179–187

The ITT 5630 digital business communication system, which is based on proven System 12 technology, cost-effectively covers the entire PABX size range from 60 to more than 10000 extension lines. Initially the ITT 5630 will be introduced as a voice communication system. However, enhancements for text and data handling up to full ISDN capability were considered as an integral part of system design and will allow further system enhancement.

Pickett, R. E.

System 12: Network 2000 Evolution in the United States

Electrical Communication (1985), volume 59, no 1/2, pp 188–194

The goal of a future ISDN able to support a wide range of voice and non-voice services is similar in the international and North American telecommunication communities. However, for a number of reasons the implementation in North America will differ in the short term, with several pre-ISDN arrangements. The author discusses these differences and the reasons for them, and looks at the way System 12 can be used in the North American network. In particular, the digital adjunct makes it possible to provide a wide range of ISDN features, including business line access services, common channel signaling, access to and transport of telemetry data, and business communication features.

Cox, J. E.; Pickett, R. E.

System 12: Role of the Digital Adjunct in Network Enhancement

Electrical Communication (1985), volume 59, no 1/2, pp 195–199

The transition from today's predominantly analog voice network to a future ISDN will be accomplished over many years. During this period it is essential to make optimum use of the investment in existing plant. The authors describe a concept using a digital adjunct to add new service capability to an analog host exchange; this will be used in the United States to overcome the problem. By associating a modular distributed control digital switching system with an existing analog exchange it is possible to extend the useful life of the analog equipment while introducing new services. This approach also enables an operating company to try out new services with minimal investment or adaptation of old switching plant.

Caballero, P. A.; de los Rios, F. J.; Casali, F.

System 12: Digital Network Planning

Electrical Communication (1985), volume 59, no 1/2, pp 200–206

Telephone networks are in a constant state of change as they are extended to meet increased demand and old equipment is replaced by more modern equipment that provides new features for subscribers and administrations. Digital network planning is essential if the correct decisions are to be made relating to future changes. From the many available options, the planner must determine the optimal solution – that is, a solution that offers the lowest cost of implementation and yet does not unnecessarily constrain further network evolution. The characteristics of the System 12 Digital Exchange were designed from the outset to simplify network planning by allowing small increases in processing capacity and easy addition of new features.

Arizzzone, D.; Peli, L.

System 12: Containerized Exchange

Electrical Communication (1985), volume 59, no 1/2, pp 207–211

In many cases the construction of a traditional telephone exchange is constrained by lack of building land, difficulties in obtaining building permission, economics, or the need to have a fully operational exchange very rapidly. The System 12 containerized exchange offers a single economic solution to these diverse problems. It allows a complete, unattended stand-alone exchange to be installed on-site within a few days. The authors describe the advantages of this approach, and the design of a containerized exchange for the Italian telephone administration SIP. This prototype exchange is now in service.

Adams, G.; Böhm, M.; Eckert, K.-D.

Cellular Mobile Radio Applications

Electrical Communication (1985), volume 59, no 1/2, pp 212–219

The fast growing interest in cellular mobile radio demands the rapid introduction of new systems. System 12 has proved a versatile contender for this new market, providing switching centers to connect the radio network to the public switched telephone network, as well as intelligent control equipment in each radio base station. The authors discuss the basic principles of a cellular mobile telephone service and the facilities offered. A network for Belgium based on the Nordic system, which uses frequency division multiple access transmission to the mobile telephones, and the new all-digital Franco-German CD900 using time division multiple access are described.

Gimpelson, L. A.; Treves, S. R.

System 12: Telecommunication Networks Beyond ISDN Transport

Electrical Communication (1985), volume 59, no 1/2, pp 220–227

Evolution of the global telephone network towards an ISDN is already underway supported by the introduction of advanced digital exchanges such as System 12. Further technological advances will eventually make it possible to introduce an even more sophisticated range of services based on wideband ISDNs (up to 2048 kbit s⁻¹) and broadband ISDNs (up to 140 Mbit s⁻¹). The impact of these new services will be felt in the home, in business, and on the factory floor. The authors discuss how the System 12 architecture can be expanded to provide a total information system capable of offering diverse services ranging from home entertainment, through teleconferencing and electronic mail, to a fully integrated factory automation system.

Fontaine, B. J.

System 12: Future Direction

Electrical Communication (1985), volume 59, no 1/2, pp 228–234

The converging technologies of communication and computers are changing the society in which we live, rapidly driving us towards what is becoming known as the information society. A major characteristic of System 12 is that it has been designed to live with changes in technology and to provide for the new services demanded by rapidly evolving private and business needs. The author takes a brief look at established technological trends and some current developments to see how System 12 might be enhanced in the light of future network changes, including the implementation of wideband and broadband ISDNs. He concludes that the modular architecture of System 12, which supports distributed control, will be a major force in the development of private and public telecommunication systems, as well as in non-telecommunication applications such as integrated factory and business automation systems.

Editorial Offices

Enquiries relating to the different language editions of Electrical Communication should be addressed to the appropriate editor, as follows:

English Edition

Editor: Michael Deason
 Deputy Editor: Rod Hazell
 Editorial Secretary: Pamela Brownjohn
 Subscriptions: Mary Lince
 Text Processing: Doreen Cullen

Otto Grewe
 Elektrisches Nachrichtenwesen
 Hellmuth-Hirth-Straße 42
 7000 Stuttgart 40
 Federal Republic of Germany

Jean Pierre Dartois
 Revue des Télécommunications
 30 Avenue George V
 Paris
 France

Electrical Communication
 Great Eastern House
 Edinburgh Way
 Harlow, Essex
 England

Antonio Soto
 Comunicaciones Eléctricas
 Ramírez de Prado 5
 Madrid
 Spain



System 12 Digital Exchange

Overview

Market Status

Integration and Field Experience

Review of the Fundamental Concepts

Technological Enhancement

Architecture for Change

Analog Line Circuit

Analog and Digital Trunk Circuits

Dual Switch Port

Software

Software Quality Assurance

Traffic Overload Control

Switching System Maintenance

ISDN Field Trials in the Belgian, Italian, and Spanish Networks

ISDN Pilot Service of the Deutsche Bundespost

ISDN Line Circuit

Data Module Architecture Including Packet Operation

Configuration for ISDN Subscriber Equipment, Network Termination,
Digital Telephones, and Terminal Adapters

Transmission at 144 kbit s⁻¹ on Digital Subscriber Loops

Technique for Wideband ISDN Applications

Switching for the German Satellite System

Acilia International Toll Exchange

Aarhus Local-Transit Exchange

Toll Exchanges for the German Network

Collado-Villalba Digital Island

Application of the Remote Subscriber Unit in the Norwegian Network

ITT 5630 Business Communication System

Network 2000 Evolution in the United States

Role of the Digital Adjunct in Network Enhancement

Digital Network Planning

Containerized Exchange

Cellular Mobile Radio Applications

Telecommunication Networks beyond ISDN Transport

Future Direction

ITT CORPORATION

The logo for ITT Corporation, consisting of the letters 'ITT' in a bold, stylized, serif font.

Volume 59
Number 1/2
1985