

42 N. J. C. Strington, N.J.

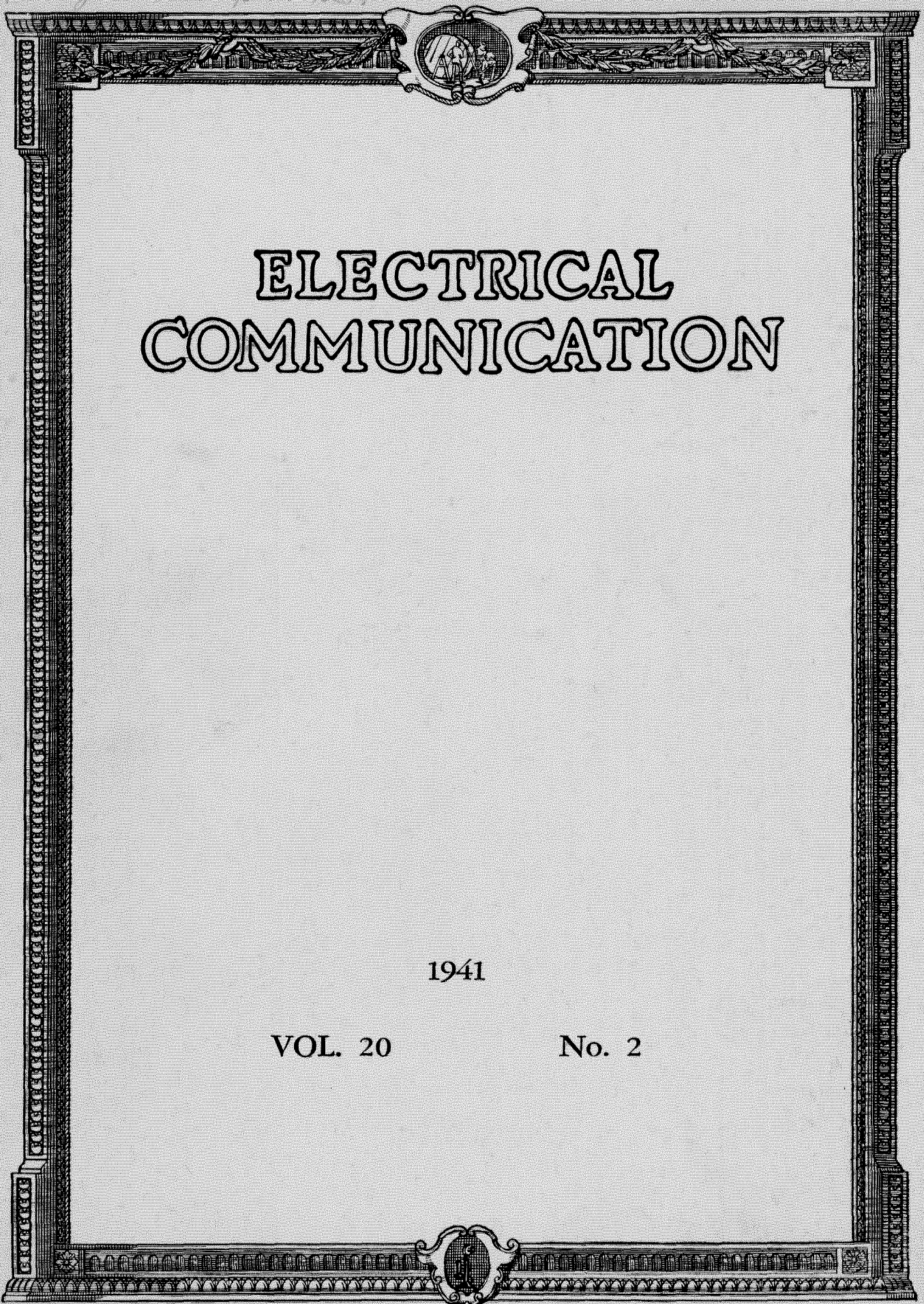

# ELECTRICAL COMMUNICATION

1941

VOL. 20

No. 2

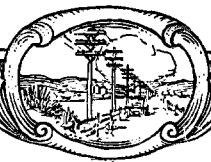

# ELECTRICAL COMMUNICATION

A Journal of Progress in the  
Telephone, Telegraph and Radio Art

H. T. KOHLHAAS, Editor

EDITORIAL BOARD

E. A. Brofos H. Busignies H. H. Buttner G. Deakin E. M. Deloraine Sir Frank Gill W. Hatton  
E. S. McLarn Frank C. Page H. M. Pease F. W. Phelan E. D. Phinney Haraden Pratt W. F. Repp

Published Quarterly by the

*International Standard Electric Corporation*

67 BROAD STREET, NEW YORK, N.Y., U.S.A.

H. M. Pease, President

S. G. Ordway, Secretary and Treasurer

Subscription, \$3.00 per year; single copies, 75 cents

Volume XX

1941

Number 2

## CONTENTS

	PAGE
A NEW MARINE RADIO UNIT FOR CARGO VESSELS .....	71
<i>By E. J. Girard</i>	
ELECTROMAGNETIC WAVES IN METAL TUBES OF RECTANGULAR CROSS-SECTION .....	73
<i>By John Kemp</i>	
12-CHANNEL CARRIER EQUIPMENT IN THE GÖTEBERG-MALMÖ CABLE .....	80
<i>By S. R. Nordström</i>	
ALARM AND CONTROL SYSTEMS—BANCO DE LA PROVINCIA DE BUENOS AIRES .....	88
<i>By W. White</i>	
DIRECTORY INFORMATION BUREAU—SHANGHAI .....	91
<i>By L. A. E. Mann</i>	
THE EFFECT OF SPACE CHARGE ON THE POTENTIAL AND ELECTRON PATHS OF ELECTRON BEAMS .....	100
<i>By D. P. R. Petrie</i>	
THEORY OF THE MAGNETRON .....	112
<i>By Léon Brillouin</i>	
POLICE RADIO IN MEXICO .....	122
SELENIUM RECTIFIERS FOR CLOSELY REGULATED VOLTAGES .....	124
<i>By J. E. Yarmack</i>	
PEDER OLUF PEDERSEN .....	133
TELEPHONE AND TELEGRAPH STATISTICS OF THE WORLD .....	136
RECENT TELECOMMUNICATIONS DEVELOPMENTS .....	140



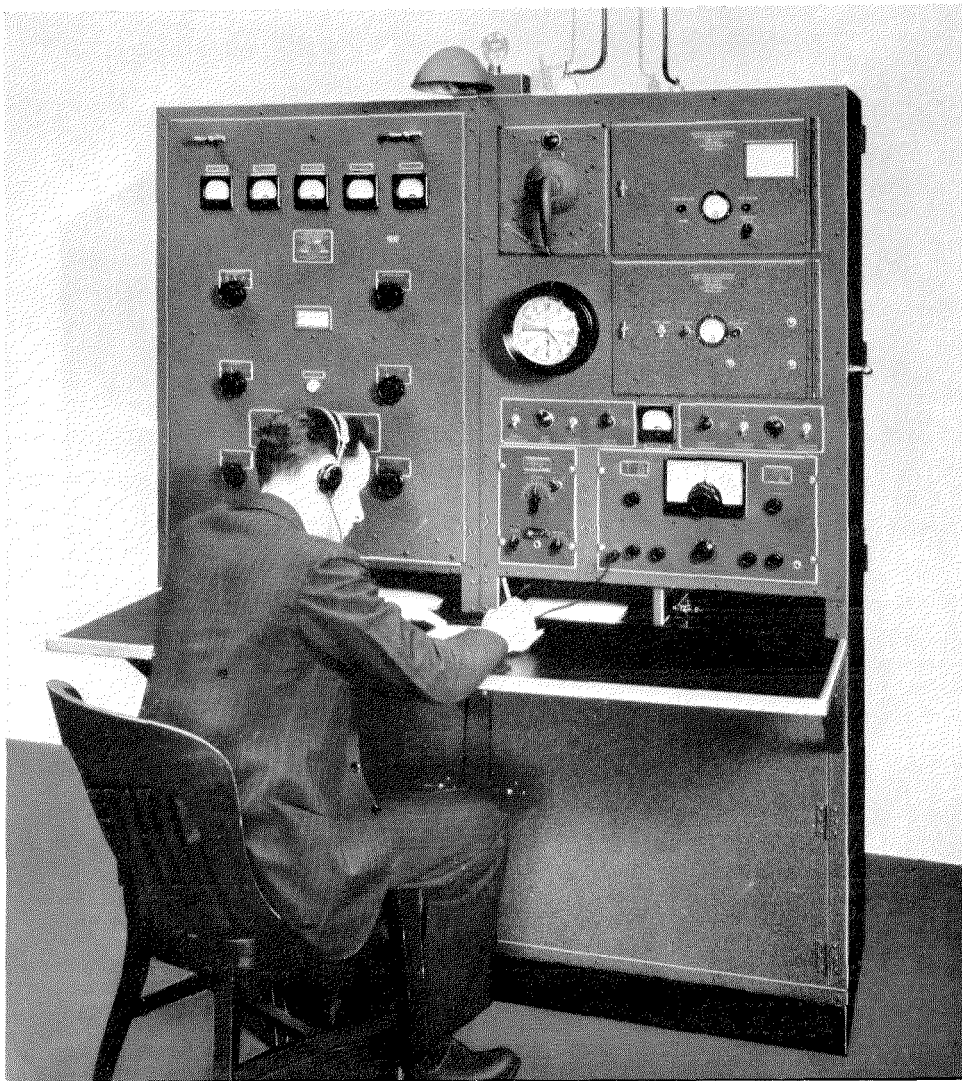

### A NEW MARINE RADIO UNIT FOR CARGO VESSELS.

THIS NEW DEVELOPMENT PROVIDES ALL NECESSARY FACILITIES FOR SAFETY AND COMMUNICATION PURPOSES AND COMBINES, IN A SINGLE COMPACT CABINET, EQUIPMENT WHICH ORDINARILY COMPRISES AS MANY AS TWELVE SEPARATE UNITS. INSTALLATION IS GREATLY SIMPLIFIED INASMUCH AS THE UNIT IS PRACTICALLY READY TO "PLUG IN" FOR POWER SUPPLY AND ANTENNA CONNECTION.

THE SET WAS DESIGNED AND IS BEING MANUFACTURED BY THE FEDERAL TELEGRAPH UNIT OF THE INTERNATIONAL TELEPHONE AND RADIO MANUFACTURING CORPORATION.

# A New Marine Radio Unit for Cargo Vessels

By E. J. GIRARD

*Federal Telegraph Company, Newark, New Jersey*

## **Historical**

**T**HE need for ship-to-ship and ship-to-shore communications, primarily involving safety considerations, provided the incentive which led to the early development of radio. Despite the fact that spectacular developments in radio during the past forty odd years have tended to obscure the importance of ship radio facilities in the public eye, marine radio nevertheless remains one of radio's most essential applications.

From 1914 on the Federal Telegraph Company has supplied marine radio equipment on a large scale, emphasizing efficiency, reliability and safety. It pioneered in the development of CW equipment of the arc transmitter type, and, in more recent years, in collaboration with the Mackay Radio & Telegraph Company, it offered to U. S. A. shipowners the first combined intermediate and high frequency transmitter, as well as the first transmitter contained in one panel capable of operating both from the ship's power supply and from a low voltage, high capacity emergency storage battery.

During the years 1920-37 the demand for ship radio facilities was mainly for additions or replacements to existing equipment rather than for complete new installations. For example, during this interval many 50 watt emergency transmitters were added to existing installations. The outlawing in 1930 of new spark transmitter installations, as well as obsolescence of such transmitters in service, created a substantial demand for intermediate wave tube type transmitters. The development of high frequency marine equipment led to the installation of high frequency transmitters and receivers on shipboard. Following the establishment of United States Government requirements in 1937, U. S. A. cargo vessels, with certain exceptions, have been equipped with auto alarm apparatus for the reception of the International Auto Alarm Signal.

Furthermore, during this period (1920-37), comparatively few new merchant vessels were constructed in the U. S. A. Ships actually built were of various designs and sizes and large scale standardization was not attempted.

Conditions prevailing during the past twenty years thus hardly encouraged departure from the established practice of "packaging" individual units in the form of transmitters, receivers, etc. Accordingly, on the majority of older vessels, installations, like Topsy, "just grew." On newer vessels, similarly, radio installations comprised various individual units more or less conveniently supported on tables or bulkheads. Interconnections were made at the time of installation, involving a lengthy and expensive procedure.

In 1936, the U. S. Maritime Commission succeeded the U. S. Shipping Board as the Government's shipping and shipbuilding organization and immediately initiated an ambitious construction program calling for the building of 500 ships over a ten year period. The resulting increased demand for radio facilities, however, was generally met by types of equipment already in existence.

An opportunity for the development of a complete unit, combining in a single cabinet all the ship radio facilities required, was presented by the inauguration of the emergency cargo vessel building program formulated by the Maritime Commission as part of the National Defense Program. The Federal Telegraph Company took advantage of this opportunity and has successfully concluded the development of a complete shipboard radio unit described hereinafter.

## ***New Marine Radio Unit***

A view of the new marine radio unit is shown in the Frontispiece. The equipment at the left is the main and emergency transmitter. When used as the main transmitter, the output on CW and MCW is in excess of 200 watts and 300 watts, respectively. When functioning as the emergency transmitter, the output is in excess of 50 watts. Hinging of the transmitter panel at the bottom enables it to be swung downward and provides ready accessibility for servicing, etc. Quick changeover can be effected on five predetermined frequencies in the operating range of 350 to 500 kc.

The antenna switch (see Frontispiece) is located in the right hand section of the unit; it

provides for auto alarm operation, direction finding position, main antenna and ground. The auto alarm panels comprise a receiver and a selector; they are shown to the right of the antenna switch and clock, respectively. Both can be swung forward providing complete accessibility from the front. The auto alarm unit operates continuously while the operator is off watch and is responsive to the International Auto Alarm Signal on the distress frequency of 500 kc.

Below the auto alarm are the controls for the battery charging and power facilities. The charging units are located towards the rear of the cabinet. A blower at the back of the cabinet circulates air corresponding to the number of chargers in use at a given time. Adequate ventilation and cooling are thus assured.

Two receivers are shown in the right hand section immediately above the operating shelf. The main receiver covers an operating range of 15 to 650 kc. It utilizes a tuned radio frequency circuit and is especially constructed for marine use. Suitable filtering and shielding insure freedom from electrical interference due to nearby equipment. The second receiver, situated at the left of the main receiver, is of the crystal detector type required by law. It serves as a standby in case the main receiver becomes inoperative. Both receivers can be pulled out from the front so that they are completely accessible.

The operating shelf is 18 inches deep and replaces the conventional radio room table.

Below the operating shelf, sections accessible through hinged doors house two motor generators. One machine energizes the transmitter at full power from the ship's mains; the other operates the main transmitter from a 24 volt storage battery.

### **Installation**

Installation of the combination unit equipment on shipboard consists chiefly in securing the unit in place in the radio room and connecting the

antenna and power leads. Estimates indicate that these operations can be completed in not more than one-fifth of the time necessary to install an equivalent installation of the ordinary type comprising separately placed transmitters, receivers, motor-generator sets, etc. The wiring problem, obviously, is greatly simplified. The importance of this saving in time and expense is apparent when it is considered that the installation of radio equipment on new vessels usually requires from six weeks to two months. Moreover, such installations tend to interfere with concurrent construction work on the ship itself. With the new Marine Radio Unit, on the other hand, practically all work on the ship can be completed prior to the time the radio room unit is placed in the position designated.

Important to naval architects and to others is the fact that radio room space requirements can be readily and accurately pre-determined.

When convenient for shipment or necessary for passage through doors or corridors on shipboard, the unit can be separated into two equal sections, each measuring  $69\frac{1}{2} \times 29 \times 19$  inches. The operating shelf is, of course, demountable.

### **Standardization**

The new combined unit standardizes the position of operating controls and thereby expedites and simplifies the training of radio operators. Regardless of the ship on which the equipment is to be installed, all controls are at the operator's finger tips in exactly the same relationship on each ship. Hence, servicing and operating instructions can be simplified and made more specific, and operators should find it easier to become familiar with the equipment.

As mentioned above, the new Marine Radio Unit resulted from the program of mass production of merchant vessels in the U. S. A. It is, however, suitable for any type or size of ship, and indications are that it will meet with a wide demand from ship owners and ship builders.

# Electromagnetic Waves in Metal Tubes of Rectangular Cross-section\*

By JOHN KEMP, M.I.E.E.

*Standard Telephones and Cables, Limited, London, England*

*The attenuation of electromagnetic waves propagated through the interior of metal tubes of rectangular cross-section is calculated by the familiar telephone transmission formulae, the top and bottom of the tube being regarded as zigzag flat-strip transmission lines while the side walls are regarded, when suitably disposed, as transmission lines of another type. From the losses occurring in these lines, the attenuation offered by the tube is obtained in a simple manner. The results are found to be in agreement with those established by more elaborate means by other investigators. The characteristic advantage of the method here described is its simplicity and the directness with which the final results emerge. The method also provides a link between electrical communication through the interior of hollow metal tubes and the transmission of waves along telegraph and telephone lines of conventional type.*

## (1) Introduction

WITHIN the last few years a number of contributions have been made to the subject of electromagnetic waves in hollow metal tubes. Although the existence of such waves has been known for a long time and although their theory was clearly stated in 1897 by Lord Rayleigh,<sup>1</sup> it is only recently that consideration has been given to them from the point of view of long-distance communication<sup>2, 3, 4, 5, 6, 7, 8, 12</sup> and that their attenuation has been calculated. The general formula for the attenuation of all types of waves in metal tubes of all cross-sections has been established by Schelkunoff.<sup>6</sup> Chu and Barrow<sup>7</sup> have also derived attenuation formulae for all types of waves supported by tubes of rectangular cross-section. The method followed thus far has involved the computation of the energy flow in the direction of the tube and the power losses in the walls by means of the Poynting flux theorem. It is proposed here to show that the same expressions for the attenuation can be derived from the ordinary telephone transmission formulae. Although this simple treatment of the problem can be applied only to one class of waves, it furnishes a link between the transmission of waves through hollow metal tubes and the transmission over telephone and telegraph lines of familiar type.

Electromagnetic waves in metal tubes are characterized by two essential features. There

is a minimum frequency below which no waves are supported by the tube. This minimum or cut-off frequency is determined by the shape and the size of the tube. As the wavelength of the cut-off frequency is of the order of the cross-sectional dimension of the tube, the frequencies of the possible waves—for air-filled tubes having dimensions in the centimetre range—are of the order  $10^9$  cycles per second and above. The second feature is that there is either an electric or a magnetic intensity in the direction of propagation of the waves, i.e., along the tube. For electromagnetic waves in free space the electric and the magnetic intensities are in planes at right angles to the direction of propagation. When, however, waves are restricted to the inside of metal tubes there is, in addition to the electric and magnetic intensities of the free-space waves, either an electric or a magnetic intensity in the direction of propagation. It is customary to use this additional property of these waves for their classification. When there is an electric intensity in the direction of propagation, the wave is designated an E-wave. When there is a magnetic intensity in the direction of propagation, the wave is designated an H-wave. Subscripts are used for further classification; thus the subscripts "*n, m*" designate a wave of order *n* and of mode *m*. The order and the mode of a wave are determined by the number of half or full sinusoidal variations of the electromagnetic field along certain specified directions of the cross-section. For a rectangular tube only half-sinusoidal variations are taken into account, so

\* Wireless Section I. E. E. paper. Reprinted from Part III, *Journal I. E. E.*, Sept., 1941.

that  $n$  designates the number of half-sinusoidal variations between the top and bottom walls of the tube, and  $m$  the number of half-sinusoidal variations between the two side walls of the tube. If the field does not vary between the top and bottom,  $n$  is zero and the wave is designated a zero-order wave.

The waves for which the attenuation will be considered here are H-waves of zero order, i.e.,  $H_{0,m}$  waves, and the cross-section of the tube is assumed to be a rectangle of height  $a$  cm. and width  $b$  cm. The principal wave of this class, i.e., the  $H_{0,1}$  wave, has been the subject of detailed study by Chu and Barrow.<sup>7</sup> As the cut-off frequency and the attenuation of this wave are lower than those of any other wave in a rectangular tube, it offers the best prospect for practical application.

Being of zero order, all waves of the  $H_{0,m}$  class are characterized by the fact that their

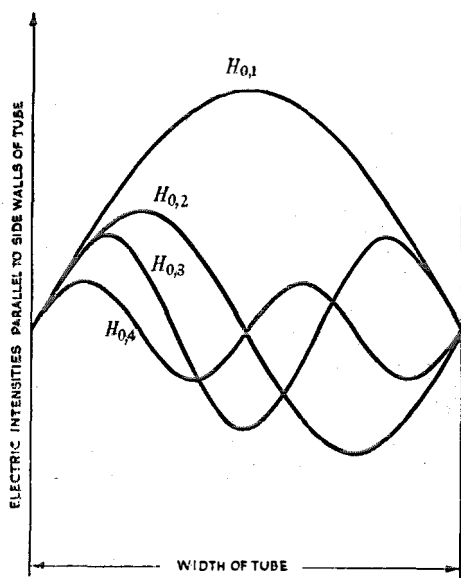

Fig. 1—Distribution of Electric Intensities of Some Waves of the  $H_{0,m}$  Class.

electric intensity is parallel to the side walls. Across the width of the tube the variations of the electric intensities follow sine curves as in Fig. 1. The wave of lowest mode, i.e., the  $H_{0,1}$  wave, possesses one half-sinusoidal variation, the wave of next higher mode, i.e., the  $H_{0,2}$  wave, possesses two half-sinusoidal variations, and so on. In addition there is, of course, a space variation along the tube, i.e., in the direction of propagation, and the usual time variation.

The cut-off frequencies of the waves of the  $H_{0,m}$  class are determined by the expression  $mv_1/(2b)$ , where  $v_1$  is the velocity of propagation of an electromagnetic disturbance in free space. When the dielectric within the tube is air,  $v_1$  is  $3 \cdot 10^{10}$  cm. per sec. These waves have, for the purpose of calculations, been resolved<sup>7</sup> into a pair of plane waves travelling across the tube with a velocity corresponding to that of plane waves in an unrestricted medium and reflected at the walls of the tube, thus constituting a number of zigzag paths. The angle between the direction of propagation of a component wave and the tube itself is then related to the frequency  $f$  and the cut-off frequency  $f_{0,m}$  by the equation  $\sin \theta = f_{0,m}/f$ . This mode of regarding the propagation of a wave in a tube as the result of repeated reflections was first suggested by Brillouin<sup>5</sup> and was also described by Page and Adams.<sup>10</sup> It is a convenient concept for the purpose of explaining some of the properties of these waves and will be used here for calculating the attenuation. Calculations relating to cross-sections other than rectangular are, for the present, in abeyance.

## (2) Outline of Method

It will be assumed that a tube of rectangular cross-section is filled with homogeneous dielectric and that its walls are of highly conducting material. Let it for the moment be imagined that the side walls are removed and that the top and bottom walls of the tube are cut up—not physically but in imagination—into a number of strips of equal width as in Fig. 2, making

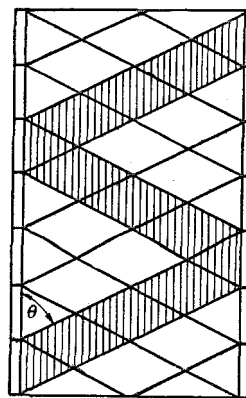

Fig. 2—Plan of Rectangular Metal Tube, Illustrating Mode in Which the Top and Bottom Walls are Imagined to be Cut into Zigzag Paths (One Path Shown Shaded).

an angle  $\theta$  with the left-hand edge. A similar set of strips starts from the right-hand edge, disposed as in the figure, so that the two sets of strips form zigzag paths. One of these zigzag paths is shown shaded. With each zigzag path of the top wall there is associated a corresponding zigzag path of the bottom wall. Each pair may be regarded as a uniform flat-strip transmission line along which a plane wave may be propagated, the tubes of electric force stretching from top to bottom and sweeping along the zigzag strips, while the adjacent strips serve as electric potential guard-planes to maintain the uniformity of the field. This flat-strip transmission line will be referred to as the "zigzag" line.

Next, the conducting side-walls are to be imagined as being cut into "slabs" as in Fig. 3,

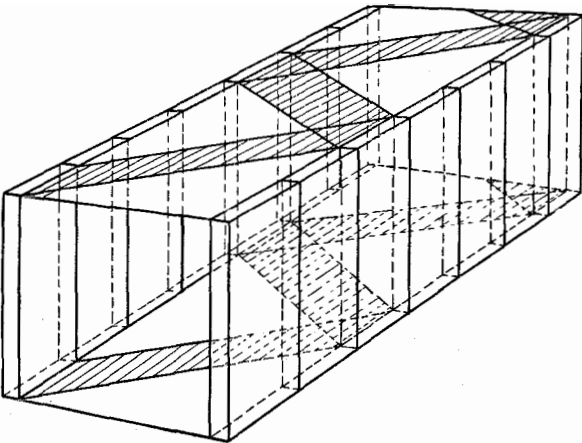

Fig. 3—Hollow Rectangular Metal Tube. Top and Bottom Walls (for Clearness Shown as Having No Thickness) Imagined to be Cut into Zigzag Transmission Lines (One Line Shown Shaded). The Side Walls of the Tube Imagined as "Slabs" Forming Semi-infinite Transmission Lines in the Direction of their Thickness.

their number corresponding to the number of vertices of the zigzag lines. Each "slab" is to be conceived as a semi-infinite flat-strip transmission line in the direction of its thickness and having the wall material as its "dielectric." They will be referred to as "slab" lines. This idea of regarding a slab of metal as a telephone transmission line was suggested and applied in 1915 by Howe<sup>13</sup> to skin-effect problems. Owing to the large difference between the characteristic impedance of a slab line and that of a zigzag line, a slab line, if connected with a zigzag line, will reflect most of the energy arriving at the junction. A small portion, however, will enter

the slab line and it is this part that will be calculated from the impedance ratio of the two lines, employing the usual formula. The effect of the presence of the slabs upon the characteristics of the zigzag line will not be considered here except so far as the attenuation is concerned, for which an additional term will emerge from the losses in the "slabs."

### (3) Attenuation for Principal Wave

For simplicity, attention is first directed to the principal wave, i.e., the  $H_{o,1}$  wave of Fig. 1. Results are later extended to waves of higher mode. Following other writers on this subject a practical system of units is here adopted.\* Unless stated otherwise, the subscript 1 refers to the zigzag line and subscript 2 to the slab line. The following notations are used:—

- $L_1, L_2$  = inductance, in henrys per cm.
- $C_1, C_2$  = capacitance, in farads per cm.
- $R_1, R_2$  = resistance, in ohms per cm. loop.
- $G_1, G_2$  = leakance, in mhos per cm.
- $a$  = distance between the two flat strips, in cm.

- $w_1, w_2$  = width of the strips, in cm.
- $\kappa_1, \kappa_2$  = permittivity, in farads per cm. cube

$$\left( \text{for air } \kappa = \frac{10^{-11}}{36\pi} \right)$$

- $\mu_1, \mu_2$  = permeability, in henrys per cm. cube, of the dielectric in the tube, and of the wall material (for air  $\mu = 4\pi \times 10^{-9}$ ).

- $\sigma_1, \sigma_2$  = conductivity, in mhos per cm. cube, of the dielectric in the tube, and of the wall material (for copper  $\sigma_2 = 5.8 \times 10^9$ ).

- $Z_1, Z_2$  = characteristic impedance, in ohms.
- $\gamma_1, \gamma_2$  = propagation constant per cm. of line.
- $\alpha_1, \alpha_2$  = attenuation constant per cm. of line.
- $\beta_1, \beta_2$  = phase constant per cm. of line.

- $v_1, v_2$  = velocity of propagation in cm. per sec.
- $\theta$  = angle between zigzag line and edges of tube.

- $b$  = width of tube, in cm.
- $f$  = frequency, in cycles per sec.

- $f_{o,1}$  = cut-off frequency of the principal wave, i.e., the  $H_{o,1}$  wave.

$$\omega = 2\pi f.$$

$$v_{o,1} = \frac{f_{o,1}}{f} = \sin \theta$$

$$\delta = \text{loss angle of dielectric} \left( \tan \delta = \frac{\sigma_1}{\omega \kappa_1} \right)$$

$$K = \sqrt{\left( \frac{2\pi\mu_2}{v_1\sigma_2\mu_1^2} \right)}.$$

\* Vide first footnote of Schelkunoff's article, reference (9).



The parameters of a uniform flat-strip transmission line provided with guard planes may be obtained from those of a co-axial cable\* if its radius is allowed to increase indefinitely, thus:

$$\left. \begin{aligned} L_1 &= \frac{a}{w_1} \mu_1 \\ C_1 &= \frac{w_1}{a} \kappa_1 \\ R_1 &= \frac{1}{w_1} \sqrt{\left( \frac{4\pi f \mu_2}{\sigma_2} \right)} \\ G_1 &= \frac{w_1}{a} \sigma_1 \end{aligned} \right\} \quad (1)$$

It will first be assumed that there are no losses in the dielectric. This is the case when the dielectric is air. An adjustment for dielectric losses will be made subsequently. Expressions for the characteristic impedance and for the propagation constant are obtained by substituting the above values (1) in the usual formulae for a uniform transmission line:

$$\left. \begin{aligned} Z &= \sqrt{\left( \frac{R + j\omega L}{G + j\omega C} \right)}, \\ \gamma &= \sqrt{[(R + j\omega L)(G + j\omega C)]}. \end{aligned} \right\} \quad (2)$$

For the attenuation constant of the zigzag line the following convenient formula also is valid in the frequency range concerned:—

$$\alpha = \frac{R}{2} \sqrt{\frac{C}{L}} + \frac{G}{2} \sqrt{\frac{L}{C}} \quad (3)$$

In using these formulae certain terms are negligibly small compared with others for frequencies of the order  $10^9$  appertaining to such waves, and for conductivities of the wall material of the order  $10^5$ . With these adjustments, and using the relation  $f_{o,1} = v_1/(2b)$ , the formulae reduce to:—

$$Z_1 \approx \sqrt{\left( \frac{j\omega L_1}{j\omega C_1} \right)} = \frac{a}{w_1} \sqrt{\frac{\mu_1}{\kappa_1}} \quad (4)$$

$$\gamma_1 \approx j\omega \sqrt{(L_1 C_1)} = j\omega \sqrt{(\mu_1 \kappa_1)} = j \frac{\omega}{v_1} = j\beta_1 \quad (5)$$

$$\alpha_1 = \frac{1}{a} \sqrt{\left( \frac{\pi f \mu_2 \kappa_1}{\sigma_2 \mu_1} \right)} = K \frac{b^{-\frac{1}{2}}}{2a} \nu_{o,1}^{-\frac{1}{2}} \quad (6)$$

where  $K = \sqrt{[2\pi\mu_2/(v_1\sigma_2\mu_1^2)]}$  is a constant depending only on the materials composing the tube.

\* Vide A. Russell: "Alternating Currents," Vol. 1, Chap. VII.

For the slab line the primary constants are

$$\left. \begin{aligned} L_2 &= \frac{a}{w_2} \mu_2, \\ C_2 &= \frac{w_2}{a} \kappa_2, \\ R_2 &= \frac{1}{w_2} \sqrt{\left( \frac{4\pi f \mu_2}{\sigma_2} \right)}, \\ G_2 &= \frac{w_2}{a} \sigma_2. \end{aligned} \right\} \quad (7)$$

Again omitting all negligible terms in calculating the characteristic impedance and the propagation constant, the formulae become

$$Z_2 \approx \sqrt{\left( \frac{j\omega L_2}{G_2} \right)} = \frac{a}{w_2} \sqrt{\left( \frac{j\omega \mu_2}{\sigma_2} \right)}, \quad (8)$$

$$\gamma_2 \approx \sqrt{(j\omega L_2 G_2)} = \sqrt{(j\omega \mu_2 \sigma_2)} = (1+j) \sqrt{(\pi f \mu_2 \sigma_2)}. \quad (9)$$

Thus

$$\alpha_2 = \beta_2 = \sqrt{(\pi f \mu_2 \sigma_2)}. \quad (10)$$

Since the orders of magnitude of  $f$ ,  $\mu_2$  and  $\sigma_2$  are respectively  $10^9$ ,  $10^{-8}$  and  $10^5$ , it follows that the attenuation constant of the slab line is of the order  $10^3$  per cm. Hence for all practicable wall thicknesses the line may be regarded as semi-infinite.

The appropriate widths of the two lines are determined by their common boundary at a vertex of the zigzag, which for convenience may

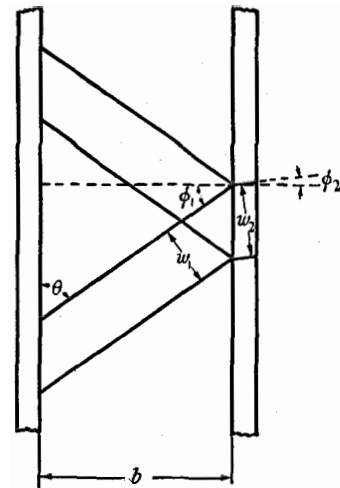

Fig. 4—Junction of "Zigzag" Line and "Slab" Line.

be assumed to be 1 cm. Fig. 4 shows this junction in detail. It follows that the width of the zigzag lines must be taken as  $\sin \theta$ , which is equal to  $f_{o,1}/f$  or  $\nu_{o,1}$ . For the slab lines it has been

assumed, so far, that the cuts are made at right angles to the edges of the tube, the width of the "slabs" thus being 1 cm. Within the range of frequencies and conductivities under consideration this mode of cutting the walls is the appropriate one; for, if the cuts were made at an angle other than 90° as in Fig. 4, the width would be  $\cos \phi_2$ . Then, since by (5) and (9)

$$\frac{\sin \phi_1}{\sin \phi_2} = \frac{\gamma_2}{\gamma_1} = \sqrt{\left(\frac{-j\omega_2\sigma_2}{\omega\kappa_1\mu_1}\right)},$$

$$w_2 = \sqrt{\left(1 + \frac{\omega\kappa_1\mu_1}{j\omega_2\sigma_2} \sin^2 \phi_1\right)} \approx 1,$$

the order of the second term under the radical being  $10^{-4}$  or less. Hence  $\phi_2$  may be regarded as zero. Substituting the values found for the widths of the strips into (4) and (8), the impedances become

$$Z_1 = \frac{a}{\nu_{o,1}} \sqrt{\frac{\mu_1}{\kappa_1}}, \tag{11}$$

$$Z_2 = a \sqrt{\left(\frac{j\omega\mu_2}{\sigma_2}\right)}. \tag{12}$$

When the dielectric is air and the wall material copper,  $Z_1$  always exceeds 377a ohms irrespective of the frequency, while  $|Z_2|$  is smaller than a, even for frequencies of the order  $10^{12}$  cycles per sec.

Attention is next directed to the losses occurring at the junction of the lines. If the impedance ratio at the junction is denoted by  $u = Z_1/Z_2$ , the ratio of the energy entering the slab line and the energy arriving at the junction is given by the formula  $4u/(1+u)^2$ . The loss expressed as an attenuation is therefore  $2u/(1+u)^2$  of which only the real part is to be taken.

Since

$$u = \frac{1}{\nu_{o,1}} \sqrt{\left(\frac{\sigma_2\mu_1}{j\omega\mu_2\kappa_1}\right)} = (1-j)\nu_{o,1}^{-1} \sqrt{\left(\frac{\sigma_2\mu_1}{2\omega\mu_2\kappa_1}\right)}$$

the loss is

$$\frac{2u}{(1+u)^2} \approx \frac{2}{u} = (1+j)\nu_{o,1} \sqrt{\left(\frac{2\omega\mu_2\kappa_1}{\sigma_2\mu_1}\right)}$$

and the real part of this is

$$Kb^{-\frac{1}{2}}\nu_{o,1}^{\frac{1}{2}}, \tag{13}$$

where again use has been made of the relation  $f_{o,1} = \nu_1/(2b)$ .\*

Now the length of the zigzag line from one side of the tube to the other is seen from Fig. 4 to be  $b/\sin \theta$  or  $b/\nu_{o,1}$ . Hence if the loss occurring at the junction is distributed over this length and added to the attenuation constant (6) obtained above, the following approximation for the total attenuation constant of the zigzag line with "slabs" is obtained:—

$$\alpha_{total} = K\left(\frac{b^{-\frac{1}{2}}}{2a}\nu_{o,1}^{-\frac{1}{2}} + b^{-\frac{1}{2}}\nu_{o,1}^{\frac{1}{2}}\right). \tag{14}$$

This is the attenuation constant per centimetre of line. To obtain the attenuation constant per centimetre length of the tube, (14) has to be divided by  $\cos \theta$  or  $(1 - \nu_{o,1}^2)^{\frac{1}{2}}$ , the final result for the attenuation constant for the  $H_{o,1}$  wave thus being:

$$\alpha_{H_{o,1}} = Kb^{-\frac{1}{2}}\left(\frac{b}{2a}\nu_{o,1}^{-\frac{1}{2}} + \nu_{o,1}^{\frac{1}{2}}\right)(1 - \nu_{o,1}^2)^{-\frac{1}{2}}. \tag{15}$$

It has already been shown in Fig. 2 that the tube is imagined to be cut up into a number of identical zigzag paths. The attenuation of the tube is therefore the same as that of each path; accordingly (15) represents the attenuation constant of the whole tube for  $H_{o,1}$  waves.

#### (4) Attenuation for Waves of Higher Mode

The result obtained for the principal wave may be extended most conveniently to waves of higher mode, i.e.,  $H_{o,m}$  waves, by inspection of Fig. 5, which represents the top of the tube for  $m=3$ . The dotted lines p, p' and q, q' indicate vertical planes along which the electric intensity is zero at all times and which divide the tube into  $m$  compartments or component tubes. Now imagine the right-hand side wall of the tube to be moved into the position p, p', and consider for the moment the first compartment alone. The attenuation formula (15) can evidently be applied, the only modification required being to replace  $b$  by  $b/m$  and  $\nu_{o,1}$  by  $\nu_{o,m}$ . If the side wall is now moved back into its original position

\* The same expression is obtained when the wave advancing along the zigzag line is, at the vertex, regarded as falling upon a metal surface at which it is partly reflected and partly absorbed. The formulae appertaining to this mode of treatment are, for example, contained in a paper by Fry.<sup>14</sup>

and a flat-strip transmission line is considered stretching across the whole tube, i.e., from A to B, it is observed that the first term of the modified formula still holds, the attenuation of the line from A to B being the same as that from A to B<sup>1</sup>; but the interval between successive reflections is *m* times the interval for the first compartment, hence the second term of the modified formula is to be divided by *m*. Applying these modifications to (15) the attenuation constant for *H*<sub>0,*m*</sub> waves is obtained. Thus

$$\alpha_{H_{0,m}} = Kb^{-\frac{3}{2}}m^{\frac{1}{2}}\left(\frac{b}{2a}v_{0,m}^{-\frac{1}{2}} + v_{0,m}^{\frac{3}{2}}\right)(1 - v_{0,m}^2)^{-\frac{1}{2}}, \quad (16)$$

which agrees with the expression established by Chu and Barrow.<sup>7</sup> It is also in complete agreement with the expression furnished by Schelkunoff's general formula, for metal tubes of any shape, when that formula is applied to *H*<sub>0,*m*</sub> waves in rectangular tubes.<sup>6\*</sup>

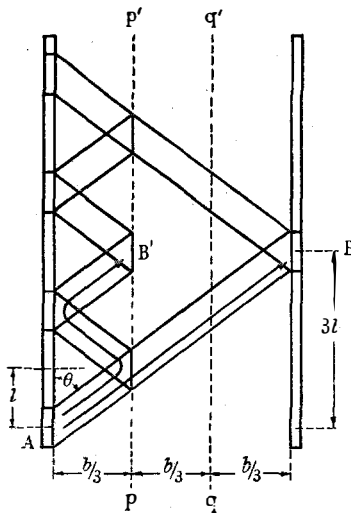

Fig. 5—System of Flat-Strip Transmission Lines for Waves of Higher Mode.

\* Two formulae are given for the attenuation constant of H-waves. The first is general, for metal tubes of all shapes, and for waves of all orders; the second is derived from the first and appertains to tubes of rectangular cross-section only. This subsidiary formula is valid for waves of all orders other than zero. The need for separate treatment of zero-order waves arises from the fact that for these waves the electric intensities between the top and bottom of the tube are constant, while for waves of all other orders they vary sinusoidally. When losses are considered, mean-square values are required, and thus there emerges a factor  $\frac{1}{2}$  for waves of all orders other than zero. An analogous position exists in respect of the losses due to the various harmonics of an alternating current and that due to a direct current, if the direct current is regarded as a harmonic of zero order.

An alternative mode of splitting up the tube into a system of flat-strip transmission lines is seen in Fig. 6. In this case *m* sets of lines are

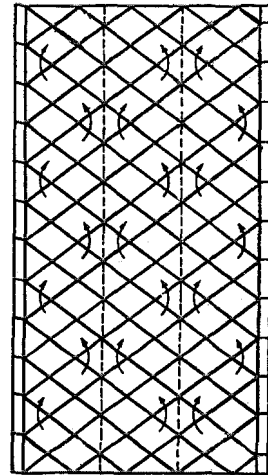

Fig. 6—Alternative System of Flat-Strip Transmission Lines for Waves for Higher Mode.

set up, each set functioning independently of the others, separated from them by planes of zero electric intensity. In fact, the tube is considered as *m* component tubes, to each of which formula (15) is applicable directly if *b* is replaced by *b/m* and *v*<sub>0,1</sub> by *v*<sub>0,*m*</sub>. For the first and last component tubes the term due to reflection losses is to be halved, as there are no losses along the interior planes of zero electric intensity. Similarly, for the interior component tubes, which are located entirely in the interior of the main tube, the second term in the formula vanishes. Thus, for the first and the last component tube the attenuation constant is

$$Kb^{-\frac{3}{2}}m^{\frac{1}{2}}\left(\frac{b}{2am}v_{0,m}^{-\frac{1}{2}} + \frac{1}{2}v_{0,m}^{\frac{3}{2}}\right)(1 - v_{0,m}^2)^{-\frac{1}{2}}, \quad (17)$$

while for the remaining *m*-2 tubes the attenuation constant is

$$Kb^{-\frac{3}{2}}m^{\frac{3}{2}}\frac{b}{2am}v_{0,m}^{-\frac{1}{2}}(1 - v_{0,m}^2)^{-\frac{1}{2}}, \quad (18)$$

and, on averaging (17) and (18), formula (16) is regained.

### (5) Losses in the Dielectric of the Tube

So far it has been assumed that the dielectric of the tube is perfect. If the conductivity of the dielectric is small, yet not negligible, an allow-

ance can be made by taking into account the second term of formula (3) for the attenuation constant. Substituting in this the values from (1), an additional term is obtained, viz.,

$$\frac{G_1}{2} \sqrt{\frac{L_1}{C_1}} = \frac{\sigma_1}{2} \sqrt{\frac{\mu_1}{\kappa_1}}. \quad (19)$$

As the conductivity of a dielectric is usually expressed in terms of the loss angle  $\delta$ , it is convenient to introduce into (19) the relation  $\tan \delta = \sigma_1 / (\omega \kappa_1)$  and, if allowance is made, as before, for the zigzagging of the line, the following expression is obtained for the adjustment due to the losses in the dielectric:

$$\frac{m\pi}{2b} v_{o,m}^{-1} (1 - v_{o,m}^2)^{-\frac{1}{2}} \tan \delta, \quad (20)$$

and this term must be added to the attenuation constant given by (16).

## (6) Conclusions

The method reveals the existence of a link between two seemingly disjointed branches of telecommunication: (1) Telecommunication of the classical character, employing a "circuit," i.e., a system comprising a "go" and a "return" path, and (2) Telecommunication through hollow metal tubes without a return path in the conventional sense.

The final expression found in equation (16) for the attenuation constant of waves propagated through hollow metal tubes is derived in a simple manner from the familiar equations for the attenuation of telephone lines, with due regard to the reflection loss at the junction of dissimilar lines. The numerical results obtained by this shortened method agree in every respect with those obtained by more elaborate means by

other investigators. The simplicity of the method and the ease with which the final results are obtained arise from the fact that the telephone transmission formulae contain implicitly the concepts required in the detailed calculation by orthodox procedure.

## (7) References

1. LORD RAYLEIGH: "On the Passage of Electric Waves through Tubes, or the Vibrations of Dielectric Cylinders," *Philosophical Magazine*, 1897, **43**, p. 125.
2. G. C. SOUTHWORTH: "Hyper-frequency Wave Guides—General Considerations and Experimental Results," *Bell System Technical Journal*, 1936, **15**, p. 284.
3. J. R. CARSON, S. P. MEAD and S. A. SCHELKUNOFF: "Hyper-frequency Wave Guides—Mathematical Theory," *ibid.*, 1936, **15**, p. 310.
4. W. L. BARROW: "Transmission of Electromagnetic Waves in Hollow Tubes of Metal," *Proceedings of the Institute of Radio Engineers*, 1936, **24**, p. 1298.
5. L. BRILLOUIN: "Propagation of Electromagnetic Waves in Tubes," *Revue Générale de l'Électricité*, 1936, **40**, p. 227.
6. S. A. SCHELKUNOFF: "Transmission Theory of Plane Electromagnetic Waves," *Proceedings of the Institute of Radio Engineers*, 1937, **25**, p. 1457.
7. L. J. CHU and W. L. BARROW: "Electromagnetic Waves in Hollow Metal Tubes of Rectangular Cross-Section," *ibid.*, 1938, **26**, p. 1520.
8. A. G. CLAVIER and V. ALTOVSKY: "Experimental Researches on the Propagation of Electromagnetic Waves in Dielectric (cylindrical) Guides," *Electrical Communication*, 1939, **18**, p. 81.
9. S. A. SCHELKUNOFF: "Electromagnetic Theory of Coaxial Transmission Lines and Cylindrical Shields," *Bell System Technical Journal*, 1934, **13**, p. 532.
10. L. PAGE and N. I. ADAMS: "Electromagnetic Waves in Conducting Tubes," *Physical Review*, 1937, **52**, p. 647.
11. S. A. SCHELKUNOFF: "The Impedance Concept," *Bell System Technical Journal*, 1938, **17**, p. 17.
12. A. G. CLAVIER: "Theoretical Relationships of Dielectric Guides (Cylindrical) and Coaxial Cables," *Electrical Communication*, 1939, **17**, p. 276.
13. G. W. O. HOWE: "The Application of Telephone Transmission Formulae to Skin-effect Problems," *Journal I.E.E.*, 1916, **54**, p. 473.
14. T. C. FRY: "Plane Waves of Light—Reflection and Refraction," *Journal of the Optical Society of America*, 1928, **16**, p. 1.

# 12-Channel Carrier Equipment in the Göteborg-Malmö Cable

By S. R. NORDSTRÖM

*Staff Engineer, Swedish Telegraph Administration*

## Introduction

SINCE the installation, in 1922/23, of the first small gauge, loaded and repeatered cable between Stockholm and Göteborg, the Swedish toll cable network, year by year, has been extended so that today it comprises a total of 5508 km of cable, covering the most important industrial and commercial sections of the country. Incidentally, the first Stockholm-Göteborg cable is now being de-loaded in order to adapt it to multi-channel telephone operation. In 1940, the latest link in the Swedish toll cable system was completed by joining the two cities of Göteborg and Malmö by a most up-to-date cable system. The distance involved is 277 km, and, since economic studies had shown that the through-circuits, at least, could most profitably be obtained by the use of 12-channel carrier circuits, two non-loaded cables were laid, side by side, throughout the whole distance.

From Göteborg to Helsingborg (217 km) each cable comprises 19 pairs of 1.2 mm conductors, whilst for the remaining 60 km, Helsingborg-Malmö, the two cables each contain 7 quads of 1 mm conductors. In order to cater for intermediate and branch traffic a third cable was installed along the same route and at the same time. This cable contains from 72 to 140 quads—as dictated by traffic considerations—of small

gauge conductors, loaded to suit the particular transmission requirements of each case; it includes three intermediate repeater stations, which coincide with some of the stations necessary for the 12-channel cables. All three cables are armored and laid directly in the ground, covered only by a creosoted board.

Fig. 1 shows, graphically, the lay-out of the repeater stations along the route. The stations at Varberg, Halmstad and Helsingborg are those common to the 12-channel and the loaded cables.

## Cable Specification

As a background to the overall transmission results, recorded further on, the main specification requirements of the cables intended for carrier operation are briefly given below. The figures apply to repeater sections and are valid for the frequency range 12,000–60,000 p/s.

The maximum attenuation shall be 0.168 neper/km (1.5 db) in the case of the cable of 1.2 mm conductors and 0.203 neper/km for the 1.0 mm conductors. The far-end crosstalk between pairs in the same cable shall be such that the difference in level at the far end between a disturbing and a disturbed pair shall be at least 8.5 nepers (74 db). The near-end crosstalk between pairs in the same cable shall not be less than 6.5 nepers (56 db) whilst, between

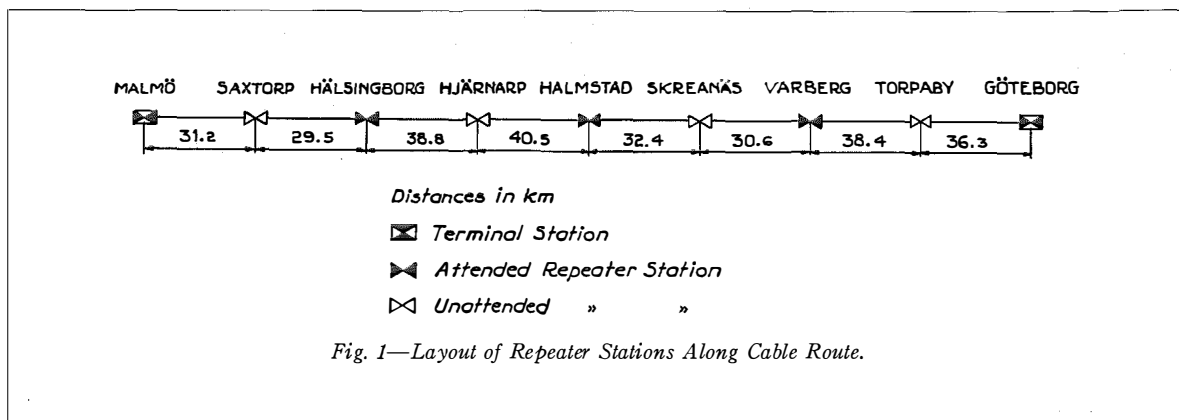

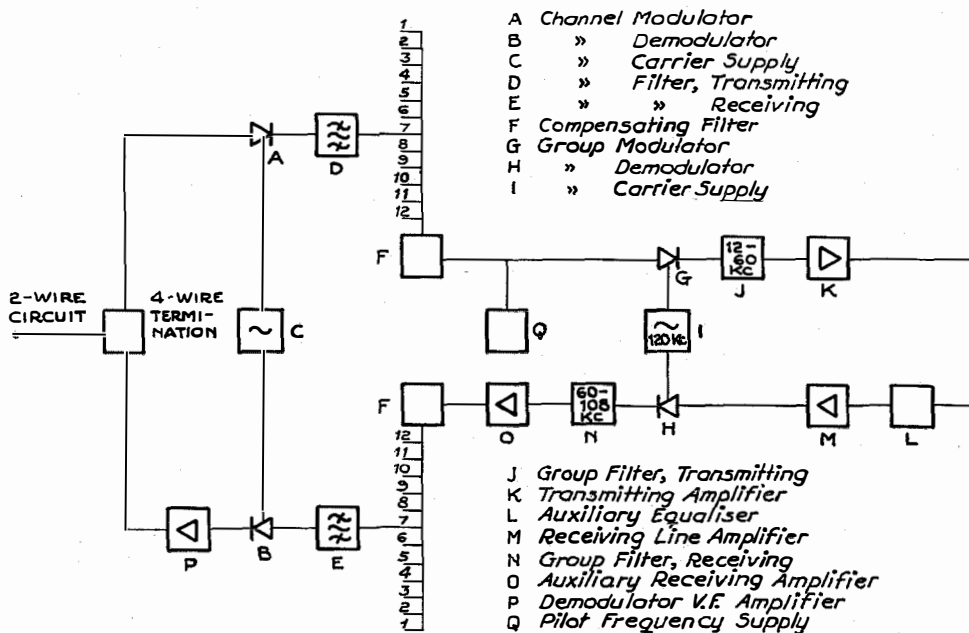

Fig. 2—General Transmission Features of Type K 12-Channel Carrier System.

pairs in separate cables, it must not be less than the cable attenuation plus 8.5 nepers.

The characteristic impedance  $Z_1$  of an arbitrarily chosen pair shall not deviate from a nominal value  $Z_0$  by more than an amount which satisfies the following relation:

$$\left| \frac{Z_0 - Z_1}{Z_0 + Z_1} \right| \leq 0.025.$$

The nominal value of  $Z_0$  was fixed by agreement between the cable contractor and the supplier of the repeater equipment.

**Twelve-Channel Equipment**

To meet the present demands of the through-traffic between Göteborg and Malmö, four Type K carrier equipments were installed, thus providing for a total of 48 circuits.

**GENERAL TRANSMISSION FEATURES**

The general transmission features of the Type K system are indicated in the block schematic,

Fig. 2. Voice frequencies, arriving from the toll board, pass through the 4-wire terminating set in the usual way. They are then modulated in the channel modulator, A, with carrier frequencies of 64, 68, 72, etc., to 108 kc/s, according to the particular channel in question. In the case of Channel 7, shown on the schematic, the channel carrier frequency is 84 kc/s. The lower sideband, resulting from this modulation, is selected by the modulator channel filter, D. This sideband, together with the eleven others, emanating from the remaining channels, passes through a compensating filter, F. All twelve sidebands, which now form a single group, occupying the frequency range, 60 to 108 kc/s, next pass through the group modulator, G, where they are modulated with a carrier frequency of 120 kc/s. The lower sideband, produced by this modulator, is chosen by the low-pass filter, J. This sideband now occupies the frequency range 12 to 60 kc/s, and is transmitted to the cable pair via the transmitting amplifier, K.

In the reverse direction, the line frequencies of

12 to 60 kc/s, corresponding to the twelve separate channels, pass as a group through the auxiliary equalizer, *L*, and the receiving line amplifier, *M*, which together compensate the attenuation and distortion produced by the cable pair. They then pass through the group demodulator, *H*, the carrier supply to which is 120 kc/s. The lower sideband produced by this demodulator lies in the range 60 to 108 kc/s. This is selected by the low-pass filter, *N*, and is stepped up to the required level by the auxiliary amplifier, *O*. It then passes via the compensating filter, *F*, to the paralleled inputs of the 12-channel demodulator filters. In the case of Channel 7 (Fig. 2), the filter, *E*, selects the frequency band 80 to 84 kc/s, which then passes through the channel demodulator, *B*. Here it is demodulated with the appropriate carrier frequency (84 kc/s in the case of Channel 7) and the sidebands produced pass on to the voice frequency amplifier, *P*. This amplifier transmits the lower sideband, 0 to 4 kc/s, and amplifies it to the appropriate level, but suppresses the unwanted sidebands. Thus the original speech frequencies are reproduced and pass on to the toll board via the 4-wire terminating set.

It will be seen from Fig. 2 that a pilot frequency supply, *Q*, is introduced at the input of the group modulator. This supply comprises three frequencies which, after passing through the group modulator, appear on the line as 15.9, 27.9 and 55.9 kc/s. These frequencies lie in the otherwise unoccupied regions of the transmitted frequency band, and their levels are accurately adjusted at the sending end to a known value. Thus, by the use of a highly selective level measuring set at any suitable point along the line—usually at the receiving end—transmission level measurements can be made at any time without interrupting any channel and without cooperation from the sending end. The three pilot frequencies lie well spaced over the transmitted frequency band and thus allow the equalization of the cable pair plus the line amplifier to be kept under constant observation.

#### SYSTEM FEATURES

The outstanding features of the constituents mentioned in the general description above are described somewhat more in detail below.

*Modulators and Demodulators*—The channel modulators and demodulators, *A* and *B* in Fig. 2, are of the bridge type and employ metallic rectifiers. The group modulators and demodulators, *G* and *H*, also employ such rectifiers, but they are of the double-balanced type, permitting a simplification of the associated filters.

*Filters*—The channel modulators and demodulator band-pass filters, *D* and *E*, are of the quartz crystal type; their schematic circuits are equivalent to two lattice sections. They are enclosed in hermetically sealed cans from which all traces of moisture have been removed. The group modulator and demodulator filters, *J* and *N*, are of the low-pass type and employ coils and condensers. This simple construction is possible because the unwanted modulation products are widely separated from the wanted lower sideband. Other filters are used in the carrier supply circuit and in the pilot supply circuit; they are of the quartz crystal type and are referred to later.

*Amplifiers and Equalizers*—The transmitting amplifier, *K*, is a three-stage, feed-back amplifier with a flat gain/frequency characteristic. The receiving line amplifier, *M*, is also a three-stage feed-back amplifier but it has a line equalizer in the feed-back circuit, producing a sloping gain/frequency characteristic. This corrects the major part of the distortion introduced by the cable pair. An auxiliary equalizer, *L*, is used to correct the small amounts of residual distortion. This is a constant resistance equalizer and is adjustable by means of soldered connections. The line amplifiers and auxiliary equalizers at the intermediate amplifier stations are of the same type as *L* and *M*, described above. The auxiliary receiving amplifier, *O*, is a two-stage feed-back amplifier with a flat gain/frequency characteristic. The demodulator amplifier, *P*, is a single-stage voice frequency amplifier with feed-back. It has a maximum gain of about 4 nepers (35 db), which can be continuously adjusted over a range of 1.15 nepers (10 db) by means of a rheostat in the feed-back circuit. It amplifies voice frequencies up to 4 kc/s, but suppresses higher frequencies, thus also performing the function of a low-pass filter.

*Carrier Supply*—A basic frequency of 4 kc/s is generated by a tuning fork in conjunction with a vacuum tube. This is amplified, first by

a "control" tube and then by a push-pull amplifier, the output being about 4 watts. The output is filtered and applied to a circuit containing a non-linear inductance coil; this circuit produces odd harmonics of 4 kc/s. The odd harmonics required for the channel carrier frequencies are selected by crystal filters, from which they pass via adjustable resistances to bus-bars and thence through protective resistances to the channel modulators and demodulators as required. These odd harmonics are 8 kc apart; a simple crystal filter equivalent to a single lattice section suffices for their separation.

The even harmonics of 4 kc/s are produced in a separate branch, consisting of a metallic bridge-type rectifier, bridged across the output of the odd-harmonic producing coil circuit. The even harmonics thus appear at the output of the rectifier circuit; they are filtered and distributed in the same way as the odd harmonics.

The harmonic producing circuit has the property of creating all required harmonics at the same level, and sufficient power is available for the channel modulators and demodulators without subsequent amplification. Small adjustments to the voltages of the various channel carrier frequencies are made by the adjustable resistances referred to above.

The group carrier frequency of 120 kc/s is obtained via a two-section crystal filter from the even-harmonic branch of the circuit. Since a higher carrier voltage is required in the group modulators and demodulators than in the channel modulators, a single-stage amplifier is employed to produce the necessary power, which is then passed on to bus-bars and distributed to the various systems via protective resistances.

In order to guard against the multi-failure of channels, which would occur if the carrier supply (and more particularly the 120 kc/s supply) were to break down, the 4 kc oscillator and harmonic producing equipment are duplicated. Also, the 120 kc/s filter and amplifier are provided in duplicate, but not the channel carrier filters or distributing arrangements. There are thus two carrier generating equipments, the regular carrier generator and the emergency carrier generator. The load is normally carried by the regular generator, whilst the emergency one is in full working condition (tuning fork vibrating and valves heated) except for the fact

that its control grid is blocked by a high negative bias, which persists as long as the 120 kc output from the regular generator is at a suitable voltage. If the 120 kc output falls below the desired value, a transfer circuit, described later, operates; the blocking voltage is removed from the emergency control tube and applied to the grid of the regular control tube, thus permitting the emergency carrier generator to take the load, blocking the regular generator. At the same time an alarm is given to indicate the change-over. The blocking voltage is produced in a carrier generator transfer circuit employing two gas-filled tubes (multiplied for safety). These tubes are normally biased by a voltage obtained by rectification from the 120 kc/s supply and is of such a value that no plate current flows. Associated with their plate circuits is a Wheatstone bridge type of network, which produces the blocking voltage for the emergency generator and the operating bias for the regular generator so long as no plate current flows. If the 120 kc/s voltage falls and reduces the bias on the gas-filled tubes below a certain point, space current flows and upsets the balance of the Wheatstone bridge with the result that the blocking and operating voltages are interchanged. Since the control is entirely electronic, the change-over is very rapid, i.e., in about 4 milliseconds. Relays are included in the transfer circuit for alarm purposes. Change-over can be effected for testing purposes by manually operated push buttons, which are also used to reset the circuit after it has operated.

The outputs of the regular and emergency generators are connected to the carrier supply filters via hybrid coils so that no switching is needed when changing over and, further, no interaction between the two generators occurs.

Synchronization of carrier frequencies is extremely simple, being effected by a small air condenser in the 4 kc tuning fork circuit. This, of course, simultaneously corrects all carriers produced by the carrier generators concerned.

*Pilot Frequency Supply*—A frequency of 3.9 kc/s is generated by a tuning fork oscillator and passed on to three bridge-type copper-oxide modulators, having carriers of 68, 96, and 108 kc/s, respectively, derived from the channel carrier bus-bars. The lower sideband frequencies, 64.1, 92.1 and 104.1 kc/s, are selected by crystal



filters (identical with the carrier supply filters), the outputs of which are connected via individual rheostats to bus-bars, and thence via protective resistances to the group modulator inputs of the different systems. After passing through the group modulator, the pilot frequencies appear on the line as 15.9, 27.9 and 55.9 kc/s. The rheostats referred to enable the pilot levels, sent to the line, to be accurately adjusted.

*Four-wire Terminating Sets*—The 4-wire terminating sets are of the familiar type. Plug-in pads are provided on the transmitting side to adjust the voice-frequency input to the channel modulator to a level of  $-1.5$  neper ( $-13$  db). On the receiving side the demodulator amplifier delivers a level of  $+0.4$  neper ( $+3.5$  db), and plug-in pads are provided to reduce this to a value suited to the circuit concerned.

*Maintenance Instruments*—A mains-operated heterodyne oscillator, Type 17-B, is provided, covering the frequency range 25 p/s to 150 kc/s. An interesting feature of this instrument is the very open frequency scale, obtained by gearing the variable condenser up to drive a cinema-film scale, 7.6 metres long. Built-in calibrating circuits are provided, and the oscillator can be adjusted to any frequency within its range with an accuracy of 25 cycles. Between 1 kc and 150 kc the output is constant within 0.1 neper (0.9 db).

A No. 30-A Transmission Measuring Set is provided for measuring gains and losses. This set is portable and employs a thermocouple circuit with the galvanometer scale calibrated in decibels so that it is direct-reading. A variable attenuator forms part of the instrument together with patching and switching arrangements, also self-contained calibrating arrangements. All the components are brought out to jacks, rendering the operation of the instrument very flexible.

For measuring transmission levels at carrier frequencies, and more particularly for measuring pilot levels, the No. 42-A Transmission Measuring System is provided. The frequency to be measured is applied, via a high impedance pad, to the input of a copper-oxide modulator, the carrier frequency supply to which is obtained from the No. 17-B oscillator. The frequency of the heterodyne oscillator is adjusted to modulate the test frequency to 130 kc/s, this frequency being selected by a 130 kc crystal filter, passing

a band confined to about ten cycles. The filtered 130 kc/s is amplified by a feed-back test amplifier and applied to a second modulator, where it is heterodyned with a 129 kc/s carrier, obtained from a crystal-controlled oscillator.

The 1 kc/s output of this modulator is amplified by a tuned 1 kc amplifier and passed on to the No. 30-A Measuring Set and there measured. A special calibrating oscillator with an accurately adjusted output is used to calibrate the system at a frequency in the middle of the carrier range. The bridging loss of the measuring system is less than 0.01 neper (0.1 db); levels of  $-2.7$  nepers ( $-23.5$  db) below 1 milliwatt can be measured without additional amplification. Arrangements can be made to measure lower levels if desired, and, as all the components are brought out to jacks, the circuit can be modified and used for special investigation work, if necessary. Owing to the very high selectivity of the set, such tests as carrier leak measurements and pilot level measurements can be made at any time without interrupting the service in any way. Measurement of carrier frequency levels on any channel can be accomplished without disturbing the other channels.

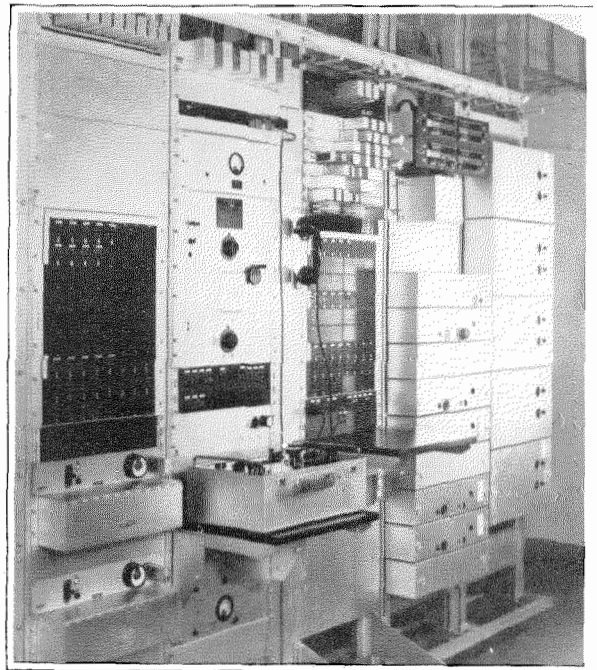

Fig. 3—Göteborg Terminal Equipment, Showing Communication, Measuring and Power Supply Bays.

*Alarm Circuits and Telephone Circuits between Stations*—One cable pair is used to transmit alarm signals from an unattended repeater station. It also serves as a telephone circuit to the unattended station. This pair is equipped with filters to suppress carrier noise, which might otherwise be introduced into the cable pair via the batteries and alarm or telephone equipment. It was originally intended to operate the alarm circuit with current normally on the line. It was found, however, quite satisfactory to have current on the line during the alarm period only, and the circuit was modified accordingly. The change enabled a 40-volt dry cell battery to be used for alarm purposes.

### Grouping of Equipment

*Channel Modem Panels*—The channel modulators and demodulators (*A* and *B*, Fig. 2), the crystal filters, *D* and *E*, and the voice frequency amplifier, *P*, together with associated pads, resistances, etc., not shown on the block schematic, are mounted on a panel known as the Channel Modem Panel. One such panel mounts equipment for two channels. These panels are mounted in groups of six, corresponding to one system, and, associated with each group, is a panel mounting the compensating filters, *F*.

*Group Modem Panels*—The group modulator and demodulator, *G* and *H*, the filters, *J* and *N*, and the auxiliary amplifiers, *K* and *O*, are mounted together on a panel known as the Group Modem Panel. One such panel caters for a complete system.

*Carrier Supply and Distribution Panels*—The regular carrier oscillator together with the harmonic producing equipment, 120 kc/s amplifier and 120 kc/s filter are mounted on one panel. An exactly similar panel is provided for the emergency generator equipment. The pilot oscillator and modulator equipment together with the pilot distributing bus-bars and resistances are mounted as a panel. The transfer circuit forms a separate panel; separate panels are also provided for filters and distributing bus-bars and resistances for the odd and even channel carrier frequencies, and for the distributing bus-bars for the 120 kc/s group carrier frequency. These panels occupy two bays and cater for ten systems.

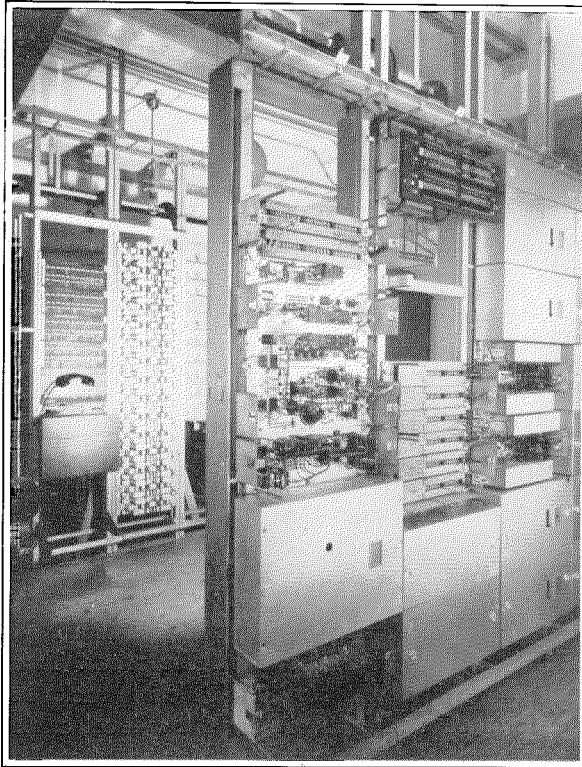

Fig. 4—Göteborg Terminal Equipment, Showing Carrier Supply and Distribution.

*Line Amplifier and Equalizer Panels*—The line amplifier, *M*, and the equalizer, *L*, are mounted on separate panels. Each line amplifier occupies one panel, whilst there are two equalizers per panel. Duplicate panels mount grid batteries for the line amplifiers and "Sensitrol" relays, respectively. The latter give an alarm if the grid battery voltage falls below a certain value. These panels also mount testing circuits for the grid batteries.

*Jack Panels*—All high frequency, high level jacks are mounted together on one panel, and all high frequency, low level jacks on another. These panels are well separated to avoid the possibility of crosstalk between them. A voice frequency jack panel, including monitoring jacks, is provided. This gives access to the voice frequency sides of the channels. Associated with these jacks are the gain-control rheostats for the channel demodulator amplifiers (*M*, Fig. 2). On the same bay as this jack panel is a vacuum tube monitoring panel as well as facilities for talking and ringing.

**Testing Equipment**—One bay mounts the 17-B heterodyne oscillator and the various other components of the No. 42-A Transmission Measuring System, not including the high frequency test amplifier which is mounted with the line amplifiers. Individual panels are cabled to a jack panel, mounted on the same bay. The No. 30-A Transmission Measuring Set, which is portable, is normally accommodated on a writing shelf on this bay, being connected to the jack field as required by a patching cord.

**Four-wire Terminating Sets**—The 4-wire terminating sets, together with their plug-in pads, are mounted on panels, there being two sets per panel.

### Cabling Arrangements

High and low level carrier frequency cables are carefully segregated. In general, the high level cables are brought down one side of a bay, and the low level cables down the other. This segregation is maintained on the cable racks in the form of a high level and a low level cable group. Specially designed rubber insulated cables of a single screened pair are used for the high frequency transmission path. This type of cable has about the same iterative impedance as the main cable pairs, and long lengths of it can be used without introducing impedance irregularities. The earthing of the screens is given special attention.

### Vacuum Tubes

With the exception of a few special tubes used in the No. 17-B oscillator, and the gas-filled tubes in the carrier generators, only two types

of tube, the No. 310-A and the No. 311-A, are used in the whole system.

### Terminal Equipment

Figs. 3 and 4 show views of the Göteborg terminal equipment. In Fig. 3, the first bay on the left contains the high frequency jacks and the grid-bias and alarm panels for the line amplifiers. On the second bay is mounted the No. 42-A Transmission Measuring Equipment with the No. 30-A Measuring Set on the writing shelf. On the third bay is the second high frequency jack panel, together with alarm equipment and telephone set for communication with the intermediate stations. The following, or fourth, bay mounts battery supply equipment, as well as receiving line amplifiers and auxiliary equalizers. The top amplifier panel on this bay is the test amplifier, forming part of the No. 42-A Measuring System. The bay on the extreme right mounts five group modem panels, the fifth panel being spare.

In Fig. 4, the first two bays on the left of the front rack mount the carrier supply and distribution equipment. The third bay mounts the 6-channel modem panels and compensating filters for one system. (Can covers of several panels are removed to show detail mounting arrangements.)

The rear rack contains, on the left, the voice frequency jacks and monitoring arrangements, and, on the right, the 4-wire terminating sets.

### Overall Results

The overall equivalent of a representative system between Göteborg and Malmö is shown

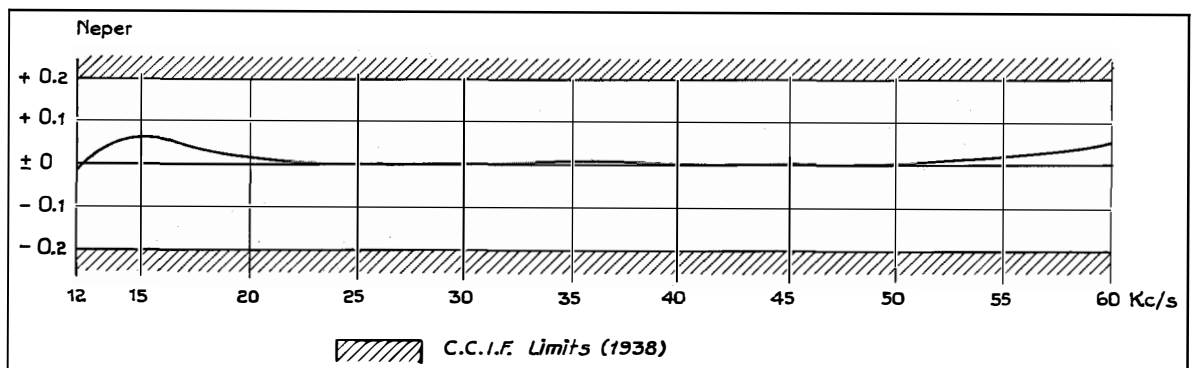

Fig. 5—Overall Equivalent of System No. 4 Göteborg—Malmö.

in the graph of Fig. 5. It will be noted that the curve falls well within the limits set by the last Assembly of the C. C. I. F. (1938).

As indicated in Fig. 6, the frequency range of one channel between Malmö and Göteborg is 160 to 3600 p/s. With five channels in tandem, the band 200-3300 p/s is transmitted.

The carrier circuits were placed in service in May, 1941.

The above-described equipment was manufactured by the Western Electric Company and supplied to the Swedish Telegraph Administration by Standard Telefon og Kabelfabrik A/S, Oslo.

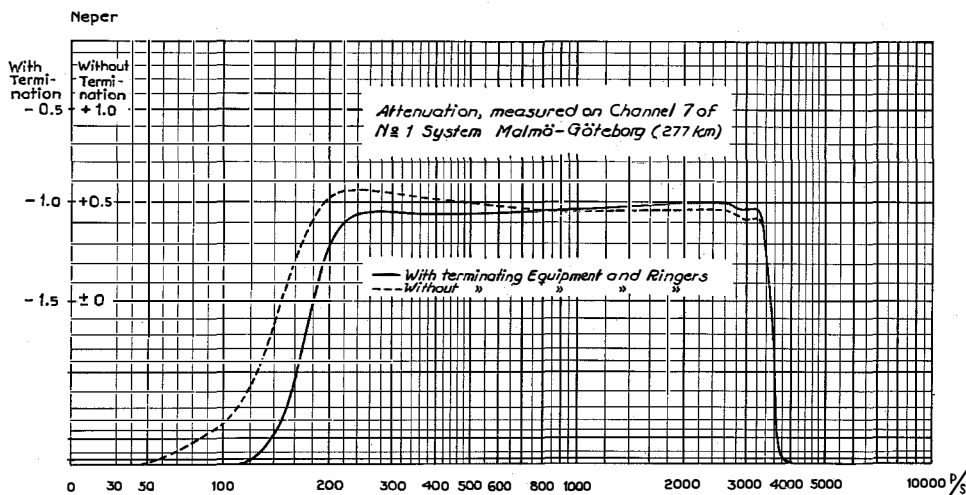

Fig. 6

### Bibliography

1. "Carrier in Cable," by A. B. Clark and B. W. Kendall, *A.I.E.E. Transactions*, 1933, p. 1050; *B.S.T.J.*, July, 1933.
2. "Wide Band Transmission Over Balanced Circuits," by A. B. Clark, *A.I.E.E. Transactions*, 1935, p. 27; *B.S.T.J.*, Jan., 1935; *Electrical Communication*, Vol. 13, No. 4, 1935.
3. "Modern Systems of Multi-Channel Telephony on Cables," by A. S. Angwin and R. A. Mack, *Journal of I.E.E.*, April, 1937.
4. "Bristol-Plymouth 12-Channel Carrier System," *Electrical Communication*, Vol. 16, No. 2, 1937.
5. "A Carrier Telephone System for Toll Cables," by C. W. Green and E. I. Green, *A.I.E.E. Transactions*, 1938, p. 227; *B.S.T.J.*, Jan., 1938.
6. "Cable Carrier Telephone Terminals," by R. W. Chesnut, L. M. Ilgenfritz and A. Kenner, *A.I.E.E. Transactions*, 1938, p. 237; *B.S.T.J.*, Jan., 1938.
7. "Crystal Channel Filters for the Cable Carrier System," by C. E. Lane, *A.I.E.E. Transactions*, 1938, p. 245; *B.S.T.J.*, Jan., 1938.
8. "Crosstalk and Noise Features of Cable Carrier Telephone System," by M. A. Weaver, R. S. Tucker and P. S. Darnell, *A.I.E.E. Transactions*, 1938, p. 250; *B.S.T.J.*, Jan., 1938.
9. "Copper Oxide Modulators in Carrier Telephone Systems," by R. S. Caruthers, *B.S.T.J.*, April, 1939.
10. "Load-Rating Theory for Multi-Channel Amplifiers," by B. D. Holbrook and J. T. Dixon, *A.I.E.E. Transactions*, 1940, p. 265.
11. "The Transmission Characteristics of Toll Telephone Cables at Carrier Frequencies," by C. M. Hebbert, *B.S.T.J.*, July, 1941.

# Alarm and Control Systems—Banco de la Provincia de Buenos Aires

By W. WHITE

*Compañía Standard Electric Argentina, Buenos Aires, Argentina*

THE recently completed building of the Banco de la Provincia de Buenos Aires offers a fine example of modern banking architecture. Equipment installations embody the latest advances, including alarm and control systems, air conditioning and moving stairways.

Requirements for the signaling and control equipment were formulated in accordance with equally up-to-date standards. The system proposed by Compañía Standard Electric Argentina, Buenos Aires, met with the approval of the banking authorities and was installed. A view of the main control panel is shown in Fig. 1.

## **Watchman's Control System**

This equipment is intended to control the movements of individual watchmen, three in all; their routes, together with time intervals between stations, are predetermined. Plans of the building appear on glass panels on which visual signals indicate the station next to be visited by a particular watchman. If, within the allotted interval, a watchman either fails to follow the prescribed route or to operate his special key at each station, an alarm is sounded and a lamp indicates the station involved. Normal movements of each watchman also are indicated on individual time charts (Fig. 2).

Watchmen's stations consist of double contact switching devices enclosed in sealed metal cases. They can only be operated by the special keys carried by the watchmen.

The central equipment has a capacity of sixty stations and three alarm groups. A separate alarm circuit is provided for each watchman.

Each alarm group comprises control relays and two step-by-step switches; one of these switches moves as a result of the turning of the watchman's key at the station, whilst the other advances through impulses from a master clock. Flexible connections between these two switches allow any time interval from one to twenty-five minutes in one-minute intervals to be allotted to any station. For the time chart record, each

alarm group is provided with an Esterline Angus time register for twenty circuits, i.e., the number of stations assigned to each alarm group. This register, when operated, indicates the station signaling and the reception time of the signal.

The visual indication being a lamp, a routiner circuit is incorporated in the system in order to check the functioning of all lamps prior to a watchman commencing his rounds. Operation of the routiner key and the alarm test key corresponding to any single group causes the routiner to make a complete round of all the lamp circuits involved. This test is accomplished rapidly; a faulty lamp results in stoppage of the routiner at the corresponding point.

In the event of an alarm caused by delayed arrival at a station, a bell is sounded and the lamp of the station to which the watchman is proceeding remains lighted in order that an investigation may be made. Insertion of the key at the station restores the system to normal functioning except that the audible alarm is not silenced until the reset key on the central panel is operated. The period of delay during which the alarm is sounded is indicated by the time register on the watchman's chart.

The time register is driven by an eight-day spring mechanism and is provided with internal illumination to facilitate observation of the chart.

Faults, such as line failures and open circuits, result in an audible alarm which can be converted into a visual signal by depressing the fault alarm key. The visual signal remains lit until the fault is cleared.

## **General Alarm**

For the general alarm service, "break-the-glass" push buttons function in association with a central alarm equipment comprising alarm relays operating visual and audible alarms as well as a chart time record. The audible signal provided for alarms on the operation of a push button is a 20 cm 24 volt bell.

Both the central equipment and the Esterline

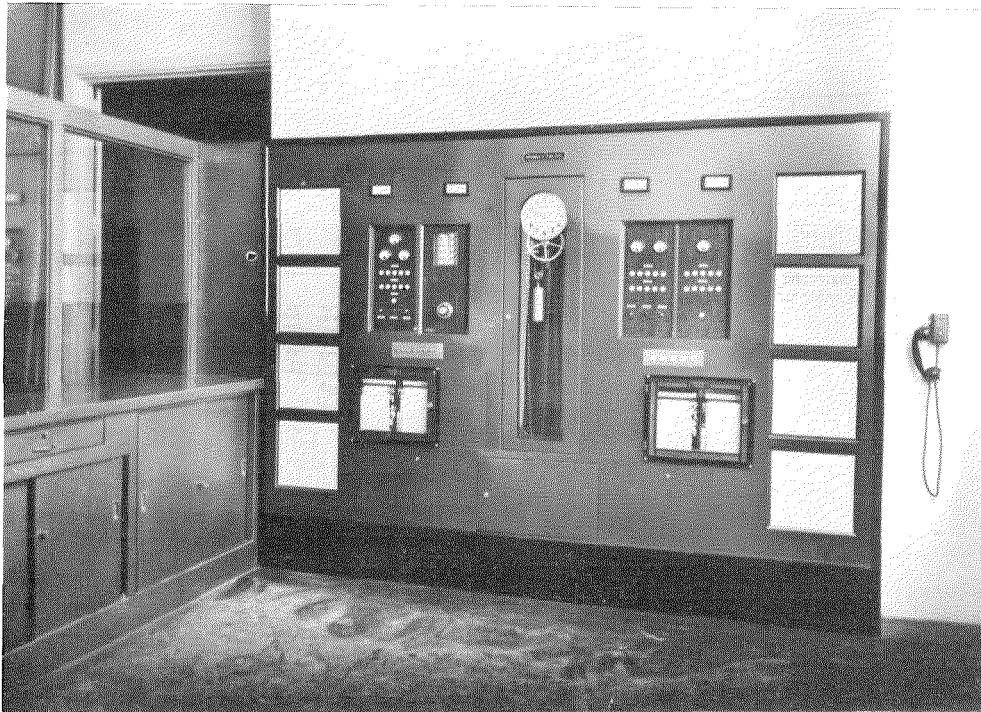

*Fig. 1—Main Control Panel.*

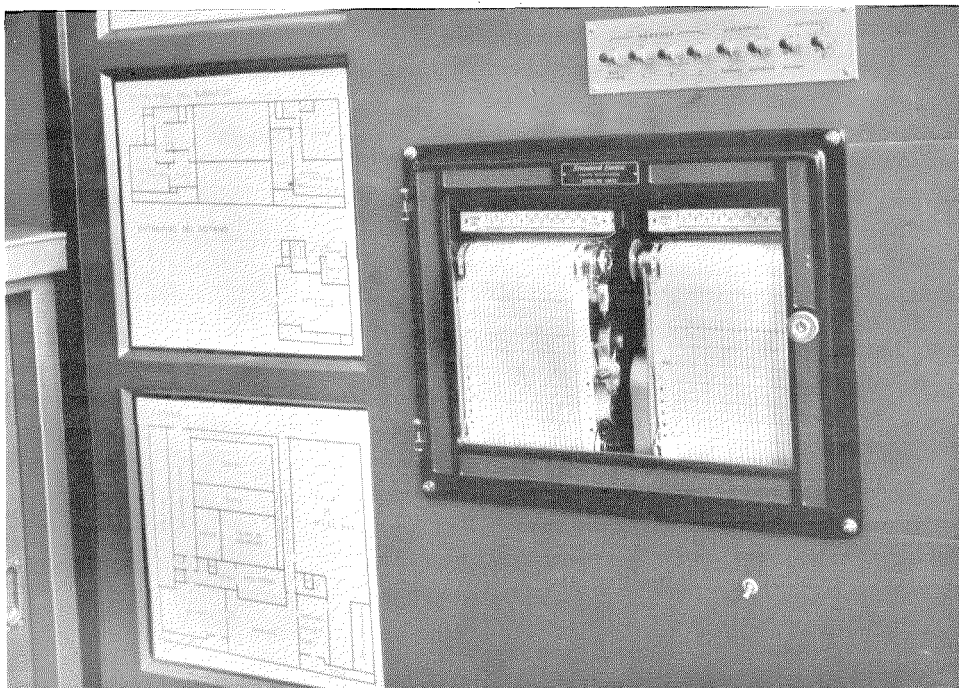

*Fig. 2—Watchmen's Charts and Part of Building Plan.*

Angus time register are designed for a capacity of sixty circuits; the present equipment consists of forty circuits.

Operation of a push button causes locking of the corresponding apparatus and recording of the alarm. To reestablish the circuit, the common reset key comprised in the central equipment must be operated.

The central equipment includes glass panels which individually represent one or two floors of the building in plan. On operation of an alarm push button, a red disc appears on the building plan indicating the point of origin of the alarm. Thus, time ordinarily lost in translating numbered lamps into actual building locations is eliminated.

The routiner used for checking the watchman's control system also serves for testing the lamps of the general alarm system; the two operations, in fact, are accomplished simultaneously, but the routiner includes two distinct circuits so that the specific failure is definitely indicated in all cases.

### ***Fire Alarms***

The thermostatic device employed for indicating room temperature rise above a predetermined level is adjustable over a wide temperature range by means of a micrometric screw and a calibrated disc. Operation of a thermostat produces an audible and a visual alarm at the central equipment.

### ***Cashier Alarm***

The cashier alarm is designed both for audible and visual alarms through the operation of foot pedals or paper sealed push buttons. When an alarm is given, a lamp indicates the circuit involved and a general audible alarm is sounded.

### ***Strong Room Alarm***

The equipment provided for each of the strong room doors consists of a delicately poised pendulum which rests on a three point contact. The pendulums are adjustable and are arranged to

respond to any slight vibration of the doors to which they are fitted and thus to alter the circuit conditions of the system.

The equipment is designed to give an audible and visual alarm in the event of tampering with the strong room doors. Suitable precautions were taken against the possibility that the system might be rendered inoperative through the injection of liquid air which would freeze the delicate contacts of the pendulum mechanism and permit motion without disturbing the electrical circuit.

Pendulum mechanisms are connected to a central equipment providing individual visual and audible alarms in association with each pendulum. The central equipment is enclosed in a special case which, after the starting key is thrown and the door closed, cannot be opened in advance of a predetermined time without giving an alarm. For emergency conditions, however, access to the cut-off switches to each of the strong room alarms may be obtained through an additional door which can be opened by a changeable code lock.

The flexible cord connection to the pendulum is such that any attempt at short circuiting, cutting of conductors, etc., immediately results in an alarm.

### ***Personnel Calling System***

The installation includes a system of lamp indicating panels for paging executives.

### ***Power Supply***

The alarm and control system herein described is operated on the constant current principle designed to indicate faults such as opens, short circuits or ground. Two separate 24 V batteries, providing reserve in case of mains failure, are fed from a 220 V a-c source converted to d-c by means of a rectifier. Batteries are operated full float and are kept fully charged. A visual signal and an audible alarm, respectively, are given in case of mains supply or local battery failure.

# Directory Information Bureau—Shanghai

By MISS L. A. E. MANN

*Service Superintendent, Traffic Department, Shanghai Telephone Company*

*This article gives an outline of the development and operation of the bi-lingual Centralised Directory Information Bureau in Shanghai and indicates some unusual problems encountered in the operation of the Bureau.*

## 1. Introduction

Shanghai is divided into three areas:

- a) The International Settlement, comprising an area of approximately 8.75 square miles with a population of about 72,000 foreigners (non-Chinese) and 2½ million Chinese. Contiguous to the International Settlement are two zones known as “‘Extra Settlement’ or ‘Outside Roads’ Areas.”
- b) The French Concession, covering an area of approximately 3.94 square miles with a population of about 35,000 foreigners and about 1½ million Chinese.
- c) Greater Shanghai, comprising the adjacent areas of Chapei, Civic Centre, Nantao and Pootung.

The Shanghai Company provides telephone service in the first two areas mentioned, including portions of the Outside Roads Area. Another Company, the Central China Telecommunications Company, furnishes service for greater Shanghai, intercommunication facilities between the two systems being provided.

Prior to 1930, when the Shanghai Mutual Telephone Company was merged into the International Telephone and Telegraph System as the ‘Shanghai Telephone Company,’ operation was largely on a local battery basis. A description of the conversion to automatic operation has been published.<sup>1</sup> The Shanghai Telephone Company now has in operation one common battery and seven full automatic central offices of the No. 7-A Rotary type, approximately 60,100 exchange lines and 93,400 stations being connected to the system at the end of August, 1941.

Shanghai is an extremely cosmopolitan city with nationals of almost every country in the

world residing within its confines and, consequently, a great variety of languages is spoken. The two principal languages—those in which the Shanghai Telephone Company contracts to give service to its subscribers—are Chinese and English.

## 2. History of the Information Bureau

Just over ten years ago, each central office had its own ‘enquiry’ bureau, maintained its own set of information records covering the entire system, and dealt with all ‘enquiries’ originated by subscribers connected to that particular office. In each office three types of records were maintained, consisting of complete lists of subscribers in alphabetical (name), street and numerical (telephone number) order. The English and Chinese Alphabetical records comprised specially bound copies of the current directories with alternate sheets of blank paper on which amendments were recorded in manuscript facing the position they would occupy if printed in the standard copy, disconnections being crossed out on the printed pages. The Numerical and Street records, in English only, were contained in drawer files and gave the same information as the alphabetical records but in telephone number and street order respectively. To obtain access to the ‘Enquiry’ operators, foreign (non-Chinese) subscribers were instructed to call ‘499’ and Chinese subscribers ‘599.’ The majority of calls, however, were received via ‘499,’ possibly because it was a much better known number since it had been in existence almost as long as the Telephone Company, and because many Chinese seemed to prefer dealing with the ‘foreign’ bureau.

At the beginning of 1930, in anticipation of the conversion to automatic, the ‘Enquiry’ service was centralised. Several of the existing English and Chinese Alphabetical records and one set of

<sup>1</sup> “The Reconstruction of the Shanghai Telephone System,” J. Haynes Wilson, *Electrical Communication*, July, 1932.



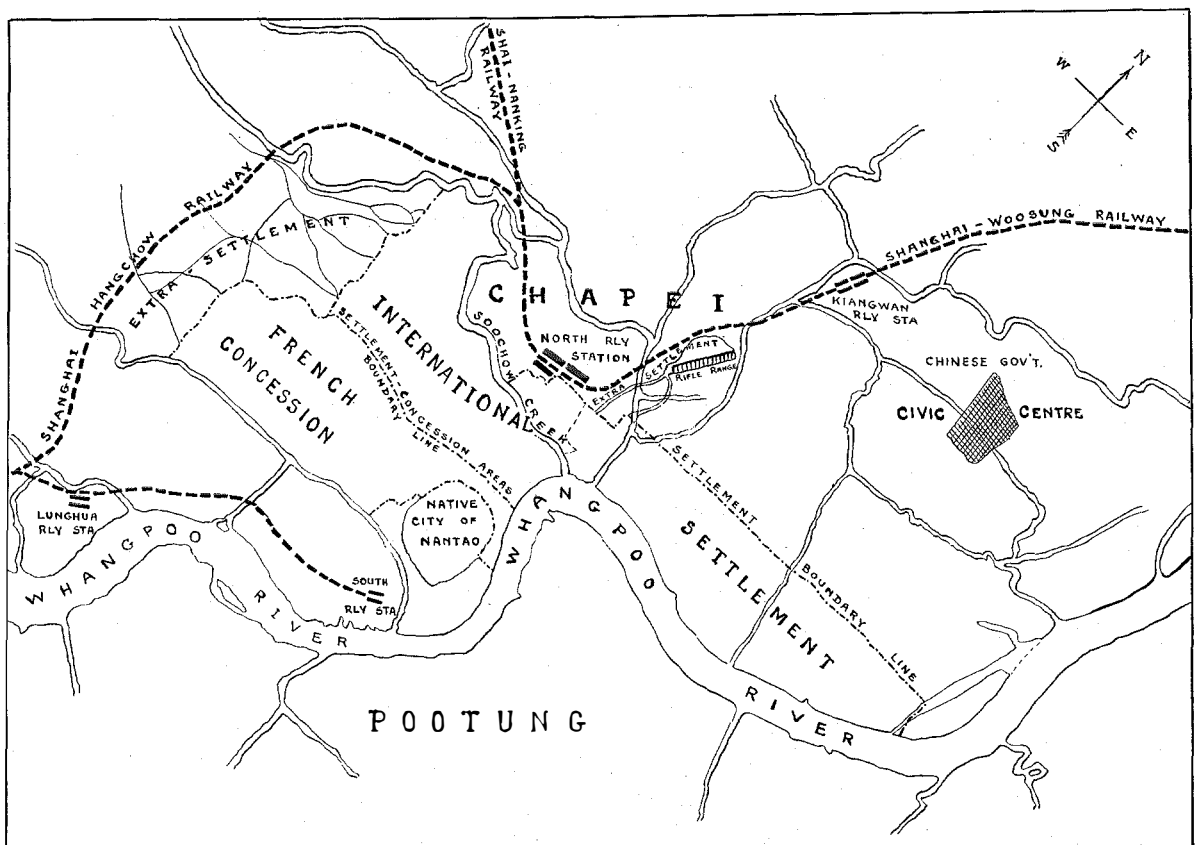

Fig. 1—Sketch Map of Shanghai.

Street records were utilised, while a new Numerical file was developed. This contained one card for each central office line, the cards being approximately  $3\frac{1}{2}$  by  $2\frac{1}{2}$  inches in size and filed in open steel trays on a special table which, together with the Street records, was located a few feet behind the suite of operating desks. Since it was not practicable to have the operators leave their positions to refer to these records, a number of 'small boy' messengers were provided. Thus, a subscriber wishing to make an 'enquiry' called '499,' where the call was transferred to the centralised 'Enquiry' operators. If the enquiry was of an alphabetical nature, that is, if the caller required the telephone number for a particular name, the operator furnished it by direct reference to one of the special directories. If, however, the caller required the name of the subscriber owning a specified telephone number, or the telephone number of a certain address, the operator requested a 'small boy' to procure the appropriate card or tray, from which the required

information was obtained and relayed to the caller, the card or tray thereafter being returned to its proper place by the 'small boy.'

This operating procedure was a definite advance on the previous decentralised scheme, but with the conversion of the system to automatic operation it was necessary to provide a more rapid and less cumbersome method of dealing with information calls. It was therefore decided to provide one centralised information bureau to serve the entire city and to adopt the rotary file type of information records, so that the receiving operator could give the required information direct to the caller.

A rotary file, as the name suggests, consists of a drum which is mounted on a vertical axis around which it can be rotated in either direction. Each drum contains a number of varying size and capacity frames which can easily be removed from the drum as required, the number of such frames on each drum depending on local requirements. Drums can be mounted singly or

one above the other but operating independently. Each of the drums used in the Shantelco C.I.B. contains 450 frames, each of which is 6 inches wide by 12 $\frac{1}{8}$  inches high. Moveable index tabs are associated with each frame so that adequate indexing can be provided to facilitate reference. The directory information is recorded on flexoline strips, usually referred to as inserts; these inserts

are supplied in sheet form and in suitable widths for various sized frames, each insert being 'scored' so that it can be easily detached. Hence it is possible to file the inserts in any order required, and amendments, deletions or additions can be quickly effected. The sheets of flexoline inserts used by Shantelco measure 6 inches in width and contain 42 inserts per sheet.

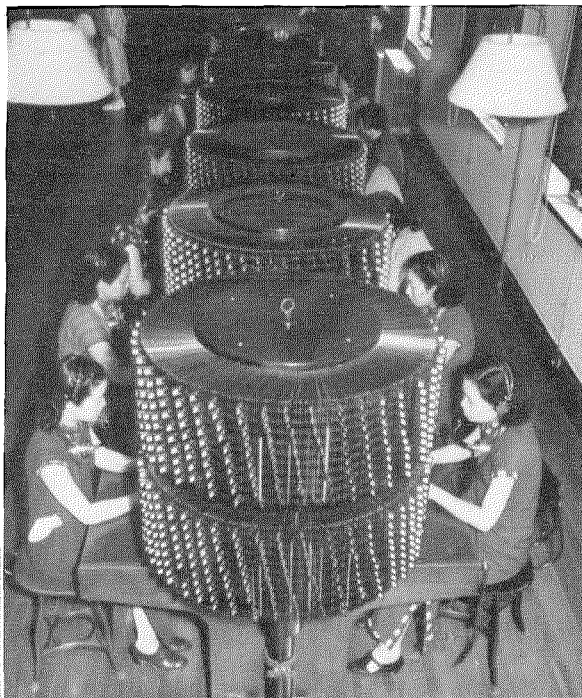

*Fig. 2—Two Views of Shanghai Telephone Company Central Information Bureau.*

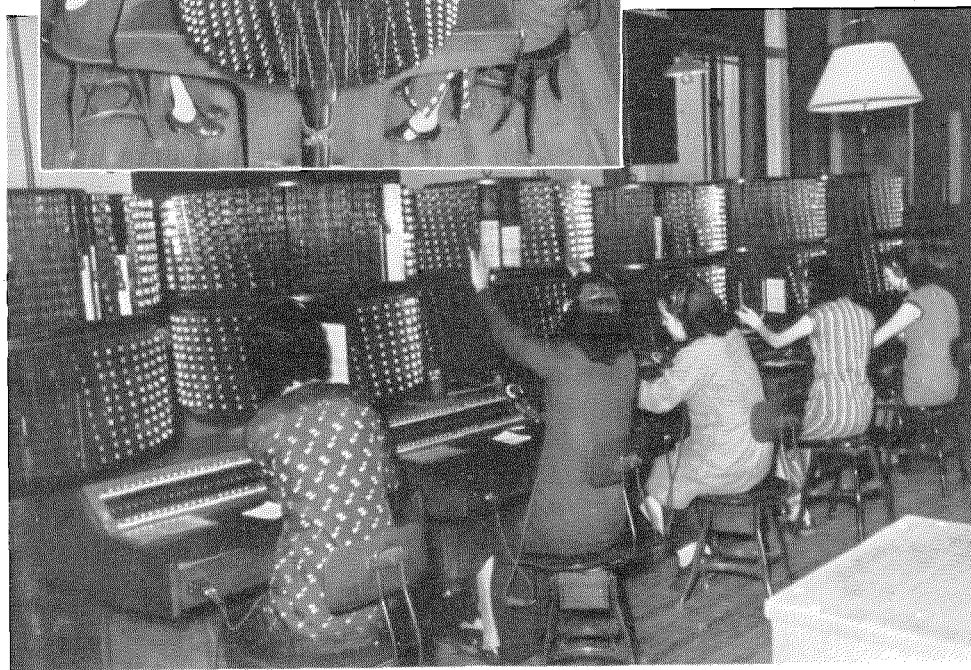

In September, 1931, the present C.I.B. was brought into operation, '09' being allocated as the 'Information' number. Until March, 1932, when the conversion of the system to automatic operation was completed, both information bureaux functioned, the old one continuing to take care of 'enquiries' from manual subscribers via '499,' whilst the new one handled 'information' calls from automatic subscribers via '09.' In the new C.I.B., the location of the information records was such that each operator had easy access to all records. English Alphabetical, Street and Numerical information was furnished from rotary files, whilst Chinese Alphabetical information was still supplied from the special interleaved directories. Towards the end of 1932 the increase in the number of information calls from Chinese subscribers, and the difficulty of accurately maintaining the special directories, necessitated the development of some other form of Chinese alphabetical reference; Chinese alphabetical rotary files accordingly were brought into operation early in 1933.

Considerable difficulty was encountered during the planning of these files due to the fact that no 'Chinese Character' typewriting machines could be found to type the flexoline inserts satisfactorily; the only suitable alternative was to 'write' the inserts, and this method was finally adopted and has proved satisfactory in all respects. While the Chinese language is usually read from top to bottom of a page and from right to left, the C.I.B. Chinese files follow the same layout as the English files, that is, with the name on the left, the address in the centre and the telephone number on the right, the latter being shown in romanised figures.

With the development of the system and the consequently increasing demands upon the C.I.B., it became necessary in the interests of economic operation to cease supplying Numerical and Street information, since the continuance of these facilities would have necessitated an increase in the number of C.I.B. operating positions and the purchase of additional rotary files. Furnishing Numerical information was therefore discontinued in December, 1932, and Street information in June, 1934. However, arrangements were made with the Plant Department for supplying the Fire and Police Departments of

the International Settlement and French Concession with information concerning the name and address of a specified telephone number.

Although Street information is no longer supplied to subscribers, in cases where the caller states that the matter is of great urgency, reference is made by the C.I.B. forces to the 'China Hong List' which includes a certain amount of street information. Any information contained therein is given to the caller with a statement as to its source.

The C.I.B. at present consists of five double-sided desks comprising ten operating positions and six complete directory information units in name order, three English and three Chinese, each unit consisting of two drums one above the other. Every operator has access to a complete English and Chinese unit. Two views of this C.I.B. are shown in Fig. 2.

WELL JAMES & CO LTD (SCOTCH BAKERY)	1489 YUWEN	23099
BRANCHES :		
187 HANKING		12765
326 AV JOFFRE		74869
135 SAYZONG		78258
NESTLE'S MILK PRODUCTS (CHINA) LTD		
9 QUAI FRANCE		62080
(2 lines) Private Exchange to all Depts		
NEHWADA & MRS	Pa 150 25 AV HAIG	70955
NETTESOFF & A	Ln 150 4 HAICAL	50403
NETHERLANDS CONSULATE GEN	9 QUAI FRANCE	80136
NETHERLANDS SELLING ORGANISATION LTD		
	46 KIUKIANG	19270
OCODON	Ln 300 61 ZHANG	58609
NETHERLANDS TRADING SOCIETY	20 BOND	19474
AFTER OFFICE HOURS :		
MANAGER		19471
SUB MANAGER		19472
CASHIER		19473
RESIDENCES :		
SCHAAP C J MANAGER	1594 AV JOFFRE	74855
VAN WEEZEL WRENS J P A		
	1202 AV JOFFRE	71104
NETUPSKY & M OFFICE	350 SZEON	19580
RESIDENCE	313 9 de SZEON	79657
NEW AMERICAN PHOTOGRAPHY PRESS		
	Pa 225 8 ZIKAWAI	72964
NEW ASIA HOTEL	422 TIEN-ONG	42210
NL MANAGER'S OFFICE		45226
NL IMOTO K RESIDENCE	Ln 175 21 E KASHTO	42522
* NEW YORK TIMES	220 SZEON	19253
TE NO ANSWER CALL TEL AND SERVICE		97222
NEW YORK TIMES	NUMBER RESERVED	
NEW ZEALAND INS CO LTD	27 BOND	19593
NEWELL H	525 EMBANKMENT BLDG	42251
NEWS REEL THEATRE	304A MOHAWK	36687
NEWSON C C	43 TUNSH	23866
NEYRONE L	73 ST WESTN	21061
NG CHEW	722 MYTEN	21522
NG KA WING	153-C SOEURE	76711
NG W C	Ln 10 26-D SEYMOUR	36028
NG YING HAI	Pa 667 2 AV POCH	78013
NGAI KUNG KWAN	Ln 129 47 KINNEAR	20742
NGO KING LOONG	Ln 230 VVIT AMY	61561
NIAGARA AERATED WATER FTY	216 FRELUPT	76796
NIGHTMOTOR CAR CO	916-7 N SZEON	41063
NOGAKA BRCS & CO LTD	24 CENTRAL	16880
BRANCH	201 KINCHONG	43664
NYI KUNG KWAN	276 WEIHAIWEI	32777
NYI LOH FUNG	NUMBER RESERVED	
O & K PRINT CO	Pa 116 7 AV JOFFRE	66934
OFOLDER ROBERT E	132 SHISI	75911
O K SHIRT & TIE CO	1281 AVENUE	62498
OAK & CO GENERAL CONTRACTOR		
	209 Y M YUEN	14177
OCEAN ACCIDENT & GUARANTEE CORP LTD		
(CHINA) BRANCH	17 CANTON	13407
(4 lines) Private Exchange to all Depts		

FIGURE 3.

Fig. 3—Frame Showing English Directory Information Listings.

3. Maintenance of Information Records

In Shanghai, the English directory information is typed and filed in alphabetical order of names; Chinese listings are written and filed in 'stroke' sequence which may be regarded as the Chinese equivalent of the alphabet. The method of indexing the English files is to show the letter of the alphabet on an index tab at the beginning of the section referring to that letter; thereafter, the index tab bears the first three letters of the first and last names listed in the frame (Fig. 3). The method of indexing the Chinese files is somewhat different. The Chinese language has a large number of 'characters,' each of which is built up by a number of 'strokes'; characters having from 1 to 27 strokes are most generally used in names. For reference purposes, all characters having the same number of strokes are grouped together, there being a varying number of characters in each group. There are, for example, two characters having one stroke, 55 having 5 strokes and 15 having 21 strokes. The method of indexing is indicated in Fig. 4. The first index tab shows four characters having ten strokes, the centre tab indicates that the eleven stroke series is commencing, while the third tab shows the first character having eleven strokes. To facilitate reference to the files, an insert indicating the stroke series is filed at the top of each frame; also, an insert showing the change to the next stroke series is filed immediately above the first listing of that series. For example, the top insert of the sample frame reads 'Stroke Ten' while the eighth insert from the bottom reads 'Stroke Eleven.'

Information concerning connections, disconnections and changes is obtained from the No. 1 copy of the Service Orders issued by the Business Office. Upon receipt of a connection order which affects directory listings, an insert is prepared for each directory unit and attached to the service order. Immediately the Plant Department notifies C.I.B. Records that the work is completed, the service order is extracted from the pending file and the inserts are filed in the rotary files, the information being available to callers within approximately five minutes after the completion advice is received. In the case of disconnections, the appropriate inserts are extracted from the rotary files immediately the advice of

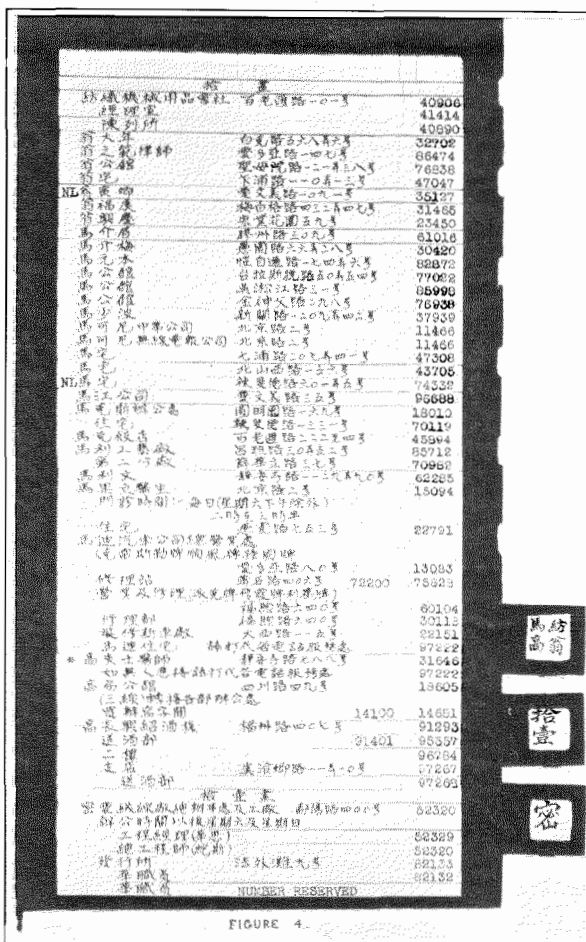

Fig. 4—Frame Showing Chinese Directory Information Listings.

completion is received. Incidentally, in normal times, approximately 80% of the total service orders issued by the Business Office affects directory listings, whereas under the sub-normal conditions which at present prevail in Shanghai, only about 45% involves the C.I.B. files; this represents approximately 60 to 100 changes per day in each directory unit as against 130 to 220 in normal times.

As far as possible every effort is made to use only one strip for each listing, and to this end abbreviations have been developed and standardised, these being used where necessary for specified words and streets; in addition, all words such as 'The,' 'Road,' 'Street' and 'Avenue' are eliminated.

When maintaining the files, consideration also must be given to Directory requirements; for,

since 1934, the C.I.B. information records have served the printers for obtaining the information used in the compilation of the alphabetical sections of the English and Chinese directories, the rotary file frames being photographed and the type set from the photographs.

Every subscriber is entitled to one line in the directory free of charge but many subscribers require, and pay for, additional listings. Furthermore, the amount of space allowed free to each subscriber for his directory listing is equal to 51 printing spaces, while the strip used in the C.I.B. files has only 47 typing spaces. Thus, if it is necessary for a subscriber's directory listing to occupy the full 51 spaces allowed, the C.I.B. must utilise two flexoline inserts for the rotary file listing. In order to meet both directory and rotary file requirements, therefore, the use of one strip in the files is not rigidly enforced, even when practicable through the use of abbreviations.

#### 4. Development of Information Records

In order to provide for expansion it is necessary to ascertain exactly how many inserts are used for each subscriber's listings and from this knowledge compile what is known as a 'double listing' factor. The Shantelco 'double listing' factors, which have remained constant since October 1938, are 1.09 for the English files and .90 for the Chinese files, the latter figure being lower due to the fact that foreign residential listings are not shown in the Chinese records or directory, owing to the difficulty of accurate translation into Chinese.

Further, due to the constant movement of subscribers, it is impracticable to fill each frame with inserts to its full capacity. In order to avoid unnecessary loss of time when new listings are being filed and to ensure speedy maintenance, it is therefore essential to determine the percentage of each frame which should normally be filled, this factor being known as the 'percentage file fill.' Each of the frames has a capacity of 140 flexoline inserts, 70 on each side, and various 'file fill' factors have been experimented with; it has, however, been found that the most satisfactory figure is around 85%. Using this figure, the total working capacity of each directory unit is 107,000 inserts. Under present sub-normal conditions it would be practicable to work to a

90% fill, thus increasing the total capacity of one directory unit to 113,400 inserts, but, pending a clarification of the situation, no file fill adjustment has been made.

These 'file fill' and 'double listing' factors are used in estimating the period over which a rotary file directory unit will serve, and are applied to the estimated number of exchange lines for the particular period under review.

Thus, from reference to Table I, it will be

TABLE I  
*File Capacity in Relation to Exchange Lines*  
File fill—85%  
Double listing factors— { 1.09 English  
                                  { .90 Chinese

No. of Drums in a Directory Unit	Insert Capacity	Exchange Line Capacity	
		English File	Chinese File
2	107,100	98,257	119,000
3	160,650	147,385	178,500
4	214,200	196,514	238,000
5	267,750	245,642	297,500

realised that under normal conditions, where English and Chinese language files are used and every operator has access to both complete sets of records, file development is governed to some extent by the number of listings which can be accommodated in the English file. Assuming a 'file fill' factor of 85% and 'double listing' factors of 1.09 and .90 for English and Chinese files, respectively, the saturation point of one English directory information unit of two drums will therefore be reached when the system attains approximately 98,000 lines, and of three, four and five drum units when it reaches around 147,000, 196,500 and 245,600 lines respectively. The same sized directory units would, however, accommodate Chinese listings for approximately 119,000, 178,500, 238,000 and 297,500 exchange lines before saturation is reached. Furthermore, if directory records in only the English language were maintained it would be possible to use rotary files up to a ten drum unit (approximately 491,000 exchange lines), every operator having access to a complete directory unit.

When planning C.I.B. file development, the problem cannot be considered entirely from the file capacity point of view since the question of operating costs is also of vital importance. The

FOUR DRUMS PER DIRECTORY. TWO DRUMS FOR ENGLISH COPY. TWO DRUMS FOR CHINESE COPY.

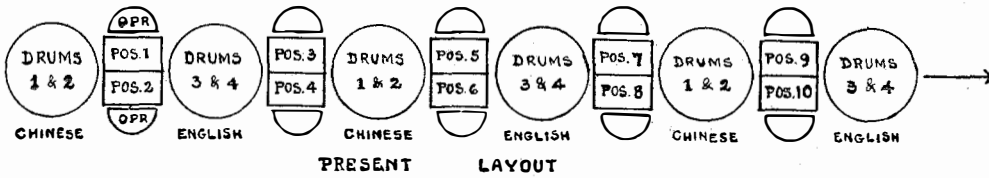

SKETCH (A)

SIX DRUMS PER DIRECTORY. THREE DRUMS FOR ENGLISH COPY. THREE DRUMS FOR CHINESE COPY.

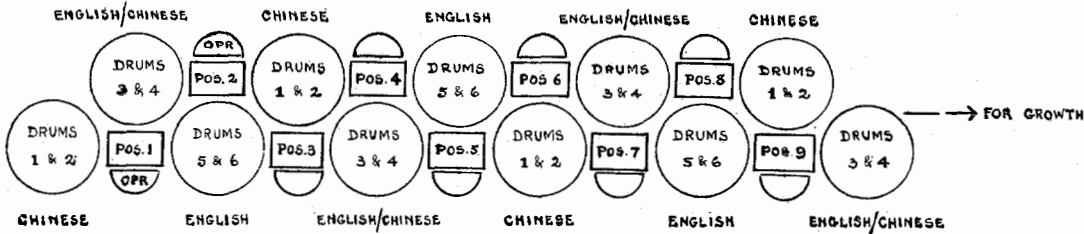

SKETCH (B)

EIGHT & TEN DRUMS PER DIRECTORY. FOUR AND FIVE DRUMS EACH FOR ENGLISH AND CHINESE COPY.

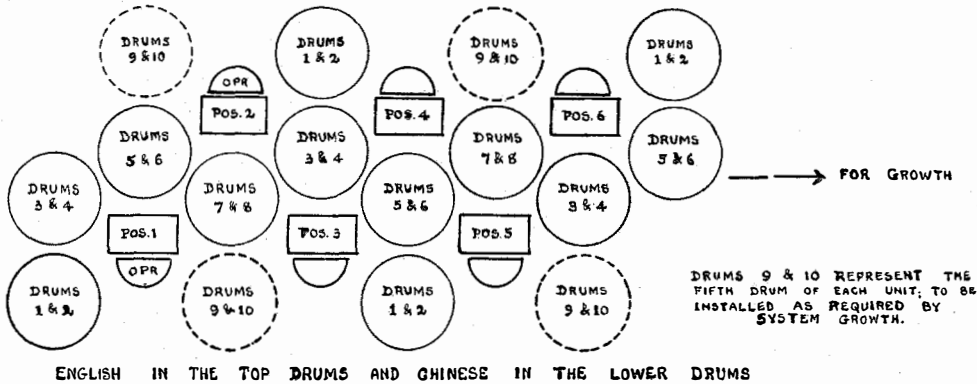

SKETCH (C)

POSSIBLE LAYOUT WITH FILTER OPERATION

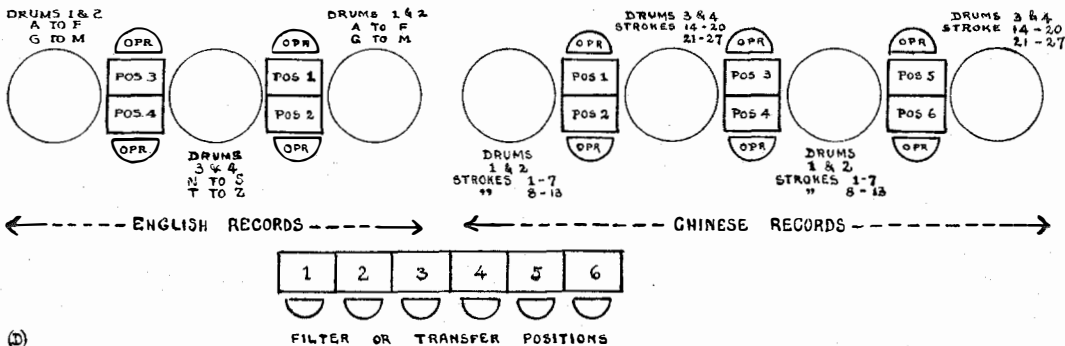

SKETCH (D)

Fig. 5—Present and Possible Directory Information Bureau Layout Designs.

number of directory information units increases in proportion to the required number of operating positions, which in turn are governed primarily by the number of calls made to the information bureau per line per busy hour. These also are studied in relation to the operating time per call, that is, the time taken by the information operator to ascertain the caller's requirements and supply the required information.

The calling rate tends to increase in relation to the time elapsed since the issuance of the directory, due to the increase in directory listing obsolescence. Records show that the amount of obsolescence varies from about 6% immediately after issuance to about 34% when the C.I.B. files are photographed for the next issue of the directory. The calling rate per line per busy hour for February, 1941, just prior to the issuance of the directory, was .00912, whilst the figure immediately after issuance was .00768. The present operating time for calls to C.I.B. is around 52 seconds; Chinese calls, which represent approximately 90% of the file references, take a little longer to handle than English calls. This is largely due to difficulty in obtaining the necessary details from Chinese subscribers, the operator often having to ascertain first the number of 'strokes' in the surname, some names being found under more than one 'stroke'; for example, the name 'Wong' can be found under 'strokes' 4 and 12. The operator frequently must also ascertain the number of 'strokes' in the given name or names and the manner of writing the characters before accurate information can be given to the caller. To a certain extent, however, information calls are answered by the operators from memory, that is, without reference to the files; roughly 22.5% of the Chinese, and 14% of the English calls, are so handled.

Under existing world conditions it is extremely difficult to make forecasts but, so far as can be estimated from information at present available, it will probably be about 1946 before the system reaches 98,000 lines, at which time the existing two drum directory information units will probably reach the saturation point. Nevertheless, a study of the problem of C.I.B. information file development was made during 1940, when three policies were given consideration: first, an extension of the present full rotary system; second, rotaries for Chinese records and directories with

daily addenda sheets for English records; and third, directories with daily addenda sheets for both English and Chinese records. In the latter two policies the daily addenda sheets would be supplied by the printer who would also have to issue periodic, probably bi-weekly or weekly, reprints of the directories for the use of the Information operators. The studies were made in collaboration with the Commercial Department Directory Section and disclosed that it would be desirable to continue with the full rotary system as long as possible, particularly since it provides such a satisfactory basis for the printing of the alphabetical sections of both directories.

Reference to Table I, indicating the relation of file capacity to exchange lines, and to Fig. 5 shows that, provided the 'double listing' factors and 'file fill' figures previously referred to remain constant, it would be possible, with a re-arrangement of the operating positions, to use rotary files until the system reaches around 245,000 lines. From an operating cost aspect, however, it is doubtful whether the four and five drum directory units will ever be adopted in Shanghai. Assuming that they were adopted, any subsequent development would have to be taken care of by the introduction of the 'filtering' method of operating, under which the call is answered by one operator and distributed or filtered to a disengaged operator who has access to the appropriate section of the records. In this connection it should be mentioned that, while filtering economises in the number of information records required, the total time taken to supply information to subscribers is considerably increased due to the call being handled by two operators. Filtering is therefore usually deferred by most telephone concerns as long as possible. but at some period of system growth its introduction becomes economically desirable. When that time arrives in Shanghai, a scheme approximating the layout shown in (d) of Fig. 5 would probably prove workable, the number of positions and the breakdown of the information records depending entirely upon traffic conditions and forecasts at the time of its introduction.

### **5. Problems Peculiar to Shanghai**

Most of the operating difficulties experienced in Shanghai involve language problems. No

only is the variety of languages very great, including English spoken with innumerable different accents, but there are also many dialects of the spoken Chinese language, though the written language is the same. While the 'Shanghai' dialect predominates, the large numbers of natives from all over China residing in the city use many other dialects. All the Information operators are able to read and speak English and Chinese (Shanghai dialect) fluently and many are also able to speak Mandarin and Cantonese as well as other dialects.

To facilitate intercommunication between the Shanghai Telephone Company and the Central China Telecommunications Company, all Shantelco operators subsequent to the Sino-Japanese hostilities of 1937 were taught the numerals and operating expressions in Japanese. The operating and supervisory forces also include individuals who can speak Japanese, Russian, Portuguese, Polish, Filipino, French and German.

Most telephone concerns undoubtedly are confronted to some extent with the problem of unnecessary calls made to the information bureau involving numbers correctly listed in the current issue of the directory. In Shanghai separate English and Chinese directories are printed, Chinese directories being issued to Chinese subscribers and English directories to subscribers of other nationalities; subscribers who desire copies of both directories can obtain them by payment of the specified charge. Records taken reveal that approximately 75% of the calls made to the C.I.B. are for numbers listed in the directories; this figure is probably higher than elsewhere and

is very largely due to language difficulties as will be seen from the following breakdown:

- a) Foreigner (non-Chinese) using a telephone belonging to a Chinese subscriber with only a Chinese directory available. 21%
- b) Chinese using a telephone belonging to a foreigner with only an English directory available. . . . . 28%
- c) Inability to read either directory. . . . . 5%
- d) Chinese calling for a non-Chinese residence (not shown in the Chinese directory). . . . . 6%
- e) Unable to find the name required—probably listed under some other name. 4%
- f) Miscellaneous (Directory not at hand; cannot be bothered to look in Directory; quicker to call '09,' etc.) . . . . . 11%

There does not appear to be any really satisfactory method of eliminating the enquiries mentioned under (a) to (d), and, so far as the other two items are concerned, various operating procedures intended to induce subscribers to use the directories have been tried out, but reduction in the number of enquiries was found to be small and more than offset by the increased time taken to deal with each call. In accordance with general practice, Shantelco makes no special charge for calls to the directory information bureau. While not directly revenue producing, directory information service, in addition to its intangible value from a 'Good Public Relations' aspect, does undoubtedly improve revenue by stimulating telephone usage, particularly in measured rate areas such as Shanghai.



# The Effect of Space Charge on the Potential and Electron Paths of Electron Beams

By D. P. R. PETRIE, M.Sc.

*Standard Telephones and Cables, Ltd., London, England*

*In this article the more important results of analyses of the effects of space charge in electron streams are collected from the existing literature and are presented in the form of curves and nomograms so that they can readily be applied to cases occurring in practice. The effects considered are: the space charge limited current in plane and cylindrical diodes; the minimum potential; maximum current and increase of transit time in the screen-anode region of tetrodes; the minimum potential, maximum current, velocity distribution and divergence of a long flat beam between parallel plates and of a long cylindrical beam in a tube.*

## 1. Introduction

When an electron stream passes through an electrode system, the potential at any point is lower than that due to the electrodes themselves in the absence of current, owing to the surrounding negative space charge. In practice, this depression of potential has three important effects:

- (a) The potential may drop to zero (the value at the cathode) at some point, forming a virtual cathode. Some electrons are brought to rest there, and return to the nearest positive electrode.
- (b) A beam which would be homogeneous in velocity is rendered inhomogeneous, because the potential is depressed by different amounts in different parts of the beam.
- (c) Electric fields may be introduced, altering the electron paths; for example, a beam which would otherwise be parallel is caused to diverge by its own space charge.

It is important for design purposes to be able to calculate the magnitude of these effects due to a given current in a given electrode system, but this is possible only in a few cases of simple geometry. Three cases have been treated at length in recent literature:

- (a) The screen-anode space of an infinite plane tetrode.<sup>1</sup>
- (b) A flat beam travelling between two parallel lateral plates.<sup>2</sup>
- (c) A cylindrical beam travelling down a cylindrical tube.<sup>3</sup>

<sup>1</sup> For references, see end of article.

The examples given hereinafter indicate the usefulness of such calculations. In the case of a beam power tetrode, the depression of potential is utilised to suppress the passage of secondaries between screen and anode; in tubes utilising long focused beams, the space charge effects are detrimental because divergence of the beam usually causes loss of current to various electrodes, while velocity inhomogeneity may cause loss of efficiency.

In collecting the main results of the papers referred to above, the aim has been to present them in such a way that they can be applied to practical cases easily and quickly. The possibility of bringing all these results within the scope of a single paper is simplified by the universal appearance in the analyses of a certain parameter, defined in the next section.

For the sake of completeness, the case of the space-charge limited diode (plane and cylindrical) has been included, this being the simplest system whose action is governed by space-charge.

## 2. The Fundamental Parameter $P$

It appears that all space-charge effects depend on a current density  $i$ , assumed constant in space, a length  $a$  and a potential  $V$  in such a way that they can be expressed most conveniently in terms of a dimensionless parameter  $P$ , first introduced by Salzberg and Heaff,<sup>1</sup> and defined by:

$$P = 3\pi^{1/2} \left( \frac{m}{2e} \right)^{1/4} \frac{i^{1/2} a}{V^{3/4}}, \quad (1)$$

where  $e/m$  is the ratio of charge to mass of an

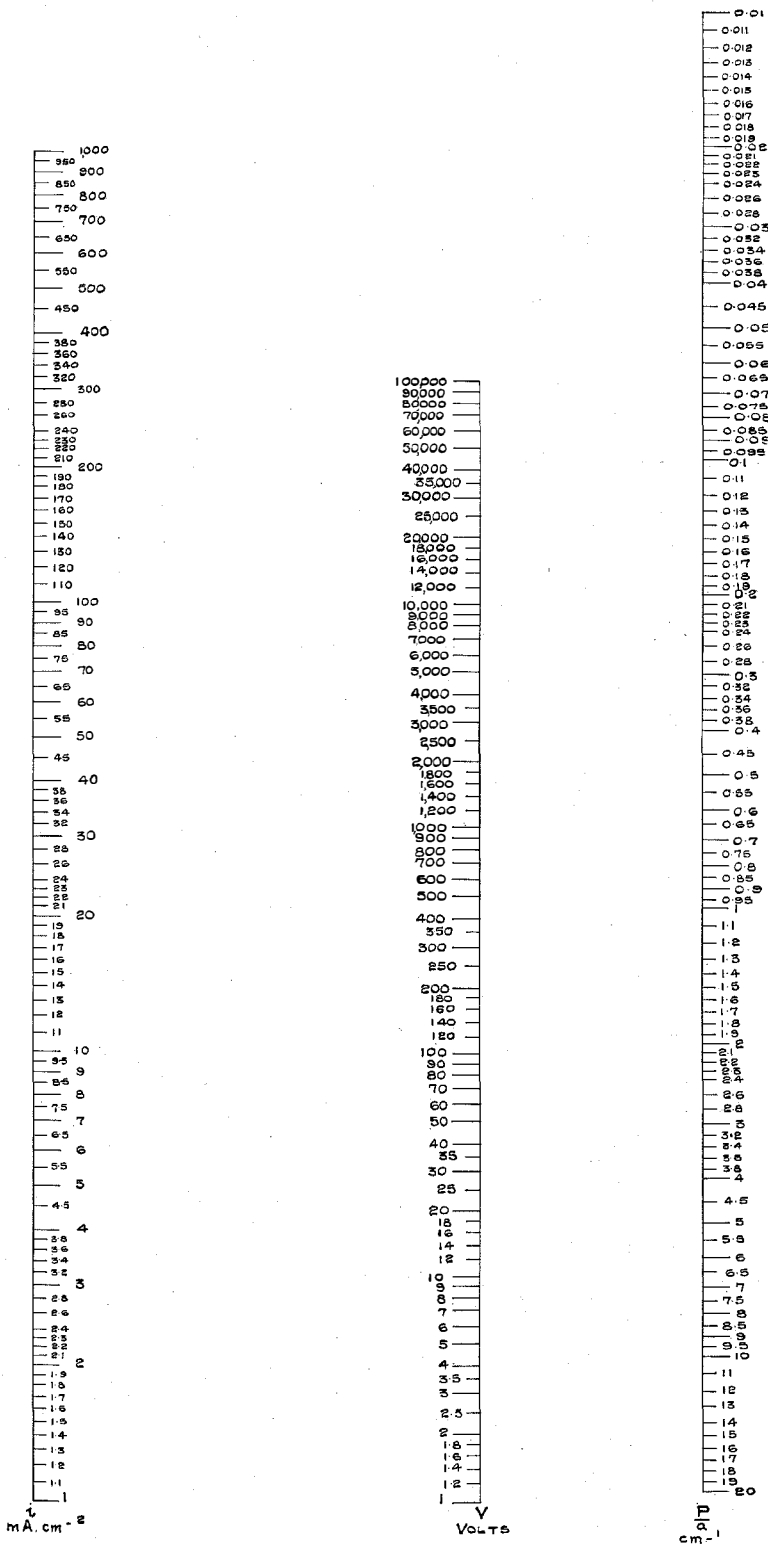

Fig. 1—Nomo-gram connecting  $i$ ,  $V$ , and  $P/a$  according to equation (2).

electron. If  $i$  is expressed in  $mA/cm^{-2}$ ,  $a$  in cm, and  $V$  in volts:

$$P = \frac{20.8i^{1/2}a}{V^{3/4}} \tag{2}$$

This relation is shown in Fig. 1 by a nomogram connecting  $P/a$ ,  $i$  and  $V$ , from which any one of the three quantities can be read off if the other two are given.

We now pass on to the consideration of specific cases, showing how the various space charge effects are related to  $P$ . It is to be remembered, however, that, although  $P$  is always of the form given in equation (1), the meaning to be ascribed to  $i$ ,  $V$  and  $a$  differs from case to case.

### 3. The Space-Charge Limited Plane Diode

Langmuir's equation for the space-charge limited current through a plane diode is

$$i_a = \frac{1}{9\pi} \left(\frac{2e}{m}\right)^{1/2} \frac{V_a^{3/2}}{l^2} \tag{3}$$

where  $i_a$  is the current density,  $V_a$  the anode potential and  $l$  the cathode-anode distance.

Taking the square root and rearranging:

$$3\pi^{1/2} \left(\frac{m}{2e}\right)^{1/4} \frac{i_a^{1/2} l}{V_a^{3/4}} = 1 \tag{4}$$

This is identical with equation (1) if

$$\left. \begin{aligned} i &= i_a \\ a &= l \\ V &= V_a \\ P &= 1 \end{aligned} \right\} \tag{5}$$

Hence, if any two of the quantities  $i_a$ ,  $V_a$ ,  $1/l$  are known, the nomogram at once gives the third, in accordance with equation (3).

### 4. The Space-Charge Limited Cylindrical Diode

Langmuir's equation in this case is

$$I = \frac{2}{9} \left(\frac{2e}{m}\right)^{1/2} \frac{V_a^{3/2}}{r_a \beta^2} \tag{6}$$

where  $I$  is the current per unit axial length,  $V_a$  is the anode potential,  $r_a$  the anode radius, and  $\beta$  the well-known function of  $r_a/r_c$  tabulated by Langmuir,  $r_c$  being the cathode radius. If  $i_c$  is the current density at the cathode surface,

$$i_c = \frac{I}{2\pi r_c} = \frac{1}{9\pi} \left(\frac{2e}{m}\right)^{1/2} \frac{V_a^{3/2}}{r_a r_c \beta^2} \tag{7}$$

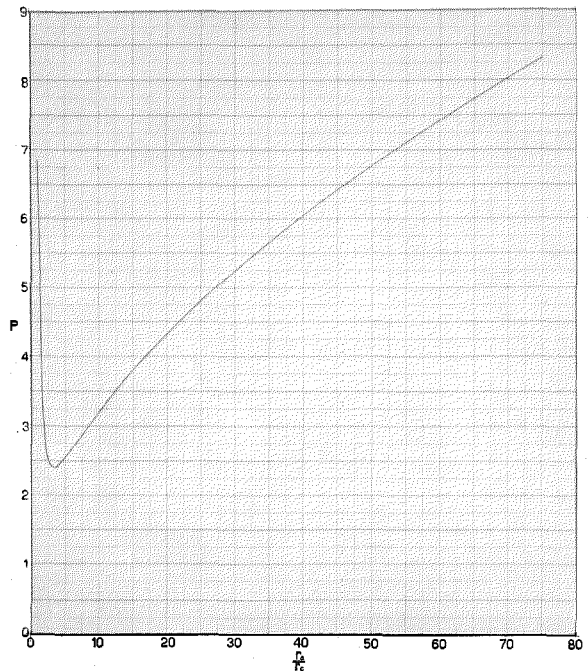

Fig. 2—Cylindrical Diode. Relation between the parameter  $P$  and the ratio of the anode radius to the cathode radius  $r_a/r_c$ .

This is clearly identical with equation (1) if

$$\left. \begin{aligned} i &= i_c \\ V &= V_a \\ a &= r_a \\ P &= \frac{1}{\beta} \left(\frac{r_a}{r_c}\right)^{1/2} \end{aligned} \right\} \tag{8}$$

$P$  is thus a function of  $r_a/r_c$  only, and is represented in Fig. 2. Hence, if any one of the four quantities  $i_c$ ,  $V_a$ ,  $r_a$ ,  $r_c$  is unknown, it may be determined by the nomogram in conjunction with Fig. 2.

### 5. Screen-Anode Region of an Infinite Plane Tetrode

Assuming the screen to be infinitely fine, the potential distribution between screen and anode is linear in the absence of space charge. If current passes through the screen to the anode, the space charge has two important effects: first, it lowers the potential in the space, and may form a potential minimum, or a virtual cathode; secondly, it increases the transit time from screen to anode, because the velocity at all points is lower. These effects have been calculated by Salzberg and Haeff<sup>1</sup> and will now be considered in turn.

(a) *The Minimum Potential and Maximum Current*

The equation given by Salzberg and Haeff for the minimum value of the potential between screen and anode is

$$P = \left[ 1 - \left( \frac{V_m}{V_g} \right)^{1/2} \right]^{1/2} \cdot \left[ 1 + 2 \left( \frac{V_m}{V_g} \right)^{1/2} \right] + \left[ \left( \frac{V_a}{V_g} \right)^{1/2} - \left( \frac{V_m}{V_g} \right)^{1/2} \right]^{1/2} \cdot \left[ \left( \frac{V_a}{V_g} \right)^{1/2} + 2 \left( \frac{V_m}{V_g} \right)^{1/2} \right] \quad (9)$$

where  $V_a$ ,  $V_g$ , and  $V_m$  are the potentials at the anode, screen and potential minimum, respec-

tively, and  $P$  is defined by equation (1) provided

$$\left. \begin{aligned} V &= V_g \\ i &= \text{Density of current from screen to} \\ &\quad \text{anode} \\ a &= \text{Screen-anode distance} \end{aligned} \right\} \quad (10)$$

In Fig. 3,  $V_m/V_g$  has been plotted against  $P$  for several values of  $V_a/V_g$ . Thus, if  $i$ ,  $V_a$  and  $V_g$  are known,  $P$  may be read off from the nomogram, and hence the potential minimum obtained from Fig. 3.

It will be noticed in Fig. 3 that, as  $P$  increases (due to increasing  $i$ , for example),  $V_m$  decreases more and more rapidly till each curve becomes

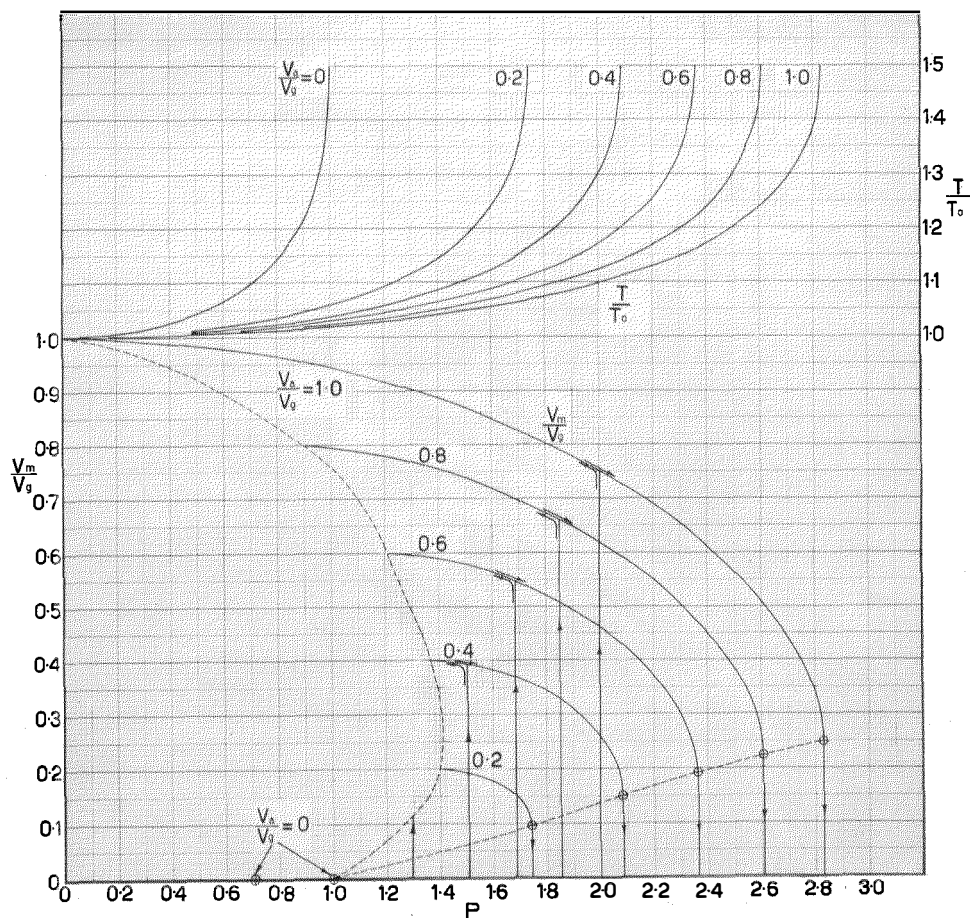

Fig. 3—Screen-Anode space of a tetrode. The upper curves show the variation of transit time  $T/T_0$  with  $P$ , the lower curves the variation of minimum potential  $V_m/V_g$  with  $P$  for several values of  $V_a/V_g$  in each case. The downward vertical arrows indicate formation of a virtual cathode, the upward arrows its disappearance.

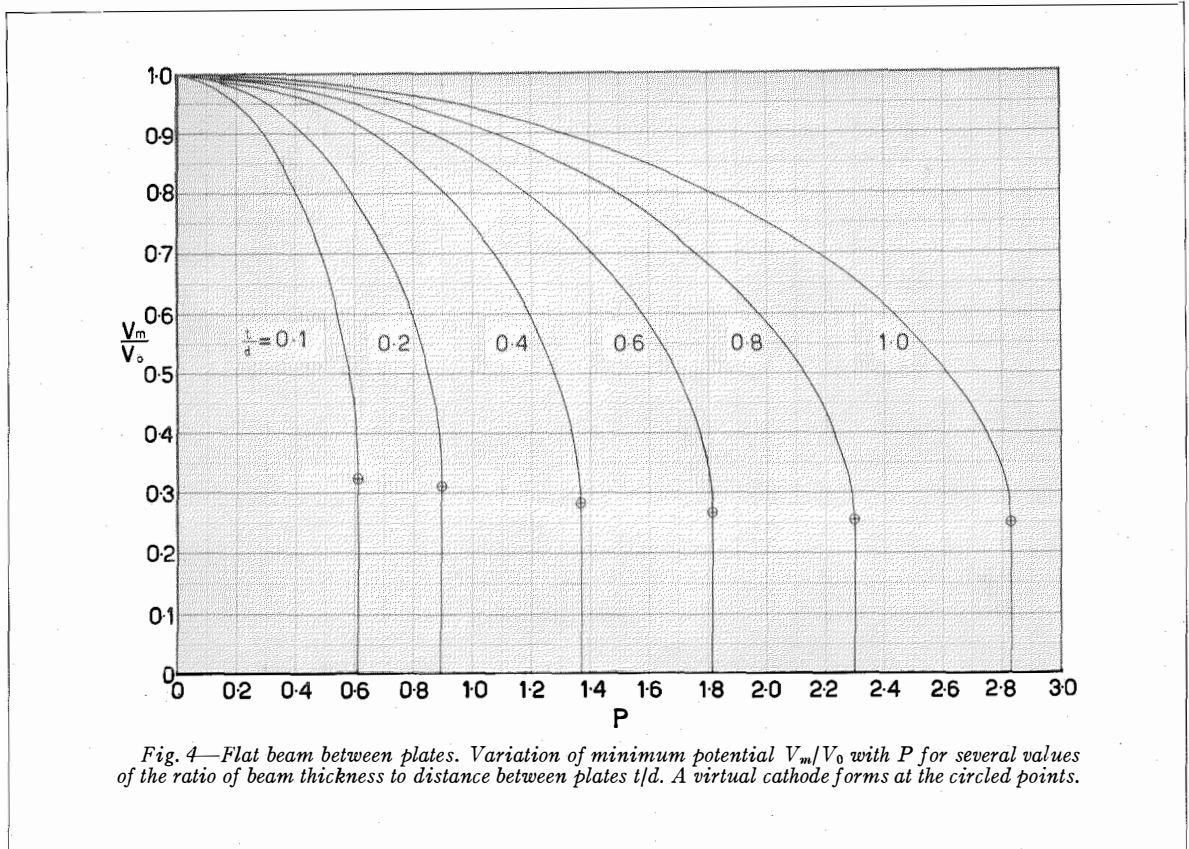

Fig. 4—Flat beam between plates. Variation of minimum potential  $V_m/V_0$  with  $P$  for several values of the ratio of beam thickness to distance between plates  $t/d$ . A virtual cathode forms at the circled points.

vertical, conditions become unstable, and the potential minimum drops suddenly to zero, forming a virtual cathode. If  $P$  is then reduced, the virtual cathode persists for a time until another unstable point is reached when the potential minimum suddenly jumps up to the curve again. The vertical lines represent these sudden jumps in  $V_m/V_0$ , the arrows indicating whether upward or downward. For example, referring to the curve for  $V_a/V_g=1.0$ ,  $V_m/V_0$  drops from 0.25 to zero at  $P=2\sqrt{2}$  ( $=2.828$ ) and jumps from zero to 0.75 at  $P=2.0$ . The curves for  $V_a/V_g$  less than 1.0 are of the same type. The curve for  $V_a/V_g=0$  degenerates into a short length of the  $P$  axis; when  $P$  is increased to 1.0, a potential minimum appears, and is also a virtual cathode. This persists until  $P$  is reduced to  $\frac{1}{2}\sqrt{2}$  ( $=0.707$ ). In the empty region on the left of the diagram, the potential is not sufficiently depressed to form a minimum. The value of  $P$  at which a virtual cathode forms can be used in Fig. 1 to read off the maximum current density that can be passed to the anode.

(b) The Transit Time

From equations (8a) and (11) of Salzgberg and Haeff, the following equation can be deduced, relating to transit time  $T$  to the parameter  $P$  and  $V_a/V_g$ :

$$P^2 = \frac{27 \left( \frac{T}{T_0} - 1 \right) \left[ 1 + \left( \frac{V_a}{V_g} \right)^{1/2} \right]^3}{4 \left( \frac{T}{T_0} \right)^3} \quad (11)$$

$T_0$  is the transit time from screen to anode in the absence of space charge; that is,

$$T_0 = \frac{a}{v},$$

where  $v = \left( \frac{e}{2m} \right)^{1/2} (V_g^{1/2} + V_a^{1/2})$   
 = average velocity in absence of space charge.

In Fig. 3,  $T/T_0$  is plotted against  $P$  for several values of  $V_a/V_g$ ,  $P$  being read off from the nomogram, with the definitions (10). It will be noticed that  $T/T_0$  reaches the value 1.5 when a virtual cathode sets in, whatever the value of  $V_a/V_g$ .

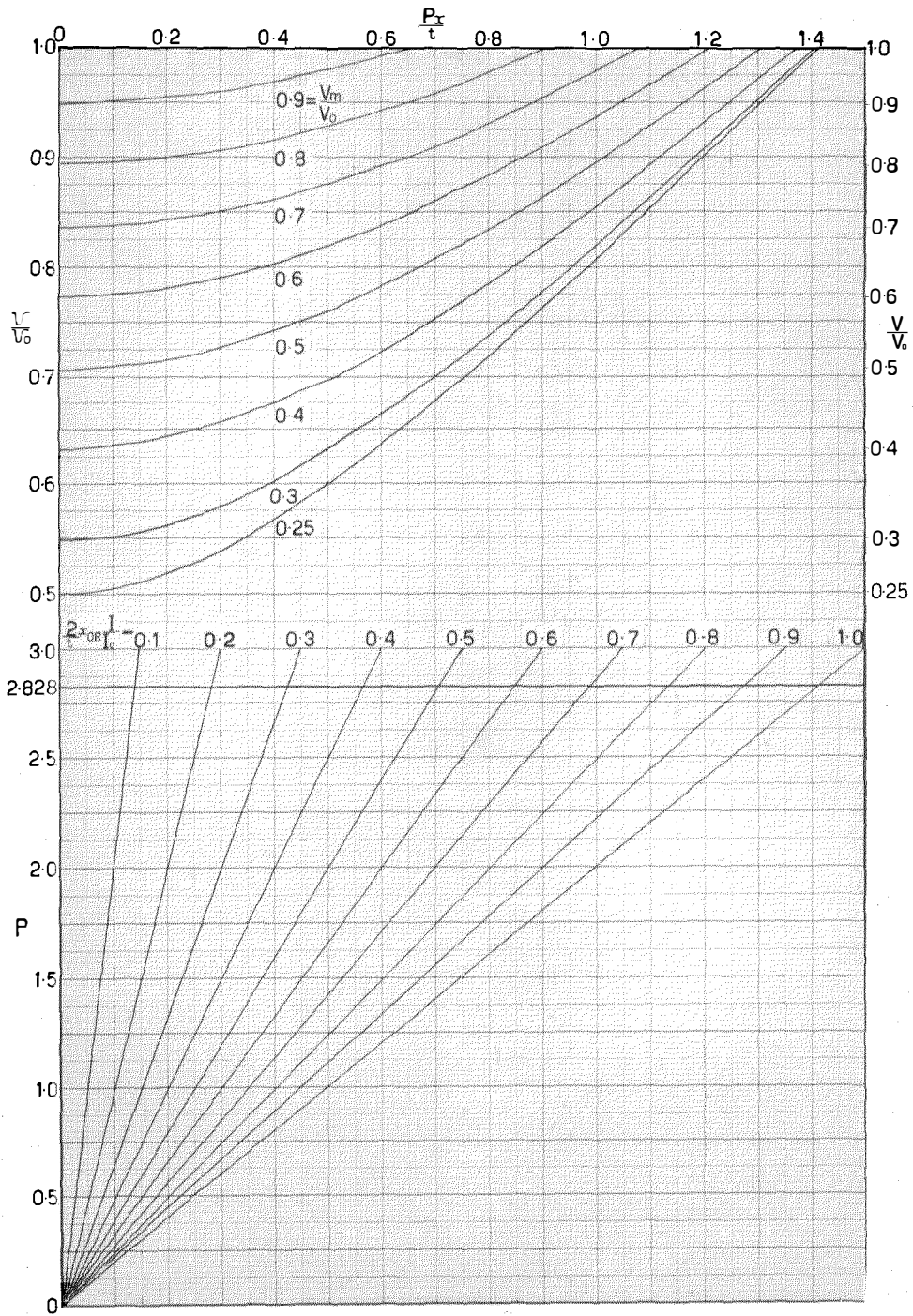

Fig. 5—Flat beam between plates. Distribution of velocity across beam for various values of  $V_m/V_0$  and  $P$ . For explanation see section 6(b).

**6. Long Flat Beam Between Two Lateral Plane Electrodes**

A beam of width  $t$ , infinite in length and depth, travels centrally between and parallel to two infinite plates, separated by a distance  $d$ . The effects of the space charge are:

- (a) The potential in the space between the plates is lower than the potential applied to the plates, and is a minimum on the central plane of symmetry of the beam. For a certain current density, a virtual cathode may form, and there is thus an upper limit to the current which can be passed.
- (b) The beam is inhomogeneous in velocity, the outer parts travelling more rapidly than the centre.
- (c) There is a lateral field between the beam and plates, which causes the beam to diverge.

The first two effects have been calculated by Haeff,<sup>2</sup> while the third may easily be deduced from his equations.

*(a) Minimum Potential and Maximum Current*

From Haeff's equations,  $V_m/V_0$  has been calculated in terms of his function  $F$ ,  $V_m$  being the minimum potential, and  $V_0$  the potential on the plates. Haeff's function  $F$  is connected with  $P$  by the simple relation

$$P^2 = \frac{4Ft}{d}, \tag{12}$$

provided in equation (1)

$$\left. \begin{aligned} i &= i_0, \text{ the current density in the beam} \\ V &= V_0, \text{ the applied potential} \\ a &= t, \text{ the beam thickness} \end{aligned} \right\}. \tag{13}$$

In Fig. 4,  $V_m/V_0$  is plotted against  $P$  for several values of the ratio  $t/d$ . As  $P$  increases  $V_m/V_0$  decreases until each curve becomes vertical, conditions become unstable, and  $V_m$  drops suddenly to zero forming a virtual cathode. The value of  $P$  at which this happens can be used, with the known  $V_0$  and  $t$ , to read off from the nomogram the maximum current density that can be passed.

*(b) Inhomogeneity of the Beam*

This is represented by plotting the electron velocity against  $x$ , the transverse distance from the centre of the beam. The velocity depends

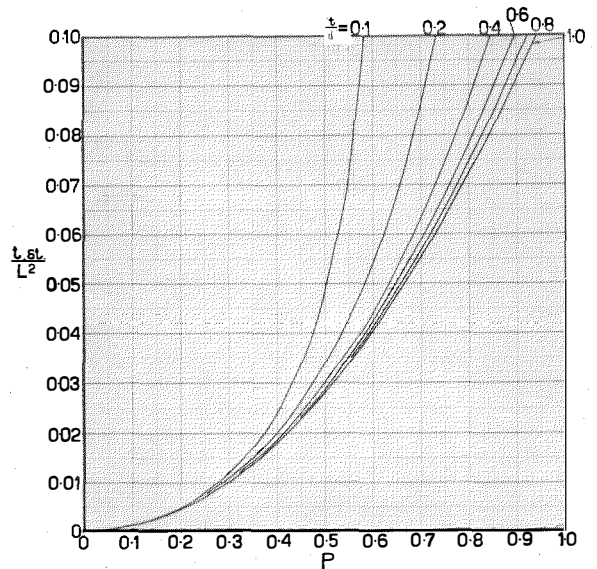

Fig. 6—Flat beam between plates. Variation of divergence function  $t \cdot \delta t/L^2$  with  $P$  for several values of  $t/d$  according to equation (17).

also on  $P$  and  $t/d$ , but these quantities enter into the equations in such a way that, by choosing  $V_m/V_0$  as a parameter, the number of parameters is reduced, and the graphical representation is simplified. The velocity is then of the form

$$\frac{v}{v_0} = f\left(\frac{Px}{t}, \frac{V_m}{V_0}\right),$$

where  $v$  is the velocity at a distance  $x$  from the axis, and  $v_0$  is the velocity corresponding to the applied potential  $V_0$ . The function  $f$  cannot be written down explicitly, but has been calculated numerically from Haeff's equations for the potential distribution.

In Fig. 5,  $v/v_0$  is plotted against  $Px/t$  for several values of  $V_m/V_0$ . A scale of  $V/V_0 = v^2/v_0^2$  is also given on the right hand side in case the potential distribution across the beam is required.

The set of lines in the lower part of the diagram is intended to derive a scale of  $2x/t$  from the scale of  $Px/t$ . If a straight-edge is placed horizontally at the appropriate value of  $P$  on the left vertical scale, the ten lines will mark off on it a linear scale of  $2x/t$  from 0 to 1. Using this as the abscissa scale, the curves in the upper part of the diagram become velocity distribution curves:  $v/v_0$  against  $2x/t$ . Since  $2x/t$  is also the fraction of the total beam current which lies between  $x$  and  $-x$ , one can read off directly the fraction of the total current having velocities

between two specified limits,  $v_1/v_0$  and  $v_2/v_0$ ; it is the interval on the appropriate  $2x/t$  scale between the values  $2x_1/t$  and  $2x_2/t$  corresponding to  $v_1/v_0$  and  $v_2/v_0$ .

(c) *Divergence of the Beam*

Since the potential  $V_a$  at the edge of the beam is less than the applied potential  $V_0$ , the electrons at the edge of the beam are in a transverse field of value

$$E = \frac{2(V_0 - V_a)}{d - t}, \tag{14}$$

which accelerates them towards the side plates. The increase in width of the beam  $\delta t$  is easily calculated if  $\delta t/t$  is small enough not to alter the current density and transverse field appreciably over the length of the beam considered.

The transverse acceleration of an electron at the edge of the beam is  $eE/m$  and hence, if the beam is initially parallel, the transverse displacement is given by

$$\frac{1}{2}\delta t = \frac{eE}{2m} \cdot T^2, \tag{15}$$

$T$  being the time taken by an electron to travel a length  $L$  of the beam. Since the axial velocity is assumed constant and corresponds to the po-

tential  $V_a$ ,  $L$  is given by

$$L = \left( \frac{2eV_a}{m} \right)^{1/2} T. \tag{16}$$

Elimination of  $T$  between (15) and (16) leads to the equation

$$\frac{t \cdot \delta t}{L^2} = \frac{\frac{V_0}{V_a} - 1}{\frac{d}{t} - 1}. \tag{17}$$

$V_a/V_0$  can be calculated numerically from Haeff's equations for given values of  $P$  and  $t/d$ . In Fig. 6,  $t \cdot \delta t/L^2$  is plotted against  $P$  for several values of  $t/d$  and thus the divergence  $\delta t$  can easily be calculated when  $P$  has been obtained from the nomogram of Fig. 1.

7. *Cylindrical Beam in a Tube*

This case is the axially symmetrical analogue of the preceding one. A cylindrical beam of radius  $\rho$  passes down a coaxial cylindrical tube of radius  $R$ , the length of the beam and tube being large compared with their radii. The principal space charge effects are:

- (a) On the axis of the beam the potential is a minimum; and, if the current is great enough, may drop to zero, forming a virtual cathode.

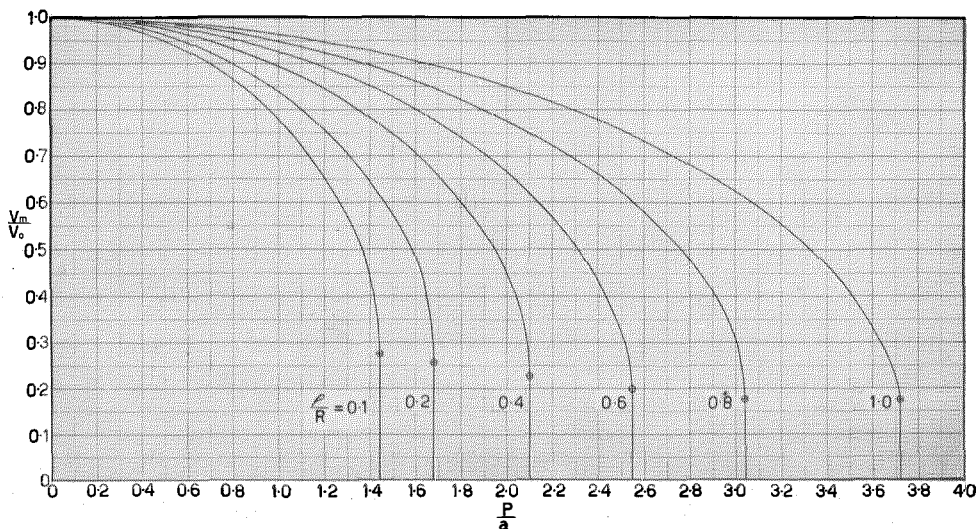

Fig. 7—Cylindrical beam in tube. Variation of minimum potential  $V_m/V_0$  with  $P/a$  for several values of the ratio of beam radius to tube radius  $\rho/R$ . A virtual cathode forms at the circled points.



- The current then stops passing down the tube, and instead drifts radially to the tube.
- (b) The beam is inhomogeneous in velocity, the outer parts travelling more rapidly than the centre.
  - (c) There is a radial field acting on the outer electrons, causing the beam to diverge.

These effects have been calculated by Smith and Hartman.<sup>3</sup>

(a) *Minimum Potential and Maximum Current*

If  $V_m$  is the minimum potential, and  $V_0$  the potential on the tube,  $V_m/V_0$  has been calculated from the equations of Smith and Hartman in terms of their function  $w$ , which is connected with  $P$  by the relation

$$\left(\frac{P}{a}\right)^2 = \frac{9\pi w}{4}, \quad (18)$$

provided in equation (1)

$$\left. \begin{array}{l} i = I, \text{ the total beam current} \\ V = V_0, \text{ the applied potential} \end{array} \right\}. \quad (19)$$

It will be noted that in this case  $a$  has no independent significance,  $P/a$  occurring as a single parameter, and that, in finding it from the nomogram, the total beam current is used, not the current density.

In Fig. 7,  $V_m/V_0$  is plotted against  $P/a$  for several values of  $\rho/R$ . The curves are qualitatively similar to those of Fig. 4 for flat beams, and each indicates the formation of a virtual cathode at a certain maximum value of  $P/a$ . Using this value of  $P/a$ , the maximum current which can be passed at any given potential can be read off from the nomogram.

(b) *Inhomogeneity of the Beam*

This is best represented by plotting the electron velocity against  $(r/\rho)^2$  where  $r$  is a radial coordinate measured from the central axis. The velocity depends also on  $P/a$  and  $\rho/R$ , but, as in the case of flat beams, the number of parameters is reduced by choosing  $V_m/V_0$  as a parameter. The velocity is then found to be of the form

$$\frac{v}{v_0} = f\left(\frac{P}{a} \cdot \frac{r}{\rho}, \frac{V_m}{V_0}\right),$$

where  $v$  is the velocity at a radius  $r$ , and  $v_0$  the

velocity corresponding to the applied potential  $V_0$ . The function  $f$  has been calculated numerically from the equations of Smith and Hartman, and the result is shown in Fig. 8, where  $v/v_0$  is plotted against  $(P/a \cdot r/\rho)^2$  for several values of  $V_m/V_0$ . A scale of  $V/V_0 = v^2/v_0^2$  is also given on the right hand side.

The set of parabolae in the lower part of the diagram serves to derive a scale of  $(r/\rho)^2$  from the scale of  $(P/a \cdot r/\rho)^2$ . If a straight-edge is placed horizontally at the appropriate value of  $P$  on the left vertical scale, the ten curves mark off on it a linear scale of  $(r/\rho)^2$  from 0 to 1. The quantity  $(r/\rho)^2$  is also the fraction of the total current which lies within a radius  $r$ , and for this reason  $(r/\rho)^2$  was chosen in preference to  $r/\rho$  as the abscissa scale for the velocity distribution curves. It is thus possible to read off directly the fraction of the total current having velocities between two specified limits,  $v_1/v_0$  and  $v_2/v_0$ ; it is the interval on the appropriate  $(r/\rho)^2$  scale between the values corresponding to  $v_1/v_0$  and  $v_2/v_0$ .

(c) *Divergence of the Beam*

Equation (18) of Smith and Hartman gives the divergence provided it is so small that the longitudinal velocity and radial field do not alter appreciably over the length of the beam. If the initial radius of the beam  $\rho$  increases to  $\rho'$  over a length  $L$  of the beam, the equation is of the form

$$\frac{L}{\rho} = F\left(\frac{P}{a}, \frac{\rho}{R}\right) \int_0^{(\log \rho'/\rho)^{1/2}} e^{x^2} dx. \quad (20)$$

This is represented in Fig. 9 by means of a nomogram in conjunction with a family of curves. The left scale of the nomogram represents  $L/\rho$ , and the right scale the divergence  $\rho'/\rho$ . The middle scale represents the function  $F(P/a, \rho/R)$  which itself has no particular physical significance and is therefore graduated in arbitrary units, but has been calculated in terms of  $P/a$  and  $\rho/R$  from the equations of Smith and Hartman.

The family of curves relates  $F$  to  $P/a$  for several values of  $\rho/R$ . Thus the procedure is as follows: Given  $I$  and  $V_0$ ,  $P/a$  can be read off from Fig. 1. Choosing the appropriate curve in Fig. 9, this value of  $P/a$  gives a point on the  $F$  scale. If a straight-edge is placed across the nomogram so as to pass through this point, it

will mark off a pair of corresponding values of  $L/\rho$  and  $\rho'/\rho$ .

**8. Conclusion**

In designing devices employing long parallel beams, either flat or cylindrical, it is important

to know what factor limits the current in the beam and what the maximum current is. In all cases likely to occur in practice, the divergence of the beam (if not prevented) sets a limit to the permissible current. If, however, the divergence can be rendered innocuous, a much larger current

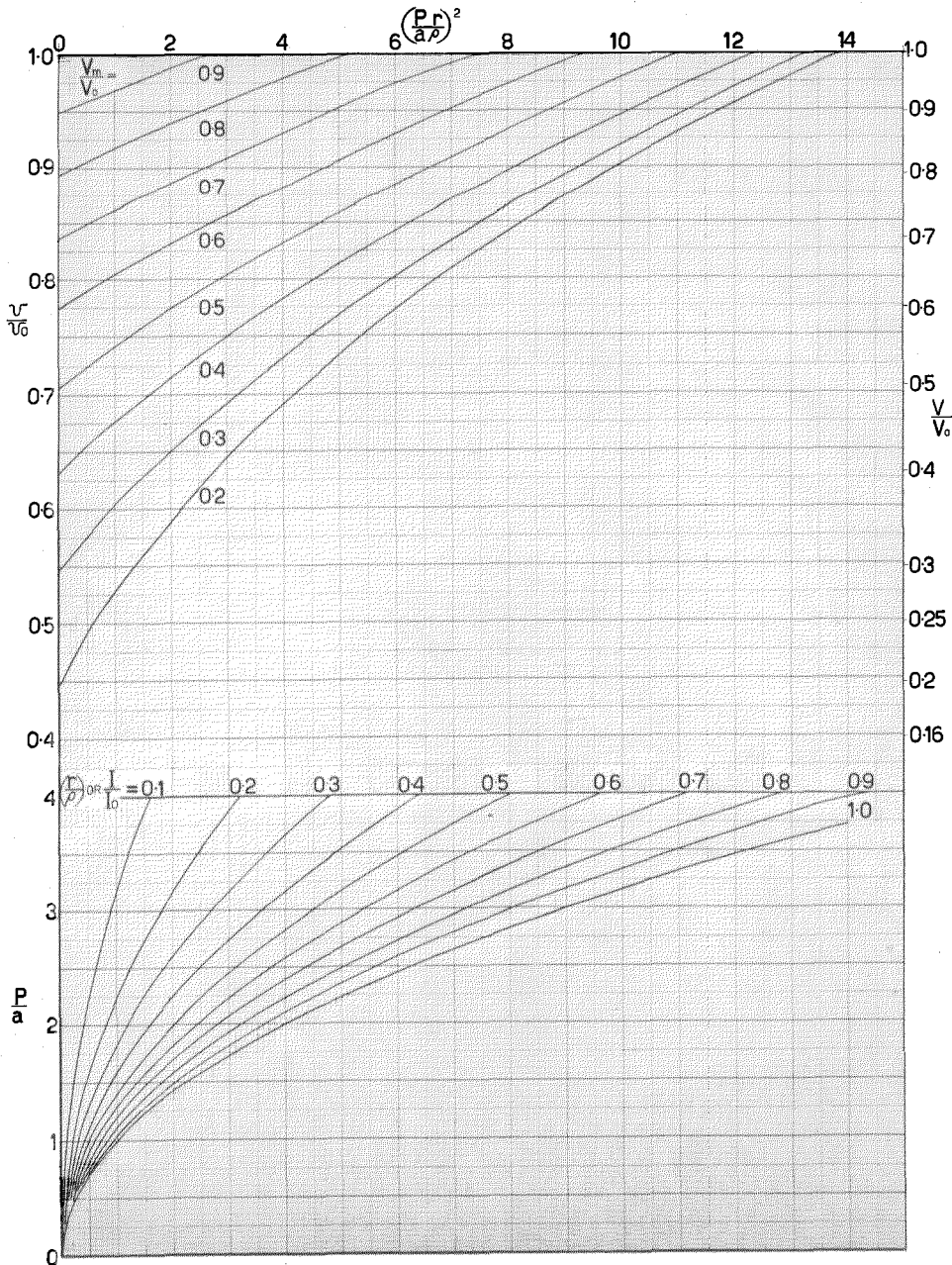

Fig. 8—Cylindrical beam in tube. Distribution of velocity and potential across beam for various values of  $V_m/V_0$  and  $P/a$ . For explanation see section 7(b).

can be allowed before another limit is set by the formation of a virtual cathode. For example, a cylindrical beam has a length five times its diameter, and its diameter is 0.8 that of the surrounding tube; if a 10% increase in diameter can be tolerated, Fig. 9 shows that  $P/a = 0.25$ , which, from Fig. 1, corresponds to a beam current of 4.5 mA at 1,000 volts. If the divergence is

prevented, Fig. 7 shows that a virtual cathode will form when  $P/a = 3.04$ , corresponding to a current of 700 mA at 1,000 volts. The divergence may be prevented by an adequate longitudinal magnetic field. On the other hand, a beam of positive ions travelling in the opposite direction to the electron beam, and coincident with it, by neutralising the space charge, will prevent

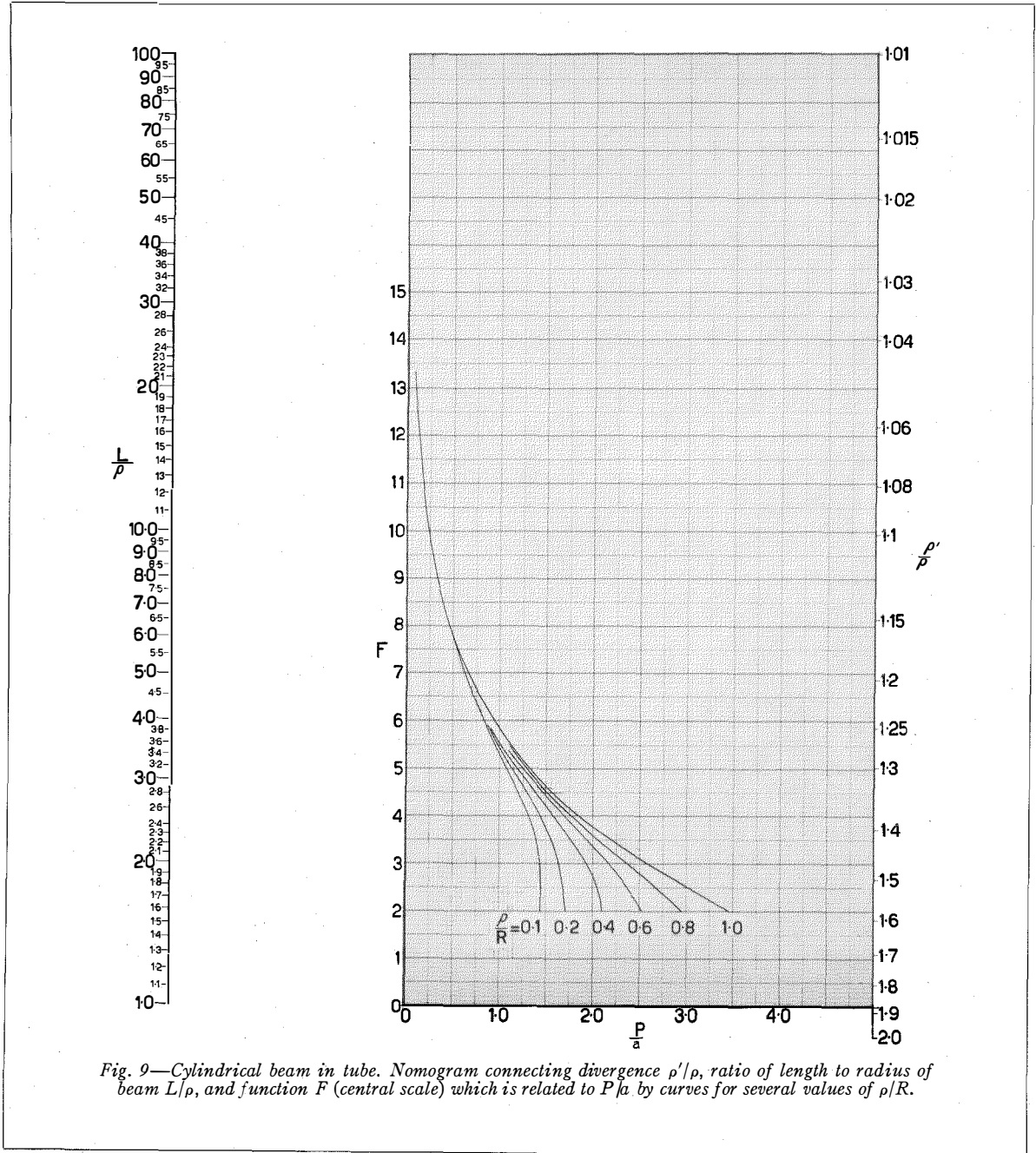

Fig. 9—Cylindrical beam in tube. Nomogram connecting divergence  $\rho'/\rho$ , ratio of length to radius of beam  $L/\rho$ , and function  $F$  (central scale) which is related to  $P/a$  by curves for several values of  $\rho/R$ .

both divergence and virtual cathode formation.

An interesting distinction between cylinder and flat beams may be made here.

In the case of cylindrical beams, the potential distribution ( $V/V_0$  in terms of  $r/\rho$ ) depends on the ratio of the beam radius to the tube radius  $\rho/R$ , also on the applied potential  $V_0$  and on the total current, but not on the actual radius of the tube. Thus in the above example, a current of 700 mA will form a virtual cathode whatever the radius of the tube is, so long as  $\rho/R$  and  $V_0$  are constant. Similarly, a smaller current will produce a minimum potential  $V_m/V_0$  independent of the tube radius. The divergence  $\rho'/\rho$  is independent of the tube radius if  $\rho/R$ ,  $V_0$ ,  $L/\rho$ , and the current are constant; but if  $L$  is kept constant instead of  $L/\rho$ , the statement is true if the current density is constant, not the current.

In the case of flat beams, the potential distribution ( $V/V_0$  in terms of  $x/t$ ) depends on the ratio of the beam width to the distance between

the plates  $t/d$ , on the applied potential  $V_0$  and on the product  $it^2$ ,  $i$  being the current density. In place of  $it^2$  we can write  $It$ , where  $I$  is the current per unit depth. Thus if  $t/d$  and  $V_0$  are fixed, a definite value of  $It$  will give rise to a virtual cathode, and hence the closer the plates the greater the current per unit depth that can be passed. If  $V_0$  and  $t/d$  are fixed, the divergence  $\delta t/t$  depends on the product  $It$  (approximately proportional for small divergences) if  $L/t$  is constant; but, if  $L$  is kept constant,  $\delta t/t$  depends on the current density  $i$  (again approximately proportional) and is otherwise independent of the thickness  $t$ .

---

<sup>1</sup>“Effects of Space Charge in the Grid-Anode Region of Vacuum Tubes,” by B. Salzberg and A. V. Haef, *R. C. A. Review*, January, 1938.

<sup>2</sup>“Space-Charge Effects in Electron Beams,” by A. V. Haef, *Proceedings of the I. R. E.*, September, 1939.

<sup>3</sup>“Formation and Maintenance of Electron and Ion Beams,” by L. P. Smith and P. L. Hartman, *Journal of Applied Physics*, March, 1940.

# Theory of the Magnetron\*

By LÉON BRILLOUIN

## 1. Introduction—General Observations on the Part Played by the Magnetic Field

FOLLOWING Hull's original work on magnetrons, a large number of theories have been formulated; the majority, however, appear inadequate or inexact. Certain authors considered the electronic motion whilst neglecting the space charge; others, the space charge computed by Langmuir for a diode without a magnetic field. Such studies necessarily are highly inaccurate since a powerful magnetic field considerably modifies the electronic paths and, consequently, the space charge. Contrariwise, authors who have endeavoured to evaluate the space charge in the presence of a magnetic field do not appear to have provided practicable solutions. It therefore appears necessary to consider the problem afresh and to compute directly both the space charge and the potential distributions in the magnetron; without these essential data, the development of a coherent theory is impossible.

Larmor's theorem<sup>1</sup> cannot be applied to the magnetron since it is invalid unless the rotation produced by the magnetic field be extremely low and is, therefore, of negligible interest in connection with the present study. Actually the theorem is applicable only where the magnetic field does not appreciably modify the anode current.

A more comprehensive theory, on the other hand, immediately yields an important result. It is known that, in the presence of a magnetic field, the definition of the components of the momentum must be modified (in non-relative mechanics, valid for low speeds) such that:

$$p_x = mv_x + eA_x; \quad p_y = mv_y + eA_y; \quad p_z = \dots \quad (1)$$

where  $m$  is the electron mass,  $e$  its charge (negative) and  $A_x, A_y, \dots$  components of the potential vector. Assuming a constant magnetic field  $H$ ,

\* Paper prepared in January, 1939, while the author was Consultant for Laboratoires Le Matériel Téléphonique, Paris, France. Since then the author has discussed the conditions of oscillation in magnetrons: vide *Physical Review*, Vol. 60, No. 5, pp. 385-396, September, 1941.

<sup>1</sup> For the classical theories, see: L. Brillouin, "l'Atome de Bohr," Presses Universitaires, Paris 1931, p. 107, 124, 134.

directed towards  $Oz$ , the potential vector is written:

$$A_x = -\frac{1}{2}\mu_0 Hy; \quad A_y = \frac{1}{2}\mu_0 Hx; \quad A_z = 0; \quad (2)$$

$\mu_0$  being the magnetic permeability in vacuum. If, also, the electric forces present a cylindrical symmetry with respect to  $Oz$ , a theorem of conservation of the moment of momentum in the plane  $xy$  is applicable:

$$J = p_y x - y p_x = C,$$

which gives

$$J = m(xv_y - yv_x) + \frac{1}{2}\mu_0 e H r^2 = C. \quad (3)$$

This means that the angular velocity  $\dot{\theta}$  around the axis  $Oz$  is completely defined by the condition

$$J = m r^2 \dot{\theta} + \frac{1}{2} \mu_0 e H r^2 = C, \quad (4)$$

$$\dot{\theta} = \omega_H - \frac{C'}{r^2}, \quad \omega_H = -\frac{1}{2} \mu_0 \frac{e}{m} H,$$

where  $C'$  is a constant determined by the initial conditions, and  $\omega_H$  Larmor's velocity of rotation, which reappears here in rigorous form. The result (4) will be found again in the equations of movement. It is well known from Hull's work but it seems useful to establish its relationship with the general theorem (1) on the definition of moments.

To determine the orders of magnitude: if  $H$  be measured in gaussess whilst all the equations are written in E.S.C.G.S. units, it is necessary to take:

$$c = 310^{10} \text{ (velocity of light); on the other hand,}$$

$$-\frac{e}{m} = +5.3 \cdot 10^{17} \text{ E.S.C.G.S.}$$

since  $e$  is negative; then

$$\omega_H = 0.884 \cdot 10^7 H, \quad (5)$$

which, for a field of 500 gaussess, gives a rotation speed of  $4.42 \times 10^9$ .

## 2. Cylindrical Magnetron—Static Case

The magnetron is assumed to consist of a filament of radius  $a$  and a cylindrical anode of radius  $R$ , the magnetic field  $H$  accurately paralleling the filament (axis  $Oz$ ). It is assumed that electrons without appreciable speed are emitted from the filament, and that the electric field on the filament is zero provided the anode

current is below saturation; hypotheses which have both been generally accepted since they were formulated by Langmuir. Distribution of the cylindrical space charge can thus be obtained if the potential  $V$  is solely a function of  $r$ . The equations of movement follow

$$\begin{cases} m\ddot{x} = -e \frac{\partial V}{\partial x} + \mu_0 e v_y H = -e \frac{\partial V}{\partial r} \frac{x}{r} + \mu_0 e y \dot{\theta} H, \\ m\ddot{y} = -e \frac{\partial V}{\partial y} - \mu_0 e v_x H = -e \frac{\partial V}{\partial r} \frac{y}{r} - \mu_0 e x \dot{\theta} H. \end{cases} \quad (6)$$

The static case, which will first be considered, is characterized by the fact that  $V$  does not depend on time.

By multiplying the first equation of (6) by  $-y$  and the second by  $x$ , adding and integrating, the integral of the moment of momentum (3) and (4) are directly obtained.

The constant  $C'$  of (4) is determined by the fact that electrons are emitted without speed from the filament, such that  $\dot{\theta}$  is zero for  $r = a$ ;

$$\dot{\theta} = \omega_H \left( 1 - \frac{a^2}{r^2} \right). \quad (7)$$

The Lorentz force, due to the magnetic field  $H$ , does not influence the velocity since it is perpendicular to the latter. Energy conservation, accordingly, may be written:

$$\frac{1}{2} m v^2 + e V(r) = \frac{1}{2} m (\dot{r}^2 + r^2 \dot{\theta}^2) + e V(r) = C,$$

and this new constant is zero if

$$V(a) = 0 \text{ on the filament;} \quad (8)$$

hence

$$\dot{r}^2 + \omega_H^2 r^2 \left( 1 - \frac{a^2}{r^2} \right)^2 + \frac{2e}{m} V(r) = 0. \quad (9)$$

The equations of movement, therefore, may be integrated directly from (7) and (9) without determining the potential distribution as a function of  $r$ .

In (9) one result is at once evident: since the velocity of rotation  $\dot{\theta}$  is determined by the magnetic field, the kinetic energy at the distance  $r$  cannot be less than:

$$\frac{m}{2} r^2 \dot{\theta}^2 = \frac{m}{2} \omega_H^2 r^2 \left( 1 - \frac{a^2}{r^2} \right)^2;$$

however, if the potential  $V(r)$  does not suffice to give the electron greater kinetic energy, the radial velocity  $\dot{r}$  is annulled and the current is interrupted. Consequently

$$\dot{r} = 0 \quad -\frac{2e}{m} V(r) = \omega_H^2 r^2 \left( 1 - \frac{a^2}{r^2} \right)^2. \quad (10)$$

This is Hull's *limiting value of the potential*  $V$ , at the distance  $r$ , where the anode current is just cut off by the magnetic field. This limiting value  $V_0(r)$  is thus defined without the necessity of determining the distribution of the space charge or the potentials between the anode and cathode—a remarkable fact which discloses the possibility of finding the correct value of the critical potential  $V_0(r)$  without considering the space charge.

Reverting to the equation of electron movement in polar co-ordinates  $r, \theta$ ; for  $\theta$ , the simple result of (7) has been derived; for  $r$ ,

$$m\ddot{r} = -e \frac{\partial V}{\partial r} + \mu_0 e H r \dot{\theta} + m r \dot{\theta}^2, \quad (11)$$

where the electric, Lorentz and centrifugal forces will be recognized. Replacing  $\mu_0 e H$  by the equivalent expression  $-2m\omega_H$ , it is found that

$$\begin{aligned} m\ddot{r} &= -e \frac{\partial V}{\partial r} - m r \dot{\theta} (2\omega_H - \dot{\theta}) \\ &= -e \frac{\partial V}{\partial r} - m r \omega_H^2 \left( 1 - \frac{a^2}{r^2} \right) \left( 1 + \frac{a^2}{r^2} \right) \\ &= -e \frac{\partial V}{\partial r} - m \omega_H^2 \left( r - \frac{a^4}{r^3} \right) \\ &= -\frac{\partial}{\partial r} \left[ +eV + \frac{1}{2} m \omega_H^2 \left( r^2 + \frac{a^4}{r^2} \right) \right]. \end{aligned} \quad (12)$$

The radial acceleration  $\ddot{r}$  is accordingly governed by an apparent spherical potential function  $P(r)$ :

$$\begin{aligned} m\ddot{r} &= -e \frac{\partial P}{\partial r}, \\ eP(r) &= eV(r) + \frac{1}{2} m \omega_H^2 \left( r^2 - 2a^2 + \frac{a^4}{r^2} \right) \\ &= eV(r) + \frac{1}{2} m \omega_H^2 r^2 \left( 1 - \frac{a^2}{r^2} \right)^2. \end{aligned} \quad (13)$$

In the function  $P(r)$  a constant  $m\omega_H^2 a^2$  is added in order to reduce  $P(a)$  to zero on the filament  $r = a$ ; thus the same function is made to appear as in the energy equation (9). A fact worthy of emphasis is the following:

With the apparent potential  $P(r)$ , the radial movement of the electron may be studied by means of equation (13) without considering the rotation  $\dot{\theta}$  around the filament. These general results are valid in all cases either with or without spacial charge.

### 3. Static Space Charge; Critical Potential

To obtain a potential distribution in a static state, it is necessary to introduce the space

charge  $\rho(r)$ , a function of the radius  $r$  and independent of time. Considering the cylindrical symmetry of the system:

$$\Delta V = \frac{1}{r} \frac{\partial}{\partial r} \left( r \frac{\partial V}{\partial r} \right) = -4\pi\rho, \quad (14)$$

$$I = 2\pi r \rho v_r. \quad (15)$$

The current  $I$ , per unit length of filament, is a constant independent of  $r$ ;  $v_r$  is taken from (9) and the following is obtained:

$$\begin{aligned} \frac{\partial}{\partial r} \left( r \frac{\partial V}{\partial r} \right) &= -\frac{2I}{v_r} \\ &= -\frac{2I}{\sqrt{-\frac{2e}{m} V(r) - \omega_H^2 r^2 \left( 1 - \frac{a^2}{r^2} \right)^2}} \end{aligned} \quad (16)$$

The conditions are the following:

$$\begin{cases} V(a) = 0, \text{ on the filament,} \\ \left( \frac{\partial V}{\partial r} \right)_{r=a} = 0, \text{ no saturation.} \end{cases} \quad (17)$$

Since the non-linear equation (16) would require detailed discussion, it is preferable to start with the simpler cases where the current  $I$  is zero. Two methods are available, according to (15):

(A)  $\rho \neq 0, \quad v_r = 0,$

yielding

$$\begin{aligned} V_0(r) &= -\frac{m}{2e} \omega_H^2 r^2 \left( 1 - \frac{a^2}{r^2} \right)^2, \quad (18) \\ P(r) &= 0. \end{aligned}$$

Expression (18) completely satisfies the two limiting conditions of (17).

(B)  $\rho = 0, \quad v_r \neq 0;$

hence,

$$V(r) = B \log r + C, \quad (19)$$

corresponding to a definitely electrostatic potential without space charge.

Let us now examine the distributions of the charges and potential in a magnetron when the potential of the anode ( $r = R$ ) is rather low so that no current flows.

The limiting case corresponding to the maximum possible potential on the plate, with no current flowing, is obtained by taking

$$V_0(R) = -\frac{m}{2e} \omega_H^2 R^2 \left( 1 - \frac{a^2}{R^2} \right)^2, \quad (20)$$

which conforms with (18) or (10); it is the critical potential. The density is not zero, but space charges are present throughout the medium between the filament and anode; equation (14) gives their value:

$$\rho_0(r) = \frac{m\omega_H^2}{2\pi e} \left( 1 + \frac{a^4}{r^4} \right). \quad (21)$$

The radial velocity is zero throughout; the electrons follow circular trajectories, centred on the filament. The Lorentz and centrifugal forces are in exact equilibrium with the electrostatic force in equation (11), as is also evident from (13) since the distribution (20), (21) completely annuls  $P(r)$ .

In the case of a potential  $V_0(R)$  below the critical potential, there is obtained a charge distribution (21) from the filament ( $r = a$ ) up to a certain cylinder  $r = b$ ; this particular form of distribution then stops abruptly; the potential distribution then continues in the form of a logarithmic potential (19). By formulating the continuity of the potential and of the field at the cylinder  $b$ , the two constants  $B, C$ , may be determined by the conditions:

$$\begin{aligned} -\frac{m}{2e} \omega_H^2 b^2 \left( 1 - \frac{a^2}{b^2} \right)^2 &= B \log b + C, \\ -\frac{m}{e} \omega_H^2 \left( b - \frac{a^4}{b^3} \right) &= \frac{B}{b}. \end{aligned} \quad (22)$$

When the potential  $V(R)$  of the anode is progressively lowered, the space charge is correspondingly restricted to a decreasing cylinder  $b$  around the filament; and, when  $V(R)$  is zero, the space charge disappears.

These results may be explained somewhat differently: assume a magnetron of anode radius  $b$  surrounded by a second cylindrical electrode of radius  $R$ . With the above distribution, no current

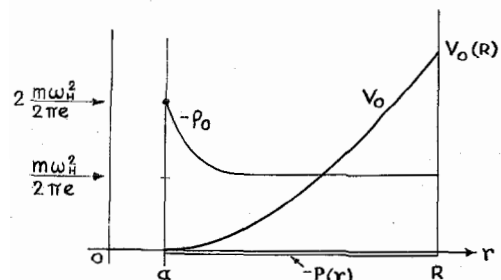

Fig. 1—Critical Condition,  $I = 0$ .

passes to the anode  $b$ , and an electrostatic field of cylindrical symmetry exists between  $b$  and  $R$ ; the anode  $b$  no longer carries any resultant charge because of the equality of the fields (22). It is thus possible to dispense with the intermediate anode  $b$  without disturbance of the field.

Fig. 1 illustrates the case of critical potential  $V_0(R)$ ; the different curves represent the space charge density  $\rho_0(r)$ , the electrostatic potential  $V(r)$  and the apparent radial potential  $P(r)$ .

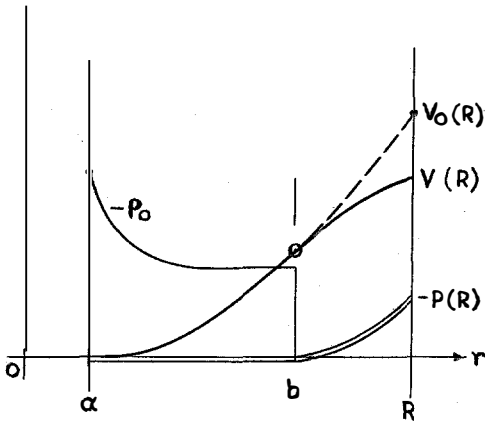

Fig. 2.

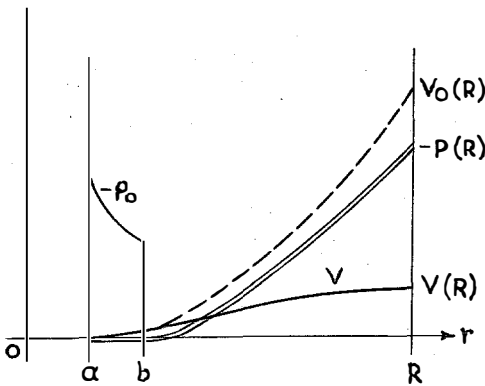

Fig. 3.

Figs. 2 and 3 show the potential distribution of  $V(r)$  for various anode potentials lower than the critical value. The apparent potential energy of the electron is  $eP(r)$  or  $-eP(r)$ ,  $e$  designating the absolute value of an electron charge. Hence,

$$-P(r) = V_0(r) - V(r), \tag{23}$$

according to (13) and (18). The behaviour of this function is easily described and is important to recognize inasmuch as the apparent energy  $P$  governs the electronic radial movements.

In the critical state (Fig. 1),  $-P$  is identically zero. The electrons of the cloud forming the space charge have no radial velocity; but, if some electrons are projected from the cathode into the filament-cathode region with low velocity  $v_r$ , these electrons will arrive at the anode with constant radial velocity  $v_r$  unimpeded by any obstacle.

*The magnetron in the critical state is a system of zero internal resistance.* This is confirmed in the following study of the non-zero current conditions.

When the magnetron is below its critical state (Fig. 2 or 3), the apparent potential  $-P$  rises between  $b$  and  $R$  in front of the anode. If electrons are projected from the cathode with low radial velocity, they will reach  $b$  at their initial velocity; there, however, they will encounter an impassable potential and will be reflected up to the cathode, returning from  $b$  to  $a$  with the velocity  $-v_r$ .

The general characteristics of the problem, simplified in accordance with section 2, are thus outlined. The critical distribution shown in Fig. 1 seems to be exactly that described by Hull<sup>2</sup> in a brief note, for which he claims to have found good experimental evidence from space charge density measurements.

#### 4. Direct Current Condition Without Saturation

Since the fundamental equation (16) has just been considered for the various cases where the current is nil, it is now desirable to determine the direct current conditions. Equation (16) will be transcribed, taking as the unknown function the apparent potential  $P(r)$  defined in (13) and (23) instead of the electrostatic potential  $V(r)$ .

$$\begin{aligned} \frac{\partial}{\partial r} \left( r \frac{\partial V}{\partial r} \right) &= \frac{\partial}{\partial r} r \frac{\partial}{\partial r} [P(r) + V_0(r)] \\ &= -I \sqrt{-\frac{2m}{e}} \frac{1}{\sqrt{P}}; \end{aligned}$$

replacing  $V_0(r)$  by its value (18):

$$\begin{aligned} \sqrt{P} \left[ -\frac{2m\omega_H^2}{e} \left( r + \frac{a^4}{r^3} \right) + \frac{\partial}{\partial r} \left( r \frac{\partial P}{\partial r} \right) \right] \\ = -I \sqrt{\frac{-2m}{e}}. \end{aligned} \tag{24}$$

This equation is rigorous. A solution  $P(r)$  such

<sup>2</sup> *Phys. Rev.*, t. 23 (1924), p. 112.



that conditions (17) will be satisfied on the filament yields:

$$P(a) = 0, \quad \left(\frac{\partial P}{\partial r}\right)_{r=a} = 0, \text{ on the filament.} \quad (25)$$

The solution of (24) can only be derived approximately; two distinct regions must be considered as limiting cases:

1. PROXIMITY TO FILAMENT

The second member remains constant and, on the filament,  $P$  is nil; the term in brackets must therefore be infinite, and consequently  $\partial^2 P / \partial r^2$  is infinite. The required solution is of the type:

$$P = A(r-a)^n, \quad (26)$$

which gives

$$A^{1/2}(r-a)^{n/2} \left[ -\frac{2m\omega_H^2}{e} 2a + nA(r-a)^{n-1} + aAn(n-1)(r-a)^{n-2} \right] = -I\sqrt{-\frac{2m}{e}}$$

Taking  $n=4/3$ , the two first terms are zero, in view of the factor  $(r-a)^{n/2}$ ; the last term remains finite and it is found that:

$$P(r) = \frac{1}{2} \left( \frac{9I}{a} (r-a)^2 \right)^{2/3} \left( -\frac{m}{e} \right)^{1/3}, \quad r-a \ll 1. \quad (27)$$

This solution is valid only in the immediate vicinity of the cathode, while  $(r-a)$  remains very small. At increasing distances from the cathode, account must be taken of the fact that  $\partial P / \partial r$  is no longer zero; and the magnetic term in  $\omega_H$  must be dealt with. Let us first determine what happens at a short distance from the filament where the magnetic term still remains very small; the problem of the ordinary diode is re-encountered.

The diode without a magnetic field has been dealt with by Langmuir;<sup>3</sup> the potentials  $V$  and  $P$

<sup>3</sup> *Phys. Rev.*, t. 2 (1913), p. 458. An approximate solution may be found:

$$P = \frac{1}{2} \left( -\frac{m}{e} \right)^{1/3} (9I)^{2/3} \frac{(r-a)^{4/3}}{r^{2/3}};$$

it yields correct results for very small or very large  $r$ ; the error is about 20% near  $r=5a$ .

are identical and equation (24) reduces to

$$\sqrt{P} \frac{\partial}{\partial r} r \frac{\partial P}{\partial r} = -I\sqrt{-\frac{2m}{e}}. \quad (28)$$

For  $r \gg a$ , far from the filament, a solution is found in  $r^{2/3}$  and the complete solution may be written:

$$P_L = \frac{1}{2} (9I\beta^2 r)^{2/3} \left( -\frac{m}{e} \right)^{1/3}, \quad (29)$$

where  $\beta$  is a function of  $r/a$ , calculated by Langmuir. (See formula at foot of page.)

Equation (29) presents the same structure as (27) and correspondence is thus established in the vicinity of the filament. The potential  $P$  is obtained by replacing  $\beta^2 r$  by  $(r-a)^2/a$ . With  $r$  close to  $a$ :

$$\beta^2 \approx \frac{\left(\frac{r-a}{a}\right)^2}{\frac{r}{a}}. \quad (31)$$

Comparison with (30) shows that this approximation is valid only up to  $r=1.25a$ ; that is, in the immediate vicinity of the filament. This indication gives the limit of validity of (27), which should be replaced by Langmuir's equation (29) when distances beyond the immediate vicinity of the cathode are involved.

Fig. 4 shows the shapes of the various curves.

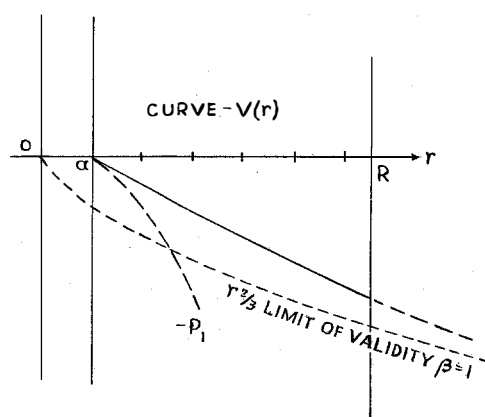

Fig. 4—Diode without Magnetic Field—Langmuir Curve.

$\frac{r}{a}$	1	1.25	1.5	1.75	2	2.5	3	4	5	6	7	8	9	10	15	$\infty$
$\beta^2$	0	0.045	0.116	0.2	0.275	0.405	0.512	0.665	0.818	0.902	0.94	0.94	0.94	0.94	1	1
								0.755	0.867	0.925	0.978					

2. DISTANT FROM FILAMENT

At a considerable distance from the filament the Langmuir equation gives low values for the term  $(\partial/\partial r)r(\partial P/\partial r)$ ; contrariwise, the magnetic term within the brackets of (24) increases indefinitely. A moment therefore arrives when this first term becomes preponderant. At the limit, the second term may be neglected and the first term kept. An asymptotic solution  $P_\omega$ , valid at a great distance, is:

$$P_\omega(r) = -I^2 \frac{e}{2m\omega_H^4} \left(r + \frac{a^4}{r^3}\right)^{-2}, \quad r \gg a \quad (32)$$

It is now necessary to discuss the junction of these two extreme cases with a view to ascertaining the corresponding values of  $r$  and obtaining the form of function  $P(r)$ .

Comparing the equations, an expression  $-eI/m\omega_H^3$  appears, homogeneous to a certain length  $L$  squared; the following gives an indication of the order of magnitude:

$$\frac{e}{m} = 5.3 \times 10^{17} \text{ (E.S.C.G.S.)}$$

$$I = 3 \times 10^6 J \text{ (} J \text{ measured in milliamperes; } I \text{ in E.S.C.G.S. units.)}$$

Calculating  $\omega_H$  according to (5) and  $H$  in gausscs:

$$L^2 = -\frac{eI}{m\omega_H^3} = 2.3 \cdot 10^3 \frac{J}{H^3} \quad (33)$$

The role played by the characteristic length  $L$  is very important and has now to be discussed.

First the condition  $r > L$  must be satisfied in order to justify use of the solution (32); this necessitates:

$$\frac{\partial}{\partial r} r \frac{\partial P_\omega}{\partial r} \ll -\frac{2m\omega_H^2}{e} \left(r + \frac{a^4}{r^3}\right).$$

Neglecting  $a$ , this condition reduces to

$$r^2 \gg L^2.$$

For weak fields, scarcely disturbing the diode, the length  $L$  is much greater than the dimensions of the bulb; if the field increases, however, the length  $L$  decreases considerably to the order of magnitude of the interior dimension of the bulb and may even drop to very low values; for some hundreds of gausscs.  $L$  is of the order of hundredths of mm.

The length  $L$  then gives the magnitude of the distance where the Langmuir solution  $P_L$  (always valid in the immediate vicinity of the filament) joins the solution  $P_\omega$  which is valid at a great distance.

Taking, as a criterion of the distance of coincidence, the condition:

$$P_L(r) = P_\omega(r),$$

then

$$\frac{1}{2}(9I\beta^2 r)^{2/3} \left(-\frac{m}{e}\right)^{1/3} = -I^2 \frac{e}{2m\omega_H^4} \left(r + \frac{a^4}{r^3}\right)^{-2}; \quad (34)$$

hence

$$9\beta^2 r \left(r + \frac{a^4}{r^3}\right)^3 = L^4. \quad (35)$$

If the length  $L$  is less than the diameter of the filament, the result is approximately

$$9\beta^2 r (2a)^3 = L^4;$$

and if  $L$  is definitely greater than  $a$ , (35) reduces to

$$9r^4 = L^4, \quad r = L \frac{\sqrt[3]{3}}{3}.$$

The curve representing the apparent potential  $P(r)$  is consequently known by the expressions  $P_L$  (for  $r \ll L$ ) and  $P_\omega$  (for  $r \gg L$ ); it can, in any case, be plotted approximately. Fig. 5 shows

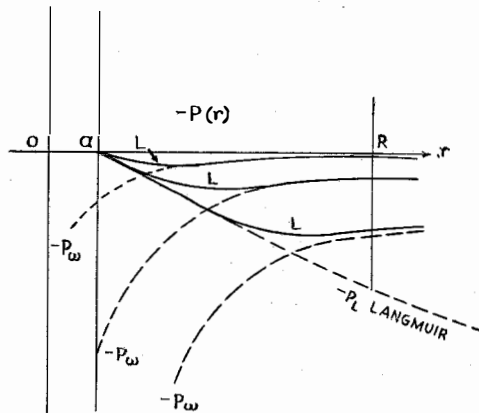

Fig. 5.

curves for various values of  $L$  between the cathode ( $r=a$ ) and the anode ( $r=R$ ).

If the anode radius  $R$  is appreciably greater than the length  $L$ , the formula  $P_\omega(R)$  of (32) gives the anode voltage (calculated from the

critical voltage  $V_0(R)$ ; if, however, the length  $L$  is very great, the magnetic field being weak, Langmuir's curve  $P_L$  is used. Fig. 6, accordingly,

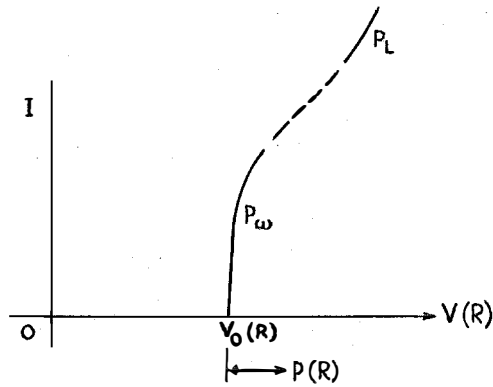

Fig. 6—Magnetron Characteristic.

shows the magnetron characteristic; the resistance  $\partial V/\partial I$  is zero in the vicinity of the critical point (section 3).

Reverting to the curves of Fig. 5, it should be noted that the electrons, after leaving the filament ( $r=a$ ), first reach the Langmuir region and then travel towards  $r=L$  through a region of low apparent potential energy, thereafter rebounding (approaching the anode) towards higher potential energies only slightly below the potential energy of the cathode. The expression  $-P(r)$  represents, but for the factor  $\epsilon$ , the apparent potential energy of the electrons, controlling their radial movements (equation 13). The speed of rotation around the filament is defined by (7). The curves,  $-P(r)$  show that the electrons are accelerated from  $a$  to  $L$  and retarded from  $L$  to  $R$ . The space charge thus is increased in the second region; close to the filament, Langmuir's space charge applies and, at a great distance, the constant space charge of (21) applies approximately:

$$r \gg L, \quad \rho = \frac{m\omega_H^2}{2\pi e}. \quad (36)$$

A more detailed study would require calculation of the junction of the curves in the region  $L$ . The following, however, is pertinent:

The electronic paths start radially from the filament; they are slightly curved in the region  $r < L$  and then turn around the filament for  $r > L$ , as shown in Fig. 7. This can be understood readily from the following considerations: Let

$v_r$  and  $v_\theta$  be the radial and rotational components of electronic velocity; equations (15) and (7) yield:

$$I = 2\pi r \rho v_r$$

$$v_\theta = r\dot{\theta} = r\omega_H \left(1 - \frac{a^2}{r^2}\right).$$

Instead of computing the ratio  $v_r/v_\theta$ , let us calculate

$$\frac{\rho v_r}{\rho_0 v_\theta} = \frac{I}{2\pi r^2 \rho_0 \omega_H \left(1 - \frac{a^2}{r^2}\right)}$$

$$= \frac{eI}{m\omega_H^3 r^2 \left(1 - \frac{a^2}{r^2}\right) \left(1 + \frac{a^4}{r^4}\right)} = \frac{L^2}{(r^2 - a^2) \left(1 + \frac{a^4}{r^4}\right)},$$

$\rho_0$  being the space charge density (21) in the region  $r \gg L$ . Neglecting the radius  $a$  of the cathode, as a first approximation, it is seen that the ratio  $\rho v_r/\rho_0 v_\theta$  equals 1 when  $r=L$ , which proves that  $v_r$  and  $v_\theta$  are of the same order of magnitude at a distance  $L$  from the filament.

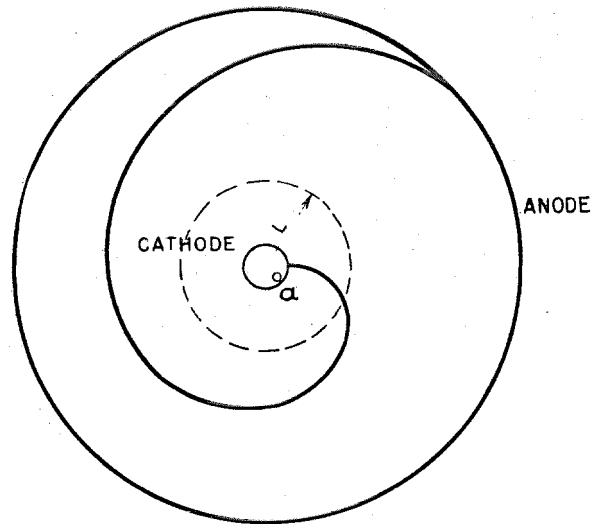

Fig. 7.

### 5. Study of the Transition Region $L$

The intermediate region may be studied either by proceeding from Langmuir's solution  $P_L$  or from the magnetic solution  $P_\omega$ . In any case a series of approximations will be obtained.

Commencing with Langmuir's distribution  $P_L$ , valid for  $\omega_H$  nil, the solution is developed in the form

$$P = P_L + \alpha P_1 + \alpha^2 P_2 \dots; \quad \alpha = -\frac{2m}{e} \omega_H^2. \quad (37)$$

The parameter  $\alpha$  is assumed to be small. Introducing this series into (24), a successive series of equations is derived by developing the radical  $\sqrt{P}$  in accordance with usual methods and assuming  $r \gg a$ ; terms independent of  $\alpha$  are:

$$\sqrt{P_L} \frac{\partial}{\partial r} r \frac{\partial}{\partial r} P_L = -I \sqrt{-\frac{2m}{e}};$$

terms in  $\alpha$  are:

$$\sqrt{P_L} \left[ \frac{P_1}{2P_L} \left( \frac{\partial}{\partial r} r \frac{\partial}{\partial r} P_L \right) + r + \frac{\partial}{\partial r} r \frac{\partial}{\partial r} P_1 \right] = 0; \quad (38)$$

terms in  $\alpha^2$  are:

$$\begin{aligned} \sqrt{P_L} \left[ \left\{ \frac{1}{2} \frac{P_2}{P_L} - \frac{1}{8} \left( \frac{P_1}{P_L} \right)^2 \right\} \frac{\partial}{\partial r} r \frac{\partial}{\partial r} P_L \right. \\ \left. + \frac{P_1}{2P_L} \left( r + \frac{\partial}{\partial r} r \frac{\partial}{\partial r} P_1 \right) + \frac{\partial}{\partial r} r \frac{\partial}{\partial r} P_2 \right] = 0. \end{aligned}$$

At the different orders, linear differential equations with second member must always be solved, the general type being:

$$\frac{\partial}{\partial r} r \frac{\partial}{\partial r} P_k - \frac{2}{9r} P_k = F_k(r), \quad (39)$$

where  $F_k(r)$  is a function which is known from the preceding approximations. Expression (39) is based on the fact that the coefficient of  $P_k$  is always  $\frac{1}{2} P^{-1}_L (\partial/\partial r) r (\partial/\partial r) P_L$ , which gives  $-2/9r$  when  $r$  is greater than  $10a$ , making it possible to insert  $\beta=1$  in Langmuir's equation (29). The second members  $F_k$  have the following values:

$$\begin{aligned} F_1 &= -r, \\ F_2 &= -\frac{1}{8} \left( \frac{P_1}{P_L} \right)^2 \frac{\partial}{\partial r} r \frac{\partial}{\partial r} P_L \\ &\quad + \frac{P_1}{2P_L} \left( r + \frac{\partial}{\partial r} r \frac{\partial}{\partial r} P_1 \right) \\ &= \frac{P_1}{2P_L} \left[ P_1 \frac{1}{9r} + r + \frac{\partial}{\partial r} r \frac{\partial}{\partial r} P_1 \right] \\ &= \frac{1}{6r} \frac{P_1^2}{P_L}. \end{aligned} \quad (40)$$

The last transformation, in  $F_2$ , is obtained with the aid of equation (39) in terms of  $P_1$ .

Equations (39), in general, admit solutions without the second member

$$P_k = r^{\pm \sqrt{2}/3},$$

such that the general solution without the second member is

$$P_k = A_k r^{\sqrt{2}/3} + B_k r^{-\sqrt{2}/3}, \quad (41)$$

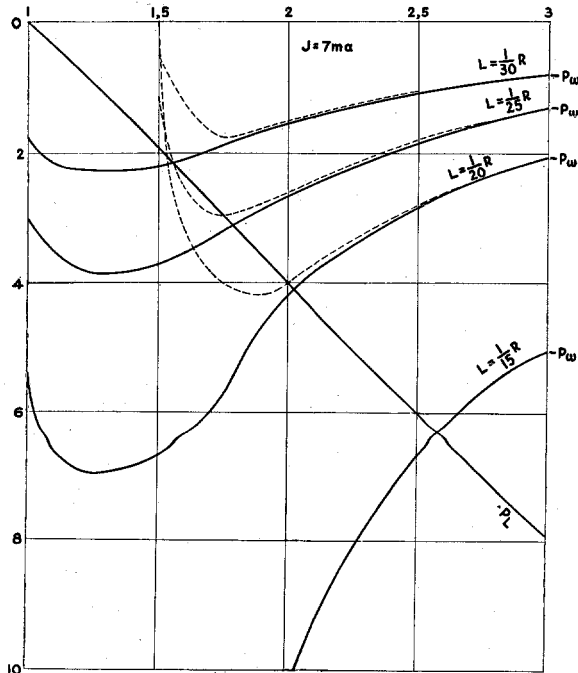

Fig. 8.

which contains two arbitrary constants. It is necessary to add a particular solution  $P_{k1}$  from the equation having the second member and to adjust the whole so as to satisfy the conditions imposed at the limit:  $P$  and  $\partial\rho/\partial r$  zero on the filament  $r=a$ .

In fact, if particular solutions  $P_{k1}$  of the equation with the second member be found of the form  $r^n (n > 1)$  satisfying the conditions imposed, the step involving solutions without the second member can be omitted (41).

For the first approximation, equation (39) becomes

$$\frac{\partial}{\partial r} r \frac{\partial}{\partial r} P_1 - \frac{2}{9r} P_1 = -r. \quad (42)$$

The particular solution is:

$$P_1 = -\frac{9}{34} r^2.$$

For the second approximation:

$$\begin{aligned} \frac{\partial}{\partial r} r \frac{\partial}{\partial r} P_2 - \frac{2}{9r} P_2 &= \frac{1}{6r} \frac{P_1^2}{P_L} \\ &= \frac{27}{34^2} \left( -\frac{e}{m} \right)^{1/3} \frac{r^{7/3}}{(9I)^{2/3}}, \end{aligned} \quad (43)$$

which may be resolved with a function

$$P_2 = K r^{10/3}, \quad K = \frac{2.17}{J^{2/3}}. \quad (44)$$

Continuing the process step by step, the terms in  $\alpha P$ ,  $+\alpha^2 P_2 \dots$  of (37) give progressively the actual curve  $P$  starting with Langmuir's approximation for values of  $r$  between  $a$  and  $L$ .

The second series of approximations in the region  $r > L$  proceeds from the magnetic solution  $P_\omega$  (32). It appears in the form of a development in powers of  $1/\alpha$ :

$$P_\omega = + \left( \frac{I}{\omega_H} \right)^2 \frac{1}{\alpha r^2}, \quad r \gg a, \quad \alpha = - \frac{2m}{e} \omega_H^2,$$

$$P = P_\omega + \frac{1}{\alpha^2} Q_2 + \frac{1}{\alpha^3} Q_3 + \dots \quad (45)$$

Introducing this expression in (24) and developing in powers of  $1/\alpha$ :

$$\frac{1}{\sqrt{\alpha}} \frac{I}{\omega_H r} \left\{ 1 - \frac{Q_2}{2\alpha} \left( \frac{\omega_H r}{I} \right)^2 \right. \\ \left. + \frac{1}{2\alpha^2} \left[ -Q_3 \left( \frac{\omega_H r}{I} \right)^2 + \frac{1}{4} Q_2^2 \left( \frac{\omega_H r}{I} \right)^4 \right] \dots \right\} \\ \times \left\{ -\alpha r + \frac{4}{\alpha r} \left( \frac{I}{\omega_H r} \right)^2 + \frac{1}{\alpha^2} \frac{\partial}{\partial r} r \frac{\partial Q_2}{\partial r} \right. \\ \left. + \frac{1}{\alpha^3} \frac{\partial}{\partial r} r \frac{\partial Q_3}{\partial r} \dots \right\} = -I \sqrt{-\frac{2m}{e}}$$

Regrouping:

$$\left\{ 1 - \frac{Q_2}{2\alpha} \left( \frac{\omega_H r}{I} \right)^2 \right. \\ \left. + \frac{1}{2\alpha^2} \left[ -Q_3 \left( \frac{\omega_H r}{I} \right)^2 + \frac{1}{4} Q_2^2 \left( \frac{\omega_H r}{I} \right)^4 \right] \right\} \\ \times \left\{ 1 - \frac{4}{\alpha^2 r^2} \left( \frac{I}{\omega_H r} \right)^2 - \frac{1}{\alpha^3 r} \frac{\partial}{\partial r} r \frac{\partial Q_2}{\partial r} \right. \\ \left. - \frac{1}{\alpha^4 r} \frac{\partial}{\partial r} r \frac{\partial Q_3}{\partial r} \right\} = 1. \quad (46)$$

Separating the successive terms in  $1/\alpha$ ,  $1/\alpha^2 \dots$ , there are obtained in terms of  $1/\alpha$

$$Q_2 = 0$$

in terms of  $1/\alpha^2$

$$-\frac{1}{2} \left( \frac{\omega_H r}{I} \right)^2 Q_3 - \frac{4}{r^2} \left( \frac{I}{\omega_H r} \right)^2 = 0,$$

$$Q_3 = -\frac{8}{r^6} \left( \frac{I}{\omega_H} \right)^4, \quad (47)$$

etc.; the solution  $Q_3$  tends towards zero when  $r$  increases indefinitely; the limiting value  $P_\omega$  of  $P$  at a great distance is thus derived in accordance with (45).

In order to obtain a concept of the practical value of these developments, it is necessary to

draw curves based on numerical values corresponding to types of magnetrons actually constructed.

Such an attempt has been made with the following numerical data:

$$\begin{aligned} \text{cathode—radius } a &= 0.005 \text{ cm,} \\ \text{anode—radius } R &= 0.1 \text{ cm,} \\ \text{current } J &= 7 \text{ milliamperes.} \end{aligned}$$

The results of the calculations are shown in Fig. 8. Abscissae are the ratios  $r/a$  of the radius  $r$  to the cathode radius  $a$ : they run from 1 to 3 and relate therefore only to the vicinity of the filament; the ratio  $R/a$  for the anode equals 20. As ordinates, the quantities  $-P$  have been chosen, and the conditions are the same as on Figs. 4 or 5. Langmuir's curve  $P_L$  gives the potential distribution near the filament, while the magnetic curve  $P_\omega$  yields the potential at greater distances. The curves  $P_\omega$  have been drawn for different values of  $L$ , corresponding to different magnetic fields; the corrections  $\alpha P_1 + \alpha^2 P_2$  to  $P_L$  (37) have proved practically negligible. On the other hand, the  $Q_2$  correction to  $P_\omega$  (45) must be taken into account and gives the dotted curves on Fig. 8; further terms  $Q_3$ ,  $Q_4 \dots$  would be necessary to join smoothly the two branches  $P_L$  and  $P_\omega$  near their intersection.

## 6. Conclusions

This study of the magnetron, in its static condition, has been pursued for the first time with strict regard to the influence of the space charge.

The speed of rotation of the electrons around the filament results from the magnetic field (7); hence, an apparent radial potential  $P(r)$  may be defined, governing the radial movements of the electrons (13). This potential  $P(r)$ , at distance ( $r$ ), is equal to the real potential  $V(r)$  less the critical potential  $V_0(r)$ , which would just prevent the electrons from reaching an anode placed at  $r$  (23). The apparent potential  $P(r)$  may be studied methodically; in the vicinity of the filament, it approaches Langmuir's result (eq. 29, diode without magnetic field); as the distance (33) becomes of the order of

$$r = L = \sqrt{-\frac{eI}{m\omega_H^3}},$$

the potential  $P$  departs from Langmuir's curve and then corresponds with a function  $P_\omega(r)$  typical of the magnetron. Under certain conditions, in the region of correspondence ( $r=L$ ), a maximum potential may be obtained such that the electronic energy  $eP = -|e|P$  is a minimum. The disposition of the apparent potential  $P$  in a magnetron under these conditions then becomes analogous to that found in a Barkhausen valve with a strongly positive grid and a moderate

anode potential. It is thus possible to foresee that, under prescribed conditions, oscillations could be maintained in the magnetron.

The study of these oscillations is practicable but demands highly rigorous analysis. It would probably also be necessary to study the magnetron when functioning at saturation. It should be emphasized that the saturated condition is conducive to obtaining maximum apparent potential  $P$ .

## Police Radio in Mexico

**A** TWO-WAY police radio telephone system, serving an area of approximately fifty square miles, was inaugurated November 28, 1940 in Mexico City.

The headquarters transmitter (XBLP) is installed in the "Caballero Alto" tower of Chapultepec Castle, on Chapultepec Hill, dominating the Valley of Mexico. A control system and a special PBX are located three miles away at Police Headquarters. Calls for patrol cars, routed through this PBX to the dispatchers, may be made from any point in the city by dialing 06. A second PBX serves Police Headquarters, police booths and street telephone boxes.

The output of nine strategically located 28-A Receivers, connected by telephone lines, is brought to Police Headquarters. Messages are reproduced by a loudspeaker adjacent to the dispatchers.

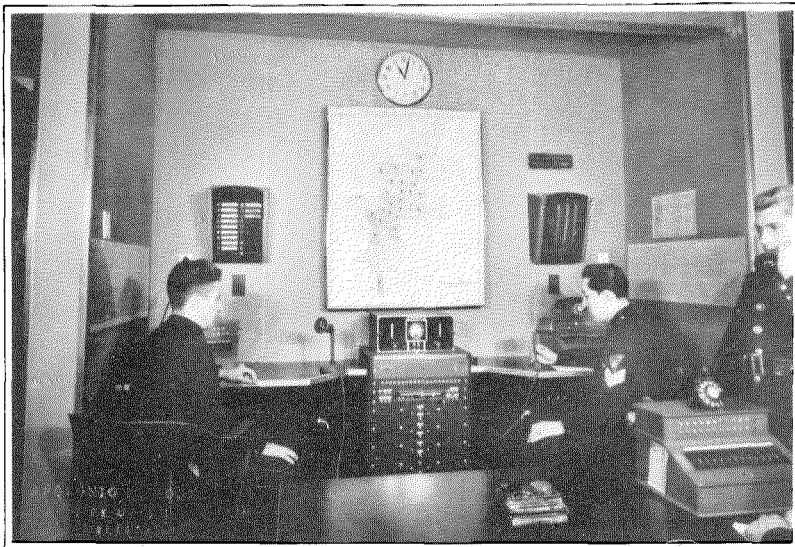

*Dispatchers' Equipment and Dispatchers Who Control the Operations of the Radio Patrol. The various patrol sectors of the city are shown on a lighted map which also indicates the positions of patrol cars.*

The system was engineered and supplied by the International Standard Electric Corporation, New York. In view of its successful operation, resulting in marked crime reduction, it will be expanded in the near future.

*Right—Mobile Equipment Lined Up in Patio of Chapultepec Castle. It consists of twenty 1941-model Buicks furnished with 228-A Mobile Radio equipment. The automobiles of the Chief of Police and the Governor of Mexico City are similarly equipped.*



*Left—Police Officer Operating Car Radio Equipment.*

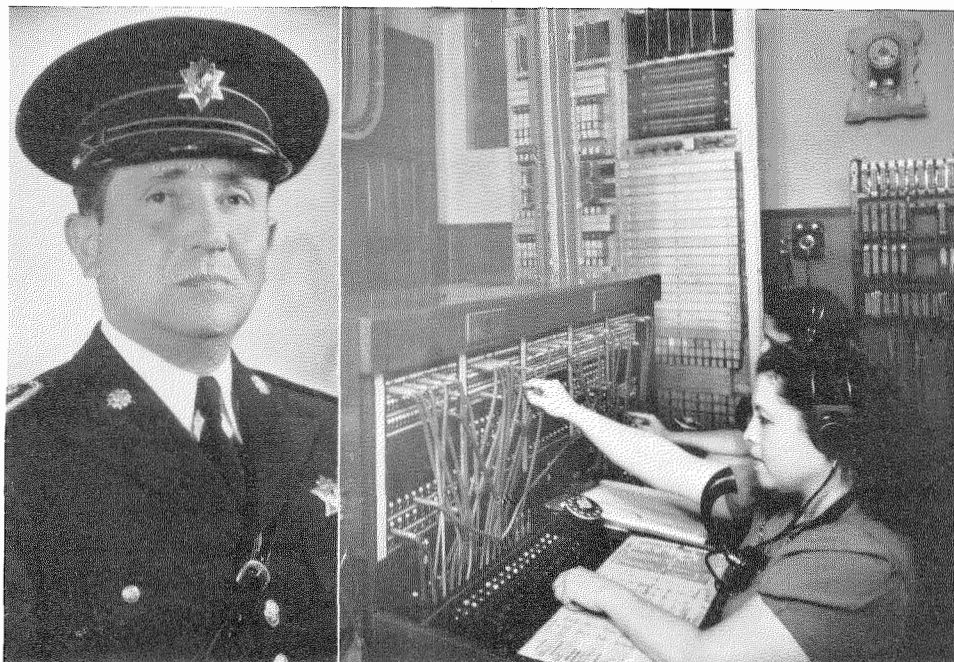

*Left—Major Alvaro Basail, Chief of the Radio Patrol. Under his leadership the “Consejo Cívico de Seguridad Pública,” by public subscription, acquired the funds necessary for the purchase of the Police Radio System. Right—Police Headquarters PBX With Twenty Trunks.*

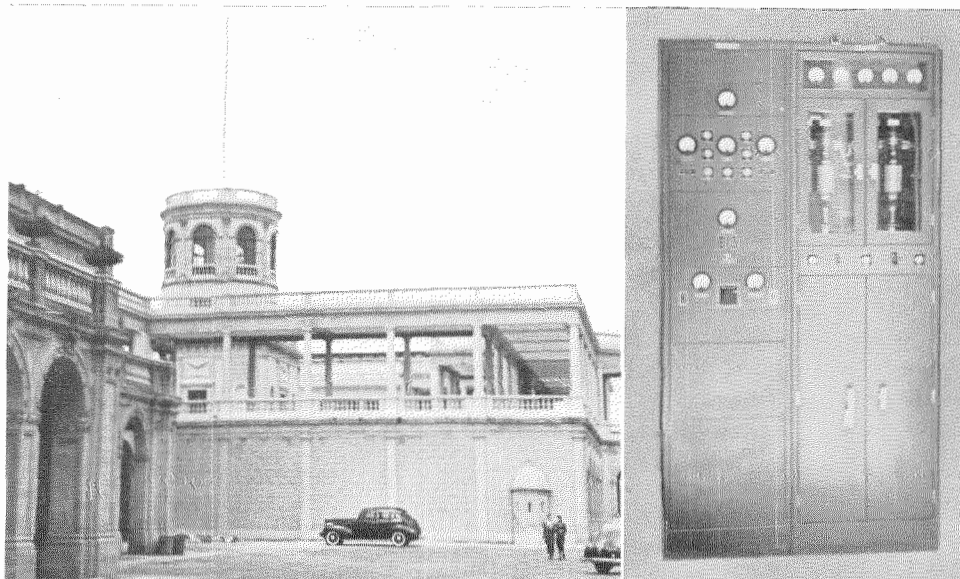

*Left—“Caballero Alto” Tower of Chapultepec Castle Showing Mast and Antenna of the Headquarters Radio Transmitter of the Mexico City Police Radio System. Right—16-B Ultra-Short Wave Radio Transmitter and 88-A Amplifier Installed in the Base of the Tower, “Caballero Alto,” of Chapultepec Casile. Output: 500 Watts.*



# Selenium Rectifiers for Closely Regulated Voltages

By J. E. YARMACK, S.B. in E.E.

*International Telephone & Radio Manufacturing Corporation, New York, N. Y.*

*This article supplements a previous publication<sup>1</sup> in this journal and describes novel applications of Selenium Rectifiers. The sections dealing with static and dynamic load characteristics of bridge connected Selenium Rectifiers, and easily attainable close voltage control, were published in the September 1941 issue of ELECTRONICS. An additional section discusses application of Selenium Rectifiers in another type of circuit now being widely used in automatic Battery Chargers; also, the application of these rectifiers in Battery Eliminators for telephone and telegraph services.*

**R**ECTIFICATION of alternating current power to direct current power is becoming increasingly common in the United States due to the prevalence of alternating current mains supplies combined with steadily increasing direct current applications. Many types of equipment are employed to furnish direct current power, but the convenience, economy and simplicity of Selenium Rectifiers make them almost indispensable for numerous applications. In many cases the source of direct current must provide a substantially constant output voltage under varying load and power supply conditions, a type of service for which Selenium Rectifiers are ideally suited.

The inherent static voltage regulation of Selenium Rectifiers is in the neighborhood of 10 to 20 percent. Its exact value depends upon the degree and nature of loading, the type of rectifier circuit and the effective rectifying area of the Selenium Rectifier plates employed. Moreover, when required, measures can be adapted for achieving extremely close regulation of the order of 2 percent. Such a scheme is described in detail hereinafter. In designing Selenium Rectifiers to give the required rectified current output, the engineer must select the proper size of plates and if necessary determine their number in parallel to provide adequate current capacity, compute the alternating current voltage to be impressed on the rectifier elements and analyze various factors involved in the selected type of circuit, such as the character of the load, duty cycle, ambient temperature and cooling requirements.

<sup>1</sup> "Selenium Rectifier Characteristics, Applications and Design Factors," Carole A. Clarke, *Electrical Communication*, Vol. 20, No. 1.

## Design of Selenium Rectifier

The size and, when necessary, the number of rectifier plates in parallel are determined by examination of ratings of all available selenium plates. The required alternating current voltage to be impressed upon the rectifier elements,  $V_{ac}$ , is usually computed by the following formula:

$$V_{ac} = k_1 V_{dc} + k_2 n v, \quad (1)$$

and the number of plates in series by the formula:

$$n = 1.1 k_1 V_{dc} / (V_p - 1.1 k_2 v) \quad (2)$$

where  $k_1$  is the form factor, that is, the ratio of the effective or root-mean-square value of the wave to the average value of rectified voltage wave,

$V_{dc}$  is the required direct current output voltage,

$k_2$  is the circuit factor and is 2 for the single phase bridge circuit or 1 for the center tap circuit,

$V_p$  is the maximum safe permissible root-mean-square voltage per plate, and

$v$  is the voltage drop per Selenium Rectifier plate in root-mean-square values.

The ten percent or 1.1 factor is the voltage variation factor and is selected upon the designer's consideration of possible alternating current input voltage fluctuations.

The quantity  $v$  plays a most important role in the performance of the Selenium Rectifier and changes slightly during the first 10,000 hours of fully loaded service, after which it remains constant. Quantitatively, the voltage drop of the Selenium Rectifier plate may vary from 0.9 to 1.3

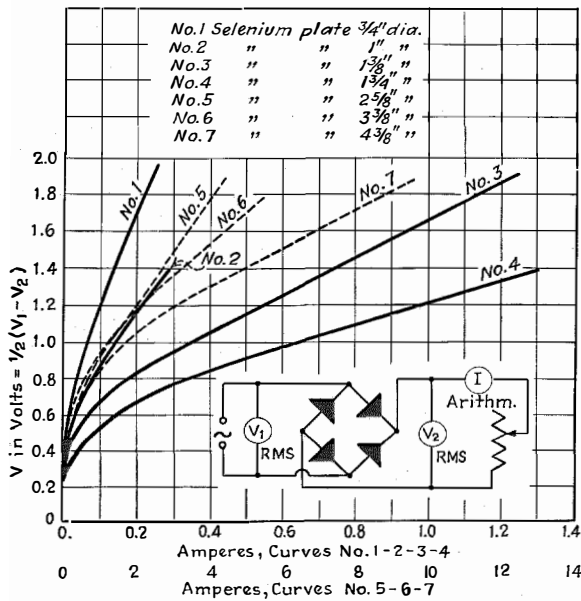

Fig. 1—Rectification Characteristics of Seven Basic Rectifier Plates.

volts for the rated plate current. At ambient temperatures less than 35 degrees C., its value increases but at ambient temperatures higher than 35 degrees C. its value slightly decreases. For practical use in designing rectifiers the relation of the quantity  $v$  to the arithmetical values of the rectifier output current have been determined experimentally for seven basic sizes of selenium plates and are portrayed in Fig. 1.

In designing the teletype rectifier unit (Figs. 2, 3 and 4), capable of delivering a dual output of 6 amperes, 120 volts each, the No. 7 Selenium Rectifier plate, 4 3/8 inches in diameter and rated at 4 amperes for the single phase bridge circuit, was selected inasmuch as it provides an ample safety factor for extended current rating. The safe maximum reverse voltage rating of this plate is 14 volts rms. Inasmuch as the complete circuit calls for a 14-volt drop between the output terminals of the rectifier and the output terminals of the unit, the alternating voltage into the rectifier can be computed by equation (1). Hence, on the basis of an operating plate rating for this case of only 3 amperes at 134 volts:

$$V_{ac} = (190 - 2 \times 15 \times 0.3) / 1.15 = 157 \text{ volts.}$$

The voltage regulation therefore is  $(157 - 134) / 134 = 0.172$  or 17.2 percent.

**Static and Dynamic Regulation**

In the application of rectifier equipment two types of output voltage regulation are of interest and must be considered when designing power supply units for various purposes. These are the static and dynamic regulation characteristics. The static regulation characteristic, the compu-

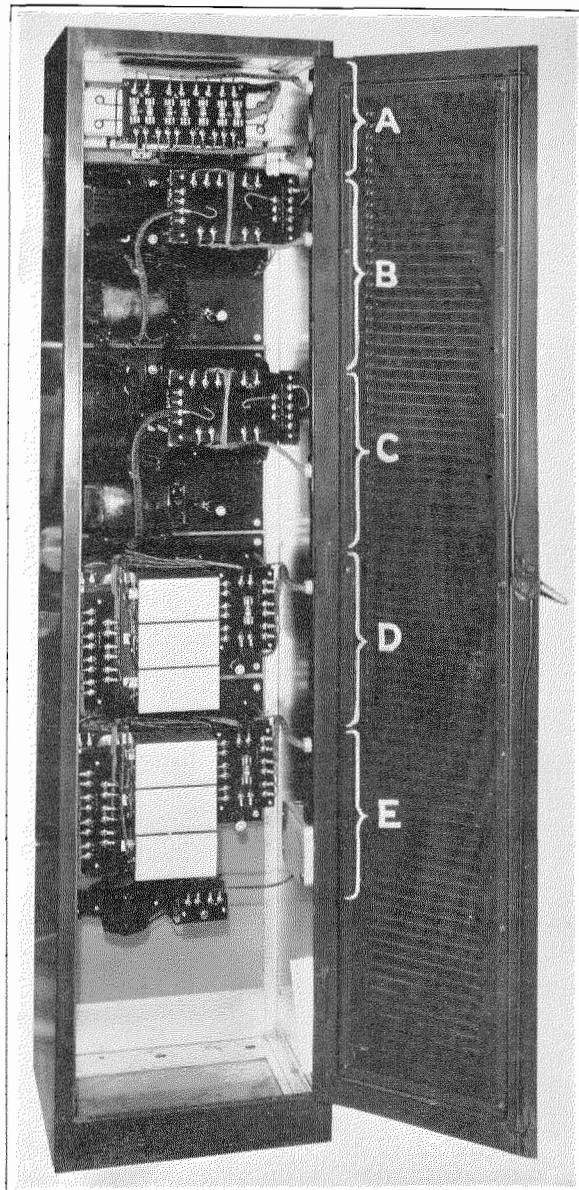

Fig. 2—Teletype Rectifier Unit. (A) Metering and Switching Panel. (B, C) Transformer Panels. (D, E) Rectifier and Filter Panels.\*

\* Equipment illustrations in this article are published by courtesy of the Power Equipment Company, Detroit, Mich.

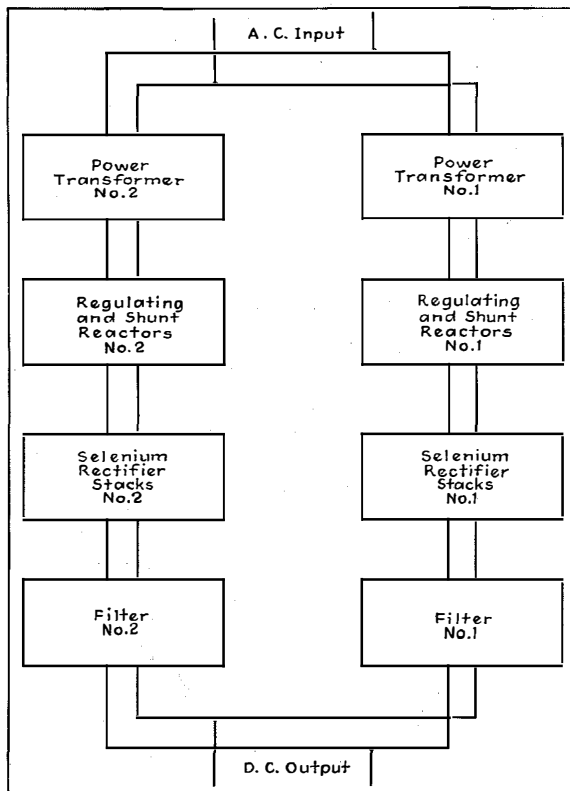

Fig. 3—Block Diagram of Teletype Rectifier of Fig. 2.

tation of which is exemplified above, represents the relation of the rectifier output voltage to the output current and is plotted from D'Arsonval meter readings of the current and voltage for a series of steady-state conditions from no load to full load (Fig. 5).

The dynamic regulation characteristic also represents the relation between the rectifier output voltage and current, but is obtained while keying or interrupting the load or a combination of loads at varying rates by measuring the instantaneous voltage and current values (Fig. 6).

The best method of measuring this type of regulation is with the oscillograph. Current and voltage values are photographed simultaneously with a 60-cps wave used for time calibration. Measurements of the ordinates of these characteristics provide instantaneous values from which the regulation may be computed.

In certain applications of rectifiers, such as those in which the load is keyed, dynamic regulation may be of great importance. When several

load circuits are operated from a common source it is usually important that none of the individual output circuits should interfere with any of the others.

The variation in output voltage of a typical regulated circuit of the type described below, with a keyed load alone, and with the keyed load superimposed upon fixed loads of different values is shown in Fig. 6. It will be noted that the voltage variation decreases with an increase in the magnitude of the fixed load. Fig. 5 shows

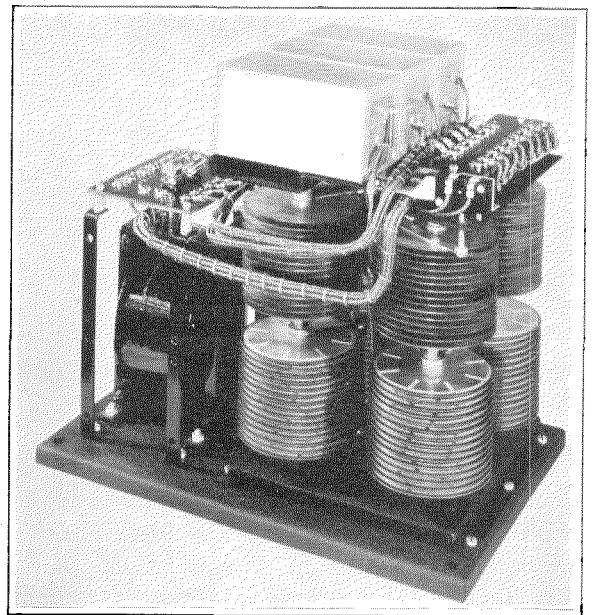

Fig. 4—A Teletype Rectifier Showing Filter and Four Selenium Stacks Connected for Two Separate Bridge Units. Output is 6 Amperes at 120 Volts.

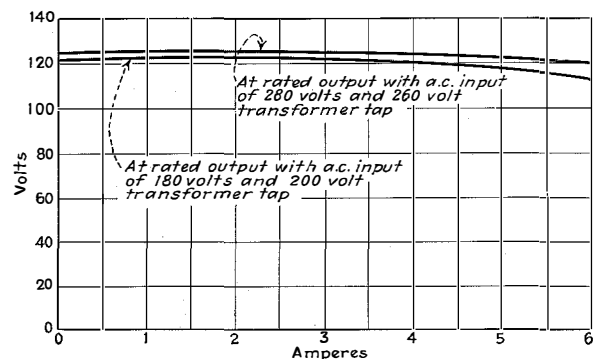

Fig. 5—Static Characteristics of 6-Ampere, 120-Volt Rectifier, Corrected by Regulating and Shunt Reactors.

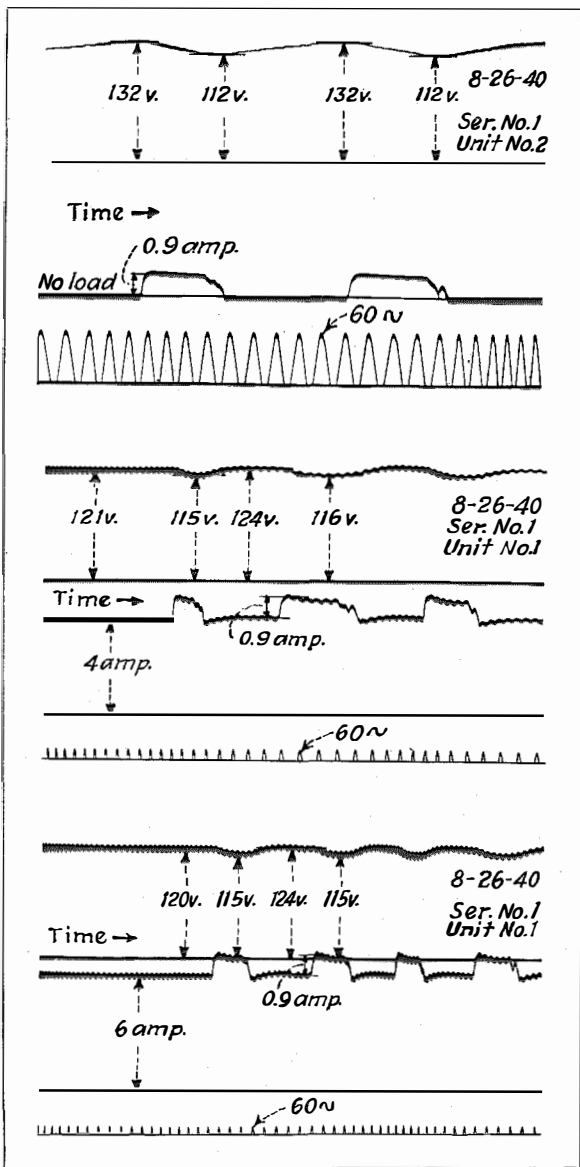

Fig. 6—Dynamic Characteristics of 6-Ampere, 120-Volt Rectifier Under Three Different Load Conditions.

the static regulation characteristics of the same type of rectifier from no load to full load. From these characteristics it can be seen that the regulation is less than 5 percent throughout the operating range even though the applied line voltage of 280 volts is in excess of the rated input voltage of 260 volts for the transformer tap used in making this test.

The static voltage output characteristics of another rectifier under various ambient tem-

peratures are illustrated in Fig. 7, and a rear view of the rectifier is shown in Fig. 8. The output voltage, while lower at sub-zero temperatures than at normal room temperature, is nevertheless remarkably constant throughout the rated current range. The four volt lower output voltage of this unit at minus 5° C. is due to increase of the  $v$  value.

As compared to mercury vapor and gas filled hot cathode tube type rectifiers, Selenium Rectifiers have relatively high internal forward resistance. In order to apply dry plate rectifiers to devices requiring constant applied voltage, it is often necessary to provide means for com-

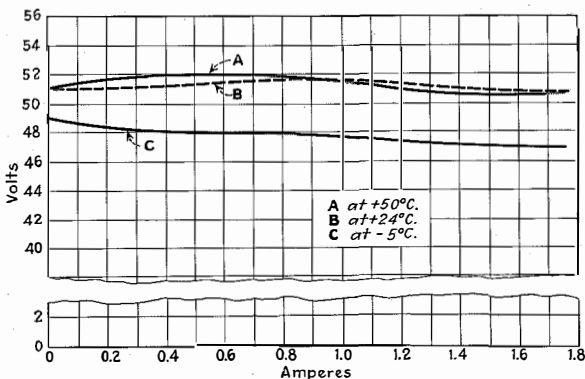

Fig. 7—Characteristics of Strowger Switch Rectifier: 0.75-Ampere Continuous, 1.75-Ampere Intermittent Load.

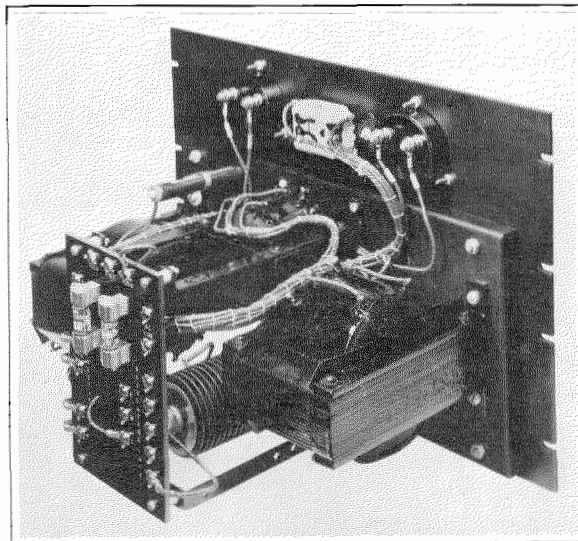

Fig. 8—Rear View of Selenium Rectifier for Strowger Switch Operation. Characteristics are Given in Fig. 7.

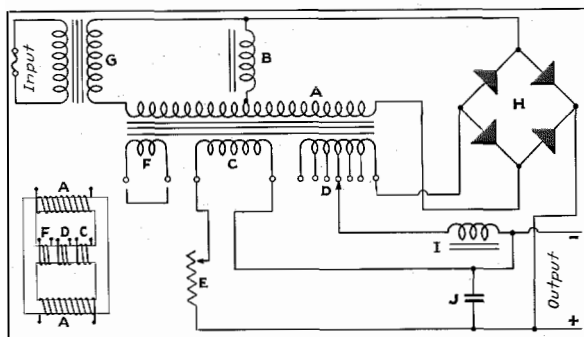

Fig. 9—Schematic Showing Principle of Controlled Output Voltage by Regulating and Shunt Reactors.

compensating for the internal resistance of the rectifier and for the transformer and filter reactor voltage drops by means of devices controlling the alternating current voltage applied to the rectifier.

A large variety of methods of voltage regulation has been developed and used. Some of them are universally successful; others are effective only within a limited field. Certain types of regulating circuits use gas or vacuum tube characteristics while other circuits employ saturable reactors to accomplish the same purpose. The circuit illustrated in Fig. 9 and described here as an example of such compensation utilizes two iron core reactors to regulate the voltage applied to the rectifier and requires no rectifier elements other than the main or power ones.<sup>2</sup>

### Circuit for Voltage Regulator

In the simplified typical circuit of Fig. 9 the control elements consist of a direct current controlled saturable three-legged reactor and an alternating current controlled saturated reactor, each having a separate core with no magnetic relation to the other. These two reactors are so proportioned that, for the rectifier with which they are used, the output voltage is held within close limits from no load to full load despite line voltage variations. By proper design of the regulating coils it is possible to arrange a circuit to give either a rising, a flat, or a dropping static voltage characteristic.

The basic circuit of Fig. 9 consists of a series reactance, *A*, and a shunt reactance, *B*, con-

nected between the transformer secondary winding, *G*, and the input terminals of the rectifier, *H*. The value of the series impedance is controlled by two direct current windings, *C* and *D*, associated with the output circuit of the rectifier. One of the windings, *D*, is connected in series with the load circuit and the other winding, *C*, is connected in parallel with the load circuit. The amount of current that flows through the shunt direct current winding, *C*, is controlled by means of the variable resistor, *E*, in the circuit, permitting adjustment of the no load output voltage. Both direct current windings are connected additively.

The shunt reactor, *B*, serves to increase the voltage drop in the series reactor, *A*, under light loads and thereby to reduce the voltage applied to the rectifier stack and to keep the light load voltage within the desired limits. Reactor *B* is

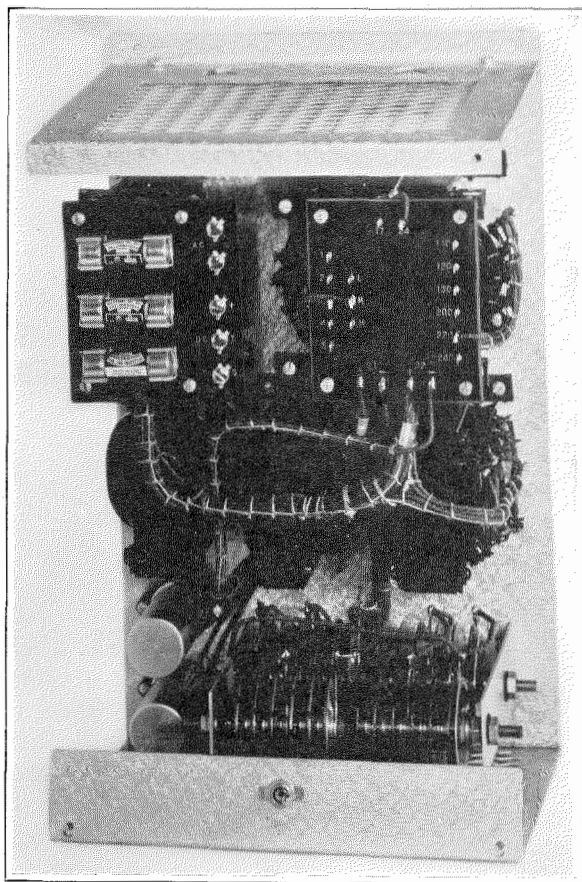

Fig. 10—Telephone Battery Eliminator: 2.4 Ampere, 17/24 Volt Rating.

<sup>2</sup> U. S. Patent No. 2,182,666.

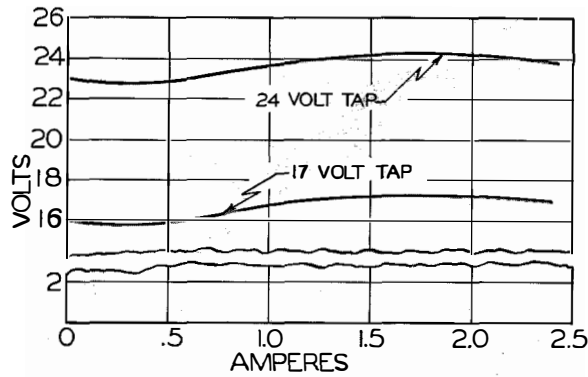

Fig. 11—Performance Characteristics of the Telephone Battery Eliminator Illustrated in Fig. 10.

also effective in compensating for line voltage variation. An increase in line voltage results in increased current in this coil and increased voltage drop in reactor *A*, so that the voltage applied to the rectifier is held approximately constant.

The series direct current winding, *D*, affects the output voltage characteristic under all load conditions and serves the purpose of lowering the impedance of the series alternating current winding, *A*, as the output current increases by increasing saturation of the core of the regulating coil. The decrease in the series reactance causes a net increase in the alternating current voltage applied into the rectifying elements, thereby maintaining the output voltage relatively constant over the rated output current range. By selecting the proper tap on the winding, *D*, the shape of the characteristic can be varied over a wide range and can be made to give a higher voltage at heavy loads than at lighter loads.

By increasing the number of turns in the direct current series winding, *D*, the reactance *A* may be decreased and the alternating current input voltage to the rectifying elements may be increased. This offers a convenient means of compensating for the increase in resistance of the rectifier stack or stacks that may take place as they reach their final condition upon full aging. The short circuited winding, *F*, usually provided, serves the purpose of eliminating the pulsating fluxes, due to the unbalanced ampere-turns in the two halves of winding *A*, in the center leg of the three-legged regulating reactor.

The alternating current taken by the rectifier stacks when the direct current load is discon-

nected stabilizes within one minute with the selenium type plates. This stabilization period with other types of dry plate rectifiers may be anywhere from a half hour to six hours and usually affects the light load portion of the output voltage characteristic.

### Battery Chargers and Eliminators

The foregoing method of regulating the rectified output voltage frequently is adapted to automatic battery chargers and battery eliminators. Fig. 10 shows the telephone battery eliminator. The electric circuit of this unit is essentially the same as portrayed in Fig. 9 except that it utilizes a two section filter, comprising one pair of reactors and one pair of high capacitance condensers for the purpose of insuring a low hum level at the output. The ripple component at full load is less than 25 millivolts. The output voltage characteristics (Fig. 11) illustrate the fact that, notwithstanding greater voltage drop in component parts of the circuit, slightly higher output voltages can be obtained

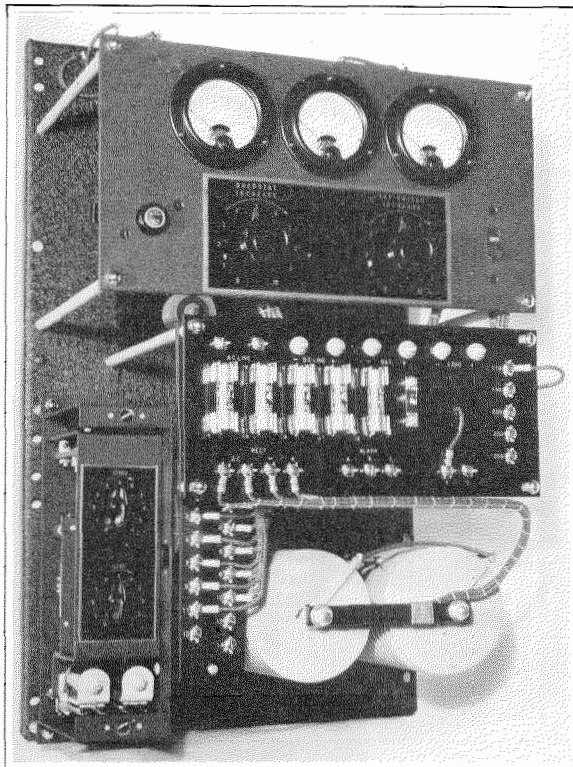

Fig. 12—Automatic Telephone Battery Charger Employing Relays.

as the current increases by suitable design and adjustment of the regulating reactors.

Selenium Rectifiers also have proved useful as automatic telephone battery chargers. A view of such a charger is shown in Fig. 12; Fig. 13 illustrates its electric circuit. An automatic battery charger of this type<sup>3</sup> is designed to maintain the battery potential between arbitrarily chosen values of 25 and 27 volts. As a rule batteries are continuously trickle charged and are given an occasional high rate charge. The normal or trickle charge rate is controlled by the rheostat *A*, manually adjusted to provide a charging current equal to the battery losses. The high rate charge, on the other hand, is controlled by the voltage relay *B*, the winding of which is connected in series with the rheostats *C* and *D*, permitting adjustment of the voltages at which the charge starts and stops. Normally the relay *B* is energized and its contacts are open but, when the battery voltage falls to 25 volts, the contact points close and short circuit the trickle charge rheostat *A* and fixed resistor *A'* through the operation of contactor *K*, thus increasing the rate of charge. At the same time the bi-metal strip begins to heat and in some two or three minutes closes the contact *E*, which in turn short circuits a portion of the relay control resistance, allowing the relay to pull up and open its contacts at 27 volts. By adjusting rheostats *C* and *D*, the battery terminal voltages can be maintained between any desired voltage limits.

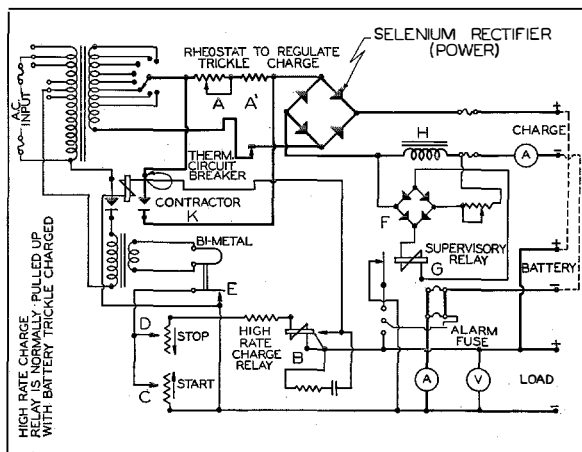

Fig. 13—Circuit of Automatic Battery Charger of Fig. 12.

<sup>3</sup> U. S. Patent No. 2,229,432.

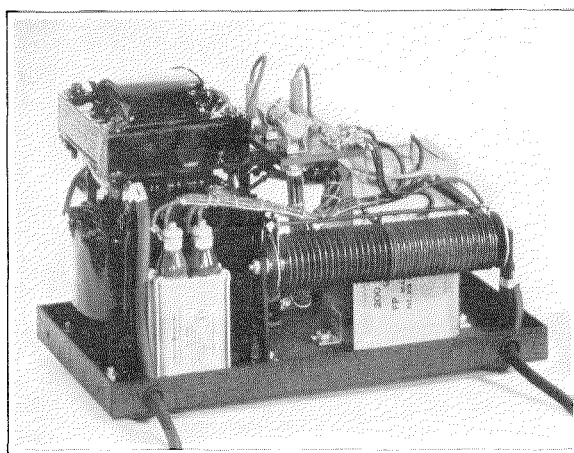

Fig. 14—Telegraph Battery Eliminator Supplying Both Line and Local Battery Current.

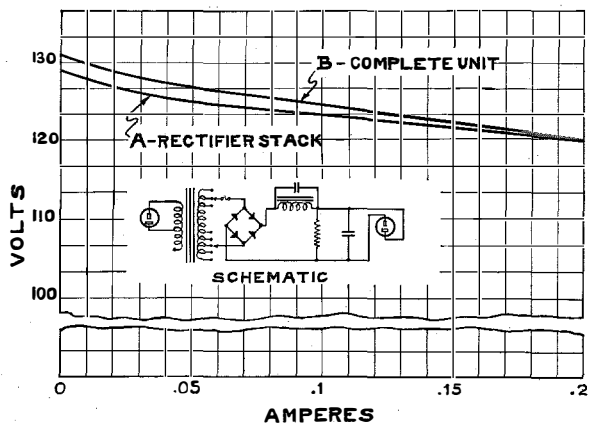

Fig. 15—Performance Characteristics and Circuit of Telegraph Battery Eliminator Shown in Fig. 14.

An interesting innovation in this automatic charger is the use of a small auxiliary bridge-connected Selenium Rectifier *F* operating the relay *G* to sound an alarm or give a visual indication in case of trouble. The reactor *H*, in series with the charging circuit, provides double frequency alternating current potential which is converted into d.c. by means of rectifier *F* energizing the relay *G*. The cessation of charging due to the line failure or any other cause results in operation of the alarm circuit. The filter reactor *H* also serves the purpose of reducing the a.c. component at the battery terminals to less than 40 millivolts.

To illustrate the inherent output voltage regulation of Selenium Rectifiers reference may be

made to the telegraph battery eliminator (Figs. 14 and 15). The characteristic *A* shows the inherent voltage regulation of the selenium stack connected in the bridge circuit, each arm containing nine  $1\frac{3}{8}$ " diameter plates in series. This rectifier uses neither saturable reactors nor relays, static and dynamic regulation being accomplished by means of a tuned filter circuit. A high

capacity electrolytic condenser is connected across the output terminals. The combination of this condenser with the tuned filter reactor reduces the a.c. component to a quarter of one percent of the d.c. voltage. The no-load output voltage is minimized by the bleeder resistor across the output terminals and a choke-input filter circuit.



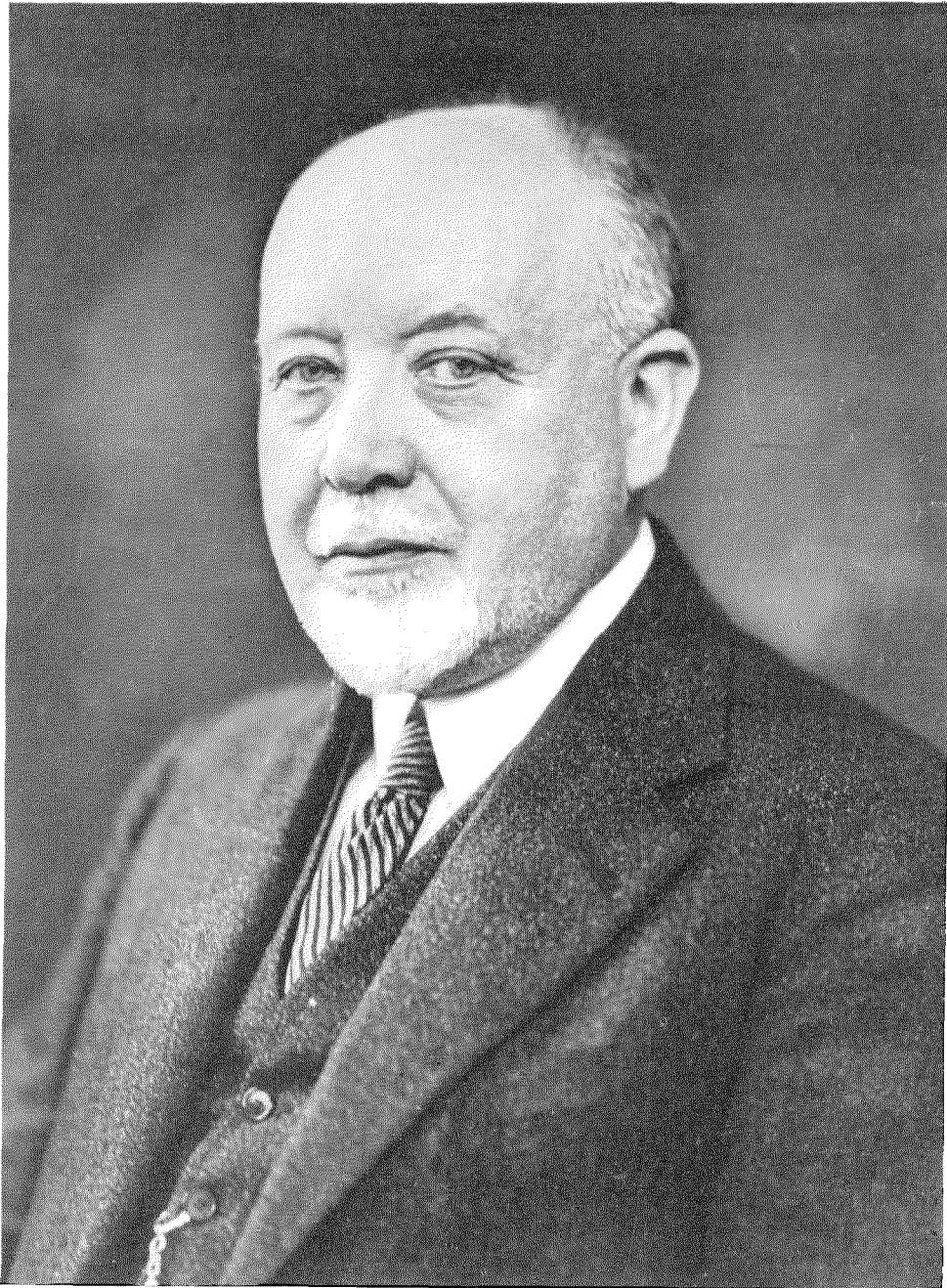

PEDER OLUF PEDERSEN

## Peder Oluf Pedersen \*

1874-1941

### The West Jutland shepherd boy who wrote to His King, who helped him to become a man of science.

*As one of P. O. Pedersen's best friends through half a century, it is with the deepest grief that I learn today (August 30, 1941) that my friend has passed away.*

*Danish engineering and technique has lost its first man.*

*In the electro-technical field, in which he was my faithful collaborator during many happy years, he was a greatly esteemed research investigator. These years are a very dear remembrance to me.*

*His enormous ability in covering a wide range and his great initiative, benefiting technical science in our country, carried him in late years into new working fields, but the friendship from our youth was continued down through all the years.*

*I keep the remembrance of him in deep gratitude.*

DR. VALDEMAR POULSEN.

IN the little volume, "Remembrances of my Childhood," published some years ago, Professor P. O. Pedersen gently and impressively tells how he started his career as one of our most esteemed scientists.

He was born 67 years ago in a modest farm house in the Varde region. His father had a little farm on the heath at Sig. Peder Oluf was an only son amongst many children. He was small for his age, slender in appearance and of delicate health. Seventeen of his ancestors had been Jutland farmers but, while he was still quite young, his parents began to fear that the boy would disappoint their expectation of carrying on the family tradition by some day taking over the heath farm at Sig.

Peder Oluf was reared in the same way as other young people of his region, and one can understand that it was an upbringing which marked all his subsequent development. He never owned bought toys and he never missed them. "There were stones in the fields," he said in his memoirs, "and they could be used in many ways, you know. There were the elder bushes whose branches could be fashioned into lovely flutes and pop-guns. When a little older

one might also beg some nails and bits of wood from father for building small wind and water mills. There was always enough to busy oneself with. I never remember having felt bored as a child, and besides, not later on in my life either."

#### *Practical Wisdom of Life from the Home and the Field*

His father and mother were both religious, and the children were brought up in a Christianity where admonitions were taken not only from Luther's Catechism, but just as often from the wisdom of life derived from the many adages ("Sejh'er," i.e., sayings), continually used both earnestly and humorously. P. O. Pedersen mentions one which expresses something deeply rooted in the minds of many West Jutlanders and which has surely been of importance in his later research work, "De maa A et sejh, for A veed et" (I must not say that because I don't know it).

P. O. Pedersen evidently was reared in one of the excellent farming homes from whence various men of genius have come—men who, through their lifework, have played their part in creating the reputation of our country. Peder was a little late in starting school. He had a speech impediment and was unable to pronounce G and K. His mother, however, taught him how to say the difficult letters correctly by letting the boy follow with his fingers the movements of her tongue as she articulated G or K. He overcame his handicap and was an apt pupil at school.

\* This article appeared August 31, 1941 in *Berlingske Tidende* and is reprinted in translated form as a tribute to one of the world's outstanding Pioneers of Electrical Communication. *Berlingske Tidende* is one of Copenhagen's leading daily newspapers; its predecessor was the *Københavnske Danske Post-Tidende* which was taken over by E. H. Berling in or about the year 1748.

Arithmetic was his favorite subject and, by the time he was fourteen years old, the boy had learned so much that his teacher did not consider himself able to instruct him further in this field, but procured for him Poul la Cour's "Historical Mathematics," leaving the boy to study it by himself. It was a magnificent companion when he was out tending the farm's cattle during the summer. There were also other books which caught his interest, such as Hannover's "Theory of Movement." He was, nevertheless, a careful and conscientious herdsman. The working day often lasted twelve hours—and in later years the Professor often dreamed that he had forgotten for a day or two to move the sheep.

### ***The Letter to His Majesty King Christian IX***

Then came the great change in the little farmer boy's existence. He became more and more absorbed by technical problems. He always tried to solve them himself even if mastery of his books proved ever so difficult. But it was one of the doctrines he had absorbed in his childhood home: "By asking others one misses the joy and satisfaction of finding out oneself, and one never understands so well when relying upon someone else's explanation as when one has solved a problem for oneself."

The soil of the southern field of the farm was very poor, and the "Kapelbakke," especially, was so sandy that both the grass and the corn suffered much from early summer droughts. It was depressing to look at. And then it was that Peder Oluf, while he was lying in the field tending his cattle, hit upon a "perpetuum mobile" by which the necessary water could be pumped over the southern field. But here, for once, he met a problem so great and difficult that he could not solve it himself. He speculated upon this matter in the field until, suddenly, it was clear to him: he naturally ought to appeal to The King, Christian IX. His Majesty was the head of the country and would best be able to decide upon the right course.

It was then that Peder Oluf wrote the touching, simple-hearted letter to the King of the country. He ended the letter by saying: "God bless Your Majesty and highly esteemed family." The King passed the letter to Professor Julius Thomsen, the Rector of the Polytechnic Acad-

emy. When the boy immediately thereafter submitted a sketch illustrating a machine, the King himself granted P. O. Pedersen 300 Kroner annually and, in addition, the Ministry of Education provided a similar subsidy. Peder Oluf also gained free admission to Galster and Holboll's Course and was admitted to the home of a lecturer, S. C. Borch. The way thus was opened up towards the honourable scientific path now terminated.

### ***The Meeting with Valdemar Poulsen***

When P. O. Pedersen had been graduated from the Polytechnic Academy it was, quite naturally, his childhood recollections of West Jutland that became the determining factor in the career on which he embarked. The thirsty fields of his native abode and the inundations at Varde Creek seemed to him far more lovely than the Rhine and the other great European rivers he viewed later in life. He started as an hydraulic engineer and obtained, together with a friend, a prize for new harbor works at Oslo (Christiania). But it then happened that he met Valdemar Poulsen at the Borch home. P. O. Pedersen was engaged to be married to Borch's sister-in-law, and this young lady was a friend of Valdemar Poulsen's wife. The two young men quickly became sympathetic and commenced a collaboration which continued for many years and greatly influenced P. O. Pedersen's lifework.

Valdemar Poulsen was occupied with the utilisation of his invention of the telgraphone, and the collaboration between the two men became closer and more intense when Valdemar Poulsen, about 1903–04, had progressed to the point of building the Poulsen arc-generator for procuring continuous oscillations—the invention which became so decisively important in the later phenomenal development of the radio art. P. O. Pedersen assisted his friend in the solution of the great problems presented. The two engineers supplemented each other exceptionally well, and Pedersen rather quickly turned from his original engineering interests; he commenced to devote himself wholly to electro-physics, electro-technics, etc. P. O. Pedersen continued his explorations of the arc-generator until 1920, and he was successful in proving that a theory originating from Gottingen on the manner of operation of the arc-generator was wrong.

### ***His Professorship—the First of its Kind in the World***

Denmark's Polytechnic Academy was the first anywhere to include electrical communication technique as an obligatory examination subject. Upon application from Director Hagemann, P. O. Pedersen accepted the post as lecturer in this subject, despite the fact that it was new to him. He himself had to arrange all the material of instruction. Here was one of the many occasions in his life when he felt the inspiration of managing the thing himself, and where the learning from the heath at Sig could be applied. In 1912 P. O. Pedersen was appointed Professor.

It would be difficult for a layman to expound the many and varied scientific contributions which made P. O. Pedersen's name famous internationally. One of his biographers, Dr. Povl Vinding, cites P. O. Pedersen's investigations of the electric arc and publication in 1927 of his great work, "Propagation of Radio Waves," in which, aided by his great mathematical and technical knowledge combined with insight into the science of meteorology, he made clear the apparently enigmatical properties of short radio waves. Here we are in a domain of daily life interest to everybody. "This book," Dr. Vinding states, "is now a classic and is known to every radio engineer in the world."

### ***The Leader and Rejuvenator of our Polytechnic Academy***

When in 1922 Hannover retired as Director of the Polytechnic Academy, P. O. Pedersen was appointed his successor. Since then he was re-elected at the expiration of each five-year period for which the appointment is in force. In July, 1941, he was again re-elected. Despite the fact that P. O. Pedersen was then 67 years old and would exceed the age limit requirement prior to the expiration of his period as Rector (as the office is now called), the Teachers' Council, nevertheless, desired his re-election. By Royal

Resolution his appointment was renewed until January 31st, 1947.

As Director and, subsequently, Rector of the Polytechnic Academy, Professor, Dr. Phil. P. O. Pedersen made an outstanding record and proved himself an eminent administrator. The development of youth always was one of his prime interests. Not least, of course, was he concerned with future engineers.

The great expansion of the Polytechnic Academy on the former military site at Østervoldgade was achieved under P. O. Pedersen's leadership and in accordance with his proposals.

### ***The Man and the Evaluation of His Work***

P. O. Pedersen was not only a scientist, but also, in marked degree, a realist. He was hearty in nature and possessed a fine mind. He was greatly interested in collaboration amongst scientists throughout the world and was seriously troubled when conditions impeded such collaboration. He thoroughly appreciated the importance of technique in progress. Hence he asserted so ardently that we were not only to keep our technical instruction on a level with that of other countries, but to surpass them where possible. He took the initiative some years ago in founding the Academy for Technical Sciences, of which he was President at the time of his death.

Many marks of honor were conferred on Professor P. O. Pedersen. He was Kommandør af 1 Grad (Commander of 1st Order) and Dannebrogsmænd. In 1913 he received the Medal for Merit in Gold for his work with Dr. Valdemar Poulsen in connection with wireless telegraphy. He held the Ørsted Medal and the Gold Medal from the American Institute of Radio Engineers. But he said about himself: "My task has been the modest one of studying and developing what others have initiated." Gentle and reserved in appearance, his was a personality that impelled respect. He was able to obtain results without applying strong measures.

# Telephone and Telegraph Statistics of the World

Compiled by Chief Statistician's Division, American Telephone and Telegraph Company

## Telephone Development of the World, by Countries January 1, 1940

COUNTRIES	NUMBER OF TELEPHONES			Per Cent of Total World	Telephones Per 100 Population
	Government Systems	Private Companies	Total		
<b>NORTH AMERICA:</b>					
United States.....	—	20,830,950	20,830,950	48.85%	15.85
Canada.....	212,619	1,184,653	1,397,272	3.28%	12.35
Central America.....	13,799	18,881	32,680	.08%	0.39
Mexico.....	1,337	174,263	175,600	.41%	0.88
West Indies—					
Cuba.....	610	56,462	57,072	.13%	1.33
Puerto Rico.....	531	16,227	16,758	.04%	0.90
Other Places in the West Indies.....	9,785	19,502	29,287	.07%	0.36
Other Places in North America.....	—	19,108	19,108	.04%	4.87
Total.....	238,681	22,320,046	22,558,727	52.90%	12.16
<b>SOUTH AMERICA:</b>					
Argentina.....	—	434,017	434,017	1.02%	3.30
Bolivia.....	—	2,611	2,611	.006%	0.08
Brazil.....	1,291	271,437	272,728	.64%	0.62
Chile.....	—	84,151	84,151	.20%	1.80
Colombia.....	8,900	32,787	41,687	.10%	0.47
Ecuador.....	4,600	3,050	7,650	.02%	0.27
Paraguay.....	—	3,658	3,658	.01%	0.38
Peru.....	—	32,286	32,286	.07%	0.48
Uruguay†.....	34,810	11,846	46,656	.11%	2.20
Venezuela.....	740	27,910	28,650	.07%	0.80
Other Places in South America†.....	3,018	—	3,018	.007%	0.54
Total.....	53,359	903,753	957,112	2.25%	1.05
<b>EUROPE:</b>					
Belgium.....	430,000	—	430,000	1.01%	5.12
Bulgaria.....	31,225	—	31,225	.07%	0.48
Denmark.....	17,813	441,944	459,757	1.08%	11.95
Eire#.....	45,513	—	45,513	.11%	1.54
Finland†.....	7,720	177,736	185,456	.43%	4.79
France†.....	1,589,595	—	1,589,595	3.73%	3.79
Germany*.....	4,226,504	—	4,226,504	9.91%	5.28
Great Britain and No. Ireland#.....	3,375,902	—	3,375,902	7.92%	7.06
Greece.....	5,967	48,437	54,404	.13%	0.76
Hungary.....	178,325	790	179,115	.42%	1.76
Italy*.....	—	650,000	650,000	1.52%	1.49
Latvia # #.....	83,650	—	83,650	.20%	4.20
Lithuania†.....	26,591	—	26,591	.06%	1.03
Netherlands.....	460,000	—	460,000	1.08%	5.22
Norway*.....	153,000	97,000	250,000	.59%	8.52
Portugal.....	52,506	72,872	125,378	.30%	0.94
Roumania.....	—	102,268	102,268	.24%	0.51
Russia†.....	1,272,500	—	1,272,500	2.98%	0.75
Spain.....	—	300,000	300,000	.70%	1.18
Sweden.....	863,102	1,697	864,799	2.03%	13.64
Switzerland.....	462,013	—	462,013	1.08%	10.99
Yugoslavia.....	72,000	—	72,000	.17%	0.45
Other Places in Europe.....	437,253	134,577	571,830	1.34%	1.11
Total.....	13,759,039	2,006,955	15,765,994	36.97%	2.74
<b>ASIA:</b>					
British India # #.....	31,878	51,500	83,378	.20%	0.02
China.....	45,000	115,000	160,000	.37%	0.04
Japan # #.....	1,367,958	—	1,367,958	3.21%	1.89
Other Places in Asia.....	211,129	99,034	310,163	.73%	0.15
Total.....	1,655,965	265,534	1,921,499	4.51%	0.18
<b>AFRICA:</b>					
Egypt.....	67,983	—	67,983	.16%	0.30
Union of South Africa#.....	220,288	—	220,288	.52%	2.13
Other Places in Africa.....	140,968	1,460	142,428	.33%	0.11
Total.....	429,239	1,460	430,699	1.01%	0.27
<b>OCEANIA:</b>					
Australia*.....	661,996	—	661,996	1.55%	9.51
Hawaii.....	—	37,154	37,154	.09%	8.78
Netherlands Indies.....	48,321	4,492	52,813	.12%	0.08
New Zealand#.....	217,869	—	217,869	.51%	13.28
Philippine Islands.....	2,410	30,386	32,796	.08%	0.20
Other Places in Oceania.....	5,213	380	5,593	.01%	0.25
Total.....	935,809	72,412	1,008,221	2.36%	1.03
<b>TOTAL WORLD.....</b>	<b>17,072,092</b>	<b>25,570,160</b>	<b>42,642,252§</b>	<b>100.00%</b>	<b>1.97</b>

† January 1, 1939. # # March 31, 1939. \* June 30, 1939. # March 31, 1940.

† U.S.S.R., including Siberia and Associated Republics, January 1, 1939.

§ Approximately 56% of this total are automatic or "dial" telephones, including 10,351,000 "dial" telephones in the United States.

Telephone and Telegraph Wire of the World, by Countries  
January 1, 1940

COUNTRIES	Service Operated By (See Note)	MILES OF TELEPHONE WIRE			MILES OF TELEGRAPH WIRE		
		Number of Miles	Per Cent of Total World	Per 100 Population	Number of Miles	Per Cent of Total World	Per 100 Population
<b>NORTH AMERICA:</b>							
United States.....	P.	95,150,000	53.12%	72.41	2,300,000	34.14%	1.75
Canada.....	P.G.	5,518,000	3.08%	48.77	367,000	5.45%	3.24
Central America.....	P.G.	62,000	.04%	0.75	23,000	.34%	0.28
Mexico.....	P.	688,000	.38%	3.47	100,000	1.49%	0.50
<b>West Indies:</b>							
Cuba.....	P.	283,000	.16%	6.60	11,000	.16%	0.26
Puerto Rico.....	P.	39,000	.02%	2.10	2,000	.03%	0.11
Other Places in West Indies.....	P.G.	116,000	.07%	1.44	8,000	.12%	0.10
Other Places in North America.....	P.	25,000	.01%	6.38	11,000	.16%	2.81
Total.....		101,881,000	56.88%	54.92	2,822,000	41.89%	1.52
<b>SOUTH AMERICA:</b>							
Argentina.....	P.	1,738,000	.97%	13.21	165,000	2.45%	1.25
Bolivia.....	P.	5,500	.003%	0.17	5,000	.07%	0.16
Brazil.....	P.	1,208,000	.68%	2.74	113,000	1.68%	0.26
Chile.....	P.	330,000	.18%	7.06	30,000	.45%	0.64
Colombia.....	P.G.	162,000	.09%	1.83	22,000	.33%	0.25
Ecuador.....	P.G.	10,000	.006%	0.35	5,000	.07%	0.17
Paraguay.....	P.	8,500	.005%	0.88	3,500	.05%	0.36
Peru.....	P.	133,000	.07%	2.00	13,000	.19%	0.20
Uruguay†.....	P.G.	160,000	.09%	7.54	8,000	.12%	0.38
Venezuela.....	P.	113,000	.06%	3.17	8,000	.12%	0.23
Other Places in South America.....	G.	6,000	.003%	1.08	500	.01%	0.09
Total.....		3,874,000	2.16%	4.27	373,000	5.54%	0.41
<b>EUROPE:</b>							
Belgium†.....	G.	2,000,000	1.12%	23.85	35,000	.52%	0.42
Bulgaria.....	G.	90,000	.05%	1.39	5,000	.07%	0.08
Denmark.....	P.	1,557,000	.87%	40.46	6,500	.10%	0.17
Eire#.....	G.	149,000	.08%	5.04	22,000	.33%	0.74
Finland†.....	P.	324,000	.18%	8.37	23,000	.34%	0.59
France†.....	G.	6,018,000	3.36%	14.35	317,000	4.70%	0.76
Germany##.....	G.	18,045,000	10.07%	22.63	237,000	3.52%	0.30
Great Britain and No. Ireland#.....	G.	16,300,000	9.10%	34.10	240,000	3.56%	0.50
Greece.....	P.G.	188,000	.11%	2.64	38,000	.56%	0.53
Hungary†.....	G.	468,000	.26%	4.63	53,000	.79%	0.52
Italy†.....	P.	1,736,000	.97%	4.01	278,000	4.13%	0.64
Latvia##.....	G.	327,000	.18%	16.43	4,500	.07%	0.23
Lithuania†.....	G.	82,000	.05%	3.18	2,500	.04%	0.10
Netherlands†.....	G.	1,385,000	.77%	15.87	9,000	.13%	0.10
Norway**.....	P.G.	738,000	.41%	25.19	22,000	.33%	0.75
Portugal.....	P.G.	199,000	.11%	2.58	18,000	.27%	0.23
Roumania.....	P.	431,000	.24%	2.15	48,000	.71%	0.24
Russia†.....	G.	2,000,000	1.12%	1.17	600,000	8.90%	0.35
Spain.....	P.	1,500,000	.84%	5.91	90,000	1.33%	0.35
Sweden.....	G.	3,358,000	1.87%	52.96	14,000	.21%	0.22
Switzerland.....	G.	1,630,000	.91%	38.76	13,000	.19%	0.31
Yugoslavia†.....	G.	153,000	.09%	0.98	57,000	.85%	0.36
Other Places in Europe.....	P.G.	1,933,000	1.08%	3.74	112,000	1.66%	0.22
Total.....		60,611,000	33.84%	10.55	2,244,500	33.31%	0.39
<b>ASIA:</b>							
British India ##.....	P.G.	460,000	.26%	0.13	366,000	5.43%	0.10
China.....	P.G.	600,000	.33%	0.14	100,000	1.48%	0.02
Japan #.....	G.	4,864,000	2.72%	6.73	233,000	3.46%	0.32
Other Places in Asia.....	P.G.	976,000	.54%	0.48	233,000	3.46%	0.11
Total.....		6,900,000	3.85%	0.65	932,000	13.83%	0.09
<b>AFRICA:</b>							
Egypt.....	G.	397,000	.25%	1.77	26,000	.39%	0.12
Union of South Africa#.....	G.	937,000	.52%	9.06	30,000	.45%	0.29
Other Places in Africa.....	G.	437,000	.22%	0.34	150,000	2.22%	0.12
Total.....		1,771,000	.99%	1.10	206,000	3.06%	0.13
<b>OCEANIA:</b>							
Australia*.....	G.	2,918,000	1.63%	41.92	108,000	1.60%	1.55
Hawaii.....	P.	125,000	.07%	29.55	0	.00%	0.00
Netherlands Indies.....	G.	262,000	.15%	0.37	20,000	.29%	0.03
New Zealand#.....	G.	670,000	.37%	40.83	18,000	.27%	1.10
Philippine Islands.....	P.	81,000	.05%	0.50	10,000	.15%	0.06
Other Places in Oceania.....	G.	17,000	.01%	0.75	4,000	.06%	0.18
Total.....		4,073,000	2.28%	4.14	160,000	2.37%	0.16
<b>TOTAL WORLD.....</b>		<b>179,110,000</b>	<b>100.00%</b>	<b>8.27</b>	<b>6,737,500</b>	<b>100.00%</b>	<b>0.31</b>

NOTE: Telegraph service is operated by Governments, except in the United States and Canada. In connection with telephone wire, P. indicates that the telephone service is wholly or predominantly operated by private companies. G. wholly or predominantly by the Government, and P.G. by both private companies and the Government. See preceding table.

\* June 30, 1939. # March 31, 1940. ## March 31, 1939.

† U.S.S.R., including Siberia and Associated Republics, January 1, 1939. \*\* June 30, 1938. † January 1, 1939.

## Telephone Development of Large Cities

### January 1, 1940

Country and City (or Exchange Area)	Estimated Population (City or Ex- change Area)	Number of Telephones	Telephones Per 100 Population	Country and City (or Exchange Area)	Estimated Population (City or Ex- change Area)	Number of Telephones	Telephones Per 100 Population
<b>ARGENTINA:</b>				<b>ITALY:†</b>			
Buenos Aires.....	3,400,000	268,956	7.91	Bologna.....	315,000	14,738	4.68
<b>AUSTRALIA:†</b>				Milan.....	1,206,000	109,168	9.05
Adelaide.....	321,000	35,935	11.19	Naples.....	920,000	31,373	3.41
Brisbane.....	326,000	35,805	10.98	Rome.....	1,280,000	122,442	9.57
Melbourne.....	1,036,000	135,518	13.08	Venice.....	284,000	10,209	3.59
Sydney.....	1,289,000	159,825	12.40	<b>JAPAN:##</b>			
<b>BELGIUM:††</b>				Kobe.....	989,000	46,265	4.68
Antwerp.....	560,000	48,696	8.70	Kyoto.....	1,160,000	51,457	4.44
Brussels.....	991,000	127,639	12.88	Nagoya.....	1,224,000	46,122	3.77
Liege.....	433,000	29,885	6.90	Osaka.....	3,321,000	176,697	5.32
<b>BRAZIL:</b>				Tokio.....	6,458,000	290,510	4.50
Rio de Janeiro.....	1,940,000	103,797	5.35	<b>LATVIA:##</b>			
<b>CANADA:</b>				Riga.....	391,000	31,795	8.13
Montreal.....	1,095,000	187,158	17.09	<b>LITHUANIA:†</b>			
Ottawa.....	203,200	40,829	20.09	Kaunas.....	110,000	10,124	9.20
Toronto.....	807,900	214,782	26.59	<b>MEXICO:</b>			
Vancouver.....	292,000	77,362	26.49	Mexico City.....	1,450,000	95,673	6.60
<b>CHILE:</b>				<b>NETHERLANDS:†</b>			
Santiago.....	860,000	44,487	5.17	Amsterdam.....	794,000	67,927	8.56
<b>CHINA:</b>				Haarlem.....	174,000	14,474	8.32
Hong Kong.....	850,000	22,606	2.66	Rotterdam.....	635,000	44,145	6.95
Shanghai.....	3,750,000	79,554	2.12	The Hague.....	540,000	57,635	10.67
<b>CUBA:</b>				<b>NEW ZEALAND:</b>			
Havana.....	725,000	45,651	6.30	Auckland.....	215,000	33,012	15.35
<b>DENMARK:</b>				Wellington.....	160,000	32,083	20.05
Copenhagen.....	900,000	220,202	24.47	<b>NORWAY:*</b>			
<b>EIRE:#</b>				Oslo.....	417,000	73,786	17.69
Dublin.....	488,000	24,893	5.10	<b>PHILIPPINE ISLANDS:</b>			
<b>FINLAND:†</b>				Manila.....	770,000	25,715	3.34
Helsinki.....	305,000	51,328	16.83	<b>PORTUGAL:</b>			
<b>FRANCE:†</b>				Lisbon.....	710,000	33,902	4.78
Bordeaux.....	260,000	23,311	8.97	<b>ROUMANIA:</b>			
Lille.....	200,000	18,566	9.28	Bucharest.....	910,000	50,347	5.53
Lyon.....	650,000	39,369	6.06	<b>SWEDEN:</b>			
Marseille.....	915,000	38,801	4.24	Göteborg.....	281,000	63,585	22.63
Paris.....	2,830,000	437,139	15.45	Malmö.....	155,000	29,862	19.27
<b>GERMANY:##</b>				Stockholm.....	460,000	184,722	40.16
Berlin.....	4,339,000	599,911	13.83	<b>SWITZERLAND:</b>			
Breslau.....	623,000	48,203	7.74	Basel.....	165,000	38,916	23.59
Cologne.....	771,000	75,393	9.78	Bern.....	125,000	31,662	25.33
Dresden.....	821,000	75,569	9.21	Geneva.....	125,000	30,950	24.76
Dortmund.....	585,000	28,945	4.95	Zurich.....	320,000	73,914	23.10
Essen.....	672,000	36,743	5.47	<b>URUGUAY:†</b>			
Frankfort-on-Main.....	647,000	68,112	10.52	Montevideo.....	705,000	33,447	4.74
Hamburg-Altona.....	1,724,000	188,861	10.96	<b>UNITED STATES:</b>			
Leipzig.....	767,000	73,959	9.64	(See Note)			
Munich.....	866,000	97,215	11.23	New York.....	7,442,000	1,669,904	22.44
Vienna.....	1,874,000	180,165	9.61	Chicago.....	3,390,000	997,174	29.42
<b>GREAT BRITAIN AND NO. IRELAND:##</b>				Los Angeles.....	1,444,000	456,564	31.62
Belfast.....	415,000	23,336	5.62	Cleveland.....	1,153,900	264,560	22.93
Birmingham.....	1,259,000	79,847	6.34	Total 6 Exchange Areas with over 1,000,000 Population.....	17,245,900	4,191,428	24.30
Bristol.....	450,000	31,376	6.97	Milwaukee.....	748,700	162,758	21.74
Edinburgh.....	465,000	47,066	10.12	San Francisco.....	648,800	290,990	44.85
Glasgow.....	1,150,000	72,359	6.29	Washington.....	654,000	254,042	38.84
Hull#.....	361,000	25,354	7.02	Minneapolis.....	541,000	155,362	28.72
Leeds.....	568,000	36,825	6.48	Total 13 Exchange Areas with 500,000 to 1,000,000 Population.....	8,922,900	2,265,558	25.39
Liverpool.....	1,265,000	79,228	6.26	Seattle.....	422,000	128,613	30.48
London— (City and County of London).....	4,028,000	717,468	17.81	Denver.....	321,500	108,244	33.67
Manchester.....	1,015,000	68,191	6.72	Omaha.....	246,600	68,452	27.76
Newcastle.....	482,000	28,167	5.84	Hartford.....	242,700	67,685	27.89
Sheffield.....	522,000	28,776	5.51	Total 30 Exchange Areas with 200,000 to 500,000 Population.....	9,503,500	2,210,282	23.26
<b>HAWAII:</b>				Total 49 Exchange Areas with over 200,000 Population.....	35,672,300	8,667,268	24.30
Honolulu.....	179,000	25,408	14.19				
<b>HUNGARY:†</b>							
Budapest.....	1,635,000	107,906	6.60				
Szeged.....	141,000	2,635	1.87				

NOTE: There are shown, for purposes of comparison with cities in other countries, the total development of all cities in the United States in certain population groups, and the development of certain representative cities within each of such groups.

\* June 30, 1939. ## March 31, 1939. † March 31, 1940. †† February 28, 1938. ‡ January 1, 1939.

≠ International Settlement and French Concession.

Telephone Conversations and Telegrams

YEAR 1939

COUNTRY	Number of Telephone Conversations	Number of Telegrams	Total Number of Wire Communications	PER CENT OF TOTAL WIRE COMMUNICATIONS		WIRE COMMUNICATIONS PER CAPITA		Total
				Telephone Conversations	Telegrams	Telephone Conversations	Telegrams	
Australia	637,000,000	17,998,000	654,998,000	97.3	2.7	91.9	2.6	94.5
Belgium†	320,000,000	5,900,000	325,900,000	98.2	1.8	38.5	0.7	39.2
Canada	2,774,000,000	11,629,000	2,785,629,000	99.6	0.4	246.3	1.0	247.3
Denmark	726,000,000	1,748,000	727,748,000	99.8	0.2	189.5	0.5	190.0
Finland†	309,000,000	811,000	309,811,000	99.7	0.3	80.3	0.2	80.5
France†	972,000,000	27,524,000	999,524,000	97.2	2.8	23.2	0.6	23.8
Germany†	3,640,000,000	21,701,000	3,661,701,000	99.4	0.6	45.8	0.3	46.1
Gt. Britain and Northern Ireland	2,255,000,000	59,484,000	2,314,484,000	97.4	2.6	47.4	1.3	48.7
Hungary†	187,000,000	2,439,000	189,439,000	98.7	1.3	19.5	0.3	19.8
Japan†	5,339,000,000	68,475,000	5,407,475,000	98.7	1.3	74.2	0.9	75.1
Netherlands†	468,000,000	3,588,000	471,588,000	99.2	0.8	53.9	0.4	54.3
Norway†	281,000,000	3,489,000	284,489,000	98.8	1.2	96.1	1.2	97.3
Sweden	1,195,000,000	4,641,000	1,199,641,000	99.6	0.4	189.0	0.7	189.7
Switzerland	335,000,000	2,039,000	337,039,000	99.4	0.6	79.8	0.5	80.3
Union of South Africa	317,000,000	6,863,000	323,863,000	97.9	2.1	30.9	0.7	31.6
United States	30,300,000,000	195,000,000	30,495,000,000	99.4	0.6	231.5	1.5	233.0

NOTE: Telephone conversations represent completed local and toll or long distance messages. Telegrams include inland and outgoing international messages.  
 † Year 1938.

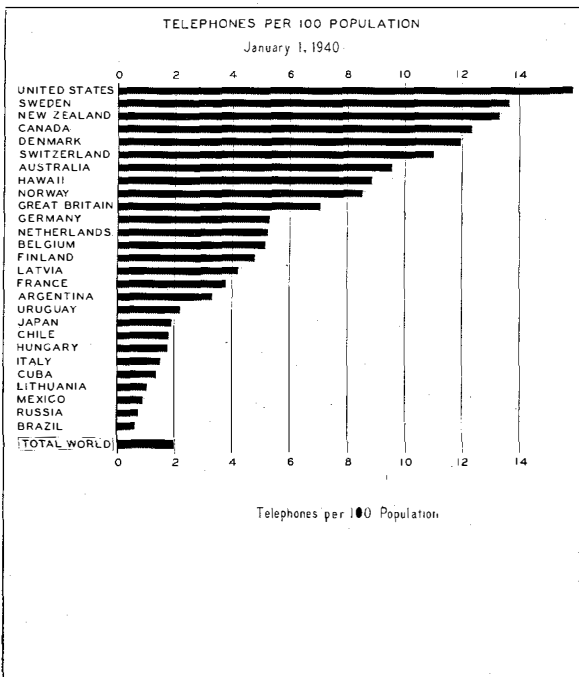
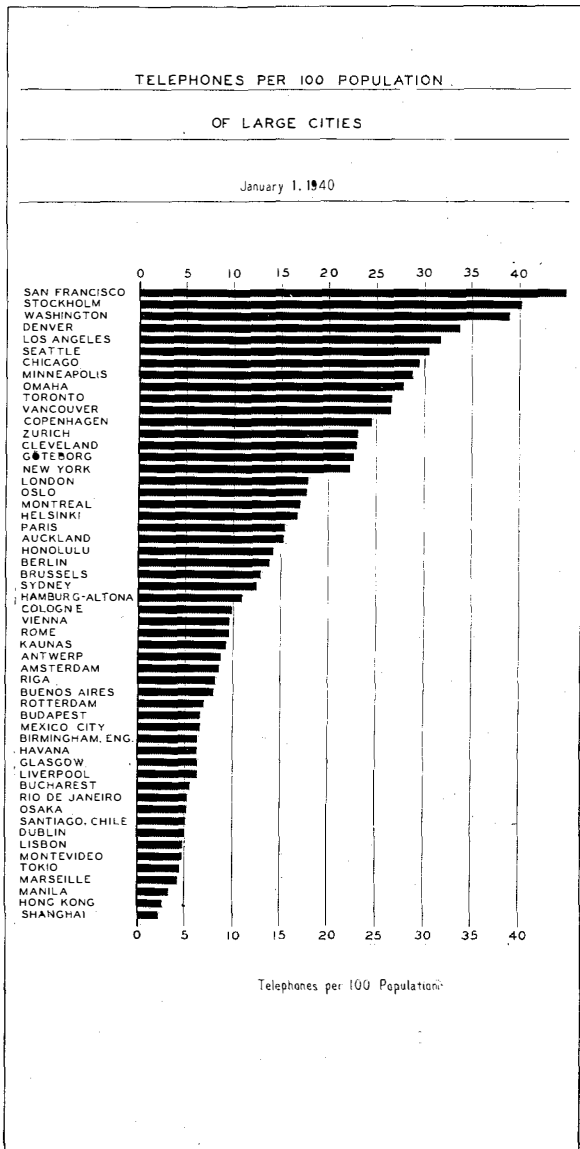
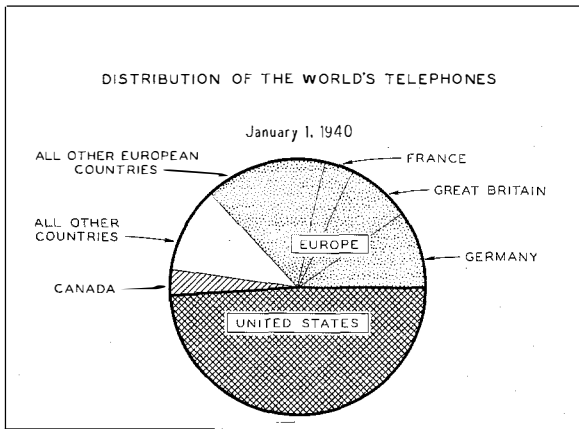



## Recent Telecommunications Developments

**C**OLUMBIA BROADCASTING SYSTEM'S NEW 50 KW BROADCASTING STATION WABC.—With a special inaugural program, the new broadcaster was placed in service October 18, 1941. The station is uniquely located on a built-up island in Long Island Sound just off New Rochelle, New York, to provide optimum coverage of Metropolitan New York. The equipment was designed and constructed to CBS specifications by the Federal Telegraph unit of the International Telephone & Radio Manufacturing Corporation.

The main transmitter provides for 50 kw output with an auxiliary 5 kw transmitter arranged for automatic cutover in case of failure of the main equipment. Performance of these equipments represents a new high in the broadcasting field.

• • •

**I**TG 200 TRANSMITTER FOR FIXED STATION USE.—This new International Telephone & Radio Manufacturing Corporation transmitter has a nominal carrier power rating of 200 watts and is arranged for continuous frequency coverage from 2 to 20 mc (150 to 15 meters). Facilities are also included for four crystal frequencies. Frequency change is accomplished entirely from front panel controls. The specially designed electric oscillator provides excellent frequency stability for CW, MCW and telephone emission. The unit operates from a 220 volt, 50/60 cycle, single phase power source.

• • •

**N**EW AIRCRAFT TRANSMITTER.—The International Telephone & Radio Manufacturing Corporation is now manufacturing the ITA 100 transmitter, an electric oscillator type unit providing continuously variable frequency coverage from 2000 kc to 16,000 kc and 250 kc to 600 kc, with a carrier power output to the antenna of 100 watts on the high, and 50 watts on the low, frequency range.

The self-contained class-B high level modulator provides for telephonic and MCW operation in addition to CW. Two individual exciter units provide a frequency stability of .05% over the

wide frequency range. A specially designed output circuit enables the transmitter to operate into a fixed or trailing wire antenna.

The transmitter is wholly self-contained in a shock mounted cabinet 12½" high, 18" long and 9½" deep. High voltage is supplied by an external dynamotor unit operating from 24 volts d.c. Alternatively, the unit may be supplied to operate from 12 volts d.c.

• • •

**P**RECISION WAVEMETER.—A portable, battery operated, absorption type wavemeter has been developed by the International Telephone & Radio Manufacturing Corporation to satisfy a definite demand in the field of frequency measurement. The instrument consists of a tuned circuit and a vacuum tube voltmeter-type of resonance indicator. Seven plug-in coils in bakelite cases are utilized to cover frequencies from 50 kc to 50 mc. Its accuracy of calibration at any frequency is better than 0.25%.

• • •

**A**USTRALIAN DEVELOPMENTS IN AUTOMATIC TELEPHONY.—Telephone development in the suburbs of capital cities is being met by the Australian Commonwealth Government in a novel manner. Small satellite exchanges of 600 to 900 lines capacity will be installed in buildings of the "double garage" type on sites subsequently to be occupied by more elaborate branch exchanges. Thus, immediate savings in line plant are achieved without heavy investment in buildings; and, when development justifies provision of the branch exchanges, the initial equipment can be utilized in its original location, or elsewhere, inasmuch as it is of standard construction.

Standard Telephones and Cables Pty. Limited has received an order for ten initial exchanges for installation in Sydney, Melbourne and Adelaide. The equipment will be the British Post Office 2000 type step-by-step system employing line finders and will be manufactured partly in London and partly in Sydney. The contract is the largest placed by the Commonwealth within the last five years for this type of equipment.