

ELECTRICAL COMMUNICATION

OCTOBER

No. 2

1937

VOL. 16



ELECTRICAL COMMUNICATION

A Journal of Progress in the
Telephone, Telegraph and Radio Art

H. T. KOHLHAAS, EDITOR

EDITORIAL BOARD

E. A. Brofos G. Deakin E. M. Deloraine P. E. Erikson F. Gill
W. Hatton W. E. Leigh R. A. Mack Kenneth E. Stockton C. E. Strong

Issued Quarterly by the

International Standard Electric Corporation

67 BROAD STREET, NEW YORK, N.Y., U.S.A.

Volume XVI

OCTOBER, 1937

Number 2

CONTENTS

	PAGE
THE 1937 PARIS EXHIBITION.....	97
<i>By P. Quéffélec</i>	
A NEW APPARATUS FOR DEMONSTRATING DIFFRACTION OF ELECTRONS..	103
<i>By J. J. Trillat</i>	
SOME ROTARY TRAFFIC SWITCHING METHODS.....	108
<i>By J. Kruithof</i>	
NO. 7-D ROTARY AUTOMATIC P.B.X. INSTALLED IN THE ADMINISTRA- TION BUILDING OF THE DANISH NEWSPAPER "POLITIKEN".....	126
<i>By K. A. Haldvig</i>	
BRISTOL-PLYMOUTH 12-CHANNEL CARRIER SYSTEM	131
PICTURE TRANSMISSION USING "TIME MODULATION".....	144
<i>By Masatsugu Kobayashi</i>	
SUPERHETERODYNE RECEPTION OF MICRO-RAYS.....	153
<i>By A. H. Reeves and E. H. Ulrich</i>	
THE REACTIVE FILTER AND ITS APPLICATION TO WAVEFORM ANALYSIS ..	158
<i>By R. M. Barnard</i>	
THE APPLICATION OF STYRENE TO H.T. CABLE SYSTEMS.....	174
<i>By T. R. Scott and J. K. Webb</i>	
RECENT TELECOMMUNICATION DEVELOPMENTS OF INTEREST.....	180

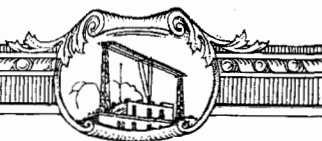



New Brussels Broadcasting House of the Institut National de Radiodiffusion. Provision is made initially for 24 different programme sources, including 17 studios (one is the largest thus far provided anywhere), 2 mixing positions and 5 recording and reproducing positions. The entire radio and speech input equipment as well as the telephone and fire alarm equipment will be furnished by the Bell Telephone Manufacturing Company, Antwerp.

The 1937 Paris Exhibition

By P. QUÉFFÉLÉAN,

Le Matériel Téléphonique, Paris, France

After a short appreciation of the Exhibition, a description is given of the equipment installed by Le Matériel Téléphonique. Brief descriptions of the exhibits follow. Reference is made to the part played by Le Matériel Téléphonique in several scientific demonstrations carried out at the Palace of Discovery.

THE 1937 Paris Exhibition affords an opportunity of making, figuratively speaking, a voyage around the world and of viewing outstanding achievements of modern art and science. Erected along both banks of the Seine, the Exhibition buildings afford a unique panorama from the numerous speedy boats plying busily from one end of the grounds to the other.

Not only is the visitor's attention attracted by the most modern architectural designs, but even the least scientifically minded is impressed by demonstrations bringing within the comprehension of the layman some of the most abstract principles of science.

Whether a visit be made in the daytime when the beauties of the extensive gardens and exotic plantings can be best appreciated, or at night when the exquisite lines of many of the buildings are accentuated by floodlighting and a perfect blending of water, sound and pyrotechnical displays takes place,—the prospect produces a never to be forgotten effect.

No attempt can be made to describe in this article so imposing a spectacle as the Exhibition as a whole. It is felt, however, that a description of the varied contributions of Le Matériel Téléphonique to the Exhibition will be of interest.

Automatic Recording of Attendance

Immediately upon entering the Exhibition Grounds the visitor's presence is automatically recorded by means of counting devices actuated by photoelectric cells.

The importance of such an installation can be judged by the fact that the Exhibition, in-

cluding the Maillot and Kellermann annexes, is served by 35 entrances with 20 gates at the most crowded entrance (Trocadéro) and a total of 180 gates. The passage of a single person through any entrance gate is immediately indicated and metered at the central station located at the foot of the Eiffel Tower.

The gates installed on this principle are characterised by their simplicity. Nothing interferes with the progress of the visitor who is not subjected to the annoyance of a turnstile ; neither does anything interfere with the rapid progress of the public through the exits in case of emergency (Fig. 1).

Visitors in their passage through the gates interrupt the light beam from a 5-watt projector impinging on a photoelectric cell of the blocking-layer type. The light from the projector is rendered practically invisible by the interposition of a blue filter.

As soon as a visitor intercepts the light beam, a galvanometric relay causes an eleven-position step-by-step switch to advance one step. When the latter has reached its tenth position, it automatically steps to the eleventh position, sending an impulse to the centralised totalisator meter in the control building. The circuit arrangements prevent the sending of simultaneous, interfering impulses.

When a meter has received 10 impulses (100 visitors), a finder of the Rotary type sends to the general totalisator meter an impulse, which records the total number of visitors to the Exhibition.

The entire installation is operated by rectified alternating current and no storage batteries are employed.

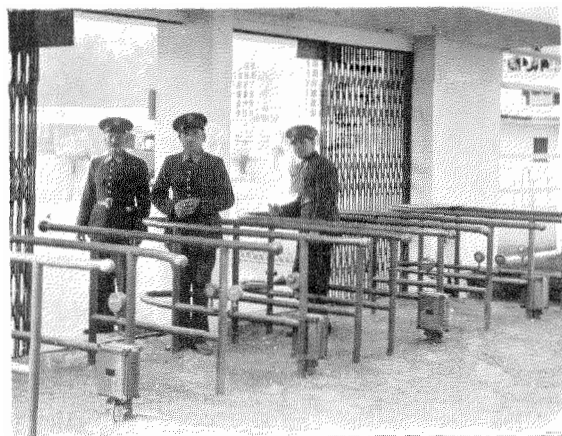

Fig. 1—Entrance Gate Showing Photoelectric Cells for Recording Attendance.

To enhance interest in this installation, a totalisator tower thirty metres high informs the public of the total number of admissions to the Exhibition since it was opened; and, further, conveys an approximation of the rate at which arrivals are taking place at the moment when the visitor himself is in the Exhibition (Fig. 2). For this purpose, on each side of this tower, a neon tube 15 metres high, which is electrically divided into fifty parts, is utilised.

When 200 visitors have entered the Exhibition, a 30 centimetre section of the neon tube is lighted, so that it becomes completely illuminated when 10 000 visitors have entered. An eight-digit meter, 5 metres long, placed at the foot of the tower, then advances the 10 000 digit and the neon tube is extinguished.

Sound Effects in the Promenades and Gardens

The sound effects in the Regional Centre and the Trades Centre are produced by L.M.T. equipment. Each of the installations includes a control unit with two 550-watt modulated amplifiers and 50 loudspeakers of the electrodynamic, permanent magnet type.

Similar installations of lower power provide the sound effects for the Radio Palace, the Pavilion of Safety, the Restaurant in the Luxemburg Pavilion and in the Press Pavilion.

Sound Effects of the "Fêtes de la Seine"

The architects, Messrs. Beaudouin and Lods,

conceived a "fairlylike" programme in which they combine the various effects of water, smoke, light and sound, in order to obtain various settings and impressions in accordance with a carefully studied fête programme.

These "fêtes" are veritable symphonies of light and water. The accompanying music was specially written by such outstanding composers as Florent Schmitt, Jacques Ibert, Darius Milhaud, Pierre Vellone, Arthur Honegger, Maurice Yvain, Ingelbrecht, Louis Auber.

Eleven pontoons, each containing four loudspeakers with special horns (Fig. 3), were constructed. Each loudspeaker pontoon is supplied by a satellite station comprising two amplifiers with a power of 60 watts. These stations, in turn, are supplied from the Floating Studio where all the control units are centralised.

Aside from the novelty of the eleven loudspeaker pontoons moored in the Seine, the main interest of this installation is in the Floating Studio (Fig. 3) where a complete supervisory system permits the conductor of the "Fête" to control the tone and colour of the programmes.



Fig. 2—Totalisator Tower. When this Photograph was Taken (August 1937) a Total of 14 830 000 Persons had Visited the Exhibition.

Means of Transport

The transport of visitors at the Exhibition is effected either by boats on the Seine or by electrically operated trains and taxis.

L.M.T. was entrusted, in the one case, with ensuring telephone connections and the control system; and, in the other, with supplying the necessary rectifiers for daily charging the accumulator batteries.

Telephone Installation on Landing Stages and River Boats

An automatic switchboard is installed on the "Concorde" wharf. It serves twelve lines connected to the ten boat-landing stations, to the garage and to the Exhibition switchboard. A conference circuit is also provided for communication from the central station to the various landing stages.

Control Equipment on Landing Stages and River Boats

Each pontoon is equipped with a signal composed of two lights—a green light normally lighted, and a red light.

In case, for any reason, a landing stage becomes unavailable for use, the depression of a key extinguishes the green light and lights the red light on the preceding landing stage. Indication is thus given to the pilot concerned that he must not continue his route.

Electric Trains and Taxis

In addition to the fleet of fast river boats, forty-five electric trains and thirty taxis circulate to all points and provide visitors with a speedy, silent and clean means of transportation. Each train contains five coaches and an electric tractor equipped with 264 ampere-hour storage batteries. Current for propelling the taxis is obtained from 240 ampere-hour storage batteries.

The storage battery capacities are sufficient for a distance of approximately 50 kilometres. When it is considered that, on the average, each vehicle covers this distance in a period of four hours, it will readily be understood that the problem of charging the batteries is somewhat difficult in view of the fact that those on the vehicles must be maintained and an equal

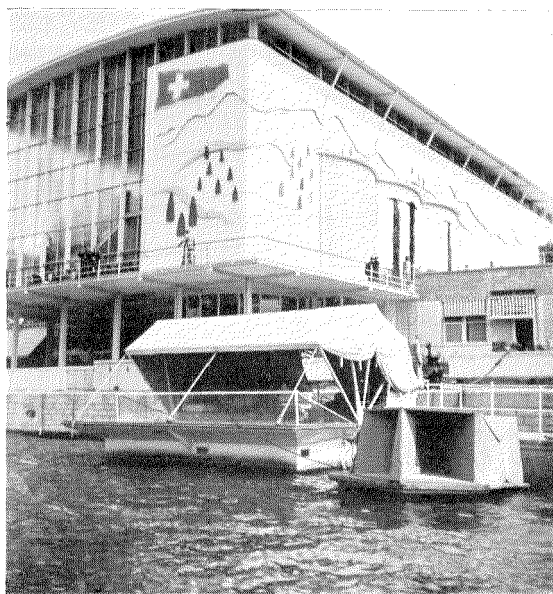

Fig. 3—View Showing One of the Loudspeaker Pontoons and the Floating Studio.

quantity of spare, charged batteries must be available at all times.

The recharging stations planned and constructed by L.M.T. comprise 65 "Selenofer" rectifiers in use night and day.

DEMONSTRATION EXHIBITS

The above-described installations are more or less intimately connected with the functioning of the Exhibition as a whole. In addition, working models and equipment displayed in the various buildings give a general idea of L.M.T. activities in a large number of fields. The following is a brief outline of these exhibits, which have evoked considerable interest largely by reason of the fact that every effort has been made to display working models which, in most cases, can be operated by the visitors themselves.

Pavilion of Tourism

In this building a model for demonstrating the operation of photoelectric devices for road and street signalling, manufactured by L.M.T., is installed. A knob placed within reach of the visitor starts its operation: four miniature automobiles begin to move along two roads passing through a miniature countryside; miniature signals at the cross-roads flash yellow

until one of the cars approaches this point when, by means of a photoelectric cell, the light controlling the traffic on that road changes from yellow to green. The control light for the other road then changes to red and cars reaching the cross-roads on it receive the stop signal. Once the first car has cleared the cross-roads, the other cars are allowed to proceed. The same process is repeated as other cars reach the cross-roads.

Safety Pavilion

In this pavilion, located outside the Exhibition proper, is displayed special equipment for fire protection: carbonic acid gas, foam, pulverised water and powder apparatus, all manufactured by L.M.T. (Fig. 4).

A model shows the façade of a factory and its porter's lodge. When a visitor presses a button, a fire breaks out in the factory. At the same time a Garrison detector cable (enlarged ten times) is subjected to the heat of a small electric stove, demonstrating that a rise in temperature due to the fire causes the operation of the detector cable within a few seconds. Luminous alarms appear simultaneously at the porter's lodge, while the extinction of the fire is effected by a battery of three flasks of carbonic gas. These flasks are shown in cross-section so that their operation is easily followed.

Mercantile Marine Pavilion

In collaboration with the "Etablissements

Phillips & Pain" and under the patronage of the Compagnie Générale Transatlantique, L.M.T. reconstructed in this pavilion the safety centre of the liner *Normandie*.¹ This centre comprises the smoke detector, fire detectors and alarms, as well as the system showing by visual signals the progress of the watchmen as they make their rounds.

Radio Palace

In this Palace, L.M.T. radio apparatus, equipment for aerial navigation by means of radio and radio transmitter tubes (Fig. 5) are exhibited.

The stand comprises a unique apparatus consisting of an indirect lighting fixture containing a television receiver, an all-wave receiver, a gramophone pick-up with turntable and space for a collection of gramophone records (Fig. 5).

The operation of the R.C.5 Automatic Radio Compass is shown graphically (Fig. 5). A miniature aeroplane takes off after having obtained by radio or teleprinter full meteorological data. While in flight, by means of the automatic radio compass, bearings are taken on radio stations and a course is set for the landing field at destination.

At about 200 km from the latter, bearings are requested by radio from the R.C.6 Radio-

¹ "The Telephone and Signalling Systems on SS. *Normandie*," by S. V. C. Scruby, *Electrical Communication*, April, 1936.

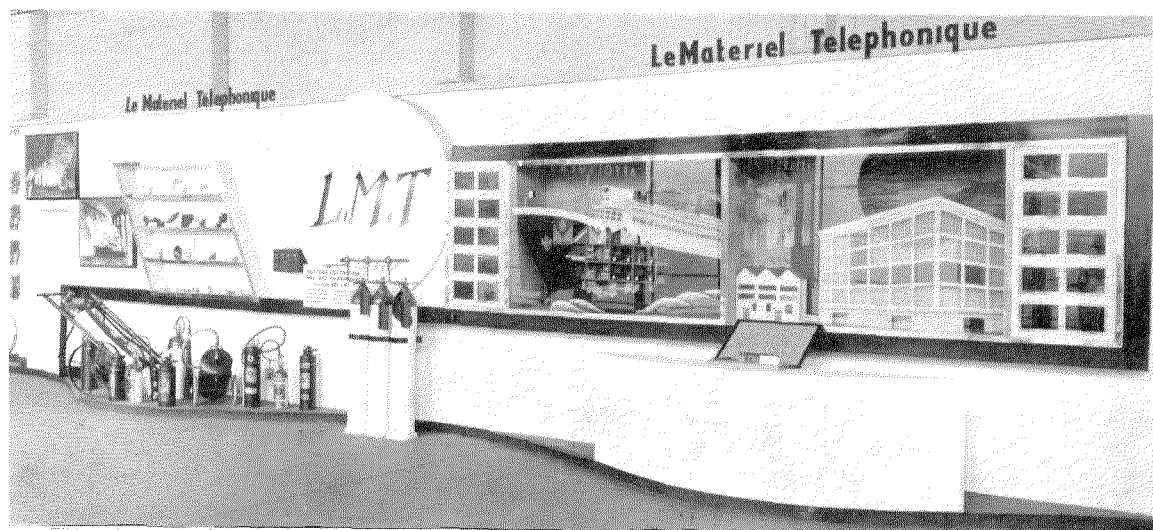

Fig. 4—Exhibit in the Safety Pavilion.

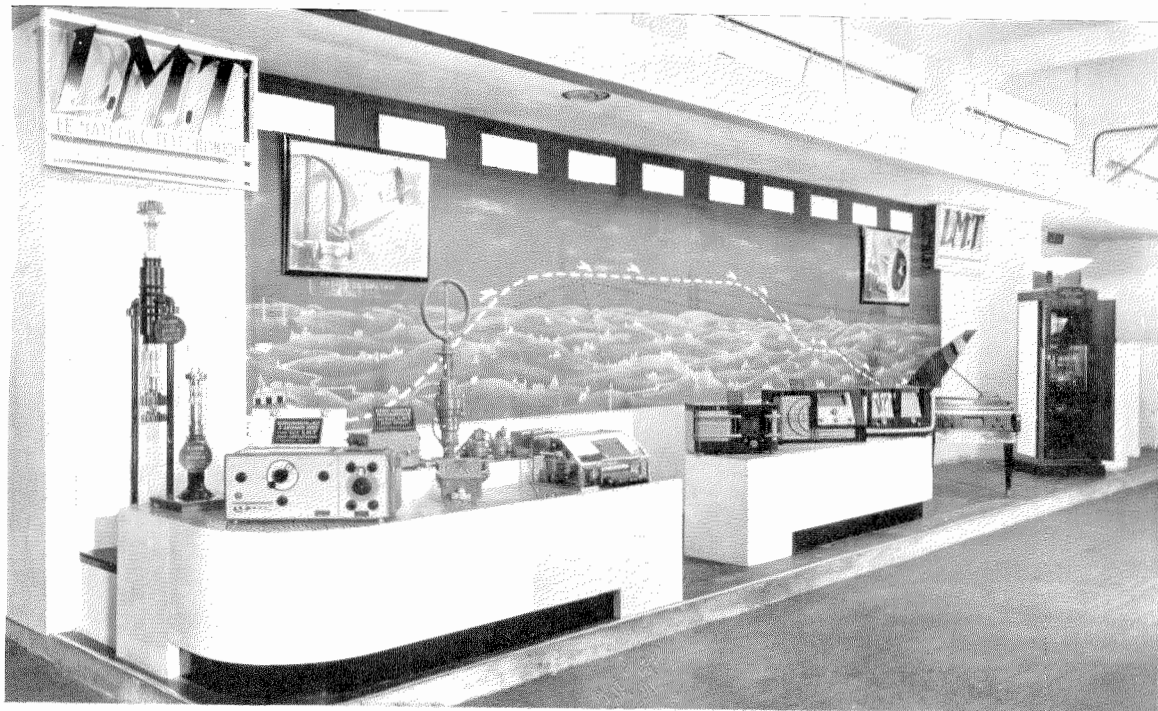

Fig. 5—Exhibit in the Radio Palace.

goniometer at the aerodrome. The aeroplane finally arrives in the zone of the landing radio beacon. The landing path is "marked" on one side by dashes, and on the other by dots. The barometric pressure is obtained by radio in order to correct the altimeter, the aeroplane keeping at an altitude of 200 metres.

When passing the approach marker beacon, a characteristic signal is heard and then the glide path is followed. On passing above the boundary of the aerodrome, the signal of the landing marker beacon is heard and a landing is made. While the aeroplane makes its journey from one end to the other of the panel, all the positions corresponding to the various phases of the aeroplane trip appear successively and automatically in the form of luminous signals: path of the aeroplane, radio bearing, signals of the radio beacon and the marker beacons.

Included in the exhibit is much of the field equipment involved: in particular, the R.C.5 Automatic Radio Compass, the receiver for the R.C.6 Radiogoniometer and the teleprinters. A 100 kW transmitter tube is also shown.

Aviation Palace

At the Palace of the Air Ministry, L.M.T. is

demonstrating in the Gallery of Aerial Navigation a working model of an automatic radio compass. This compass, in use in the French Army, permits the direction of any radio station within receiving range to be obtained automatically from an aeroplane in flight.²

Palace of Discovery

Assembled in the Grand Palais, re-named for the period of the Exhibition, Palace of Discovery, is a striking collection of scientific instruments and demonstration equipment.

In the meteorological section are displayed a precision lux-meter and a specially designed model of the same apparatus of spectacular dimensions, both of L.M.T. manufacture.

Vacuum tubes constructed by L.M.T. at the request of Professor Trillat of the University of Besançon are employed in a most interesting equipment demonstrating the molecular construction of metals.³

Crystal oscillators were used by Professor

² "The Automatic Radio Compass and Its Applications to Aerial Navigation," by H. Busignies, *Electrical Communication*, October, 1936.

³ A description of this exhibit is given elsewhere in this issue of *Electrical Communication*.

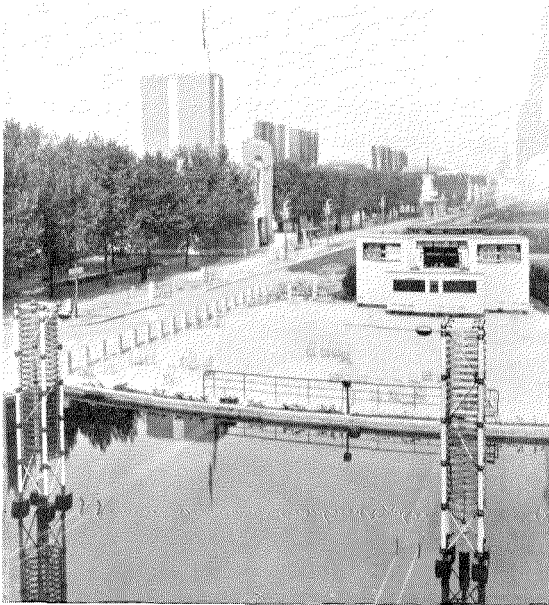

Fig. 6—Electrodes Between which a High Frequency Spark is Produced.

Tournier of the École de Physique et Chimie of Paris, to demonstrate the synthesis of sounds. These oscillators were supplied by Les Laboratoires, Le Matériel Téléphonique.

Professor R. Lucas of the University of Paris shows an experiment illustrating the remarkable accuracy which can be obtained in controlling oscillations by means of piezoelectric quartz. The crystals and oscillators used were loaned by Les Laboratoires, Le Matériel Téléphonique.

PALACE OF LIGHT

Surmounted by an immensely powerful light-house (1 000 000 candle power), the Palace of Light is one of the most prominent buildings of the Exhibition. Immediately in front of the

entrance the Paris Electric Light Company (Compagnie Parisienne de Distribution d'Electricité), in a reflecting pool, has erected two pylons supporting two electrodes between which is produced a high frequency electric spark (Fig. 6). This installation is based on studies carried out in 1936 by Les Laboratoires L.M.T. which furnished the 100 kW vacuum tubes used in producing the spark, 23 feet in length.

EIFFEL TOWER TELEVISION

No description of the 1937 Paris Exhibition would be complete without mention of the Eiffel Tower. Although constructed for the Exhibition of 1899 and therefore nearly fifty years old, this work of genius is one of the features of an Exhibition devoted to all that is new in this progressive age. Incongruous as it might seem the Eiffel Tower, the oldest building in the Exhibition, plays an important rôle in one of the most recent developments of science, inasmuch as on its summit there is mounted the antenna of one of the most powerful television transmitters in the world. This television transmitter, which is installed at the base of the Eiffel Tower and which was ordered by the French P.T.T. from Le Matériel Téléphonique, will be fully described in a subsequent issue of *Electrical Communication*.

ACKNOWLEDGMENT

Because of the diverse fields covered in this article, it was necessary for the author to call on others for certain of the facts presented. Acknowledgment for their collaboration is due to Messrs. P. Gares, M. Lucas, G. Meunier and V. Poret.

A New Apparatus for Demonstrating Diffraction of Electrons

By J. J. TRILLAT,

Professor of Physics at the University of Besançon (France)

The Principle of the Diffraction of Electrons

ACCORDING to the theories of Louis de Broglie, which gained the Nobel Physics Prize for their author, it is known that every moving material particle is accompanied by a wave which occupies all the space peculiar to it. Consequently, every material particle having a certain velocity must be considered as linked with an "associated" wave system, the wavelength being given by the basic formula of Wave Mechanics :

$$\lambda = \frac{h}{m_0 v}$$

where h = Planck's constant = 6.55×10^{-27} ergs per second,
 m_0 = mass of particle at rest,
 v = its velocity.

This formula applies for velocities which are small compared to the velocity of light ; for velocities greater than 40 to 50 thousand km per second, a relativity correction is required and the formula becomes :

$$\lambda = \frac{h}{m_0 v} \sqrt{1 - \frac{v^2}{c^2}}$$

where c = velocity of light ;
 or, as a function of the accelerating voltage V :

$$\lambda = \sqrt{\frac{150}{V}} \cdot \frac{1}{\sqrt{1 + 9.78 \times 10^{-7} V}} \text{ \AA.}$$

These relations indicate that the associated wavelength decreases as the velocity and mass of the particle increase.

The particles generally utilised are electrons which can readily be obtained from many sources ; for example, a metallic filament made incandescent in a vacuum. In order that the electrons may be extracted from the filament, it is further necessary that the latter be arranged

in an electro-static field and given a negative potential with respect to its surroundings. In the apparatus described below, the applied constant potential is of the order of 40 to 50 kV. Under these conditions, the wavelengths

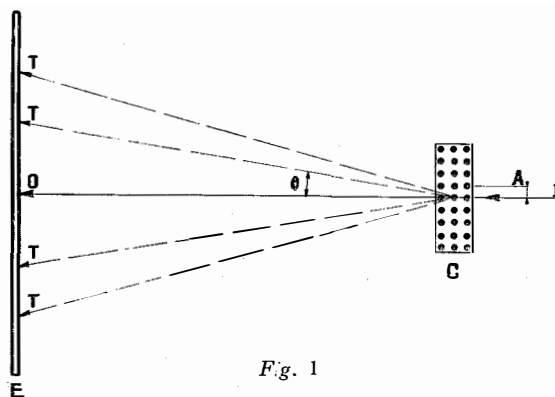

Fig. 1

associated with the monocinetic electrons thus accelerated, are between 0.06 and 0.05 Angström units ($1 \text{ \AA} = 10^{-8} \text{ cm}$).

The conception of the "associated waves," as is generally known, has led to the development of the theory of Wave Mechanics according to which the optics of the associated wave govern the mechanics of the "point." It is therefore necessary to recognise the fact, at first sight paradoxical, that a corpuscle or an electron in motion is accompanied by a wave, and consequently the phenomena normally produced by waves, such as interference and diffraction, must also be produced in some indirect manner by such particles in movement. It is thereby possible to unite in a harmonious whole the corpuscular and undulatory theories of light, as well as to account for phenomena which it is impossible to explain by either the undulatory or the quantum theory.

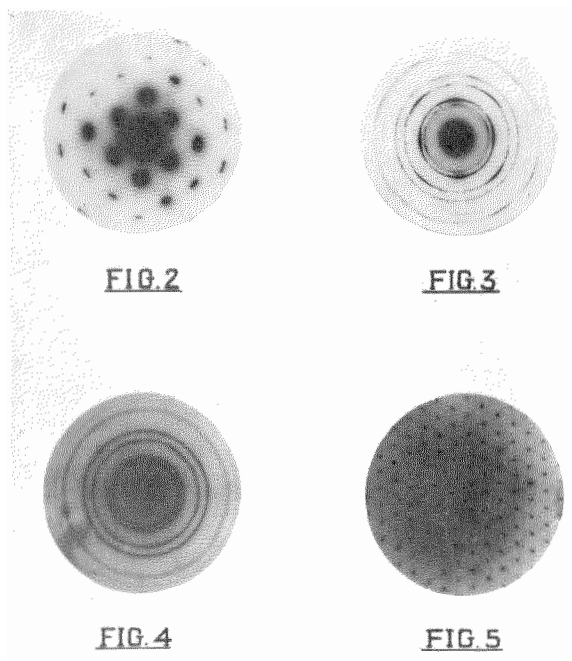

Fig. 2—Beaten Platinum Foil, Single Crystal.

Fig. 3—Beaten Silver Foil, Fibrous Structure.

Fig. 4—Gold Foil, Homogeneous Structure.

Fig. 5—Mica, Single Crystal.

According to Louis de Broglie, it may then be anticipated that when a beam of monocinetic electrons impinges on or traverses a crystalline plate whose atoms, being systematically arranged in space, constitute a three-dimensional grid, it will be diffracted in the same manner as a beam of X-rays is diffracted by a crystal.

The term "diffraction of electrons" indicates that the incident electronic beam will be deviated in certain particular directions according to the wavelength associated with the electrons and the spacing of the atoms forming the crystal, that is, by the crystalline structure of the material under consideration. If, for example, the structure is cubic with a characteristic spacing a , the beam will be diffracted in the directions θ defined by Bragg's Equation :

$$n\lambda = 2a \sin \frac{\theta}{2} \quad (\text{Fig. 1})$$

where $n = 1, 2, 3 \dots \dots n$; $a =$ characteristic spacing in Angströms.

If the beam thus deflected encounters a glass plate coated with willemite or zinc sulphate, the points of impact will exhibit a brilliant fluorescence, producing diffraction figures depending

upon the symmetry of the substance under examination, and can be directly recorded on a photographic plate. Figs. 2, 3, 4 and 5 illustrate characteristic examples of diffraction figures which give important information as to the arrangement of the atoms in the body studied. These illustrations are reproduced from photographs obtained at the Institut de Physique of Besançon.

This new process of *electronic analysis* furnishes valuable indications regarding the more or less crystalline condition of the substance under study, ranging from the amorphous state to the perfect crystalline condition; also, regarding the arrangement of constituent elementary crystals, the distortions to which they may be subjected by thermal or mechanical treatment, the modifications in structure which may result from the absorption of various gases, surface oxidisation and corrosion, as well as to the formation and character of different monomolecular layers, etc. This very incomplete enumeration shows what an enormous field of exploration is opened up by means of this new technique. Many of those engaged in research are already using it with success in various scientific and even commercial laboratories.

Apparatus for the Study of Diffraction of Electrons

Discovery of the diffraction of electrons was made in 1927 by the American physicists, Davisson and Germer. It brilliantly confirmed Louis de Broglie's theoretical assumptions. Since these memorable discoveries, the technique of the diffraction of electrons has developed considerably. The fundamental factors involved will be briefly indicated.

In principle, it suffices to produce in a very high vacuum (Fig. 6) a narrow cylindrical beam of electrons at constant velocity and to allow them to fall on the surface or across a thin layer "A" of the substance which it is desired to study. Illumination of the fluorescent screen "B" results from the diffracted electrons impinging thereon, thus producing a diffraction diagram.

The exigencies of experimentation necessitate the use of an apparatus arrangement whereby materials under test may be changed, moved, or their position adjusted; also photo-

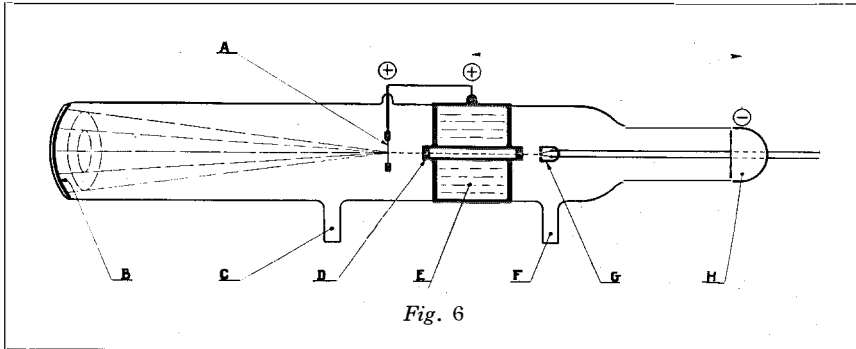

Fig. 6

graphic plates or other devices inserted, such as heat resistances, lead screens, Faraday chambers, etc. Fig. 7 illustrates apparatus used by the author at the Institut de Physique of Besançon. It contains no less than 30 joints, the majority of which are removable at will, and obviously require a high degree of perfection in grinding and the preparation of jointed parts as well as powerful vacuum pumps (molecular or oil vapour diffusion pumps).

One of the main difficulties in electronic analysis is the production of the very fine, cylindrical beam of electrons necessary to obtain good diffraction images. The problem is very different from that encountered with the cathode ray oscillograph where a conical beam of electrons is concentrated on the screen by means of magnetic or electrostatic lenses. In electronic analysis it is indispensable that the beam remain cylindrical through the whole length of its path, say approximately 40 cm, and that its diameter be less than 0.1 mm. To achieve this result, very fine collimators, "D" (Fig. 6), are used. They consist of a brass tube pierced at either end with holes equal to or less than 0.1 mm in diameter to a depth of about 1 mm. Since the total length of the collimator is 20 cm, very fine beams of electrons are obtainable.

In practice, nevertheless, it becomes very difficult to force the electrons issuing from the tungsten filament cathode "G" (Fig. 6) through this channel. The majority impinge near the entrance to the collimator, producing X-rays. To overcome this difficulty the author devised a scheme permitting displacement of the cathode so as to obtain perfect centring. It consists in mounting the filament supports in a vacuum-tight, flexible tube capable of being adjusted

to the required position by the operator. This very simple arrangement makes extremely accurate adjustment possible and gives most interesting results. It has been applied in a new apparatus which will be described presently.

To obtain uniform electron velocity, use is

made of a constant potential generator consisting of a transformer, condensers and rectifiers such as are commonly employed in X-ray work and are too well known to require description. The necessary power is very low, a few watts being amply sufficient to produce the required phenomena.

Improved Apparatus for the Demonstration of Diffraction of Electrons

The apparatus to be described was specially designed for the Paris International Exhibition of 1937. Demonstration of the diffraction of electrons to the public in some automatic fashion

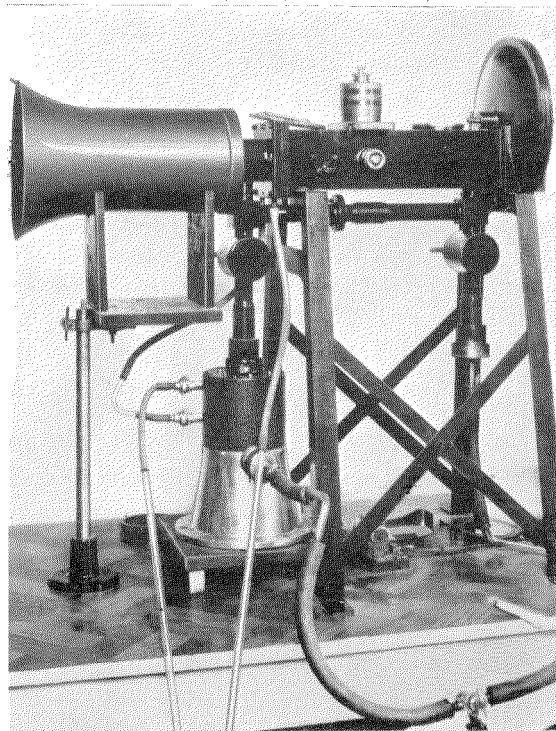

Fig. 7

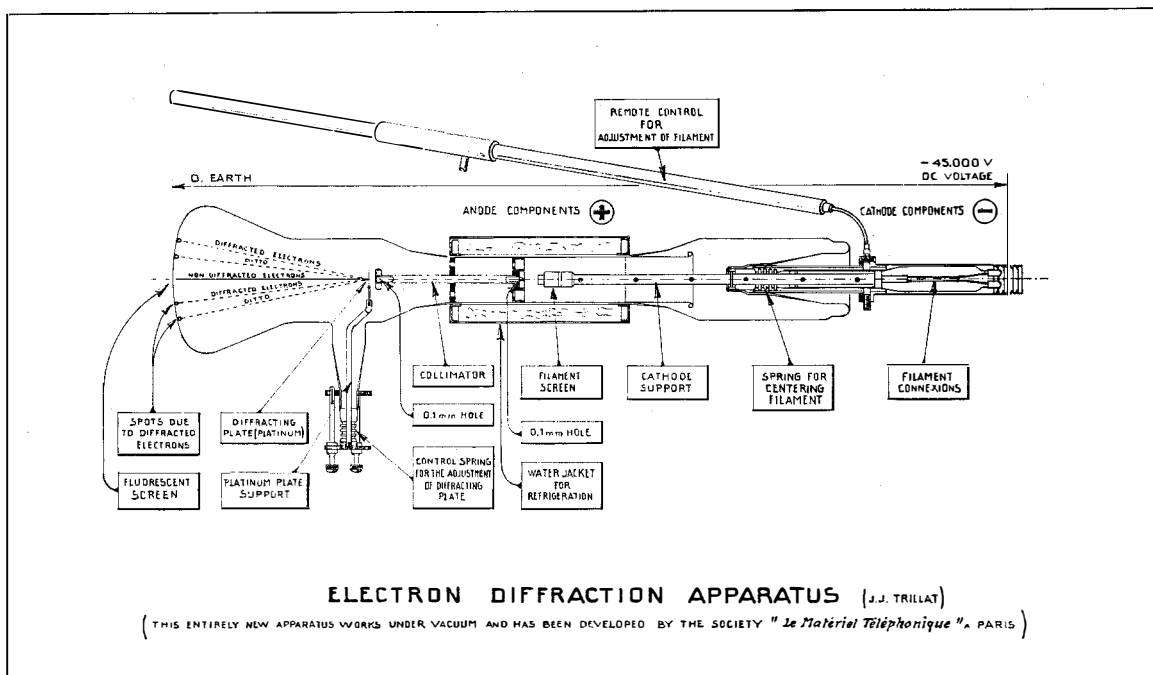

Fig. 8

with a minimum of adjustment was required. The public was to be able to operate the apparatus, and the possibility of incorrect operation was to be excluded.

The problem involved was fairly complicated. Any device necessitating the use of pumps and joints had to be eliminated off-hand, and consideration given to a *permanently evacuated tube*, such as an X-ray tube. It was, however, essential that it should be possible to adjust the centring of the cathode beam with respect to the collimator, and also to explore from the outside the diverse surfaces of the diffracting material in order to obtain the maximum intensity of the phenomena.

Fig. 8 illustrates the solution adopted. The cathode, consisting of a filament supporting rod and a filament in a centring hood, can be adjusted from the outside by means of screws displacing a flexible tube. These screws are controlled by large insulating rods which can be turned while the apparatus is working. Thus the beam of electrons issuing from the filament can be accurately centred with respect to the axis of the collimator.

Adjustment is exceedingly accurate, and the arrangement permits obtaining a cylindrical beam of electrons (diameter of the beam

0.1 mm). If, in course of operation, the apparatus gets out of adjustment (for example, as a result of filament distortion) the device provides an easy remedy.

The collimator consists of a copper tube 20 cm in length, equipped at either end with copper plugs pierced with holes 0.1 mm in diameter to a depth of 1 mm. It is surrounded by a water jacket for cooling purposes. The latter is of metal and constitutes the positive pole, connected to ground for convenience.

At the outlet of the collimator, the beam of electrons traverses the diffracting material which is placed on a metal disc. The latter is supported by a nickel rod, which can be adjusted by means of a flexible copper joint. All points of the material under observation can thus be explored, and a particularly clear and sharp diagram obtained.

The diffracting preparation is a film of beaten platinum thinned down by slowly dissolving in aqua regia to about 40–50 millimicrons in thickness. Platinum was chosen because it gives good diffraction and, further, it does not evaporate when the tube is heated during the pumping operation. These beaten platinum films give electronic diagrams of separate crystals (Fig. 2) corresponding to an orientation

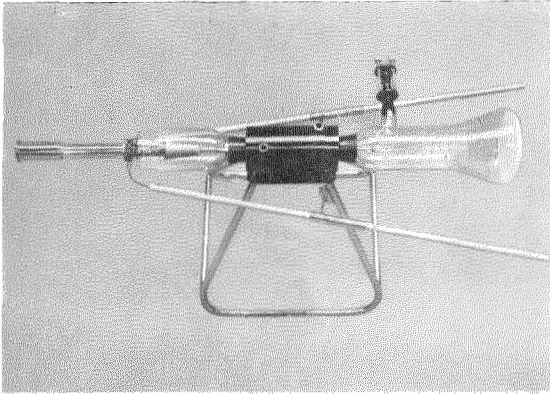

Fig. 9

of certain planes (100 or 110) perpendicular to the incident electronic beam.

The diffracted beam strikes the base of the apparatus consisting of a fluorescent screen which lights up brilliantly, giving electronic diagrams similar to that in Fig. 2. When the apparatus is properly adjusted, one can observe ten different successive orders of diffraction.

The applied constant voltage is produced by a special generator (Cie. Française de Radiologie), consisting of a transformer, condensers and valve rectifiers in an oil bath. As a rule, a voltage of 35–45 kV is applied with an output of 5 milliamperes.

Figs. 9 and 10 give a general view of the apparatus in use at the "Palais de la Découverte."

In order to avoid any misuse or faulty manipulation by the public, the operation of the diffractor is entirely automatic. The voltage is applied by pressing a single button and the time of operation is 10 seconds. Operation is interrupted by means of a fairly complicated system of contactors, and a time relay permits renewed operation only after a lapse of two minutes. These time intervals have been selected to enable the apparatus to cool properly; the quantity of water in the water jacket is such that the temperature does not exceed a maximum of 70° C. by the end of the day.

This is the first time that an experiment of this character could be carried out in public and, moreover, entirely automatically. It seemed to the author, therefore, that a brief

description of the apparatus would be of interest. The latter was constructed by Les Laboratoires Le Matériel Téléphonique, Paris, which rapidly succeeded in solving difficulties which in the first instance appeared practically insurmountable.

For applications other than the presentation of electronic diagrams, this apparatus can be used as an *absolute electrostatic voltmeter*. In fact, if the crystalline structure of the platinum (cubic system, face centred $a = 3.916 \text{ \AA}$) and the geometric dimensions of the apparatus are known, it is easy to determine by calculation the exact positions which the different diffraction spots (corresponding to the various reticular planes of the metal) should occupy on the fluorescent screen. Conversely, from the position and spacing of two spots of the same index, a simple calculation gives the velocity of the electrons and, consequently, the (constant) voltage applied to the tube. It then suffices to measure the distance between two corresponding spots and by means of a distance-voltage curve to determine the voltage; even more simply, by graduating the screen in millimetres or even in

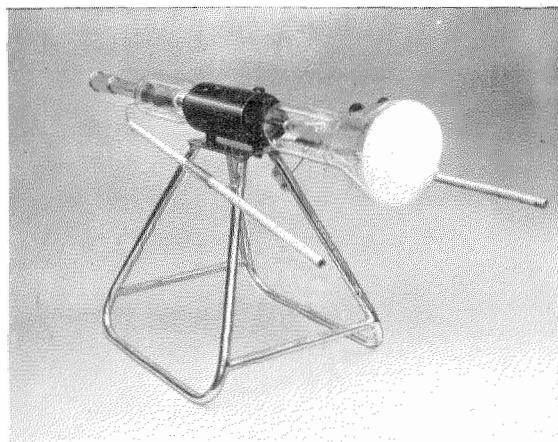

Fig. 10

kilovolts, a direct reading apparatus may be obtained. This method, which yields the most accurate results, is constantly employed to control the electrostatic voltmeters in use at the Institut de Physique of Besançon.

Some Rotary Traffic Switching Methods

By J. KRUIHOF, e.i.,

Bell Telephone Manufacturing Company, Antwerp, Belgium

1. INTRODUCTION

THE constant search for improvement in the performance of the Rotary Switching Systems has brought about a number of innovations resulting in new or improved switching methods.

All of these switching methods are developed for the purpose of reducing the amount of telephone equipment, or of improving the efficiency of the telephone plant whilst maintaining or ameliorating the performance of the system as a whole. The majority of these methods is based on the well-known principle that the average efficiency of a switching element of a perfect group improves when the size of the group is increased, whilst maintaining the probability of delayed or lost calls constant. The switching element involved may be either an automatic circuit or a trunk line in an outside cable.

Other methods developed aim to decrease the time required to establish a selection.

The new or the improved switching methods described hereinafter comply with the fundamental principle of the Rotary systems, that is, they strive towards economy in the telephone plant as a whole even, if justified, when an increase in cost of the automatic part of the exchange equipment *per se* is involved.

2. CLASSIFICATION

The various switching methods described in this article may be classified according to the following principles :

(a) *Methods Based on Grading Principle*

It is a well-known fact that the last few junctions of a group, when hunted over in a definite order, are not efficiently utilised. Grading of the junctions is therefore applied, the principle being to let the last junctions serve in common for several junction sub-groups and thus improve the overall efficiency. Full avail-

ability is not realised by grading of a group of switching elements since, under all conditions, each "inlet" does not have access to every free "outlet," as is the case with an ideal group of switching elements.

(b) *Methods Based on Principle of Full Availability*

The optimum efficiency of a group of switching elements is attained with full availability, i.e., when the linking equipment between this group and the "inlets" is so arranged that any calling "inlet" has access at any time to any free "outlet."

(c) *Methods Based on Principle of Both-way Trunking*

Traffic in opposite directions is combined over a single group of switching elements.

(d) *Tandem Trunking Method*

By tandem trunking, traffic from various sources flowing in the same direction is combined on a reduced number of switching elements of a reduced number of groups. It involves the introduction of one or more additional switching points.

(e) *Methods Reducing the Switching Time*

In the Rotary systems special attention is paid to the time of selection. Besides obvious means such as increased speed of the switches, other methods have been devised tending to speed up selection and compensating for the loss of time spent on translation of some digits, tandem selections, etc.

3. METHODS BASED ON GRADING PRINCIPLE

3.1 *Overflow Applied to Inter-office Trunks*

In city areas, where the principal exchanges are ordinarily interconnected by direct trunks,

a considerable saving on trunk equipment can be effected by introducing overflow facilities from the groups of minor importance to the group leading to a centrally located exchange, e.g., the City Main Exchange.

Fig. 1 illustrates the switching principle of this scheme. Owing to the continuous hunting feature of the Rotary system, where the register is signalled each time a selection is completed, further selections can temporarily be suspended in case no free direct trunk is available. This facility permits the insertion of one or more additional selections.

The exchange illustrated by Fig. 1 forms part of a multi-exchange 7-A City Area. The minor traffic to distant exchanges is tandemed via the tandem main exchange and, therefore, passes with the traffic to the subscribers connected to this exchange via the second level of the 1st group selector.

The 17 trunk groups shown lead to several nearby exchanges and are reached via the levels either of 1st, or of 1st and 2nd group selectors.

The full complement of each level is not utilised for the connection of these trunks, but the last few terminals lead to overflow junction circuits which in turn are connected to the arcs of finders associated with the trunks leading to

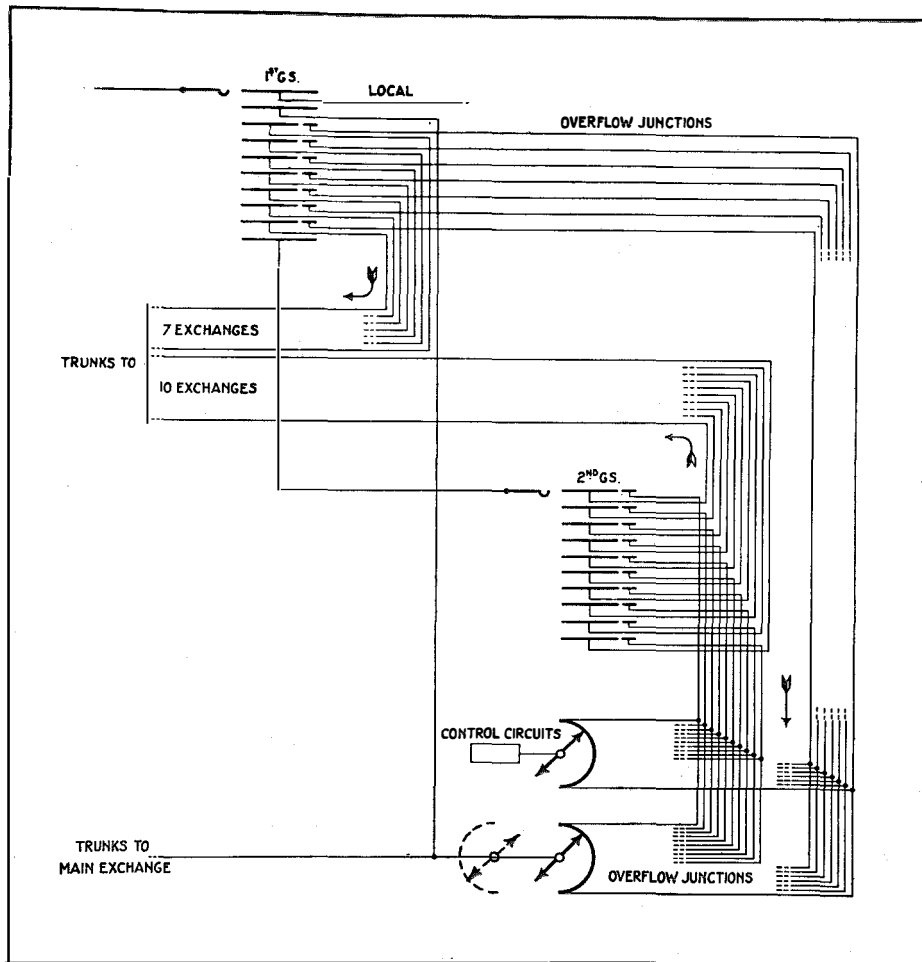

Fig. 1—Overflow Applied to Inter-office Trunks.

the main exchange of the city area. The method of operation is as follows:

On calls to a certain exchange, a 1st or a 2nd group selector ordinarily seizes a direct trunk connected to the assigned level but, in case the switch hunts over all trunks without finding a free one, it continues hunting over a small group of local overflow circuits. The selector seizes a free overflow circuit, whereupon the call is extended via a backward hunting finder to a trunk to the main exchange. Simultaneously, a control circuit is also connected to the overflow circuit but no back signal is as yet sent to the controlling register. The control circuit now controls as required, one or two selections at the main exchange corresponding with the direction of the wanted exchange.

This ingenious scheme was originated by the

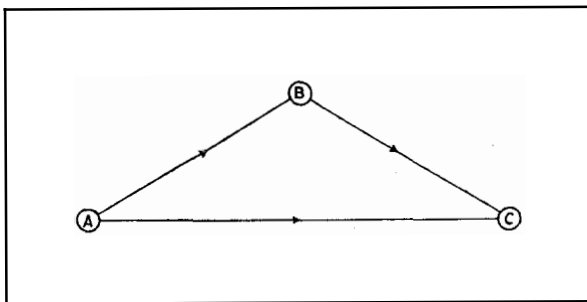

Fig. 2—First Method of Alternative Routing.

engineers of the Copenhagen Telephone Co. It may still be perfected by abolishing common graded circuits on the last terminals of the level to the main exchange and by introducing instead intermediate circuits which are also connected to the arcs of the finders associated with the trunks to the main exchange. In this manner, full availability would also be obtained on the main exchange level, even if the number of trunks should exceed the level capacity. Where the number of trunks to the main exchange is rather large, link circuits may be used to advantage, as shown in dotted lines in Fig. 1. The number of link circuits required need only be sufficient for carrying the overflow traffic.

An interesting feature of the manner in which the scheme is applied is that the control circuits may be common for the 17 groups shown. The number of selections and the number of impulses per selection depend on the overflow circuit on which the control circuit finder is centred, i.e., on the position of this finder, so that it may also serve as a translator. The control circuit finder, therefore, comprises six brushes, three of which serve for the necessary talking and signalling connections, while the remaining three carry local jumperings to

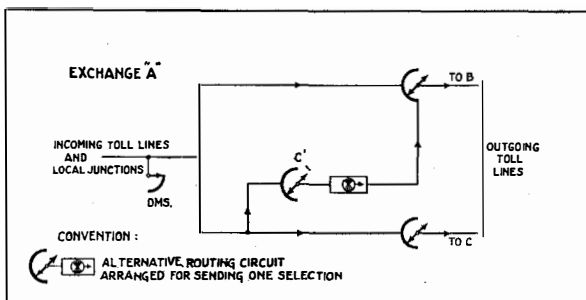

Fig. 3—Switching Principle of First Method of Alternative Routing.

terminals in the control circuit. The number of additional selections and the number of impulses per additional selection are controlled by means of these jumpers.

The above example illustrates a case where a considerable saving in trunk cable is effected at the expense of some additional automatic exchange equipment.

3.2 Alternative Routing in the Rotary Automatic Toll System (1st Method)

The Rotary Automatic Toll System¹ is designed so that the extremely expensive toll circuits, which in many instances include one or more repeaters, are utilised with maximum efficiency.

The ability of the register to withhold a subsequent series of impulses until a selection is completed, permits full availability of ex-

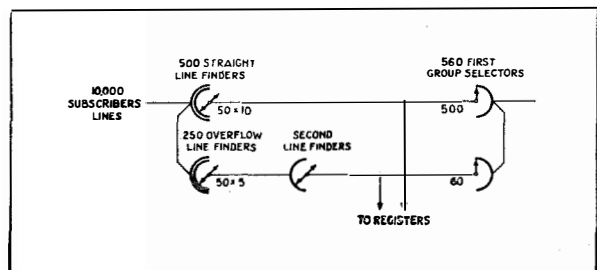

Fig. 4—Overflow Principle Applied to Line Finders in the 7-A2 Rotary System.

tremely large toll line groups and so-called alternative routing. Such routing permits traffic overloads to be routed via alternative paths and can be effected in a variety of ways.

A first method, which is of the overflow type, is illustrated by Figs. 2 and 3, where the primary toll exchanges A, B and C are interconnected by direct toll lines. Whenever a call from A to C finds all direct toll lines to C engaged, it is automatically directed via exchange B, where an additional selection is made to exchange C.

The equipment required at A is diagrammatically shown in Fig. 3. The incoming toll lines and the trunks from the local area of exchange A are connected to the arcs of the

¹ "Automatic Long Distance Switching—Rotary System," by J. Kruithof, e.i., and M. den Hertog, *Electrical Communication*, January, 1934.

finders associated with the outgoing toll line circuits to the B and C exchanges. Parallel to the toll line circuits to C the alternative routing circuits C', which are placed on the same multiple, are shown. The brushes of these alternative routing circuits are connected to the arcs of the B toll line finders.

The finders of the alternative routing circuits are only started when all toll lines to C are engaged; and, whenever they seize a calling toll line or junction, no back signal is returned to the controlling register, so that the latter is left waiting whilst the alternative routing circuit calls for a toll line to exchange B and sends an additional selection to this exchange. Only when the selection at B of a toll line to C is completed does the register receive the back signal, whereupon it sends the next selection.

With this type of alternative routing, the number of trunks from A to C should be less than that of the routes A-B and B-C.

The economy in cable pairs effected by the above scheme is considerable, since the number of toll lines to C can be restricted to approximately two-thirds of the number actually required, depending on the size of the group; further, for the number of toll lines from A to B and from B to C, only a small extra allowance need be made—if at all necessary—to cope with the traffic overflowing from route A-C.

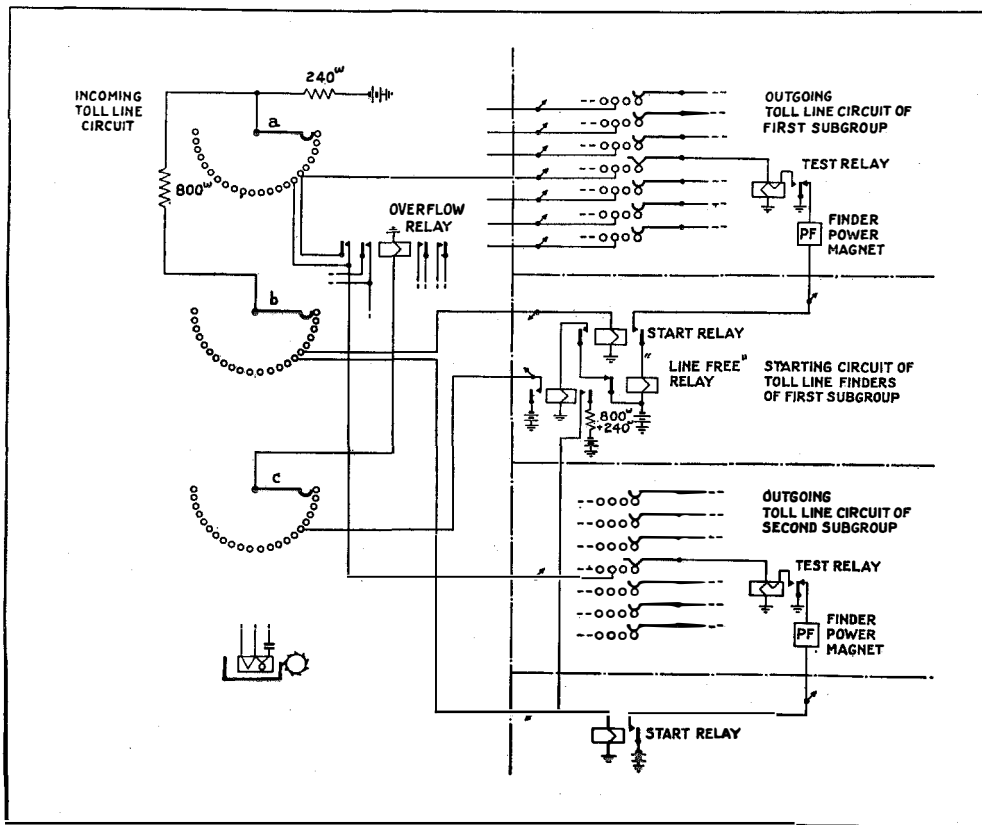

Fig. 5—Overflow Principle as Applied in the Rotary Automatic Toll System.

Other methods of alternative routing are described hereinafter.

The design of the Rotary automatic toll system provides for automatically maintaining the required overall transmission equivalent on calls switched via alternative routes.

In automatic toll practice, continuous hunting between two selections is generally limited by the controlling register to a predetermined time, for example, five seconds.

3.3 Overflow Applied to Rural Tie Lines

In order to meet conditions which are encountered in rural practice when an existing group of tie lines between two rural exchanges is to be retained with the introduction of automatic service, the 7-D Rotary system is designed to render such tie lines useful even though their number may be insufficient to carry the entire traffic on a no-delay basis.

These tie lines find their origin in standard manual practice, where direct trunks between any two exchanges are introduced whenever

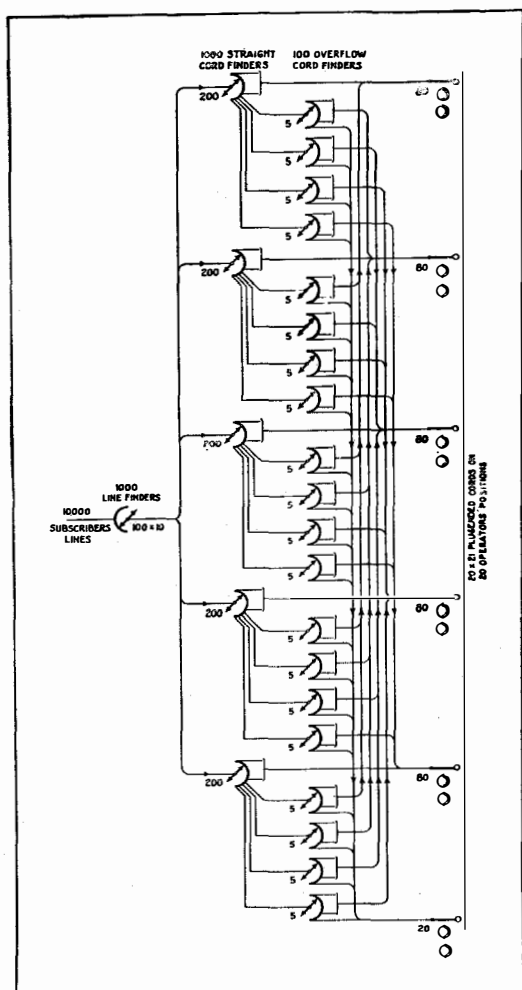

Fig. 6—Ideal Call Distribution.

justified by the traffic load. In automatic practice, however, the star type of junction layout prevails.

In the 7-D System, the tie lines are used in an economical manner by routing the bulk of the traffic over them; but, in addition, an alternative route (for example, via the Rural Main Exchange) is provided to handle the traffic when all the tie lines are engaged. The tie line group is thus operated at a high efficiency, whereas the number of trunks to the Rural Main Exchange need hardly be increased because of the small amount of traffic overflowing from the tie line group.

This scheme, therefore, has the same object as that described in the preceding section. It operates, however, by direct signalling from the tie line group to the registers whenever all

junctions are engaged. The register then changes the routing on all subsequent calls in that direction until one or more tie lines become free.

3.4 Overflow Applied to Subscribers' Line Finders

Besides offering many new and useful features, the 7-A2 System differs from the 7-A1 System in that 200-point finders are used as line finders. The manner in which this type of finder is used has been fully described² and, therefore, needs little further comment.

The underlying principle is that of grading. Approximately 2/3 of the line finders are directly connected to 1st group selectors, whereas the remaining 1/3 (approximately five machines) are connected via secondary finders. With each secondary finder, a first group selector is associated. Thus the small peaks of overflow traffic from a number of finder groups are concentrated on a minor number of 1st group selectors.

The starting circuits of the subscribers' line finders are so arranged that the overflow finders are not started until all but one of the straight finders are engaged.

The principal aim of the scheme, therefore, is economy. A typical example is illustrated by Fig. 4.

3.5 Overflow in the Rotary Automatic Toll System

The Rotary Automatic Toll System is designed to achieve economy in the use of high quality toll lines by dividing the toll lines connecting two primary toll exchanges into two or more sub-groups in accordance with the grade of transmission. The one sub-group, for example, may carry the traffic from the local subscribers of one primary toll exchange to the local subscribers of a second primary toll exchange, whereas the circuits of the 2nd sub-group, being of a higher grade, are reserved for the traffic which is tandemed through one or both primaries. The exact subdivision is carried out for each individual case in accordance with the quality of the circuits available and the volume of traffic.

² "7-A2 Rotary Automatic Telephone System—Part II," by L. Schreiber and W. Hatton, *Electrical Communication*, July, 1933.

From a switching point of view, the incoming line circuit of a toll line which only carries traffic terminating at its own primary does not require selective equipment or switched repeater access equipment. The above subdivision, therefore, also results in economy in automatic apparatus.

In order to counteract the decrease in efficiency caused by the subdivision of the toll lines, overflow facilities are provided from the low grade sub-group to the high grade sub-group. The circuit principle is shown in Fig. 5, which operates as follows :

The direction marker positioned on terminal 6 selects an outgoing toll line of the first sub-group by placing a test potential via brush "a" on the test terminal of the finder arcs and by starting via brush "b" the common starting relay. Should all finders of this sub-group be engaged, the "line free" relay of the starting circuit does not energise and allows the operation of the "overflow start relay." The latter relay, in the calling circuit, causes the operation of the overflow relay via brush "c" of the direction marker, and also of the start relay of the other sub-group.

This method of overflow from one sub-group to another has the special advantage of being extremely fast.

4. METHODS BASED ON PRINCIPLE OF FULL AVAILABILITY

4.1 Ideal Call Distribution

Some Telephone Administrations still favour manual systems supplemented by modern features, such as automatic call distribution, automatic testing, ringing, etc.

The most recent Rotary Call Distribution Scheme is shown in Fig. 6. The Rotary finder as used in the latest form of the 7-D Rotary system is employed throughout. This switch provides full availability to all operators and operators' cord circuits without providing an extravagant number of switches.

The subscribers' lines are subdivided into groups of 100, each group being served by a group of finders, the number of which corresponds to the expected calling rate. Each line finder forms part of a link circuit comprising a 100-point cord finder and a limited number of relays. The hunting of both the line finders

and the cord finders is controlled by common control circuits which, for the sake of simplicity, have not been shown in the figure.

The operators' cord circuits form an ideal group as explained hereinafter, and the 400 cords assumed in the example are divided into five sub-groups of 80 circuits each. An allowance has been made for cord circuits out of order on account of defective cords and plugs. The arcs of the 1 000 cord finders are correspondingly arranged in five multiple groups.

Each cord finder has direct access to 80 cords, i.e., four cords per operator, the total number of which has been assumed as 20. The number of operators required, of course, depends on the speed of the system and on the features incorporated in the cord circuits, such as automatic connection of the operator's telephone circuit, automatic answering by means of tone or talking machine, automatic testing of the wanted line with busy back tone or ringing tone, automatic ringing, etc.

Each sub-group of 4-cord circuits per operator tests busy to a hunting cord finder when all are engaged on a connection, and also when the operator by whom they are served is engaged in establishing a connection.

A cord finder, therefore, can only seize a

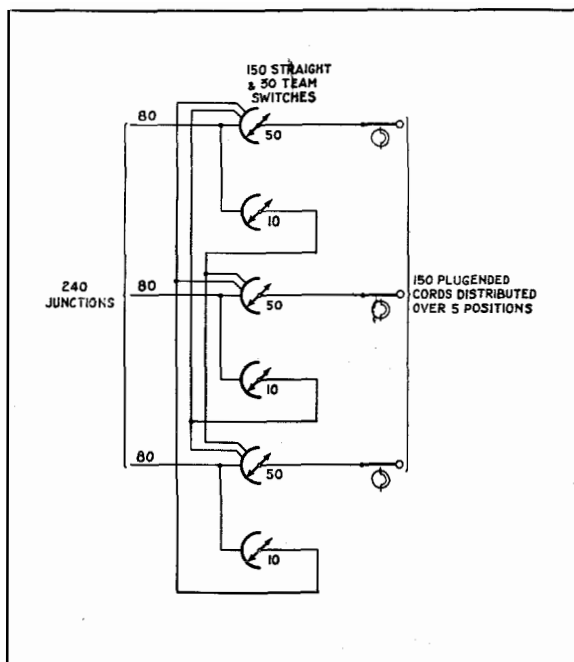

Fig. 7—Team Switching.

free cord of a free operator. Only when there is no free cord to a free operator available among the aforementioned 80 cords does the cord finder hunt for a free overflow cord finder circuit connected to one of the remaining 20 terminals of its arc. Each group of 200 cord finders has access to 4 small groups of 5 overflow finders, placed on the multiple of the other 4-cord finder groups, as illustrated in the figure. A small overflow finder group as a whole again tests busy to a hunting cord finder in case, momentarily, access to a free cord of a free operator is not available.

Each cord finder thus has access to the full number of 5×80 -cord circuits. The number of overflow finders shown is estimated to be amply sufficient to prevent congestion because of lack of overflow finders.

Should the 4×5 cords of the free operators be engaged, a hunting cord finder would test busy on all 100 terminals. At such a rare occurrence, however, the cord finder is allowed to seize any free overflow circuit to which it may have access, whereupon the overflow finder in question hunts for a free cord of an extra group of 20, solely reserved for this purpose. These cords are again distributed over the 20 operators' positions.

The method of call distribution described may, in a similar manner, be applied for distribution of Rapid Toll (C.L.R.) calls, recording calls, etc.

The advantage of the scheme is that perfect call distribution is obtained by simple and straightforward means and with a considerably reduced amount of equipment as compared with other methods thus far applied.

4.2 Team Switching

In the method just described, the overflow principle is utilised to obtain full availability by means of forward hunting finders. This section describes a scheme using backward hunting finders. Where and when the one or the other method should be applied depends on considerations of economy.

In Fig. 7 a typical case has been assumed, where 240 switching junctions terminate on a number of "B" positions. The switching operator receives only the wanted number from the incoming toll operator and completes

the connection in the multiple field without testing for busy and without supervision. The calls are released by the controlling toll operator, a signal by means of a lamp being given to the "B" operator.

The 240 switching junctions are connected in groups of 80 to the arcs of 100-point finders, thus leaving 20 sets of terminals spare and serving, as shown, for the connection of overflow finders. These overflow finders enter into action only when there are no freestraight finders of free operators in the sub-group of 50.

The economy of the scheme becomes evident when considering the fact that the 180 100-point finders (18 000 sets of soldering points) give the same performance as 150 240-point finders (36 000 sets).

It will further be evident that the switching time for the method described is considerably less than by using large capacity switches.

4.3 Alternative Routing in the Automatic Toll System (2nd and 3rd Methods)

The overflow principle of Figs. 2 and 3, when applied to both directions as shown in Figs. 8 and 9, makes possible consideration of the two toll line groups A-B and A-C as a *single ideal group*.

Calls from A to B, when no direct circuit to B is available, overflow to the group of toll lines to exchange C where they are switched to exchange B. Calls to exchange C, when no direct outlet to this exchange is available, are routed in a similar manner via exchange B.

The only additional equipment required at exchange A for this purpose consists of the alternative routing circuits B' and C', which are similar in all respects to the alternative routing circuits C' of Fig. 3.

A small allowance should be made, if necessary, for the trunk routes B-C and C-B for traffic overflowing from routes A-B and A-C.

The alternative routing circuits B' and C' of Fig. 9 are arranged to suppress the back impulse to the register and to create one artificial selection.

Figs. 10 and 11 show a method whereby the alternative routing circuits B' and C' do not suppress the back impulse to the register but control the distant selection only after the receipt of the next selection from the register.

In Fig. 10, exchange A is shown linked to two exchanges B and C. Both B and C are connected directly to exchanges D, E and F. With alternative routing as described above, a call, for example, from A to D when all outlets to B are engaged, would involve the selection of a line to C where it would be routed back to B and then to D, although exchange C has direct lines to exchange D. To avoid the introduction of such an additional tandem point as well as to improve transmission conditions and to accelerate connections, the alternative routing circuits B' and C' are arranged first to accept the waiting tandem selection from the controlling toll register and then to send the proper digit to exchange C or B where it directly selects the wanted exchange.

It will be evident that the two trunk groups A-B and A-C, from a theoretical point of view,

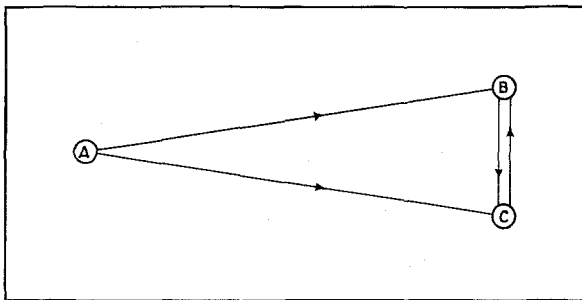

Fig. 8—Second Method of Alternative Routing.

can again be considered as forming one ideal group.

Each of the two methods of alternative routing described in this section can theoretically be extended to three and more groups of trunks but is generally restricted to two groups only to prevent complication. Both trunk groups outgoing from exchange A to exchanges B and C must possess suitable transmission characteristics to complete calls to the most distant subscribers, a restriction which does not apply to the scheme described in section 3.2.

The purpose of alternative routing is to economise in toll cable plant at the expense of a perhaps slightly increased amount of apparatus and prolonged selection time. Its advantage may be illustrated by the following example encountered in practice.

Exchange A directs 162 and 465 minutes' traffic to exchanges B and C respectively,

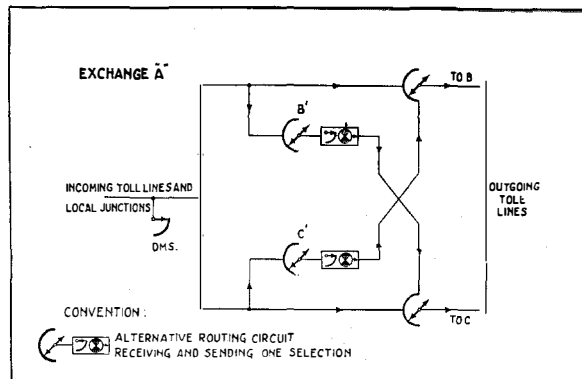

Fig. 9—Switching Principle of Second Method of Alternative Routing.

requiring on a probability basis of $P = 0.017$ and 15 toll lines. By providing at A alternative routing facilities between the two toll line groups in both directions B and C, that is, for calls to B an alternative routing via C, and for calls to C an alternative routing via B, these two toll line groups may be considered as forming a single ideal group. The traffic totals 627 minutes, and the necessary 18 outlets may be subdivided into 5 lines to B and 13 lines to C. The saving, therefore, amounts to 4 complete toll lines outgoing from A, representing for the case in question a total saving of \$30 000.

The traffic routed via the alternative routes amounts to approximately two times 15 minutes, and is added to the bulk of traffic passing via the toll lines between B and C. Since the traffic between B and C in both directions totals, for the case in point, 1 229 minutes, the additional overflow calls may be neglected as they hardly necessitate an increased number of lines between

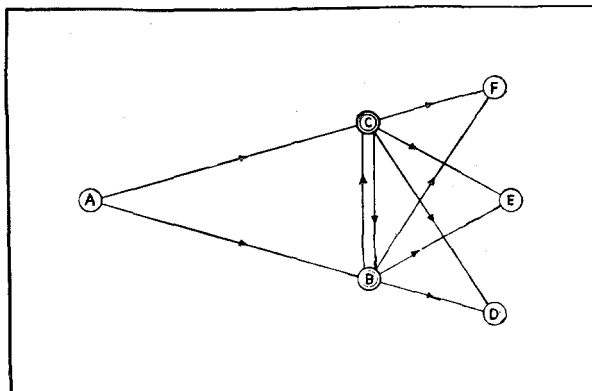

Fig. 10—Third Method of Alternative Routing.

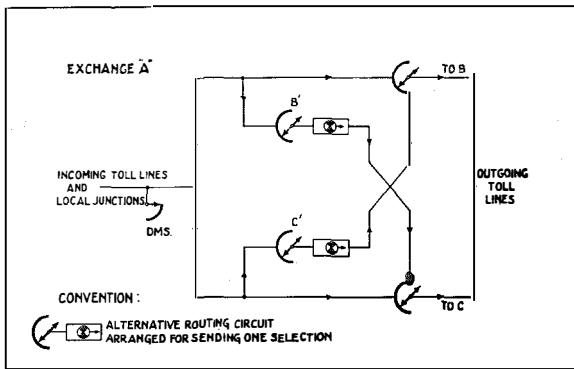

Fig. 11—Switching Principle of Third Method of Alternative Routing.

B and C. This example clearly illustrates one of the economic features of the Rotary Automatic Toll System.

Alternative routing circuits are blocked if no free toll line is available in the toll line group they lead to.

4.4 Increased Access of 7-D Group Selector to Subsequent Stage

The single motion switch employed in the 7-D Rotary system, aside from its recognised mechanical characteristics, offers the possibility of grouping the 100 points of the arc in any desired arrangement, i.e., without the restriction of having exactly 10 levels each with exactly 10 outlets.

The first group selector of the example shown in Fig. 12 gives access to 10 groups of local 3rd group selectors (subscribers' numbers 10 000—19 999), a group of special service 2nd group selectors (digits 00 to digits 09), and a group of junctions to Rural (digit 2). With the arrangement shown, a complete switching stage of 2nd group selectors is omitted.

Allowing 20 points on the 1st group selector arc for the special service 2nd group selectors and the junctions to rural, 80 points are left for the 10 groups of local 3rd group selectors, i.e., only eight per 1 000 line group. The switching arrangement shown, however, allows on the 1st group selector, on calls to local, access to 16 3rd group selectors, i.e., twice the number of outlets, by assigning to the group of 3rd group selectors identified by the two first figures "11" as a second choice the group identified by "12." The process can be extended by coordinating the two groups identified by 12 and 13, etc.

Under normal conditions, i.e., when the 1st group selector has access to a free outlet in the wanted 1 000's group, the 1st group selector control circuit controls the selection in the well-known manner by marking the 8 terminals assigned to the group. If, for example, the wanted line belongs to the 11 000 group, a 3rd group selector giving access to the 10 final groups of the 11th thousand will be selected. If, however, all 8 outlets to the proper thousand group are engaged, the first group selector continues hunting over the 8 terminals of the attending (N°12) 3rd group selector group. The seizure of a circuit in the latter group is recognised by the 1st group control circuit, which then signals to the 3rd group control circuit to start the selector hunting in a group of overflow 3rd group selectors. The 3rd group control

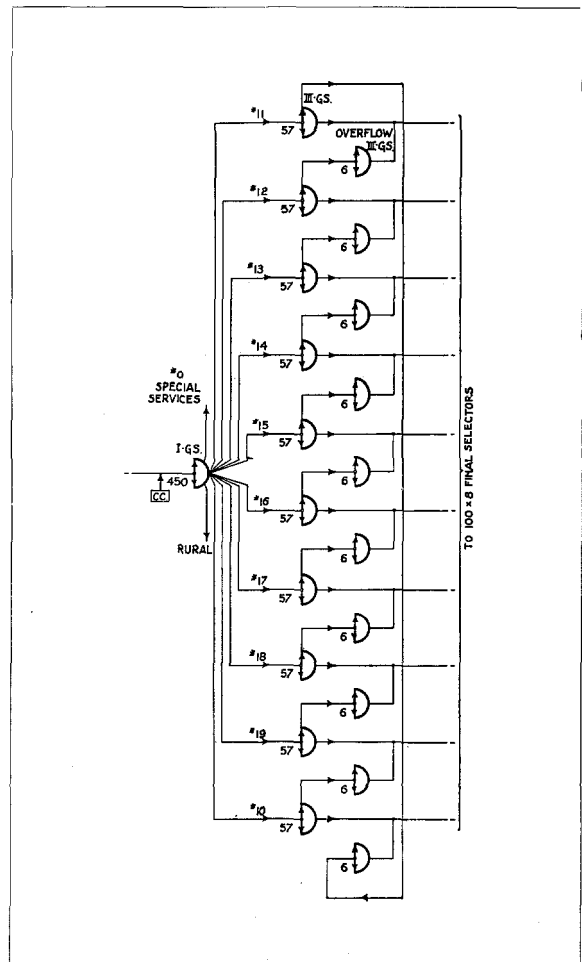

Fig. 12—Increased Accessibility of 7-D 1st Group Selector.

circuit, therefore, upon receipt of this special indication from the 1st group control circuit, does not wait for the 100's digit. The moment an overflow circuit is seized, the back signal is sent to the register whereupon the overflow 3rd group selector control circuit receives the next selection.

With the above switching method the amount of automatic equipment is considerably reduced, inasmuch as a complete switching stage is omitted.

In the orthodox manner, a 7-D exchange of the size and traffic capacity corresponding to that of Fig. 12 requires approximately 420 2nd group selectors and ten groups of 73 3rd group selectors.

When omitting 2nd group selectors and using exclusively 8 points in the 1st group selector arcs per 3rd group selector group, i.e., without the overflow facilities described in this section, 10 groups of 86 3rd group selectors are required, constituting a saving of 290 group selectors.

When omitting 2nd group selectors and introducing the overflow feature described, 10 groups of 57 3rd group selectors are required. Another 290 3rd group selectors are, therefore, dispensed with, but this saving is partly off-set by an additional number of 60 overflow 3rd group selectors.

In the Rotary 7-D urban centre exchange these additional overflow circuits are simple "metallic through" circuits, whereas the eliminated 3rd group selector circuits would contain the ringing equipment.

5. COMBINED LINE FINDERS AND FINALS

The scheme shown in Fig. 13 is based on the principle of both-way trunking where the finder and final equipment serving one group of 100 subscribers' lines consists of 4 ordinary line finders, 4 ordinary final selectors and 5 combined finals and finders. This number of circuits is sufficient to cater for a calling rate of one two-minute call per subscriber per busy hour.

The purpose of the scheme is to combine traffic in opposite directions on a single group of both-way junctions. This group may either be of the ideal or of the graded type, as illustrated by Fig. 13. Thus, a dual object is achieved:

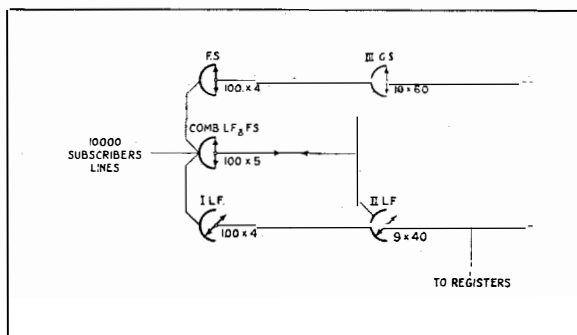

Fig. 13—Combined Line Finders and Final Selectors.

first, the size of the group is increased and consequently the junction efficiency is improved; secondly, traffic in opposite directions, perhaps showing different characteristics, is combined.

Should the traffic flowing in opposite directions show a difference in "phase" and the busy hours not coincide, the combined both-way traffic will be less than the arithmetical addition of the single-way traffic.

With the scheme illustrated by Fig. 13, part of the circuits serve as line finders only, part as finders only, whereas approximately 1/3 of the circuits serve as finders and finals, the circuit arrangement being such that the combined circuits are only required on overflow calls. They only enter into operation as line finders when all finders are engaged, and they are only seized by 3rd group selectors when all straight finals are engaged.

The saving in the number of switches, on the average, equals 20 per cent., and, obviously, may influence the total number of units or bays required.

It should be noted that in the 7-D urban exchange equipment the finder and final selector circuits are simple "metallic through" circuits. The transmission bridges are located in the link circuits and incoming group selectors, and the ringing equipment is concentrated in the penultimate group selectors.

6. METHODS BASED ON PRINCIPLE OF TANDEM TRUNKING

Tandem trunking is a universally recognised means of increasing the efficiency of the outside cable plant. Its underlying principle involves the reduction to a strict minimum of the number of trunk groups interconnecting several

exchanges, by abolishing numerous inefficient small trunk groups and, instead, routing calls via one or more intermediate "tandem" points.

The advantages are twofold. In the first place, the number of junction groups is decreased and, consequently, the trunk efficiency is increased; and, secondly, traffic of different characteristics is combined. Where coincidence in the busy hour load of the constituent exchanges does not occur, a reduced traffic volume may be used as a basis for trunk computations.

Another important benefit resulting from tandem trunking is that, for special reasons,

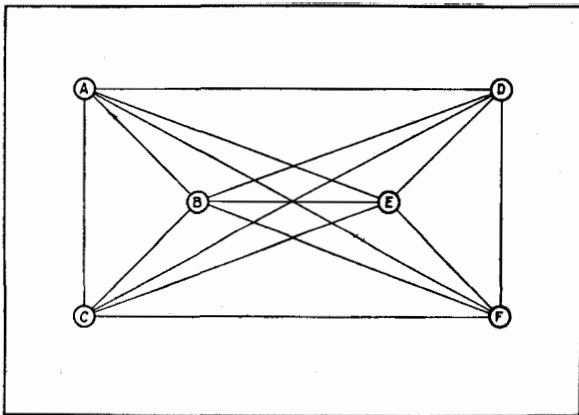

Fig. 14—Direct Trunking.

traffic between any two exchanges may show a temporary peak without causing unduly increased selection time, which would necessarily occur if direct trunks existed between the two exchanges. Furthermore, the tandem trunks are specially designed to handle a large amount of traffic originated by and directed to other exchanges, and the probability is great that the occurrence of traffic peaks between certain exchanges will coincide with traffic troughs between certain other pairs of exchanges. However, even if such is not the case, a traffic peak will increase the total traffic passing via the tandem trunks only by a small percentage and, therefore, without perceptibly affecting the overall quality of the service.

Generally speaking, tandem trunking takes advantage of the equalization of traffic which results from combining several traffic groups and thus improves the overall efficiency of the cable network.

It is difficult to express the resultant economy specifically owing to the variety of cases and types of networks encountered. The following typical calculation, however, demonstrates the order of the effect.

Fig. 14 shows a typical case of 6 exchanges interconnected by 15 direct trunk groups, while Fig. 15 shows the same 6 exchanges interconnected by 5 trunk groups only. In Fig. 15 exchanges B and E are so-called tandem exchanges.

On the assumption that a trunk layout as shown in Fig. 14 exists and that the same cable network is converted to the one shown in Fig. 15, the resulting percentage saving in kilometre-pairs has been calculated by arbitrarily supposing an equal number of circuits in each direct trunk group and by varying the number of circuits per direct trunk group from 2 to 10. The saving is represented by the curve shown in Fig. 16, from which it is seen that the economy varies from approximately 46 to 29 per cent. An average value of 35 per cent., therefore, seems justified as the overall saving obtained by tandem trunking. It has been confirmed by an extensive investigation carried out on a complete existing toll cable network.

Tandem trunking is based in principle on translating in the register two or more digits received from the subscriber's dial. The rotary register circuit, if required, contains for this purpose a translator of the finder type which is introduced between the digit receiving equipment and the equipment which controls the various selections. The fundamental translating circuit shown in Fig. 17, functions as follows:

Two marker switches on the left of this circuit receive the 1st and 2nd digits dialled by the subscriber. The moment these digits are received, the translator is started and assumes a position determined by the jumper wire between the arcs of the two markers and two levels of the translating finder, respectively. In the case shown, when No. 57 has been dialled, the finder moves to position 4 where the test relay circuit is closed via the test brush, a jumper to the arc, terminal 5 of the 1st digit switch, a brush of each marker, terminal 8 of the 2nd digit switch, a jumper to terminal 4 of the second row of the translator finder arc, and a brush of the translator to ground.

After the translator is set, the selection sending equipment operates as follows :

The elements utilised in making the third tandem selection (forward impulse sending) are shown in the circuit of Fig. 17. As soon as the distant receiving equipment shown diagrammatically on the right of the figure is connected, relay Ar operates followed by relays Sdr and Sar. Relay Sdr locks over a back contact of Str and connects the winding of Sir to an interrupter which operates at an exact speed of 10 closures per second. Each time relay Sir is operated, the distant stepping relay releases and both the distant marker and the counting switch of the register advance a step. The moment the latter switch arrives at position 6, relay Str operates via a jumper wire connected to terminal 4 of the translator level controlling the third tandem selection. As a result, relay Sdr releases and the sending of impulses over the line ceases.

It will be evident from the above that the number of tandem selections and the number of impulses per tandem selection may arbitrarily be chosen for each combination of the first two figures received from the subscriber's dial.

7. METHODS REDUCING THE SWITCHING TIME

7.1 Backward Hunting Finder

The functioning of the backward hunting finder used in the Rotary Automatic Toll System has been fully described in this journal.³

Stress is laid upon one special feature of the backward hunting finder since the present-day tendency in the development of automatic switching apparatus is to design high speed switches which allow hunting over large groups without unduly increasing the switching time. The backward hunting finder is interesting from this viewpoint in that, for the larger groups, it constitutes a high speed switching mechanism, as will be apparent from the average hunting times which have been calculated for a group of backward hunting finders for variable traffic expressed in hours. The results of these calculations are shown in Figs. 18 and 19.

It will be noted from Fig. 18 that a group of eleven 100-point finders which hunt at a speed

of 45 steps per second requires an average hunting time of 300 milliseconds when handling an average traffic of 4 hours. The number of eleven finders carrying a traffic of 4 hours corresponds to a probability of $P = 0.001$, as shown in the figure. It appears that the smaller the group of backward hunting finders, the higher the average hunting time will be ; and, similarly, the greater the group, the shorter the hunting time. The method by which the curves of Fig. 18 are computed is explained in Appendix I.

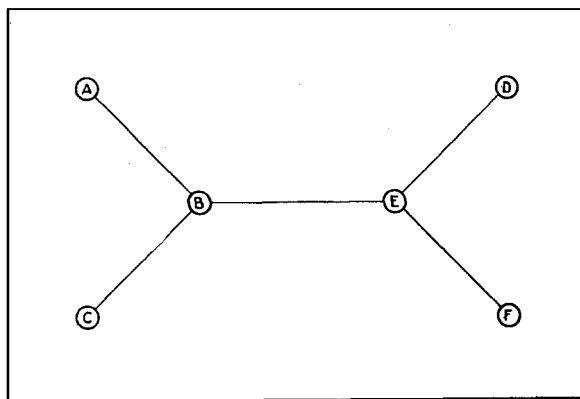

Fig. 15—Tandem Trunking.

With a forward hunting finder, the opposite takes place, viz., the larger the group of outlets, the longer the average hunting time. The average hunting time for a forward hunting finder when operating at 45 s.p.s. is shown in Fig. 19, and the manner in which the curve has been calculated is explained in Appendix II.

In comparing Figs. 18 and 19 it appears that, for values around 30 outlets ($P = .01$), the forward and backward hunting finders consume approximately the same hunting times. Below the value of 30, the forward hunting finder appears to give shorter hunting times whereas, above this limit, the backward hunting finder is preferable. With large groups in the neighbourhood of 40 to 50 outlets, the average hunting time of the backward hunting finder is approximately half that of the forward hunting finder. High speed forward hunting switches, therefore, would have to go to hunting speeds of 100 steps per second in order to equal the performance of the backward hunting finder.

From this comparison it clearly appears that

³ See reference 1.

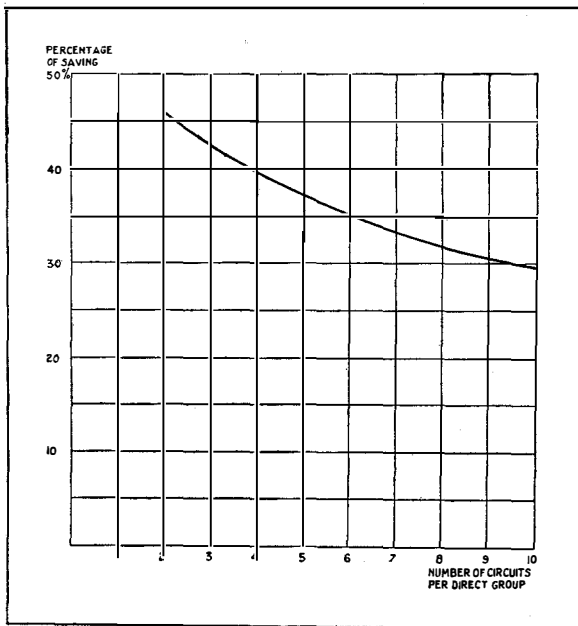

Fig. 16—Saving Obtained by Tandem Trunking.

the backward hunting finder is an ideal switching mechanism in systems dealing with large trunk groups such as toll networks.

7.2 Simultaneous Hunting by Backward Hunting Finders

Fig. 20 shows in diagrammatic form part of the exchange equipment, A. Directions B and C are both equipped with intermediate finders, and direction B is provided with alternative routing facilities via exchange C (see section 3.2). When an incoming toll line or a junction from local calls for direction B, the intermediate finders serving this direction are started and hunt for the calling incoming circuit.

After an intermediate finder has seized the calling toll line or junction from local, a normal procedure would be for it to signal for a free toll line in the direction B and, therefore, to start

all free B toll line finders. The hunting of the intermediate finders and the toll line finders would then take place in sequence, with the result that the introduction of intermediate finders would delay the selection. Similarly, on calls routed “alternatively” via C to B, first the intermediate finders, then the finders of the alternative routing circuit B’ and at last the C toll line finders would hunt. Thus alternative routing would also considerably delay selection.

The Rotary Automatic Toll System, however, is so designed that the hunting of the two or more successive groups of finders takes place simultaneously. This feature is incorporated in the finder starting circuits and operates as follows :

When the DMS switch is set in a certain direction, it starts both the free intermediate finders and the free toll line finders of the wanted group. The intermediate finders hunt for the calling circuit and, simultaneously, the toll line finders hunt for free intermediate finder circuits, which are purposely grouped together in the toll line finder arcs. The circuits are so arranged that only one toll line finder can be stationed on any one of the hunting intermediate finders. When a toll line finder has stopped, the remaining free toll line finders continue hunting, and can then test only on the terminals preceding and not on the terminals succeeding the one on which the first

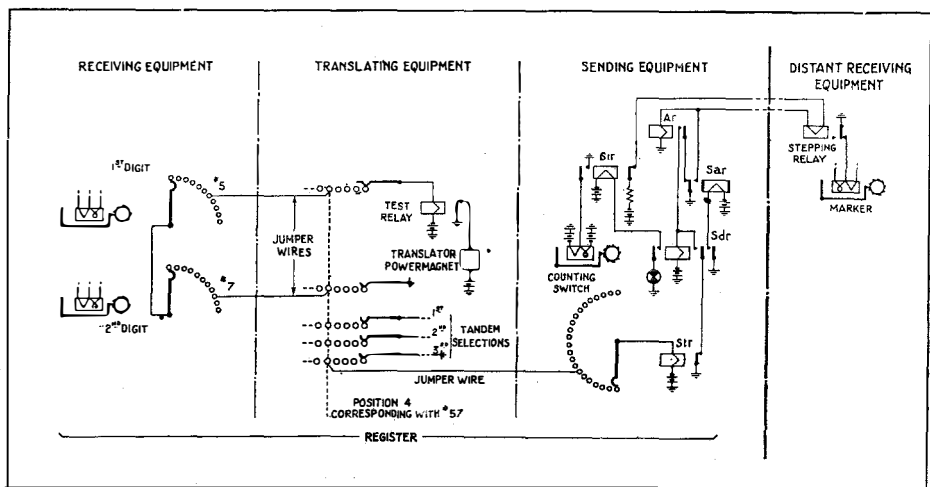

Fig. 17—Circuit Principle of Tandem Trunking.

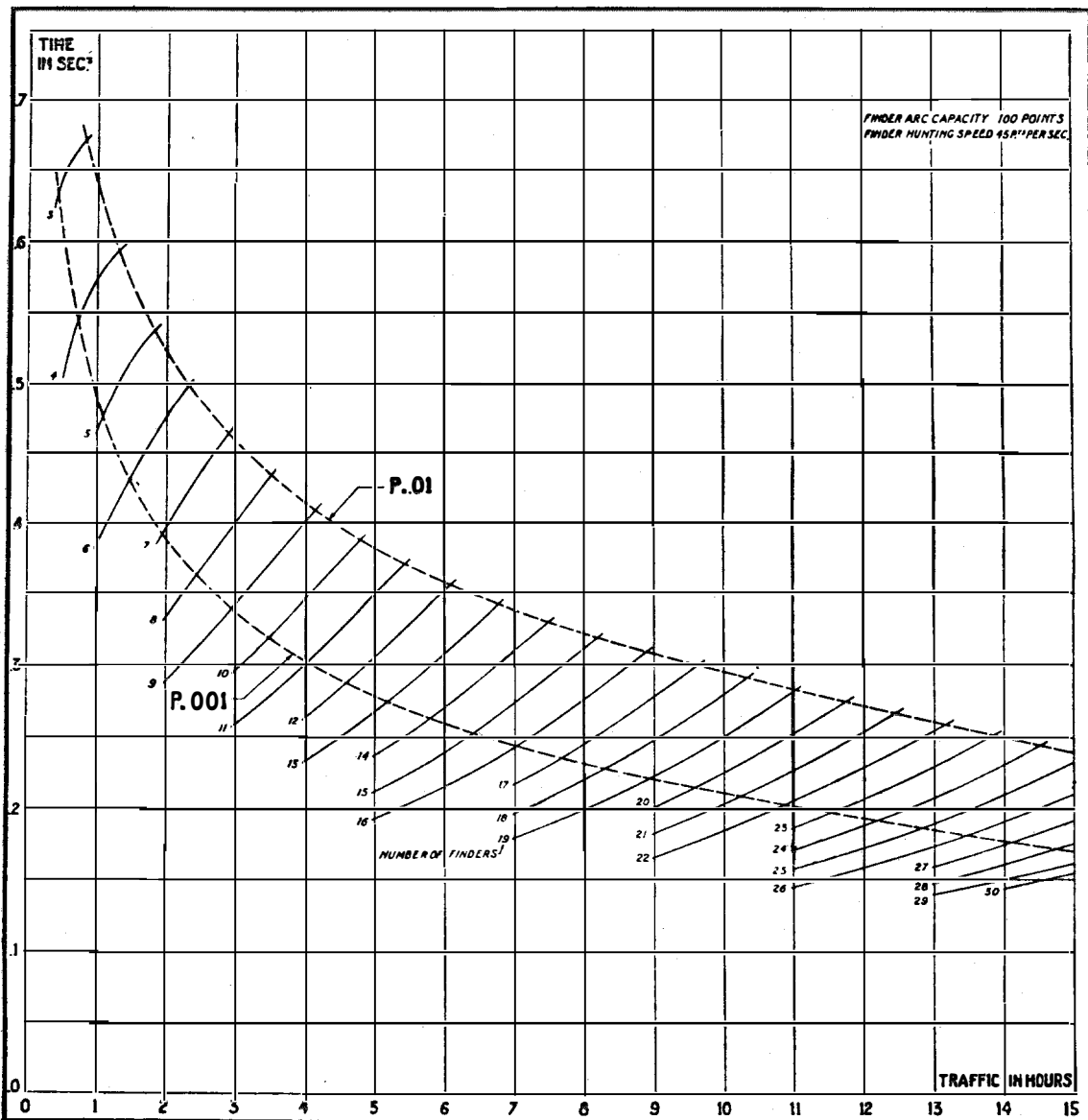

Fig. 18—Average Hunting Time with Backward Hunting Finders.

finder is standing. When any one of the hunting toll line finders stops on one of the preceding terminals, the finder already stationary is released and again starts rotating. The tendency thus is to attach a single outgoing toll line to an intermediate finder circuit located progressively nearer to, or at the beginning of, the series of terminals allotted to the group.

As soon as one of the hunting intermediate finder circuits seizes the calling circuit, the test potential is removed from the terminals of the

free intermediate finders of the same group, thus releasing any prepositioned toll line finder, and the successful intermediate finder alone calls for a toll line finder. The preliminary hunting of the toll line finders very greatly increases the probability that an available finder will reach the calling intermediate finder circuit within a few steps.

The switching time can be reduced still more by increasing the number of intermediate finders which may, for example, without prohibitive increase in cost, be provided on the

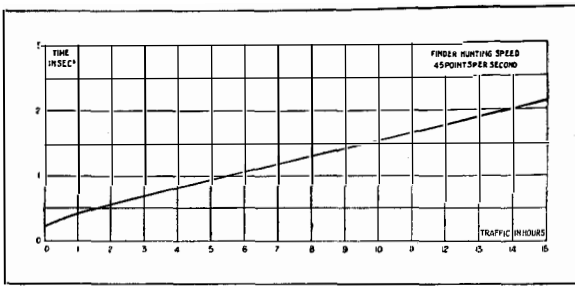

Fig. 19—Average Hunting Time with Forward Hunting Finders.

basis of a diminished delayed call probability of, say, $P = 0.001$.

The introduction of intermediate finder circuits often reduces the number of terminals occupied in the toll line finder arcs to an extent such that some or all of the connected circuits may be multiplied to more than one arc terminal. This feature tends to halve the average hunting time of the toll line finders and thus results in a further speeding-up of the switching process.

On calls routed via an alternative route, the three finder groups hunt simultaneously. Thus, in most cases, the additional delay due to alternative routing is limited to the hunting of a finder over a number of terminals equal to the number of alternative routing circuits.

7.3 Chasing by Single Motion Selectors

In the 7-D Rotary System means are provided, during the time the impulses are received from the distant register, to rotate the single motion switch to the first terminal of the selected group. Hence dead hunting time of the finder between the moment the selection is received and the testing in the wanted group commences is avoided.

The circuit principle is illustrated in Fig. 21. At the moment the stepping relay operates, relay Gcr energises the power magnet of the single motion switch and the brush carriage starts rotating. Each time the stepping relay releases and operates, the marker advances a step and transfers the test relay to the marking wire of the next group of terminals. Consequently, the hunting for a free outlet in the wanted group commences immediately after the necessary number of impulses has been received, so that the total time required for selection and hunting is reduced to a minimum.

It should be noted that, due to the character of the timing action performed by the rotating finder, the slow releasing relay marking the end of the digit, could be dispensed with. However, to avoid any danger of incorrect selection due to the variation in speed of the sending of the impulses and the rotation of the finder, the switching through of the selector circuit is postponed until the moment hunting is finished and the slow releasing relay has released.

APPENDIX I

Calculation of the Average Hunting Time of a Group of Backward Hunting Finders

Assume 100 inlets connected to the arcs of a group of 100-point Rotary line finders hunting at a normal speed of 45 steps per second. Whenever a call arrives at one of the inlets, it starts the brushes of all free finders rotating and hunting for the calling inlet. Evidently the time the free finders hunt equals the distance between the calling terminal and the brushes of the nearest finder measured in the direction opposite to hunting, divided by the finder speed. When observing such a switching arrangement, it will be found that, at certain times, all finders but one are engaged. The average hunting time t_1 then equals :

$$t_1 = \frac{1}{2} \frac{a}{v},$$

where a = the arc capacity expressed in terminals,

and v = the finder speed expressed in terminals per sec.

At some other moments, it will be found that all finders but two are engaged. The average

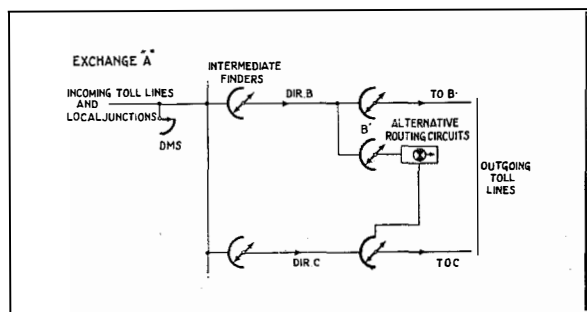

Fig. 20—Switching Principle of Simultaneous Hunting Feature of Backward Hunting Finders.

hunting time for this case may be evaluated as follows:

Assume the finder arc opened at the calling terminal 0' and 0" as shown in Fig. 22. Let one of the two finders be positioned on terminal *P* and the position of the other finder be variable.

When the 2nd finder stands between 0' and *P*, i.e., in front of the 1st finder, it will be first in seizing the calling terminal. When the former finder finds itself between *P* and 0", the finder at *P* will be the successful one. The average hunting time, therefore, equals :

$$\frac{\left(a - \frac{1}{2} p\right) p}{av},$$

where *p* = the parameter 0' *P*.

Varying the position of point *P* from 0' to 0" we find the average hunting time when any two finders are free :

$$t_2 = \frac{1}{a^2 v} \int_{p=0}^{p=a} \left(a - \frac{1}{2} p\right) p \cdot dp = \frac{1}{3} \frac{a}{v}.$$

In a similar manner, the average hunting time when three finders are idle is :

$$t_3 = 1/4 \frac{a}{v}.$$

And further :

$$t_4 = 1/5 \frac{a}{v},$$

$$t_5 = 1/6 \frac{a}{v},$$

$$t_n = 1/n + 1 \frac{a}{v}.$$

The above average hunting times can also be derived by other quite independent methods yielding the same results.

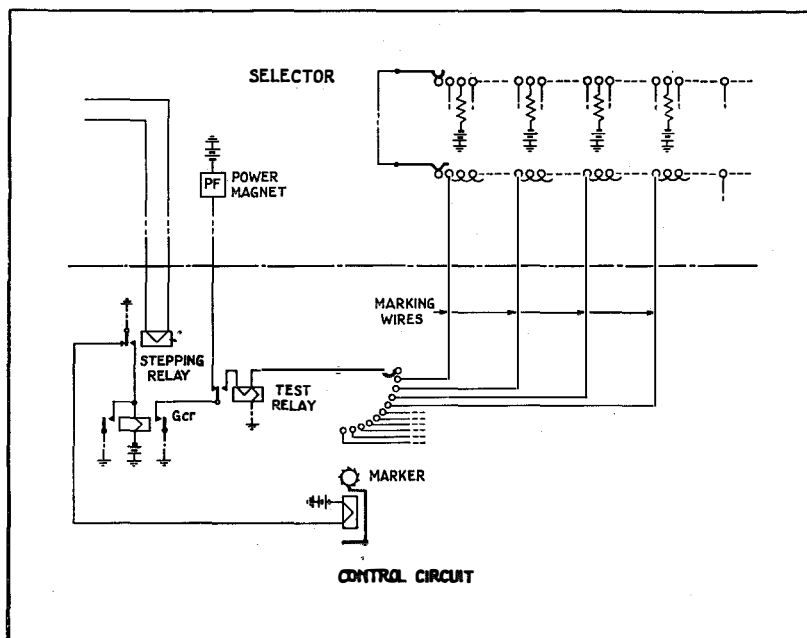

Fig. 21—Circuit Principle of the Chasing Feature of Single Motion Selectors.

These results are rather interesting inasmuch as they differ from what might be expected. It can, for example, be argued as follows :

The average position of the brushes of, say, two free finders will be opposite each other, and the average position of the calling terminal will be at equal distance from these two finders so that the average hunting time would appear to be $1/4 \frac{a}{v}$. It will be evident from the above calculation that this result is incorrect.

From the above formulae for the average hunting times, it may be deduced that with 2 finders, for example, the average distance between the calling terminal and any one of the two finders equals $1/3$ of the arc. This may be explained by the fact that, instead of placing 2 points, called finder brushes, at random on the finder arc, 3 points are so placed, two of which are called finder brushes and one the calling terminal (or observer). The reason why this point is emphasized is that the conclusion arrived at has a bearing on the correct application of probability theories to telephone trunking problems, since it implies that *the observer counts as a call*.

Knowing the average hunting times when 1, 2 or more finders are free, the arithmetical

average must not be taken in view of the fact that the probability that 1, 2 or more finders are free has no constant value. As a close approximation we may use

$$\begin{aligned} F_n &= P_0 \\ F_{n-1} &= P_1 \\ F_{n-2} &= P_2, \text{ etc.}, \end{aligned}$$

where F_n is the probability that the available n finders are all free; F_{n-1} is the probability that the available n finders are all free but one, etc.

P_0 is the probability that no finders are engaged; P_1 is the probability that exactly one finder is engaged, etc. The total average hunting time, therefore, equals:

$$\left(P_0 \times \frac{1}{n+1} + P_1 \times \frac{1}{n} + P_2 \times \frac{1}{n-1} + \dots + P_{n-1} \times \frac{1}{2} \right) \frac{a}{v}$$

The chances $P_n, P_{n+1},$ etc., do not enter into this formula as they represent cases where there

is a shortage of machines so that no hunting takes place. They certainly add to the time the call will have to wait, but not to the hunting time of the finders.

Based on the above approximate formula, various average hunting times have been calculated and the family of curves shown in Fig. 18 plotted.

These curves, although only valid for the 100-point rotary finders hunting at a speed of 45 steps per second, can readily be used for other machines with different capacity and speed by simply changing the scale. For example, with a group of 11 finders having a capacity of 50 points and hunting at a speed of 20 steps per second, the average hunting time would be:

$$\frac{50}{100} \times \frac{45}{20} \times 300 = 340 \text{ ms.}$$

APPENDIX II

Calculation of Average Hunting Time of Forward Hunting Finder

Assuming a number of trunks hunted over in a definite order and calling the traffic overflowing from the first, second, etc., trunks $0_1, 0_2,$ hours, etc., the average hunting time is expressed by:

$$\frac{1}{y \cdot v} (y + 0_1 + 0_2 + 0_3 + \dots + 0_n + \dots \text{etc.})$$

where y = the total traffic applied to the trunk group,

v = the speed of the finder expressed in steps per second.

For calculating the quantities $0_1, 0_2,$ etc., the well-known Erlang formula may be used:

$$0_n = \frac{y^{n+1}}{n!} \frac{1}{1 + y + \frac{y^2}{2!} + \frac{y^3}{3!} + \dots + \frac{y^n}{n!}}$$

The number of trunks may be assumed as infinite as it has little influence on the accuracy of the calculation. In this instance we therefore obtain a single curve as compared with a family of curves for the average hunting time of a group of backward hunting finders.

With the aid of the above formula, the curve shown in Fig. 19 was plotted.

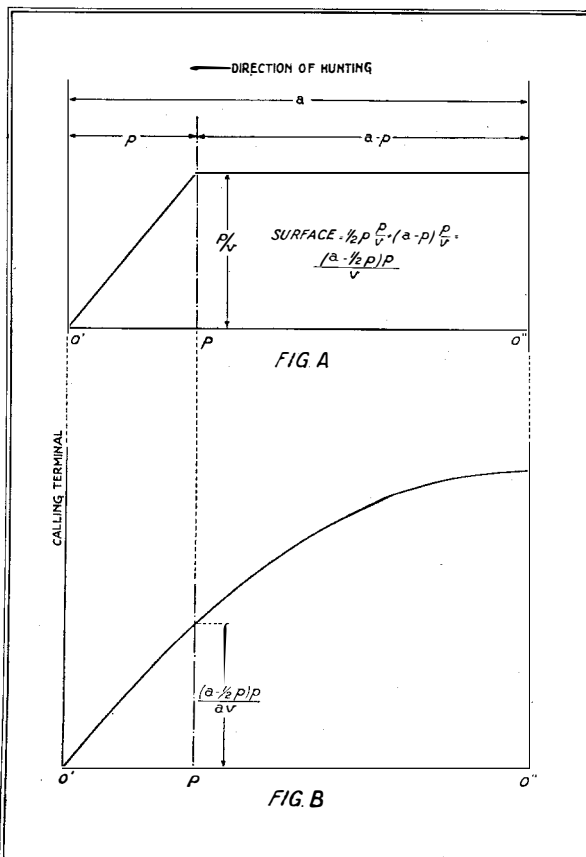

Fig. 22—Average Hunting Time of Two Backward Hunting Finders.

In Appendices I and II, the problems of the hunting times of both the forward and the backward hunting finders have been treated in their simplest form. No attention has been paid to the influence of refinements obtained by special multiple and switching arrangements.



Marine radio installations suitable for every class of ship were shown by the International Marine Radio Company, Limited, at the Engineering and Marine Exhibition held in London in September, 1937. Special interest was displayed by the public in a large illuminated photograph of the I.M.R.C. radio installation in the R.M.S. "Queen Mary."

No. 7-D Rotary Automatic P.B.X. Installed in the Administration Building of the Danish Newspaper "Politiken"

By K. A. HALDVIG, B.Sc.,

Assistant Chief Engineer, Copenhagen Telephone Company, Denmark

Introduction

APPROXIMATELY 100 P.B.X. equipments of Standard Electric manufacture have been installed in the Copenhagen area, with a total of more than 6 000 subscribers' stations in service. The types vary according to the number of stations connected and the amount of traffic to be handled.

In the case of minor equipments, incoming as well as outgoing traffic to public exchanges is handled manually by the attendant without the aid of the automatic switching equipment so that only the wholly local traffic is handled by the automatic switching equipment. For more important equipments, with heavy traffic to the public exchange, the outgoing traffic is handled by the automatic switching equipment so that the attendant's cabinet serves only the incoming traffic.

An example of the latter type of equipment is the P.A.B.X. recently placed in service in the Administration Building of the newspaper "Politiken" in Copenhagen.

When planning the P.B.X. for this great modern newspaper, special precautionary measures were required to ensure rapid and safe operation, the reason for which will readily be appreciated in view of the high rate of activity prevailing at certain hours due to the

necessity of including urgent news items in an edition that is in process of printing. Under such conditions, not only city connections but, also, all local connections must be obtainable promptly, since the presses may have to be stopped in order to substitute important news for less pressing material.

It was felt that a P.B.X. of the Standard Electric 7-D Rotary type with its simple and robust apparatus would satisfy the requirements of reliability; and, on account of the high speed of the 100-point selector, would provide the desired quick establishment of connections.

The arrangement of the "Politiken" P.A.B.X. is indicated schematically in Fig. 1. The designations used in the figure signify:

- O—Attendant's cabinet to which the singleway junctions from the public exchange are connected;
- P—The automatic P.B.X. arranged for local traffic and also for outgoing city connections via a special group of junction finders;
- A—Single line subscriber set with unrestricted service;
- K—Double line subscriber set for unrestricted service, provided with 2 push-buttons—one red and the other white. The red button is used on incoming traffic from the public exchange; the white button, on outgoing traffic to the public exchange and for local traffic. Each of the two lines is provided with a bell, and the subscriber set is not busied for incoming traffic even if a connection is established over the other line;
- L—Single line subscriber set with restricted service (local service only).

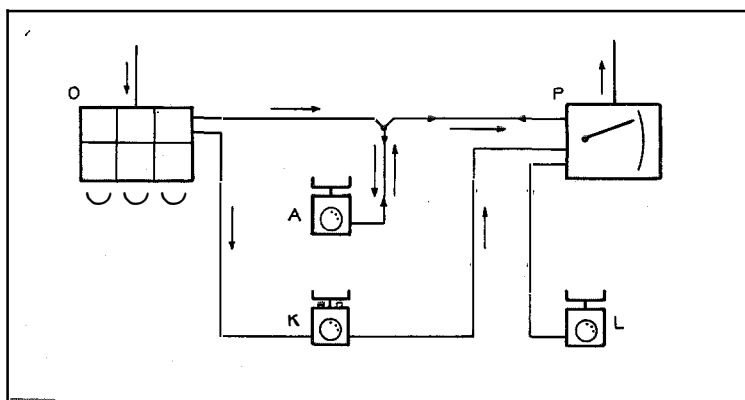

Fig. 1—Traffic Routing Diagram.

Description of the Automatic Switching Equipment

The junction diagram for the entire equipment comprising 300 lines is shown in Fig. 2.

The links are divided into 3 groups of 19 each. One group only is shown on the junction diagram. Each link comprises two 102-point finders, LF (line finder), and GS (group selector), each having 5 brushes. The finals, FS, are also divided into 3 groups, one for each 100 sub-

scribers, with 10 finals in each group, and all the finals are connected to the multiple of the group selectors. The group selector multiple moreover comprises singleway outgoing trunks to the public exchange and trunks for special services, such as attendant's local line, etc.

Each register R is provided with a 51-point link chooser, CC, with 14 brushes. The registers are divided into 2 groups comprising 6 and 5 registers, respectively. To the first group of registers are connected 31 links uniformly distributed over the 3 link groups serving, respectively, the first, second and third group of 100 subscribers. To the second group of registers are connected 26 links, likewise uniformly distributed over the 3 link groups.

Each of the registers, moreover, comprises 3 11-point markers and 1 set of relays. The setting of the final selectors is controlled by means of 2 control circuits, CR, for each group of final selectors. Each of the control circuits comprises 2 11-point markers and 1 set of relays.

The 300 subscribers' lines are connected to the attendant's cabinet. The incoming trunks from the public exchange are likewise connected to this cabinet. Incoming calls are signalled by means of lamps and are extended to the subscribers by means of double cords.

Method of Operation

A subscriber originates a call by removing the receiver and depressing the white button, if any, causing the line relay to energize, whereupon the link choosers of all free registers start to hunt for a free link in the 100-group of the calling subscriber. Immediately a link has been picked up, the line finder of this link hunts for the calling subscriber's line, which is busy, and the subscriber receives dialling tone. If a local connection is wanted 3 digits are dialled, and the register is set accordingly. The group selector of the link is set via the marking multiple according to the first digit received by the register, as described in detail below.

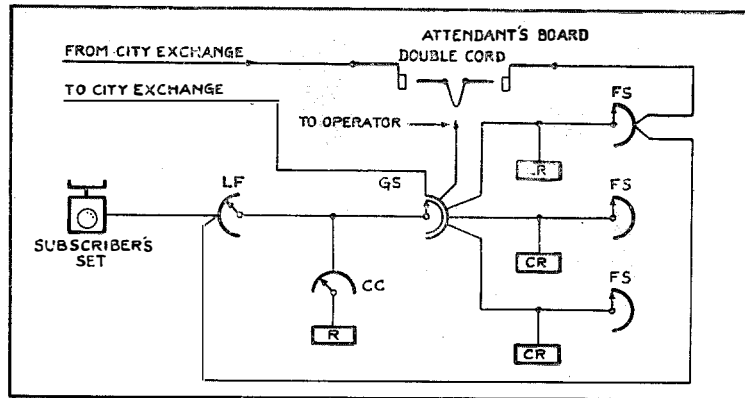

Fig. 2—function Diagram.

Each group of links serving a group of 100 subscribers is divided into 2 sections, each of which is connected to one of the two register groups. Further, the totality of the links connected to a group of registers is divided into 3 groups, each of which has an individual marking multiple. Each aforementioned group contains links of every 100's group in the P.A.B.X. so that any subscriber has access to

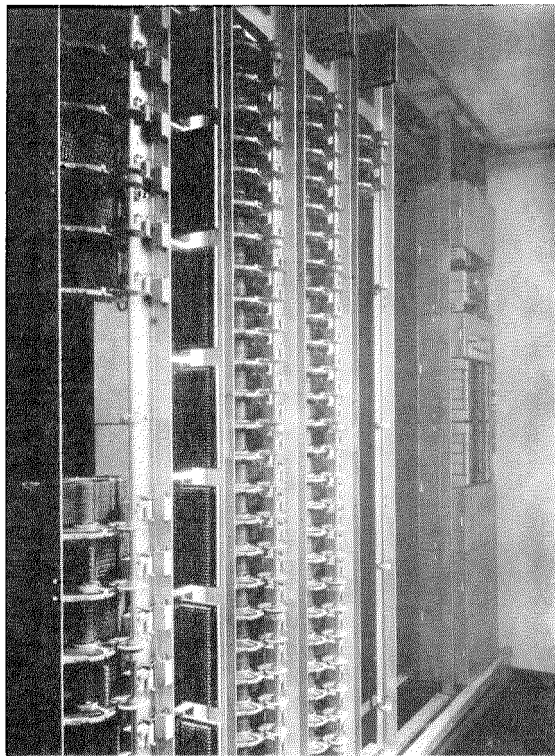

Fig. 3—7-D Rotary Automatic Equipment—'Politiken' P.A.B.X.

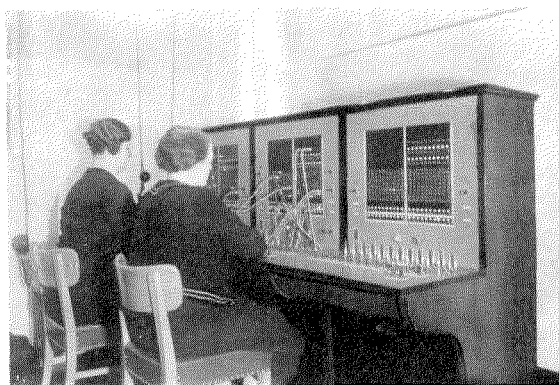

Fig. 4—Attendant's Board.

links pertaining to any one of the marking multiples. Through these marking multiples the registers can direct the group selectors to a free junction in the required group, whether looking for a free final within the wanted 100-group, or an outgoing trunk to the public exchange, or a line to the attendant.

To explain the method of operation of the register, it will be assumed that the link chooser has picked up a free link and that the register has forwarded dialling tone, after which local subscriber No. 375 has been dialled. Immediately upon receipt of the first digit the group selector starts hunting for a free final in the 100-group 300-399 and, via the marking multiple, the register prepares the test circuit for all free finals in the required 100's group so that the first free final encountered in the arc of the group selector will be picked up. The 10 finals within each 100-group are divided into 2 sections, each section having a common control circuit. The group selector, therefore, will hunt for a free final selector of a section in which the control circuit is also free. When the first final selector fulfilling these 2 conditions has been found, the group selector stops and the register forwards the 10- and unit digit to the control circuit via brushes of the group selector. Each section of final selectors is provided with a marking multiple connected to the respective common control circuit, and the setting of the final selector to the wanted subscriber is controlled by the control circuit via this marking multiple.

Part of the automatic equipment containing link choosers and group selectors is shown in Fig. 3.

To obtain a connection to the public exchange, digit 1 is dialled. On receipt of this digit in the register, the group selector starts and is directed, via the marking multiple, to a set of terminals where a free junction to the public exchange is connected. Calls to the Attendant's set are obtained in a manner exactly similar, but "0" instead of "1" is dialled.

Any local station line can be prevented from obtaining connection with the public exchange by simply connecting a ground in the subscriber's line circuit. It is possible to obtain group hunting by means of suitable jumpering.

In addition to the ordinary miscellaneous circuits, such as motor start, ringing and tone circuits (the latter with reserve), a number of special circuits are provided. They comprise permanent glow, wrong number (busy tone in case a non-existing number is dialled), and alarm circuits. The equipment is also provided with routine test circuits for the links, registers and finals.

Attendant's Cabinet

Fig. 4 shows the attendant's board consisting

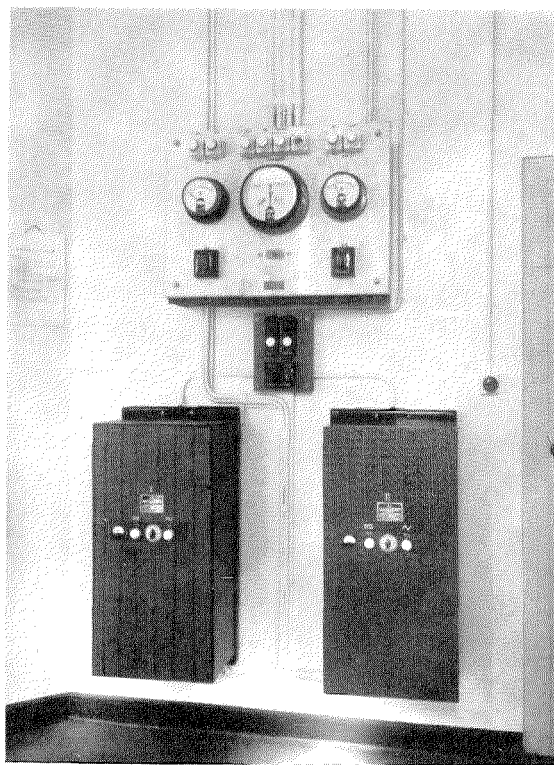

Fig. 5—Power Board and Dry Rectifiers.

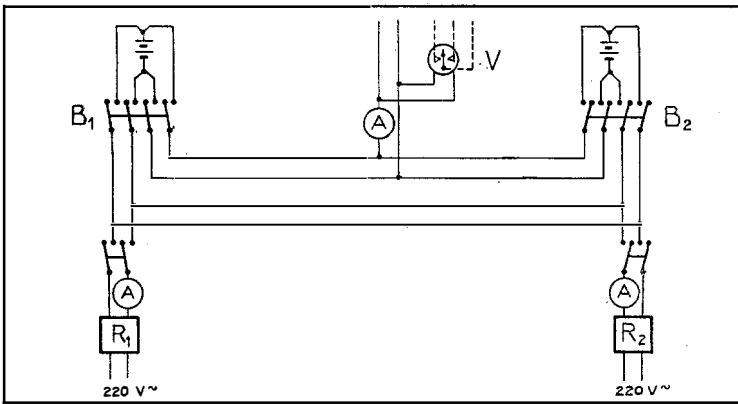

Fig. 6—Schematic of Power Plant Circuit.

of 3 positions, each with 12 cords associated with keys and lamps.

The incoming junctions are provided with a jack and calling lamp in each position, and the full line multiple of 300 numbers is represented in each position. Incoming calls are extended by means of ordinary double cords. Each cord circuit provides means for transferring incoming calls to other local subscribers. Transfer is accomplished by dialling digit 1 from the called subscriber's station whereupon the green lamp of the cord in question starts to flicker. The operator gets in on the connection by depressing the key of the cord circuit and establishes the new connection on learning the number of the wanted subscriber.

Power Plant

The power plant consists of 2 48-volt batteries, each having a capacity of 180 A.H. and charged by means of 2 220-volt A.C. 5 amp. dry rectifiers. In case of emergency the output of each rectifier, by throwing a switch, can be raised to 10 amperes by short circuiting the choke coil. The arrangement is shown schematically in Fig. 6 in which B_1 and B_2 refer to the batteries and R_1 and R_2 to the rectifiers.

The charging current from the rectifiers is taken over independent cables, and the discharge current is taken over another set of cables. In the event of repairs, the bat-

teries can be separated from the power board by means of 4-pole switches and, similarly, each of the rectifiers can be separated from the main supply as well as from the batteries.

V (Fig. 6) is a contact voltmeter which, besides recording the voltage, is arranged for starting the alarm circuit when the tension exceeds the limits prescribed.

Fig. 5 is a view of the rectifiers arranged for wall mounting and of the power board with the contact voltmeter in the centre.

Capacity of the Equipment

The equipment comprises 3 principal types of apparatus, namely, 102-point line finders, 11-point markers and relays.

Notwithstanding its simplicity, the capacity of the equipment is capable of being increased economically to 1000 lines with 3-digit numbering and to approximately 1 800 lines with 4-digit numbering. The latter figure is approximate since it is dependent on local as well as external traffic in view of the fact that the required local finals and junctions to city must be located within 100 points of the group selector arcs.

The floor plan is shown in Fig. 7. The equipment is located on a double row switch-

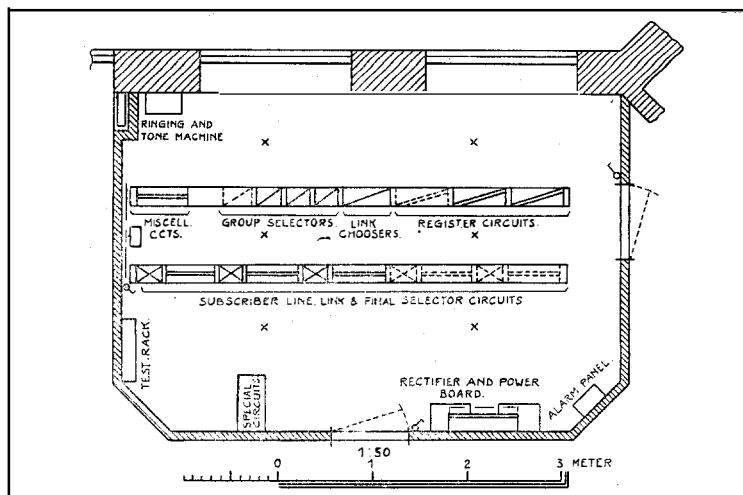

Fig. 7—Floor Plan.

rack equipped for 300 lines and having a maximum capacity of 400 lines.

Results Obtained

A similar equipment with an initial capacity of 250 lines was placed in service at "Rigs-

hospitalet," Copenhagen, 14 days after the cut-over of the "Politiken" 7-D P.A.B.X. Both equipments have fulfilled the requirements imposed and it may, therefore, be stated that the 7-D system is very well suited for large P.A.B.X. working.



View of Czeija, Nissl & Company's exhibit at the First International Congress for Short Waves held at Vienna, July 12th to 17th, showing applications of short waves in diverse fields. This display included transmitter valves and testing apparatus as well as electro-medical, ultra-short wave police radio and aircraft blind landing equipment, representing products of International System companies.

Bristol-Plymouth 12-Channel Carrier System

EDITOR'S NOTE: *The following gives an account of the carrier system operating between Bristol and Plymouth, England, and is extracted from a paper* "Modern Systems of Multi-Channel Telephony on Cables," by Col. A. S. Angwin, British Post Office, and R. A. Mack, Standard Telephones and Cables, Limited, London, presented before the Institution of Electrical Engineers on 15th April, 1937.*

(a) GENERAL DESIGN CONSIDERATIONS

THE Bristol - Plymouth 12 - Channel Carrier System was designed with a view to providing circuits which would be adequate for distances up to 400 miles and more.

A working repeater gain of the order of 60 db was regarded as the maximum practicable for a multi-channel system of the type in question. The advantages of controlling the production of carrier frequencies from a single-frequency source of high stability was an important factor in the decision to allocate equal frequency bands to all channels, though filter technique indicates that for equal quality the spacing of channels should be opened out towards the upper end of the frequency scale. A frequency of 4 kc, which was allocated for each channel, was sufficient to allow of meeting expected C.C.I.F. recommendations in regard to frequency characteristics of individual channels operated with carrier frequencies up to 60 kc, provided some improvement in existing manufacturing technique was attained. At the same time the 4-kc band was known to be sufficient to afford possibility of extension of the range of effectively transmitted audio frequencies by the use of quartz-crystal filters when the economy and stability of this type of filter should be demonstrated. Apart from the use of crystal filters, improvements in technique are likely which will enable the expected demands for still further extension of the transmitted band of speech frequencies to be met, without alteration of carrier frequencies, in later designs.

At 60 kc the contribution of skin and proximity effects to the effective resistance of pairs in telephone cables tends to become the dominating factor when the wires are increased in diameter, and it was found that little advantage

would be gained by increasing the gauge beyond 40 lb. per mile, which was decided upon. The maximum spacing of repeaters was fixed at 22 miles, corresponding to an attenuation of somewhat less than 60 db per repeater section.

(b) CABLE

Cross-talk between two pairs in a short length of cable depends upon the electrostatic unbalance coupling K and the electromagnetic coupling M between the pairs.

The electrostatic cross-talk current may be represented by ωKZ and the electromagnetic cross-talk current by $\omega M/Z$, where $\omega = 2\pi \times$ frequency, and $Z =$ the characteristic impedance of the pairs.

The technique whereby the cross-talk inherent in individual lengths of a loaded cable designed for voice-frequency working is balanced out in the field by selection of wires to be jointed is, however, based upon measurements of capacitance unbalances alone. As the frequency band to be transmitted is raised, the effect of a given unbalance, in producing cross-talk current, is increased approximately in direct proportion to frequency. The problem of eliminating cross-talk in a carrier cable is accordingly much increased and in addition it is necessary to take into account the effect of electromagnetic couplings which, by virtue of the low impedance of non-loaded pairs, plays a proportionately larger part than in the normal loaded cable for voice-frequency operation.

The use of separate cables for go and return transmissions for practical purposes eliminates near-end cross-talk between oppositely transmitting pairs, leaving distant-end cross-talk between pairs in the same cable as the major problem.

Detailed study and the construction of experimental lengths of cable indicated that it was unlikely that it would prove practicable to

* Awarded the Fahie Premium by the Council of the Institution of Electrical Engineers.

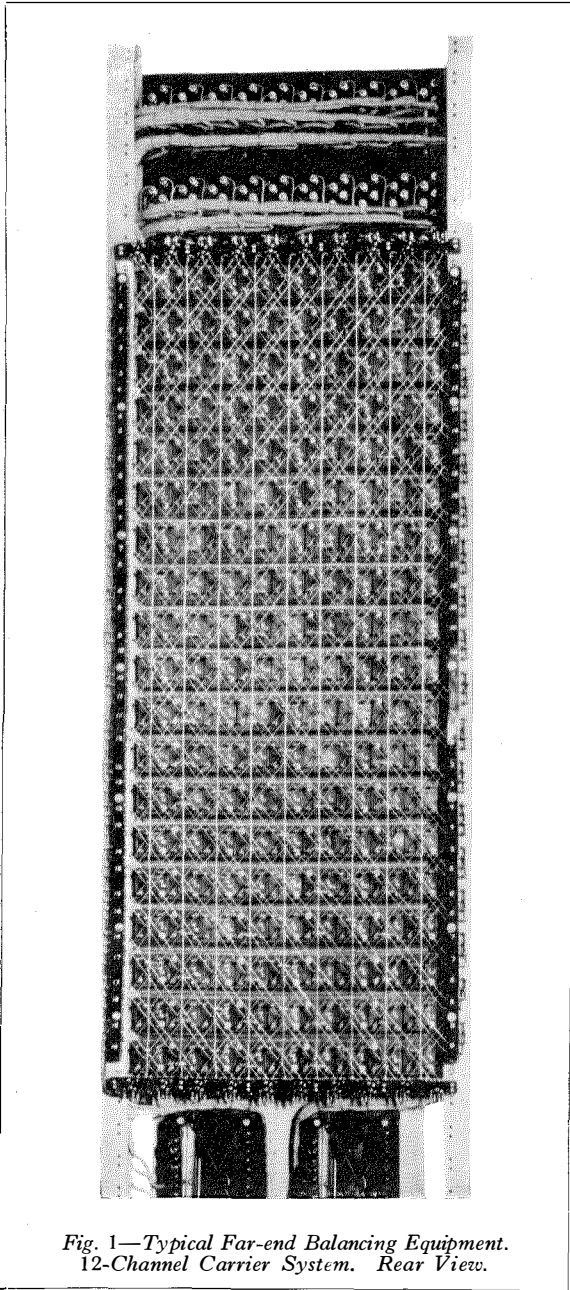

Fig. 1—Typical Far-end Balancing Equipment.
12-Channel Carrier System. Rear View.

control the accuracy of manufacture of cable within sufficiently fine limits to enable the distant-end cross-talk requirements to be met by an extension of normal voice-frequency methods of balancing in the field. Far-end cross-talk, however, unlike near-end cross-talk, results from a summation of currents, which, having traversed the whole length of cable from repeater station to repeater station, partly on

the disturbing and partly on the disturbed pair, arrive at the distant-end with definite phase relationships. It is therefore possible to correct distant-end cross-talk by means of networks of simple type connected between appropriate wires of the pairs concerned.

At voice frequencies electrostatic cross-talk between pairs in adjacent quads in the same layer is greatly reduced by arranging that quads having the same length of twist or lay shall not be adjacent, and one intermediate quad is a sufficiently good electrostatic screen between quads having the same lay. At the much higher frequencies concerned in the present case quads having the same lay, though separated by one or more quads, are electromagnetically coupled to a degree that would result in excessive cross-talk.

In addition, the coupling between quads having the same lay in positions near the lead sheath may have a considerable resistance component due to eddy currents induced in the sheath. In such cases the mutual inductance between the pairs varies widely over the frequency range, making network balancing less practicable. The resistance component is rarely entirely absent, and in the circumstances "mutual impedance" is perhaps a better term than "mutual inductance."

The cable that was designed for the Bristol-Plymouth installation was a paired cable, i.e., pairs were not twisted together in groups of two to form quads as is usual in voice-frequency cables. The chief advantages of this feature are that the higher couplings between pairs within a quad are avoided and that the effective resistance at 60 kc for a given capacitance is less than in a star-quad cable. Each cable comprised nineteen 40-lb. pairs, which was the maximum number that would permit of the two cables (with special protection) being drawn into one way of the normal 3-in. duct lines. The outside diameter of each cable is 1.1 in. Each pair was made with a different length of twist to minimize mutual impedance between pairs. To minimize increased resistance due to eddy currents induced in the sheath by pairs near the sheath, the lead sheath was spaced from the outer layer by a thick layer of insulation.

The actual spacing of repeater stations was determined by the existing stations at Taunton,

Exeter, and Tavistock, and the distances between stations vary between $21\frac{1}{2}$ and 14 miles, the average length being 18 miles. The balancing networks are accommodated in small buildings near the mid-point of each repeater section.

With a view to minimizing minor reflection effects caused by variations in characteristic impedance due to differences in capacitance per mile between successive lengths, $\frac{1}{10}$ -mile lengths of the "go" and "return" cables of each repeater section were graded separately. Lengths with average capacitance were selected for the two ends, and the remaining lengths were arranged to give a smooth gradation of capacitance.

The jointing of the two cables was carried out in such a way that side-to-earth capacitance unbalances and mutual-capacitance deviations were reduced at alternate joints. Twelve to fourteen lengths were jointed in this way, corresponding to loading section lengths, additional tests comprising loop resistance, resistance deviation, insulation-resistance and air-pressure tests being then applied. The link joints at existing loading points on the route were then made until each repeater section was built up into four approximately equal sections, after which mutual impedance, effective resistance, and inductance, were measured at high frequency as a check on theoretical calculations before making the final joints.

Both electrostatic and electromagnetic cross-talk currents are approximately proportional to frequency, and condensers bridged between appropriate wires of the pairs concerned can effect a considerable improvement in far-end cross-talk, but a more exact nullification over a wide frequency range can be obtained by the use of three-element networks which include resistance. Provision for the mounting of re-

sistances was made, but sufficient improvement was obtained with condensers alone. For each 19-pair cable 171 networks are necessary to provide for balancing all combinations. Balancing equipment is shown in Fig. 1. The differential air condensers give adequate fineness and ease of adjustment with stability. For each combination one of four different sizes of condenser was used.

Table I summarizes the cross-talk values obtained on a typical repeater section before and after connection of the balancing networks.

TABLE I
MEASURED FAR-END CROSS-TALK (IN DB) AT 60 KC
Tavistock-Moretonhampstead Repeater Station

Length of repeater section. Miles	Cable	Before balancing		After balancing	
		Mean	Max.	Mean	Max.
21.4	No. 1 ..	72.7	62.2	85.2	75.6
	No. 2 ..	72.4	64.0	85.4	74.4

One repeater section was equipped with far-end balancing networks alternatively at the mid-point and at the ends in order to ascertain the extent to which mid-section balancing is technically preferable to end-of-section balancing. The results obtained indicate that upon

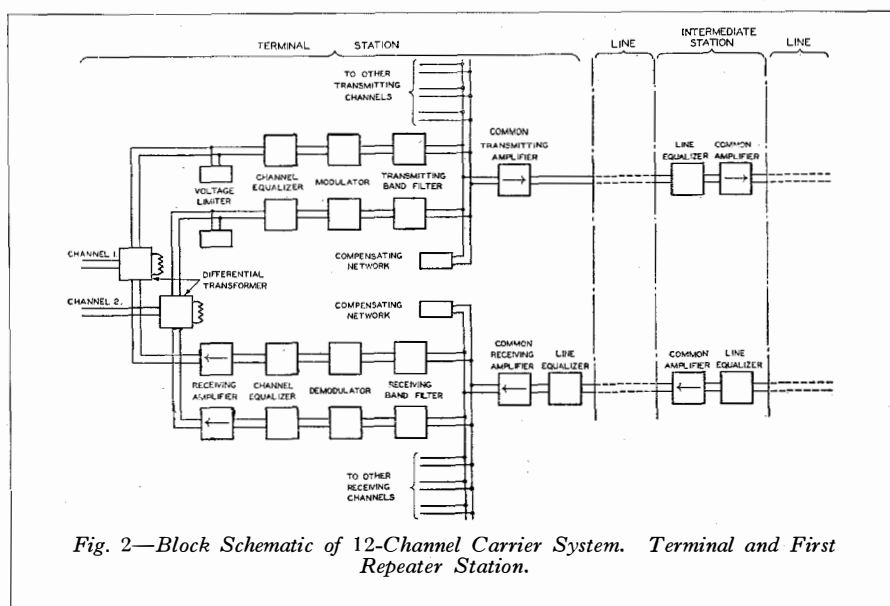

Fig. 2—Block Schematic of 12-Channel Carrier System. Terminal and First Repeater Station.

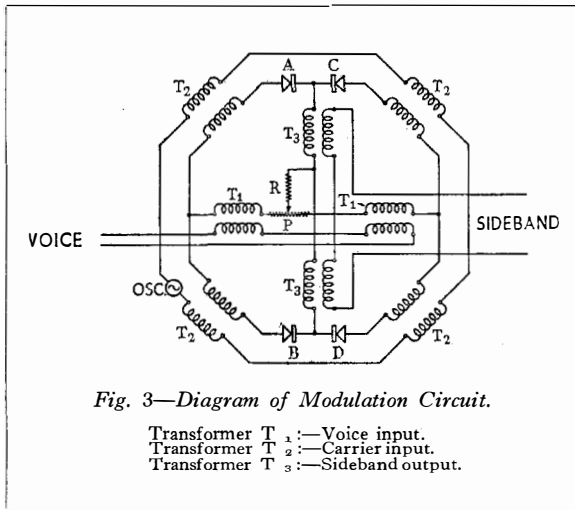

Fig. 3—Diagram of Modulation Circuit.

Transformer T₁ :—Voice input.
 Transformer T₂ :—Carrier input.
 Transformer T₃ :—Sideband output.

this cable end-of-section balancing gave results but little inferior to mid-section balancing.

A typical attenuation/frequency curve for a repeater section of 21.4 miles is given in Fig. 7.

(c) EQUIPMENT

Fig. 2 is a block schematic of equipment for one terminal of a 12-channel system and the first intermediate repeater station. The chief difference in principle from a multi-channel aerial line system is the use of separate pairs of conductors for the “go” and “return” directions of transmission, and the consequent omission of filters at the terminal and intermediate stations which would otherwise be necessary. Before

referring in detail to items of equipment the mode of operation of the equipment represented will be indicated in general terms.

At the left of the diagram are the differential transformers which are required in transmission systems operated on the “four-wire” principle (i.e., the principle of providing separate paths for the currents transmitted in the “go” and “return” directions) to combine these paths to give a two-wire connection to the switchboard. Speech currents from a subscriber, via the switchboard, will take the upper path past the voltage limiter, the function of which is to ensure that no excessively intense peak voltages shall be permitted to pass, with risk of interference to other channels by momentarily overloading the line repeaters. The currents pass to the channel equalizer, which discriminates against all the frequencies except those corresponding to the side-band frequencies which will suffer attenuation at the edges of the band in the filters which follow the modulator. (The carrier supplies to the modulators are not shown in the diagram.) The output from the modulator, which suppresses the carrier frequency, includes both side-bands, the unwanted (upper) side-band being eliminated by the band-pass filter. The band filters are teed together to the input of the transmitting amplifier, which simultaneously amplifies the high-frequency currents of all 12 channels, which then pass over a pair in the “go” cable towards the first repeater station.

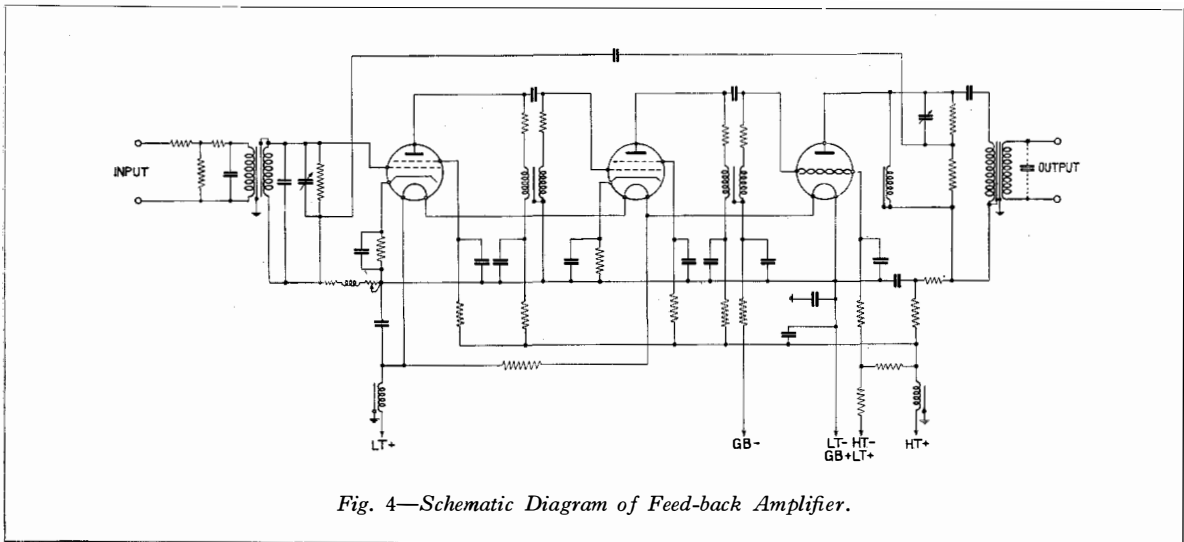

Fig. 4—Schematic Diagram of Feed-back Amplifier.

Turning to the receiving side of the equipment, high-frequency currents arriving at the terminal station from the distant end of the circuit (over a pair in the "return" cable) are attenuated in the line equalizer according to frequency in such a way as to compensate for the unequal attenuation of the line. The band filters permit currents within the appropriate frequency ranges to pass to the different demodulators and channel equalizers, and to the demodulator amplifiers which make up the losses in the demodulators, filters, etc.

The equipment has been designed to operate from the normal repeater-station voltages, viz., 130 V regulated to within ± 2.5 V for anodes, and 21 V regulated to within ± 0.25 V for filaments.

Modulator and Demodulator

A schematic diagram of the modulator circuit, of which the modulating elements are cuprous-oxide rectifiers, is shown in Fig. 3. Carrier current is supplied through coil T_2 and, depending on the phase of the carrier voltage at any time, either rectifiers A and D or B and C are in a conducting condition.

The carrier supply voltage is arranged to be large compared with the speech voltage, and the circuit then gives an approximation to square-wave modulation, and theoretically components of modulation involving only the voice and carrier with its odd harmonics should be produced, no components involving harmonics of the voice appearing. Measurements show that the level of the unwanted components of

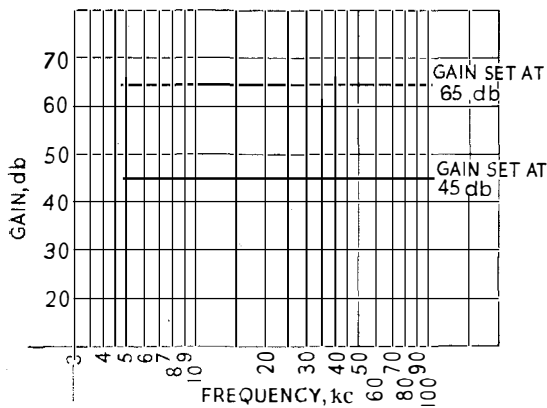

Fig. 5—Typical Gain Curves of Feed-back Amplifier.

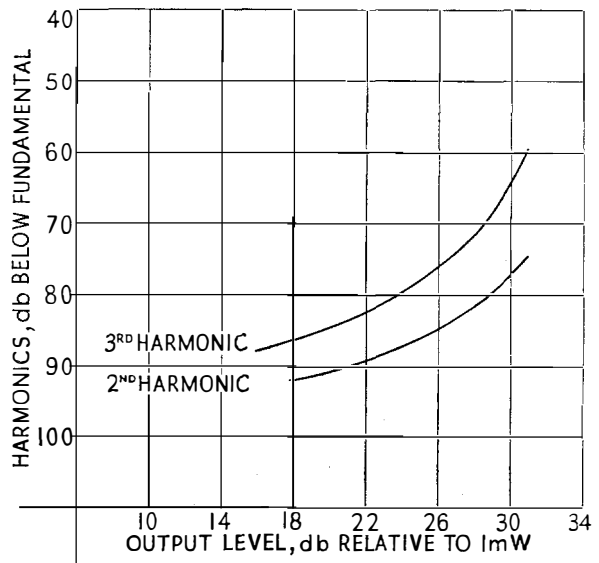

Fig. 6—Harmonic Content in Output of Feed-back Amplifier.

modulation are 45 db below side-band level, whereas in former modulators this figure has been 30 db.

The resistance R enables a useful working carrier voltage to be produced, while, as can be seen, it has no adverse effect on the voice-input circuit. The potentiometer P is introduced to enable small adjustments of balance to be made to ensure satisfactory carrier suppression, and to enable adjustments to be made to counter possible ageing effects in the rectifiers.

The limiter actually comprises a transformer stepping up to a neon tube so that any voltage peaks in excess of 1.53 volts at the entrance to the modulator will cause the neon tube to "strike" and prevent further rise in voltage. It has been found by tests on voice circuits that limitation of voltage to this extent does not have any appreciable effect on articulation.

The demodulator circuit is similar to that of the modulator, with the exception that a low-pass filter is necessary to eliminate unwanted frequencies outside the normal speech range, present as the result of the several frequency conversions.

Filters

The filters are of conventional design, electrically, consisting of inductance coils and condensers. In view of the higher frequencies involved, filter sections must be made more

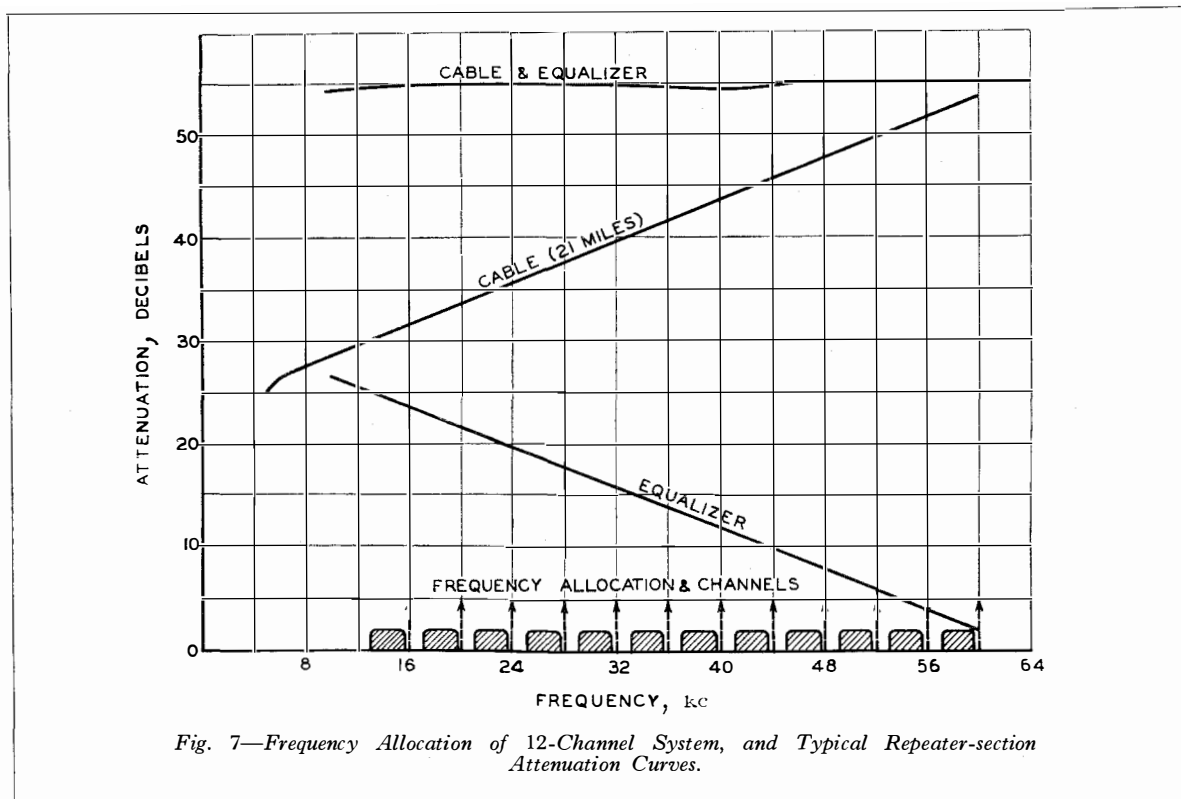

Fig. 7—Frequency Allocation of 12-Channel System, and Typical Repeater-section Attenuation Curves.

accurately than formerly, and so each arm of a filter comprising a coil and condenser in series (or in shunt) has been made into a unit and resonated to a predetermined frequency by means of a small variable condenser, before being assembled on the filter-mounting plate. In this way the accuracy of the filters has been improved so that the characteristics of the highest channels are similar to those formerly obtained at frequencies not higher than 30 kc.

Amplifiers

Equipment in repeater stations in this country has generally been designed to have input and output impedances approximating to 600 ohms, and this practice has been followed in the design of terminal equipment except the transmitting line amplifiers, which are identical with the amplifiers at the intermediate repeater stations. In these amplifiers the output impedance has been designed to match the impedance of the line (135 ohms), so avoiding the use of line transformers between the amplifier output and the line.

The receiving amplifier differs from the trans-

mitting amplifiers and the line amplifiers at the intermediate stations in having its output matched to the 600-ohm impedance of the filters.

The design of these amplifiers follows closely the principles described by H. S. Black of the Bell Telephone Laboratories. The amplifier circuit is shown in Fig. 4. It is a three-stage amplifier, the feed-back circuit being connected between the output of the last stage and the input of the first stage. A bridge circuit is inserted in the output circuit of the last valve to separate the feed-back circuit, on which the gain of the amplifier depends, from the line circuit and so to make the feed-back conditions independent of the impedance of the line to which the amplifier is connected. Gain is controlled in the feed-back path by means of a potentiometer which permits continuous variation of the gain within a range of 20 db. The amplifier can give an overall maximum gain of 65 db, and provision is therefore made for initial gain settings of the amplifier to be made by means of attenuation pads.

The remarkably flat gain/frequency char-

acteristic, typical of a well-designed feed-back amplifier, is clearly shown in Fig. 5. More important, however, is the very low value of non-linear distortion which is possible in this type of amplifier. The levels of harmonics in the output from a typical amplifier resulting from a pure sinusoidal input are shown in Fig. 6.

These low values of harmonic content enable 12 channels to be operated each at an output

level 5 db above the level of speech at the switchboard without production of excessive noise.

Most important perhaps of all, when the number of amplifiers in any long distance connection is considered, is the almost complete immunity of the amplifier gain from variations due to changes in power supplies, whether caused by the discharge of batteries or variations of mains voltage. In the amplifier discussed

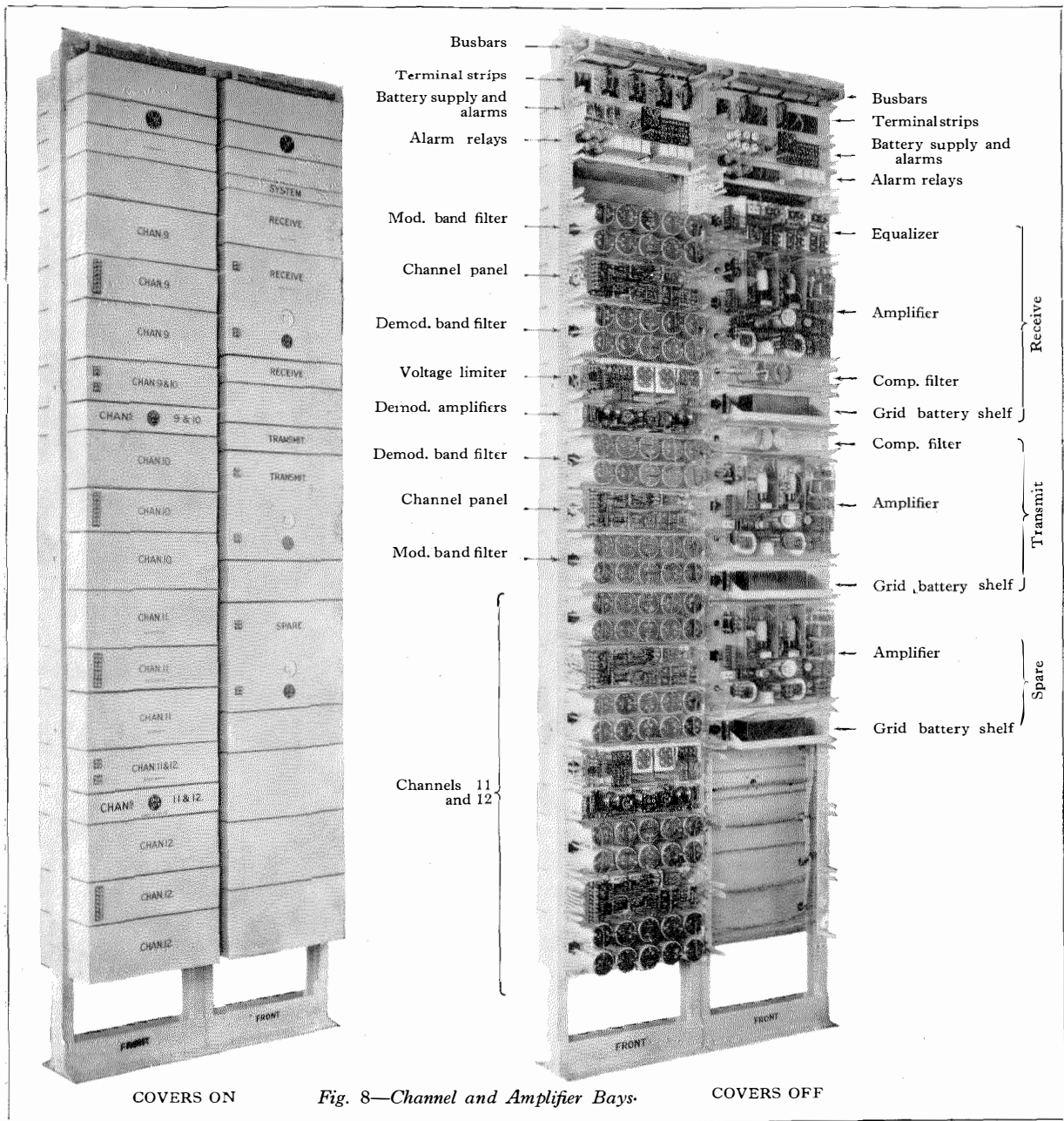

COVERS ON

Fig. 8—Channel and Amplifier Bays.

COVERS OFF

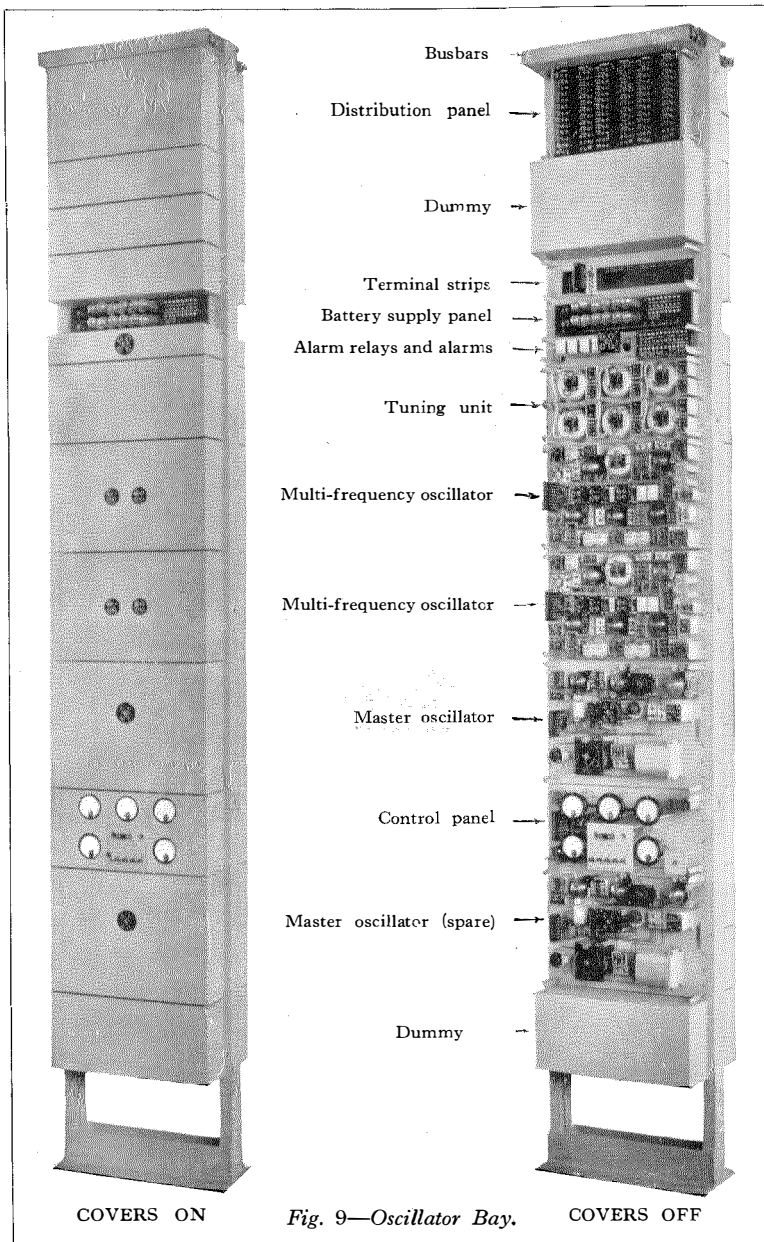

Fig. 9—Oscillator Bay.

here, a change of 10 volts in the anode voltage (130 V) will produce a change in gain of less than 0.1 db.

Equalization

The loss in the feed-back circuit of a negative feed-back amplifier determines the gain/frequency characteristic of the amplifier. The loss in the feed-back circuit of the amplifiers actually installed is constant over the range of frequencies for which the gain characteristic has been

plotted in Fig. 5. If the loss had been made to simulate the repeater section loss (Fig. 7), the gain/frequency characteristic of the repeater would have been that required to offset exactly the attenuation of the line at all frequencies. Equalizing by a network in the feed-back circuit in this way, however, involves considerable difficulties in design due to the phase shift added by the network and complication of the gain controls. Further, if this method of equalization had been adopted it would not have been possible to make practically similar amplifiers for all purposes. The amplifiers were therefore designed to give flat gain/frequency characteristics, and line equalization was effected by means of external networks.

Each equalizer consists of constant resistance networks, the basic equalizer being made for a repeater section of approximately 13 miles, which was assumed to be the smallest likely to be encountered in practice. Small networks to provide for additional lengths of $6\frac{1}{2}$, $3\frac{1}{4}$, and $1\frac{1}{2}$ miles, are mounted with the basic equalizer so that, by means of soldered connections, equalization can be adjusted to fit the particular repeater section involved. A typical equalizer

characteristic is shown in Fig. 7 against the repeater-section attenuation/frequency curve for which it was adjusted. The frequency allocation of the Bristol-Plymouth carrier system is indicated at the bottom of the diagram.

Carrier-Frequency Supply

All channels have carrier frequencies which are multiples of 4 kc, and the oscillators which generate the carrier frequencies are all locked to a supply of this frequency. The master

oscillator is, therefore, a three-valve oscillator of good stability which generates at 4 kc. The individual carrier frequencies are generated by multi-frequency oscillators, each of which produces three of the required frequencies.

In principle, each of these consists of an oscillator circuit tuned broadly to the middle frequency of the three to be generated. A frequency of 4 kc from the master oscillator is injected into the oscillating circuit, and the appropriate harmonic of this serves to control the oscillator frequency in a well-known manner. In addition to the middle frequency oscillation of the panel a 4-kc modulation of this frequency is produced, with the result that the circuit produces a middle frequency f_m and also $(f_m - 4 \text{ kc})$ and $(f_m + 4 \text{ kc})$. These frequencies are separated by means of tuned circuits and valves to provide three of the carrier frequencies.

Each frequency is led to a distribution panel at the top of the oscillator bay and thence to 12 modulators and 12 demodulators through independent circuits, the bay thus catering for 12 complete systems. Connection between oscillator supply and system on the distribution panel is made by means of U links which connect the supply either to a channel or to an equivalent resistance, so that each carrier supply is operating always into an approximately constant load.

In view of the dependence of the station on its master oscillator it has been thought desirable to duplicate this equipment in each terminal station. A control panel equipped with meters is therefore supplied which provides for switching-in the reserve oscillator without interruption.

Layout of Equipment

In mounting the various units on rack frameworks, it has been found possible to accommodate a complete 12-channel terminal (less carrier supply apparatus) on the four sides of two 10 ft. 6 in. \times 20½ in. bays. A terminal is shown in Fig. 8. The method of mounting resembles that now used for repeater equipments, but there is one important difference. This is that the jack or U link field, normally used in present practice, has been replaced by U links mounted on the individual panels. The reason for this change of practice lies in the desire to avoid, as far as possible, all but the shortest connections between panels, and by

abandoning the central jack field it has been possible to save the wiring which would have led from panel to jack field and back.

The channel bay, one of the two forming a 12-channel terminal, carries equipment for eight channels, four on the front and four on the back of the bay. Each channel panel comprises modulator and demodulator. Modulator band filter and demodulator band filter are mounted on separate panels.

The amplifier bay, which completes the

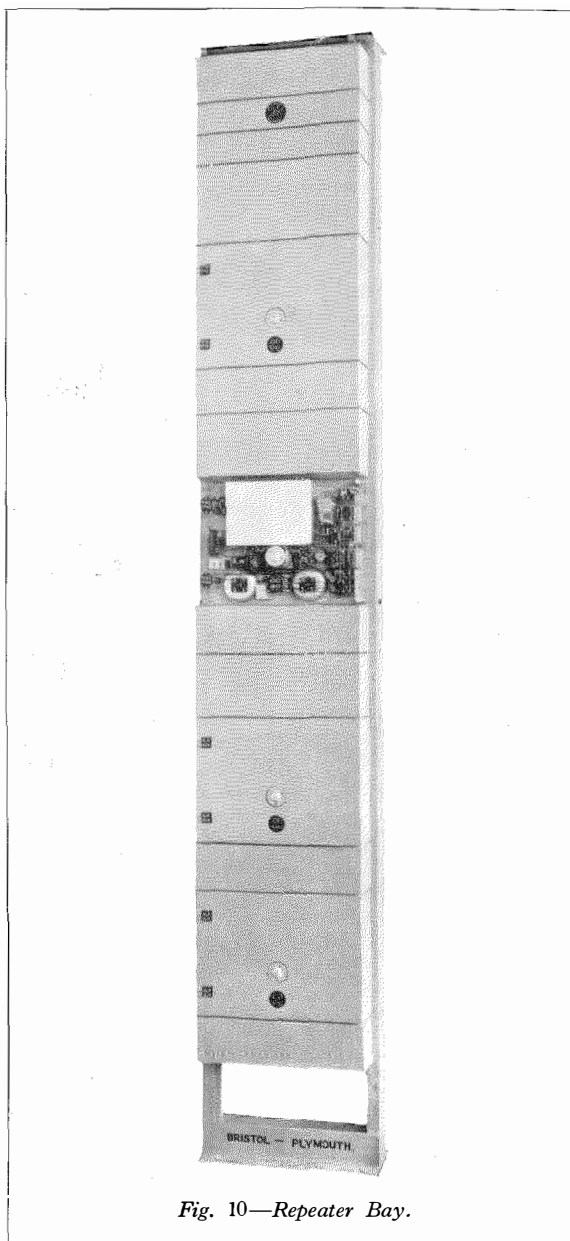

Fig. 10—Repeater Bay.

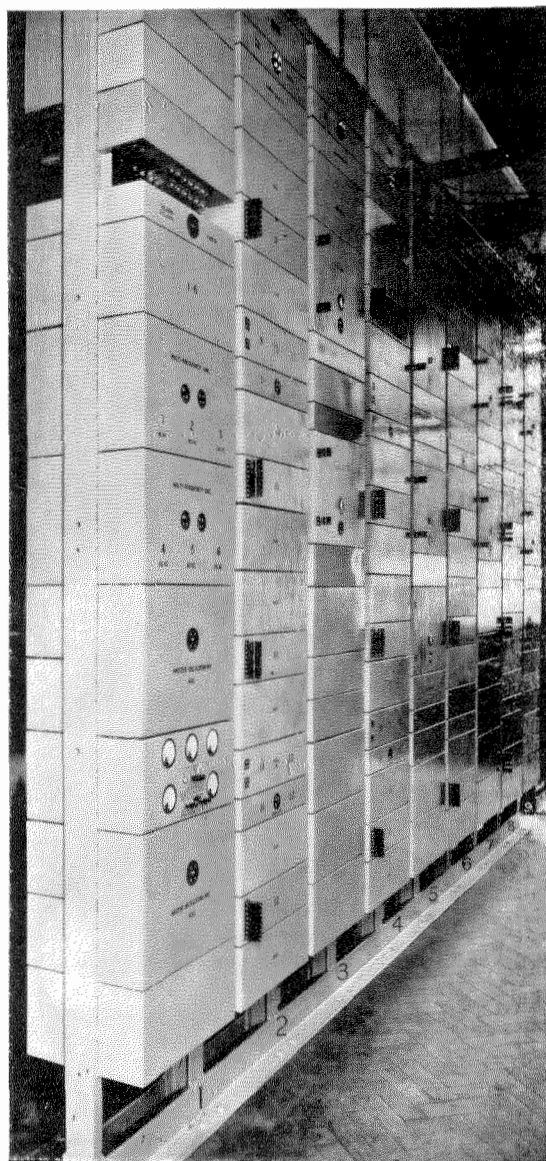

Fig. 11—Typical Terminal Station.

- | | |
|--|--|
| 1. Oscillator bay. | 6. Channel bay. |
| 2. Channel bay. | 7. Channel and amplifier bay (system 3). |
| 3. Channel and amplifier bay (system 1). | 8. Channel bay. |
| 4. Channel bay. | 9. Channel and amplifier bay (system 4). |
| 5. Channel and amplifier bay (system 2). | |

12-channel unit, carries equipment for four channels on one side and the common apparatus on the other; this consists of transmitting amplifier, receiving amplifier, equalizer, and compensating filter, together with the necessary power supplies and alarm features.

The complete carrier-frequency supply equipment for 12 systems is mounted on one 10 ft. 6 in. bay, the equipment of which is

shown in Fig. 9. The two master oscillators, and four multi-frequency oscillators (two on the front and two on the back of the bay), together with the control panel and the distribution panels, are indicated.

A typical repeater bay for installation at an intermediate repeater station is shown in Fig. 10. The amplifiers and associated panels are mounted four on each side of a 10 ft. 6 in. bay. Associated with each of 6 repeater amplifiers is a line equalizer and a grid supply panel from which the grid priming voltage necessary for the output valve is obtained. The two remaining amplifiers are available as spares. The amplifiers for use in the "go" direction are mounted on one side of the bay and those for the "return" direction on the other.

Figs. 11 and 12 are typical views inside terminal and intermediate stations, respectively.

Routine Testing

Measurements are made by means of level-measuring sets, in most cases of a portable type. In addition to the level-meter the set incorporates a "sending circuit" which enables a specified level to be applied to the transmission circuit at desired points.

A point of interest in connection with feedback amplifiers is that the measurement of amplifier gain is no longer a useful indication of the state of the valves. This follows from the fact that the amplification depends on the feedback rather than on the "gain" path, and power changes and changes of valve characteristic due to age or to actual change of valve, do not affect the gain given by an amplifier. It is, in fact, possible for a measurement of the amplifier, equipped with valves that are seriously defective from the point of view of emission, to indicate the normal gain value. The amplifier characteristic which would show the amplifier to be faulty in such a case is of course that which indicates the amount of harmonics produced, and it accordingly follows that the correct routine test for an amplifier of this nature is a measurement of valve characteristics or of harmonic content rather than a measurement of gain.

The remaining equipment is entirely static with the exception of the demodulator amplifier, for which ordinary routine methods of maintenance suffice.

(d) FIELD TESTS AND OVERALL SYSTEM RESULTS

Tests were made in the field on the individual terminal and repeater stations and on the completed circuits, both Bristol to Exeter (three intermediate repeaters with a total length of 76 miles), and Bristol to Plymouth (6 repeaters with a total length of 123 miles).

The input impedances of repeaters (and terminal amplifiers) were found to match the cable to such an extent that singing points, as calculated with reference to the cable impedance, of approximately 26 db, were obtained at all frequencies from 12 to 60 kc. The output impedances, while giving approximately the same values of singing points down to 20 kc, fell off to 20 db at 12 kc, but this is well in excess of actual requirements.

Cross-talk between repeaters operating in the same direction was measured, and with the amplifiers set on maximum gain the worst figure obtained at a frequency of 60 kc was 80 db. At lower frequencies the results were considerably better.

The overall line characteristics taken at carrier frequencies on the whole repeatered circuit from Bristol to Plymouth (including the receiving amplifiers at Plymouth) showed a total variation, down to a frequency of 20 kc, of less than 1 db. The total variation of output level at any repeater station was found not to exceed 2 db over the range required for the 12 channels, and the overall equalization was such that the effect on the frequency characteristic of any one channel was almost negligible.

The overall loss/frequency characteristic of each channel was measured on all systems in both directions on a 4-wire basis (i.e., not including 4-wire terminating sets). Typical curves obtained on Exeter-Bristol system 3 are shown in Fig. 13 together with the specified limits.

With the circuit set up for zero equivalent, 2-wire to 2-wire, noise measurements were made at the 2-wire side of the 4-wire terminating set at a point of zero level with a psophometer equipped with a weighting network as recommended by the C.C.I.F. With no speech on any of the circuits the measurements showed that the noise was approximately the same on all channels and on the Bristol-Exeter circuits

averaged 0.22 mV, under C.C.I.F. conditions of measurement.

Inter-channel interference was measured at points of zero level on the 2-wire side of the terminating sets with the circuits lined up to give zero equivalent 2-wire to 2-wire. At the distant end, arrangements were made for 11 persons to talk continuously and simultaneously into the channels at a level 12 db below reference volume. At the receiving end the



System 1-3 and
spare amplifier.

System 4-6 and
spare amplifier.

Fig. 12.—Typical Repeater Station.

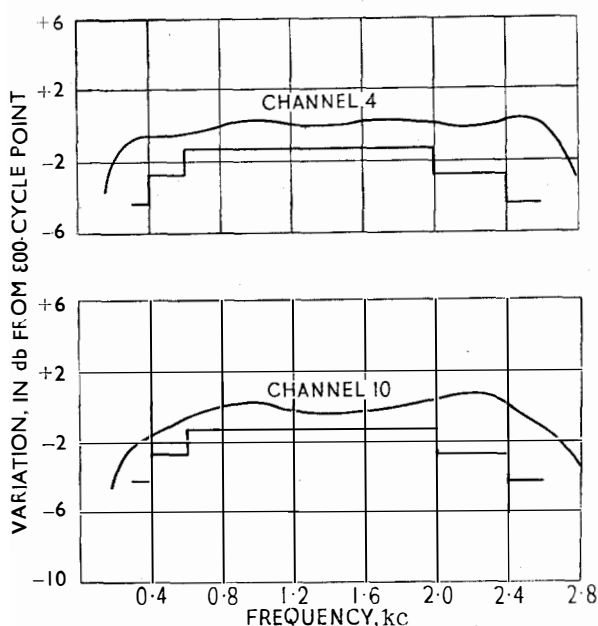

Fig. 13.—Overall Loss/Frequency Characteristics of Typical Channels.

noise voltage was then measured on the disengaged channel with a psophometer having a weighted frequency response. An average figure for the noise voltages obtained under the above conditions on the Exeter-Bristol systems was 0.4 mV under C.C.I.F. conditions of measurement* and the complete figures for the three Exeter-Bristol systems are shown in Table II.

Table II also shows figures for system 2 when the level of all the talkers has been raised to approximately 3 db below reference level. While these figures are naturally considerably higher than the previous ones, it will be seen that they are still well within the limit of 2 mV, showing that the system has ample margin.

In order to make some estimate of the effect of connecting systems in tandem, arrangements were made on one of the Bristol-Plymouth systems to loop back the channels on the 2-wire sides. Using 3 channels in tandem, the quality as judged by ear was no different from that obtained on the normal circuit between Bristol and Plymouth. With 6 channels in series the quality was still good but some slight deterioration could be detected. As a final test the whole

*See Bibliography (21).

12 channels were looped back on one another, when it was found that, if the gains were suitably adjusted so as to give an overall equivalent of 3 db, the speech, although considerably degraded, was still easily understandable. This last case is equivalent to a circuit approximately 1 500 miles in length, in which the signals pass through 96 repeaters in tandem.

The degradation referred to was, of course, due chiefly to the accumulation of terminal distortion and would not be present on circuits

TABLE II

CROSS-TALK ON EXETER-BRISTOL SYSTEMS

(All readings are in millivolts, under C.C.I.F. conditions of measurement.)

Channel	Talking level—12 db. System :—			Talking level— 3 db. System :—
	1	2	3	2
1	0.4	0.34	0.4	0.9
2	0.38	0.34	0.35	1.2
3	0.42	0.4	0.38	1.4
4	0.35	0.4	0.32	1.2
5	0.38	0.36	0.38	0.85
6	0.46	0.36	0.38	1.1
7	0.44	0.4	0.38	0.9
8	0.45	0.4	0.4	0.85
9	0.38	0.4	0.46	1.2
10	0.38	0.4	0.38	1.3
11	0.38	0.4	0.4	1.1
12	0.45	0.36	0.3	0.8

of the same total length with carrier-modulating equipment provided only at its ends.

Equipment for 3 Bristol-Exeter systems (36 circuits) and 3 Bristol-Plymouth systems (36 circuits) has been installed, 31 circuits being brought into service during December, 1936. The number of circuits in service at the end of January, 1937, was 48, and of these a large proportion are extended, four-wire, on audio circuits, including London circuits. A further installation of carrier equipment on the Bristol-Plymouth cables is in hand.

The results obtained on the Bristol-Plymouth installation have justified the expectations with which the experiment was launched, and in the planning of the trunk network of this country 12-channel carrier has already taken its place as the premier means of providing additional long circuits.

SELECTED BIBLIOGRAPHY

(Abbreviations. *A.I.E.E.*—American Institute of Electrical Engineers; *B.S.T.Ĵ.*—Bell System Technical Journal; *E.E.*—Electrical Engineering; *E.F.D.*—Europäischer Fernsprechdienst; *E.T.Z.*—Elektro-technische Zeitschrift; *I.P.O.E.E.*—Institution of Post Office Electrical Engineers.)

- (1) H. S. BLACK: "Stabilized Feed-back Amplifiers," *E.E.*, 1934, vol. 53, p. 114.
- (2) E. K. COLPITTS and B. BLACKWELL: "Carrier-Current Telephony and Telegraphy," *A.I.E.E. Transactions*, 1921, vol. 40, p. 205.
- (3) H. S. BLACK: "Carrier System for Short Toll Circuits," *A.I.E.E. Transactions*, 1929, vol. 48, p. 117.
- (4) H. A. AFFEL, C. S. DEMAREST, and C. W. GREEN: "Carrier Systems on Long-Distance Telephone Lines," *B.S.T.Ĵ.*, 1928, vol. 7, p. 564.
- (5) N. W. LEWIS: "The Carrier System No. 3," *I.P.O.E.E. Journal*, 1936, vol. 29, p. 152.
- (6) R. J. HALSEY: "A Simplified Carrier Telephone System for use on Open Lines," *I.P.O.E.E. Journal*, 1933, vol. 26, p. 90.
- (7) H. W. HITCHCOCK: "Carrier Current Communication on Submarine Cables," *E.E.*, 1926, vol. 45, p. 923.
- (8) H. A. AFFEL, W. S. GORTON, and R. W. CHESNUT: "A New Key West-Havana Carrier Telephone Cable," *B.S.T.Ĵ.*, 1932, vol. 11, p. 197.
- (9) N. W. V. HAYES and C. ANGUETIL: "Mainland-Tasmania Cable," *Telecommunication Journal of Australia*, 1936, p. 81.
- (10) "The 1935 Bass Strait Telephone Cable," *Siemens Magazine (Engineering Supplements)*, January and July, 1936.
- (11) "Australia-Tasmania Cable," *Electrical Communication*, 1936, vol. 15, p. 19.
- (12) A. B. CLARK and B. W. KENDALL: "Carrier in Cable," *E.E.*, 1933, vol. 52, p. 477.
- (13) A. H. DE VOOGT: "A New Telephone System in Holland," *I.P.O.E.E. Journal*, 1932, vol. 25, p. 195.
- (14) K. DOHMEN and H. F. MAYER: "Carrier-Frequency Systems for Trunk Cable Circuits," *E.F.D.*, 1934, No. 34, p. 11.
- (15) G. WÜCKEL: "The Occurrence and Nature of the Magnetic Cross-talk Couplings in Telephone Cables," *E.F.D.*, 1934, No. 34, p. 18.
- (16) A. C. TIMMIS: "Recent Developments in Long Distance Telephony," *I.E.E. Journal*, 1936, vol. 78, p. 601.
- (17) R. J. HALSEY: "Recent Advances in Carrier Telephony," *I.P.O.E.E. Professional Paper*, No. 157.
- (18) E. J. WOODS: "Reconditioning Telegraph Circuits for Audio and Carrier Working," *I.P.O.E.E. Journal*, 1934-35, vol. 27, p. 133.
- (19) R. J. HALSEY and D. P. MILLAR: "Carrier System No. 4," *I.P.O.E.E. Journal*, 1936-37, vol. 29, p. 226.
- (20) A. B. CLARK: "Wide-Band Transmission over Balanced Circuits," *E.E.*, 1935, vol. 54, p. 27.
- (21) C.C.I.F. LIVRE BLANC (tome 1 bis): "Psophometric E.M.F.," p. 65.

Picture Transmission Using "Time Modulation"

By MASATSUGU KOBAYASHI,

Nippon Electric Company, Limited, Tokyo, Japan

Introduction

IN transmitting pictures by short wave radio, the ordinary amplitude modulation system of transmission is considerably affected by the so-called fading effect, and a number of dark lines appear on the picture surface, such as shown in Fig. 1. It is quite evident that if amplitude is taken as the element determining



Fig. 1—Effect of Fading on Picture Transmitted Using Amplitude Modulation.

the colour tone of pictures, they will most likely be badly affected when they are transmitted by circuits of unsteady amplitude characteristic. Various methods, therefore, have been devised

for picture transmission without resorting to amplitude modulation, viz., frequency, phase and time modulation. Transmissions by frequency modulation and phase modulation have been investigated but, due to certain difficulties in applying them in practice, they have not as yet actually been used. Transmission using time modulation has, however, been found to be very practicable.

The author has succeeded in devising a system of time modulation utilising a gas-filled discharge tube and subsequently in obtaining time modulation by means of an oscillograph vibrator. This last method is so successful and satisfactory that various trial transmissions have been conducted by Teishinsho between Tokyo and Formosa in 1935, and also between Tokyo and Berlin in August, 1936, between Tokyo and London in January, 1937, and between Tokyo and San Francisco in April, 1937.

The two above-mentioned ways of applying time modulation in a picture transmission system are briefly presented in the following pages.

Time Modulation Using a Gas-filled Discharge Tube

The moment at which a gas-filled triode starts its discharge varies with the grid and plate voltages; but, after the discharge has started, the plate current is no longer affected by the grid voltage. By utilising these characteristics, a system of time modulation was obtained, a No. 277-A gas-filled triode being used (argon-filled side-heater type). The plate voltage at which the discharge takes place is a function of the grid voltage, as shown in Fig. 2.

By applying a voltage such as shown in Fig. 3 (a), which is proportional to the tone values of the picture, together with the saw-tooth voltage shown in (c) to the grid of the

gas-filled triode, and by impressing an interrupted voltage (b) of the same frequency and phase upon the plate, discharge currents such as (e) will flow with durations proportional to the tone of the picture. A time modulated current of constant frequency is obtained in this way, the circuit shown in Fig. 4 being utilised.

Voltages of a saw-toothed shape can easily be made available by using a gas-filled triode. By inserting a resistance and a condenser in the plate circuit of the discharge tube (277-A) as in Fig. 4, a constant frequency, saw-toothed waveform oscillation can be produced and applied to a bridge circuit. The bridge consists of 3 resistances and an inductance. The voltage drop across the inductance will be the differential value of the supplied current. The waveform of (b) Fig. 3 will then be obtained and be supplied to the plate circuit of the last 277-A tube. If a picture current such as (a) Fig. 3 be impressed at "Input" in series with a resistance arm of the bridge, the grid voltage of the last 277-A tube will have the waveform of (d) Fig. 3. Thus the time modulated wave (e) Fig. 3 in the plate current of the last 277-A tube can be obtained. Fig. 5 is a

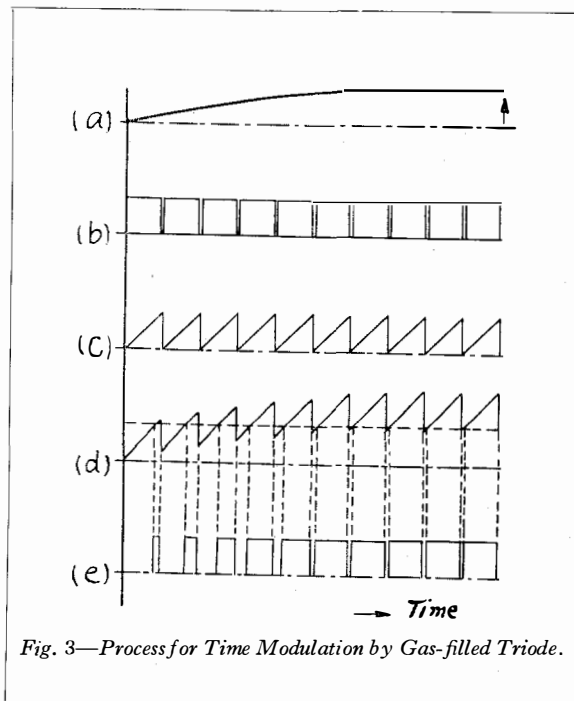

Fig. 3—Process for Time Modulation by Gas-filled Triode.

reproduction of the oscillogram showing currents thus produced. The upper curve represents the current corresponding to the tone value of a picture, and the lower curve, the time modulated current.

Optical Time Modulation System Using an Oscillograph Vibrator

Fig. 6 shows diagrammatically the method of obtaining the time modulated current using an oscillograph vibrator. Light coming from the lamp through lens (I) passes into screen (I) which has a very narrow slit, passing only a very narrow strip of light. The beam thus reaching the vibrator is reflected by a mirror to screen (II). By applying both the picture current and the saw-tooth current to the vibrator, the reflected beam is made to vibrate, and the amount of the light passing through screen (II) will then be time modulated in accordance with the tone values of the picture. The light is further interrupted by a rotating toothed wheel and falls upon a photoelectric cell from which is obtained the interrupted carrier current, the dashes of various lengths being proportional to the corresponding tone values of the picture.

Fig. 7 shows diagrammatically the results achieved with the converting mechanism of

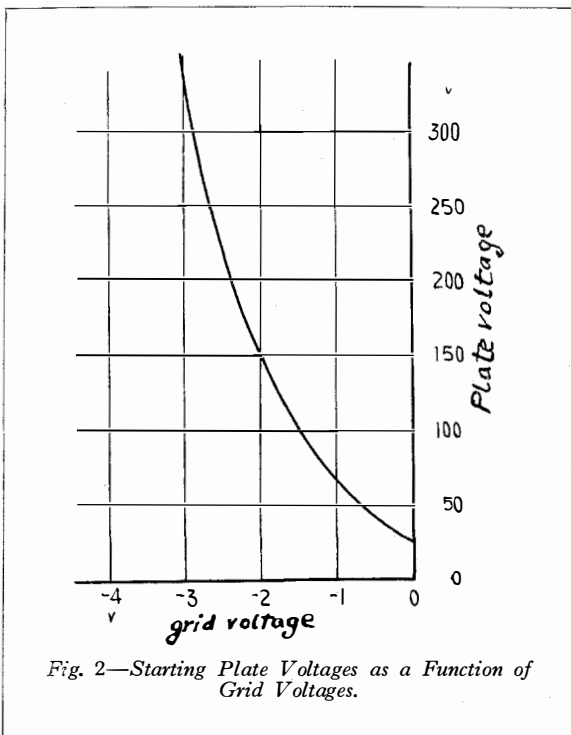

Fig. 2—Starting Plate Voltages as a Function of Grid Voltages.

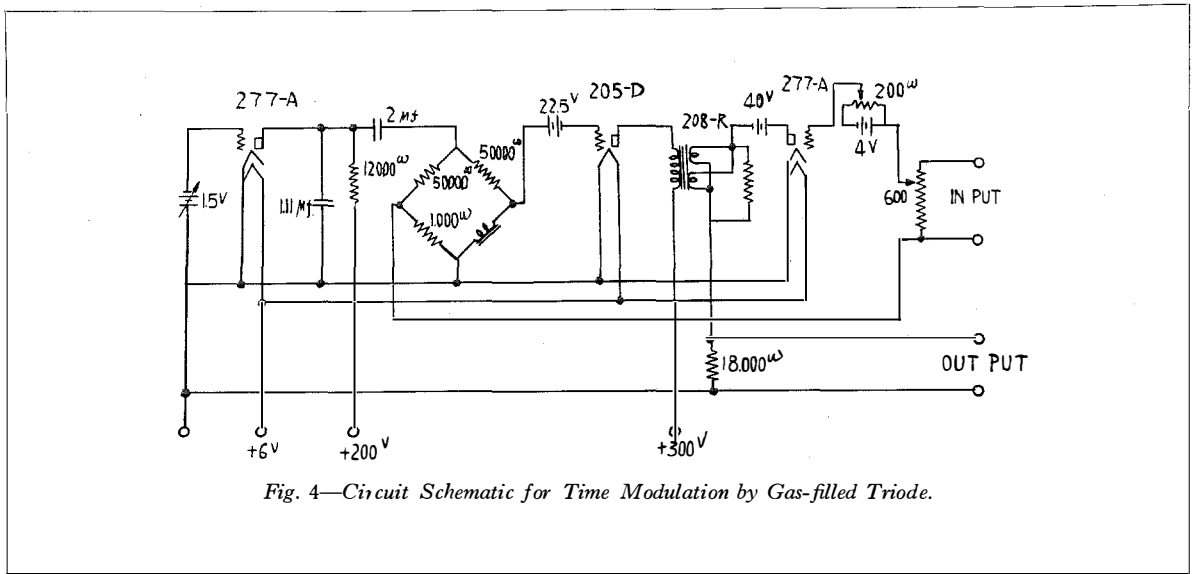

Fig. 4—Circuit Schematic for Time Modulation by Gas-filled Triode.

Fig. 6; (a) represents the current that varies according to the tone values of the picture. The curve (b) is a current of saw-tooth waveform which can be obtained by an oscillator using a gas-filled discharge tube or by some similar method. These two superposed currents flowing in the vibrator and producing a waveform similar to (c) cause the vibrator to vibrate according to the waveform. By placing a screen (II) in a position to cut off all light below the dotted line in (c) and allowing only the upper portion to pass through the screen, a time-modulated light beam is obtained. This process will be more apparent by reference to Fig. 8 in which the shaded portions of the drawing represent the screen (II) which cuts off

the light when the beam falls upon it. When the light reaches the edge of the screen it will pass freely, and as the beam is very narrow the amount of light in any position such as (a) or (b) remains the same. Consequently the waveform of the light passing at the side of the screen may be represented by A in Fig. 8 and also corresponds to the part of the waves designated by A in Fig. 7 (c). Similarly, B in Fig. 8 corresponds to B in Fig. 7 (c), and C in Fig. 8 to C in Fig. 7 (c). The time modulated beam may be represented by (d) in Fig. 7. For dark parts of the picture the dashes will be long while, for white parts, they will be short, the length being proportional to the colour tones of the picture. After translating the light, such as

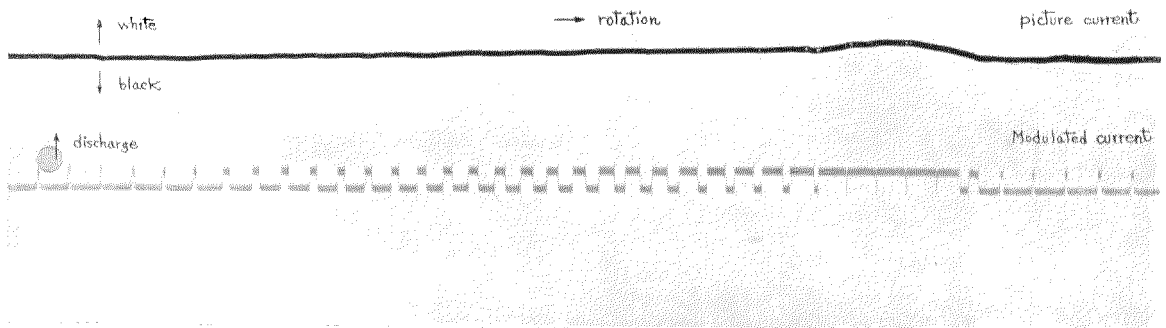

Fig. 5—Oscillogram for Time Modulation by Gas-filled Triode.

indicated by (d) in Fig. 7, into electric current by means of a photoelectric cell, it is possible to transmit the picture; but, in cases where the picture transmitter is located at a considerable distance from a radio transmitting station, it is more convenient to send it by carrier current. As indicated in Fig. 6, a rotating wheel is therefore inserted in the path of the beam to interrupt the light at the carrier frequency, after which it is allowed to fall on the photoelectric cell, thus in turn producing current of the character shown in Fig. 7 (e). This current after amplification and filtering becomes similar to that shown in Fig. 7 (f), and can be sent to the radio transmitter through a toll line equipped with repeaters.

By means of the above method of obtaining a time modulated current using a vibrator, an experimental transmission was conducted with

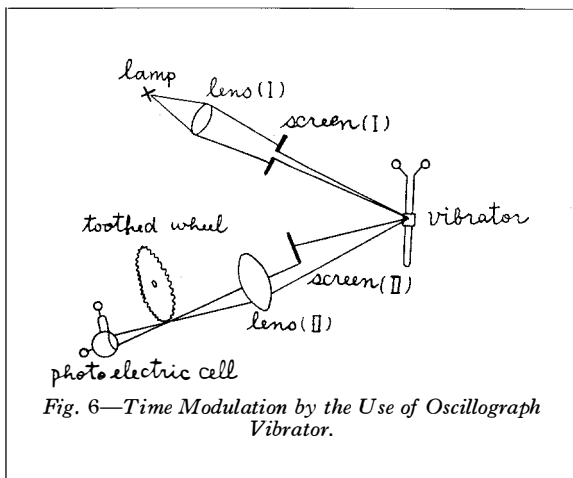

Fig. 6—Time Modulation by the Use of Oscillograph Vibrator.

an equipment which will be described in outline form. The equipment is shown schematically in Fig. 9.

For the tone current of the picture, such as (a) of Fig. 7, the light from the picture might be changed to an electric current by a photoelectric cell and amplified to a suitable value, but for this purpose much difficulty would be encountered in using a D.C. amplifier. A carrier current method was therefore adopted. The amplified current is brought to the input of the modulator where it is rectified and then passed through the filter (I). The carrier current is eliminated here so that only the picture current remains. The filter (I) is a low pass filter with

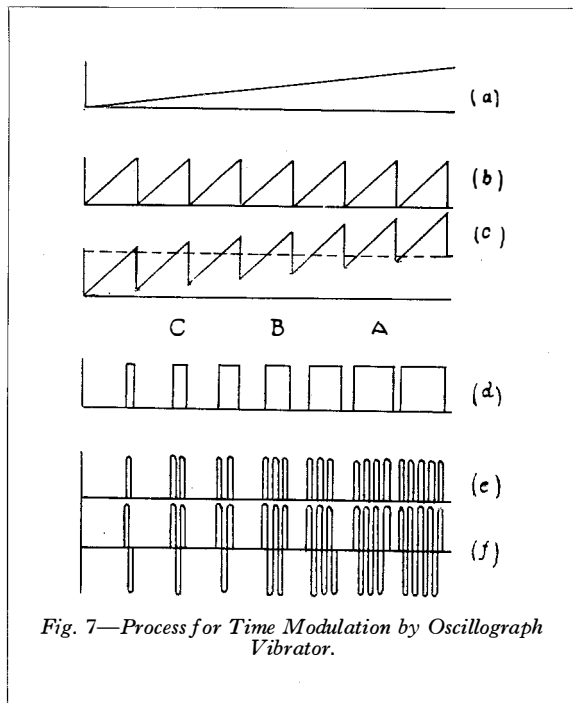

Fig. 7—Process for Time Modulation by Oscillograph Vibrator.

a cut-off frequency of 1 000 cycles, and is connected in series with the dot frequency oscillator and the vibrator. The light from the source, being reflected by the mirror of the vibrator, is time modulated as in (d) of Fig. 7. The current coming from the photoelectric cell is amplified and then filtered by the high-pass filter, which eliminates the waveform (f) of Fig. 7, and is then sent out to the telephone line. In Fig. 10 are shown oscillograms of an amplitude modulated input current and of a time modulated carrier current. The frequency of the interrupted light beam is taken at 2 300 p : s and the cut-off frequency of the high-pass filter (II) at 1 600 p : s. At the radio transmitting

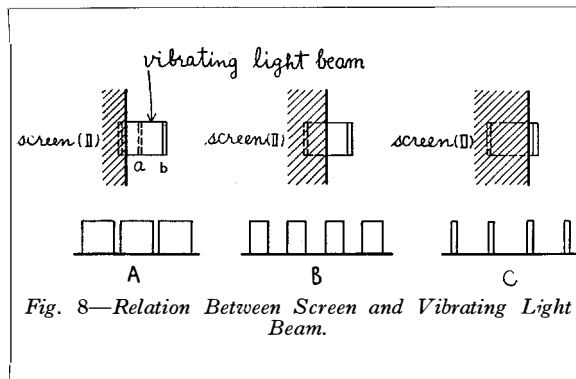
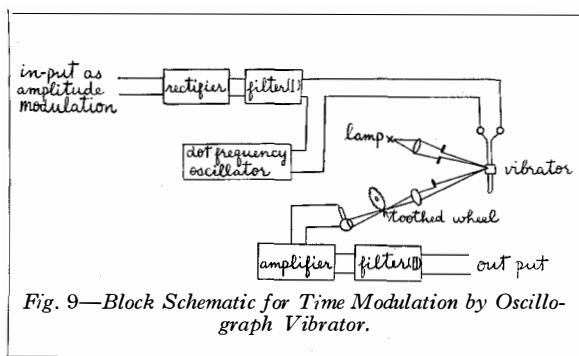

Fig. 8—Relation Between Screen and Vibrating Light Beam.



station, after being amplified to a suitable level, the current is again rectified and passed through a low-pass filter in order to eliminate the carrier current. This current then operates the keying for the transmitter and the radio energy is discharged through the antenna with a definite dot frequency. The length of each dot is approximately proportional to the tone value of the picture.

Reception of Time Modulated Waves

The waves thus transmitted are received at the receiving station by an ordinary heterodyne receiver, rectified, and then passed through a current limiter to eliminate the effect of fading.

The resulting current operates the keyer of the local oscillator (about 3000 cycle frequency), the output of which is led into the picture receiving equipment.

The employment of this time modulated carrier current of waveform such as (f) of Fig. 7 for picture reproduction may be accomplished in the following two ways :

- (1) The method of reproduction employing rectified carrier current ;
- (2) The method of reproduction employing unrectified carrier current.

In method (1), referring to Fig. 11, the received carrier current is first amplified, then rectified and, after passing through the filter to eliminate the carrier current, is finally conveyed to the vibrator. The light from the source is converted into a narrow beam by the first screen and is projected upon the vibrator. Reflected by the mirror of the vibrator, passing through the second screen and being concentrated by a lens, the light then falls upon the receiving drum. Reproduction of the light beam proportional to the tone values of the picture is graphically shown in Fig. 12, in which A relates to negative reproduction and B to positive reproduction. In the case of A the screen is

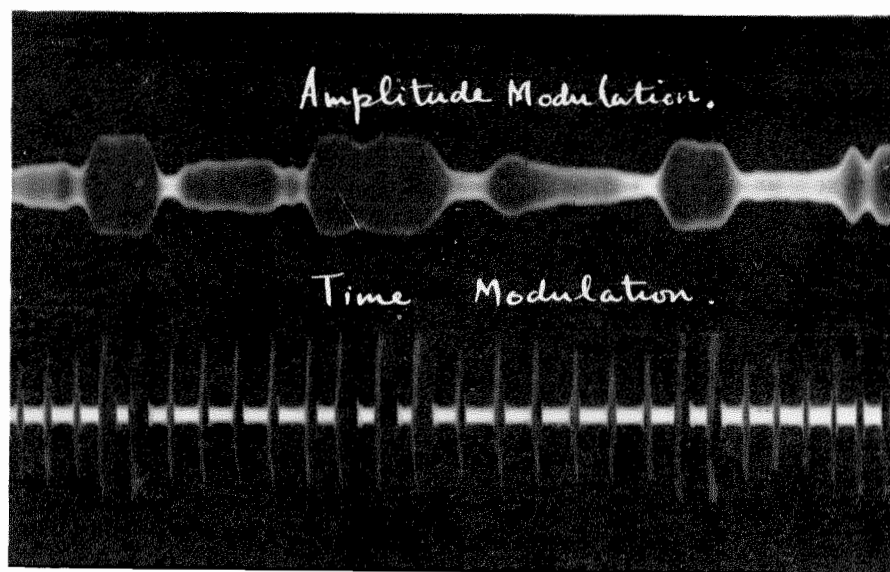

Fig. 10—Oscillogram of Time Modulation by Oscillograph Vibrator.

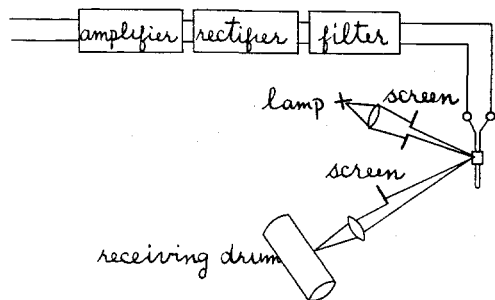

Fig. 11—Block Schematic of Picture Receiver for Time Modulated Wave.

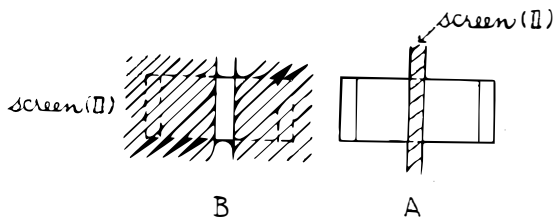

Fig. 13—Receiving Screen and Vibrating Light Beam—Carrier Current not Rectified.

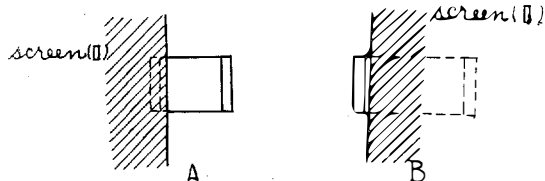

Fig. 12—Receiving Screen and Vibrating Light Beam—Carrier Current Rectified.

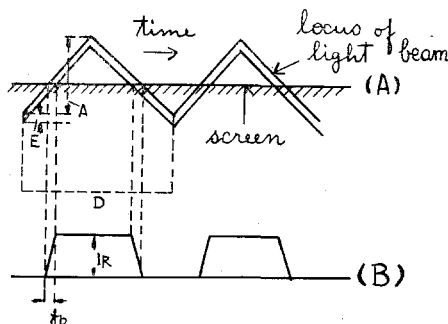

Fig. 14

placed in a position such that when the vibrator is at rest, the light beam is totally cut off. When the vibrator swings to the side, the beam leaves the screen and passes by it on to the photographic film or paper. The dark part of the transmitting picture gives short dashes, so that the length of the received dashes is also short, causing the received picture to be reproduced in white. Conversely, for the white part of the picture longer dashes are sent, making the received picture dark; that is, the reproduction is negative. The case of B, Fig. 12, is exactly opposite to A so that the reproduction is positive.

Reception of a picture, in the case of either method A or B, is thus made possible without interference due to the fading effect. The basic reason is, as discussed previously, that the amount of light falling upon the photographic film is always constant regardless of the amplitude of vibration. In other words, fading has no effect upon the reception of pictures.

In method (2) in which the carrier frequency is not rectified, the incoming current is first amplified, then brought to the vibrator. The second screen is placed as shown in Fig. 13 where A is for negative and B for positive reproduction. In A, a screen of the same width as the width of the light beam is placed at the centre of vibration so that when the vibrator is stationary, the reflected light falls right upon it. Vibration back and forth across the screen permits the reflected light to pass by the screen and to fall on the sensitised paper. In this operation, fading may affect the amplitude of vibration, but not the amount of light falling upon the receiving paper; that is, fading does not affect the picture so received. Case B, Fig. 13, is exactly opposite to case A: a narrow slit in the screen is positioned so as to allow the reflected light to pass through it when the vibrator is stationary. When the vibrator begins to move, the reflected light swings across the slit and the amount of the light passing through



Fig. 15—Picture Transmitted Using Time Modulation and Oscillograph Vibrator.

it is very much decreased. Thus the received picture is a positive reproduction. In this case the effect of fading is reduced to a minimum by making the width of the light beam sufficiently narrow and the amplitude of vibration as great as possible.

Consideration of Transmission Time

Time modulation utilises the method of translating colour tones of pictures into dashes of different lengths. Compared with the method of amplitude modulation, which expresses the tone values by the instantaneous values of the current, it is inevitable that the time required for transmitting a picture by time modulation is somewhat longer.

Let “*a*” be the width of the picture and “*b*” its length. The density of scanning is *S* lines

per millimetre, and the picture elements thus determined are sent by the time modulation system at a speed of *D* dots per second. The time required for transmission of the picture is

$$T = \frac{ab S^2}{D} \text{ seconds} \dots \dots \dots (1)$$

That is, the speed is determined by *D* and *S*. Increase of *D* shortens the time, and increase of *S* improves the quality of the received picture, but the frequency band introduces a limitation.

Let us now consider the frequency band of the time modulated current obtained by the above mentioned optical vibrating system. For the sake of convenience, a triangular waveform is taken instead of the saw-toothed form. In

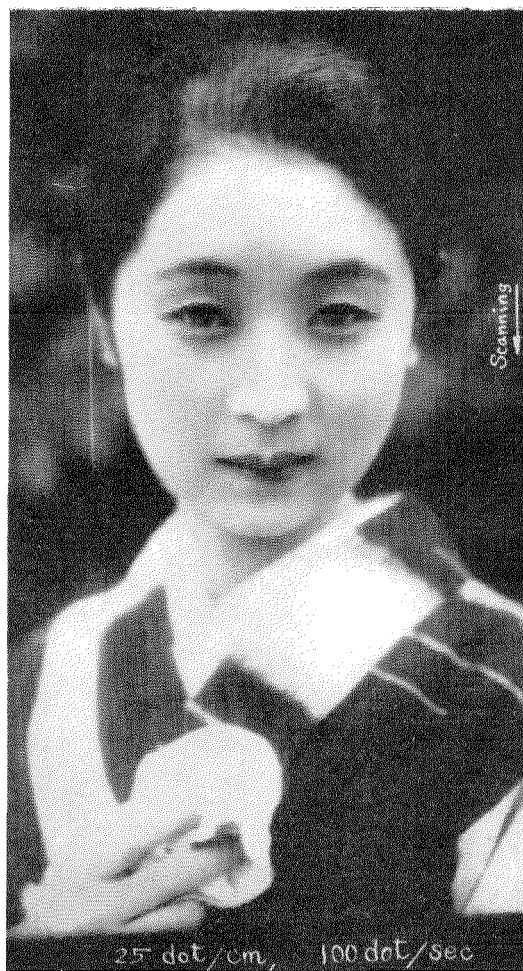

Fig. 16—Picture Transmitted Using Time Modulation and Gas-filled Triode.

Fig. 14, (A) illustrates the case of the light beam vibrating in the triangular form, one side being cut off by the screen, while (B) represents the time modulated waveform thus obtained. The triangular waveform determines the dot frequency D . The light beam vibrates at the amplitude of A but has a certain amount of width giving the waveform the appearance of (B) in Fig. 14. It requires the time t_b for the light to travel from the zero point of the current to its full amplitude I_R .

First the value of t_b will be calculated. The speed v of the vibrating light beam is

$$v = A \div \frac{1}{2D} = 2AD.$$

The light beam of width E passes by the screen with this speed; therefore, the value t_b becomes

$$t_b = \frac{E}{2AD} \text{ sec.} \dots\dots\dots(2)$$

The frequency determined by the waveform of (B) in Fig. 14 may be found by the Fourier Analysis to have very high frequencies for the higher harmonics, but the maximum frequency necessary for picture transmission is

$$f_{max} = \frac{1}{2t_b} \dots\dots\dots(3)$$

For the case of triangular waveform,

$$f_{max} = \frac{AD}{E} \dots\dots\dots(4)$$

Let us assume, for example, $A = 10$ mm, $E = 1$ mm, $f_{max} = 1\,000$ p : s. From equation (4),
 $D = 100$ dots/sec.

With this value of D , the transmitting time becomes

$$T = \frac{abS^2}{100}.$$

Now, if $a = 180$ mm, $b = 210$ mm,

$$T = \frac{180 \times 210}{100} S^2 = 378S^2.$$

Taking $S = 2$ lines per mm,
 $T = 25.2$ minutes;

With $S = 3$ lines per mm,
 $T = 56.7$ minutes.

Consideration of the Dot Frequency Current

In order to obtain dashes which are proportional to the colour tones of pictures, it is quite



Fig. 17—Picture Transmitted from Berlin to Tokyo Using Time Modulation and Oscillograph Vibrator.

desirable for the dot frequency current to be of either saw-tooth or triangular waveform. The triangular waveform may be somewhat difficult to obtain, but the saw-tooth form can be secured very easily by employing a gas-filled discharge tube. In this way a picture may be reproduced at the receiving end very satisfactorily because the lengths of the dashes obtained are proportional to the tones of the transmitting picture. However, the author has experimented with dot current of other than straight line waveform to see what the effect would be. As the sinusoidal wave could most readily be obtained, it was used for this purpose. The result was rather good.

Let us now consider what kind of dot frequency is generated when the sinusoidal waveform is employed. Replacing the triangular wave in Fig. 14 by the sinusoidal wave, the vibration of the light beam is

$$f(t) = \frac{A}{2} \sin 2\pi Dt.$$

Hence, the speed of vibration of the light beam is

$$v = \frac{df(t)}{dt} = \pi DA \cos 2\pi Dt.$$

Now, if the position of the screen is assumed to be at a point A_x distant from the centre of the sinusoidal wave, the velocity v_x at which the light passes across the screen is

$$v_x = 2\pi D \sqrt{A^2 - 4A_x^2}.$$

Consequently, at this position,

$$t_b = \frac{E}{2\pi D \sqrt{A^2 - 4A_x^2}},$$

t_b varying with the value of A_x and the minimum time being obtained at $A_x = 0$; that is, when the screen is placed at the centre of the sinusoidal wave. For this case,

$$t_b \text{ min} = \frac{E}{2\pi DA};$$

and the maximum frequency is

$$f_{m \bullet x \text{ sin}} = \frac{1}{2t_b} = \frac{\pi DA}{E} \text{ p : s.}$$

But the maximum frequency in the case of the triangular wave is

$$f_{m \bullet x \triangle} = \frac{DA}{E};$$

therefore, the ratio between these two will be

$$f_{m \bullet x \text{ sin}} : f_{m \bullet x \triangle} = \frac{\pi DA}{E} : \frac{DA}{E} = \pi : 1.$$

In other words, when the sinusoidal wave is used, the frequency band becomes π times as great as the frequency band for the case when

the triangular wave is used. From this consideration, it is more desirable to use the triangular waveform. However, even with sinusoidal waves the author has been able to obtain comparatively fine reproduction, such as illustrated in Fig. 15, by using filters to make the frequency band nearly similar to the case with the triangular form.

Conclusion

In the foregoing, two methods of time modulation are discussed; one using a gas-filled discharge tube, and the other using a mechanical vibrator with a photoelectric cell. By resorting to time modulation, pictures can be transmitted over short wave radio transmitters and receivers just as well as over a wired circuit without being affected by interference due to fading. The time modulation system using a vibrator is somewhat more steady than the method using the gas-filled discharge tube, and has been employed on various occasions with considerable success when experimental transmissions have been conducted between Tokyo and Taihoku, Formosa, by the Department of Communications since November, 1935; also between Tokyo and Berlin in 1936; Tokyo and London in 1937; and Tokyo and San Francisco in 1937.

Fig. 16 represents a picture transmitted in a local test by time modulation with gas-filled tubes. Fig. 15 represents a picture obtained in a local test by optical modulation using sinusoidal dot current, and Fig. 17 is a picture transmitted from Berlin to Tokyo by the same modulation system.

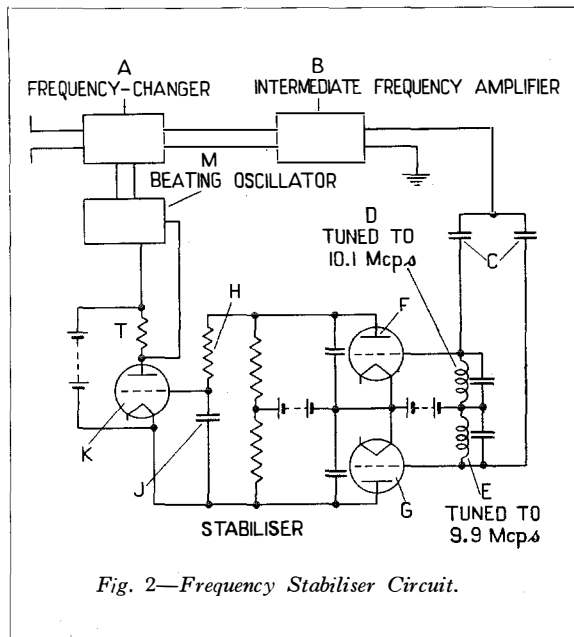

Fig. 2—Frequency Stabiliser Circuit.

Heating current is supplied by means of the transmission line H through the slideable metal screen J, the position of which is so chosen that line H is effectively a quarter wavelength long. Appreciable loss of micro-ray power in the heating circuit is thus avoided. The anode current is measured by means of milliammeter K, which is isolated for high frequency from the line C by the combination of the auxiliary line L and mirror P. The micro-ray peak voltage on G is observed by the "slide-back" method, using the battery N. The D.C. voltage applied at cut-off is thus equal to the high-frequency peak voltage. The fact that the dimensions of the plate-filament system are not small compared with the wavelength is of no importance; the method gives the peak voltage of *some* part of the plate-filament system, even if this voltage is not uniform. A typical result with a specially designed micro-ray diode was a plate current of 670 microamperes for an input peak voltage of 10.5 volts. This value is of the same order as the change produced by a peak voltage of the same value at 50 cycles per second (610 microamperes); in fact, for some unexplained reason, it is actually greater than the latter. The use of this tube as a frequency-changer was, however, not promising, since it caused a reduction of voltage by damping of the order

of 6 db, as measured by the micro-ray thermocouple M, which was fed from the dipole E loosely coupled to D.

In the case of a diode, some damping is, of course, unavoidable. This damping may, however, cause a loss in signal-noise ratio, so that the maximum permissible loss was considered to be 2 db.

For this reason a micro-ray tube was used with a sufficiently positive grid bias for this damping to be neutralised by the negative damping of the tube. The negative damping of the tube was, however, far too small to lead to instability. A typical result with this arrangement is an anode current of 3.1 milliamperes for an input voltage of 15 volts. This appeared to be satisfactory, but it still remained to try the arrangement out as a frequency-changer. A beating oscillator voltage of 30 volts and a signal frequency voltage of 15 volts were accordingly applied to the tube. The coupling between the beating oscillator and the detector was effected by means of two loosely-coupled antennae in a manner similar to that shown in Fig. 1. The difference-frequency of 10 megacycles per second was applied to a tuned circuit and measured by an ordinary tube voltmeter. A difference-

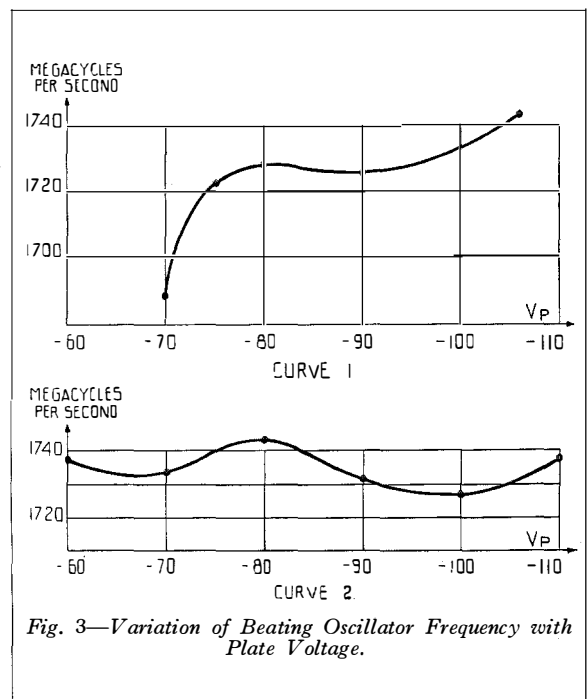

Fig. 3—Variation of Beating Oscillator Frequency with Plate Voltage.

frequency voltage of 31 volts was obtained, corresponding to a frequency-changer step-up of 6 db.

A single micro-ray tube was then tried as an oscillator-detector, the input voltages being applied to the grid. The same frequency-changer gain was obtained. This simpler arrangement was thereafter used when simple reception only was required; for field strength measurement, two separate tubes were used, as the step-up is then much more easily measured. As the signal frequency was about 1 700 megacycles per second and the intermediate frequency band-width one megacycle per second, it was naturally not possible to keep the difference-frequency within the range of the intermediate frequency amplifier for much more than a minute on end without special precautions. The circuit seen in Fig. 2 was accordingly used. M denotes the beating oscillator, A the frequency changer, and B the intermediate frequency amplifier, the output of which is coupled through small condensers with circuits D and E. These two latter are tuned to frequencies of 10.1 and 9.9 megacycles per second, respectively. Their damping is so chosen that the amplitude at the point of intersection of the two resonance curves is approximately 4 db less than at the point of resonance. This point of intersection corresponds exactly to 10 megacycles per second. At this frequency the two tubes F and G, which are biased as detectors, are equally excited so that their anode currents are equal. If, however, the intermediate frequency rises above 10 megacycles per second, the anode current of F becomes greater than that of G, so that the anodes of F and G are no longer at the same D.C. potential. The D.C. difference-voltage between these two anodes is applied via resistance H between grid and cathode of tube K. Resistance H, shunted by condenser J, determines the time-constant. The D.C. voltage drop along resistance T in the output of tube K, also biased as a detector, is placed in series aiding or series opposition with the anode battery of the beating oscillator tube, so that an increase or decrease of the intermediate frequency produces an increase or decrease of this supplementary voltage, which is applied in the necessary sense for the frequency of the beating oscillator to be changed in that direction

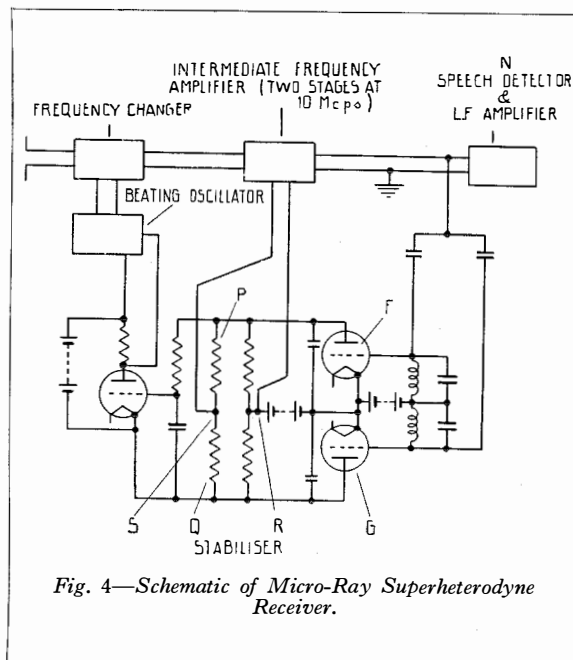

Fig. 4—Schematic of Micro-Ray Superheterodyne Receiver.

which tends to reproduce the original intermediate frequency.

Fig. 3 shows two typical curves of beating oscillator frequency against anode voltage. The curve is usually of a rather complicated nature containing at least one point of inflection. The working voltage of the beating oscillator is preferably chosen to correspond to a point of inflection.

To test the stabiliser, the frequency of the beating oscillator was varied. For a change of 18 megacycles per second, i.e., between the extreme limits of the stabiliser of 1 720 and 1 738 megacycles per second, an intermediate frequency change of only 155 kilocycles per second was measured. In other words, the variation of the intermediate frequency was reduced in a ratio of 1 : 115.

Fig. 4 shows the circuit diagram of the superheterodyne receiver. It is the same as that of Fig. 2 except that a speech detector and low frequency amplifier N and two equal resistances P and Q have been added. It is to be noted that a variation of the intermediate frequency so changes the excitation of F and G that, if the excitation of one tube increases, that of the other decreases equally, the average excitation and, therefore, the average anode potential thus remaining the same. The latter is, therefore,

substantially independent of the frequency of the intermediate frequency wave but is proportional to its amplitude. The average anode voltage of F and G is the D.C. potential between points S and R, which is accordingly applied to the intermediate frequency amplifier tubes to provide an automatic gain control. Such an automatic gain control is necessary since considerable fading is encountered

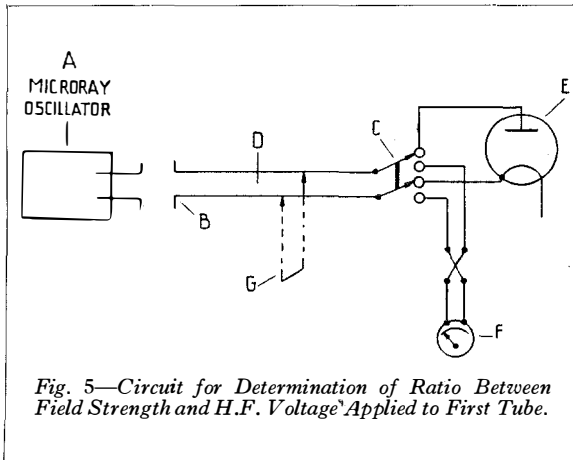

Fig. 5—Circuit for Determination of Ratio Between Field Strength and H.F. Voltage Applied to First Tube.

on these wavelengths even within optical visibility.

The time-constant employed was approximately 1/10 of a millisecond. With this value, carrier frequency variations are compensated in a time of the order of one ten-thousandth of a second. As the highest speech frequency in commercial telephony is about 3 000 cycles per second, all carrier frequency variations caused by modulation are compensated. Microphonic frequency-modulation, resulting in noise during windy weather, was also neutralised by this means.

The signal-noise ratios were very variable on account of deep fading. Typical figures, however, are :

With superheterodyne reception : 37 db.

With super-reaction reception : 18 db.

Thus the signal-noise ratio improvement due to superheterodyne reception was 19 db. In other words, the signal-noise ratio obtained by substituting a superheterodyne receiver for a super-reaction one is the same at these wavelengths as at long and short waves.

The signal strength is given by the formula :

$$H = 10^6 \times v/hgabc,$$

where

H = signal strength (in microvolts per metre);
 h = effective height of receiving antenna (in metres);

g = gain of mirror system (if any);

a = input "step-up" ratio (i.e., volts input to frequency-changer for 1 volt induced in the antenna);

b = frequency-changer gain;

c = intermediate frequency gain (i.e., frequency-changer "out" to speech detector "in");

v = I.F. carrier volts received by the speech detector.

The speech detector N is calibrated as a tube-voltmeter—"v," therefore, is measured directly;

"c" is measured by a standard signal generator;

"b" is measured as explained above;

"h" is easily calculated from the antenna dimensions; and

"g" is determined by measurement of the received carrier voltage

from a strong local oscillator both with and without the mirror. Hence, to complete the calibration as a field strength measuring set, it only remains to measure "a"—the "step-up" ratio. This was accomplished by the circuit arrangement shown in Fig. 5. Micro-ray voltage at the correct frequency was induced in the antenna B from the oscillator A, and conveyed by the transmission line D to the switch C, through which voltage was applied between plate and filament of the frequency-changer E—connected and adjusted normally for reception. The building-out section G was adjusted so that that part of the transmission line D, lying to the left of G, was terminated by its characteristic impedance. The length of line D to the right of G was adjusted so that the cathode-plate system of tube E was near a voltage antinode. The high-frequency peak voltage applied to E was measured by the "slide-back" method in the manner already described, the grid voltage of E being so chosen that the latter introduced no damping on the line, i.e., that the line current of D was the same in the normal receiving condition as when the plate current of E was just reduced to zero. In the other switch

position, transmission line D was terminated by a 24-ohm thermocouple F, G being again adjusted so that that part of transmission line D, lying on its left, was terminated by its characteristic impedance. If losses are neglected, the power absorbed by the aerial is equal to that dissipated in the thermocouple. The characteristic impedance of the transmission line is known and the aerial impedance may be taken as 73 ohms approximately. The E.M.F. induced in the aerial may thus be calculated.

The peak voltage on E was found to be 4.5 (3.0 R.M.S.) and the value of "a" thus determined was 18 (= 25 db).

The accuracy of the measurement of "v" depends on the calibration of the signal generator. A figure of 20% may be assumed. The error in "c" should not exceed 10%, the errors in "b," "g" and "h" are each approximately 20% and, finally, that of "a" is of the order of 30%. As these errors do not always

operate in the same direction, the probable overall error is of the order of 50% (about 6 db). If all the errors operated in the same direction, the overall error would be approximately 12 db.

According to these measurements, the field strength measured at Dover of the Calais 17 cm transmitting station, 35 kilometres away, was approximately 4 microvolts per metre. This figure is about 30 db less than that calculated on the basis of optical propagation. Several explanations of this loss have been given, but in the authors' opinion no convincing solution has yet been propounded. It seems difficult to explain it on the basis of interference between two or three paths since it would not be expected that there would be maintained a permanent balance of such a high degree that the unbalanced remainder represents a 30 db loss. It may be that the loss is to be ascribed to some unexplained absorption or to diffraction at the cliff edges on both sides of the Channel.

The Reactive Filter and its Application to Waveform Analysis

By ROY M. BARNARD, B.Sc., A.M.I.E.E., A.M.I.R.E.,

Standard Telephones and Cables, Limited, London, England

AN alternating e.m.f. having a non-sinusoidal waveform has been shown by Fourier to be the equivalent of a combination of a number of alternating e.m.f.'s of different magnitudes with frequencies that are multiples of the original non-sinusoidal e.m.f. Since the general electrical circuit theory as applied to alternating e.m.f.'s has been developed on the assumption that the waveform of the e.m.f.'s is sinusoidal, it is essential in solving design problems to be able to reduce the various waveforms met with in practice to an equivalent sine wave or waves. An extension of the problem, which frequently occurs, is the analysis of the voltage waveform which results after applying two or more substantially sinusoidal e.m.f.'s to some non-linear device; that is to say, the process of modulation or demodulation. The mathematical analysis of the process of modulation, assuming a non-linear device in which the output is a function of the square of the sinusoidal input, indicates that the resultant e.m.f. is the equivalent of two sinusoidal e.m.f.'s with frequencies equal to the sum and difference of the applied frequencies. In actual practice, due to the many differences between the mathematical assumptions and the conditions actually prevailing, an analysis of the resultant waveform would indicate the presence of quite a number of other e.m.f.'s of sinusoidal waveform. Thus two distinct problems are involved: (a) Harmonic analysis and (b) Measurement of modulation and demodulation products. For convenience it has become customary to refer to "complex waveforms," as distinct from the resultant of the process of modulation, in terms of their sine wave components, the lowest frequency present being referred to as the fundamental and the higher frequencies, if multiples of the fundamental, as harmonics.

This convention will be followed herein.

REQUIREMENTS FOR A WAVEFORM ANALYSER FOR COMMUNICATION WORK

For measurements on transmission apparatus associated with modern communication networks, it is necessary to be able to analyse any complex waveform having a frequency between 35 p : s and 5 Mc. For frequencies below 3 kc, the waveforms to be analysed are generally the results of amplitude distortion occurring in amplifiers, etc., and hence are limited to harmonic analysis pure and simple. For frequencies above 3 kc, the waveforms to be investigated may also be the results of modulation. The selectivity requirements below 3 kc are, therefore, limited to discriminating between multiples of the fundamental, but above 3 kc the waveform to be analysed may contain components separated by only a few cycles. The normal harmonic content tolerated in public address systems, radio receiving sets, etc., is about 5 per cent. of the fundamental measured on a voltage basis, or 26 db; but, for speech input equipments and high quality systems, a harmonic content of less than 1 per cent. is required for frequencies around 1 000 p : s. It seems probable, therefore, that an analyser that would measure to about 0.1 per cent., or 60 db, would be suitable for most measurements below 3 kc. For carrier systems where the presence of spurious modulation products may cause interference in adjoining channels, the interfering voltage due to any one frequency in any one modulator is generally considered satisfactory if it be less than 70 db below the wanted product. This figure, however, includes distortion in auxiliary apparatus, the harmonic content of which must, therefore, be less than 70 db.

For measurements below 3 kc, therefore, the requirements are: the selection of the harmonics of all frequencies from 35 p : s, and discrimination greater than 80 db against any other source ;

for frequencies above 3 kc, assuming a speech band width of 200 p : s to 2800 p : s, a discrimination of approximately 90 db is required for a change in frequency of 200 p : s in order that a measure can be obtained of the modulation product of a 200 p : s source combined with 3 kc. Actually it is possible that an even greater discrimination may be necessary if an examination of the possible modulation products in, say, a 12 channel system is required. For carrier systems operating above 60 kc where a double modulation system is used, the problem is one of measuring modulation products separated approximately by 60 kc from the wanted signal.

The requirements for a general purpose Analyser for communication work, therefore, may be formulated as follows :

From 35 p : s to 3 kc, the device must be capable of discriminating against harmonic frequencies to a greater degree than 80 db, and of measuring harmonic levels of 60 db below the fundamental. This means that the accuracy of the 60 db measurement will be 10 per cent., i.e., the harmonic level will be 60 db \pm 1 db below the fundamental.

From 3 kc to 60 kc, the device must be capable of discriminating between two frequencies, 200 p : s apart and differing in level by 90 db. This means that spurious modulation products differing in frequency from the wanted product by 200 p : s and in level by 70 db can be measured to an accuracy of \pm 1 db.

Above 60 kc, the device must be capable of discriminating between two frequencies 60 kc apart and differing in level by 90 db. This means that spurious modulation products differing in frequency by 60 kc and in level by 70 db can be measured to an accuracy of \pm 1 db.

For complete harmonic analysis it is necessary to know the phase as well as the magnitude and frequency of the component of the complex waveform, but in earlier communication work very little attention was paid to the measurement of the phase of harmonics. This neglect was due largely to the difficulty of measuring phase at high frequencies, as well as the questionable importance attached to the phase of the components present; and it was possibly fostered by the contention of Von Helmholtz that the phase relationship of the components of a complex wave have very little effect on the ear. Modern

tendencies in the communication art, particularly in connection with the development of negative feedback amplifiers and television systems, seem likely to increase the importance of phase relationships. Inasmuch, however, as this article is concerned with equipment primarily designed for making measurements on telephone transmission systems, only the frequency and magnitude of the components of complex waves will be considered.

REVIEW OF EXISTING METHODS AND THEIR APPLICATION TO COMMUNICATION WORK.

A tremendous amount of work has been expended on harmonic analysis, although it has been largely confined to measurements on power circuits and electrical machinery where the waveform is of much less importance than in electrical communication. Early attempts at harmonic analysis generally followed the obvious but laborious method of taking a curve of the actual waveform and reducing it to its sinusoidal components by mathematical and graphical means. Subsequently, mechanical devices for avoiding the mathematical computation were evolved. In certain types of problems, such as in the study of special waveforms required for time base circuits, etc., this form of analysis still has application, but for communication work the distortion tolerated has such a small effect on the waveform that the graphical representation of the impure wave is indistinguishable from a pure sine wave. A less obvious but more practical method is to measure directly by electrical means the magnitude, frequency and phase of each component of the complex wave source to be analysed.

Such a waveform analyser is essentially a voltmeter arranged to measure voltage at one selected frequency only, the frequency being capable of selection over quite a wide range. It is, however, obviously impossible to arrange for the voltmeter to respond to any one frequency exactly, as such a meter would involve constructing an infinitely variable band pass filter of zero band width. An approximation to this condition is necessary, its degree depending on the resources available and the accuracy required.

As far as can be ascertained, seven main methods of analysis have been evolved and the

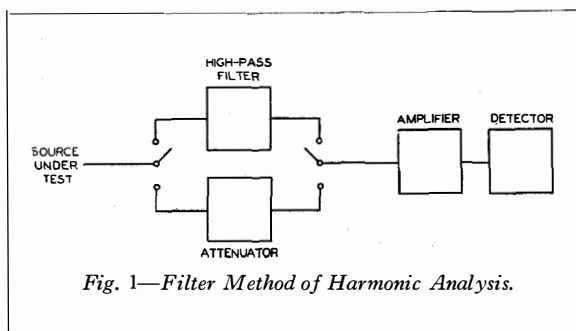

reader is referred to the following for descriptions of representative methods :

1. RECTIFIER METHOD

“Condenser Current Method for the Determination of Alternating Waveform,” by F. Bedell, *Electrical World*, 23rd August, 1913.

2. A.C. POTENTIOMETER METHOD

“A Device for Separating the Harmonics of Complex Waves with Special Application to the A.C. Potentiometer,” by D. C. Gall, *Journal of Scientific Instruments*, August, 1932.

3. DYNAMOMETER METHOD

“A Portable Electric Harmonic Analyser,” by R. Thornton Coe, *Journal of the I.E.E.*, October, 1929.

4. RESONANCE METHOD

“The Resonance Method of Wave-Form Analysis,” by C. F. J. Morgan, *Journal of the I.E.E.*, November, 1932.

5. HETERODYNE METHOD

“An Analyzer for the Voice Frequency Range,” by C. R. Moore and A. S. Curtis, *Bell System Technical Journal*, April, 1927, and *Bell Telephone Laboratories Reprint B.253*.

6. FILTER METHOD

The origin of this method has so far been untraceable, but it has been used generally for fixed frequency analysis. Considering Fig. 1, the source to be analysed is connected by two change-over switches to an amplifier through either an attenuator or a high-pass filter, which must attenuate the fundamental to a considerable degree. The measure of the harmonic level is obtained by connecting the filter in circuit and adjusting the gain of the amplifier until the standard level is obtained. The

attenuator is then put into circuit and the attenuation adjusted until the same standard reading is again reached. The attenuator reading then gives the ratio between the fundamental and the sum of all the harmonics.

7. BRIDGE METHOD

“The Alternating-Current Bridge as a Harmonic Analyser,” by I. Wolff, *Journal of the Optical Society of America and Review of Scientific Instruments*, September, 1927.

Reviewing the methods referred to above, the graphical methods and methods 1 to 4 have been expressly developed for analysis on power circuits, although it is possible that some of these methods may be applicable to communication work.

Graphical Methods

These methods, besides being very slow, are unsuitable for most forms of communication transmission measurement, as the harmonics tolerated would be much too small for graphical representation of any change in the waveform.

Rectifying Method

This method has the same limitations as the graphical method, together with difficulties of synchronous commutation at high frequencies.

Potentiometer Method

This method is similar to the rectifying method in many ways, but is much more accurate as the unwanted components at each

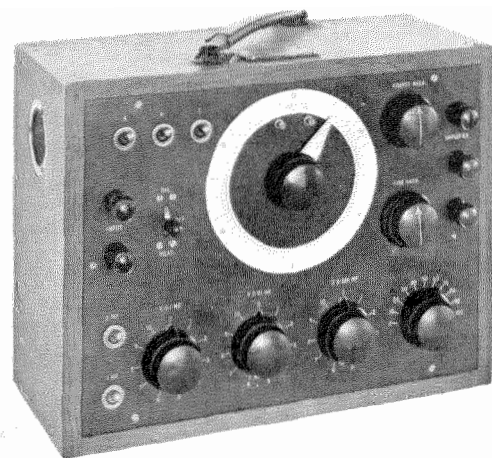

Fig. 2—74300—A Distortion Factor Meter (Front View).

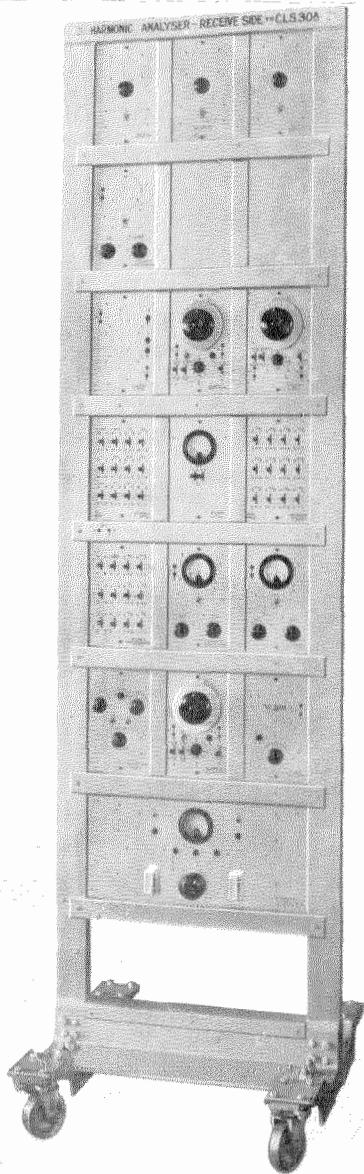

Fig. 3-A—Harmonic Analyser (Front View).

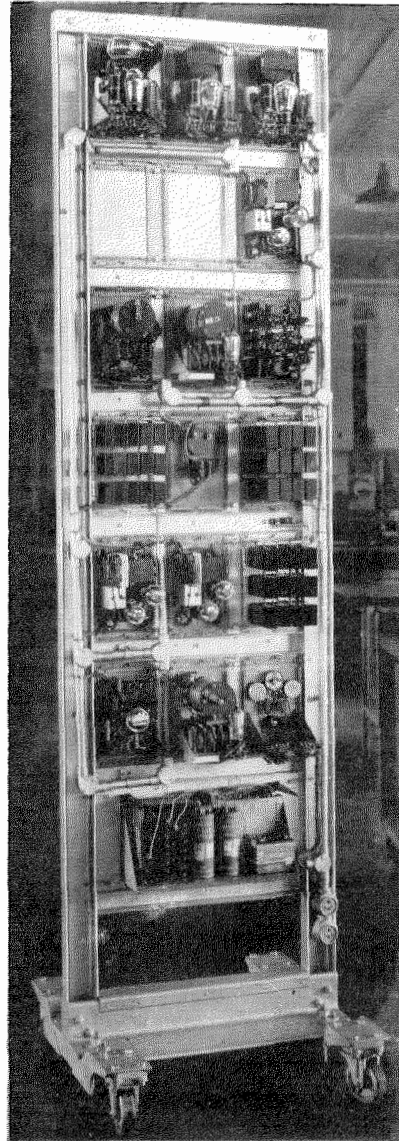

Fig. 3-B—Harmonic Analyser (Rear View).

harmonic measurement are eliminated; hence a sensitive instrument can be used to record the wanted components. The sensitivity is of the order of 0.1 per cent., but there seems to be difficulty in developing this method for frequencies higher than 50 p : s. The possibility of extending it by frequency changing along the lines described in Method 5 might be considered, but difficulties would probably arise due to

oscillator instability if an intermediate frequency as low as 50 p : s had to be used.

Dynamometer Method

For low frequency measurements this appears to be a very quick and reliable method, but again some difficulties would probably be experienced in increasing the frequency of operation due to commutator troubles and

induction effects in the dynamometer. Frequency changing might solve some of these problems, but would involve all the troubles mentioned in the discussion on the Heterodyne Method.

Resonance Method

This method is basically suited for operation at all frequencies, although in the particular reference the design has been made suitable for power frequencies only. A considerably modified version of this circuit suitable for operation over a range of 3 to 50 kc and capable of measuring harmonics within that range of 0.05 per cent. to an accuracy of about 10 per cent. has been developed* and, at certain frequencies, better results are obtainable. Selectivity in this analyser is achieved by a frequency changing stage and a fixed frequency selector.

Heterodyne Method

The heterodyne method is essentially one developed for communication work. Its major difficulty is that the selectivity device referred to the signal side of the frequency changer has a fixed band width; thus, at the low frequency end of the range, the selectivity is not particularly good, whereas at the high frequency end of the range the discrimination is so good, compared with the stability of either the local oscillator or the source, that the reading becomes unreliable.

Another difficulty is the introduction of harmonics by the frequency changer circuit. They can be reduced by introducing a certain amount of discrimination before the frequency changing stage, and also by using an intermediate frequency higher than the frequencies to be analysed.

The first expedient to a certain extent begs the question, while the second adds another limitation to the frequency range.

Filter Method

This method is very useful for harmonic measurements at one frequency but is not of much use for the analysis of modulation products. Its limitations are obvious inasmuch as each filter requires several sections and is

only suitable for a very restricted frequency range.

Bridge Method

This is another method which is very suitable for communication work at audio frequencies, although the circuit would probably present difficulties above frequencies of about 10 to 20 kc.

As will be seen from Fig. 2, an instrument designed to incorporate a bridge principle can be arranged to be direct reading. In this particular case, a frequency range of 20 to 3000 p : s is covered with a sensitivity from 0.1 per cent. to 10 per cent. It will be observed, however, that the instrument measures the total harmonics without segregating the components, and hence would not be suitable for quite a number of transmission measurements.

Summarisation of Preceding Methods

For general use on high grade transmission measurements, the most suitable form of analyser appears to be the Heterodyne type; for frequencies below 3 kc, a type similar to that described by Moore and Curtis, is used; while, for frequencies from 3 kc to 50 kc, a combination of the heterodyne and resonance type as produced by A. G. Landeen appears to have many advantages.

With the growth of transmission technique, it has become necessary to develop an analyser covering a much wider frequency range than any of the types mentioned above; and, if possible, provide for an even greater degree of accuracy. Both of these requirements have been met to some degree by the Reactive Filter Method hereinafter described. The reactive filter principle, thus far, has been used over a frequency range of 35 p : s to 2 000 000 p : s, and this range may be capable of extension. The range covered on one instrument can also be made quite large: the analyser illustrated in Figs. 3-A and 3-B covers the range 4 kc to 400 kc; another model covers the range 200 p : s to 80 kc, or a frequency ratio of 400 : 1.

The sensitivity and selectivity of the reactive filter is such that harmonics 90 db below the fundamental can be measured to an accuracy of about 30 per cent. or ± 2 db over most of the frequency range, although at 100 p : s (2nd

* "Analyser for Complex Electric Waves," by A. G. Landeen, *Bell Telephone Laboratories Reprint No. B. 254.*

harmonic of 50) the accuracy is reduced to about 50 db ± 2 db and at 150 p : s (3rd harmonic of 50 p : s) the limit of measurement is 56 db ± 2 db.

THE REACTIVE FILTER—GENERAL THEORY

The reactive filter consists of some conventional form of selective circuit in which the dissipation factor has been artificially reduced by the introduction of negative resistance or regeneration. In the simple case and the one treated herein for use in waveform analysis, the selective circuit is the ordinary parallel resonant circuit. The reduction in dissipation factor is of the order of 50 : 1. Dissipation factor values of 2×10^{-4} , corresponding to a selectivity of 0.2 per cent. change in frequency for 30 db discrimination are obtainable ; and, in a particular model, this discrimination was

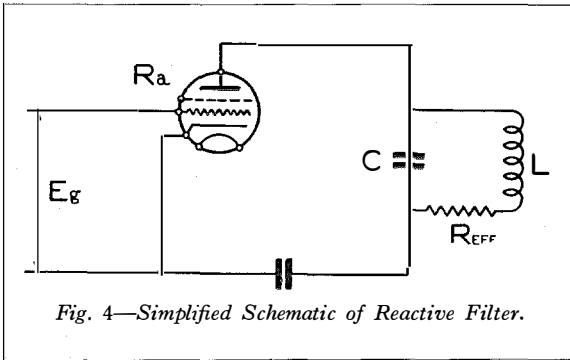

Fig. 4—Simplified Schematic of Reactive Filter.

possible over a frequency range extending from about 1 to 500 kc. For frequencies below 1 000 cycles, the discrimination achieved becomes less, a dissipation factor of 7×10^{-4} being obtained at 200 cycles.

Hitherto one or two attempts have been made to improve the performance of filters by introducing regeneration which has not been widely adopted due to lack of stability. The analysis which follows indicates the conditions necessary in this form of circuit for the most stable operation.

Considering the circuit shown in Fig. 4 in which a valve is shunted across the parallel tuned circuit C, L and R_eff. Let the valve impedance be R_a.

Then if f =the natural frequency of the tuned

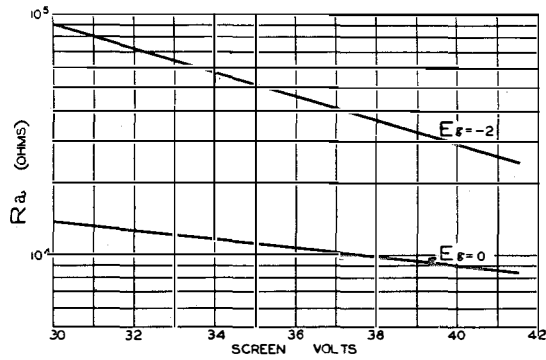

Fig. 5— R_a - E_s Characteristics of Screen Grid Valve with Optimum Anode Volts $E_a=10.9V$.

circuit, it can be shown that the gain of the circuit at any frequency is given by :

$$\frac{I_c X_c}{\mu E_g} = \frac{X_c (R + jX_l)}{(R_a R_{eff} + X_c X_l) + j[R_{eff} X_c - R_a (X_l - X_c)]} \quad (1)$$

where μ = amplification factor of the valve,
 X_c or X_l = impedance of condenser or inductance,
 I_c = current through condenser C,
 E_g = a.c. volts on grid.

If $R_a \gg X_l$ or $X_c \gg R_{eff}$

$$\text{then } \frac{I_c X_c}{\mu E_g} = \frac{R_a (X_l - X_c) - j(R_a R_{eff} + X_l X_c)}{R_a^2} \dots\dots (2)$$

At resonance when $X_l = X_c$, i.e., at frequency f,

$$\left| \frac{I_c X_c}{\mu E_g} \right| = \frac{R_a R_{eff} + X_l X_c}{R_a^2} ; \dots\dots\dots (3a)$$

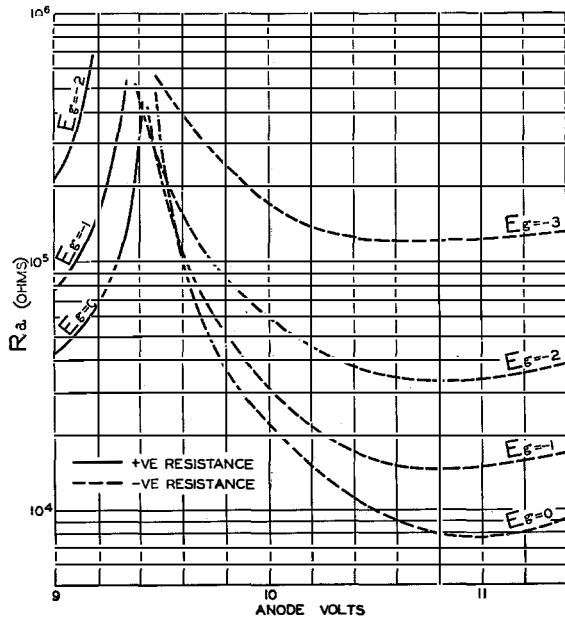

Fig. 6— R_a - E_a Characteristic of Screen Grid Valve $E_s=35 V$.

and at frequency $f + \delta f$,

$$(X_L - X_C) = 4 \pi \delta f L ; \text{ if } \delta f \text{ is small}$$

$$\left| \frac{I_c X_c}{\mu E_g} \right|^2 = \frac{(R_a 2\pi \delta f L)^2 + (R_a R_{eff} + X_c^2)^2}{R_a^4} \dots (3b)$$

If N = ratio of gain at frequency f to gain at frequency $f + \delta f$, then

$$N^2 = \frac{(R_a 4\pi \delta f L)^2 + (R_a R_{eff} + X_c^2)^2}{(R_a R_{eff} + X_c^2)^2} \dots (4a)$$

or $\frac{\delta f}{f} = \sqrt{N^2 - 1} \left(\frac{1}{2Q} + \frac{X_c}{2R_a} \right), \dots (4b)$

where Q = coil constant = $2 \pi f L / R_{eff}$.
If R_a is assumed to be negative, then the expression becomes :

$$\frac{\delta f}{f} = \sqrt{N^2 - 1} \left(\frac{1}{2Q} - \frac{X_c}{2R_a} \right) \dots (5a)$$

$$= \sqrt{N^2 - 1} \left(\frac{1}{2Q} - \frac{X_L}{2R_a} \right); \dots (5b)$$

and it follows that the attenuation at frequency $f \pm \delta f$ can be made to approach ∞ by arranging the value of R_a so that

$$R_a \rightarrow Q 2\pi f L.$$

Also, if $R_a \ll Q 2\pi f L$, it may be shown that the system is self-oscillatory and hence there will be some limit for the factor $R_a / 2\pi f L$; but the more nearly it can approach Q , the greater will be the selectivity.

Considering equation (5b), it will be seen that for a given inductance and selectivity the expression contains three variables, R_a , f and Q , in which R_a and f are independent, but Q is a function of f . In investigating the stability of the system, it will therefore be necessary to take two cases, one in which f is fixed and one in which R_a is fixed.

Case 1. Variation of R_a

Considering the circuit shown in Fig. 4 and also equation (5b), it follows that for any particular frequency and value of Q and L , R_a may be adjusted to give a predetermined selectivity. Having adjusted R_a to give this desired selectivity, it is required to find the change in value of R_a to produce oscillation. Writing these conditions down mathematically we have for condition 1 :

$$\frac{\delta f}{f} = \sqrt{N^2 - 1} \left(\frac{1}{2Q} - \frac{2\pi 1000 f L}{2R_a} \right) \dots (6a)$$

and for condition 2 :

$$O = \sqrt{N^2 - 1} \left(\frac{1}{2Q} - \frac{2\pi 1000 f L}{2(R_a + \delta R_a)} \right) \dots (6b)$$

Also, for any given core material, it may be shown that

$$\frac{\delta R_{eff}}{L} = (A_1 + A_2 B_m) f + A_3 f^2 \dots (7)$$

where δR_{eff} = change in effective resistance,
 f = frequency in kc
 A_1, A_2 and A_3 = constants for the material
 B_m = maximum flux density (a.c. component).

Then, if R_{dc} = the d.c. resistance of coil,

$$\frac{R_{eff}}{L} = \frac{R_{dc} + \delta R_{eff}}{L} = \frac{R_{dc}}{L} + A_1 f + A_3 f^2 \dots (8)$$

since for small signals B_m is small and may be neglected.

$$\therefore Q = \frac{2\pi 1000 f L}{R_{eff}} = \frac{E f}{A + B f + C f^2} \dots (8a)$$

where $E = 2\pi 1000$

$$A = \frac{R_{dc}}{L}$$

$$B = A_1$$

$$C = A_3.$$

In actual practice, particularly at the higher frequencies in high inductance coils, the actual "Q" law is modified due to losses in the self capacity of the coil, insulation resistance, etc. The total effect of these losses when the coil is used in an anti-resonant circuit can be represented by a shunt resistance across the coil. If Q = the actual "Q" of the coil, then the actual dynamic impedance equals

$$\frac{1}{Q' E f L} = \frac{1}{Q E f L} + \frac{1}{R_s}$$

where R_s = equivalent shunt resistance ;

$$\therefore \frac{1}{Q'} = \frac{1}{Q} + \frac{E f L}{R_s} \dots (8b)$$

$$\text{or } \frac{1}{Q'} = \frac{A + B f + C f^2}{E f} + \frac{E f L}{R_s} \dots (9)$$

Substituting (9) in equations (6a) and (6b) we get :

$$\frac{\delta f}{f\sqrt{N^2-1}} = \left(\frac{A+Bf+Cf^2}{Ef} + \frac{EfL}{R_s} - \frac{EfL}{R_a} \right) = \alpha \text{ (say) } \dots\dots\dots(10a)$$

$$\text{and } \frac{A+Bf+Cf^2}{Ef} + \frac{EfL}{R_s} - \frac{EfL}{(R_a+\delta R_a)} = 0 \dots\dots(10b)$$

$$R_a + \delta R_a = \frac{EfL}{\frac{A+Bf+Cf^2}{Ef} + \frac{EfL}{R_s}}$$

$$\frac{R_a + \delta R_a}{R_a} - 1 = \frac{\frac{EfL}{\frac{A+Bf+Cf^2}{Ef} + \frac{EfL}{R_s}}}{\frac{EfL}{\frac{A+Bf+Cf^2}{Ef} + \frac{EfL}{R_s}}} - 1$$

$$\text{or } \frac{\delta R_a}{R_a} = \frac{\frac{A+Bf+Cf^2}{Ef} + \frac{EfL}{R_s} - \alpha}{\frac{A+Bf+Cf^2}{Ef} + \frac{EfL}{R_s}} - 1$$

$$= \frac{-\alpha}{\frac{A+Bf+Cf^2}{Ef} + \frac{EfL}{R_s}} \dots\dots\dots(11a)$$

$$= -\alpha Q', \dots\dots\dots(11b)$$

where Q' is the effective coil constant.
 It is evident from equation (11b) that, for a given accidental variation of the value of R_a due to valve, battery and contact resistance changes, the maximum possible selectivity is

proportional to the true Q of the coil, i.e., Q' .
 As indicated in the schematic (Fig. 4) the negative resistance is obtained by means of a screen grid valve, and the value of the resistance is adjusted by regulation of the grid bias (not shown). Thus it follows that the main limitations of the constancy of R_a is variation in grid voltage. To date, a large capacity dry cell has been used for the bias with reasonable satisfaction, but it is possible that some form of stabilising device may be an advantage. Other voltage variables which affect the negative resistance are: (1) anode, (2) screen, and (3) heater.

The heater supplies are obtained from the power mains and, in general, the short period stability is reasonably good; furthermore, the heat capacity of the cathode is generally sufficiently large to take care of small irregularities so that the heater does not have much effect on R_a .

Considering the anode and screen voltages, an examination of the curves of Figs. 5 and 6 indicates that a given variation of anode voltage has a much greater effect on the negative resistance than the same variation of screen voltage. The screen voltage may, therefore, be considered as producing a second order effect. Variation in anode voltage is compensated for by adjusting the working anode voltage for a maximum negative resistance; this, as will be seen from Fig. 6, occurs at about 11 volts. It will also be noted that the anode voltage corresponding

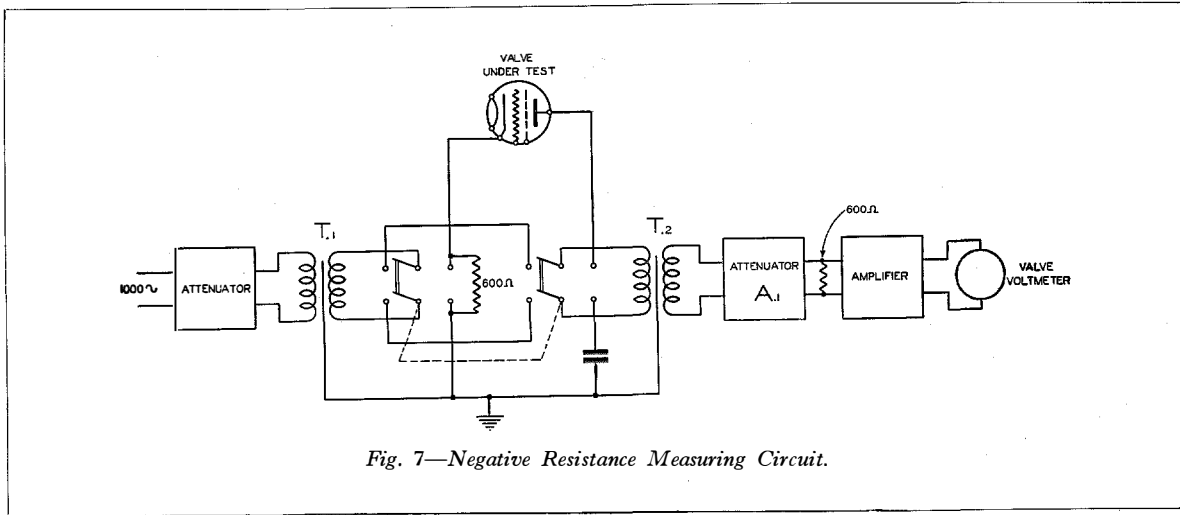

Fig. 7—Negative Resistance Measuring Circuit.

to a maximum negative resistance at one value of grid bias is also a maximum for all other values of grid bias.

The values of negative resistance shown in Figs. 5 and 6 were obtained on the negative resistance measuring set shown in Fig. 7, the principle of operation being as follows :

The valve whose negative resistance is to be measured is connected between transformers T_1 and T_2 , and a 1 000 p : s input applied between the screen and the anode. As the transformer T_2 is terminated in 600 ohms through the attenuator A_1 , the voltage across T_2 depends directly upon the value of the resistance of the valve, whether positive or negative, the effect of the valve and transformer being that of a potentiometer. The value of the voltage applied to the resistance under test is that developed across T_1 and can be determined by short circuiting the resistance and thus applying the test voltage across the transformer T_2 , which may then be measured by means of attenuator A_1 and the amplifier and valve voltmeter. By inserting the resistance to be measured and noting the change in setting of attenuator A_1 to produce a standard reading on the valve voltmeter, the value of the resistance inserted, whether positive or negative, can be obtained.

Case 2. Variation of 'f'

Assuming, as in Case 1, that the circuit conditions have been adjusted to produce a certain selectivity, it is now required to find what will be the effect of a small accidental variation in the natural frequency of the tuned circuit $L.C.R_{eff}$. The initial condition can be represented as before by equation (10a).

$$\frac{\delta f}{f\sqrt{N^2 - 1}} = \left(\frac{A+Bf+Cf^2}{Ef} + \frac{EfL}{R_s} - \frac{EfL}{R_a} \right) \quad (10a)$$

Assuming that the maximum frequency variation for stability is δf ,

$$0 = \frac{A+B(f+\delta f)+C(f+\delta f)^2}{E(f+\delta f)} + \frac{E(f+\delta f)L}{R_s} - \frac{E(f+\delta f)L}{R_a} \quad \dots\dots\dots(12)$$

or from (12)

$$\frac{A+Bf+Cf^2}{E} + \frac{(B+2Cf)\delta f}{E} + \frac{C\delta f^2}{E} = \left(\frac{EL}{R_a} - \frac{EL}{R_s} \right) (f^2 + 2f\delta f + \delta f^2); \dots\dots(13)$$

but from (10a)

$$\left(\frac{EL}{R_a} - \frac{EL}{R_s} \right) f^2 = \frac{A+Bf+Cf^2}{E} - \alpha f \dots\dots(14)$$

Substituting (14) in (13) and collecting the δf , δf^2 terms, etc.

$$\left(\frac{\delta f}{f} \right)^2 \left(\frac{A+Bf}{Ef} \cdot \frac{1}{\alpha} - 1 \right) + \frac{\delta f}{f} \left(\frac{2A+Bf}{Ef} \cdot \frac{1}{\alpha} - 2 \right) - 1 = 0; \dots\dots\dots(15)$$

$$\therefore \frac{\delta f}{f} = \frac{-b}{2a} \left(1 \pm \sqrt{1 + \frac{4a}{b^2}} \right), \dots\dots\dots(16)$$

Where $a = \left(\frac{A+Bf}{Ef} \cdot \frac{1}{\alpha} - 1 \right)$

and $b = \left(\frac{2A+Bf}{Ef} \cdot \frac{1}{\alpha} - 2 \right);$

$$\therefore \frac{\delta f}{f} = \frac{-b}{a} \text{ or } + \frac{1}{b} \text{ as } a \text{ is approximately}$$

equal to b .

But $\frac{\delta f}{f}$ cannot be greater than 1 ;

$$\therefore \frac{\delta f}{f} = \frac{1}{b} = \frac{E\alpha}{2A+f(B-2E\alpha)} \dots\dots\dots(17)$$

Thus from equation (17) it follows that $\frac{\delta f}{f}$ is approximately equal to $\frac{\delta R_a}{R_a}$ at low frequencies

and, at high frequencies, it approaches a constant value of $\frac{E\alpha}{B}$. If, therefore, the accidental

fractional changes in frequency are the same as the fractional changes in negative resistance,

then the lower limits on the frequency range on any coil are the same whether taken on the assumption of a frequency drift or a negative resistance drift. The upper limit appears to be decided purely by the resistance variation inasmuch as a fractional change in frequency has less and less effect on the stability as the frequency increases. In practice it seems from the nature of the case that accidental variations in the natural frequency of the tuned circuit will be of considerably lesser magnitude than variations in negative resistance.

ELECTRICAL DESIGN

The electrical design characteristics of the reactive filter as elucidated by the foregoing analysis are as follows :

- (I) The frequency range of any coil covers the range over which the coil constant (Q) is above a certain value depending on the selectivity required ;
- (II) The possible selectivity is directly dependent on the coil constant ;
- (III) The anode voltage is critical and must therefore be adjustable to close limits ;
- (IV) The grid bias is critical and requires close adjustment ; furthermore, it must remain constant for any setting ;
- (V) Since the discrimination of the filter is a function of the coil constant (Q), care must be taken to ensure that the coil constant is not unnecessarily reduced by the load of the succeeding stage.

The foregoing conditions are met by the circuit shown in Fig. 8. The valve V_1 is the

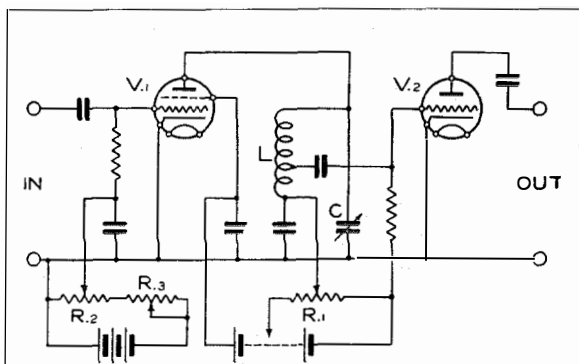

Fig. 8—Schematic of Reactive Filter.

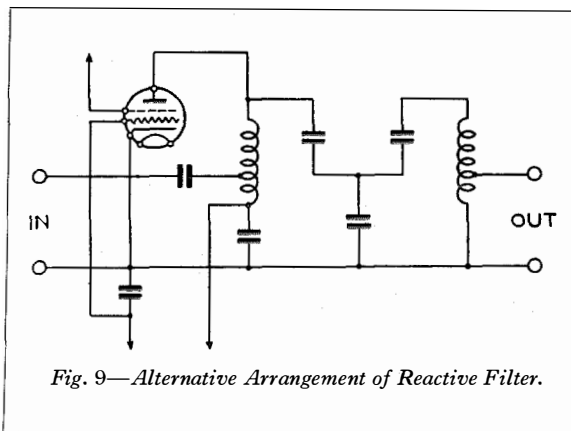

Fig. 9—Alternative Arrangement of Reactive Filter.

negative resistance device and the tuned circuit LC is the filter, the signal being applied to the grid of V_1 . The output is taken from a tap on the coil giving a high impedance ratio and thus reducing the load on the tuned circuit. It is important at high frequencies to keep the lead from the coil to the grid of the amplifier as short as possible, otherwise the resistance components in the stray capacities may have serious effects on the Q of the coil.

The power supplied to the valve V_1 is from batteries of generous capacity, a potentiometer R_1 being incorporated to adjust the anode voltage. This potentiometer should be of low resistance (about 20Ω) since increasing the resistance in the anode circuit tends to produce "back lash" due to the operating point on the anode voltage-negative resistance curve shifting with change of anode current. The grid bias is obtained from a high capacity battery, feeding potentiometer R_2 in series with a variable resistance R_3 . Resistance R_2 acts as a coarse grid-bias control and resistance R_3 as a fine control, the ratio of the two resistances being about $10 : 1$, respectively. Here again, the grid circuit resistances should not be too high as drift of negative resistance due to rectification of the signal on the grid will tend to occur as the input level is increased. The value of the grid circuit resistance should not exceed about $10\ 000\Omega$.

For inputs in excess of 0.2 volts, the performance of the filter can be improved by using a resistor in the cathode circuit to obtain part of the bias. In this way any rectification of the signal by the valve as an anode bend detector will automatically increase the bias in the

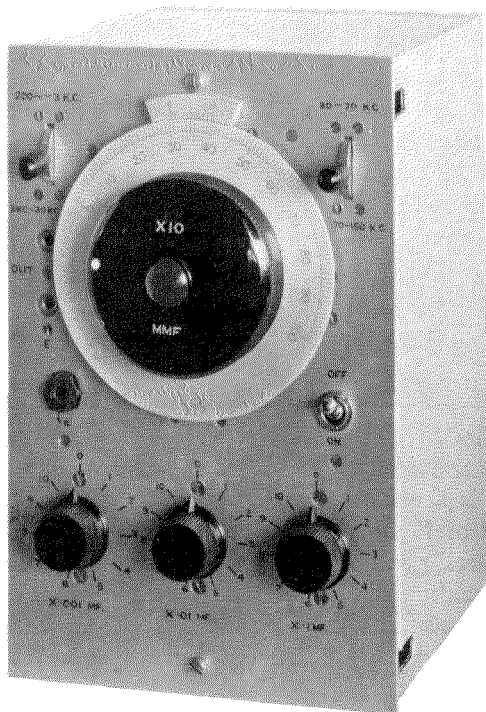

Fig. 10-A—Reactive Filter (Front View).

negative direction and tend to greater stability. For very large inputs, say in excess of 1 volt, a possibly superior arrangement is as shown in Fig. 9, but care must be taken to ensure that both the input and output impedances are large. This arrangement results in a slight overall loss compared with a gain of about 34 db for the circuit shown in Fig. 8, and does not appear to offer any advantages other than the capability of handling high levels.

For frequencies up to about 30 kc, the values of A, B and C in equation (11a) can be determined for the core material with a reasonable degree of accuracy, but at high frequencies the mechanical design of the coil has a considerable effect on the value of the constants. For design purposes at high frequencies, therefore, the best procedure is to determine the value of the constants for the core and coil shape by measuring a coil of any value but of suitable mechanical design.

Thus far reactive filters have been constructed for operation at any frequency from 200 p : s to 2.0 Mc, and there does not seem to be any great

difficulty in extending the range considerably in the upward direction. In the downward direction it is possible that considerable improvement in selectivity can be obtained by using the reactive filter principle ; but, owing to the very narrow band widths encountered, tuning becomes a little difficult due to the long "build-up" time.

The selectivity obtainable cannot be adequately represented by a curve, but Table I presents typical figures :

TABLE I

Loss in db.	Percentage of Nat. Freq. Off Tune.	
	+	-
0	0	0
5	0.0106	0.009
10	0.0212	0.018
20	0.0725	0.073
30	0.24	0.22
40	0.92	0.86
50	3.5	3.1

Some idea of the variation in selectivity to be expected over a wide frequency range can be gained by perusal of Table II. The figures do not necessarily represent the best possible performance obtainable but are the results of a compromise between the number of coils, physical size, etc. The selectivity is given in terms of percentage change of natural frequency for an attenuation of 30 db.

The drop in selectivity in the middle of the range of some of the coils is due to absorption in surrounding circuits via key capacities.

MECHANICAL DESIGN

The possible physical forms of the filter are obvious, but some idea of compactness may be obtained from Figs. 10-A and -B. The model shown covers a frequency range of 200 cycles to 150 kc. As will be seen, two keys are provided for the selection of coils. The controls on the front are :

- (a) Two coil keys for selecting one of 4 coils ;
- (b) A condenser decade consisting of a 1 200 μ F variable condenser and three decade switches having ranges of 0.01, 0.1 and 1.0 μ F, respectively ;
- (c) An on-off switch ;

TABLE II

RANGE 1 200-1 000 p : s		RANGE 2 800-13 000 p : s		RANGE 3 4 kc-25 kc		RANGE 4 25 kc-80 kc		RANGE 5 80 kc-200 kc		RANGE 6 200 kc-500 kc	
Freq. in p : s	Selectivity in % for 30 db attenuation	Freq. in p : s	Selectivity in % for 30 db attenuation	Freq. in p : s	Selectivity in % for 30 db attenuation	Freq. in p : s	Selectivity in % for 30 db attenuation	Freq. in p : s	Selectivity in % for 30 db attenuation	Freq. in p : s	Selectivity in % for 30 db attenuation
200	0.93	800	0.375	3.5	0.33	25	0.52	80	0.67	200	0.5
300	0.74	1 000	0.26	5.0	0.44	30	0.32	90	0.27	300	0.2
400	0.53	2 000	0.25	7.0	0.36	40	0.45	100	0.35	400	0.375
600	0.25	4 000	0.4	10.0	0.20	50	0.55	125	0.25	500	0.44
800	0.62	6 000	0.28	13.0	0.154	60	0.46	150	0.29		
1 000	0.61	8 000	0.12	15.0	0.346	70	0.59	175	0.285		
1 500	1.04	10 000	0.23	17.0	0.13	80	0.78	200	0.15		
		12 000	0.185	20.0	0.3						
		13 000	0.22	25.0	0.29						

(d) A jack for measuring the anode current. The power supplies to the unit are located on a separate panel.

Important points in the mechanical design are:

- (1) Keeping the capacities between the key contacts used for coil switching to a minimum so as to obviate absorption effects between the coil in use and the others.
- (2) Keeping the capacity to earth of the lead between the output and the grid of the following valve as small as possible and free from dielectric losses, etc. Any losses in this lead will obviously reduce the effective Q of the coil.
- (3) The P.F. of the condensers, both tuning and by-pass, should be kept low; otherwise the effective Q of the coil, particularly at high frequencies, will be reduced.

OPERATION OF REACTIVE FILTER

With the circuit of the reactive filter shown in Fig. 8 and an amplifier connected to a suitable visual indicator, as shown in Fig. 11, the method of setting up the filter and its operation is as follows:

Having inserted the valve and checked up the appropriate power supplies, the grid bias control (coarse) should be set to give zero bias and the grid bias control (fine) maximum bias. Assuming that the anode voltage is approximately 11 and the screen voltage 35, the valve should oscillate and the output indicator show full scale deflection. The grid bias should then be increased slowly in the negative direction until oscillations suddenly cease. The anode voltage control should now be adjusted until oscillation again occurs and the grid bias controls readjusted until oscillation again

just ceases. This process should be continued until a position of the anode voltage control is obtained where further adjustment does not necessitate an increase in the negative direction of the grid bias to prevent oscillation. The anode voltage then will be at the critical setting necessary for stability and will not require further setting unless the valve is changed or the batteries fail.

For normal use it is best to set the tuning controls to approximately the right setting, and adjust the bias to the valve until the condition

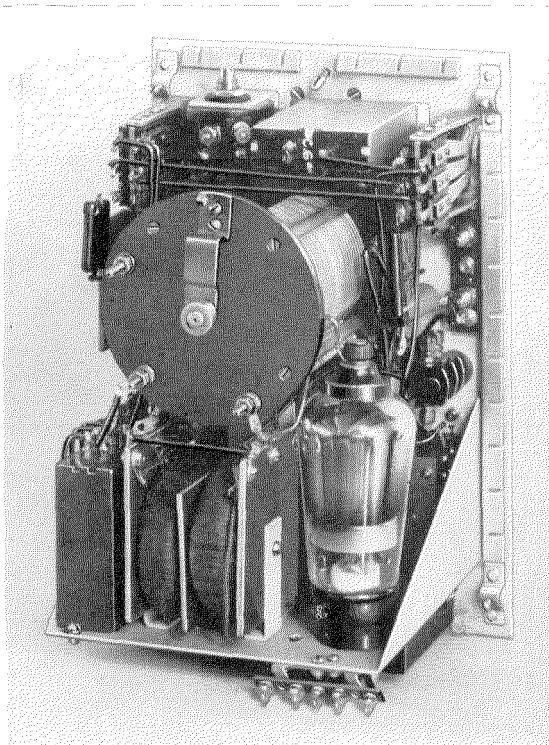

Fig. 10-B—Reactive Filter (Rear View).

of maximum stability and sensitivity is reached. Retune the filter to give an absolute maximum on the output indicator and reset the bias on the "fine" control. The measurement can then be made and the reactive filter and amplifier calibrated in terms of sensitivity and frequency.

FEATURES OF REACTIVE FILTER

The chief characteristics of the reactive filter may be summarised as follows :

- (i) Its selectivity approaches that of a coil having a "Q" of approximately 10 000 and is of the same order as a crystal ;
- (ii) It can be made continuously variable over a wide frequency range ;
- (iii) Its constancy of frequency appears to be independent of the valve and is purely a function of the constancy of the coils and condensers used ;
- (iv) The gain over the frequency band is substantially constant and is equal to a multiplication of about 50 on a voltage basis ;
- (v) There is a maximum limit on the input impedance and a minimum limit on the output impedance ;
- (vi) The maximum input level is approximately 1.0 volt, a level at which harmonics are produced in the output circuit about 57 db

below the fundamental. It will be noted that these harmonics are only passed when the filter is tuned to accept the respective harmonics, as explained hereinafter.

APPLICATION OF THE REACTIVE FILTER TO WAVEFORM ANALYSIS

In actual practice the substitution of a reactive filter for the modulator and selective device used in the heterodyne method involves various circuit changes. The block schematic shown in Fig. 11 indicates the arrangement necessary for the measurement of harmonics in an amplifier. With certain fairly obvious modifications, the circuit can be made suitable for other waveform measurements.

Oscillator 1 provides the standard tone to be analysed, the output being measured on valve voltmeter 1 and the waveform being made sinusoidal to the required degree of accuracy by means of the harmonic suppressor. The output level to the apparatus under test is adjusted suitably by attenuator 1. It is found convenient to use one standard level for measurement throughout, generally about 1.2 volts (4 db above 1 milliwatt into a 600 Ω impedance); the output of the apparatus under test is measured by means of attenuator 2 and valve voltmeter 2.

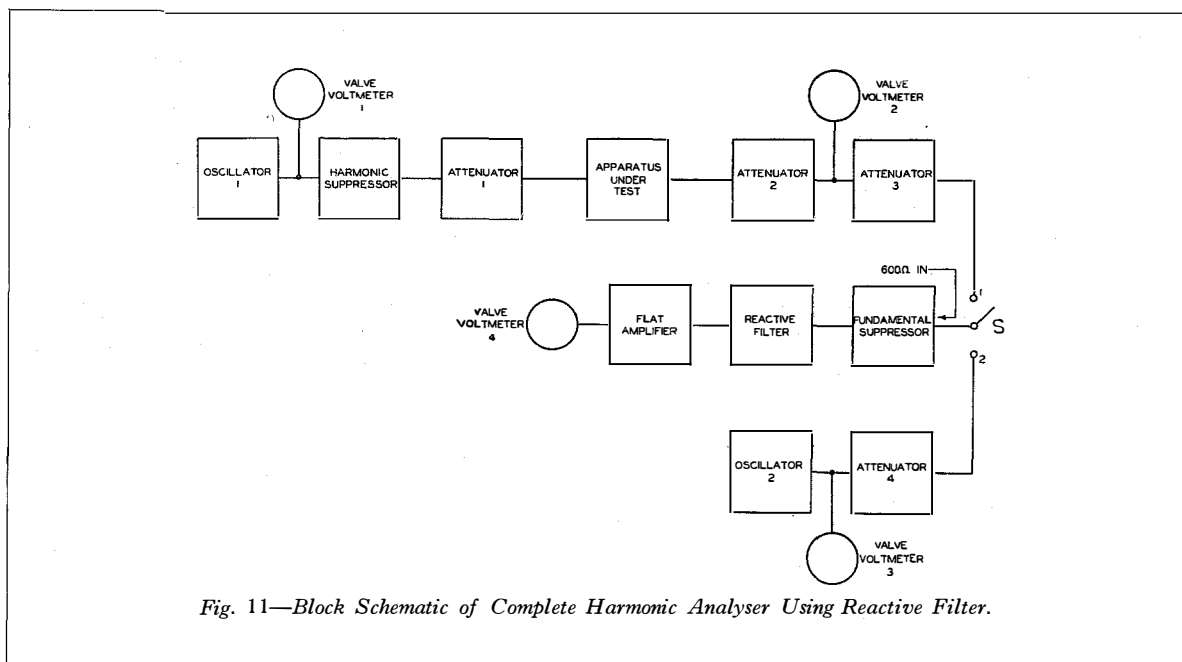

Fig. 11—Block Schematic of Complete Harmonic Analyser Using Reactive Filter.

With the key thrown to S_1 , the output to be analysed is fed via the fundamental suppressor to the reactive filter and thence to the flat amplifier and valve voltmeter 4. The calibration of the circuit is accomplished as subsequently outlined but, before describing the operation in greater detail, a digression must be made to explain the significance of the fundamental suppressor.

It is well known that the harmonics present in the anode current of a valve increase with the applied grid voltage. In the case of the screen grid valve used, an input level of 1 volt produces 2nd and 3rd harmonics about 61 and 57 db down, respectively. By operating the filter at a level of -30 db, these harmonics drop to less than 110 db. It would be rather inconvenient

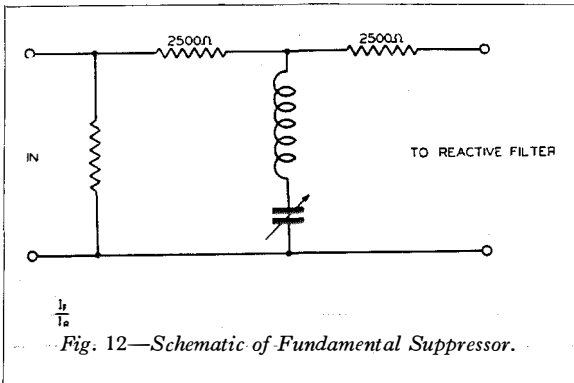

Fig. 12—Schematic of Fundamental Suppressor.

to supply another 30 db gain on top of that necessary to measure harmonics to 95-100 db; hence, arrangements are made to suppress the fundamental, but not harmonics, by 30 or 40 db before it reaches the grid of the valve. This is accomplished by the circuit shown in Fig. 12, which is a T network with a selective shunt arm.

Great care is required in choosing the coil for the series resonant circuit, particularly at low frequencies, since the harmonics generated in the coil are likely to be very much less than 100 db unless the coil is designed on very generous lines. It is impracticable to use an air-cored coil in the circuit as it is almost impossible to screen it adequately to prevent picking up the fundamental frequency present in the output of the amplifier under test and in the associated leads. For frequencies down to 4 kc, a radio dust-cored coil is adequate, whilst

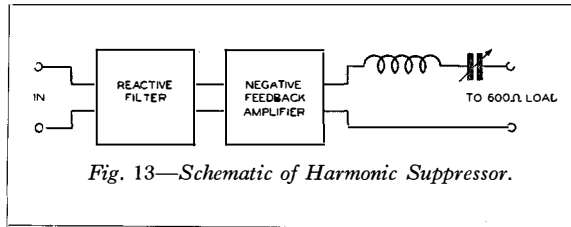

Fig. 13—Schematic of Harmonic Suppressor.

for frequencies below 4 kc a large permalloy dust-cored coil is used.

Returning to the principle of operation: the output across valve voltmeter 2 consists of a fundamental and a range of harmonics in which all the harmonics are generated in the apparatus under test, the applied voltage being suitably filtered. The switch S is thrown into position 1 and the shunt circuit of the fundamental suppressor is disconnected by setting the coil switches to normal. The reactive filter is adjusted to receive the fundamental, and adequate attenuation on attenuator 3 is inserted to set valve voltmeter 4 to a standard deflection. The appropriate coil switch on the fundamental suppressor is thrown and the latter tuned so that valve voltmeter 4 reading is a minimum. The reactive filter is set to the first harmonic frequency to be measured and attenuator 3 is adjusted so that the standard deflection is obtained on this voltmeter. The filter circuit is now calibrated by throwing S into position 2 and adjusting oscillator 2 to the harmonic frequency; and, after setting the output of

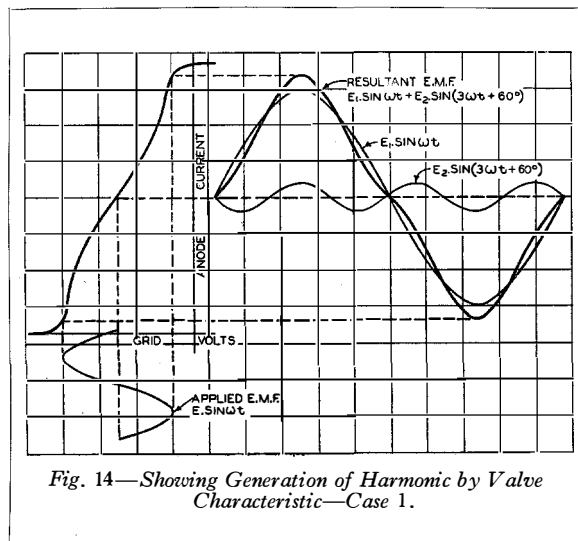

Fig. 14—Showing Generation of Harmonic by Valve Characteristic—Case 1.

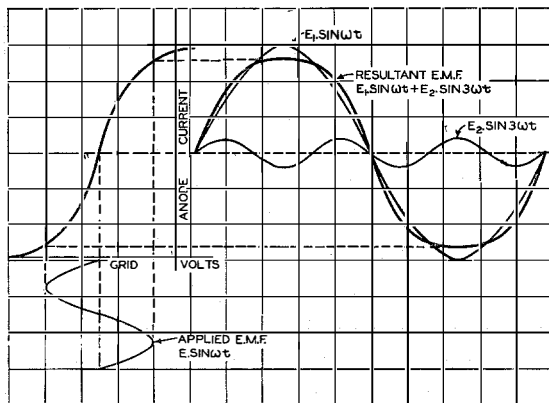

Fig. 15—Showing Generation of Harmonic by Valve Characteristic—Case 2.

oscillator 2 to the standard level, attenuator 4 is adjusted so that voltmeter 4 gives the same standard deflection as that obtained with switch in position 1. The harmonic level is then the difference in setting of attenuator 3 and attenuator 4 expressed in decibels below the fundamental. It is very important that the fundamental suppressor be set in the manner outlined above and not subsequently reset; for, by detuning the fundamental suppressor when the reactive filter is tuned to a harmonic, it is possible to introduce harmonics out of phase with those generated in the amplifier and effect cancellation, thus producing an erroneous result. It should also be noted that it is possible only to calibrate approximately the various tuning controls in terms of frequency, so that these controls may be set; the final adjustment, however, must be made by obtaining a peak reading on the valve voltmeter 4. This comment applies particularly to the reactive filter.

The remaining problem in waveform analysis is the provision of standard tone having considerably less distortion than that to be measured in the apparatus. With an analyser of the type described, harmonic levels of 90 db can be measured with a fair degree of accuracy and ease; it is, in fact, possible to read to 100 db. The production of suitable tone is therefore no mean task as it must have a harmonic content not greater than 110 db at any frequency. The existing method of producing this tone is to use a multi-circuit L.P. filter following the oscillator; and great care must

be exercised to ensure that the coils in the last section do not themselves produce harmonics. It is possible to use the reactive filter as a smoothing device; but, since it needs to be followed by a high impedance circuit, it is difficult to avoid reintroduction of the harmonics removed by the filter.

The arrangement indicated in Fig. 13 has been used experimentally for providing a standard tone, but appears to be rather cumbersome and expensive. It has the merit, however, of being continuously variable in frequency over a wide range. The input was taken from an ordinary oscillator and fed in at a level of about 60 db below 1 volt, filtered by the reactive filter, and afterwards amplified by an amplifier in which the harmonic had been reduced by negative feedback to about 90 db. The series resonant filter in the output increased the suppression by about another 20 db, thus producing a source of tone in which the harmonics are suppressed to at least 110 db.

An illustration of a harmonic analyser, as described with reference to Fig. 11, is shown in Figs. 3-A and 3-B.

HARMONIC ANALYSIS AT LOW FREQUENCIES

An interesting phenomenon observed when measuring harmonics at low frequencies (below 200 p : s say) is the marked variation in harmonic level with changes of valves in the apparatus under test. An actual test of a batch of valves checked in a resistance coupled stage indicates that valves of similar characteristics, i.e., mutual conductance, impedance, etc., have substantially equal harmonic contents; but, upon inserting the same valves in a transformer coupled amplifier, most erratic results were produced. A valve, for example, giving a harmonic level of 5 per cent. for a certain loading, may yield anything from 1 per cent. to 10 per cent. in a transformer coupled stage under the same conditions. This discrepancy is possibly due to partial cancellation or augmentation of the harmonics from the coils by the harmonics produced by the valves, a comparatively small change in phase producing a large effect.

The small degree of difference in valve

characteristic necessary to produce a phase reversal is indicated in Figs. 14 and 15. It will be seen that, if the valve characteristic is such that the slope increases slightly before saturation, a peaked wave is produced and a third harmonic introduced 60° out of phase. If, however, the slope decreases steadily towards saturation, then a flat topped curve is produced and the third harmonic is introduced in phase with the fundamental, i.e., both fundamental and harmonic pass through zero in the same direction. It will be appreciated that these curves are shown merely for illustrative purposes, actual conditions being complicated by the introduction of many other harmonics in various phases.

FEATURES OF THE WAVEFORM ANALYSER

Summarising the foregoing, the chief features of the above waveform analyser are :

- (i) It is continuously variable in frequency over a very wide range ;
- (ii) It can be used to analyse waveforms having components of levels as low as 90 db ;
- (iii) The percentage discrimination of the analyser does not decrease with frequency ;
- (iv) The discrimination is sufficiently "sharp" to make it suitable for analysis of a waveform in which the sine wave components are more closely spaced than the harmonics, e.g., the analysis of modulation products in a modulator or demodulator.

The Application of Styrene to H.T. Cable Systems

By T. R. SCOTT, D.F.C., B.Sc., M.I.E.E., and J. K. WEBB, M.Sc., A.M.I.E.E.,

Standard Telephones and Cables, Limited, London, England

PART I

In this preliminary section of the paper, an account is given of the reasons which led originally to the development of styrene joints. The practical success of these joints, despite theoretical weaknesses, led to the extension of the technique to the construction of terminations and "plugs." At this stage two main problems had to be faced: (1) the problem of multicore cables—(2) difficulties in connection with producing and handling the raw materials required.

In parts of this paper to be published in the future, an account will be given of the development work involved in meeting these two problems. In particular, the evolution of styrene products known under the trade mark "Superstyrex" to meet the difficulties associated with the material will be discussed, and the problems and phenomena arising from compound migration in cable systems will be considered. Some specific applications of these products to special power cables, joints, terminations, etc., will be described.

IN a previous paper⁽¹⁾ some account was given of the development of the technique of utilising monomeric (liquid) styrene in forming solid insulating materials of various types and forms. Reference was made in that paper to certain applications to high tension cables. The developments in this direction have been so rapid and important that it appears to be useful to expand the information already published by dealing in detail with various aspects of the development work in this particular field—underground transmission at high voltage.

In 1928, the Power Cable Laboratory of Standard Telephones and Cables, Limited, commenced a series of life tests on cables for working voltages of 33 kV and 66 kV. At a later date, 132 kV cables were added. The cables were all of the solid or mass-impregnated type, which is the only type considered in this first section of the present paper. These tests, which are described in an article now in preparation, were designed to simulate service conditions as far as possible, and were run at voltages which set up predetermined values of electrical stress in the insulation. The cables were subjected simultaneously to fluctuating loads, the current being varied so that the cables were subjected to variations of conductor temperature ranging from the ambient temperature to 75°C. Readings of dielectric loss, ionisation factor, insulation resistance, etc.,

were taken at frequent intervals during the life of the cable. The electrical stresses applied to the insulation were in general such that the cable resisted breakdown for 50 to 300 days.

Since it was desired to test a large number of cables each varying in make-up of insulation, e.g., material (oils and paper) and/or impregnation process, etc., arrangements had to be made to test many cables simultaneously. This involved either excessive kVA capacity of testing plant or severe restriction of cable lengths. The difficulty arose, however, that if the length of each cable were restricted to (say) 50 yards, as compared with a normal service length of about 200 yards, it was noticeable that the behaviour of the cable was determined largely by the interference action of the potheads or joints at the ends of the cable.

It is necessary to deal herein somewhat fully and in detail with this phenomenon since the major commercial gain resulting from the utilisation of styrene joints, terminations, etc., in service lies in the protection afforded to the cable by the sealing-off of each length so that longitudinal flow is reduced to a negligible value. In the case of "plugs" situated in the cable length itself, this sealing-off effect is applied to sub-lengths.

Longitudinal flow in solid or mass-impregnated cables, hung vertically down shafts, etc., or laid on gradients, is a recognised phenomenon, and it is common practice in such cases to

¹ For numbered references see Bibliography.

insert barrier or stop joints so that the hydraulic head is subdivided into units of from 50 ft. to 80 ft. to prevent cumulative building up of pressure to a point at which lead sheath distention might become serious.

In general, however, one finds a tendency to serious under-estimation of the effects produced by longitudinal flow in such cables laid horizontally or on slight gradients where the hydraulic pressure applied to the lead sheath is negligible. Since, as mentioned above, the most important property of the styrene joints, terminations, plugs, etc., is that of restricting longitudinal flow, it will be necessary in a later section of this paper to consider in detail the phenomenon of compound migration in cables. For the moment, it is sufficient to note that the primary objective in developing the styrene joint was to obtain from short lengths of cable (say) from 30 to 60 yards, results equivalent to those obtainable from "infinite" lengths of cable. It may be mentioned here in advance that, so far as subsequent life test results indicate, this object was successfully achieved by the introduction into the life test cable system of styrene joints whereas ordinary barrier or stop-joints did not bring about this result.

At the time the development commenced, the Laboratory was familiar with the phenomenon of converting liquid monomeric styrene into solid polymeric styrene by the application of thermal energy⁽¹⁾. It was, therefore, conceived that, if the ordinary form of taped joint were employed using monomeric styrene throughout in place of oil or joint compound and if thermal energy were subsequently applied to the joint, the formation of polymeric styrene would convert the joint into an ideal barrier joint.

The design of this joint is illustrated in Fig. 1 which, however, represents up-to-date practice in respect to certain details.

The paper tapes are cut, dried and impregnated in (liquid) monomeric styrene which has a viscosity at ordinary atmospheric temperature of the order of that of water. Absorption is, therefore, rapid and the impregnation process is simpler than that in which oil (or compound) is employed. The papers after impregnation are stored in tins filled with monomeric styrene. Taping follows normal practice and evacuation and filling are identical to the processes used

with oil or compound. Polymerisation is usually effected by circulating current in the joint sleeve, 2 or 3 kVA being applied by means of a $10 \alpha : 200 \alpha$ current transformer. A set-up of this nature is shown in Fig. 2.

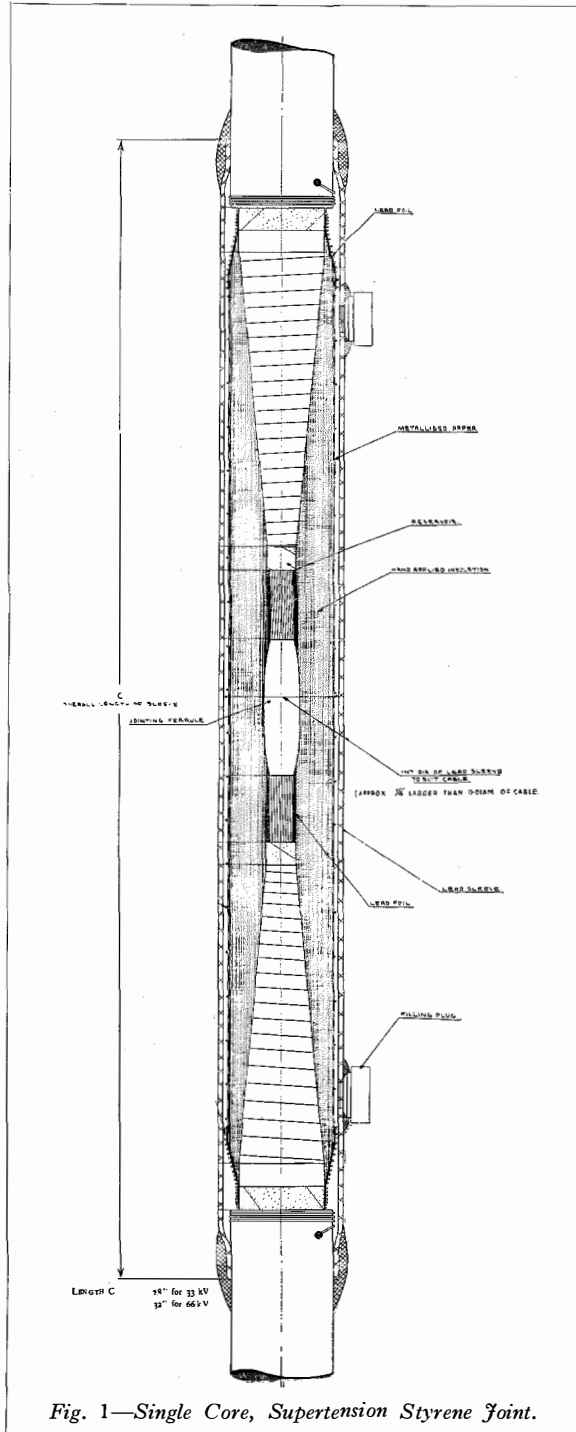

Fig. 1—Single Core, Supertension Styrene Joint.

In constructing the original joints in the Life Test System, several known weaknesses in the basic idea were taken into account. It was realised, for example, that the total shrinkage in volume due to polymerisation of the styrene and to cooling from the temperature of poly-

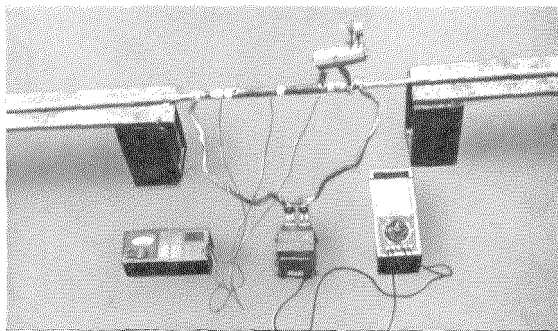

Fig. 2—Equipment for Electrical Heating of Styrene Joint or Plug.

merisation would be of the order of 15%. It was hoped that, apart from anything which could be achieved by pressure feeding during polymerisation (polystyrene being thermoplastic at the temperature specified for polymerisation), the breaking up of the polystyrene into thin films by the paper tapes would prevent voids of ionisable dimensions being formed. It may be noted here that not only was this forecast substantiated by results, but also another favourable factor was later found to be operating towards the total elimination of voids.

It was known, too, that while monomeric styrene (being of the benzene class) dissolved oil, polymerisation threw down discrete particles of polymer from the oil/styrene liquid so that heterogeneity was likely to result. Since it was hoped that the monomeric styrene would penetrate the cable tapers in the joint and go into solution therein so that a "weld" would be effected between the applied insulation (tapes and filling material) and the cable insulation (oil-impregnated paper tapes) this effect during polymerisation was undesirable. It was decided, therefore, to add a percentage of a chlorinated aromatic hydrocarbon, e.g., chlorinated naphthalene (halowax) or chlorinated diphenyl (arochlor) so that a homogeneous plastic solid oil/poly-styrene/"aromatic" should be obtained as a final product. It was anticipated that the

chlorinated aromatic hydrocarbon would act as a "common solvent" for the oil and polymeric styrene.

It was further realised that the quality of the joint might depend quite largely on the effect produced on the extremities of the cable by the heating of the oil therein during polymerisation. In view of the fact that the polymerisation process was suspected to be strongly exothermic, it was decided to keep the polymerisation temperature low even at the expense of a prolonged period of time allotted to polymerisation.

Lastly it was felt that if the theory* of the joint proved correct then, at least, a technique would be available for constructing a joint on the principle of "replacing removed insulation" rather than that of "insulating two cable terminations."

It was, consequently, decided to design the joints so that the diameter of the joint was no greater than that of the cable except in so far as it was necessary for the internal diameter of the joint sleeve to be larger than the external diameter of the cable sheath in order that the sleeve could be taken back over the sheath during the construction of the joint. It was felt that such a design would yield the most rapid and instructive results in the long-time life tests to which the joints were subjected.

The initial joints were made on 66 kV cable and were subjected to 45 kV to earth for 5 months, followed by 58 kV for 5 weeks with conductor temperature varying from 0°C. to 75°C. In each and every case the joint survived the test intact. Moreover, when the joints were cut out owing to the completion of the tests on the cables so jointed, they all survived short time breakdown tests, in that breakdown always occurred in the cable exterior to the joint. The joints also withstood severe hydraulic tests and proved themselves to be perfect stop-joints. A longitudinal section of one of these pioneer joints is shown in Fig. 3.

Thus in the very first experiment three things were proved, viz., that a styrene joint of the type described above would meet stop-joint requirements in respect to :

- (1) Hydraulic barrier action ;

* This theory has been developed by one of the authors in an earlier paper.⁽²⁾

- (2) Appreciable B.D.V. value ;
- (3) Satisfactory behaviour under severe service conditions.

Patent protection was obtained⁽³⁾ on the main principles since it was apparent that it would be well worth while to expend some development effort on this type of joint. It was soon appreciated that the detailed development work would be fairly extensive. Among the obvious problems awaiting attention were the following :

1. There was no commercial supply of monomeric styrene available. The process used for manufacturing was relatively simple, but commercial supplies and prices would be necessary before the economics and commercial possibilities of the joint could be fully analysed.
2. The period of time required for polymerisation of the monomeric styrene varied from batch to batch. These laboratory check times did not agree in general with the time required for the polymerisation of the joint. The time of polymerisation of the latter was inconveniently long.
3. The use of chlorinated aromatic hydrocarbons introduced certain risks which had to be guarded against, e.g., the formation of chlorine products if the temperature during polymerisation rose too high and decomposition occurred. The dielectric loss and other electrical characteristics were also somewhat undesirable.
4. The use of "common solvents" (such as the chlorinated aromatic hydrocarbons) in general introduced difficulties since the time of polymerisation was increased and the problem of oil seepage into the joint, with consequent further increase in time of polymerisation, was aggravated. This increase was rapid, particularly in the case of joints on multicore cables where the fillers or wormings of the cable increased the oil seepage problem.
5. Monomeric styrene tended to polymerise even at ordinary atmospheric temperature. It could not, therefore, be shipped to a job unless it were doped with an inhibitor. The known inhibitors were erratic in

preventing polymerisation and were somewhat difficult to remove before use. In the case of the paper tapes, no inhibitor could apparently be added since removal was impracticable.

The problems raised by these five factors alone constituted a formidable research pro-

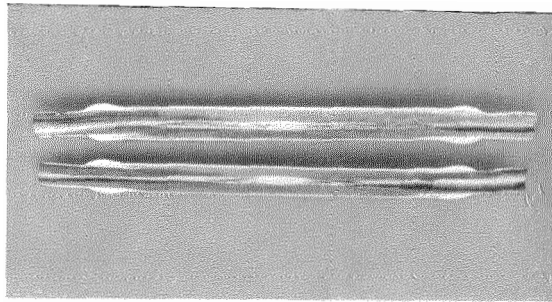

Fig. 3—Longitudinal Section of Original 66 kV Joint.

gramme, as will be seen from the later discussion of the results achieved in producing solutions.

Right at the start extreme difficulty was experienced in inducing manufacturers to produce on a commercial scale pure monomeric styrene. The general attitude was that the supply would become available when the demand arose. It became necessary, therefore, immediately to attempt to stimulate demand in order to encourage supply.

The styrene joint was in consequence introduced to the technical public in the course of a lecture given to the Electrical Power Engineers Association (Technical Section) by one of the present authors early in 1934. This lecture was afterwards published as a paper⁽²⁾ in addition to a short article.⁽⁴⁾ A multicore joint was exhibited at the British Industries Fair in February, 1935.

Somewhat earlier a well-known Power Supply Company in England had been convinced that the joint had potentialities and, during 1934, they installed three 66 kV single core joints which thus far have given "no-trouble" service although the line in which they are operating is a short cable termination to an overhead line and is reputed to receive considerable over-stressing from surges. The service performance of the joint has therefore been well established.

The prosecution of development work on the joints would not have been so vigorous had

it not been for the discovery of a second method of applying styrene to H.T. cable systems. As noted above, styrene is related to benzene and is therefore an effective solvent for oil. The Laboratories had developed the process of impregnating a cable after sheathing⁽⁵⁾—a process which will be discussed in some detail in the section on compound migration—and were therefore familiar with the hydraulic effects likely to be obtained if two nipples were inserted in holes in a cable sheath some distance apart and if liquid were introduced under pressure through one nipple while vacuum was applied at the other. It was found, when this was attempted with monomeric styrene, that first of all pure oil was drawn off by the vacuum; thereafter, oil/styrene came through, the proportion of styrene steadily increasing until finally the styrene emerging was approximately pure. The flow was of course considerably expedited by heating the cable since the viscosity of the oil was thus considerably reduced. Maintaining the cable hot when the oil in the section of cable under treatment had been replaced by styrene caused polymerisation of the styrene and the formation of a complete barrier or “plug” in the cable without opening up of the sheath and without manual interference with the machine-applied insulation of the cable. It should be noted that the styrene finds its easiest paths by way of the stranded conductor and through any space existing between the cable insulation and the lead sheath so that the paths offering lowest resistance to the migration of compound in the cable system are the first to be attacked by the styrene in forming the barrier. The method is therefore extremely effective.

While the first attempts at styrenation were confined to single core cables, it was evident

that a demand would soon arise for the treatment of multicore cables, and a considerable amount of development work was undertaken to elucidate the associated problems. The styrenation of single core cables is a relatively simple matter since the styrene may readily be made to flow in the prescribed paths and permeate the entire dielectric and strand. In

the case of multi-conductor cables, however, the interstices or fillers between the cores have such a low fluid resistance that it is difficult to reach the cores with the styrene and so form a complete barrier.

Such cables fall into two main categories :

- (1) Screened type ;
- (2) Belted type.

In the former, the interstices or wormings are never under electrical stress so that the problem can be solved by first treating

these filler spaces with materials other than styrene, even conducting materials. Following this line of investigation it is, for example, possible to replace the fillers by cast metal so that each core appears inset in solid metal for a length of two or three feet. The cable is thus reduced to the equivalent of the single core cable, and styrenation may be proceeded with accordingly. The metal worming, besides providing a perfect barrier to the flow of oil, acts as a mechanical reinforcement and gives excellent thermal dissipation. The principle of metal filling can also be extended with success to the construction of 3-core screened type joints, several of which have recently been installed on 22 kV and 33 kV systems. Fig. 4 illustrates the cross sectional appearance of such a joint.

Belted cables present a more formidable problem since the insulating property of the wormings must here remain intact. Such cables are, however, always employed on lower voltages so that the electrical stress require-

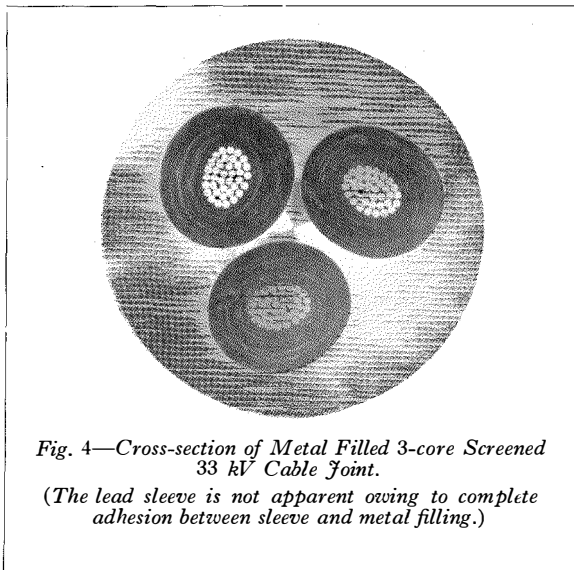

Fig. 4—Cross-section of Metal Filled 3-core Screened 33 kV Cable Joint.
(The lead sleeve is not apparent owing to complete adhesion between sleeve and metal filling.)

ments are not very severe. The styrenation may be carried out in two or more stages, the barrier at the end of each stage thus becoming more complete. Generally it is found that the first styrenation fails to penetrate the belt and only chokes up the space between insulation and sheath. The nipples are of course clogged by the polymerisation so that they must be spaced further apart for the succeeding stage. In this second stage the styrene penetrates the belt but selects the wormings or fillers as the path of lowest resistance. A third stage is therefore necessary with the nipples placed still wider apart. The whole process is therefore tedious and costly.

For such cables, an oil solvent for preliminary treatment to remove the oil—the process of applying styrene then becoming practically that of re-impregnation of the short portion of the cable undergoing treatment—seems to be the only economic method. Considerable development work was necessary to establish the optimum process.

If in any type of cable, instead of employing two nipples a foot or two apart, one nipple be placed at some distance from the end of the cable, the barrier or “plug” is obtained at the cable terminations. Methods were devised for the subsequent stripping of the lead sheath for a portion of the styrenated end, and thus a styrenated termination was obtained ready for insertion in a pothead or cable end box.

This styrenated termination proved immediately to have valuable practical applications. The problems arising from the interaction between cable oil or compound and box oil or compound have been dealt with by one of the authors in considerable detail.⁽²⁾ In particular, there is the danger of ingress of air or moisture, or both, from the pothead or end box. There is also the problem of development of hydraulic pressure in the pothead or end box with consequent risk of serious mechanical damage. These risks are eliminated by the styrenated termination. Patent protection was therefore obtained on these “plug” and termination features⁽⁶⁾ and a note on the technique was contributed to the C.I.G.R.E. of 1935.⁽⁷⁾ Negotiations were started for a commercial service trial and in June, 1936, a 33 kV 6 termination installation was made on the system

of an English municipal power supply undertaking.

This second type of application of styrene naturally intensified the need for detailed and definite work, which was consequently accelerated. It increased interest among power supply engineers so that, during 1936, a considerable number of demonstrations were given, several small orders were booked and 18 66-kV single core joints were also installed. During 1936, furthermore, it was evident that the commercial value of monomeric styrene was becoming appreciated by chemical manufacturers. Samples were received from several suppliers. The test results on these samples confirmed the findings made on material manufactured by the Laboratories, viz., that the rate of polymerisation was variable unless a somewhat high standard of purity was established; also that, if this standard were adopted, the problem of stabilisation for storage and transport would be even more difficult.

The guarantee of sources of supply of styrene and the probability of cost reduction, however, were indicative that the time had arrived for more active exploitation of the new technique.

Already this technique has been applied commercially to cables working at 2 kV, 6.6 kV (belted and screened), 11 kV (belted), 22 kV, 33 kV and 66 kV, and it may be anticipated with confidence that its use will be widely extended over the whole voltage range. Moreover, the above mentioned difficulties have been overcome to the extent that commercial installations have been made on an economic basis. These aspects of the application of styrene to high tension cable systems will be considered further in later sections of this paper.

BIBLIOGRAPHY

- (1) T. R. SCOTT: “Superstyrex,” *Electrical Communication*, July, 1937.
- (2) T. R. SCOTT: “Supertension Joints and Terminations,” *The Electrical Power Engineer*, Nov. and Dec., 1934.
- (3) B.P. 429 611.
- (4) J. K. WEBB: “New Joint for Supertension Cables,” *Electrical Times*, 12th July, 1934.
- (5) B.P. 379 704.
- (6) B.P.’s 449 868 and 460 031.
- (7) T. R. SCOTT and J. K. WEBB: “Recent Developments in Connection with Joints and Terminations,” *Conference Internationale des Grands Reseaux Electriques à Haute Tension*, Session 1935, Bulletin No. 209.

Recent Telecommunication Developments of Interest

Rome Short Wave Broadcaster.—The Italian broadcasting authorities have placed an order with Fabbrica Apparecchiature per Comunicazioni Elettriche (F.A.C.E.) for a high power short wave broadcasting transmitter. It is being constructed by F.A.C.E. in Milan in accordance with Standard technique and will be installed in 1938.

The carrier power will be 100 kW, which is in advance of the powers hitherto obtained in such equipment.

Economical operation will be secured consistently with a high degree of fidelity by the adoption of high power Class "B" modulation with reverse feed-back.

A point of special interest will be the use of the inverted amplifier system in the final radio frequency stage, resulting in improved efficiency and other advantages.

• • •

Automatic Ticketing.—Following the successful field trial of Automatic Ticketing between Bruges and Blankenberghe reported in the April 1937 issue of *Electrical Communication*, the Belgian Régie decided to proceed with the automatization of the seaside towns of Knocke, Le Coq, Heyst and Zeebrugge. An order for new automatic equipment of the 7-D Rotary type, including automatic ticketing facilities, was placed with the Bell Telephone Manufacturing Company, in November 1936, and these exchanges have been successfully cut over. The pivotal switching centre of the network is the town of Bruges where the printing

registers are centralised. All multi-fee calls outgoing from the outlying exchanges of Knocke, Heyst, etc., are trunked through Bruges and the main novelty of the automatic ticketing equipment is that when a subscriber is calling from an outlying exchange, the identification of his line is controlled automatically from Bruges and his telephone number is conveyed to Bruges and printed there on a ticket. The telephone number of the called subscriber and other necessary information are, of course, also printed on the ticket, the same as for a call originated in Bruges itself. Formerly, this traffic was handled manually and ticketed manually by operators in Bruges. The new equipment replaces the operators and the manual ticketing methods, and represents a considerable advance in the development of automatic ticketing systems.

Knocke has equipment for 1 500 subscriber lines; Heyst, for 450; and Zeebrugge, for 1 500. The 300 subscriber lines for Le Coq ultimately will be transferred to the Ostend area, which is the second one to be provided with automatic ticketing.

New system features of interest include :

1. All multi-fee outgoing calls are ticketed automatically and include calls from Knocke, Heyst or Zeebrugge to Bruges or Le Coq or vice versa; calls from Le Coq to Bruges or vice versa; calls from Knocke or Bruges to Blankenberghe. The printing registers for all these calls are centralised at Bruges, which is the administrative centre for the area, and are arranged in a common group with finder access to the different junction groups carrying this class of traffic. The tickets are thus produced where they are most useful to the Administration.
2. On calls from an outlying exchange, such as Knocke, to Bruges or beyond, since the printing registers are located at Bruges, identification of the calling subscriber has to be initiated from, and his number recorded at, the latter exchange. This operation is performed by two-way alternating current signalling over the two-wire junctions; and since it occurs during conversation, "simplex" signalling is used.
3. Calls originated in Zeebrugge reach Bruges via Heyst (see junction diagram, Fig. 2) and the simplex identification signals in both directions are necessarily repeated at the tandem point.

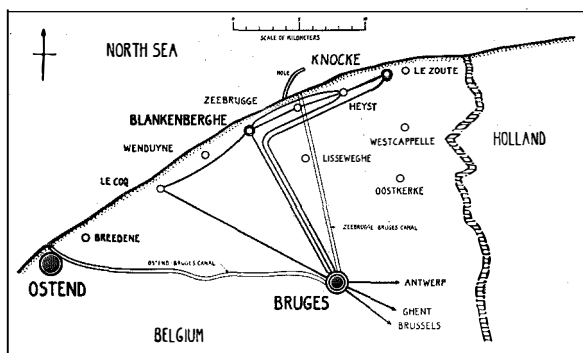

Fig. 1—Network Diagram, Bruges Area.

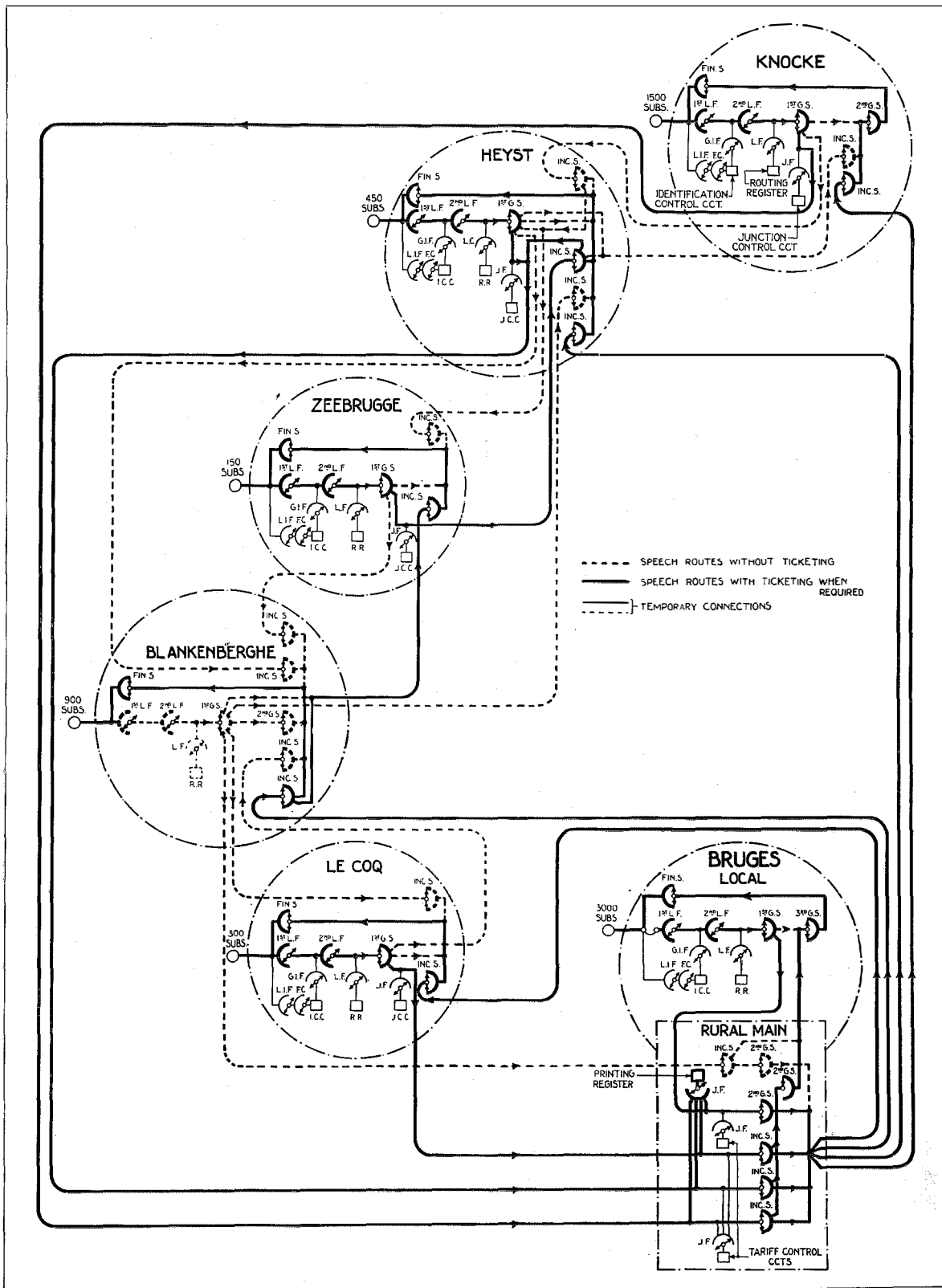

Fig. 2—Junction Diagram, Bruges Area.

4. Means are provided to prevent mutilation of the signals, conveying the identity of the caller, by stray currents induced on the junctions, or by deliberate interference on the part of the caller with intent to defraud.
5. Improved identification equipment is used in the outlying exchanges and includes only two identification finders per 500 lines instead of per 300 lines as in the original Bruges equipment.
6. The determination of the charge per time-unit of conversation (the "tariff") is also centralised at Bruges. The tariff is determined as a function both of the exchange of origin and the exchange of destination.

This item merely records the cut-over of these new exchanges and the further advance of the development of the new facility known as Automatic Toll Ticketing. A full description of the operation of the network (see Fig. 1) will be given in a later article.

• •

Bathroom Subscribers' Sets.—A line of common battery Bathroom Subscribers' Sets has been developed by the Bell Telephone Manufacturing Company, Antwerp. The design is such that it is impossible for the user to contact metallic parts of the set or dial, and the interior components are specially treated to withstand a high degree of humidity and heavy vapour condensation. The electrical characteristics are the equivalent of the standard sets.

The housing, finger stop and finger plate are made of plastic material. A transparent insulating film covers the dial number-plate and the dial frame. The metal base plate is protected by a phenol fibre plate, insulating all the

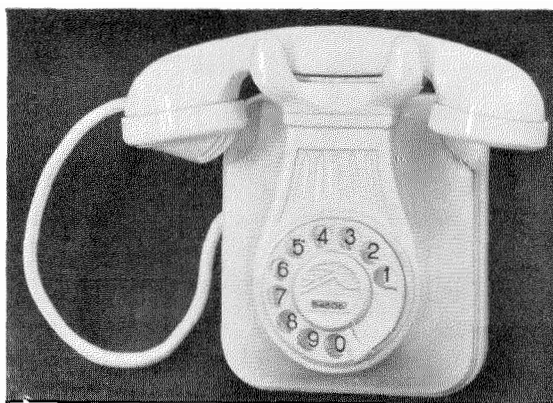

Bathroom Subscriber's Set (Wall-type).

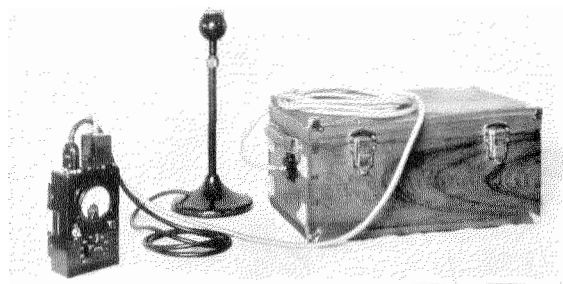

Objective Noise Meter.

interior components, and the cords are rubber covered.

The sets are finished in white and are available in wall and table types; if desired, a different colour can be provided to meet individual requirements.

• • •

Objective Noise Meter.—The No. 74100-A Objective Noise Meter, a simple portable piece of apparatus developed by Standard Telephones and Cables, Ltd., for the rapid determination of noise, is very suitable for the measurement of aircraft, motor-vehicle, street and all industrial noises.

The measuring range of the instrument is from 60 to 140 phons*. It is therefore possible to cover noise levels ranging from those experienced in an average office up to the highest noise levels experienced in industry.

The noise level is indicated on a meter contained in a small control unit which may be held on the palm of the hand or strapped to the knee (the usual method when measuring in aircraft). This control unit contains all the switches required for the operation of the amplifier and measurement of the noise. The amplifier is robust and free from vibration pick-up and includes a self-calibrating device. It operates from its own self-contained batteries.

The set can be used either with a flat characteristic from 50 p:s to 10 000 p:s or with a characteristic which correctly "weights" the noise for the 70 phon loudness level.

The dimensions of the amplifier are 19½" × 12" × 9"; those of the accessory box containing the control unit, cords and microphone, 14" × 11" × 6". The total weight is 67 lbs.

* For definition see British Standards Specification 661—1936.

Licensee Companies

BELL TELEPHONE MANUFACTURING COMPANY.....	<i>Antwerp, Belgium</i>
<i>Branches : Brussels</i>	
BELL TELEPHONE MANUFACTURING COMPANY.....	<i>Berne, Switzerland</i>
BELL TELEPHONE MANUFACTURING COMPANY.....	<i>The Hague, Holland</i>
CHINA ELECTRIC COMPANY, LIMITED.....	<i>Shanghai, China</i>
<i>Branches : Canton, Nanking, Tientsin.</i>	
COMPAÑÍA RADIO AEREA MARITIMA ESPAÑOLA.....	<i>Madrid, Spain</i>
COMPAÑÍA STANDARD ELECTRIC ARGENTINA.....	<i>Buenos Aires, Argentina</i>
CRED AND COMPANY, LIMITED.....	<i>Croydon, England</i>
FABBRICA APPARECCHIATURE PER COMUNICAZIONE ELETTRICHE.....	<i>Milan, Italy</i>
<i>Branch : Rome.</i>	
INTERNATIONAL MARINE RADIO COMPANY, LIMITED.....	<i>London, England</i>
INTERNATIONAL STANDARD ELECTRIC CORPORATION, <i>Branch Office</i> ,...	<i>Rio de Janeiro, Brazil</i>
JUGOSLAVIAN STANDARD ELECTRIC COMPANY, LIMITED.....	<i>Belgrade, Jugoslavia</i>
KOLSTER-BRANDES, LIMITED.....	<i>Sidcup, England</i>
LE MATÉRIEL TÉLÉPHONIQUE.....	<i>Paris, France</i>
<i>Branch : Rabat, Morocco.</i>	
NIPPON DENKI KABUSHIKI KAISHA.....	<i>Tokyo, Japan</i>
<i>Branches : Osaka, Dairen, Taihoku.</i>	
SOCIÉTÉ ANONYME LES TÉLÉIMPRIMEURS.....	<i>Paris, France</i>
STANDARD ELECTRIC AKTIESELSKAB.....	<i>Copenhagen, Denmark</i>
STANDARD ELECTRIC COMPANY W POLSCE SKA Z O. O.....	<i>Warsaw, Poland</i>
STANDARD ELECTRIC DOMS A SPOL.....	<i>Praha, Czechoslovakia</i>
<i>Branch : Bratislava.</i>	
STANDARD ELECTRICA.....	<i>Lisbon, Portugal</i>
STANDARD ELECTRICA ROMÁNÁ, S.A.....	<i>Bucharest, Rumania</i>
STANDARD ELÉCTRICA, S.A.....	<i>Madrid, Spain</i>
<i>Branches : Barcelona, Santander.</i>	
STANDARD ELEKTRIZITÄTS-GESELLSCHAFT A.G.....	<i>Berlin, Germany</i>
STANDARD TELEFON-OG KABELFABRIK A/S.....	<i>Oslo, Norway</i>
STANDARD TÉLÉPHONE ET RADIO, S.A. Zürich.....	<i>Zürich, Switzerland</i>
STANDARD TELEPHONES AND CABLES, LIMITED.....	<i>London, England</i>
<i>Branches : Glasgow, Leeds, Dublin, Cairo, Pretoria, Calcutta.</i>	
STANDARD TELEPHONES AND CABLES (AUSTRALASIA), LIMITED.....	<i>Sydney, Australia</i>
<i>Branches : Melbourne ; Wellington, New Zealand.</i>	
STANDARD VILLAMOSSÁGI RÉSZVÉNY TÁRSASÁG.....	<i>Budapest, Hungary</i>
SUMITOMO ELECTRIC WIRE & CABLE WORKS, LIMITED.....	<i>Osaka, Japan</i>
VEREINIGTE TELEPHON- UND TELEGRAPHENFABRIKS AKTIEN-GESELLSCHAFT, CZEIJA, NISSL & CO.....	<i>Vienna, Austria</i>

Sales Offices and Agencies Throughout the World