

ELECTRICAL COMMUNICATION

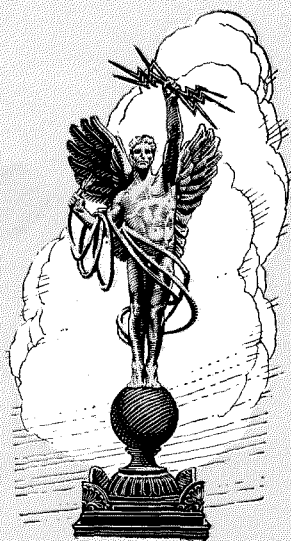

OCTOBER
1927

No. 2
VOL. 6

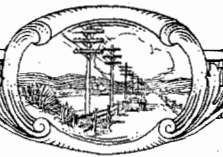

ELECTRICAL COMMUNICATION

A Journal of Progress in the
Telephone, Telegraph and Radio Art

EDITORIAL BOARD

J. L. McQuarrie	F. Gill	G. Deakin	P. E. Erikson	G. H. Nash
G. E. Pingree	P. K. Condict	E. A. Brofos	E. C. Richardson	F. A. Hubbard
H. T. Kohlhaas, Editor				

Published Quarterly by the

International Standard Electric Corporation

Head Offices

41 BROAD STREET, NEW YORK, N. Y., U. S. A.

European General Offices

CONNAUGHT HOUSE, ALDWYCH, LONDON, W. C. 2, ENGLAND
75, AVENUE DES CHAMPS-ELYSEES, PARIS (8e), FRANCE

G. E. Pingree, President	L. N. Rock, Secretary	H. B. Orde, Treasurer
--------------------------	-----------------------	-----------------------

Subscription \$1.50 per year; single copies 50 cents

Volume VI

OCTOBER, 1927

Number 2

CONTENTS

PIONEERS OF ELECTRICAL COMMUNICATION — HEINRICH RUDOLF HERTZ—V.....	63
<i>By Rollo Appleyard</i>	
AN AUTOMATIC TELEPHONE SYSTEM FOR RURAL EX- CHANGES.....	78
<i>By L. J. Saltoft</i>	
THE 7-A ROTARY MACHINE SWITCHING SYSTEM IN NEW ZEALAND.....	85
<i>By E. A. Shrimpton</i>	
INTERNATIONAL CHAMBER OF COMMERCE STOCKHOLM (FOURTH) CONGRESS.....	91
AERIAL CABLE ACROSS THE MOERDIJK BRIDGE—HOLLAND.	98
<i>By E. Williams</i>	
TRAIN DESPATCHING IN SPAIN.....	104
<i>By D. B. Baker</i>	

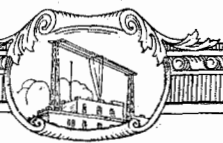



Portrait of Heinrich Hertz

Pioneers of Electrical Communication

HEINRICH RUDOLF HERTZ—V

By ROLLO APPLEYARD

European Engineering Department, International Standard Electric Corporation

THE work of the earliest pioneers of electrical communication culminated in the spring of 1886, when Heinrich Rudolf Hertz demonstrated at Karlsruhe the wave character of electrical transmission through space and through wires. With self-detachment as worthy of remembrance as the discovery itself, he hastened to suggest that he had but verified what others had foretold, that some phenomena exhibiting electric waves had been observed earlier by von Bezold, and that the theory upon which the Karlsruhe results were based was derived from Faraday, Maxwell and von Helmholtz. Physicists throughout the world at once recognised, however, that where others had hesitated Hertz had gone forward with firm steps, that where others had surmised he had measured, and that where others had comprehended in part he had established the theory of a universal group of converging facts. To all experimenters his announcement brought encouragement and inspiration. It was the old injunction, *Fiat lux*.

Heinrich Rudolf Hertz was born at Hamburg on February 22, 1857. He was the eldest son of the advocate, Gustav Hertz. On his father's side he was of Jewish origin. His mother, whose maiden name was Elizabeth Pfefferkorn, was of Frankfort-on-Main where her father was a doctor of medicine, descended from a family that for generations had been Lutheran preachers in south Germany. The Hertz family had long resided as merchants in Hamburg. The grandfather of Heinrich was successful in that business and became a townsman of considerable local importance. This ancestor, as a pastime, studied natural science, and made for himself a small laboratory, the apparatus from which came into the hands of Heinrich as a boy. There is still treasured by Frau Professor Hertz at Bonn a chemical balance that belonged to that precious collection.

The father of Heinrich practised at Hamburg,

Lubeck and Bremen. He was selected from the jurists to be Oberlandesgerichtsrat and afterwards to be a Senator of Hamburg. For him also natural science had attractions, but his principal study was language. Even when he attained the age of eighty-six and his eyes were no longer able to discern the text, he employed a scholar to read to him from the classics. This delight in language was transmitted to his son. Heinrich was an eloquent master of his own tongue; he was familiar with English and French, he knew enough Italian to read Dante with pleasure, and he retained intimate knowledge of the humanities. It is said that, as a youth in Hamburg, he purchased from a book-stall an Arabian grammar, he decided to master it, and he engaged a teacher—one Redlob—to instruct him in Arabic.

Thus the great physicist was born of dual race, into a family that had risen in the scale, and that by nature was intent upon intellectual studies. While he was a lad, there moved over Europe the trade-winds of technical education with a pressure centre in Germany. Under this influence the relative prospects of "techniker" and "klassiker" were freely discussed, and choice had to be made between a commercial and a professional career. It is remarkable that, notwithstanding these circumstances, the education of Hertz was throughout unorthodox, and to some extent self chosen. Rudiments were acquired by him at the private Bürgerschule of Dr. Lange, in Hamburg, where boys were prepared for city avocations as practical townsmen, without Greek or Latin. Hertz was quick to discern that his friends at other schools derived advantage from the classics, and he persuaded his father to arrange for him to have special lessons in those subjects. Accordingly, he left the Bürgerschule at fifteen, and had a private tutor every day for one hour. During the remainder of each day, he studied by himself, and it was at this period that he

fitted out a room at home with bench and lathe to make simple apparatus for experiments in physics and chemistry.

At seventeen he entered the Gelehrtenschule of the Johanneums at Hamburg, where he completed his classical studies. He left there at Easter, 1875, with the diploma. It was at this stage that he realised the distinction between engineering and pure science. He doubted whether he was adapted for scientific work; he was conscious of the pleasure to be derived from problems of mechanical construction, and he decided to study for a "practical year" with a firm of engineers at Frankfort-on-Main. At nineteen he proceeded to the Technical High School of Dresden, where he remained for six months. Then followed a year of military service with the Eisenbahn-Bataillon, of Berlin. Once more he had to choose between the same two careers, but at last—in November, 1877—he realised that only in natural science could he find the freedom, the scope and the field of discovery for which he longed. He went to Munich, nominally for engineering studies, "surveying, building construction, builders' materials, and such like"; actually, however, after consulting his parents and obtaining their approval, he diverted his course towards mathematical and experimental physics—the territory he was destined to make his own. That winter was spent in seclusion for the study of mathematics, mechanics, and physical laboratory work. A year later he was transferred to Berlin to acquire the stride of the giants—von Helmholtz and Kirchhoff.

His first independent research in physics had its origin in a question set as a prize subject by the philosophical faculty of the university of Berlin:

"If electricity moves with inertia in bodies, then this must, under certain circumstances, manifest itself in the magnitude of the extra-current—i.e., in the secondary current which is produced when an electric current starts or stops. Experiments on the magnitude of the extra-current have to be made such that a conclusion can be drawn from them concerning inertia of the electricity in motion."

It will be recalled that a somewhat similar

question had presented itself to Maxwell. In the endeavour to solve the riddle, Hertz carried out at the university a series of investigations, using some of the apparatus from his home. He wrote the account of his results during a period of military service, at Freiburg, and he gained the prize—a gold medal. The research in itself was of little importance, for the results were negative in character. Its value was in revealing the philosopher and in giving him a bent and encouragement upon the threshold of his career.

The speed at which he reasoned and worked on this investigation, on his subsequent researches on induction in rotating spheres, and on the distribution of electricity over the surface of moving conductors, was astonishing. It can only be accounted for by the zeal and delight with which he entered into the game of scientific discovery. His merit was at once recognised by the Berlin Philosophical Faculty. The university of Berlin conferred upon him the distinction of doctor and the rare award, *magna cum laude*.

His paper on induction in rotating spheres—the subject of his inaugural dissertation when taking his degree—reveals how early he became acquainted with the theorems of Maxwell, for it bears the date of March 15, 1880.

In October, 1880, Hertz was selected by von Helmholtz as demonstrator in physics. This association lasted until Easter, 1883. There is a legend that when von Helmholtz, at this period was asked to explain any obscure points in electrical theory, he would advise his interrogators to consult his assistant, adding that "Dr. Hertz has already arrived at the answers to these questions." Two centuries earlier a relationship somewhat of like kind existed between Galileo and Torricelli.

From Berlin, Hertz departed in 1883 to take up the appointment of lecturer in theoretical physics at the university of Kiel. There he devoted himself partly to the solution of theoretical problems, and partly to the clearing up of doubtful questions by experiment. What the future held in store for him was indicated by definite foreshadowings. On January 27, 1884, he wrote in his diary: "Thought about electromagnetic rays. Reflected on the electromagnetic theory of light"; and in May of that

year there are the entries: "Hard at Maxwellian electromagnetics in the evening. Nothing but electromagnetics. Hit upon the solution of the electromagnetic problem this morning."

His colleagues at Kiel recognised his qualities. They expected that his skill in experimental demonstration would lead him to things of importance. In two respects he quickly justified their conjectures. At Easter, 1885, he became professor in ordinary of experimental physics at the Technische Hochschule at Karlsruhe; and in 1886, at the age of twenty-nine, he married Elizabeth Doll, the daughter of Dr. Doll who was teacher of surveying at Karlsruhe University. The home of Hertz became a happy centre of university life. The laboratory at the Hochschule provided him with the means of materialising his ideas in electromagnetics.

In the spring of 1886, he found amongst the apparatus stored in the small but well equipped preparation room at Karlsruhe, "a pair of so-called Riess or Knochenhauer spirals," flat coils insulated with sealing wax (Figure 1); and he

concluded that the series of oscillations in the conductor was regular.

By the courtesy of the administrators of the Deutsches Museum of Munich, it is possible here to illustrate some of the original apparatus used by Hertz in those early experiments. The collection was acquired partly from Frau Elizabeth Professor Hertz, and partly from the Technische Hochschule of Karlsruhe. To realise its significance, it is necessary to consider where the work of Hertz enters the pages of electrical history. It was pointed out by Oliver Heaviside, in the "Philosophical Magazine" of March, 1877, that the oscillatory nature of a condenser discharge in association with self-induction was first discovered by Joseph Henry, in 1842, and that this work had been somewhat overshadowed by the discoveries made by Faraday. The theory of the reaction between a condenser and coil was given by Sir William Thomson—afterwards Lord Kelvin—in the "Philosophical Magazine" of June, 1853. The effect of self-induction in association with capacity in a tele-

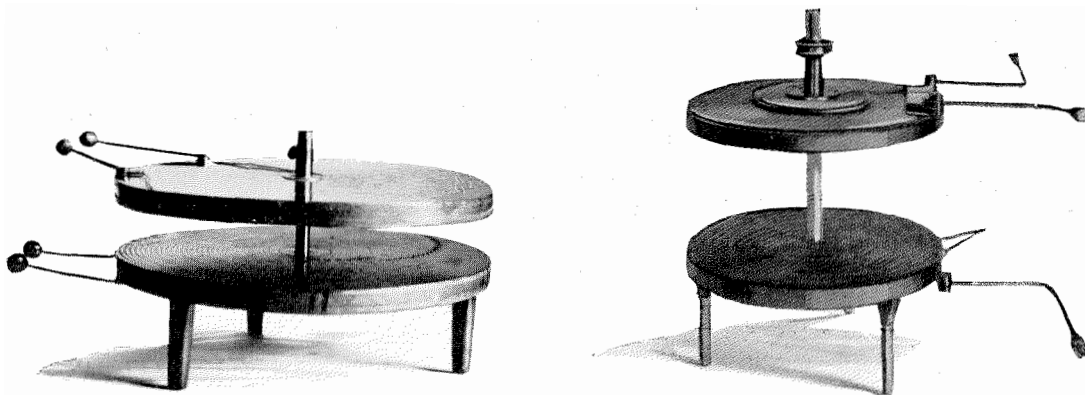

Figure 1—The Knochenhauer Spirals Used by Hertz at Karlsruhe

observed that the discharge of even a small Leyden jar through one of these sufficed to cause a spark to pass across a short air-gap between the ends of the other. It was the smallness of the jar needed for this purpose that first attracted his attention. Then he observed that, in a neighbouring conductor, side-sparks were produced. With a special form of sparking device he investigated the matter, and he discovered along this neighbouring conductor a neutral point. He thus recognised that he was dealing with oscillatory discharges, and he

graph line was first considered by Kirchhoff, in 1857, on the basis of the electrodynamic theory propounded by William Weber. Von Helmholtz dealt with the problem of the oscillations of a Leyden jar in 1847. It was worked at by Fedderson in 1858, and in the years 1861–1862 he demonstrated the phenomenon with revolving mirrors. Fedderson's original apparatus for this purpose is at Munich; it includes the negative he obtained of the light-band corresponding to the fluctuations of illumination at a frequency in agreement with Kelvin's formula connecting

periodic time with self-induction and capacity. In 1864, Maxwell predicted that electromagnetic waves, in free space, would have the velocity of light. Upon this basis, the oscillations observed for example in the particular cases examined by Feddersen would have corresponded to wave-lengths of about 30 metres—lengths so great in comparison with the dimensions of the laboratories, that the wave character of the propagation in free space escaped notice by physicists preceding Hertz.

Next in order of time came the results of W. von Bezold. These were described in the "Berichte der Bayrischen Akad. d. Wissensch," in 1870 and were summed up by von Bezold himself as follows:

1. If, after springing across a spark-gap, an electric discharge has before it two paths to earth, one short and the other long and separated by a test-plate, the discharge current splits up, so long as the sparking distance is small. But when the sparking distance is larger the electricity rushes only along the shorter path, carrying with it, out of the other branch, electricity of the same sign.
2. If a series of electric waves is sent along a wire which is insulated at the end, the waves are reflected at the end, and the phenomena that accompany this process in the case of alternating discharges appear to be caused by interference between the advancing and reflected waves.
3. An electric discharge traverses wires of equal lengths in equal times, whatever may be the material of which these wires consist.

The early experiments of Hertz were carried out without knowledge of what had been accomplished by von Bezold. When the attention of Hertz was drawn to those results he paid a graceful tribute to them, and ultimately

in his treatise upon electric waves he reproduced von Bezold's paper in a place of honour as an early chapter.

Hertz knew that the time of oscillation of

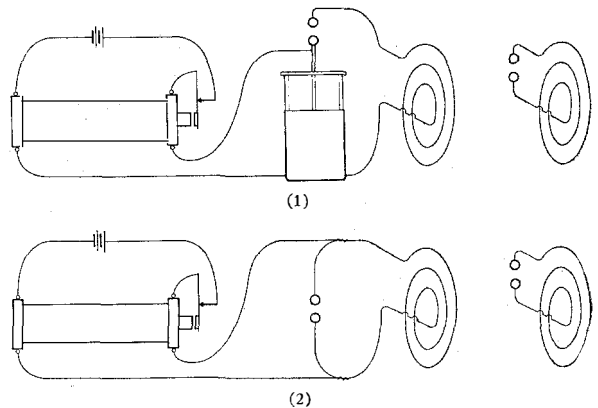

Figure 2—Arrangement of Knochenhauer Spirals

- (1) With Leyden jar charged by induction coil
- (2) Without Leyden jar, so as to obtain higher frequency by reduction of capacity

small quantities of electricity in a circuit such as he was using is determined by an equation involving the resistance, self-inductance, and capacity of the circuit, including the spark-gap, and he proceeded to vary these cardinal factors to obtain quantitative results. He quickly realised that, by appropriate adjustment, a condition of "harmony," i.e., resonance, could be brought about between oscillating conductors and neighbouring circuits. In Figure 2, the upper part illustrates the method of operating the Knochenhauer spirals, where as was usual before Hertz, a Leyden jar is discharged through a circuit with no pretence to resonance. To increase the frequency, Hertz sought to reduce the capacity; he therefore eliminated the Leyden jar, as indicated in the lower part of Figure 2. By removing the Leyden jar, the two circuits became automatically resonant with one another. The



Figure 3—The First Oscillator of Hertz. Two copper wires, each 1 metre in length, supported on rods of sealing wax. The large spheres are of sheet zinc, and are 30 centimetres in diameter. Base 260 x 7.5 centimetres

primary circuit in this second arrangement was energised directly from the induction coil. By this means he produced electric waves. But he was not only concerned with the production

His investigations then extended to the study of reflection, refraction, and polarisation, in the optical sense, of electromagnetic waves. For this purpose the oscillator and the resonator

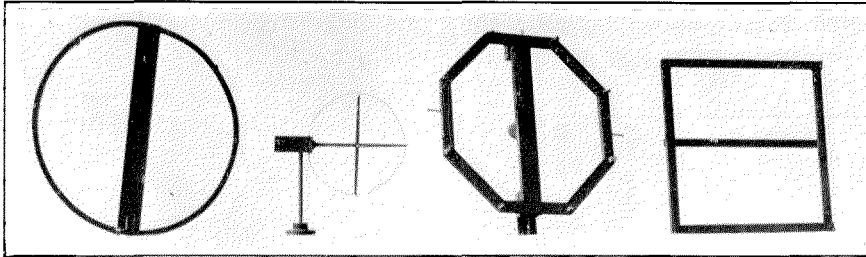

Figure 4—Four Resonators Used by Hertz. Dimensions, left to right, 70, 35, 67, 60 centimetres

of waves. He was intent upon investigating the nature of the "polarisation," if any, that the theories of Faraday and of Maxwell require in the medium between the generating and resonant circuits. At his hands, therefore, the dielectric received special attention.

The next development was to replace the generating spiral by a straight conductor, Figure 3, containing a central spark-gap. To adjust the capacity, the outer ends of the rods forming the conductor could be fitted with metal spheres or plates. This apparatus, when connected to an induction coil as in Figure 2, became the Hertz oscillator. The original apparatus had a frequency of about a hundred million oscillations a second. He found that the receiver also might be a straight conductor of similar construction, but he generally preferred a resonator of circular, square, or octagonal form, with a spark-gap, Figure 4. The gap could be adjusted by a micrometer. Care was taken that the oscillator and the corresponding resonators should be in "tune" with one another. To get rid of spurious sparks resulting from electrostatic induction he occasionally interposed a wet thread between the electrodes of his spark-micrometer.

In most cases Hertz used as a detector the spark directly observed at the gap in a resonator, and measured by the spark-micrometer. Occasionally he employed a hot-wire galvanometer, and in some circumstances a suspended tube of gilt paper, Figure 5. By such means, he surveyed space and determined the positions of nodes, and anti-nodes, and the length and frequency of waves.

were placed respectively at the principal foci of two parabolic mirrors of sheet zinc, each 2 metres in height, illustrated in Figures 6 and 7. A wave-length of about 50 centimetres was used. The receiver consisted of two thin brass wires, each about 52 centimetres in length, connected to a spark-gap outside the parabolic mirror. He obtained results up to a distance of about 16 metres; and he found that the waves could penetrate a wooden door, but not a zinc screen. The ordinary laws of reflection were proved by him to hold for electric waves. To examine the phenomenon of refraction he employed a prism of pitch weighing about 800 kilogrammes. He stated that in passing from air into a solid transparent medium the action exhibits a refraction like that of light, but that it is more strongly refracted than is visible light.

In the earlier experiments his induction coil was 52 centimetres in length and 20 centimetres

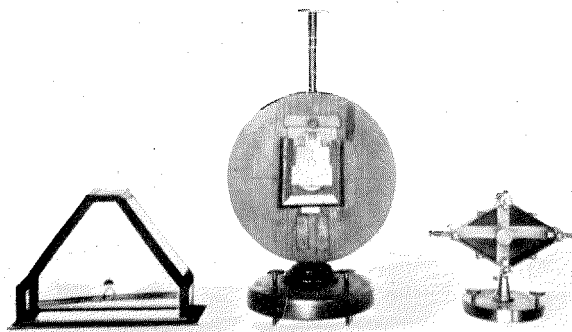

Figure 5—Detector (at left) Consisting of a Tube of Gilt Paper and Case 16 Centimetres in Height. Tangent Galvanometer, Height 40 Centimetres, Diameter of Disc 22 Centimetres. Hot-wire Galvanometer in Lozenge-shaped Case 17 Centimetres High, 18 Centimetres Wide

in diameter. It was operated by six large Bunsen cells, through a mercury interrupter, Figure 8. Later he preferred a smaller induction coil, having a maximum spark-length of 4.5 centimetres. It was operated by three accumulators. Sparks from 1 to 2 centimetres between the knobs of the primary conductor sufficed for

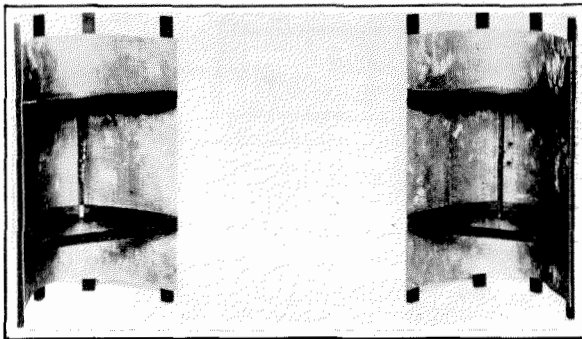

Figure 6—Parabolic Mirrors 2 Metres in Height. One contained an oscillator and the other a resonator. (See also Figure 7.)

many of his experiments. The spark-gap in the resonators was small—in some cases about 3 millimetres. With such apparatus he satisfied himself that the propagation is rectilinear. To demonstrate the phenomenon of polarisation, in the optical sense, he utilised his mirrors in a manner similar to that applied to the polariser and analyser of an optical polarisation apparatus. He made (Figure 7) an octagonal frame, 2 metres high, across which he stretched copper wires 1 millimetre in diameter, parallel to one another, 3 centimetres apart. It behaved as a tourmaline crystal behaves towards a plane-polarised beam of light.

Hertz soon confirmed the views of Heaviside and Poynting that the process whereby currents are induced in secondary circuits by such oscillations as he was employing, takes place for the most part in the surrounding dielectric, and that the interior of secondary conductors plays scarcely any part. As the action from the primary in his experiments traversed the air point-to-point to the secondary, propagation was there of necessity concerned with the dielectric. At high frequencies a metallic sheet, placed round the secondary, effectively screened that circuit. He then asked, to what extent may the thickness of the sheet be reduced? Such tin-

foil as was available was thick enough to prevent penetration; so was gilt paper. Below the mere surface of the conductors, therefore, all was complete calm. He deduced that such electric waves scarcely penetrate further than does the light reflected from the surface of a conductor.

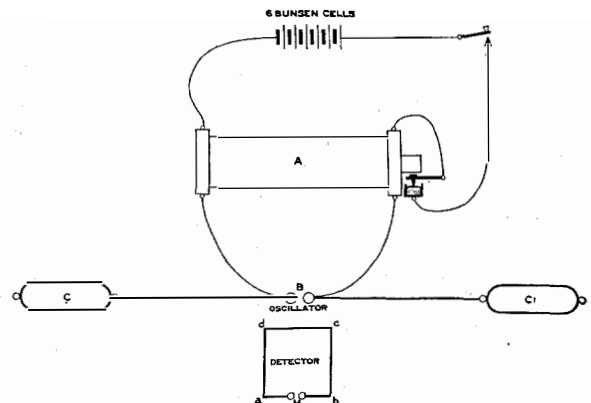

Figure 8—General Arrangement of Hertz Oscillator and Resonator

Near one of the end plates of his primary conductor he then placed a conducting plate and fastened to it a long straight wire. In his earlier experiments, he had already shown how the action of the primary oscillation could be conveyed to great distances by such a wire. He now demonstrated by suitable screening that all the effects are restricted to the surface and to the space outside such a wire, and that the interior knows nothing of the waves. He went so far as to try screening with glass-tubes chemically silvered, and at last, with this screen immeasurably thin, it was possible to penetrate the conducting barrier. The sparks at the detecting gap within appeared only when the film of silver was no longer opaque to light, and when it was certainly thinner than $\frac{1}{1000}$ millimetre.

Like results were obtained by screening the primary. Care had to be taken, however, to avoid openings at the ends and elsewhere in the screens. It was in the course of these experiments that he constructed the apparatus for stationary electric waves, resembling an elongated squirrel-cage (Figure 7, No. 40070) 5 metres long and 30 centimetres in diameter. It was built up of twenty-four copper wires extended parallel to one another along the gen-

erating cylindrical surface, over seven rings of wire equally spaced. It was provided with a central wire, and he constructed a very small exploring resonator, with an adjustable spark-gap, for examining the distribution of nodes and anti-nodes within the cage. Thus he satisfied himself, and thus he propounded the paradox that

Whereas all propagation of electrical disturbances takes place through non-conductors, conductors oppose this propagation with a resistance that in the case of rapid alternations is insuperable.

Then reverting to the idea of electrical "polarisation," he regarded the oscillations as being so rapid—he was dealing with about a hundred million a second—that the quantities of electricity displaced in insulators by such "polarisation" are of the same order of magnitude as those set in motion by conduction in metals.

When iron wire replaced copper, he obtained similar results and thereby confirmed his supposition that with iron the magnetism cannot follow such exceedingly rapid oscillations. He expressed regret that he had no experimental data with regard to how the discharge of Leyden jars is affected by the presence of iron. Probably he conceived that such discharges, owing to the comparatively great capacity of the jars, would be of considerably lower frequency than discharges from his ordinary oscillator of very small capacity.

To increase the self-induction of the resonating circuits he introduced loose spirals, Figure 9. He also examined the effect of using wires of different metals, particularly of iron. Conductors such as those illustrated in Figure 7, No. 40069, were for modifying the capacity of his circuits. Occasionally he explored the circuits for nodes by spark-gap tests carried out by the aid of a small insulated metal sphere brought near to

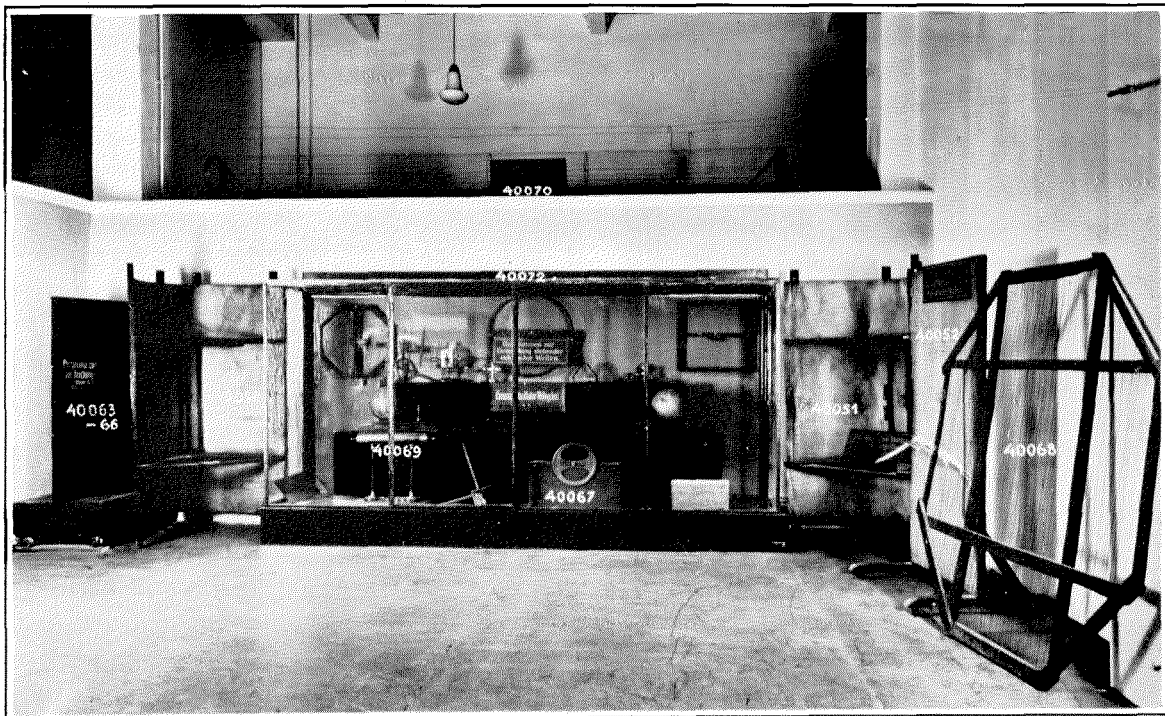

Figure 7—Collection of Hertz Apparatus at the Deutsches Museum, Munich. No. 40050, parabolic mirror with resonator. No. 40051, parabolic mirror with oscillator. No. 40052, plane mirror, 2 metres high and 1 metre wide, of sheet zinc. No. 40063—66, pitch prism, height 1.59 metres, width 1.20 metres, weight 1200 kilogrammes, for refracting electro-magnetic waves. No. 40068, octagonal grating of wires on frame 2 metres high, made by Hertz for experiments on "polarisation." No. 40069, cylindrical conductor upon two glass supports, used for varying the capacity of circuits. No. 40070, "squirrel-cage" consisting of 24 copper wires, each 5 metres long, forming a cage about 30 centimetres in diameter for experiments on stationary electric waves. No. 40072, wooden trough, 21.5 centimetres wide and 45 centimetres in length, for experimenting with electric waves in liquids

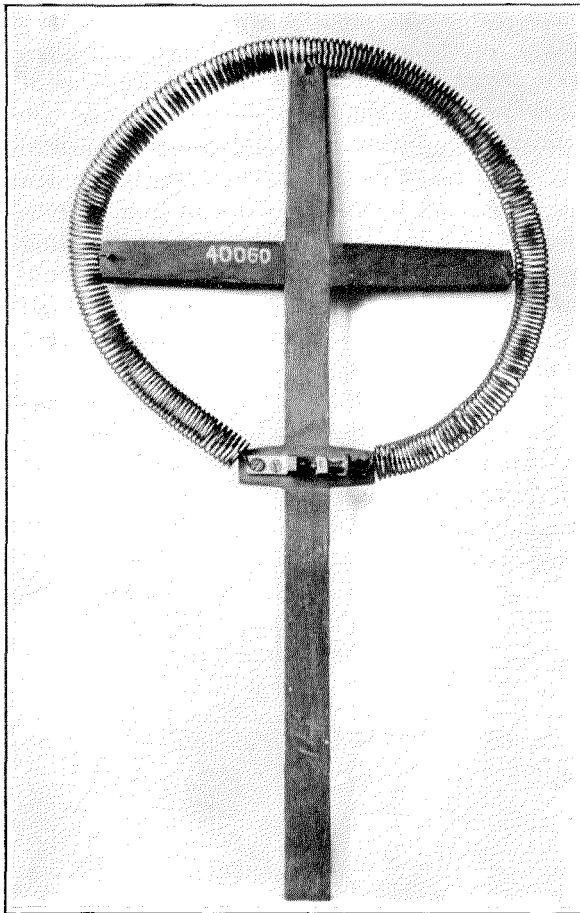

Figure 9—Circular Form of Resonator, 21 centimetres diameter, of brass wire wound into a spiral to increase self-induction for long waves. The micrometer spark-gap is here illustrated

the conductors at various points. It was by this means that he first became aware that "overtones" were present, and that irregular effects were superposed upon regular effects.

From the tangled threads of growing knowledge concerning these irregular effects he proceeded to weave a new research. He observed that the sparks at the gaps of the exploring resonators were influenced by light from any neighbouring sparks—for example, by light from the originating spark at the induction coil. He was in this manner led to discover the influence of ultra-violet light upon electric discharges. The original apparatus employed by Hertz at Karlsruhe to demonstrate this effect is illustrated in Figure 10. A vacuum is first formed in the receiver by an air-pump, and the spark-gap is adjusted so as to be somewhat too long

to allow the discharge, with ordinary illumination, to take place. Ultra-violet light, from another spark or from some other source, is then allowed to fall upon the gap, ionization consequently occurs, and the spark passes. Screening of the spark-gap from ultra-violet light consequently diminishes the maximum spark-length in a resonator corresponding to any given arrangement of the resonator. These results were published by him in June, 1887.

In the summer of 1887, Hertz studied the influence that he thought might be exerted by dielectrics upon electromagnetic waves. His usual mode of investigation was to examine the effect of the presence or absence of a block of insulating material upon the position of the neutral point in one of his radiators. The form of his original apparatus for this purpose is illustrated in Figure 11. He subsequently regarded this work as fruitless—his efforts being frustrated by the occurrence of subsidiary sparks. Ultimately he followed a new line, and was rewarded by finding that the distance to which he could detect electromagnetic waves might be extended. Distance in fact was not determined by the Newtonian law of inverse squares. He pressed on, and succeeded in transmitting up to the then enormous distance of 12 metres. His experiments on the reflection

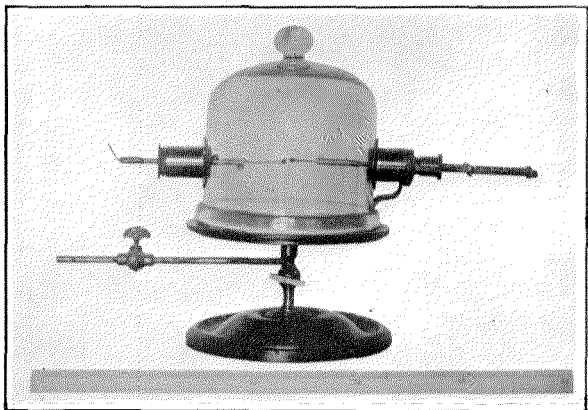

Figure 10—Original Apparatus Used by Hertz at Karlsruhe, to illustrate the effect of ultra-violet light on electric discharge

of waves were completed in March, 1888. The summer of that year was given to the study of the propagation of waves by means of wires, and in September, 1889, he delivered at Heidel-

berg his famous lecture on the relations between light and electricity.

To obtain an idea of the conditions under which the earliest experiments in Hertzian wave

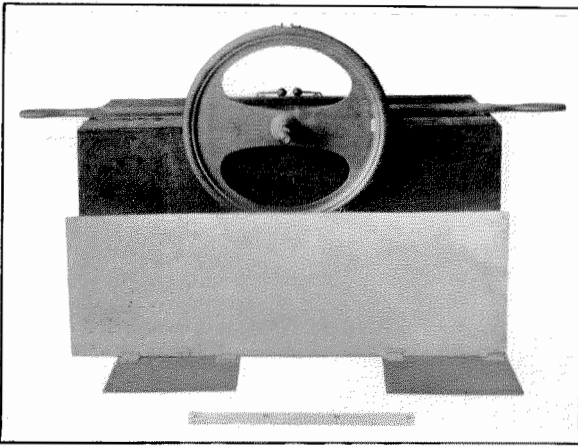

Figure 11—Wooden Box Containing a Block of Paraffine Wax, 70 x 32 x 18 Centimetres. Resting on the box are rectangular brass plates forming an oscillator, the spark-gap of which is seen through the aperture. The oscillator was raised or lowered onto the block to observe the effect, if any, of the presence of the dielectric (wax). The circular apparatus carries a wire, forming a resonator, the small spark-gap of which is seen at the top. In front is a metal sheet, used by Hertz as a plate of a condenser

transmission were carried out, a visit was paid to Karlsruhe (Baden). By the kindness of Professor Gaede, who now (1927) occupies the professorship held by Hertz, the Hertzian apparatus was reassembled in the lecture theatre of the Physikalisches Institut of the Technische Hochschule, in the positions where Hertz originally arranged them, and the photograph reproduced in Figure 12 was obtained to illustrate the present account of the experiments. From left to right, there is first seen upon a small table some bichromate cells, and the original induction coil used by Hertz. Then appears the parabolic mirror of sheet zinc containing the *Sender*, or oscillator. Next to this is the pitch prism, and then the second mirror containing the *Empfänger*, or receiver. These mirrors are exact duplicates of the originals, and were made by the Institutsmechaniker, Amann, who constructed the originals for Hertz. The originals are at Munich (Figures 6 and 7). To the right of the *Empfänger* in Figure 12 is the wire cage for experiments on skin-effect, and on the extreme right is the

plane mirror of sheet zinc. In the foreground on the right is a corner of the lecture table. The preparation room is approached by a door at the back of the lecture table. An inscription on the wall of this lecture theatre, not visible in Figure 12, reads:

“In diesem Saale stellte Heinrich Hertz seine ersten Versuche mit Elektrischen Wellen an.”

It was also in 1889 that Hertz was appointed to succeed Clausius and Ketteler as ordinary professor of physics at the university of Bonn. At Bonn he had as colleagues Breisig, Lenard, and his own brother-in-law, Carl Pulfrich. He there set before himself the task of building up a simple electromagnetic theory upon the principles of Maxwell, as confirmed by his own experiments. He also directed his attention to the discharge of electricity in rarefied gases; an appropriate research, for Bonn had already to its credit the achievements of Hittorf, Geissler, Kayser, Pluecker and others, and a laboratory scintillating with original apparatus—the weapons of their victories in this field. Pluecker in 1859 had studied the fluorescent effect that cathode rays produce upon the glass walls of a discharge tube; Hittorf, Goldstein, Puluje and Crookes had continued the investigation. Hertz gave new direction to scientific thought. He experimented with thin plates of metal fixed inside a discharge tube, and he was rewarded by the discovery that cathode rays can be made to pass through metals. Then his colleague Professor Philipp Lenard conceived the idea of inserting such a metal plate in the glass wall of the tube, as a “window” through which the cathode rays, imprisoned within the glass, might escape. They did. The rays stole out into the open and assumed disguise as “Lenard rays.” Lenard is said to have given one of these tubes to Roentgen of Würzburg. In the autumn of 1895, Roentgen was experimenting with invisible light—from a discharge tube enclosed in black paper. He discerned the penetrative power of rays that proceeded from the bombarded regions, i.e., from the regions of impact of the cathode rays against the interior surfaces of the discharge tube in which they were generated. So nearly did Hertz and Lenard find the little more that was to be so much.

The sequence of discoveries by Pluecker, Goldstein, Hertz, Lenard and Roentgen must remain an example of the ease with which observers can hit or miss what may be just behind the surface of achievement in natural science.

Most of the discoveries with which the name of

These papers included an account of the earlier investigations, and brought together writings otherwise difficult of access. The work was translated into English by Professor D. E. Jones and Professor G. A. Schott. To complete the collection there was also issued Hertz's "Prin-

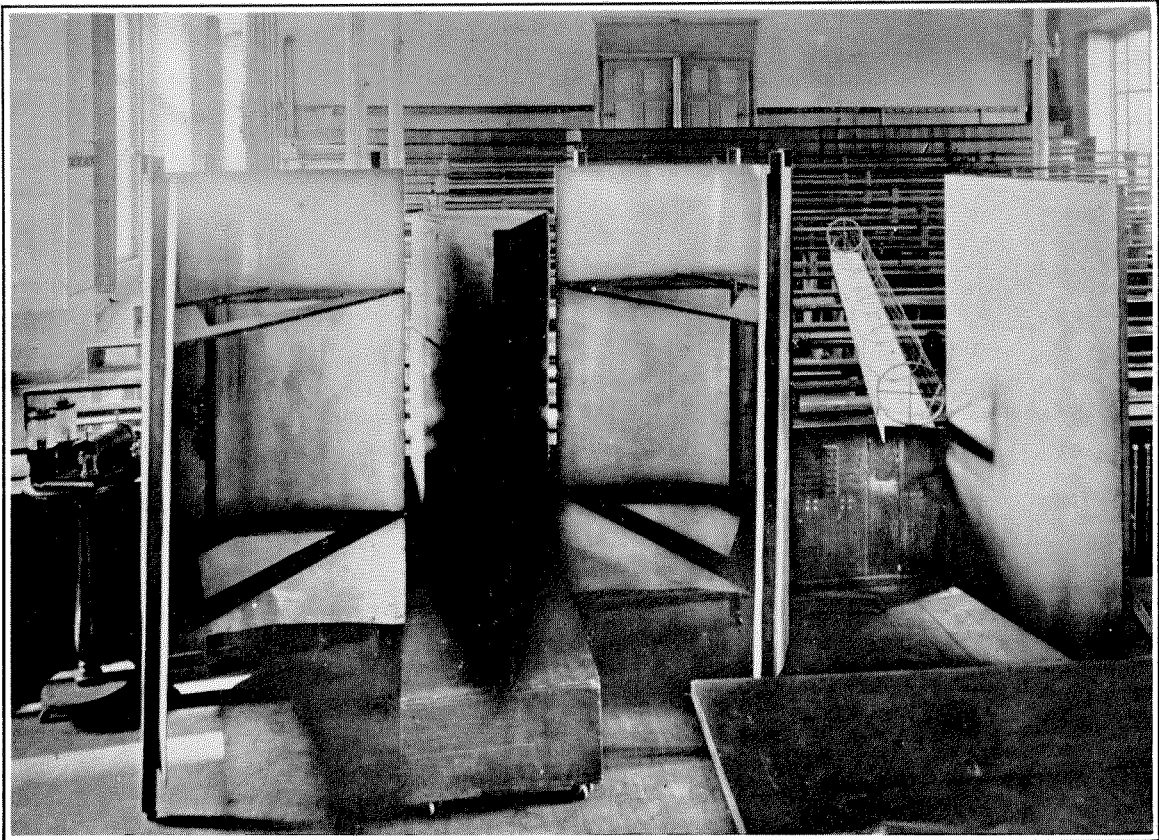

Figure 12—The Lecture Room at the Physikalisches Institut at Karlsruhe, with apparatus as arranged in the experiments by Hertz in the years 1885 to 1889, that led to his discovery of Hertzian waves

Hertz is associated were made known originally in "Annalen der Physik und Chemie." These writings were collected by him. After adding some explanatory notes, and a dedication to von Helmholtz, he published them in 1891 as a treatise, with the title "Untersuchungen ueber die Ausbreitung der elektrischen Kraft." This book was admirably translated into English by Professor D. E. Jones, and a preface to the English edition was written by Lord Kelvin. The English title of it was "Electric Waves, being researches on the propagation of electric action with finite velocity through space." Later there was issued "Miscellaneous Papers" with an introduction by Professor Philipp Lenard.

principles of Mechanics." The whole series was edited by Professor Lenard. Additional notes of a biographical character are to be found in the address given in 1894 by Professor Franz Richarz to members of the University of Bonn, and in some brief writings of Dr. F. Breisig. Useful particulars concerning the relics of apparatus are contained in a short article by Dr. Franz Fuchs in "Der Radio-Amateur" for April, 1926.

The closer the early papers are studied, the greater becomes the amazement that Hertz who had applied himself seriously to mathematical physics for rather less than two and one-half years should have obtained so quickly such a grasp

of the most intricate part of the subject. He himself confessed to the inestimable value of the inspiration that von Helmholtz imparted to him and to other pupils, to the preeminent fitness that von Helmholtz possessed for guiding them in original research, and to the value of this personal influence, that led them to see things as part of all creation instead of as separate entities. This guidance by von Helmholtz was free to all who came under the care of that illustrious and beneficent philosopher—it could direct but could not evolve such genius as that of Hertz. The truth is that Hertz possessed remarkable powers of sweeping away from elaborate theories everything but the part needed to assist in attaining his object. This hint he has left us. The remainder of the secret was bequeathed by him as a theme for research students for all times.

In his philosophy, Hertz was in all respects a Newtonian. For him, the group constituting electricity, magnetism, and light, belonged to mechanics. The difficulty was, as he confessed, that the mechanics of that group had not been completely disclosed to human understanding. In his earliest work (1886–1887) he had not perceived that the laws of electricity applicable to the steady state differ from those of electricity in motion. When he realised the distinction, he immediately advanced. He first ascertained that the oscillations with which he had to deal were characterised by variety and regularity. Then, out of confusion came order; but it was not the old order, for the amplitudes of these regular oscillations decreased more slowly than inversely as the square of the distance from the source. Next, the distances traversed by the electric waves surprised him, even with his crude means of detecting them. Moreover, the waves had finite velocity. He then knew that the immemorial doctrine of “action-at-a-distance” must die, and that the Faraday-Maxwell theory, which had not yet been fully appreciated in Germany, must supersede it.

Hertz saw that Maxwell's theory involved three assumptions, all relating to the dielectric medium through which the electric and magnetic forces are exerted. In effect, he said, consider the space between the two plates of a simple condenser. Apply a battery suddenly to the terminals. There is an initial current

through the dielectric—Maxwell's displacement current—but not a continuous steady current. The electric stress has produced in the condenser an electric strain, a strain not exceeding the limits of the tenacity of the dielectric. Maxwell had assumed:

- (1) That such changes of electric stress correspond to the same electro-magnetic forces as do the steady currents equivalent to them.
- (2) That forces, electromagnetic as well as electrostatic, are able to produce dielectric stresses.
- (3) That air and empty space behave like all other dielectrics.

Hertz then deduced, from Maxwell's equations, that if (1) and (2) are correct, waves of the kind expected by Maxwell could be propagated in any given dielectric with finite velocity, not necessarily the velocity of light. Hence, if a wave could be shown to be propagated at finite velocity in air, (1) and (2) might be proved to hold. In this demonstration, after some preliminary failures, he succeeded. Then he investigated stationary waves along straight wires, their nodes and anti-nodes, their wavelengths, their phases and their phase-differences, their reflections and their mutual interferences. At about this time he became for once disheartened—the rate of propagation seemed to be infinite, and the phase of the interference seemed different at different distances. Was Maxwell's theory then false? He left the matter alone for a few weeks, and then tried again. His genius had left him desolate. He was moreover disturbed because the account of his research was marred by an error of calculation—to which Poincaré had drawn attention. Further, could it be that electricity possesses inertia, after all?

Discouragement did not restrain him from research. Freeing himself from preconceived notions, he repeated his experiments and found that the set of wave interferences which he had observed could not be harmonised upon the assumption of infinite velocity. He now thought that velocity in air must be finite, and greater than that in a wire. Then followed misgivings concerning the possible effect of the neighbouring walls, the iron stove, and other obstructions. It is said that at this time he remarked upon the

benefits that might result if science had available an enclosed space comparable with that of Cologne Cathedral. During this period he discovered that for long waves the velocity was greater in air than in wires, but for short waves he found practical equality. He declared the result to be so surprising that he could not accept it as certain. His doubt arose once more from the environment, for he reasoned, if long waves cannot be developed, they cannot be observed. He knew that the velocity of the wave in any case depended upon the reciprocal of the square-root of the product of specific inductive capacity and permeability. He also knew that, at such high frequencies as he was using, only the surface layers of conductors come into play. These facts, however, did not completely satisfy him. Again he appealed to experiment. In the autumn of 1888, while investigating waves in the narrow interspace between wires, by means of small detectors, he found distinct nodes at or near the ends of the wires, even when the detectors were very small. This brought him on to the track of very short electric waves and enabled him to repeat, with waves only 30 centimetres in length, all his earlier experiments. He found that in wires such waves travel with very nearly the same velocity as in air. But he was still dissatisfied, for his view was that an experiment carried out under proper conditions would prove not only that the velocity in air is finite, but that the velocity in air and in wires is equal. Also he was influenced by the teaching of von Helmholtz that a distinction must be maintained between the electromagnetic and the electrostatic forms of force, and that until the contrary is proved they must be assigned two different velocities. He sought to establish the true relationship between the two forms by observing the mechanical forces exerted by the waves upon ring-shaped conductors.

It is well to remember that these famous experiments were carried out with apparatus simple and inexpensive. In the physics departments at Karlsruhe and at Bonn were indeed precious relics of the preceding age, but Hertz converted to his purpose the ordinary contrivances in metal, wood, glass, silk, tin-foil and sealing wax that might have been found in any university laboratory of his time. What further was needed he made, after the manner of the

pioneers, with his own hands, out of bits of wood and wire and sheet-zinc, so that all was infinitely adjustable.

The error that crept into the calculations relating to his work, and that caused him such annoyance, was of a subtle kind. He was determining the time of oscillation of his usual form of oscillating system, consisting of a straight conductor with a sphere at each end, as in Figure 3. The expression for this time involves the square-root of the capacity of one of the equal spheres. When the spheres are far apart, the charge on each is the product of this capacity and the potential difference between the sphere and the earth. In his calculation he took the potential difference to be that between the two spheres. This was equivalent to calculating the capacity of one of the spheres to be 15 instead of $15/2$. The effect was that he estimated the required time of oscillation as 1.77 instead of 1.26 hundred millionths of a second. That so great a philosopher should have been thrown into despondency concerning a matter of only 5.1 thousand millionths of a second is probably unique in the history of human effort. Even after Poincaré had placed the fine point of his cambric needle upon this error, Hertz was not content, for in 1891 his own comment was:

“Abgesehen davon, dass in der Rechnung der eben erwähnte Fehler zu corrigiren wäre, ist auf die Dämpfung durch Strahlung keine Rücksicht genommen, an welche ich bei Abfassung dieser Abhandlung noch nicht dachte.”

In other words, he accused himself, in addition, of having neglected the chance losses by radiation. These radiation losses have since received the attention of profound mathematicians including Larmor, Lorentz, Planck and Schott, and the outstanding fact remains that, as Hertz realised, a rigorous method of evaluating losses by radiation has yet to be found. To derive from the life and works of Hertz the greatest help and encouragement, the investigator must realise how completely he combined those qualities of a philosopher that make an observer, a logician, and a mathematician.

Although he derived his primary inspiration from the mathematics of von Helmholtz and

Clerk Maxwell, he was able at will to free himself almost completely from the allurements and restrictions of symbolism. By direct experiment he proved that the propagation of electric waves through space is an affair of time as well as an affair of distance—a point to point process through a continuous entity that can undulate. He thus disposed of the theory of electrical action-at-a-distance, i.e., the theory that electrical actions, like thought itself, can spring instantly across space. Following Faraday and Maxwell, he taught that electrical and magnetic forces can disentangle themselves from inert bodies, and that they can continue to exist as wave conditions or changes in the state of the medium. Finally, he confirmed by experiment the close correspondence between electric and magnetic forces and light.

Between the teachings of the English and German schools of thought he was in a position of some delicacy. He saw that with the acceptance of Maxwell's idea, the physical basis of von Helmholtz's theory must disappear—for action-at-a-distance would become intolerable. He had therefore to go carefully through Maxwell's work step by step, stumbling as others had done "upon unwonted mathematical difficulties," and again as others had done abandoning hope of forming for himself an altogether consistent conception of Maxwell's ideas. "What, he asked at last, is Maxwell's theory? Maxwell's theory is Maxwell's system of equations." The recognition of this fact enabled him to be up and doing, and to follow further the injunction of Maxwell, to sweep the cobwebs off the sky.

His analysis began with scrutiny of the four theories that in his day held the field, relating to the attraction between two electrified bodies. Briefly; the first of these presupposed a kind of spiritual affinity. It recognised that the force exerted by the first body is intimately associated with the presence of the second body, thus resembling the attraction between two magnets. Here was primitive action-at-a-distance, naked and unashamed. It was consistent with Coulomb's law. It held for gravitation. With what happened in empty space it had no concern. For electricity this theory had to be abandoned. The second was also of a pseudo spiritual character. It too applied to the case

of two bodies, but each body strove to attract in all directions with forces of definite magnitudes, even if no other bodies were present to respond. Space was filled with strivings that varied from consecutive point to consecutive point of a vague universe. Each body was at once the seat and the source of forces. Whether space was full or empty was immaterial. Hertz considered that Maxwell adopted some but not all of this second theory. The third was a development of the last. The attraction between the two separate bodies was not in this third theory determined solely by forces operating in accordance with the principle of action-at-a-distance. Space came into it. Space was no longer empty. The forces induced changes in the condition of space. These changes gave rise to new action-at-a-distance forces. Electricity and magnetism implied here the "polarisation" of each of the smallest parts of space matter, and this "polarisation" was brought about by the forces. The attraction between the two electrified bodies depended partly upon the influence of changes in the medium. Similarly, the energy was, in general, partly in the electrified bodies and partly in the medium. In the limiting case of this theory, the whole energy was in the medium, and there was no so-called "free" electricity; consequently in the limiting case the action-at-a-distance force vanished. Hertz saw that this limiting case led to Maxwell's theory, although the physical ideas were, in his view, not Maxwell's. The fourth theory transferred the action entirely to the agency of the medium. The changes in the medium—contemplated in the third theory—were present in the medium in the fourth theory, but in the fourth there were no action-at-a-distance forces to cause "polarisations." Yet "polarisations" were the only means of action present. They caused the movements of the attracted bodies. How the "polarisations" were formed was unknown—consideration of the physics of that matter was to be deferred. Thus, according to Hertz, did Maxwell view the physical universe, thus did Maxwell discard action-at-a-distance, and upon the foundation of this fourth theory did Maxwell build his System of Equations.

As a mathematician, Hertz possessed more than ordinary knowledge and skill; his mind

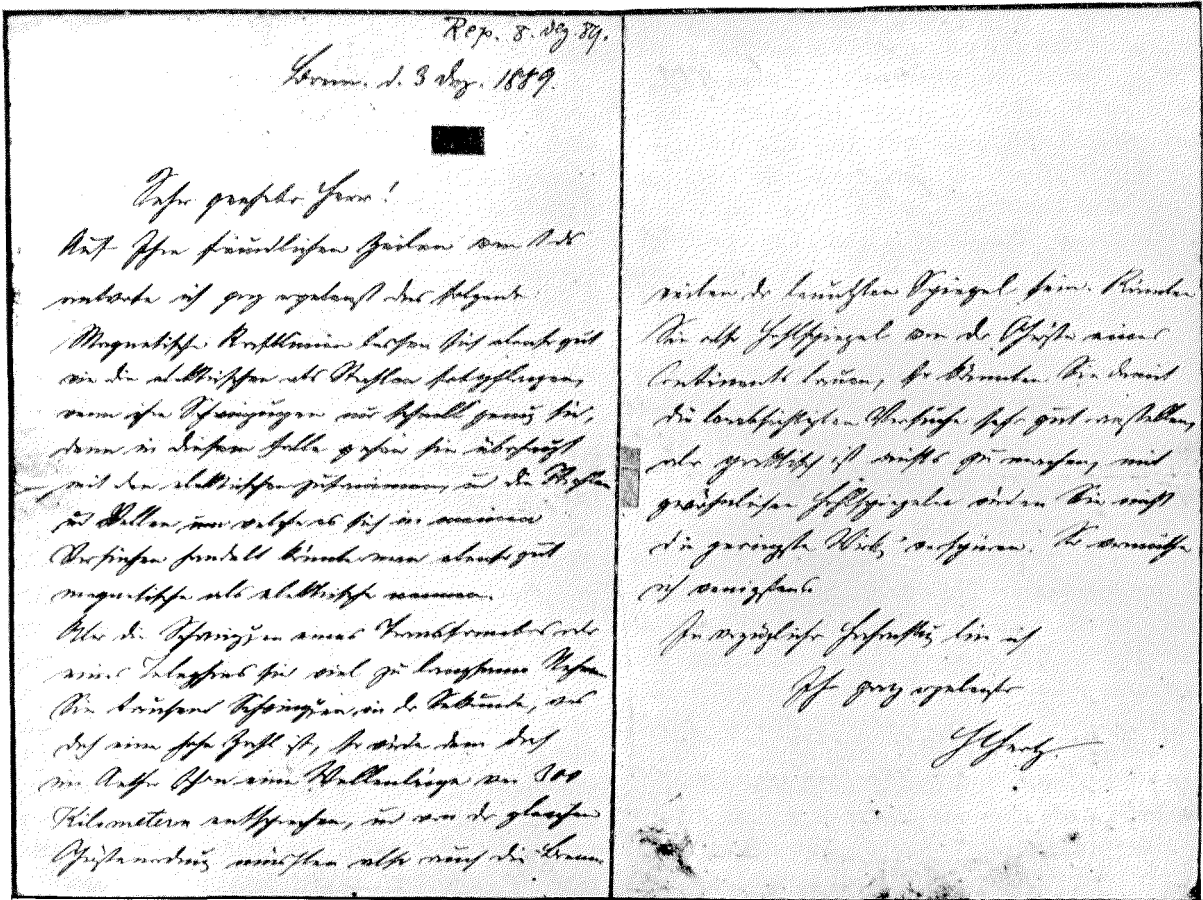

Figure 13—Hertz's Letter to Herr Huber, Reproduced by Courtesy of the Deutsche Museum, Munich

TRANSLATION

Bonn, Dec. 3rd, 1889.

DEAR SIR:

Replying to your kind letter of 1st, I have pleasure in giving you the following particulars:

Magnetic lines of force may be propagated just as well as electric, as rays, if their vibrations are sufficiently rapid; in this case they proceed together, and the rays and waves dealt with in my experiments could be designated magnetic as well as electric.

However, the vibrations of a "Transformator" or telegraph are far too slow; take, for example, a thousand in a second, which is a high figure, then the wave-length in the ether would be 300 kilometres, and the focal length of the mirror must be of the same magnitude. If you could construct a mirror as large as a Continent, you might succeed with such experiments but it is impracticable to do anything with ordinary mirrors, as there would not be the least effect observable.

With kind regards,

Yours ———

HERTZ.

was as clear as crystal, his methods of attack were direct, original, penetrating. He operated with conspicuous courage. As an example may be taken his method of treatment of a spherical wave in a medium that is homogeneous except near the origin of co-ordinates. Lord Kelvin singled out for special praise his method of dealing with the problem of the elastic contact of two spheres. Hertz at first found difficulty in accepting the corpuscular theory of cathode rays, i.e., the theory advocated by Stokes and Crookes, and now confirmed, that they consist of particles projected from the cathode, in straight lines, at high velocities. He could not readily imagine corpuscles penetrating metals, and accordingly he was, for a time at least, inclined to interpret cathode rays as waves.

The laboratory in which Hertz worked at Bonn was in part of the ancient palace of the Prince Elector. At the time of the Roman-German empire the neighbouring city of Cologne was one of the Electoral principalities, and the Prince Elector was also Archbishop of Cologne. But Cologne, being a free city, did not permit the Archbishop to reside there except for clerical functions. There being no palace for him in Cologne, in accordance with the predilections of princes of Bavaria for castles in those days, he provided himself with one at Bonn. From the year 1320 this was the constant residence of the Archbishop of Cologne. In the nineteenth century, when the Rhineland went to Prussia, the University of Bonn was endowed with the archiepiscopal palace. Clausius resided there, but Hertz preferred to have a private residence elsewhere in the vicinity.

At Bonn, in July, 1892, Hertz was attacked by a pernicious illness, attributed to a carious

tooth that caused ulceration of the upper jaw. Repeated operations, a sojourn in the Riviera in the spring of one year, and a holiday at Reichenhall in the autumn of the next, so improved his condition that the danger was believed to have passed. General symptoms of blood-poisoning next showed themselves, and extended to the bones. Nevertheless, until the middle of December, 1893, he delivered his lectures and he prepared new experiments. The disease, however, reasserted itself and on January 1, 1894, he died.

Amongst those who knew him best, the remembrance that remains of him is of a man of amiable disposition, social, genial, a good lecturer, possessed of singular modesty, who gave himself no airs as of a great professor, and who, even when speaking of his own discoveries, never mentioned himself. When the Royal Society presented him with the Rumford medal, he silently disappeared from Bonn for a few days—none knew why—and he returned as silently. The habit he formed early in life of solving difficulties for himself continued with him; he preferred, upon occasion, to puzzle things out in loneliness in the laboratory. His decision to follow pure science instead of a technical career was faithfully kept, and yet the importance of the part he played in the ultimate technical advance in electrical science is beyond measure. It can be definitely stated that concerning the future employment of Hertzian waves for telegraphy and telephony he had no anticipations. For there exists a letter written by him to one, Herr Huber, who wanted to know whether there was a prospect in that direction. Hertz regarded it as impracticable. His reply, which is reproduced in Figure 13, was to the effect that it would need a mirror as large as a continent.

An Automatic Telephone System for Rural Exchanges

By L. J. SALTOFT

Assistant Chief Engineer, Technical Department, The Copenhagen Telephone Company

Introduction

IN rural districts, where residents are scattered over wide areas with consequent necessity for the installation of many small telephone exchanges, it often happens that the location most favourable from the point of view of the economical planning of the line plant is unsuitable for the accommodation of the operating staff. Automatic rural exchanges, which obviate the necessity for staff accommodation, therefore, become a necessity.

Automatic rural exchanges are proving of value also in decentralising important city exchange areas which often serve extensive localities where telephone lines, installed as required, are not very economical on account of excessive length. These lines gradually increase in the outlying parts of the exchange areas, and necessitate the installation of large and expensive cable plants in order to avoid a too heavy loading of the aerial routes. In cases where operating companies are facing the problem of projecting new and expensive cable plants under such conditions, it becomes necessary to consider the possibility of reducing expenditures on cable plant through decentralisation by means of small rural automatic equipment connected to the city exchanges through a limited number of junction lines.

It is for such reasons that the Copenhagen Telephone Company for a long time had been awaiting an opportunity to make a trial of rural automatic telephone exchanges. The occasion presented itself in a little village, Brøndbyvester, situated approximately nine English miles west of Copenhagen. The area covered by this 100-line exchange, which formerly was of the local battery type, is shown in thick lines in Figure 1.

It will be seen that the village itself is situated in the northern part of the area, and originally the telephone density was highest in this vicinity with very few subscribers' lines running toward the coast. However, development of the territory during recent years necessitated the installation of a relatively large number of lines towards the coast in the southern part of the

central office district. The result was that the pole line from Brøndbyvester southwards, having become too heavily loaded, had to be replaced by a cable. In view of the fact that difficulties had arisen regarding the question of attending to the service in the old local battery exchange, it was decided to install an automatic rural equipment, the location of which is shown in Figure 1 by a black rectangle.

On local traffic in the Brøndbyvester district, the introduction of the full automatic system offers to subscribers the advantage of 24-hour interrupted service, a benefit not previously provided. As regards the control of the traffic outgoing from and incoming to Brøndbyvester, this exchange is operated as a sub-office to the nearest larger local battery city exchange; i.e., Glostrup. This means that all traffic other than local in Brøndbyvester exchange has its switching centre in Glostrup manual exchange, and is there controlled by the operators.

Requirements

The automatic equipment had to be arranged so as to work in conjunction with the Glostrup manual local battery exchange. In calling for tenders, the following requirements were laid down:

1. The system must work on a line resistance of 1,000 ohms and on a minimum insulation resistance of 10,000 ohms between line wires, and between each line wire and ground. (This was required on account of the long aerial lines used in the rural area for subscribers and for junctions to the city exchange.)
2. The system, in any case, must work with 24 volts potential in so far as the line is concerned; i.e., line, transmission bridge and dial response relays must work on 24 volts.
3. The system must work in connection with a local battery exchange; i.e., an automatic subscriber in Brøndbyvester must be able to select a free 2-way junction to the manual city exchange and the city operator must be able to call the Brøndbyvester subscribers by dialing over one of the idle 2-way junctions.

Furthermore, in short and long haul toll service, a facility was required whereby the toll operator, after having dialed and obtained the wanted subscriber in the rural automatic area, must be able to cut in on a busy connection previously established by this subscriber, offer a

alarm devices by means of which the automatic rural office can send alarm signals to the city exchange over one of the junctions, when important failures, such as in the exchange battery voltage, exchange ringing, etc., occur.

5. Short-circuited subscribers' lines must be



Figure 1—Map of Brøndbyvester

toll call and eventually also break down the existing connection, thus giving preference to toll connections.

Supervisory signals must be given both to city and toll-board operators engaged in the toll connection after the Brøndbyvester automatic subscriber hangs up his receiver, regardless of whether he has called or was himself called by the city exchange.

4. Provision must be made for automatic

removed automatically from service so that apparatus will not be occupied for an unduly long time. (This feature was required because of the open wire circuits in the rural districts.)

As a result of the offers submitted, the Copenhagen Telephone Company decided that for trial installation and practical investigation of the operation of automatic rural exchanges a 100-line Standard Electric equipment with an ultimate capacity of four hundred lines should be

ordered since it fulfilled all the requirements enumerated. In general principles, the exchange which was furnished is similar to the well-known International Standard Electric Rotary Machine Switching System with motor driven switches except for adaptation of the equipment to the special requirements of automatic rural exchange operation.

Description of Equipment

Figure 2 shows the junction diagram of a 200-line full automatic rural exchange working in connection with a local battery city exchange, the line finder side being shown only for one

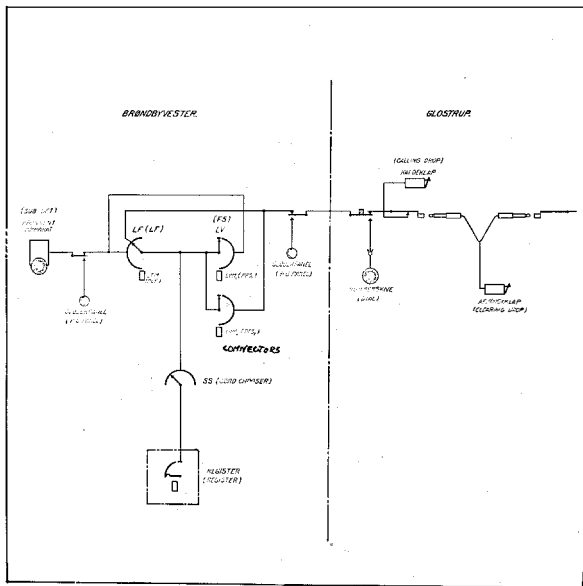

Figure 2—Junction Diagram

hundred subscribers' lines. The latter are cabled to one hundred arc contacts on the connectors, the respective arcs being connected in multiple in the well-known manner with silk ribbon cable. The subscribers' arc contacts are grouped in two levels of fifty contacts, each set of contacts consisting of five terminals, arranged vertically, corresponding to the five brush arms of the line finder and the selector brush carriages forming the link circuit. There are at present in all twelve link circuits for the one hundred subscribers connected to Bröndbyvester.

Each link, as shown in Figure 2, consists of one line finder and two or more selectors, according to whether the capacity is for two or more hundred lines. The construction of the line finders and

selectors is practically the same. They both have a brush carriage with two arms and five double brushes on each arm. The two arms are mounted 180 degrees from each other. Thus, when the brush carriage rotates, it hunts first for the fifty subscribers situated in one of the two levels, then for the other fifty subscribers situated in the other level. The contact arcs have one hundred and two contacts (fifty-one in each level), the first contact in each level being reserved for routine test purposes. The selector is arranged with a home position.

The first ten terminals of the multiple arc belonging to the subscribers numbered 300-399 are reserved in Bröndbyvester exchange for junctions. These ten terminals can be used for nine junctions, the tenth terminal being required for stopping the selector on it and sending a busy tone in case all junctions are busy.

All link circuits, as indicated in Figure 2, are cabled to two contact banks each consisting of twenty-four sets of contacts. Each set of contacts contains eight terminals arranged vertically. Two such sets of eight contacts belong to each link circuit. The capacity of this arc is thus sufficient for twenty-four links. The arc with its brush carriage forms the "Link Chooser" associated with each register, by means of which the register involved in the call finds an idle link belonging to the group of one hundred subscribers where the call is originated. Three registers are now equipped in the Bröndbyvester exchange, but space is reserved on the frame for a fourth register.

The registers consist of the instepping relays and necessary counting relays for the selection control. Furthermore, the registers have test relays and other relays required for the control of the different classes of calls, in all about seventy relays of the Standard Electric flat type. There is also a sequence switch and a time alarm switch associated with each register circuit.

All switches are operated by means of electromagnetic clutches and gears of the improved disc type, energized in their respective circuits at given moments in the progress of the call. The gears engage in the drives mounted on the vertical shafts. The vertical shafts terminate with a bevel gear at the bottom, the gear engaging in a corresponding gear mounted on the main horizontal shaft which connects with a

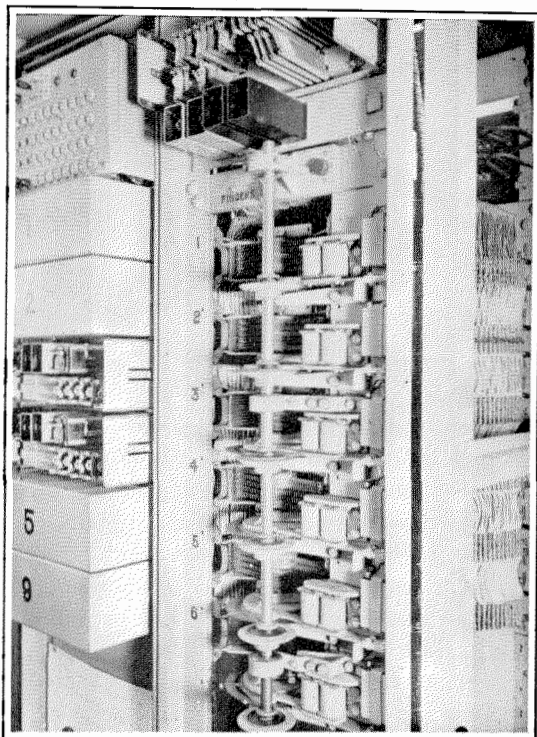

Figure 3—Bay Unit

$\frac{1}{16}$ H.P. 48-volt switch motor by means of a worm gear. Figure 3 shows a bay unit with six line finders on which is seen the Standard Electric gear driven devices now used.

If no switch clutch is energized, the vertical shaft revolves freely and the driven gears are kept away from the driving gears by the heavy back pressure of the clutch armature deflecting the former gear. When the clutch magnet of the switch is energized, the armature is attracted and releases the driven gear which, returning to its normal position, engages in the driving gear of the vertical shaft.

It should be noted that the switch motor starts up automatically when a call is originated, and runs during selection and release, but not during conversation or when the equipment is normal.

Apart from the switches already mentioned, the equipment contains the necessary subscribers' line and cutoff relays and starting relays, link circuit relays, signaling devices, etc. The whole of the equipment is enclosed in sheet iron cabinets with easily removable doors in order to permit access to the apparatus from both sides.

There are in all four bays, one for line relays, two for line finders and final selectors and one for

registers and signaling devices. There is also a separate bay, constructed by the Copenhagen Telephone Company itself, for charging machines and power board.

The subscribers' sets are of the ordinary common battery type with dials for selecting local numbers or trunk lines (see Figure 4).

Subscribers' telephone lines are numbered from 200-299 and from 310-399, and it is, therefore, necessary to dial in all three digits for local selection. Numbers "0" and "9" are reserved for calling on junctions: "0" for connection to Glostrup exchange—the main city exchange for Brøndbyvester—and "9" for eventual connections with another rural sub-exchange of Glostrup. Furthermore, the number "1" is reserved for special services.

In Glostrup central office (see Figure 2) the trunk line ends in a drop and an ordinary jack which operates on receipt of a call from Brøndbyvester. In Glostrup the connection is then put through by means of a double cord circuit, containing a bridged clearing out drop signal which operates when the Brøndbyvester subscriber hangs up his microtelephone. In order to enable the operators in Glostrup to call subscribers in Brøndbyvester, each position is equipped with a dial and one dialing key for each junction. Operation of this key connects the operator's dial in the junction as soon as a link circuit and a register have been obtained by plugging into the jack of the corresponding junction. The key also enables the operator to cut in on a busy subscriber's line in Brøndbyvester, offer a toll connection and eventually break down the subscriber's local connection in

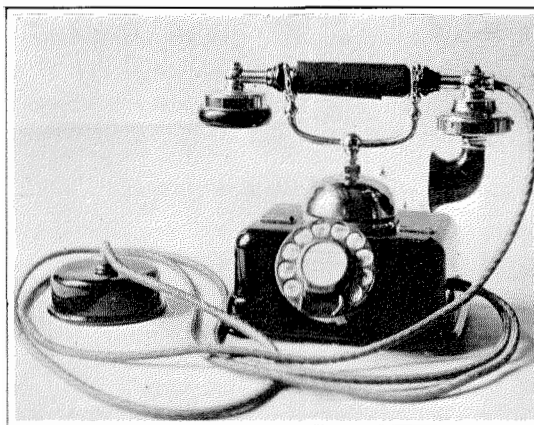

Figure 4—Subscriber's Set

order that toll service may be given preference over local connections.

The system is arranged for P.B.X. hunting and revertive party line calling.

If a wrong number is dialed, a special interrupted dialing tone signal is given to the subscriber, in order to acquaint him with this fact.

Handling of Faults

An arrangement is provided for signaling to the main exchange over one of the regular trunks the occurrence of certain faults at the rural installation. The selected trunk is taken over contacts of a relay in the fault alarm circuit which when operated disconnects the rural side and connects the signaling apparatus towards the main exchange.

Main fuse failure, ringing failure and shaft failure, have been considered as faults of major importance. Individual circuit fuse, voltage alarm and operation of the common time alarm associated with the register circuits, indicating the fact that all registers have been engaged for thirty seconds, are regarded as of secondary importance.

Each subscriber's line and junction circuit is provided with a special permanent loop relay, which enables a short-circuited or grounded line or junction to be eliminated from service and prevents it from interfering with the equipment. Such a faulty line or junction otherwise would unduly occupy links and registers until the fault had been cleared. In order to enable the operators in Glostrup from time to time to determine whether there are permanent loops on the lines or equipment in Brøndbyvester, they can go in on one of the junctions, connect to the Brøndbyvester equipment and dial a definite number. If there are one or several permanent loops in the Brøndbyvester area, the operator receives a special tone in her receiver.

Outgoing Call to Main Exchange

When the single digit "0" is dialed the particular switch in the link to which the outgoing junctions are connected must be advanced from normal to the first terminal in readiness to hunt for a free junction. During the time the switch is rotating the number of steps made is registered by the counting relays and when the last junction is reached hunting is stopped.

Toll Connection

The register circuit is provided with means for enabling the toll operator to listen-in on a busy connection and to break down such a connection if necessary. Further, a check is provided to ascertain whether or not ringing current shall be sent to the wanted subscriber's line after breaking down of the local call.

Ringing Current

Ringing current is generated by means of a transformer. The centre point of the primary winding is connected to battery through a low resistance retardation coil which is shunted by a 4 M.F. condenser. The outside windings of the primary are connected through an interrupter to ground. The interrupter closes each winding alternately; a ringing current is generated with a frequency of approximately 17.6 periods per second. The secondary winding of the transformer is connected to battery and is shunted by a condenser of 8 M.F. capacity.

Dialing and Busy Tone

Dialing tone for each register is provided by means of an individual transformer, the secondary windings of which are connected in series with the instepping relay. The primary winding of the transformer is connected to ground through an interrupter which creates a tone of 133 periods per second.

The busy tone is supplied to the calling subscriber over the same transformer in the register circuit, but the primary winding is in this case connected to ground through an interrupter which creates a tone of 400 periods per second.

Routine Tests

Simple means are provided for obtaining connection with any particular link circuit or any particular register. The circuits are tested by sending calls from a regular subscriber's instrument to a test number. On each link circuit a key is provided which disconnects the link circuit from the common starting circuit and connects it to the routine test circuit.

Last P. B. X. LINE

When P.B.X. hunting is provided each group is followed by a dead terminal. If all lines in the

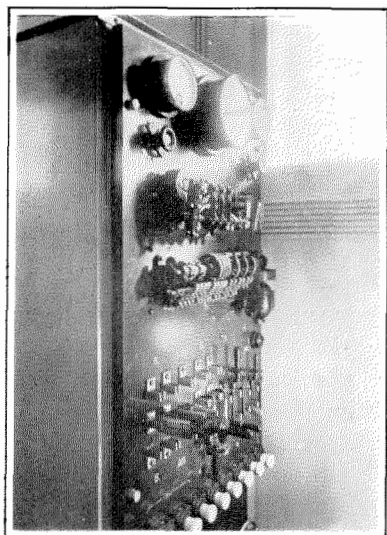

Figure 5—Power Board

group are found busy, the hunting selector is stopped on this terminal.

Power Arrangements

In the Bröndbyvester exchange two different voltages are used for the operation of the equipment; i.e., 48 volts for the switches and certain relays, and 24 volts for the line relays, link supervisory relays (microphones) and instepping relays.

The main power supply in Bröndbyvester is 380 volts A.C., 3-phase, 50 cycles. Inasmuch as the power-leads there, as in most other rural districts, are run on aerial routes and may often fail, the Bröndbyvester exchange is supplied with two 48-volt accumulator batteries, one being charged while the other is discharging. Each battery has a capacity of 300 ampere-hours. The 24-volt supply mentioned previously is obtained by inserting a small battery of C.E.M.F. cells of 24-volt, 24-ampere-hour capacity in the power circuit.

The advantage of using such a battery of C.E.M.F. cells is that it does not require any special attendance. The battery is charged each time there is a connection established in the exchange. Experience has shown that ten C.E.M.F. cells are satisfactory.

The power machines consist of a motor-generator set of 2.2 H.P., 3-phase, 380 volts–1,200 watts, 80 volts. In addition, there is a small regulating motor of $\frac{1}{8}$ H.P. which is operated

from the battery on discharge. To avoid supervision of battery charging, an automatic cut-out is arranged in the charging circuit. In case the main power supply should fail during charging the battery is cut out, and also is cut in automatically when the main power supply is restored. This is accomplished by means of the $\frac{1}{8}$ H.P. regulating motor in connection with a phase break relay having special voltage and current coils.

The controlling motor, when running, governs the various manipulations by means of a specially arranged sequence switch, so that all manual regulation of the dynamo voltage is avoided.

Figure 5 shows the power-board and the motor-generator set; Figure 6, the accumulator room with one 40-volt battery on each side of the middle aisle and one C.E.M.F. battery at the end of the aisle.

Building and Layout

Figure 7 shows the floor plan of the building for the automatic rural exchange. The interior measurement is 9 x 4 $\frac{1}{2}$ metres and is intended to include the space necessary for machine

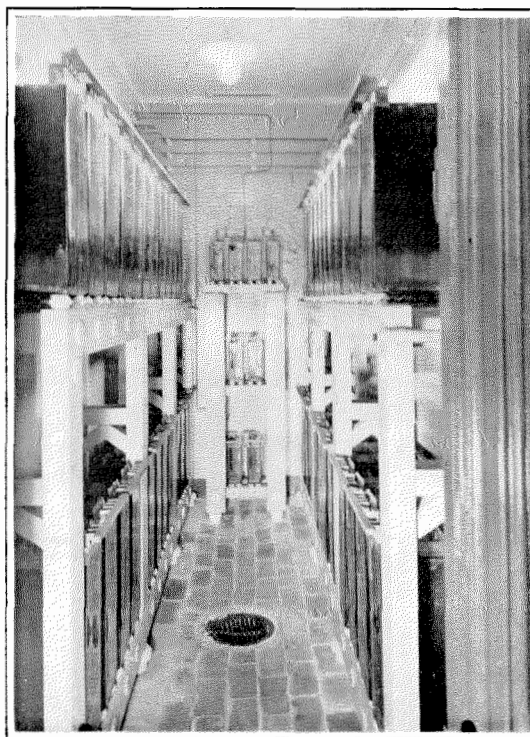

Figure 6—Accumulator Room

switching equipment for four hundred subscribers' lines. From the main entrance door there is direct access to the main frame room where all necessary cross connections for connecting subscribers to the exchange can be carried out.

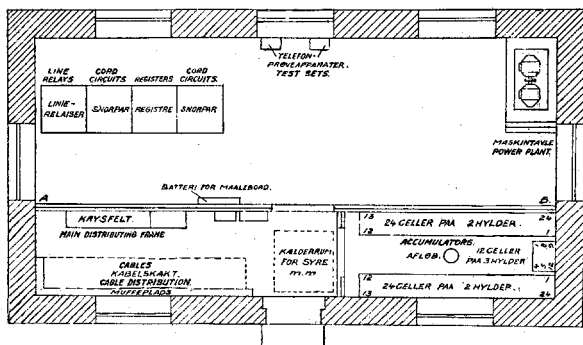

Figure 7—Floor Plan of Rural Exchange

In this room the wire-chief's desk also is installed. This desk is combined with a lamp box for permanent glow lamps indicating short-circuited or grounded lines. The main frame room is accessible to a concrete cellar which serves as a storeroom where acid and distilled water intended for the accumulators can be stored without being exposed to frost.

The battery room is separated from the main frame room by a double door and is specially ventilated. In the switchroom itself, which is separated from the main frame room by a door, the automatic switchboard is installed starting from the left hand side of the room. The frames enclosed in the iron cabinets have a capacity of two hundred lines. At the right-hand side of the switchroom the power plant is installed, enclosed in a similar iron cabinet.

Figure 8 shows the exchange building itself, which is provided with windows of Monier glass six feet from the ground. The house is built of brick. Special consideration was given to humidity conditions and temperature variation.

As the thatched roof used presents danger in case of fire, special precautionary measures were taken, the ceiling of the switchroom being made of stamped clay. Such a roof can burn without the fire gaining immediate access to the switchroom. As a protection from lightning, a net of copper wire is drawn under the roof. By means of four external connections soldered to the inside net, connection is made to the main earth bar which is carefully embedded adjacent to the building. Connections to earth are made also from the main, switch and machine iron frames. The building is not centrally heated but, by means of a thermostat, electric lamps placed in the switch cabinets are cut into the power supply circuit automatically whenever the temperature

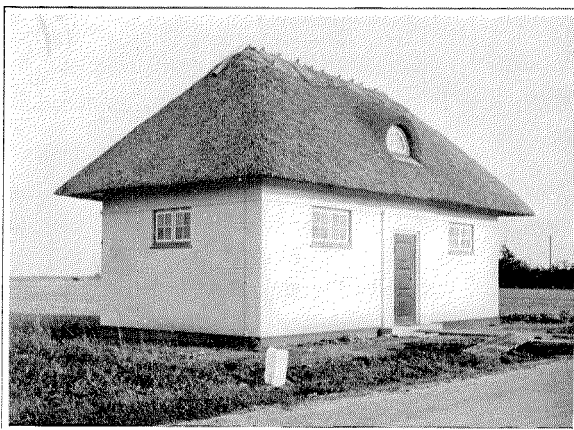

Figure 8—Rural Exchange Building

in the cabinets drops below 6 or 8 degrees centigrade. The lamps are extinguished when the temperature rises again. To provide for high humidity all wires and cables have an especially good black enamel finish.

Results of Operation

The Brøndbyvester rural exchange was placed in operation at the end of July, 1926, and has been operating very satisfactorily.

The 7-A Rotary Machine Switching System in New Zealand

By E. A. SHRIMPTON

Standard Telephones and Cables (Australasia), Ltd.

NEW ZEALAND consists of North Island, South Island, and several small islands in the South Pacific. It has a total area of 104,900 square miles, and it occupies an important position about 1,200 nautical miles to the south-east of Australia. Including the out-

horse-power and over, on a 50 per cent load-factor, available in the North and South Island, respectively, is said to be 776,000 and 4,110,000. The Government has made a beginning with power development, and has brought some schemes into operation in comparative proxim-



Mount Egmont, 7800 Feet above Sea Level—New Zealand's Fujiyama

lying islets and the Ross Territory, the boundaries stretch from the tropics to the Antarctic. The climate is generally equable, mild and salubrious, as might be expected within latitudes corresponding to those of the Mediterranean region between North Africa and the South of France.

Among the most striking physical characteristics of New Zealand are its mountains. From the mountains rise numerous rivers. This feature, together with large and small lakes and glaciers, which nature has provided for storage, has placed the country in possession of enormous reserves of energy awaiting exploitation. The country is destined to become one of the manufacturing centres of the southern hemisphere.

The total estimated power of schemes of 1,000

ity to the centres of industry, but they represent only an infinitesimal portion of the energy available.

The population of New Zealand and dependencies, including Maoris and residents of Cook and other Pacific islands, is about one and a half millions; nearly 95 per cent of this total is of the British race. The Maori population is about 63,000. The Maoris are a superior race of Pacific islanders. The educated Maori competes successfully with his white brethren. He has held some high positions in the land; he has even represented white constituencies in the House of Representatives, and is a born orator.

In New Zealand, sport is so pleasantly associated with marvelous scenery that visitors from

all parts of the world acknowledge this country to be "The Sportsman's Paradise." Railroads and motoring roads give easy access to the hundreds of streams and lakes in which acclimatised trout and salmon attain a size far surpassing the measurements and weight of their largest

ulation is 9.5, a figure which places New Zealand well up in the list of "Telephone Development of the World, by Countries." The number of telegrams forwarded annually per head of population is nearly five—the highest in the world.

New Zealand is also well placed in the list of



Primitive Communication. Maori Women greeting by rubbing noses

ancestors in the northern hemisphere. It is similarly easy for sportsmen to make their sallies in launches for large swordfish and Mako shark. Many of the places where deer, wild pig, and feathered game are plentiful can be reached without difficulty. Some of the deer-stalking country is, of course, rugged, but the keen sportsman likes to work for his trophies.

Telephones were used in New Zealand as far back as 1880 when Edison and Bell instruments were installed for bringing the "outback" into touch with the telegraph system. They assisted materially in opening up the back country for settlement. Figure 1 illustrates this first type of telephone used in New Zealand. The resistance of the bell coils was 100 ohms. Wet Leclanché cells were employed; they were contained in a battery-box, not shown in Figure 1. The telephone now enters very largely into the business and social life of the Dominion.

The number of telephones per 100 of the pop-

"The Number of the Population per Motor Vehicle, by Countries." The United States of America leads with 5.8, followed by Canada 12, and New Zealand 12.5.

The first telephone exchanges were installed in 1881. They were "Earthworking" with locally made magneto switchboards, and Edison and Bell instruments. The exterior of the Wellington (New Zealand) Telephone Exchange as it existed in 1887, is illustrated in Figure 2. At that time it had 550 earthworking lines. The cables shown as "lead-in" were 30-core rubber covered wires. The wires going skywards in Figure 2, terminated on a hill. Some of the spans were more than 1,000 feet in length. The interior of the Wellington (New Zealand) Telephone Exchange in 1887 is illustrated in Figure 3. The racks on top of the switchboards carried serrated lightning protectors followed downward by drops, jack-fields, and transfer board. The resistances of the drop coils were about 100 ohms,

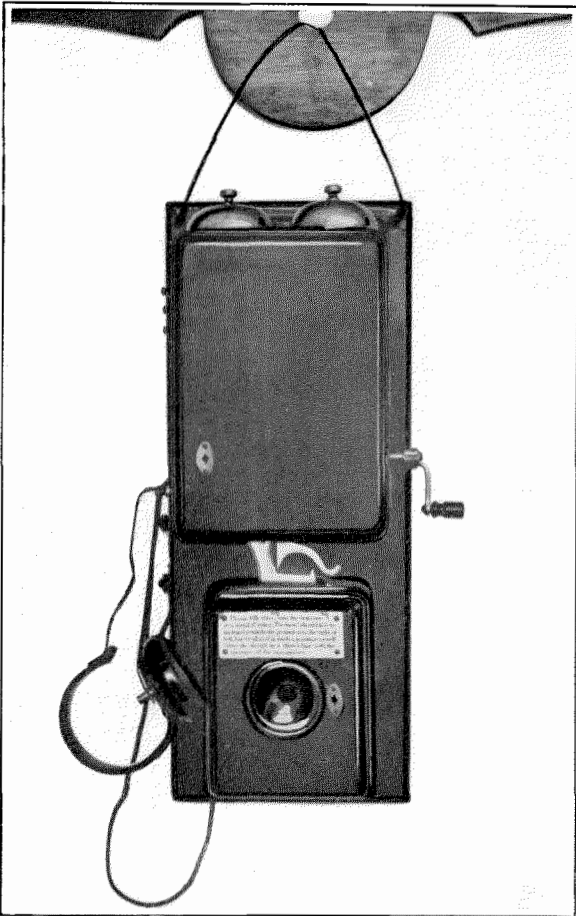

Figure 1—Example of the First Telephones Used in New Zealand

and were always in series with the line. Since then the telephone exchange business has increased steadily, the Administration passing through various stages and phases as in the older countries of the world. Western Electric standard switchboards, and magneto telephones having solid back transmitters, later replaced locally-made switchboards and Edison and Bell telephones.

In the early nineties, trolley trams were introduced which caused, with feverish haste, the general conversion of earth-working to metallic circuit. About this time the exchanges at the four chief centres had grown too large for the traffic to be handled by non-multiple switchboards. Consequently, Western Electric branching multiple switchboards were installed, and a little later these were installed also in various provincial towns. Thereafter the Administra-

tion was faced with extensive modernisation of its entire telephone exchange equipment. The branching multiple switchboards had long served their period of usefulness and several had more lines connected to them than the estimated ultimate capacity. The question of the hour was, "What is it to be, manual or automatic?"

To help in solving this problem the Administration sent a representative to the United States and to Europe with instructions to enquire into and report generally upon the trend of events in older countries. After studying his report it was decided that automatic exchanges would give the required service for small and large communities in New Zealand.

In 1913, tenders were invited for two multi-office and four single-office areas. On receipt of

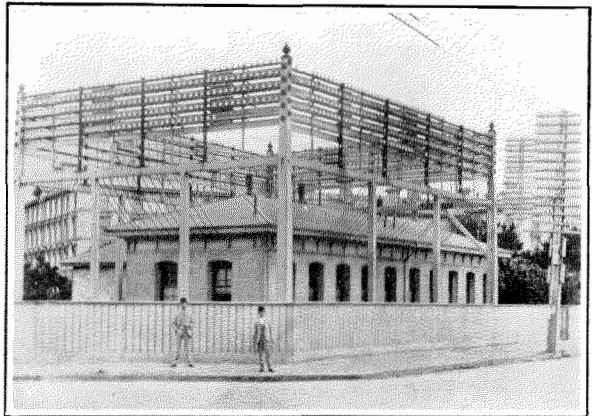

Figure 2—The Wellington Telephone Exchange in 1887

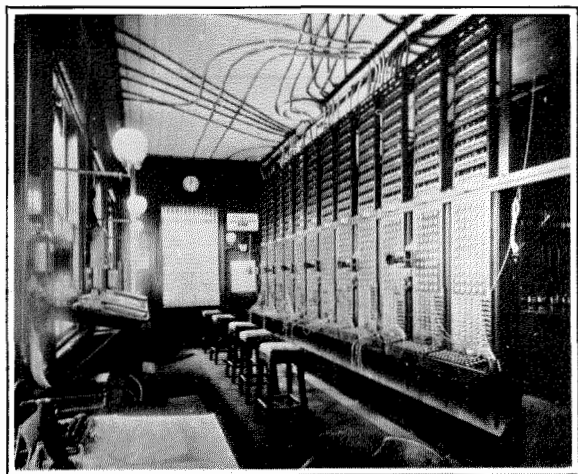

Figure 3—Interior of Wellington Exchange in 1887

the tenders, the Administration engineers very carefully and exhaustively studied the services that were offered and finally selected the Western Electric No. 7-A Rotary Machine Switching System. Early in 1914 it was decided to place the No. 7-A Rotary System in two more multi-office areas (six offices) and another single office area. On the announcement of this decision, criticisms were levelled at the Department for adopting, as it was alleged, so extensively a practically untried system. This criticism eventually proved to be entirely unwarranted, as will be seen from what follows.

Before suitable buildings could be provided for housing these seventeen exchanges, and be-

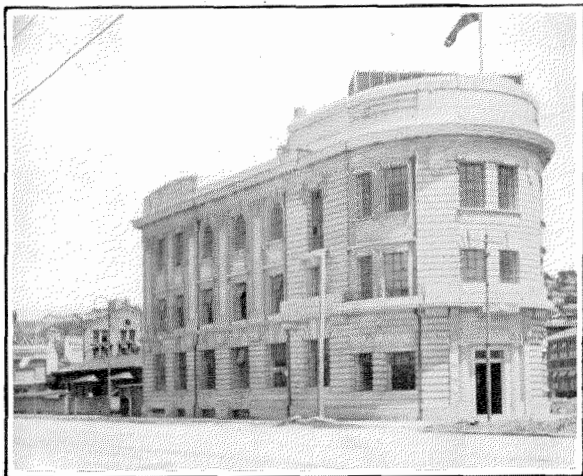

Figure 4—Stout Street (Main) Wellington Telephone Exchange in 1927

fore any installing work was done, the war came and everything was dropped but the main chance. New Zealand vigorously entered to assist the Empire. An indication of the magnitude of New Zealand's efforts is that ten per cent of the population fought overseas. During the war, a certain amount of installation work was done, but owing to the difficulty of getting apparatus—several ships bringing it were torpedoed—it could only be carried out in a partial manner. The want of suitable staff was also a deterring factor.

As already indicated, the New Zealand Government was one of the first to adopt the No. 7-A Machine Switching System. The installing was done by the Administration assisted by a small engineering staff forming part of the or-

ganisation of the manufacturer, The Bell Telephone Manufacturing Company of Antwerp.

The first exchange cut-over was such a success that the Administration was besieged by de-

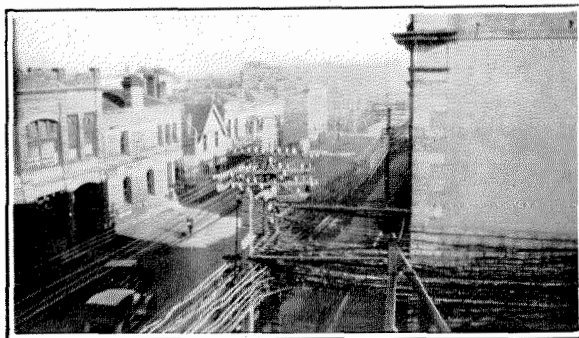

Figure 5—Overhead Cables at Christchurch, New Zealand, now being replaced by underground cables

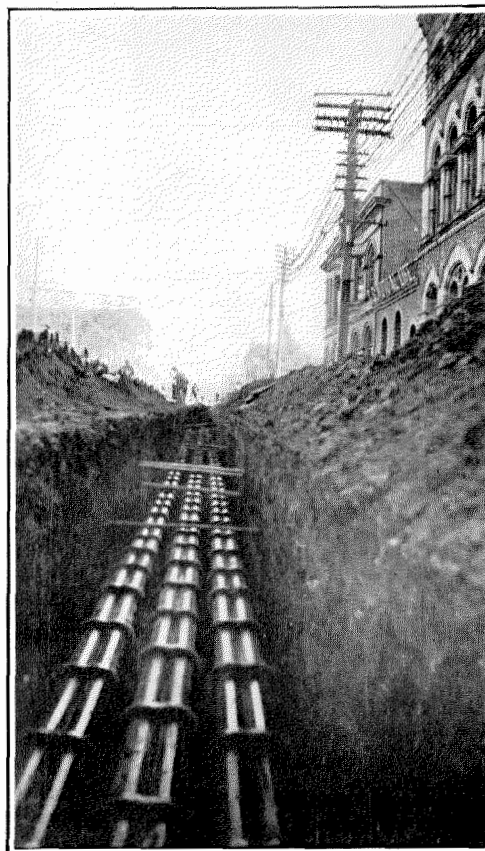

Figure 6—Underground Conduit, Christchurch, New Zealand

mands from other communities for the same equipment to be installed in their areas. In contrast with the 1887 exchange, Figure 4

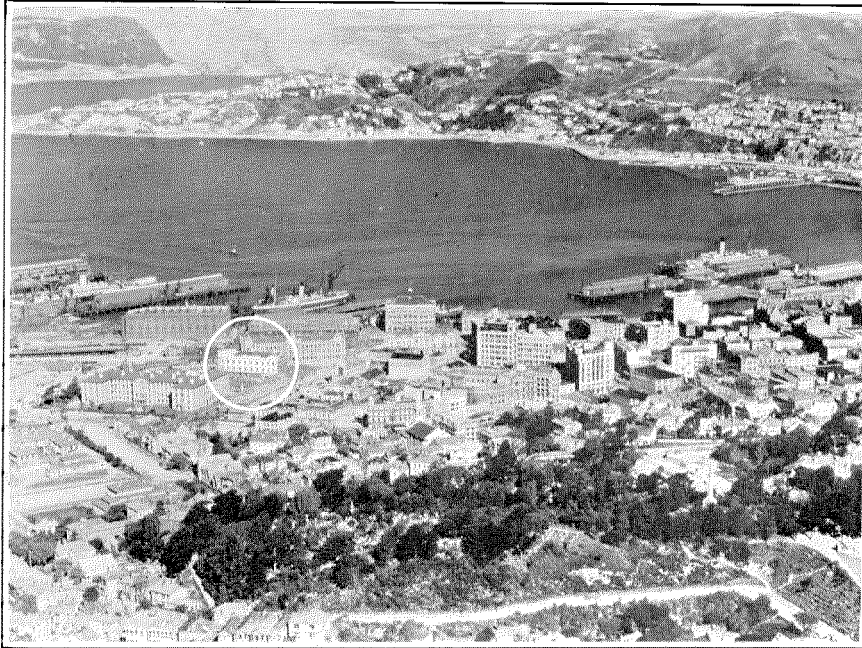

Figure 7—Wellington, the Capital of New Zealand. Stout Street Telephone Exchange is seen within the circle

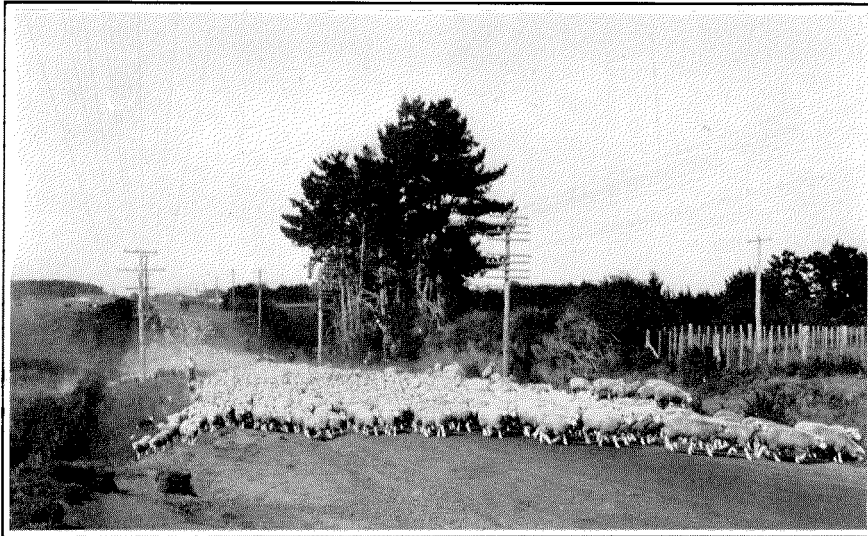

Figure 8—Telephone Trunk Line and Subscribers' Line, New Zealand

represents the modern Stout Street (Main) Telephone Exchange at Wellington (New Zealand). It contains about 8,000 lines of the Western Electric 7-A Machine Switching System. The road to the right is cut up for a new trolley car line. All cables lead in underground. To the left is the old exchange.

Up to the present, No. 7-A equipment is

installed in New Zealand in the following areas:

	Number of Offices	Number of Lines
Auckland.....	7	13,300
Wellington.....	5	15,800
Dunedin.....	3	6,300
Single Office.....	5	6,300

In the Christchurch area No. 7-A equipment for 9,000 lines (two offices) will be cut over in

1927. Overhead cables entering the Christchurch (New Zealand) Telephone Exchange are shown in Figure 5. These cables are of 100 pair dry core lead-covered type. They will all be replaced within the next few months by

are pending for several exchanges throughout the country.

Wellington, the capital of New Zealand, is illustrated in Figure 7. The greater part of the business quarter of the city is to the right,

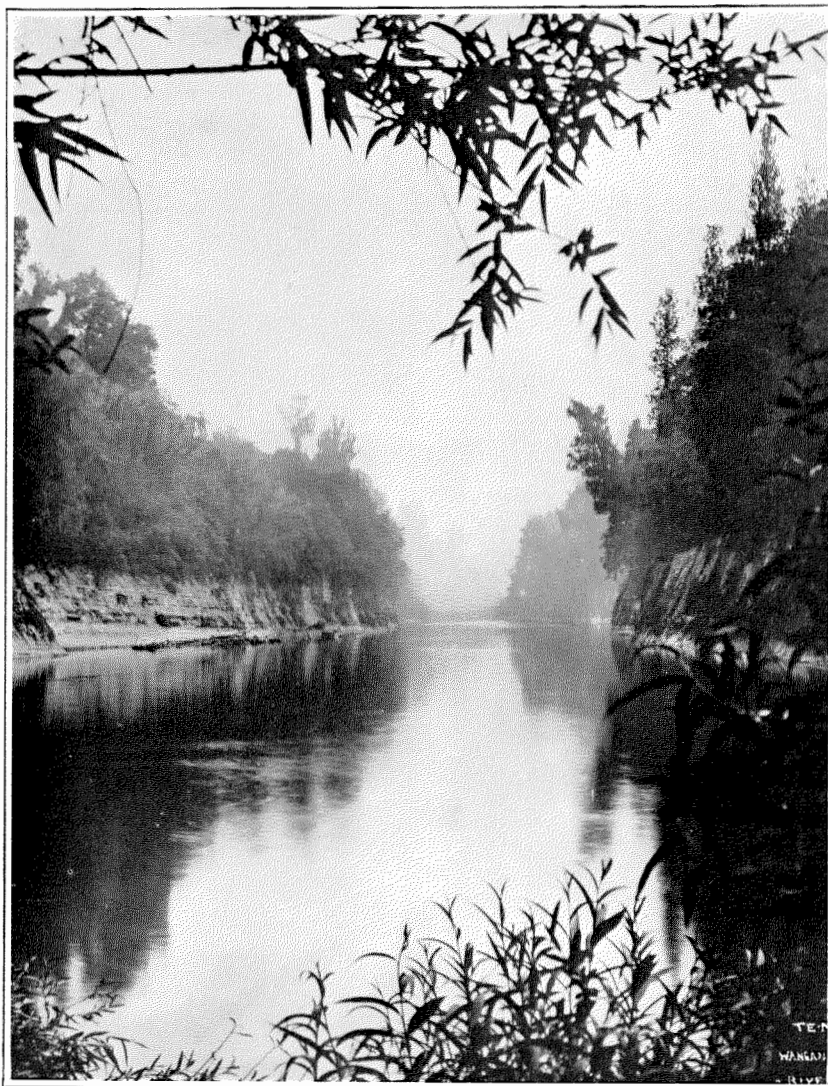

Scene on the Wanganui River, New Zealand

underground cables. Figure 6 represents the same locality, with the street opened up and conduits being laid for underground cables.

Extensions to equipment already in service are being installed at several exchanges totaling 2,500 lines, making a grand total of 53,000 lines. Enquiries have been received for another office of 1,100 lines for the Wellington area and others

beyond the picture. The Stout Street Telephone Exchange (Main) is the white building with the rounded end, seen below the bows of the steamer somewhat to the left of the middle of Figure 7. An idea of overhead construction in New Zealand can be obtained from Figure 8 which illustrates, on the left, power and lighting lines, and, on the right, telephone trunk lines and subscribers' lines.

International Chamber of Commerce Stockholm (Fourth) Congress

AT the Fourth Congress of the International Chamber of Commerce held at Stockholm from June 27 to July 2, 1927, international telephony was again discussed. At the Third Congress, which was held at Brussels in 1925, a Special Committee was appointed to study and report upon this question, and since

Great Britain. At the plenary meeting they were proposed by Sweden, and supported by France. At both meetings they were carried unanimously.

It was greatly to be regretted that the Chairman of the Special Committee, Sir Martin Abrahamson of Copenhagen, was prevented, by



Riksdagshuset (Parliament House, Stockholm) Where the 1927 Congress of the International Chamber of Commerce Was Held

then a considerable amount of work has been done, mainly for the purpose of determining:

What are the services actually open to the public?

What is the opinion of business men with regard to the range, the audition and the rapidity of the service?

What can be done by the Chamber to promote the widest possible extension of international telephone service?

One of the points specially noticeable at Stockholm was the general recognition of the immense importance of international telephony to business. At the group meeting the resolutions were proposed by a representative from Germany and they were seconded by one from

illness, from presiding at the plenary meeting. His place was ably taken by Mr. J. S. Edström, Managing Director of the Svenska Elektriska, A.B.

The following are the Report of the Special Committee and the resolutions that were passed:

I. Reference of the Brussels Congress

At the Brussels Congress under the heading of "International Telephony," the following resolution was unanimously adopted:

"*The Congress* of the International Chamber of Commerce recognizes the importance of an international telephone service in the promotion of commerce and trade between the nations, and the betterment of international relations.

"It Recommends:

"That the Council of the International Chamber appoint a special Committee to study and report to the Council upon the possibility of assistance by the Chamber in the improvement of existing international telephone facilities, and the widest possible extension of an international telephone service."

In the discussion attending the presentation of the resolution it was stated that the International Consultative Committee on Long Distance Telephony, made up of technical representatives of the various Administrations interested, had already undertaken the technical work; that it was not a question of the International Chamber of Commerce going over the same ground as the International Consultative Committee, but of aiding the latter with its advice, and giving it its support.

An International Telephone Committee was appointed, which has held several meetings, in all of which, the Secretary General and other representatives of the International Consultative Committee have participated.

The following summarizes the activities of the International Telephone Committee, their findings and recommendations:

II. The Importance of International Telephony

In the consideration of the subject by the Committee, there early developed a growing realisation of the importance of international telephone service.

- (a) As an effective instrumentality for removing impediments to international trade, and
- (b) That the ability to secure speedy personal communication between distant cities should be a factor in stabilizing business through a more orderly and economic movement of goods;
- (c) That effective telephone service tends to facilitate all the processes of production and distribution;
- (d) That ability to communicate information quickly, tends to minimise the range of price fluctuations and thereby lessen the tendency to speculation;

- (e) That any instrumentality which tends to stabilize business, facilitate its processes, and effectively extend the field of operations with consequent increase in the volume of trade, should lessen the difficulties of international settlements, as after all, all settlements have to be made ultimately in goods or services;
- (f) That the ability to communicate voice-to-voice, easily and speedily, whenever desired or needed, cannot but be a means of improving social relationships and developing a common economic and social viewpoint which inevitably must have an effect in promoting a better understanding between nations.

III. The European Situation in 1922

To appreciate properly this problem of international telephony, it is necessary to know the conditions under which the telephone service in Europe was carried on up to the end of 1922.

At that time the outstanding features were:

- (a) The construction and improvement of the telephone plants had been at a standstill during the whole of the war period.
- (b) About forty self-contained local operating organisations, each also conducting a part of the international telephone service.
- (c) No organisation controlling or coordinating the various local operating organisations which had to function together in handling international calls.
- (d) No organisation of any kind which made plans for the international service as a whole.
- (e) No common research, standard practice or technique of construction, maintenance or operation.
- (f) No common agreement as to manufacture.

It is true that, even under these conditions, certain channels of international communication had been built up, but they were the result of individual effort, not the working out of any comprehensive plan.

Further difficulties to be overcome in the European situation arose out of the fact that long distance services were subject to budget and legislative requirements. The experience of established Government Departments up to

that time (1922) had not demonstrated the necessity of the flexibility, now generally recognized, so essential to the conduct of great commercial services of a highly technical and rapidly expanding nature.

The European situation was, and is, rendered still further difficult by reason of the variation in language, in habits of the different nationalities and by international trade barriers.

IV. Formation of the International Consultative Committee¹

Recognizing the need of a central body to consider international requirements, in 1923 a preliminary expert committee on long distance telephony met, at the suggestion of France, to enquire into the question of long distance telephony in Europe. This preliminary committee laid the ground for the work of, and recommended the appointment of an International Consultative Committee on long distance telephony composed of representatives of all European Telephone Administrations.

The International Consultative Committee on long distance telephony met for the first time in 1924, the official representatives of the Telephone Administrations of nineteen European countries being present.

As a result of enquiries initiated at this meeting, the Consultative Committee, at its second general meeting in 1925, outlined a first and temporary solution of the principal problems involved, after consultation with the experts of many business enterprises specialising in electrical and telephone matters.

During the International Telegraph Conference of Paris in 1925 the Consultative Committee received its official sanction, and was definitely asked to prepare model arrangements relating to the technical construction and operation of international long distance telephony. It was also decided that Administrations belonging to the International Telegraph Union should as far as possible follow these arrangements.

Since then the International Consultative Committee has made thorough investigation of

¹For a more complete summary of the International Consultative Committee and its work, the reader is referred to an article in the July, 1927, issue of ELECTRICAL COMMUNICATION.

these matters. Regulations for the operation of long distance telephones as recommended by it have been officially endorsed by the International Telegraph Union.

The International Consultative Committee has also studied costs so as to furnish a basis for the calculation of international telephone rates and charges.

The Consultative Committee for each group of new questions investigated appoints subcommittees of experts which have at their disposal information gathered from all over Europe and from the United States. Their recommendations are considered and, if approved, accepted, once a year at a general meeting attended by the official delegates of the Telephone Administrations.

V. Improvements Which Have Already Been Made Under the Programme of the International Consultative Committee

In 1925, the Telephone Administrations belonging to the International Consultative Committee outlined a comprehensive plan of international telephone cables between the larger

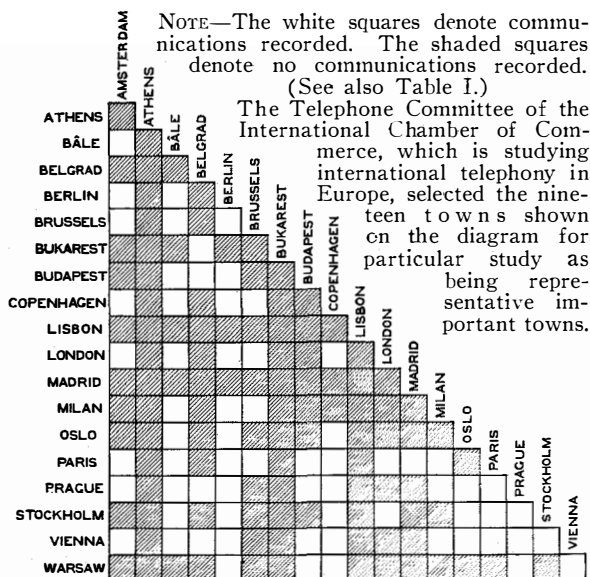

Telephone Communication Between Nineteen Important Towns of Europe in 1927

cities in the several European countries. This plan provided for their construction being carried out during the period from 1926 to 1930.

Early in 1927 it was possible to see the first

results of the efforts made by the Telephone Administrations belonging to the Committee:

- (a) New connections have been established between cities which formerly had no telephone connection between them (see Table I for examples).
- (b) Numerous additional circuits have been placed in service on existing lines, which

be seen by reference to section VII of this report, the charges are considerably less. These delays in many countries in Europe can be reduced by "urgent" calls at triple rates, and by "lightning" calls, which provide immediate connection at ten times the ordinary rates.

Additional service features have been generally provided in connection with international service:

TABLE I

The following shows nineteen of the principal cities of Europe and the total of the other eighteen with which each city had telephone communication in the periods indicated

	1925	1926	1927* (15th July)		1925	1926	1927* (15th July)
Amsterdam.....	5	7	8	London.....	4	5	7
Athens.....	0	0	0	Madrid.....	1	1	1
Basle.....	4	10	12	Milan.....	2	5	6
Belgrade.....	2	3	4	Oslo.....	3	4	6
Berlin.....	10	13	13	Paris.....	6	9	12
Brussels.....	3	6	7	Prague.....	3	8	12
Bucharest.....	1	1	1	Stockholm.....	3	4	8
Budapest.....	4	6	7	Vienna.....	3	8	12
Copenhagen.....	4	4	11	Warsaw.....	0	4	5
Lisbon.....	0	0	0				
				Totals of actuals.....	58	98	132
Percentage of actuals to possibles.....					17.0	28.6	38.5

Possibles = $19 \times 18 = 342$.

* Note: In this Table the figures for 1927, and the additions and percentages, are obtained from other sources, and are not included in the Report as issued.

TABLE II

A few examples of average delays in minutes during the busy hours. (C. C. I. Records.)

	1925	1927		1925	1927
Berlin-Paris.....	130	68	Paris-Brussels.....	180	180
Berlin-Vienna.....	143	62	Paris-Turin.....	180	10
Berlin-Stockholm.....	89	39	Stockholm-Copenhagen.....	8	8
Berlin-Prague.....	133	45	Vienna-Zurich.....	140	101
London-Amsterdam.....	61	34	Vienna-Cracow.....	90	74
London-Brussels.....	31	19			

has noticeably reduced either the delay during hours of heaviest traffic or the daily delay (see Table II for examples).

- (c) Communication has been improved on already existing connections between many cities through the use of improved apparatus and by the replacement of overhead lines by cables.

It is evident also that while the delays for ordinary service in Europe are still very much greater than those in the United States, as will

- (a) Conversations exceeding three minutes are now charged for per minute extra, instead of by unit of three minutes.

- (b) Fixed time calls and subscription calls are now allowed in business hours.

- (c) "Notice" (préavis) calls have been introduced, permitting calls for a particular person by name.

On the recommendation of the Consultative Committee, the various Telephone Administrations, as a first step in improving the interna-

tional service, will endeavour to provide facilities that will permit them to keep delays in the future within the following limits:

On circuits of less than 500 kilometers (310 miles) 30 minutes.

On circuits of less than 1,000 kilometers (620 miles) 60 minutes.

On very long circuits 90 minutes.

It should be noted that there is evidence that the extreme delays in obtaining connec-

VI. Enquiry Made by the Telephone Committee of the International Chamber of Commerce

Although the members of the International Telephone Committee had themselves considerable personal knowledge of the service, yet in order to develop concrete expression of the needs of users, a questionnaire was issued to the National Committees in 1926 and by them was passed on to individual firms and persons using or desiring international service.

NOTE—Diagram shows telephone communication as distinct from circuits existing between certain capitals or other important towns of Europe. Those towns which are shown without any lines radiating from them have no recorded international telephone communication

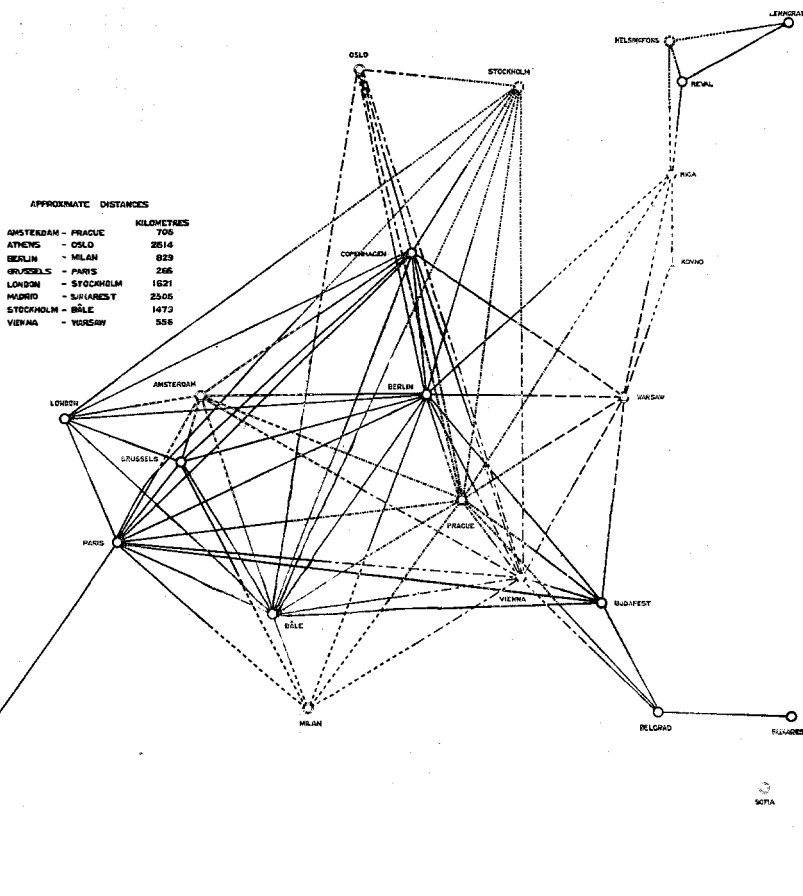

Telephone Communication Existing Between Certain Capitals or Other Important Towns of Europe

tions in the past have formed an inhibition against the use of calls; that a latent demand existed is well demonstrated by the result of increasing the number of circuits between Paris and Berlin. Within three months after the addition of new circuits the number of calls increased nearly threefold.

The attention paid to this questionnaire varied greatly, and while many replies were received from some nations, a surprisingly inadequate response was obtained from others.

Yet there was clearly indicated the general trend of feeling to the effect that industry and commerce required long distance telephony; that

it was not satisfied with the extent, quality or speed of the international service then available; and that what was required was reliable and fast service with good audition over a very wide area.

VII. Reference to the Commercial Telephone Service in Use in U. S. A.

The Committee has investigated the long distance service in the United States. It has been able to secure considerable data through the American Section of the Chamber, and the Chairman of the Committee has made investigation in person during a stay of some weeks duration in that country. Some of the facts developed are outlined in the following:

Long distance service was in commercial use between New York and Chicago, 736 miles (1,187 kilometers), in 1892; between Boston and San Francisco, 2,760 air line miles (4,450 kilometers), in 1915.

The long distance service, as now effective in the United States, has been the result of an evolution extending over a number of years. It has been developed under a well defined business policy, some of the features of which are:

- (a) Providing adequate audition between *all* points where there is an existing or potential demand for calls.
- (b) The constant objective is to make the speed of connection between any two points as prompt, uniform and dependable as possible and approximately the same at *all* hours of the day. *All* calls are "urgent."
- (c) In providing circuits, operating equipment, and operating staff, the primary consideration is the requirements of the user; that is, the volume of calls offered during the busiest hour of the day.
- (d) There is no time limit to the use of the circuit except in the case of serious accidents to lines or other emergencies. Talks of from thirty minutes to several hours, without interruption are not infrequent.

It has been the constant aim to provide a long distance service which will be so satisfactory to the business man as to audition, depend-

ability and speed, that it will be the communication medium to which he will instinctively first resort whenever need for communication arises.

The fact that a uniformly fast long distance service is available has led to its extensive use by business firms in selling goods to their customers in distant cities.

During the ten years from 1915 to 1925, while the population increased about 15 per cent and the number of telephones about 66 per cent the number of interurban calls increased 156 per cent.

This increasing utilisation of long distance service could never have taken place if adequate, speedy and dependable service had not been made available first, and its availability and utility demonstrated to business men.

About 900,000,000 interurban calls per year are now made in the United States. About 70 per cent of these are for relatively short distances, and the average speed of connection of these calls is less than one minute, the calling party waiting at the telephone for completion of the connection as in the case of a local call.

The remaining 30 per cent, or about 270,000,000 calls, are handled through toll boards, at an average speed of connection of four minutes, including calls for designated persons (*pré-avis* or notice calls).

Over routes carrying relatively heavy traffic and between large cities, in some cases for distances of over 1,000 miles (1,600 kilometers), about 70 per cent of the connections are completed within two minutes, the average speed being less than five minutes, while about 97 per cent are completed within ten minutes.

The transcontinental calls between New York and the larger cities on the Pacific Coast, an air line distance of over 2,500 miles (4,032 kilometers), are connected during business hours on the average in ten minutes. Calls between Chicago and these same cities on the Pacific Coast, an air line distance of over 1,740 miles (2,806 kilometers), are completed on the average in six minutes, during business hours.

To summarise, this long distance service affords adequate audition and high speed of connection at a very low average delay throughout the United States, and with Canada and Cuba.

VIII. Conclusions, and Action Recommended

The International Telephone Committee, after consideration of the facts developed through its investigations of existing conditions, is satisfied that international telephony in Europe is in need of further improvement.

The Committee realizes that permanent improvement is, of necessity, an evolution. It is impressed with the progress already made in improving the international telephone service by the Administrations, particularly in view of the conditions which existed before the formation of the International Consultative Committee.

The work of that Committee deserves the support of the business men of Europe, who should urge upon their several Administrations the importance of international telephone communication, especially in view of its economic importance as noted in Section II of this report.

The International Telephone Committee realizes that the activities of the International Chamber should be constructive and cooperative, that its function is to express the requirements of the business men and that it should cooperate with existing administrative agencies in the attainment of sound objectives.

These objectives can be expressed very simply, they are:

Uniform, dependable, fast service with good audition between all important trading centres in Europe.

The following resolutions were, therefore, submitted:

RESOLUTIONS PASSED

Resolution No. 18
of the
Stockholm Congress

INTERNATIONAL TELEPHONY

The Congress of the International Chamber of Commerce, *Recognizing* that Telephony has been so much developed that satisfactory speech is practicable across Continents and further recognizing that efficient and speedy com-

munication by speech tends to remove many impediments to the conduct of Trade and Industry, and,

Considering that, in spite of the great improvement effected through the efforts of the International Consultative Committee and the thorough studies it has conducted and is continuing, the service on the whole is still far from that required to satisfy the present day requirements of business,

Resolves that National Committees of the International Chamber of Commerce be again requested to interest themselves in this matter and urge upon their respective Telephone Administrations the importance of providing the facilities for communication essential to their share of International Trade, with due regard to practical limitations as to the speed at which an adequate service can be developed.

Resolution No. 19
of the
Stockholm Congress

COMMUNICATIONS

The Congress of the International Chamber of Commerce, *Recognizing* that the International Chamber of Commerce represents the users both of "Transportation," which applies to the transfer of persons and goods, and of "Communications" which applies to the transfer of ideas,

Recommends:

1. That the Bureau at Headquarters known as "Transport" shall henceforth be entitled "Transport and Communications."
2. That under "Communications" there be set up Standing International Committees to consider the most effective methods by which the International Chamber of Commerce can promote usefully the development of the various elements of International Communication, viz.:
Telephone Service, with and without wire,
Telegraph Service, Cable and Radio,
Postal Service.
3. That all National Committees be requested to form special Committees and in their selection of members to include a majority representation of users.
4. That the work of these Committees be guided by the following principles:
 - (a) The general requirements of the users of international communication in each country to be regularly investigated.
 - (b) The specific requirements of the principal industrial, commercial and agricultural activities to be investigated with the assistance of experts in each class of activity.
 - (c) The requirements as to the different classes of Communications and as to the scope of the services to be investigated.
 - (d) Technical questions as to the methods by which the requirements of the users shall be met to be excluded from consideration by the Committees.
 - (e) The Committees should endeavour to work in close collaboration with telephone, telegraph and postal administrations of the different countries and with international bodies interested.

Aerial Cable Across the Moerdijk Bridge—Holland

By E. WILLIAMS

European Engineering Department, International Standard Electric Corporation

ATOLL cable forming part of the European Telephone Network has been installed recently between Rotterdam and Roosendaal, by the Dutch Administration. It consists of 45 quads, 19 of 1.8 mm. gauge and 26 of 1.23 mm. gauge, and it will provide direct cable communication between the north of Holland, including The Hague and Amsterdam, and countries south, including Belgium (Brussels) and France. A section of this cable involving special features in carrying out the work has been erected aerially across one of the sea inlets, known as the Hollandsche Diep, where it is spanned by the Moerdijk Bridge.

The position of the main cable is indicated by the sketch-map, Figure 1. The Moerdijk

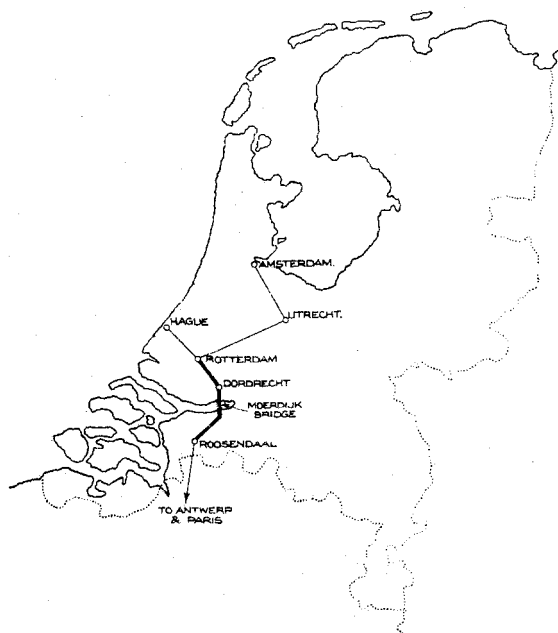

Figure 1—Map of Holland, showing the route of the Rotterdam-Roosendaal Cable and the aerial section across the Moerdijk Bridge

Bridge is situated about 10 kilometres south of the old city of Dordrecht. This bridge is of braced arch construction and is approximately 1.6 kilometres in length, consisting of fourteen spans, each of 105 metres, resting on stone piers. It was built between 1869 and 1872 and was

at that time the longest single track railway bridge on the Continent. On the southern side of the bridge a swing portion provides two openings, each of 20 metres, to permit vessels having high masts to be navigated up or down stream. Figure 2 is a general view of the bridge from the north shore.

Each span is constructed with one end rigid and the other movable. Each shore-end is rigid and the two ends of the first and second spans, resting on the first pier, are free on rollers, while those on the second pier are both rigid and so on alternately across the stream. In addition to the expansion and contraction of the metal due to temperature changes, there is very considerable movement of the free ends on alternate piers, as well as some vibration at the centre of each span whenever a train passes. Observation at selected points has shown that the vibration may last for two minutes. A speed limit of 10 kilometres per hour has been set for all trains.

In 1923 an armoured cable was installed in steel tubing under the footway at the side of the railway track. Owing to the mechanical conditions of the bridgework, some trouble was experienced in maintenance at each of the free points on the piers. In 1925 the lead sheath was found to have crystallised at some of these points. This was due to vibratory movement caused by the trains, to provide flexibility and overcome the difficulty, loops of armoured cable were spliced into the cable and carried over rollers. The loops measure about 10 metres between rollers, and the sag is approximately 1 metre.

To avoid the possibility of troubles of the character mentioned, the Dutch Administration when designing the new cable, decided that the best type of construction to adopt was an aerial cable suspended on existing steel telephone standards clear of the bridge.

There are two open wire routes parallel to the bridge. One of these, i.e., that on the west side of the bridge, is a telephone route, the circuits being carried by double steel standards of

angle iron, and the width between uprights being 2 metres. Four 1-inch tie rods are used to brace the standards to the masonry of each pier. The other route, which is on the east side of the bridge, consists of single steel standards that carry the railway telegraph circuits. Both of these routes are separate from the bridge spanning. The design approved provides

a few inches, and for this reason the aerial cable-sags must be maintained within narrow limits at all temperatures and seasons of the year.

In order, therefore, to provide a suspension structure of the requisite strength and at the same time to meet these conditions, it was necessary to design a bi-suspension consisting of an

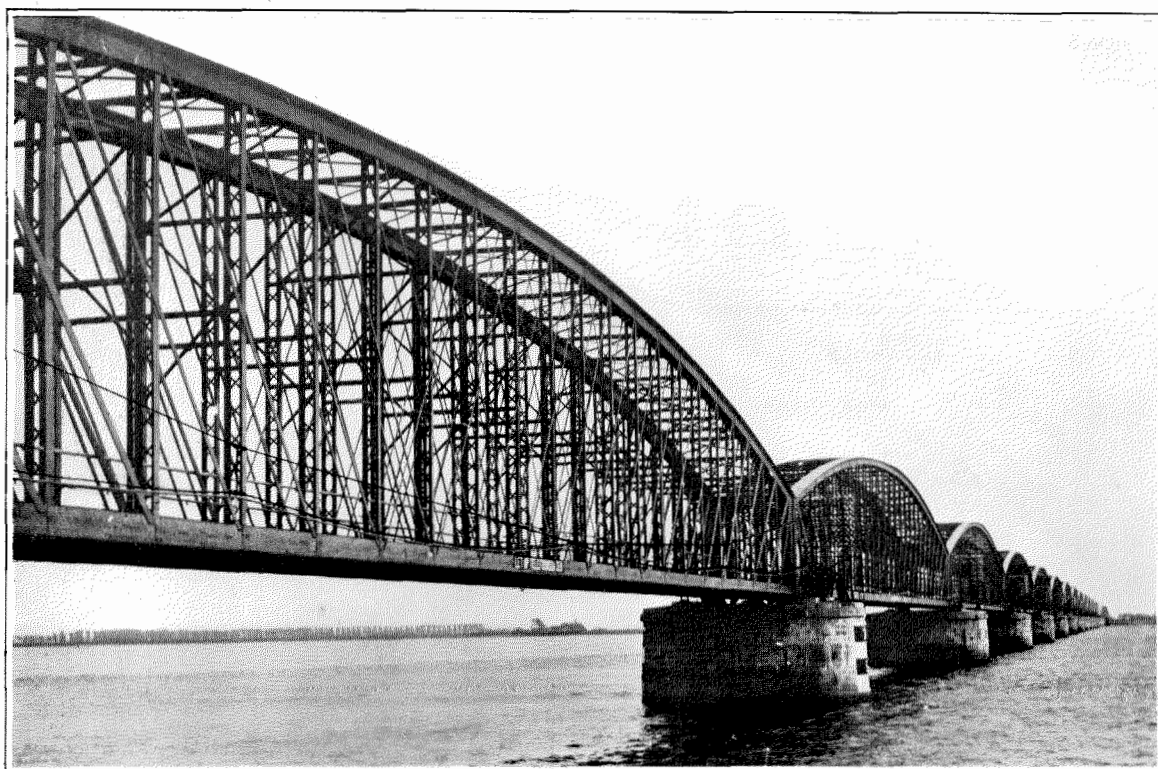

Figure 2—The Moerdijk Bridge, showing the aerial cable with suspensions in position

for the suspension of the aerial cable with attachments to the inner uprights of the telephone standards at a distance of 4 feet from the bridge girders.

The plan, Figure 3, indicates the position of the aerial cable relatively to the bridge spanning.

In designing the suspension, two factors have had to be taken into account:

(1) The abnormal length of each span; viz., 105 metres (345 feet).

(2) The restriction which limits the extent of the dip permissible in the cable, on account of the very small amount of clearance which is given between the superstructure of passing vessels and the under side of the bridge girders. This clearance, at high tide levels, may be only

upper supporting strand attached to a lower suspension by clamps at the centre and by suitable tie rods placed at the quarter spans. The lower suspension strand thus holds the rings and cable in four catenaries over each span.

The separation between the upper and lower strands on the steel standards is 3 metres. The suspension was designed so as approximately to equalise the load imposed by the cable between the upper and lower strands.

Tension and stretch charts were plotted, and from these the initial sags were calculated for both strands dividing the load; also, graphs were prepared giving the initial and ultimate tensions over the desired range of temperatures,

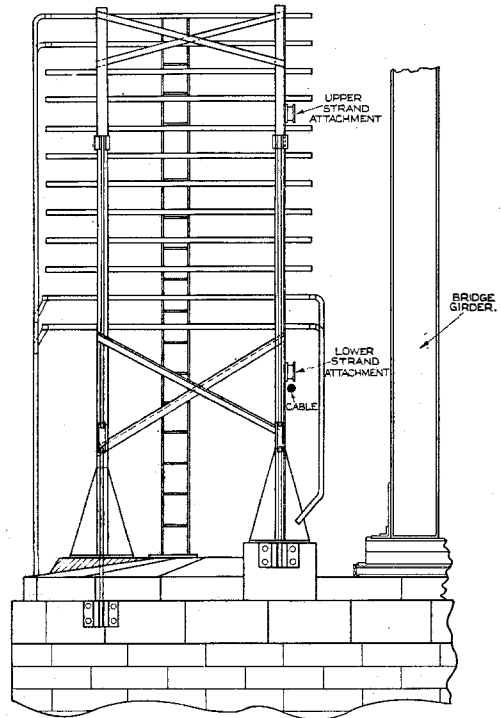
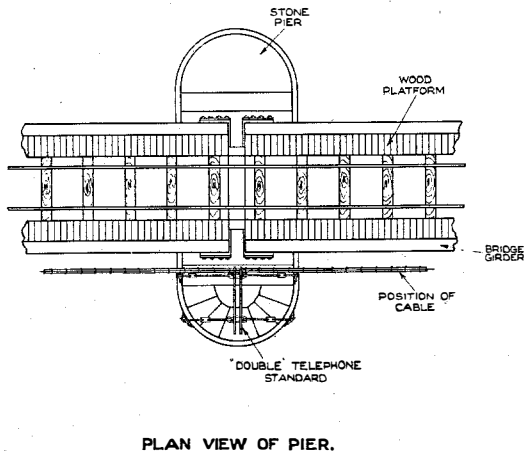
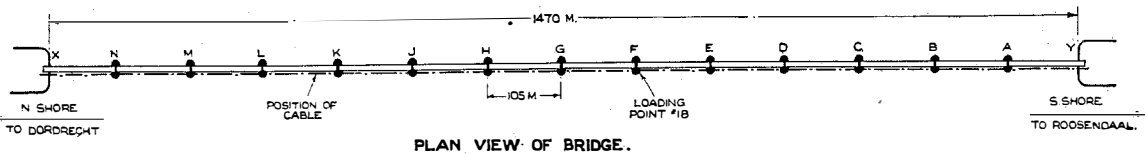

Figure 3—Plan of Bridge, showing piers, span lengths and position of aerial cable

based on a factor of safety of 2.5. Figures 4-A and 4-B indicate in graph form the tension and sags actually obtained on each of the strands.

It was decided to terminate the upper guy strand by means of a dead-end or make-off on each alternate standard. In order to obtain a satisfactory and secure type of fitting for the

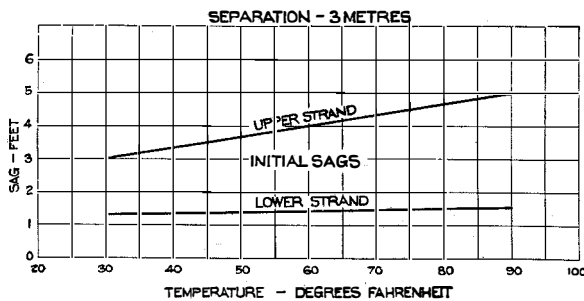

Figure 4-A—Sags—Upper and Lower Strands

purpose, a cast iron bollard having a drum diameter of 6 inches was designed. This was bolted to a 50 x 20 centimetre metal plate which was in turn attached to the angle-iron inner uprights of the standard by six bolts. Figure 5 illustrates this type of metal fitting and also shows the upper strand coming from either direction, terminated in each case with three guy clamps in the standard manner.

In the case of the intermediate through points, the attachment to the standard was made by means of a single cable-suspension clamp bolted to a smaller metal plate secured to the standard. This fitting is illustrated in Figure 9.

In the case of the lower strand, the number of through points was governed by the manufactured lengths which it was possible to obtain. Two lengths were erected each covering four spans with three intermediate attachments and

two dead ends, and two each covering three spans with two intermediate attachments.

The strand was run out by means of hooks attached to the bridge and was hauled to position by a winch, placed on one of the bridge

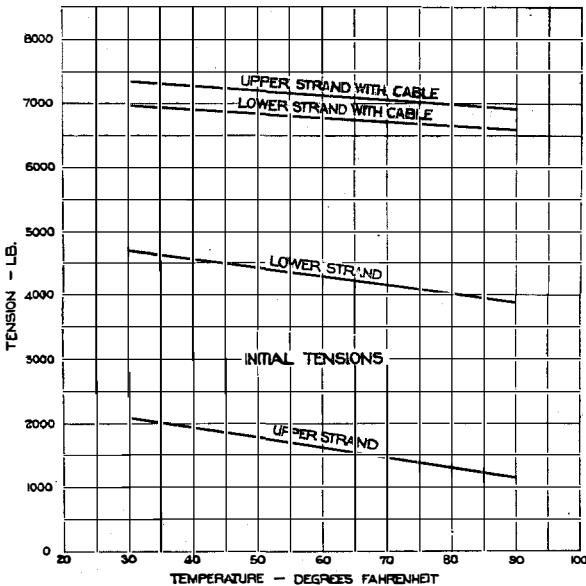

Figure 4-B—Tensions for Strands—With and Without the Cable Load

piers. It was drawn up to tension by a gang of five men with block and tackle. The sag desired for each span was sighted between the two standards by the aid of glasses, and when obtained the attachments were secured. The tension was then checked by oscillation tests.

The following are the particulars of the two strands respectively:

No. of Wires	Average Diameter Each Wire	No. of Spans	Length of Span	Mean Temp. When Erected (Degrees Fahr.)	Sag Allowed	Oscillations per Min.	Calculated Tension
(1) UPPER GUY STRAND							
7	0.142 ins. = (0.36 mm.)	14	344.5 ft. 105 metres	52	3 ft.-8 ins. = (1.118 M.)	32	1,850 lb. = (839 kg.)
(2) LOWER STRAND							
7	0.142 ins. = (0.36 mm.)	14	344.5 ft. 105 metres	48	1 ft.-3 ins. = (0.407 M.)	52	4,470 lb. = (2,028 kg.)

A laboratory test was made on a sample of the strand (16,000 lbs.). It showed a result of 8.82 tons (19,757 lbs.), an ultimate stress of 79.6 tons per square inch.

The upper and lower strands were drawn together at the centre of each span by means of a special tool, and held by means of four clamps. A temporary portable staging attached to the bridge girders was used for giving the workman a foothold. Afterwards the tie-rods were placed on the quarter spans. At this stage the position of the centre clamps was 175 centimetres below the points of suspension of the upper guy strand, the lower strand forming an arch with the centre 125 centimetres above its suspension points.

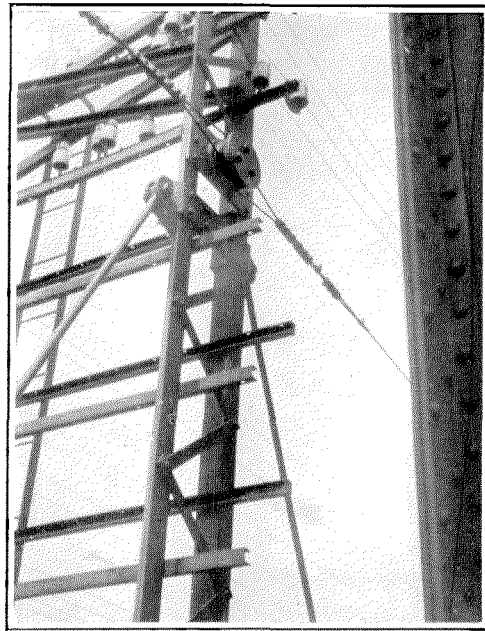

Figure 5—Telephone Standard on a Pier, showing cast iron bollard with upper strand terminated with three clamps on both spans

The placing of the rings and cable in position lowered the centre and tie rods to levels approximately in line with the points of suspension, the cable on each span remaining in the

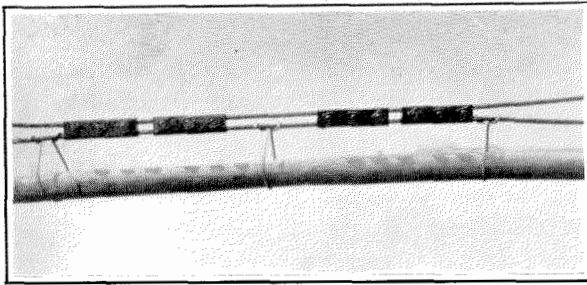

Figure 6—Centre Span Clamps

form of four catenaries 26.25 metres in length with sags approximating 30 centimetres.

It was possible to make oscillation tests on the first quarter of the upper guy strand after

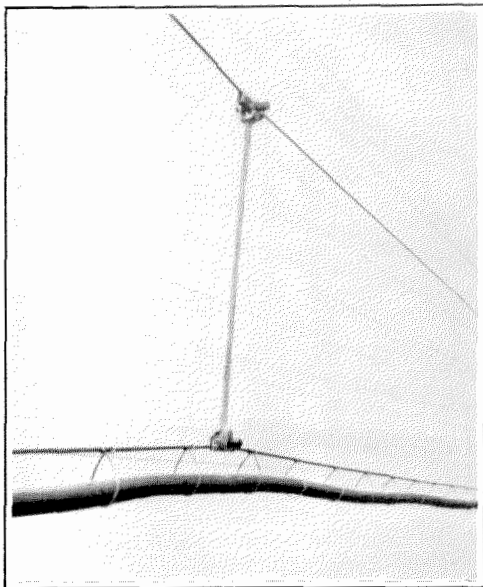

Figure 7—Quarter Span Tie Rod

the cable had been erected, as the weight of the cable was sufficient to prevent the oscillations from extending beyond the tie rod position. From the readings obtained the tensions were calculated and these agreed approximately with the previous calculations as shown in the graphs. The load on each quarter span of the lower suspension also was calculated. The results showed that the object of dividing the load approximately equally between the two spans had been achieved.

The cable was drawn out in nine lengths, with a splice at each alternate standard except

in the case of the loading point situated on Pier F.

The weight of the cable is approximately 7 lbs. (3.17 kg.) per foot, so that a load of about 21 hundredweights is borne on each span. Its diameter is 2.36 inches (60 mm.). A $3\frac{1}{2}$ inch

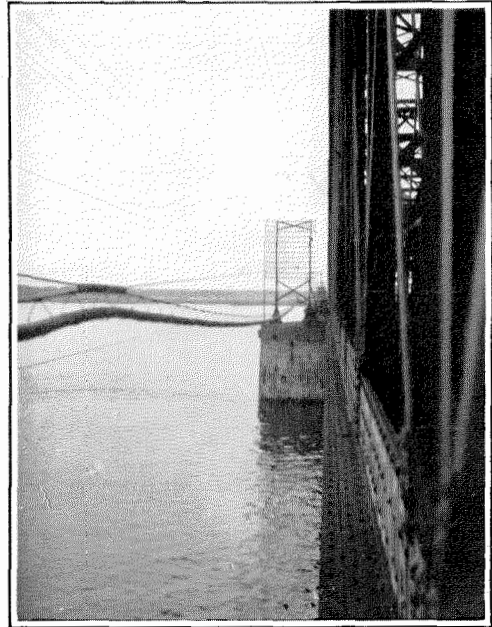

Figure 8—View of Cable from Centre of Span to Standard

(8.9 cm.) "Bonite" type of ring, spaced at 16 inches (40.65 cm.) was used.

Figures 6 and 7 show close views of the centre span attachment consisting of four 3-bolt clamps

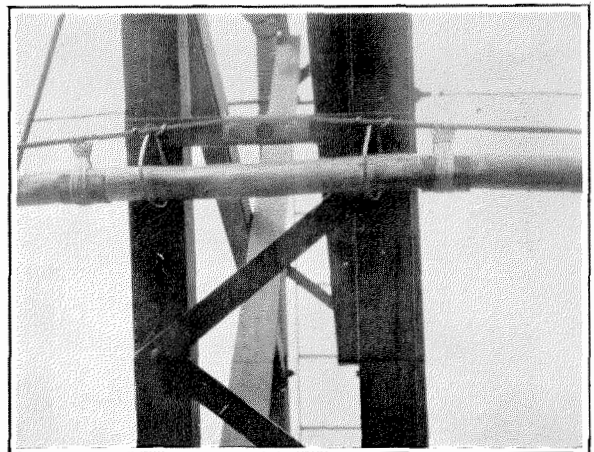

Figure 9—Cable Lifted from Rings by Wire Ties at a Through Strand Position

and the tie rod placed at the quarter span. Figure 8 is a view of the cable from the centre of the span to one of the standards.

Figure 9 depicts the cable carried through and lifted with ties at the point of attachment on one of the standards.

A cable joint on one of the piers is illustrated in Figure 10.

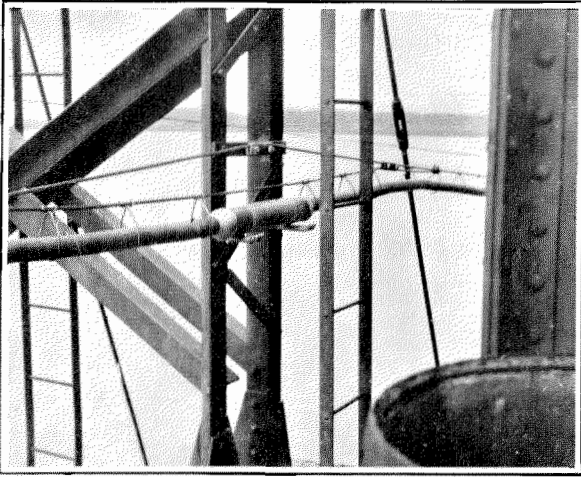

Figure 10—Cable Splice Resting on Brackets with the Cable Supported by an Auxiliary Strand

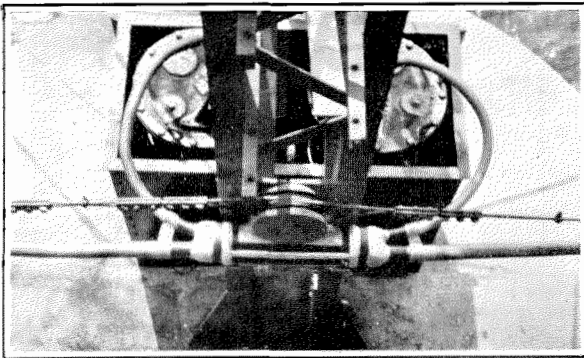

Figure 11—Loading Position, showing two loading coil pots placed in a metal tank and loading splice resting on brackets beneath a bollard holding the lower suspension strands

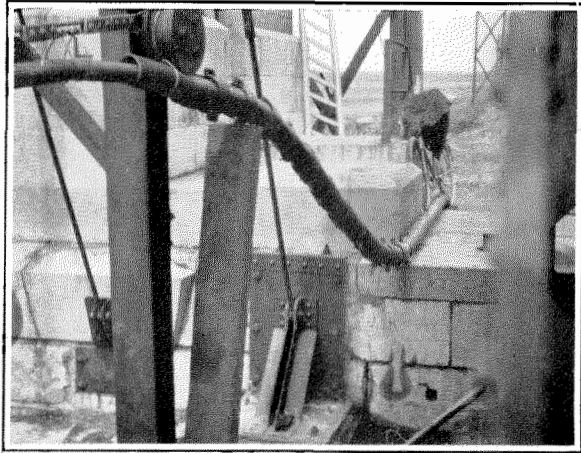

Figure 12—Method of Carrying the Cable Underground from the Shore Standard

A feature of interest is a loading point at one of the bridge piers, consisting of two pots of twenty-six and nineteen units, respectively. Figure 11 shows the loading pots in position.

The method of carrying the aerial cable from the shore standard to the ground and continuing it underground is illustrated in Figure 12. A short length of rubber hose was drawn over the cable extending from the standard to the ground, and a protective split flexible metal tubing was then placed over the hose. The section of cable laid underground is protected to the point where it is jointed to the armoured underground cable with Zores iron tubing.

During the period of installation, May and June of 1926, the day temperature varied between 40 degrees and 75 degrees Fahrenheit. Notwithstanding generally stormy weather and very severe conditions, the work was completed successfully. Installation was carried out by the Dutch Telegraph Administration with a gang of seven men. Testing, balancing and the loading of the cable was performed by Standard Telephones and Cables, Limited, London.

Train Despatching in Spain

By D. B. BAKER

Vice President, Standard Electrica S. A.

IN 1924, the last year for which the statistics are available, Spain had 15,473 kilometres of railway line, of which 11,684 kilometres was of standard broad gauge, 1.67 metres in width. Most of the lines of any length are standard broad gauge; the narrow gauge lines are almost in every case for local service only. Railway service in Spain is provided by ninety-three companies, made up of twenty-seven companies using standard broad gauge, and sixty-six companies using narrow gauge. Only a few of these companies are of more than local importance.

The most important lines are the Cia. de los Ferrocarriles de Madrid a Zaragoza y a Alicante (M.Z.A.),¹ Cia. de los Caminos de Hierro del Norte de Espana (Norte), Cia. de los Ferrocarriles Andaluces (Andalucian), Soc. de los Ferrocarriles de Madrid a Cáceres y a Portugal (M.C.P.).² These can be considered as representative of the railway business in Spain. Combined they constitute 80 per cent of broad gauge and 60.3 per cent of all broad and narrow gauge lines in existence in the country. The M.Z.A. have 3,663 kilometres, the Norte 3,581 kilometres, the Andalucian 1,307 kilometres and the M.C.P. (including the "Western" lines) 777 kilometres of broad gauge line. As regards traffic, in 1924 these four companies combined accounted for 86 per cent of passenger traffic over broad gauge lines and 51 per cent of all railway passenger traffic, 83.1 per cent of goods traffic over broad gauge lines and 61.2 per cent of all railway goods traffic.

During the last decade or so the Spanish railway traffic has considerably increased. This development is apparent from the curves (Figures 1 and 2) showing the increase of passenger traffic and goods traffic of the four principal railways of Spain. These figures are inclusive of 1924, the last year for which official figures are available. The passenger traffic of these four railways has grown steadily; it has been doubled since 1910, and in 1924 it was three times as great as in 1900. The M.Z.A. has

¹ Madrid—Zaragoza—Alicante.

² Madrid—Portugal.

doubled its passenger traffic during the last ten years and more than trebled it since 1900; the Norte Company has doubled its passenger traffic during the last fifteen years. These two companies account for 89 per cent of the total for the four leading companies.

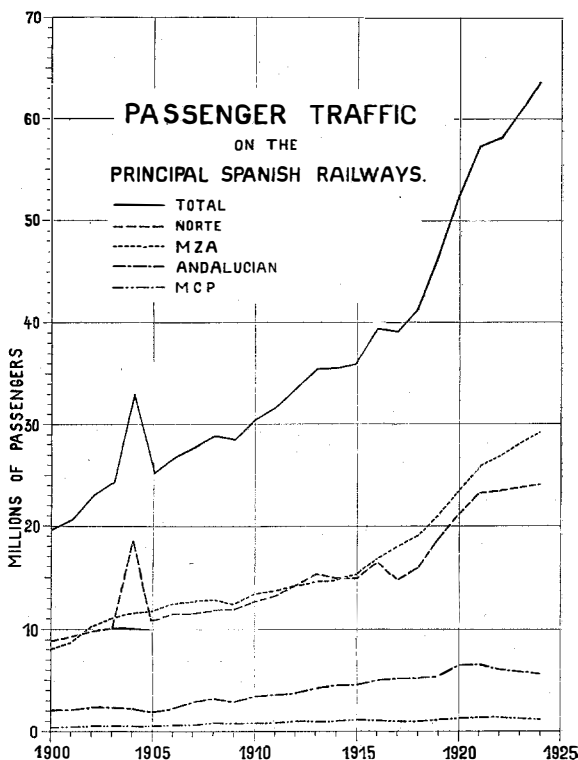

Figure 1—Passenger Traffic Chart

As regards goods traffic, the M.Z.A. and Norte again hold approximately equal positions. Combined they account for 87 per cent of the total of the four leading railways considered. The growth of goods traffic has been much slower than that of passenger traffic. During the last ten years goods traffic has increased only about 43 per cent; since 1900, it has doubled. Great fluctuation in goods traffic has taken place during the last ten or fifteen years, with three "boom" periods, 1912-13, 1916-19 and 1924, and two "slump" periods in 1914 and 1919. During the period of 1919-1922 the

M.Z.A. suffered more from economic depression than the Norte, and its goods traffic fell to about what it was in 1913. During the last two years it has fully recuperated, very considerable growth having taken place during this period.

The above figures show healthy and steady

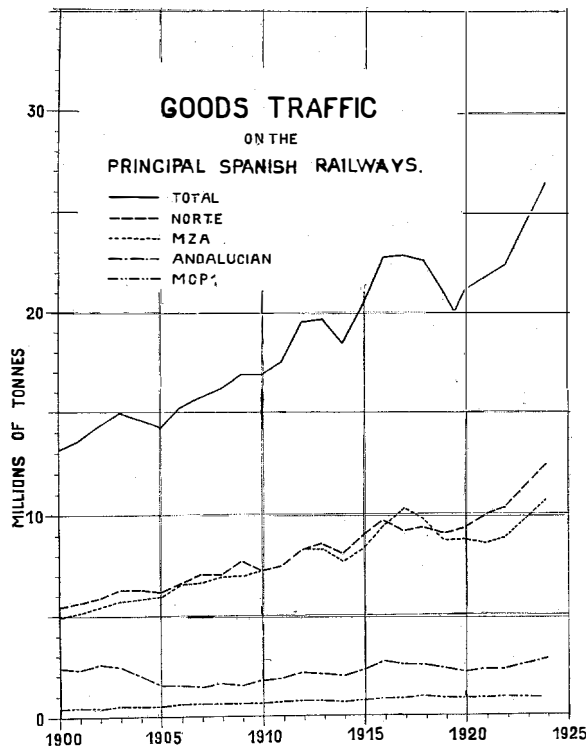

Figure 2—Goods Traffic Chart

growth of railway business, necessitating the extension and modernisation of the operating methods in several directions. The necessity for modernisation is fully appreciated by the General Railway Council (Consejo Superior de Ferrocarriles) as indicated by the radical programme of reconstruction and extension of the railway system that was put in force recently, and by the fact that P.300,000,000³ was voted for this work during 1926. Of this sum, P.130,000,000 was for rolling stock alone.

Some of the improvements necessary were undertaken by the railway companies long before this grand programme of reconstruction was thought of, and the most important among

³ P = peseta. About 28 pesetas are at present equivalent to £1.

these was the adoption by the leading railway companies of modern signaling systems.

Several years ago the railway companies found that the old fashioned telegraph signaling system was neither adequate nor efficient, nor was it satisfactory in its operation. The railway companies consequently investigated the various modern methods of signaling available. The outcome of this was that the Western Electric Train Despatching System was adopted by the two leading companies in Spain, the M.Z.A. and the Norte, and later also by the Ferrocarriles Catalanes, in preference to all other systems.

The verdict of the railway companies in favour of the Western Electric Train Despatching System was based on the fact that in their investigation they found that:

1. The Polarity System, a selective ringing system depending upon polarised and biased ringers for selection, did not allow of the inclusion of a sufficient number of stations.
2. The Harmonic System, a selective system with tuned reeds provided at each subset, each reed having a particular natural frequency, and signaling being effected by alternating currents of different frequencies, was too complicated, and required high technical training for the personnel.
3. The Selector System, a selective system in which the selectivity is obtained by some form of stepping mechanism—a definite number of direct current impulses of the same size being used for each station to be signaled—was untrustworthy inasmuch as the signals under certain line conditions did not arrive in proper form at the receiving station.
4. The Western Electric System using positive and negative impulses and condenser discharges to operate these selectors was more trustworthy and satisfactory in every way.

Fundamentally the Western Electric Train Despatching System is a selective-call omnibus telephone system, that is, all stations are connected parallel to a single pair of wires and the different stations are called by a series of positive and negative impulses which operate the

selector at the called station without interfering with any other station. The heart of this system is the selector, a simple piece of apparatus consisting of an electromechanically operated stepping device, which permits the calling of any station without affecting the remaining stations. The operation of these selectors is controlled by the impulses sent out by the sending key at the dispatcher office.

After the decision to adopt the Western Electric System was made, work of installation on the different lines was urged forward with considerable speed. The M.Z.A. Company ordered the first Train Despatching System in 1922 and in February, 1923, the system was in operation on certain important main lines. The Norte Company placed its first order for material in March, 1923.

The extent to which the Train Despatching System has been applied in Spain is apparent from the map, Figure 3. To the present mo-

ment the following systems have been installed or are being projected.

M. Z. A. Company
Installed

Madrid—Zaragoza	} 6 Dispatcher Stations 77 Way Stations
Madrid—Alicante and Cartagena	
Barcelona—Zaragoza	
Barcelona—Port Bou	
Barcelona—Tarragona	
Barcelona—Empalme	

In Process of Installation

Madrid—Sevilla	} 1 Dispatcher Station 16 Way Stations

Projected

Madrid—Badajoz	} 1 Dispatcher Station 19 Way Stations

Norte Company

Installed

Madrid—Medina	} 4 Dispatcher Stations 90 Way Stations
Madrid—Venta de Baños	
Venta de Baños—Leon	
Venta de Baños—Miranda	

Projected

Miranda—Irun
Miranda—Barcelona

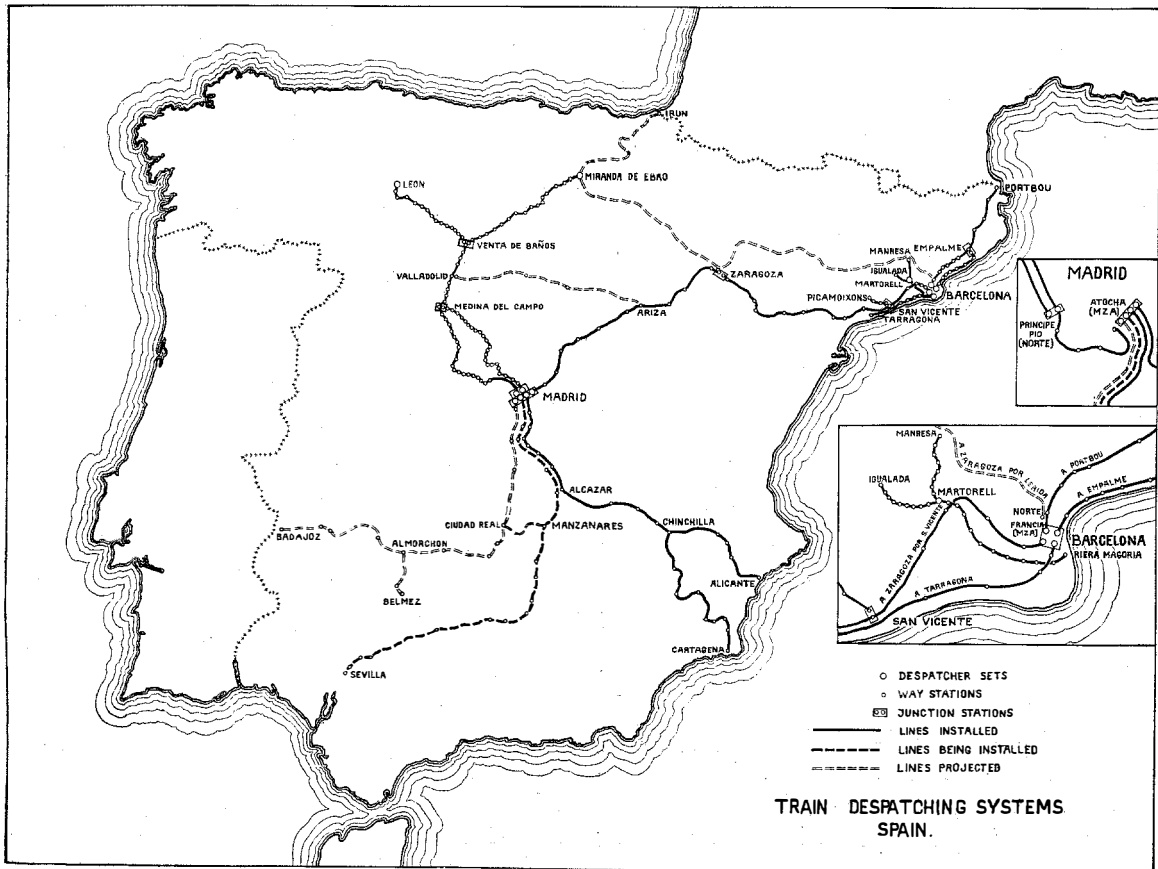

Figure 3—Train Despatching Map of Spain

F. C. Catalanes	
Installed	
Martorell—Barcelona	} 1 Despatcher Station, 28 Way Stations
Martorell—Manresa	
Martorell—Igualada	

The lengths of line equipped or to be furnished with Train Despatching Systems are as follows:

M. Z. A.	
Installed	1,641 Kilometres
In Process of Installation	574 Kilometres
Projected	830 Kilometres
Norte	
Installed	781 Kilometres
Projected	785 Kilometres
F. C. Catalanes	
Installed	102 Kilometres

The total length of line on which the Train Despatching System is at present in operation is 2,524 kilometres or 21.6 per cent of the total broad gauge railway in Spain; installed and in process of installation, 3,098 kilometres or 26.5 per cent; installed in process of installation and projected, 4,719 kilometres or 41 per cent.

The line from Madrid to Sevilla is at present being installed and the line from Madrid to the Portuguese Frontier is projected. The Norte Company also propose an extension from Miranda to Irun on the French Frontier and to Barcelona from Miranda via Zaragoza and Lerida.

In Spain, Train Despatching Systems are not used for controlling train traffic as for instance in the United States, but for information service. The Train Despatchers in Spain do not give orders to the Station Masters; they only give information and advice which the Station Master uses according to his best judgment. The Spanish Station Masters welcomed the Train Despatching System because by its means they have at their disposal the fullest and latest information about all traffic and other services and they can control and make up trains at their own stations with much greater facility and satisfaction. Perhaps the greatest assistance was in respect to the making up of goods trains.

In Spain also, way stations are not installed at every station, but only at the more important points, such as sorting, make-up, foot of incline and junction stations, locomotive sheds and inspection or control centres.

The experience of the Railway Companies already obtained, is such that they propose ultimately to extend the system of signaling to all their lines.

M. Z. A. Railway

The Train Despatching System as installed on the M.Z.A. Railway is shown in Figure 4. The first installations, as previously mentioned, were opened in February, 1923, and additional systems are being ordered from time to time, the policy of the Company being to install them on all their lines. A complete change-over from the old signaling system is not proposed, for the simple reason that such a radical change would dislocate the service and there would be no time to instruct the staff in the use of this new method of signaling.

On the M.Z.A. Railway, at present, three types of stations are used; namely, despatcher station, junction station and way station. The railway net is divided into several sections, each one of which is provided with a despatcher station and a certain number of way stations. End stations of each section are provided with the necessary apparatus to make them junction stations. These junction stations render possible the connection between the despatcher station and way stations of one section with those of another.

Some of the more important despatcher stations are provided with a cordless local battery switchboard by means of which different important officers and departments of the Railway Companies can be connected to the Despatching System. These cordless switchboards are at present installed at Barcelona and Madrid. They are provided with circuit facility for four train Despatching Systems and fifteen local lines, and a test line by means of which daily tests can be carried out. The microphone battery used is 6 volts.

Apart from the standard equipment there is also a considerable number of portable sets in use, chiefly by the permanent way staff.

The line construction is of the M.Z.A. standard open wire type employing hard drawn copper conductors varying from 2.5 to 4 millimetres in diameter.

Madrid—Sevilla Line	} 4 Millimetres
Madrid—Barcelona Line	

Madrid—Alicante.....	} 3½ Millimetres
Madrid—Cartagena.....	
Madrid—Badajoz.....	
Barcelona—Tarragona.....	} 3 Millimetres
Barcelona—Empalme (Mataro).....	
Barcelona—Port Bou.....	2½ Millimetres

Attenuation of these lines is within the permissible limit for this type of circuit. The line from Madrid to Port Bou, the longest, has a theoretical attenuation of $B=2$ or 17.4 TU under wet weather conditions.

The insulators used are of Spanish make and are of good quality. The open wire lines are transposed every 500 metres using rotating transposition in clockwise direction.

The method for taking the lines through the tunnels was carefully investigated. It was decided not to use open wire lines over the hills but to install cables. On the M.Z.A. railway on the section on which Train Despatching has been installed there are one hundred and sixty-two tunnels of a total length of 50 kilometres. In all these tunnels cables have been installed. The cable is air spaced paper insulation, armoured and lead covered. The characteristics of the cable are as follows:

3-pair cable, having 2 millimetre conductors, capacity 0.067 mfd. per kilometre, resistance 11.5 ohms per kilometre, insulation resistance 65,000 megohms per kilometre.

The cables are suspended from the walls of the tunnels and are connected to the aerial line by means of terminal boxes provided with protective apparatus (Figure 8). The protection of these cables was most carefully studied and that finally adopted is efficient and robust. The protective gear is placed at the mouth of

the tunnels so as to be easily accessible, and is designed to protect the cable against lightning, static charges and direct induction.

An inductance with closed magnetic circuit is connected on one side to the cable and on the other to the open wire line. On the line side a spark-gap lightning arrester is bridged to ground and adjusted so as to break down at 1,000 volts or half the voltage at which the cable is tested.

At 250 metres from the tunnel another inductance is placed in series with the line, each side being connected to earth through a spark-gap protector. The position of the inductance is arranged so that the frequency of the free oscillations of the circuit is sufficiently high to prevent the passage of the oscillations through the inductance.

The apparatus and the lines are carefully maintained and for this purpose definite rules have been laid down for routine testing. The tests prescribed are as follows:

1. The resistance and insulation of the lines are measured every day. Breaks, short circuits and earth are located in the usual manner using a Western Electric Testing Cabinet.
2. Every five days the main battery voltage and local battery voltages are read. This test is carried out when normal current is carried by the line. For each installation the initial voltage of the battery is determined according to the length of line. The local battery voltage must be approximately 10 volts and never less than 7½ volts. When accumulators are used, the minimum voltage is 9 volts.

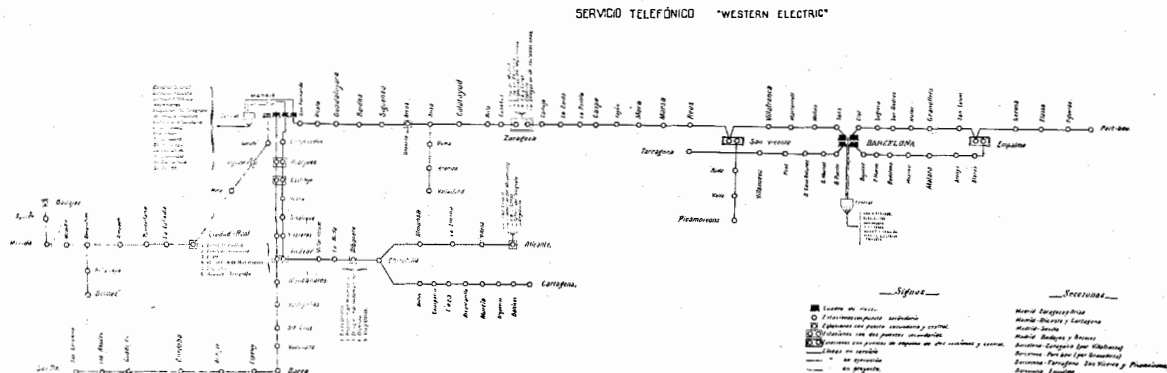

Figure 4—Train Despatching System, Madrid-Zaragoza-Alicante Railway (M.Z.A.)

3. Every month each calling key is tested to see that the duration of the positive impulses is the same as that of the negative impulses.
4. Every month all keys are tested to see whether the time taken to return to normal is correct. For 60-A keys this time is $7\frac{1}{2}$ to 8 seconds.
5. Before the installation is put in operation and every three months thereafter a general test is carried out. This consists in reducing the main battery voltage by 30 per cent and calling each station successively.

As regards the routine tests of the lines, actual limiting values are prescribed for each circuit.

The Barcelona Despatcher Station is the largest in existence in Spain. From the Barcelona Despatcher Station four systems radiate, namely:

- Barcelona—Zaragoza, via Villafranca
- Barcelona—Tarragona
- Barcelona—Port Bou, via Granollers
- Barcelona—Empalme, via Mataro

The equipment of this station consequently consists of four Despatcher Sets, one for each of the sections, and also a special cordless switchboard which connects certain important officers and departments of the Railway Company to the Train Despatching Systems. A general view of the Barcelona Despatcher Station is shown in Figure 5.

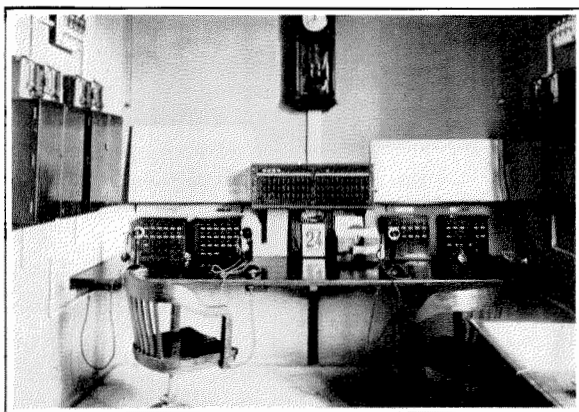

Figure 5—Barcelona Despatching Station, Madrid-Zaragoza-Alicante Railway

The Madrid Despatcher Station will have four Despatcher Sets. Of these, two are at present in operation; one is being installed; and the fourth will be added when the Madrid-Badajoz line is installed. The lines actually in operation are: Madrid-Zaragoza, Madrid-Alicante and Cartagena (Figure 4). At this station also there is the special cordless switchboard.

A way station which also serves as a junction station, is illustrated in Figure 6. An ordinary way station is illustrated in Figure 7.

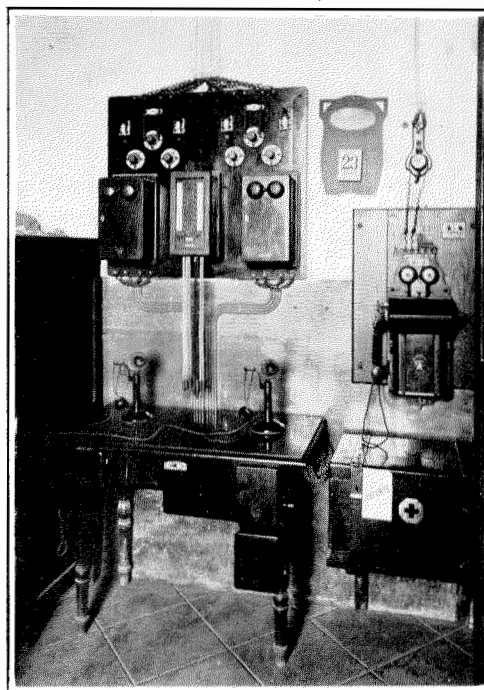

Figure 6—Junction Station, Madrid-Zaragoza-Alicante Railway

Norte Railway

The Norte Railway has had Train Despatching Systems installed for about three years and has found them most satisfactory and useful, so much so that at the present moment studies are in hand for the extension of the system from Miranda to Irun on the French Frontier, and to Barcelona via Zaragoza and Lerida. At Miranda, owing to the length of open wire line, which is of 3 millimetre hard drawn copper, and the number of way stations connected, the attenuation limit is very nearly reached. Consequently for this extension special studies have had to be undertaken.

The present installation of the Train Despatching System on the Norte Railway is indicated in Figure 9. A despatcher station is shown in Figure 10.

There are at present four sections installed: one from Madrid to Medina via Segovia, one

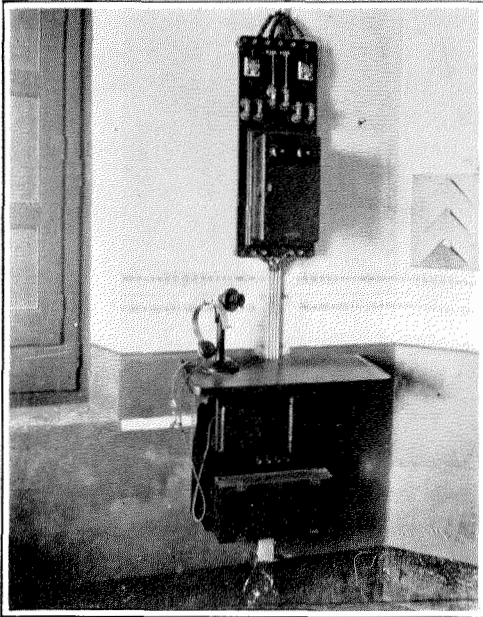

Figure 7—Way Station, Madrid-Zaragoza-Alicante Railway

from Madrid to Venta de Baños via Avila, one from Venta de Baños to Leon and another from Venta de Baños to Miranda.

Switches are provided at Madrid and Medina to connect the Venta de Baños line to Madrid via Segovia when the Avila line is out of order. Leon and Miranda are at present terminal stations and each have a Despatcher Set. The whole installation of the Norte Railway consists of four Despatcher Sets and ninety-one way stations.

At Venta de Baños there is a four line switchboard and a changeover switch. This station has three selectors—one each for the Madrid, Miranda and Leon lines—and by their means Madrid can be connected either to Miranda or Leon, or the Miranda and Leon lines can be interconnected.

The line construction is open wire of 3 millimetre hard drawn copper conductors, having a resistance of 2.5 ohms per kilometre. The line is transposed.

The maintenance of open wire lines is carefully organised and there are maintenance centres at the following places: Madrid, Villalba, Navalperal, Sanchidrián, Cercedilla, Neva de la Asunción, Medina, Valladolid, Venta de Baños, Quintana del Puente, Burgos, Pancorbo, Cisneros and Santos Martas.

The line men are required to report twice daily, once when they start out and once when they finish working. These reports are made to the Despatcher regardless of whether the lines are in perfect order or not. The line man also states his location so that in case of necessity he can be communicated with.

The apparatus maintenance is also very carefully organised and apparatus maintenance staffs are located at Madrid, Avila, Valladolid, Miranda and Leon. The maintenance men

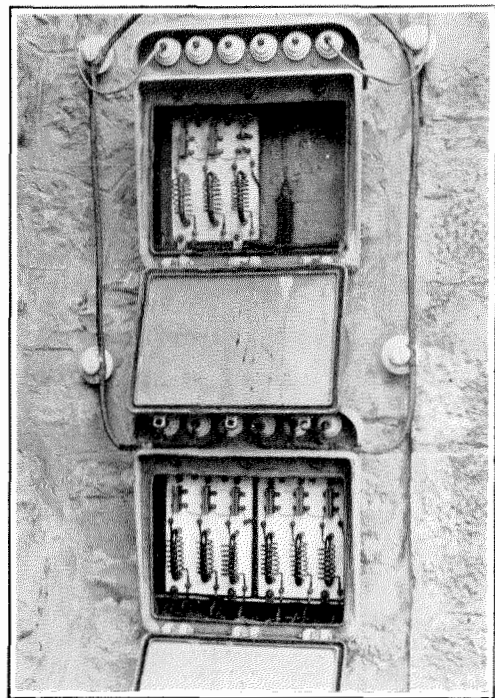

Figure 8—Cable Terminal and Protector Box, Madrid-Zaragoza-Alicante Railway

located at Madrid, Leon and Miranda, must visit the offices at least twice daily to see how the apparatus works, and when away from headquarters, they must always advise the Despatcher of their location so that they can be communicated with in case of emergency. When traveling they must look out for faults on the

open wire and give orders to the line men as to how the faults are to be located and rectified.

The maintenance of the selectors and other apparatus is carried out in accordance with special instructions. The Despatchers work in shifts of eight hours each, and each Despatcher has one telephone operator who is continuously listening-in on the line and who passes out orders as directed by the Despatcher. At Madrid, as there are two distinct lines going out, there are two telephone operators. At some stations, instead of headsets, loud speakers are used.

The Despatchers are under the orders of the Servicio Central de Explotacion (Operating De-

partment) and in case of emergency the Inspector Principal de Demarcaciones personally gives the necessary orders. The business of the Despatchers is to know all the traffic conditions of their corresponding sections so that the best possible traffic developments may be obtained. The Despatcher communicates with stations giving information, advice and warning, and the Station Masters then act on their best judgment. The Train Despatching System can be used also to transmit very urgent messages.

Normally, the circuits from Madrid, Leon and Miranda, terminate at Venta de Baños. If any Despatcher desires to communicate with a station beyond Venta de Baños, the operator

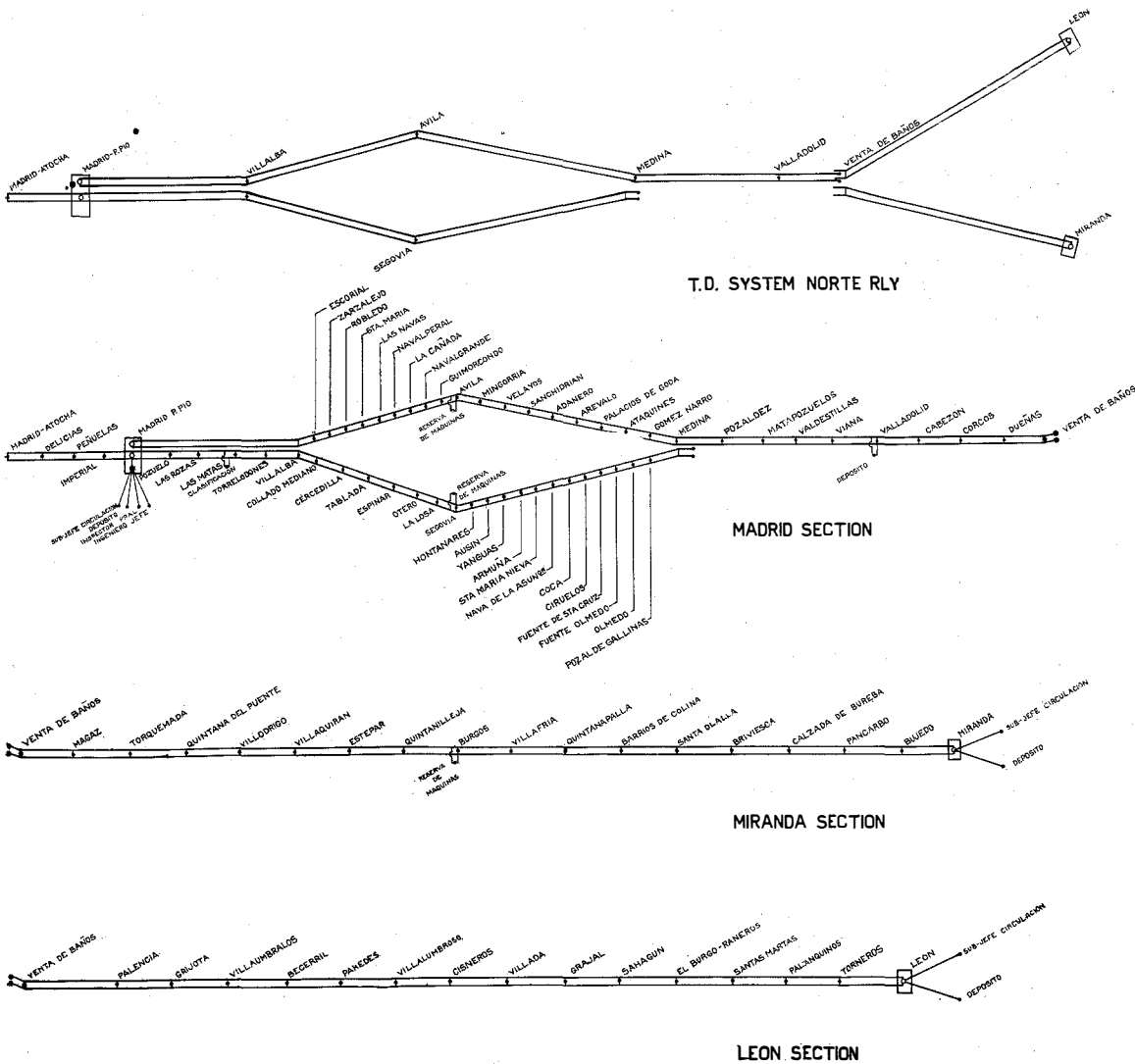

Figure 9—Train Despatching System, Norte Railway

at this latter place connects the circuit through so that the required station is in direct communication with either Madrid, Leon or Miranda as the case may be. As soon as the call is finished the operator at Venta de Baños disconnects the circuit.

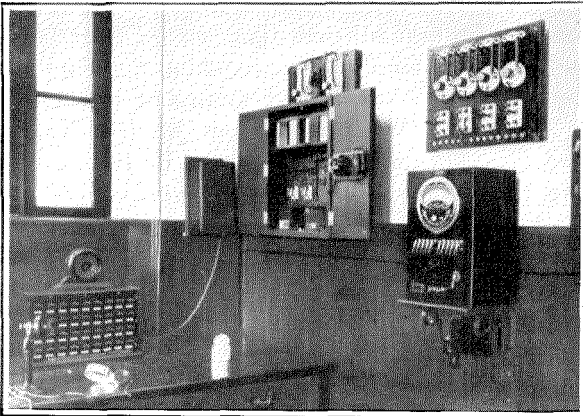

Figure 10—Dispatcher Station, Norte Railway, Madrid

The Train Dispatchers on the Norte Railway have to fill out different types of forms to record all movements and other information. The three most important forms used are Control of Train Movement, Locomotive Requirements and Goods Despatch. On the form of Control of Train Movement, entries are made of the arrival and departure of all trains at all stations of the section. The causes of delay are indicated on the back of the form. The forms for Locomotive Requirements are used to indicate the make-up of train, the number of trucks and tonnage and also the number of locomotives used to pull the train. In these entries are indicated also the goods yards where the trains

are made up and the foot of incline where additional locomotives are required.

Goods Despatch forms are used to indicate the number of wagons loaded and empty that are ready for despatch at 7 o'clock in the morning at the station indicated. All stations provided with Train Despatching telephones must report the arrival and departure of all trains to the Dispatcher.

Ferrocarriles Catalanes

This is a narrow gauge, one metre, railway, which provides service between Barcelona and Igualada and Manresa. It has one dispatcher station and twenty-eight way stations. In the dispatcher station of this railway a three-key box is installed by means of which one, two or all three of the lines arriving at the dispatcher station, Martorell, can be disconnected and switched to an extension bell so that continuous listening-in is not necessary. This extension bell is provided with a small central battery, and each way station is provided with a push button which when operated rings this bell, and advises the Dispatcher that a station is calling.

For further particulars of traffic control apparatus, including applications to train despatching and tramway service control, reference may be made to:

"Telephone Traffic Control for Tramways," "ELECTRICAL COMMUNICATION," Vol. 2, No. 2, October, 1923, p. 141.

"Telephone Train Control in the Argentine Republic," C. F. Bulstrode Whitlock, "ELECTRICAL COMMUNICATION," Vol. 4, No. 4, April, 1926, p. 253.

"Modern Methods in Train Dispatching," "ELECTRICAL COMMUNICATION," Vol. 3, No. 1, July, 1924, p. 57.

International Standard Electric Corporation

Head Offices

NEW YORK, U. S. A.

European General Offices

LONDON, ENGLAND

PARIS, FRANCE

Associated and Allied Companies

Standard Telephones and Cables, Limited *Aldwych, London, England*
Branches: Birmingham, Glasgow, Leeds, Manchester, Dublin,
Cairo, Johannesburg, Calcutta, Singapore.

Standard Telephones and Cables (Australasia), Ltd. *Sydney, Australia*
Branches: Melbourne, Wellington.

Bell Telephone Manufacturing Company *Antwerp, Belgium*
Branches: Berne, The Hague, Brussels.

Standard Electric Doms a Spolecnost *Prague, Czecho-Slovakia*

Standard Electrica, S. A. *Madrid, Spain*
Branch: Barcelona.

Standard Elettrica Italiana *Milan, Italy*
Branch: Rome.

Standard Electric Aktieselskap *Oslo, Norway*

Le Materiel Telephonique *Paris, France*

United Telephone and Telegraph Works, Ltd. *Vienna, Austria*
Branches: Riga, Tallinn (Reval).

Standard Electric Company W. Polsce *Warsaw, Poland*

United Incandescent Lamps and Electrical Company, Limited.
Budapest (Ujpest), Hungary

Compania Standard Electric Argentina *Buenos Aires, Argentina*

International Standard Electric Corporation, Branch Office.
Rio de Janeiro, Brazil

Nippon Electric Company, Limited *Tokyo, Japan*
Branches: Osaka, Dalny, Seoul, Taihoku.

Sumitomo Electric Wire & Cable Works, Limited *Osaka, Japan*

China Electric Company, Limited *Peking, China*
Branches: Shanghai, Tientsin.

Sales Offices and Agencies Throughout the World

To those interested in better communication the International Standard Electric Corporation and its Associated and Allied Companies offer the facilities of their consulting engineering departments to aid in the solution of problems in Telephony, Telegraphy and Radio.