

ELECTRICAL COMMUNICATION

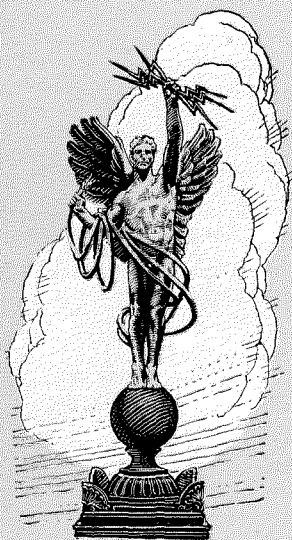

OCTOBER
1926

No. 2
VOL. 5

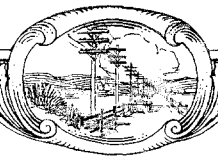

ELECTRICAL COMMUNICATION

A Journal of Progress in the
Telephone, Telegraph and Radio Art

EDITORIAL BOARD

J. L. McQuarrie F. Gill G. Deakin P. E. Erikson G. H. Nash
G. E. Pingree P. K. Condict W. E. Leigh E. A. Brofos E. C. Richardson F. A. Hubbard
H. T. Kohlhaas, Editor

Published Quarterly by the

International Standard Electric Corporation
Formerly
International Western Electric Company
INCORPORATED

Head Offices

41 BROAD STREET, NEW YORK, N. Y., U. S. A.

European General Offices

CONNAUGHT HOUSE, ALDWYCH, LONDON, W. C. 2, ENGLAND
75, AVENUE DES CHAMPS-ELYSEES, PARIS (8e), FRANCE

G. E. Pingree, President K. E. Stockton, Secretary H. B. Orde, Treasurer
Subscription \$1.50 per year; single copies 50 cents

Volume V

OCTOBER, 1926

Number 2

CONTENTS

PIONEERS OF ELECTRICAL COMMUNICATION—JAMES CLERK MAXWELL—I.....	73
<i>By Rollo Appleyard</i>	
THE MILAN BROADCASTING STATION.....	87
<i>By E. M. Deloraine</i>	
IN MEMORIAM—CHARLES E. SCRIBNER.....	97
TELEPHONE RECONSTRUCTION IN TOKYO AND YOKOHAMA..	99
<i>By Sannosuke Inada</i>	
THE PUBLIC ADDRESS SYSTEM IN LIVERPOOL CATHEDRAL..	111
<i>By Ashley F. Rickard</i>	
THE LONDON-GLASGOW TRUNK TELEPHONE CABLE AND ITS REPEATER STATIONS.....	119
<i>By A. B. Hart</i>	
NEW PROJECT FOR LONG DISTANCE CABLE SYSTEM IN ITALY.....	156

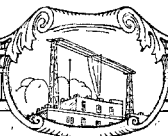

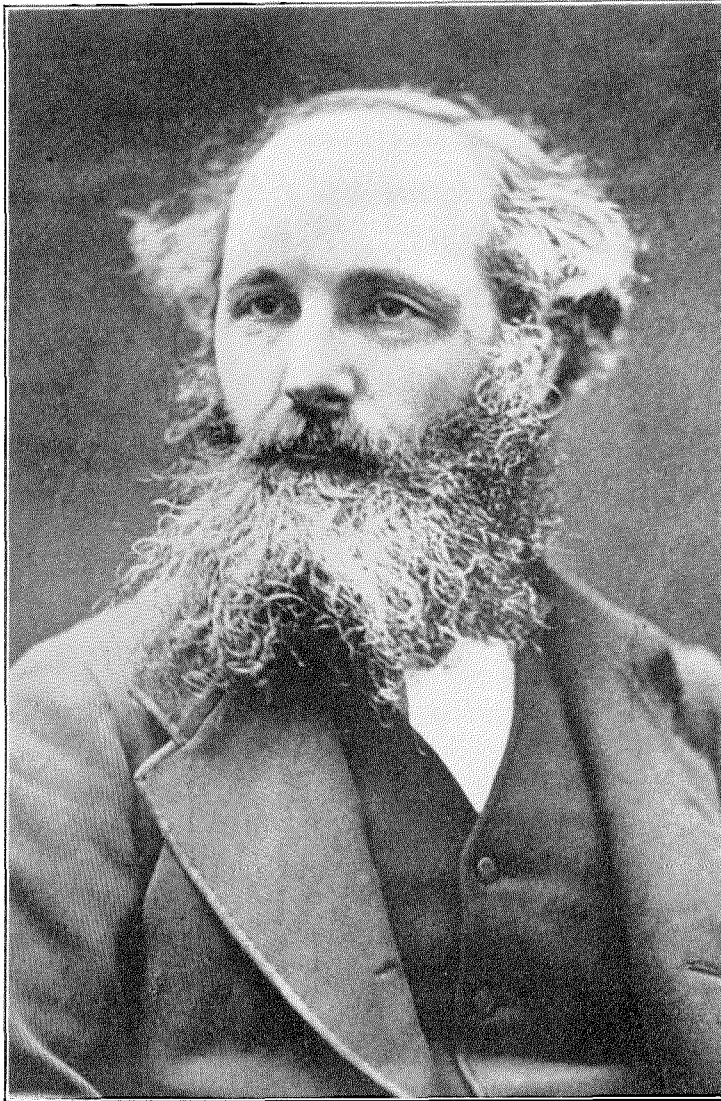

James Clerk Maxwell

Pioneers of Electrical Communication— JAMES CLERK MAXWELL—I

By ROLLO APPLEYARD

European Engineering Department, International Standard Electric Corporation

Editor's Note: This issue of "Electrical Communication" introduces a series of articles by Mr. Appleyard on "Pioneers of Electrical Communication". It is proposed to include in them biographical and other notes relating to men who have led the way to progress in the science and art of electrical communication throughout the world.

MACAULAY wrote of Newton that in no other mind have the demonstrative faculty and the inductive faculty co-existed in such supreme excellence and perfect harmony. Throughout the history of natural philosophy there is no name, except Newton's, more honoured by men of science than that of James Clerk Maxwell. It is difficult to compare the works of these two men, for Newton lived to 85, and Maxwell only to 48; yet they had much in common. To claim Maxwell as a pioneer of electrical communication is to direct attention to but a single field of activity in which his influence has hastened progress. Events, however, have proved it to be a field of sufficient scope to exemplify his labours in innumerable phases of research; for it was this territory among the mountaintops of electrical theory relating to transmission that Clerk Maxwell surveyed. When he had constructed paths across it, mapped it, illuminated it, and had placed at its salients landmarks for future explorers, he left it to us as an inheritance.

For the last sixty years his contributions to theory have been an inspiration to the physicist. They remain authoritative, and a never-failing source of enlightenment. At first, their mathematical character was a barrier rarely crossed by engineers; but with the advance of applied science, and with the steady movement of physical research from academical to industrial centres, mathematics in the electrical laboratory has become an open book, and Maxwell's influence is now everywhere manifest. Hence, the story of Clerk Maxwell can no longer be limited to biographical details of his parentage, childhood, under-graduate life, friendships, and

general career. An attempt must be made to indicate something of his work and influence, and to obtain a hint of the circumstances that produced in him those transcending qualities that have crowned his work with permanence and his name with immortality. With this in view, it is best to contemplate first the broad outline of his whole career and of his achievements, and then to select, from what is known concerning him, such details as may help to reveal something of his mode of thought, the secret of his thoroughness, and of his perceptive faculties relating to the physical interpretation of nature.

James Clerk Maxwell was born on June 13, 1831 at 14, India Street, Edinburgh. His father, John Clerk Maxwell, was of the family of the Clerks of Penicuik in Midlothian. His mother was the daughter of R. H. Cay, of Charlton, Northumberland. In addition to the usual characteristics of parents, his father took "persistent-interest in all useful processes", and he inculcated upon his son the doctrine of knowing how things are done and how they work. Their home Glenlair, was a country house and estate of modest dimensions, by the pleasant water of Urr, about a day's journey, at that time, from Edinburgh. In 1841 James was sent to Edinburgh Academy, where his schoolfellows, with the humour that makes Scotland what it is, nicknamed him "Dafty". His reply to them was to take the first place in English, the prize for English verse, and the Mathematical Medal. At the age of 14 he made his first contribution to science in the form of a paper "on the description of Oval Curves and those having a plurality of Foci". This was ultimately printed, with remarks by Professor J. D. Forbes, in the Proceedings of the Royal Society of Edinburgh, for April, 1846. At 15, Clerk Maxwell, with enthusiasm derived largely from Forbes, was giving attention to chemistry, magnetism, and the polarisation of light; and what was of equal

importance, he was discussing these and kindred matters with his school-fellow Peter Guthrie Tait. At 16 he entered the University of Edinburgh, where he remained for three Sessions. There he attended the Logic Class of Sir William Hamilton, the founder of Quaternions, who developed his speculative faculties. Meanwhile he absorbed mathematics, and all that he could find in relation to mechanics, optics, and the theory of heat. In October, 1850, he went up to Cambridge, taking with him, be it observed, his scraps of gelatine, gutta-percha, unannealed glass, his bits of magnetised steel, and other portions of matter dear to his peripatetic mind.

At Cambridge, he soon migrated from Peterhouse College to Trinity College. Adam Sedgwick (1785-1873) the renowned geologist was then at Trinity. Sir George Gabriel Stokes (1819-1903) mathematician and physicist, was at Pembroke. Stokes had, in the years 1845-1850, published important memoirs on the motion of viscous fluids, and he had investigated "with dynamical implications" Newton's coloured rings, diffraction, polarisation, and the propagation of disturbances from vibrating centres. Clerk Maxwell attended Stokes' lectures, and they became intimate friends. In the words of Sir Joseph Larmor, in a biography of Stokes, the way was thus prepared for Clerk Maxwell's interpretation of Faraday, and for the modern wide expansion of ideas.

In the mathematical contest at Cambridge in January, 1854, Routh of Peterhouse appeared as Senior Wrangler and as Smith's Prizeman. Clerk Maxwell was Second Wrangler and was bracketted with Routh for Smith's Prize. When the stress of examinations was over, his attention at once reverted to optics and to the study of matter and dynamics. A year later, in a letter to his father, he wrote "I am reading Electricity and working at Fluid Motion". It was in October of that year that he gained his fellowship at Trinity. Soon afterwards he was appointed lecturer there in Hydrostatics and Optics. It is characteristic of him that, notwithstanding his advances, he regarded it desirable still to attend the lectures of Professor Willis on Mechanics. He was considering also the transformation of surfaces by bending, the quantitative measure-

ment of mixtures of colours, and the cause of colour blindness. Meanwhile he was coordinating his ideas relating to Faraday's Lines of Force. Then, as subsequently, his procedure was from clear notion to clear notion—symbols and equations were merely secondary aids to thought.

Clerk Maxwell entertained a dread that he might "crystallise" at Cambridge. Against this he took two precautions: in 1856 he accepted the professorship of Natural Philosophy at Marischal College, Aberdeen, and in June, 1858, he married Katherine Mary Dewar. She was the daughter of the Principal of that College. He remained at Aberdeen until 1860, when he became professor of Physics at King's College, London. In 1865 as the result of illness, he withdrew to Glenlair, where he remained, except during short intervals, until February, 1871, when he was appointed to the Chair of Experimental Physics at Cambridge University. It is to be observed that his residence in London brought him into close fellowship with Faraday, and that his subsequent retirement to Glenlair gave him the opportunity to prepare the manuscript for his great work "Electricity and Magnetism". It has also to be remembered that between the years 1851 and 1865 great advances had been made in submarine telegraphy, bringing with them innumerable problems and a wealth of data for Clerk Maxwell to interpret.

Clerk Maxwell's ideas were established primarily upon Newton, with regard to work, energy, and acceleration as applied to systems of bodies. Davy, Rumford, and Joule had disposed of the doctrine that work spent in friction was necessarily lost; they had proved that it could be transformed equivalently into other forms of energy. These principles were extended by Clausius, Helmholtz, Mayer, Rankine, and Kelvin. "Perpetual Motion" had been discarded, and observation, experiment, and measurement had come into their own. But Clerk Maxwell's mission was not merely to interpret by equations and quantitative tests the soundness or otherwise of this or that guess at the answer to the riddle of the universe. His purpose was the elucidation of matter, motion, and electricity. He pointed out that many problems in nature, especially

those in which the dissipation of energy comes into play, are not capable of solution by the principles of thermo-dynamics alone, but that in order to understand them "we are obliged to form some more definite theory of the constitution of bodies". When seeking to explain structure, he admitted the difficulty of accounting for the identity in the properties of a multitude of bodies, each unchangeable in magnitude, and some separated from others by distances that astronomy attempts in vain to measure; but he agreed that "the idea of the existence of unnumbered individual things, all alike and all unchangeable, is one which cannot enter the human mind and remain without fruit".

Referring in an early paper to Kelvin's theory of vortex atoms, he asked: "What if these molecules, indestructible as they are, turn out to be not substances but mere affections of some other substance?" The truth is that although the principle of the Conservation of Energy had opened the way to a rational hypothesis concerning the constitution of matter, the proposals of W. Weber (Poggendorff's *Annalen*, Vol. 73, 1848) concerning the nature of electricity had led to a condition of stimulating perplexity.

Clerk Maxwell (Transactions of the Cambridge Philosophical Society, Vol. X, Part I, 1855) decided neither to be drawn aside by analytical subtleties, nor to be carried beyond the truth by any alluring hypothesis, but steadily to plod along the road of Faraday's experiments, and in particular to study Faraday's lines of force. He hoped at least to find a temporary theory that should guide other experimentors "without impeding the progress of the true theory when it appears". Then as now, more was known concerning the laws that appertain to matter, motion, and energy, than about the constitution of the stuff that seems to be everything and that may be nothing.

It is helpful at this stage to realize how completely he recognized the two-fold character of the task that is set before the man of science in the realm of physics. Let us not confuse here the issue by attempting to distinguish between mathematicians, physicists, chemists, or logicians. He saw that "the work of mathematicians is of two kinds, one is counting,

the other is thinking. Now these two operations help each other very much, but in a great many investigations the counting is such long and hard work that the mathematician girds himself to it as though he had contracted a heavy job, and thinks no more that day". He regarded thinking as "a nobler though more expensive occupation" than counting.

As an undergraduate he had described Cambridge mathematics as rather elementary. Later (1872) his opinion was:

"...Algebra is very far from O.K. after some centuries, differential calculus is in a mess, and is equivocal at Cambridge with respect to sign. We put down everything, payments, debts, receipts, cash credits, in a row or column, and trust to good sense in totting it up....I am going to try to sow quaternion seed at Cambridge....May one plough with an ox and an ass together?"

His chief complaint was against "insufficient interpretation—letting your equations lead you by the nose". To his mind the physical universe was to be interpreted not in directionless symbols that denote mere quantities, inert and dead, but in vector terms that allow any defined material system to be thought about in respect to the relative positions of its parts, the directions of their velocities, the stresses between the parts, and generally in terms that aid in representing the eternal conspiracy between change of configuration, matter, and motion, appertaining to defined material systems. "What", he asked, "is the most general specification of a material system consistent with the condition that the motions of those parts of the system which we can observe are what we find them to be?" For many purposes of physical reasoning he thought it desirable to fix the mind at once on a point of space instead of upon its three coordinates, and on the magnitude and direction of a force instead of on its three components. He gave full credit to Lagrange, to Hamilton, to Kelvin, and to Tait for their pioneer work in establishing appropriate dynamical concepts. It was to the task of arriving at logical consequences in general terms that he applied his penetrative and creative genius. He also developed strongly what was described by Tait as "the habit of

constructing a mental representation of every problem". He thought of realities.

Of his many triumphs, probably the chief was the publication of his account of his *Dynamical Theory of the Electromagnetic Field* (Royal Society Transactions, Vol. CLV, Received October 27, 1864. Read December 8, 1864.) By that time, he seems to have discarded the hypothesis of molecular vortices. He applied the principle of energy to investigate the properties of the medium. He supposed statical electricity, electromagnetic attractions, the induction of currents, and diamagnetic phenomena, to be produced by actions which go on in the surrounding medium as well as within the excited bodies, and he explained the action between distant bodies without assuming the existence of forces capable of acting directly at sensible distances. It was a medium through which light and heat could be transmitted, it could store the energy of motion, it could also store the energy of elastic resilience, it possessed inertia, and through it waves could be propagated.

He then applied his equations to the case of a magnetic disturbance propagated through a non-conducting field, and he showed that the only disturbances that can be so propagated are those which are transverse to the direction of propagation, and that the velocity of propagation is the velocity found by experiment to express the number of electrostatic units of electricity in one electromagnetic unit. He proceeded:

"This velocity is so nearly that of light, that it seems we have strong reason to conclude that light itself—including radiant-heat, and other radiations if any—is an electromagnetic disturbance in the form of waves propagated through the electromagnetic field according to electromagnetic laws. If the same character of the elasticity is retained in dense transparent bodies, it appears that the square of the index of refraction is equal to the product of the specific dielectric capacity and the specific magnetic capacity."

Thus by contemplating the electromagnetic field, and by accepting Ohm's law as a cardinal principle, he established the electro-

magnetic theory of light, and deduced all the known laws of electricity and magnetism.

The importance of defining the term "resistance" was fully appreciated by him. The verification of Ohm's Law for metallic conductors by Chrystal (British Association Report 1866, page 36), was a further necessary step in the advance.

Maxwell wrote:

"There are no landmarks in space; one portion of space is exactly like every other portion, so that we cannot tell where we are. We are, as it were, on an unruffled sea, without stars, compass, soundings, wind, or tide, and we cannot tell in what direction we are going. We have no log which we can cast out to take a dead reckoning by; we may compute our rate of motion with respect to the neighbouring bodies, but we do not know how these bodies may be moving in space. . . . Energy cannot exist except in connection with Matter."

The greatness of Maxwell consists therefore in this, that out of confusion he made order, out of conjecture he moved towards certainty; and having developed at last a helpful theory, he demonstrated its validity by establishing from it the relationship between electricity, magnetism, and light. He may be said to have founded a dynasty of natural philosophy following that of Newton and succeeded by that of modern physics. To judge of his significance, he must be placed in that long dynastic line, a central figure of a mighty group, and his influence must be sought along the two roads, Before and After, that lead respectively to and from his achievements.

Before, came Tycho Brahe the observer, John Kepler and Galileo the coordinators, and Newton who associated matter and motion with time, distance, velocity, acceleration, mass, and force, in quantitative terms. In those happy days the fixed stars were at rest in a frame of adamant that was rigidly bolted down upon the concrete of eternity. Any point upon that frame could be selected as a datum of time and space for a rotating mechanical system of bodies. This frame served for Newton and it served for Maxwell, with reservations. Huygens was content with it, and so

perhaps was Young when, in 1801, he revived the wave-theory of light. For these last, the frame was filled with aether, a type of matter that could undulate and that obeyed Newtonian laws. Except for its undulations, this aether was at rest in the motionless frame.

Clerk Maxwell's aether was not merely "luminiferous". He had to show in what manner stresses within it could produce electric and magnetic effects. On this account, he realized that in establishing a theory of electricity and magnetism he had to deal with internal relations more complex than those of any other science examined up to his time. His method of attack was to scrutinize all the known phenomena, to examine how they could be subjected to measurement, to trace the mathematical relationships of the quantities measured, to compare the mathematical forms with those of dynamics, to deduce the most general conclusions possible from the data, and to apply the results to simple cases. He began with Faraday's researches because Faraday had seen lines of force where mathematicians had seen centres of force acting at a distance, because Faraday had seen a medium where they had seen nothing but space, because Faraday had sought the seat of the phenomena in that medium, while they were content when they had found it in a power of action at a distance impressed on electric fluids, because Faraday had begun with the whole and had arrived at the parts by analysis, while they had begun with the parts and had endeavoured to build up the whole by synthesis.

Electricity was admitted by Clerk Maxwell to the rank of a physical quantity, but he warned us that we must not too hastily assume it to be a substance, or to be a form of energy. All that he would regard as having been proved was that electricity could not be created or annihilated. In his theory, an electrified system was said to have a certain amount of energy, which could be calculated by multiplying the quantity of electricity in each of its parts by the "potential" of that part, and taking half the sum of such products. The resultant intensity at any given point of the medium surrounding a given point-charge of electricity was proportional to the charge divided by the square of the distance between

the given point and the charge. This resultant intensity was accompanied by a "displacement of electricity" in a direction say outwards from the charge. The term "displacement" has occasionally led to misapprehension. It must be remembered that he was concerned with the language of Faraday who adopted lines of force where Clerk Maxwell would have preferred lines of induction. The whole phenomenon of attraction or repulsion between two electrified bodies, when both bodies are contemplated, he called stress—a transference of momentum from one body to another. With him the mechanical action between two charged bodies is a stress, and that on one of them is a force. The force on the point-charge is proportional to the charge.

To exemplify his method of presenting profound truths in plain language, it suffices to recall his statement of the four theorems:

- I. If a closed curve be drawn embracing an electric current, then the integral of the magnetic intensity taken round the closed curve is equal to the current multiplied by 4π .
- II. If a conducting circuit embraces a number of lines of magnetic force, and if from any cause whatever the number of these lines is diminished, an electromotive force will act round the circuit the total amount of which will be equal to the decrement of the number of lines of magnetic force in unit time.
- III. When a dielectric is acted on by an electromotive force, it experiences what may be called electric polarisation. If the direction of the electromotive force is called positive and if we suppose the dielectric bounded by the conductor is A on the negative and B on the positive side, then the surface of the conductor A is positively electrified and that of B negatively.
- IV. When the electric displacement increases or diminishes, the effect is equivalent to that of an electric current in the positive or negative direction.

To him the aether was more real than matter. Stresses within it produced electric and magnetic forces. Vibrations were propagated across it as light. Speculation found scope in discerning how matter could pass through



Figure 1—James Clerk Maxwell. Marble Bust by Boehm

it, and in explaining such phenomena as stellar aberration. Arago cast doubt upon some of the properties ascribed to it. The “dragging coefficient” introduced by Fresnel did not work out quite as expected, and there was a general appeal for further experiments to account for the discrepancy.

Clerk Maxwell had not applied his theory to moving media. After him, therefore, Hertz took the equations and modified them to the required conditions. Fresnel’s “dragging coefficient”, however, still caused misgivings. Thereupon Lorentz introduced into the modified equations a fictitious variable called “the proper time”, to take account of the motion of the earth with respect to the aether. Einstein interpreted this variable, and thus brought Clerk Maxwell’s equations into conformity with later theory. Concerning the accuracy and the interpretation of the tests upon which the validity of this later theory depend, judgment may properly be suspended, but concern-

ing the basic soundness of Clerk Maxwell’s equations there is common agreement.

The cause of the stability of Clerk Maxwell’s work, here indicated, may be traced to the care he took to extend his results always to the most general case he could imagine. He taught us to conceive the energy of a material system as determined by the configuration and motion of that system, and to generalize our ideas of configuration, motion, and force “to the utmost extent warranted by physical conditions”. He advised us “to become acquainted with these fundamental ideas, to examine them under all their aspects, and habitually to guide the current of thought along the channels of strict dynamical reasoning”. Many have found the task difficult—so much easier is it to learn from a particular case than from one more general. It is for this reason that certain parts of Clerk Maxwell’s writings constitute such hard reading for students at an elementary stage, and such delightful reading for investigators to return to when they have schooled themselves in mathematics and dynamics. It is for this reason also that the physicists of today, in search of inspiration, resort to the writings of Clerk Maxwell many times more often than to the writings of his contemporaries in the domain of natural science.

Our heritage from Clerk Maxwell is rich in ideas comprising notions of space and time, matter and motion, aether and light, electricity and magnetism. Of his own equipment, apparatus, and instruments, there are comparatively few relics. Thanks to Sir Ernest Rutherford, however, it has been possible to examine some of these treasures of the Cavendish Laboratory and to illustrate them.

Here let it be observed that Maxwell was of middle height, and strong of frame. He was possessed of dark eyes, jet black hair and beard, and in complexion he was somewhat pale. His mirth was real, but never boisterous—he was never fretful, never irascible. In disposition he was genial and patient, and he had great power of concentration even amidst distractions. He had considerable knowledge and discrimination in literature, he was a rapid reader, and he had a retentive memory. He loved his dog, his horse, his friends—such are the characteristics and such the virtues recorded of him.

The portrait in the frontispiece is copied from a photograph now on the staircase of the Cavendish Laboratory. At the Cavendish Laboratory also is the marble bust (Figure 1) by Sir J. E. Boehm, R. A. This bears on the reverse side the inscription:

“ $\frac{dp}{dt}$
Boehm Fecit
1879.”

The crypthonym $\frac{dp}{dt}$ was occasionally used by Maxwell as a substitute for his initials “J. C. M.” Writing J for Joule’s Equivalent, C for Carnot’s

Function, and M for the rate at which heat must be supplied per unit increase of volume at constant temperature, $\frac{dp}{dt} = JCM$ becomes a statement of the Second Law of Thermo-

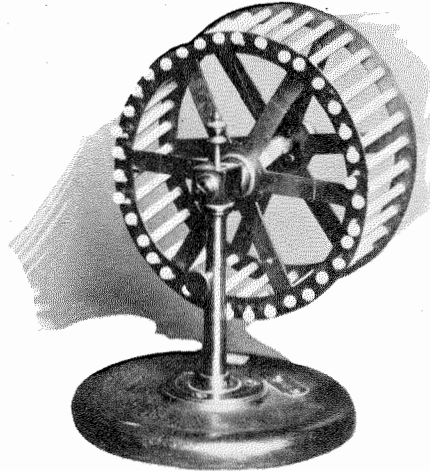

Figure 3—Clerk Maxwell’s Model of Saturn’s Rings

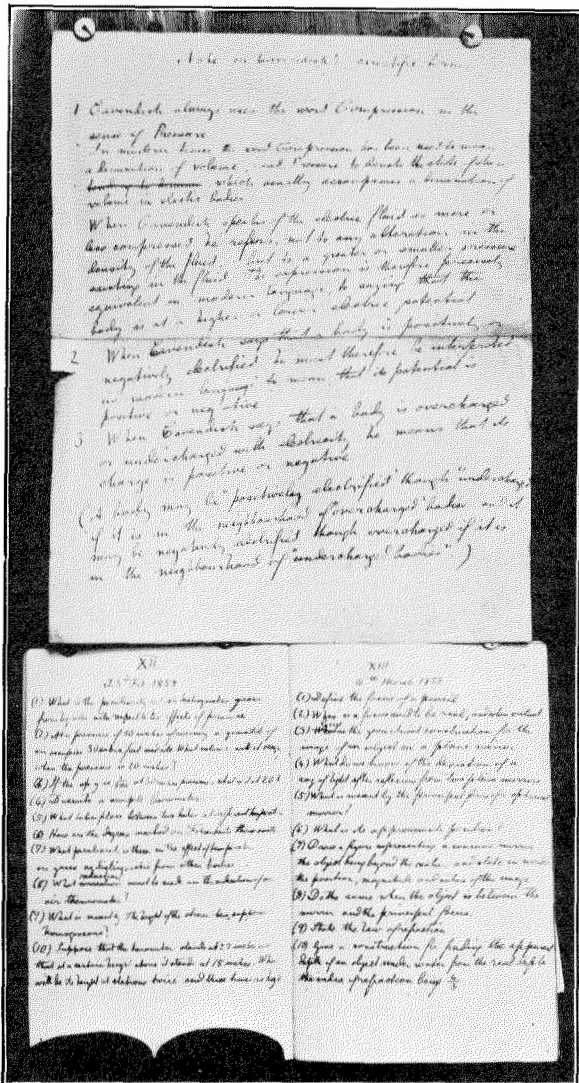

Figure 2—Handwriting of Clerk Maxwell

dynamics. Figure 2 is an example of the handwriting of Clerk Maxwell. The lower pages are from examination-questions set by him in 1858. The upper page is from his notes on Cavendish and was probably written about the year 1870.

In 1857 the examiners for the Adams Prize Essay chose for their subject “The Stability of Saturn’s Rings.” It could be supposed that the rings were rigid, or fluid and in part aeriform, or that they consisted of masses not materially coherent. Maxwell worked very hard at this problem. He found that the only system that could exist is one composed of an indefinite number of unconnected particles—“a flight of brick-bats” as he afterwards termed them. His essay secured the prize, and at once placed him in the first rank of men of science. To exhibit the movements of the satellites he designed a model (Figure 3) (Scientific Papers Vol. 1., pp. 286–376). He described this model to a friend as “two wheels turning on parallel parts of a cranked axle; thirty-six little cranks of same length between corresponding points of the circumference; each carries a little ivory satellite;” these satellites are made to go through the motions

belonging to a series of waves. This description corresponds to the model in the Cavendish Laboratory. The ring can either be rotated as a whole about the central axis, or the central axis can be locked by inserting a pin, in which case the back brass circle rotates in its own plane about an axis eccentric to the

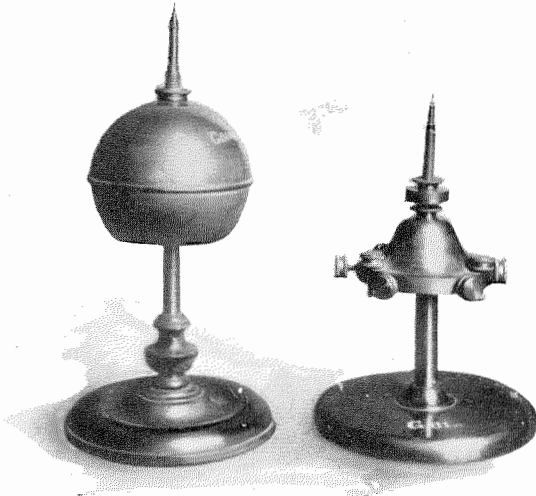

Figure 4—Clerk Maxwell's Dynamical Tops. The Larger Top is of Wood, the Smaller is of Brass

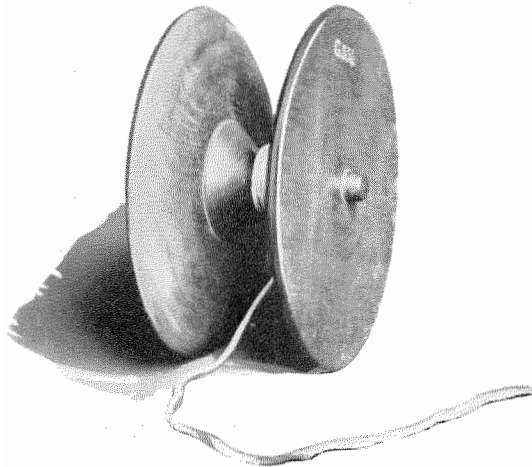

Figure 5—Clerk Maxwell's "Spinning Wheel"—Diabolo Pattern

front brass circle, and simultaneously the white beads rotate in circular paths of small radius.

In April, 1857, Maxwell communicated to the Royal Society of Edinburgh (Vol. XXI. pt. IV). an account of a dynamical top (Figure 4) for exhibiting the phenomena of the motion of a system of invariable form about a fixed point, with some suggestions regarding the

Earth's motion. The paper illustrates to perfection the method of "proceeding from one distinct idea to another, instead of trusting to symbols and equations". It also develops the use of the method depending upon the compounding of angular moments. Provision was made for eleven adjustments of the dynamical top. The instantaneous axis about which the top is revolving is ascertained by means of a colour-disc placed near the upper end of the axis. Figure 5 represents Maxwell's Spinning Wheel—"diabolo" pattern. The brass top

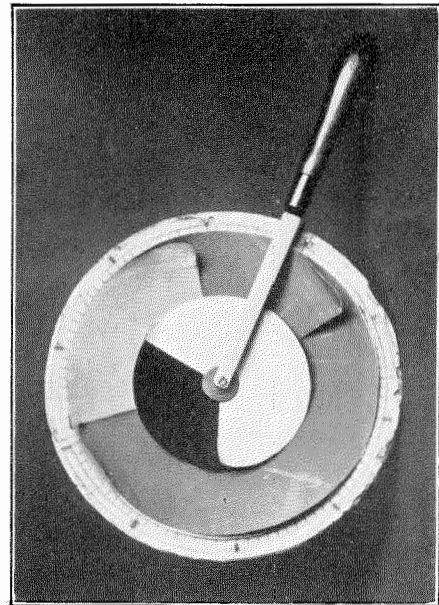
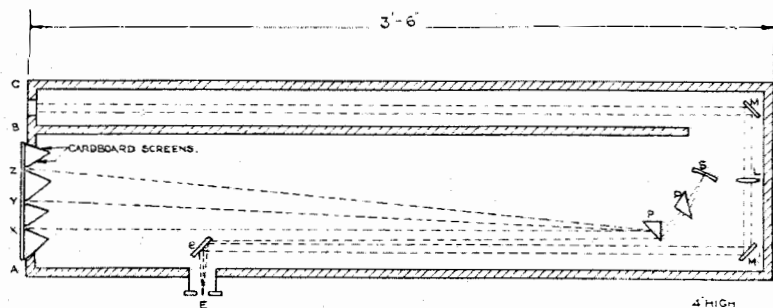

Figure 6—Clerk Maxwell's "Colour Top." At the back, the spindle carries a grooved pulley for spinning by a string-drive. Also the edge of the pulley is milled for spinning by hand

(Figure 4) was made by Ramage of Aberdeen, and Maxwell took it up to Cambridge with him in 1857 and exhibited it at a tea-party. His friends left it spinning, and next morning Maxwell, noticing one of them coming across the court, leapt out of bed, started the top, and retired between the sheets. It is said that thereafter the spinning-power of the top commanded great respect as to its power of illustrating Poinso't's theory of rotating bodies. Ramage made such dynamical tops "for several seats of learning".

As a boy, one of Maxwell's amusements when not swimming, fishing, or riding, was making magic discs. In January, 1855, he

described his theory of colours in relation to colour-blindness to the Royal Scottish Society of Arts, and explained the use of colour-discs for such investigations. By spinning the colour top (Figure 6), carrying discs of various colours, each colour is presented to the eye for a time proportional to the angle of the sector exposed. Any given colour may be imitated by combining discs of different colours, and of different angular widths. Radial slits enable the angular adjustments to be made, and the proportions of the respective colours can be registered by the graduations on the rim of the top. By this means Maxwell derived his colour equations. In the outer ring the three sectors were vermilion, ultramarine, and emerald green, respectively; in the inner ring were



Length of Spectrum from Spectral Line A to Spectral Line R was 3.6"

Figure 7—Schematic of Clerk Maxwell's Colour Box

two sectors—black and white. Writing to his father about this top in 1855 he said, "I have a new trick of stretching the string horizontally above the top, so as to touch the upper part of the axis. The motion of the axis sets the string a-vibrating in the same time with the revolutions of the top, and the colours are seen in the haze produced by the vibrations."

In relation to these experiments on colour and vision Maxwell said: "we are indebted to Newton for the original design, to Young for the means of working it out, to Professor Forbes for a scientific history of its application to practice, to Helmholtz for a rigorous examination of the facts, and to Professor Grassman (Philosophical Magazine 1852) for an admirable exposition of the subject."

His paper on the theory of compound colours, and the relations of the colours of the spectrum (Philosophical Transactions of the Royal Society, March 1860) describes two methods that

involve what might be termed a "colour box". The apparatus (Figure 11) at the Cavendish Laboratory may be identified as similar to that represented on Plate VII of that paper; it is described on page 437 of Scientific Papers. It is provided with a light-proof lid.

Referring to the arrangement indicated in Figure 7, light from a sheet of paper illuminated by sunlight admitted at the slits X Y and Z, falls upon the prisms P P' (angles = 45°), and then on to a concave silvered glass S of radius 34 inches. After reflection, the light passes again through the prisms P' P and is reflected by a small mirror e to the slit E, where the eye is placed to receive the light compounded of the colours corresponding to the positions and breadths of the slits X Y and Z. At the same time, another portion of the light from the illuminated paper enters at BC, is reflected at the mirror M, passes close to the prism P, and is reflected along with the coloured light at e, to the ey slit at E. In this way the compound colour is compared with a constant white light in optical juxtaposition with it. The mirror M is made of silvered glass, that at M' is of

glass "roughened and blackened" at the back, to reduce the intensity of the constant light to a convenient value.

Amongst his neighbours, his optical investigations caused some consternation. His house in London was at 8, Palace Gardens Terrace. It is now No. 16, and it is marked by the London County Council with an appropriate plaque. He experimented at the window with a colour-box which was painted black, and nearly eight feet long. The people of Kensington decided that it was his coffin, and that his particular mental defect disposed him constantly to stare into it. It was at this house also that he experimented on the viscosity of gases at different pressures and temperatures (Figure 10).

Maxwell made frequent use of the "moving-picture" of his day. The Wheel of Life was invented under the name of the Daedaleum by Dr. Horner of Bristol in 1838. In 1860 a

patent was taken out for the same apparatus by Devignes who called it a Zoetrope. A disc-form of a similar apparatus called a Phenakistoscope was invented by Plateau of Ghent, upon the suggestion of Roget (Phil. Trans. R. S. 1825). This was produced under the name of the Fantoscope in 1833. The drawings in Figures 8 and 9 are by Maxwell. The more serious ones represent respectively vortex rings passing through one another and expanding, and the movement of a conductor through the aether. The less serious are self-explanatory.

Maxwell's apparatus for determining the viscosity of gases is shown in Figure 10. A system of circular discs is suspended by a steel torsion wire, coaxially with a fixed system, so that alternate discs are fixed and free to turn, respectively.

Figure 11 illustrates the apparatus constructed for Maxwell in 1861 for the investigation of the kinetic energy of an electric circuit in rapid motion. The central electromagnet is capable of rotating about the horizontal axis between the pivots, within a ring which revolves about a vertical axis. The earth's field is neutralized independently. Current is led into the coil through the pivots. Observation is made to determine whether there is any angular movement of the coil with respect to the vertical during the rotation of the ring. He deduced that if a magnet contains matter in rapid rotation, the angular momentum of this rotation must be very small compared with any quantities which he could measure. ("Elec. and Mag." Vol. II. pp. 211-222).

Figure 12 is from a photograph of the Lecture Room designed and used by Maxwell, at the Cavendish Laboratory. Special features are the wide space for experiments behind the lecture-table, sliding panels in the roof giving access to beams for suspensions, and sliding side shutters for darkening—operated from floor level.

The illustration in Figure 13 of Maxwell's model to demonstrate the equations of electric

currents, especially for the case of two inductive circuits, is from a photograph of the apparatus at King's College, taken by kind permission of the authorities. A description of this model is to be found in Andrew Gray's "Treatise on Magnetism and Electricity" pp. 344-345. There is a similar model at the Cavendish Laboratory.

On behalf of a Committee of graduate members of the university of Cambridge, and of other friends who were desirous of securing a fitting memorial to Clerk Maxwell, the late W. D. Niven, F.R.S. undertook the work of editing the "Scientific Papers" and of reproducing them in two volumes. These were published by the Cambridge University Press in 1890.

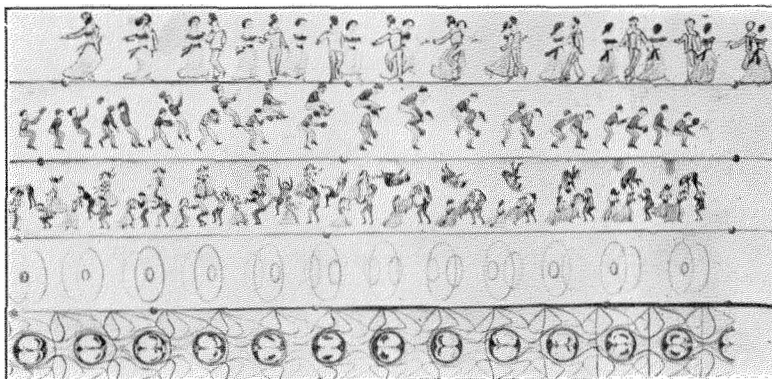

Figure 8—Clerk Maxwell's Zoetrope Diagrams

The first complete book written by Clerk Maxwell was the "Theory of Heat" (1871). It was followed by his work on "Electricity and Magnetism" (1873) in two volumes. In 1876 there appeared his treatise, small but of immeasurable worth, entitled "Matter and Motion". Finally, in 1879, there came from the Cambridge University Press his account of "The Electrical Researches of the Honourable Henry Cavendish, F.R.S." The intention of Clerk Maxwell had been also to write for students an introductory text-book on the theory of electricity, and he prepared the manuscript of the greater part of it. This was subsequently completed by Professor Garnett and was published in 1881, with the title "Elementary Treatise on Electricity".

Although in this literature the records of Clerk Maxwell's scientific contributions are

well preserved, the account of his life has yet to be treated adequately. "The Life of James Clerk Maxwell" (1884), by Lewis Campbell and William Garnett, is a faithful compilation of selections from his correspondence, from his occasional writings, and from his numerous experiments in versification. It also contains particulars of his career; but it leaves

concerning physical science was advancing in the Victorian age. That natural phenomena were the result of forces acting between one body and another had for centuries been conceived, but his task broadly was to direct attention to the distribution and balance of energy as determined by the configuration and motion of a material system. Hence-

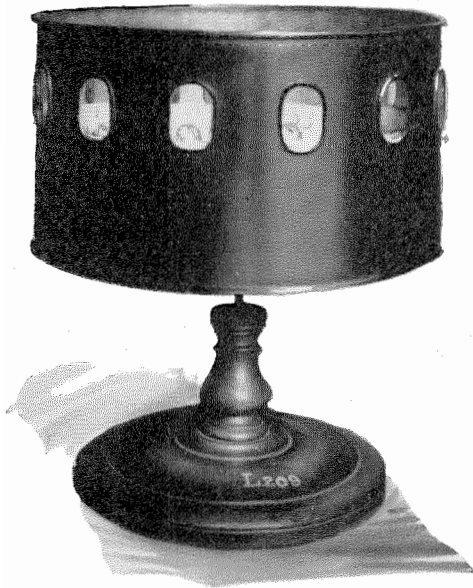

Figure 9—Zoetrope Used by Maxwell

to futurity the task of revealing yet more of the man and his work, and of demonstrating his leadership in contemporary thought, and his influence upon subsequent progress. His close and happy companionship with Kelvin and Tait may furnish the clue needed by such a biographer; for in such treatises as Tait's "Thermodynamics" and C. C. Knott's "Life and Scientific Work of Tait", Clerk Maxwell is frequently in evidence.

On the occasion of his Rede Lecture at Cambridge in 1878, which was his last public utterance, James Clerk Maxwell asked his audience to regard the telephone as a material symbol of the widely-separated departments of human knowledge, the cultivation of which led by as many converging paths to the invention of that instrument by Professor Graham Bell. From his youth up, through the wilderness of these departments, Maxwell had wandered and had realized the extent to which knowledge

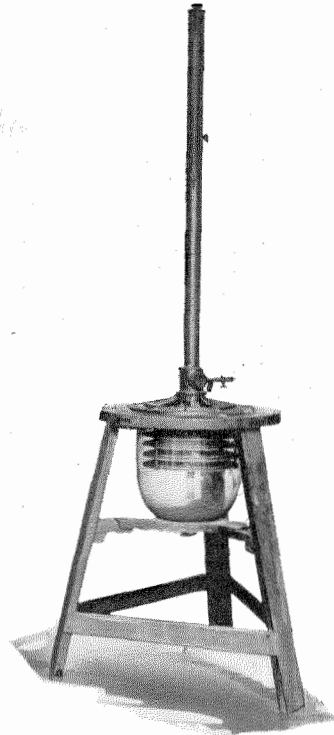

Figure 10—Maxwell's Apparatus for Determining the Viscosity of Gases

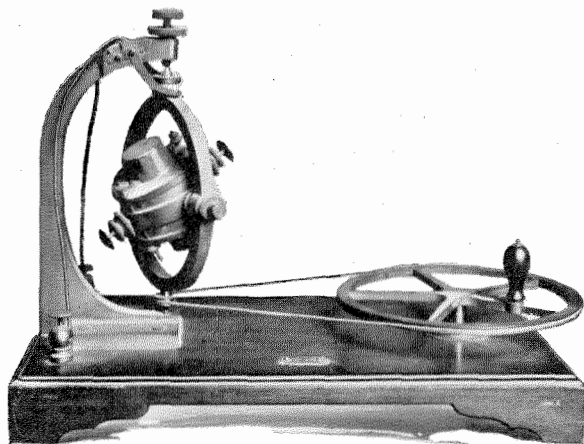

Figure 11—Maxwell's Apparatus for Investigation of Possible Inertia of Electricity

forward progress was to be along the channels of strict dynamical reasoning, aided by the science of experimenting accurately. He declared it to be "the glory of true science that all legitimate methods must lead to the same final results". He took heed lest the multiplication of symbols might put a stop to the

of "Smith's Prize", the Master of Trinity, and the Master of Mechanics to George II. Then followed the famous George Atwood (1746–1807). William Whewell (1794–1866), the son of a carpenter of Lancaster, was also the Master of Trinity; he raised the standard of Cambridge education, awakened interest in natural phi-

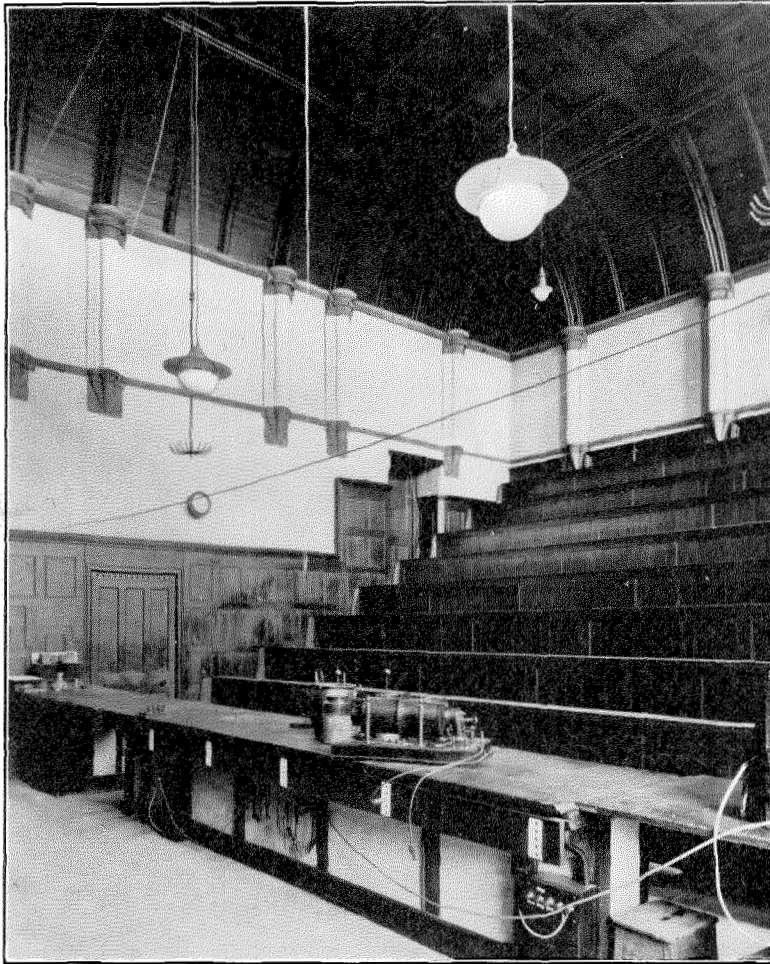

Figure 12—Clerk Maxwell's Lecture Room at the Cavendish Laboratory, Cambridge

development. Accordingly he directed his efforts to "sweeping cobwebs off the sky".

It was no mean realm of learning into which Clerk Maxwell entered at Cambridge. Newton (1642–1727) in 1669 had there succeeded to the Lucasian chair vacated by Barrow. Roger Cotes (1682–1716), though "his style was concise even to obscurity", was a Cambridge mathematician of a high order. Next in the line was Robert Smith (1689–1768) the founder

of philosophy, helped to found (1818) the Cambridge Philosophical Society, and produced works that considerably relieved the dull mechanic exercises of the pure analysts. Maxwell's object, and that of the joyous fraternity to which he belonged, was to extend the later teaching. Briefly, he interpreted Physical Science as the cultivation of the sense of energy, and as the guidance of thought along the channels of dynamical reasoning.

As an example of his "occasional verse", the following bears appropriately upon electrical communication and indicates his sub-

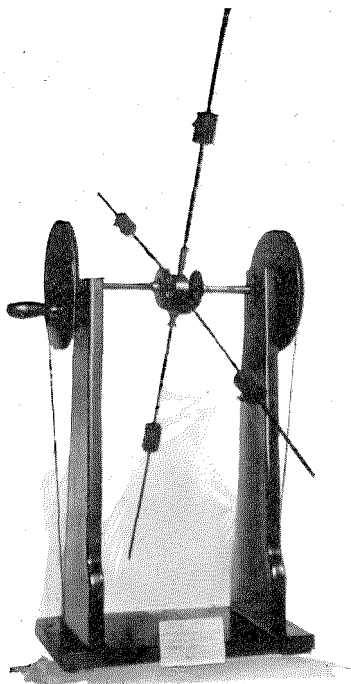

Figure 13—Maxwell's Dynamical Model to Illustrate the Equations of Electric Currents

stantial belief in the future of telegraphy. It was written by him in 1857 while on a railway journey to Glasgow.

"THE SONG OF THE ATLANTIC
TELEGRAPH COMPANY".

Let (U) = 'Under the Sea',

I.

2 (U)

Mark how the telegraph motions to me,

2 (U)

Signals are coming along,
With a wag, wag, wag;
The telegraph needle is vibrating free,
And every vibration is telling me,
How they drag, drag, drag,
The telegraph cable along.

II.

2 (U)

No little signals are coming to me,

2 (U)

Something has surely gone wrong,
And it's broke, broke, broke;
What is the cause of it does not transpire,
But something has broken the telegraph wire,
With a stroke,
Or else they've been pulling too strong.

III.

2 (U)

Fishes are whispering. What can it be,

2 (U)

So many hundred miles long?
For it's strange, strange, strange,
How they could spin out such durable stuff,
Lying all wiry, elastic and tough,
Without change, change, change,
In the salt water so strong.

IV.

2 (U)

There let us leave it for fishes to see;

2 (U)

They'll see lots of cables ere long,
For we'll twine, twine, twine,
And spin a new cable, and try it again,
And settle our bargains of cotton and grain,
With a line, line, line,—
A line that will never go wrong.

In 1866 Maxwell returned to Cambridge as Moderator in the Mathematical Tripos. There was a movement in favour of introducing problems relating to heat, electricity, and magnetism into those examinations, and Maxwell was instrumental in bringing about the reforms. In 1870 the Duke of Devonshire expressed a desire to build and to furnish a Physical Laboratory for Cambridge. A professorship was thus rendered necessary, and accordingly the Senate founded in 1871 the

chair of Experimental Physics. To this Maxwell was appointed on March 8, of that year. He devoted himself whole-heartedly to the task of designing and superintending the erection of the now world-famous Cavendish Laboratory. By 1873 he had completed his book on electricity and magnetism and it had been published, and he had begun the labour of going through the electrical researches of the Hon. Henry Cavendish (1731–1810), the first of the quantitative electricians. The Duke of Devonshire had supplied the means of equipping the laboratory, and he generously proposed to present any additional apparatus that was needed for the advancement of science. Maxwell lectured there on Heat and the Constitution of Bodies, Electricity, and Electro-Magnetism—his inaugural lecture in October, 1871, was on Colour Vision.

The work at "the Cavendish" thus began under the most favourable conditions. Maxwell encouraged and was encouraged by the new devotees of physics. He derived for

example special satisfaction from the success achieved by George Chrystal in the verification there of Ohm's law, for metallic conductors; and although some have lamented the deviation of his own line of research at this period to the records of Henry Cavendish, there is no doubt that he found in those records something inspiring—possibly it was their close bearing upon the relation between physical phenomena and sensation.

Although nearly half a century has passed, it is still hard to write that in November, 1879, at the prime of normal life, Clerk Maxwell, the supreme interpreter of the world of Physics, died. To those proceeding to extend his victories along the road of electrical communication he left his sword and his chariot—his equations and his theories. He left also an example of individual thought and achievement and a plea for fellowship between all men of science that proves his cherished motive and purpose to have been no less exalted than his consummate mind.

The Milan Broadcasting Station

By E. M. DELORAINE

European Engineering Department, International Standard Electric Corporation

THE fame of the Scala attracts a large number of performers to Milan, and almost any evening it is possible to hear excellent music with a choice possibly of a hundred different programmes. It is consequently an exacting task to supply such a town with a broadcasting equipment capable of attracting the attention of the public by the quality of its transmission. This, however, has been accomplished in the case of the station supplied by Standard Elettrica Italiana to the Unione Radiofonica Italiana late last

the occasion of the third anniversary of the march of the Fascists to Rome.

The installation was carried out in a way which gives to the various rooms a very attractive appearance. The engineer-in-charge of the station, Mr. Corravio Tutino, was responsible for this tasteful and efficient arrangement. Standard Elettrica Italiana was responsible for the technical features of the installation, including the meeting of certain tests prescribed in the contract placed by the Unione Radiotelefonica.

The general layout of the various rooms is shown in Figure 1. It will be noted that the transmitting room is not shown, the antenna being installed on the roofs of buildings located on the other side of the courtyard. The main

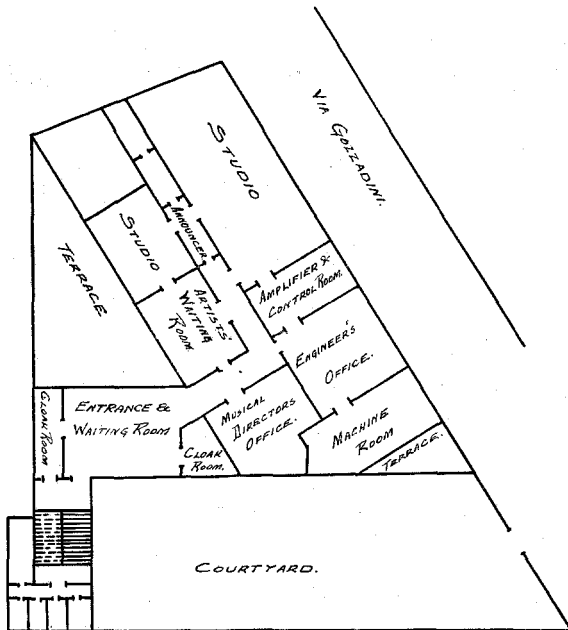

Figure 1—Layout of Station

year, for nearly every listener has declared enthusiastically that the transmission is "bellissima." In the case of the few who have not expressed this opinion, the blame must be ascribed to the receiving apparatus rather than to any defect in artistic appreciation.

The station was opened in a most brilliant manner on December 8, 1925. Before the official opening, it was used to broadcast a speech given at the Scala by the Premier, Signor Mussolini, on



Figure 2—Main Studio

studio, illustrated in Figure 2, was designed in accordance with the latest practice of covering only part of the surface of the walls, floor and ceiling with damping material. Its acoustic characteristics are very satisfactory, with the result that brilliancy is given to the music with freedom from reverberation and echo. The locations of the piano, microphone, etc., were chosen in accordance with previous experience and proved to be quite satisfactory.

Referring to the layout, Figure 1, the two studios are situated on either side of a small room in which the announcer normally sits. From this small room he can follow all that is taking place

in either studio by looking through glass doors. The ordinary procedure during broadcasting is as follows:

The artists are called by the attendant into the waiting room and are shown into the studio in which they will perform—for instance, Studio No. 1. They have ample time to arrange their music, tune their instruments, and take the positions indicated by the person in charge of the studios. During this time the performance which is being broadcast is given from Studio No. 2. When this item on the programme is finished, the announcer disconnects the microphone in Studio No. 2, and, connecting his own microphone, makes any announcements he wishes; then, after giving due warning, he switches on the microphone in Studio No. 1. During this time the artists leave Studio No. 2, and those who will give the next item on the programme are admitted. This scheme of changing alternately from one studio to the other allows the performance to proceed without interruption and gives the artists ample time for preparation and for leaving the studio. The general arrangement of locating the announcer in a separate room and of separating his duties from those of the studio manager conduces to the smooth running of the programme. In order to prevent a possible mistake on the part of the announcer when switching the microphones from one studio to the other, or to his own position, and also, for instance, to prevent his leaving two microphones connected in parallel, the switching over is done by means of a system of push-buttons which are interlocked in such a way that only one microphone is con-

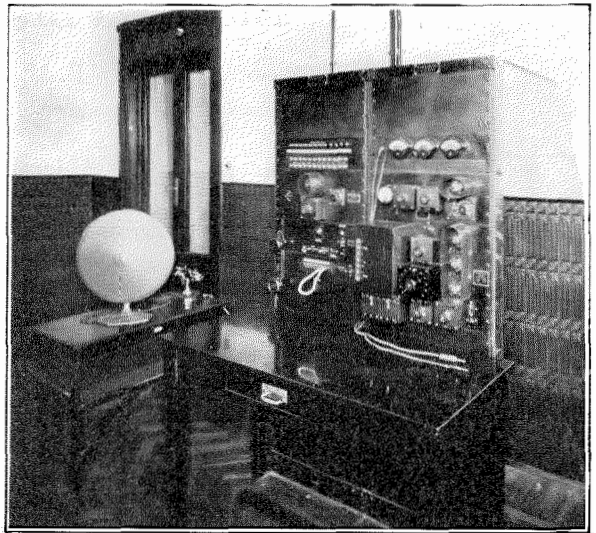

Figure 3—Amplifier Room

nected at a time; and when a new one is cut into circuit, the one previously used is first automatically disconnected. One push-button also enables the announcer to disconnect all the microphones. The main studio is provided with two microphones, either or both of which can be used during a performance.

It will be seen from the layout that ample space has been provided for artists' waiting rooms. The larger waiting room is fitted with a loud-speaker which reproduces the programme being broadcast. The smaller waiting room is near the small studio. The office of the engineer-in-charge is between the amplifier room and the machine room. The musical director's office is near the artists' waiting rooms.

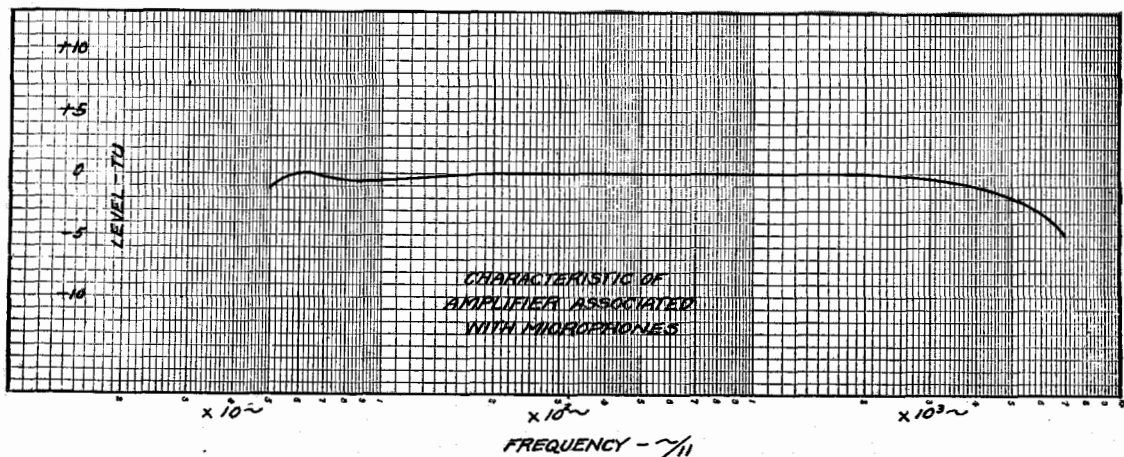

Figure 4—Characteristic of Amplifier Associated with Microphones

The amplifier and control room, Figure 6, is adjacent to the main studio. The control apparatus, which is mounted on panels placed on two vertical racks, comprises the necessary apparatus for amplifying the microphonic currents to a sufficient volume to modulate the radio transmitter, and for measuring, controlling and monitoring all these amplified currents from the microphones. It also comprises means for communicating and signalling between the studio

provided for switching the "Kone" loud-speaker either to the monitoring amplifier or to a rectifier, which works in connection with the radio transmitter in a way to be explained later. This key enables the attendant to listen to the transmission either before it is impressed on the radio transmitter or when it is delivered into the antenna, and makes it easy to compare the quality of speech and music before and after going through the radio transmitter, so that any defect

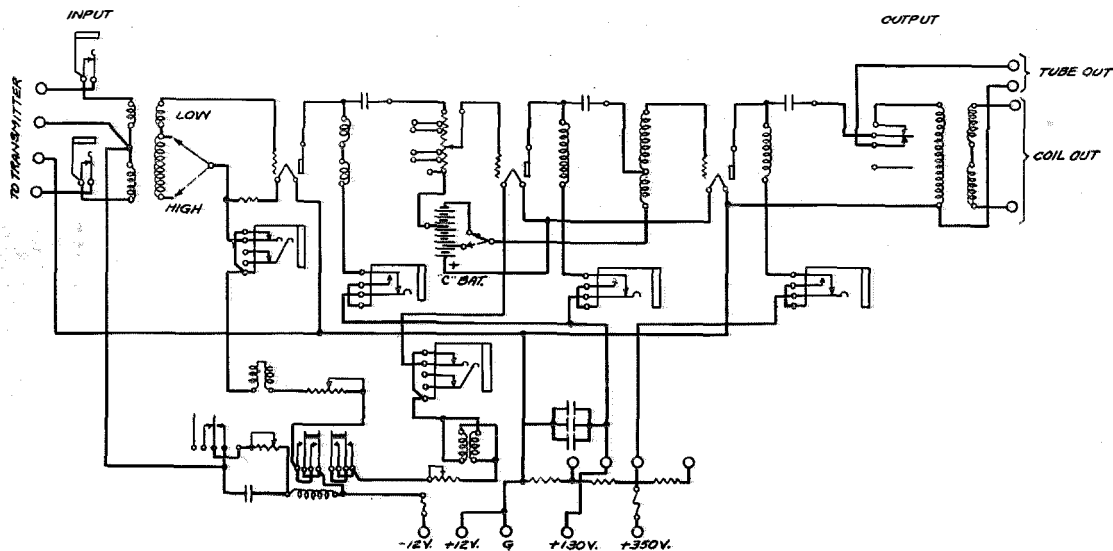

Figure 5—Schematic of Amplifier Associated with Microphones

and the control position and for connecting to the transmitting equipment the lines for outside broadcasting.

Starting from the top of the left-hand rack containing the control apparatus are the battery-supply panel, containing switches and protection for the various circuits in the speech-input equipment, and the monitoring amplifier panel, consisting of a one-stage amplifier with gain control. This amplifier is connected across the output of the speech-input amplifier associated with the microphones. It is designed to work in conjunction with a "Kone" type loud-speaker and is used to monitor the currents after they have been amplified, but before they are impressed on the radio transmitter. The next panel is the signal and control panel; it provides means for connecting the input of the amplifier associated with the microphones to the announcer's position, to the lines for outside broadcasting, or for speaking from the control position. A monitoring key is

in the adjustment of the transmitter, which might cause the quality to deteriorate, can be detected immediately. A number of keys and lights are provided for signalling from the control position to the studio, and a hand telephone fitted with push-buttons, which will light a lamp or operate a buzzer at will, is provided for talking to the announcer. The next panel comprises a number of jacks, which are connected to the various lines used for outside broadcasting. Any desired line can, therefore, be connected to the equipment by means of a cord.

At the top of the right-hand control apparatus rack is a meter panel which provides facilities for measuring filament, plate, and microphone currents in the various circuits of the speech-input equipment. The next panel is a volume-indicator provided for measuring the volume of the audio-frequency currents as they leave the amplifier associated with the microphones. The apparatus is essentially a peak-voltmeter and

gives a comparatively accurate measure of the speech or music, thus enabling the attendant at the amplifier to adjust the degree of amplification so that optimum modulation of the transmitter may be obtained. The overload point of the radio transmitter is determined when the station is tested after installation, and readings are taken on the volume-indicator. During normal working, the degree of amplification is adjusted to keep the output of the amplifier below the overload point, independently of the type of performance being handled. The last panel is the speech-input amplifier panel, comprising three stages of amplification. It is provided with all

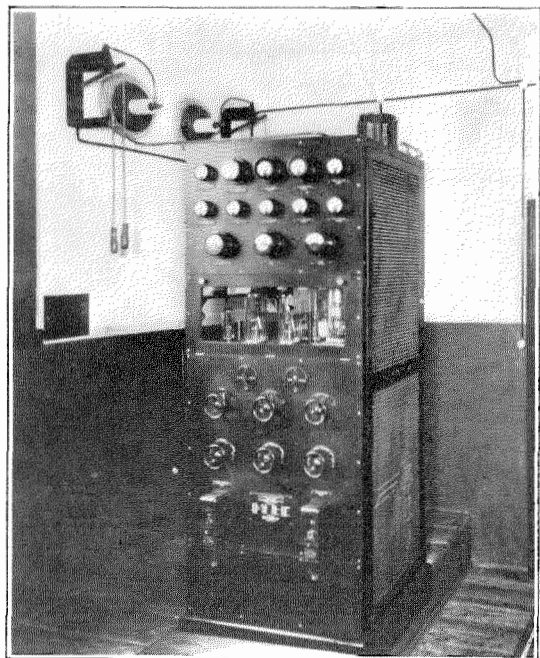

Figure 6—Radio Transmitter—Front View

the necessary jacks for measuring the plate and filament currents of the various tubes, and rheostats for adjusting these to the correct values. Jacks are provided also for measuring the current-supply to the two carbon buttons of the microphone. The amplification is controlled by a potentiometer, which operates on the first two stages. The overall characteristic of the amplifier is extremely good. The curve, which is almost flat between the frequencies of 50 cycles and 7,000 cycles, is shown in Figure 4. A diagram of the amplifier is given in Figure 5.

The radio transmitter, which is installed at a little distance from the control room, is illustrated in Figure 6. It is designed for an output of one kilowatt and comprises essentially one stage of audio-frequency amplification, an oscillator-modulator unit, and one stage of radio-frequency amplification. A rear view of the transmitter is shown in Figure 7 and a diagram of connections with the associated power circuits, in Figure 8. The currents delivered by the

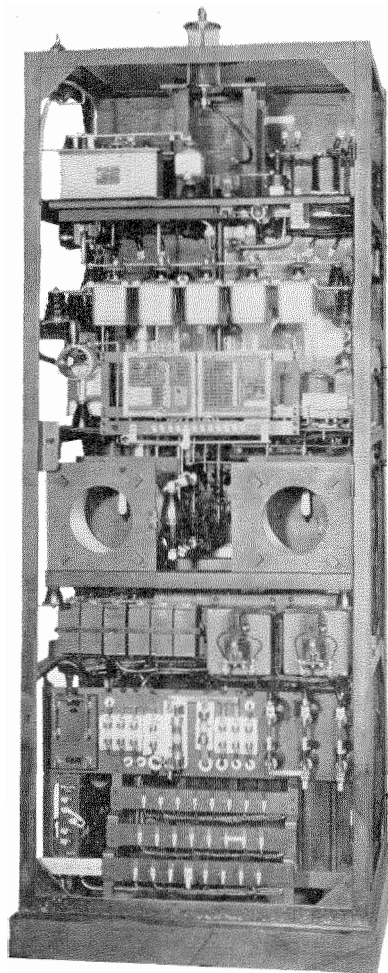

Figure 7—Radio Transmitter—Rear View

speech-input amplifier are impressed, through a transformer, on the grid of the low-frequency amplifier tube, which has a plate power dissipation of 50 watts. This tube can be seen on the extreme left of the glass window of the transmitter, Figure 6. The speech amplifier plate current can be read on a meter located on the front panel of the transmitter.

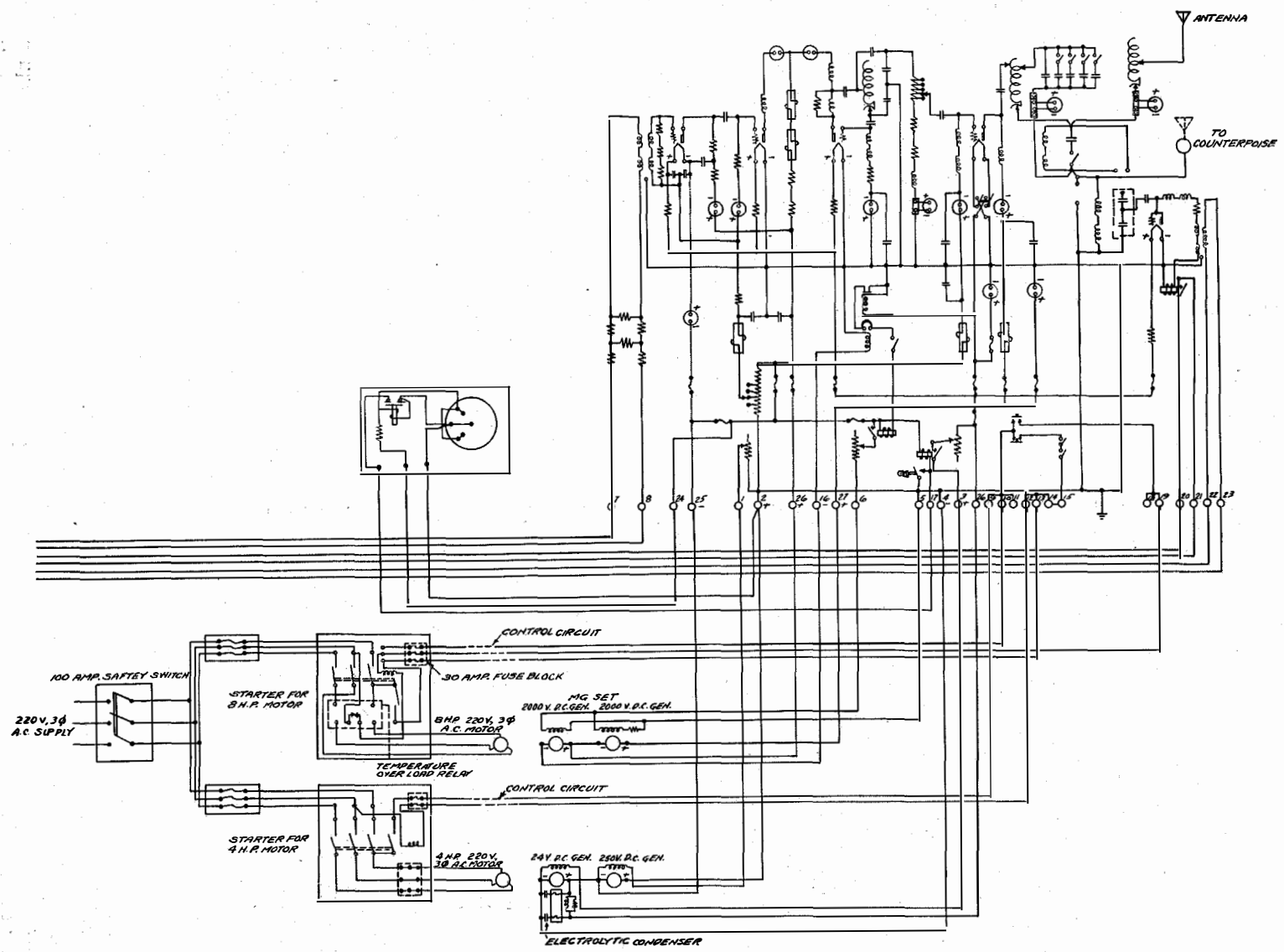

Figure 8—Schematic of Transmitter Connections

The two tubes in the oscillator-modulator unit of the radio transmitter are located adjacent to the low-frequency amplifier tube and are of a larger type capable of dissipating 200 watts. Both the amplifier tube and the modulator-oscillator tubes derive their plate power from a 2,000-volt generator. The modulation is of the choke control type, the amplitude of the currents delivered by the oscillator being directly controlled by the variations of plate voltage produced by the modulator tube. The oscillator-frequency is controlled by the value of inductance inserted between grid and plate of the oscillator tube. Large changes in frequency are made by changing a tap on the coil, which is accessible from the rear of the transmitter. Small changes in frequency are made by means of a slider which covers three turns at one end of the coil. A resistance is bridged across the oscillatory circuit and acts as a load for the oscillator. The modulator grid current, modulator plate current, oscillator grid current, oscillator plate current, and oscillator load current are all shown at the front of the board by meters connected in the respective circuits. The modulator grid current meter is provided to serve as an indication of overload at the input of the modulator. The input to the radio transmitter should be kept low enough to prevent frequent indications on this meter.

The necessary negative grid voltage, required for the operation of the low-frequency amplifier and oscillator-modulator tubes of the radio transmitter, is obtained from a potentiometer connected across a 250-volt generator, the ripple from which is cut out by means of a filter consisting of a series inductance and a parallel condenser. The power for heating the filaments of these tubes is obtained from a 24-volt, D.C. generator, suitable resistances being inserted in series with the filaments to limit the filament current to the proper value. The filaments are of the platinum-nickel, oxide-coated type and are operated at a dull red temperature; the emission obtained from these filaments is, nevertheless, large enough to prevent the introduction of any distortion due to saturation.

The high-frequency power amplifier transmitter tube is of the water-cooled type. It can be seen through the window of the transmitter on the right-hand side. The plate is in the form

of a cylinder, which is sealed to the glass, according to the technique specially developed in connection with the manufacture of vacuum tubes of this type. The anode is inserted in the water-jacket in which a current of water is kept flowing in order to carry away the heat dissipated in the anode of the tube. The glass provides the necessary insulation between the filament supports and the plate, and also between the grid and filament structure. The filament of the tube is supplied with D.C. current from the 24-volt, D.C. generator. It is made of pure tungsten and is worked at high temperature. Because of the superposed plate current, there is always more current flowing in one end of the filament than in the other; a switch is provided to reverse the filament current at regular intervals and thereby extend the life of the tube through more uniform filament consumption. Through a high-frequency choke coil, a satisfactory negative grid voltage is applied to the tube from the 250-volt generator. The anode voltage is derived from a 4,000-volt supply, through a low-frequency coil and a high-frequency choke coil in series.

Meters are provided on the front of the panel for reading the power-amplifier grid current and the power-amplifier plate current. The high-frequency voltage for grid excitation is obtained through a blocking condenser from a tap on a potentiometer connected across the oscillatory circuit. The plate output circuit is of the tuned type. The high-frequency currents flow through a blocking condenser to a parallel circuit with variable inductance and capacity. Part of the capacity inserted is used to supply voltage for exciting the antenna circuit. The type of circuit used is designed to prevent the radiation of harmonics produced by the high-frequency amplifier tube, which works with a negative grid voltage near the cut-off value in order to give increased efficiency. The plate output circuit has the optimum impedance for the band of frequencies to be transmitted, and has a very low impedance for all other frequencies, the result being that the harmonic currents flowing from filament to plate in the amplifier tube are almost short-circuited in the output circuit. The energy corresponding to these harmonics is, consequently, dissipated almost entirely inside the tube. Furthermore, the efficiency of the antenna coupling is greater for the fundamental frequency

than for harmonics. These two facts combined reduce the radiation of harmonics to such an extent that radiation harmonics are found to be entirely negligible. The antenna circuit is tuned by means of an inductance coil mounted on top of the radio transmitter. This coil and the one used in the plate output circuit are varied by changing the tapping at the back of the transmitter, when large variations of inductance are necessary, and small variations are made by means of sliders which cover three turns and are controlled by handles on the front of the transmitter. The antenna circuit is designed to operate with an antenna and earth or, if desired, with an antenna and an insulated counterpoise.

A vacuum tube with a dissipation of 5-watts is used as a rectifier for monitoring purposes. It is coupled to the antenna circuit by means of a potentiometer made of series condensers connected across the antenna coupling condenser. The output of the rectifier passes through a transformer and is connected to a loud-speaker of the "Kone" type. A line is connected across the output terminals of this transformer back to the control equipment in the amplifier room and is used for comparing the quality on the input and output side of the radio transmitter. The necessary circulation of water for cooling the power-amplifier tube is obtained from a water system arranged in such a way as to enable either the local supply or a closed circulating system to be used. In the latter case the water is cooled by passage through a radiator, and an expansion tank is provided in order to prevent increase in pressure. A pressure-gauge with electrical contacts is connected on the inlet side of the water-cooled tube, these contacts operating for excess or lack of pressure, caused by some obstruction in the pipe or by failure of the circulating power. When this pressure gauge operates, it trips both the filament and the plate supply to the radio transmitter.

The necessary power for supplying the filaments, grids and plates of the various vacuum tubes is obtained from machines or batteries, located in a small power room. One end of this power room can be seen in Figure 9. The machine shown in the reproduction consists of two 2000-volt D.C. generators coupled to a single driving motor. These generators have double armature windings, each winding supplying 1000

volts. By series connection of the two armature windings of the two machines, and of the two machines themselves, a 4,000-volt supply is obtained. The first machine has a larger current-carrying capacity than the second one; it is used to supply not only the anode power to the water-cooled tube, but also the anode power to the radiation-cooled tubes. The other motor-generator, which is not visible in the picture, supplies current to the grids and filaments of the various vacuum tubes.

A filter, seen in the foreground on left of Figure 9, is inserted in the filament supply in order to smooth out commutator-ripples. This filter is

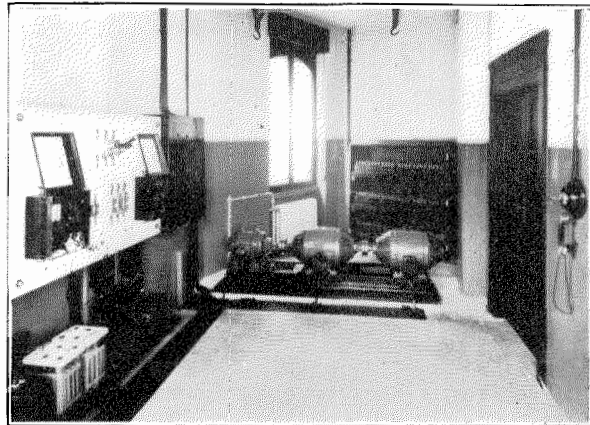

Figure 9—Power Room

made of a series choke and parallel condenser bridged between both terminals of the choke and ground. These condensers are of a newly developed type and have a capacity of approximately 1,000 microfarads. They derive their high capacity from a very thin dielectric film, which is formed electro-chemically on the positive, corrugated aluminum electrode (Figure 10). When the aluminum electrode is the anode in a suitable condenser fluid, the film maintains itself. The flat, negative, electrode serves only as a means of passing current to and from the condenser fluid. A layer of oil covers the condenser fluid to prevent evaporation.

The power necessary for supplying plates and filaments of the vacuum tubes at the control position is obtained from accumulators, which are seen at the end of the room, Figure 9. The plate-supply consists of a large number of cells of small capacity connected in series and giving a

total of 350 volts. The filament supply consists of two 6-volt accumulators of large capacity placed in series. Both of these accumulator-batteries are charged by means of Tungar rectifiers, seen next to the electro-lytic condenser in Figure 9. Both of the motor-generator sets are remote-controlled, being started and stopped by means of push-buttons located directly under the

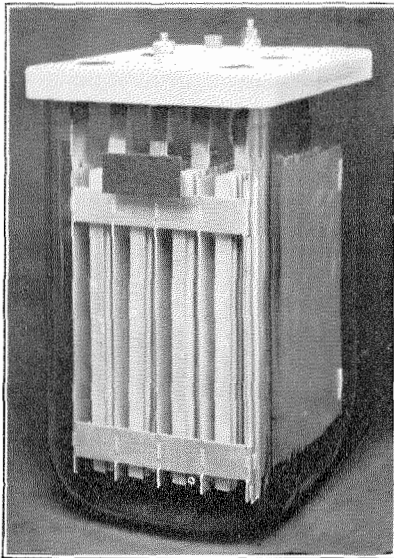

Figure 10—Electrolytic Condenser

glass window of the transmitter. The filament, grid, and plate voltages obtained from the various machines can be read on meters, on the lower part of the front panel of the transmitter. Three rheostats are provided for adjusting these voltages to the required values.

The operator and the equipment are protected

by switches and relays inserted in various parts of the supply. The transmitter is designed in such a way as to be started automatically, by properly interlocked relays, upon operation of the master control push-button on the radio transmitter. The operation of this push-button starts both motor-generator sets and first of all applies the filament heating power to the various vacuum tubes. The anode voltage is applied after a lapse of ten to twenty seconds, in order to ensure warming of the vacuum tubes before they are connected to the plate-supply. An overload relay is connected in the plate circuit in order to trip the plate-supply in case of excessive plate current. The failure of the cooling-water supply will remove both plate and filament voltages, as explained previously. The window in the transmitter, and the door at the back, are provided with safety switches, and when opened the switches operate and remove the transmitter plate-supply.

The audio-frequency characteristic of the radio transmitter (Figure 11) is extremely flat. Between frequencies of 35 and 7,000 cycles the characteristic is almost a straight line.

The antenna is shown in Figure 12. Owing to local conditions, it had to be installed on the roofs of buildings forming a quadrangle, with a garden in the center. A fairly extensive insulated counterpoise was installed over the courtyard. The counterpoise is made of a central bus-bar running under the antenna, the distance between this bus-bar and the antenna-cage being approximately 25 metres. Wires, approximately 50 centimetres from one another, are connected across this bus-bar and are separated by insula-

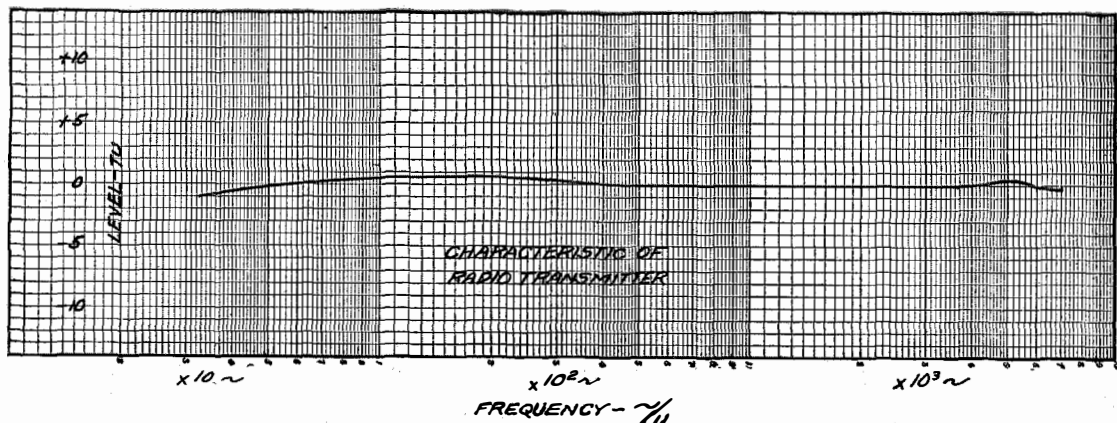

Figure 11—Characteristic of Radio Transmitter

tors on the roofs. The antenna consists of a single cage with one down-lead at each end, thus

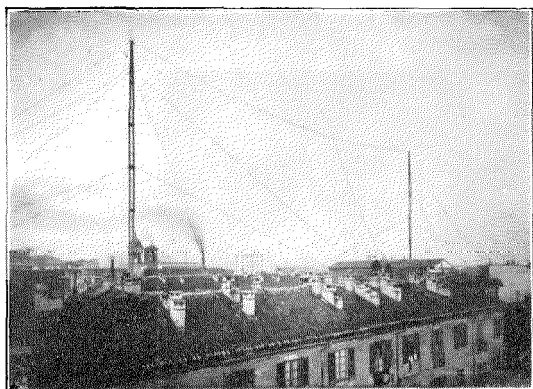
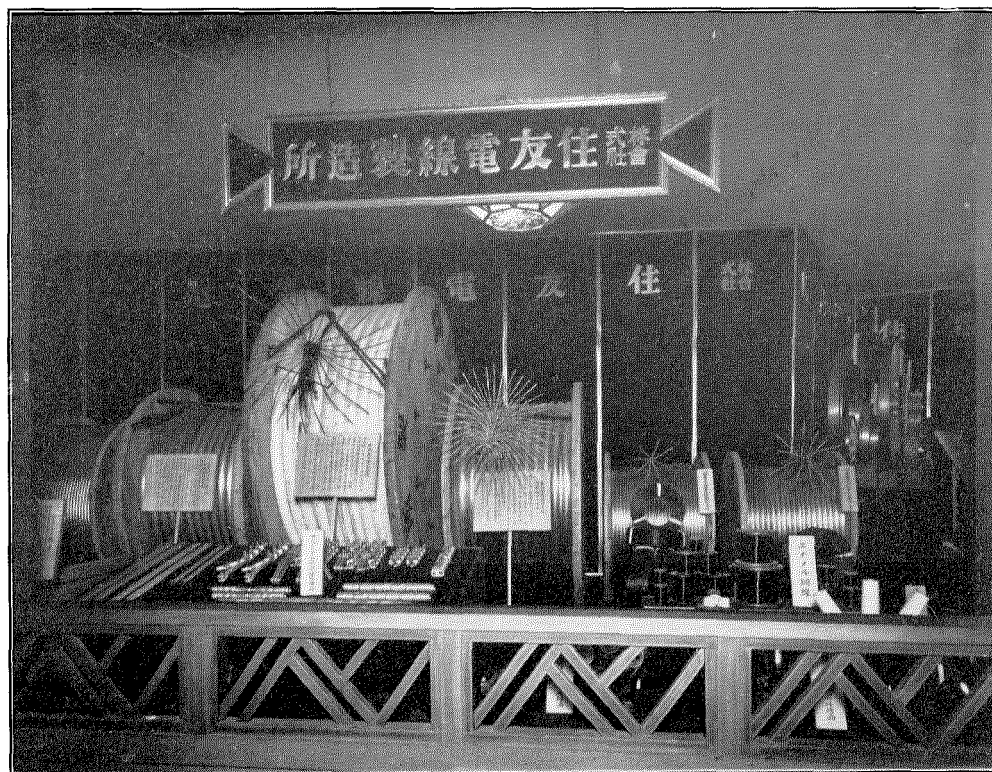

Figure 12—Antenna

forming the simplest type of multiple-tuned antenna. Both down-leads are 6-wire cages approximately 6 centimetres in diameter. The

horizontal part is a 6-wire cage with a diameter of approximately 60 centimetres. The efficiency of this type of antenna is appreciably higher than that of an ordinary "T" or "L" type antenna. It has, however, no definite directive properties. The tuning is done at both ends by means of antenna loading-coils, which have to be adjusted for equal currents. The total antenna effective resistance at a wave-length of 330 metres is approximately 7.5 ohms, and the efficiency of the antenna as a radiating system is about 50 per cent.

The station has been operating regularly since the beginning of the year and is heard very well in a great many countries. In the fortnight succeeding the first test, 350 letters were received from 17 different countries, 79 of these letters being from Great Britain. In practically every case the reports were full of praise for the transmission.



Products of the Sumitomo Electric Wire and Cable Works, Ltd., Recently Displayed at an Electrical Exhibition in Osaka, Japan.



Charles E. Scribner
1858-1926

In Memoriam Charles E. Scribner

Charles E. Scribner, an outstanding pioneer in telephone engineering and Chief Engineer of the Western Electric Company, Inc. for a period of twenty-three years, died on June 25th at his summer home in Jericho, Vermont.

Mr. Scribner was one of the three greatest electrical inventors the United States has known in the last several decades and was credited with holding more patents than any other man with the exception of his friend, Thomas A. Edison. As an inventor and an engineer, his contributions to the progress of our foreign business were conspicuous and fundamental.

F. R. Welles, Vice President of the International Western Electric Company, Inc. in charge of our European business at the time of his retirement, was associated intimately with Mr. Scribner for many years. When he learned of the death of his old friend, he sent a communication from Bourre, France, to the "Western Electric News" from which the following is quoted.

"In the latter part of 1876 a Toledo, Ohio, boy of 18 got his first job from Mr. Barton (of the firm of Gray and Barton, predecessors of the Western Electric Company) as inspector of Gray printers on leased private lines in Chicago. He was a bright, likable boy, and I took him in as chum in the old Chicago University.

"The next year he was transferred to the factory as 'Electrician', and soon turned to inventing, which he had begun as a boy at Toledo by inventing a telegraph repeater for use on lines built by a group of boys from house to house, under his leadership. He quickly gave himself up entirely to the telephone, just showing up as a field of future development. By 1878 the outlook opened still wider. In that year and in 1879 rudimentary telephone exchanges were built.

"When development once got under way he took as his province the main problem in the situation, the switchboard for large offices, and devised the multiple, or the 'duplicate switchboard', as it was first called. In those days an exchange of one or two thousand subscribers was a 'large office'.

"The main features of switchboard development for large exchanges were due to Scribner. He did not originate the central battery system, but when its feasibility became evident he took it up and carried on the development.

"The switchboard story is fully told by J. E. Kingsbury in 'The Telephone and Telephone Exchanges' (London, 1915). In that work, which is authoritative and abundantly documented from early source material, the leading part played by Scribner comes out clearly.

"After my transfer to Europe at the end of 1881 I naturally saw less of Scribner, meeting him only on my occasional brief visits to America, or when he came over to help us out on European questions.

"Under these circumstances Scribner's counsels were of the greatest value, and he came over now and then to keep us up to date on developments and to help out on any special problems. Thus he and I had occasion to work together in Antwerp, Berlin, London, Paris, Rome and elsewhere, always in good will and mutual confidence."

Mr. Scribner was a man of simple tastes, modest as to his achievements and friendly with everybody. His many friends among the directors, officers and employees of our Corporation learned of his death with deep sorrow.

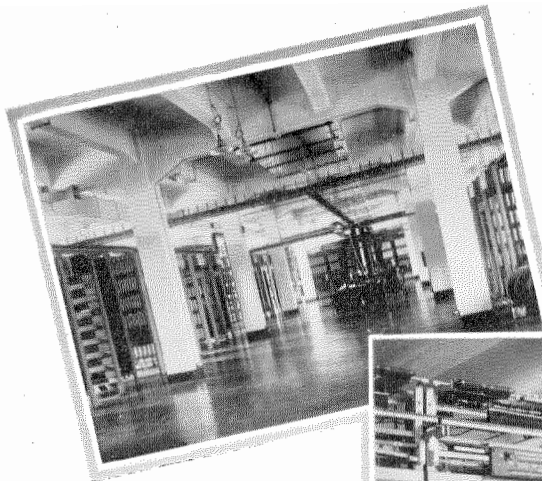

Switch Room, Kyobashi Exchange, Tokyo

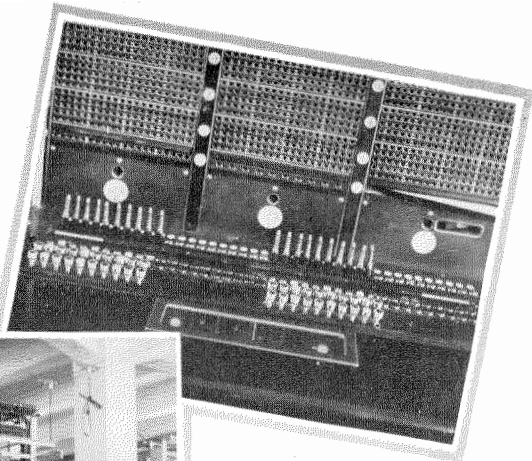

Portion of Trunk Boards, showing Call Indicator Key Shelf, Ginza (Manual) Exchange, Tokyo

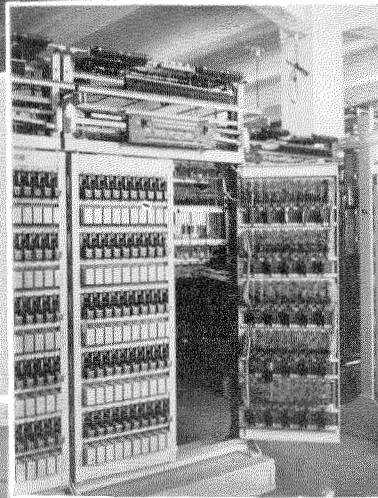

Subscribers Line Switch Racks, Kyobashi Exchange, Tokyo

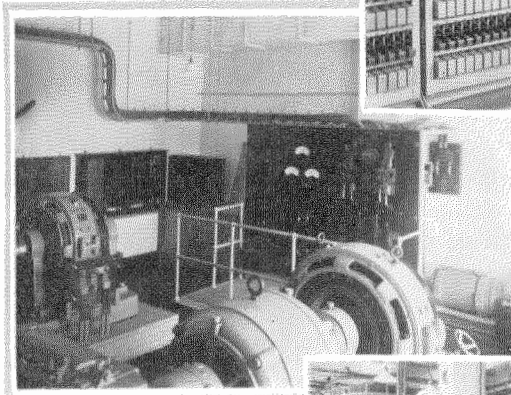

Machine Room, showing Charging Generators and Power Board, Kyobashi Exchange, Tokyo



Kyobashi Exchange, Side View, Tokyo

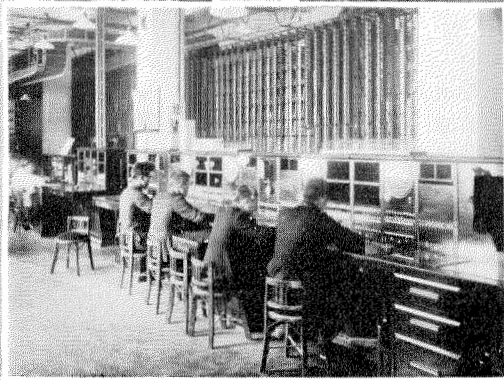

Terminal Room, showing Interception, Complaint and Wire Chiefs' Desks, Kyobashi Exchange, Tokyo

Telephone Reconstruction in Tokyo and Yokohama

By SANNOSUKE INADA

*Director General of Telegraph and Telephone Engineering,
Department of Communications, Japan*

IN the October, 1924, issue of ELECTRICAL COMMUNICATION, the author contributed an article which gave the details of the almost complete destruction of the telegraph and telephone plants in Tokyo and Yokohama by the earthquake and consequent conflagrations of September 1, 1923. That article also described the emergency measures taken immediately after the disaster for restoring the services and gave a brief outline of the plan for the permanent restoration project. It is proposed, in this article to describe in somewhat more detail the execution of this plan.

As stated in the previous article, there were, in Tokyo, before the earthquake, approximately 83,000 telephone stations, served from nineteen central offices, all but three of which were equipped with No. 1 type common battery switchboards. Toll service was provided over more than 300 toll circuits, through a common battery toll board, located in the toll exchange office.

Before the disaster, the slightly more than 10,000 telephones in Yokohama were served from two central offices, one equipped with a No. 1 type common battery switchboard and the other with a magneto switchboard. The construction of a building for a new office (Kannai), to replace the magneto office, was almost completed at the time of the earthquake. Toll service was given over somewhat more than 100 circuits.

Permanent Reconstruction

The loss of the traffic and plant records was, of course, most seriously felt in connection with the preparation of plans for the permanent part of the restoration project. At the time of the earthquake, a new commercial study and a new fundamental plan for the exchange areas were being made, but the data for these studies were lost. Faced with this situation, it was decided to collect all data possible and from these to make the necessary traffic and plant estimates for completing the reconstruction work, in both Tokyo and Yokohama, by the end of the fiscal

year 1927, and to care for growth in these exchanges in an orderly manner over a period of approximately ten years.

Type of Central Office Equipment

When these estimates were completed, indicating the amount of equipment required, the next important decision to be made was what type of equipment should be used in the new offices. Before the disaster, considerable thought had already been given to the use of automatic equipment in large telephone exchange areas and, in January, 1922, a 500-line experimental Strowger type automatic switchboard was installed as a private branch exchange in the building of the Department of Communications. The results of these studies indicated that, ultimately, large savings and a better grade of service should be obtained if automatic equipment were used. However, there were many factors, due to local conditions in the Tokyo exchanges, which tended to make the introduction of automatic equipment more costly than in most other places. The existing manual equipment was comparatively new and would not reach the end of its useful life for many years. If removed from service, a long time would elapse before any large part of it could be reused in exchanges outside of Tokyo. Consequently, its replacement by automatic equipment would entail an excessive transfer loss. On the other hand, if automatic equipment were used only to care for growth and necessary replacement, there would be a long period during which its use would result in a heavy loss. This, of course, was because of the limited saving that could be made on the relatively small amount of traffic handled on an automatic basis during this period and the heavy initial cost of arranging the existing manual switchboards for interchange of traffic with the automatic equipment. These two factors were more serious in Tokyo than in many other places because of the somewhat slow rate of growth and the large number of positions required to handle a given amount of traffic, due to the low efficiency

of the operators, which is largely brought about by their short reach.

The destruction of so large a part of the manual equipment by the earthquake removed all of these objections and it was accordingly decided to install automatic equipment, provided it could be obtained in time to meet the reconstruction schedule.

After studying the various types of automatic equipment available, it was decided to use the step-by-step type. The principal reasons leading to this choice were that the amount of step-by-step equipment in use over a long period of time in all parts of the world indicated it to be entirely dependable in operation. It appeared to be somewhat less liable to damage by earthquakes of comparatively heavy intensity than other types. Its cost compared favorably with that of other types. Even if, in the future, the Tokyo exchange became so large that the use of the straight Strowger system would be uneconomical, the required flexibility and economies could be obtained by introducing the director system. It was, accordingly, decided to adopt the step-by-step system.

Reconstruction in Tokyo

As stated in the previous article¹, the project of reconstruction in Tokyo was divided into two stages: the first to be finished at the end of the fiscal year 1925, and the second at the end of 1926. The first stage of the work was completed satisfactorily at the stated time. Six exchange offices, Ote, Yotsuya, Asakusa, Ginza, Naniwa and Sumida, were equipped with No. 1 type common battery switchboards, and telephone service restored. Additions to the central office equipment and outside plant were made to bring the capacity to 70,000 lines by January 1, 1926. Five automatic offices, Kyobashi, Honjyo, Shitaya, Kanda and Kayabacho, and a switching office (Kudan) were opened in new buildings and the total capacity of the telephone plant was brought to 83,000 lines by the end of March, 1926. All suspended stations were accordingly restored by that date.

The magneto toll board, which had been installed on an emergency basis, was replaced

¹"A Brief Description of the Damages Done by the Earthquake to the Wired and Wireless Telegraph and Telephone Installations of Japan," S. Inada, ELECTRICAL COMMUNICATION, Vol. 3, October, 1924.

on September 25, 1925, by a 100-position No. 1 type toll board, and service was resumed over 2.0 toll lines. The number of toll lines had been increased to 358 by the end of March, 1926, which was sufficient to care for the normal growth of toll service.

The second stage of the reconstruction work is now being carried out as a continuation of the first stage.

Schedules for Project of Automatic Office Installation

The traffic and plant estimates indicated that ten partial units of new equipment should be installed on an automatic basis by the end of the fiscal year 1926, to replace destroyed plant and to care for normal growth. For reasons of finance, and because of the volume of work involved, it was necessary to divide the project into two stages: The first, comprised of five local units and one switching unit to serve approximately 27,000 lines, to be completed during the fiscal year 1925, would provide sufficient facilities to restore service to all subscribers; the second, comprised of five local units serving approximately 18,000 lines, to be completed in 1926, would provide relief for the overloaded manual units and permit the distributing plant to be rearranged to conform to the proper central office areas. For both stages it was, of course, also necessary to provide the necessary call indicator and "A" board dialing facilities in the existing manual offices to care for inter-change of traffic between the manual and automatic subscribers.

The important factors determining the time intervals of the schedule for the first stage of the project were the time required for doing the engineering work, the time required for the erection of the new buildings, and the time at which the equipment could be delivered. None of the domestic factories were prepared to manufacture automatic equipment. Delivery for the first stage of the project was requested from both American and European factories. At that time, the schedules of all foreign telephone manufacturing companies were crowded in order to care for the excessive demand for telephone service brought about by the post-war conditions. However, Tokyo's need was considered paramount and, by taking extraordinary measures,

it seemed likely that the equipment could be delivered in the time required for the erection of the central office buildings. The detailed engineering was accordingly undertaken on an automatic basis.

Numbering Scheme

The number of units required in the exchange area at the time of the completion of the reconstruction work, made it necessary to use six-

code, was not feasible, for, while all of the telephone users are familiar with the Arabic numerals, many of them would be unable to read the English names. With the numbering scheme finally adopted, each number is given two listings in the directory, one for use when called by a manual subscriber and another when called by an automatic subscriber. The number to be used by manual subscribers consists of the office name written in Japanese characters and four Arabic numerals. Those to be used by automatic subscribers consist of six Arabic numerals with a space separating the second and third digits. Ultimately, when all of the units in the exchange area are converted to automatic equipment, one number only, comprised of six Arabic numerals, will be used for each station. Figure 1 shows a section from the present Tokyo directory.

Subscriber's Name	Office Name for Manual Use	Address
渡邊 シヅ	大手22-6339	神、佐柄木、五、堀方
渡邊 儀太郎 ヤマト商店	墨田74-4825	所、小泉、二一
渡邊 シヅエ	四谷35-3949	豊、東大久保、四四三
渡邊 周	浪花67-1578	日、堀江四ノ二、八木商店 東京出張所内
渡邊 修	四谷35-2443	麴、平河、六ノ二〇
渡邊 脩 平	浪花67-3303 浪花67-3812	日、郷藏、一ノ二
渡邊 充 郎	小塚85-5732	小、新諏訪、一五
渡邊 重 吉	牛込34-0476	牛、上宮比、三、松本方
渡邊 重 治	高輪44-1564	芝、田、五ノ三
渡邊 重 太郎	小塚85-3199	郷、駒込追分、三一
渡邊 重 太郎	青山36-1813	赤、青山南、五ノ四五
渡邊 銃砲店 渡邊 吉	浅草84-5133	浅、御藏前片、一〇
渡邊 寫眞館 渡邊 鳴瀧	墨田74-4303	南葛、龜戸、三八一
渡邊 俊吉 蝶々井造總本店	墨田74-0136	所、太平、一ノ六一
渡邊 凌 郎	牛込34-0827	牛、早稲田南、一一

Figure 1—Portion of Page of Telephone Directory

digit numbers for a considerable part of the stations, and if a combination five and six-digit numbering scheme were adopted it would be necessary later, as the number of units increased, to change the five to six-digit numbers. Largely for this reason, and also because the use of six-digit numbers permitted fuller advantage to be taken of tandem centers, it was decided to use six-digit numbers for all stations in the exchange area.

Due to the peculiarities of the Japanese written language, no satisfactory method was evolved for using characters for the first two digits of a station number to indicate the office code. Consideration was given to using one Japanese character to indicate one of the major districts into which the exchange area was divided, and five Arabic numerals. It was thought, however, that such numbers would be little, if any, easier to remember than numbers comprised of six Arabic numerals. The use of names written in English, with the first two letters used as an office

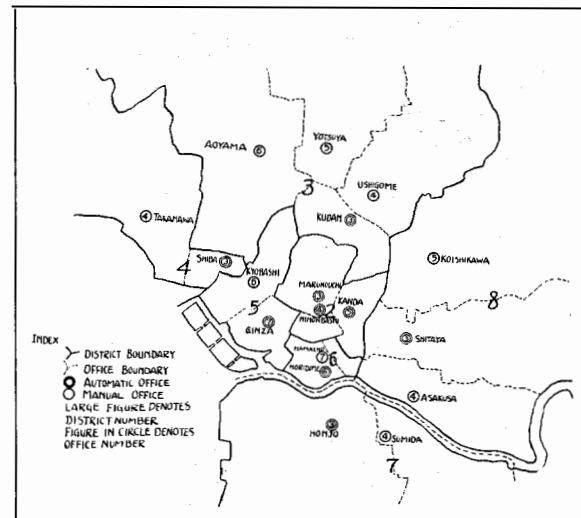

Figure 2—Seven Major Districts of Tokyo Telephone Area

Trunking Systems

The choice of the trunking and equipment arrangements was largely influenced by the numbering scheme adopted. The entire exchange area naturally divided itself into seven major districts, as indicated on the map shown in Figure 2. Studies were made to determine the relative economies of a trunking system using direct trunks between all offices, as compared with a system locating second selectors at tandem centers in each district. In making the studies individual consideration was given to the traffic from automatic offices to other automatic

offices, from automatic to manual offices, and from manual to automatic offices. The results indicated that large savings could be made by using tandem centers for routing traffic between automatic offices and for the traffic from automatic to manual offices. In the case of traffic from manual to automatic offices, the saving of trunks and selectors was not considered sufficient to off-set the loss of operating efficiency

least for a number of years to come, the savings, if there were any, due to using the director, would not offset the disadvantages introduced by the more complicated circuits and consequent increase in maintenance costs. Moreover, in Tokyo, full advantage could not be taken of any economies in outside plant that might result from the director, due to the fact that conduit lines and cables for inter-office trunks were already in

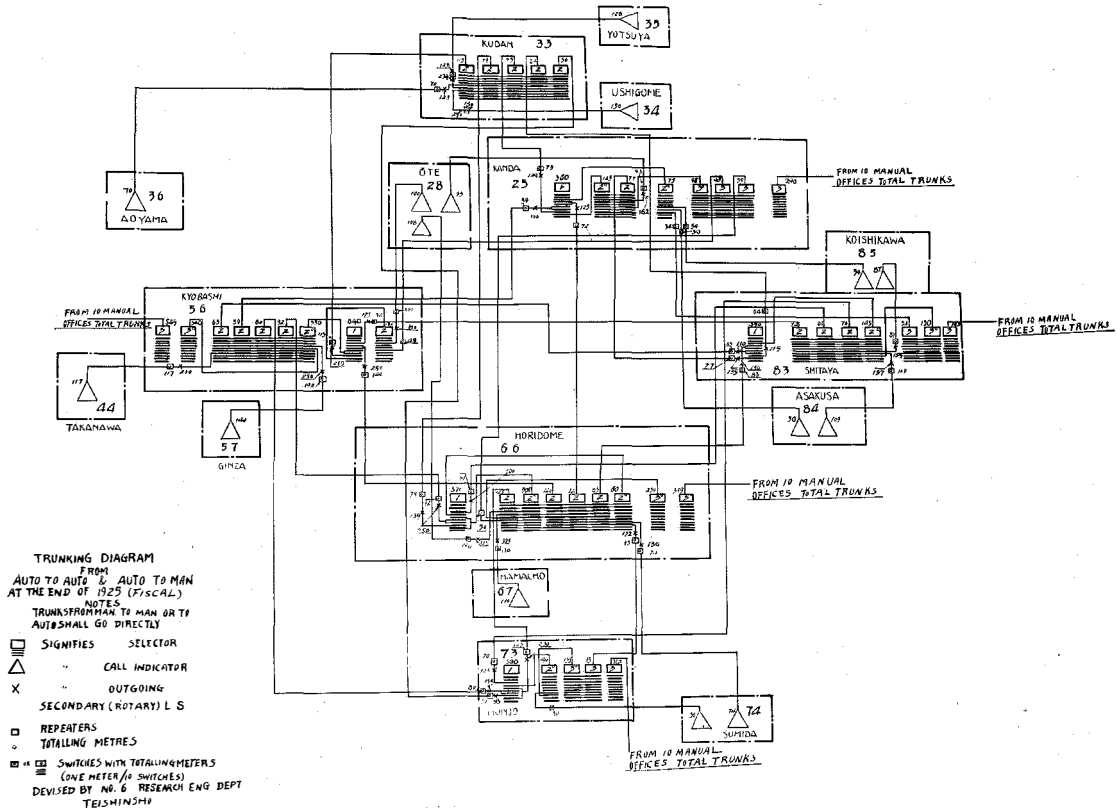

Figure 3—Trunking Diagram for First Stage Installation, Tokyo

introduced by requiring the operators to dial five-digit numbers in order to route the calls through the tandem centers.

Consideration was also given to the use of the director system. Sufficient data as to the costs and economies obtained with the director were not available at that time to permit a detailed study to be made. However, the use of numerals instead of letters in the office codes for the numbering scheme, made it impossible to obtain much benefit from the chief advantage claimed for the directors; that is, the ability to dissociate the routing of the calls from the actual office code digits dialled. It seemed that, at

place. Although some of these cables were damaged by the earthquake, the cost of restoring them would not be excessive. It was also thought that the director system was still in the development stage and that, if it were ordered, the chances of securing the deliveries required would be decreased. In view of these considerations, it was decided to proceed on the basis of a straight step-by-step trunking system. Figure 3 shows the trunking diagram adopted for handling the trunking between automatic offices and from automatic to manual offices for the first stage of the project. Figure 4 shows a similar diagram for the trunking system at the completion of the

second stage. The direct dial trunks from each manual to each automatic office and the direct call circuit trunks from each manual office to every other manual office are not shown on the diagram.

First Stage of Automatic Office Installation

The estimated traffic data for the end of the fiscal year 1925, on which the engineering for the first stage equipment was based, is shown on Table No. I.

Equipment Features

As indicated on the trunking diagrams, practically no features are used requiring special apparatus. 25-point primary rotary line switches without local secondaries were used in all offices.

mission and through ringing and supervision for the toll operator. The usual special services were provided, separate intercepting, repair and test desks being located in each office. The toll recording operators and the centralized information bureau are reached over a group of special service trunks, outgoing from special selectors in each office and terminating on a group of special incoming third selectors located in the building housing the toll board and information desks. As soon as space in the new Marunouchi Building is available it is planned to install there a new toll board and a new central information board. At that time a new group of incoming special third selectors will also be provided.

Each trunk board was located on a bed plate

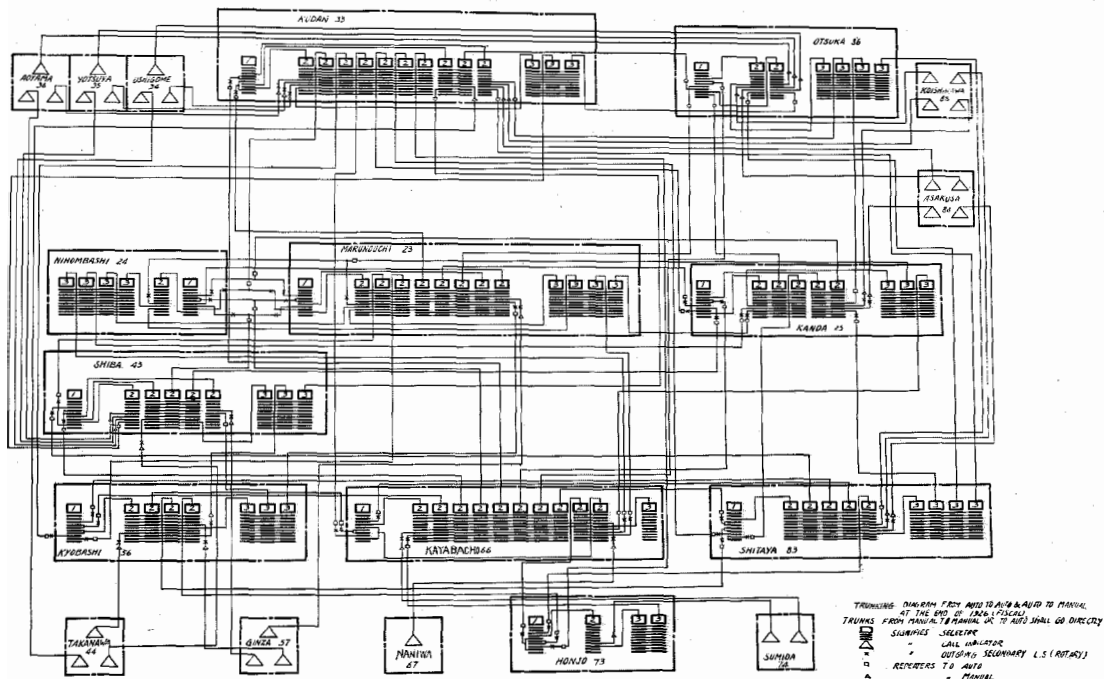

Figure 4—Trunking Diagram for Second Stage Installation, Tokyo

The same type line switches were also used as out-trunk secondary switches wherever the size of the trunk groups made it economical. The delayed impulse type dial standardized by the British Post Office was used to minimize the possibility of trouble which would result if the outgoing trunk secondary switch did not complete its hunting during the time interval between dialling the digits of a called number.

Toll train equipment was installed in each automatic office providing high efficiency trans-

mission and through ringing and supervision for the toll operator. The usual special services were provided, separate intercepting, repair and test desks being located in each office. The toll recording operators and the centralized information bureau are reached over a group of special service trunks, outgoing from special selectors in each office and terminating on a group of special incoming third selectors located in the building housing the toll board and information desks. As soon as space in the new Marunouchi Building is available it is planned to install there a new toll board and a new central information board. At that time a new group of incoming special third selectors will also be provided.

Each trunk board was located on a bed plate of $\frac{1}{4}$ " boiler plate set flush with the floor, in order to distribute the weight of the board as a protection against earthquake shock. Special bracing between boards was also provided, amounting practically to a grill work over the entire equipment.

In all first stage offices power plants having duplicate sets of batteries are used, each battery having capacity for carrying the office twenty-four hours. The wiring and control apparatus are arranged for charging one battery while the

TABLE I—Main Traffic Data for the First Stage Job (at the End of the Fiscal Year 1925)

Districts	Inward		Ote	(Kanda)	Ushigome	Yotsuya	Aoyama	Takanawa	(Kyobashi)	Ginza	(Kayabacho)	Naniwa	(Honjyo)	Sumida	(Shitaya)	Asakusa	Koishikawa	Total
	Outward	B.H.C. per Line No. of Lines																
2	Ote	4,545	2.57	(3,697)	(1,700)	(1,119)	(441)	(1,057)	(1,885)	(2,760)	(847)	(1,868)	(842)	(953)	(792)	(1,062)	(635)	(20,309)
	(Kanda)	3,722	1.45	1,796	1,122	685	306	853	1,593	1,360	715	1,454	570	358	485	568	403	12,919
				763	547	590	186	285	451	320	200	625	349	166	382	305	350	6,825
3	Ushigome	6,202	2.04	(2,250)	497	4,100	728	1,025	1,426	(2,300)	546	625	566	(563)	485	(488)	853	(17,972)
	Yotsuya	6,587	1.00	1,798	1,387	2,235	603	580	667	1,165	404	410	351	155	500	277	670	15,766
	Aoyama	7,143	1.10	(1,354)	680	1,387	2,235	603	580	(1,046)	404	410	351	(337)	500	(500)	670	(11,724)
				809	1,387	2,235	603	580	667	640	404	410	351	130	280	280	670	10,346
				(717)	1,387	2,235	603	580	667	(906)	404	410	351	(205)	(270)	(270)	670	(8,204)
				546	820	835	1,555	870	497	633	200	300	225	68	300	145	265	7,499
4	Takanawa	6,965	1.19	(1,360)	1,128	767	934	2,768	1,044	(1,847)	486	578	441	(437)	373	(470)	410	(13,438)
				986	1,128	767	934	2,768	1,044	1,264	486	578	441	183	373	395	410	12,152
5	(Kyobashi)	6,112	2.00	(2,014)	1,149	720	446	1,015	3,338	1,438	757	800	780	(772)	408	(500)	427	(15,050)
	Ginza	4,195	2.47	1,709	(1,650)	(1,000)	(650)	(1,450)	1,495	(6,150)	485	(1,800)	429	324	377	381	500	14,178
				(2,850)	1,429	855	585	1,373	1,495	2,856	485	502	429	(1,210)	377	(917)	(500)	(21,383)
				1,423	1,429	855	585	1,373	1,495	2,856	485	502	429	194	377	286	399	13,108
6	(Kayabacho)	2,955	3.10	(1,225)	593	552	319	461	900	456	2,340	1,212	580	200	370	350	380	(10,218)
	Naniwa	6,146	1.85	1,055	714	546	311	487	729	(2,075)	971	3,040	855	(900)	656	(800)	411	10,048
				(2,326)	714	546	311	487	729	506	971	3,040	855	408	656	620	411	(15,633)
				1,521	714	546	311	487	729	506	971	3,040	855	408	656	620	411	12,587
7	(Honjyo)	5,000	1.40	(930)	521	290	144	307	713	359	540	810	2,760	505	382	(650)	271	(9,488)
	Sumida	2,841	1.33	752	(480)	(320)	(170)	(330)	330	(1,295)	175	(1,000)	504	(3,230)	372	(900)	(280)	9,074
				433	217	230	137	223	330	190	175	443	504	843	247	372	179	(10,775)
				970	217	230	137	223	330	190	175	443	504	843	247	372	179	4,687
8	(Shitaya)	5,796	0.92	(923)	518	444	171	282	445	395	420	674	303	205	1,012	659	570	(7,456)
	Asakusa	5,905	1.05	578	(637)	(600)	(230)	(460)	469	(1,331)	(550)	(850)	(470)	(840)	675	(2,655)	(650)	7,111
	Koishikawa	6,886	1.06	(1,163)	305	293	395	148	363	358	350	797	366	330	675	(600)	345	(12,056)
				682	305	293	395	148	363	(794)	395	657	294	148	622	322	2,066	8,044
				(988)	381	960	1,004	380	474	479	395	657	294	148	622	322	2,066	(10,437)
				705	381	960	1,004	380	474	479	395	657	294	148	622	322	2,066	9,400
	Total	81,000	1.54	(23,530)	(16,904)	(12,542)	(7,268)	(11,851)	14,610	(23,451)	(9,316)	(15,449)	(9,749)	(10,832)	(7,581)	(11,126)	(8,940)	(190,968)
				15,556	15,498	11,668	6,953	11,366	14,610	12,419	8,984	13,127	9,373	4,217	7,274	7,542	8,001	153,744
	Grouping Factors...			0.80	0.80	0.75	0.75	0.75	0.80	0.90	0.85	0.80	0.85	0.85	0.80	0.75	0.85	

Remarks: Names in Brackets denote automatic exchanges.

Bracketed figures indicate traffic for which the office was designed, and allow for changes resulting from cut-over of the new offices at various periods.

other is in service so that no counter E.M.F. cells are required. Two motor-driven charging generators are provided, each having capacity to charge the battery, one for regular charging and one for reserve. Both are telephone type machines, so that, in case of emergency, they can be used to carry the switchboard load direct without introducing undue noise in the talking circuits.

Two ringing machine sets are provided, one A.C. motor generator set, operated by current from the commercial power supply (for regular service) and one dynamotor for emergency service, operating from the 50-volt central office battery. The ringing machines are fitted with the necessary interrupters for furnishing the tones and flashes required by supervisory and discriminating features.

Buildings

The building program for the first stage of the project included six new buildings, each providing space for one full unit of automatic equipment and for tandem switches where required. As stated above, only five local units were to be installed during the first stage, but, in order to house the tandem switches required for the trunking system for that stage, it was necessary to advance the completion of one of the second stage offices (Kudan).

All the buildings are of reinforced concrete, fireproof construction. Full advantage was taken of the information available from analysis of injuries done to buildings by the 1923 earthquake and conflagration. They were designed in accordance with the latest engineering practice to withstand an earthquake shock having a seismic factor of 0.2 (ratio of acceleration of earthquake to that of gravity), which is twice the intensity of that of the earthquake of 1923.

Metal sheathed doors and double windows are provided for the terminal and switch rooms. The inner windows are of the French type, using hinged metal frames. The outer windows are wire glass set in metal sashes. Steel roller fire shutters are provided at all windows and doors of the switch and terminal rooms, arranged to close by their own weight after being manually released. In addition, water curtains are provided at the windows, arranged to be turned on

from a point outside the building after the fire shutters are closed.

In order to provide against a failure of the water supply in case the mains were broken at the time of an earthquake, an elevated reinforced concrete storage tank for water is provided, adjacent to each of the buildings, with a capacity estimated to be sufficient to supply the water curtains and local fire hose during a conflagration. These tanks are designed to withstand an earthquake of an intensity equal to that against which the buildings themselves are designed.

To insure the satisfactory operation of the equipment during the periods of extreme humidity which prevail during the summer season, a combined heating and air-conditioning plant is provided at each building. The system used, known as the "Adosole" system, was developed in Japan, and consists of four principal elements: a heating plant of the usual hot-air furnace type, and "Adosole" de-humidifying plant, an air-washing plant, and a circulating system of pipes and blowers. The piping is so arranged that the heating, drying and washing features may all be used at the same time or any of them by-passed when desired.

The de-humidifier consists of a tank holding, in the case of the telephone buildings, approximately ten tons of a porous mineral mined and treated chemically in Japan and given the trade name "Adosole", which absorbs the moisture from the air driven through it. After drying out, "Adosole" may be reused and duplicate tanks are accordingly provided, with piping so arranged that, while one is in service, in the air-circulating system of the building, the other is connected to a pipe line which blows air heated by a separate heater through it and dries it. These plants are expected to maintain at all seasons a temperature between sixty-five and eighty-five degrees Fahrenheit and a relative humidity between sixty and seventy in the switch and terminal rooms.

The precautions necessary for protection against earthquakes rather than economies in ground area or equipment lay-outs were in general the controlling factors in determining the height of the buildings and the beam spans and column centers. Standards for the dimensions between columns were established and used in all buildings. All terminal and switch rooms

were made three bays wide and the differences in floor space requirements for the various offices were cared for by buildings of different lengths. Figure 5 shows a typical floor plan arrangement for a switch room. It will be noted that an arrangement satisfactory from a cabling and maintenance standpoint is obtained without excessive waste of space.

Installation and Cutovers

The reconstruction of the buildings was far enough advanced and sufficient equipment was

on hand so that the installation in two offices was started in February, 1925. The installation work was performed by the installing forces of the Tokyo Operating Division.

The usual training methods were followed in familiarizing the manual operators with the new methods of operating involved at both the "A" positions and the call indicator positions. Several demonstration sets of automatic equipment were set up in accessible places in the automatic office areas and used as widely as possible for training the public in the use of dial stations.

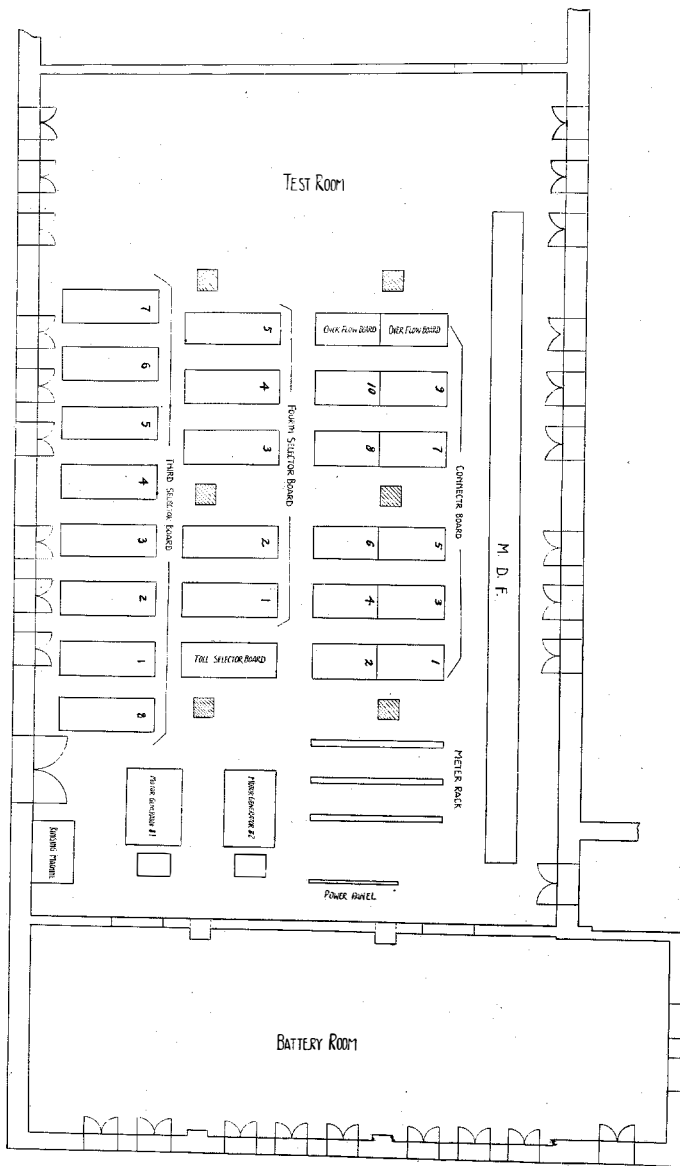

Figure 5—Floor Plan for Switch Room, Ground Floor, Otsuka Office, Tokyo

TABLE II—Main Traffic Data for the Second Stage Job (at the End of the Fiscal Year 1926)

Districts	Inward		(Marunouchi)	(Nihonbashi)	(Kanda)	(Kudan)	Ushigome	Yotsuya	Awoyama	(Shiba)	Takanawa	(Kyobashi)	Ginza	(Kayabacho)	Naniwa	(Honiyo)	Sumida	(Shitaya)	Asakusa	Koishi-Kawa	(Otsuka)	Total	Ote		
	B.H.C. per Line	No. of Lines																						Outward	
2	(Marunouchi).....	3,800 4.07	3,420	1,780	640	540	370	765	750	500	760	2,020	2,050	755	815	735	300	510	390	(640) 465 (370)	175	(17,915) 17,740 (11,425)	1,320		
	(Nihonbashi).....	4,300 2.15	1,140	1,640	530	285	220	340	275	310	410	1,350	720	580	1,440	520	260	440	490	265	105	11,320 (9,140)			
	(Kanda).....	4,500 1.45	765	640	1,580	365	(620) 180	(590) 350	225	155	(285) 190	545	390	240	755	420	200	460	370	305	115	8,250			
3	(Kudan).....	4,150 0.95	625	435	435	620	(280) 585	380	170	(380) 210	410	460	250	285	200	80	300	185	265	105	(6,895) 6,280 (18,050)	405			
	Ushigome.....	5,200 1.03	580	460	240	345	(4,600) 460	(1,720) 255	140	(1,150) 200	340	340	215	300	145	70	240	160	390	200	(11,545) 6,340 (11,545)				
	Yotsuya.....	4,000 1.05	575	380	410	595	(1,570) 440	(2,235) 980	390	150	(585) 185	(667) 420	(640) 335	(410) 220	(351) 235	(130) 80	(500) 320	(280) 160	(670) 335	125	(11,045) 6,565 (11,045)		640		
	Awoyama.....	8,100 1.10	760	515	270	430	280	510	2,900	475	510	560	720	225	340	255	80	340	165	220	80			9,635	
4	(Shiba).....	3,000 1.45	600	370	260	210	(430) 195	235	480	800	560	550	750	315	315	220	80	200	140	(245) 180	65	(6,825) 6,525 (13,528)	645		
	Takanawa.....	5,400 1.15	740	480	220	220	(395) 170	(430) 265	(934) 645	500	(2,768) 1,480	(1,044) 710	(1,264) 780	(486) 275	380	310	140	255	335	180	70	8,155			
5	(Kyobashi).....	7,050 2.00	1,480	1,520	560	390	(1,300) 280	(720) 440	510	470	(1,015) 700	3,840	1,650	870	920	900	370	470	440	(490) 355	135	(18,050) 16,300 (18,278)	2,000		
	Ginza.....	5,100 2.47	1,940	1,070	510	530	(1,610) 380	(855) 510	715	950	(1,373) 730	1,830	3,500	590	615	525	240	460	350	(485) 355	130	15,930			
6	(Kayabacho).....	3,500 3.10	820	945	330	325	(670) 180	(552) 325	375	295	(461) 240	1,060	540	2,750	1,430	685	235	440	410	(450) 325	125	(12,898) 11,835 (15,688)	1,180		
	Naniwa.....	7,100 1.85	920	1,410	710	310	(800) 260	(546) 325	360	270	(487) 295	845	590	1,130	3,760	990	475	760	720	(475) 345	130	14,605			
7	(Honiyo).....	5,800 1.40	635	720	355	120	(590) 120	(290) 220	170	155	(307) 200	830	420	630	940	3,200	585	440	480	(315) 225	90	(11,272) 10,535 (6,133)	905		
	Sumida.....	3,500 1.33	340	385	200	100	(245) 80	(230) 185	170	140	(223) 135	400	235	215	545	620	1,040	305	460	160	60	5,775			
8	(Shitaya).....	6,700 0.92	535	520	500	230	(585) 215	(444) 285	200	160	(282) 105	520	460	490	780	350	240	1,170	765	(665) 480	185	(9,081) 8,250 (9,888)	705		
	Asakusa.....	6,800 1.05	450	540	350	225	(330) 135	(395) 230	170	175	(363) 240	540	410	400	920	420	380	780	2,490	(400) 295	150	9,300 (12,318)			
	Koishikawa.....	8,000 1.06	560	500	320	370	(770) 320	(690) 340	(440) 480	(500) 320	(1,080) 230	(1,004) 480	(440) 320	(315) 230	(474) 175	(595) 405	(555) 335	(460) 550	(760) 250	(340) 125	(170) 520	(720) 270		(375) 270	(2,400) 1,850
(Otsuka).....	2,000 1.00	210	190	120	130	230	180	120	85	65	165	150	125	210	90	45	200	155	250	330	305	3,050			
Total.....	96,000 1.56	(17,305) 17,095	(14,690) 14,500	(9,430) 8,540	(7,015) 6,340	(18,065) 5,615	(13,288) 7,670	(10,595) 9,390	(6,475) 6,130	(12,813) 7,450	(19,381) 17,465	(16,824) 14,905	(11,530) 10,640	(16,523) 15,520	(11,902) 11,070	(5,268) 5,025	(9,408) 8,610	(9,370) 8,935	(10,535) 7,245	2,605	(223,024) 184,750	21,270			
Grouping Factors..		0.90	0.90	0.80	0.75	0.75	0.75	0.75	0.80	0.80	0.90	0.90	0.85	0.85	0.85	0.80	0.80	0.75	0.80	0.75	0.80	0.75	0.80		
Ote.....	5,200 2.57	850	780	550	940	740	685	540	780	2,250	1,850	890	1,510	840	370	630	590	675			18,850				

Remarks: 1. Names in Brackets denote automatic exchanges.

2. Bracketed figures indicate traffic for which the office was designed, and allow for changes resulting from cut-over of the new offices at various periods.

3. Ote is to be replaced by Marunouchi and Nihonbashi.

Individual instruction was also given the subscribers at the time the dial stations were installed.

In order to avoid the confusion and resultant reaction on the service incident to cutting over large numbers of subscribers from manual to the new automatic equipment, it was decided to first connect to the automatic equipment only subscribers to whom it had until that time been impossible to restore service. The automatic offices were opened, serving from 1,200 to 4,000 such subscribers. As soon as feasible, after the offices were opened, subscribers were transferred from manual to automatic offices in order to relieve the overloaded condition in the former.

The installation of the equipment in the first two automatic offices to be opened, namely, Kyobashi and Honjyo, together with the tandem switches at other centers required for their operation, as well as all call indicator and "A" dialing equipment, was completed and the two offices placed in operation in January of this year. The remaining three offices, Shitaya, Kanda and Kayabacho, were cut into service in March.

Second Stage of Automatic Office Installation

The equipment engineering for the second stage of the reconstruction project was based on the traffic data shown in Table No. II. The data shows the estimated traffic at the end of the fiscal year 1926, proper allowances being made to take care of normal growth and operating margins.

Two of the three new buildings required for the second stage (Shiba and Otsuka) are of the same design as those for the first stage and each provide capacity for one full unit of automatic equipment. The Marunouchi Central Office Building also follows the same general design as that for the first stage offices. It is, however, four stories high instead of two, and of sufficient length (approximately 250 feet) to provide space for ultimately housing two automatic units, the Tokyo toll switchboard and the switchboard and associated equipment necessary for the centralized special services. The width of the switch rooms and the dimensions for column centers have, however, been kept the same for this building as for the other offices.

The charging circuits and equipment for the

second stage offices were engineered in approximate accordance with the standards used by the Bell System in America. Two sets of batteries will be provided, each having capacity sufficient to carry the office for a period equivalent to four times the busy hour drain instead of each set having twenty-four hours capacity. Emergency cells will be provided and arranged so that, in an emergency, they can be placed in series with the main batteries, and advantage taken of the full reserve capacity of the cells without lowering the voltage below the operating limits of the equipment. The power wiring and control apparatus will be so arranged that the Central Office load may be supplied directly from the charging generators with either one or both sets of batteries floating; also, either set of batteries may be charged while the other is in service.

Equipment will be at hand so that installation can start when the new second stage buildings are ready. The units are scheduled for completion in time to permit all offices to be placed in service before the end of March, 1927. At that time the Tokyo exchanges will have capacity for slightly less than 100,000 lines, of which approximately one-half will be served by automatic central office equipment.

Reconstruction in Yokohama

Two new automatic offices were opened in Yokohama in March, 1926, having capacity for a total of 10,600 stations. This capacity was sufficient to permit the cut-over of 4,500 stations from the temporary manual office which had been installed on an emergency basis and to restore to service all other stations to which it had been necessary to suspend service since the earthquake.

The construction of a building for housing a permanent common battery toll office has been delayed, due to difficulty in determining the site boundaries, which will be affected by the city's reconstruction plan.

Numbering Scheme

It is expected that it will be far in the future before the Yokohama exchange will require more than eight central office units and, accordingly, a five-digit numbering scheme was adopted; That is, each telephone number consists of one office code number and four numerical digits.

For the initial offices, Honkyoku and Chojyamachi, the code digits are two and three, respectively.

Equipment Features

Secondary line switches are provided between the primary line switches and first selectors, in order to increase the selective range of the primary switches. Special relay groups were installed on the secondary line switchboards which give a busy-back tone to the calling subscriber when no idle trunk is found between the

Each power plant has duplicate batteries and charging sets. Each battery at Honkyoku has a capacity of 2,400 ampere hours and each battery at Chojyamachi has a capacity of 1,000 ampere hours. One of the charging machines is motor-driven from the commercial source of power; the other is driven by a Diesel engine and is used for emergency purposes.

Buildings

The Yokohama Central Office Buildings are of the same general type as the Tokyo buildings.

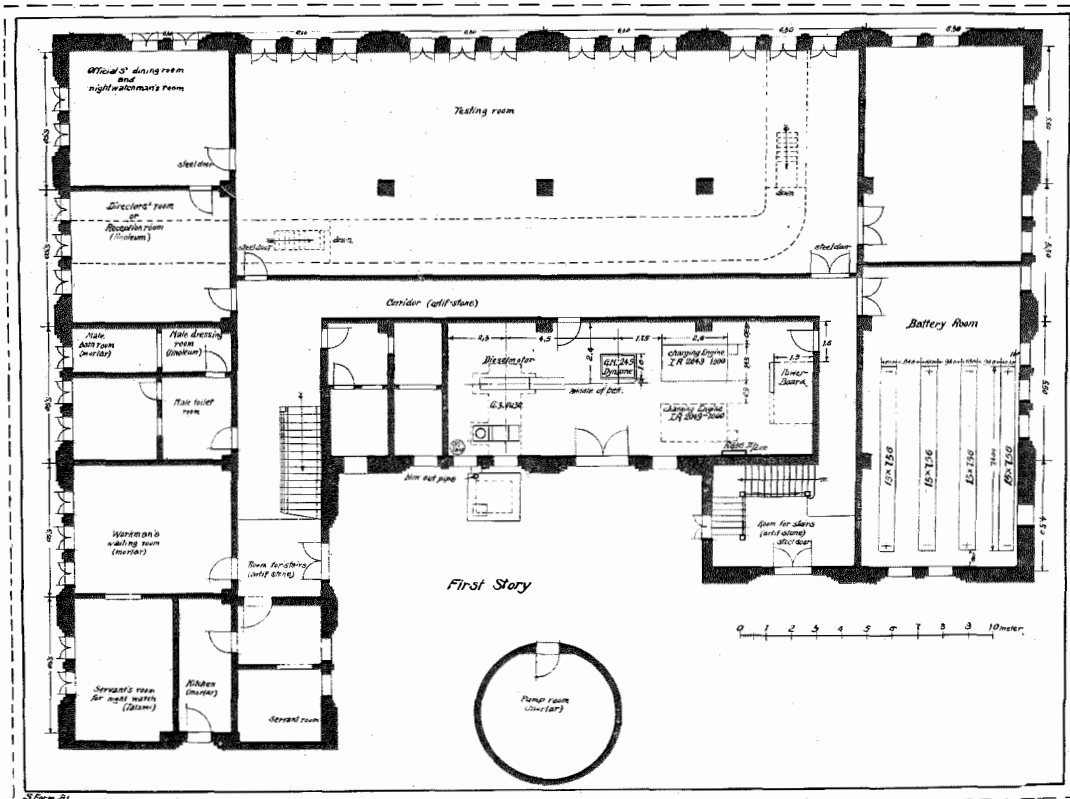

Figure 6—Plan of Building with Equipment, Honkyoku, Yokohama

primary line switches and first selectors. Incoming inter-office trunks terminated at secondary selectors and repeaters are provided at the outgoing end of such trunks. In order to secure higher trunk efficiency special grading is used on all switches. The grading is actually effected at the terminals of intermediate distributing frames installed between switchboards. Intercepting and test desks are provided in each office, but the information and recording service is centralized at the toll office.

The emergency lighting circuit is, however, fed from the 60-volt main battery instead of from 50-volts, as in Tokyo. Floor plans of the Honkyoku Building are shown on Figure 6.

Installation and Cutovers

The installation of the two initial offices was started on July 1, 1925, and both offices were cut into service on March 25, 1926, each office providing approximately one-half of the combined capacity of 10,600 stations. The equip-

ment was engineered on the traffic data shown in Table No. III.

TABLE III
Main Traffic Data for Reconstruction Job, Yokohama.

Outward	Number of Lines	B.H.C. Inward per Line	Honkyoku	Chojyamachi	Total
Honkyoku	5,224	1.63	6,620	2,000	8,620
Chojyamachi . .	5,216	0.75	2,000	1,912	3,912
Total	10,440	1.20	8,620	3,912	12,532

The same methods as those used in Tokyo were followed in Yokohama for training the public and the special service operators.

Conclusion

From the above description it is seen that the reconstruction project for Tokyo and Yoko-

hama is not remarkable because of novel engineering methods, service practices, or equipment arrangements. It is, however, remarkable because of the magnitude and difficulty of the work undertaken on an emergency basis. The amount of plant destroyed by the earthquake and fire exceeded that lost in any other disaster in the history of the telephone business and most of the replacing equipment had to be secured from factories thousands of miles distant.

The successful co-ordination of the efforts of the Department of Communications of the Japanese Government and the factories in Asia, Europe and America, is a proof that the telephone industry's ideal of "Service First" is an international standard.

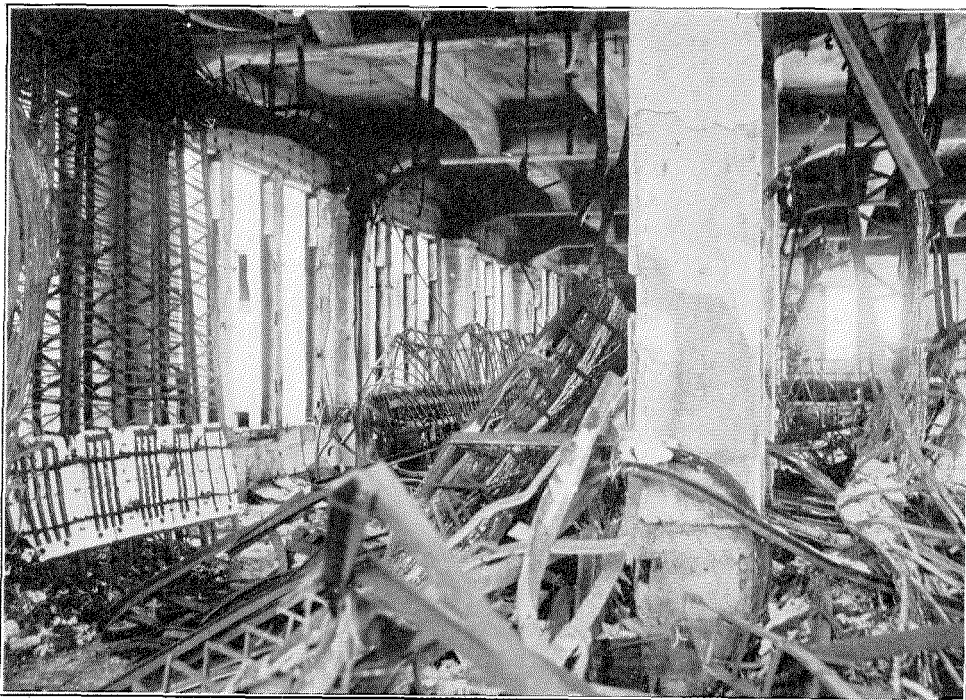

Ginza Office Terminal Room, Tokyo, after the Earthquake of September 1, 1923.

The Public Address System in Liverpool Cathedral

By ASHLEY F. RICKARD

European Engineering Department, International Standard Electric Corporation

IN the history of the Church of England the opening of Liverpool Cathedral on July 19, 1924, was a most important event; for since the Reformation in the 16th century, this is the first Anglican Cathedral Church to be constructed in the Northern Ecclesiastical Province. From the time of the Reformation only three

mates will not be finished for fifteen or twenty years.

About three months before the Consecration and official opening of the Cathedral, Sir Gilbert Scott, the architect responsible for its design, had under consideration with Standard Telephones and Cables, Limited, the installation of

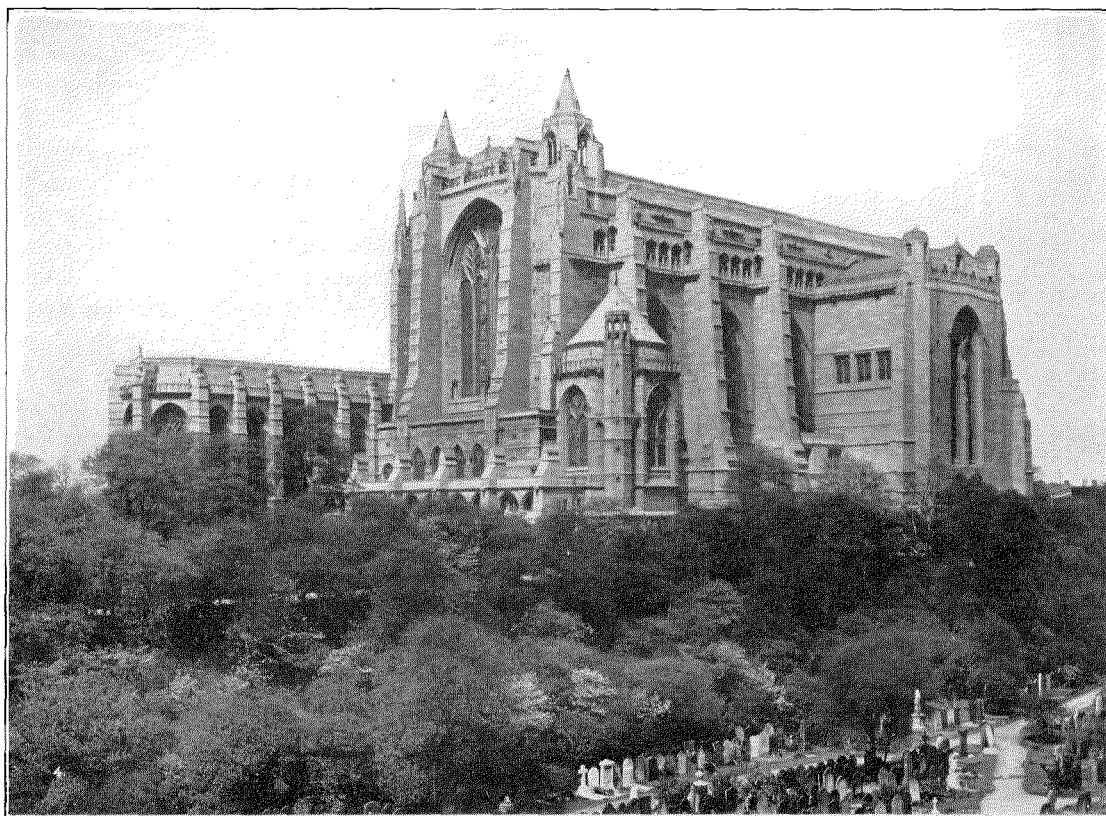

Figure 1—Liverpool Cathedral

Cathedrals have been built in England. Liverpool Cathedral ultimately will be the largest church in England, and in point of size it will be exceeded only by St. Peter's at Rome and by the cathedral of Seville. The portions opened in 1924 consist of the East End comprising Sanctuary and Choir, and the North and South Transepts. The West End or Nave is now in process of construction, and according to esti-

a Public Address System for the Consecration Ceremony. A large attendance was expected, including Their Majesties the King and Queen; and the Cathedral Authorities were most anxious that the sermon, preached by the Archbishop of York, should be heard in every part of the building. Special arrangements were being made for the accommodation of the great congregation that would attend the service, and



Figure 2—The Choir, Looking East

temporary stands and galleries had been erected behind the choir stalls and in the aisles on either side of the Sanctuary.

The problem was entirely different from that usually met with in the installation of Public Address Systems, and the difficulties presented were altogether greater. It will be appreciated from the illustrations of the interior (Figures 2 and 3) that the Cathedral is a magnificent structure in Gothic style (Figure 1), the conception of which seems to be not of a unit built up of several parts but of a solid mass hollowed out and carved. There is, therefore, a notable absence of detached piers and shafts. The introduction of Loud Speaking Projectors in positions suitable for their proper use with the Public Address System, without detracting from the general architectural effect, consequently was difficult.

For the purposes of the Consecration Ceremony, it was thought that the best solution of the difficulty would be to mount the projectors in the electric-light pendants. The illustration (Figure 2) showing the Choir, discloses the electric-light pendants hanging over the central space. The pendant on the left hangs in front and above the Lectern, which is situated at the foot of the left-hand column of the Chancel Arch. Although the electric-light pendants look comparatively small, they are actually twelve feet in height and seven feet six inches in diameter. Two folded type box projectors were fixed inside the upper hexagonal portion of the pendant above the Lectern, one pointing down into the North Transept and the other pointing forward into the central space. A single projector was fixed in the other pendant, shown on the right pointing down into the South Transept. Two other folded type projectors were installed in the choir, one beneath the organ balcony and the other behind

the left column of the central arch.

As it was not permissible for any of the cable leading to these projectors to be seen, it was necessary to run the cable feeding the projectors in the electric-light pendants carefully along the suspension chains from the roof, which at these points was 110 feet from the floor. It will be appreciated that considerable difficulty and not a little risk was involved in this work. The running of cable to the projectors in the choir was a much simpler matter, as easy routes for the wiring could be found where the cable was hidden from view. To provide for the Consecration Ceremony, the Amplifier System was located in the organ loft; it consisted of the standard apparatus comprising a No. 2 Public Address System. One microphone-position only was required, this being in the Lectern. The cable running to

this microphone was laid in a vertical crevice in the moulding of the left column supporting the Choir Arch, in such a way that it was inconspicuous. The microphone itself was mounted in a temporary fixture clamped to the front of the Lectern, so that it would be located about four feet from the speaker. It should be explained that, owing to the fact that the Pulpit proper is not yet built, the Lectern is used by the preacher as well as by the reader of the Lessons.

As the result of the success of the Public Address System in amplifying the address given by the Archbishop of York at the Consecration Ceremony, the Bishop of Liverpool decided that it would be necessary to have it installed in the Cathedral as a permanent fixture, and the description of the permanent system subsequently installed is the real object of this article.

In designing the layout of the permanent installation, a number of changes in the method adopted for the temporary system were necessary. In the first place, the position of the projectors in the electric-light pendants was not considered to be correct. These projectors were forty feet from the ground and although the results obtained in this position were reasonably good, it was realized that great improvements could be effected by reducing the height to twenty-five feet. As it was obviously impossible to lower the lighting pendants, the idea of using them for containing the projectors had reluctantly to be abandoned. After a considerable amount of discussion with the Cathedral Authorities, permission was obtained to fix the projectors on the stone columns (Figure 3) in positions where they would be correctly disposed to the microphone and at the same time where they would cover the desired areas in the most efficient manner.

Another important change, in-

volving complete revision of the Cabling System, was the relocation of the Amplifier System (Figure 4) from the organ-loft into the basement below the Cathedral floor. The position in the organ-loft was obviously unsuitable for anything but a temporary demonstration, on account of the restricted space. The position in the basement finally chosen was a very suitable one, the floor space available being ample, and as the Cathedral heating apparatus is situated in the basement the atmosphere is warm and dry at all seasons of the year.

It will be remembered that for the Opening Ceremony only one microphone, located at the Lectern, was used, but in the permanent installation it was necessary to arrange for two other positions, one at the Bishop's Throne and the other at the High Altar. The microphone at

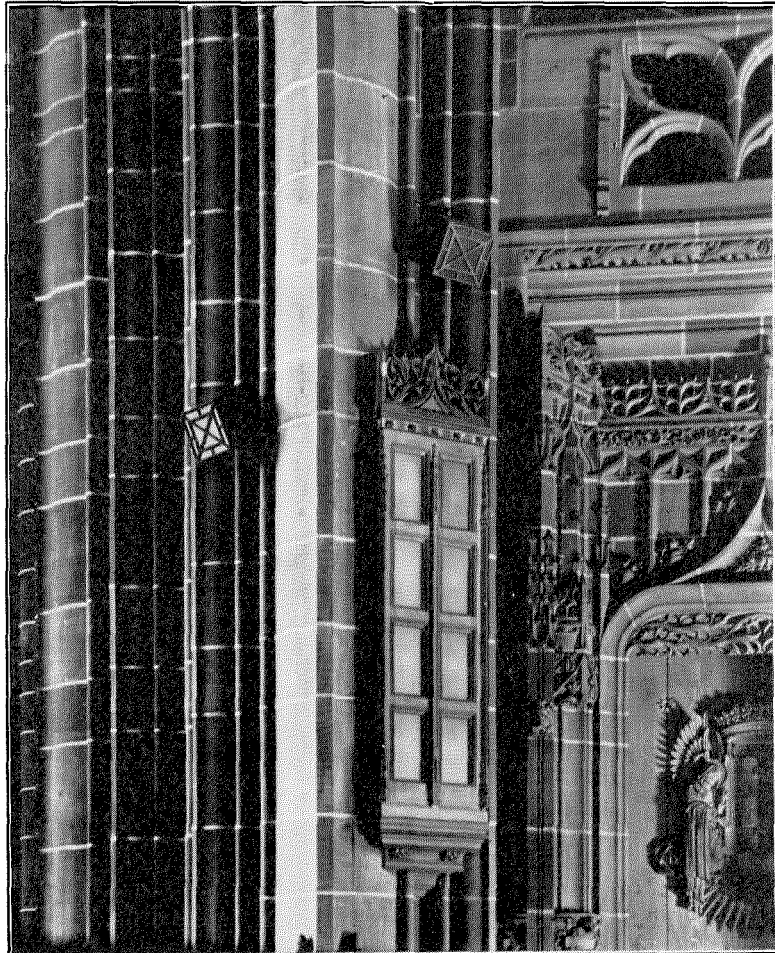

Figure 3—Column on North Side of Chancel, Showing Voice-projectors in Position

the Bishop's Throne was required to be fixed in such a way that it, together with the mounting bracket, could be removed at a moment's notice. The microphone at the High Altar normally would not be in position but arrangements were to be made so that it could be plugged in and mounted in the desired position when required.

In addition to these requirements, two observation telephone points were to be estab-

measuring 5 ft. x 5 ft. x 4 ft. and weighing over three tons.

The cabling from the output side of the amplifier to the various projector units is carried out with No. 18 S.W.G. V.I.R. twin lead covered round cables and from the microphone positions to the input side of the amplifier with No. 18 S.W.G. V.I.R. 3-conductor lead covered round cables. There are seven projector circuits, four of which follow one route and the

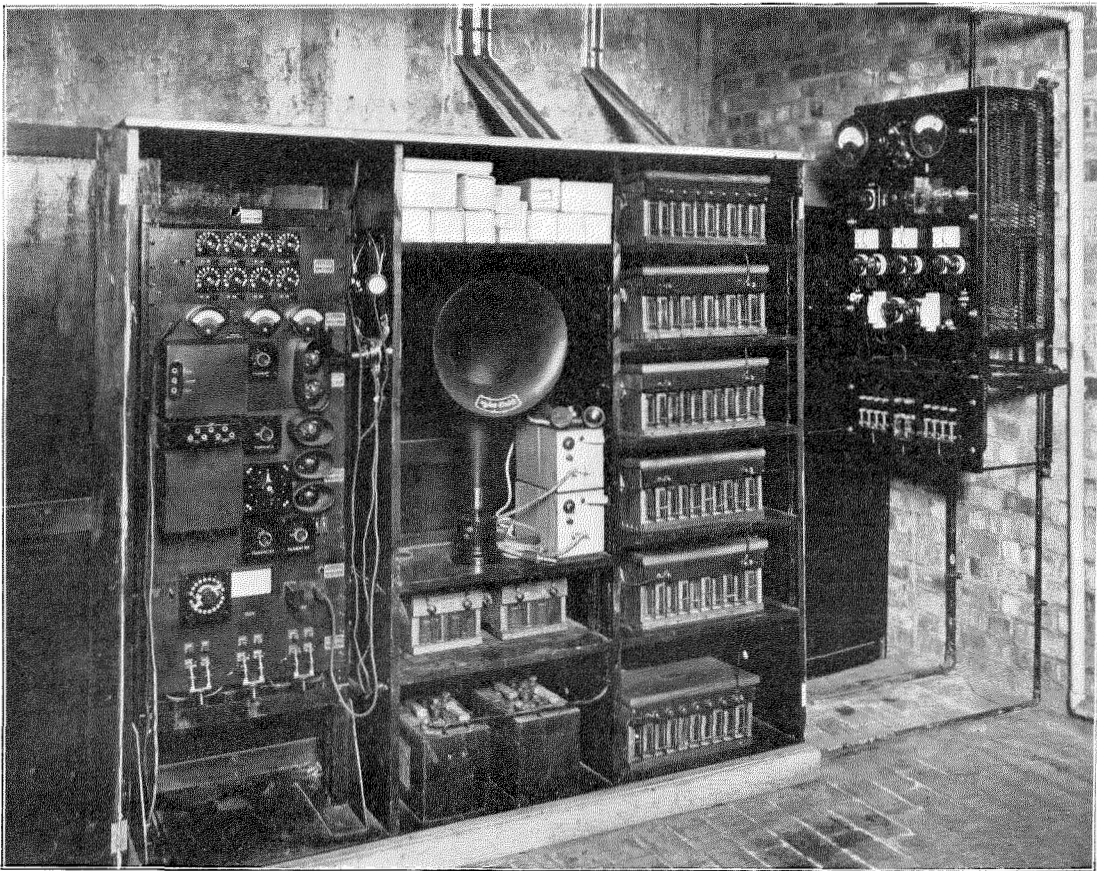

Figure 4—Amplifying and Battery Charging Equipment

lished, one in the South Transept and the other in the South Sanctuary Aisle. None of the cabling used throughout the System was to be visible at any point inside the Cathedral.

Those who have had experience in the installation of an invisible cabling system in a finished building of this type will appreciate that the task was by no means easy, especially as the Cathedral has massive columns, marble flooring and stone walls, some of the stones

remaining three another route. The whole of the cabling throughout the system runs on wooden baseboards in the manner illustrated in Figure 4.

Four of the projector cables run across the basement, and at the other side three of them enter one of the air-ducts and run along the duct until a vertical airshaft is reached. They are brought up this shaft into a space occupied by a group of organ pipes and led to a point

on the main right-hand column supporting the chancel arch. There are two projectors on this column, and the two cables leading to them are buried in the cement between the stones of the column, so that they are hidden entirely. The other is taken through into the South Transept Annexe and to the projector which serves this area, the cable being buried in the cement at all points where it otherwise would be visible.

The fourth projector cable continues along the length of the basement, enters another duct, and is brought up through an air-shaft on the left side of the Sanctuary. From there it is carried to a projector mounted on the balcony surrounding the organ. The same cable is extended also to another projector which serves the aisle on the left of the Sanctuary, that is, it is in parallel with the projector mounted on the organ balcony.

The remaining three projector circuits are carried round the wall of the basement and by means of a duct through a shaft are brought into the organ-loft. From the organ-loft the three cables are carried to the left column supporting the Chancel Arch and then to the three projectors which are mounted on this column, the cable being buried in the cement.

There are two microphone cables, one leading to the Lectern (Figure 5) and the other to the Bishop's Throne (Figure 6). The latter cable also has an extension to the High Altar, so that the microphone from the Bishop's Throne may be placed on the High Altar when required. These cables run from the amplifier in much the same way as already described for the projector cables, but by different routes. The ends are finished on a special jack box which provides for bringing the microphone into use by means of a 4-way plug.

Two observation circuits may be seen (Figure 4) running alongside the microphone cables at the point where they leave the amplifier; they are brought out at the desired points by running them through different ducts and bringing them up through airshafts into the Cathedral. One telephone point is in the aisle on the right of the Sanctuary and the other in the corner of the South Transept.

The amplifier equipment is housed in a cupboard (Figure 4), specially made for the purpose, with hinged doors on the front and sliding doors

at the back. The cupboard stands out about two feet from the wall, so that the back of the equipment may be conveniently inspected. In the compartment on the left-hand side of the cupboard is the Amplifier System, consisting of the Power Switching Panel, Transmitter Control Panel, Transmitter Amplifier, Power Amplifier, Meter Panel and Volume Control Panel. The two-pole switch on the left of the Power Switching Panel is for the 12-volt filament supply, the centre switch for the 130-volt supply to the plates of the Transmitter Amplifier, and the switch on the right for the 350-volt supply to the Transmitter Amplifier and Power Amplifier. In the case of the Liverpool Cathedral installation, the 130-volt switch is not brought into use, as the Transmitter Amplifier is supplied with a 350-volt plate potential from the 350-volt switch. The Transmitter Control Panel is provided with a rotary switch enabling any number of transmitters, up to eight, to be connected to the board. On the right of this panel is a plug and jack arrangement for the purpose of connecting the operator's head-set to the observation circuits.

The Transmitter Amplifier, No. 4006, requires two No. 4102-D Valves in the first two stages, and a No. 4025-D Valve in the third stage. Filament rheostats are provided for controlling the current taken by the filaments, and a third rheostat for adjusting the transmitter current.

The Power Amplifier, No. 4007, employs a push-pull power stage of two No. 4205-D Valves. The currents in the filaments are controlled by a single filament rheostat.

The Meter Panel contains an ammeter reading 0-5 amperes for measuring the filament currents, a milliammeter reading 0-100 milliamperes for measuring the plate currents in the No. 4205-D Valves and a milliammeter reading 0-5 milliamperes for measuring the plate currents in the No. 4102-D Valves. The panel is provided with two cords terminating with plugs of different sizes. These plugs are associated with the corresponding jacks on the Transmitter Amplifier and Power Amplifier in order to read the transmitter, filament and plate currents.

The Volume Control Panel employs eight rotary switches, the points of which are wired to tapings on an auto-transformer for the purpose of controlling the "gain" on any desired circuit

independently of the rest of the system. These switches make it possible also to obtain a setting which ensures a proper impedance-balance between the output of the amplifier and the load on the system. A master switch is provided on the left of the panel, and eight individual switches allow any desired projector circuit to be brought into use as required.

The right-hand compartment of the cupboard is divided into six sections for housing the high tension storage battery (Figure 4). This battery consists of six separate units, each unit being of 60 volts and made up of thirty small cells in glass boxes. The actual capacity of these cells is 3.5 ampere-hours, and the thirty cells which form one unit are mounted in a teak crate fitted with a lid, rubber carrying-strap and rubber feet. In order to prevent possible leakage, all

terminals are mounted on an ebonite rail. The centre compartment of the cupboard is divided into four sections. The bottom section contains two 6-volt Storage Batteries of 120 ampere-hours actual capacity, which are connected in series for supplying the current to the valve filaments. The next section contains the two 22-volt grid-bias batteries, which are very small accumulator batteries of 1 ampere-hour capacity. The large section houses the monitoring loud-speaker, and in addition is employed when the system is not in use for storing the two observers' telephones. The top section is for storing spare valves and fuses, so that these are handy in the event of a replacement being necessary.

The Charging Board is shown on the right of the picture and consists of enamelled slate panels mounted on a framework which is fixed to the wall. The electric power supply available for charging purposes is direct-current at 460 volts.

A 15-ampere double-pole tumbler switch controls the main supply, and two 15-ampere enclosed fuses protect the board. These fuses in their porcelain mountings are located on either side of the main switch. A 15-ampere automatic cut-in and out is also provided in the main circuit.

The switching panel at the bottom of the board is arranged so that when the three knife-switches are thrown into the lower position, the low tension, high tension and grid batteries are extended to the Power Switching Panel on the Amplifier rack, and this is, therefore, the normal position for discharging. When the three batteries are to be charged, the three switches are thrown into the upper position. The three double-pole tumbler switches, located immediately above the main switch, control the divided main supply for the three charging circuits, and each circuit is



Figure 5—Lectern, Showing Microphone

protected by enclosed fuses of appropriate carrying capacity. These fuses in their porcelain mountings are immediately above the tumbler switches.

For the charging purposes, the high-tension battery is divided into two sets, each of 180 volts. These are charged in parallel through a 560-ohm $\frac{1}{2}$ -ampere enclosed ventilated resistance mounted at the back of the board. The low-tension battery is charged through a 45-ohm, 10-ampere ventilated resistance also mounted at the back of the charging board.

The grid batteries are charged through two 210-volt, 30-watt lamps connected in series. These charging lamps are mounted on the front of the board to the right of the automatic cut-in and out.

The total charging current is read on an ammeter having a range of 0-15 amperes. The voltages of the two halves of the high-tension battery, the low-tension battery, and each of the grid batteries is measured on a voltmeter range 0-250 volts by means of a 5-way voltmeter switch, which is mounted on the front of the board between the ammeter and voltmeter. Cabling between the charging board and batteries is run in enamelled conduit, and the charging board is earthed to a water-pipe in order to meet the Board of Trade regulations.

As already indicated in describing the cabling system, eight projectors are used on the system, three on the left-hand column supporting the Chancel Arch, two on the right hand column, two in the Choir and one in the South Transept Annexe. The way in which these projectors are installed is clearly indicated in the illustrations. They are painted the same colour as the sandstone masonry of the Cathedral in order to make them less conspicuous.

Three projectors on the left-hand Chancel column cover the North Transept, part of the



Figure 6—Bishop's Throne—Showing Bishop's Microphone

Central space, and part of the Choir. The two projectors on the right-hand column cover the South Transept and part of the Central space. Two projectors in the Choir cover part of the Choir, the Sanctuary and the aisle on the north side of the Sanctuary. A single projector is installed in the South Transept Annexe, as this part would be very inadequately dealt with by the projector serving the Transept itself.

The way in which the microphones have been installed is clearly shown in the photographs of the Lectern and the Bishop's Throne. The microphone at the Lectern is a permanent fixture, and the bracket supporting it and the microphone housing are of dull bronze finish to harmonize with other metal parts in the Cathedral. The microphone at the Bishop's Throne is arranged in much the same way, except that it is made so that the whole bracket,

complete with microphone and housing, may be slid out of place and removed at a moment's notice.

The microphone position at the High Altar is very rarely used, but when the microphone is required it is removed from the Bishop's Throne and is mounted on the Altar, where a socket has been placed for its reception. On account of the fact that the microphone is never required at the same time as that on the Bishop's Throne, the microphone cable to the High Altar is extended from the Bishop's Throne so that the microphone may be plugged in, either at the Bishop's Throne or at the Altar. This arrangement, of course, obviates the necessity for a third 3-conductor cable to deal with the Altar microphone.

The Public Address System at Liverpool Cathedral is used for all services in which addresses are given from the Lectern or from the Bishop's Throne. This means that it is used at least once every day and three times every Sunday. The officiating clergy very soon adapted themselves to the system, and quickly found that they could speak in a normal voice and avoid the strain of raising their voices in order to emphasize their remarks or to attempt to make their voices reach the congregation. The whole system has been working under the care of the Cathedral electrician nearly twelve months, and so far no troubles have developed. The system is giving every satisfaction both to the Cathedral Authorities and to the congregation.

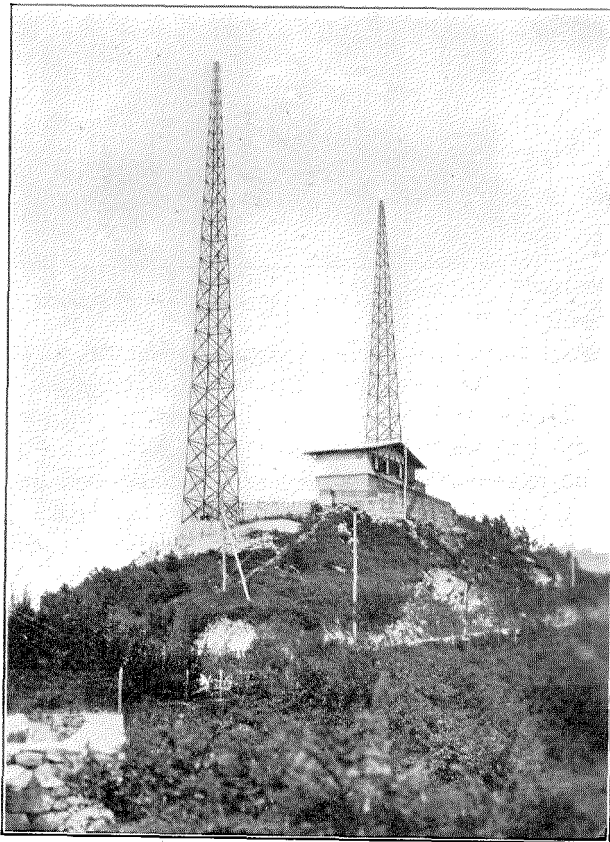

Radio Transmitting Station Located on Monte Igueldo, San Sebastian. The Equipment was furnished by Standard Electrica, S. A., Madrid and is of 500 Watt Capacity. Call Letters are EAJ8.

The London-Glasgow Trunk Telephone Cable and Its Repeater Stations

By A. B. HART

Staff Engineer, British Post Office

Editor's Note: Reprinted from *The Post Office Electrical Engineers' Journal*, Vol. 19, Part 2, July, 1926, by the kind permission of the Institution of Post Office Electrical Engineers.

THE London-Derby No. 2 cable, which was accepted by the British Post Office from the Contractors (Standard Telephones & Cables Limited) in December last,

vided by means of spare quads in the London-Derby No. 1 cable.

The object of this article is to describe particularly the London-Derby No. 2 cable, which represents the most modern practice in telephone cable manufacture and installation, and the

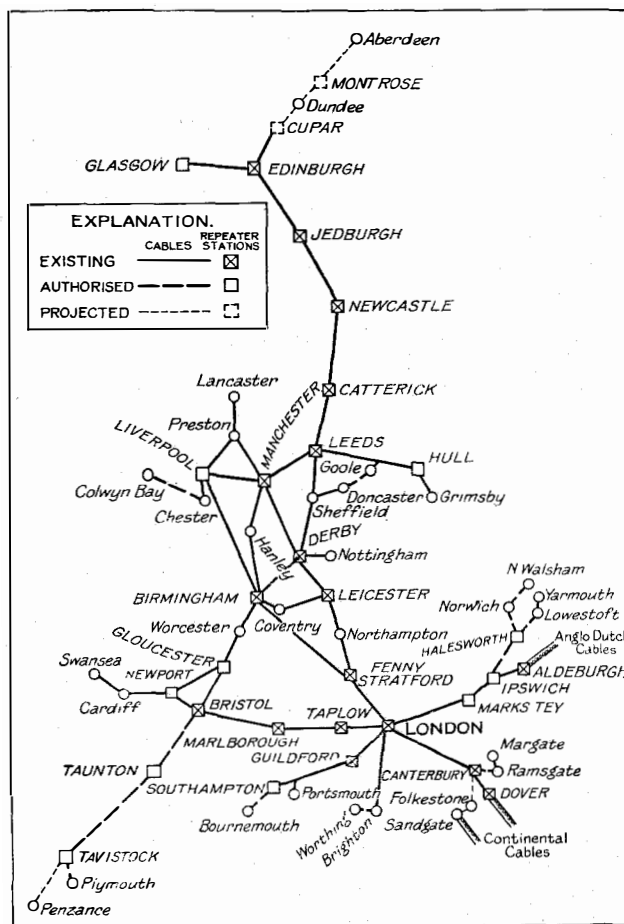

Figure 1—Telephone Repeater Stations—Plan of Systems

completes the London-Glasgow cable, the backbone of the trunk telephone cable network of Great Britain. The Derby-Glasgow section of the cable has already been in partial use for about a year, extension to London being pro-

Repeater Stations between London and Glasgow, all of which were equipped by the Standard Telephones & Cables Limited (formerly the Western Electric Co. Ltd.).

Figure 1 shows the route of the main cable

with its spurs and the location of the Repeater Stations.

As an indication of the density of traffic it may be noted that there are three telephone cables in the section London to Fenny Stratford, comprising a total number of 200 quads together with 28 telegraph quads, and between Fenny Stratford and Derby there are two cables, comprising a total of 202 quads including the

Manchester cable, which is a medium-medium loaded cable installed immediately after the War and worked exclusively on a 2-wire basis and also furnishes the telegraph quads previously mentioned, and runs from London to Manchester with repeaters at Fenny Stratford and Derby. The third is a new cable furnishing the long circuits going North of Derby on the Glasgow route. A cross-section of this cable is

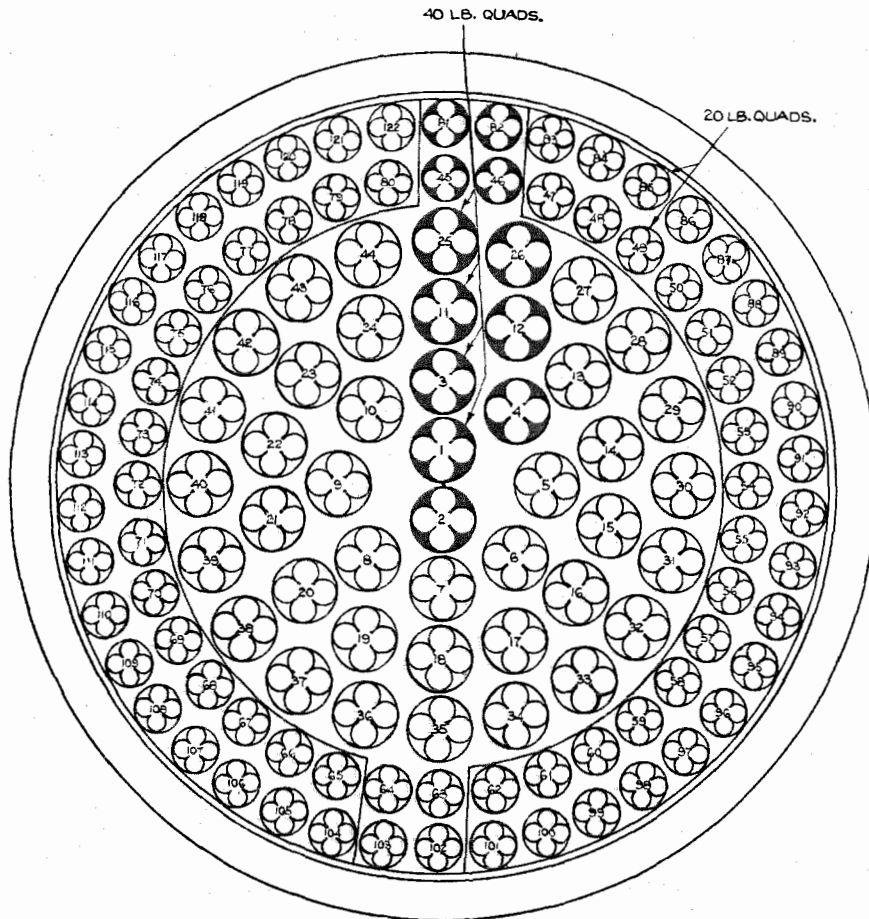

Figure 2—Section, London-Derby Cable

telegraph quads previously mentioned, while the Derby repeater station is designed for an ultimate equipment of 1,500 repeaters.

Cable

Of the three cables between London and Fenny Stratford, one is the old London-Birmingham cable which was described in *The Post Office Electrical Engineers' Journal*, Volume VIII, page 206. The second is the London-

shown in Figure 2. This route runs from London to Glasgow with repeaters at London, Fenny Stratford, Derby, Leeds, Catterick, Newcastle, Jedburgh, Edinburgh and Glasgow. This cable is of particular interest as it shows the segregation of the 4-wire circuits in the Up and Down groups, while the 2-wire circuits form the centre of the cable. The 4-wire circuits are 20 lb. and are medium-heavy, half medium-heavy and extra light loaded in accordance with

their allocation to various points on the route, while the 2-wire circuits are 40 lb. medium-heavy loaded throughout.

this long cable together with its loading equipment was placed in November, 1924, and the cable was completed in December, 1925.

The order for the London-Derby portion of

During this period nearly 130 miles of cable

C.L.T.3. STANDARD TELEPHONES & CABLES LTD

L.S. N° _____
Type of Test _____

CAPACITY UNBALANCE DATA SHEET. BUFE.....

Date.....

LONDON				SIDE				CALCULATED RESULTANT		CHECK TEST		DERBY.				
QUAD N°	1 3	U V	PH to S S to S	JOINTING DIAGRAM	PH to S S to S	U V	QUAD N°	PH to S S to S	U V	PH to S S to S	U V	1 3	PH to S S to S	U V	1 3	QUAD N°
1			-25 -30 -15		+15 +50 +35		26	+10 +20 0					+25 -5 -5			1
2			-30 -20 +15		+30 +15 -10		27	0 -5 +5					+5 -45 +15			2
3			-25 +45 +5		-5 +30 -15		20	-10 +15 0					+50 +40 +5			3
4			-25 -25 +10		-10 -20 -25		32	0 -5 0					-20 -30 +15			4
5			-5 +10 +5		+5 +10 +10		9	0 0 -5					-30 -10 -25			5
6			+25 -30 +15		-15 -15 +15		36	+10 -15 0					-5 -15 -25			6
7			-15 -5 +25		+25 -15 +10		34	-5 +10 0					+5 0 -25			7
8			+10 +10 -10		+15 +10 +10		31	-5 0 0					+15 +30 +15			8
9			-20 +5 +5		+10 +10 +25		29	+5 -5 -5					+5 +10 +10			9
0			+25 -30 -10		-35 -30 -20		33	-10 0 +10					-5 +25 -5			0
11			+30 +25 -25		-20 -30 +15		4	+10 -5 -10					-25 +10 -35			11
12			+20 +10 -10		+15 +5 +15		35	+5 +5 +5					-60 +5 +10			12
13			+10 +5 -30		+15 +10 +25		28	-5 -5 -5					+10 +10 +25			13
14			-20 +25 -30		+35 -15 +30		30	+10 +10 +5					-30 +10 +10			14
15			-20 -20 +10		+5 -45 +15		2	-5 +25 +5					+10 -5 -30			15
16			+25 -25 +5		+5 -10 -20		43	+5 -15 0					-5 -20 -25			16
17			-45 -30 -10		+45 +10 +5		24	0 -20 -5					+20 +15 0			17
18			-40 +10 -5		+50 +10 +5		18	+10 +20 0					+50 +10 +5			18
19			+20 +5 +25		-25 -15 -25		38	-5 -10 0					+5 -10 -60			19
20			-15 -5 -15		+25 +10 +15		40	+10 +5 0					-5 +30 -15			20
TESTER							LOCATION					REMARKS.				
JOINTER							TEST POINT									
WEATHER							TO									
SET N°							AND									

Figure 3—Typical Jointing Diagram

were pulled in, tested and jointed and over 450 loading coil cases were installed. The cable consists of 44 quads of 40 lbs. conductors and 78 quads of 20 lbs. conductors arranged as shown in Figure 2. The loading is H-177-107, H-89-50 and H-44-25 (known as medium-heavy, half medium-heavy and extra light respectively, where H represents the loading coil spacing and equals 6,000 ft., the first figure the side circuit

usually three or seven such test splices made in each loading section.

Loading. In connection with the loading of the new cable, of which a cross-section was shown in Figure 2, single stub loading coil cases have been used. This method of jointing loading coils into cables has an advantage over the two-stub method generally used on previous cables as it makes the loading coil manhole lay-

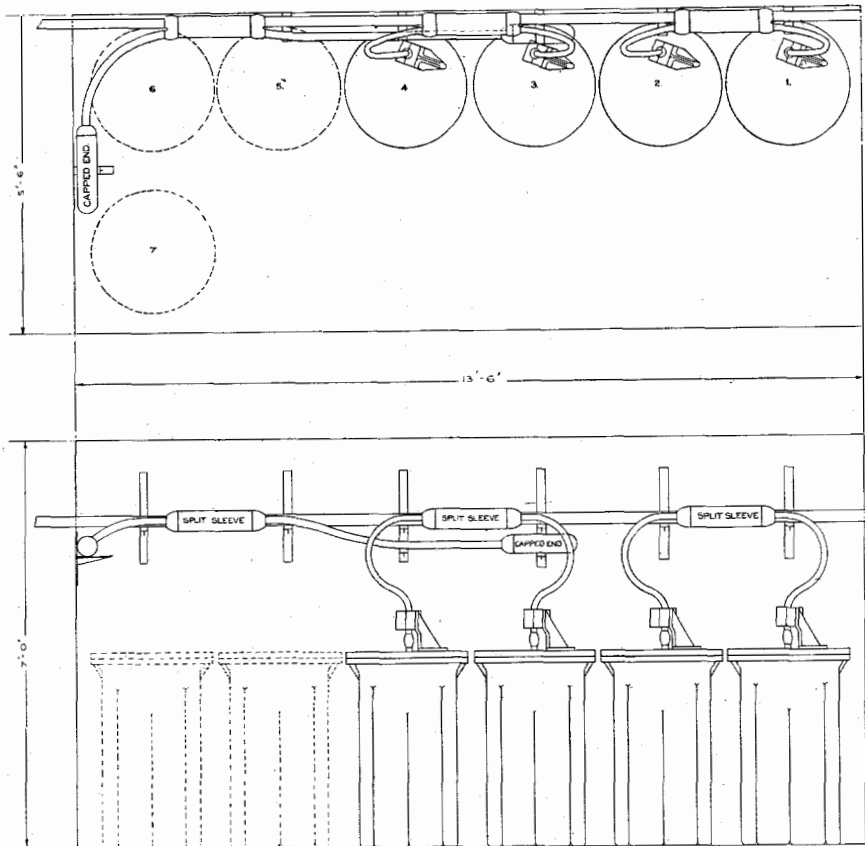

Figure 4—Layout of Manhole with Single Stub Cases

coil inductance and the second figure the phantom circuit coil inductance). The following circuits are initially provided:—

102	circuits	40	lbs.	H-177-107	for	2-wire.
6	"	40	"	H-44-25	"	transatlantic work.
60	"	20	"	H-177-107	"	4-wire.
42	"	"	"	H-89-54	"	"
6	"	"	"	H-44-25	"	"

A typical jointing diagram for this cable is shown in Figure 3, which illustrates the method of jointing a cable by which the capacity unbalance is reduced by cross-splicing. There are

out very much simpler. Figure 4 shows the layout of loading coil cases in a manhole on this cable and illustrates the simplicity and advantages of using the single stub construction. A photograph of one of the loading coil cases with a single stub, as used on this cable, is shown in Figure 5.

Repeater Sections. From the point of view of obtaining good transmission results from a repeatered system it is necessary that the constants such as impedance, attenuation, etc., of each repeater section shall be as uniform as

possible, both as regards the values when plotted against frequency for any individual circuit as well as within each type of group. It is also essential that the cross-talk in the repeater section of cable shall be held within fairly close

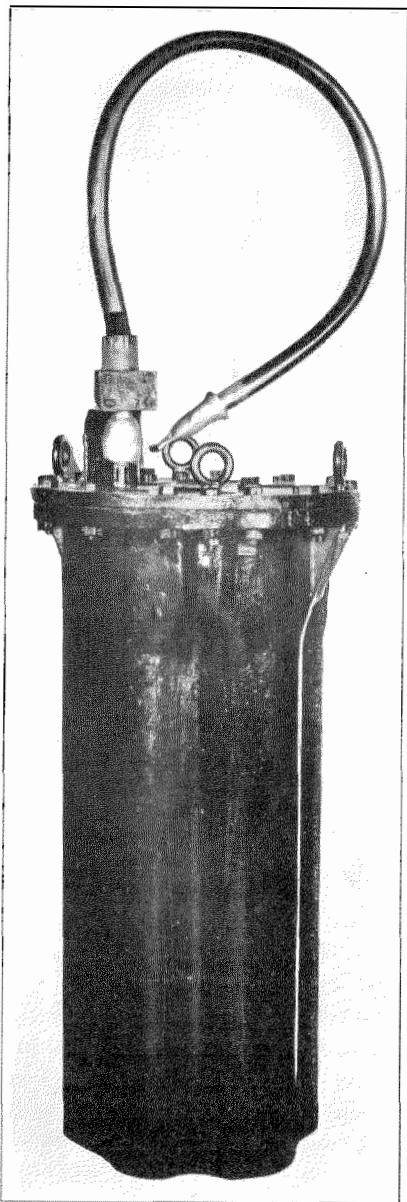

Figure 5—Loading Coil Case with Single Stub

limits, since it can be proved that the repeater section cross-talk is the most important factor in the overall circuit cross-talk.

As explained above, it is important that the characteristics of the circuits shall remain as

constant as possible, and for this purpose the following methods were adopted:—

Capacity Unbalance and Resistance Unbalance. These unbalances were reduced as much as possible during the manufacture of cable lengths. Further reductions were obtained in the field by means of special test joints. Capacity unbalance was reduced generally at 3 test joints in each loading section, this number being increased to 7 at the ten loading sections adjacent to each repeater station.

Capacity Deviation. The “regularity” to be maintained on the circuits, which was referred to earlier in this article, is closely connected with the deviations from the average mutual capacity. These capacity deviations are of two kinds, circuit deviations and section deviations. By the former is meant the deviations of the individual circuits of a group in a loading section from the average capacity of all the circuits in that group. By section deviation is meant the deviation of the average mutual capacity per loading section of a group of circuits from the average capacity for that group for all loading sections.

Circuit deviation was reduced both in the factory and in the field. In the latter case one test joint was made in each loading section, but this was confined to the ten loading sections adjacent to each repeater station.

The final tests on this cable were of two kinds, those on repeater sections and those on the repeatered system.

The following tests were made on the two repeater sections:—

- (i) Loop Resistance.
- (ii) Resistance Unbalance.
- (iii) Insulation Resistance.
- (iv) Singing Point.
- (v) Impedance Frequency.
- (vi) Attenuation.
- (vii) Cross-talk.

Tests Nos. (iv) (v) and (vii) were made from each end of each repeater section, the others being made from one end only. The results of these tests are summarised below:—

(i) *Loop Resistance.* This test was made chiefly as an assurance as to the uniformity of resistance of all similarly loaded circuits of the same gauge.

(ii) *Resistance Unbalance.* This test was made to measure the resistance unbalance be-

tween the wires of each pair. In no case was a resistance unbalance of more than 2 ohms found, the average unbalance being about 0.2 ohms.

(iii) *Insulation Resistance.* The insulation resistance was measured on all wires, and no value lower than 50,000 megohms per mile observed.

(iv) *Singing Point.* The singing points of all 2-wire circuits were measured from each end of each repeater section. The results are tabulated later.

Two distinct methods of measurement were adopted, one using a singing point test set and the other an impedance unbalance measuring set.

and the impedance unbalance between two circuits or a circuit and its balancing network.

Figure 6 shows the essential part of the circuit by which singing points are measured when using the Impedance Unbalance Measuring Set. The coil shown in the figure is the so-called "hybrid" coil which is used in 2-wire repeaters to obtain duplex operation. If the balance between line and network were perfect, the transmission loss between A and B would be infinite—*i.e.*, all current entering the circuit at A is divided between the line and network, no current passing across the windings to B. As soon, however, as there is any impedance unbalance between the line and network some

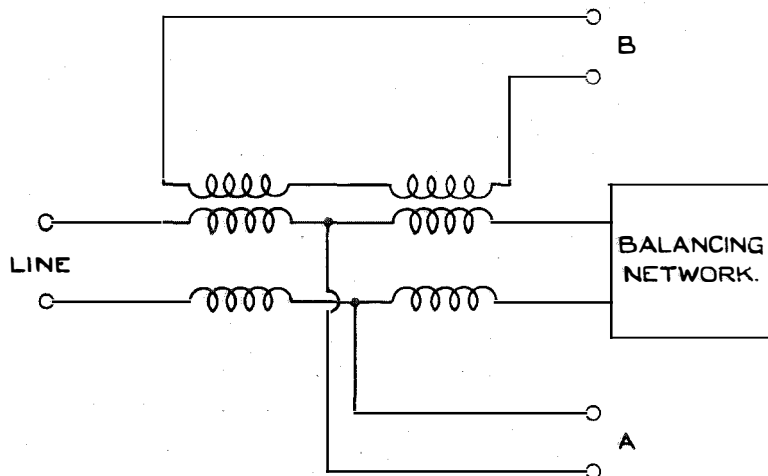

Figure 6—Circuit of Unbalance Set

The singing point test set is virtually a portable 2-wire repeater and the results of the tests made with it are therefore a direct indication of the maximum gain which could be inserted in the line at the point at which the test is taken. As the maximum gain which it is usually desirable to obtain from a 2-wire repeater is of the order of 15 TU it will be seen from the results of the singing point test, that a very ample margin of safety exists on the circuits of the London-Derby cable. This margin, however, has a directly beneficial effect on the quality of speech transmitted.

From the results obtained in this way typical circuits were selected for further analysis.

The other method of measuring singing points is based on the relation between singing point

current does flow from A to B, the amount of this current depending on the magnitude of the impedance irregularity.

The Impedance Unbalance Measuring Set is designed to measure the transmission loss between A and B, and since both this loss and the singing point are dependent on the degree of balance between the line and network the set may be calibrated to read the singing point of line and network.

With this apparatus it is possible to measure the singing point of the line at any required frequency, whilst the singing point test set merely selects the frequency, within the efficient range of the repeater, at which the unbalance is greatest and the singing point consequently lowest.

Singing points were measured with this set at frequency intervals of 20 p.p.s. from 200-2400 p.p.s.

This frequency range was then divided up into bands and the lowest value of singing point recorded for each band.

(v) *Impedance Frequency.* Impedance frequency tests were made on about 10% of the loaded circuits in the cable, the 2-wire circuits being the same as those selected for the singing point tests made with the impedance unbalanced set.

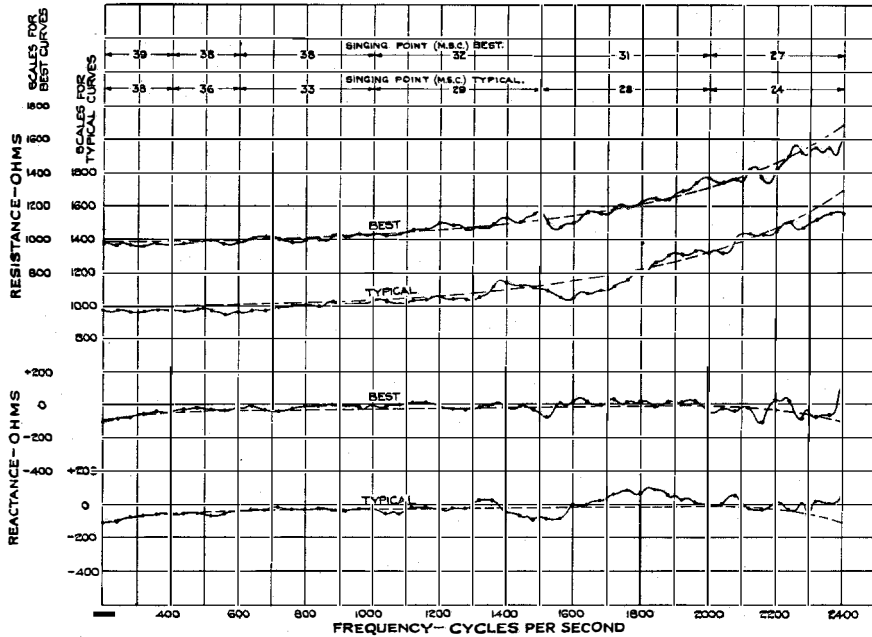

Figure 7—Impedance Curves H-177-107. Medium Heavy 40 Lbs. Phantom Circuits

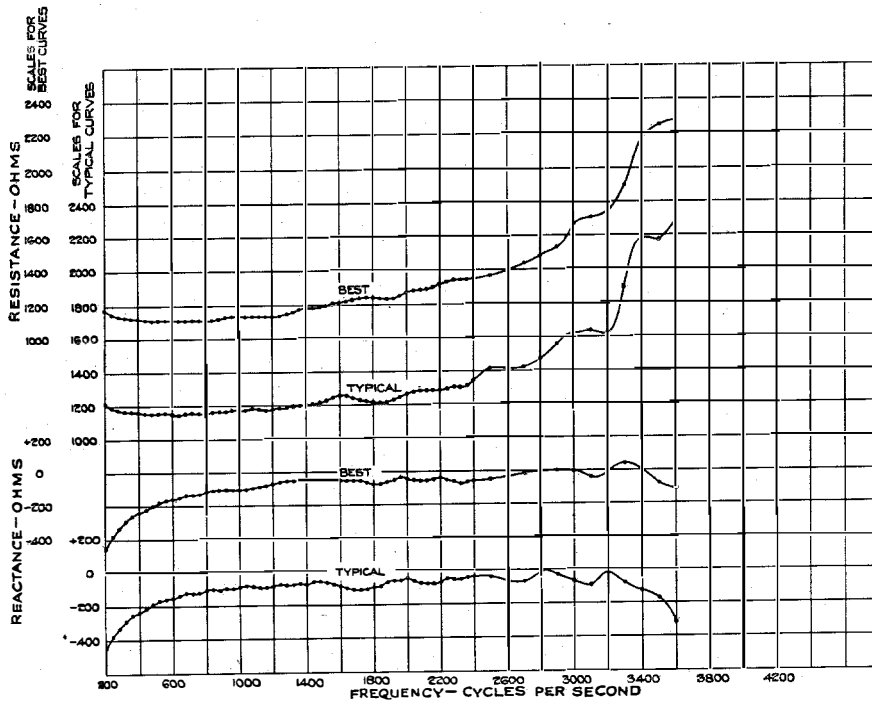

Figure 8—Impedance Curves H-89-54. 20 lbs. Side Circuits

Typical curves are shown in Figures 7, 8 and 9. Impedance frequency curves afford a ready means of ascertaining the degree of regularity obtained on the circuits. Ideally, of course, the impedance frequency curve for the line would be quite smooth, and in such a case a perfect balance would be possible between a line and its balancing network, which would give an infinite value for the singing point, provided

With cables constructed, installed and tested by the method employed on this cable the networks can be designed from the prime constants of the cable and one network will furnish excellent results with all circuits. Details of these networks and a multi-unit condenser which is used as a building-out section will be dealt with under Repeater Equipment.

(vi) *Attenuation.* Measurements of attenu-

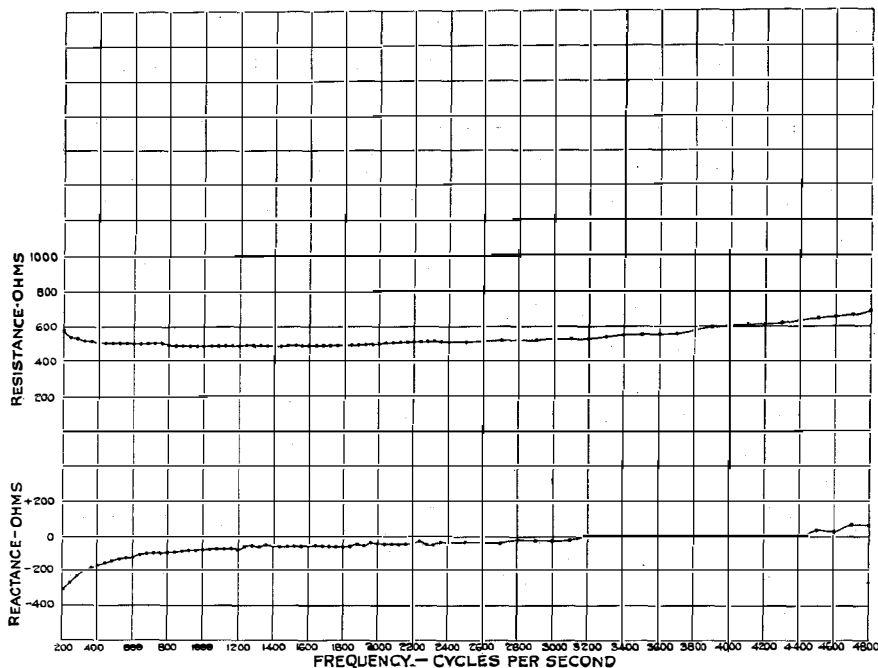

Figure 9—Impedance Curves H-44-25. 20 Lbs. Phantom Circuit

always that the repeater itself were perfectly balanced.

In practice, however, irregularities will always appear in the curve and since it is not practically possible to construct a balancing network which would follow the irregular shape of the curve there will always be impedance unbalances between line and network at many points in the frequency range.

The singing point of the line will depend on the magnitude of these unbalances.

One point is of considerable interest in this connection and is illustrated by Figure 7, which shows the impedance frequency curve of one of the 2-wire circuits. On the same curve is plotted the impedance frequency curve of the standard network with building out condenser which is employed at the repeater stations.

uation were made at various frequencies, all loaded circuits being measured at 800 and at 2000 p. p.s., and a number of circuits, typical of each circuit group, over a frequency range.

The average attenuation, corrected to 50° F., for each type of circuit at 800 and 2000 p.p.s. is given in the following table:—

		<i>Attenuation (β per mile at 50° F.)</i>	
Type of Circuit		800 c.p.s.	2000 c.p.s.
40 lb. H-177-107	Side	.0177	.0230
	Phantom	.0145	.0194
20 lb. H-177-107	Side	.0306	.0354
	Phantom	.0249	.0292
20 lb. H-89-54	Side	.0398	.0416
	Phantom	.0320	.0339
40 lb. H-44-25	Side	.0288	.0301
	Phantom	.0238	.0253
20 lb. H-44-25	Side	.0537	.0553
	Phantom	.0451	.0468

In Figure 10 is shown a typical attenuation frequency curve.

SINGING POINTS (TU)

Repeater Section	Tested from	Circuit	Singing Point Measured with Impedance Unbalance Set Frequency Bands						S.P. Measured with S.P. Test Set
			200-400	400-600	600-1000	1000-1500	1500-2000	2000-2400	
London	London	Side Best	37	38	36	35	28	22	32
"	"	" Worst	37	38	33	26	24	23	24
"	"	Phant. Best	34	33	32	29	28	25	30
"	"	" Worst	36	36	32	26	24	24	22
"	Fenny Stratford	Side Best	38	38	35	30	32	24	32
"	"	" Worst	38	38	30	24	24	26	26
"	"	Phant. Best	37	36	36	30	29	26	32
"	"	" Worst	38	34	30	29	25	25	26
Derby	Fenny Stratford	Side Best	37	36	35	34	32	28	32
"	"	" Worst	37	35	34	34	27	27	29
"	"	Phant. Best	38	34	35	33	24	23	21
"	"	" Worst	38	31	32	28	24	25	24
"	Derby	Side Best	35	38	31	32	29	26	32
"	"	" Worst	34	35	32	26	28	25	27
"	"	Phant. Best	36	37	37	36	28	21	32
"	"	" Worst	35	32	32	30	30	22	25

N.B.—The above figures are the lowest values of singing point recorded in the various frequency bands.
 "London" Repeater Section means London to Fenny Stratford.
 "Derby" Repeater Section means Derby to Fenny Stratford.
 Tests apply to 2-wire circuits only.

(vii) *Cross-talk.* Cross-talk measurements were made on all loaded circuits, using as testing current a complex tone which gives results very close to those which would be obtained in a speech test.

Near End cross-talk was measured on all 2-wire circuits. In these tests the measuring apparatus and the source of tone were always at the same end of the circuit.

Far End cross-talk was measured on the 4-wire circuits, tone being placed at one end of the circuit and the measuring apparatus at the far end.

All cross-talk results given in this article have been corrected in the case of phantom to side cross-talk on the basis of the phantom and side circuit impedances, and in the case of Far End cross-talk on the basis of the equivalent of the circuit over which the testing tone is sent.

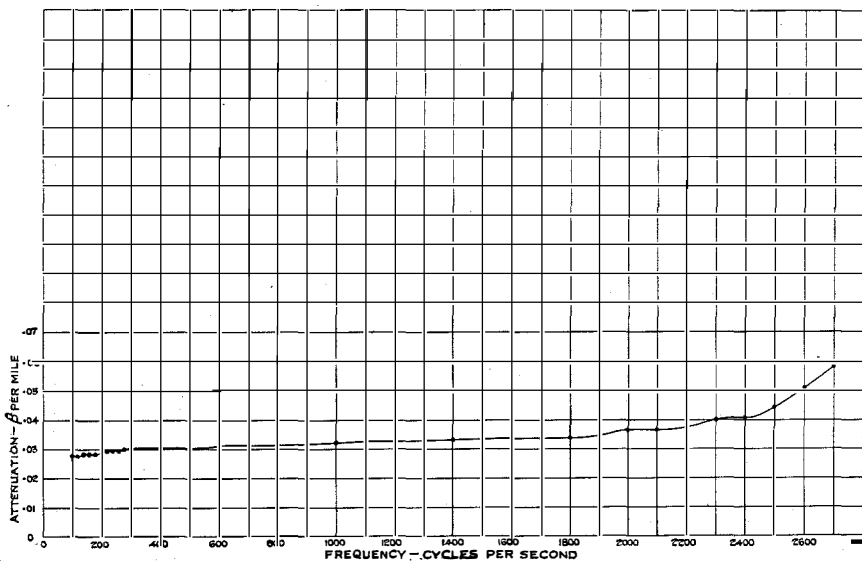

Figure 10—Attenuation vs. Frequency Curve H-177-107. 20 lbs. Side Circuit. Measuring Current 0.5 m.a.

The results are tabulated below:—

Near End Cross-talk (Cross-talk Units)

	Phantom-Side Ave. Max.		Side-Side Ave. Max.		Phantom- Phantom Ave. Max.	
40 lb. H-177-107	185	320	105	160	105	250

Far End Cross-talk (Cross-talk Units)

	Phantom-side Ave. Max.		Side-side Ave. Max.		Phantom- Phantom Ave. Max.	
London Repeater Section. 46.4 miles.						
20 lb. H-177-107	130	295	55	110	45	115
20 lb. H-89-54	90	190	25	60	25	45
20 lb. H-44-25	75	120	15	15	—	—
40 lb. H-44-25	180	250	65	75	—	—

	Phantom-side Ave. Max.		Side-side Ave. Max.		Phantom- Phantom Ave. Max.	
Derby Repeater Section. 81.5 miles.						
20 lb. H-177-107	85	115	15	30	10	25
20 lb. H-89-54	60	85	5	5	5	5
20 lb. H-44-25	20	30	5	5	—	—
40 lb. H-44-25	155	175	130	145	—	—

Overall Tests. The final series of tests made were system tests over repeatered circuits. The cable was completely installed before the repeaters were in operation and temporary re-

would then be set up from London to Derby and back again to London. Figure 11 shows the arrangement of the repeaters on these circuits, from which it will be seen that both ends of the circuits were available in London.

The following tests were made on these 250 mile circuits:—

- (i) Overall transmission equivalent.
- (ii) Cross-talk.

(i) Here again, all circuits were measured at 800 and 2000 p.p.s., the results of the tests being given below:—

800 and 2000 c.p.s. tests.

2-wire. Average overall equivalents in S. M. (1 S.M. = 0.109βl)

	800 p.p.s.	2000 p.p.s.
Side	10.0	21.0
Phantom	9.0	20.0

4-wire. Average overall equivalents in S.M.

	800 p.p.s.	2000 p.p.s.
H-177-107	8.0	10.0
Side	6.0	7.0
Phantom	8.0	10.0
H-89-54	13.5	15.0
Side	9.0	10.0
Phantom		

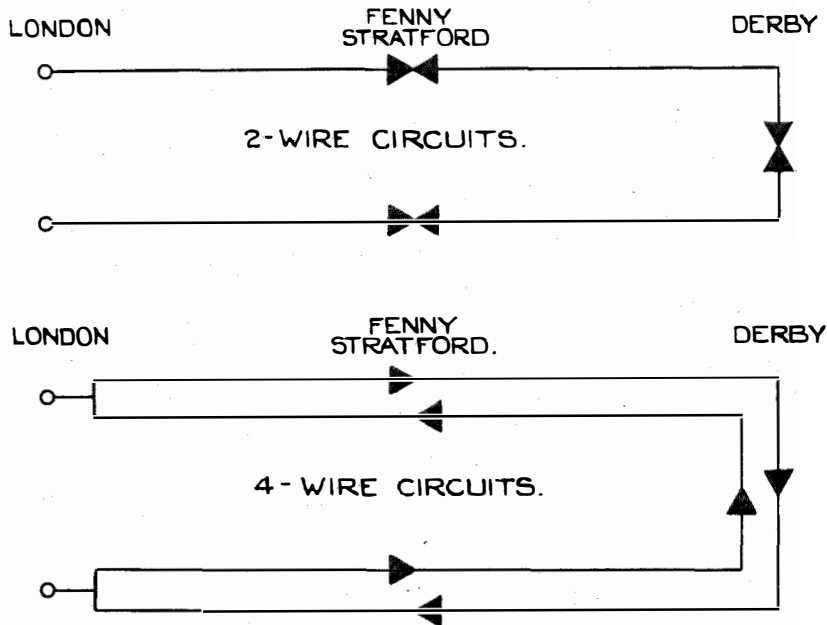

Figure 11—Overall Tests: Arrangements on Repeaters

peater equipment was installed in order to enable overall tests to be made.

This temporary equipment was installed at London, Fenny Stratford and Derby in such a way as to allow both 2- and 4-wire repeaters to be inserted in any required cable circuits, which

In the case of the half medium heavy circuit the above figures are somewhat high, due to the conditions of test. Under actual working conditions terminal repeaters will be used at London on the circuits, resulting in lower overall equivalents.

(ii) Cross-talk was measured through all the terminating equipment and the following results obtained:—

Overall Cross-talk (Cross-talk Units).

Near End Cross-talk			Far End Cross-talk			
40 lb. H-177-107			20 lb. H-177-107	20 lb. H-89-54.		
Ph-S.	S-S.		Ph-S.	S-S.	Ph-S.	S-S.
Avg. 283	163		510	272	300	128
Max. 400	200		836	418	485	165

station; repeater bays, coil racks and test units at the Derby repeater station, and individual photographs of the repeater units, both 2-wire and 4-wire. It is thought that the photographs are sufficiently self-explanatory not to need any description and that there is more interest in a description of the circuits involved on the whole system than on the equipment.

As a matter of interest the following table

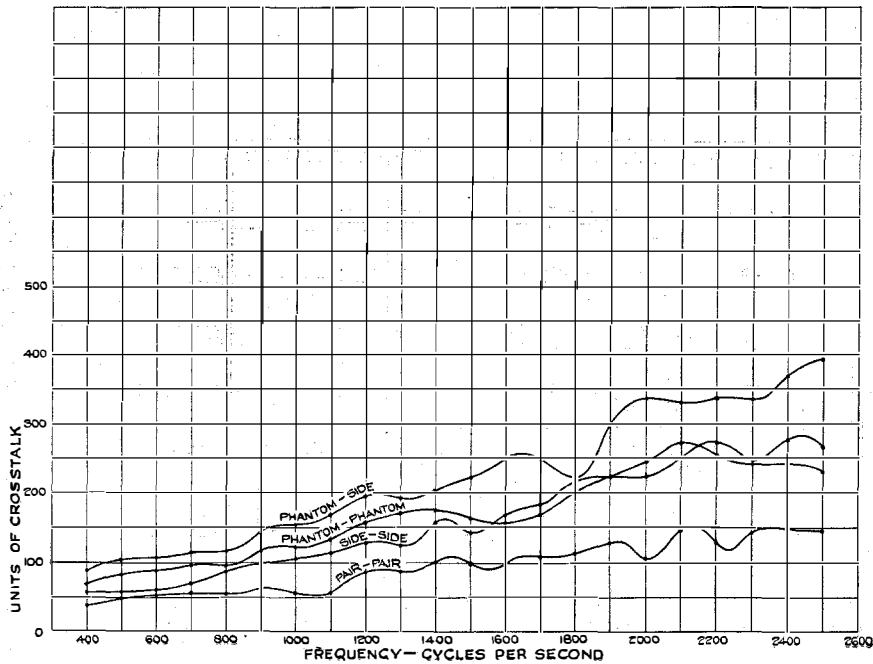

Figure 12—Average Cross-talk Curves

Particular attention should be paid to the cross-talk frequency curve shown in Figure 12, which gives the average figures obtained on the medium-heavy 40-lb. circuits for Phantom-Side, Side-Side, Phantom-Phantom and Pair-Pair, where the pairs are located in different quads.

REPEATER STATION EQUIPMENT.

To give a general picture of the apparatus, power plant, etc., used in the repeater stations on the North-East route, Figure 13 shows a floor plan of the Derby repeater station. This floor plan does not cover the final station, which will cater for 1500 repeaters, as previously stated, but only with the repeaters installed up to the present time.

A series of photographs is given illustrating the power board, etc., at the Leeds repeater

gives the initial number of repeaters at the various stations on the route as well as data on various other points:—

	Repeaters		Vacuum Tubes
	2-wire	4-wire	
London	6	54	228
Fenny-Stratford	268	54	752
Derby	308	54	832
Leeds	130	60	500
Chatterick	70	50	340
Newcastle	20	50	240
Jedburgh	30	50	260
Edinburgh	50	50	300
Glasgow	—	45	180
Total	882	467	3632

Repeater Circuits. It will be realised there is of necessity a number of special cases calling for special circuit arrangements in such a network, but it is not felt necessary to emphasize these particular arrangements. Accordingly,

only typical arrangements have been dealt with, these, of course, forming the majority of the cases on the North-East route. The following typical circuits are illustrated:—

- 2-wire repeatered phantom group Figure 14.
- 2-wire terminal with V.F. signaling Figure 15.
- 4-wire repeatered phantom group (Through) Figure 16.
- 4-wire repeatered terminal with V. F. signaling Figure 17.

Dealing with the 2-wire through phantom group, the method of connecting the repeaters to the lines and networks is illustrated and shows the U links from which the lines are tested and the jack arrangements by which the repeater units are patched when necessary and are tested with the gain measuring sets. A schematic

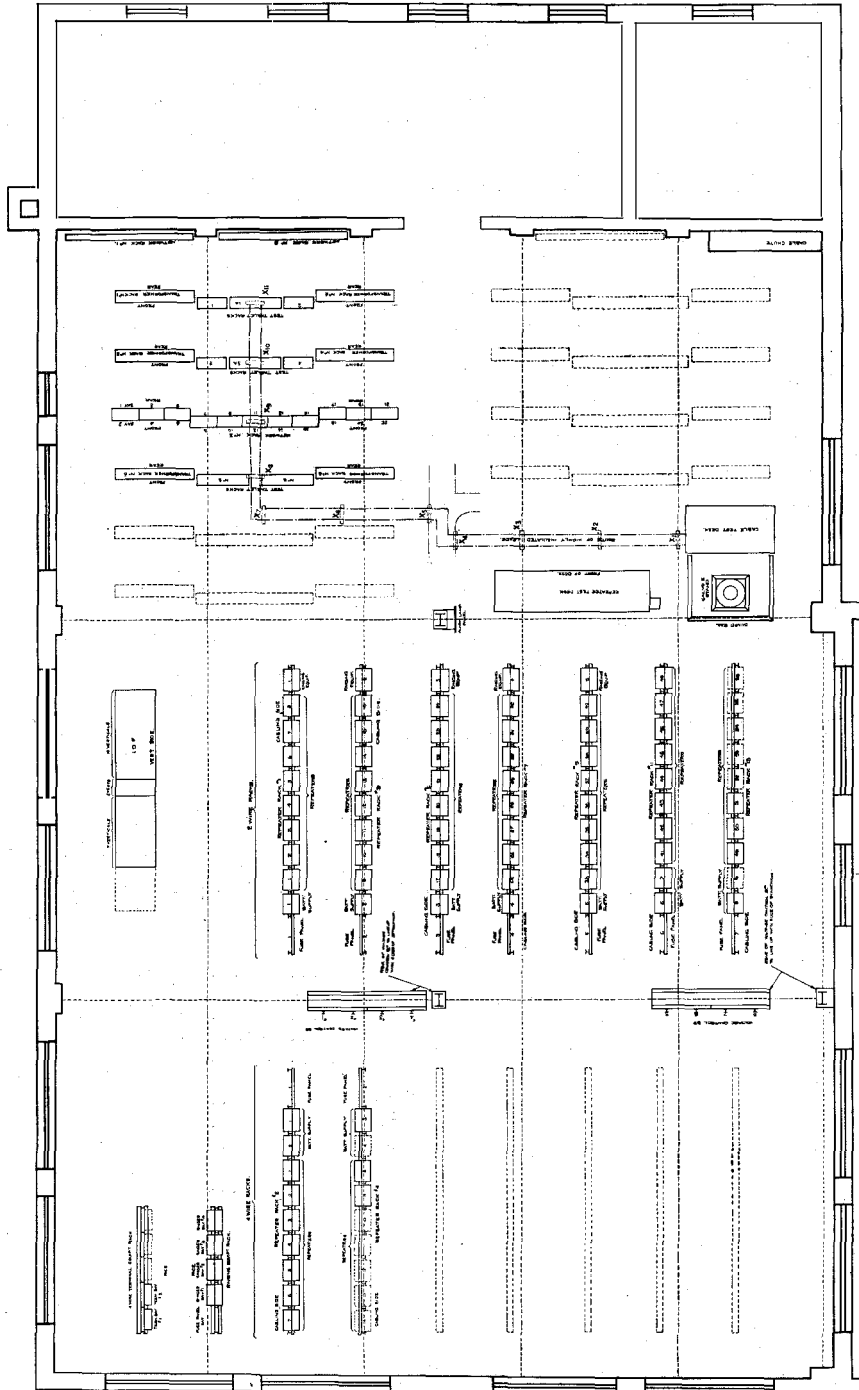
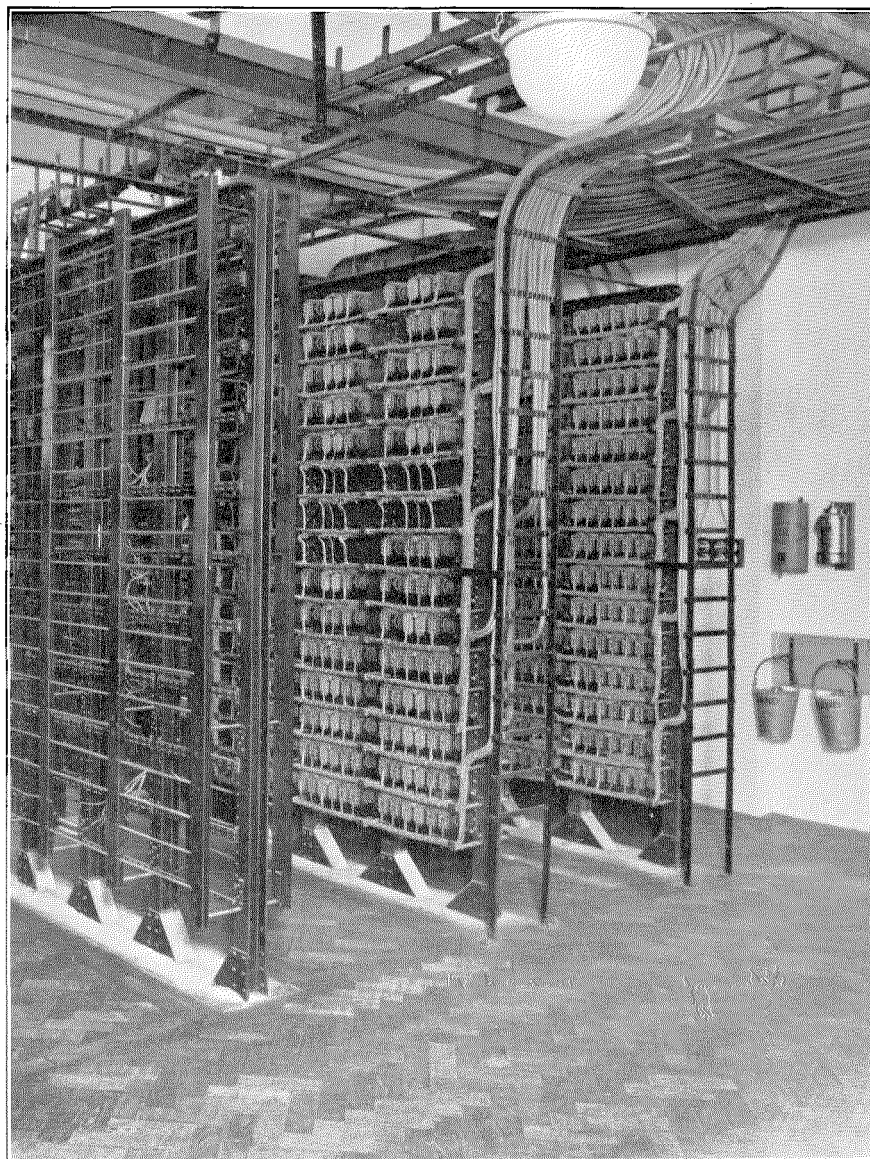
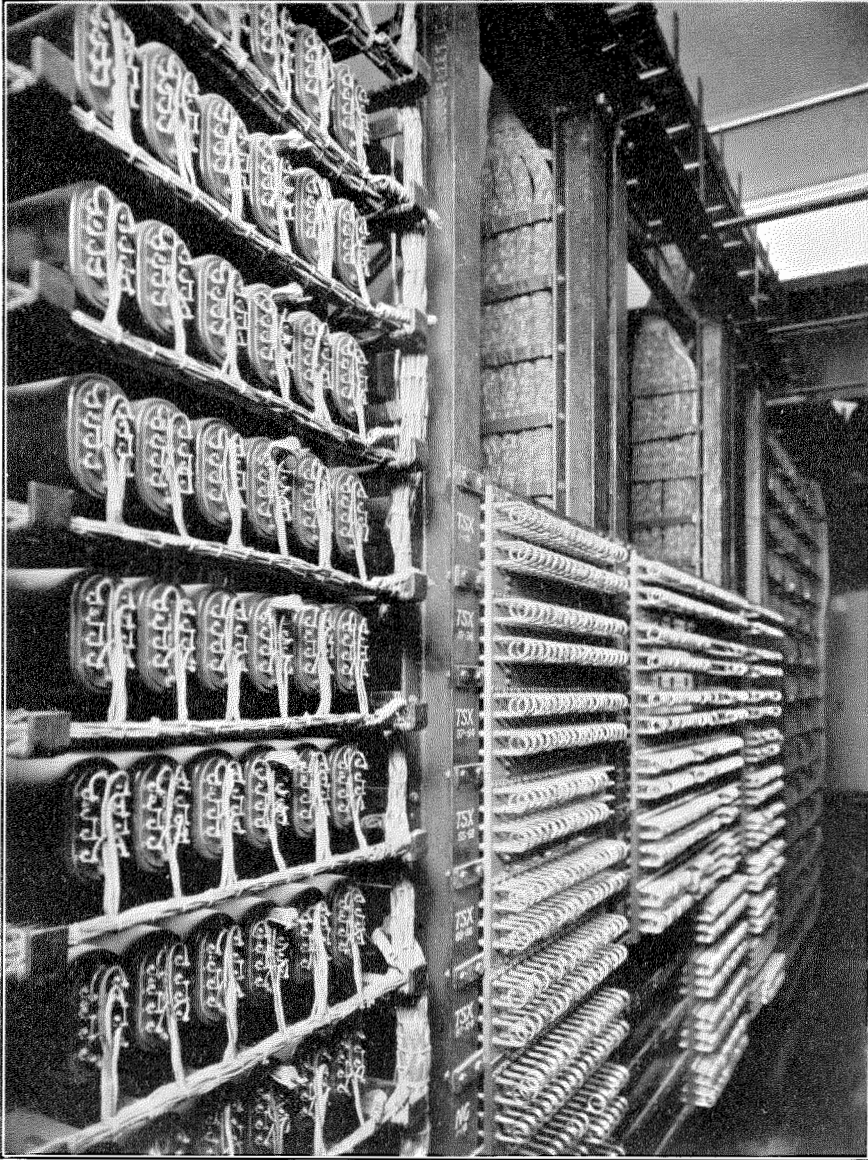

Figure 13—Floor Plan, Derby Repeater Station. (S.T. and C. Ltd. Drawing, L 32669)



Test Tablet and Transformer Racks. General View



Test Tablets and Transformers

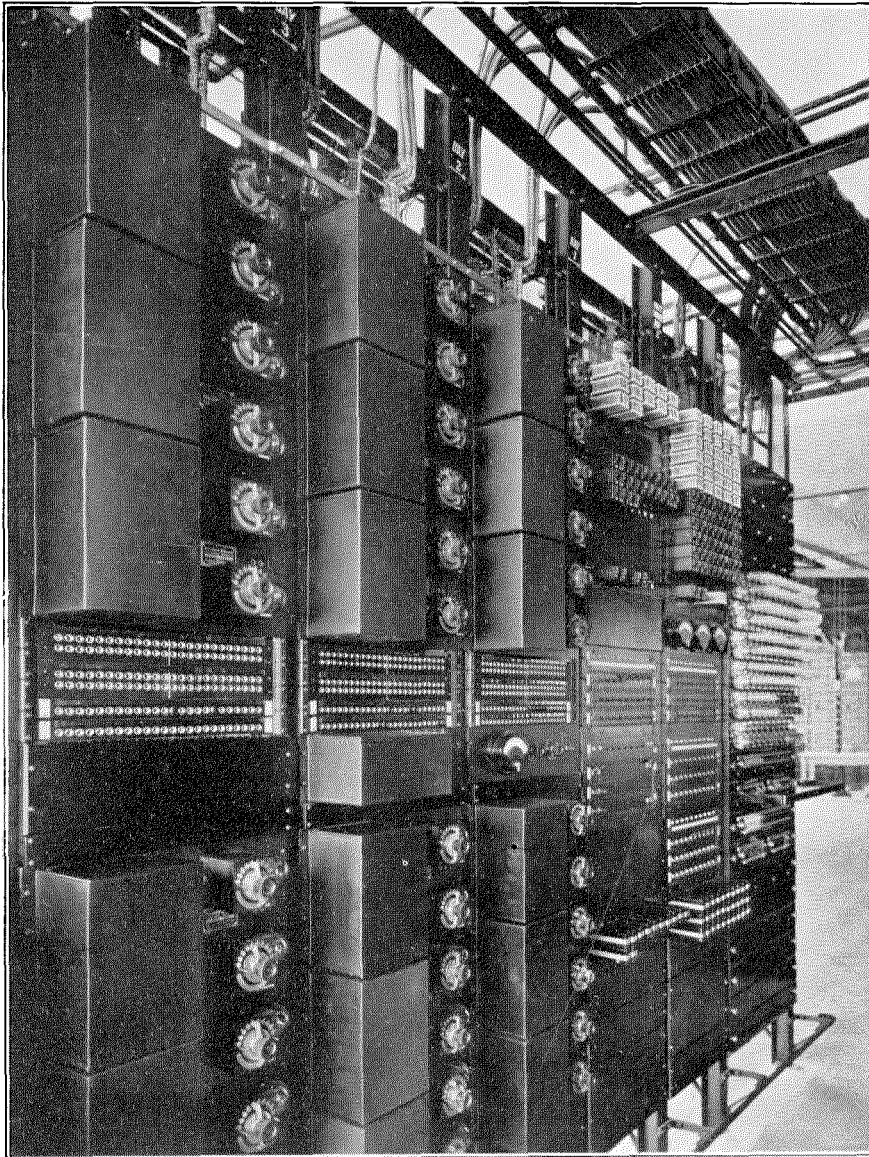

4-Wire Repeater Rack

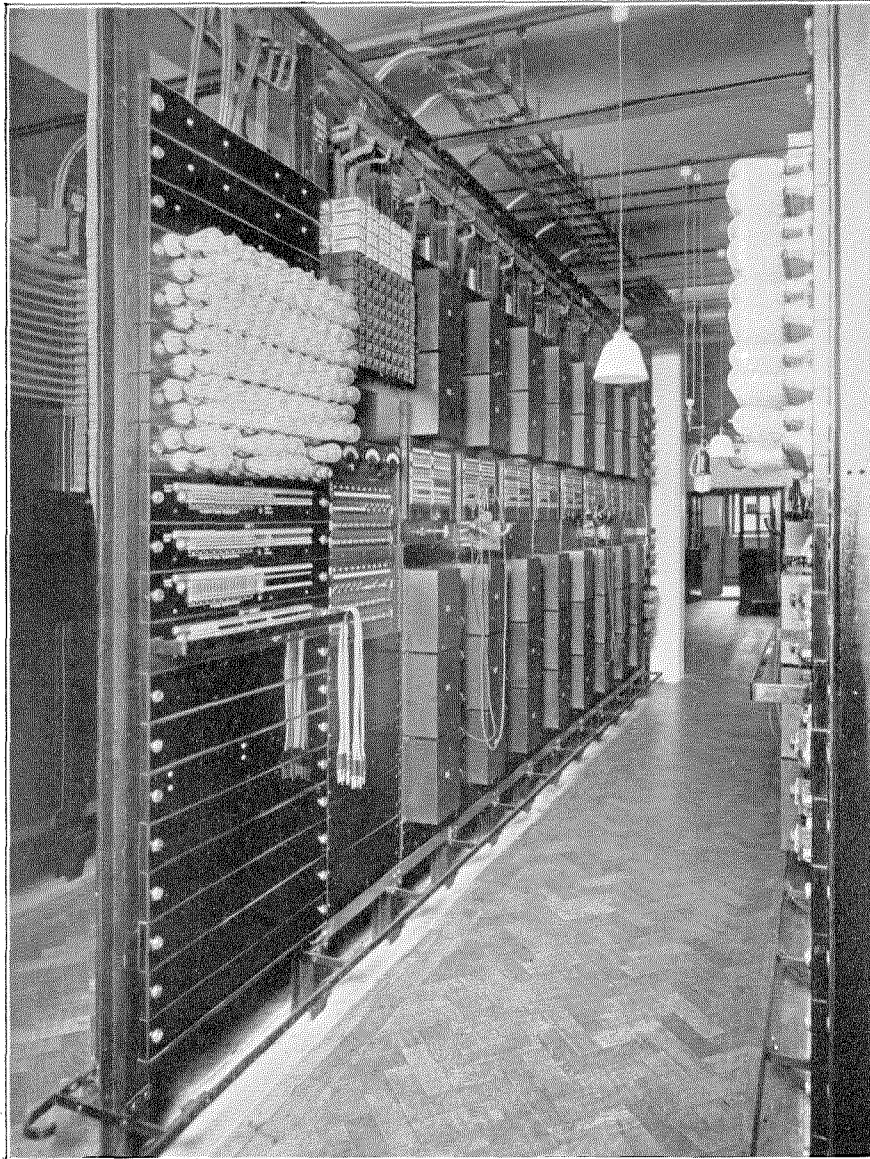

2-Wire Repeater Rack. Repeaters and Low-Frequency Signaling Apparatus

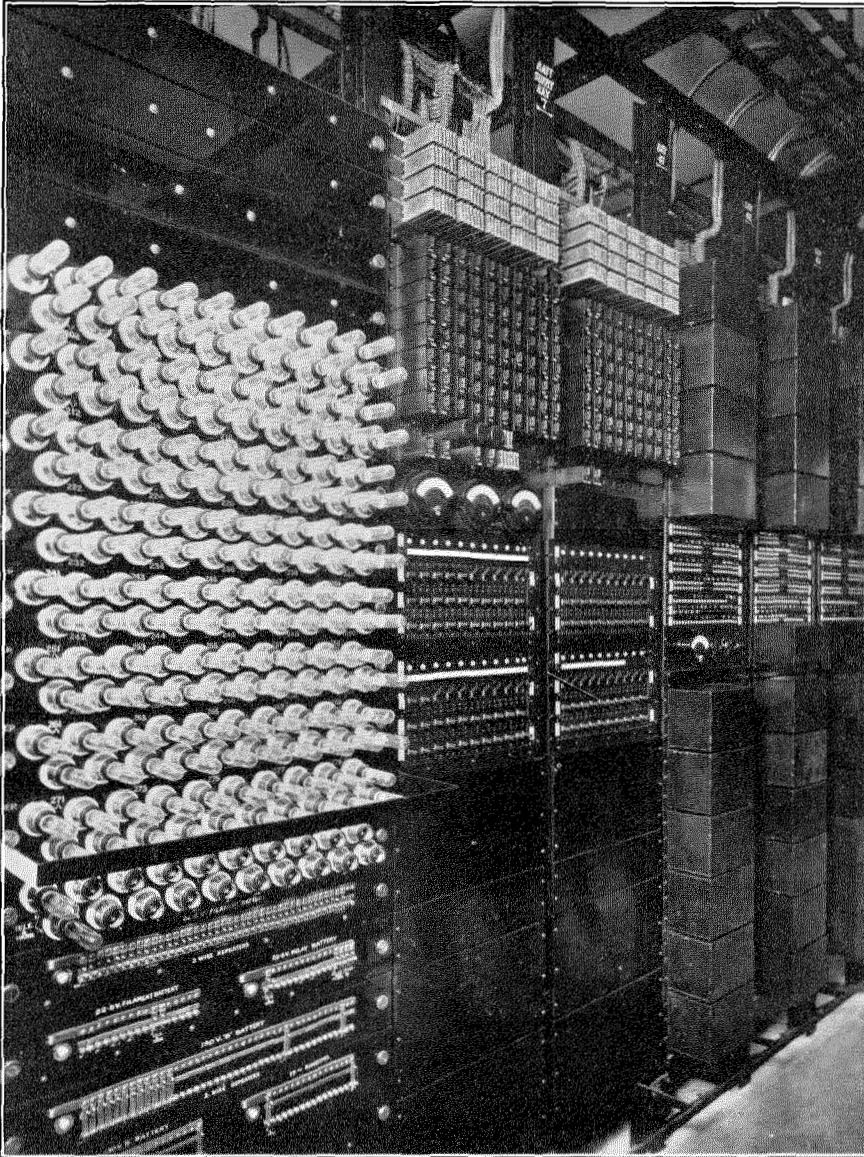

2-Wire Repeaters and Battery Supply Apparatus with Voice Frequency Signaling

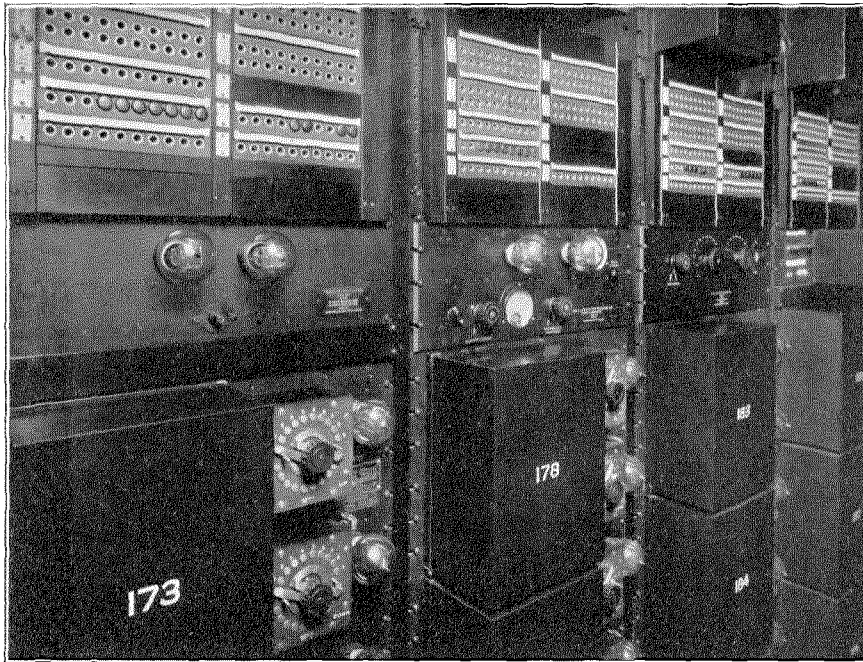

Gain Measuring Instruments

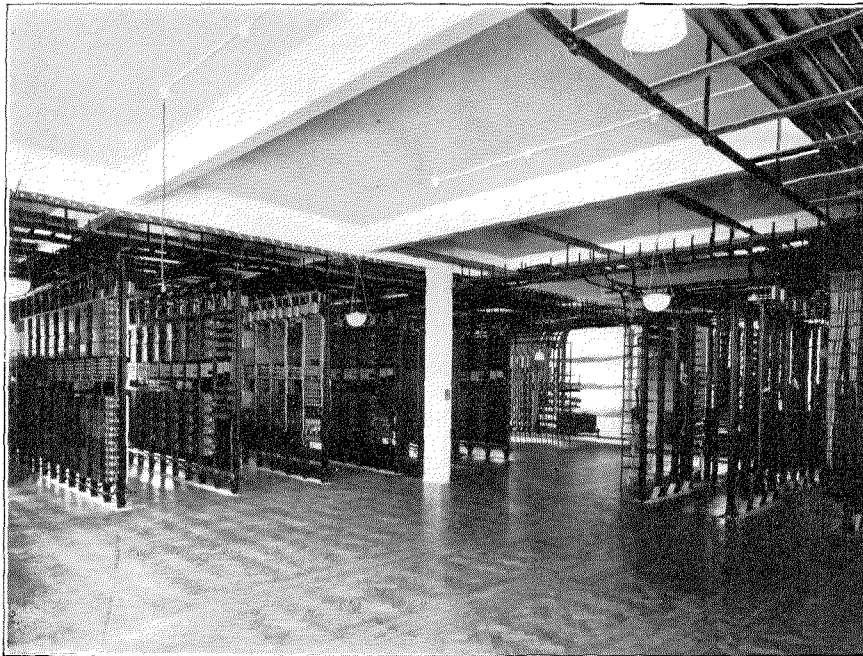

General View. Repeater Apparatus Room, Derby



General View. Power Room, Derby

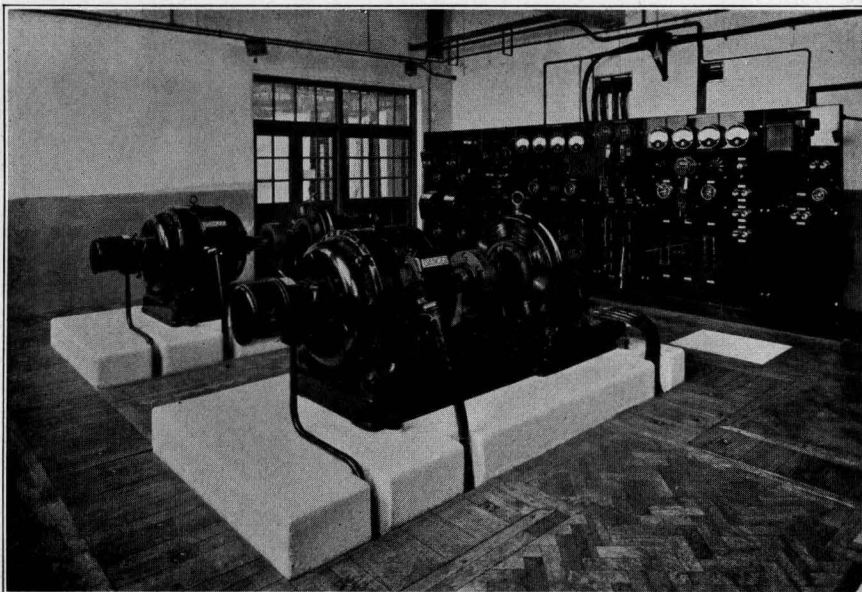

Filament Battery Charging Sets and Power Board, Leads

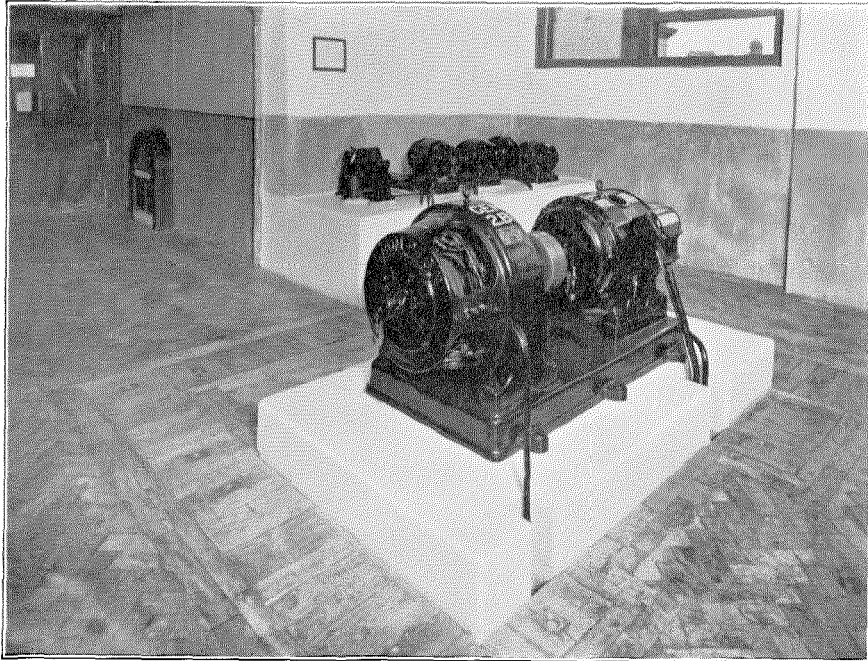
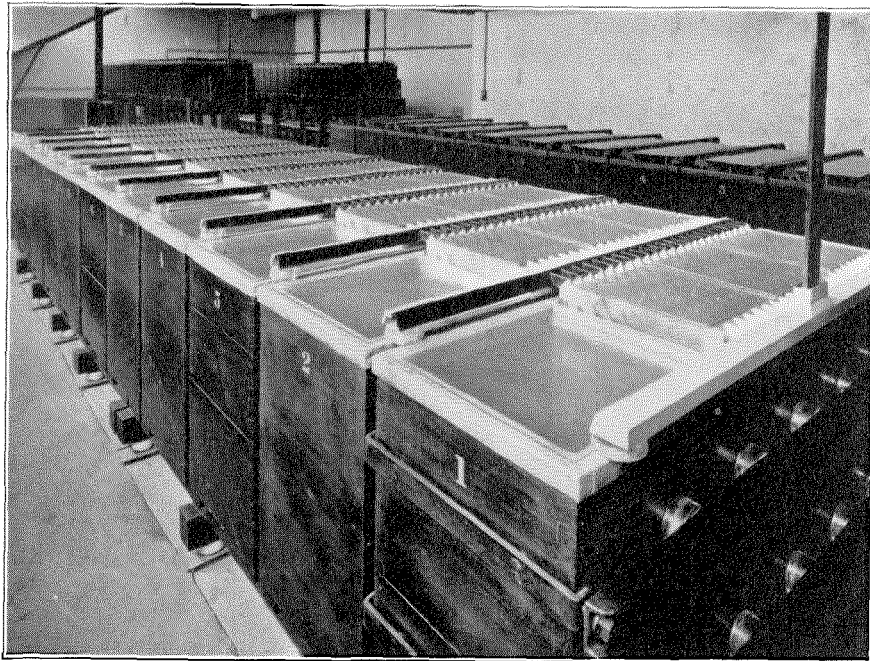
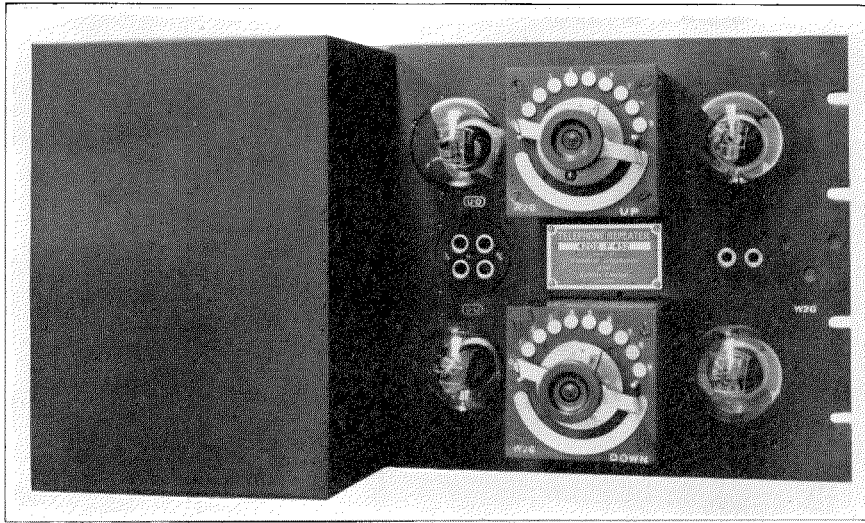

Plate Battery Charging and Ringing Machines, Leeds



Filaments and Plate Batteries, Leeds



4-Wire Repeater Unit. Front View. Cover on

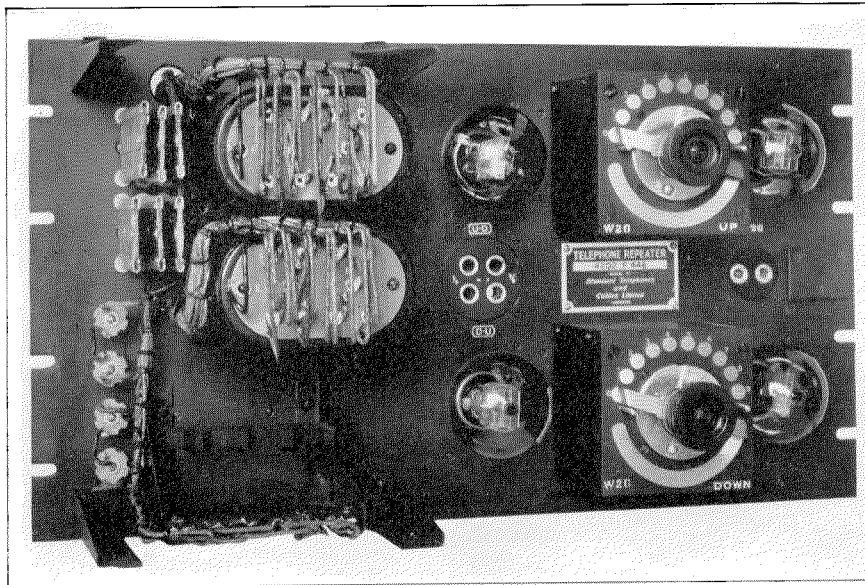

4-Wire Repeater Unit. Front View. Cover off

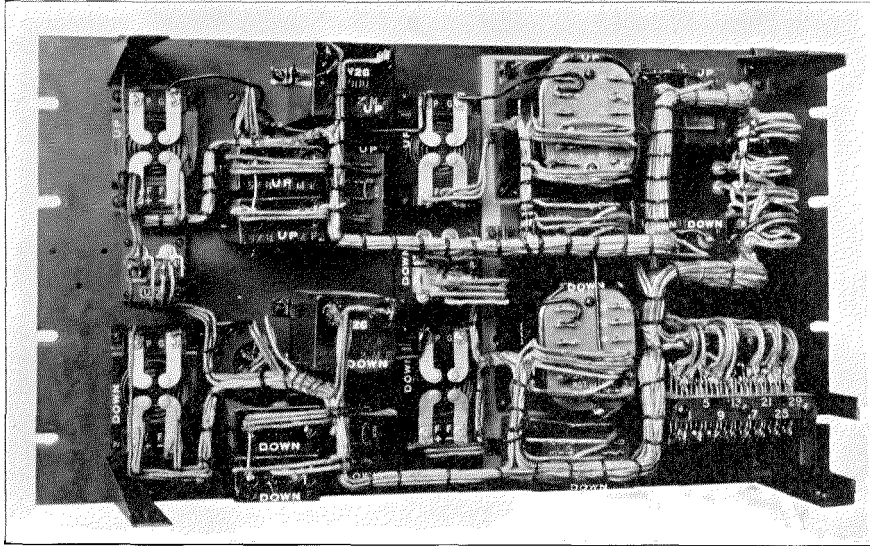

4-Wire Repeater Unit. Rear View. Cover off

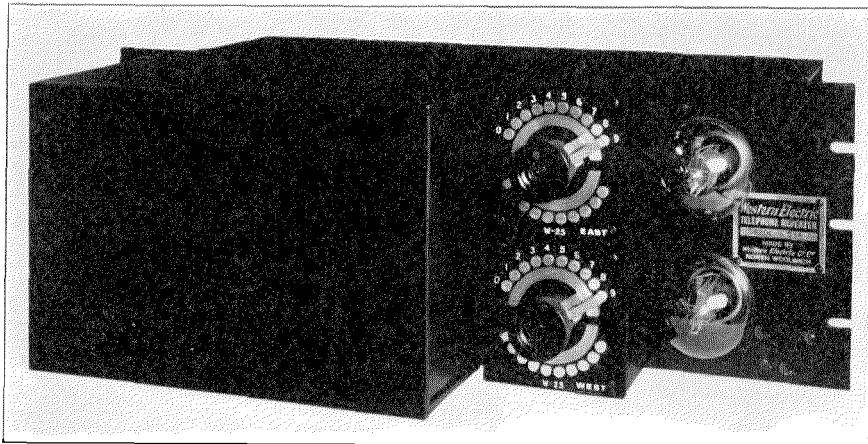

2-Wire Repeater Unit. Front View. Cover on

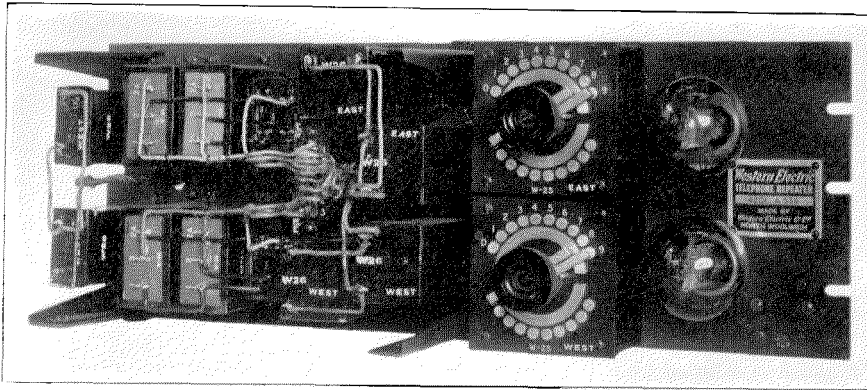

2-Wire Repeater Unit. Front View. Cover off

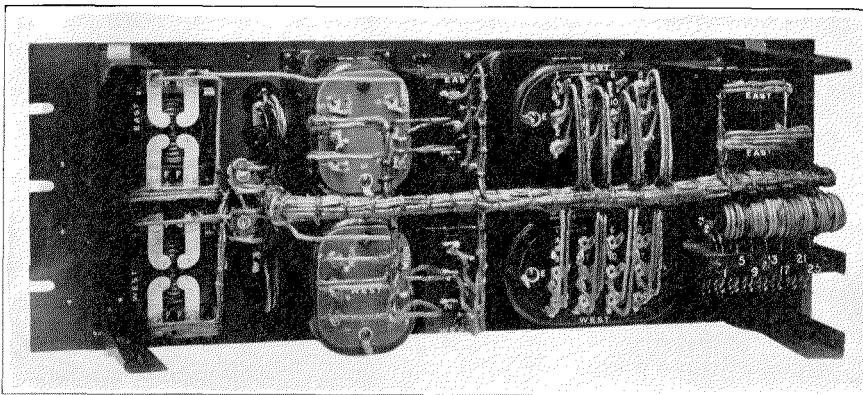

2-Wire Repeater Unit. Rear View. Cover off

drawing of a complete 2-wire repeater circuit with its associated battery supply apparatus, operator's telephone and trunk panel and filament control panels is shown in Figure 18. There are several points on this figure which are worth noting. In the first place, the filters are located in the output circuit, which results in a simpler and cheaper design than when they are located in the input circuit. Potentiometers are of the constant impedance type that permits improved impedance of the repeater, and the listening arrangements are such that the repeater attendant can listen and talk in either direction as required or in both simultaneously if necessary. The battery supply arrangements are so designed that the vacuum tubes of two repeater units are worked off one filament circuit, permitting a reduction in the power plant. This arrangement of working necessitates the use of

means for reducing the filament cross-talk and the power plant is equipped with a power filter employing electrolytic condensers, thus obviating the necessity for individual filament choke coils.

Since voice frequency signalling is used with these repeater units, there is, of course, no necessity for relaying ringing current at the repeater stations as it is amplified in the same manner as the speech currents, although means are provided for inserting 17-cycle ringers when required.

The basic network used for all 40 lb. medium-heavy loaded circuits is shown in Figure 19, and the building-out capacity necessary for each circuit is obtained from a multi-unit condenser containing 10 units, permitting values of capacity to within .001 mf. being obtained up to a maximum value of .1 mf. Since the repeaters are designed to give a better low frequency gain

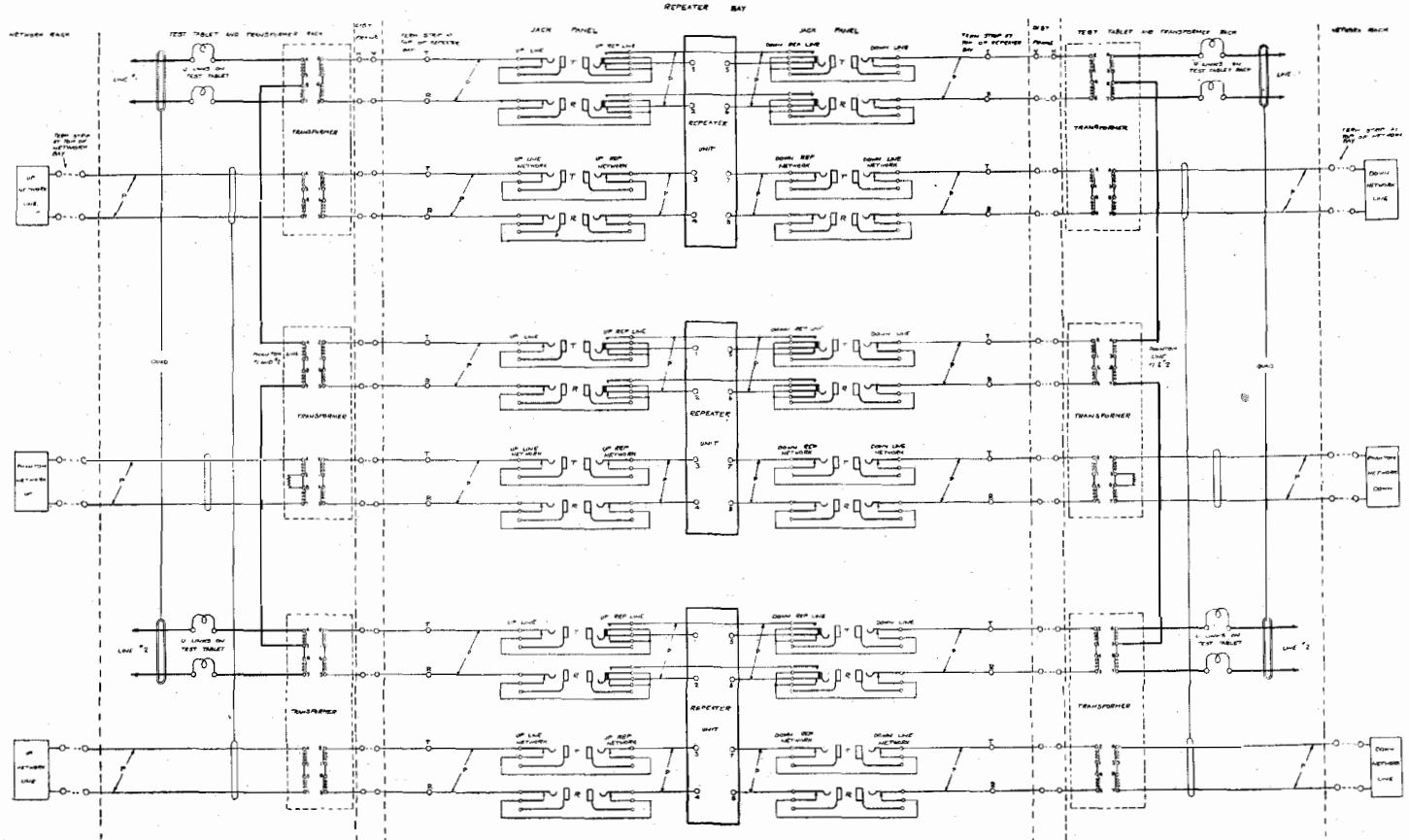

Figure 14—Schematic of 2-Wire Repeatered Phantom Group, with Balancing Network

than has been obtained hitherto, it is necessary to employ a network which gives good simulation at low frequencies and this is obtained by means of an excess simulator included in the standard networks, as shown in Figure 19.

At the terminal of the 2-wire group as described above, the arrangements shown in Figure 15 are used. This arrangement consists of the line repeating coils for obtaining a phantom circuit

and adjusted, as well as checking the complete operation of the panel from the two directions. Facilities are also provided for testing the 20-cycle relays.

The cut-off relay shown in Figure 20, when operated, closes the line through a resistance, which is necessary in order to prevent serious echo currents if the line were open-circuited during the ringing period.

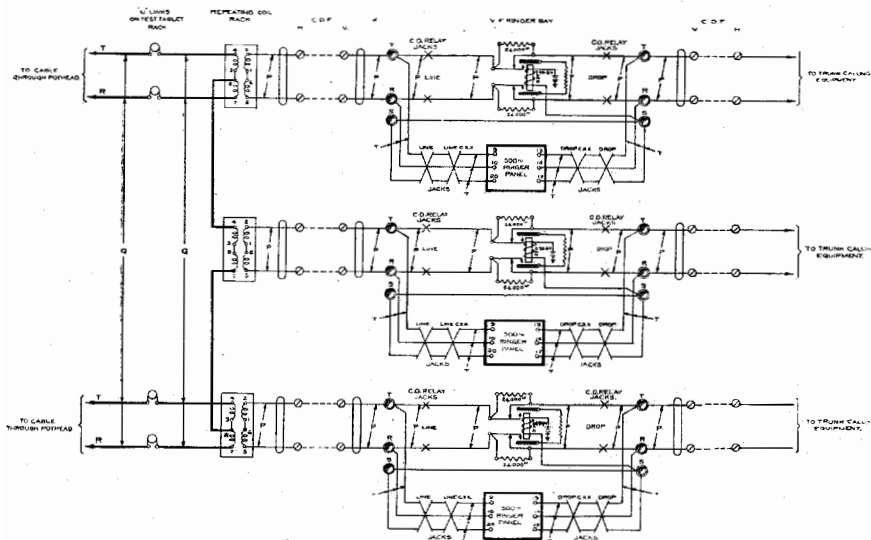

Figure 15—Schematic of 2-Wire Terminal with V.F. Signaling

together with the 500 cycle ringer panels and cut-off relays. The ringer panels and cut-off relays are illustrated in more detail in Figure 20, which shows the jacks used for testing the ringer panel by means of the ringer test panel shown in Figure 29. The ringer panel is equipped with a 500-cycle relay of a new design which permits of the modulating feature used with these frequency ringing circuits for protection against false operation to be obtained from the incoming signaling current. This modulating feature operates the 20-cycle circuit, which immediately follows the voice frequency relay, and the final relays in the train do not operate unless the alternating current operating the voice frequency relay has the correct frequency of modulation.

The test panel associated with these ringers is shown in Figure 29, and permits of the time delay feature in the ringer panel being tested

A 4-wire through cable group with repeaters is shown on Figure 16, segregation of input and output circuits is shown as well as the jacks used for patching and testing the repeater units. Low frequency corrector condensers are included in the input repeating coils, when necessary, on extra light loaded circuits to equalize the attenuation of a line at the low frequencies and so prevent excess gain at these frequencies.

The 4-wire repeater unit is shown in Figure 21, which shows the unit together with its jacks, telephone and trunk panel, battery supply circuit, meter panels and filament control panel. The listening arrangements are similar to those on the 2-wire repeaters.

The gain of the repeater unit is adjusted by means of the tapped input transformer and inter stage transformer, while a fine adjustment is obtained by means of resistances in the output circuit. The repeater unit will cater for medium-

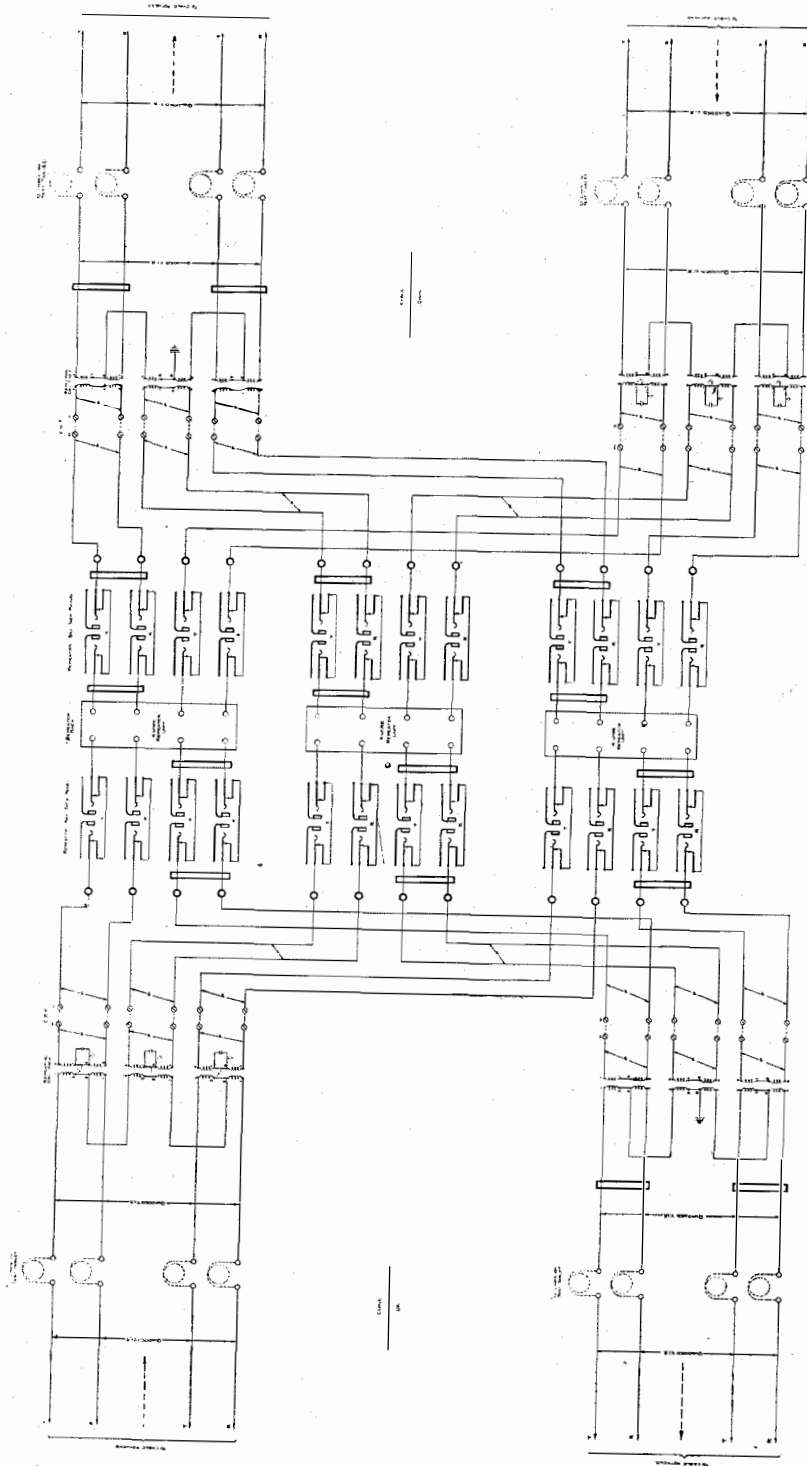

Figure 16—Schematic of 4-Wire Repeated Phantom Group

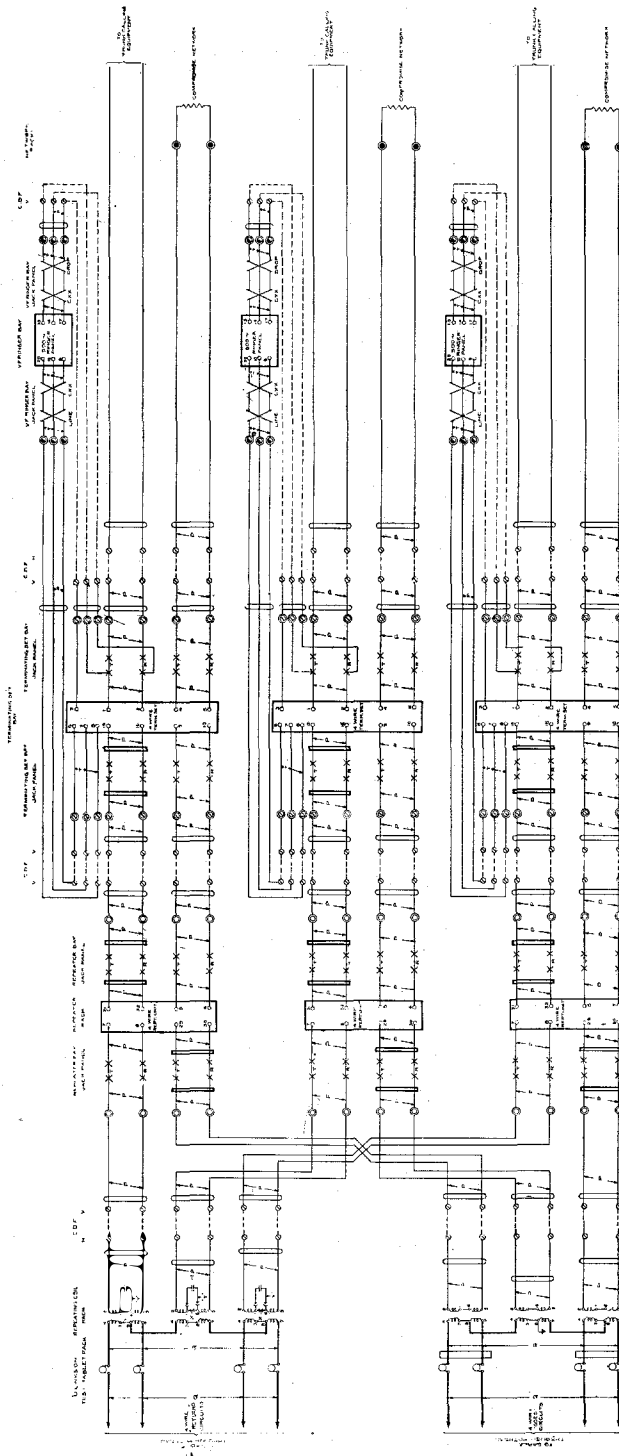

Figure 17—Schematic of 4-Wire Repeated Terminal with V.F. Signaling

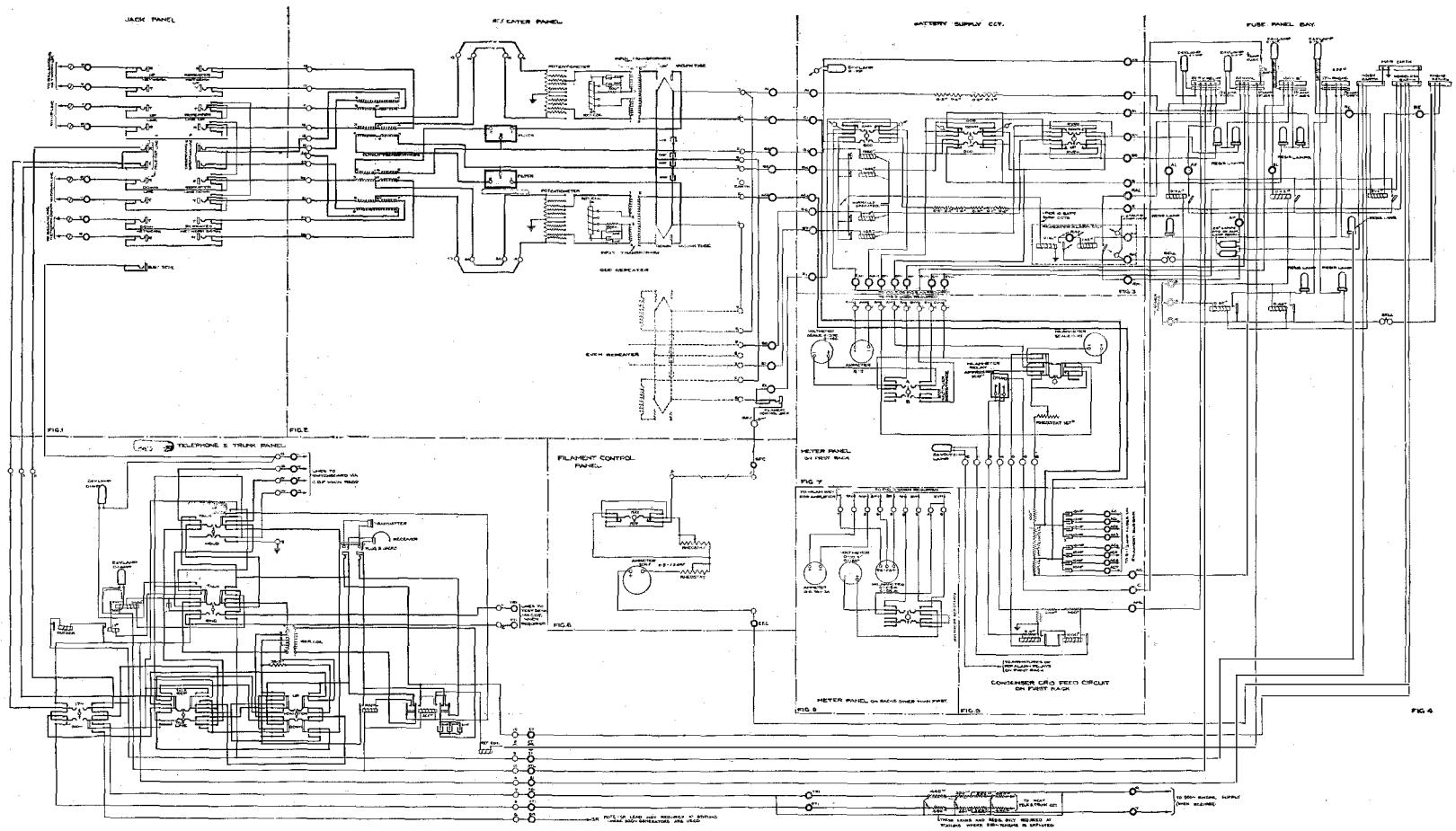

Figure 18—Diagram of 2-Wire Repeater Circuit with Associated Apparatus. (S.T. and C. Ltd. Drawing, L 36415)

heavy loaded lines and extra light loaded lines, the gain frequency curve being adjusted for the former type by means of the retard coil and condenser associated with the first input transformer.

A schematic of the terminating arrangements employed for the 4-wire system is shown in Figure 17. This covers the use of terminal 4-wire repeaters, 4-wire terminating sets, and 500 cycle ringer panels. The 4-wire terminating set and the method of connecting the 500-cycle ringer panel to it are illustrated in more detail in Figure 22. The operation of the ringer panel

tions of zero load and when closed through a load impedance of 6000 ohms.

The tube operates normally with a plate voltage of 130 volts and a negative grid voltage of 9 volts. Under these conditions it will be seen from the load curve that the asymmetric distortion introduced by the tube is negligible.

In order to maintain the overall circuit equivalent under all ordinary conditions of battery fluctuation which occur in practice, vacuum tubes are rejected when the gain of a repeater varies by more than $0.11 \beta l$ or a change of filament current from 0.93 amp. to 1.00 amp.

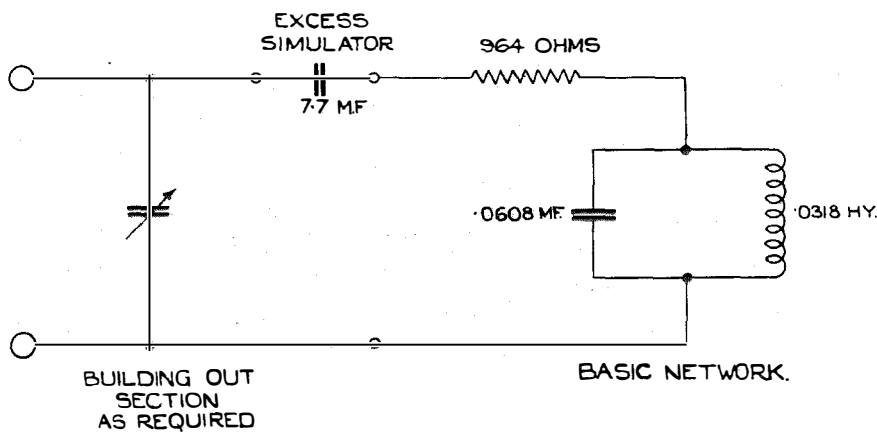

Figure 19—Balancing Network for H-177-107 Phantom Circuit

is the same as that described for the 2-wire case, except that the cut-off relays are included in the 4-wire terminating set. The 4-wire terminating set consists of repeating coils and condensers so connected that they serve the double function of a hybrid coil and of a high pass filter.

In connection with the voice frequency signaling arrangements a schematic of the 500-cycle machines and control gear is shown in Figure 23. This machine is designed so that its output from the winding is in the form of modulated 500 cycles, thus replacing the old arrangements of commutator output.

Vacuum Tubes. The vacuum tubes used on the repeaters on the London—Glasgow repeater stations have oxide-coated filaments taking a current of 0.97 amperes. An illustration of one of these tubes indicates the design of the tubes and they are so designed that microphonicity is reduced to a minimum. Figure 27 gives the characteristic of the 4101-D tube under condi-

This tube rejection test is made by means of the filament control panel and gain set previously mentioned.

The 4101-D vacuum tube is capable of handling an output power of 0.059 watts, which is a factor to be borne in mind when laying out the transmission level diagrams.

Repeater Apparatus. Gain frequency curves of the 2-wire repeaters for medium-heavy loaded circuits are shown on Figure 25 for all potentiometer settings from 1 to 9. These curves show a remarkable uniformity of curve for all settings.

Gain frequency curves of the 4-wire repeater unit are shown in Figure 26, the medium-heavy loaded values lying between the two curves shown and various tappings on the retard coil previously mentioned give maximum values at intermediate points. The extra light loaded characteristic is shown below the medium-heavy loaded characteristic.

In setting up a 4-wire medium-heavy circuit

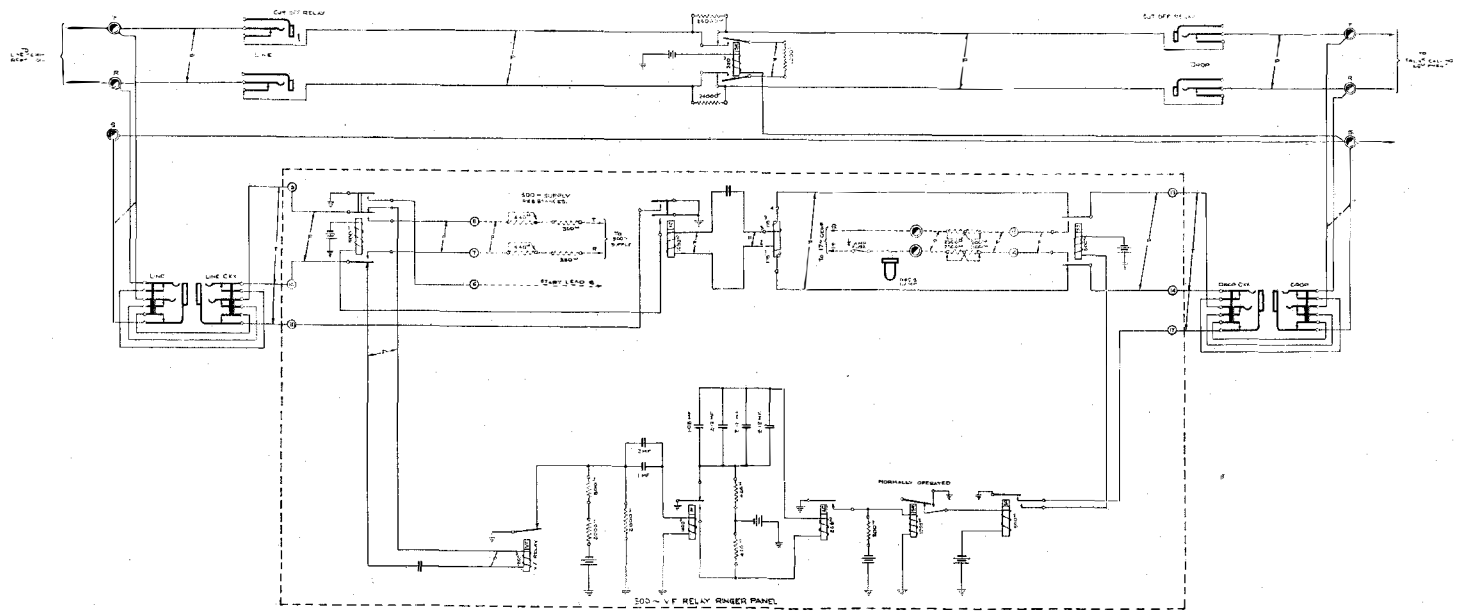

Figure 20—Schematic of 2-Wire Terminal. 500 Cycle—20 Cycle Ringing

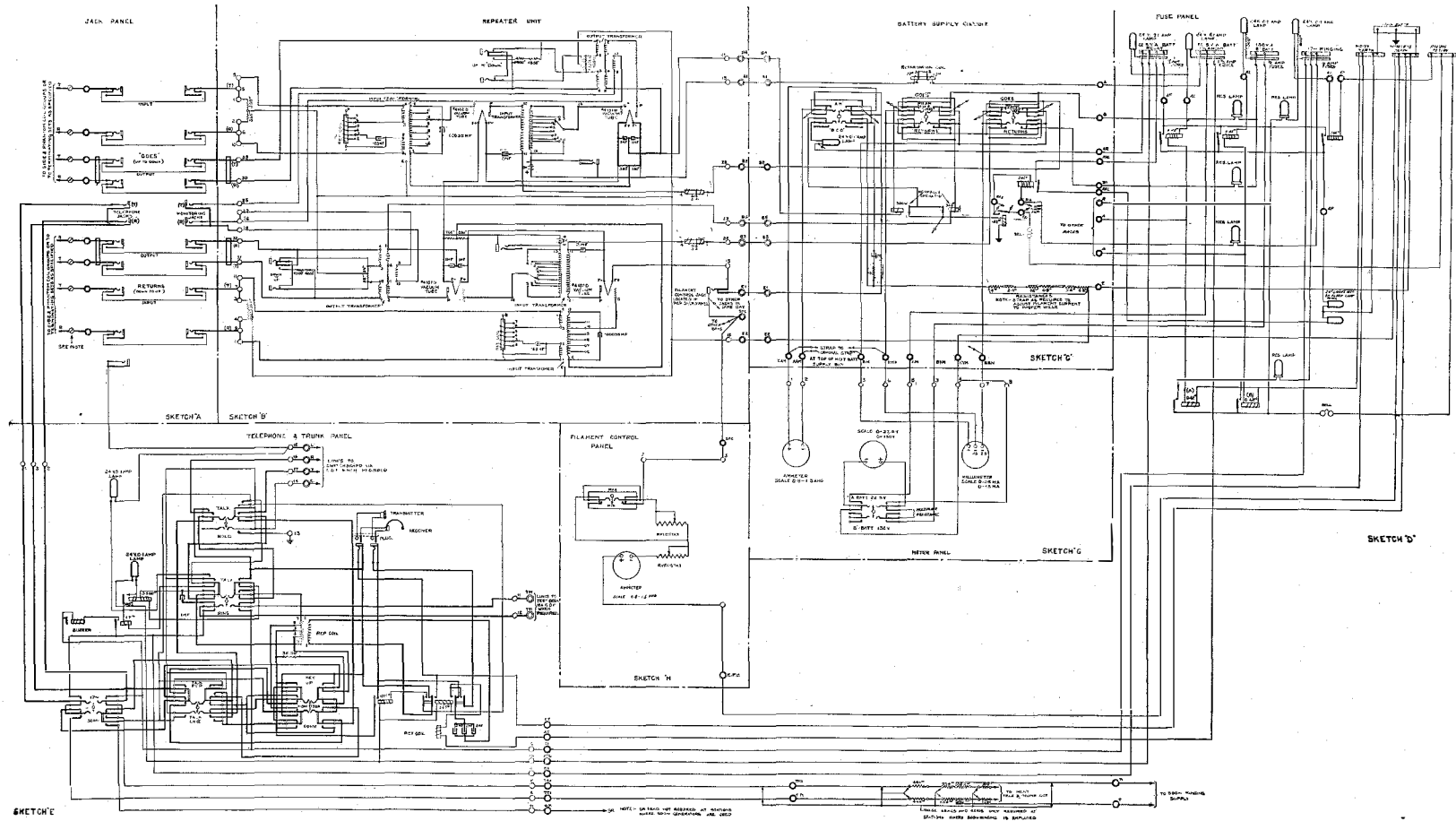

Figure 21—Schematic of 4-Wire Repeater Circuit with Associated Apparatus. (S.T. and C. Ltd. Drawing, L 36416)

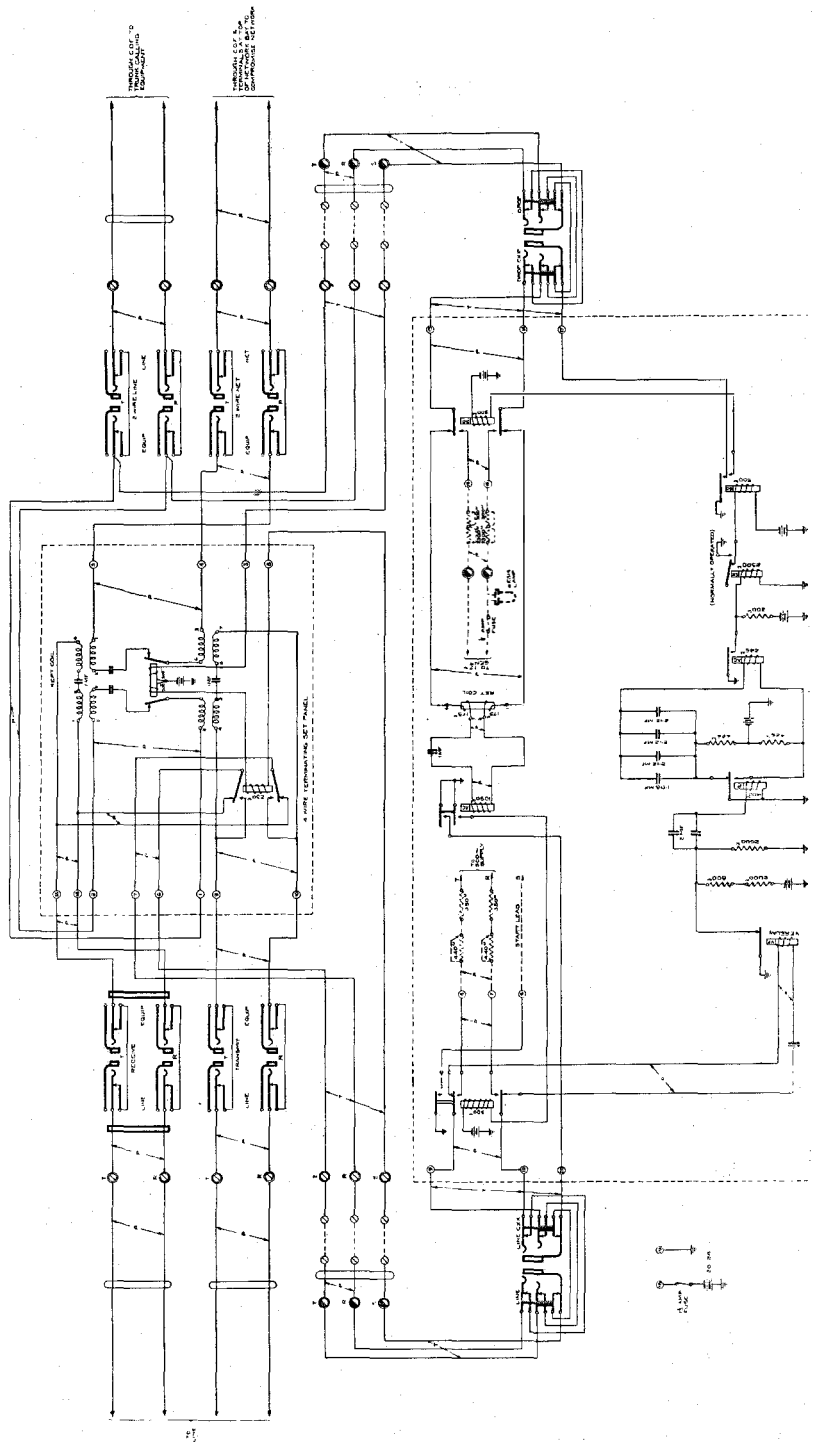

Figure 22—Schematic of 4-wire Terminating Set and Method of Connecting

the transmitting half of the repeater at the terminal stations is given an extra-light setting having the required 1000-cycle gain obtained from the transmission level diagrams.

All other repeaters, including the receiving halves of the terminal repeaters, are set so that

the gain-frequency curve compensates for the attenuation-frequency curve of the previous repeater section. By means of the adjustable tuning circuit mentioned above, it is possible to equalize for any repeater section between the maximum and minimum lengths met with in practice.

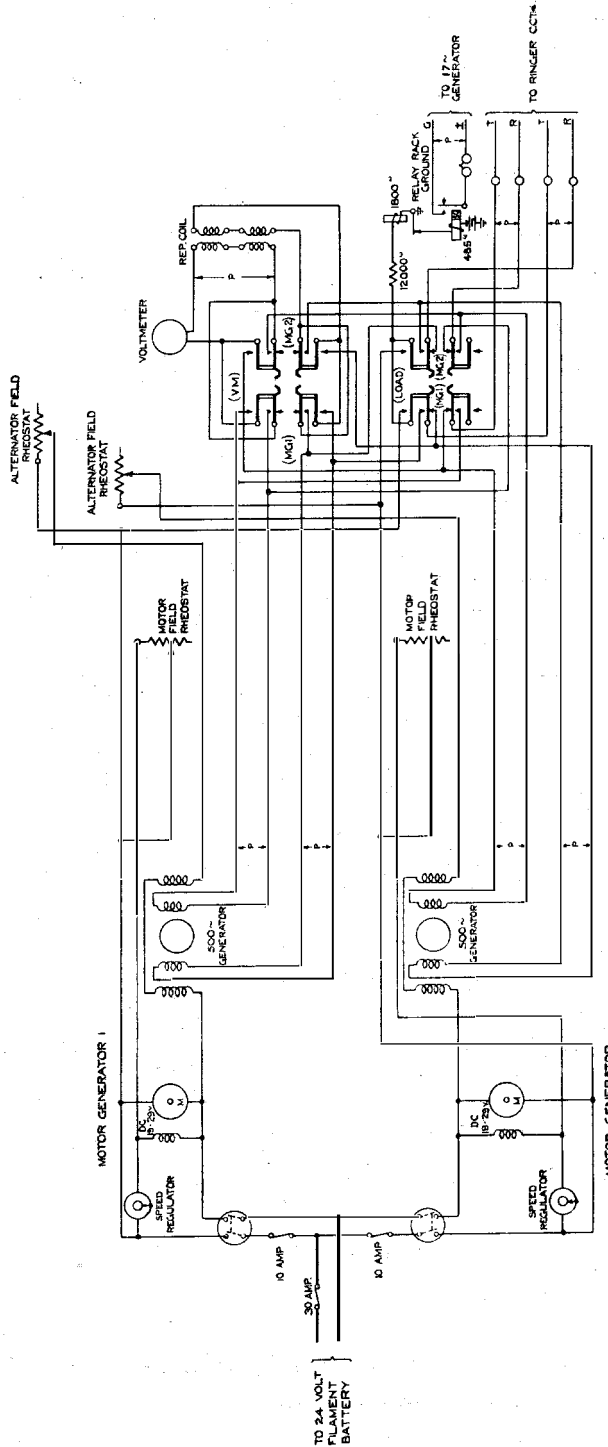

Figure 23—Voice Frequency Signaling Machines

Power Plant. The principal features of repeater station power plants have been previously described in *The Post Office Electrical Engineers' Journal*, and it is proposed in this article only

Station as representing the system under consideration, which is distinguished from previous systems by the operation of the batteries on a floating routine.

In this instance the power plant supplies both the local telephone exchange and the repeater equipment, and for this reason particular care has been exercised in obtaining a perfectly noiseless supply for the cable circuits. The 22 to 30 volt generators which are used for charging and floating the filament or "A" batteries are of special construction, embodying the usual features of telephone type machines—a large number of commutator segments and armature slots per pole, a long air gap, chamfered pole shoes and skewed armature slots. Such means alone, however, are insufficient to ensure noiseless operation of repeated circuits, and a special filter is inserted between the generator and the battery when floating. This filter consists of suitable choke coils in the negative lead and a bank of three electrolytic condensers connected across the negative and earth leads. The use of electrolytic condensers enables a high electrostatic capacity to be obtained in a small space. Three condensers, each of 1000 mf., are connected in parallel. In this way all noise arising from the machines and from the relay and miscellaneous exchange circuits is prevented from reaching the repeater circuits.

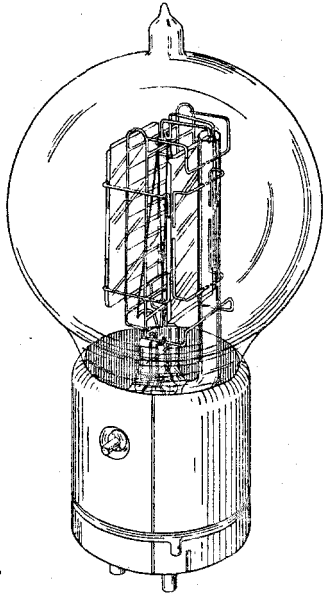

Figure 24—Type 4101-D Tube

to refer to those features of the power plants for the repeater stations on the North-Eastern cable which differ from the system previously explained. Photos on pages 137 and 138, and Figure 28 illustrate the general arrangement of a typical plant and refer to Leeds Repeater

For repeater working the normal permissible

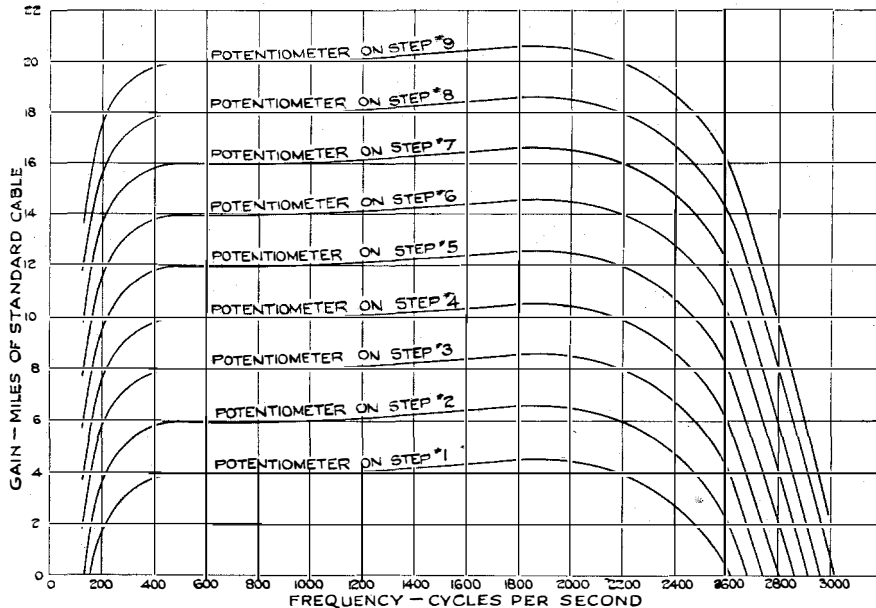

Figure 25—Gain vs. Frequency. 2-Wire

voltage variation at the fuse panel bus-bar is ± 0.5 volt. The floating battery system provides a ready means of maintaining a steady bus-bar voltage, even over a certain range of load fluctuations, and it is necessary only for the attendant to adjust the generator field regulator when considerable changes of load take place. During periods of failure of the outside power supply the two "A" batteries may be connected in parallel for discharge to the exchange and

capacity of 5000 ampere hours at the 9 hour rate, suitable for extension to a capacity of 7500 ampere hours at the same discharge rate. The batteries are illustrated on page 138, the space in the cells available for extension being clearly shown.

The duplicate plate, or "B" batteries, each of 65 lead-lined cells, are arranged for initial and ultimate capacities of 150 and 300 ampere hours respectively at the 9 hour rate. These

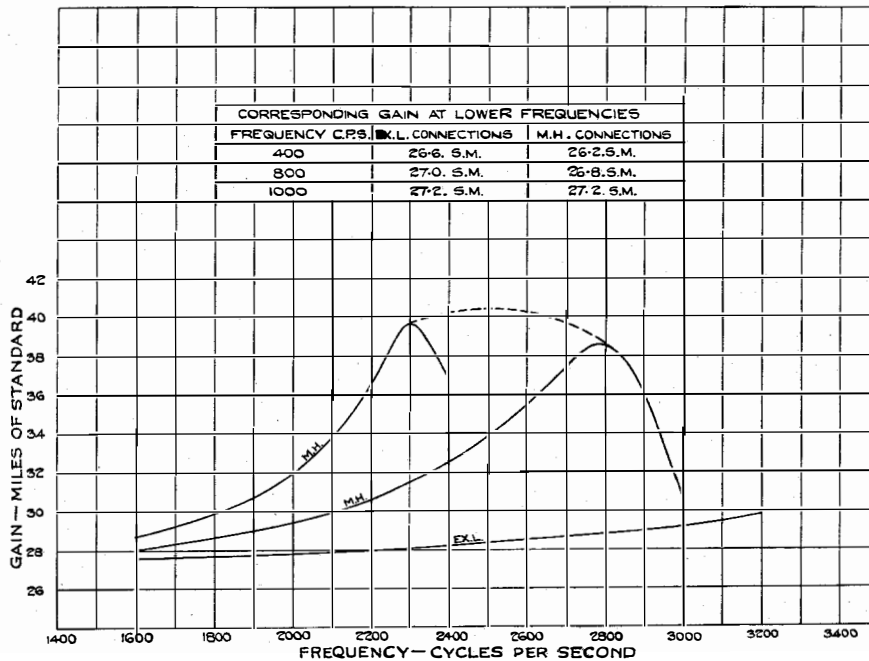

Figure 26—Gain vs. Frequency. 4-Wire

repeater equipment, in which case a further fall of 0.9 volts is allowable at the fuse panel bus-bars.

The emergency reserve power plant at Leeds consists of an engine coupled to a generator which will produce 60 K.W. at the same voltage and frequency as the normal power supply.

The floor plan lay-out of Leeds repeater station battery and power rooms is shown in Figure 28, these rooms being located adjacent to the repeater room on the second floor. The equipment is so arranged as to require the shortest possible length of cabling between the batteries, machines and apparatus racks.

The duplicate filament or "A" batteries each consist of 11 wood lead-lined cells with an initial

batteries, mounted on double tier wooden stands, are seen in the background of the same figure. The voltage limits for the "B" batteries are 125 to 135 volts measured at the repeater fuse panel, which limits are readily met by charge-discharge operation.

Duplicate grid, or "C" batteries, are supplied, each consisting of 5 glass cells of 20 ampere hours capacity at the 9 hour rate for both the initial and ultimate repeater equipments. The voltage limits for the "C" batteries are 9.5 to 11 volts measured at the repeater fuse panel. The "C" batteries are operated on a charge-discharge routine, charge being effected from the "A" battery bus-bar through a suitable resistance.

The whole of the above batteries are of the Chloride Co.'s manufacture.

A general view of the "A" battery machines and power board is shown on page 137. Each of these motor generator sets consists of a Crompton Co.'s slip ring induction motor operating on a 200 volt, 2-phase, 4-wire 50 cycle

for operation from the outside power supply and the other suitable for running from the "A" batteries. The line driven machine is normally used and the battery driven dynamotor is operated only during periods of power supply failure.

The power board mounts the necessary switch-

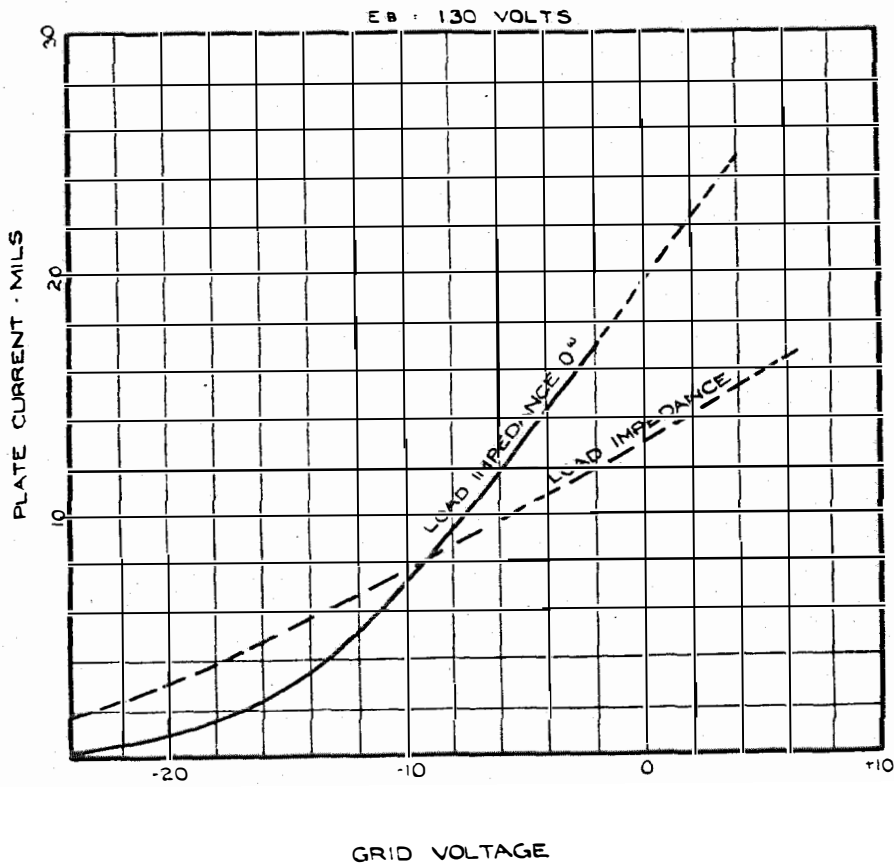

Figure 27—Characteristic of Type 4101-D Tube

supply and direct coupled to a 22 to 30 volt, 650 ampere telephone type generator, as mentioned above. The motor-starting panel for these machines may be seen on the extreme left of the power board.

Two 130-180 volt, 50 ampere, "B" battery motor generator sets are provided for charging purposes, the generators of which are ordinary commercial type machines manufactured without special restrictions regarding commutator ripple. One of these machines is shown on page 138. The photo also shows the two 17 cycle ringing machines which are provided, one

gear, instruments and meters for the machines and batteries described above and calls for no further comment.

We are indebted to the International Standard Electric Corporation for much of the technical detail and the diagrams included in this article; and we desire to take this opportunity of acknowledging the extent to which the present advanced stage of the art of long distance cable telephony has been due to the basic work of the Bell System Laboratories of the American Telephone and Telegraph Company and to the information published in their technical literature.

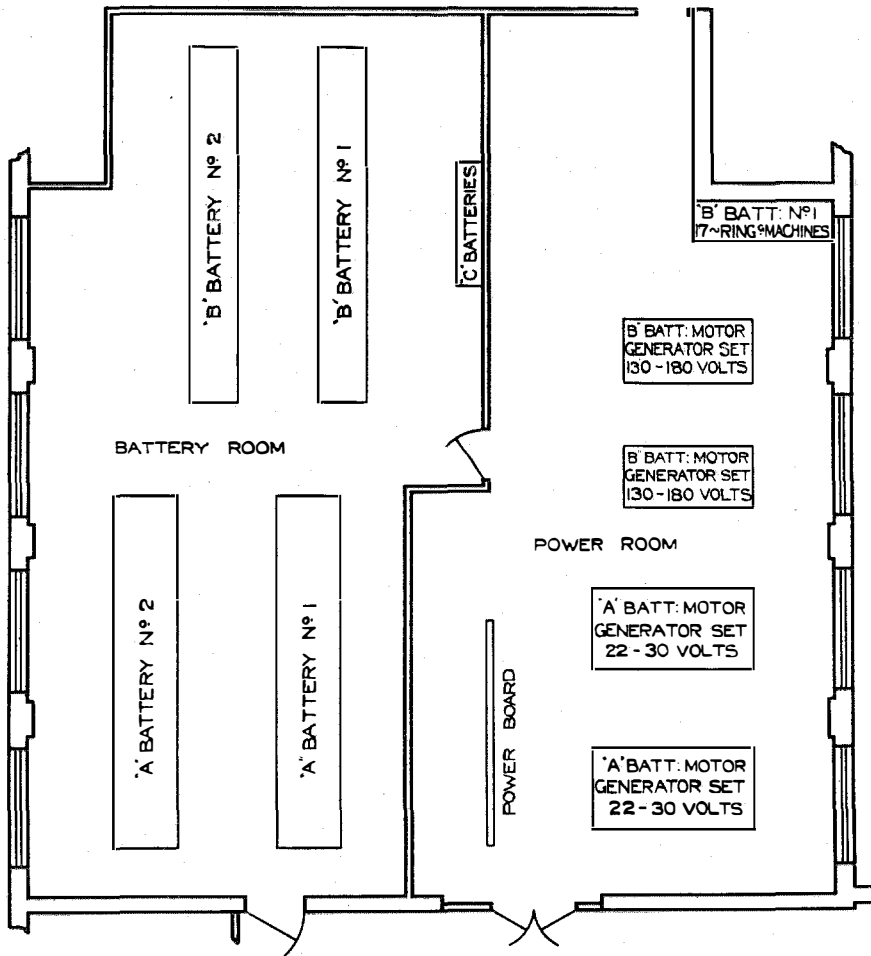

Figure 28—Layout of Battery and Power Room, Leeds

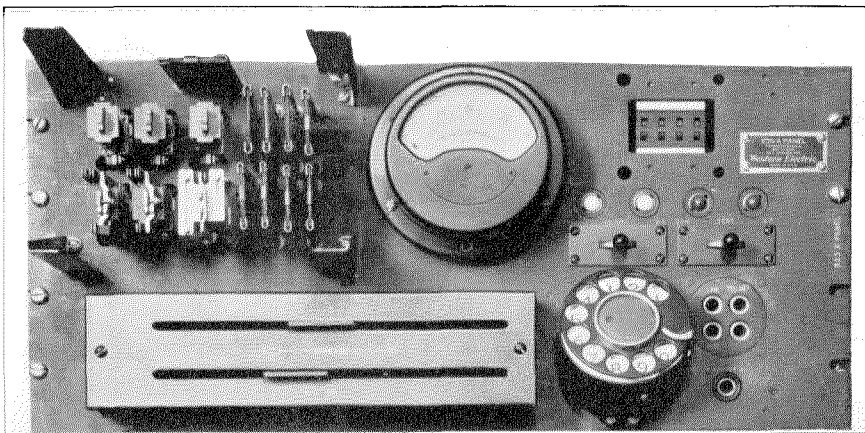
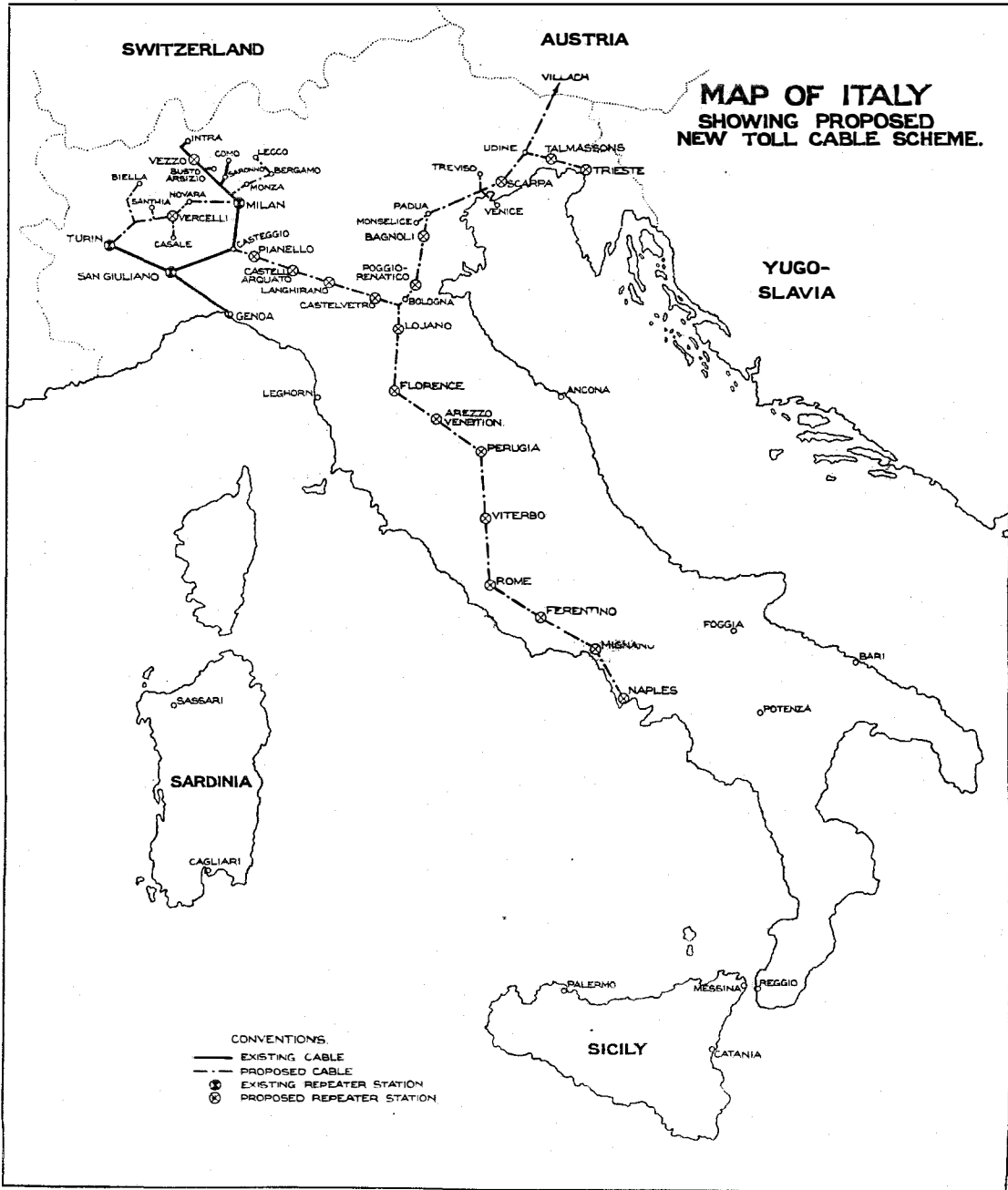

Figure 29—Ringing Test Panel



New Project for Long Distance Cable System in Italy

THE article by Ing. G. Magagnini in a previous issue of ELECTRICAL COMMUNICATION¹, which dealt with the cable system then being installed in Northern Italy between Milan-Turin and Genoa, referred to the general plan of toll cable development in Italy. It is interesting to note that the Italian Administration are pressing forward with this development and that a contract has already been placed with Società Italiana Reti Telefoniche Interurbane (S.I.R.T.I.) covering the extension of the Milan-Turin-Genoa toll cables over the following routes:

Casteggio-Bologna-Florence-Rome.
Bologna-Padua-Venice-Udine-Triest.
Milan-Simplon.
Rome-Naples.

It will be seen from the map that these cables in conjunction with the existing cables will provide a backbone system serving the long distance telephone requirements of the whole country. It is planned that the new construction will be completed over a period of five years.

Although the Milan-Turin-Genoa cable was completed only two years ago, there have been many advances in the art of long distance telephony since this installation was planned and the new cable will include many new features. Not only have loading systems changed but repeaters have been entirely remodelled so that the new cable will bear but little resemblance to the earlier cable. No difficulty will, however, be experienced in linking up circuits in the existing cable with those to be installed over the new portion, as this necessity is one of the first considerations when developing new and improved methods of construction. The types of circuits and apparatus which will be employed on the new cable are the result of extensive research work over a long period and these improved methods bid fair to remain standard for several years to come.

The loading spacing will be 1830 meters throughout and two types of loading will be

used; namely, "medium" with 177 mh. side circuit coils and 63 mh. phantom circuit coils and "extra light" with 44 mh. side circuit coils and 25 mh. phantom circuit coils. The following types of circuits will provide the facilities required over the new extensions.

- (a) 0.9 mm. or 1.3 mm. medium loaded 2-wire circuits, non-repeated or repeated at approximately 80 km. or 160 km. spacings (according to gauge) for the shortest circuits.
- (b) 1.3 mm. extra light loaded 2-wire circuits, repeated at approximately 80 km. spacings for some long national circuits.
- (c) 0.9 mm. medium loaded 4-wire circuits, repeated at approximately 160 km. spacings for some long national and international circuits.
- (d) 0.9 mm. extra light loaded 4-wire circuits, repeated at approximately 80 km. spacings for the longest national and international circuits.

All of the cable will be manufactured by Società Italiana Reti Telefoniche Interurbane in their Italian factories. The major portion of the loading coils and repeaters will be furnished by the International Standard Electric Corporation who together with Società Italiana Reti Telefoniche Interurbane have planned the whole project and are responsible for overall results.

The entire network shown will be under the direct control of the Italian Post and Telegraph Administration except in the northwest territory where the local concessionaires, Società Telefonica Interregionale Piemontese E Lombarda (STIPEL), have control. The STIPEL cables will comprise Turin-Vercelli-Milan and Milan-Intra, with branches. The main system will be extended from Milan via Chiasso and the St. Gothard Tunnel to Switzerland and northern Europe. The STIPEL cable Milan-Intra will also include international circuits to Switzerland via Simplon Tunnel.

¹ ELECTRICAL COMMUNICATION, Vol. II, No. 3, January, 1924.

International Standard Electric Corporation

Formerly
International Western Electric Company
INCORPORATED

Head Offices
NEW YORK, U. S. A.

European General Offices
LONDON, ENGLAND
PARIS, FRANCE

Affiliated Companies

Standard Telephones and Cables, Limited *Aldwych, London, England*
Branches: Birmingham, Cardiff, Glasgow, Leeds, Manchester, Newcastle-on-Tyne, Southampton, Dublin, Cairo, Johannesburg, Calcutta, Singapore.

Bell Telephone Manufacturing Company *Antwerp, Belgium*
Branches: Berne, The Hague, Brussels, Riga, Reval.

Standard Electric Company W Polsce *Warsaw, Poland*

Le Materiel Telephonique *Paris, France*

Standard Electrica, S. A. *Madrid, Spain*

Standard Elettrica Italiana *Milan, Italy*
Branch: Rome.

Standard Electric Aktieselskap *Oslo, Norway*

Vereinigte Telephon und Telegraphen Fabrik *Vienna, Austria*

United Incandescent Lamps and Electrical Company, Limited
Budapest (Ujpest), Hungary

Standard Telephones and Cables (Australasia), Ltd *Sydney, Australia*
Branches: Melbourne, Wellington.

Nippon Denki Kabushiki Kaisha *Tokyo, Japan*
Branches: Osaka, Dalny, Seoul, Taihoku.

Sumitomo Electric Wire & Cable Works, Ltd *Osaka, Japan*

China Electric Company, Limited *Peking, China*
Branches: Shanghai, Tientsin.

International Standard Electric Corporation *Rio de Janeiro, Brazil*

Compania Standard Electric Argentina *Buenos Aires, Argentina*

Sales Offices and Agencies Throughout the World

To those interested in better communication the International Standard Electric Corporation and its Affiliated Companies offer the facilities of their consulting engineering departments to aid in the solution of problems in Telephony, Telegraphy and Radio.