

Mr. Tingle

FILE COPY
Not to be removed from
the Office of Electrical
Communication.

ELECTRICAL COMMUNICATION

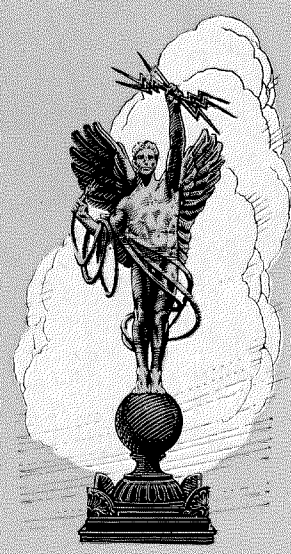

OCTOBER
1923

No. 2
VOL. 2

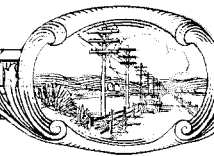

ELECTRICAL COMMUNICATION

A Journal of Progress in the
Telephone, Telegraph and Radio Art

EDITORIAL BOARD

F. B. Jewett E. B. Craft F. Gill J. L. McQuarrie
G. E. Pingree P. K. Condict C. H. Minor
J. F. Rhame, Editor

Published Quarterly by the
INTERNATIONAL WESTERN ELECTRIC COMPANY
INCORPORATED

195 BROADWAY, NEW YORK, N. Y., U. S. A.

Charles G. DuBois, President George C. Pratt, Secretary J. W. Johnston, Treasurer

Subscription \$1.50 per year; single copies 50 cents

Volume II

OCTOBER, 1923

Number 2

CONTENTS

EUROPEAN LONG DISTANCE TELEPHONY.....	61
Report of Preliminary Technical Committee at Paris Meeting, March 12-20, 1923.	
TELEPHONE TRANSMISSION OVER LONG DISTANCES.....	81
<i>By H. S. Osborne</i>	
TWENTY-FIVE YEARS OF SUCCESSFUL COOPERATION IN JAPAN.....	95
<i>By D. F. G. Eliot</i>	
RECENT DEVELOPMENTS IN TELEPHONE EQUIPMENT FOR TRAIN DISPATCHING CIRCUITS.....	111
<i>By Wm. H. Capen</i>	
TELEPHONE TRAFFIC CONTROL FOR TRAMWAYS.....	141
TELEPHONE AND TELEGRAPH STATISTICS OF THE WORLD..	146

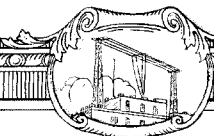



CONNAUGHT HOUSE
ALDWYCH, LONDON, ENGLAND

Headquarters, European General offices of
INTERNATIONAL WESTERN ELECTRIC COMPANY
and
WESTERN ELECTRIC COMPANY, LIMITED

European Long Distance Telephony

The problem of international long distance telephony has become a subject of universal interest, to the study of which telephone engineers and executives throughout the world are giving their closest attention. The solution of this problem has been materially advanced by the work of the delegates comprising the Preliminary Technical Committee for European Long Distance Telephony at a meeting in Paris on March 12-20, 1923; their recommendations, unanimously adopted, having been approved by the Administrations of the six countries represented. The report of this Committee has been published in the September, 1923, issue of the "Annales des Postes, Télégraphes et Téléphones," by whose courtesy the following translation is permitted.—EDITOR.

RECENT progress in telephony has made it possible to increase considerably the range of telephone communication, and at the same time to reduce the cost per unit length of circuit. Long distance communications are, however, dependent upon the provision of a proper organization and the adoption of certain practices. In particular, it is necessary to standardize the methods of construction, upkeep and operation of international circuits; and to increase the rapidity and security of communications by the establishment of new telephone lines properly constructed and operated.

Early in 1923, Mr. Paul Laffont, Under-Secretary of State for Posts and Telegraphs, convened at Paris a preliminary technical committee consisting of the delegates of the West-European countries, who in this first meeting were to confine themselves to a general survey of the complex question of European long distance telephony; this survey to be almost exclusively of a technical nature.

All the countries invited to attend, namely Belgium, Spain, Great Britain, Italy and Switzerland, accepted the invitation and sent to Paris their most capable technical experts, including

Belgium: Mr. Dethioux, Engineer in Chief of the Telephone System; Mr. Bocquet, Engineer, and Mr. Fossion, Departmental Head.

Spain: Messrs. Nieto, Cabrera and Miguel, members of the staff of the Office of the Director General of Posts and Telegraphs.

France: Mr. Dennery, Inspector General of Posts and Telegraphs; Mr. Francois, Engineer in Chief; Messrs. Velensi and Leduc, Engineers.

Great Britain: Major Purves, Engineer in Chief of the Post Office; Messrs. J. G. Hill and

A. B. Hart, Engineers; Mr. H. G. Trayfoot, Traffic Inspector.

Italy: Mr. Di Pirro, Director General of the High School of Posts, Telegraphs, and Telephones; Mr. Marchesi, Head of the Electrical Service Division.

Switzerland: Mr. Muri, Head of the Technical Division of the Office of the Director General of Telegraphs; Mr. Möckli, Electrical Expert of the Installation Division, and Mr. Forrer, Head of the Department for the Test of Material and Electrical Tests.

The Committee met from the 12th to the 20th of March, and by a unanimous vote unreservedly adopted the recommendations hereinafter listed. These recommendations have been approved by the Administrations of the six countries represented on the Committee.

RECOMMENDATIONS

Technical reasons warranting the organization of centralized control, in so far as European International Telephony is concerned, the question arises as to how this centralized control should be organized.

The Preliminary Technical Committee,

Considering that the financial and executive control of the International Telephone System, in each country, is to remain in the hands of the Minister responsible before Parliament;

Considering that in order to facilitate understandings between the various Administrations, and in order to shorten and speed up the work, there is required a central organization, consisting of high ranking officials of each one of the various Administrations, familiar with the technical matters involved, and as far as possible familiar also with the administrative matters involved;

Recommends:

That the Preliminary Technical Committee be transformed into a permanent International Consulting Committee, that said Committee prepare in all its details the organization of European International Telephony, in the meantime insure a uniformity of purposes and views in the International Telephone Service, and centralize all technical and statistical information concerning European International Telephony. This

Committee shall bear the following name: "INTERNATIONAL CONSULTING COMMITTEE FOR INTERNATIONAL TELEPHONE CONNECTIONS."

The recommendations made by the International Consulting Committee for long distance telephony shall be recommendations of a general character which the various European countries are requested to carry out in so far as possible, both in their own and the general interest. It is necessary, however, to anticipate the existence in each particular line of effort, of novel cases due to technical improvements or of exceptional cases due to special circumstances.

The International Consulting Committee shall be made up of delegates appointed by the various Administrations.

The delegation of each individual country to this Consulting Committee shall consist of not more than four members, and each delegation shall have a single vote.

The Consulting Committee shall meet in ordinary meeting, at least once a year in the month of April.

Considering that the Consulting Committee will as a rule, meet only once during the year;

Considering that to make its operation more efficient it is necessary to make provision for a permanent organization entrusted with the task of preparing the plenary meetings;

It is recommended:

That the International Consulting Committee appoint a permanent sub-committee consisting of the delegates of such countries as are more directly interested in the establishment of direct international connections. At the start, the permanent sub-committee to be made up of not more than 12 members, comprising not more than two members for each of the following countries: Belgium, Spain, France, Great Britain, Italy, Switzerland, each one of these countries to have but a single vote. In the event of questions arising which directly affect a country which is not represented on the sub-committee, the sub-committee may call in to sit on the sub-committee one of the members of the delegation to the International Consulting Committee, of the country in question.

The permanent sub-committee shall prepare and facilitate the work of the International Consulting Committee, and shall work out and develop in all their practical details the resolutions adopted by the International Consulting Com-

mittee, and shall point out the methods to be followed in carrying out such resolutions. It shall be called upon to decide matters of detail wherever direct action on the part of the Consulting Committee is not required.

The Administrations being members of the system may at any time appeal to the permanent sub-committee, but the resolutions adopted by this sub-committee shall be subject to regular approval by the International Consulting Committee, at the meeting immediately following.

The sub-committee shall be assisted by a permanent Secretary appointed by the International Consulting Committee to be selected from among persons properly qualified for such office, due to their technical knowledge and as far as possible, due to their familiarity with foreign languages.

The permanent Secretary is not necessarily bound to devote all his time to his duties as such permanent Secretary, and there may be appointed as permanent Secretary an official in charge of a branch of the service. The duties of the permanent Secretary shall consist particularly in collecting reports of studies, researches, and technical work carried out in the laboratories of the various telephone administrations, and forwarding such data, on behalf of the permanent sub-committee, to the principal delegates of the European Administrations which are members of the system, said permanent Secretary to act as the connecting link between the permanent sub-committee and the European Administrations which are members of the system. By way of remuneration for his services as permanent Secretary, he will receive an annual allowance, the amount of which shall be fixed by the International Consulting Committee.

The comparatively small expenses entailed by the operation of the office of the Secretary, shall be borne at the start in equal proportion by all the Governments which are members of the system, irrespective of the greater or smaller importance of each individual country as far as telephone connections are concerned.

The annual total expenses shall not exceed 30,000 gold francs.

The permanent Secretary shall have his official residence at Paris, but the permanent sub-committee, which as a rule will meet at Paris, may meet in other cities as circumstances may

require. The International Consulting Committee shall meet either at Paris, or in any such other city as the permanent sub-committee may designate.

To make provision for the continuity of the work, the Secretary of the Preliminary International Technical Committee shall act as permanent Secretary until the Consulting Committee is organized, upon which body the appointment of the permanent Secretary devolves. In the interval the Secretary of the Preliminary International Committee shall keep in touch with the various Administrations which are members of the system through the principal delegate of each Administration to the Preliminary Committee.

Considering that the International Consulting Committee will in the future comprise delegates of further European States aside from the delegates of such Western European countries as are already represented on the Preliminary International Technical Committee;

Recommends:

That the recommendations made by the Preliminary Technical Committee be brought to the knowledge of said European States, after such recommendations have been approved by the Administrations represented on the Preliminary Technical Committee.

Considering that the selection of the official language should rest with the language spoken by the majority of the delegates;

Recommends:

That the language to be used, as a rule, in plenary meetings be the French language. Nevertheless, the services of interpreters may be resorted to wherever it may be found advisable to call in interpreters.

Being unwilling to reject, *a priori*, such reasonable solutions of new or special problems as may be devised, but being desirous of maintaining that unity of purposes and views which is required for the proper protection of the interests of International telephony; in particular with respect to matters affecting transmission,

The Preliminary Technical Committee,

Recommends:

That the future preliminary sub-committee of the International Consulting Committee be called upon to consider and examine all such

projects of new International lines, as swerve, with respect to any particular point, from the general recommendations adopted, and to consider such modifications if any, as may be introduced in the rules now recommended.

Furthermore, any country that may deem the general rules set up by the Preliminary Technical Committee not to be sufficiently definite, in particular with respect to matters concerning transmission, shall have the right to apply for further information to the permanent sub-committee, and pending the organization of such permanent sub-committee, to the Chairman of the Preliminary Technical Committee.

The Preliminary Technical Committee,

Considering that it may happen that certain countries lack the necessary experience for the proper selection of cables, and that it is necessary to insure a uniform practice in this matter;

Recommends:

That during the first years at least, the plans for International trunk lines be submitted to the consideration of the permanent sub-committee, which within the shortest possible time will give its opinion on the technical clauses of the specifications drawn up by the interested countries;

Considering that at its first meetings the Preliminary Technical Committee had not available the data required to enable it to complete the study of its program;

Considering that the organization of the International Consulting Committee will require some time,

Recommends:

That the International Consulting Committee be organized within the shortest possible time and that in the meantime the Preliminary Technical Committee carry on its work;

That the International Consulting Committee elect its own Chairman, and that all resolutions of such International Consulting Committee be adopted by a majority vote;

That the information to be supplied by the delegates of the various countries be addressed to the Chairman of the Preliminary Technical Committee, it being understood that upon the organization of the International Consulting Committee, any and all documents, papers, records, etc., shall be forwarded to the permanent Secretary to be appointed by the International Consulting Committee.

Furthermore, the Preliminary Technical Committee,

Recommends:

That the meetings of the technical experts of European Telephone Administrations, such as the meetings that have taken place in Budapest in 1908 and in Paris in 1910, in the future be called by the permanent sub-committee of the International Consulting Committee.

WIRELESS TELEPHONY

Although long distance wireless telephony cannot be considered otherwise than as intimately connected both technically and commercially with ordinary wire telephony, the Preliminary Technical Committee did not find it advisable to deal with the matter of long distance radio telephony which is still in an experimental stage. Nevertheless, as soon as radio telephony, which at the present time is progressing at a very rapid rate, has reached such a stage of development as to warrant the insertion of radio telephone connections in the International Telephone System, the International Consulting Committee shall consider the matter of coordinating, as far as the operation of the International System is concerned, wireless telephony and ordinary wire telephony. Nevertheless, the Technical Committee is of the opinion that the use of radio telephony in the organization of the International Telephone System should not be resorted to unless in cases where connections by wire are impossible.

RELATIONS WITH INTERNATIONAL TELEGRAPH AND TELEPHONE CONFERENCES

As a rule, the International Consulting Committee for long distance telephony shall keep in touch with the various existing international organizations intended to regulate International telephony.

RECOMMENDATIONS OF THE PRELIMINARY TECHNICAL COMMITTEE WITH RESPECT TO MATTERS AFFECTING TRANSMISSION

- I. General Recommendations
- II. Aerial Lines
- III. Cables
- IV. Composite Lines.

TRANSMISSION

I. GENERAL RECOMMENDATIONS

Selection of the equipment for Long International Lines

The Preliminary Technical Committee, Considering that the range of long distance telephony depends not only on the theoretical possibility of securing good transmission, but also on the quality and maintenance of the apparatus and installations utilized for the equipment of the circuits;

Recommends:

1. That the greatest attention be given to the selection, to the installation, and to the maintenance of apparatus and installations used for the equipment of trunk circuits intended for long distance international telephony.

2. That the telephone administrations equip themselves with the necessary measuring apparatus required for the proper supervision and the proper maintenance of the installations.

The permanent sub-committee may be entrusted with the duty of collecting and distributing the necessary information as to the selection of the proper apparatus.

SUBSCRIBERS' SETS

The Preliminary Technical Committee,

Recommends:

1. That the same standard telephone apparatus be adopted by all European countries.

2. That for the time being, this standard apparatus be a solid back microphone with Bell receiver in accordance with detailed specifications attached as annex No. 1.

3. That the efficiency of any subscriber's set used in Europe, both as to transmitter and receiver, should not be less than the efficiency of this standard apparatus.

LOCATION OF THE AMPLIFYING RELAY STATIONS

The Preliminary Technical Committee,

Recommends:

That the location of the amplifying relay station be determined upon technical consideration, and not upon political consideration.

SELECTION OF THE AMPLIFIERS

The Preliminary Technical Committee, Considering unanimously that experience shows that it is impossible to insure (in such a

manner as to bring about a satisfactory operation of the system from a business point of view) the security of operation of two or more telephone amplifying relays without artificial lines inserted in series on the same line,

Recommends:

That on two-wire circuits (whether aerial circuits or underground circuits), there be used exclusively in the future, reversible amplifying relays provided with two artificial lines balancing separately the two sides of the telephone line.

USE OF INTERNATIONAL CIRCUITS FOR TELEGRAPHIC PURPOSES

The Preliminary Technical Committee,

Considering that the use for telegraphic purposes of international trunk circuits may at the outset jeopardize the proper operation of these circuits;

Recommends:

1. That for the time being International circuits and in particular, such circuits as are provided with amplifying relays, be not allowed to be used for telegraphic purposes.

2. That, however, the use of the circuits for the telegraphic announcement of conversations be allowed in the case of such International circuits as are not used as transit circuits.

COMBINATIONS OF INTERNATIONAL CIRCUITS

The Preliminary Technical Committee,

Recommends:

That in order to insure the security of transmission the combining of international telephone circuits should not take place unless on complete stretches ending at each end with an amplifying relay station.

TRANSMISSION OF CALLS ON AERIAL LINES AND CABLES

The Preliminary Technical Committee,

Recommends:

1. That on aerial lines which, as a rule, are provided with only a small number of amplifying relays, there be used for calls a low frequency current (16 to 20 cycles per second), these calls being repeated at each intermediate relay station between the two terminal offices by means of an electro-magnetic device.

2. That in connection with main international cables, for which this process cannot

be utilized due to the large number of amplifying stations with which these cables are provided, there be undertaken as soon as possible, the necessary researches for the purpose of devising a call system actuated by a current of a sufficiently high harmonic frequency to enable amplifiers to amplify the call in the same manner and to the same extent as they amplify telephone currents.

RING OFF OR CLEARING SIGNALS

The Preliminary Technical Committee

Recommends:

That the ring off or clearing signals inserted on international telephone lines, be provided with a large impedance.

ADMISSIBLE VARIATION IN THE TOTAL TRANSMISSION EQUIVALENT OF THE LINES

The Preliminary Technical Committee,

Recommends:

That in the event of the traffic being insufficient to remunerate the cost of a line of a transmission equivalent smaller than, or equal to twelve miles of standard cable, this being the limit equivalent set forth further on for International aerial and cable lines, an excess of six miles of standard cable may be allowed in the case of lines on which the traffic is small.

The total transmission equivalent between two subscribers' stations exchanging an international communication would work out in this case at not more than 38 miles of standard cable.

II. AERIAL LINES

PUPINIZATION (LOADING) OF AERIAL LINES

The Preliminary Technical Committee,

1. Considering that the Pupinization of aerial lines makes difficult the operation of these lines, due to insulation variations and due to the magnetization of the coils, owing to atmospheric discharges;

2. Makes difficult the operation of these lines with amplifiers.

3. Makes it impossible to operate these lines by high frequency telephone currents.

4. Brings about too great a variation in the transmission of the various frequencies of speech, brings about distortions, and consequently interferes with the clearness of the conversation (articulation);

Recommends:

That aerial telephone lines provided with amplifier relays, and intended for long distance international connections, should not be Pupinized.

ESTABLISHMENT OF AERIAL LINES

The Preliminary Technical Committee,

Considering that the establishment of long distance international telephone communications requires at the present time the use of aerial lines;

Considering that the highest efficiency of these lines is obtained by resorting to combined circuits, to the use of amplifying telephone relays, and to the installation of a high frequency multiple telephony system;

Considering that in order to insure the proper operation of these various devices, and to avoid the attenuation due to losses by reflection, it is indispensable to bring about an electrical balancing of the circuits as well as a uniform distribution of the electrical constants along the entire length of the line between two successive amplifiers;

Considering that while it is impossible to determine in a hard and fast manner the geometrical or mechanical constants of the configuration of the lines, the value of these constants being a function not only of electrical factors but also of economic factors which vary from time to time and from country to country, it is none the less desirable to lay down at once certain limits within which such constants are to range and in particular to determine the resistivity of the metal and the minimum diameter of the conductors in such a manner as to make full provision for the mechanical strength that all international lines should possess in order to avoid interruptions in the service;

Recommends:

1. That the long aerial lines intended for international communications be properly balanced and that furthermore there be avoided any electrical discontinuity between two successive amplifiers, i.e., that over their entire length the electrical constants of these lines be distributed in a uniform manner.

2. That the conductors be made invariably of copper or of a copper alloy whose resistance does not exceed the resistance of copper of high conductivity by more than 10%.

3. That there be used in the construction of long distance international telephone lines conductors of a diameter equal to or greater than 3 millimeters and possessing a sufficient mechanical strength to reduce to a minimum the risk of accidental breakages.

TRANSMISSION EQUIVALENTS

The Preliminary Technical Committee,
Recommends:

1. That for the time being and until a final agreement has been arrived at, the attenuation or the transmission equivalents as far as international telephone communications are concerned, be expressed in miles of standard cable (the standard cable is an artificial line having for each one-mile loop 1,609 meters) the following constants:

Resistance: 88 ohms

Inductance: 1 millihenry

Capacity: 0.054 microfarad

Admittance: 1 micromho

Attenuation constant at 5,000 cycles 0.1061

2. That the maximum attenuation between two successive relays in long distance international lines should not exceed 12 miles of standard cable.

That the maximum attenuation of all the sections making up an international line should not be greater than 12 miles of standard cable.

That the total transmission equivalent of an international connection between any two subscribers should not exceed 32 miles of standard cable.

That the total attenuation on the line connecting a subscriber with the international telephone office of the subscriber's country, namely, with the office effecting the international connection, should not exceed 10 miles of standard cable.

CROSS-TALK

The Preliminary Technical Committee,
Recommends:

That it be agreed that the cross-talk between any two circuits (whether combining or combined) being constituent parts of an aerial telephone line intended for long distance international telephony, should always be less than the value corresponding to 65 miles of standard

cable, this cross-talk to be measured by means of a cross-talk meter at any amplifier relay station or at any central exchange along the line.

ELECTRO-MAGNETIC INDUCTION ORIGINATING FROM POWER TRANSMISSION LINES

The Preliminary Technical Committee,
Considering:

That aerial lines are a necessity in the establishment of long distance international telephone communications;

That these long lines are particularly exposed to electro-magnetic disturbances originating from power transmission lines,

Considering that it has been found that the best means for eliminating these disturbances is to make provision for a sufficient separation between telephone lines and power transmission lines,

Considering that it is difficult to lay down at once the maximum allowable induced voltage or the maximum allowable induction noise and that it is nevertheless advisable to carefully define these limits,

Recommends:

1. That parallel construction of telephone lines and power transmission lines without adequate separation be avoided.

2. That there be carried out during the year 1923 by the various telephone administrations interested in the matter, as complete tests and researches as may be possible for the purpose of determining the maximum induced voltage and the maximum induced noise allowable in long distance international telephone circuits.

III. CABLES

ESTABLISHMENT OF A SYSTEM OF CABLES

The Preliminary Technical Committee,

Considering that long distance connections have already been carried out by means of cable circuits through the use of Pupinization and of amplifier relays;

That the information available on these lines makes it possible to determine, in the present stage of development of telephony, the distances beyond which it is impossible to go when using two-wire or four-wire cable circuits;

Recommends:

1. That the use of Pupinized cables provided with amplifier relays be not resorted to for long distance international communications unless

the distance between the two international exchanges to be connected, does not exceed 1,000 miles; i.e., 1,600 kilometers, until such time as the very rapid progress which is being made in telephony, may afford the possibility of establishing telephone connections in a thoroughly satisfactory manner, from a business point of view, over greater distances.

2. That there be utilized for these connections four-wire circuits wherever the distance between the two international exchanges to be connected, is in excess of 500 kilometers, this being the limit that in the present stage of the development of telephony, is set by economic considerations for the use of two-wire circuits.

SPECIFICATIONS FOR PUPINIZED CABLES

The Preliminary Technical Committee,

Considering that a heavy Pupinization of long distance cable circuits carrying a heavy traffic, interferes with the clearness of the conversation, and magnifies in an intolerable manner transient phenomena and the echo;

Considering that the manufacture of cables of a length of 1,600 kilometers has led to investigations for the purpose of determining the requirements to be fulfilled for the establishment by means of cables of long lines carrying a heavy traffic;

Considering that it is possible to carry out an international telephone service on distances up to 1,600 kilometers, by means of conductors of the usual diameters of 0.9 mm. and 1.3 mm;

Considering that it is advisable for the efficiency of transmission and for the standardization and flexibility of operation, to fix with respect to long international cables a uniform spacing of the coils to be adopted in all countries;

Is of the opinion,

1. That satisfactory results would be obtained by using for long distance cable telephone lines, circuits made up of four wires loaded at the rate of approximately 24 millihenrys per kilometer, this inductance being obtained by means of 44 millihenrys coils, spaced at intervals of 1,830 meters (this value of the inductance determines the natural impedance and the natural frequency of the cable).

2. That as far as telephone connections over distances equal to or smaller than 500 kilometers are concerned, satisfactory results would be

obtained by the use of two-wire circuits loaded at a rate not in excess of 96 millihenrys, this maximum inductance being obtained by means of 176 millihenrys coils spaced at intervals of 1,830 meters.

3. That there should be recommended the use of conductors of the usual diameters of 0.9 mm. and 1.3 mm.

4. That there should be recommended as to all cable circuits the adoption of a spacing for the coils of 1,830 meters, this spacing being the one in use at the present time in several European countries.

TRANSMISSION EQUIVALENT

The Preliminary Technical Committee,
Is of the opinion,

1. That it is desirable that the transmission equivalent should not exceed 12 miles of standard cable between the ends of an international telephone line, established by means of cable, regardless of the length of such line, and whether such line is a two-wire or four-wire line.

2. That it is desirable that the total transmission equivalent of an international line between any two subscribers' sets should not exceed 32 miles of standard cable.

CROSS-TALK

The Preliminary Technical Committee,
Recommends:

That the cross-talk between any two circuits, whether combining or combined, of the same cable carrying circuits intended for long distance international telephony, should always be less than the value corresponding to 75 miles of standard cable, this cross-talk being measured by means of a cross-talk meter, at any relay station or at any central exchange along the line.

HOMOGENEOUSNESS

The Preliminary Technical Committee,

Considering that it is absolutely necessary in order to insure the proper operation of the amplifying relays and in order to avoid the attenuation due to losses by reflection, to bring about a uniform distribution of electric constants along the entire length of a section ending at both ends with an amplifier;

Recommends:

That provision be made for absolute homogeneousness of the lines established by means of

cables between two successive amplifiers and that regulations be enacted to the effect that the structure of the cable should be such as to cause the circuits to be perfectly balanced, and as to cause the electrical constants of the circuits to be distributed in a uniform manner.

CABLES INTENDED FOR THE INTERNATIONAL SERVICE

The Preliminary Technical Committee,

Considering that when the cables of the interior systems of the various States closely conform with the specifications for international cables, which specifications cover the usual types of cables used in the various European countries;

Recommends:

That the telephone administrations of the various European countries be requested to conform as far as possible in the establishment of their domestic systems of long distance cables for domestic service with the rules set forth above, relating to the diameter of the conductors, to the spacing of the coils, and to the location of the amplifying relay stations.

TELEGRAPH AND TELEPHONE CABLES

The Preliminary Technical Committee,

Considering that economic considerations suggest that in large cables certain pairs of wires be allotted to telephone communications and other pairs of wires to telegraph communications;

That experience shows the feasibility of this arrangement without telephone communications being interfered with, provided certain precautionary measures are taken,

Is of the opinion

That there is no objection as far as the large international cables are concerned, for the allotment of certain pairs of conductors to the telephone service, and other pairs of conductors to the telegraph service, provided the cable is properly balanced, and provided all the pairs of wires allotted to the telegraph service are combined together in the manufacture of the cable.

LOCATION OF AMPLIFYING RELAYS

The Preliminary Technical Committee,

Recommends:

1. That in the selection of the location of the amplifying relays, the purpose held in view be always the reduction to a minimum of distor-

tions on sections of cable between two successive relays.

2. That under the present conditions of operation the distance between two successive amplifiers should not be greater than the distance corresponding to a transmission equivalent of

20 miles of standard cable for two-wire circuits;

40 miles of standard cable for four-wire circuits;

3. That the location of the relays be selected in such a manner as to make it possible to connect with each other international lines established by means of cables and provided with amplifiers in such a manner as to insure the best possible transmission.

SPECIFICATIONS FOR THE AMPLIFYING RELAYS

The Preliminary Technical Committee,

Recommends:

That the amplifying relays should be such as will faithfully reproduce speech; i.e., that they should amplify to the same extent all the frequencies ranging from 200 to 2,500 cycles per second.

It may be advisable under certain circumstances, to supplement these amplifiers with an independent correcting device to counteract possible distortions due to any fact whatsoever.

CROSS-TALK IN RELAY STATIONS

The Preliminary Technical Committee,

Recommends:

That the cross-talk introduced by an amplifying relay station between any two international circuits be smaller than the value corresponding to 75 miles of standard cable, this cross-talk being measured at the inlet and at the outlet of the relay station.

DETERMINATION OF THE AMPLIFICATION OF THE RELAYS

The Preliminary Technical Committee,

Considering that good transmission cannot be obtained on a line provided with amplifying relays, unless the amplification given by each relay remains within certain limits;

Considering, furthermore, that it appears advisable that the aggregate amplification supplied by all the relays of a line be distributed, in a suitable manner among these various relays and in such a manner as to cause the actual value of

the telephone currents at any point of the line to each particular case;

Recommends:

1. That there be fixed for each international line the limits within which the distribution of the aggregate amplification is to take place among the various relays;

2. That provision be made for the installation of automatic or semi-automatic amplification control devices wherever transmission over a long distance cable is made, particularly if the line includes long stretches of aerial cable and is subject to frequent and large fluctuations due, for instance, to temperature variations. In such a case the amplifying stations in which such control devices are set up, should operate as control stations as far as the regulation and the distribution of the amplification between the various relays is concerned.

PUPIN COILS

The Preliminary Technical Committee,

Considering that in the present stage of development of telephony such Pupin coils, not of the type with compressed iron core, are liable to become magnetized, and that it is in such a case impossible to restore to their constants (actual resistance and inductance) their standard values;

Recommends:

That on long distance telephone cables intended for international service, no Pupin coils other than the ones with a compressed iron core be used.

INTERCONNECTION OF FOUR-WIRE CIRCUITS

The Preliminary Technical Committee,

Recommends:

1. That wherever two four-wire circuits are to be connected with each other through amplifying relays resort should be had, in order to avoid transmission losses, to the use of special cores establishing the continuity of the four-wire circuit in exactly the same manner as in the intermediate stations of the standard line.

2. That wherever two four-wire circuits are to be connected with each other, without insertion of amplifying relays, this connection should be made directly by joining the metal of the four wires of the first line with the metal of the four wires of the second line, without insertion of intermediate two-wire devices.

IV. COMPOSITE LINES

GENERAL RECOMMENDATIONS

The Preliminary Technical Committee,

Considering that on composite lines, namely, on lines made up of aerial sections and cable sections, it is difficult to have the amplifying relays operate efficiently and reliably.

Considering that at line junctions the constants are always different, and there take place losses by reflection which bring down the total efficiency of the circuit;

Considering that the insertion of stretches having different constants even though of an extremely short length (crossing of tunnel, crossing of large cities, etc.) in telephone lines, is bound, as shown by experience in several countries represented on the Preliminary Technical Committee, to interfere seriously with the development of long distance telephony due to the disturbances arising in the operation of amplifying relays and of high frequency telephone installations;

Considering that it is therefore necessary to avoid this process unless one is compelled to resort to it;

Considering, nevertheless, that in individual cases it may become necessary to resort to such practices, in which cases however special precautions should be taken,

Recommends:

1. That wherever possible, the resort to composite lines for long distance international telephony be avoided.

2. That on composite lines the various sections between successive amplifiers be made absolutely homogeneous.

3. That the principle be laid down that exceptions to the foregoing rule are to be as few as possible; it would be advisable to enact that these exceptions should be submitted to the previous approval of the preliminary sub-committee of the International Consulting Committee.

Furthermore, in such a case it will be advisable to select the constants of the cables and of the aerial lines within the limits set forth above, in connection with long homogenous lines, in such a manner as to bring down to a minimum the serious troubles originating from the junction of lines of different nature. In particular, pro-

vision should be made for the use of properly Krarupised cables.

TRANSMISSION EQUIVALENTS

The Preliminary Technical Committee, Recommends:

That in the case of a composite line of any length whatsoever, the transmission equivalent between the two ends of the international line be as close as possible to 12 miles of standard cable, this being the figure contemplated for homogenous lines; nevertheless, in this particular case of composite lines, there may be allowed a variation not in excess of six miles of standard cable. The total transmission equivalent from subscriber's set to subscriber's set would not in such a case exceed 38 miles of standard cable.

JUNCTION AND TERMINAL TRANSFORMERS

The Preliminary Technical Committee,

Considering that for the purpose of decreasing transition or terminal losses at junctions or at the ends of the various sections making up a composite line, the use of transformers may be resorted to with good results.

Considering that in the present stage of development of telephony it is none the less advisable to determine a transformer loss limit.

Recommends:

1. That for any transformer inserted in a telephone circuit, including combining transformers and telegraph current transformers, the loss should not be in excess of one mile of standard cable (this rule does not apply to the transformers of the amplifying relays).

2. That such exceptions to the foregoing rule as may be suggested be submitted to the preliminary approval of the permanent sub-committee of the International Consulting Committee.

ANNEXES

RELATING TO MATTERS AFFECTING THE TRANSMISSION

1. Detailed specifications of a standard set with solid back microphone and Bell receiver.

2. List of the points to be considered in drawing up specifications for Pupin coils to be used in long international cables.

3. List of the points to be considered in drawing up specifications on a long international cable.

4. List of points to be considered in drawing up specifications on amplifying relays.

ANNEX I

Specification relating to the international standards referred to hereinafter.

A. Subscriber's telephone set.

B. Standard circuits for transmission measurements.

A standard telephone set shall be made up of the parts set forth hereunder, all of which parts shall comply with the attached specifications.

A. Microphone: Figure *a* and *a*₁ of the attached diagram.

B. Telephone receiver: Figure *b* and *b*₁ of the attached diagram.

C. Induction coil: Figure *c* and *c*₁ of the attached diagram.

D. Ringing device: Figure *d* and *d*₁ of the attached diagram.

E. Condenser: Figure *e* and *e*₁ of the attached diagram.

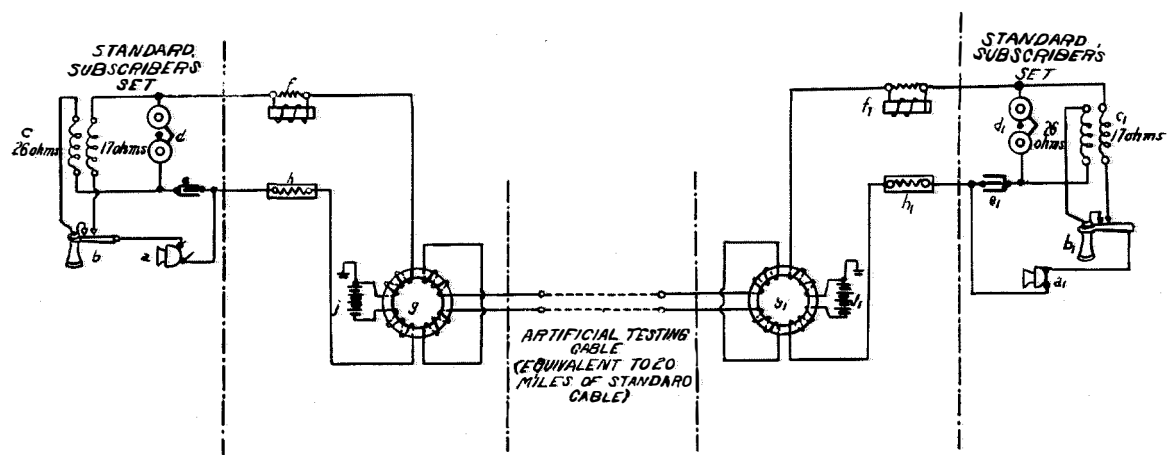

Figure 1—Standard Circuit for Transmission Measurement

Besides the equipment listed above for the two terminal telephone stations, a standard transmission measuring circuit shall include:

F. A supervision relay: Figure *f* and *f*₁ of the diagram.

G. A transformer or repeating coil: Fig. *g* and *g*₁ of the diagram.

H. A resistance: Figure *h* and *h*₁ of the diagram.

J. A storage battery: Figure *j* and *j*₁ of the diagram.

As shown by the diagram, the various parts are connected with each other and with an artificial line corresponding to 20 miles of standard cable.

SPECIFICATIONS OF THE VARIOUS PARTS MENTIONED ABOVE

A. *Microphone*—The transmitter shall be a central battery solid back microphone similar to No. 1 of the British Post Office, gauged with respect to its transmission efficiency by comparison with the British absolute standard microphone, the other features being the ones of the absolute standard microphone of the British Post Office.

B. *Telephone Receiver*—The receiver is to be a Bell two-pole receiver (Bell receiver No. 1) gauged with respect to its efficiency by comparison with the British absolute standard receiver, the other features being the ones of the absolute standard receiver of the British Post Office.

C. *Induction Coil*—The induction coil is to be the 2 windings coil; the inner winding made up of 1,400 turns of copper wire (beneath a single layer of cotton) of a diameter equal to 0.2134 mm. and having a resistance of ap-

proximately 26 ohms; the outer winding made up of 1,700 turns of copper wire (beneath a single layer of cotton) of a diameter of 0.376 mm. and having a resistance of approximately 17 ohms; as to all other features the coil shall be in accordance with the standard induction coil of the British Post Office.

D. *Ringling Device*—The ringling device is to be a polarized magnetic ringling-device having a resistance of approximately 1,000 ohms and being in accordance with the standard ringling device of the British Post Office.

E. *Condenser*—The condenser of a capacity

of approximately 2 microfarads shall be enclosed in a metal casing; the assembly shall be certified to agree with the standard condenser of the British Post Office.

F. Supervision Relay—The supervision relay shall be made up of an electro-magnet with 2 windings. The inner winding shall be made up of 3,000 turns of copper wire (beneath a layer of silk) of a diameter of 0.355 mm. and shall have a resistance of approximately 30 ohms; the outer winding (copper alloy wire) shall be wound in duplicate in order to be non-inductive; its resistance shall be approximately 70 ohms. This relay shall agree with the standard supervision relay of the British Post Office.

G. Transformer or Repeating Coil—This coil shall consist of a ring-like core on which there shall be wound the two primary windings and the secondary windings, each of which shall have a resistance of 22.5 ohms. It will be entirely similar to coil No. 25c of the British Post Office and shall be certified to agree with the standard coil of the British Post Office.

H. Resistance—The resistance shall be a non-inductive resistance of 300 ohms.

J. Storage Battery—The battery shall consist of 11 cells having a difference of potential of 22 volts, the positive pole of each battery being grounded.

CABLES

ANNEX 2

List of points to be considered in drawing up standard specifications on Pupin coils for long international cables.

1. Admissible variation in the effective resistance, on alternating current, at telephone frequencies and in direct current resistance.
2. Allowable variation of inductance above and beneath the standard value. Allowable lack of balance of inductance between the various windings.
3. Allowable variation of electrostatic capacity between the various windings.
4. Cross-talk in all the combinations.
5. Mechanical construction of the case and of the outgoing cables.
6. Description of the cables used to connect the case with the outer cables; description of the sheath of the outgoing cable.

7. Insulation of the coils against the ground. Insulation test voltage.

8. Dielectric strength test voltage.

9. Core magnetization test current.

10. Processes and methods for measuring the electrical constants of the coils.

ANNEX 3

A list of points to be considered in drawing up standard specifications on international cables with combination pairs of wires.

In preparing these specifications a distinction shall be made between the two following cases:

a—Cables for two-wire circuits.

b—Cables for four-wire circuits.

There are two possible methods to secure this type of cables:

1. Detailed specifications for the cable alone where the Administration itself places a separate order for the cable;

2. A very general specification covering only the assembly of the cable and of the loading coils.

The various points to be considered in these cases are the following:

General specifications applying to all cases.

Conductivity (resistances on direct current).

It should be measured at a certain fixed temperature, a slight variation being allowed.

Insulation resistances under a certain tension measured at the manufacturer's plant.

Insulation of the cable after it has been laid down.

Maximum and average electrostatic capacity per unit of length.

Quality and thickness of the materials (lead, paper).

Drying (hot air or gas) pressure, etc.

Voltage to be employed in the tests to be carried out both at the manufacturer's plant and after the cable has been laid down.

Mechanical tests of the materials at the factory.

Supply of measuring apparatus.

Colors of the insulating paper and manner to be followed for winding the insulating tape.

Case a (1)—Aside from the points aforementioned, it will be advisable to contemplate the following points wherever the balancing of the cable is entrusted to the manufacturer.

Length of the sections of cable laid down, measured and connected together to constitute the balanced groups or sets of combination pairs.

Maximum length of the cable to be wound on the drum.

BALANCING

The specifications shall contain the following indications and shall contemplate the following allowable variations which in no case are to be exceeded (see Figures 2 and 2a).

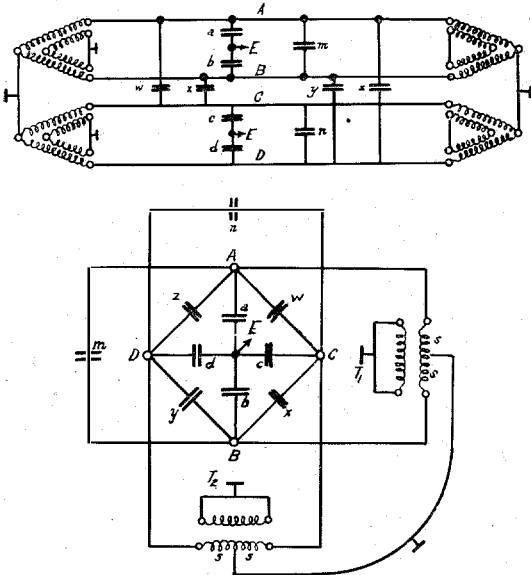

Figures 2 and 2a

$$(w-x) = p, (z-y) = q, (w-z) = r, (x-y) = s, \\ (a-b) = u, (c-d) = v.$$

	Unbalance Between Wires	Unbalance Between Pairs of Wires	Unbalance Between Wire and the Ground
	$(p-q)$ $(r-s)$	$2(p+q) + u$ $2(r+s) + v$	u v
Mean value			
Maximum value			
Admissible variation for a number of groups or sets not in excess of 2% of the sets of the cable			

Maximum admissible cross-talk in 98% of the cases.
Maximum admissible cross-talk in 2% of the cases.

The balancing of the mutual capacity between

pairs of wires over the entire length of the cable, namely, the capacity in any pair whatsoever and in any Pupinization section whatsoever, should not differ from the average mutual capacity of all the pairs of the section by a quantity greater than a fixed percentage; furthermore, any two pairs of successive Pupinization sections should not differ from each other by a quantity greater than a certain determined percentage.

Cross-talk between the phantom circuits of the various groups or sets of the cable should not differ from the specified value by a quantity greater than a certain determined allowable variation. (The foregoing table does not make any reference to this clause.)

Case a (2)—Besides the general specifications it will be advisable to contemplate the following points:

(a) Attenuation or damping at a frequency of such as $2\pi f = 5,000$ both of the combining circuits and of the combined circuits.

(b) Admissible variation in the attenuation or damping as the frequency varies.

Cross-talk in all possible combinations.

Balancing between artificial lines and actual lines.

Selection of circuits intended for telegraphic purposes (if any).

Protection against disturbances originating from exterior sources of electrical power.

Case b (1)—The same as in case (a) (1); furthermore the sets or groups of the cable are to be grouped in such a manner that the portions utilized to constitute the four-wire circuits for the sending are as widely separated as possible from the portions utilized for the receiving.

Case b (2)—The same as in case (a) (2), the artificial line being simplified and modified accordingly.

ANNEX 4

List of points to be considered in drawing up standard specifications on amplifying relays.

1. Features of the amplifying elements (*i. e.* of the 3 electrode lamp) with respect to the following points:

(a). A Reasonable amplification coefficient.

(b). A straight line "grid voltage-plate current" constant for the purpose of avoiding distortions of the voice.

(c). Small inner impedance in order to simplify the construction of the outlet transformer.

(d). Lamps of the same type interchangeable.

(e). Uniform heating current to make it possible to operate several lamps arranged in series from a storage battery or a generator.

(f). Operating adjustments as few as possible.

(g). Power consumption as low as possible.

(h). Long duration in standard operation.

2. Admissible variation in the amplification (or transmission gain brought about by the amplifying relays).

(a). In the event of a fluctuation in the power available at the inlet.

(b). According to the frequency of the current supplying this power.

3. Frequency limit or cut-out critical frequency.

4. Adoption of a standard impedance value for all the amplifying relays utilizing transformers with different transformation ratios in order to make the amplifying relations suitable for the various types of line.

5. Impedance of an amplifying relay compared with the immediately following relay station.

6. Methods for the adjustment of amplification, namely, of the transmission gain brought about by the amplifying relays.

7. Value of actual amplification and methods for the measuring of such amplification.

8. Measurement of the unbalance of an amplifying relay.

9. Limit at which the relays start to "howl" due to the starting of undamped oscillations.

10. Methods for the repetition of call signals on circuits provided with amplifying relays.

11. Methods for the computation and the establishment of the artificial balancing lines of the amplifying relays.

RECOMMENDATIONS OF THE PRELIMINARY TECHNICAL COMMITTEE ON MATTERS RELATING TO TRAFFIC

Determination of the number of conversations admissible on a circuit.

Rates.

Decentralization of international traffic.

Preparation of conversations.

Traffic statistics.

TRAFFIC

DETERMINATION OF THE NUMBER OF CONVERSATIONS ADMISSIBLE ON A CIRCUIT

The Preliminary Technical Committee,

Considering that the present condition of international telephone connections does not meet the requirements of the public owing to the long delays in establishing connections due to the congestion of existing circuits;

Recommends:

That efforts be made to fulfill the following requirements:

1. On international circuits of a length of less than 500 kilometers, the number of circuits should be such that the wait at rush hours should not be greater than half an hour, the fulfillment of this requirement according to British statistics corresponding to 50 conversation units during day hours.

2. On circuits ranging from 500-1,000 kilometers, the wait should be less than one hour, the fulfillment of this requirement corresponding to 75 units during day hours.

3. Circuits of more than 1,000 kilometers should be constructed, taking as a basis 100 conversation units during day hours.

VARIABLE RATES FOR DIFFERENT HOURS OF THE DAY

The Preliminary Technical Committee,

Considering that an effort should be made to better equalize the traffic during the day.

Recommends:

That the permanent sub-committee makes an investigation of the system according to which three different rates are charged during the course of 24 hours, this system being similar to the one adopted by the companies supplying electrical power, the charging of these rates being subject to the connection being established within the waiting times set forth above.

DECENTRALIZATION AND INDEPENDENCE OF INTERNATIONAL TRAFFIC

The Preliminary Technical Committee,

Considering that an international system

should not be confined to the establishment of telephone connections between the various capital cities, as such a system would entail delays in the traffic, a lengthening of the distances to be covered and the congestion of the national system,

Recommends:

That for the purpose of decentralizing the international system and making it independent, there be organized international transit centers similar to the region or zone centers of the national system, these centers to be connected with each other either directly or indirectly through circuits meeting the requirements of international circuits.

NUMBER OF CIRCUITS SERVED BY AN OPERATOR

The Preliminary Technical Committee,

Considering that the cost of long distance communications depends mainly on the cost of the establishment and of the maintenance of the circuit and only to a small extent on operating costs at the terminal exchange;

Considering therefore that it is necessary to secure a maximum efficiency in the operation of circuits,

Recommends:

1. That International circuits be operated in the following manner:

One operator for one circuit if there is but a single circuit between two centers;

An operator for two circuits, if there are at least two circuits between the two centers.

2. That international circuits be divided into incoming circuits, outgoing circuits, transit circuits.

PRELIMINARY ARRANGEMENTS FOR THE ESTABLISHMENT OF CONNECTIONS

The Preliminary Technical Committee,

Considering that the idleness of circuits originates mainly from the time elapsing between the subscriber's call and the answer to the call and from the exchange of service communications,

Recommends:

1. That a proper preparation for connections should be made on each circuit.

2. That it would be advisable to secure the possibility of offering to a subscriber an inter-

national connection even during the course of a city connection to which the subscriber is a party.

3. That an attempt should be made to make preliminary arrangements for connections by telegraph wherever it is technically possible to do so. Information on the results obtained by the use of different methods will be gathered by the permanent sub-committee in order to make it possible to reach a decision in due course as to the standard operation method.

4. That in the case of two centers being connected by numerous circuits gathered in a cable, the Administration of the countries in question should devise a system of operation similar to the system of operation adopted for city connections (service circuits, position *b*; tandem positions), the results obtained in the course of such researches to be communicated to the permanent sub-committee.

SPLITTING OF THE THREE MINUTES UNIT

The Preliminary Technical Committee,

Considering that the high rates to be charged for long distance connections over very long distances, such as will be available in Europe in the future, may suggest the advisability of splitting the three minutes unit,

Is of the opinion

That as far as the operation of the lines is concerned there is no objection, in this case, to the unit period following the first three minutes units being split into one-half units of one minute and a half each.

TRAFFIC STATISTICS

The Preliminary Technical Committee,

Considering that in order to facilitate the supervision of the traffic and to make available the necessary data for the improvement of the service, it is desirable that statistical information be made available in a standard form.

Recommends:

That there be gathered at the start, at least during two days per month, such days to be determined by the Administrations of the respective countries, the information listed in the following table for each group of international circuits connecting any two places.

Number of Existing Circuits	Number of Circuit-Hours Actually Available from 7 o'clock A.M. to 9 o'clock P.M.	Number of Conversation Units from 7 A.M. to 9 P.M.			
		Direct Connections		Transit Connections	
		Incoming	Outgoing	Incoming	Outgoing

Number of cancelled calls	Average wait between 10 and 11 A.M. and between 2 and 3 P.M.

The distribution of the transit traffic shall be set forth in an attached table laid out according to the specimen hereunder.

Number of conversation units exchanged between the cities of.....(1) and.....(2) during the two days of....

sumption that the rate of increase in the future will be the same as during the five immediately preceding years.

If the wait, the articulation or clearance of transmission or the rates had undergone modification in the five years under consideration, or were to undergo modification in the future period covered by the estimate, it will be necessary to make the proper allowances in the estimates and the necessary information will be entered in the column headed Remarks.

If the two places under consideration are not yet connected by a telephone line, the estimate may be based on the results of the telephone and telegraph traffic between places of the same

OUTGOING			INCOMING		
From	To	Number of Units	From	To	Number of Units
(3)	(3)		(3)	(3)	

- (1) Name of the country compiling the statistics.
- (2) Name of the country with which the conversation takes place.
- (3) Names of the central exchanges.

STATISTICAL INFORMATION INTENDED TO AFFORD THE MEANS OF ESTIMATING THE DEVELOPMENT OF TRAFFIC IN THE FUTURE

The Preliminary Technical Committee, Considering that for the purpose of facilitating the drawing up of plans for work to be carried out, it would be advisable to adopt certain general rules for the estimate of future traffic and to adopt a uniform pattern for the statistics relating to the traffic between a certain given country and the countries with which said country is connected or is intended to be connected,

Recommends:

1. That in estimating the probable development of traffic the estimate be based on the as-

order of importance, starting from the assumption that the rate of increase of telephone traffic will be the same in the future as in the past.

2. That traffic estimates be drawn up in accordance with the specimen table appearing hereafter.

LANGUAGE TO BE USED FOR THE MAKING OF CONNECTIONS

The Preliminary Technical Committee, Considering that the use of different languages is bound to interfere with the proper operation of international circuits;

Recommends:

- That in the exchange of service communications the French language be used between any

TRAFFIC BETWEEN X* AND Y*

Terminal Exchanges (1)	Number of Conversation Units During the Day (2)	Number of Calls Not Followed by Conversations (3)	Total Traffic (2+3) (4)	Number of Circuits in Operation (5)	Number of Circuits Required for the Present Traffic (6)	Average Wait at the Busy Hour (7)	Estimated Value of Traffic at the End of		Remarks (10)
							5 Years (8)	10 Years (9)	

* X and Y designate the two countries within which the connection is established.

two countries of different languages, unless arrangements have been made between any two countries for the use of a different language.

RECOMMENDATIONS OF THE PRELIMINARY TECHNICAL COMMITTEE AS TO MATTERS RELATING TO UPKEEP

Protection of International circuits against damages and injuries caused to the staff and to the material by high voltage lines.

Upkeep and supervision of the lines.

UPKEEP

Protection of International circuits against damages and injuries which may be caused to the employees and to the material by high voltage lines.

The Preliminary Technical Committee,

Considering the great variety of arrangements adopted in the various countries to protect telephone lines against damages and injuries arising to the employees and to the material from high voltage lines, in order to afford to all the countries the possibility of taking advantage of such arrangements as experience has shown to be the most efficient;

Recommends:

That the regulations in force in the various countries be communicated to the permanent sub-committee and that said permanent sub-committee draft a set of efficient uniform rules identical for all countries as soon as possible.

CUTS IN INTERNATIONAL CIRCUITS

The Preliminary Technical Committee,

Considering that the locating of faults is to

be effected mainly by means of accurate measurements to avoid line cutting as far as possible;

Considering on the other hand that circuit cuts at numerous exchanges increase the attenuation and destroys the homogenousness of the line;

Recommends:

1. That the number of cuts which are a frequent source of trouble, be kept as small as local requirements allow.

2. That measuring stations making it possible to take correct measurements be set up in the exchanges located along the route of the circuit, at intervals of approximately 200 kilometers. These exchanges shall be designated as the main cutting points, and the section of circuit between two main cutting points shall be called "main section." In each individual main section the location of a fault shall be effected by measurements taken concordantly at the cuts located on either side of the fault. The results of these measurements shall be communicated from either exchange to the other.

If the circuit is provided with amplifier the amplifying relay stations shall be main cutting points.

It is advisable to avoid the permanent insertion of a great length of cable in an aerial circuit for carrying such circuit through a main cutting point by resorting to the use of a distance cutting device.

The position of the main cutting points shall be set forth on the plan submitted to the permanent sub-committee.

CUTS ON INTERNATIONAL LINES ESTABLISHED BY MEANS OF CABLES

The Preliminary Technical Committee,

Is of the opinion that in International lines established by means of cables, it is advisable, in order to simplify tests, to do away with cuts at points other than the amplifying relay station.

SUPERVISION OF THE LINES

The Preliminary Technical Committee,

Considering that it is advisable to make provision for a constant supervision of the lines to prevent troubles as far as possible, and to insure a speedy repairing upon troubles arising;

Is of the opinion that it would be advisable to organize wherever the importance of the line is such as to warrant the taking of this step, a patrolling of the lines as it is the case in certain countries.

EXCHANGE OF INFORMATION CONCERNING THE CONFORMATION OF INTERNATIONAL CIRCUITS AND PERIODICAL TESTS

The Preliminary Technical Committee, Recommends:

1. That for the purpose of facilitating the upkeep and maintenance of international circuits, and the location of faults, the interested countries give to each other information on the conformation of the circuits in their respective territories, as well as any material changes that may be introduced therein;

2. That tests for the determination of the conductivity and of the insulation of the conductors be carried out each month at the terminal stations or at the amplifier stations nearest to the frontier if necessary. The results of these measurements shall be communicated by one administration to the other.

QUICK RESTORATION OF INTERNATIONAL CONNECTIONS

The Preliminary Technical Committee,

Considering that public interest demands that, in case of breaks whose repairing requires a certain time, international connections be restored as soon as possible;

Recommends:

1. That the country on whose territory the breaking down of an International line has oc-

curred, endeavors as far as possible, to replace the section of the International line thus made inoperative by a circuit of the National System.

2. That in order to insure the proper operation of the International line, a preliminary survey be carried out in each country for the purpose of determining the circuits of the National System that are to take the place of the International line in case of breaks.

RECOMMENDATIONS OF THE PRELIMINARY TECHNICAL COMMITTEE FOR WORK TO BE CARRIED OUT IMMEDIATELY AND PRELIMINARY PROGRAM OF WORK TO BE CARRIED OUT WITHIN A LONG PERIOD

Work to be carried out immediately in Western Europe to meet the most urgent international requirements.

Program of the work that ought to be carried out in the various west European countries in order to make it possible to lay down in the future an international telephone system meeting satisfactorily the requirements made upon it.

PROGRAM OF WORK TO BE CARRIED OUT IN THE IMMEDIATE FUTURE

Whereas the Preliminary Technical Committee has gathered the necessary statistical information making it possible to draw up at once a program for the urgent work to be carried out in 1923 and 1924;

NOW THEREFORE

Said Preliminary Technical Committee recommends:

That the following direct connections be established:

England-Belgium—4 circuits, London-Brussels; 2 circuits, London-Antwerp.

England-France—3 circuits, Paris-London, to be opened to traffic in 1923.

England-Switzerland—3 direct aerial connections via Basel.

2 combining circuits, one combined circuit on a route as short as possible.

England-Italy—A circuit London-Milan, via Basel.

With respect to these connections England-Switzerland and England-Italy, it would be advisable to proceed at once to a careful survey in order to determine the cost and the time required. The interested countries desire to have these three connections established at once without waiting for cable lines to be laid down in France.

In the event of France being unable to meet their desires, the British, Swiss and Italian administrations may find themselves compelled to select another route.

France-Switzerland—There should be established as soon as possible the circuits contemplated in the 1920 arrangement made between the interested administrations, to wit:

(2 combining circuits plus 1 combined circuit)

- 3 circuits—Paris-Geneva
- 1 circuit —Paris-Basel
- 1 “ —Paris-Zurich
- 1 “ —Lyons-Geneva
- 1 “ —Nancy-Basel
- 1 “ —Belfort-Basel
- 1 “ —Geneva-Thonon
- 1 “ —Geneva-Annecy

France-Spain—

- 1 circuit—Paris-Madrid
- 1 “ —Paris-Barcelona
- 1 “ —Bayonne-Saint Sebastien
- 1 “ —Hendaye-Irun
- 1 “ —Cerbere-Port Bou

Belgium-Switzerland

1 circuit Brussels-Basel (already mentioned by the three interested administrations).

Italy-Switzerland

- 1 circuit—Milan-Berne
- 1 “ —Milan-Geneva
- 1 “ —Milan-Basel
- 1 “ —Milan-Zurich
- 1 “ —Milan-Lugano
- 1 “ —Genoa-Zurich

PROGRAM OF WORK TO BE CARRIED OUT IN THE DISTANT FUTURE

(Preliminary Program)

With respect to the program of work to be carried out (aside from the work aforementioned to be carried out in the immediate future) in the distant future, to wit: within a term ranging from five to ten years,

The Preliminary Technical Committee,

Considering:

That it is absolutely necessary that the statistical information gathered in all the interested countries be gathered according to certain general rules.

Considering:

That at the present time the Preliminary Technical Committee lacks the necessary correct statistical information gathered along the uniform lines referred to above,

Recommends:

That studies be carried out in each country for the purpose of estimating the probable traffic increase for periods of five and ten years.

That these studies be carried out according to the rules laid down by the Preliminary Technical Committee;

Considering nevertheless that the Preliminary Technical Committee has been able to gather some information on the future needs of certain countries represented on the Preliminary International Committee,

Recommends:

That there be taken into consideration the suggestions made hereunder relating to the program of the work to be carried out in a term ranging from five to ten years.

	Total Number of Circuits Necessary	
	Within a Term of 5 Years	Within a Term of 10 Years
England-Belgium		
London-Brussels.....	12	16
London-Antwerp.....	7	9

England-France—The 21 circuits of the contemplated Paris-London cable are considered sufficient to cope with the requirements within

the first period of 5 years. At the end of this period there will be required in addition:

- 3 circuits London-Lille and
- 2 circuits London-Boulogne-sur-Mer.

England-Switzerland	Total Number of Circuits Required	
	Within a Term of 5 Years	Within a Term of 10 Years
London-Geneva.....	2	3
London-Basel.....	2	3
London-Zurich.....	2	3
London-Lausanne.....	None	1
London-Berne.....	None	1

England-Italy—Further direct Anglo-Italo connections would be desired as soon as the completion of the French telephone system will make such connections possible.

France-Switzerland—New circuits to be laid down in a period of 10 years.

- 3 circuits—Paris-Geneva
- 3 “ —Paris-Basel
- 3 “ —Paris-Berne
- 2 “ —Paris-Lausanne
- 2 “ —Paris-Neuchatel
- 3 “ —Paris-Zurich
- 1 “ —Lyons-Geneva
- 2 “ —Lyons-Basel
- 2 “ —Lyons-Zurich
- 1 “ —Nancy-Basel
- 2 “ —Nancy-Zurich
- 3 “ —Strasbourg-Basel
- 3 “ —Strasbourg-Zurich
- 1 “ —Besancon-Neuchatel

The interested countries recommend that the contemplated connection Cette-Geneva be substituted by a Marseilles-Geneva circuit.

Switzerland-Italy:

- 1 circuit—Turin-Lausanne
- 1 “ —Turin-Geneva
- 1 “ —Turin-Basel
- 1 “ —Turin-Zurich
- 1 “ —Geneva-Lausanne
- 1 “ —Genoa-Berne
- 1 “ —Genoa-Basel
- 1 “ —Genoa-Zurich
- 1 “ —Rome-Geneva
- 1 “ —Rome-Berne
- 1 “ —Rome-Zurich
- 1 “ —Bologne-Zurich
- 1 “ —Bologne-Lausanne
- 2 “ —Milan-Lausanne
- 1 “ —Milan-Geneva
- 1 “ —Milan-Rome
- 2 “ —Milan-Basel
- 3 “ —Milan-Zurich
- 3 “ —Milan-Lugano
- 2 “ —Milan-Chiasso

Furthermore, an undefined connection extending from Switzerland towards Venice.

Belgium-Italy—A direct Italo-Belgian connection is desirable as soon as the French telephone system will make such connection possible.

Spain-Italy—A direct Spanish-Italian (Barcelona-Genoa) connection is likewise desired as soon as the completion of the French telephone system has made such connection possible.

France-Italy—

- 2 circuits—Paris-Turin
- 2 “ —Paris-Milan
- 2 “ —Paris-Rome
- 2 “ —Lyons-Milan

These French-Italian connections ought to be realized within a period of five years.

Telephone Transmission Over Long Distances*

By H. S. OSBORNE

Transmission Engineer, American Telephone and Telegraph Company

At a convention where the main topic of discussion is the transmission of power over long distances, it would appear interesting to review some of the problems involved in the transmission of telephone currents over long distances. This review does not contribute very much which could be used directly in solving the power problems but serves to point out some interesting similarities and some very important differences between these two branches of electrical art.

In essence, both consist in the transmission of alternating currents over very long electrical circuits and in both, therefore, the problem of reducing the losses of electric power in transmission is very important. In the case of power transmission, however, the commodity delivered is the power itself and, therefore, for commercial success a large percentage of the power transmitted into the line must be delivered at the output. In the telephone problem, on the other hand, the commodity delivered is communication and the delivery of electrical power is only a means to this end. The efficiencies of the telephone transmitter and of the telephone receiver are such that under many conditions satisfactory communication can be given when only a small fraction of 1 per cent of the transmitter output is delivered to the receiver at the distant end of the line, the rest being absorbed largely in line losses. Furthermore, in many

features of economy, the frequency of alternating current to be used. As a result, a relatively low frequency is always chosen. In telephone transmission, on the other hand, the frequency of transmission is necessarily high, for it cannot be lower than the important harmonic components of the complex waves which constitute speech. How complicated these waves are is

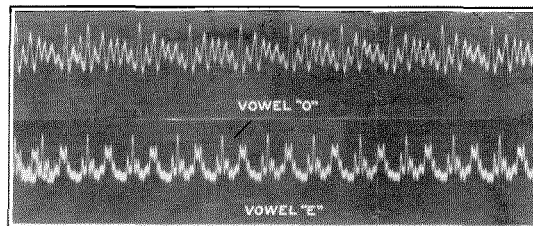

Figure 1

illustrated by Figures 1 and 2. Figure 1 shows oscillograms of telephone currents corresponding to the vowels "o" and "e." The most prominent oscillation in the vowel "o" is, roughly, 800 cycles a second and the most prominent oscillation in the vowel "e" is about 1900 cycles. Figure 2 is an oscillogram of the word "Pacific." The pronunciation of this word occupies less than a second, but the oscillations are so complicated that it has been necessary to crowd them together very closely in order to get the whole word in one figure.

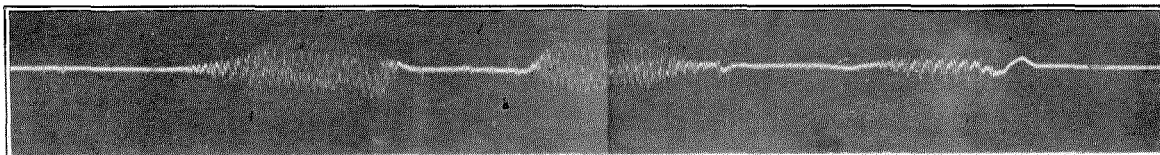

Figure 2

cases the power delivered does not come directly from the transmitting end but comes only from the nearest repeater station on the line.

The power engineers are free to choose, with a view to transmission efficiency and other

*Presented at the Pacific Coast Convention of the A. I. E. E., Del Monte, Cal., October 2-5, 1923 and printed in the *Journal* of the A. I. E. E. Vol. XLII, No. 10, October 1923.

These two figures are illustrations of the fact that the important harmonic components of telephone currents cover a frequency range from 200 cycles to well over 2000 cycles and that components as high as 3000 or 4000 cycles in frequency contribute somewhat to the intelligibility of speech. By using the speech currents to modulate a carrier current the fre-

quencies transmitted over the line can be raised as may be desired, but no feasible method has been suggested for lowering them materially.

This difference in frequency between power and telephone currents is an important difference from the standpoint of transmission, because the losses per unit length go up rapidly with the frequency. Furthermore, the wave lengths are shorter for higher frequencies, so that long telephone lines may be many wave lengths in length.

Another fundamental difference between the power and telephone transmission systems arises from the difference in type of service which they perform. In the case of the power system all customers can be served from the same circuit and the tendency is, therefore, towards interconnection and toward the development of large systems consisting of a relatively small number of very large units. In the telephone system, on the other hand, an independent channel of communication must be given to each pair of talkers. This necessity has led to great efforts to find ways to make a moderate amount of copper provide a large number of circuits either by the use of small conductors or by the superposition of a number of independent channels of communication on one pair of wires.

In the telephone system also the amount of power is necessarily small. When talking in an ordinary tone of voice the power delivered to the telephone transmitter in the form of acoustic waves by the talker is in the order of millionths of a watt. The telephone transmitter amplifies this power by a large ratio, so that the power delivered to the telephone lines has peak values of the order of 0.001 to 0.01 watt.

Both power and telephone transmission systems have important insulation difficulties. In the telephone system, however, the difficulty is of course, not in the strength of the insulation to withstand voltage stresses but is to prevent, as far as practicable, the absorption of power in or over the surface of the insulation at the relatively high frequencies of the alternating currents transmitted.

TRANSCONTINENTAL TELEPHONY

As a result of the different fundamental requirements and different technical conditions,

the development of the two industries has led to the transmission of telephone currents over considerably greater distances than power currents. A conspicuous example of long distance telephone transmission is the much used service between the Atlantic and Pacific Coasts. The circuit between New York and San Francisco is about 3400 miles (5500 kilometers) long, largely in open-wire construction of copper weighing 435 pounds to the wire mile. (600 kg. per km.) Recent improvements in this circuit have very greatly increased its over-all transmission efficiency, and it is believed that a brief discussion of these improvements will be of interest as illustrating the technical problems involved in telephone transmission over very long open-wire lines.

As originally constructed, this line was loaded throughout and was provided with six repeater points between New York and San Francisco.

Loading¹ is the means by which in telephone practise the electrical efficiency of the line is increased by using lower currents and higher voltages to transmit a given amount of power. In a power circuit the voltage can be raised by simply changing the ratio of terminal transformers. In a long telephone circuit the voltage cannot be raised in that way. The ratio of voltage to current at the transmitting station depends not on the impedance of the receiving station, but as the telephone line is electrically long, it depends upon the characteristics of the line itself. Therefore, to raise the impedance, the characteristics of the line itself must be changed.

There are several ways in which this can be done. For the transmission of a single frequency, it can be done very effectively by connecting inductive loads across the circuit at regular intervals. For telephone transmission, however, where a uniform efficiency of transmission over a wide range of frequencies is necessary, the result is accomplished by the use of series inductance loads, designed for very low energy losses and located regularly at eight-mile intervals throughout the line.

¹ For detailed information regarding the loading of telephone circuits, see paper entitled: "Commercial Loading of Telephone Circuits in the Bell System," by B. Gherardi, *Transactions*, American Institute of Electrical Engineers, 1911.

The extent to which the efficiency can be improved is rather narrowly limited in open wire by the insulation losses in the line which are, of course, increased as the voltage is raised and in part offset the decrease in series resistance losses due to decreased current. By means of loading, however, it is possible on a circuit such as the transcontinental telephone line to raise the voltage by about 80 per cent and reduce the losses per unit length by a factor of about 2.2 in dry weather.

The benefits from the use of loading are insufficient to make transcontinental telephony commercially practicable without the use also of telephone repeaters² which receive the at-

points of the circuit when 1000 microwatts are delivered to the circuit at the San Francisco end. The power rapidly decreases along the circuit, due to line loss, at Winnemucca is amplified to 700 microwatts, falls off again rapidly, and so by successive stages of attenuation and amplification 10 microwatts are at last delivered to the local telephone circuits at New York.

The improvements in the transcontinental line mentioned above have been brought about by removing the loading from the circuit and modifying the characteristics of the repeaters. Also, in view of the much larger line losses to be made up by the repeaters and in order to stay within economical upper and lower limits of power output and input of the repeaters, the number of repeaters was doubled. This change, however, was not essential and would not have brought about the improvements in transmission without the other changes. The energy level at different points in the circuit under the improved conditions is indicated in the lower part of Figure 3, and it will be seen that now instead of 10 microwatts, 70 microwatts are delivered at New York when 1000 are transmitted into the San Francisco end of the line.

In view of the benefits which can be obtained by loading, it may seem surprising that improvements in the efficiency of this circuit were obtained by removing the loading. The explanation of this result requires the discussion of some very interesting transient phenomena which are important in very long distance transmission.

When a train of oscillations is launched upon a long electrical circuit, it travels along the circuit attenuating in magnitude but without reflection so long as the impedance characteristics of the circuit are uniform. When a non-uniformity in line impedance is reached a part of the wave is reflected and the reflected wave travels back towards the transmitting end, being of course attenuated in the process. By this process of successive reflection the steady state of transmission is produced, although in the process there are of course other transient components of the currents which do not concern us here. In open-wire telephone circuits a few hundred miles in length, or less, the steady state is established very rapidly and the reflected currents are not noticeable. In very long circuits, however, which are made of high

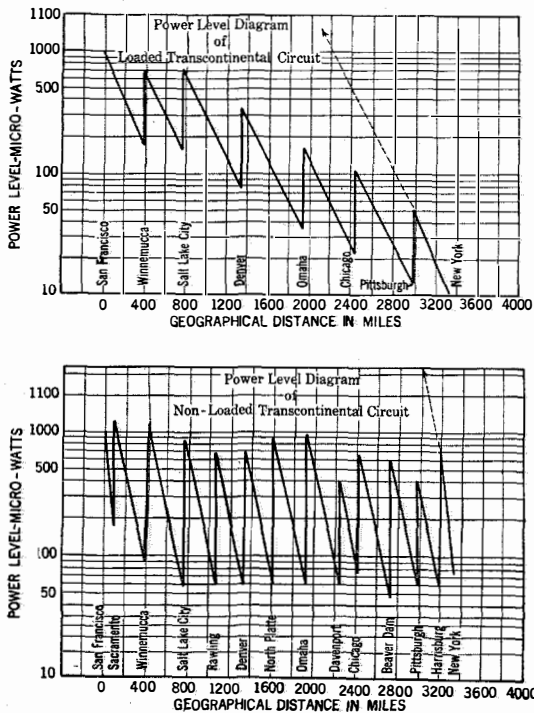

Figure 3

tenuated telephone currents after transmission over a few hundred miles of line and deliver to the adjacent section of line greatly amplified currents of the same wave shape. The results obtained on the transcontinental circuit by the combination of loading and repeaters are shown in the upper part of Figure 3 which is drawn to represent the amount of energy at different

² For discussion of the design and action of telephone repeaters see paper entitled: "Telephone Repeaters," by B. Gherardi and F. B. Jewett, *Transactions*, 1919, Vol. XXXVIII.

over-all efficiency by the use of repeaters or otherwise, the reflected current may have sufficient volume and time lag to be noticeable and even to be heard as distinct echoes. Hence they have been named "Echo Currents."

Echo currents, of course, may be heard by the listener as well as by the talker, for the reflected current, striking a second irregularity, is reflected again towards the listener.

In order that the transmission may be satisfactory the conditions of the circuits should be such that this echo current is not noticeable,

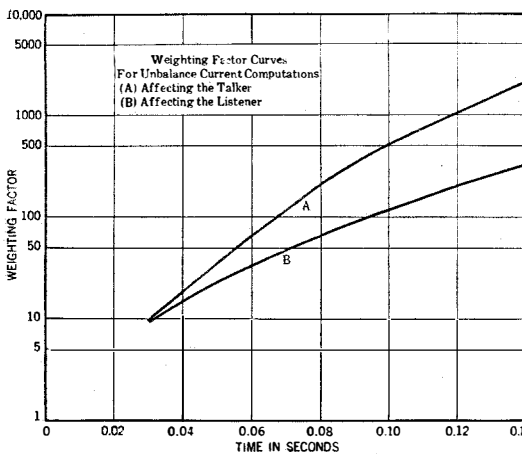

Figure 4

having either a very short time interval or a small magnitude. It has been found that there is a definite relation between the time lag of an echo and the maximum amount of echo current which can be permitted without appreciable effect on the clearness of speech. This is indicated in Figure 4 in the form of relative weighting factors for echo currents of different time lags, showing for both talker and listener and for different time lags the reciprocal of the relative maximum amount of power in the echo for no material interference with conversations.³

In the transcontinental line, which is chosen as our example, the most important echoes heard by the talker come from the irregularities at the distant end of the line where there is a marked change in the characteristics of the line due to the change from toll line to local construction. With the loaded circuit the velocity of propagation is about 55,000 miles (88,000

³For further discussion of echo currents, see Mr. A. B. Clark's paper on "Telephone Transmission on Long Cable Circuits," *Journal A. I. E. E.*, January, 1923 and *Electrical Communication*, Vol. 1, No. 3, February, 1923.

km.) per second, and the time lag of this echo is about 0.11 second. On the non-loaded circuit, however, the velocity of propagation is much faster, being about 180,000 miles (290,000 km.) per second, and the time lag of the echo from the distant end is only about 0.04 second. The corresponding weighting factors are 670 and 15, which means that on the non-loaded line this echo could be about 44 times as loud as on the loaded circuit for the same effect of the terminal irregularities on transmission.

The magnitude of the echo for a given irregularity depends upon the over-all transmission efficiency of the circuit, and the increase in permissible volume of echo current, therefore, means that the over-all efficiency of the circuit may be increased without interference from the echo currents.

So far we have been discussing the effect of reflected currents due to terminal irregularities. This, however, is not the whole story. On a line provided with repeaters there are irregularities not only at the terminals but also at the repeater points, due to the impracticability of making the impedance of the repeaters identical with that of the lines at all frequencies. In making the line non-loaded, it was found possible by modifying the telephone repeaters to improve the similarity of impedance of the repeaters and the line, thus reducing the amount of reflected current at these points. The extent to which this was practicable is indicated in Figure 5 which shows the ratio of difference to

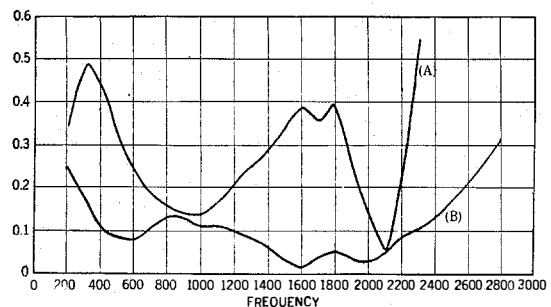

Figure 5—Difference between Line and Repeater Impedance Expressed as a Fraction of the Sum of these Impedances

- (A) The Loaded Transcontinental Circuit
(B) The Non-Loaded Transcontinental Circuit

sum of line and repeater impedance over a range of frequencies for the loaded circuit condition and for the non-loaded circuit condition.

The result of these two improvements, namely, increasing the velocity of transmission over the line and decreasing the amount of the irregularities is indicated in Tables I and II.

TABLE I
LOADED TRANSCONTINENTAL CIRCUIT OVER-ALL
TRANSMISSION EFFICIENCY 1 PER CENT
Unbalances Affecting Talker

	No. of paths	Length in miles	Time in seconds	Weighting factor (a)	Energy ratio (b)	Weighted index (aXb)	
Worst Path.....	1	6000	0.107	670	0.0001	0.067	
Total-All Paths.....	6	Varying for Different Paths					0.248

Worst Path includes all repeaters, i. e. is the over-all path.

Unbalances Affecting Listener

	No. of paths	Length in miles	Time in seconds	Weighting factor (a)	Energy ratio (b)	Weighted index (aXb)	
Worst Path.....	1	1040	0.1037	4.35	0.0035	0.015	
Total-All Paths.....	21	Varying for Different Paths					0.160

Worst Path includes end repeater and next adjacent repeater.

TABLE II
NON-LOADED TRANSCONTINENTAL CIRCUIT OVER-ALL
TRANSMISSION EFFICIENCY 7 PER CENT

Unbalances Affecting Talker

	No. of paths	Length in miles	Time in seconds	Weighting factor (a)	Energy ratio (b)	Weighted index (aXb)	
Worst Path.....	1	6500	0.037	15.3	0.0019	0.29	
Total-All Paths.....	12	Varying for Different Paths					0.191

Worst Path includes all repeaters, i. e. is the over-all path.

Unbalances Affecting Listener

	No. of paths	Length in miles	Time in seconds	Weighting factor (a)	Energy ratio (b)	Weighted index (aXb)	
Worst Path.....	1	6200	0.035	11.8	0.00072	0.0085	
Total-All Paths.....	78	Varying for Different Paths					0.199

Worst Path includes all repeaters, i. e. is the over-all path.

Table I summarizes the effect of echo currents on the loaded circuit. This table shows for the worst current path the percentage of transmitted and received energy appearing as echo current, the time lag in seconds, the corresponding weighting from Figure 4 and the product of energy and weighting.

This detail is shown only for the worst echo current but has been computed for all the echo current paths, and the sum of the products of energy ratios and weighting factors is given in the table. This total gives a good means for comparing the echo-current effect in different circuits.

Table II shows the corresponding figures for the non-loaded transcontinental circuit after improvement of the repeaters and establish-

ment of the higher over-all efficiency. It will be noted that in spite of the facts that the amount of energy represented by the worst echo current paths is greatly increased and that the number of echo paths is also increased, the much shorter time lag due to the higher velocity of propagation results in a total weighted echo current of about the same magnitude as the total for the loaded circuit at a very much lower efficiency.

For comparison, Table III is made up for the loaded circuit, assuming it to be operated at the

TABLE III
LOADED TRANSCONTINENTAL CIRCUIT OVER-ALL
TRANSMISSION EFFICIENCY 7 PER CENT

Unbalances Affecting Talker

	No. of paths	Length in miles	Time in seconds	Weighting factor (a)	Energy ratio (b)	Weighted index (aXb)	
Worst Path.....	1	6000	0.107	670	0.0055	3.68	
Total-All Paths.....	6	Varying for Different Paths					5.24

Worst Path includes all repeaters, i. e. is the over-all path.

Unbalances Affecting Listener

	No. of paths	Length in miles	Time in seconds	Weighting factor (a)	Energy ratio (b)	Weighted index (aXb)	
Worst Path.....	1	5200	0.093	97	0.0054	0.52	
Total-All Paths.....	21	Varying for Different Paths					1.58

Worst Path includes all repeaters, i. e. is the over-all path.

same over-all efficiency as the non-loaded circuit, i. e., 7 per cent. This table shows how much greater the effect of the echo currents would be at that equivalent.

In addition to the improvements discussed above, the changes in the transcontinental line made it practicable to improve the quality of telephone transmission by increasing the degree of uniformity of transmission of the different frequencies within the important telephone range. For long stretches of line the non-loaded open-wire transmits current with much more uniform efficiency than the loaded open wire. This is illustrated in Figure 6 which shows the percentage of output to input power at different frequencies in the telephone range for a 281 mile (452 km.) section of non-loaded open wire 0.165 inches in diameter (435 pounds per wire mile) and a 563 mile (907 km.) section of loaded open wire of the same size. The distances chosen are in each case an average repeater section.

Furthermore, in modifying the telephone repeaters, changes were made to improve the uniformity of amplification given by the re-

peaters over a wide range of frequencies. Figure 7 shows the amplification frequency charac-

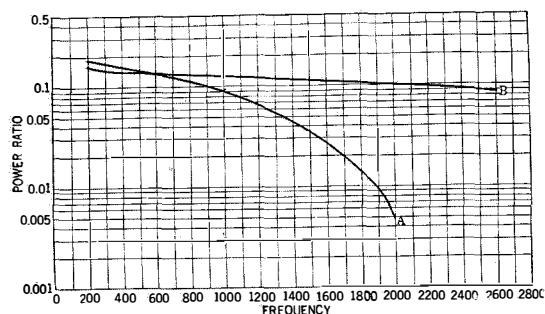

Figure 6—Power Ratio—Frequency Characteristics of Average Repeater Sections on Transcontinental Circuit
(A) Loaded Transcontinental Circuit
(B) Non-Loaded Transcontinental Circuit

teristic of these repeaters before and after their modification.

These improvements in the transmission characteristics of the line and repeaters made it possible to get a very good over-all transmission frequency characteristic in spite of the very great length of this line. The result expressed in terms of net over-all efficiency is indicated in Figure 8.

An incidental advantage of the change from loaded to non-loaded construction is greater independence of weather conditions. The loaded

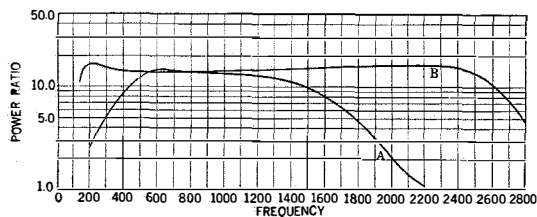

Figure 7—Power Ratio—Frequency Characteristics of Telephone Repeater Used on Transcontinental Circuits
(A) Loaded Transcontinental Circuit
(B) Non-Loaded Transcontinental Circuit

circuit being a higher voltage circuit, varies much more in efficiency between wet and dry weather conditions than the non-loaded circuit. On the other hand, the non-loaded circuit involves twice as many telephone repeaters and the over-all efficiency of the circuit depends on a very exact maintenance of the amplification of each of these repeaters. This requires very carefully planned and faithfully executed maintenance routines. It should be said that the results which have been obtained over this circuit have been exceedingly satisfactory.

TOLL CABLES⁴

The transmission of telephone currents through cables has always been difficult in comparison with the transmission over open-wire lines. One factor of difficulty is the much greater loss in the cable circuits per unit of length. This is due in part to the close proximity of the two sides of the circuit and in part to the fact that economical construction in cable requires relatively small conductors. The telephone re-

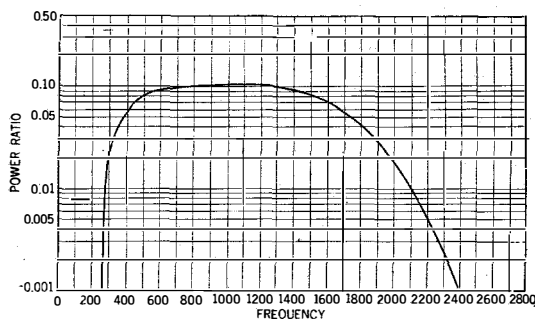

Figure 8—Power Ratio—Frequency Characteristics of Complete Non-Loaded Transcontinental Circuit

peater has been developed to a point where a practically unlimited number of them can be used in tandem in a circuit without distortion of the telephone currents. This has, therefore, removed the limitations which were set by high attenuation losses in the cable conductors. Although there are other important limitations and there have been large difficulties to overcome, cable transmission has been made practicable up to distances of at least 1000 miles (1600 km.).

As a result, the development of toll cables has become an exceedingly important phase of long distance telephone development and during the next few years it is expected that toll cables will be built in the Bell System at the rate of more than 500 miles (800 km.) a year. The extent of present and prospective use of this type of construction is illustrated by Figure 9 which indicates important toll cable routes in the Northeastern part of the country. In this section, because of the congestion of population

⁴ For a more detailed discussion of modern toll cable developments, see paper entitled: "Philadelphia-Pittsburgh Section of the New York-Chicago Cable," by J. J. Pilliod, *Journal A. I. E. E.*, August, 1922, and "Telephone Transmission on Long Cable Circuits," by A. B. Clark, *Journal A. I. E. E.*, January, 1923, and *Electrical Communication*, Vol. No. 3, February, 1923.

and business, the toll cable development has been most pronounced, and as you will note, the cable which was completed some years ago up and down the Atlantic Coast, between Boston

single route. Typical aerial toll cable construction is shown in Figure 10 which shows a section of the cable between Pittsburgh and Cleveland, carrying about 260 circuits. In

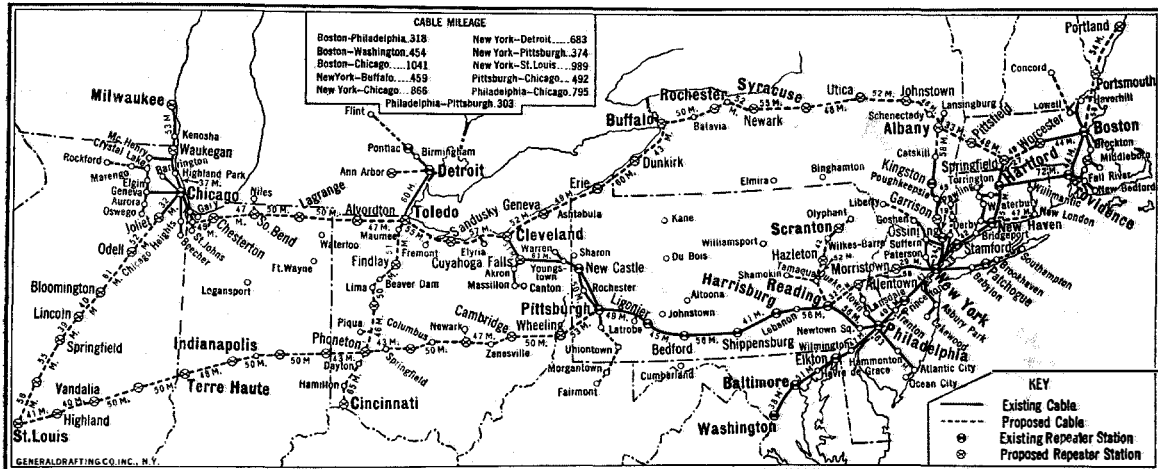

Figure 9—Long Toll Cables, Existing, Proposed and Important Branches

and Washington, has been supplemented by cable stretching westward now as far as Cleveland. This cable will be extended as far as Chicago as rapidly as the work can be carried

open-wire construction 6 or 7 very heavy pole lines would be required to provide this number of circuits. In many places where cable construction is now being used the available high-

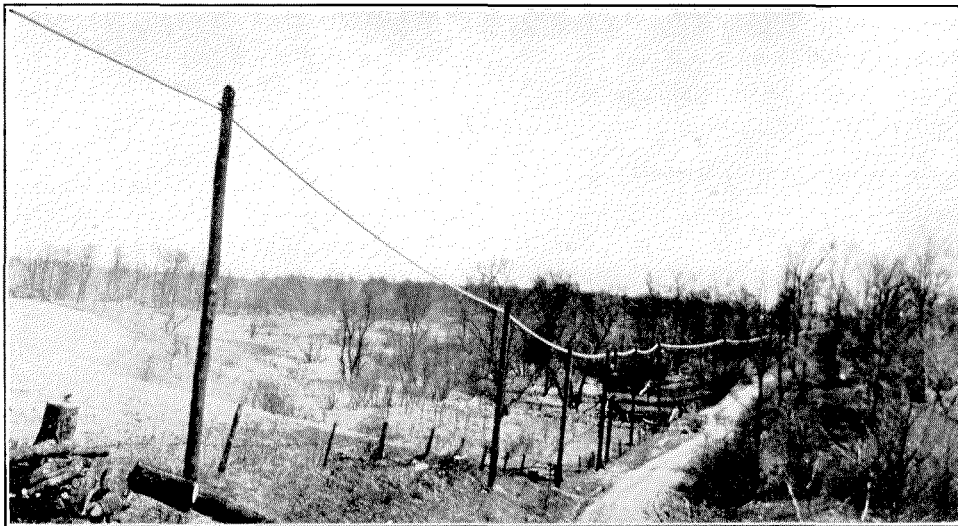

Figure 10

out and will provide high grade telephone circuits entirely in cable between Chicago and the Atlantic seaboard cities.

An outstanding advantage of the cable type of construction is the ability thereby to concentrate very large numbers of circuits along a

way routes for pole lines are largely occupied and purchase of numbers of rights-of-way would be exceedingly expensive, so that in many cases the toll cable development furnishes almost the only practicable method of providing for the large numbers of circuits which

the great development of toll business is requiring.

Another advantage of cable construction is the fact that where underground sections are necessary in passing through cities no irregularity

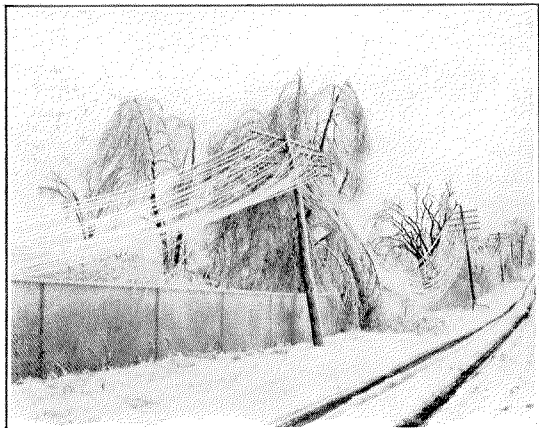

Figure 11

is caused in the constants of the circuit as is the case with open-wire construction. With the general use of repeaters in connection with long toll circuits these irregularities in type of construction are important factors in limiting the efficiency.

Another important advantage of cable construction is its relative immunity from the effect of weather and particularly from the effect of sleet. The damage which can be done by sleet



Figure 12

storms is illustrated in Figures 11 and 12. The cable construction can be made very substantial and capable of withstanding severe conditions of sleet.

The large number of circuits provided by one cable are obtained by the use of very small conductors, the gages in common use being 19 B. & S. (20 lb. to the wire mile) and 16 B. & S. (40 lb. to the wire mile). In the longest cir-

cuits two 19-gage circuits are required, each carrying the transmission in one direction only. Nevertheless, the amount of copper required is only 80 pounds to the mile as contrasted with 870 pounds per mile for the open-wire circuits which these circuits replace.

In contrast to the recent developments on open-wire lines discussed above, toll cable circuits are always loaded. A non-loaded cable circuit consists largely of resistance and capacity, and as a result there are very wide differences in efficiencies of transmission at different frequencies. By loading, this variation is reduced with a corresponding improvement of the quality of transmitted speech and at the same time the efficiency of transmission is raised. This is

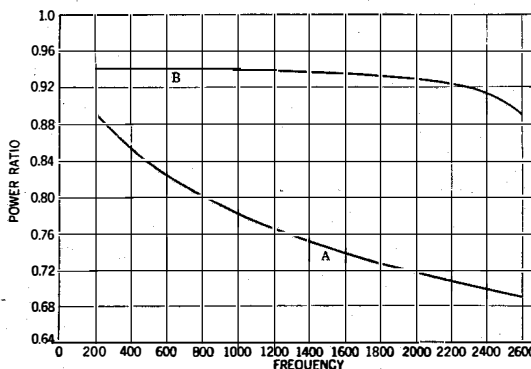

Figure 13—Power Ratio—Frequency Characteristics for No. 19 Gage Side Circuits
(A) Without Loading
(B) With Medium Heavy High Cut-Off Loading

illustrated in Figure 13 which shows the transmission efficiency at different frequencies of 1 mile (1.6 km.) of 19-gage toll cable circuit non-loaded and when provided with the type of loading most used for toll cables. With the type of loading shown in the figure, the voltage for 1000-cycle transmission is increased by loading by 70 per cent and the losses per unit length are reduced by a factor of about 3.6.⁵

In the loaded cable circuit, as in the loaded open-wire circuit, the velocity of transmission is relatively low, being about 10,000 miles (16,000 km.) per second for the type of loading mentioned above, as compared with 180,000 miles (290,000 km.) per second on non-loaded open-wire lines. Therefore, for circuits more than a few hundred miles long, care must be taken to

⁵ In part, this improvement is due to improvement in power factor, in addition to the improvement caused by higher impedance.

avoid excessive echo currents. On the very long toll cable circuits, say over 500 miles (800 km.), a lighter weight of loading is used, whereby, because of the lesser inductance per mile inserted in the cable, the velocity of propagation is as high as 20,000 miles (32,000 km.) per second. In addition to the echo currents, care must be taken in the design of the cables to avoid interference with speech by the transients produced by the periodic structure of the loaded cable circuit.

One of the interesting problems involved in the design of long toll cables is the prevention of excessive crosstalk, that is, of excessive transfer of electrical energy from one circuit to another. The difficulty of avoiding this with a very large number of circuits crowded within a 2 $\frac{5}{8}$ -in. sheath, is increased in the long circuits by the very long distances throughout which these circuits parallel each other and the frequent large amplifications of both transmitted current and crosstalk at repeater stations along the line. An adequate discussion of this problem would require a paper in itself. In this paper we must be content to note merely a few of the more important methods which have been developed.

The problem starts with the construction of the cable, and manufacturing methods have been carefully worked out to give the greatest possible degree of symmetry in the construction of the two insulated conductors which are twisted together to form a pair and of the two pairs which are twisted together to form a quad. The construction of the various pairs and quads, also, is such as to properly coordinate all of the circuits which will be near each other in the cable.

These manufacturing precautions are supplemented by very careful tests made when the cables are installed, and by splicing procedure by means of which, based on the results of the tests, the induction between circuits is still further greatly reduced. As a precaution against slight series unbalances, all joints are soldered. Further precautions include the segregation into different parts of the cable of groups of circuits which would be particularly likely to interfere with each other.

Similar precautions are used in the design, manufacture and installation of loading coils and other apparatus used with the circuits.

The toll cables require telephone repeaters at intervals of 50 or 100 miles (80 or 160 km.), and this has led to much work in the development of economical repeaters and auxiliary equipment for use with cable circuits.⁶ Figure 14 shows a

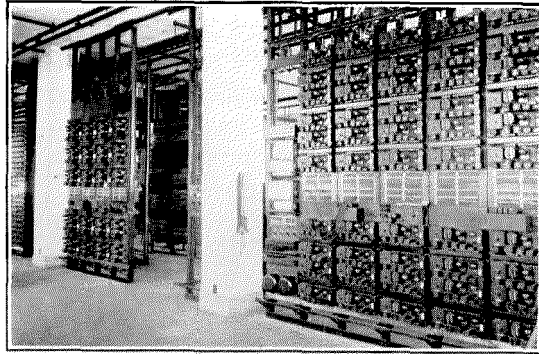

Figure 14

considerable group of telephone repeaters in the repeater station at Bedford, Pa., and illustrates the degree of condensation which has been worked out in the present types of apparatus developed for this service.

The telephone cable benefits not only traffic between points along its route, but at important points connects to open-wire lines along other routes. This use of the toll cable is well illustrated by Figure 15, which shows the relative

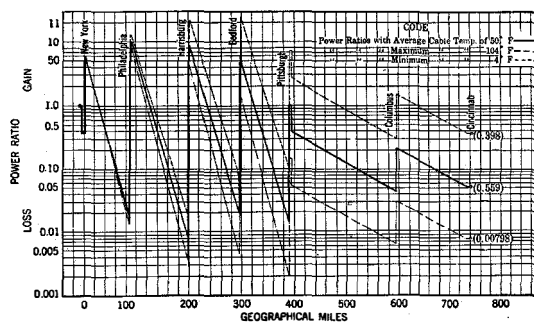

Figure 15—Transmission on Level Diagram of New York-Cincinnati, No. 1

power levels at different points of a typical circuit now in use in the New York-Chicago cable route. This circuit is in cable between New York and Pittsburgh and takes open-wire between Pittsburgh and Cincinnati, forming a New York-Cincinnati circuit. This figure has

⁶ Refer to paper by Mr. Pilliod noted above and to paper entitled: "Telephone Equipment for Long Cable Circuits," by C. S. Demarest, *A. I. E. E. Convention*, Swampscott, June, 1923.

been drawn to represent the ratio of power at any point in the circuit to power transmitted to the circuit at New York and shows the variations in the amount of power transmitted due to variations in the resistance of the cable with temperature. It is to be noted that these resistance variations would introduce a variation of more than 7:1 in the amount of received power, which would be sufficient to prevent a satisfactory use of the circuit. These variations are automatically compensated for by the use of the automatic transmission regulators described in Mr. Clark's paper.

CARRIER-CURRENT SYSTEMS

It has already been mentioned that the necessity for providing large numbers of mutually non-interfering telephone circuits has led to great efforts to find ways of making a moderate amount of copper provide a large number of independent telephone and telegraph channels. One way in which this is done is by the use of very small conductors in toll cables which have just been discussed. This is in general economical only where the traffic is heavy.

Another way of obtaining the same result is by requiring each pair of conductors to transmit a wider range of frequencies and using different portions of this range for independent channels of communication. A telephone conversation occupies the range between 300 cycles and something over 2000 cycles. It has long been the custom to use the range below 300 for telegraph and signaling purposes. The range above two or three thousand, however, was not commercially useful until the development of carrier-current systems.⁷

In the carrier-current telephone system the voice frequency telephone currents are made to modulate a higher frequency current. The frequencies of the modulated currents used in the carrier system represent the same width of band arithmetically as the original telephone frequencies, but all are shifted in magnitude by the frequency of the carrier current. That is, a telephone band of 300 to 2000 cycles, when used to modulate a 15,000-cycle carrier current; produces a band of frequencies ranging between 15,300 and 17,000 cycles in addition to other

⁷ Refer to paper entitled: "Carrier-Current Telephony and Telegraphy," by E. H. Colpitts and O. B. Blackwell, *A. I. E. E. Transactions*, Vol. XL, 1921.

bands which are not used in existing systems and which need not be considered in this discussion. The principle of modulation is the same as is employed in radio telephony, but in the carrier system the modulated waves are carried along wire circuits, rather than radiated into space.

This development considerably increases the range of frequencies which can be used commercially for communication. The present situation is indicated in Figure 16 which shows the

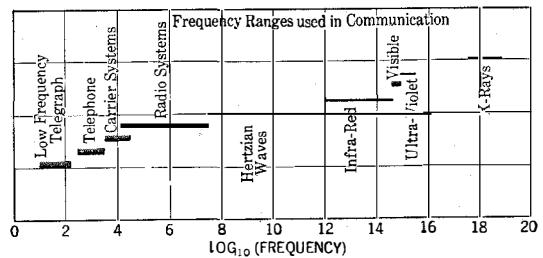

Figure 16

ranges of frequency of electromagnetic waves which are used in different ways for communication, together with the frequencies which at the present time have no practical application to communication.

The question may naturally arise why the lower frequencies have been chosen for the wire carrier systems developed for commercial use. A very important argument for using the lower frequencies in commercial telephone practice is that a number of carrier systems covering the same frequency ranges are used on different pairs carried on the same pole line. The crosstalk between the pairs is prevented by specially designed systems of transpositions in the circuits. The difficulty of preventing interference between the two circuits, however, goes up more rapidly than the frequency of the currents, so that at frequencies very much higher than those now used it would probably be impracticable with present forms of construction to avoid excessive interaction between the circuits.

Another important reason for using the lower carrier frequencies is the relatively great effect on high-frequency currents of short sections of cable inserted in the open-wire line. These effects can be reduced to a considerable extent by loading but the difficulties of loading efficiently increase rapidly with the frequency. The types of loading which were designed for voice frequency currents do not transmit cur-

rents of more than 3000 cycles frequency and for the carrier frequencies used in commercial telephony special loading with a very close spacing of loading coils has been developed.

Another way in which the lower frequency is advantageous is indicated in Figure 17 which

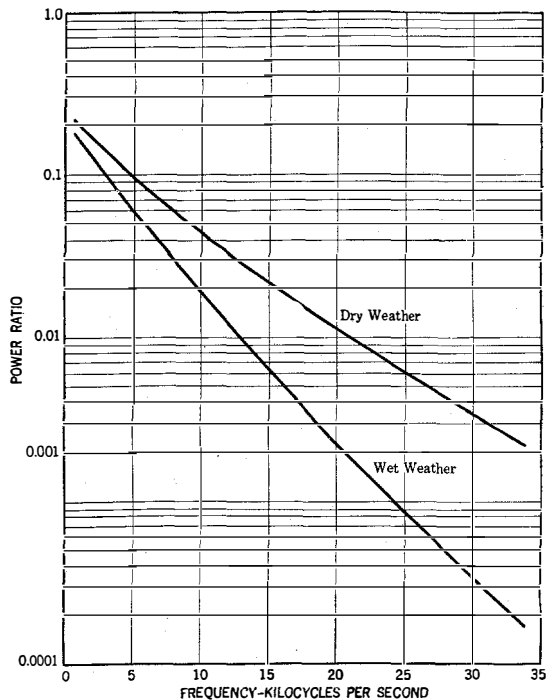

Figure 17—Typical Power Ratio-Frequency Characteristics of 165-In. Diameter Copper Open Wire, 200 Miles Long

shows the ratio of output to input power at different frequencies under typical wet and dry weather conditions, for 200 miles (320 km.) of metallic circuit composed of copper wire 0.165 inch in diameter (435 pounds per wire mile). It will be noted that this loss increases rapidly with increasing frequency and furthermore that the variation of the loss between the wet and dry weather conditions also increases with frequency.

One of the problems involved in using low-frequency carrier currents for telephony arises from the fact that the width of the band of frequencies is appreciable compared with the frequency of the carrier current. For example, the carrier band of lowest frequency used in present Bell System practise is the band between 4000 and 6000 cycles. It is necessary to transmit all frequencies within that range with approximately uniform efficiency and to

sharply cut off frequencies outside the range. A sharply tuned circuit would obviously be of no use, as it would very greatly distort the speech. This problem is beautifully solved by the invention of the electrical filter which provides a path for transmitting with almost uniform efficiency any selected band of frequencies and excluding all others. The action of an electrical filter is illustrated in Figure 18 which shows the measured transmission characteristics of one of the filters in use in a carrier-current system.

The use of carrier systems saves the installation of additional copper conductors, but to offset this requires the use of relatively expensive terminal apparatus and of repeaters at frequent intervals. The expense of terminal apparatus is such that carrier telephone systems are economical under present conditions only on the longer circuits, or in cases where their installa-

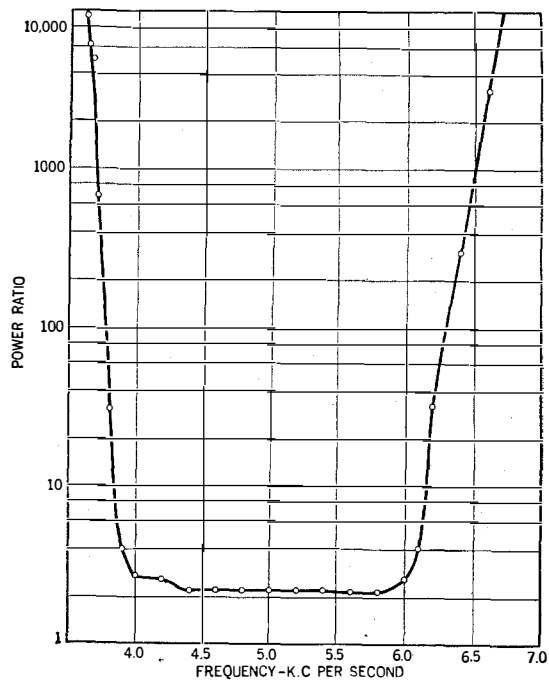

Figure 18—Attenuation of the 4-6 K. C. Band Filter

tion makes possible the deferment of a large expense such, for example, as a new toll cable. The extent of use of carrier systems in the Bell System is indicated in Figure 19. Each line in this figure represents a system, that is, in the case of carrier telephone, three or four telephone circuits, and in the case of carrier telegraph, usually ten telegraph circuits. The total carrier

circuit mileage now in use is about 20,000 miles (32,000 km.) of carrier telephone and 88,000 miles (140,000 km.) of carrier telegraph. The

shifted to provide carrier circuits from Chicago to St. Louis, Omaha and other points not reached by the cable system.

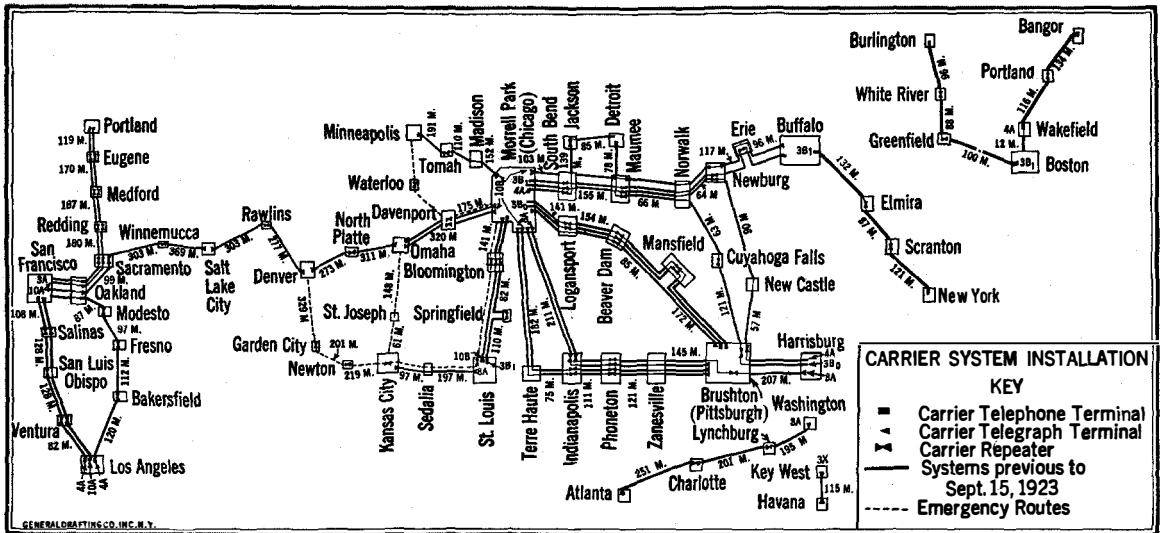

Figure 19



Figure 20

considerable number of carrier systems between Chicago and eastern points are required largely to take care of growth on congested routes pending the completion of the New York-Chicago toll cable. The terminal apparatus can then be

CONCLUSION

The developments which are briefly discussed above have made it possible to realize in a large measure the goal of a universal telephone service throughout the country, making use of a

network of very long telephone circuits covering the country. A number of the more important routes are indicated in Figure 20. It is of interest to note that the growth in traffic has so loaded up the central transcontinental route as to make desirable the establishment of a southern route from Los Angeles across Arizona and New Mexico. This route is now under construction and will be in service by the end of the year. With the completion of this line there will be at least two independent routes all the way from the Atlantic to the Pacific Coast, whereas at the present time through traffic is dependent upon a single route in the section between Denver and Salt Lake City. Further development of traffic will no doubt require later a route to the Pacific Coast across the northern part of the country and that, with a connecting line across the State of Texas, will provide a very complete gridiron of high-grade routes over the western part of the country, as now over the eastern part.

By means of the trunk lines indicated in Figure 20 and a much more extensive network of shorter lines, it is possible to carry on satisfactory telephone conversations between any two cities of moderate size in the country and to a large extent even small places can communicate with each other, irrespective of their relative location. A demonstration which was given in connection with the formal inauguration of service between the United States and Cuba in April, 1921, is a striking illustration of what can be done.

The service to Cuba was established by means of the extension of the wire lines to Key West along the viaduct of the Florida East Coast Railroad and the installation of long submarine telephone cables between Key West and Havana. The construction of the cables involved a considerable number of very interesting problems.⁸ The demonstration referred to was a conversation between Havana and Catalina Island. This circuit was about 5500 miles (8800 km.) long, included the submarine cables lying at the bottom of the Florida Straits, open-wire lines extending up the Atlantic Coast to New York, across the continent to San Francisco and down the Pacific Coast to Los Angeles, and finally the

⁸ Refer to paper entitled: "Key West-Havana Submarine Telephone Cable System," by Messrs. Martin, Anderegg and Kendall, *A. I. E. E. Transactions*, Vol. XLI, 1922.

unique circuit from Los Angeles to Catalina Island which at that time included a wireless telephone link between Long Beach and the Island.

A feature of interest in connection with this demonstration is to note that the telephone circuits involved carry regularly in commercial service not only the voice frequency channel used for the demonstration but many other channels of communication. This is indicated in Figure 21, which shows the number of inde-

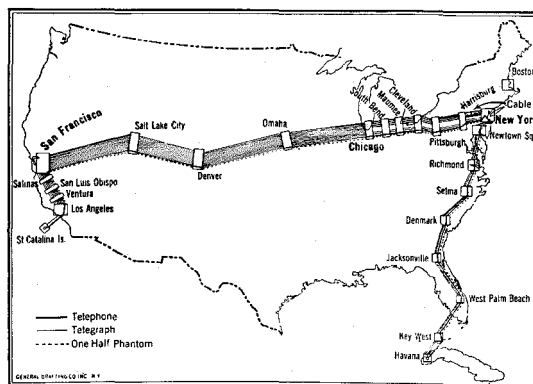

Figure 21

pendent channels of communication provided in the different sections by the single pair of conductors used. The heavy line represents a telephone conversation and the dotted heavy line indicates that the wires used form one of two pairs which together provide a phantom circuit. The heavy lines between Harrisburg and Chicago and between San Francisco and Los Angeles represent additional channels obtained by carrier telephone systems. The light lines indicate telegraph circuits, two circuits being obtained over the pair of wires throughout by direct-current composite telegraph system and 10 additional telegraph circuits being obtained between San Francisco and Chicago by carrier telegraph systems.

It is interesting to note that the sound is transmitted over this 5500-mile circuit in less than one tenth of a second. This emphasizes the necessity for using electrical means for the transmission of speech over great distances. If the means were acoustic and transmission was through the air, it would take seven hours for the sound to be transmitted from one end of the circuit to the other.

The essential part which amplifiers at intermediate points play in giving service over these very long circuits is evident. The Havana-Catalina circuit passed through 25 amplifying stations. The impossibility of getting equivalent results by amplification of the terminals is perhaps best illustrated by an example. In talking from San Francisco to Havana, for example, with the transmitter delivering 1000 microwatts at San Francisco, the power delivered at Havana is about 25 microwatts. If there were no intermediate amplifiers, and assuming for the moment that the circuit could carry unlimited power without burning up, it would be necessary in order to deliver 25 microwatts at Havana that power sufficient to light an incandescent lamp would be flowing in the circuit at some point in North Carolina, and at Philadelphia the power would amount to five kilowatts. It is estimated that the total mechanical and electrical power generated in the world is equivalent to that required for about 20 billion electric lamps, and this power would have to be flowing in the circuit a little east of Denver. This power is, however, only about 1/200,000 of the power which is received by the earth from

the sun, but all of this power would be required to be flowing in the circuit at Sacramento.

As pointed out at the beginning of this paper, the practical requirements of telephone transmission and of power transmission over long distances are very different. However, to solve the telephone transmission problems it has been necessary to work out the electrical transmission theory both for steady and for transient states⁹ for circuit conditions which are more extreme than any which are likely to be met with in power transmission, and it may be that the solution of these purely electrical parts of the problem will contribute to some extent to the power transmission problem in cases where very long distances are involved.

The writer gratefully acknowledges the assistance of Mr. O. B. Jacobs and of many others of his associates in the Departments of Development and Research and of Operation and Engineering in the American Telephone and Telegraph Company in the collection of data used in this paper.

⁹ Refer to paper entitled: "Theory of Transient Solutions of Electrical Networks and Transmission Systems," by John R. Carson, *A. I. E. E. Transactions*, Vol. XXXVIII, 1919.

Twenty-five Years of Successful Cooperation in Japan

A Quarter Century Completed by the Nippon Electric Company, Limited

By D. F. G. ELIOT

Comptroller, Nippon Electric Company

(Lacking only one month of the completion of a quarter century of uniformly successful operation, and with a happy personnel busily engaged on plans for a celebration on its twenty-fifth anniversary, the Nippon Electric Company on September 1, 1923 was one of the many victims of the recent earthquake disaster, resulting in the loss of one of its American representatives, a number of its Japanese employees and the destruction of a number of its modern buildings. Although but meagre reports have so far been received, plans are already in process for the creation of an even greater plant than that destroyed. In the following article, which was received just prior to the disaster, the remarkable progress of the Company is outlined. Its success has resulted from the able management of its Japanese directors, the efficient work of its employees, and the splendid cooperation between the Japanese and American interests; the Company may therefore look to the future with full assurance for continued progress and success.—EDITOR.)

OCTOBER 1, 1898 to October 1, 1923; twenty-five years of phenomenal growth and success have come to a close; twenty-five years of successful cooperation between American and Japanese interests have been completed, and the Nippon Electric Company, Limited, the affiliated company in Japan of the International Western Electric Company, Incorporated, with its first Managing Director, Mr. K. Iwadare, still active in the affairs of the Company, is ready for the next step in the journey towards further prosperity and success in the development of the telephone industry in Japan.

HISTORY OF THE DEVELOPMENT OF THE TELEPHONE IN JAPAN

The introduction of the telephone into the Empire dates back to the year 1877, when a Japanese brought back from America a magneto telephone. The interest created by this new and wonderful machine gradually made itself felt; the first practical use of the telephone, so far as we have been able to discover, being made a few years later by the Police Department in Osaka, where circuits were constructed as long as thirty miles, and as many as ten instruments were connected in series on a single iron wire circuit.

Encouraged by the success of this installation, a private company was formed in 1883 to exploit the telephone. It accomplished but little, however, and it was not until 1889, when the Government decided to take over the telephone business as a government monopoly, that the



Temple Gate at Nikko

development of the art began to make appreciable progress.

The occurrences leading up to this important step on the part of the National Government take us back a year, to 1888. During that year Dr. S. Oi was sent abroad by his Government to study telephone and telegraph development. During the same year, Mr. K. Sawai was sent

on a similar mission by the promoters of the private company. Mr. Sawai and Dr. Oi met in London and exchanged views on their observations and experiences. While they were together in London they received news from Japan that telephones and telegraphs were to be developed as a government monopoly. On the return trip to Japan, Mr. Sawai was unfortunately taken ill and Dr. Oi was forced to carry the entire burden of the development of telephony for his Government. He was subsequently placed in charge of the first telephone exchange in Japan, later became the first Chief Engineer of Telegraphs and Telephones, and is now a Director of the Nippon Electric Company, Limited.

In the course of his travels through Europe and America Dr. Oi made the acquaintance of and was greatly assisted by Mr. H. B. Thayer, at that time Manager of the Western Electric Company, New York, and now President of the American Telephone and Telegraph Company; Mr. J. J. Carty of the American Telephone and Telegraph Company; and Mr. F. R. Welles, Manager for the Western Electric Company in Europe. From this visit dates the first connection of the Western Electric Company with Japanese telephone development.

Dr. Oi, on his return to Japan in 1889, brought with him the first Western Electric switchboard equipment used in Japan, a 100-line standard board, and three 240-line series multiple boards. With this equipment public telephone service was started. The Japanese, holding the same doubts as their American friends had held a few years previous, were inclined to look askance at this talking machine, and subscribers were not readily obtained. Statistics show that when telephone service was started in 1890, there were but 200 subscribers in Tokyo and forty in Yokohama. With this modest beginning, the telephone started to take hold; in 1895 there were nearly 3,000 subscribers' stations; in 1910, over 100,000, while today, in Japan and its possessions, there are 416,000 subscribers' stations, not including telephones connected through private exchanges.

The development of long distance communication through open wire lines was carried on simultaneously with the development of local traffic. In 1888, experimental lines were installed between Tokyo and Atami, a distance of about sixty-five miles, and in the following year between Tokyo and Shizuoka, the great tea center, distant about 120 miles, using No. 12 S W G

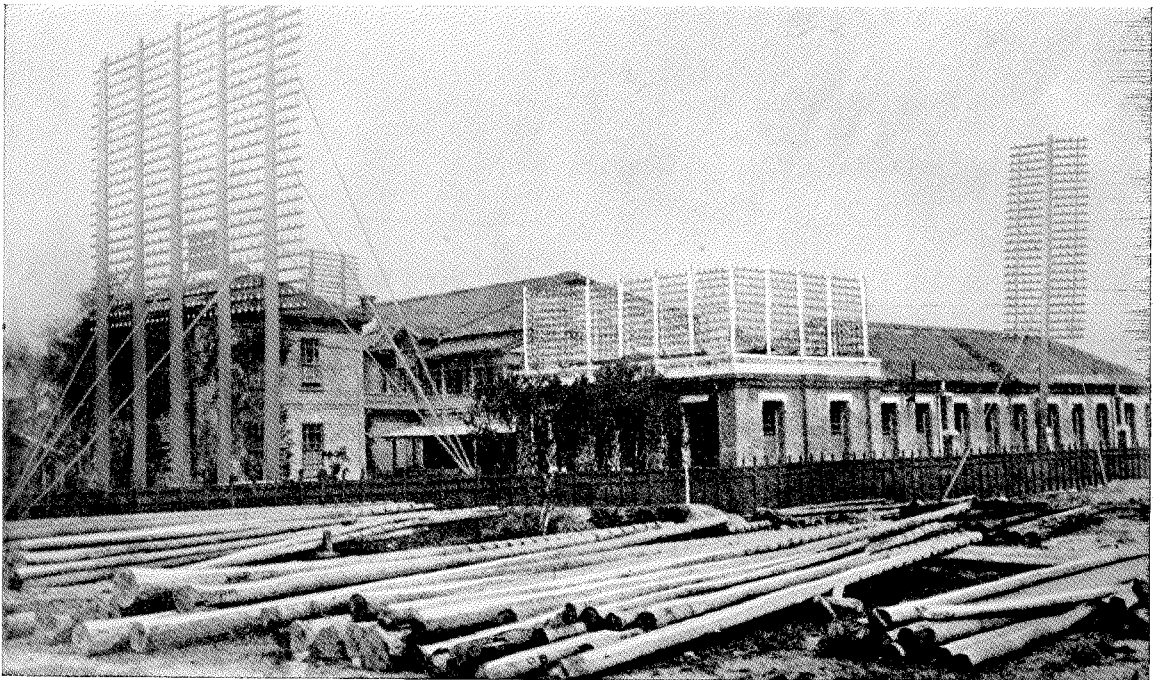

Early Open Wire Construction in Tokyo

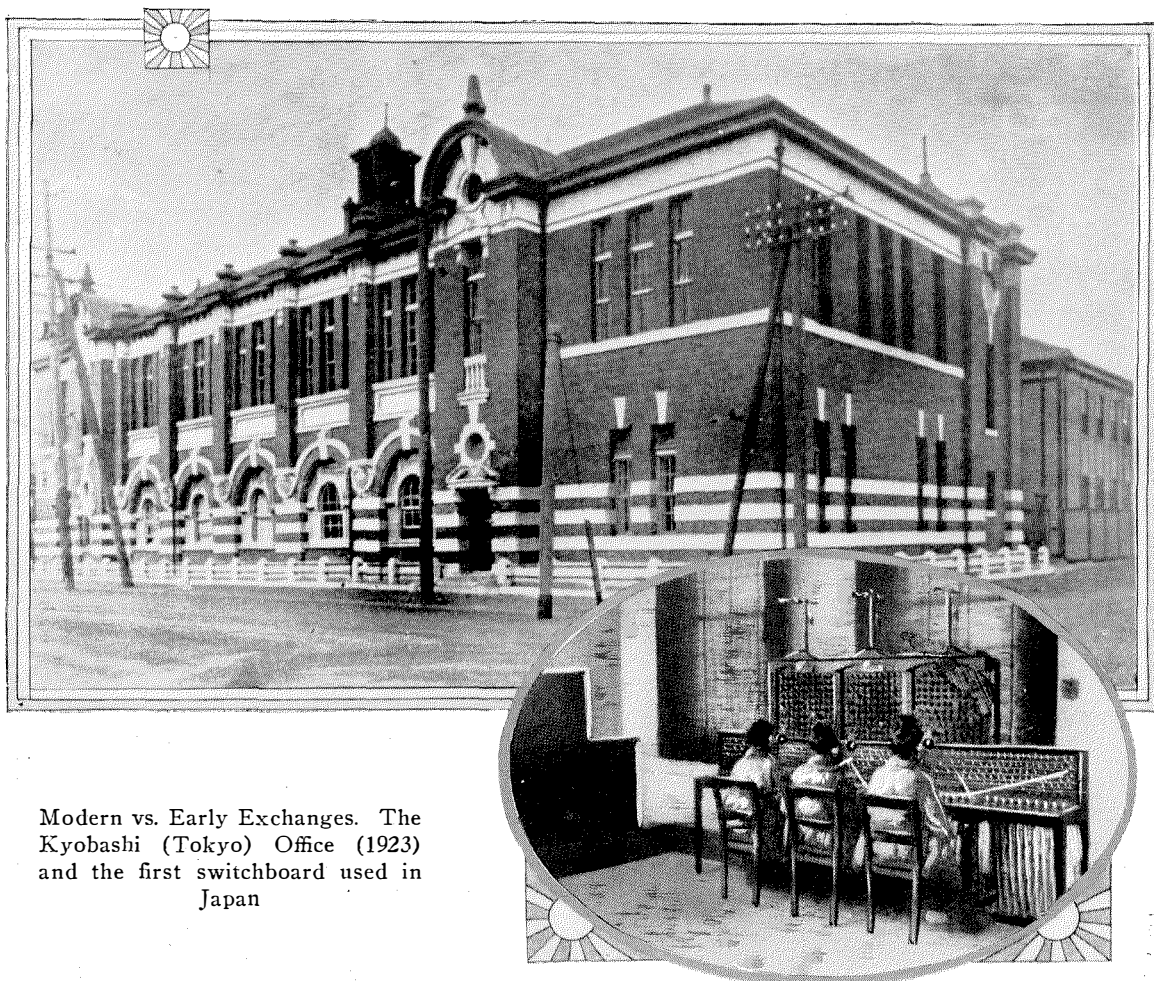

Modern vs. Early Exchanges. The Kyobashi (Tokyo) Office (1923) and the first switchboard used in Japan

bare copper wire. In 1890, Tokyo and Yokohama, distant eighteen miles, and in 1899, Tokyo and Osaka, about 350 miles apart, were connected, and the lines opened to the public. Other important cities were connected as the development progressed.

The first use of telephone cable came in 1897, when 25- and 50-pair aerial cable of the "Patterson" type and 100-pair underground cable, supplied by the Western Electric Company's Hawthorne factory, were installed in Tokyo for local subscribers' lines. Two years later, in 1899, 200-pair cable was installed in Tokyo and Osaka.

The first long distance telephone cables were laid in 1922, between Tokyo and Yokohama, and between Kobe and Osaka, each cable being

(*) For description see *Electrical Communication*, February 1923.

approximately twenty miles long.* Development of long distance communication through cable is now being actively taken up by the Government, and plans are under way for the installation of a loaded toll cable, containing 184 pairs of wires, to connect Tokyo and Osaka, the first two sections, comprising about sixty miles of cable, having already been manufactured and delivered to the Government.

Thus for thirty years or more, the Nippon Electric Company has been the pioneer in assisting the Government of Japan in the latest developments known to the telephone art.

In addition to standard telephone equipment and cable, Western Electric printing telegraph equipment is now in use by the Government Telegraph Department, and Western Electric train despatching equipment is extensively used by the government railways.

NIPPON DENKI KABUSHIKI KAISHA
(*Nippon Electric Company, Limited*)

Keeping pace with, and in recent years somewhat ahead of, the development of the telephone in Japan, has been the work of this affiliated Japanese Company, whose history is one of steady progress.

Prior to the year 1895, the Western Electric had been represented in Japan for three or four years by Takata & Company of Tokyo. During that time there was but very little telephone business, as the equipment then being used, standard switchboards and Gower-Bell type telephones with battery calling, were being made partly in the government shops and partly by local electrical factories. Early in the year 1895 Mr. Kunihiko Iwadare was appointed agent for the Western Electric Company in Japan, and one year later Mr. Thayer visited the country

to investigate the possibilities of business. After Mr. Thayer's visit it was decided to make more permanent arrangements for handling the business in Japan, and in 1898 Mr. W. T. Carleton was sent to Tokyo to further the Company's interests as special representative.

On October 1, 1898 there was formed a limited partnership, the Nippon Denki Goshi Kaisha (Nippon Electric Limited Partnership) to handle the Western Electric agency, between Mr. Iwadare and Mr. Takeshiro Mayeda (who for many years was Sales Manager of the Nippon Electric Company). The capitalsubscribed by the partners was 50,000 yen (1 yen equals U. S. \$.50 at par exchange) fully paid. Of the original capital, 40,000 yen was spent in buying up the plant of an old motor and generator factory. This plant consisted of thirteen small buildings, having about 28,000 square feet of floor space; a small power plant and about seventy-five



Nippon Electric Company—Switchboard Assembly



Nippon Electric Company—Telephone Assembly

machines, fifty of which were small lathes. With this equipment the Nippon Electric Company started its manufacturing career in Japan. In spite of its inadequacy, this purchase of a going concern enabled the Company to enter into immediate competition for some of the small telephone work which was being done at that time, and permitted much more rapid advancement than would otherwise have been possible.

On July 1, 1899, after the laws of Japan had been changed to permit of the investment of foreign capital in Japanese companies, the Nippon Denki Kabushiki Kaisha was formed with a capital stock of 200,000 yen, fully paid. The promoters of the Company were Messrs. Kunihiko Iwadare, Takeshiro Mayeda, Rokuichiro Masujima, Yasusaburo Fukushima, Koreteru Fujii, Walter T. Carleton and Ernest W. Clement.

At the first meeting of the Board of Directors of the newly formed Company, Mr. Iwadare was

elected Managing Director, in which position he has served for twenty-five years.

The first government budget for telephone extension had been started April 1, 1896, extending over a period of seven years. As the Japanese Government had, in a large measure, adopted the approved practice of the American Telephone and Telegraph Company, the Nippon Electric Company received a substantial share of the orders placed, most of the apparatus sold being imported from America and Belgium, the principal work of the Company's shops being that of repair. The rapid growth in popularity of the telephone soon made it evident, however, that the original plan for the import of American and European made apparatus would have to be abandoned and that manufacture in Japan would be necessary in order to keep ahead of government demands and give satisfactory service.

In the shops
Nippon Electric Works-1922



*Making the tiny
switchboard
lamps*



*Winding paper and
tinfoil to make
telephone condensers*

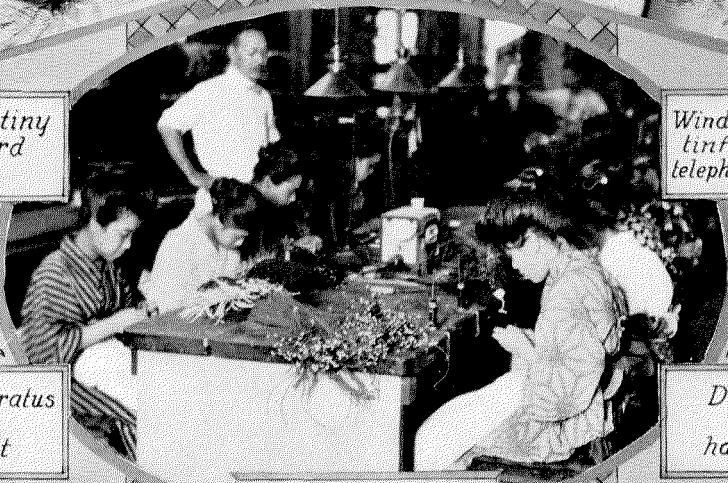

*Packing apparatus
for
shipment*

*Delivering
by
hand cart*

*Finishing
switchboard
cords*

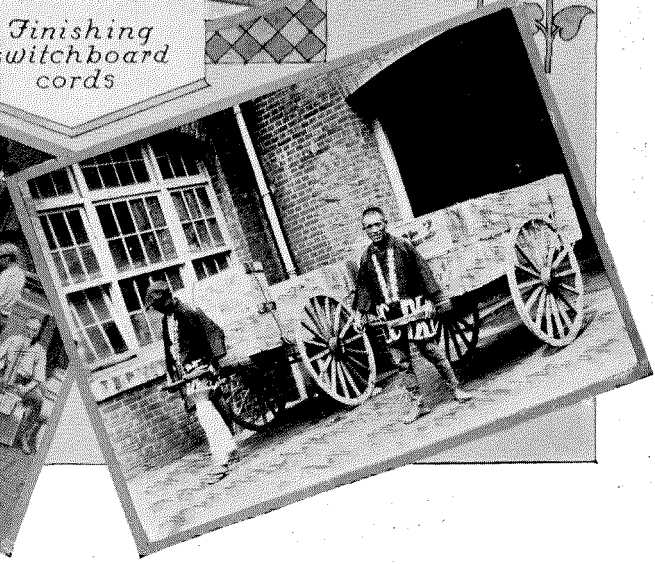
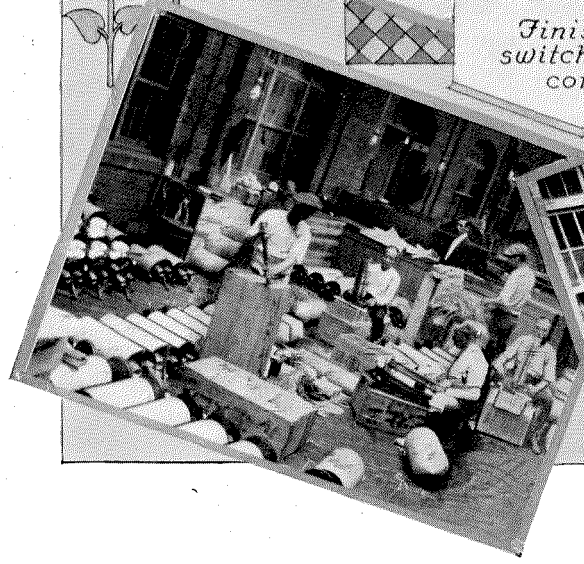

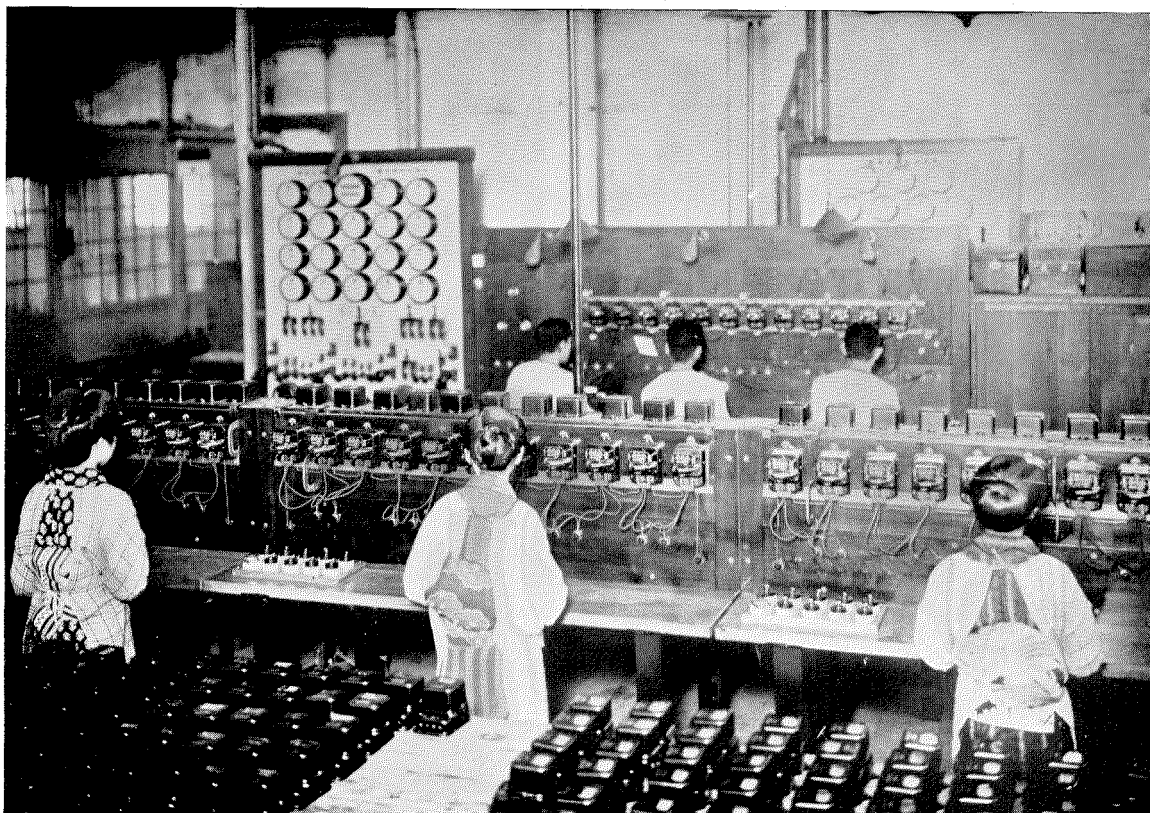

Nippon Electric Company—Watt-hourmeter Testing

GROWTH OF THE BUSINESS

Toward the latter part of the year 1899, 1,769 tsubo (1 tsubo equals 36 square feet) of land were acquired, and a number of new buildings were constructed, including a new office building, a warehouse, a one-story factory building and a boiler house. All of the early buildings were of brick and of earthquake-proof construction. A machine shop was laid out, a new power plant (35 H.P.) was purchased, and new up-to-date machinery installed. With the completion of this new plant the old buildings were sold and the lease of the original property was given up.

While the outbreak of the Russo-Japanese war resulted in the Government deferring its program of telephone extension, the Company was very busy with orders for the Army and Navy. The activities of the factory were further increased by orders from the Chinese Government, which were very satisfactory in size. In 1905, the first branch office of the Company was opened at Osaka, with Mr. M. Matsushiro, later General

Sales Manager, as Osaka Manager. In the same year more land (1,484 tsubo) was acquired for the Tokyo plant.

In 1906 the business of importing electrical supplies had reached important proportions, and this, added to the increase in local manufacture, created a need for more warehouse space. To meet this need, a second three-story warehouse was built. In the same year additional land (2,080 tsubo) was purchased and the capital of the Company was increased to 500,000 yen. In the following year, in anticipation of an increase in the amount which the Government would vote for telephone extension, a two-story brick factory building was constructed, having 14,000 square feet of floor space. Upon the completion of this building, in April 1907, the telephone assembly, testing and inspection departments, and the shop office, were moved out of the office building and located in the new factory building, as were also the wood-working, insulating and winding departments. That was fifteen years ago, when all the manufacturing

Clerical Departments- Nippon Electric Works 1922



*American
& Japanese Typewriters -
latter with native characters
-are used*

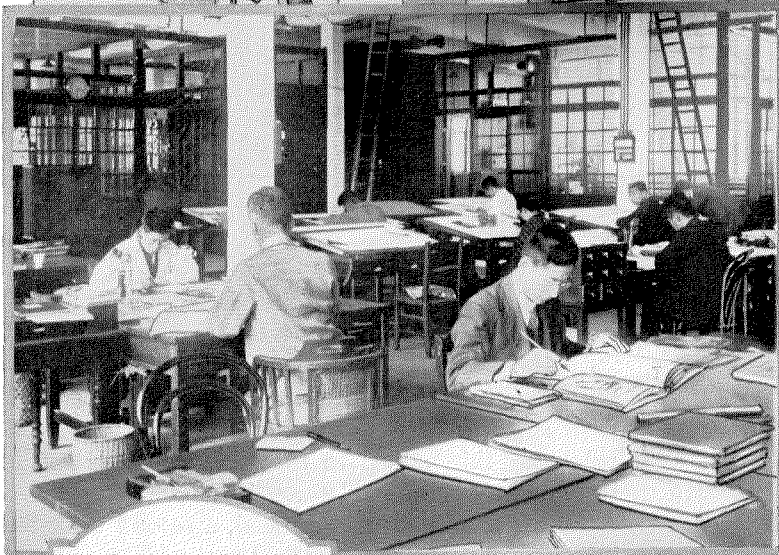

*Both
American & Japanese
adding machines are some
times needed*

*In the
shop offices*

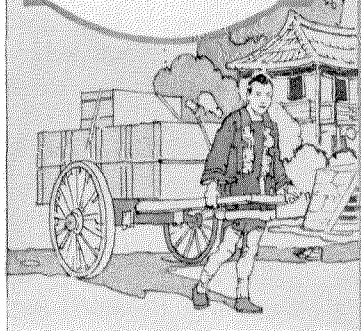

activities of the Company were carried on in two buildings. Today, the increased activities of the Company require about ten buildings for manufacturing purposes alone, and the combined floor space of all buildings has increased from 43,000 square feet in 1907, to 320,000 in 1922.

Commencing in 1907, with the second government telephone extension, the Nippon Company has grown very rapidly. The amount voted by the Diet (Japanese House of Representatives) for this extension was 20,000,000 yen over a six-year period, but further money was granted from time to time, and a considerably larger amount was spent. It must be understood that these amounts voted by the Government for extensions covered not only the cost of apparatus, but all expenditures for telephone work, and the proportion allotted to the purchase of apparatus was not a large percentage of the whole.

The year 1907 proved to be an active year. As the need for more manufacturing space was becoming important a comprehensive study was made of conditions and requirements, and a definite plan adopted for the extension of the Company's facilities. A new one-story brick "saw-tooth" roof building was erected on the new land which gave the Company about 10,000 square feet of additional floor space, and increased the total floor space to about 54,000 square feet. It was immediately put into use, all of the machine departments being moved in and the additional space thus made available made it possible to do away with a number of sheds which had previously been built.

At this time the motive power of the factory machinery was changed from steam to electricity, the machines being operated by overhead shafting, which in turn were operated by electric motors, the new layout including the installation

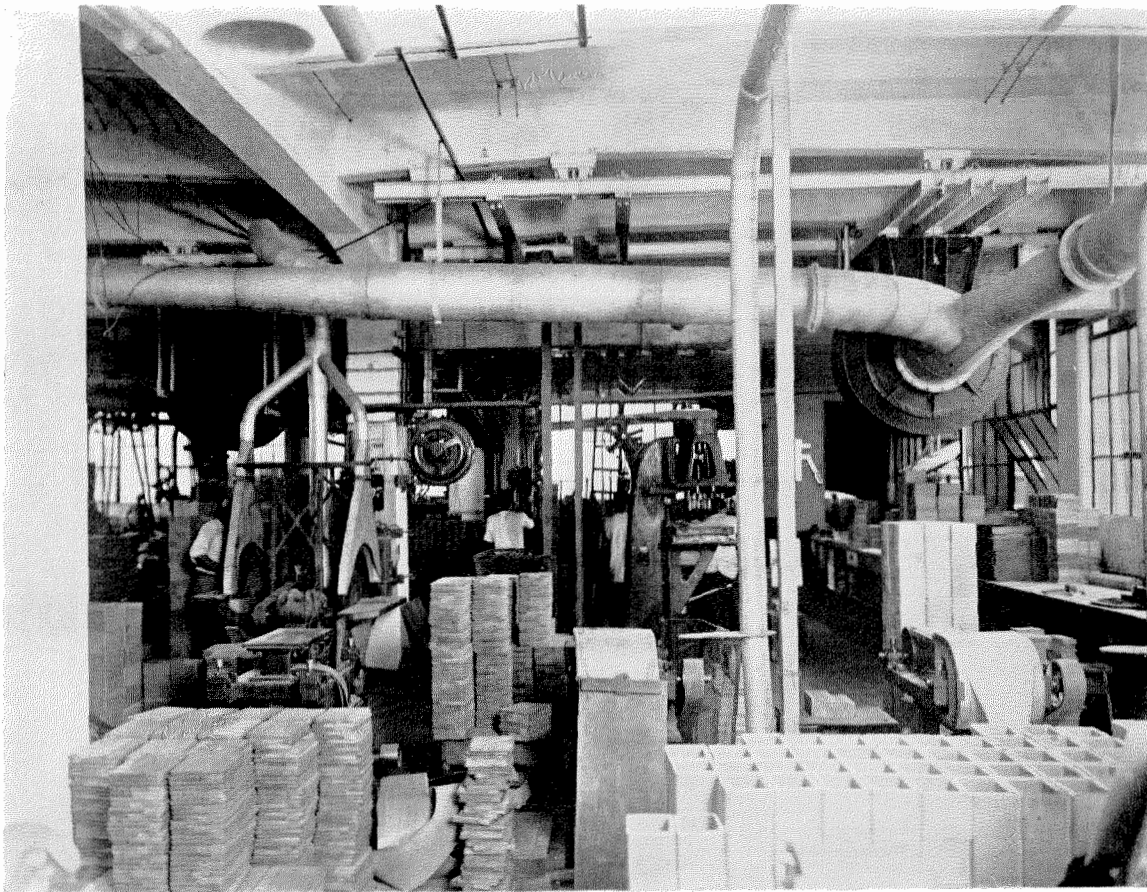

Nippon Electric Company—Carpenter Shop

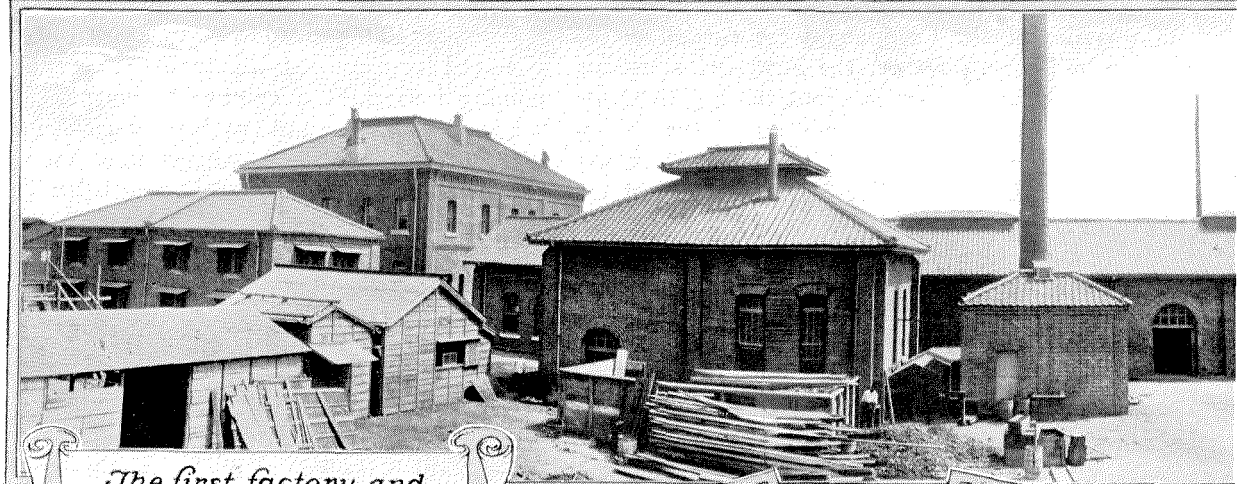

The first factory and office buildings -1901

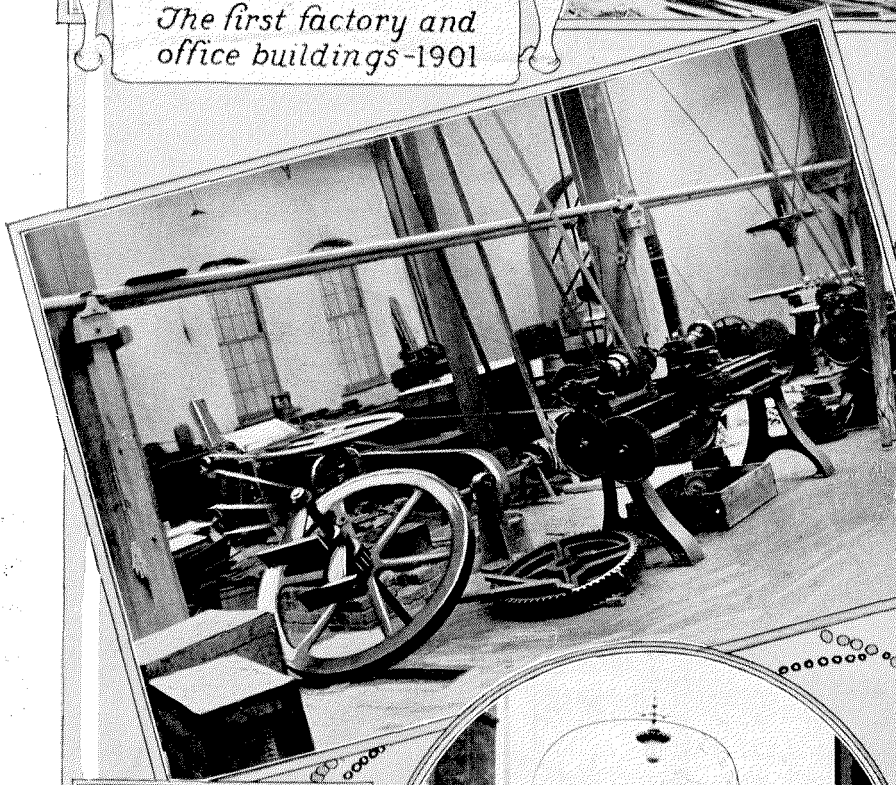

Machine shop in first factory



Inside the compound preparing for new building construction

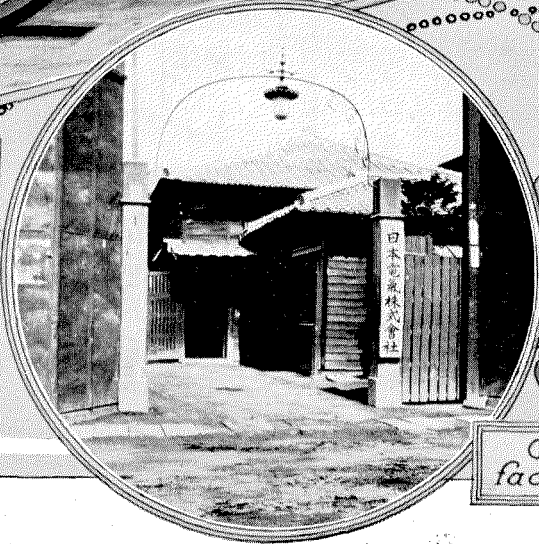

Old gate to factory compound

*Nippon
Electric Works
in Tokyo
1901 and 1922*

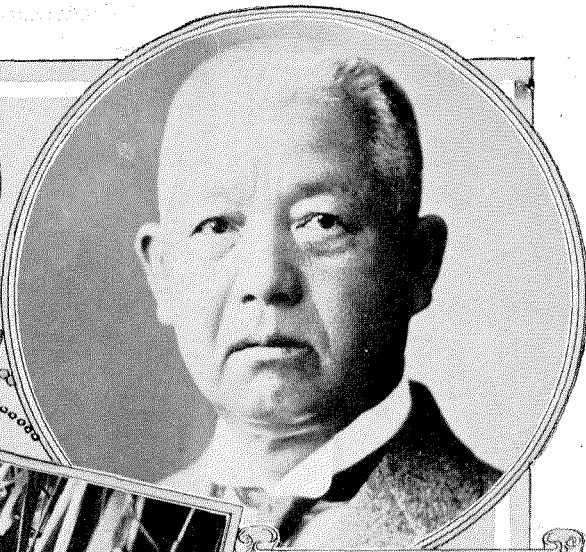

*K. Iwadare
Managing Director
Nippon Electric Company*

*Automatic Screw
machine department
1922*

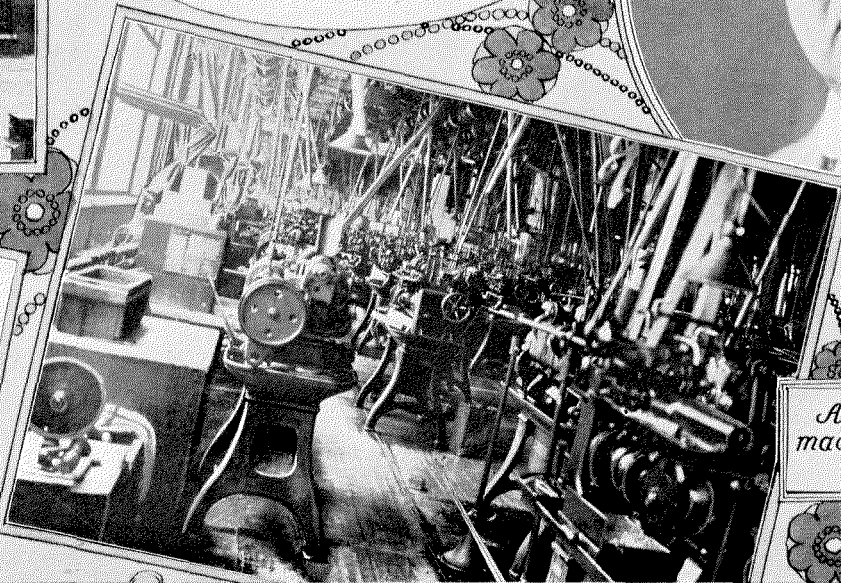

Nippon Electric Works - 1922

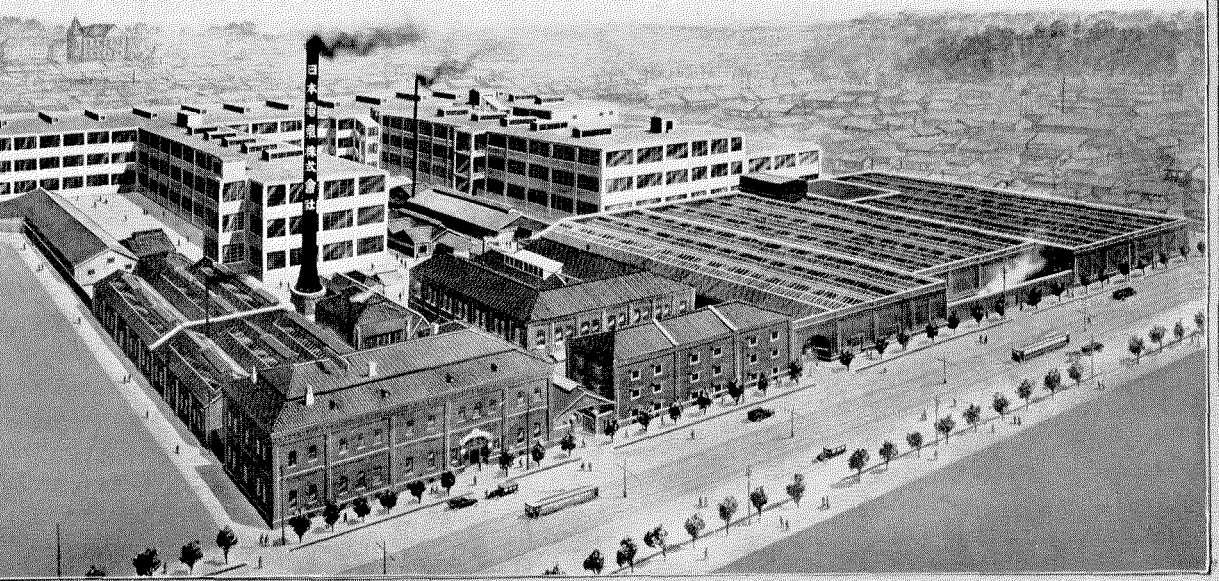

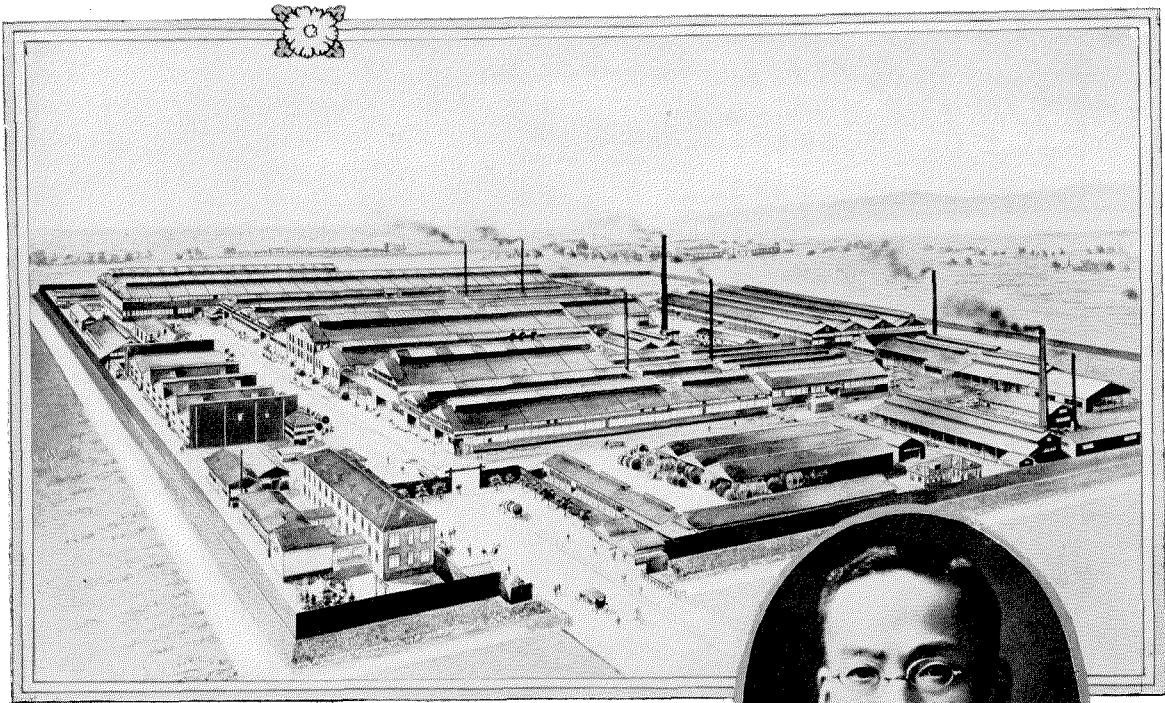

Sumitomo Electric Wire and Cable Works, Osaka, Baron K. Sumitomo, President

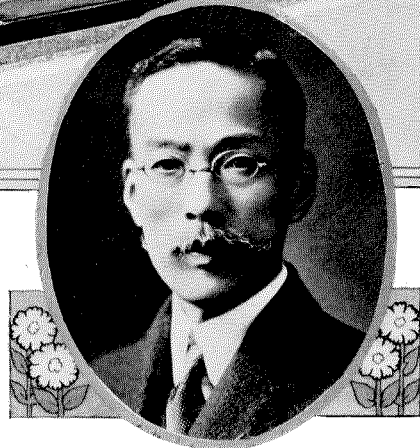

of a new 200-horse power boiler and a 100-kilo-watt generator set.

One more important step was taken during this year, namely, the opening of a second branch office in Seoul, the most important city in Korea.

During the period 1908 to 1911 the factories were very busy. The telephone business in Japan continued to grow, and it became necessary for the Company to further increase its manufacturing facilities. Up to this time many piece parts, as well as certain types of switchboards, had been purchased from America and Europe, but during the year 1911 practically all telephone apparatus was manufactured in Japan.

The capital stock had been again increased in 1909 to 1,000,000 yen. In 1910 the second one-story "saw-tooth" factory building was started, increasing the total floor space of the plant to about 67,000 square feet. Additional boiler and generating equipment was purchased and this necessitated the building of a new steel earth-

quake-proof chimney, six feet in diameter and 123 feet high. In 1911 the third section of the new one-story factory was completed, a new one-story building was erected for the nickel-plating and polishing departments, and a blacksmith shop was completed. Local conditions at that time made it advisable to erect small buildings, and a number of them were built for various purposes, such as oil and varnish storage, wood drying, etc.

In 1910 the Company opened a third branch office, this time in Dairen, Manchuria. In 1911 Mr. Eisaburo Hata, a former Government telephone engineer, who had for a time been Superintendent of the Yokohama Wire Works, was engaged as Shop Superintendent. During the next few years great improvements were made in the factory, resulting in a much stronger organization than had hitherto been possible. About 1,300 tsubo of additional land were also purchased in preparation for future growth.

At this period it became evident that the amounts to be allotted by the Government to telephone development would be appreciably increased, and in order to prepare for this increase in business which required additional buildings and machinery, the capital of the Company was increased (1912) to 2,000,000, yen of which 1,500,000 yen was immediately paid up. Following this, work was started on the plans for a new two-story factory building, the sixth factory, to be constructed of reinforced concrete. This building was one of the first reinforced concrete factory buildings erected in Japan. The building was completed in 1913 and provided over 30,000 square feet of additional floor space for manufacturing and offices.

In 1913 a new department was started for the manufacture of telephone condensers; and in 1914 a complete plant was installed for the manufacture of paper-insulated lead-covered cable. In the same year the manufacture of "Meggers" and watt-hourmeters was started.

In 1917 the capital of the Company was increased to 2,500,000 yen; at the same time the employees of the Company were given an opportunity to purchase capital stock, and the Mitsui Bussan Kaisha, one of the largest and oldest banking and trading industries in Japan, became a stockholder.

October of the same year witnessed the incorporation of the China Electric Company, Limited, a joint Chinese Government, Nippon Electric and Western Electric enterprise. This Company took over the business of the Nippon Company in China, and started the manufacture of certain telephone equipment.

In 1918 the capital of the Nippon Electric Company was increased to 5,000,000 yen, and in 1919 a new three-story, reinforced concrete building was erected, providing about 40,000 square feet of additional floor space. This was the first three-story factory building erected by the Company.

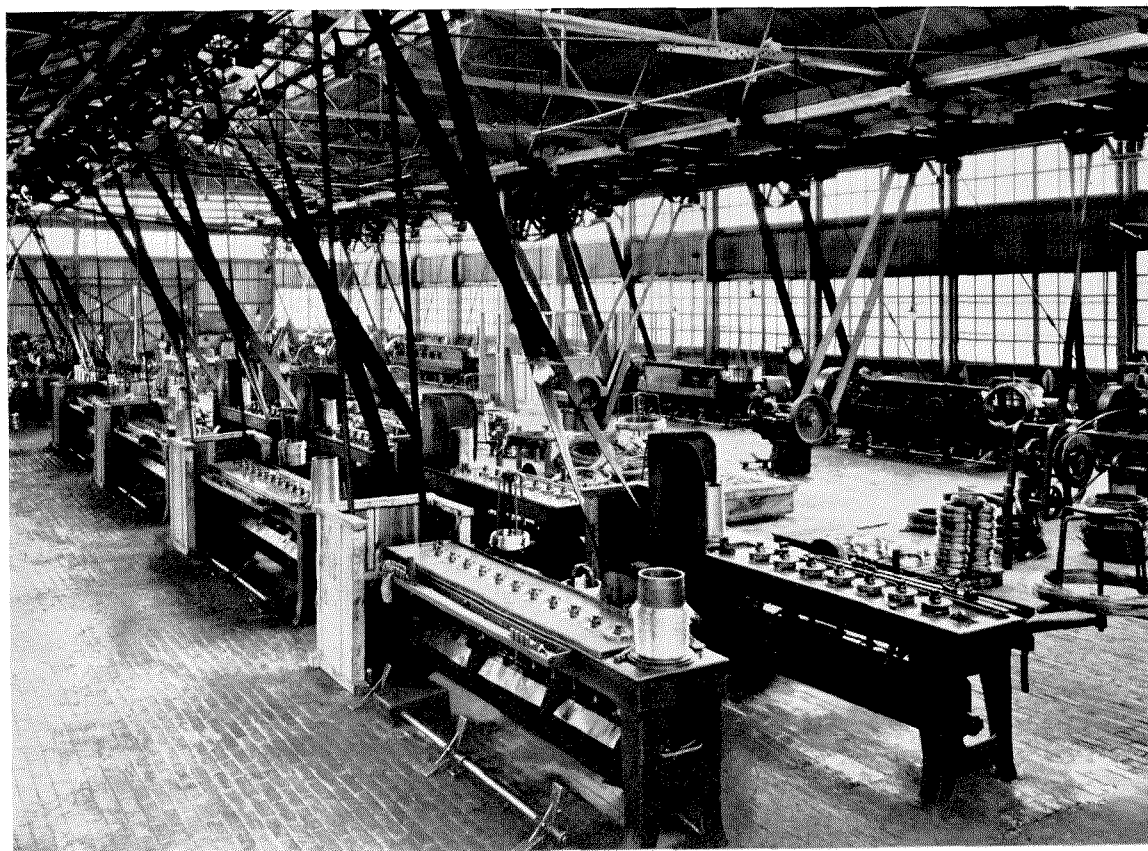

Sumitomo Electric Wire and Cable Works—Wire Drawing Machines

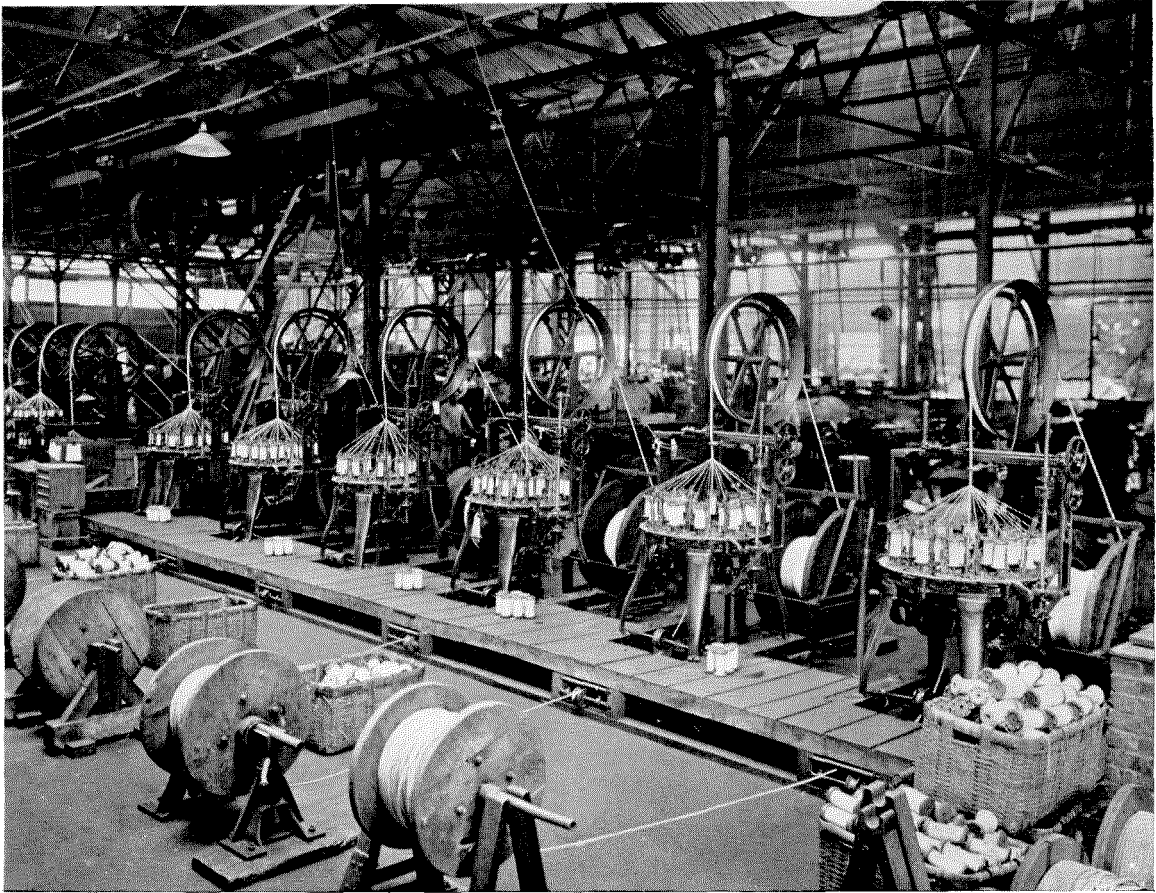

Sumitomo Electric Wire and Cable Works—Braiders

In 1920 machinery was installed for the manufacture of black enamelled wire and switchboard lamps and the capital was increased to 10,000,000 yen, full payment being completed early in 1923.

In the fall of 1920, an important affiliation was made between the Nippon Electric Company and the House of Sumitomo, one of the oldest and strongest manufacturing, banking and commercial organizations in Japan. The existing wire and cable manufacturing plant, known as the Sumitomo Electric Wire and Cable Works, was incorporated as the Sumitomo Electric Wire and Cable Works, Limited, with a capital of 10,000,000 yen. To this new Company, the Nippon Electric Company sold its lead cable manufacturing plant and granted certain patent rights, manufacturing information and assistance relating to the manufacture of wires and cables.

In order to give an idea of the size and stability of the Sumitomo Organization, and an under-

standing of the great variety of enterprises guided, so wisely and efficiently, by Baron Sumitomo, it will be of interest to first take a bird's-eye view of the foundation and development of this vast organization.

In 1690 a copper mine was discovered in Japan in which the Sumitomo family became interested, and it was with this humble beginning that the cornerstone of a great business was laid. This mine was subsequently named the "Besshi Copper Mine" and for a number of generations the Sumitomo family devoted themselves largely to this enterprise.

The next step came two hundred years later when, due to the growing requirements of the mining business, there were formed sales, warehousing and banking companies to develop more actively these branches of the business. Thus there came into being the Sumitomo Copper Sales Company, the Sumitomo Bank, and the

Sumitomo Warehouse Company, with offices in Tokyo, Osaka and Kobe. This was followed by the organization of the Sumitomo Copper Works, formed to manufacture plates, sheets, tubes, rods, bars, etc.; the Sumitomo Steel Works, the first steel fabricating company in Japan, comprising a large plant manufacturing a broad line of forgings and castings; the Sumitomo Fertilizer Works, which utilizes certain by-products of the copper mine; the Sumitomo Wakamatsu Coal Department, distributing the bituminous coal output of the Sumitomo mines; and the Sumitomo Electric Wire and Cable Works, Limited, established in 1908, manufacturing a complete line of wires and cables of every description. It is with this corporation, now formed into a limited company, that the Nippon Electric Company is affiliated.

The Sumitomo Electric Wire and Cable Works, Limited, has a large factory in Osaka, with mod-

ern buildings and up-to-date equipment. It was here that the first paper-insulated telephone cable made in Japan was manufactured, and it is interesting and significant that, after the affiliation with the Nippon Electric Company (in 1920), the first quadded telephone toll cable made in Japan was fabricated in these same works, and the Company is now fully equipped to manufacture Western Electric types of toll cable.

The years 1921 and 1922 were active years in building construction for the Nippon Company and the eighth factory, three stories of reinforced concrete, was erected, providing 43,000 square feet of additional floor space. Later, the ninth and eleventh factories (84,000 square feet in total) were started, in anticipation of increased requirements by the Government Department of Communications.

During the past few years consistent work has

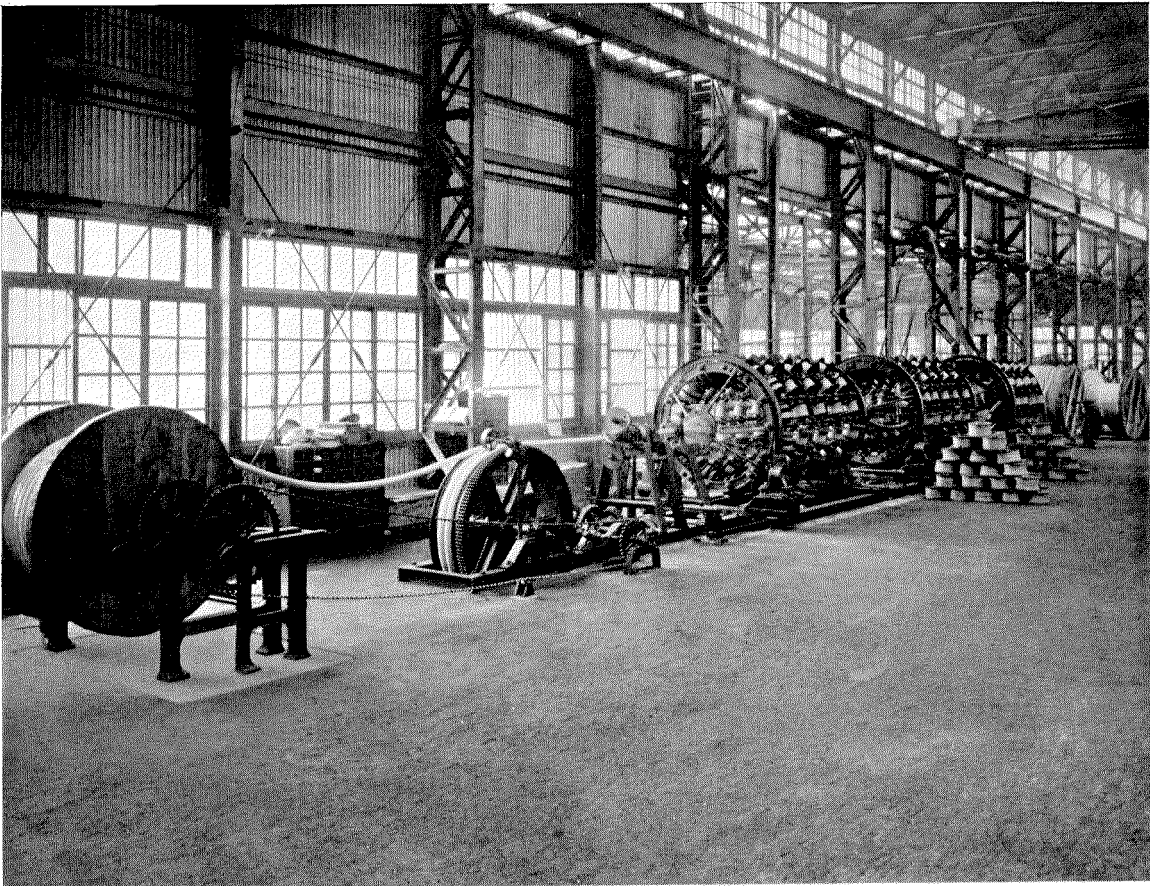

Sumitomo Electric Wire and Cable Works—Cable Making Machinery

been done looking toward taking up the manufacture of new and up-to-date equipment for telephone systems.

The Manufacturing Branch has developed and is working under a functionalized organization; consistent progress is being made in the improvement of protective devices and exhaust

systems for removing dust and objectionable vapors, and fire prevention equipment is constantly being improved.

This brings us through twenty-five years of progress; the future holds bright promise for another period of development and progress for the Company.



Nippon Electric Company—Dinner to Employees on Occasion
of Annual Award of Service Buttons

Recent Developments in Telephone Equipment for Train Dispatching Circuits¹

By WM. H. CAPEN

Engineering Department, Western Electric Company

SYNOPSIS—This paper presents in detail the recent developments in telephone equipment for train dispatching, including a brief outline of its history up to the present time, the transmission requirements of dispatching circuits as compared to those of ordinary telephone circuits, together with the effect of the electrical characteristics of the line, number of sets, etc., on the proper design for maximum efficiency; curves which show the effect of these several variables on the efficiency, for open wire and loaded cable lines; the interesting phenomenon of "standing waves" and means for their elimination; diagrams showing the circuits for the dispatcher's and waystation sets; the development of the vacuum tube amplifier with loud speaker for both dispatcher and waystation use; diagrams and photographs illustrative of the apparatus discussed; discussion of the practical application and limitations of the present train dispatching apparatus. An appendix follows, giving in detail the development of certain mathematical formulæ used in the design of the apparatus.

HISTORY AND DEVELOPMENT

THE telephone as a means of communication for the dispatching of trains came into use in the United States about 1907. Various telephone sets and calling equipment have been developed for this purpose and extensively used until the telephone has become recognized as the most suitable means for dispatching work.

The first equipment which was developed met the requirements as then existing. Just previous to our entry into the World War, another change of conditions made it necessary to develop still more efficient train dispatching equipment to replace that which was no longer entirely satisfactory.

At this time a fundamental study of existing conditions and requirements was undertaken. This investigation has continued until apparatus has been developed which takes care of the greatly increased traffic conditions, meets higher standards of service, and includes equipment for the present types of line or those likely to be used in the future, that is, open wire copper lines, non-loaded and loaded cable. The increasing desire of certain railroads for satisfactory loud speaking equipment for use at both dispatchers' offices and waystations has led to the development of efficient circuits and vacuum

tube amplifiers to meet these needs, replacing the former mechanical type which has inherent limitations, making it much less satisfactory than the vacuum tube type.

The object of this paper, therefore, is to consider the transmission features of train dispatching circuits in general, and to discuss the solution of the problems involved in the design of the most recent apparatus.

GENERAL TRANSMISSION THEORY

The problem of telephone transmission, as here presented, consists in the establishment of a system between two or more parties by means of which intelligible speech may be interchanged. In ordinary telephone communication it is generally required to transmit as much as possible of the electrical power generated by the transmitter at one end of the system to the receiver at the other end. Like the ordinary telephone system the train dispatching circuit must be a two-way system and transmission in either direction must be approximately the same. Not only must the amount of power generated by the action of the sound waves on the transmitter be adequate to actuate the receiver at the distant end sufficiently to produce clearly audible sounds, but these sounds must bear enough resemblance to the original ones to produce intelligible speech. The frequencies of the sounds in the human voice that are necessary for satisfactory transmission vary from perhaps 200 cycles to 2,000 cycles per second. Since the loss of power in the connecting telephone lines may be over 99 per cent. in ordinary two-party service, it is obvious that we have a very nice problem to solve when the requirements make it necessary for a considerable number of parties to simultaneously listen to one talker using a standard type of microphone with its limited power output.

It is evident that in a dispatching line which may be upwards of 300 miles in length and on which there may be 50 or 60 waystations simultaneously listening, the stations nearest to the

¹Paper presented at the Annual Convention of the Telegraph and Telephone Section of the American Railway Association, held at Colorado Springs, September 19, 1923.

talker will absorb most of the power and the distant stations will therefore be inoperative if the usual method of designing these sets to absorb maximum power is used.

There is no inherent reason why the waystations could not be inserted in series in the line, and it may be of interest to briefly cite the reasons why the bridged type has been adopted as the best. In the first place, precedent favors this type. Among the objections to the series set are the following:

(1) For installation reasons it appears better to bridge the stations than to loop the circuit through each, since the station may be located at some distance from the main line.

(2) Any open in the local circuit would put entirely out of commission that part of the circuit beyond the affected station, some transmission being likely up to this point. With the bridged type an open in the local circuit would only cut off that one station. On the other hand, a short in a series set would cut out the one station, and in a bridged type set would cut out a part of the line and would probably still permit some transmission over the majority of the line between the shorted station and the dispatcher. Even if there is no actual open, poor contacts or connections are liable to occur and with the series set these would impair the transmission on the entire system. It would appear that there is considerably greater probability of having an open in the local circuit than of having a short.

(3) If the dispatching circuit is to be used as one side of a phantom it will, of course, be necessary to insure that it be balanced, and when a system is equipped with a series type set the balancing can only be obtained by dividing the impedance of the set equally between the two line wires. Such a requirement would, therefore, necessitate four wires from the main line to the sub-set as compared to two wires when the bridged type set is used. These station leads are often of considerable length and an appreciable additional expense would be incurred, therefore, in connection with the installation of the series type set. Even if the dispatching circuit were not used as one side of a phantom the great unbalance introduced by use of the series type set would greatly increase the susceptibility of the system to inductive interfer-

ence, necessitating the balancing method in most cases.

(4) The present standard selector apparatus is of the bridged type, and would, therefore, require at least three wires between the main line and the waystation set if the series type is used, as compared with two wires when the bridged type is employed.

Consideration of the above facts seems to leave little question as to the greater desirability of the bridged type.

As has been recognized for many years it is necessary to increase the impedance² of the nearby bridged stations sufficiently so that the power absorbed by each will not be a large proportion of the total at that point and yet sufficient will be available at each station to give a satisfactory volume of sound in the associated receiver.

In order to obtain the most ideal results with bridged stations it is more or less evident that the waystations nearest the dispatcher should have a high impedance, gradually decreasing for the more distant stations. This method has, in fact, been tried² and various patents covering the circuits have been taken out. Such a scheme, however, not only complicates the design and the installation of the set, but would give unsatisfactory transmission from distant stations towards the dispatcher. As will be shown later, satisfactory results can be obtained with properly designed sets having the same characteristic at each waystation.

It is readily seen that simply because a waystation has high impedance it does not signify that it will be satisfactory, since it is possible to bridge a station of such high impedance that the voltage across the telephone line will be insufficient to produce enough current flow through the station for conversion to adequate volume of sound. Furthermore, consideration

² Throughout this paper the impedance of a piece of equipment is understood to be the vectorial sum of the alternating current resistance and reactance at the frequency under consideration. If R is the resistance and X the reactance (either positive for inductance or negative for capacitance), the impedance Z of the apparatus is $Z = \sqrt{R^2 + X^2}$. Since the absolute value of the impedance is not always sufficient, it is often desirable to indicate the angular relation of the total impedance to its resistance component. The resistance and reactance components are always in quadrature (90° apart) and therefore $Z/\theta = R + jX$ in which θ signifies the angle between the vectors Z and R , or the angle of the impedance, and j indicates the 90° relation between R and X .

will show that the amount of current flowing through the waystation will not determine the power available in that station for the production of sound since a pure inductance or a pure capacitance will have no resistance component to absorb the power which is the product of the resistance and the square of the current ($I^2 R$). It is quite obvious, then, that the satisfactory solution of the problems involved in train dispatching systems depends, among other things, upon the proper proportion of resistance for a given impedance. It may be added that the angle of the waystation impedance for most efficient results is also greatly affected by the characteristics of the line connecting the stations.

Although the method of setting up an artificial line and actually testing the efficiency with waystations of different impedances was used in some preliminary investigations, it was believed that the more complete solution lay in determining the best impedance values by computing methods which had already been highly developed in the solution of other telephone problems. These solutions could be checked by actual test of the adopted design. By using the computation method it was possible to obtain a very thorough understanding of the relations of the variables involved and certain interesting facts were brought to light which it would probably have taken a much longer time to discover had the testing method alone been used.

CONSIDERATION OF LINE CONDITIONS

It is evident that the solution of the problem will depend largely on the type and length of line, the number of sets in simultaneous use, and the grade of transmission required. It was, therefore, necessary to survey the dispatching field thoroughly in order to determine the variations in the above mentioned conditions.

The great majority of dispatching lines in this country are of open wire copper, usually No. 9 A. W. G. Iron wire has been and is, unfortunately, still used in some cases, but is so rapidly being discarded that it was left out of consideration. Besides the open wire lines there are some paper cable dispatching lines in the East. At present these are non-loaded, but some consideration has been given to the extension of these cable facilities by means of loading coils. In some cases, of course, dispatching lines are a

mixture of open wire and cable and in the East there are a number of open wire circuits terminated at the dispatcher's end in 7 or 8 miles of underground cable where the circuit passes through a city to the railroad terminal, as at New York and Chicago.

A complete solution of the problem, then, appears to divide itself into the solution of three problems, namely, those of open wire lines, non-loaded cable and loaded cable, since the characteristics of these three types of lines are so different that the waystations for each must be of widely different impedances.

The grade of transmission generally acceptable as satisfactory for regular telephone service, namely, a 30-mile equivalent,³ was formerly considered adequate for dispatching service. With this value and the maximum length of lines in use at that time, some 25 to 30 stations could be simultaneously receiving from the dispatcher. This was also approximately the maximum number of waystations expected to be simultaneously in use. As traffic conditions increased it was found that not more than about 10 to 15 stations could be simultaneously in use and still obtain satisfactory results. Investigation has since shown that the grade of transmission now thought satisfactory requires an equivalent of not more than about 20 miles.

Table I gives a list of some of the typical dispatching lines in this country and Canada. The data here given were used as representative of the existing conditions at the time this investigation was undertaken. Subsequent changes quite likely may have modified the conditions to some extent. Investigation has shown the advisability of assuming that under the most severe conditions all of the stations on a line would be simultaneously in service for receiving. In order that any equipment may meet all conditions arising in practice it is necessary to con-

³ The transmission equivalent of a system is defined as the number of miles of standard cable required in the standard reference circuit to give the same volume of sound from the receivers of the reference and compared systems for the same loudness of speech in the transmitters of both systems. The standard reference circuit is generally accepted and has been standard for many years with the Bell Telephone System, and has been adopted by the Independent Telephone Association of America—Ref., "Tentative Stds. of Transmission," Bulletin No. 1, Dec., 1915, Independent Telephone Association of America. "Some Facts Concerning Telephone Transmission," Elam Miller and C. A. Robinson, Proceedings of Association of Railway Telegraph Superintendents, Annual Meeting, St. Louis, May, 1913.

sider the most severe ones likely to exist. From the data given in the table and from a consideration of the probable future growth of dispatching systems it was felt that No. 9 A. W. G. copper could be considered representative of

is, therefore, given to non-loaded cable circuits in this paper, although information is available regarding the impedance requirements, etc., for sets for use with these circuits, should the need for such sets arise.

TABLE I

Road	From	To	Miles	No. of Stations	Type of Line
N. Y. Central.....	N. Y. City.....	Albany.....	145	41	Mostly No. 9 A.W.G. Copper N.L.O.W.
"Big Four".....	Indianapolis.....	Bellefontaine.....	140	45	No. 9 A.W.G. Copper N.L.O.W.
	Cleveland.....	Bellefontaine and Columbus.....	140	30	No. 9 A.W.G. Copper N.L.O.W.
	Branch: Galeon... Cincinnati.....	Columbus.....	60	15	No. 9 A.W.G. Copper N.L.O.W.
		Columbus and Delaware.....	175	50	No. 9 A.W.G. Copper N.L.O.W.
	Springfield.....	Sandusky.....	140	30	No. 9 A.W.G. Copper N.L.O.W.
	Cincinnati.....	Indianapolis.....	110	35	No. 9 A.W.G. Copper N.L.O.W.
	Indianapolis.....	Kankakee.....	140	35	No. 9 A.W.G. Copper N.L.O.W.
	Indianapolis.....	Mattoon.....	130	35	No. 9 A.W.G. Copper N.L.O.W.
	Mattoon.....	St. Louis.....	135	45	No. 9 A.W.G. Copper N.L.O.W.
	Indianapolis.....	Springfield.....	140	35	No. 9 A.W.G. Copper N.L.O.W.
	Indianapolis.....	Peoria.....	240	40	No. 9 A.W.G. Copper N.L.O.W.
	Danville.....	Mt. Carmell.....	140	30	No. 9 A.W.G. Copper N.L.O.W.
	Mt. Carmell.....	Cairo.....	140	30	No. 9 A.W.G. Copper N.L.O.W.
Southern.....	Alexandria.....	Monroe.....	160	40	No. 9 A.W.G. Copper N.L.O.W.
	Monroe.....	Spencer.....	169	33	No. 9 A.W.G. Copper N.L.O.W.
	Spencer.....	Charlotte.....	47	12	No. 10 N.B.S. Copper N.L.O.W.
Canadian Pacific...	Fort Williams.....	Schreiber.....	133.4	35	No. 9 A.W.G. Copper N.L.O.W.
	Schreiber.....	White River.....	118.5	20	No. 9 A.W.G. Copper N.L.O.W.
	White River.....	Chapleau.....	131.8	25	No. 9 A.W.G. Copper N.L.O.W.
	Chapleau.....	Cartier.....	136.4	20	No. 9 A.W.G. Copper N.L.O.W.
Seaboard Air Line..	Jacksonville.....	Columbia.....	283.0	34	No. 9 A.W.G. Copper N.L.O.W.
Penn. R. R.....	Jersey City.....	"H. C." Interlocking Station.....	78.4	28	No. 13 A.W.G.
	Jersey City.....	Phila. St.....	89.1	12	No. 10 A.W.G.
	Harrisburg.....	Phila. St.....	104.0	No. 13 A.W.G.
	Altoona.....	Harrisburg.....	131.0	Not determined
	Pittsburgh.....	Altoona.....	114.0	16	Not determined
N. Y., N. H. & H. R. R.....	Harlem.....	So. Norwalk.....	35.8	28	No. 13 A. W. G.
	Harlem.....	New Haven.....	67	12	No. 10 A. W. G.

that type of line and that an average maximum length of 250 miles with 40 stations would be a reasonable assumption. For loaded cable two typical conditions were considered: 100 miles of No. 13 A. W. G. with 25 stations, and 30 miles of No. 16 A. W. G. with 15 stations were assumed representative conditions for design purposes. There appears to be little likelihood of much non-loaded cable being used in the future, as the distances over which such circuits can be worked are rather limited except by the use of so large a gage that the cost of the copper would be excessive. No special consideration

DETAILED DESIGN CONSIDERATIONS

In order to simplify the preliminary investigation it was assumed:

1. That a typical line could be used.
2. That if the power in the last station on the line were sufficient, the intermediate stations would receive sufficient power.
3. That the power consumed in the way-station impedance could be satisfactorily converted into sound.
4. That the stations were equally spaced along the line.

5. That the transmission from the dispatcher to the waystations was of primary importance and that if this were satisfactory, transmission from the waystations to the dispatcher would be satisfactory.

6. That the loss introduced by the selectors was negligible.

lines; (2) Loaded cable. These conditions will be considered in the above order.

For the assumed typical open wire condition Figure 1 gives the transmission equivalent at the last station on the line with various values of impedance and impedance angle. These curves are plotted for the impedance of the way-

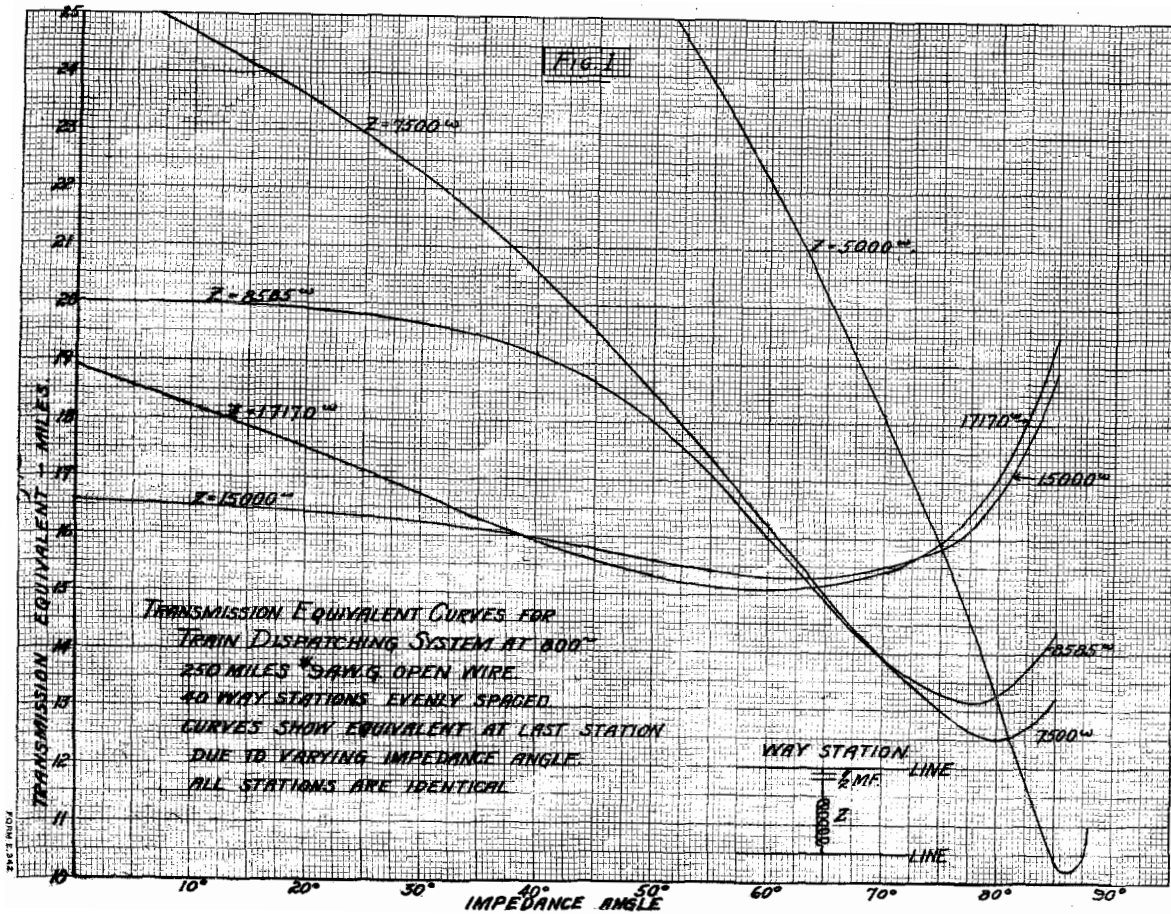

Figure 1

7. That single frequency computations would give satisfactory results.

Having obtained a value for the best impedance based on the above assumptions, further investigation was made in order to determine whether with this waystation impedance satisfactory transmission could be obtained for the other conditions, such as unequally spaced stations, transmission from the waystation to the dispatcher, etc. In all cases this was found to be so and no modifications in the waystation impedance were required. The investigation was undertaken in two parts: (1) Open wire

station exclusive of the 1/2 mf. condenser required in series with the set in order to keep down the loss of the low frequency selector currents. The curves substantiate what has already been said regarding the absolute value of the waystation impedance and its angle. As the absolute value of the impedance is increased above a certain amount, the loss increases. As the impedance angle approaches 90°, that is, as the resistance component approaches zero, the loss approaches infinity, since no power can be consumed by the station in the limiting condition. Figure 1 also shows that for the im-

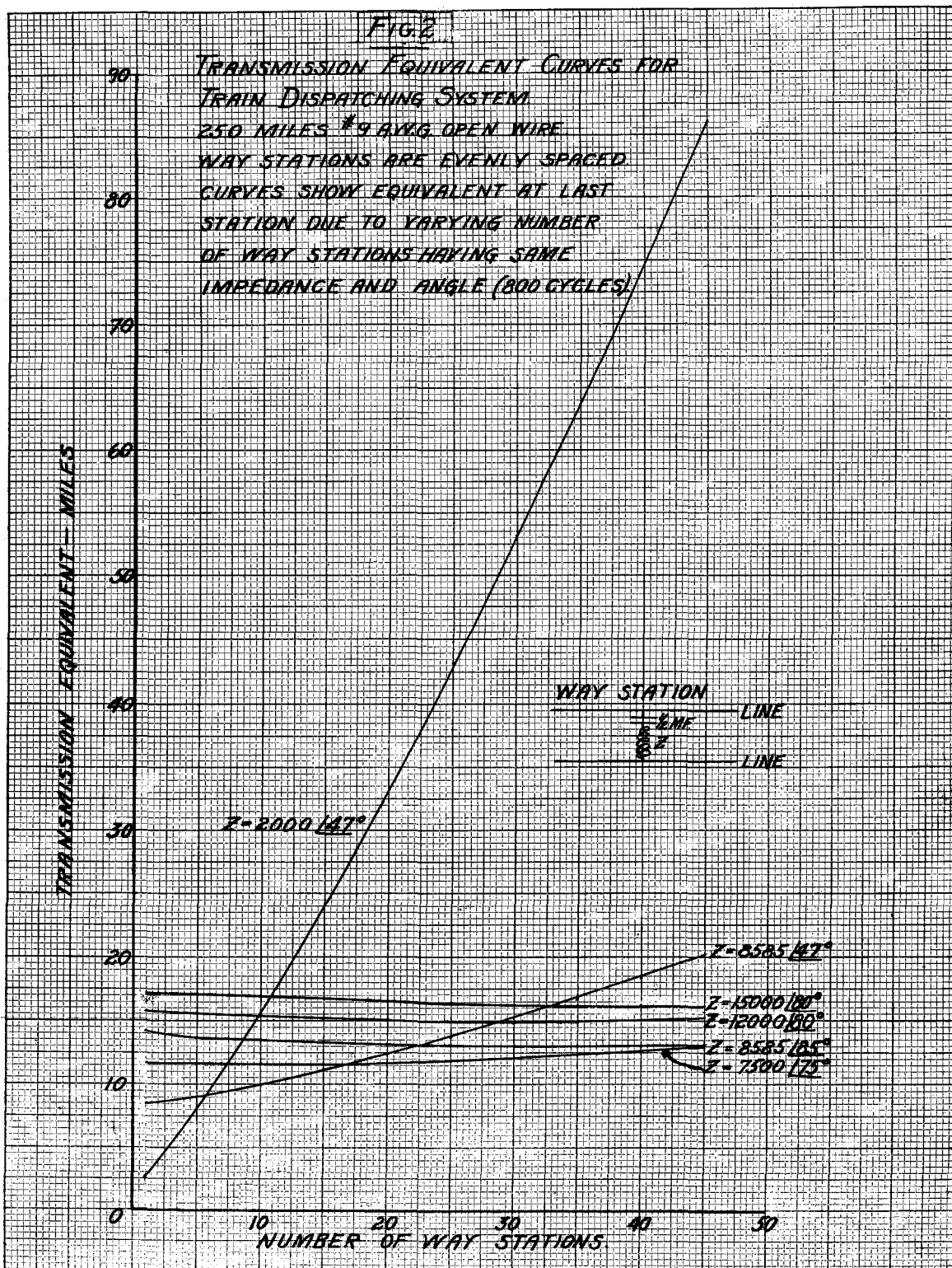

Figure 2

pedances considered the best value for the waystation is about 5,000 ohms having an angle of 86° . Considerations, which will be discussed later, made it impracticable to obtain an impedance with as high an angle as 86° , so the

on the circuit varies is not at all desirable. Not only is the change very large with the old type station, but when a few stations are in service the equivalent is small, making the volume of sound uncomfortably loud.

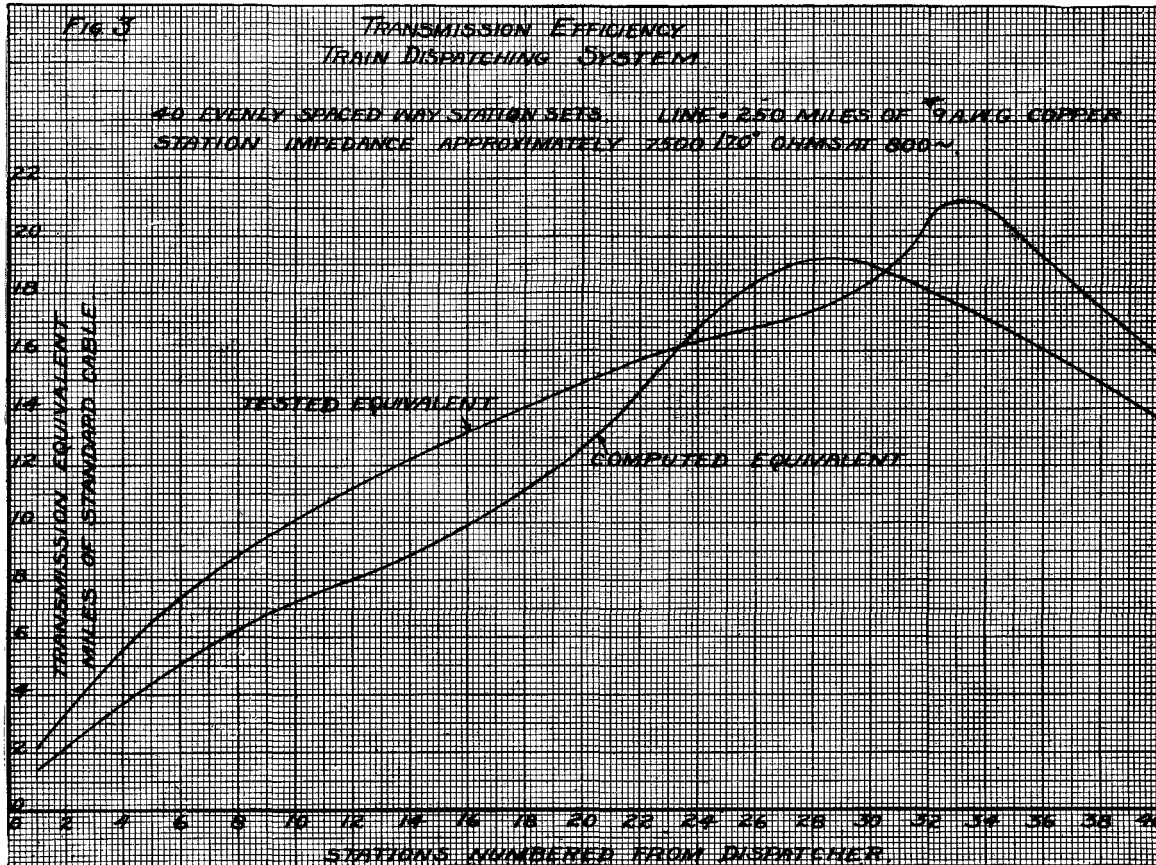

Figure 3

value of 7,500 ohms with a positive angle of 75° was tentatively adopted.

Figure 2 shows the variation of transmission equivalent at the last station on a 250-mile line for different impedances and numbers of waystations. The curve marked $2000/47^\circ$ is that for the type of waystation formerly in use. It is seen that with the present desired equivalent of 20 miles it will not be possible to use more than 12 stations simultaneously. It is also seen that with stations having the proposed value, the equivalent is considerably below the limit, and changes very little with a variation of stations from 1 to 45. This is quite an important point since any considerable change in the transmission efficiency as the number of stations

Figure 3 shows the variation in equivalent at the stations along the typical line when all are in service. Each station has a total bridging impedance of $7500/70^\circ$, which includes the condenser, and is the value of impedance actually obtained on the final design of the set. Two curves are shown, one obtained by computation and the other by test in the laboratory with an artificial line of No. 9 A. W. G. copper equipped with actual sets. The curves of Figure 3 bring out a condition which was expected to exist, namely, that the farthest station on the line does not necessarily receive the smallest amount of power. The condition is due to the so-called "standing wave" effect and is much more pronounced on loaded cable, under

which heading it will be more fully discussed. It is seen that although this effect causes an equivalent at a station 4 or 5 from the end of the line to be about 5 miles greater than at the last station, the equivalent is still sufficiently low to be satisfactory.

circuit with 34 waystations. The results of this installation were entirely satisfactory and the equipment has been in continuous use ever since.

On Figure 5 are shown several curves for circuit loss⁴ vs. length of line with different numbers of waystations having an impedance of

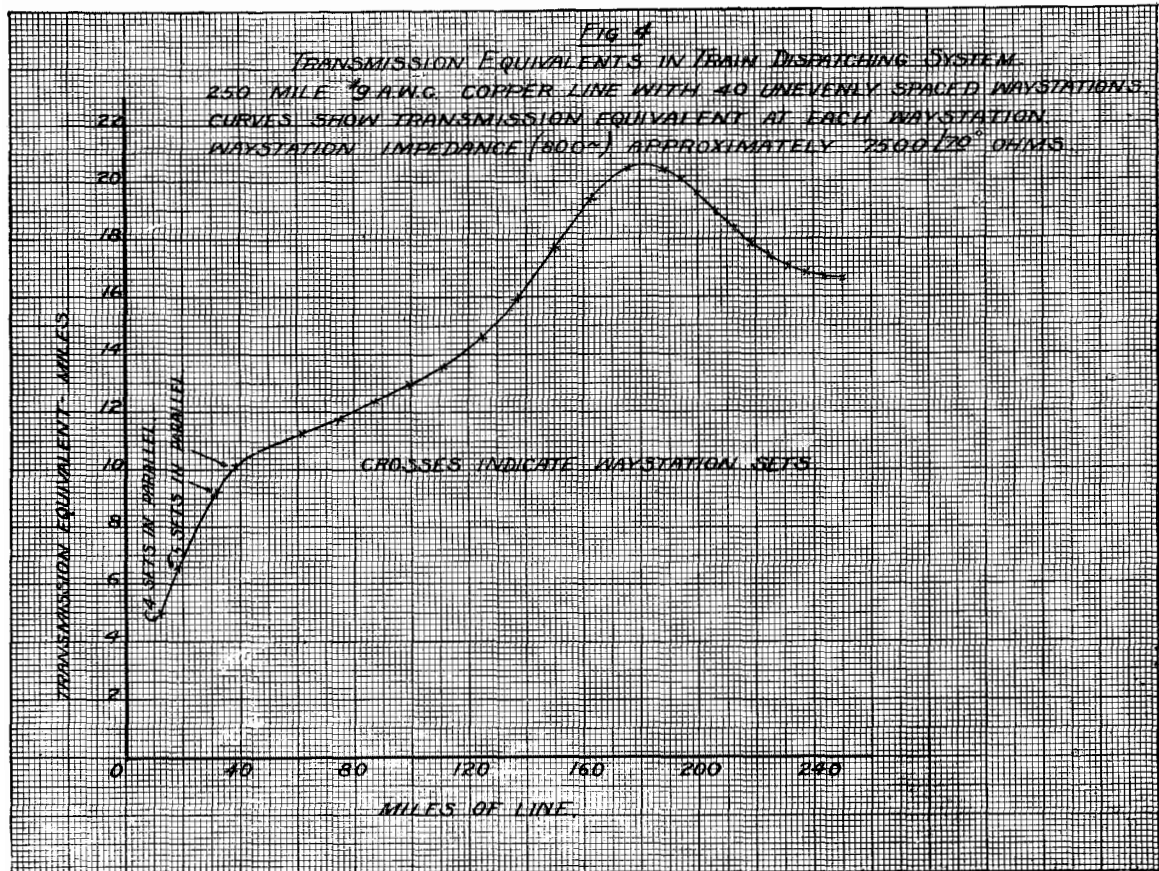

Figure 4

Some investigation was made in order to determine whether very irregular spacing of stations would greatly increase the equivalent at any point. Figure 4 shows the results of such a computation, and although the equivalent at the worst point was slightly increased, it is believed that the conditions assumed were much more severe than would probably be found in any actual circuit.

When the laboratory tests were completed an installation of the sets was made in October, 1917, on the dispatching line of the Seaboard Air Line Railroad between Columbia, S. C., and Jacksonville, Fla. This line consists of 283 miles of No. 9 A. W. G. open wire copper

7500/70°. The losses are those at the last station on the line. It is safe to assume that the maximum loss at any other station on the line will not be more than about 5 miles greater than these values. The actual equivalents for the conditions shown in this figure will be about 2 miles greater than the losses indicated. The shape of the curves is interesting

⁴In order to avoid confusion in regard to negative equivalents, these curves and certain of those following are plotted in terms of circuit loss, giving the miles of standard cable corresponding to the difference in the power consumed at a given station and that in the receiver of the reference circuit with zero trunk. These loss values do not include corrections for the differences in the efficiency of the receivers and transmitters used in the two systems.

and may at first seem inexplicable. The fact is that this type of waystation causes a slight loading effect on the line which actually tends to reduce the attenuation of the line. It is, of course, possible to load a line by means of shunt inductances as well as the more usual method

LOADED CABLE

As in the case of the open wire circuits certain assumptions were made for the loaded cable condition in regard to the typical lines, number of stations, etc. The problem was, however,

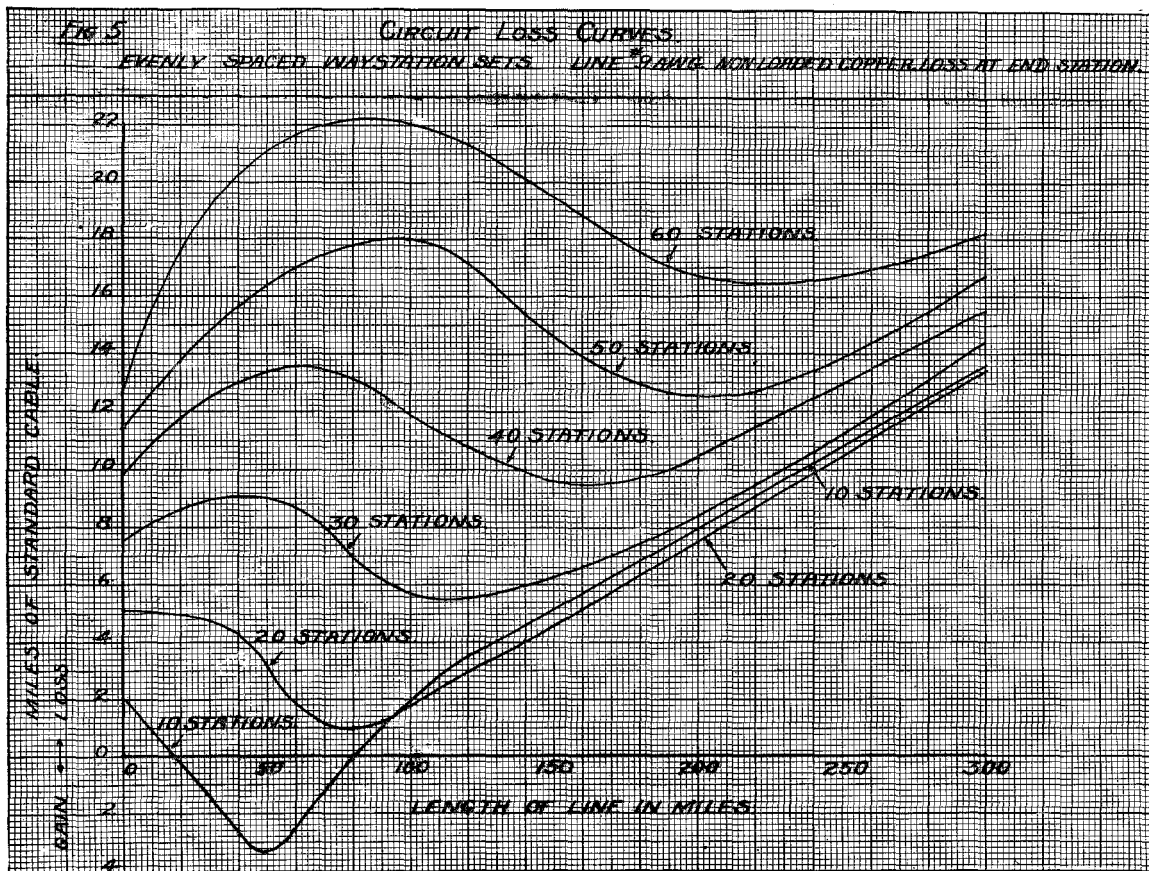

Figure 5

of series inductances. Examination shows that the minimum loss occurs in each case when the stations are approximately 4 miles apart. Under these conditions it is found by computation that this is the spacing for which the loading effect is a maximum. The curve for 10 stations crosses that for 20 stations at about 95 miles for the length of line, and for longer lengths gives slightly greater losses. This is due to the fact that on the longer lengths the advantage of the shunt loading effect is not obtained with so few stations as 10, and that the gain from this cause with the 20 stations offsets the increased loss of this larger number of stations.

not so simple as for the open wire case since there is not the uniformity of practice in the use of a particular gage. Indications are that Nos. 10, 13, 16 and 19 A. W. G. may be used. It was already mentioned that 100 miles of 13 A. W. G. cable and 30 miles of 16 A. W. G. cable, with 25 waystations and 15 waystations respectively, were considered representative, the preliminary investigation being based on these two conditions. The two weights of loading assumed in this work were 0.175 henry coils on $1\frac{2}{3}$ miles spacing, and 0.205 henry coils on 1.4 miles spacing, as those most likely to be used.

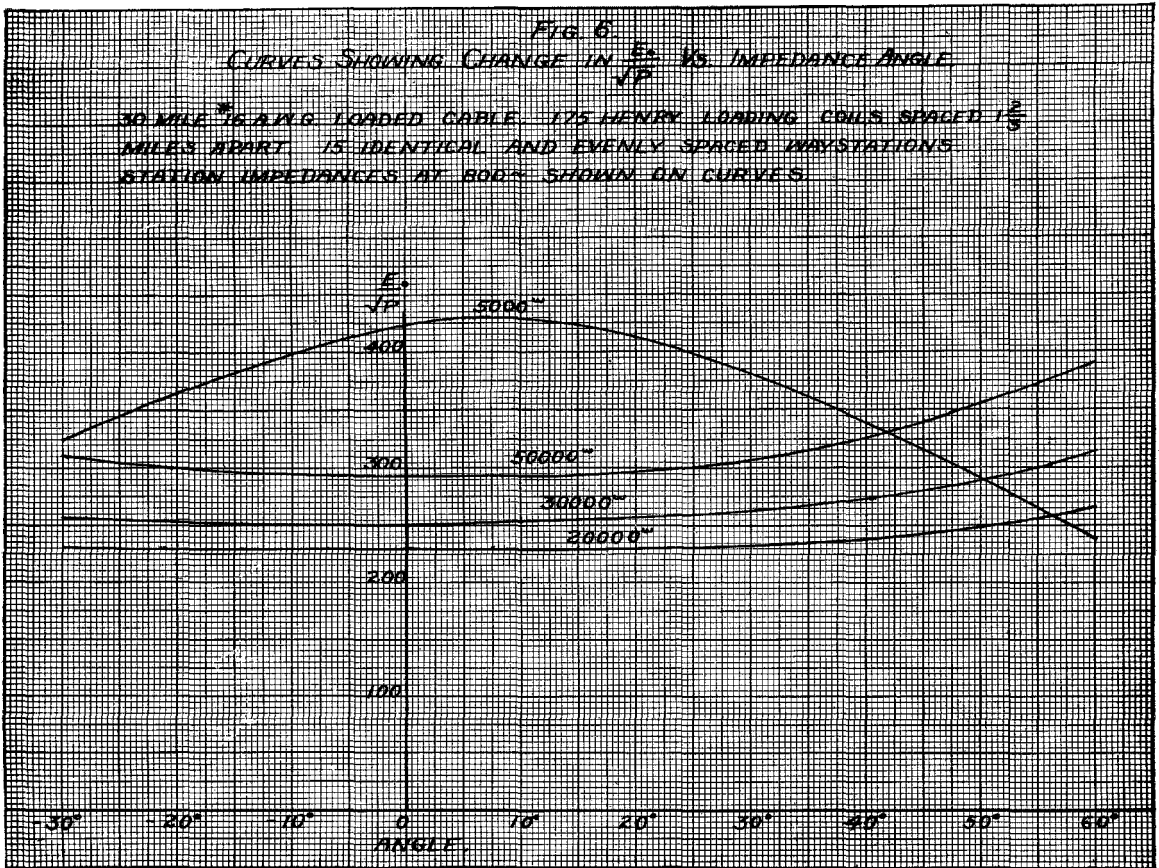

Figure 6

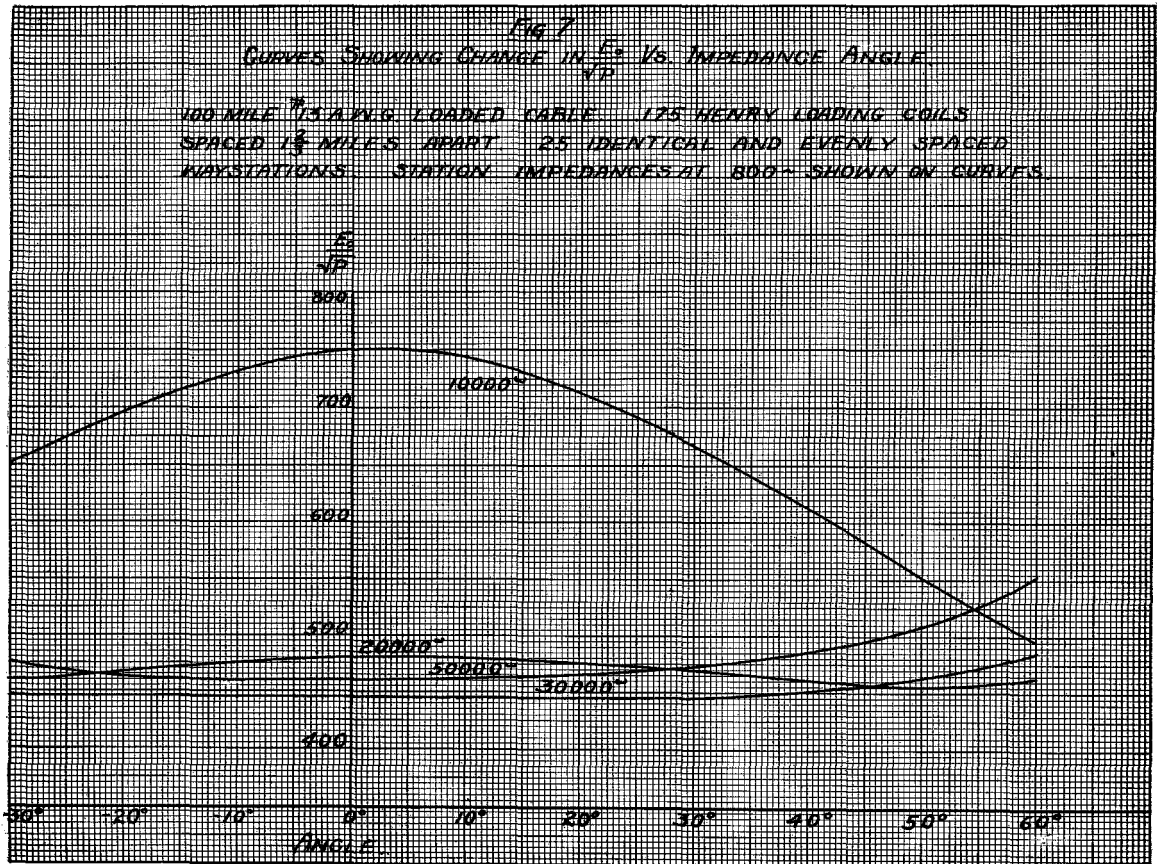

Figure 7

Although the detrimental effect of "standing waves" was appreciated early in the investigation and the final solution eliminates them, it is felt that the phenomenon is of sufficient interest to justify a somewhat detailed discussion of it,

Using impedances actually obtained with an experimental set, some computations were made to determine the change in efficiency at the different stations along the line, the results being shown on Figures 8 and 9. As shown on these

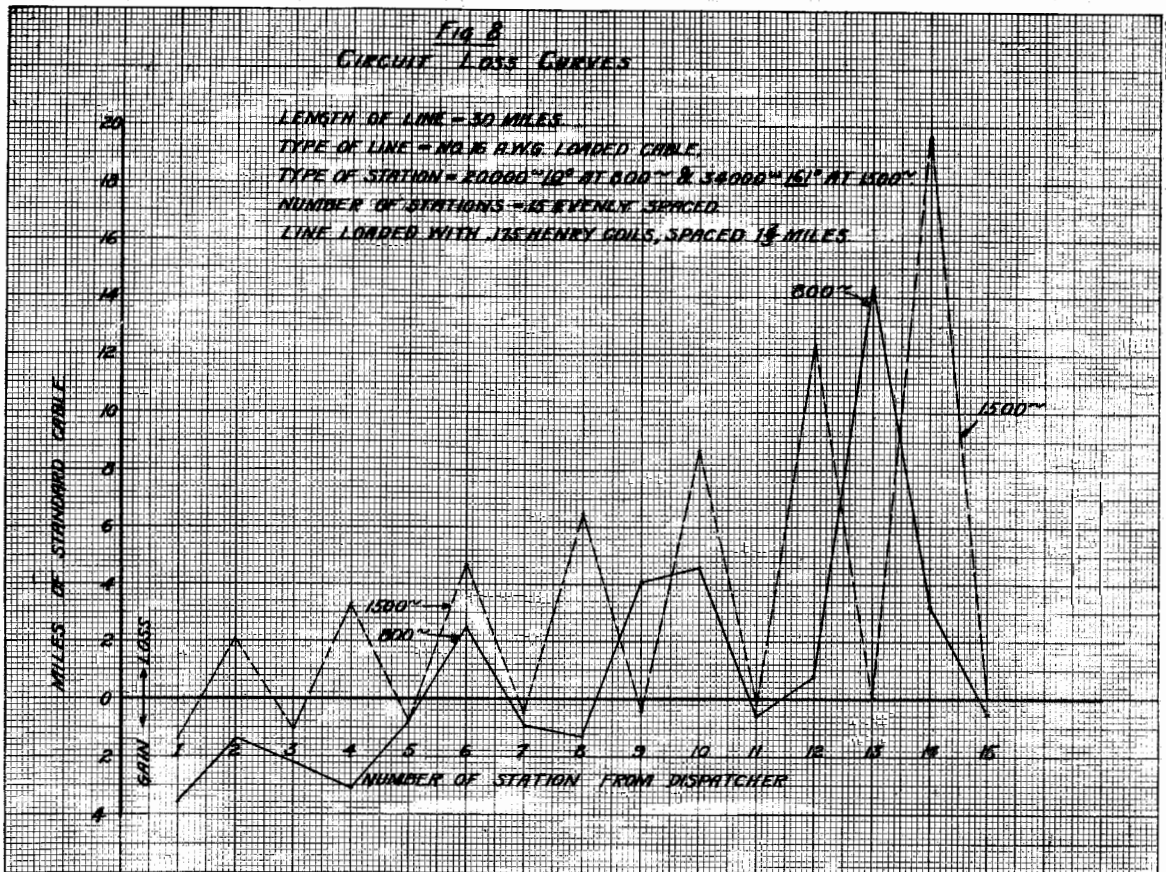

Figure 8

since such a consideration brings forth certain important facts.

Preliminary computations showed that the best value of waystation impedance at 800 cycles was 20,000 ohms or more at a small angle, although the values were not at all critical, as may be seen from Figures 6 and 7, which show the variation in the ratio of voltage impressed on the sending end of the line to the square root of the power consumed in the last station. The curves are shown in this form since, as explained in the appendix, they are more simple to determine than the actual equivalents or losses, a minimum value for this ratio, of course, corresponding to minimum loss.

figures the values of station impedance at 800 cycles and 1,500 cycles were 20,000/ 0° and 34,000/ 61° respectively. In both Figures 8 and 9 the 800 cycle efficiencies, and on Figure 8 the 1,500 cycle also, pass through maxima and minima at approximately regular intervals. Further investigation showed that these maxima and minima occur at approximately one-half wave-length⁵ points, the greatest loss being at

⁵ A current or voltage wave propagated along a line of uniform construction is shifted in phase as well as reduced in magnitude. The actual velocity of propagation is a function of the frequency of the impressed wave as well as the line characteristics, and the length of line required to produce a 360° or 2π radians shift in the phase is called the wave-length for that frequency.

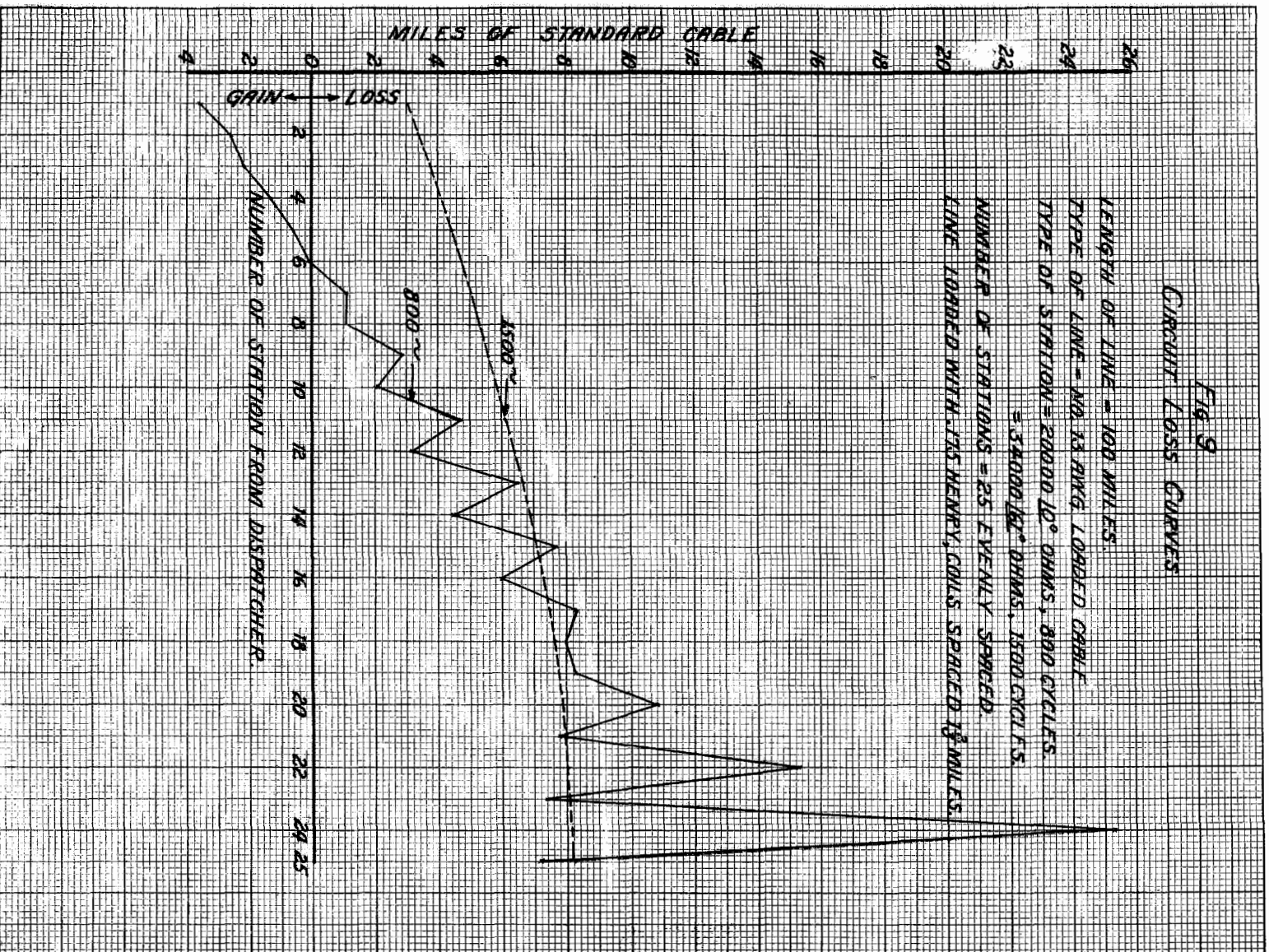

Figure 9

one-quarter wave-length from the distant end of the line. The sudden changes in efficiency are due to the interference phenomenon known as "standing waves."

When a voltage wave is propagated along a line of uniform structure the changes in phase and magnitude are uniform. If, however, a sudden change in the character of the line occurs, the voltage wave will be more or less reflected from this discontinuity and a reflected wave will start back along the line. This reflected wave will also follow the law of uniform change in magnitude and phase until a discontinuity is again encountered, with consequent reflection. The shift in phase of the reflected wave at a junction depends upon the nature⁶ of this discontinuity.

It can easily be seen, therefore, that with stations of as high an impedance as here assumed the terminal of the line is in effect approximating an open circuit which is, of course, the maximum discontinuity and gives total reflection. A large reflected wave would, therefore, be expected. The combined effect of the original and reflected waves on the voltage at any point on the line will depend upon the relative magnitudes and phases of the two waves. This phenomenon results in maxima and minima voltages along the line, although the voltage at any one point remains constant since the phase relation at any point between the advancing and reflected waves does not change. This causes the so-called "standing wave."

From the above it is clear that the irregularities in efficiency at the several stations on the line are due to standing waves; i.e., the voltage wave which is reflected from the end of the line meets the advancing waves in opposite phase at a quarter wave-length from the end of the line and at each succeeding odd multiple thereof, namely, $\frac{1}{4}$, $\frac{3}{4}$, $\frac{5}{4}$, etc., or in Figure 8 at the 13th, 10th and 9th, 6th and 2nd stations for 800 cycles.⁷ It becomes apparent that at these points the voltage across the line will be the difference between the amplitudes of the direct and reflected waves, this difference in amplitude

⁶ The proportion of a voltage wave reflected at a discontinuity in a uniform line is given by the formula $\frac{Z_L - Z_R}{Z_L + Z_R}$ in which Z_L is the characteristic impedance of the line and Z_R is the impedance of the termination. The characteristic impedance of any line is the impedance of an infinitely long line of uniform structure. (See Appendix.)

being due to the greater attenuation of the reflected wave. If, therefore, there happens to be a station at or near one of these null points, the current through it must consequently be small and a considerable loss will occur. From this reasoning it would be expected that the greatest loss would occur at the interference point nearest the end of the line and show a gradual decrease towards the sending end, since the difference in the amplitude of the two waves will be greater as the sending end of the line is reached. This tendency is borne out by the curves which show that these excessive losses diminish towards the dispatcher's end of the line.

From the above consideration one would not expect to find these maxima if the stations occurred at points on the line even multiples of $\frac{1}{4}$ wave-length from the end, since at such points the two waves will be in phase giving minimum losses. Since the wave-length is approximately inversely proportional to the frequency, it is obvious that for 1,500 cycles the stations will be electrically at nearly twice the 800 cycles spacing. Therefore, if at 800 cycles the stations are at odd multiples of $\frac{1}{4}$ wave-length, at 1,500 cycles they will be approximately at even multiples of a quarter wave-length. Hence those stations having the greatest losses at 800 cycles will have minimum losses at 1,500 cycles. This theory is upheld by the data on Figure 8. Furthermore, for 1,500 cycles there are twice as many maxima and minima points, and those stations, which for 800-cycle computations are at approximately the mid points between the poor stations, or at $\frac{1}{8}$, $\frac{3}{8}$, $\frac{5}{8}$, etc., of a wave-length from the end of the line, come at approximately $\frac{1}{4}$, $\frac{3}{4}$, $\frac{5}{4}$, etc., of a wave-length for 1,500 cycles, which are the minimum voltage points giving high losses. On the particular line of Figure 8, as is indicated by the curves, the 1,500-cycle computations bring the poor stations more nearly at the exact $\frac{1}{4}$ wave-length points, and hence the maximum losses for this frequency are considerably greater than for 800 cycles.

In Figure 9 the 800 cycle curve shows maxima and minima, but the losses at 1,500 cycles vary

⁷ Due to the lumping of the loading coil inductance at definite points instead of being uniformly distributed as assumed in the computations (see appendix), the stations having maxima and minima losses on the actual line will not in general be geographically located just as shown on the attached curves.

uniformly. On this line the stations are so spaced that at 800 cycles each is approximately at either a maximum or a minimum point. As shown above, the maximum losses at 800 cycles become minimum at 1,500. The stations which at 800 cycles have minimum losses are at approximately $\frac{2}{4}$, $\frac{4}{4}$, $\frac{6}{4}$, etc., of a wave-length

than one wave-length. The speed of propagation on open wire is very much greater than on loaded cable.

Not only will the efficiency at these maximum loss points on such lines be low for actual voice currents as talking tests on artificial cable have shown, but even more important is the effect

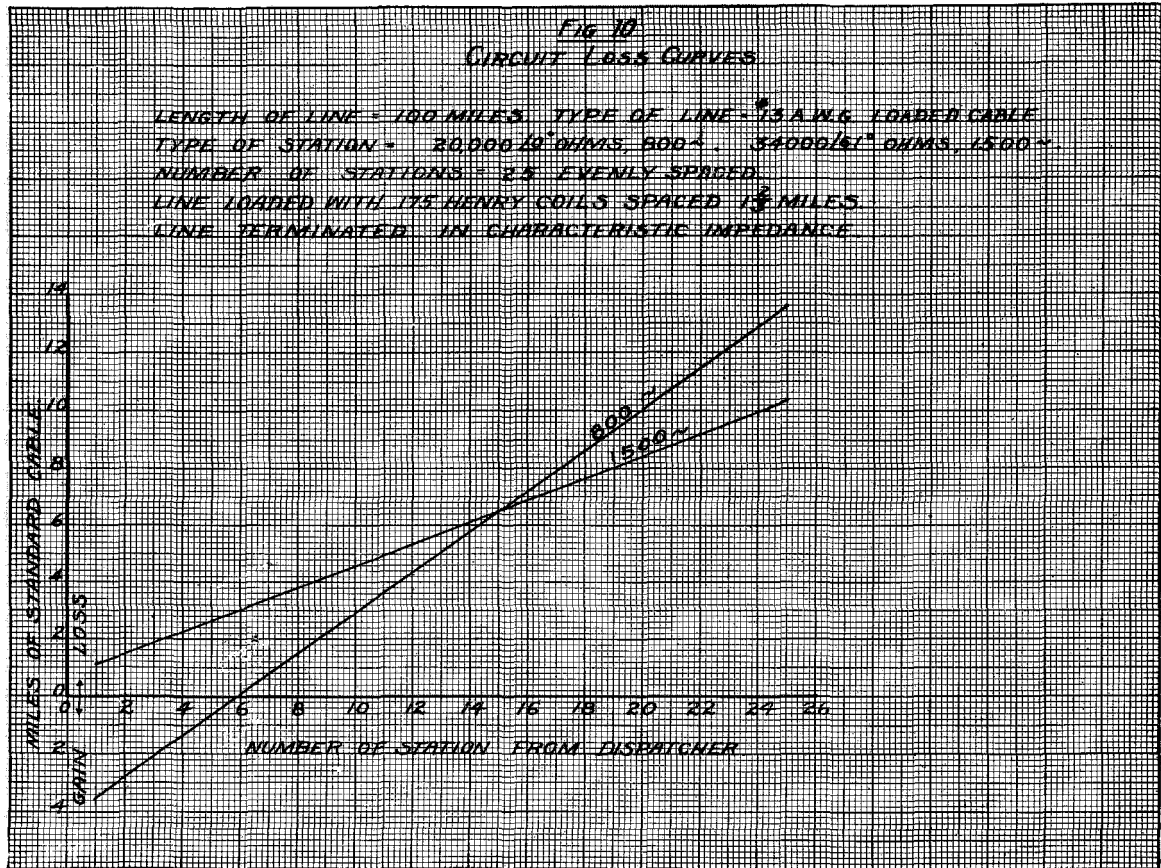

Figure 10

from the end of the line, will be, as previously shown, at $\frac{1}{4}$, $\frac{3}{4}$, $\frac{5}{4}$, for 1,500 cycles. These are also even multiples of a quarter wave-length and hence are still at minimum loss points. Therefore, it follows that for 1,500 cycles all the stations will have minimum losses, which explains the shape of the curve.

In passing it is well to note that the effect of standing waves is not serious on the open wire lines because the reflected wave is not so large, due to the fact that the lower impedance of the end stations does not so nearly approximate the open circuit condition. Only one maximum is found, the longest line considered being less

on the quality. As the curves indicate, there is a great difference in the efficiency of some of the stations between 800 and 1,500 cycles. The efficiencies will vary materially at other frequencies in the voice currents, and may be greater or less than those shown, so that at all stations distortion of the voice waves results due to the standing wave effect. The distortion is so serious that means were sought to avoid it.

Since the reflected waves are caused by a discontinuity at the line terminal, it was decided that the best way to avoid the trouble was to so terminate the line that no reflection occurs, which would be the case if the line continued

indefinitely beyond the last station, for no discontinuity would exist. As applied to the case under consideration, the elimination of the reflected wave may be accomplished by terminating the line in its own impedance.⁷ Practically, this can be done by shunting the last station with a resistance of approximately

sufficiently to make it advisable to redetermine the most desirable impedance values. Numerous computations were made on the typical lines and 35,000 ohms $\sqrt{20^\circ}$ at 800 cycles, and 20,000 ohms at 1,500 with as low a positive angle as possible were considered the best compromise values.

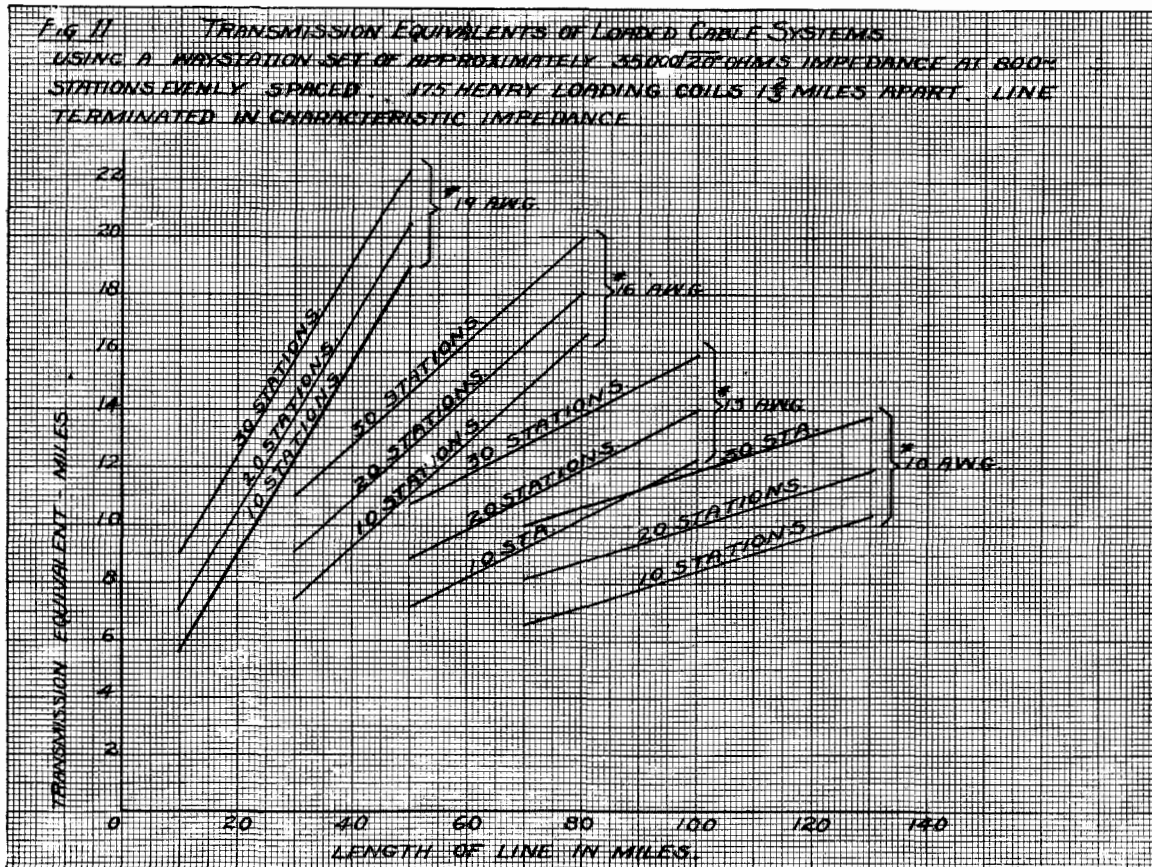

Figure 11

1,260 ohms, since the characteristic impedance of the lines here considered is about this value.

The curves on Figure 10 show the results of computations on the typical 100-mile line when the terminal is shunted with an impedance equal to the characteristic impedance of the line. It may be observed that the efficiency varies proportionately to the attenuation of the length of line and that the difference between 800 and 1,500 cycles is not great.

Having determined upon the method of eliminating the standing waves, the impedance to be used for the waystation was considered. The shunting of the line changes the condition

It may be remarked that our final computations covered a rather wide range of conditions and brought out several interesting points, one of which was that the most desirable angle at either 800 cycles or 1,500 cycles was 30° , irrespective of whether it was negative or positive. This is due to the fact that the line impedance of the loaded cable is practically pure resistance, so that there is no loading effect obtained from the waystations; or, in other words, the maximum efficiency is obtained when the ratio of the resistance of the station to its total impedance is $\cos 30^\circ$. The change in angle from -30° to $+30^\circ$ caused only a small change in efficiency.

The optimum impedance at 1,500 cycles was considerably lower than that at 800 cycles.

Computations further showed that there was practically no advantage in using a heavier weight of loading than 0.175 henry on $1\frac{2}{3}$ miles spacing. For example, computations were made with 0.205 henry coils on 1.4 miles spacing. With 13 gage cable the respective attenuations per mile without the bridged stations were 0.01 and 0.0085 respectively, but with the bridged stations, located every 4 miles, the attenuations were approximately 0.019 in each case. The latter is due to the greater effect of leakage when the heavier weights of loading

WAYSTATION SET DESIGN

Having determined upon the impedances for the waystations, it next became necessary to design a set which would have the desired operating features as well as the proper impedance relations. After careful consideration of the requirements, the following were agreed upon as desirable:

1. The set must have a condenser in series to reduce losses to selector currents.
2. The set should have a key to be operated for talking; the transmitter to be open during listening.

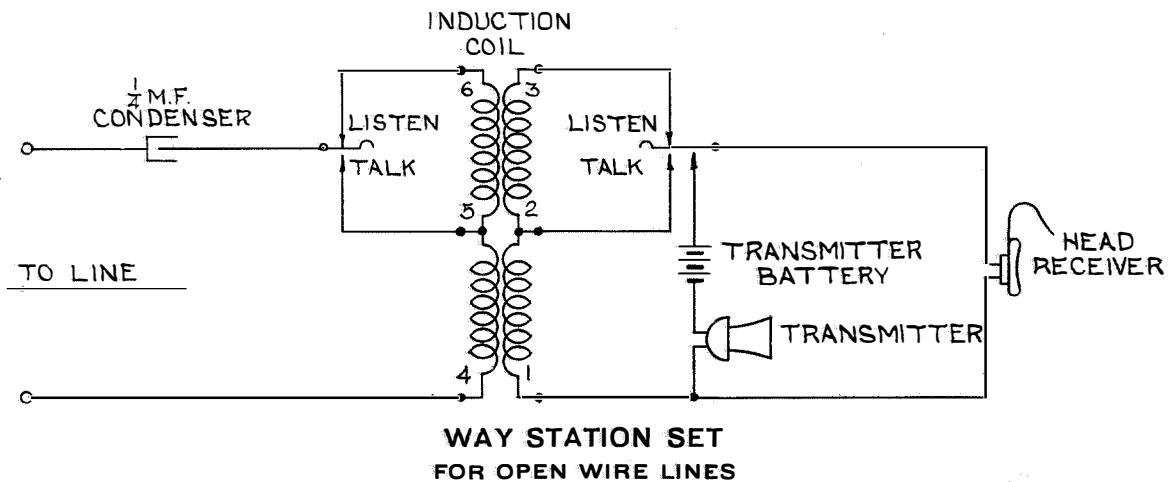

Figure 12

are used and has been known to be so serious that on certain lines with high leakage the loaded lines may be less efficient than the non-loaded lines.⁸ The waystation has the effect of increasing the leakage.

Figure 11 gives the results of computations for a wide range of line conditions and shows the equivalent at the last station on the line when the stations are all the same and have the impedance above determined. The end of the line is shunted with an impedance equal to the characteristic impedance of the line. The equivalent at the last station is in this case greatest since the effect of standing waves has been eliminated.

⁸ Bancroft Gherardi, "Some Recent Advances in Transmission Efficiency of Long Distance Circuits" (Address), New York Telephone Society, April 18, 1911.

3. There should be sufficient "break-in" efficiency during talking to attract the operator's attention.

4. Transmitting efficiency should be a maximum.

5. The receiver and the transmitter should be insulated from the line by an induction coil.

6. The impedance in the receiving condition must be as close to the desired theoretical values chosen as practicable.

These conditions are met by the circuit shown in Figure 12 for the open wire set.

In the receiving condition the low impedance receiver is connected to an induction coil, the secondary winding of which is in series with the $\frac{1}{4}$ mf. condenser and bridged across the line. The number of turns on the coil is such that the

combined impedances of the coil, receiver and condenser give approximately $7500/70^\circ$ as required. The $\frac{1}{4}$ mf. condenser is required to reduce the losses at the low frequencies of the selector currents. It was found desirable to use this value of condenser in place of the original $\frac{1}{2}$ mf. condenser since the increased efficiency of selector operation was considerable. Besides providing suitable insulation between the receiver and the line the use of the induction coil makes it possible to obtain a higher positive impedance angle than could be obtained by use of a receiver alone. Referring back to the original curves it will be seen that the efficiency

of the set is somewhat higher than in the normal receiving condition, giving rather lower losses to the other stations. The insulation between the primary and secondary windings of the induction coil is tested with 1,000 volts, as is also that between the contacts of the key. This insures adequate protection to the operator from induced voltages between the line and ground.

Because of the more difficult impedance conditions to be met by the loaded cable set, two additional condensers are required. Figure 13 shows the circuit. Figure 14 shows the impedance of the set for different frequencies. It will be noted from this figure that the impedance

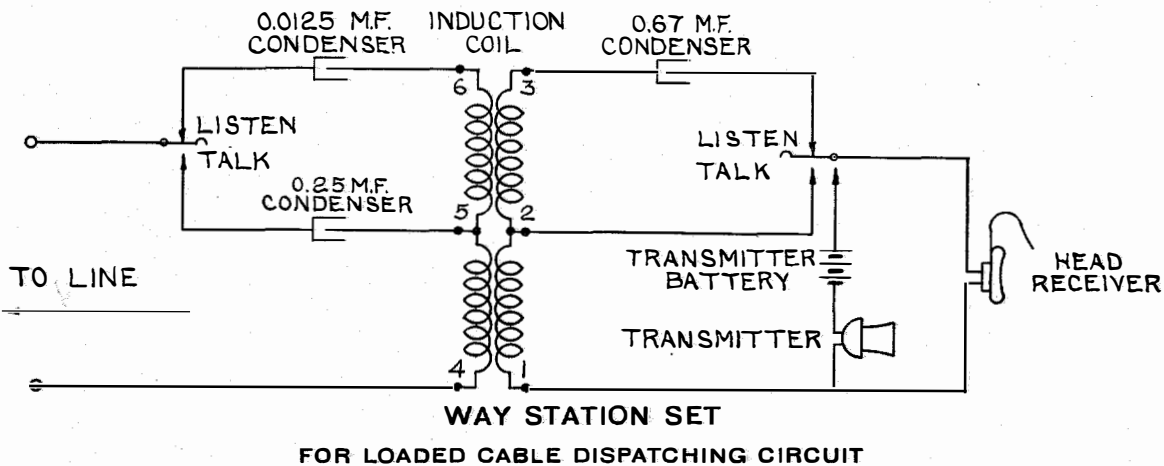

Figure 13

decreases rapidly as the impedance angle is reduced.

In order to obtain a high transmission efficiency into the line, it is necessary to change the ratio of the turns on the coil when used to connect the transmitter in circuit. This is accomplished by depressing the key which also closes the transmitter circuit. To give satisfactory "break-in" efficiency the receiver is bridged directly across the transmitter winding of the coil. The impedance of the receiver is relatively high compared to that of the coil winding so that no great loss in efficiency of transmission occurs from high frequency losses. The desk stand contacts operate to open the receiver and transmitter circuits in the normal way. With the receiver on the hook, only the secondary of the coil in series with the condenser is bridged across the line. In this condition the impedance

of the set varies considerably for different frequencies, although at the two computed values is close to that desired. A study of all the data obtained by computation, together with the results of certain talking tests on artificial loaded cable circuits, showed that throughout the range of important frequencies the impedance of this set would be satisfactory, and that detailed computations at other frequencies than 800 and 1,500 cycles were not justified.

The operating features of the set are the same as those of the open wire set. In the receiving condition the secondary series condenser is of a small value, .0125 mf., and is required primarily to obtain the desired impedance; a larger one would, of course, be satisfactory for selector operation, as in the case of the open wire set. The 0.68 mf. condenser in series with the low impedance receiver is also required to give the

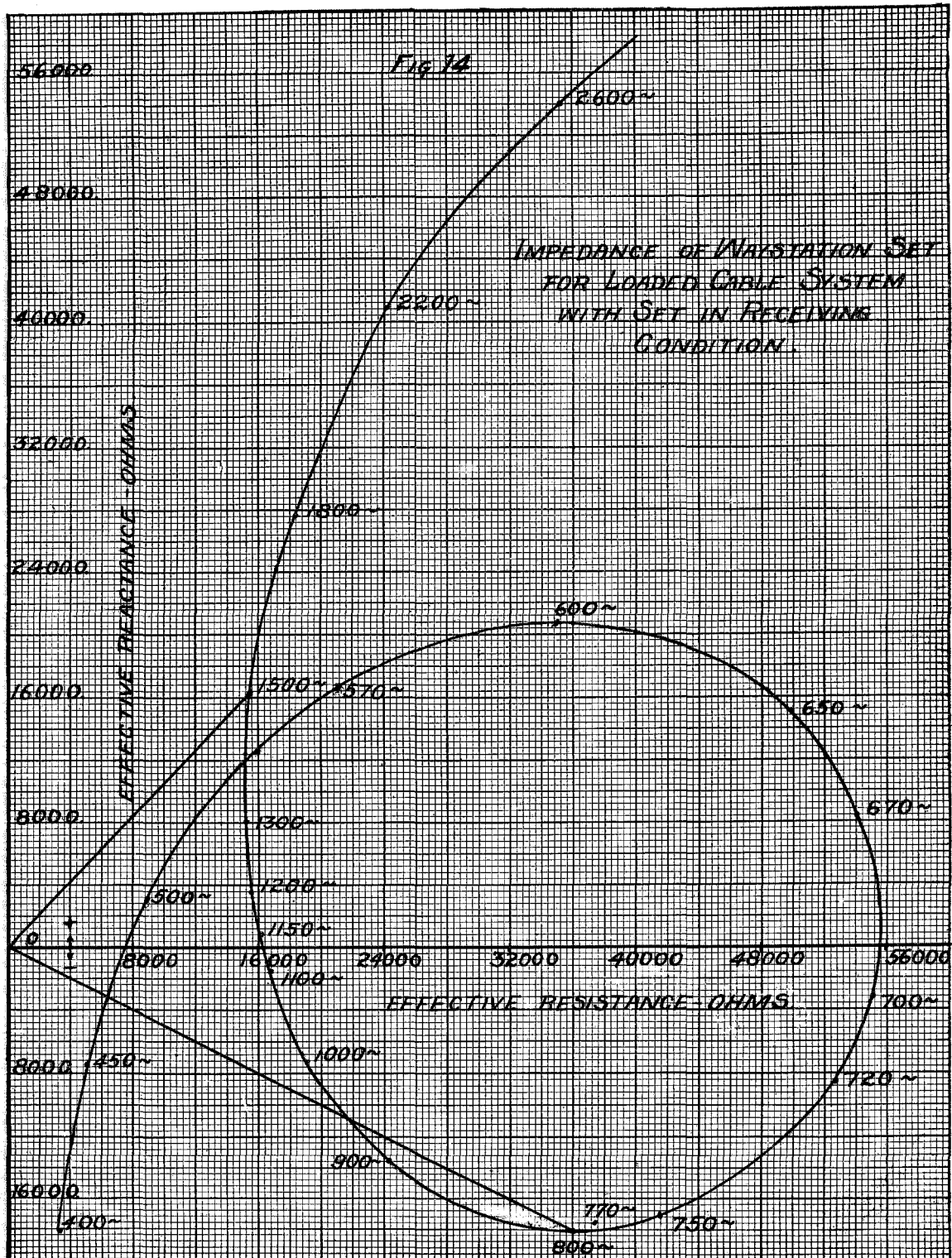

Figure 14

proper impedance and slightly increases the receiving efficiency of the set itself. The small condenser in the line side would offer such a high impedance in the transmitting condition that the efficiency would be greatly impaired. For this reason it was necessary to use a third condenser of $\frac{1}{4}$ mf., as shown when the circuit is switched to the transmitting condition.

The shunt at the end of the line could, from a transmission standpoint only, be a pure resistance of 1,250 to 1,300 ohms, but because of losses to selector currents it is necessary to use a one or two mf. condenser in series with this resistance.

DISPATCHER'S EQUIPMENT

The requirements for a dispatcher's set are, of course, different from those of a waystation set. The dispatcher is required to listen on his set practically continuously for 8-hour periods. It is necessary that in addition to high receiving efficiency, the "break-in" efficiency as well as the transmitting efficiency be as high as possible. In order to save the transmitter batteries a foot switch is usually provided, which, when depressed, closes the transmitter battery circuit for talking.

In the usual type of set the power from the transmitter is divided between the line and the receiver, and often the energy into the receiver approximates that into the line. This, of course, means that the talker's voice sounds very loud in his own receiver and that while listening any room noise will appear as a disturbing sound in the local receiver tending to obscure the received voice sounds, thus effectively decreasing the efficiency of reception. Not only because this "side tone" may be loud enough during transmitting to be decidedly annoying to the dispatcher, but because of the effect on the reception it was believed that an anti-side tone set was advisable for this class of service.

A set which is variable between the receiving and transmitting conditions, and in which only the receiver is in circuit in the receiving condition and only the transmitter while talking, is inherently about 3 miles more efficient than an invariable set in which both receiver and transmitter are in circuit in the same relation during both transmitting and receiving. In the prac-

tical case of the waystation set, where the receiver actually obtains a certain amount of energy from the transmitter during transmitting, the transmitting efficiency will be about 2 miles greater than in the case of an invariable set where only approximately half of the energy is delivered to the line. Even at the sacrifice of these 2 miles in transmission efficiency of the dispatcher's circuit it seemed advisable to use the invariable type of set in order to obtain the maximum "break-in" efficiency.

Since there is only one dispatcher on the line it is required that the dispatcher's set be designed to transmit and receive most efficiently when connected to an impedance equal to that of the lines occurring in practice. It was found that the impedance of the open wire lines for the most severe conditions, as regards length and number of stations, was approximately 925 to 1,265 ohms, with impedance angles varying from negative 6° to positive 15° ; similarly for loaded cable circuits the impedances vary from about 1,250 to 1,300 ohms, with small negative angles of not more than about 2° . The impedances of the two types of line are sufficiently alike to make it advisable to design one dispatcher's set for use with both. The gain in efficiency by using two sets would, at best, be only a fraction of a mile, and the decrease in side tone not very large. The circuit of the set finally adopted is shown in Figure 15.

A brief discussion of the action of an anti-side tone set may be advisable at this point. The operation of the anti-side tone circuit is based on the Wheatstone bridge principle, in which a balance is obtained between the line and a network having the same impedance as that of the line. Referring to Figure 15, the analogous Wheatstone bridge circuit indicates the relation between the various elements. It is obvious from this that when the network N has the same impedance as that of the line L , no current will flow in the receiver from an electromotive force connected across the bridge since a balance exists. On the other hand, any electromotive force in the line L will cause current to flow through the receiver. The first mentioned arrangement corresponds to the transmitting condition of the set, and the second to the receiving condition. In the actual circuit the transmitting voltage is applied to the bridge network through the coil, the two windings C

and B of which are balanced; but this does not alter the bridge analogy. This arrangement also makes it possible to include the resistance component of the network as a part of the re-

dispatcher's equipment a simple resistance and a condenser are sufficient. A line condenser is required to keep selector currents from being shunted through the set as in the case of the

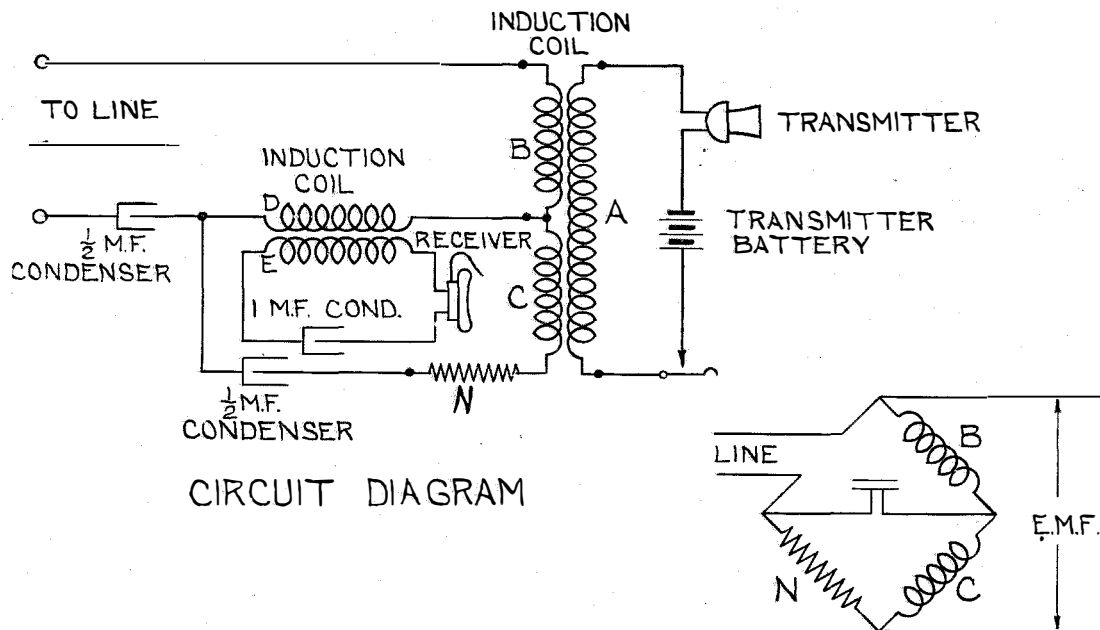

ANALOGOUS BRIDGE CIRCUIT DISPATCHER'S SET

FOR NON-LOADED OPEN WIRE METALLIC LINES AND LOADED CABLE CIRCUITS

Figure 15

sistance of the winding C . This may be accomplished by either using a small gage wire for winding C or adding some high resistance wire.

As has been pointed out before,⁹ the impedances of telephone lines vary considerably over the range of telephone frequencies. Furthermore, different lines, such as those generally used in dispatching work, may differ appreciably. It is, therefore, not possible nor practicable to design a single balancing network to exactly equal the impedance of different lines at all frequencies of interest. A compromise must be used, but it is possible to obtain sufficient balance by this means to produce a considerable reduction in the current flowing in the receiver circuit while transmitting. In the case of the

waystation set. This condenser must be balanced by a similar one in the network side.

The coil in the receiver circuit is used to insulate the receiver from the line and afford the same protection as in the waystation set. The condenser in series with the receiver increases the receiving efficiency.

A set of the type just described will have a transmitting efficiency about two miles less than that of the waystation set, but a receiving efficiency about six miles better. The side tone will be in the neighborhood of 15 miles less. The "break-in" efficiency of the dispatcher's set is the same as its receiving efficiency.

The possibility of using the waystation set for a dispatcher has been considered. In certain cases, of course, it may give satisfactory service, but since the requirements for a waystation and a dispatcher's set are different, it does not seem advisable in general to use a waystation

⁹ Gherardi and Jewett, "Telephone Repeaters." Paper before joint meeting of American Institute of Electrical Engineers and the Institute of Radio Engineers, New York, Oct. 1, 1919.

set for a dispatcher. The anti-side tone feature alone would seem to justify the more complicated set.

Figure 16 shows the circuit of the dispatcher's equipment and Figure 17 is an assembly photograph of the apparatus, while Figure 18 shows an

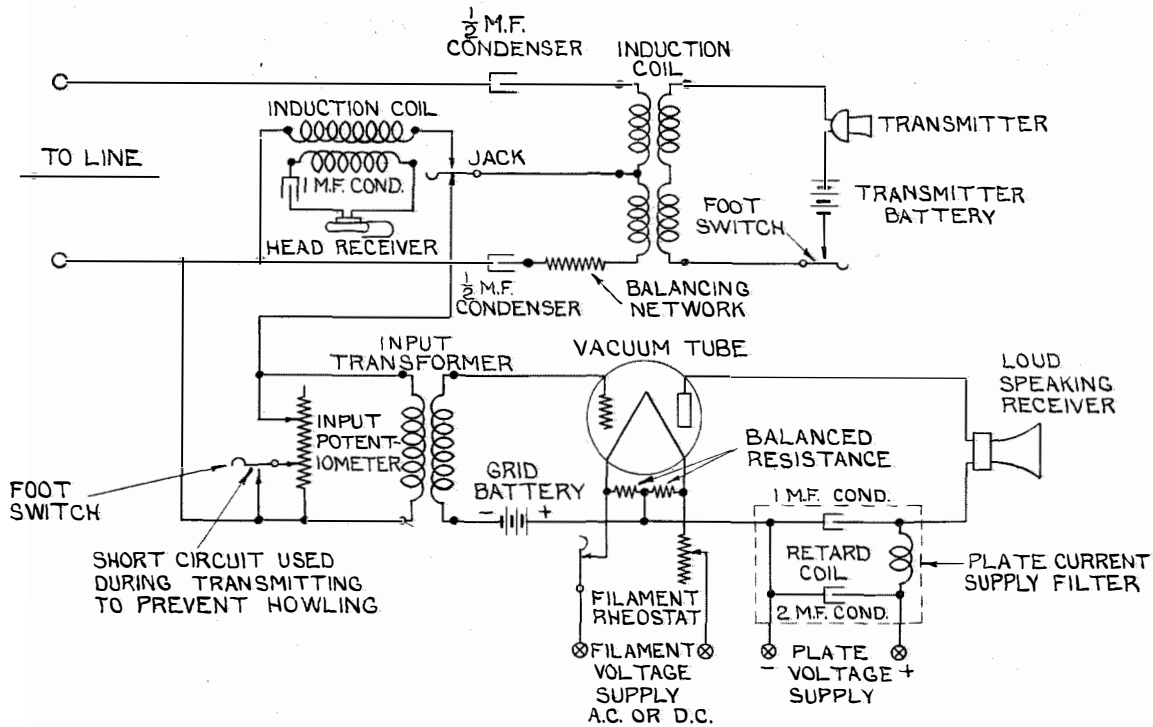

LOUD SPEAKING DISPATCHER'S SET

Figure 16

LOUD SPEAKING EQUIPMENT

Even with the improved anti-side tone dispatcher sets, the necessity for the dispatcher to wear a head receiver for a considerable period of time has developed the need for satisfactory loud speaking equipment. Although in a few special cases loud speakers with mechanical amplifiers have been in use for some years, it has only been since the development of the vacuum tube amplifier that the demand for such apparatus could be satisfactorily met. As previously mentioned, the mechanical amplifier has inherent characteristics which limit its usefulness. The greater stability and freedom from distortion of the present day vacuum-tube amplifier make its general use much more certain. The perfecting of loud speaking equipment for dispatchers' use was undertaken first, and later similar equipment for use at waystations was developed.

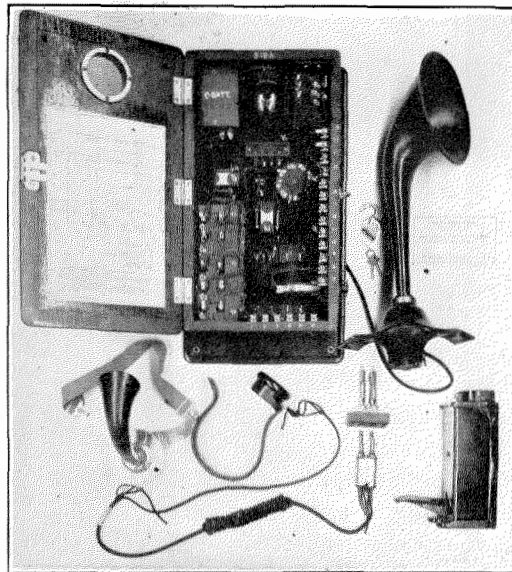

Figure 17—Train Dispatcher's Loud Speaking Equipment

actual installation consisting of two equipments in the same office. As indicated in Figure 16 the dispatcher's circuit is the same as that for the one described above with the addition of the amplifier and loud speaker. Ordinarily, the latter are in circuit, but in case of emergency it

tion of amplification is, however, not sufficient to decrease the "break-in" below a satisfactory volume.

The amplifier itself is a simple one-tube circuit and is arranged in the customary way with input transformer and suitable current supply con-



Figure 18—Train Dispatcher's Office. Loud Speaking Equipment Installation

is possible to plug in the head receiver and use the circuit in this way. The loud speaking equipment should be used with an anti-side tone circuit in order to reduce the tendency toward local oscillations between the loud speaking receiver and the transmitter from setting up a howling condition. In addition to the balancing network of the set itself, it was necessary to reduce the amplification of the amplifier while transmitting in order to prevent howling. This is accomplished, as shown on the drawing, by means of an additional contact on the foot switch which decreases the potentiometer resistance across the input of the amplifier. This reduc-

nections. In order that either A. C. or D. C. may be used for the filament supply, the talking circuit is connected to the filament by means of balanced resistances bridged directly across it, the connection being made at their mid point. The magnitudes of these resistances are sufficiently high to prevent any further appreciable current drain. The voltage for the filament must be approximately 6 volts and is ordinarily supplied from a lighting circuit by means of a step-down transformer and rheostat in the case of A. C. supply, or by means of suitable resistances in the case of D. C. supply. Small flashlight batteries are used for the 9-volt grid

battery to give the proper potential on the grid. The plate voltage may be obtained from storage batteries or from a D. C. lighting circuit. The filter shown on the drawing effectively eliminates such variations from the supply as would cause disturbing noises in the loud speaker. The fila-

gives a photograph of it. The set has been developed for open wire circuits and is designed to have a sufficiently high bridging impedance so that the efficiency at the waystations will be as good as with the sets already discussed. It is intended to be bridged directly across the line

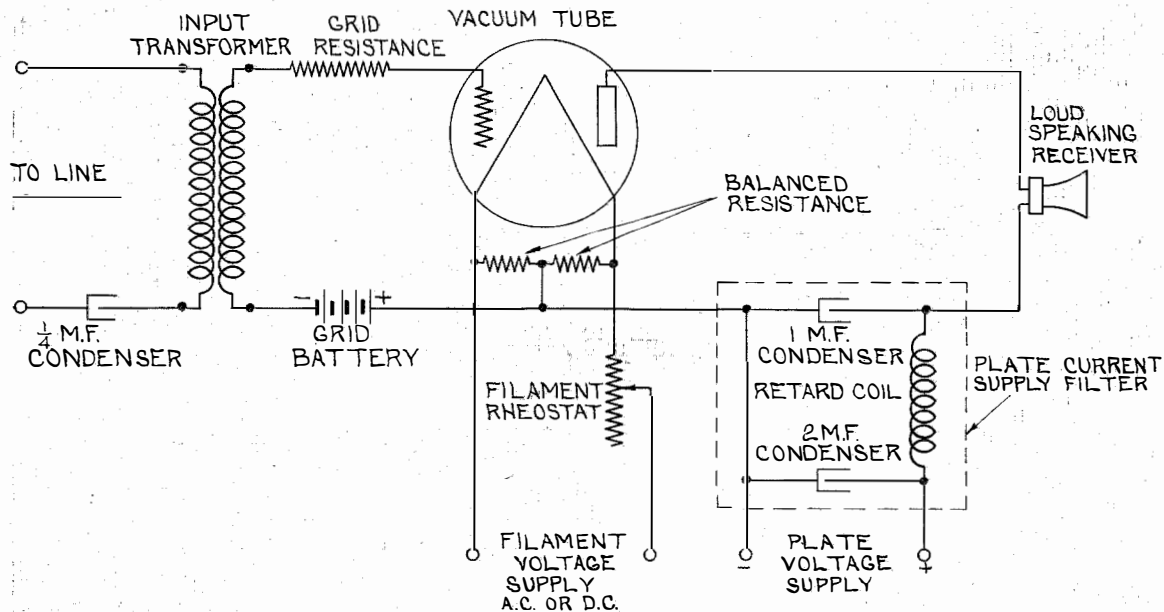

**LOUD SPEAKING AMPLIFIER CIRCUIT
FOR WAY STATIONS**

Figure 19

ment current is approximately one ampere and the plate current about .01 ampere at 130 volts. The impedance of the loud speaking receiver is such that no output transformer is required between the vacuum tube and the receiver. The gain of the amplifier may be set for the desired value by means of the input potentiometer.

Certain dispatchers' circuits are not equipped with selectors, and the use of loud speaking equipment at each waystation enables the operators on the line to hear all of the messages transmitted and to be called directly by voice without the necessity of wearing the head receiver all the time. On dispatching lines where the waystation is in a switching tower, and where the switchman is the only operator, it would be practically impossible for him to wear a head receiver. For such circuits a loud speaking amplifier set has been designed. Figure 19 shows the circuit of this amplifier, and Figure 20

and when necessary for the switchman to talk, the operation of the key, in addition to arranging his regular set for transmitting, removes the amplifier from the circuit. In the transmitting

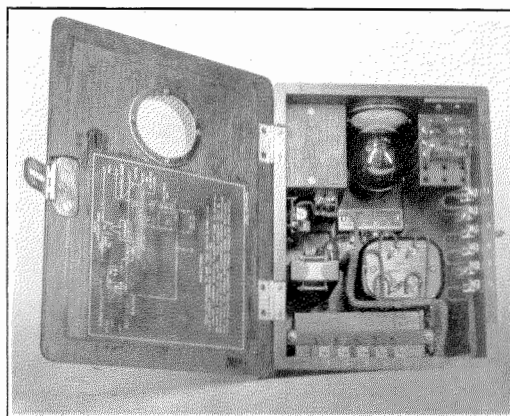

Figure 20—Amplifier. Loud Speaking Equipment for Waystations

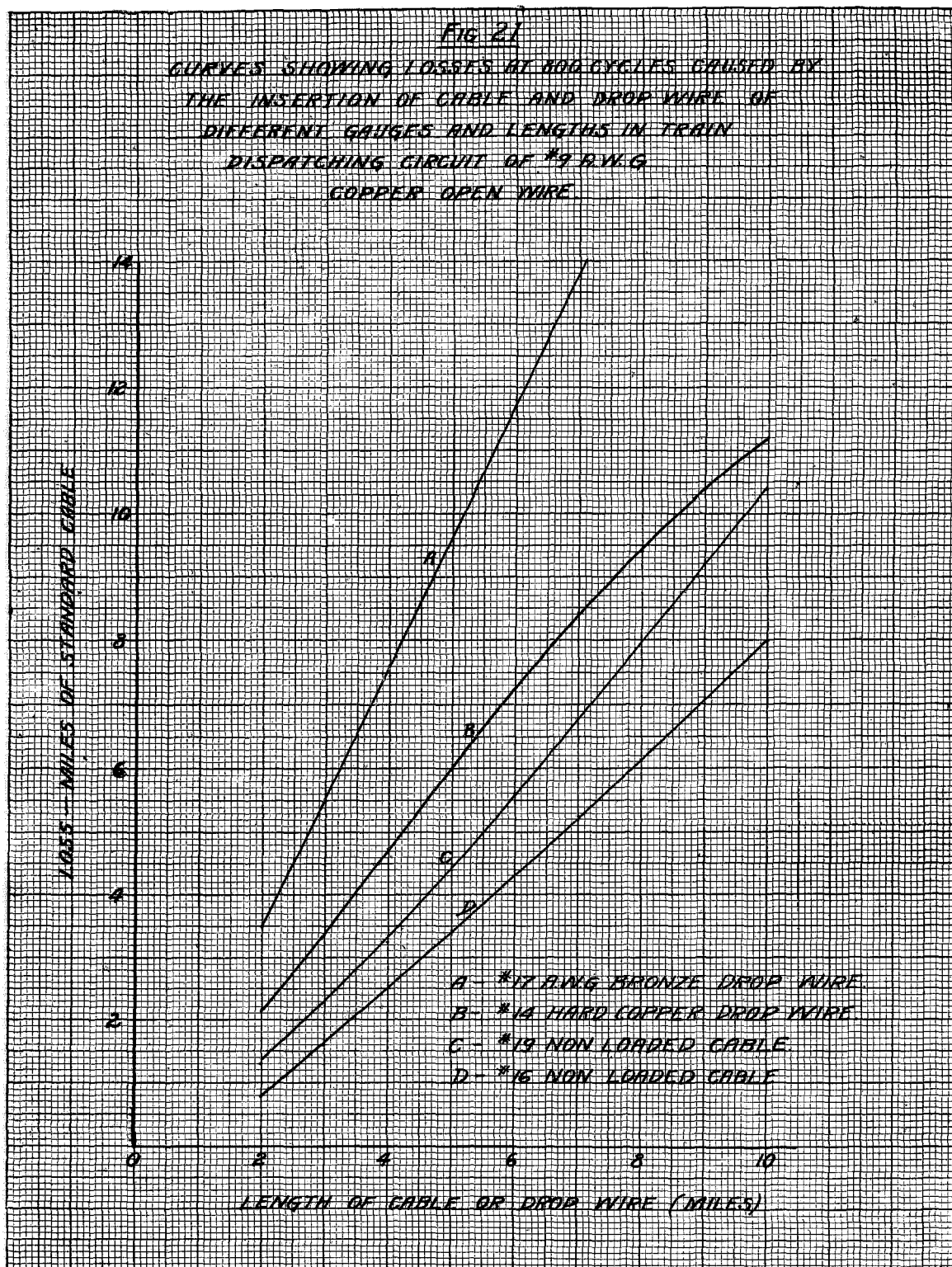

Figure 21

condition, therefore, he will be using his head receiver and there will be no necessity for considering the elimination of possible howling since the loud speaker is not in service. The circuit of this amplifier is essentially the same as that of the dispatcher's set except for the characteristics of the input transformer, the elimination of the input potentiometer, which was not believed necessary for waystation use, and the addition of the grid resistance. This resistance is of a high value and is necessary to maintain the correct input impedance for the set, as otherwise the volume of transmission from nearby sets would, by overloading the amplifier, upset the impedance relations above discussed.

SELECTOR EQUIPMENT

On such dispatching circuits as are equipped for selector calling, there is a selector permanently bridged across the line. With the most improved type of A. C. selector now in quite general use, any loss caused by the selector may be neglected, as the impedance of these selectors at voice frequencies is extremely high, $\frac{1}{2}$ megohm or more.

On loaded cables it is in general advisable to have not more than 20-25 selectors bridged on the line because of the possibility of magnetizing the loading coils with the higher selector currents when a greater number of selectors are in circuit. This magnetization of the coils would cause a decrease in the loading effect of the coils by decreasing their inductance.

GENERAL TRANSMISSION FEATURES

As a great percentage of the dispatching circuits in use are of uniform construction, the equipment above described has been designed to meet these conditions. Cases exist, of course, where some special consideration may be necessary.

In such cities as New York and Chicago, as has already been mentioned, there is usually a 5 to 8 mile section of cable, through which the dispatching circuits pass, between the dispatcher and the open wire line. This condition changes the line impedance at the dispatcher's set sufficiently to require some modification of the windings of the coils and of the balancing network in order to obtain maximum efficiency and reduction of side tone.

In some cases the main dispatcher's circuit may be of loaded cable but with open wire branches. Under such conditions it is advisable to use the open wire waystation sets on these branches.

Another condition sometimes arising is the insertion of short lengths of cable and twisted pair at certain points along the line. This is usually at river crossings, under bridges, or through towns, etc. In general such short lengths cause no serious loss in efficiency. Figure 21 shows the loss of different lengths of a few gages of twisted pair and cable when inserted in an open wire dispatcher's line.

The open wire set may be used satisfactorily on No. 10 and No. 12 N. B. S. open wire lines of which there are a few in use, since their characteristics do not differ greatly from those of No. 9. A. W. G.

It may be well to mention here that the transmission equivalents given in this paper are, of course, based on results obtained from talking close to the mouthpiece of the transmitter. Even casual observation of telephone users will show that they do not realize how rapidly the efficiency of a transmitter decreases as the distance between the speaker's lips and the transmitter mouthpiece increases. If this fact were more widely appreciated and more care taken to use the instrument correctly the average grade of transmission would undoubtedly be considerably improved, and many cases of extremely poor transmission eliminated. Figure 22 shows the decrease in transmitter efficiency as the distance between the mouthpiece of the transmitter and the lips of the speaker is increased. The curve is based on average results from tests on local battery instruments of some half dozen manufacturers. It is not uncommon to find dispatchers and waystation operators talking at least four inches from the edge of the mouthpiece, which, as shown on the curve, will mean a decrease in efficiency of 11 miles. Even one inch away causes a loss of about $3\frac{1}{2}$ miles. When the instruments are used properly, the lips are about $\frac{1}{2}$ inch from the mouthpiece. High losses with decreasing sound intensity are desirable, since such a characteristic renders the transmitter less sensitive to room noises, thus limiting the disturbing noise currents in the local receiver and on the line. If the lips are much closer than about $\frac{1}{2}$ inch, there is a loss

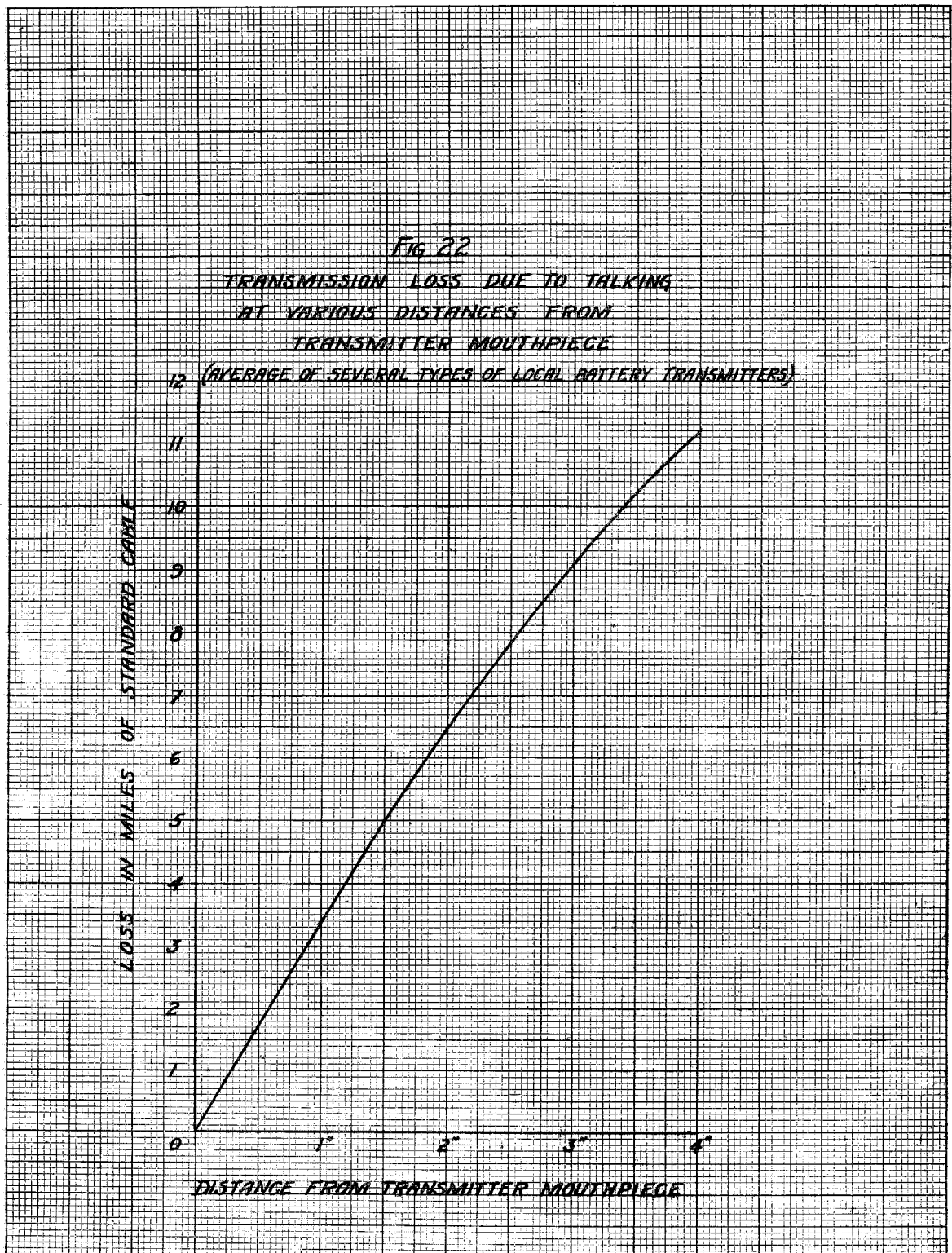

Figure 22

in articulation, or clearness of the speech, which more than offsets the gain in efficiency. Too much emphasis cannot be placed on the proper use of telephone transmitters on such important circuits as those of train dispatching lines.

CONCLUSION

This paper has shown in considerable detail the methods used in designing the latest telephone circuits to meet the severe requirements of present day train dispatching lines. It de-

scribes the first application of modern vacuum tube amplifiers to train dispatching. One of the most interesting features of the investigation has been the working out of means to prevent distortion in electrically long circuits of this type. The data presented and their practical application to existing problems leave little doubt as to the most efficient methods available at the present time for handling with the aid of the telephone this most important and vital outgrowth of modern industrial life.

APPENDIX

It is the purpose of this appendix to develop briefly the formulæ used in determining the best type of waystation for use with the various types of dispatching circuits discussed in the paper.

The following notation is used throughout:

r_1 = line resistance per loop mile.

l_1 = line inductance per loop mile.

g_1 = line shunt conductance per loop mile.

C_1 = line shunt capacity per loop mile.

$\omega = 2 \pi f$, where, f = frequency in cycles per second.

Z = modified line series impedance per loop mile.

Y = modified line shunt admittance per loop mile.

$Z_1 = r_1 + j \omega l_1$ = line series impedance per loop mile.

$Y_1 = g_1 + j \omega C_1$ = line shunt admittance per loop mile.

$Z_e = r_e + j \omega l_e$ = impedance of loading coil.

m = distance between loading coils in miles.

$Z_r = R_r + jX_r$ = impedance of waystation.

$Y_r = \frac{1}{Z_r}$ = admittance of waystation.

Φ = arc tan $\frac{X_r}{R_r}$ = waystation impedance angle.

d = distance between waystations.

n = number of waystations.

p = number of given waystation from receiving end.

$L = nd$ = total length of line.

α = propagation constant of line with waystations = $\alpha_1 + j \alpha_2$.

α_0 = attenuation constant per mile of standard cable.

Z_0 = characteristic impedance of line with waystations.

$\Theta = nd \alpha$ = hyperbolic angular length of line with waystations.

$\delta = d \alpha$ = hyperbolic angle subtended between stations, with waystations.

E_0 = voltage at sending end of line.

E_n = voltage at n th station.

H = Transmission Efficiency in miles of standard cable.

In a loaded cable line the loading coils are so closely spaced that the series line impedance, within the range of frequencies of telephonic interest, is effectively increased by an amount equal to the impedance of the loading coil. That is, the line series impedance per loop miles becomes,

$$Z = Z_1 + \frac{Z_e}{m} = \left(r_1 + \frac{r_e}{m} \right) + j \omega \left(l_1 + \frac{l_e}{m} \right) \quad (1)$$

In a non-loaded cable or non-loaded open wire line, $Z = Z_1$.

It has been determined, similarly, that, in a dispatching circuit, where a comparatively large number of waystations are bridged across the line simultaneously, it is sufficiently accurate, for ascertaining the voltage distribution in the line, to assume that the line shunt admittance is effectively increased by an amount equal to the waystation admittance. That is, in such a

circuit the line shunt admittance per mile becomes:

$$Y = Y_1 + \frac{Y_r}{d} = \left\{ g_1 + \frac{|Y_r|}{d} \cos \Phi \right\} + j \left\{ \omega C_1 + \frac{|Y_r|}{d} (-\sin \Phi) \right\} \quad (2)$$

where $|Y_r|$ indicates the numerical value of Y_r . The accuracy of this assumption of an equivalent "smooth" line depends upon several factors, for instance, the interval between waystations must not be too great, and the waystation impedance must be large compared to the line impedance across which it is bridged, etc.

A dispatcher's circuit may, then, be considered as a "smooth" line with modified primary constants as far as the voltage distribution is concerned. These modified primary constants lead to a modified effective characteristic impedance and a modified effective propagation constant, that is,

$$Z_o = \sqrt{\frac{Z}{Y}} = \sqrt{\frac{Z_1 + \frac{Z_e}{m}}{Y_1 + \frac{Y_r}{d}}} \quad (3)$$

and

$$a = \sqrt{ZY} = \sqrt{\left(Z_1 + \frac{Z_e}{m} \right) \left(Y_1 + \frac{Y_r}{d} \right)} \quad (4)$$

Under these conditions a line with n waystations may be considered as a "smooth" line open circuited at the receiving end and the e.m.f. across the line at this last station is

$$E_n = \frac{E_o}{\cosh \Theta} \quad (5)$$

At the next to the last station the e.m.f. across the line is

$$E_{n-1} = E_n \cosh d \alpha = E_n \cosh \delta$$

and in general, at the $(n-p)$ th station the e.m.f. across the line is

$$E_{n-p} = E_n \cosh p \delta \quad (6)$$

The current entering the last station is

$$I_n = E_n Y_r \quad (7)$$

and the power consumed by the last station is

$$P_n = E_n^2 Y_r \cos \Phi = \frac{E_o^2 Y_r \cos \Phi}{\cosh^2 \Theta} \quad (8)$$

or in terms of the resistance of the waystation, R_r , since

$$R_r = Z_r \cos \Phi$$

$$P_n = \frac{E_o^2 \cos^2 \Phi}{R_r \cosh^2 \Theta} \quad (9)$$

It is desirable to compare this power with the power in the Standard Reference Circuit with zero trunk and one volt in the transmitter, and to express the difference in miles of Standard Cable, considered as a loss or gain as the case may be. Since the equivalent current ratios vs. miles of Standard Cable are generally used it is more convenient to deal with the square root of the power in any station. If P_s represents the power in the receiver of the Standard Reference Circuit under the conditions assumed above, and r represents the ratio of the square root of the power in a given waystation to the square root of the standard power,

$$r_n = \sqrt{\frac{P_n}{P_s}} = \frac{E_o \cos \Phi}{\sqrt{R_r P_s} \cosh \Theta} \quad (10)$$

Since the final sending end impedance under these assumed conditions is

$$Z_o' = Z_o \coth \Theta \quad (11)$$

and the current entering the line is I_o , where I_o is determined by assuming one volt in the dispatcher's transmitter and computing the current through the dispatching network, we have

$$r_n = \frac{I_o Z_o \coth \Theta \cos \Phi}{\sqrt{R_r P_s} \cosh \Theta}$$

$$= \frac{I_o Z_o \cos \Phi}{\sqrt{R_r P_s} \sinh \Theta} \quad (12)$$

It must be remembered that it is the modulus of the ratio expressed by (12) in which we are interested, and hence it is more convenient to use the modulus only of each of the terms I_o , Z_o and $\sinh \Theta$. Equation (12) is sufficient to determine the loss (or gain) at the last station for a given circuit having given the waystation impedance, Z_r/Φ .

Since the current in any intermediate station is proportional to the e.m.f. across the station and it is seen in equation (6) that this e.m.f. is proportional to the e.m.f. at the last station, the ratio r , at an intermediate station, the $(n-p)$ th, is

$$r_{n-p} = r_n \cosh p \delta \quad (13)$$

From equation (13) the loss at any intermediate station may be obtained.

The power in the last station on any given line depends upon the station impedance, both modulus and argument. It is necessary, then, to determine the station impedance for greatest transmission efficiency at the last station. This may be obtained from equation (9) by differentiation and equating to zero, which will give Y_r in terms of the other quantities involved. Unfortunately this results in a complicated transcendental equation rather difficult to solve. It is, therefore, more convenient to determine the optimum station impedance graphically. Referring to equation (9), this may be put in the following form:

$$\frac{E_o}{\sqrt{P_n}} = \frac{\sqrt{R_r} \cosh \theta}{\cos \Phi} \quad (14)$$

The right-hand side of equation (14) is an expression for the reciprocal of the square root of the power in the last station with one volt at the sending end of the line. Hence when equation (14) has a minimum value, the power in the last station is a maximum. This minimum value of equation (14) is easily obtained by plotting $\frac{E_o}{\sqrt{P_n}}$ against station impedance for various values of the latter.

In general the value of station impedance as determined above will be large compared to the effective characteristic impedance, Z_o , of the line across which it is to be bridged, and under these conditions, as noted, the modified line is effectively open circuited at the receiving end. Consequently standing waves of e.m.f. are set up in the line and the worst transmission will not in general be at the end station but at a station back from the end station where $\cosh p \delta$ is a minimum. In most cases this worst station will be a quarter of a wave-length back from the end of the line. The effect of the standing waves in the line is to decrease the transmission efficiency at some stations and increase it at others and to seriously distort the quality at practically all stations near the end of the line.

The standing waves and their harmful effects may be eliminated by making the terminal impedance of the line equal to the modified characteristic impedance. This may be done by

shunting the end station by this impedance or by making this station offer this impedance to the line. When either of these methods is used the formulas given above for computing the loss at the various stations and for determining the optimum value of station impedance are no longer available because they are based on the assumption that the line is effectively open circuited at the receiving end.

When the line is closed through its characteristic impedance the distribution of e.m.f. in the line is an exponential of the distance from the sending end. Corresponding to equation (5), then, we have,

$$\begin{aligned} E_n &= E_o \epsilon^{-L\alpha} \\ &= E_o \epsilon^{-n\delta} \end{aligned} \quad (15)$$

and in general, at the $(n-p)$ th station.

$$E_{(n-p)} = E_o \epsilon^{-(n-p)\delta} \quad (16)$$

The current in the $(n-p)$ th station is

$$I_{(n-p)} = E_o Y_r \epsilon^{-(n-p)\delta} \quad (17)$$

and the power in this station is

$$P_{(n-p)} = E_o^2 Y_r \cos \Phi \epsilon^{-2(n-p)\delta} \quad (18)$$

Since the final sending end impedance is equal to the characteristic impedance it follows that

$$E_o = I_o Z_o$$

and equation (18) becomes

$$P_{(n-p)} = I_o^2 Z_o^2 Y_r \cos \Phi \epsilon^{-2(n-p)\delta}$$

or in terms of station resistance

$$P_{(n-p)} = \frac{I_o^2 Z_o^2}{R_r \cos^2 \Phi} \epsilon^{-2(n-p)\delta} \quad (19)$$

In particular, then, corresponding to equation (12) as the square root of the power ratio at the $(n-p)$ th station.

$$r_{(n-p)} = \frac{I_o Z_o \cos \Phi \epsilon^{-(n-p)\delta}}{\sqrt{R_r P_s}} \quad (20)$$

The loss at the last station will depend upon the device used to obtain a termination of characteristic impedance. If it is assumed that this correct termination is obtained by shunting the last station with the proper impedance, the current ratio at the last station is

$$r_n = \frac{I_o Z_o \cos \Phi \epsilon^{-n\delta}}{\sqrt{R_r P_s}} \quad (21)$$

To find the optimum value of station impedance under these conditions we can transform (19) similar to equation (14) and obtain

$$\frac{E_o}{\sqrt{P_n}} = \frac{\sqrt{R_r} \epsilon^\Theta}{\cos \Phi} \quad (22)$$

Equation (22) is to be plotted for different values of station impedance and the minimum point selected from the graph as described in connection with (14).

Other things being equal the value of station impedance obtained from equation (22) will differ from the value obtained by (14), due to the different rate of change of $\cosh \Theta$ and ϵ^Θ .

Equation (20) which expresses the current ratio at the $(n-p)$ th station may be put in a more convenient form for ascertaining the circuit efficiency at that station in terms of miles of Standard Cable.

Since

$$H_{(n-p)} = \frac{1}{\alpha_o} \log_e e^{r_{n-p}}$$

we have

$$\begin{aligned} H_{(n-p)} &= \frac{1}{\alpha_o} \log_e \frac{E_o \cos \Phi \epsilon^{-(n-p)\delta_1}}{\sqrt{R_r P_s}} \\ &= \frac{1}{\alpha_o} \left\{ \log_e \frac{E_o \cos \Phi}{\sqrt{R_r P_s}} - (n-p)\delta_1 \right\} \quad (23) \end{aligned}$$

where δ_1 is the real part of δ .

Equation (23) is a straight line between the variable $(n-p)$ and H . Under the conditions

assumed above the effect of the station on the attenuation is constant and may be separated from the true line attenuation in the term δ_1 . If the line attenuation per unit length be designated by α :

$$\delta_1 = d \alpha_1 = d \alpha : + \log_e \frac{|Z_o + Z_r|}{|Z_r|} \quad (24)$$

Substituting (24) in (23)

$$\begin{aligned} H_{(n-p)} &= \frac{1}{\alpha_o} \left\{ \log_e \frac{E_o \cos \Phi}{\sqrt{R_r P_s}} - (n-p) \left(d \alpha : \right. \right. \\ &\quad \left. \left. + \log_e \frac{|Z_o + Z_r|}{|Z_r|} \right) \right\} \quad (25) \end{aligned}$$

which is still a straight line in $(n-p)$ and H .

It should be remembered that the above formulas are not accurate unless the bridged impedances are high compared to the line impedances and unless the distance between bridged stations is small. However, for the main purpose of determining the optimum way-station impedance, and within limits of interest, the method is entirely satisfactory and is a great saving of time over the exact method of equivalent networks¹⁰ which was used in computing the curves for irregular station spacing and some of the curves where the number of stations on the line was relatively small, and in certain cases, as a check on the above method.

¹⁰Kennelly: Hyperbolic Functions Applied to Electrical Engineering, 1916.

Telephone Traffic Control for Tramways*

Installation on London County Council Tramways

ON a large tramway network, it is of fundamental importance that the various traffic regulators should be in close touch with headquarters. Any delay in the handing in of information by them or in the passing of instructions to them, whether in connection with breakdowns or unexpected traffic fluctuations, entails loss of revenue, so that a speeding up of communication is a direct financial advantage to the undertaking. In the past, while the usual method of maintaining such communication has been the telephone, the results obtained have left much to be desired. The establishment of call boxes each with its own leads, even when restricted to section posts and a small number of intermediate places, was a serious undertaking and entailed the laying of copper wire amounting on the whole to several times the length of track. A telephone exchange had of course to be maintained, and the attendant even if empowered to exercise control had ordinary telephone duties to perform, which resulted in delays and inconveniences. In this and other respects, the new system designed and manufactured by the Western Electric Company has important advantages. This system has been adopted by the London County Council Tramways for use on their northern section, and as this covers approximately 23 square miles, extending from Hampstead to Poplar, with about 53 miles of route, there will be every opportunity for demonstrating its economic possibilities on large scale tramway work. Similar installations have been in use for many years on railway systems in all parts of the world. In the tramway field the advantages of the system were somewhat tardily recognized, but towards the end of the war an installation was carried out on the West Ham Corporation Tramways. Somewhat later, similar installations were effected at Southampton and Plymouth, and in all these instances very satisfactory results have been obtained.

A description of the earlier apparatus of the Western Electric Company as installed at West Ham, the first tramway to adopt this modern

method of control, was given in the July 1919 issue of the *Tramway and Railway World*. As outlined in that article a single pair of wires is sufficient to maintain communication with any reasonable number of instruments which it may be desired to connect. These are bridged across the circuit and any officer with a key to the boxes has only to lift the receiver and speak to the traffic controller at the central headquarters. (Figure 1.) If a conversation is in progress he can either await its termination or break in according to the urgency of his message. In practice every car is provided with a key to the speaking boxes, and as these are distributed along the track at intervals of only half a mile the controller can be very promptly informed of any emergency. In the event of there being more than one claimant for his attention, he has very little difficulty in deciding which message is the more urgent and in conveying his decision to the speakers. He comes in direct personal contact with the men at the point of trouble, thus eliminating the uncertainties arising from telegraphic communication or the handing on of messages by intermediaries. Once informed of the facts of the case, the controller acts. He is in a better position to do so than the man on the spot, because he knows what resources are available, where the breakdown gangs are, and the nature of traffic conditions on adjoining parts of the system. The nearest regulator cannot know all these and consequently would not be expected as a rule to take the most suitable steps from the point of view of the network as a whole. In any case he cannot order changes on adjacent routes on his own authority. In practice it has been found more convenient to subdivide the section into nine areas, so that actually there are nine control circuits running out from the Mare Street Depot at Hackney (Figure 2). By using the existing telephone lines this additional convenience has been obtained without sacrificing any of the economy in wire which the Western Electric System could otherwise secure.

The principal feature of the Western Electric Company's system is the means by which the

*Reprinted from the *Tramway and Railway World*, Vol. LIV, August 23, 1923.

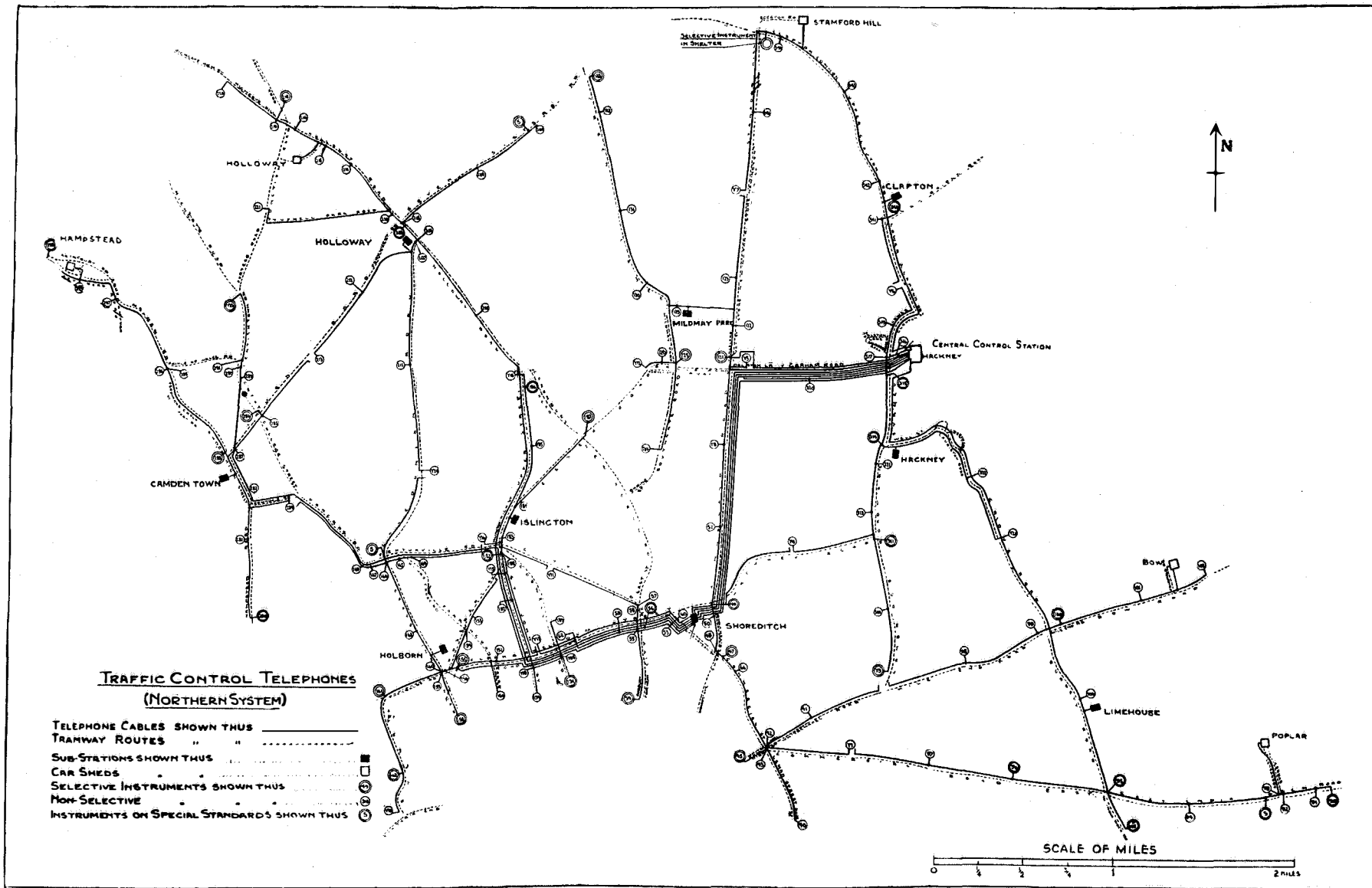

Map showing distribution of Traffic Control Telephones, London County Council Tramways, Northern Section

central controller can call up any particular instrument on the line. The controller has before him a table of selector keys (Figure 1), one for each instrument on the line, and by giving the appropriate key a quarter turn to the right, a bell is set ringing at the station called up within six seconds. It is, of course, useless

or through the nearest traffic regulator, if the gang is then engaged on the road, thus avoiding an unnecessary double journey and bringing help to the point of difficulty with the least possible delay. He then considers the traffic, arranging for a temporary turning back of the cars on either side of the block should that be

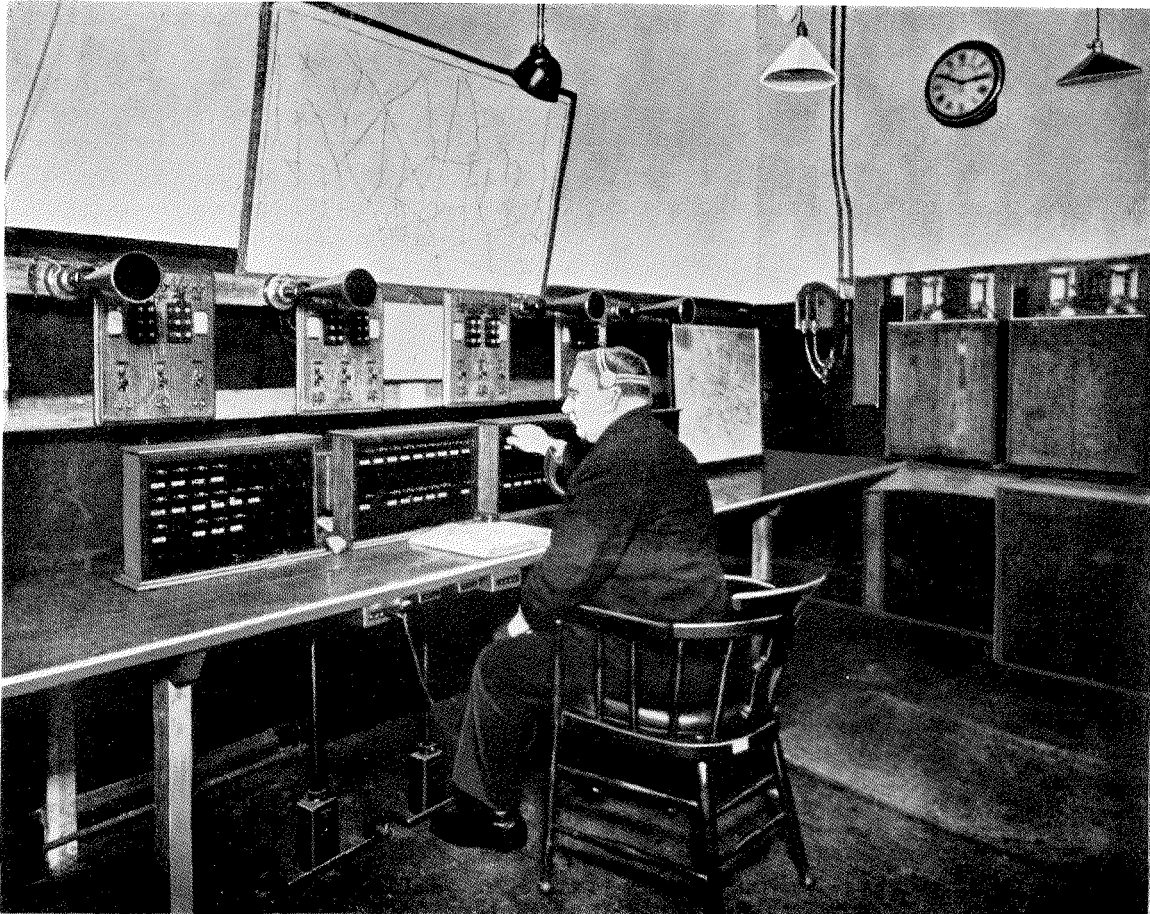

Figure 1. Central Control Room—London County Council Tramways, Northern Section

to call up a station unless there is someone in the neighborhood, so only those situated at power substations, car sheds, traffic regulating points, etc., are equipped with the selective device. The bells are very loud, and of a special tone to avoid confusion with fire engine or other bells that might be heard on the street, so that the traffic regulator has no difficulty in recognizing the call even if he is momentarily at some distance from the box. In the case of a car failure being reported the controller will at once call the appropriate breakdown gang either at the sheds,

necessary, or merely diverting cars to an alternative route. These manoeuvres depend for their effectiveness on the speed with which they are carried out, and although formerly applied in the cases of the most serious breakdowns, often came too late to save great dislocation of traffic. The increased speed of communication now enables such measures to be more easily and more frequently applied, to the great convenience of the passengers and to the financial benefit of the undertaking.

The selective device referred to above depends on the use of alternating current and marks an important advance on the direct current selector previously described. Like the earlier pattern it consists essentially of three parts, the operating keys, the relay apparatus for transmitting the impulses from the keys in the form of alternating current to the line, and the selector itself, which receives the impulses and closes the bell circuit of the particular instrument called. As already mentioned, the keys are grouped together in four cases on the controller's table seen in Figure 1. When a key is turned, it immediately starts to return to its original position, revolving at a definite rate by a clockwork mechanism. As it turns, a sliding contact is held close to a toothed wheel making the primary circuit each time a tooth comes round, breaking the circuit in between. The toothed wheel, however, is not free all round, as the teeth may be covered in varying positions by two segments. While the contactor passes over the segments there is a cessation of the impulses for a period depending on the number of teeth covered up. In the standard form of instrument employed on this installation the segments are of such a size that $8\frac{1}{2}$ teeth remain uncovered, corresponding to 17 makes and breaks, in the primary circuit. The segments divide these 17 impulses into three sets separated by two definite intervals in between; and by different settings of the segments, up to 78 different combinations could be obtained and as many different instruments separately called on the same line.

On a side wall of the control room, just seen on the right in Figure 1, are four oak cases, one for each key case; these contain the necessary protectors and apparatus for converting the direct current impulses of the primary circuit into alternating current at the higher potential (about 90 volts) of the outgoing control circuits. The energy for the latter is derived from batteries of 60 dry cells acting through relays, and there are also sets of retardation coils to ensure that smooth impulses are sent out and no objectionable clicking is heard in the telephone receivers.

The bell calling up the traffic regulator near a given instrument is of direct current vibrating type and is provided with contact springs for opening its own circuit intermittently. The bell coils have a resistance of about 8 ohms, and

could be actuated by a single cell. The energy is obtained locally from two or three dry cells and is only supplied for a space of about two seconds, while the selector in the box concerned waits upon the ringing terminal and actuates the bell relay. For the same period the local bell current makes an intermittent circuit with the line, so that an answering back vibration is heard in the controller's receiver, proving to him that the bell at the station called is actually sounding. This device is of obvious value in keeping the controller informed of any local faults of mechanism as opposed to inattention of personnel. The selector in each box, which responds to a call from its own particular key in the controller's office by sounding the bell—it remains silent towards a call from any other key—is the most important part of the way station equipment. It consists essentially of a perforated wheel that can be rotated by successive alternate pulls from two electromagnets. These are actuated by the impulses originating from the contactor which rests on the toothed wheels of the selector keys. The first of the three groups of impulses will bring the perforated wheel of the selector to a certain position, and if a code pin has been placed in the appropriate perforation, a holding spring will engage it and keep the wheel in that position during the ensuing interval. The remaining selectors on the same circuit will all have been advanced an equal number of stages in the first instance, but those which have not code pins at the particular perforation will drop back to zero under their own springs during the interval. The second group of impulses will similarly advance all selectors a certain number of points, those which had been held after the first movement, advancing from that point. This time, only the selector called will have its second code pin in position to engage the holding spring, all other selectors that had remained in the advanced positions after the first set of impulses now dropping back to zero, while a few will be held in their first advanced positions as a result of the second set of impulses. On receiving the third set, the instrument called will be brought to its seventeenth or ringing position with its contact spring on the terminal of the bell acting relay. By this time a few of the selectors will be held on their first or second advanced positions, but no other will have made

the 17 steps; and as soon as the two-second ringing period is over, one further impulse is delivered to the line by the calling key as before, and all selectors advance one more step. This releases all springs and every selector returns to its normal position.

As already indicated, the way station boxes are of two kinds, selective and non-selective. The former are placed at power substations, car sheds, traffic regulating points, etc., where an official is always in the neighborhood, while the latter are distributed at approximately half mile intervals along the track. All officials and car crews are supplied with interchangeable keys to the fronts of the boxes by which they can reach the speaking apparatus, while the rear doors giving access to the bells, connections, and batteries can only be opened by the repair staff, etc. The distribution of the principal points on the nine lines referred to is shown on the accompanying route diagram (Figure 2).

There are altogether 36 instruments at traffic regulating points, 17 in car sheds, etc., all of which can be called up by the controller, and in addition 111 non-selective points along the track. The complete northern section is split up into the following areas, each with its control line terminating at Hackney (Figure 2)—

Clapton	Mildmay Park	Camden Town
Hackney	Shoreditch	Holborn
Limehouse	Holloway	Islington

In the controller's office the calling keys corresponding to these lines are grouped in four cases, originally intended for the use of four men. The demands upon them were found not to be as heavy as expected and by means of a few modifications a single controller can now always cope with the work, except at the busiest times. Each key case is provided with a loud speaker, so that anyone coming on the line has only to shout "control" to draw the attention of the controller, even if he is not wearing the headpiece. He then plugs into the circuit concerned and takes the message. Should it be a long report he can plug that line through to the office with instructions to take down the message in writing while he attends to other calls. Any of the nine circuits can be interconnected, so that the controller can receive calls from any part of the system without changing the plug of his own headpiece; on the other hand, if a

conversation between two outlying points is required, he can connect their lines while leaving himself free to communicate with a third; in the meantime the conversation is heard from the loud speaker so that the controller will know when it is finished. He acts in this way as an exchange, for one station cannot call another except through his intermediation, and he is thus kept informed of all that is taking place. The controller's speaking circuit is closed by a foot control beneath the keyboard table (Figure 1), so that discussion in the office is not heard on the line unless by intention.

The difficulties encountered in the course of the installation have been mainly connected with the traffic conditions in London streets. The heavy and continuous vibration necessitates periodic inspection of the street boxes in order to secure freedom from minor faults; while the exposed positions of many of the feeder pillars, used as supports for the telephone boxes, has led to their being carried away occasionally by unwieldy road vehicles. It is of interest from the point of view of the location of faults that it is frequently possible to speak over a broken line. The controller can thus receive reports from a district which he would be unable to call on his own initiative. The interconnecting of the various lines has been required much more frequently than in railway practice and this is now conveniently provided for.

The work of installing the system, which was begun last November, has recently been completed, and tramway officers finally took over the working from the Western Electric Company on July 26th. The installation appears to give complete satisfaction, and the only modification now in contemplation by the tramways department concerns the supply of energy; it is thought that a more economical method than the large batteries of dry cells might be employed.

In the event of the continued efficient working of the installation its very great advantages over the previous telephone system will necessarily open the question of its extension to the southern section of the Council's tramways. Considerable difficulty is frequently met with in operating the very complicated network on the southern side, and there can be no doubt that such an extension of the system would prove invaluable.

Telephone and Telegraph Statistics of the World

Compiled by Chief Statistician's Division, American Telephone and Telegraph Company

Telephone Development of the World, by Countries January 1, 1922

	Number of Telephones			Per Cent of Total World	Telephones Per 100 Population	Increase in Number of Telephones During 1921†
	Government Systems	Private Companies	Total			
NORTH AMERICA:						
United States.....		13,875,183	13,875,183	63.22%	12.7	545,804
Canada.....	192,817	709,273	902,090	4.11%	10.2	45,824
Central America.....	6,672	9,905	16,577	.08%	0.3	627
Mexico.....	1,860	43,556	45,416	.21%	0.3	632
West Indies:						
Cuba.....	500	37,538	38,038	.17%	1.3	3,662
Porto Rico.....	560	8,542	9,102	.04%	0.7	1,132
Other W. I. Places*.....	3,388	7,512	10,900	.05%	0.2	762
Other No. Am. Places*.....	50	3,400	3,450	.02%	0.9	250
Total.....	205,847	14,694,909	14,900,756	67.90%	10.1	598,693
SOUTH AMERICA:						
Argentine.....		130,727	130,727	.59%	1.5	14,174
Bolivia.....		2,609	2,609	.01%	0.1	92
Brazil.....	1,247	86,339	87,586	.40%	0.3	2,495
Chile.....		29,661	29,661	.13%	0.7	-206
Colombia.....		7,301	7,301	.03%	0.1	458
Ecuador.....	1,425	2,611	4,036	.02%	0.2	90
Paraguay.....	86	320	406	.002%	0.04	0
Peru.....	2	8,619	8,621	.04%	0.2	69
Uruguay.....		24,048	24,048	.11%	1.6	1,667
Venezuela.....	444	8,737	9,181	.04%	0.4	285
Other Places.....	2,133		2,133	.01%	0.5	235
Total.....	5,337	300,972	306,309	1.38%	0.5	19,359
EUROPE:						
Austria.....	132,300		132,300	.60%	2.1	#
Belgium.....	80,509		80,509	.37%	1.1	17,642
Bulgaria.....	6,600		6,600	.03%	0.1	1,600
Czecho-Slovakia.....	81,953		81,953	.37%	0.6	4,758
Denmark (March 31, 1922).....	9,869	260,757	270,626	1.23%	8.2	18,305
Finland*.....		70,000	70,000	.32%	2.1	#
France.....	513,307		513,307	2.34%	1.3	40,095
Germany.....	1,945,601		1,945,601	8.86%	3.3	136,027
Great Britain and Ireland.....	997,805		997,805	4.55%	2.1	11,841
Greece*.....	5,000		5,000	.02%	0.1	300
Hungary.....	62,500		62,500	.28%	0.8	5,491
Italy (June 30, 1921).....	82,887	37,214	120,101	.55%	0.3	5,124
Jugo-Slavia.....	21,698		21,698	.10%	0.2	5,259
Netherlands.....	175,027	997	176,024	.80%	2.5	14,091
Norway (June 30, 1921).....	85,514	66,828	152,342	.69%	5.7	16,970
Poland.....	50,118	27,801	77,919	.35%	0.3	5,469
Portugal.....	1,890*	14,819	16,709	.08%	0.3	1,288
Roumania (March 31, 1922)*.....	28,000		28,000	.13%	0.2	3,299
Russia.....	170,741		170,741	.78%	0.1	#
Spain*.....	9,600	72,900	82,500	.38%	0.4	12,500
Sweden.....	383,877	1,726	385,603	1.76%	6.5	-2,527 =
Switzerland.....	161,705		161,705	.74%	4.2	9,369
Other Places in Europe*.....	44,237	2,472	46,709	.21%	0.3	15,184
Total.....	5,050,738	555,514	5,606,252	25.54%	1.2	342,085
ASIA:						
British India (March 31, 1922).....	12,399	23,958	36,357	.17%	0.01	2,089
China*.....	59,390	24,046	83,436	.38%	0.03	8,976
Japan.....	425,037		425,037	1.94%	0.8	54,000*
Other Places in Asia*.....	54,585	5,844	60,429	.27%	0.05	6,109
Total.....	551,411	53,848	605,259	2.76%	0.1	71,174
AFRICA:						
Egypt.....	25,185		25,185	.11%	0.2	2,905
Union of South Africa§.....	56,081		56,081	.26%	0.8	4,679
Other Places in Africa*.....	44,933	1,130	46,063	.21%	0.04	17,539
Total.....	126,199	1,130	127,329	.58%	0.1	25,123
OCEANIA:						
Australia (June 30, 1921).....	240,507		240,507	1.10%	4.4	16,507
Dutch East Indies.....	34,936	1,905	36,841	.17%	0.1	2,337
Hawaii.....		15,124	15,124	.07%	5.6	748
New Zealand (March 31, 1922).....	94,683		94,683	.43%	7.6	6,244
Philippine Islands*.....	2,110	11,420	13,530	.06%	0.1	1,079
Other Places in Oceania*.....	2,000	370	2,370	.01%	0.1	60
Total.....	374,236	28,819	403,055	1.84%	0.6	26,975
TOTAL WORLD.....	6,313,768	15,635,192	21,948,960	100.00%	1.3	1,083,409

* Partly estimated. † Minus sign preceding figure denotes decrease.

§ March 31, 1922.

Accurate data not available, and basis for reliable estimate lacking. An arbitrary estimate, however, is included in total for Europe.

= Decrease caused by consolidation of telephone plants in Stockholm.

Telephone and Telegraph Wire of the World, by Countries

January 1, 1922

	Service Operated by (See Note)	Miles of Telephone Wire			Miles of Telegraph Wire (See Note)		
		Number of Miles	Per Cent of Total World	Per 100 Population	Number of Miles	Per Cent of Total World	Per 100 Population
NORTH AMERICA:							
United States.....	P.	34,000,000	59.74%	31.2	1,805,000	30.12%	1.7
Canada.....	P. G.	2,268,271	3.99%	25.5	250,802	4.19%	2.8
Central America.....	P. G.	33,055	.06%	0.6	21,511	.36%	0.4
Mexico.....	P. G.	115,688	.20%	0.8	75,636	1.26%	0.6
West Indies:							
Cuba.....	P. G.	109,735	.19%	3.7	17,698§	.29%	0.6
Porto Rico.....	P. G.	12,752	.02%	1.0	1,523	.03%	0.1
Other W. I. Places*.....	P. G.	20,778	.04%	0.4	4,814	.08%	0.1
Other No. Am. Places*.....	P. G.	6,600	.01%	1.7	9,000	.15%	2.4
Total.....		36,566,879	64.25%	24.7	2,185,984	36.48%	1.5
SOUTH AMERICA:							
Argentina.....	P.	396,382	.70%	4.4	169,893	2.84%	1.9
Bolivia.....	P.	3,217	.01%	0.1	6,957#	.12%	0.2
Brazil.....	P. G.	235,778	.41%	0.8	90,861	1.52%	0.3
Chile.....	P.	48,143	.08%	1.2	37,876	.63%	0.9
Colombia.....	P.	10,017	.02%	0.2	13,382	.22%	0.2
Ecuador.....	P. G.	5,080	.01%	0.3	4,622	.08%	0.2
Paraguay.....	P. G.	144	.0003%	0.01	1,457	.02%	0.1
Peru.....	P.	31,322	.05%	0.6	10,178§	.17%	0.2
Uruguay.....	P.	44,980	.08%	2.9	5,124	.09%	0.3
Venezuela.....	P. G.	23,993	.04%	1.0	6,240	.10%	0.3
Other Places.....	G.	3,273	.01%	0.7	770	.01%	0.2
Total.....		802,329	1.41%	1.2	347,360	5.80%	0.5
EUROPE:							
Austria.....	G.	314,226	.55%	4.9	46,587	.78%	0.7
Belgium.....	G.	362,090	.64%	4.8	27,480	.46%	0.4
Bulgaria.....	G.	24,307	.04%	0.5	16,568	.28%	0.3
Czecho-Slovakia.....	G.	155,871	.27%	1.1	45,439	.76%	0.3
Denmark, (March 31, 1922).....	P. G.	564,352	.99%	17.1	9,547	.16%	0.3
Finland.....	P.	133,000*	.23%	3.9	10,635	.18%	0.3
France.....	G.	1,494,611	2.63%	3.8	478,616	7.99%	1.2
Germany.....	G.	5,562,930	9.77%	9.6	381,247	6.36%	0.7
Great Britain and Ireland†.....	G.	4,036,317	7.09%	8.4	309,021	5.16%	0.6
Greece*.....	G.	9,000	.02%	0.2	2,500	.34%	0.4
Hungary.....	G.	183,121	.32%	2.3	51,292	.86%	0.6
Italy (June 30, 1921).....	P. G.	350,505	.62%	0.9	248,665	4.15%	0.6
Jugo-Slavia*.....	G.	65,100	.11%	0.6	46,000	.77%	0.4
Netherlands.....	G.	359,670*	.63%	5.2	30,161	.50%	0.4
Norway (June 30, 1921).....	P. G.	318,583	.56%	11.8	16,603	.28%	0.6
Poland.....	P. G.	325,963	.57%	1.2	99,223	1.66%	0.4
Portugal*.....	P. G.	56,373	.10%	0.9	17,900	.30%	0.3
Roumania* (March 31, 1922).....	G.	73,000	.13%	0.4	47,000	.78%	0.3
Russia.....	G.	637,934	1.12%	0.5	346,816	5.79%	0.3
Spain*.....	P. G.	165,000	.29%	0.8	74,878	1.25%	0.3
Sweden.....	G.	822,593	1.45%	13.8	50,952	.85%	0.9
Switzerland.....	G.	380,648	.67%	9.8	23,828	.40%	0.6
Other Places in Europe*.....	P. G.	91,249	.16%	0.5	24,405	.41%	0.1
Total.....		16,486,443	28.96%	3.4	2,423,363	40.47%	0.5
ASIA:							
British India (March 31, 1922).....	P. G.	179,075	.31%	0.06	332,566†	5.55%	0.1
China*.....	P. G.	90,570	.16%	0.03	79,000	1.32%	0.02
Japan.....	G.	977,078	1.72%	1.7	143,848	2.40%	0.3
Other Plaees in Asia*.....	P. G.	152,927	.27%	0.1	151,807	2.53%	0.1
Total.....		1,399,650	2.46%	0.2	707,221	11.80%	0.1
AFRICA:							
Egypt.....	G.	96,269	.17%	0.6	20,976	.35%	0.1
Union of South Africa.....	G.	163,768	.29%	2.3	43,263	.72%	0.6
Other Places in Africa*.....	P. G.	92,702	.16%	0.08	117,885	1.97%	0.1
Total.....		352,739	.62%	0.2	182,124	3.04%	0.1
OCEANIA:							
Australia (June 30, 1921).....	G.	867,695	1.52%	15.9	94,690	1.58%	1.7
Dutch East Indies.....	P. G.	125,714*	.22%	0.3	19,991	.32%	0.04
Hawaii.....	P.	49,515	.09%	18.4	0	.00%	0.0
New Zealand (March 31, 1922).....	G.	236,940	.41%	19.0	22,766	.37%	1.8
Philippine Islands*.....	P. G.	25,800	.05%	0.2	7,000	.12%	0.1
Other Places in Oceania*.....	P. G.	4,360	.01%	0.3	1,320	.02%	0.1
Total.....		1,310,024	2.30%	1.9	145,767	2.41%	0.2
TOTAL WORLD.....		56,918,064	100.00%	3.3	5,991,819	100.00%	0.3

NOTE: Telegraph service is operated by Governments, except in the United States and Canada. In connection with telephone wire, P. indicates telephone service operated by private companies, G. by the Government, and P. G. by both private companies and the Government.

*Partly estimated. †March 31, 1921. ‡January 1, 1920. §January 1, 1921. ¶March 31, 1922.

Telephone Development of Important Cities January 1, 1922

Country and City (or Exchange Area)	Estimated Population (City or Exchange Area)	Number of Telephones	Telephones per 100 Population
ARGENTINE:			
Buenos Aires.....	1,700,000	73,828	4.3
AUSTRALIA:			
Adelaide.....	261,000	17,022	6.5
Brisbane.....	218,000	13,202	6.1
Melbourne.....	795,000	50,777	6.4
Sydney.....	926,000	62,295	6.7
AUSTRIA:			
Gratz.....	158,000	4,800	3.0
Vienna.....	1,842,000	90,000	4.9
BELGIUM:			
Antwerp.....	469,000	12,565	2.7
Brussels.....	861,000	28,760	3.3
Charleroi.....	206,000	2,698	1.3
Ghent.....	279,000	3,740	1.3
Liege.....	300,000	6,247	2.1
CANADA:			
Montreal.....	840,000	83,917	10.0
Ottawa.....	159,000	24,996	15.7
Toronto.....	570,000	101,452	17.8
CHINA:			
Canton.....	900,000	2,475	0.3
Shanghai.....	1,500,000	16,466	1.1
Tientsin.....	800,000	6,631	0.8
Peking.....	1,300,000	30,000†	2.3
CUBA:			
Havana.....	456,000	27,318	6.0
CZECHO-SLOVAKIA:			
Prague.....	677,000	20,008	3.0
DANZIG, FREE CITY OF:			
Danzig.....	357,000	12,957	3.6
DENMARK:			
Copenhagen.....	717,000	106,105	14.8
FRANCE:			
Bordeaux.....	267,000	8,285	3.1
Lille.....	201,000	5,281	2.6
Lyons.....	562,000	11,891	2.1
Marseilles.....	586,000	12,444	2.1
Paris.....	2,906,000	173,300	6.0
GERMANY:			
Berlin.....	3,804,000	347,735	9.1
Bremen.....	270,000	19,684	7.3
Breslau.....	528,000	27,736	5.3
Chemnitz.....	304,000	15,051	5.0
Cologne.....	634,000	38,666	6.1
Dresden.....	588,000	36,218	6.2
Düsseldorf.....	407,000	26,288	6.5
Essen.....	439,000	15,717	3.6
Frankfort-on-Main.....	433,000	37,705	8.7
Hamburg-Altona.....	1,155,000	95,534	8.3
Hanover.....	393,000	23,102	5.9
Leipzig.....	604,000	41,906	6.9
Magdeburg.....	286,000	14,654	5.1
Munich.....	631,000	46,214	7.3
Nuremberg.....	353,000	23,671	6.7
Stuttgart.....	309,000	26,211	8.5
GREAT BRITAIN AND IRELAND:*			
Belfast.....	414,000	9,168	2.2
Birmingham.....	1,286,000	27,615	2.1
Blackburn.....	252,000	4,972	2.0
Bolton.....	282,000	4,684	1.7
Bradford.....	379,000	12,118	3.2
Bristol.....	409,000	10,202	2.5
Dublin.....	391,000	11,294	2.9
Edinburgh.....	424,000	16,670	3.9
Glasgow.....	1,273,000	42,655	3.4
Hull.....	328,000	13,570	4.1
Leeds.....	541,000	13,287	2.5
Liverpool.....	1,202,000	38,895	3.2
London.....	7,139,000	341,498	4.8
Manchester.....	1,607,000	48,274	3.0
Newcastle.....	603,000	13,620	2.3
Nottingham.....	337,000	9,281	2.8
Plymouth.....	232,000	3,852	1.7
Sheffield.....	510,000	11,939	2.3

*Statistics as of March 31, 1922.

† Partly estimated.

Telephone Development of Important Cities—(Concluded)

January 1, 1922

Country and City (or Exchange Area)	Estimated Population (City or Exchange Area)	Number of Telephones	Telephones per 100 Population
HUNGARY:			
Budapest.....	926,000	40,993	4.4
Szegedin.....	110,000	2,023	1.8
ITALY:†			
Florence.....	247,000	4,667	1.9
Genoa.....	299,000	7,999	2.7
Milan.....	701,000	16,944	2.4
Naples.....	770,000	6,344	0.8
Palermo.....	400,000	2,342	0.6
Rome.....	637,000	14,025	2.2
Turin.....	500,000	7,438	1.5
Venice.....	165,000	2,451	1.5
JAPAN:			
Kobe.....	637,000	18,725	2.9
Kyoto.....	613,000	17,786	2.9
Nagoya.....	617,000	15,008	2.4
Osaka.....	1,296,000	58,590	4.5
Tokio.....	2,304,000	103,524	4.5
Yokohama.....	431,000	12,380	2.9
JUGO-SLAVIA:			
Belgrade.....	112,000	2,937	2.6
NETHERLANDS:			
Amsterdam.....	689,000	32,931	4.8
The Hague.....	362,000	24,306	6.7
Rotterdam.....	524,000	26,057	5.0
NEW ZEALAND:*			
Auckland.....	161,000	10,678	6.6
Christchurch.....	107,000	8,265	7.7
Wellington.....	109,000	11,405	10.4
NORWAY:†			
Bergen.....	95,000	8,450	8.9
Christiania.....	258,000	30,356	11.8
ROUMANIA:			
Bucharest.....	350,000	8,600‡	2.5
RUSSIA:			
Kazan.....	246,000	1,126	0.5
Kharkov.....	474,000	5,008	1.1
Moscow.....	1,028,000	54,707	5.3
Odessa.....	565,000	1,600	0.3
Petrograd.....	706,000	40,000	5.7
SWEDEN:			
Göteborg.....	205,000	22,804	11.1
Malmo.....	114,000	12,043	10.6
Stockholm.....	377,000	110,095‡	29.2‡
SWITZERLAND:			
Basel.....	136,000	12,179	9.0
Berne.....	105,000	10,205	9.8
Geneva.....	135,000	14,199	10.5
Zurich.....	207,000	20,983	10.1
UNITED STATES:			
New York.....	5,796,000	979,534	16.9
Chicago.....	2,808,000	605,495	21.6
Total of the 5 cities with over 1,000,000 population.....	13,170,000	2,317,830	17.6
Cleveland.....	966,000	153,951	15.9
Los Angeles.....	722,000	162,118	22.5
Total of the 12 cities with 500,000-1,000,000 population.....	8,239,000	1,322,036	16.0
Washington.....	449,000	96,111	21.4
Minneapolis.....	411,000	96,166	23.4
Denver.....	267,000	58,751	22.0
Total of the 16 cities with 250,000-500,000 population.....	5,105,000	928,175	18.2
Total of the 33 cities with over 250,000 population.....	26,514,000	4,568,041	17.2

* Statistics as of March 31, 1922. † Statistics as of June 30, 1921. ‡ Partly estimated.

§ The greater part of this development was secured by a private Company which was purchased by the Government in 1918. On January 1, 1922, the process of merging the private Company's plant with the Government's local system was not fully completed. Therefore, the total number of telephones includes a certain number of duplicates.

Telephone Development of Large and Small Communities in Important Countries January 1, 1922

Country	Service Operated by (See Note)	Number of Telephones		Telephones per 100 Population	
		In Communities of 100,000 Population and Over	In Communities of less than 100,000 Population	In Communities of 100,000 Population and Over	In Communities of less than 100,000 Population
Australia	G.	152,288	97,204*	6.4	3.1
Austria	G.	94,800	37,500	4.7	0.8
Belgium	G.	54,010	26,499	2.5	0.5
Canada	P. G.	318,599	583,491	15.2	8.6
Czecho-Slovakia	G.	26,626	55,327	3.0	0.4
Denmark	P. G.	106,105	159,946*	14.8	6.2
France	G.	251,316	261,991	4.1	0.8
Germany	G.	1,039,778	905,823*	6.9	2.1
Great Britain and Ireland	G.	752,446	260,308	3.2	1.1
Hungary	G.	44,161	18,339	3.9	0.3
Japan	G.	256,058	168,979	3.5	0.3
Netherlands	G.	88,660	87,364	5.2	1.7
New Zealand (March 31, 1922)	G.	30,348	64,335	8.0	7.4
Norway (June 30, 1921)	P. G.	30,356	121,986	11.8	5.0
Russia	G.	102,441	68,300	3.4	0.1
Sweden	G.	144,942	240,661	20.8†	4.6
Switzerland	G.	57,566	104,139	9.9	3.1
United States	P.	5,725,902	8,149,281	16.5	11.0

NOTE: P. indicates telephone service operated by private companies, G. by the Government, and P. G. by both private companies and the Government.

† The majority of this development is due to Stockholm. See note on Stockholm in table of Telephone Development of Important Cities.

* Partly estimated.

Telephone Conversations and Telegrams in Important Countries Year 1921

Country	Number of Telephone Conversations	Number of Telegrams	Total Number of Wire Communications	Per Cent. of Total Wire Communications		Wire Communications Per Capita		
				Telephone Conversations	Telegrams	Telephone Conversations	Telegrams	Total
Australia	227,929,000	17,197,000	245,126,000	93.0%	7.0%	42.9	3.2	46.1
Belgium	100,850,000	5,547,000	106,397,000	94.8%	5.2%	13.6	0.7	14.3
Czecho-Slovakia	167,332,000	5,990,000	173,322,000	96.5%	3.5%	12.4	0.4	12.8
Denmark	396,610,000	2,536,000	399,146,000	99.4%	0.6%	120.6	0.8	121.4
France	662,624,000	64,385,000	727,009,000	91.1%	8.9%	17.0	1.7	18.7
Germany	2,970,612,000	75,841,000	3,046,453,000	97.5%	2.5%	51.3	1.3	52.6
Great Britain and Ireland	757,307,000	66,784,000	824,091,000	91.9%	8.1%	15.9	1.4	17.3
Hungary	239,661,000	6,131,000	245,792,000	97.5%	2.5%	30.4	0.8	31.2
Italy†	309,595,000	20,011,000	329,606,000	93.9%	6.1%	7.7	0.5	8.2
Japan	1,669,364,000	60,670,000	1,730,034,000	96.5%	3.5%	29.7	1.1	30.8
Netherlands*	354,885,000	6,870,000	361,755,000	98.1%	1.9%	51.4	1.0	52.4
Norway†	323,015,000	4,864,000	327,879,000	98.5%	1.5%	120.6	1.8	122.4
Sweden	540,741,000	4,738,000	545,479,000	99.1%	0.9%	91.2	0.8	92.0
Switzerland	119,907,000	3,559,000	123,466,000	97.1%	2.9%	31.0	0.9	31.9
United States	17,520,000,000	142,000,000	17,662,000,000	99.2%	0.8%	162.0	1.3	163.3

NOTE: Telephone conversations include local and toll or long distance conversations. Number of telephone conversations in the United States includes completed messages only.

* Partly estimated.

‡ Year ended March 31, 1922.

† Year ended June 30, 1921.

International Western Electric Company

INCORPORATED

Head Offices

195 BROADWAY
NEW YORK, U. S. A.

European General Offices

CONNAUGHT HOUSE
ALDWYCH, LONDON, ENGLAND

Affiliated Companies

Western Electric Company, Limited *Aldwych, London, England*
Branches: Birmingham, Cardiff, Glasgow, Leeds, Manchester, Newcastle-on-Tyne, Cairo, Johannesburg, Simla, Singapore.

Bell Telephone Manufacturing Company *Antwerp, Belgium*
Branches. Berne, The Hague, Riga, Reval.

Le Materiel Telephonique *Paris, France*

Telefonos Bell, S. A. *Madrid, Spain*

Western Electric Italiana *Milan, Italy*

Western Electric Norsk Aktieselskap *Christiania, Norway*

Vereinigte Telephon und Telegraphen Fabrik *Vienna, Austria*

United Incandescent Lamps and Electrical Company, Limited
Budapest (Ujpest), Hungary

Western Electric Company (Australia) Limited *Sydney, Australia*

Nippon Denki Kabushiki Kaisha *Tokyo, Japan*
Branches: Osaka, Dalny (Manchuria), Seoul (Chosen)

Sumitomo Electric Wire & Cable Works, Ltd. *Osaka, Japan*

China Electric Company, Limited *Peking, China*
Branches: Shanghai, Tientsin

Northern Electric Company, Limited *Montreal, Canada*
Branches: Quebec, Halifax, Toronto, London (Ontario), Hamilton, Windsor, Winnipeg, Calgary, Regina, Vancouver

Compania Western Electric Argentina *Buenos Aires, Argentina*

International Western Electric Company *Rio de Janeiro, Brazil*

Sales Offices and Agencies Throughout the World

To those interested in better communication the International Western Electric Company and its Affiliated Companies offer the facilities of their consulting engineering departments to aid in the solution of problems in Telephony, Telegraphy and Radio.