

# ELECTRICAL COMMUNICATION

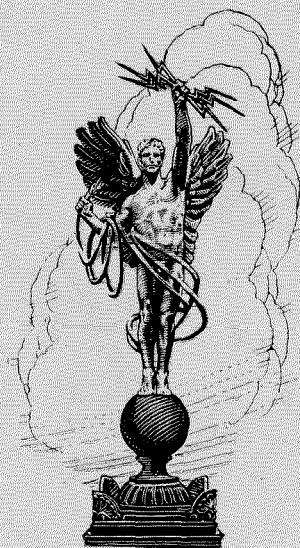

FEBRUARY  
1923

No. 3  
VOL. 1

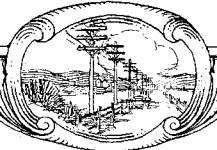

# ELECTRICAL COMMUNICATION

A Journal of Progress in the  
Telephone, Telegraph and Radio Art

Published Quarterly by the  
INTERNATIONAL WESTERN ELECTRIC COMPANY  
INCORPORATED

195 BROADWAY, NEW YORK, N. Y., U. S. A.

Charles G. DuBois, President      George C. Pratt, Secretary      J. W. Johnston, Treasurer

Subscription \$1.50 per year; single copies 50 cents

Volume I

FEBRUARY, 1923

Number 3

## CONTENTS

|  |    |
|--|----|
| A NATIONAL TELEPHONE SERVICE.....  | 3  |
| <i>By H. B. Thayer</i>   |    |
| THE RECENT TRANSATLANTIC RADIO TELEPHONE TESTS...  | 12 |
| NOTES ON RADIO .....   | 15 |
| <i>By O. B. Blackwell</i>  |    |
| INSTALLATION OF THE FIRST TELEPHONE TOLL CABLES IN<br>JAPAN.....   | 21 |
| <i>By R. P. Ashbaugh</i>   |    |
| TELEPHONE TRANSMISSION OVER LONG CABLE CIRCUITS...   | 26 |
| <i>By A. B. Clark</i>  |    |
| FLAT TYPE RELAYS.....  | 41 |
| <i>By D. D. Miller</i>   |    |
| SPECIALIZING TRANSPORTATION EQUIPMENT IN ORDER TO<br>ADAPT IT MOST ECONOMICALLY TO TELEPHONE<br>CONSTRUCTION AND MAINTENANCE WORK..... | 50 |
| <i>By J. N. Kirk</i>   |    |
| TELEPHONE AND TELEGRAPH STATISTICS OF THE WORLD....  | 60 |
| <i>By S. L. Andrew</i>   |    |

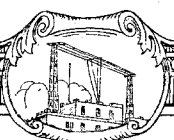

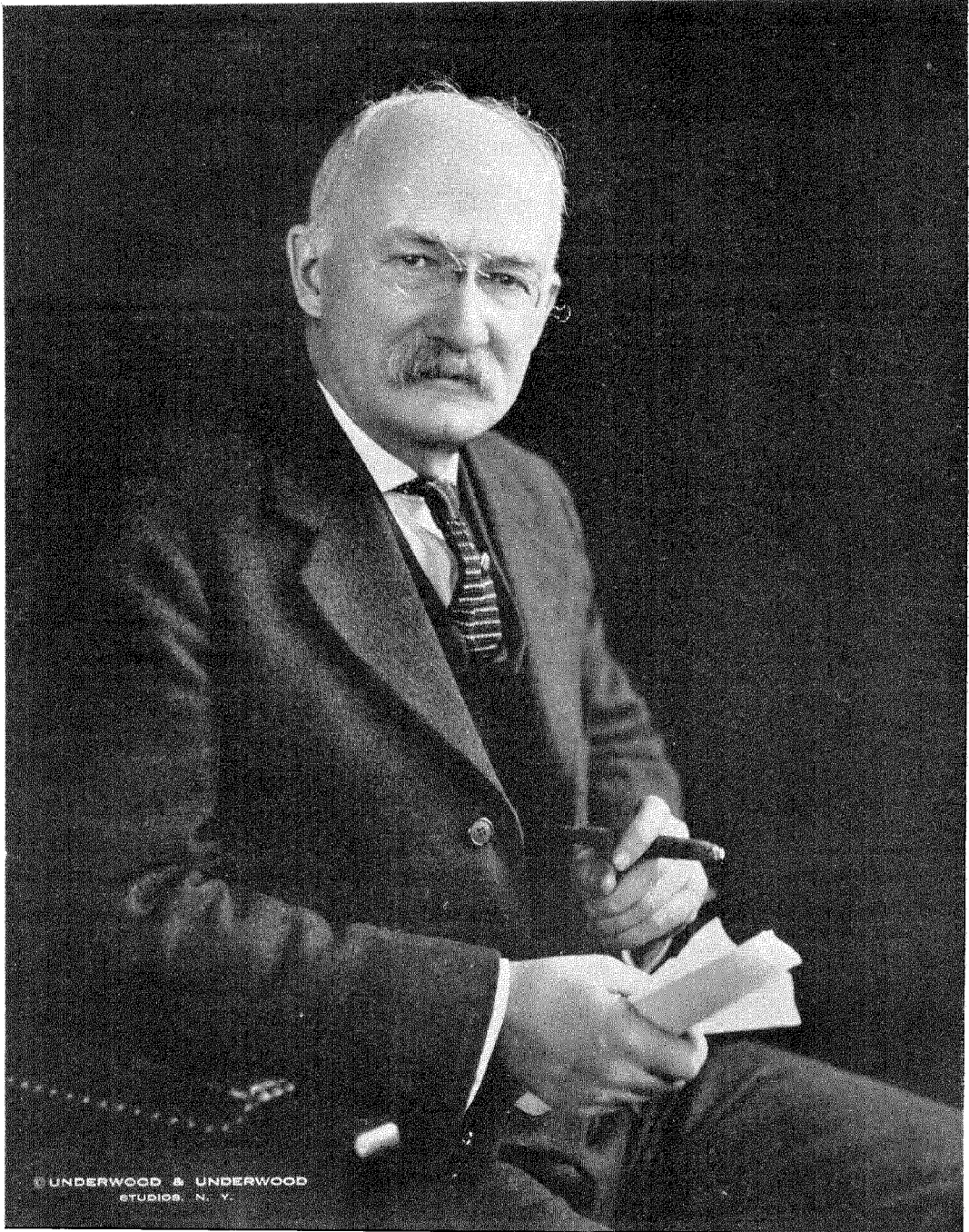

H. B. THAYER  
PRESIDENT, AMERICAN TELEPHONE AND TELEGRAPH COMPANY

# A National Telephone Service

By H. B. THAYER

*President, American Telephone and Telegraph Company*

*(This address was given at the thirty-fourth Annual Convention of the National Association of Railway and Utilities Commissioners held at Detroit, Michigan, on November 15, 1922.—EDITOR.)*

**I**N your broad consideration of telephone service in its relation to the public it is undoubtedly important that you should consider the application of fundamental principles and the soundness of theories which might have a bearing upon the subject. Study of the relative economies and efficiencies of large operating units and small ones, of the waste in competition and how far it can be obviated—of the danger in monopoly unregulated and to what extent it exists if regulated, comes within that field. Competition and monopoly are human agencies. Like most human agencies they have potentialities in them for good or for evil, but the human element in them must be taken into account as well as the theories. The results of the operation of these agencies are beneficent or otherwise accordingly as they are directed—accordingly as the potentialities for good or evil are developed. I have strong opinions as to the relative values of these agencies as applied to communication and transportation services, which I think are in accord with the drift of public opinion, but my opinions cannot possibly be of as much value as facts in helping you to reach a conclusion.

If I can contribute anything to this discussion, it will be by telling what the methods of the Bell System have been and are, what it has done and hopes to do and how it has accomplished what has been accomplished. If the motives seem to you to be worthy and the results to be good, it may help you to consider whether the method has been the best.

The telephone business is a very young business. The first man who ever spoke over the telephone was living when I received your invitation to come here. The first man who ever heard a spoken word over the telephone line is still living. Its history has not acquired the obscurity of a remote past. A large part of that history in this country has been the history of the Bell Organization.

From the very beginning a general plan has governed the policies of that organization which appears in its records and publications. Beginning in 1878 and before there was a telephone exchange in existence, Professor Bell's vision of the future was given in a statement to intending investors. He said:

"It is conceivable that cables of telephone wires could be laid underground, or suspended overhead, communicating by branch wires with private dwellings, country houses, shops, manufactories, etc., etc.—uniting them through the main cable with a central office where the wire could be connected as desired, establishing direct communication between any two places in the city. Such a plan as this, though impracticable at the present moment, will, I firmly believe, be the outcome of the introduction of the telephone to the public. Not only so, but I believe in the future wires will unite the head offices in different cities, and a man in one part of the country may communicate by word of mouth with another in a distant part.

"I am aware that such ideas may appear to you Utopian and out of place, for we are met together for the purpose of discussing, not the future of the telephone, but its present.

"Believing, however, as I do that such a scheme will be the ultimate result of the telephone to the public, I will impress upon you all the advisability of keeping this end in view, that all present arrangements of the telephone may be eventually realized in this grand system."

If we analyze the early contract relations of The American Bell Telephone Company with the operating telephone companies which were its licensees and with the Western Electric Manufacturing Company, it becomes very apparent that they were based upon the assumption that its function was intended to be to provide a national telephone service. The Company undertook forty years ago in these contracts to provide not only instruments but also a system of inter-communication between territories and

to perform certain general services necessarily going with the development and management of a national system.

Again, the charter of The American Telephone and Telegraph Company taken out in March, 1885, shows that the Company had in mind the establishment of a national service.

"The general route of the lines of this association, in addition to those hereinbefore described or designated, will connect one or more points in each and every city, town or place in the State of New York with one or more points in each and every other city, town or place in said State, and in each and every other of the United States, and in Canada and Mexico; and each and every of said cities, towns and places is to be connected with each and every other city, town or place in said States and Countries, and also by cable and other appropriate means with the rest of the known world, as may hereafter become necessary or desirable."

The purpose consistently followed through has been the creation of a national as distinguished from a sectional service.

Now let us think for a moment of how this country of ours differs from any other in the world. It covers an immense area and but one language comparatively free from dialects is generally spoken. In government, it is a confederation of states, but our state boundaries are no barriers to commerce. There are no customs frontiers between the states. Contrary to the case of most other countries, it is the exception here when a man lives where his father or grandfather lived, and, I think, we could almost say that it is the exception when a man lives in the same state as the one in which his grandfather lived. This has been a nation of pioneers and colonists with the result that more than in any other country families are separated so that, more than any other area in the world of similar size, it is one country, one people with far-reaching commercial and domestic relations. It follows that such a nation must have a complete telephone service covering the whole country; a service that has no narrower boundaries than the boundaries of the nation.

A national service can exist only through an organization which provides for a uniform policy and coordinated action. Uniformity of policy

and cooperation comes to the Bell System through contract relations and community of ownership. The American Telephone and Telegraph Company owns directly or indirectly all of the voting stock of 14 Associated Companies, 78 per cent. of 9 others and 31.5 per cent. of two others. The Associated Companies are responsible for telephone service in 5,848 communities and operate about 9,000,000 stations out of a total in the country of about 14,000,000. There is no autocratic control of the System. Its government is more like that of a republic. The policies and problems are carefully considered in view of the local conditions and under nation-wide conditions. They are discussed in common by those in the business having only nation-wide responsibilities and by those having also direct local responsibilities. When the conclusions are reached, they are the conclusions of the Bell System. The policies established become the policies of the Bell System. In operation the Associated Companies are autonomous. In the organization of each Associated Company, the plan is to centralize as little as possible except in the establishment of policies and methods—to leave in the organization of each community the greatest amount of authority and responsibility for operation—to get the greatest economy and efficiency and satisfaction to the public, unhampered by any unnecessary reference to higher officials in the Company.

A national telephone system could not be embraced in one corporation on account of the wide variation in corporation laws in different states. That being the case, in structure it is necessarily an organization of corporations, one of them exercising certain general functions for the benefit of the others.

Its history proves that in the operation of this organization all other considerations have been subordinated to the development and improvement of its public service. Its program has been one of attempted foresight and anticipation of public requirements extending through all of the necessary steps—construction and maintenance of a sound financial structure the first essential to service, continual study of the future as to requirements and possibilities of meeting them, construction of adequate plant and the maintenance of an adequate personnel.

The road by which the Bell System has pro-

gressed has not been like a city street where the traveller could find on either side supplies suited to all his requirements. The journey has been more like blazing a trail through the wilderness. You will recall that when the telephone was new, the commercial and domestic uses of electricity were limited to the simplest form of the telegraph and electric bells. Every telegraph operator knew as much about useful applications of electricity as the college professor.

Let me give you a picture of the conditions by reading to you extracts from the recommendation for the building of the first commercial long distance line:

“May 12, 1885.

“The successful operation of the experimental circuit between New York and Boston has demonstrated that the telephone is a practical instrument for transmitting messages over long distances. \* \* \*

“There are, however, a number of mechanical, electrical and financial problems still to be solved before that success can be achieved. \* \* \*

“Highway lines of the size and character required for this work have never before been attempted. \* \* \*

“The telephone seems to require a non-magnetic material in the line. Copper is the only available metal, and its use \* \* \* is still experimental. The results, so far are highly satisfactory, but only time and experience will determine its lasting qualities and the best methods for its manufacture and use.

“We know that a one-metallic circuit can be operated between New York and Boston, but we do not know that additional parallel circuits can be successfully worked; we have reason to fear that they cannot be if constructed in the ordinary way.

“To run a number of circuits between and into large cities involves the use of both aerial, underground and submarine cables to a very large extent. There seems to be a wide diversity in the opinions of electricians and manufacturers both as to the practicability of working through long cables and as to the size of conductors, nature and thickness of insulation, etc., which will secure the best attainable results. \* \* \*

“The switchboards now in use are all

planned for singlegrounded circuits, and it will be necessary to arrange special apparatus for our circuits.

“It will be for many reasons desirable to introduce at the outset of our long distance business, a transmitter adapted in qualities and form to the requirements of this service, and to know as definitely as possible what kind and amount of battery will give the best results. \* \* \*”

Problems were so far solved as to make possible the building and opening of the first commercial line which was built from New York to Philadelphia. Problems were subsequently solved which made it possible to carry a line from New York to Boston and then one to Chicago and then to carry it on to Denver and then to the Pacific Coast.

After the sleet storms of last winter telephone conversation was carried on between Boston and Pittsburgh through cables. It was only by the solution years before of very difficult problems that that was made possible.

By the growth of cities and the increase in the use of the telephone the number of stations within the limits of a single city has mounted in several cases to over a hundred thousand and in one case to over a million, and the number of central offices within a city to over one hundred. Under one roof as many as 20,000 lines are switched. Some central offices are now planned for more than double that number. The accomplishment of these results with a continually improving service has presented problems.

I am not going to rehearse what these things meant in the way of development, research, manufacturing plants, new types of construction, improved methods of operation or, in fact, in any of the ways which you have undoubtedly heard rehearsed in evidence, but I want to call your attention to one thing of great importance vital to the development and which may have escaped your notice. As other lines of electrical work developed, electric light and power and heating, transportation, it has often happened when our people have come to a decision as to a necessary improvement in our art, that we have found that in one of the other arts or in a college laboratory or in the telephone business not controlled by us, inventions have been made and patents have been taken out, of which

some claims might be interpreted in a way to interfere with our future progress or covering inventions which might be of value in operation. As we have undertaken to provide a free path for the development of the business, that has involved the expenditure of millions in the acquisition of patent rights or licenses from others in addition to the millions that we have had to expend ourselves on development, research and experiment.

It was in line with that same policy of providing a free path in which progress would be unhampered that in the early days we made the manufacturing arrangement with the Western Electric Company. In other public services the manufacturers make what they think is needed, and they control the patents upon their output. The Western Electric Company makes what we know that we need, and we control the patents.

As I have said before, we have gone beyond the point of having a purpose to establish a national service. There is a national service. Its maintenance is a responsibility—yours and ours. The responsibility upon us covers extensions into fields wherever population develops. It does not involve, to my mind, extension of direct operation by us into the fields now served by others, nor does such extension seem to me to be desirable except when greater efficiency or economy or better service point clearly to such a move. It does involve connection with the companies serving such fields. There are 9,290 connecting companies. In a few of these the Associated Companies have a direct financial interest. In the most of them they do not. The relation between the Associated Companies and the Connecting Companies is mutually helpful, and the tendency is all in the direction of standardization on the things which make for good service. They are a very important part of the national service serving over 4,500,000 stations.

In a few localities two companies are attempting to serve the same community. That means neither serves it wholly. It must mean either partial service or two charges for the users in that community. The public and you, Gentlemen of the Commissions, have repeatedly indicated your belief that such a condition is economically unsound and against the public interest. Whenever the desire of the public

that such a condition shall be eliminated shall be expressed through you, the public's representatives, we shall feel under an obligation to do our part with your approval, in endeavoring to remedy that condition.

The policy of the system is very simple. The fact that we are the servant of the Public is fundamental. We must satisfy and please our master. All of our efforts must be directed toward what will produce that result. We must give good service. The only test we can apply to any practice or project under consideration is to resolve the question as to whether it is for the betterment of the service. We believe that the public wants the best service that we can give, that it is satisfied to pay a fair price for good service and does not want, in the settled communities, anything less than a dependable service at any price.

From the fact that the sender of a telephone message is himself waiting when there is a delay in furnishing service—that he is therefore personally experiencing an inconvenience—he is more critical of bad telephone service than of any other bad service, or putting it conversely, the public expects a higher standard of service from the telephone company than from anyone else, and it is important that it should be better than any other service because it is the public's reliance more than any other in times of commercial or domestic emergency.

To give that kind of service we must pay wages which will attract and hold a picked lot of people, and we must stimulate in them an enthusiasm for the business. They must know what we are trying to do and be in sympathy with it. We consider it as much a part of our work to foster a spirit of service among the people in our business as it is to furnish poles and wire.

There is no organization for giving telephone service elsewhere which very closely resembles the one I have been describing. It is a purely American institution. Before we attempt to decide whether it is a good institution or the best for its purpose, let us see what it has accomplished. There is a development of one telephone to every eight persons in this country so distributed and inter-connected that a telephone is practically within reach of every human habitation or place of business in the country for communication with any other, every hour

of every day and night. Nowhere else does such a condition exist. Europe has over four times the population of the United States; it has less than half the number of telephones. Great Britain has fewer telephones than Greater New York. Germany has only 3 telephones per 100 inhabitants. France has about 1 per 100, having less telephones than the State of Michigan, though having 10 times the population. Detroit has more telephones than Brussels, Liverpool, Budapest, Rome, Amsterdam and Marseilles combined, with about one-fifth of the population. Except in the more important places in foreign countries, the telephone service is not a twenty-four-hour service. In Switzerland, in some ways an example of the best service in Europe, on week days 96 per cent. of the telephone exchanges are closed at 8:30 P. M.; 23 per cent. are open from 7:45 A. M. until 12:15, then close an hour and three-quarters, open again until 6 P. M., close an hour and a half, and finally open at 7:30 P. M. for half an hour, when the shutters are put up for the night, while on Sunday and holidays the service is even more restricted. The difficulties of telephone service increase in more than direct ratio with the development. There is no public which exacts as high a standard of service as the American Public. I believe that my statement will be unquestioned, that the difficulties in the way of giving a satisfactory telephone service are for the above reasons greater by far in this country than anywhere else. Yet I am confident that nowhere else is the Public so near to satisfaction with its telephone as here.

With the potentiality for connection with a continually increasing percentage of a continually increasing population, the value of service has continually increased.

If we take the present value of the dollar, measuring it by what it will purchase at the present average wholesale price of commodities, the average charge for telephone service is more than 10 per cent. lower than in 1914, although using that same present value of the dollar we pay over 15 per cent. higher wages than we did then, so that I am justified in saying that although we are paying more for material—more for labor, we are giving more value in service, for less real money, now than before the war.

Since the beginning of this Century, the

population of this country has increased 45%. The investment in railroad plant and equipment has increased 135%. During that period we have been obliged to increase the investment of the Bell telephone plant 960% to take care of an increase in the number of telephones of 1240%.

The purpose, methods and policies I have described have produced the best service, the greatest development and the best satisfied public in the world. That is not my opinion alone. It is the general opinion here and abroad. I assume that it is your opinion. Now then, when we consider any change we must have it in mind that it is a change from what has produced the best known result in its line of work. We do not rest on that result. We are looking for something better than the best. But if we, all of us, you of the regulation and we of the management, should abandon or displace proven methods for visions, we could not escape a very definite responsibility to the nation.

As to regulation of such a system as we are dealing with, I assume that you do not expect me to discuss the general principles of regulation which apply to all public services, but only to present our point of view on some of the special problems which arise in your regulation of Bell Companies.

There is a strictly community service furnished by the telephone and a state service and an inter-state service. The same terminal stations used in the community service are used or usable in the state and inter-state services; other parts of the plant and the service of personnel used in the community service are used or usable in state and inter-state service.

When it comes to the regulation of charges, it is sometimes by communities, sometimes by states and sometimes by the Inter-state Commerce Commission, according to the laws of the states and of the nation as they exist.

Except with reference to inter-state toll rates, the regulation is under state laws and generally by the state commissions, so that you, Gentlemen of the State Commissions, are confronted with the problem of considering the value to your constituents of development outside your states, and the cost of service to your public, part of which is rendered beyond your jurisdiction and, furthermore, some of the Companies



servicing you perform some of their functions outside the state and have other functions performed for them by another company outside your jurisdiction. These difficulties come out of the fact that your jurisdiction is necessarily limited to your states, while telephone service cannot be limited by state boundaries. They introduce into the expenditures of these companies, subject to your regulation, certain general charges covering necessary services of great value, but of such a nature that precise values cannot be easily ascertained, so that the charges can be verified only as less than value received.

While you are circumscribed to a State point of view, if in arriving at your conclusions, you think it advisable to study the financial results of the national system, it is possible for you to do so. Sworn statements of each company forming a part of the national operating organization, including the American Telephone and Telegraph Company, are matters of public record filed with the states and with the Interstate Commerce Commission, and a compilation of those statements, eliminating only inter-company transactions so as to present the operations of the organization as a whole, is presented annually in the report of the American Telephone and Telegraph Company.

The license contract between the American Telephone and Telegraph Company and the Associated Companies was intended to afford, and has afforded, the basis absolutely essential to a national telephone system. Aside from all questions of economy and efficiency, a national universal service could not be provided at all by a large number of uncoordinated local units. As a part of its plan, the contract provides in general terms for such services to the Associated Companies as can be most economically and efficiently rendered by one central agency. It includes the obligation on the part of the American Company to construct, operate and extend the long distance lines connecting the various companies into an harmonious national operating unit. The payment under this contract of four and one-half per cent. of the revenue to the American Telephone and Telegraph Company is not a levy of tribute. It is an apportionment among the state services of the compensation which must necessarily be paid for the extremely valuable benefits which

they receive from the national organization. Logical operating divisions are not bounded by state lines. A division between national and sectional toll lines cannot follow state lines. The undertaking by the national organization to construct, maintain and extend the long lines is not a device for taking away from the state organizations the cream of the toll business. The long lines form one part of the national machine, designed to handle such long distance service as may be most efficiently and economically provided through this means, and so designed to make the national machine as a whole operate most efficiently and economically.

The purpose of this contract is to provide a national universal service which shall be as efficient and economical and of as high standard as is attainable. It provides that all services essential to that end shall be rendered to the Associated Companies for a compensation adjusted upon an equitable basis.

The license contract is usually between two companies in which there is a community of interest, although when the contracts were originally made this was not true, the parties then being entirely independent of each other and dealing at arm's length. The present relations between the companies suggest that you closely scrutinize these contracts. The American Telephone and Telegraph Company does not object to such scrutiny; on the contrary, it is constantly inviting it. Contracts made between corporations subject to a common control are not illegal. If close scrutiny develops the fact that they are fair, they must be accepted. It is only where such scrutiny shows them to be so unfair as to demonstrate an abuse of the relations between the parties to the material injury of one of them that the injured party may complain. Concretely, whether any license contract of the Bell System is unfair to the licensee or whether its effect is to work serious injury to the licensee, is a legitimate matter of inquiry, but the inquiry is as to the effect of the contract upon the licensee, not as to its effect upon the American Company; and if such inquiry develops that the contract is beneficial to the licensee, that the benefits received by the licensee under it not only exceed the payments which it makes but are to be evaluated at many times the amount

of such payments, then the contract stands upon the same basis as any other contract.

Of whatever the Bell System has accomplished in the way of realization of its ideal of a national service or in the way of improvements in the service or economies in the service, the public is the beneficiary. The license contract arrangement which has made this all possible has passed the essential test. It has been of far greater value to the public than what the public has paid on account of it.

You have sometimes asked for the cost of the services under the contract performed by us within a state. It is impossible for us to ascertain the cost of the services rendered to an Associated Company for any state. Let me give you an example: We spent over four hundred thousand dollars in the State of Connecticut on study and experimentation with the railroad to determine how our service and the electrical transportation service could exist side by side without detriment to our service. That was not a service primarily for the State of Connecticut. It was a service for the whole system. We are spending this year and every year large sums in the improvement of the art of telephony with no knowledge as to where and when the first application of those improvements will be made. There can be no way of determining the cost of such services as these by states.

Then the question is sometimes asked—What is the cost of these services for all of the states, and what does the American Telephone and Telegraph Company receive for them? From our point of view, the whole purpose and business of the American Telephone and Telegraph Company looks to a single end—furnishing a national telephone service. For that purpose it was organized; for that purpose it owns stock in the operating companies; for that purpose it owns stocks in a manufacturing company; for that purpose it spends money upon a great variety of services to the operating companies; for that purpose every dollar of its expense is incurred. Our income from these operations comes from interest, dividends, from the earnings of the Long Lines Department, and from payments under the license contract. These sources of income are separate and distinct, so that the amount of the income derived from any particular source

may readily be ascertained with substantial accuracy. This is not true as to the expense items. They are all devoted to the single purpose of the company, and it is not possible under the system of accounts prescribed for the company, or under any system of accounts which we have been able to devise, accurately to allocate expenses of the Company specifically to that portion of the license contract which covers the general services rendered to Associated Companies. This question has interested us as well as you, and we have tried to solve it from time to time. Our estimates have led us to conclude that we spend on these services substantially all or more than the 4½% payments.

Another question sometimes asked—Why is the payment for these services made in the form of a percentage upon revenue? Since it began to be made in that way about twenty years ago there have been many changes in the official families of the Companies, parties to the contract. Many men coming into positions when that contract became one of their responsibilities have themselves asked that question. No one has suggested a better or fairer way. Any attempt to apportion values to different parts of the business would meet all of the difficulties that would go with an attempt to apportion value by States. It has seemed to me that the method was the logical one. The benefits from the service accrue in benefits to the public in lower rates or better service. How can they be measured better than by a relation to what is paid for service?

The better case a man has, the more it is to his interest that the one passing upon the merits of his case should be well informed as to his case. Obviously, a Commission keeping in close touch with the operations and results of operations of a public service will be better informed than any agency which only occasionally attempts to inform itself on the occasions when a change in the charges to the public is to be considered. That is why we have consistently advocated regulation by Commissions. In 1913 Mr. Vail made this statement:

“We believe in and were the first to advocate state or government control and regulation of public utilities; that this control or regulation should be by permanent

quasi-judicial bodies, acting after thorough investigation and governed by the equities of each case; and that this control or regulation, beyond requiring the greatest efficiency and economy, should not interfere with management or operation. We believe that these bodies, if they are to be permanent, effective and of public benefit, should be thoroughly representative; they should be of such character and should so conduct their investigations and deliberations as to command such respect from both the public and the corporations that both will without question accept their conclusions."

We believe that the best results for the service and, therefore, for the public will be attained by a relation of confidence and cooperation between the Commissions and ourselves. We intend to deserve the confidence of the Commissions by the utmost frankness and straight-forwardness in our dealings with them, and we hope for a time when the Commissions will be kept so well informed continually as to our operations and results and problems and necessities that the great expense of occasional investigations may be saved. We are making systematic efforts to widen the ownership in the Bell System because people will inform themselves and their neighbors about the operations of an institution in which they are partners, and we welcome every opportunity to increase the knowledge of our operations among telephone users. No institution is more publicly owned. Its plant has been built out of savings of the people. It is being extended out of such savings. It is the people's institution more than any other.

From the character of its ownership and because a large proportion of the people of this country depend upon the Bell System for their telephone service, its management and operation is a trust and obligation to the public which must be fulfilled to the satisfaction of the public. It will not be completely fulfilled until rates are low enough to impel everyone to have a telephone in his own residence or office who ought to have one for his own convenience or the convenience of the country. Consistent with this belief, I feel safe in saying that the desirability of lower rates is more in our minds than in the minds of the public and at least

as much as in the minds of the commissioners.

The value of the service to the large user is so much in excess of its cost and so much increased by a wider extension of the service, that I am firmly of the opinion that whenever a reduction is possible it should be in the charges to the small user. It seems proper to me that Commissions should take value into consideration in the making of rate schedules and I think that they should take it into consideration in comparing costs of service.

The interest of the public and our interest are identical in the direction of greatest value which includes greatest extension of the service at fair rates. Sound, efficient and economical regulation involves, therefore, cooperation between the Commissions and our Companies to produce that result. It involves, when the time comes for a change of rates, a study between them as to what increase or decrease in revenue is indicated, followed by another study on rates with a view to effecting the necessary change in such a way as to make the service available to the greatest number.

I can imagine a Commission, in fulfilling its obligations, calling to account a Company not sufficiently alert as to its conditions and instructing it that its rates must be increased so that its service to the public may not be in danger. There have been cases where that kind of caution was necessary.

Commission regulation, on the whole, has been satisfactory. We have intended to present our views to them fairly, completely and in a straightforward way. We haven't always reached our standards. Commissions as a rule have manifestly intended to be judicial and fair. Occasionally they have temporized. They have during the past three or four years passed through a very difficult period in which, in order to maintain service of the utilities, rate changes have been advances and not decreases.

Since the beginning of the war our cost of labor per station per annum has increased over 100%; maintenance material over 40%; taxes over 106%. The Bell System is being taxed now at the rate of over \$40,000,000 per year. It will be a long time, if ever, before these increases in cost fade away. Other expenses, including management, 4½ per cent. payments, depreciation, etc., in that same period have increased between 2½% and 3%.

Since the termination of the period of Federal Control, the Associated Companies of the Bell System have been before State Commissions and other regulatory bodies in 205 separate proceedings, some of them involving the change in a rate in a single city, some of them involving changes in rates in practically all the cities of a state. The decisions of the Commissions have been accepted in all but 20 cases, although in some of those cases accepted it has been felt by the companies that they were not getting all to which they were either legally or fairly entitled. If there seemed even a possibility of going on without detriment to the maintenance and extension of the service they accepted the decisions. When we have appealed from the Commissions to the Courts it has been with reluctance and because we believed it our duty in order to preserve and extend the service. In the 20 cases which have been taken into the courts, decisions have been rendered in 11. In all but one of the 11 our contentions have been upheld.

Take the Bell System as a whole; it has an investment of about two billions of dollars, between two and three hundred thousand employees—serves about nine millions of customers directly and is responsible for returns to four or five hundred thousand stock and security holders. That puts it among the large business enterprises of the world. I do not mention this as a glorification, but only to call attention to this advantage to the public in dealing with such an institution. We are about as conspicuous as a pyramid in a desert. We cannot afford at the risk of losing any part

of public approval to vary a hair from the course toward the objective which we are convinced is the only objective which the public will finally approve. And that is the best and broadest service which can be given at fair rates. We must have its approval all along the course which means that none of our methods of operation or of our rules of conduct must fall below the highest standards.

I have been talking about the Bell System of today, but we are all looking forward to the task of tomorrow, and if we are to meet our increasing obligations, we must have the confidence and cooperation of the Public and of you, its representatives.

We are studying the probable telephone requirements for the next five, ten and fifteen years; we are considering the new capital that will be required to meet the demanded growth; we have men studying the innumerable inventions and technical improvements without which we could not reach our objective. We have to think in big figures, big figures for labor, material and financial resources, for if we did not, we would be overwhelmed by the increasing public demands.

If we can make you see our objective as we see it, if we can make the picture of the future live in your minds as it does in ours, I am confident that you will see it as an objective of far-reaching national importance, which commands the utmost seriousness on your part and on our part, and that from that seriousness should come such cooperation as will bring the results which the country demands.

## The Recent Transatlantic Radio Telephone Tests

ON Sunday, January 14, while seated in his office in the New Southgate plant of the Western Electric Company, Limited, Frank Gill, European Chief Engineer of the International Western Electric Company, together with the Postal Officials of the British Government listened for two hours to H. B. Thayer, President of the American Telephone and Telegraph Company and others talking from Mr. Thayer's office on the twenty-sixth floor at 195 Broadway, New York.

For some weeks the scientific staff of the American Telephone and Telegraph Company in cooperation with the Radio Corporation of America has been conducting experiments with special radio telephone apparatus and methods. During these experiments these engineers have used the station of the Radio Corporation of America at Rocky Point, Long Island, to send signals and words to other engineers sent to New Southgate, England, to assist in tests and observe results obtained under all possible conditions. On this eventful Sunday evening complete messages were scheduled for transmission and President Thayer telephoned from his office to England via Rocky Point Radio Station as follows:

"This is Mr. Thayer of the American Telephone and Telegraph Company speaking from 195 Broadway, New York City, through the Rocky Point station of the Radio Corporation of America.

"The radio apparatus and system used in this test is made possible by cooperation between the American Telephone and Telegraph Company and the Radio Corporation of America and is the result of research and experimental work in the laboratories of the American Telephone and Telegraph Company and in the laboratories of the Radio Corporation of America and its associated companies.

"In 1915 the American Telephone and Telegraph Company transmitted a message across the Atlantic by radio telephone from Arlington, Virginia, to the Eiffel Tower in Paris, where it was heard and understood by our own engineers and by others. During 1915 we also sent a telephone message from Arlington part way

across the Pacific Ocean to the Hawaiian Islands, where it was heard and understood by our own engineers and by officers of the United States Navy. Since then great improvements have been made in the art not only of radio but of telephony and of radio telephony. In the experiments which we are now conducting we are making use of these improvements.

"Beyond a small group listening for this message in England, I do not know whose ears this message may reach. To all who hear it, I wish health and prosperity. Will you who are now hearing it inform me that you have heard it and tell me how clearly it comes to you."

Mr. Thayer began speaking at nine P.M. which was two A.M. Greenwich time in England. At 9:11 word had been received back from England by cable announcing the complete success of the experiment.

General Carty sent a message at 9:07 P.M. and at 9:14 a cablegram arrived reading: "Purves recognized Carty's voice." This refers to Major T. F. Purves, who is Engineer in Chief of the British Postal System. Further messages were sent by Mr. Gifford and others all of which were heard distinctly by a group of editors, scientists, engineers and press representatives in England invited to form audience during the experiment.

During the progress of the test the British Press Representatives cabled Mr. Thayer as follows: "Representatives of British press congratulate A. T. & T. Co. and Radio Corporation in their epoch making experiment the success of which has exceeded their expectations, and in which they see the dawning of a new era in long distance speaking which will be of the greatest value to the press of the world."

Toward the end of the experiment the loud speaker was used successfully. The following message at eleven P.M. was received from Frank Gill, European Chief Engineer of the International Western Electric Company and President of British Institution of Electrical Engineers. "Loud speaker now being used—good results—great enthusiasm. Your interview on loud speaker came through fine." A final message from Mr. Gill at eleven P.M. read as follows:

“On conclusion of these most successful and historic tests which have made a profound impression, all those assembled at the London end wish to congratulate most heartily the A. T. & T. Co. and the Radio Corporation of America.”

very important data have been obtained from the work of the American engineers sent to England and of those here. The tests have been very rigorously conducted and for weeks our scientific staff has been sending signals of

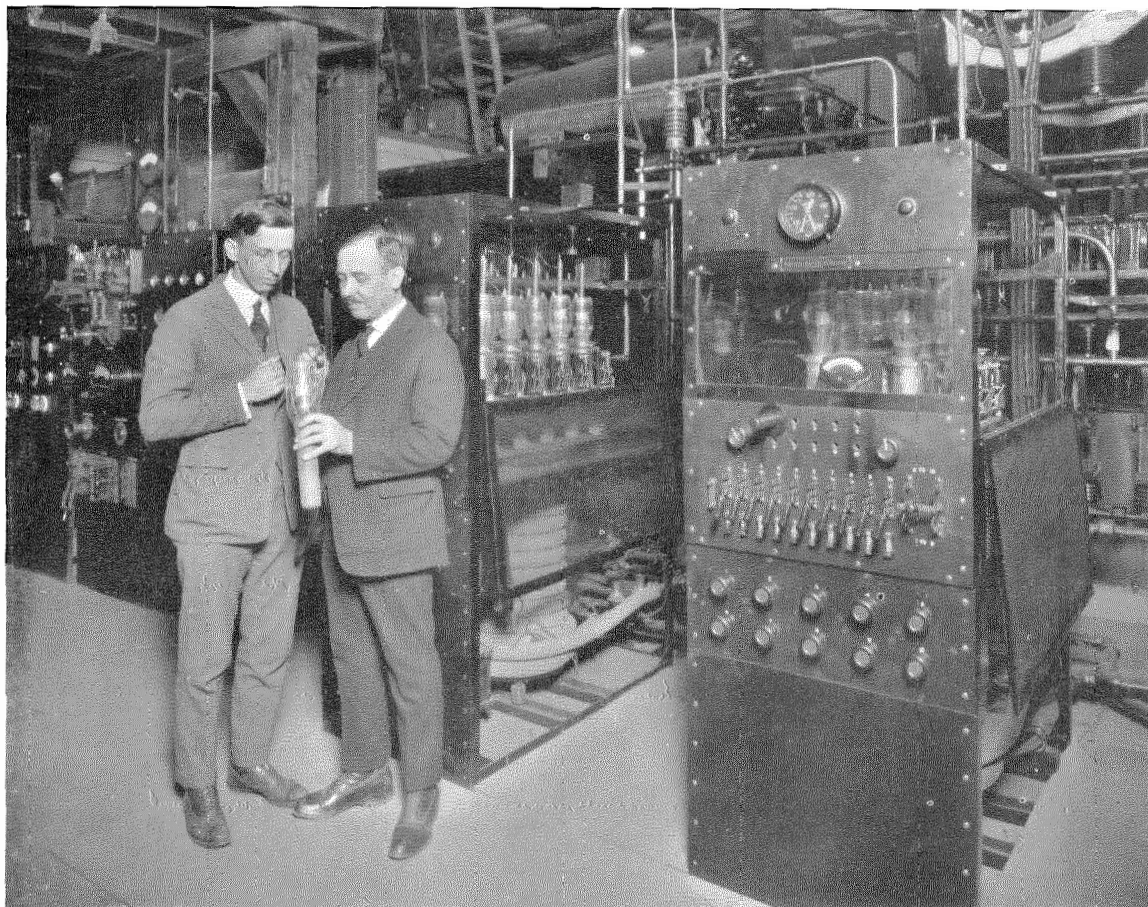

The two halves of the final stage of the high frequency amplifier. Each half contains 20 water-cooled three-electrode thermionic tubes. The power panel is seen on the extreme left

At the conclusion of the experiment Mr. Thayer issued a statement. He said: “These experiments are part of our effort to determine to what extent the radio telephone may ultimately be employed in talking across great bodies of water where talking through telephone wires is not feasible. We are making steady progress, but there is much more to be done before we can speak definitely about establishing practical commercial radio telephone service across the Atlantic.

“The tests we are now conducting are adding a great deal to the knowledge of the art. Some

many kinds under a great variety of conditions. Selected words with no context as a guide to their meaning have been repeated thousands of times. The quality of transmission at all times, and under all circumstances, and the functioning of the special receiving apparatus set up in England, as well as that in America, have been observed with extreme scientific care.”

One of the developments which has been in progress since the demonstration of transoceanic radio telephony in 1915 has to do with the perfection of high powered vacuum tubes. The tubes used in the present tests are charac-

terized by a large external anode which is cooled by water. By virtue of water-cooling each tube can readily handle as much as 10 kilowatts of power.

In the present installation, which is located on Long Island at the large Rocky Point station of the Radio Corporation of America, the final stage of amplification comprises a group of twenty of these tubes operating in parallel. The output of 100 kilowatts is delivered to the antenna and, due to a new system of radio transmission employed, is as effective as 300 kilowatts would be in the systems commonly used. In the systems commonly in use about two-thirds of the energy goes into waves other than those which comprise the message, these waves being needed by many of the receiving sets in use for detection of the message. The new system suppresses the waves which do not comprise the message and reception is accomplished by generating locally at the receiving set a small high frequency current

which corresponds in frequency to the suppressed waves. In the present tests this frequency is 55,500 and corresponds to a wave length of 5,400 meters.

The present system differs from the usual radio transmitting systems in another important respect. The usual type of transmitter sends out, in addition to the group of waves which does not comprise the message (the so-called "carrier" wave), two groups each of which does carry the message (the "side bands"). In the new apparatus only one of these groups is radiated. This makes possible the sending of approximately twice as many messages at the same time without interference. This feature is particularly important at long wave lengths where fewer messages can be carried simultaneously than at short wave lengths. The present system was perfected in connection with the so-called carrier telephone which is now in use in the United States on certain long distance telephone lines.

# Notes On Radio

By O. B. BLACKWELL

*Transmission Development Engineer, American Telephone and Telegraph Company.*

THE following notes may be of some help to those who are trying to gain a better idea of radio and what it means to the telephone business. The first part is intended to assist in forming a clear picture of the physical nature of both wire and radio transmission. The latter part is a brief discussion of the fields of use for which radio has been developed, or for which it is being considered.

## CHARACTERISTICS OF WIRE TRANSMISSION

It is undoubtedly the popular idea that in our wire circuits the telephone waves are inside of the conductors, somewhat in the manner that a liquid is inside of the pipe conducting it. This is a very incomplete picture. It is true that electrical currents are in the wires, but the energy of the electromagnetic waves is largely outside of the wires, and surrounds them. We must imagine these invisible waves, in the case of our open wire circuits, filling up all the space around the wires, and within a distance of several feet of them, and rushing along the circuit at a speed of many thousands of miles a second, but prevented from spreading and guided by the wires to exactly the place to which we wish the waves to go.

In these wire systems, the electromagnetic waves (except in the recent carrier systems) are transmitted just as they come from the telephone transmitter, that is, they have the same frequencies as does the voice which causes them. They consist, therefore, of constantly changing complex waves, made up of frequencies varying from perhaps 200 cycles or less to over 2500 cycles per second.

## CHARACTERISTICS OF RADIO TRANSMISSION

In a radio system, on the other hand, while electromagnetic waves are also used, these are transmitted into wire arrangements which we know as "antennae," so designed that a part of the waves become entirely detached from the wires and spread out in all directions, with no wire guides whatever, and limited in spreading

only by the surface of the earth and perhaps also by layers of the upper atmosphere which have such electrical characteristics as to reflect them back.

Thus, in our radio systems, we have no line problems. We have acquired, however, several new sets of problems. I refer to (1) putting the voice waves into such a condition that they may be radiated into space and received from space, (2) separating the different radio messages from each other, and (3) the problems arising from the transmission characteristics of the space through which the radio waves travel.

Our ordinary telephone waves do not radiate appreciably from our circuits, partly because they are of too low frequency to be effectively sent out from structures of any ordinary size, and also because our wire circuits are not of a form which radiates easily. However, if these waves were liberated into space, they would travel just as well, and in fact somewhat better than the higher frequencies used in radio. Supposing they could be liberated, however, it is evident we would be met by the difficulty that all of our messages would interfere one with another, since they would all have the same range of frequencies, and since radio waves spread out in all directions.

The above difficulties are overcome in radio by generating a high frequency current for each message we wish to send, and causing the voice currents to control the magnitude of the high frequency waves that are sent out. It is a characteristic of high frequency waves that they may be radiated from comparatively small antennae systems. By employing a different high frequency for each of the telephone messages which we wish to send, we may at any receiving point separate any particular message from other messages which may be in space at the same time, provided the message we desire is at a frequency differing sufficiently from the frequencies of the others. This separating is done by using so-called electrical tuning or electrical filter systems, which will let through the desired frequencies, but will stop all others.



It should be noted that in discussing radio, we refer to a message being sent out at a certain "frequency," or at a certain "wave length." All radio waves travel practically at the same speed, that is, the speed of light, which is 300,000,000 meters in a second. Now the distance traveled in a second is the frequency multiplied by the wave length. If we know the frequency, therefore, we can divide it into 300,000,000, and obtain the wave length and vice versa. The longer the wave length, therefore, the lower the frequency.

A good example of the difference in frequency required for separate messages is in the case of broadcasting. Until recently, all private broadcasting in the United States had been at a wave length of 360 meters, which is a frequency of about 830,000 cycles per second. It has now been decided to permit broadcasting simultaneously at a second wave length of 400 meters, which is a frequency of 750,000 cycles per second. If the waves were any closer together in frequency than this, it would not be possible, in some sections, for many of the present types of receiving sets to listen to the entertainment being sent out on one without also overhearing the other in sufficient amount to cause interference. The number of simultaneous messages, therefore, is limited by the degree to which the receiving sets can pick up one message and separate it from all others, and by the total range in frequencies which can be used in radio.

#### "MESSAGE CAPACITY OF THE ETHER"

In discussing radio we commonly think of space as being filled with a medium called the "ether," and that it is this medium through which the electromagnetic waves are transmitted. There is considerable question whether this is a proper physical picture, but it is anyhow a convenient manner of speaking. We should note, however, that if there is an "ether," the electromagnetic waves which we employ in our wire systems are transmitted through it just as truly as are the radio waves. With wire transmission, however, the electromagnetic waves travel through, and disturb only a relatively small region in the ether immediately surrounding the wires, whereas the radio waves disturb the ether for a very large region extending in all directions from the transmitting station.

We sometimes hear in radio the expression "message capacity of the ether." By this is meant the number of simultaneous radio communications that can be carried out in any region without interference. Evidently this depends greatly on the locations of the stations, on the type of apparatus used, and on the amount of interference permitted. Roughly speaking, however, it can be said that if the entire range of frequencies which have been developed for radio could be applied to radio telephony, it would be possible with the type of sets in general use to establish perhaps twenty-five simultaneous non-interfering two-way channels in any given region. In view, however, of radio telegraphy and radio broadcasting, of the radio compass and beacon stations which the United States Government is establishing, and of the setting aside of wave lengths for military purposes, difficulties have already arisen in obtaining non-interfering wave lengths.

The radio conference which was brought together by the United States Department of Commerce to consider the matter recommended an allocation of wave lengths which, if carried out, would leave the radio telephone situation as follows:

For the ship-to-shore business a range of frequencies is allocated which would permit two simultaneous conversations to be carried on in any one region, by making use of the best methods which have been developed in the art. This space, however, is not set aside exclusively for telephone service, but may also be occupied with certain types of ship-to-shore telegraph. This might seriously interfere with the telephone service.

For trans-oceanic telephony no space was definitely set aside, although a range of frequencies was designated which would be sufficiently wide for one conversation, and it was recommended that tests of such transmission be permitted in this range.

For connection between fixed points, there were set aside two narrow frequency bands. These are at wave lengths best adapted for distances of several hundred miles. Each of these, with a small amount of further development work, could be made to carry a single conversation. They are not assigned exclusively to telephony, and so may be interfered with by telegraphy.

In each of the above cases, we have in mind two-way communication which could be connected into the wire system so that the radio would be an extension of the wire service, and without the necessity of the talkers using "push buttons" or other mechanical contrivances for switching their sets from the talking to the listening condition. The present art requires two wave lengths for such a radio communication, since the same wave length cannot ordinarily be used for each of the two directions.

Comparatively liberal provision was made by the committee for broadcasting purposes. Space was set aside in the general region in which broadcasting is now being done, permitting at least four simultaneous broadcast channels with present sets in the districts along the coast. This could be increased by at least two in the interior of the country by using, in addition, wave lengths which along the coast are employed in marine telegraphy. Furthermore, a space was set aside using much shorter wave lengths, in which several more broadcast stations could work, although these wave lengths would probably be less satisfactory for such service. The above is in addition to several frequency bands set aside for government and other official broadcasting.

It is evident that the above does not give much room in which radio telephony, as developed from broadcasting, can develop. However, methods have been worked out theoretically, and to some extent in practice, by which it would be possible to increase the message capacity by several times. Such systems bring in considerable complexity and expense, and these increase rapidly as the channels are crowded closer together. With developments along this line, however, and with the further developing of shorter wave lengths than are now in use, we believe that the radio message possibilities can be increased sufficiently to take care of the services which require radio.

#### TRANSMISSION CHARACTERISTICS OF THE "ETHER"

Radio transmission is generally more variable than is wire transmission. This depends, however, largely on the wave lengths employed, and the distances covered. As an example, the power received from the usual type of broad-

casting station at a distance of 30 miles is usually fairly constant. At 200 miles, if the distance is over land the power received may vary hundreds of times within a few hours, or even within a few minutes. For longer distances the amount of variation rapidly increases.

Radio transmission over water is much less variable than over land. The amount of variation increases rapidly as the wave length is shortened.

Perhaps the most unhappy feature of transmission through space is the well-known "static." This appears to come from lightning and other electrical disturbances in space, and varies tremendously in volume from summer to winter, from day to day, and from hour to hour. Tests made at a point in northern New Jersey for long wave lengths show the average static at that point this summer about 50 times as great in power as the average static last winter. Variations of 25 times in static power were recorded within single days. As it is generally possible with modern receiving sets to amplify the received signals to the point where static interference becomes so loud that further amplification is useless, this large variation in the static means a large variation in the distance to which the station may be heard.

It is because of these great variations in transmission and in static that it is nearly impossible to state the "range" over which a station may be heard. For example, under favorable conditions, a broadcasting station in the vicinity of New York has been heard far out on the Pacific Ocean. Under unfavorable conditions, the same station could not be heard satisfactorily at a 30 mile distance.

#### DIRECTIVITY AND SECRECY

Directivity in radio consists in the use of an antenna system so arranged that it does not radiate equally in all directions, but sends out or receives very much better in the direction of the station with which it is operating than it does in other directions.

The advantage of directivity at the transmitting end is a saving in power, since a larger percentage goes in the desired direction, and an increase in the degree of privacy of the message, since fewer stations will be in the region where it can be effectively picked up. A large diffi-

culty here is that it is a physical law that it is not possible to devise a radiating system which will be efficient and which will also give sharp directivity unless the antenna structure is large compared to the wave length. As the radio waves which are generally in use are comparatively long (for example the usual broadcast waves are over 1000 feet in length, and the longest trans-oceanic radio telegraph waves over ten miles), it is not possible, without large expense, to give such waves more than a small degree of directivity at the transmitting station. In receiving systems, however, efficiency is not so important, as it can be made up to a considerable extent by amplifiers, so that a moderate degree of directivity at the receiving end can be frequently employed. This has the advantage of cutting down the amount of disturbance from static or from other stations which may be coming in from directions other than that from which the desired message is being received.

Reports have been given out of tests carried on in England covering directed radio system with 15 meter wave lengths (20,000,000 cycles) and giving a much greater degree of directivity than with the usual wave lengths. There is considerable question, however, as to the usefulness of so short wave lengths, in view of the readiness with which they are absorbed.

Various means have been proposed for giving some degree of secrecy to radio telephone messages. These have depended generally on some action at the sending point, such as distortion of the voice waves, adding a noise frequency to them, continuously varying the wave length on which they are sent out, or similar propositions which would make it difficult for them to be picked up and understood. At the desired receiving point these systems depend on arrangements for removing the distortion or noise, or compensating for the changing wave length. While it is undoubtedly possible to devise a secret radio method which it would be practically impossible to tap, it would involve so great complication as to make it unsuitable for general use. Other systems have been developed which, while not "secret" are "private," in that they could be tapped only by those intending to do so, and using apparatus not generally owned by the amateur. Even with such systems, however, the complication and expense

of any so far developed are larger than radio services can generally afford.

With this general discussion of radio, it will be interesting to consider some of the fields for which radio has been developed or considered.

#### TELEPHONE SERVICE TO SHIPS OR OTHER MOVING VEHICLES

A radio station was established at a point in New Jersey, and radio connections set up to a ship at sea through this station and then by wires to points as distant as San Francisco and Los Angeles. In some of the tests, connections were established simultaneously to two ships and to a third land station. The nominal range of the station is considered to be 200 miles. Under favorable conditions, it has talked to a ship 1600 miles distant. Local conditions in summer may interrupt the service at distances less than 200 miles. The ultimate range given the station must, of course, depend on commercial requirements as well as the technical questions involved. Since the course of the trans-oceanic liners parallels the coast for a considerable way, it would be possible to reach such ships after they are out of range of a New Jersey station, by other stations on the coasts of New England.

A development now being considered and which may be undertaken is a short range telephone system for use around the important harbors. This might be of considerable importance to the railroads and other companies operating tug boats, as it would permit the tug boat dispatchers to keep closely in touch with their craft, thus more efficiently keeping them in use. It is possible that no wave length assignment can be found for this service in the range now generally used for radio, and it will be necessary to go to shorter wave lengths.

Another use of radio telephony which may ultimately be made is that of connection to moving trains. This is entirely a feasible proposition, but the cost of developing, setting up and operating such a system at present would, we believe, be too large in comparison with the probable amount of service which would result.

#### RADIO ACROSS NATURAL BARRIERS

Perhaps the most spectacular service for which radio will probably be applied in the future is the connection of the wire telephone

system in America with the wire telephone systems in Europe and in other continents. Communication over such distances was shown possible by the tests of the Bell Telephone engineers in transmitting from Arlington to Paris and Honolulu in 1915. Large developments have been made in the art since that time, as illustrated by the transatlantic tests on January 14, 1923, but considerable further work remains to be done before such a system can be established and operated at an annual charge sufficiently low to justify it commercially. There may also be difficulty in obtaining suitable wave lengths.

The Catalina Island system was the first radio telephone system to go into regular commercial use. It spans a 25 mile gap of water between the mainland near Los Angeles and Catalina Island. It is the only case, at least in so far as information has been published, in which radio is furnishing a commercial service, and meeting in both transmission and signaling, but not as regards secrecy or economy, the ordinary requirements of wire service.

There are undoubtedly a large number of other cases in this country where radio will be used for establishing connections with districts to which it would be difficult or impossible to maintain wires. This will probably not be done on any large scale, until radio apparatus, by further development has been somewhat simplified and cheapened.

In many of the cases where radio will be used for reaching outlying points, the necessary reduction in cost to prove it in will be obtained by making use of systems which do not meet the requirements of ordinary wire systems, but which will be sufficiently good for the limited service required by these points. For example, in one case recently considered it was thought satisfactory for the system to operate merely between a pair of telephone sets, one at each terminal, with no signaling devices whatsoever, and with communication carried on only for a few hours each day, and then at appointed times.

#### BROADCASTING

A service for which radio, by its inherent nature, is particularly fitted, is that of broadcasting music, news, etc., to a large number of people who can listen to it by means of comparatively simple receiving sets. This type of system has become so thoroughly known as to

require no explanation here. It is not a two-way service, and is not, therefore, of the same type as the usual telephone service. In this case the usual difficulties with radio of lack of secrecy and of spreading out over a large territory are the particular features fitting it for broadcasting economically over a wide area.

#### TELEPHONE SERVICE FOR RURAL COMMUNITIES

While, from the inherent nature of radio, it is entirely absurd to consider it for carrying on the usual telephone service in place of wire systems in districts which are well developed in population, we have attempted to determine whether it could be developed to give telephone service at a sufficiently low cost to find a field in very sparsely settled country districts.

In this connection, it should be pointed out that radio is purely a method of transmission of messages. In giving telephone service, it is necessary that we not only have means of transmitting our messages, but also means of connecting the transmitting channels together, so that any two subscribers may be permitted to talk. This is the function of the central office, and of the operators who are employed there. Radio in no way avoids the necessity of this switching function.

As in the case of a multi-party wire line, it would be possible to arrange with radio so that a small group of subscribers could directly connect with each other. This, however, would not relieve the necessity of their being able to connect through a central office into the wire system, in order to reach more than a very restricted district.

A radio system, for connecting together a group of farmers and connecting the group to a central office, would need to include transmitting and receiving apparatus, and also the necessary power supply and calling devices, in addition to ordinary substation apparatus. Since a part of the apparatus would need to be continuously energized to receive signaling, tube renewals would be an important factor in the annual charges. It is evident that the radio art, as it now exists, cannot meet these requirements at anything like the \$2.00 or \$3.00 per month which the farmer usually pays for his wire service. Even with an optimistic estimate as to changes which can be brought about by

development, it appears that in the rural field, as elsewhere, radio telephony will be limited to giving telephone service to comparatively isolated places, or under conditions which make the maintenance of wires more than usually difficult.

This does not mean, however, that low power radio transmitting sets, perhaps for use in combination with broadcast receiving sets, may not be used in considerable numbers as an amusement, permitting a number of people in a community to talk together as a group in the evenings or at other appointed times.

#### SOME CONDITIONS OF RADIO DEVELOPMENT

The tremendous range of frequencies and energies employed in radio bring in many difficult but interesting technical problems. The frequencies employed vary from around 50,000 cycles per second, which was used in telephoning to Paris and Honolulu, to frequencies of around 20,000,000 cycles per second, which have been employed in experimental radio work. The energy put into the antenna in the usual broadcasting radio station is about  $\frac{1}{2}$  kilowatt. In experimental telephone work, powers have been produced up to 100 kilowatts. These should be compared to about 0.1 watt, which is the maximum voice wave energy, under usual conditions, that is put on our wire circuits. At the receiving end of radio the powers are extremely small. At a distance of say 30 miles from a broadcasting station the usual amateur antenna will pick up perhaps a few millionths of a watt.

From the discussion which we have given it may be evident why it is that the development engineer has viewed radio with somewhat con-

flicting emotions. In perhaps no other part of the communication art have there been developed more beautiful technical methods or apparatus, or is there presented to him a more intensely interesting group of technical problems. It has opened up possibilities of giving new fields of telephone service, and the results which it has yielded and promises to yield in these fields appeal greatly to his imagination, as they do to that of the general public. Yet in perhaps no other field has the development engineer dealt necessarily with factors inherently so variable, or so little under his control, or has the development work yielded so little in results of practical commercial importance, as compared to the large expenditures made. Furthermore, to put radio telephony into such shape that it can give those services for which it is fitted will require intensive development for many years.

It must be borne in mind, however, that with the constantly increasing demands for all types of communications the radio field, limited though it is in scope, may be expected to grow to considerable proportions. The appeal of radio telephone broadcasting to the general public is being watched with great interest. As already noted, the difficulties of radio for ordinary telephone work, that is, the spreading out over wide territory and non-secrecy are just the characteristics which are desirable in broadcasting. It may be that here there is a service in which radio telephony can assume considerable commercial importance, and much more than justify the large amount of development work which must be given to it.

# Installation of the First Telephone Toll Cables in Japan

By R. P. ASHBAUGH

*Engineering Department, Western Electric Company*

OWING to the mountainous nature of the central portion of the main island of Japan, the population of the country has concentrated on the coasts. The development of the Pacific coast cities, lying as they do at the Gateway to the Orient, has been most rapid by reason of their location. Telephone toll service, inaugurated between Tokyo and Yokohama in 1890, has been steadily extended; Tokyo and Osaka, distant 350 miles, being connected in 1897, and telephone circuits at present extend from Sapporo, on the island of Hokkaido, to Nagasaki, on the island of Kiushiu, a distance of about 1500 miles. All of this service has until recently been supplied over open wire lines.

The demand for power in the industrial centers led to an early consideration of methods for

tribution networks. As the topography of the country limits the number of possible routes which may be utilized for pole line construction, these routes must be shared by both signal and power circuits. The signal circuits are subjected to the possibility of inductive interference and hazard from crosses inasmuch as the width of the roads and streets, particularly in the villages, prohibits adequate separation.

The natural conditions in the country have made it particularly difficult to maintain the open wire lines in a satisfactory condition and to insure continuity of service. Japan is situated in the typhoon area. During the summer months it is often visited by devastating storms which do great damage and in many cases have destroyed large sections of telephone lines.

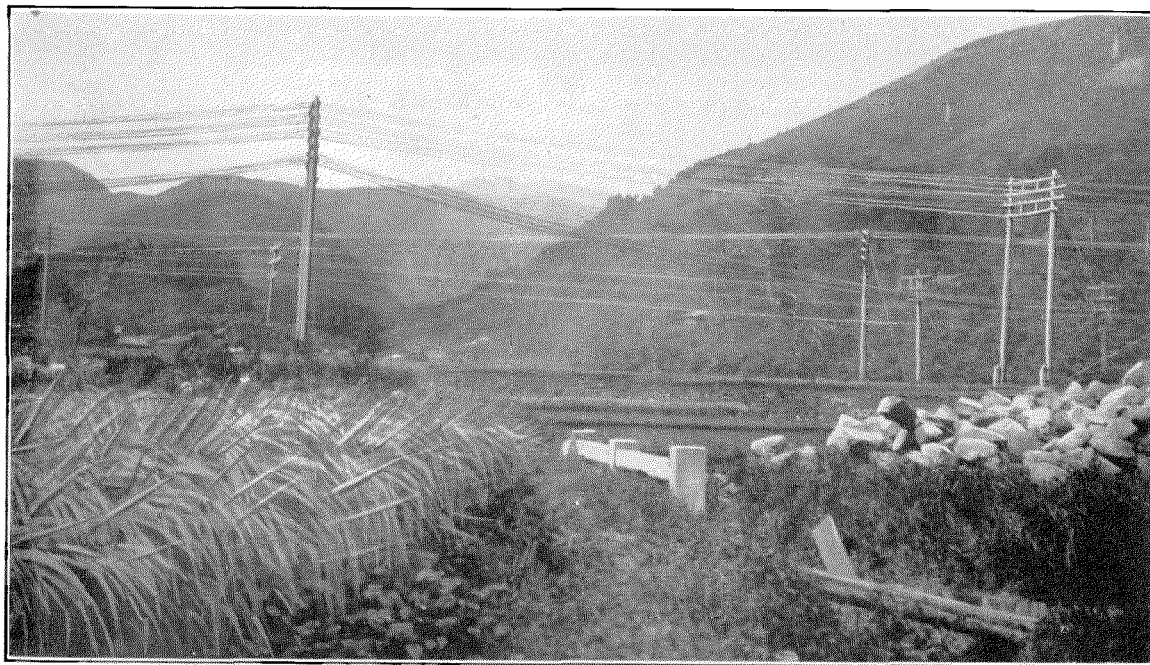

Telephone, High Tension and Low Tension Lines Near Odawara

utilizing the very extensive water power of the country and the growth in hydroelectric installations has been rapid, involving a considerable extension of the high tension electric power dis-

There are also a great many rivers which are subject to floods during the stormy seasons. These add to the difficulty of making satisfactory crossings, the river beds being unstable

and from time to time shift. They are often half a mile or more in width. Further inland, the rugged mountainous country which is often volcanic, presents other difficulties on account

and 34 quads of No. 19 A.W.G. conductors). The cables are loaded throughout with medium heavy loading on 6,000 ft. spacing, the inductance of the side circuit coils being approximately



Survey Party on Route of Tokyo-Odawara Cable

of steep grades and the frequent occurrence of land slides due to the rather rapid erosion of the mountains. In some cases it is not possible to avoid proximity to hot springs which give off sulphurous fumes, adding greatly to the corrosion of the open wire lines. The humidity throughout Japan, particularly along the coast, is very high and makes it difficult to maintain a satisfactory insulation.

In order to overcome these difficulties and relieve the serious congestion in toll traffic which existed between Osaka and Kobe, and also between Tokyo and Yokohama, the Japanese Government placed orders with the Nippon Electric Company, Limited, an Affiliated Company of the International Western Electric Company, for loaded duplex toll cables, to be installed between these cities. Both cables are of the same size and type and of approximately the same length, 22 miles. Each cable consists of 52 quads (4 quads of No. 13 A.W.G. conductors, 14 quads of No. 16 A.W.G. conductors

0.175 henry and of the phantom circuit coils 0.107 henry. The equivalents of these circuits in miles of standard cable (one mile equals an attenuation of 0.109 at 800 cycles per second) range from approximately 2 miles to about 6½ miles, depending on the gauge of the circuit.

Both the cables and loading coils were manufactured at the Hawthorne Works of the Western Electric Company at Chicago and shipped the latter part of 1921. The installation of the Osaka-Kobe section was completed in the fall of 1922, and installation is in progress on the Tokyo-Yokohama section. The Osaka-Kobe section is almost entirely underground, the only exception being a small amount of aerial construction at two river crossings and another where the cable crosses a river on a railroad bridge.

The underground conduit is about one-half concrete block and one-half iron pipe. Man-holes in Kobe and Osaka and in the larger villages and at all loading points between are

similar to the types standard in America. In the remainder of the line where concrete block conduit is used, the manholes comprise small rectangular concrete boxes placed just beneath the roadway. Where the iron pipe conduit is used no manholes are provided, but after the joint in the cable is made, a larger section of iron pipe is slipped over it and then the earth filled in over the joint. Throughout all this part of the line the roadway is dirt with some admixture of sand and gravel, so that it is not difficult to dig down to the splice whenever necessary. Some interesting features of the construction work are shown in the group photographs on pages 24 and 25.

During the summer and fall of 1922, the Japanese Government telephone engineers, co-operating with engineers of the International Western Electric Company and its Affiliated Companies, the Nippon Electric Company of Tokyo and the Sumitomo Electric Wire and Cable Works, Ltd., of Osaka, undertook a survey for a toll telephone cable project to reach from Tokyo to Odawara, a distance of about 60 miles.

The cable will include both aerial and underground construction, depending on the conditions encountered in the various localities through which it passes. Where routes through open country are possible, aerial construction will be used. Through the usually narrow and congested streets of the more populous villages and through the cities, the cable will be laid underground. This is an important measure toward avoiding possible interruptions to the service as a result of fires in the villages and towns.

This cable, with the necessary loading coils, is now being manufactured at the Hawthorne Works of the Western Electric Company at Chicago. It will be of the quadded type and consist of 54 pairs of No. 16 A.W.G. conductors and 130 guaranteed pairs of No. 19 A.W.G. conductors. All of the No. 19 gauge circuits

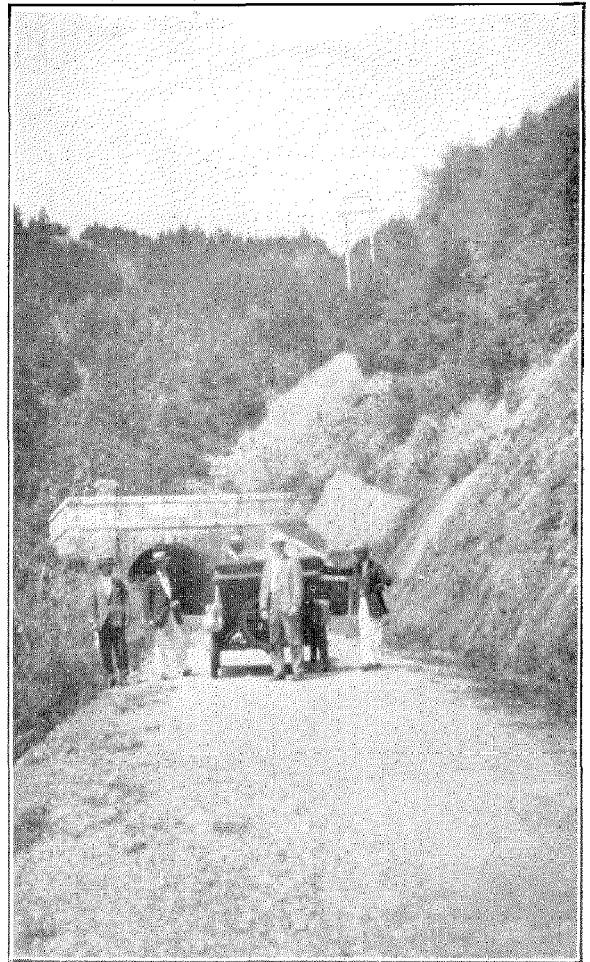

Along the Route of the Tokyo-Odawara Cable

will be suitably arranged for 4-wire operation, the No. 16 gauge conductors being used for 2-wire operation only.

Japanese telephone engineers have shown great interest and a keen insight in the recent advances which have been made in the art of long distance telephone cable transmission. The decision of the Government to undertake construction work of this nature will materially assist in the creation of an adequate toll line plant and will place Japan among the foremost countries of the world in the development and operation of long distance telephony.



# Construction Scenes Installation of OSAKA-KOBE Cable

*Cable Wagons  
Crossing Muko River*

*Resting at Top  
of a Hill*

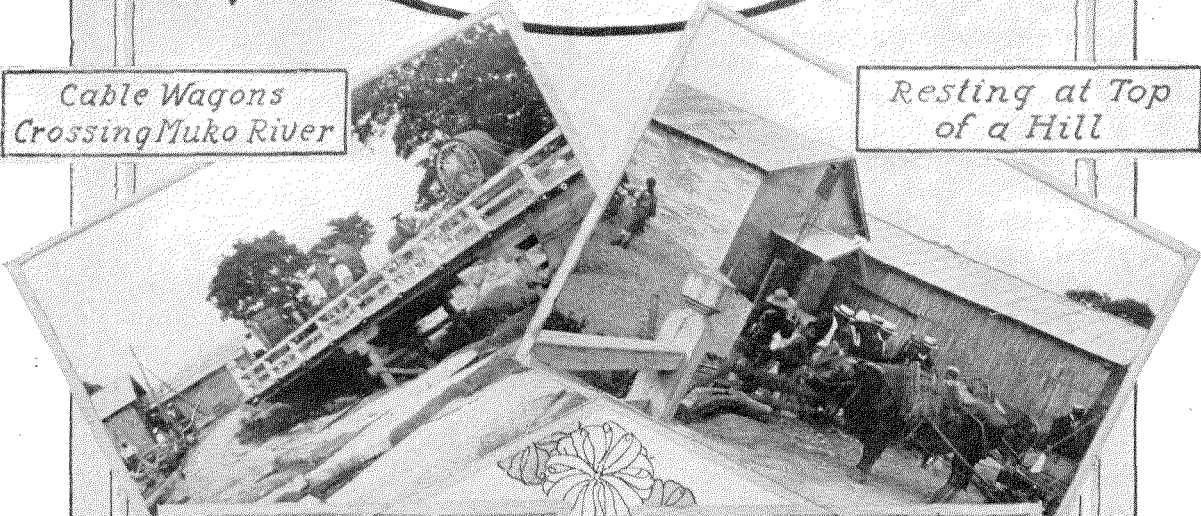

*Lowering Loading  
Coil Into Manhole*

*Getting Ready for  
Cable Pulling*



*A Hard Pull and  
Altogether*

*Carts on Roadway Leave  
Little Room for Splicers*

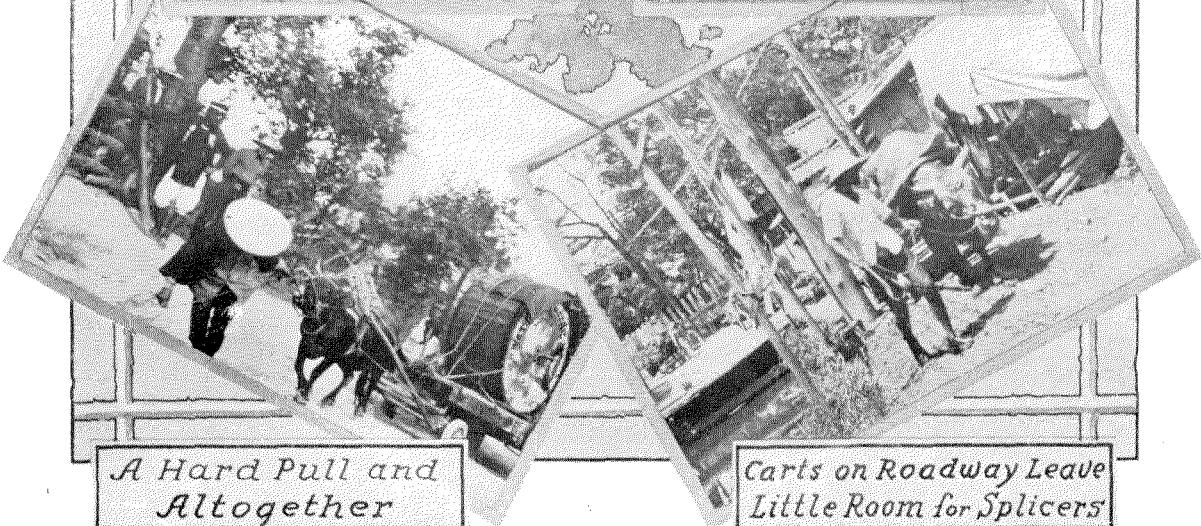

# Construction Scenes Installation of OSAKA-KOBE Cable

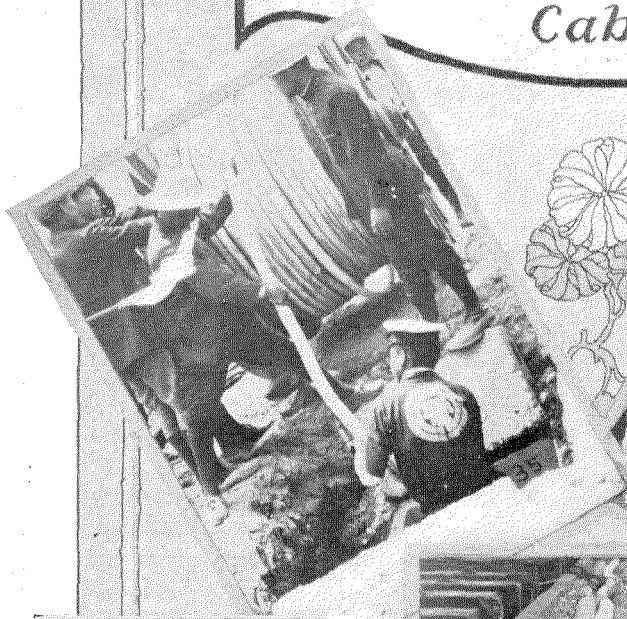

*Pulling in  
Cable*

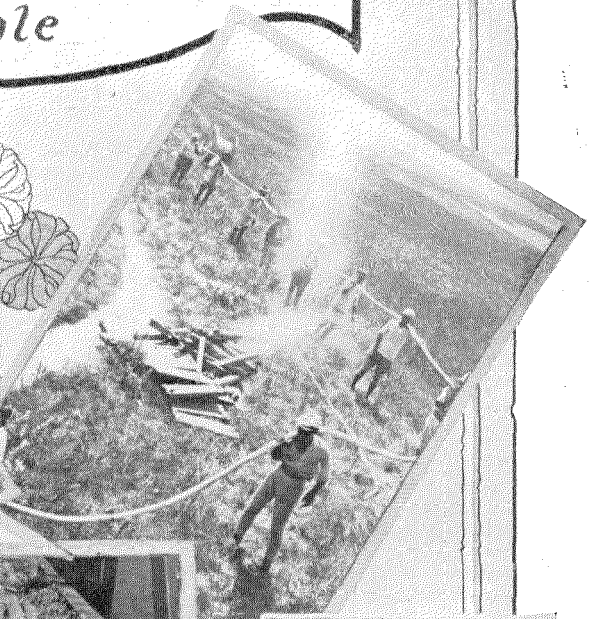

*Carrying Cable  
Along River Bank  
to Place on Bridge*

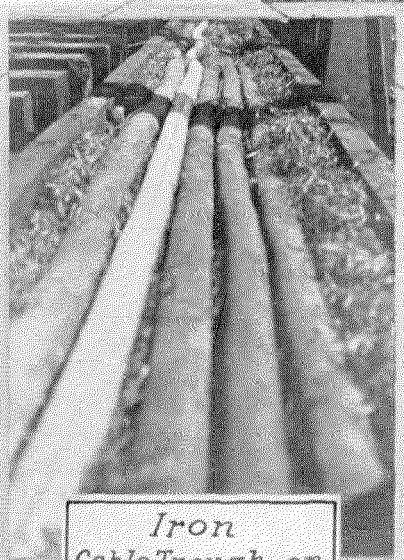

*Iron  
Cable Trough on  
Yodo River Bridge*

*Excavating—  
Cable Reels in  
Back Ground*

*Placing Cable  
on Bridge Over  
Yodo River*

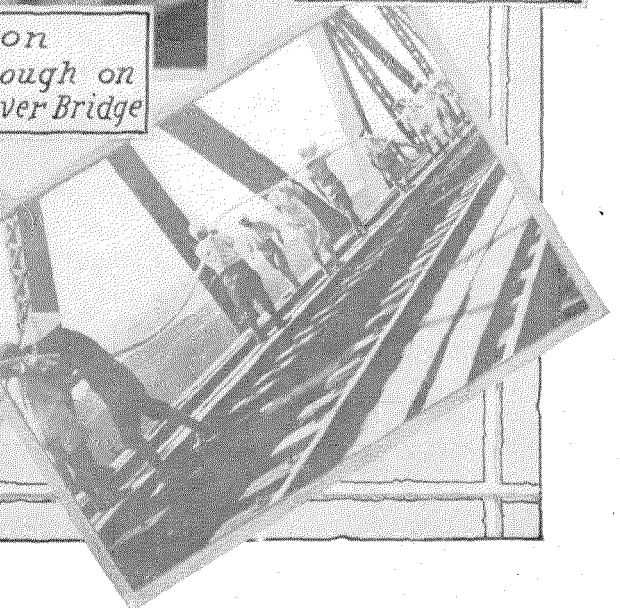
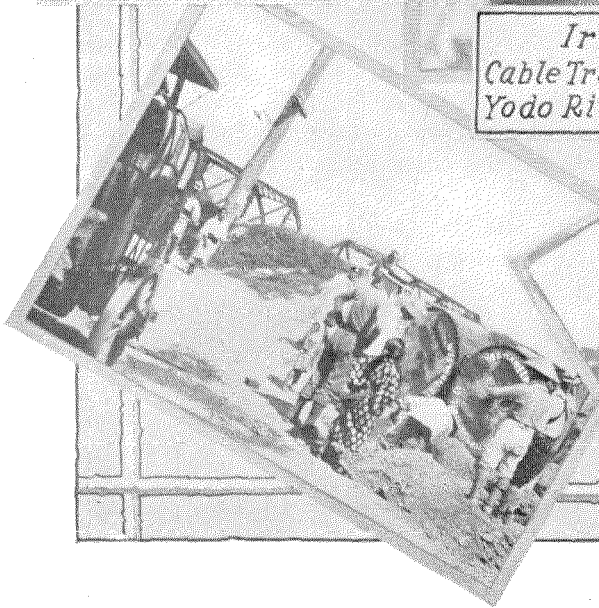

# Telephone Transmission Over Long Cable Circuits\*

By A. B. CLARK

*Department of Development and Research, American Telephone and Telegraph Company.*

**SYNOPSIS:** *The application of telephone repeaters has made it possible to use small gauge cable circuits to handle long distance telephone service over distances up to and exceeding 1,000 miles.*

*Many of the circuits in these toll cables are so long electrically that a number of effects, which are comparatively unimportant in ordinary telephone circuits, become of large and sometimes controlling importance. For example, the time required for voice energy to traverse the circuits becomes very appreciable so that reflections of the energy may produce "echo" effects very similar to echoes of sound. The behavior of the circuits under transient impulses, even when two-way operation is not involved so that "echoes" are not experienced, is very important. In order to keep within proper limits of variation of efficiency with frequency over the telephone range special corrective measures are necessary. Owing to the small sizes of the conductors, the attenuations in the longer circuits are very large. Special methods are, therefore, required to maintain the necessary stability of the transmission, including automatic means for adjustment of the repeater gains to compensate for changes in the resistance of the conductors caused by temperature changes.*

**T**HIS paper aims to present an idea of what is involved in the transmission of voice currents over long toll cable circuits. Because of the breadth of the subject covered, no attempt has been made to make the discussions of the various items complete, or to include many of the results of the experimental and theoretical work which contributed to a solution of the problems and which has involved the cooperative efforts of a large number of engineers and investigators. This paper should be considered merely as an introduction to the subject. It is hoped that subsequent papers will be presented dealing with these matters in more detail.

For the benefit of those who are not intimately in touch with telephone transmission work, the different types of circuits used in toll cables are first briefly reviewed. The important characteristics of the loading systems are then presented. Following this, various important effects encountered in long cable circuits are discussed and their reactions on the design of cable systems indicated.

In view of the discussion on telephone repeaters given in the Gherardi-Jewett paper,<sup>1</sup> which was presented before this Institute on October 1,

<sup>1</sup> Transactions of A. I. E. E., Vol. XXXVIII Part 2—Page 1287.

\* Presented at the Midwinter Convention of the A.I.E.E., New York, N. Y., February 14-17, 1923 and published in the Journal of the A.I.E.E., Vol. XLII—No. 1—January 1923.

1919, it will be assumed that the reader of the present paper is familiar with the general features possessed by the various types of such devices and, accordingly, no descriptions of them are given, their overall performance only being of interest in the present connection.

## I. DIFFERENT TYPES OF CIRCUITS

The different types of circuits used in toll cables are illustrated in diagrammatic form in Figure 1. Circuit "b" is a two-wire telephone circuit employing a 21-type telephone repeater. This type of circuit is employed only for handling connections on which but one telephone repeater is involved. Circuit "c" is a typical two-wire circuit on which the familiar 22-type telephone repeaters are operated. Circuit "d" is of the four-wire type which employs two transmission paths, one for each direction. The function of the pilot wire circuits, "a", will be taken up later.

With the exception of circuit "b", which possesses the limitation that it cannot advantageously be connected to another circuit containing telephone repeaters, the circuits shown in the figure may be connected when required to circuits of the same or other types, such as open-wire circuits, to build up various telephone connections. In general, circuits such as "c", employing 22-type repeaters, are used for handling connections of moderate lengths, while circuits such as "d", of the four-wire type, are employed for the longer connections where the transmission requirements are more severe.

In addition to employing the cable conductors for furnishing telephone service, these may also be arranged to furnish D.C. telegraph service. Apparatus for compositing the circuits so as to permit this superposition of the D.C. telegraph is indicated on the drawing. In general, the method of compositing the small gauge cable circuits is the same as that employed for compositing open-wire lines. The telegraph circuits in cable, however, operate with

a metallic instead of a grounded return and employ much weaker currents than those common on open wires. Telegraph currents employed in the cables are comparable in magnitude with the voice currents.

The two-wire circuits in toll cables employ conductors of No. 19 or No. 16 American wire

Figure 2 shows the attenuation-frequency characteristics of No. 19 and No. 16 gauge side circuits with the two types of loading. It will be observed that the M.H.L. circuits have lower attenuation for frequencies below about 2500 cycles, as should be expected from the fact that the inductance per mile introduced by the load-

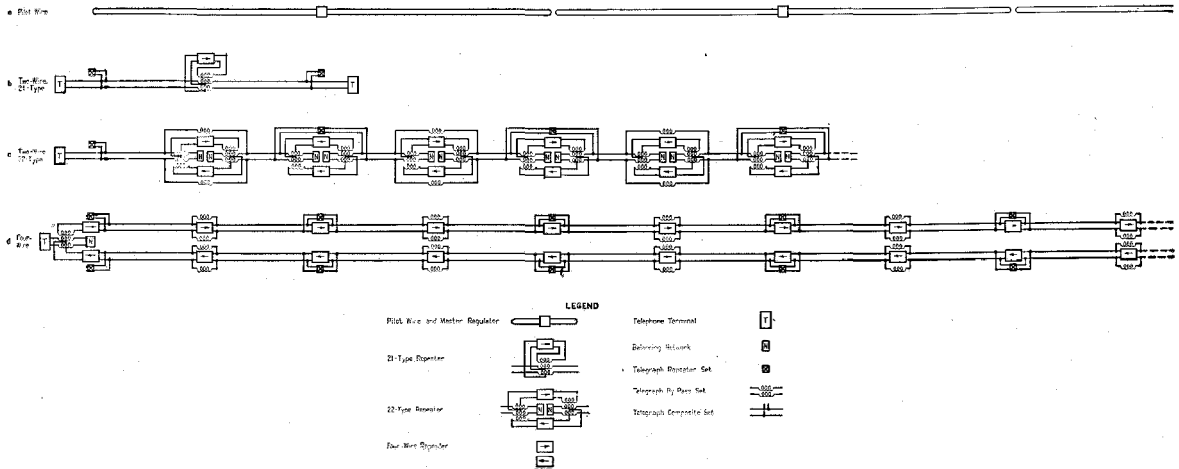

Fig. 1—Different types of cable circuits.

gauge, while for the four-wire circuits, No. 19 gauge conductors are usually employed. (No. 19 gauge weighs  $20\frac{1}{2}$  pounds per wire mile or 5.8 kilograms per kilometer. No. 16 gauge weighs twice as much.)

## II. LOADING CHARACTERISTICS

Two weights of loading are usually employed. These are commonly known as "medium heavy loading" and "extra light loading" and in this paper they will be referred to for brevity as "M.H.L." and "X.L.L." respectively. The medium heavy loading employs coils having an inductance of about 0.175 henry in the side circuits, spaced 6,000 feet apart (approximately 1.8 kilometers); the extra light loading employs coils having an inductance of about 0.044 henry for the side circuits with the same spacing. The capacity per loading section for the side circuits is approximately 0.074 mf.

The medium heavy loaded side circuits have a characteristic impedance of about 1600 ohms, and a cutoff frequency of about 2800 cycles. The extra light loaded side circuits have an impedance of about 800 ohms and a cutoff frequency of about 5600 cycles.

ing coils is greater. However, the attenuation is more nearly equal at different frequencies in the case of the X.L.L. circuits, this being particularly true at the higher voice frequencies.

Another important characteristic of loaded circuits when repeaters are involved is their velocity of propagation. Since the inductance per mile of X.L.L. circuits is only  $\frac{1}{4}$  of that for M.H.L. circuits, the velocity of propagation is twice as great for the X.L.L. circuits as indicated by the well-known approximate formula—

$$V = (LC)^{-\frac{1}{2}}$$

Where  $V$  is the velocity in unit lengths per second,  $L$  is the inductance in henries per unit length and  $C$  is the capacity in farads per unit length, the unit of length for expressing velocity, inductance and capacity being the same.

The X.L.L. type of loading is best for the longer circuits, because of the more nearly equal attenuation of currents of different frequencies, its higher velocity of propagation which permits more efficient operation of telephone repeaters, and also its comparative freedom from transient effects, as will be explained in more detail later. For the shorter circuits where these effects are

not so important, the M.H.L. type is satisfactory electrically and is therefore employed since fewer repeaters are required owing to the lower attenuation.

### III. "ECHOES"

As is well known, whenever points of discontinuity or unbalance occur in a telephone circuit, reflections of electrical energy take place.

It should be understood that the echo effects which are experienced in long repeated circuits are due to the same unbalances, which, on shorter circuits, bring in trouble due to "singing", or distortion of the voice waves due to "near-singing". On electrically long circuits, due to the comparatively great time lags involved, the echo effects become of controlling importance. Consequently, it is, in general,

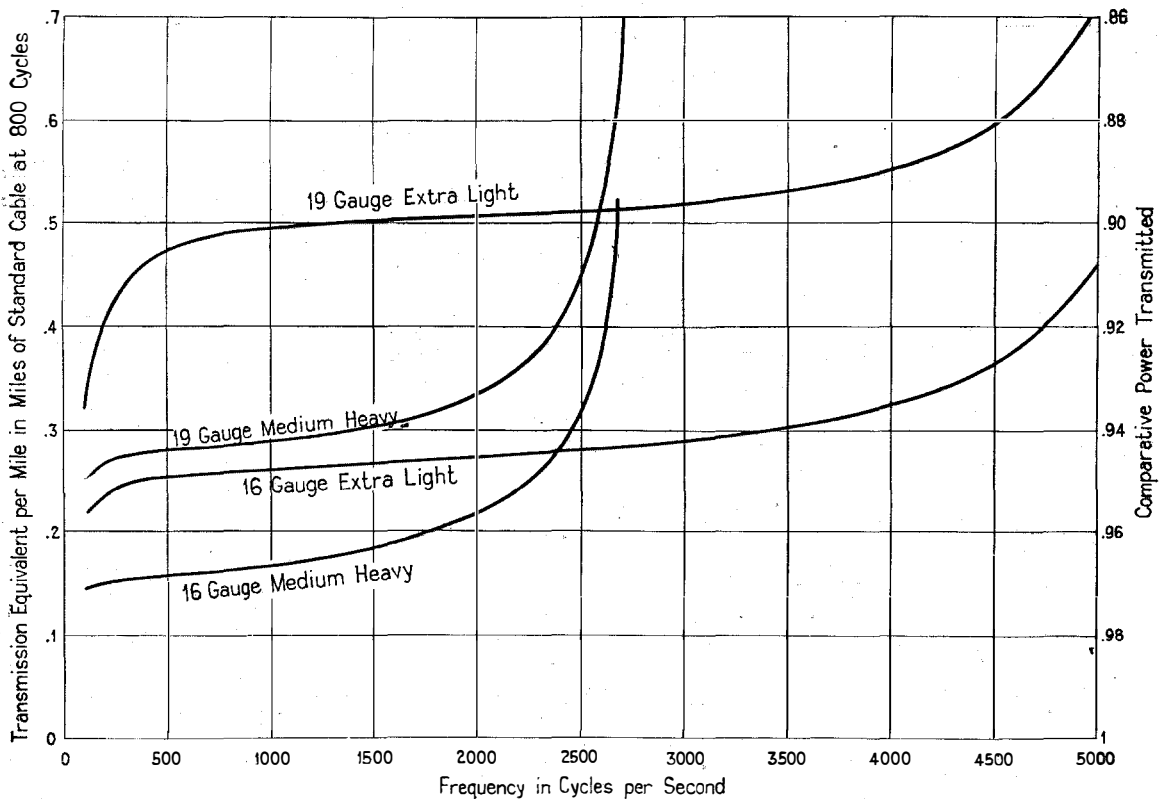

Fig. 2—Attenuation-frequency characteristics of loaded cable side circuits.

If the circuit is long so that the time for transmission is appreciable and if also the losses are not so great as to cause the reflected energy to become inappreciably small before it reaches the ear of a listener, echo effects will be experienced. While, in general, reflections take place in any telephone circuit actual echoes are never appreciable unless telephone repeaters are employed. In the case of circuits with repeaters, the electrical length is usually great enough so that an appreciable length of time is required for the voice currents to travel to some discontinuity and back again. Furthermore, the repeater gains keep the reflected voice currents large.

necessary on such circuits to work the repeaters at gains well below those at which "singing" or distortion due to "near-singing" is experienced.

The echo effects which occur in four-wire circuits will first be discussed, since the effects are simpler in this case than they are in the case of a two-wire circuit.

Figure 3-a shows a four-wire circuit in diagrammatic form, while Figure 3-b shows the echoes which are caused by the unbalances at the terminals. When someone at terminal A talks to a person at terminal B, the heavy line in Figure 3-b shows the direct transmission, which takes place over the top pair of wires in

Figure 3-a. When this current reaches the distant terminal, part of it goes to the listener while another part, due to the imperfections of balance between the line and network at that terminal, travels back through the pair of wires at the bottom of Figure 3-a toward terminal A. The talker at terminal A will hear this current as an echo if the four-wire circuit is long enough so that the time lag is appreciable. This first echo

meters) this energy must have traveled the distance around the world before becoming inaudible.

In order that a circuit will be satisfactory for regular telephone use, the echoes must be kept small as compared to the direct transmission. Evidently if the first echoes are small as compared to the direct transmission, the later echoes will be much smaller in magnitude. For ex-

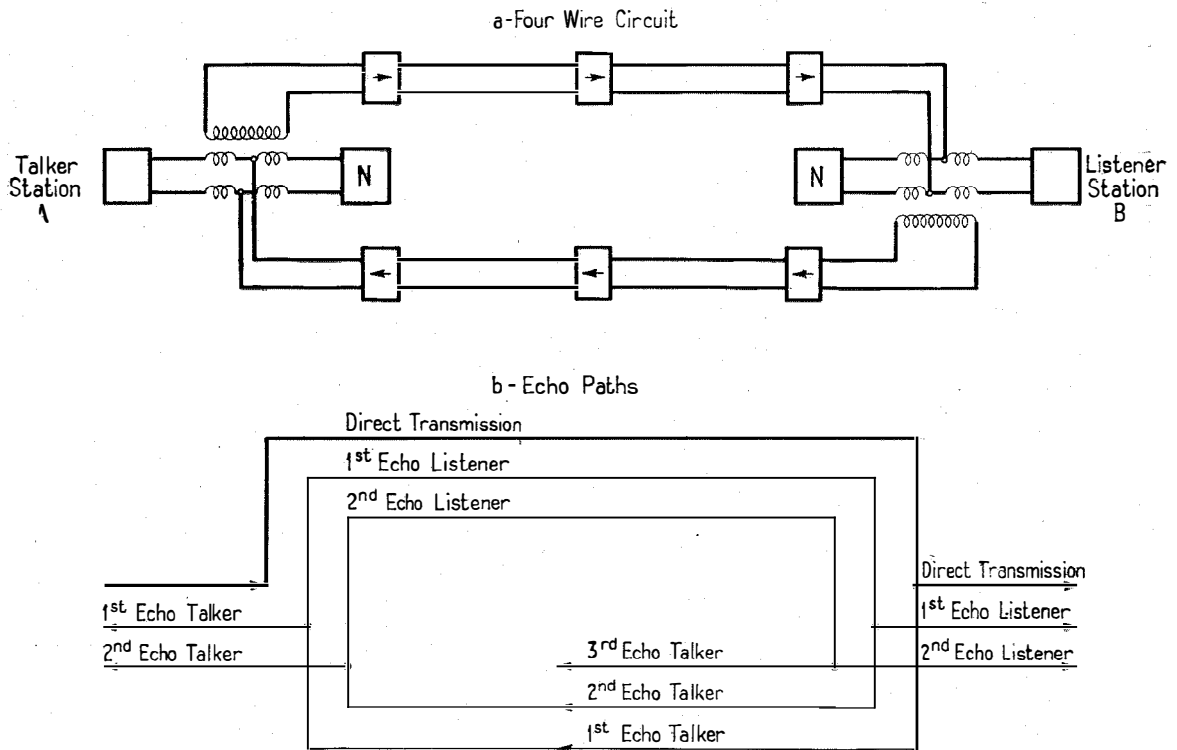

Fig. 3—Echo paths in four-wire circuit.

heard by the talker divides at terminal A in the same way as did the direct transmission at terminal B, part of it taking the upper path of figure 3-a back toward the listener. The listener will, therefore, first receive the direct transmission and then a little later an echo. This process is repeated producing successive echoes which are received at both terminals A and B as indicated.

A four-wire circuit 1000 miles (1600 kilometers) long has been set up in which the balances at the two ends were deliberately made poor so as to exaggerate the effects. More than a dozen successive echoes could be heard before they became inaudible. Since for each echo the voice energy traveled 2000 miles (3200 kilo-

ample, if the power in the first echo, heard by the listener, is 1-10 as great as the directly transmitted power, the second echo will have only 1-100 as much power, the third echo 1-1000 etc.

The velocity of an X.L.L. circuit is approximately 20,000 miles (32,000 kilometers) per second, while the velocity with M.H.L. is only 10,000 miles (16,000 kilometers) per second. It is thus seen that the time required for voice energy to travel from one end to the other of an X.L.L. circuit 1,000 miles (1600 kilometers) long is 0.05 second. An echo traveling from one end of the circuit to the other and back again would, therefore, arrive 0.1 second behind the

impulse which started the echo. With M.H.L. circuits these times are of course doubled.

Figure 4 illustrates the condition existing in a two-wire circuit. For simplicity, the first echoes only are shown, the later echoes being less important owing to their comparative weakness as explained above. In such a circuit reflec-

ities between the "talker" station and the nearest repeater. These reflections have not been indicated since their effects are of negligible importance. Six sets of echoes affect the "listener". Both for the echoes affecting the "talker" and the "listener", the dotted lines indicate reflections from a number of different

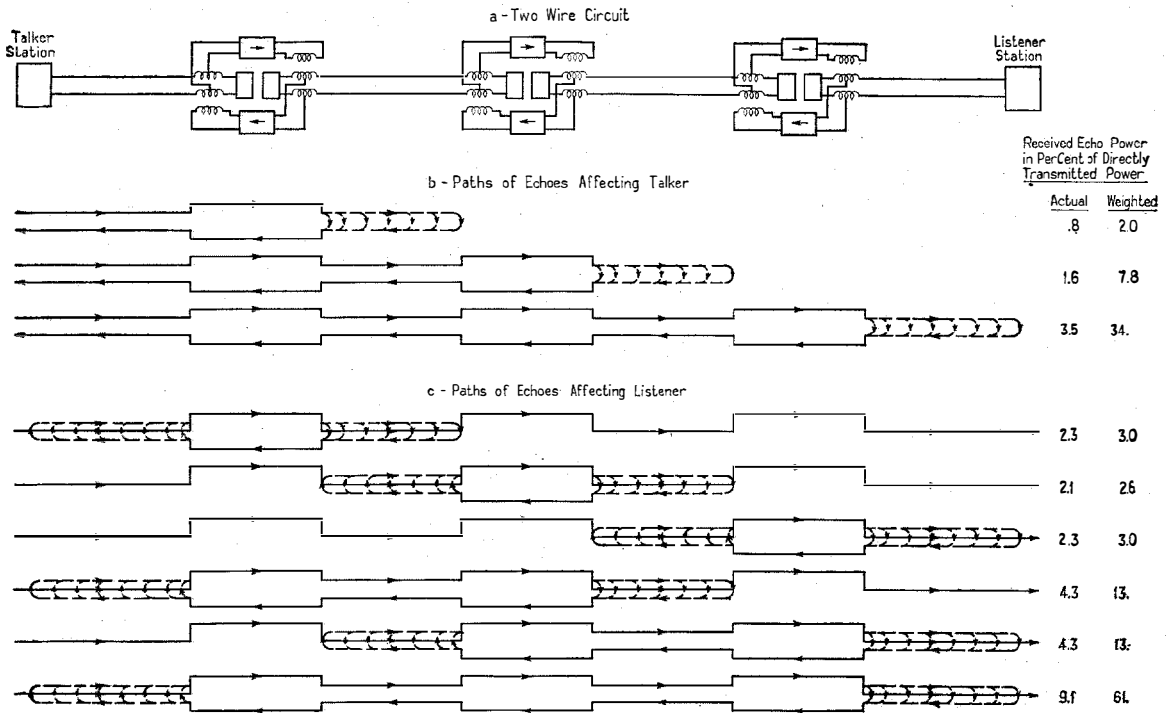

Fig. 4—Echo paths in two-wire repeated circuit.

tions occur not only at the terminals, but at a number of intermediate points in the circuit, the condition of balance between the networks associated with the telephone repeaters and the corresponding lines being necessarily imperfect. This imperfection of balance is due in part to lack of perfect balance of the apparatus closely associated with the repeater, and in part to the small irregularities which exist in the make-up of any practical loaded line. A further cause is the reflection at the adjacent repeaters, due to the difference between the repeater impedance and the line impedance.

It will be noted that three sets of echoes are shown which affect the "talker". In addition to these which involve one or more repeaters, a comparatively small amount of power is reflected back to the "talker" from the various irregular-

ities between the "talker" station and the nearest repeater. These reflections have not been indicated since their effects are of negligible importance.

Six sets of echoes affect the "listener". Both for the echoes affecting the "talker" and the "listener", the dotted lines indicate reflections from a number of different points where irregularities exist as explained above. In circuits containing a larger number of repeaters the numbers of sets of echoes affecting the talker and listener are, of course, greater. The number of sets of first echoes affecting the talker is equal to the number of repeaters. The number affecting the listener is equal to  $\frac{N(N+1)}{2}$  where  $N$  is the number of repeaters.

It is, of course, obvious, that, for either four-wire or two-wire circuits, if the circulating energies are large, they will have an adverse effect on the ability of two people to carry on a conversation over a telephone circuit. Not only will the transmission received by the listener be adversely affected, but the talker will be considerably distracted, particularly when

the time of the transmission over the circuit is so long that he hears a distinct echo of his words.

Experiments have shown that the effects of the echoes both on the listener and talker become more serious as their time lag is increased. This means that as telephone circuits are made longer it is necessary either to improve balances or to design the telephone circuits so that the velocity of propagation will be higher. This necessity for making the velocity of propagation high on long circuits was one of the principal reasons which led to the selection of extra light loading for the longer circuits.

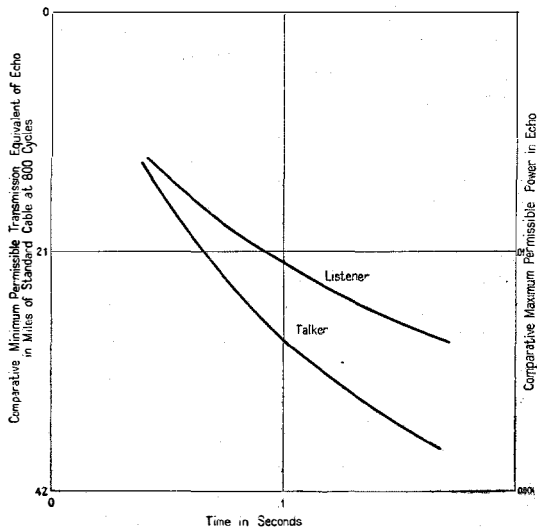

Fig. 5—Effect of echoes on talker and listener.

Figure 5 shows very approximately how the effects of the echoes vary with the length of time by which they are delayed. One curve is given for the effect on the "talker", another for the effect on the "listener". Both curves indicate, for various time lags, the comparative magnitude of echoes which are small enough to be inappreciable when ordinary telephone conversations are carried on. The curve applying to the "listener" is referred to the direct power which he receives, while the curve for the "talker" is referred to the power which he puts into the circuit.

In Figure 4 showing the condition existing in a two-wire circuit, the comparative magnitudes of the power in each echo are indicated, a typical condition of the lines being assumed. For the listener the echo power is expressed as a per-

centage of the directly transmitted power which he receives. In the case of the talker, it is expressed as a percentage of the power which he puts into the circuit. In addition to the comparative amounts of power in each echo, "weighted" magnitudes are indicated. The "weighted" figures take account of the fact that the effects of a given amount of echo become more serious as the time lag is increased as indicated by the curves in Figure 5. Referring to Figure 4, it will be noted that the "weighted" magnitudes of the power in the echoes are largest for the long paths. In general, this condition exists in the case of the majority of long two-wire repeatered circuits in cable.

In order to compare the behavior of a four-wire circuit with a two-wire circuit, consider again Figures 3 and 4. It will be observed that in Figure 4, showing the two-wire circuit, there is one echo received by the talker which travels from one end of the circuit to the other. Referring to Figure 3 showing a four-wire circuit, it will be seen that this echo corresponds to the one labelled "1st echo talker". Similarly for the echoes affecting the listener, the echo whose path is longest in the two-wire circuit corresponds to a similar echo in the four-wire circuit. Since many additional echo paths are present in the two-wire circuit, it is evident that, other things being equal, the overall transmission result obtainable from the two-wire circuit cannot be made as good as that obtainable from the four-wire circuit.

In a two-wire circuit it is, of course, obvious that any defect in the lines which will cause a large irregularity will result in a considerable impairment of the circuit. Figure 6 shows the effect of omitting a loading coil at an intermediate point in a circuit, the conditions in this circuit being assumed to be the same as those in Figure 4 with the exception of the omitted loading coil. The omitted loading coil introduces a large impedance irregularity which causes certain of the echoes to be made much greater in comparative magnitude as indicated. In order to reduce the echoes in the circuit with the omitted loading coil sufficiently to make the circuit satisfactory for telephone use, it is necessary to reduce the repeater gains. In this particular case it is necessary to lower the total gain about 4 miles, which increases the overall transmission equivalent of the circuit from about



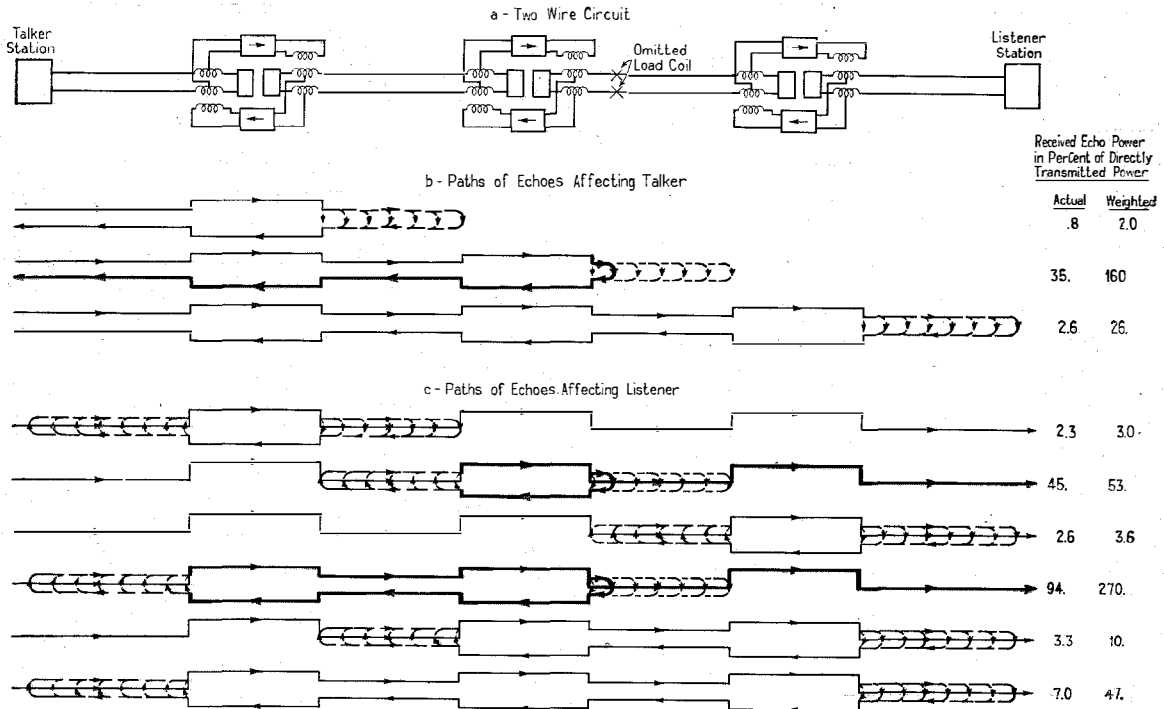

Fig. 6—Echo paths in two-wire repeated circuit with omitted loading coil.

10 miles for the normal condition to about 14 miles for the condition with the omitted loading coil.

Before leaving the subject of "echoes" it is believed that it will be of interest to point out some of the important characteristics of two-way repeated circuits which result from these effects.

1. The minimum permissible net equivalent (total loss minus total repeater gain in one direction) of a four-wire circuit of a given length depends only on the velocity of propagation and the balance conditions at the terminals of the circuit. When conditions are such that the balance conditions cannot be improved, increasing the velocity of propagation will enable a lower net equivalent to be obtained.
2. In the case of a two-wire circuit with reasonably smooth lines, the exact location of the repeaters and the gains at which individual repeaters are worked have little effect on the overall result so far as echo effects are concerned. This follows from the fact that the echo paths from end to end of such a circuit are usually of more

importance than the shorter echo paths. Evidently, moving the individual repeaters about or altering their gains has no effect on the longest paths, provided the total gain in each direction is kept constant.

3. In the case of a two-wire circuit of a given length, the velocity of propagation and smoothness of the lines are of most importance in limiting the possible net equivalent, the line attenuation being of secondary importance.

For example, in the case of the transcontinental (New York-San Francisco) open-wire line, the original circuit was loaded. (Although this paper deals particularly with repeaters on cable circuits this example was selected because it so well illustrates this point.) The velocity of propagation was such that voice currents required about 0.07 second to travel from one end of the circuit to the other. The total line equivalent was equal to about 56 miles of standard cable. By applying repeaters to this circuit it was possible to obtain a working net equivalent of about 21 miles.

The unloading of the circuit increased the velocity so that the time of transmission was reduced to 0.02 second, about 0.3 of the time required when the circuit was loaded. The attenuation was increased so that the total line equivalent without repeaters was equal to about 120 miles of standard cable, a little more than twice the equivalent of the loaded circuit. By applying repeaters of an improved type to this circuit so as to keep the quality good in spite of the increased attenuation and correspondingly increased gain required, it was possible to obtain a working equivalent of only 12 miles of standard cable as compared to the original figure of 21 miles. This means that with the same amount of speech power applied at one end, the power received over the non-loaded circuit is 7 times as large as that formerly received over the loaded circuit.<sup>2</sup>

The example of the transcontinental line, above, may well bring up the question as to why it is that cable circuits are loaded. This is done for two reasons: In the first place, it is in general cheaper to load cables than it is to make up the increased attenuation by means of more repeaters. In the second place the loading lessens the amount of distortion introduced by the cable circuits. In the case of open wire circuits, their series inductance is sufficient to keep the distortion small.

#### IV. ATTENUATIONS AND CORRESPONDING AMPLIFICATIONS—POWER LEVELS

Owing to the fact that the weight of loading applied to the longest cable circuits is very light, the attenuation of such circuits is very great. A four-wire X.L.L. 19 gauge circuit 1,000 miles long has the enormous line equivalent of 500 miles of standard cable. The total power amplification applied to this circuit by the repeaters exceeds  $10^{17}$ . This amount of amplification is more than enough to talk half way around the world at the equator using non-loaded No. 8 Birmingham Wire Gauge open-wire commonly employed for handling very long distance business (No. 8 B.W.G. copper weighs 435 pounds per wire mile, or 120 kilograms per kilometer).

In order to obtain an idea of how enormous

<sup>2</sup> A material improvement in the telephone quality was also effected by the unloading of the circuit.

this amplification is, assume that no repeaters were employed and an attempt were made to apply enough power at one end of the circuit to enable the normal amount of speech power to be received at the distant end. The power applied at the sending end would then have to be about 50 quadrillion times as great as the total power which it is estimated is radiated by the sun.

While the total amount of power amplification is very great, the amount of amplification put in at any one point is, of course, limited. The maximum amount of power at a repeater point is limited partly by the capacity of the vacuum tubes and partly by the power carrying capacity of the telephone circuit, including the loading coils. (By power carrying capacity is here meant the ability to carry voice waves without serious distortion.) It is also necessary to limit this power to avoid serious crosstalk into other circuits.

In addition to these limitations on the maximum power, it is necessary to insure that the power at any point in a circuit does not become too small. Otherwise, the normal voice power will not be sufficiently large as compared to the power of crosstalk from other circuits. It is, furthermore, evident that the ratio of power from extraneous sources, such as paralleling telegraph circuits and power supply circuits, to the voice power should be as small as practicable in order to keep the circuits free from noise.

Figure 7 will give an idea of how the telephone power attenuates and is amplified in a long circuit. The circuit shown is similar to those which it is proposed to employ between New York and Chicago, *i. e.*, it is a four-wire X.L.L. 19 gauge circuit largely in aerial cable, equipped with automatic means for compensating for the changes in attenuation caused by the effects of varying temperatures on the resistance of the conductors. (These automatic devices are described in a later section of this paper.) For simplicity, the power levels for transmission in one direction only are shown. The solid lines show the power levels when the temperature is a maximum so that the attenuations are greatest, while the dotted lines show the levels when the temperature is a minimum and the losses are, therefore, also a minimum. The shaded areas between the lines represent the changes which take place during the course of a year.

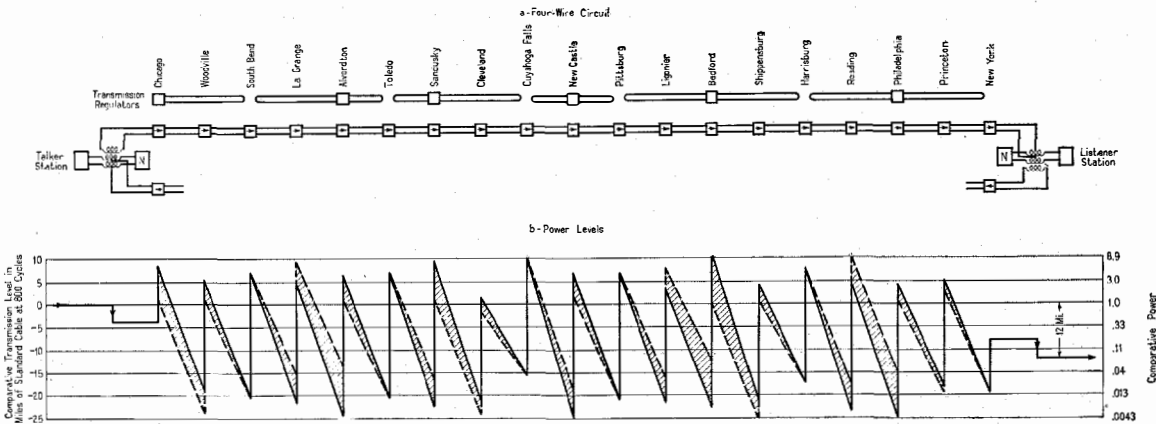

Fig. 7—Power levels in New York-Chicago extra light loaded four-wire circuit.

When the requirement is introduced that transmission must take place in both directions it is found that at the points in the circuits going in one direction where the power is a maximum, the power going in the opposite

direction, the other for transmission in the opposite direction, taking care that these two bunches of conductors are separated electrically as far as possible. In the loading coil pots the coils employed on the circuits for transmission

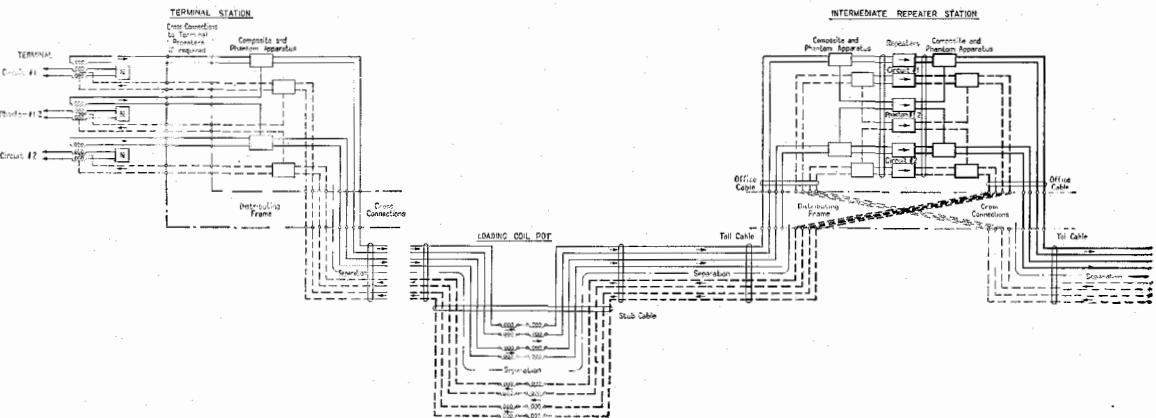

Fig. 8—Four-wire system—Segregation method to reduce cross-talk.

direction in other circuits is a minimum. This represents a very bad condition for crosstalk from one four-wire circuit into another. In order to overcome this the conductors carrying strong voice power are kept electrically separated or shielded from those carrying weak power as indicated schematically in Figure 8. The conductors which carry strong voice power are shown heavy, while those carrying weak power are shown light. In the cable proper the separation is effected by grouping the conductors in two bunches, one for transmission in one

direction and the other for transmission in the opposite direction, taking care that these two bunches of conductors are separated electrically as far as possible. In the offices the separation is effected by arranging the repeaters and other apparatus as shown in the figure. It will be observed that no special separation is shown between the repeaters transmitting in the two directions, since to keep the conductors carrying weak power separated from those carrying strong power, it is merely necessary to keep the apparatus and cabling connected to the inputs of the repeaters separated from the apparatus and the cabling connected to the repeater outputs.

## V. STEADY STATE DISTORTION

The possible sources of distortion may be divided broadly into (1) repeaters and auxiliary apparatus and (2) the lines.

With reference to the distortion introduced by the repeaters, the vacuum tube is fortunately very nearly perfect, at least in so far as concerns practical telephony. At one time, for purposes of test, a circuit was set up containing 32 vacuum tubes in tandem. On this circuit the distortion was so small that when listening to ordinary conversation it was difficult to detect any difference in the quality of transmission before and after traversing the 32 vacuum tubes.

It is beyond the limits of this paper to enter into the problems of design which were encountered in the development of the repeater circuits. For the present purpose of considering the overall performance of repeated circuits in cable no serious error will be made if it is assumed that the complete repeater circuits meet the requirements for an ideal repeater as set up in the Gherardi-Jewett paper.

Considering next the lines, it is necessary to make the loading very regular so that balance difficulties will not cause an undue amount of trouble on two-wire circuits. Regularity of the loading is also essential in order to avoid irregular transmission of different frequencies. In order to secure this regularity of loading, it is necessary that the spacing between loading points be made very uniform and that the cable be so manufactured that the electrostatic capacity of its circuits be held within close limits. The loading coils themselves must be closely alike in their electrical properties and furthermore, the coils must be stable, *i. e.* these electrical properties must not change appreciably due to the passage of voice currents or other currents required for cable operation through them.

Next, it is necessary to design the repeaters and associated apparatus used on the longer circuits, particularly the four-wire circuits, so as to put in different amounts of gain at different frequencies, thereby making the overall transmission at different frequencies approximately constant in spite of the fact that the loss introduced by the cable circuits at different frequencies is not constant. Figure 9 shows the overall or net transmission equivalent plotted against frequency for an X.L.L. four-wire cir-

cuit 1080 miles long (1750 kilometers) which was set up for purposes of test. The heavy line in this figure shows the overall result which was actually obtained with repeaters and associated

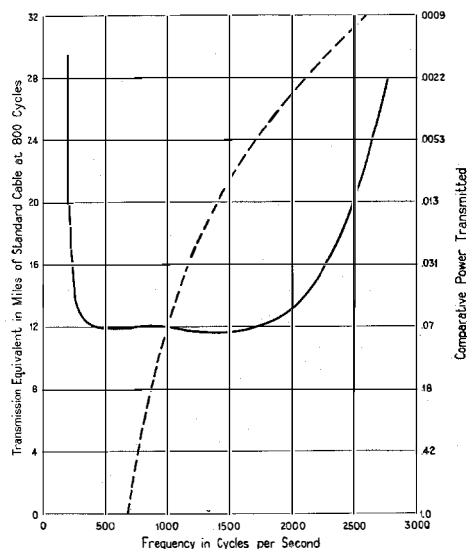

Fig. 9—Transmission frequency characteristic of long extra light loaded four-wire circuit.

apparatus designed to equalize the transmission, while the dotted line shows what the characteristic would have been had the repeaters introduced exactly the same amount of gain at all frequencies.

## VI. TRANSIENTS

In comparatively short telephone circuits, good quality will usually be assured if the transmission, as measured at different single frequencies within the voice range, is kept approximately constant. For electrically long circuits, however, this is not sufficient. Not only must the "echo" effects be kept within proper limits, but consideration must be given to the fact that when electrical impulses are applied to such circuits, peculiar transient phenomena are experienced. These transient phenomena occur in equal degree in two-way circuits and in circuits arranged to transmit in one direction only, that is, they are not related to "echo" effects.

In order to give an idea of the nature of some of the transient effects, some oscillograms are shown in Figures 10, 11, 12 and 13. Figure 10 shows an 1800-cycle current before and after traversing a cable circuit of an earlier type 1050 miles (1700 kilometers) long. This particular circuit was No. 13 A.W.G. weighing 82 pounds

per wire mile (23 kilograms per kilometer) loaded with inductance coils of 0.2 henry spaced 1.4 miles (2.25 kilometers) apart and contained 6 one-way repeaters. It will be noted that the first sign of the arrival of the received current occurs about 0.1 second after the wave is put on

it becomes the same as that of the source. The magnitude of the received current also increases until at point "b" it reaches a value corresponding to the steady-state transmission equivalent of the line. The interval "a-b" is determined solely by the structure of the line and has nothing

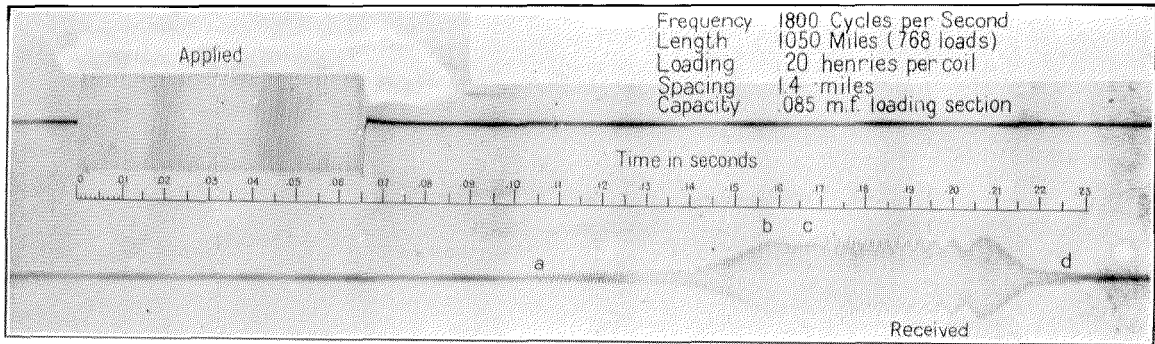

Fig. 10—Transients in 13-gauge medium heavy loaded cable.

at the sending end. This time checks with the formula for velocity given above. The time required after arrival of the first impulse (point "a") until the wave builds up to a practically steady-state condition at point "b" is about 0.055 second. The steady condition is inter-

rupted at point "c" by the arrival of the break transient, the time interval between points "b" and "c", representing the period when the wave is in the steady-state, being only 0.01 second.

The dying-out process can be considered to be caused by the application at the time of break of a second current equal in value to the current originally applied but opposite in phase, so that

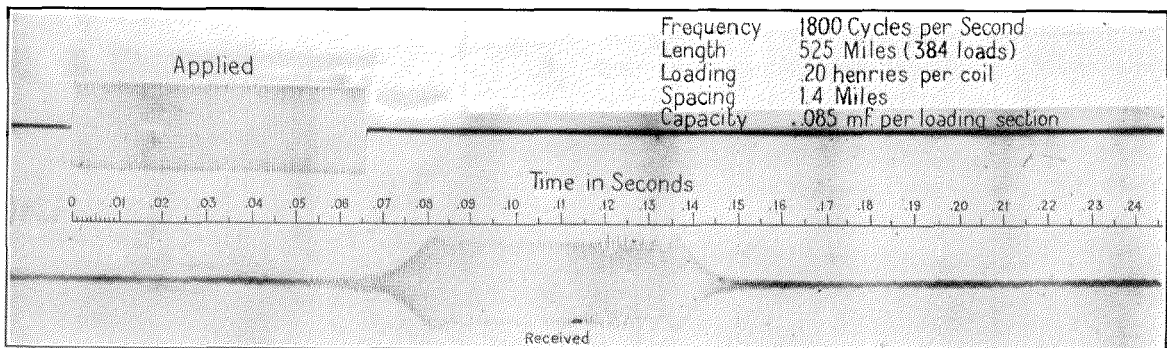

Fig. 11—Transients in 13-gauge medium heavy loaded cable.

rupted at point "c" by the arrival of the break transient, the time interval between points "b" and "c", representing the period when the wave is in the steady-state, being only 0.01 second. The wave required about 0.055 second to die out—interval between points "c" and "d".

It is interesting to note the behavior of the current during the building-up and dying-out intervals. During the building-up process the frequency of the received current increases from a very low value at point "a" until at point "b"

the sum of the two currents will be zero. Hence, it is to be expected that the received current will disappear by adding to the steady-state a transient similar to the building-up transient in the interval "a-b". That this is true is indicated by the behavior during the interval "c-d". At first the low frequency current of the break transient produces a displacement of the axis of the steady current. As the frequency approaches a steady value a beating effect becomes noticeable which grows smaller until complete

opposition of phase obtains and the received current disappears.

Figure 10 clearly indicates that a pulse of voice current having a frequency in the neighborhood of 1800 cycles, even though received in

sient effect is proportional to the length of the circuit furnishes the reason why a short circuit may give tolerably good results, while a long circuit gives poor results.

Figure 12 is of interest as indicating what takes

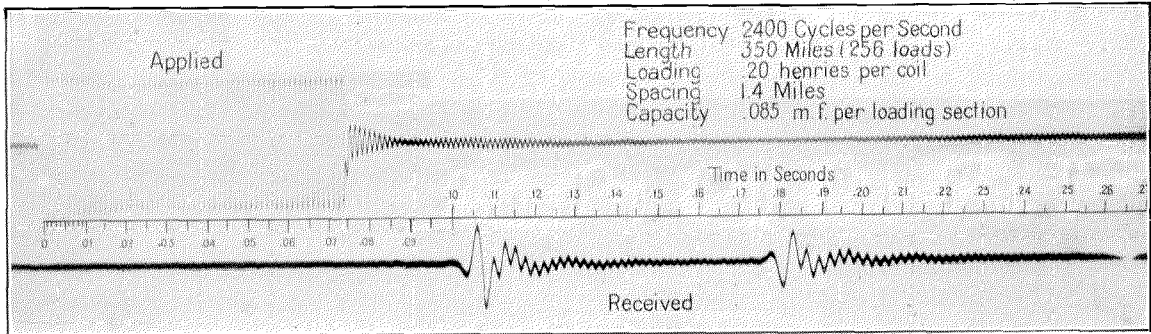

Fig. 12—Transients in 13-gauge medium heavy loaded cable.

proper volume if steadily applied, would be badly distorted.

When carrying on a conversation over such a circuit as this, distortion of the voice waves makes understanding difficult while peculiar metallic ringing sounds are very noticeable.

place when we apply a current at the sending end of the circuit whose frequency is so high that no appreciable amount of the steady current will pass through the circuit. In this case only transient oscillations appear at the receiving end of the circuit. This particular circuit

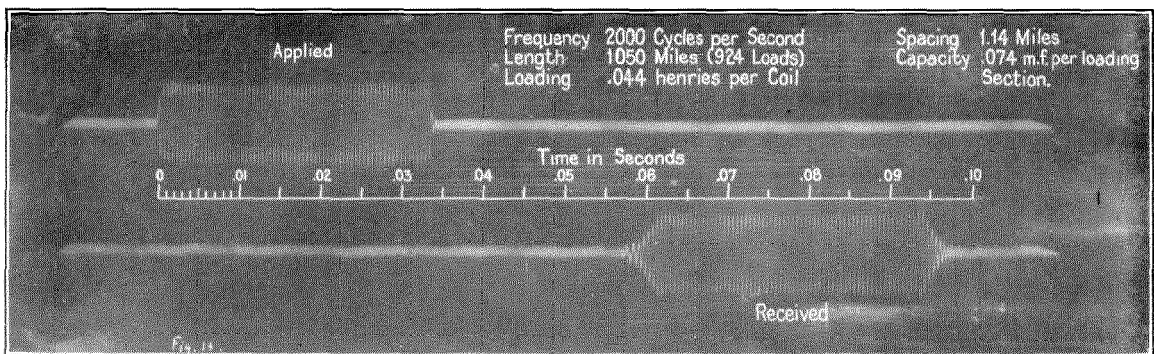

Fig. 13—Transients in 19-gauge extra light loaded cable.

Next consider a circuit of the same character with half the length. The effect of a circuit of this length on an 1800-cycle wave is shown in the oscillogram of Figure 11. It will be observed that the propagation time has been cut in half while the lengths of time for the received wave to build up and die out have also each been cut in two. This checks with theoretical work, indicating that the severity of this type of transient effect is directly proportional to the length of the circuit. This fact that the tran-

was of the same type as the above, although it was only 350 miles long (570 kilometers).

A large number of oscillograms of this sort have been taken in connection with the study of these transient effects. From these and theoretical considerations<sup>3</sup> it has been proved that the effects in a given circuit are much worse at high frequencies than at low frequencies, the

<sup>3</sup> John R. Carson—"Theory of the Transient Oscillations of Electrical Networks and Transmission Systems". Transactions of A. I. E. E. Vol. XXXVIII, page 407.

severity of the effects, within certain limits, being a function of the ratio of the frequency being transmitted to the frequency of cutoff of the loaded circuit. The gauge of the circuit has practically no effect.

Since in order to give good quality it is necessary to transmit fairly well all frequencies up to at least 2000 cycles, it is obvious that on long circuits in order to keep the transient effects small, the frequency of cutoff must be kept high. In order to do this, it is necessary either to make the loading coils of very low inductance or to space them very close together. This is another one of the reasons why extra light loading was adopted for the long cable circuits. (It will be remembered that the inductance of the side circuit loading coils is only 0.044 henry and the spacing 6000 feet.)

The effect of lighter loading on the transient behavior of telephone currents, is shown in Figure 13, which shows a 2000-cycle wave transmitted over an X.L.L. circuit about 1050 miles (1700 kilometers) long. This circuit contained 23 one-way repeaters. It will be observed that both the building-up and dying-out transient periods are very much reduced, which means that all pulses of telephone currents up to at least 2000 cycles will pass through such a circuit with very little distortion.

## VII. STABILITY

As has been pointed out, the magnitude of the line transmission loss in a repeatered circuit is of comparatively small importance in determining its possible transmission equivalent, whether the circuit be worked on a four-wire or two-wire basis. However, it is of extreme importance to be sure that the repeater gains are kept adjusted so as to compensate exactly for a large part of the transmission loss in the circuit, so that the difference between the total loss in the circuit and the total gain, which represents the net equivalent of the circuit, will be kept constant.

On certain of the long circuits this difference is very small as compared to the quantities which are subtracted. For example, in the case of a 1000-mile four-wire circuit using X.L.L. 19-gauge conductors, the total line transmission loss is about 500 miles. Not counting the gain required to make up for losses in apparatus and

office cabling, the total gain is about 488 miles, the difference, 12 miles, representing the net equivalent. Evidently only a very small percentage change in either the transmission losses or the gains will have a large effect on the net equivalent. This represents about the most severe condition. Some examples of less severe conditions are—

2-Wire 19-gauge M.H.L. circuit 200 miles long (320 kilometers). Line equivalent 58 miles. Repeater gain exclusive of gain required to make up for loss in apparatus and office cabling 46 miles. Net equivalent 12 miles.

4-Wire 19-gauge M.H.L. circuit 500 miles long (800 kilometers). Line equivalent 145 miles. Repeater gain exclusive of gain required to make up for loss in apparatus and office cabling 133 miles. Net equivalent 12 miles.

In order to maintain the necessary constancy of the overall or net transmission equivalent of long repeatered circuits in cable, it is necessary first of all to maintain the gains of the individual repeaters within close limits. In addition, periodic transmission measurements are required over the complete circuits, supplemented by suitable adjustment of certain of the individual repeaters whenever the overall equivalent falls outside of the prescribed limits. Also, on the very long small gauge circuits, the changes in attenuation, due to the resistance changes caused by temperature variations, become so large that it is practically essential to provide automatic means for overcoming these effects.

The methods employed in maintaining the gains of the individual repeaters and of the overall transmission equivalents within proper limits will first be described, after which the automatic transmission regulators will be discussed.

## VIII. IMPORTANT TESTS AND ADJUSTMENTS

In order to hold the repeater gains constant, close inspection limits are placed on the vacuum tubes during the course of manufacture to insure great uniformity of the product, as well as consistency of performance. In operating the repeaters, considerable care is taken to maintain constancy of the operating currents and voltages. The operating limits of currents and

potentials together with the corresponding gain variations for one of the types of tube in common use are given in the following table:

| Variable Quantity     | Prescribed Limits     | Gain Variation   |
|-----------------------|-----------------------|--|
| Plate Potential.....  | 130 $\pm$ 5 volts     | $\pm$ .2 mile  |
| Grid Potential.....   | 9 $\pm$ 1 volt        | $\pm$ .3 mile  |
| Filament Current..... | 1.25 $\pm$ .05 ampere | Very small for new tube—1 mile for tube just before replacement. |

In addition to maintaining the tube currents and voltages within the required limits, the gains of the individual repeaters are checked periodically. Suitable adjustments are made when the repeater gains fall outside of the prescribed limits. When the filament emission of a tube becomes so low that the above specified variation in the filament current results in more than 1 mile gain variation the tube is replaced.

A gain measuring device as indicated schematically in Figure 14 is employed for this purpose. The measurement of gain is effected by comparison of the voltages across two resistances, one of which forms part of a circuit which includes the repeater, the other being simply a reference circuit. An amplifier-detector com-

ment is similar in principle to the method employed for measuring the gains of the individual repeaters, it will not be described.

By means of this device, it is readily possible to measure the gain of a repeater within a few tenths of a mile. Owing to the fact that the measuring circuits are comprised entirely of resistances, the readings of the set are independent of frequency, so that gains can be measured at all important telephone frequencies.

As pointed out above, transmission measurements over the complete circuits including the telephone repeaters are required at periodic intervals in order to insure that proper transmission standards are being maintained. By means of such measurements, the variations in the overall equivalent of the circuits due to the cumulative effect of small gain variations, slight variations which remain after the automatic transmission regulators have compensated for the major variations in the conductors and variations from other causes including the effect of different conditions of humidity on the wiring in the offices, are determined and compensated for. These measurements are made by applying a known electromotive force through a known resistance to one end of the circuit and receiving the current at the distant end with a suitable calibrated arrangement employing an indicating meter. Since this type of measure-

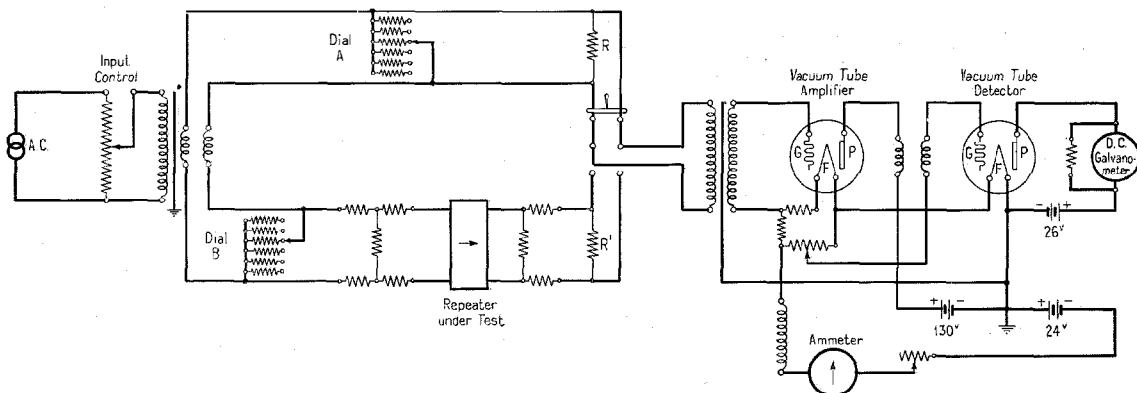

Fig. 14—Device for measuring telephone repeater gains.

bination amplifies the voltages across these resistances and then rectifies them so as to obtain an indication on a d.c. galvanometer. Equality of voltages across the two resistances, which are designated as  $R$  and  $R'$  in the figure, is thus indicated by equal deflections of the galvanometer. When this condition is secured, the repeater gain is read directly from the dials

ment is similar in principle to the method employed for measuring the gains of the individual repeaters, it will not be described.

#### IX. AUTOMATIC TRANSMISSION REGULATORS

Since the resistance of long cable circuits employing small gauge conductors is comparatively large, it is, of course, evident that changes



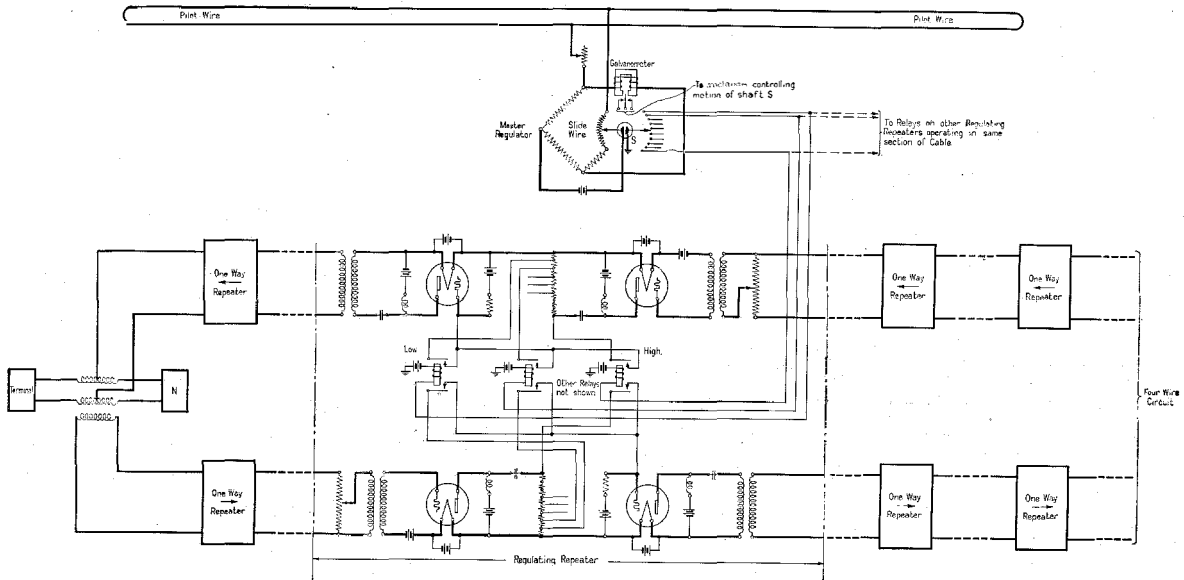

Fig. 15—Pilot wire automatic transmission regulator.

in this resistance caused by temperature changes to which the cable circuits are subject will have a large effect on transmission. For example; in the case of an X.L.L. 19-gauge 1000-mile circuit (1600 kilometers) in aerial cable, the total attenuation changes more than 110 transmission miles during the course of a year. This corresponds to a variation in the received power of more than  $10^{10}$  or ten billion times.

It is, of course, essential to provide special means to counteract these effects. Furthermore, since the temperature changes which occur in an aerial cable are very rapid, it is practically essential to make these means automatic. In the case of X.L.L. 19-gauge circuits whose variation is greatest, it is necessary to locate the automatic regulators, in general, at every third or fourth repeater station in order to keep the transmission levels within proper limits. In Figure 1-a, a typical method of locating the regulating devices along a cable is indicated. In this sketch each square indicates a master automatic transmission controlling device while the loops extending in either direc-

tion from the squares indicate the cable circuits which control the functioning of these devices.

An automatic transmission regulator is shown schematically in Figure 15. The device comprises a Wheatstone bridge arrangement. In one arm of the bridge, pilot wire pairs, extending in either direction in the cable, are included as indicated in the figure. The Wheatstone bridge has associated with it certain apparatus which will not be described here in detail, which functions in such a manner as to automatically keep the bridge balanced at all times. In the process of maintaining balance of the bridge, angular motion is conveyed to a shaft which is proportional to the resistance variations which the cable circuits undergo. The movement of the shaft causes different contacts to be made and thus controls relays which in turn control the gains of the telephone repeaters, one way of doing this being indicated in the figure. The repeater gains are thus caused to be raised and lowered automatically, and thereby overcome the differences in attenuation caused by the temperature changes in the cable conductors.

# Flat Type Relays

By D. D. MILLER

*Engineering Department, Western Electric Company*

RELAYS, as generally used in the telephone plant, are simply switches which are controlled electromagnetically. These switches may be required to open or close a number of separate and distinct electric circuits simultaneously or in a certain sequence. In many cases it is necessary that the relay switch be opened or closed very quickly as this period of time may have a direct influence on the amount of switchboard apparatus required and consequently the first cost of the switchboard. The operating time of the relays also has a direct influence on the time required to establish a telephone connection. The above statements are particularly evident in automatic systems where selector apparatus is required to establish a connection between parties but is released during the conversation. It follows that the number of selector circuits and relays therein, depends upon the amount of traffic and the time required for the selectors to establish the connection.

For instance, to establish a telephone connection between two parties in certain automatic telephone systems requires the "opening" and "closing" of about 2000 electric switches of which 1200 are operated by relays. In a typical manually operated system a call is completed by the "opening" and "closing" of about 112 switches of which 70 are operated by relays. It is therefore evident that the relay switches must operate both quickly and reliably and maintain a high degree of stability throughout a long period of service.

In controlling the various circuits in telephone systems by relays, the character of the circuits determines the construction of the relay switches. If large currents are to be controlled, the ruggedness of the relay switch construction differs materially from the construction required where relatively small currents are to be controlled. In the operation of the relays, larger amounts of power of course are required for those having the more rugged construction. It is also evident that more power is required for fast operation than for comparatively slow operation of the relay switches since the additional force and

energy required to accelerate the moving parts must be provided for by additional electrical power. Fast operation of relays is also dependent upon circuit arrangements which are effective in lowering the electrical "time constant" of the circuits in which the relays operate.

To any one familiar with telephone systems, equipment and circuits, it is obvious that it is impracticable to design all the relays required at maximum efficiency and economy for each particular condition that arises. Such a procedure would involve endless equipment changes as well as the large and unnecessary manufacturing expense of making an excessive number of types of relays. Much of the relay engineering work of the past few years has therefore been directed toward the standardization of relay designs which would be flexible, reliable and economical as a whole in the telephone plant rather than the most efficient in all respects for any specific condition. The flat or punched type relay manufactured by the Western Electric Company represents largely the result of this effort.

The flat relay is essentially a punch press product manufactured yearly in large quantities in about 3000 varieties of windings and switching arrangements. About twenty million of these relays are already in service in various telephone plants throughout the world. The punch press method produces parts which are exact duplicates and therefore interchangeable, which is particularly advantageous both for assembly and replacements or repairs. All the springs as well as the core and armature are punched and formed in bending fixtures to the required shapes. The mounting plates are also punched and designed to permit of uniform and economical mounting of the relays.

A number of these relays are shown on a punched mounting plate in Figure No. 1. Referring to the figure it will be seen that the relays are insulated from the mounting plate by phenol fibre insulators "A", which are securely fastened to the mounting plate by means of metal eyelets. The armature "B" which is the movable element is hinged at the rear by the use of a

thin, steel reed, securely riveted to the armature. The switching arrangements which the armatures control are in the form of nickel silver springs "C" with the contacts "D", at the front and in plain view. The springs and contacts are vertically mounted, which is particularly

a larger size for the somewhat more severe conditions of wear frequently encountered in automatic systems. All contacts are electro-welded on their respective spring supports and the two sizes are shown in Figures No. 2 and No. 3 respectively.

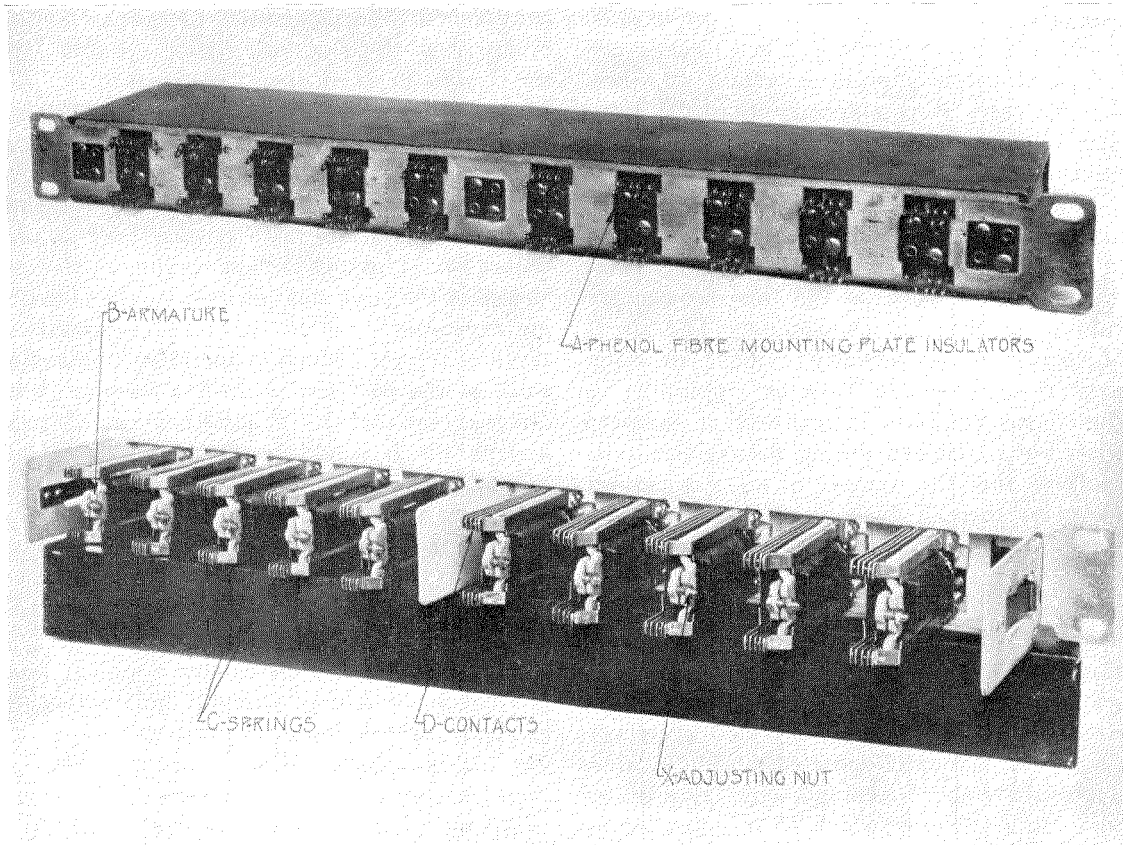

FIGURE 1

effective in keeping the contacts clean. The contacts are made from platinum or a recognized equivalent, and are designed in the form of points and discs to facilitate alignment and adjustment. Two designs of contacts have been standardized; one size being used for the customary electric currents and wear conditions encountered in manually operated systems and

The springs and their associated contacts are designed in twenty-six switching arrangements or combinations as shown in Figure No. 4. A single relay may be provided with one of these switching arrangements or any one of the twenty-six arrangements may be paired with any other arrangement. Thus on a single relay there may be chosen any one of 377 switching combinations.

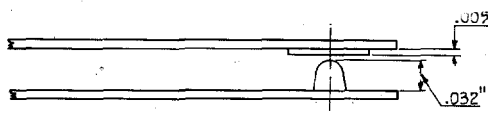

FIGURE 2

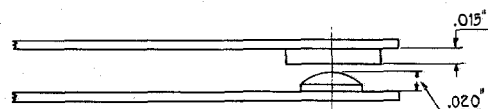

FIGURE 3

SPRING COMBINATIONS—FLAT TYPE RELAY

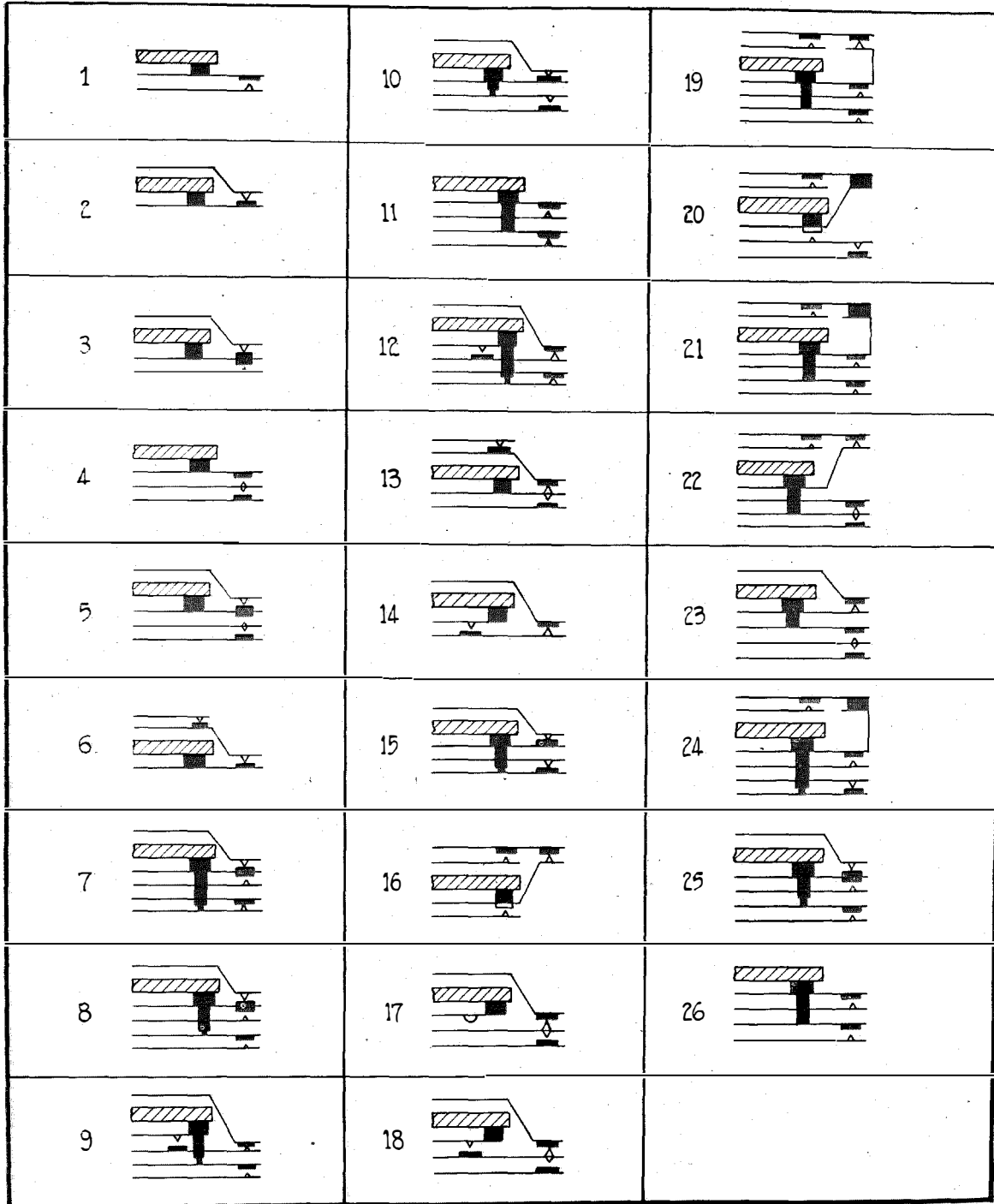

FIGURE 4

The 377 spring combinations provide a great flexibility in circuit design and permit of uniform and efficient equipment layouts.

In manufacturing the relays, the spring assemblies are clamped together under high compression before tightening the screws which hold them together. This insures that the springs retain their position and adjustment throughout a long period of time. The arrangement of the springs is such that definite stops or supports are provided for each spring either on the front spool heads or on the armatures. In tensioning or adjusting the relay springs against their supports, sufficient tension is set up in the springs to insure a pressure of at least 15 grams between all contacts at the time of closure. In some cases where a slight amount of contact chatter or vibration does not materially affect the circuit controlled by the contacts, it has been found permissible to use a minimum contact pressure of 8 grams.

The amount of current and power required to operate each relay is dependent upon the tension and number of springs that must be moved and the distance through which this movement takes place. Relays or electromagnets operate most efficiently with the armature magnetic air gaps set at the minimum required for satisfactory opening and closing of the contacts. Consequently a system has been carefully worked out for these relays in which the armature travel is set in accordance with the requirements of the particular spring combination by the adjustment of the friction lock nut "X" shown in Figure No. 1. This setting of the armature insures a normal separation of contacts of approximately .010 inch and at least .005 inch in contact "follow" after closure of the contacts. The "follow" allows for a certain amount of contact wear as well as insuring a slight wiping action which gives a certainty of contact closure. The electrical operating current requirements are figured and specified on the basis of obtaining 20 grams pressure between all contacts; this margin being allowed so that no undue hardship will be experienced in maintaining the minimum requirement of 15 grams.

With these mechanical adjustments applied to the relay springs and armature, certain electrical requirements formerly used in the adjustment of the relays, such as non-operating or

releasing currents, may be omitted. An operating current, of course, is applied which depends on the spring combination, number of turns and resistance of the coil as well as the circuit conditions under which the relay is required to operate. In general no additional mechanical adjustments whatever are necessary except in cases where the actual circuits require a severe non-operating or releasing condition of the relay. In cases where a quick and reliable release is required the armatures are provided with electro welded non-magnetic stops of approximately .005 inch in height. When the relays are assembled and adjusted as described they are capable of withstanding shipment and cabling without readjustment. It follows, of course, that where these relays are properly specified and used in circuits, satisfactory results in service should be obtained throughout a long period of time without appreciable maintenance.

The insulating materials used throughout in the construction of flat relays have been carefully studied and the best materials known to the present day art have been used. Thus the wire used in the windings is insulated with a high grade enamel and the insulating papers used on the cores are practically inert from an electrolytic corrosion standpoint. The coils are covered with a serving of cotton, treated with unbleached shellac which acts as a seal against moisture and protects the winding from abrasion. With the present day construction of coils it has been found unnecessary to impregnate the windings even though the relays may be used under extreme climatic conditions of temperature and humidity.

The phenol fibre spool heads and spring insulators are much superior to hard rubber particularly in regard to their capability to withstand a wide temperature range without appreciable expansion or contraction. For this reason it is permissible to work these relays at higher temperatures without danger or deterioration than relays insulated with hard rubber parts. These higher temperature limits permit a wider usefulness of the relays in circuits as well as economy in the construction as the size of the coil depends on the necessary area for radiation and this area of course is fixed by the permissible temperature range.

Where the relays are to remain operated a considerable length of time throughout the day

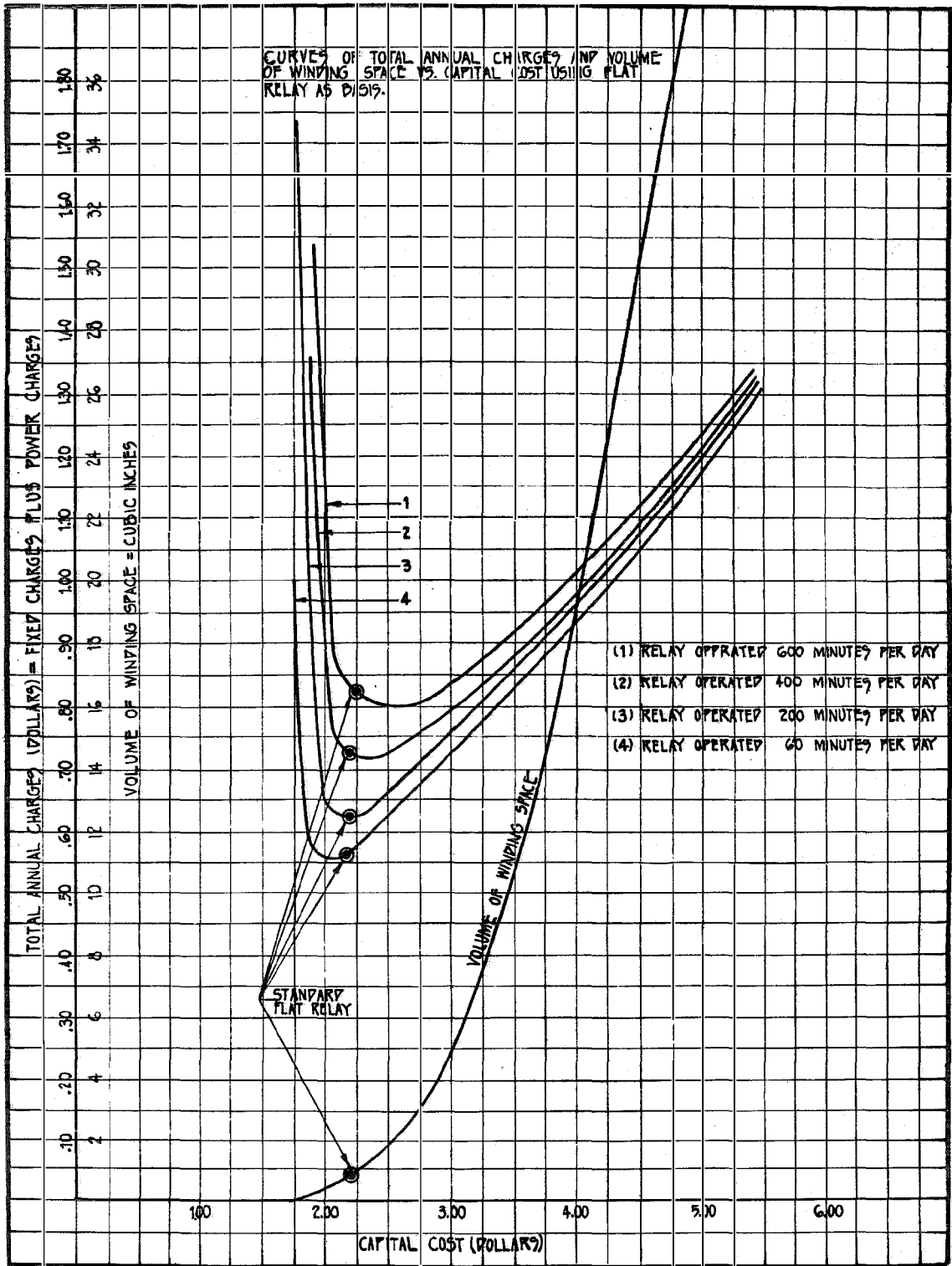

FIGURE 5

the annual power charges become important and the design of the winding, and in some cases, the size of the design must be altered to give the minimum annual charge. The group of curves in Figure No. 5 show how nearly correct the flat relays have been designed for conditions where the operating ampere turns are 260 and the relays remain operated from 60 to 600 minutes per day. The capital cost and annual charge figures should be taken as relative only as the correct values of course will vary with manufacturing conditions and with the cost of power for different localities.

As compared to the customary types of round core relays it is evident from the foregoing that these flat relays have the following advantages.

- (1) There is an economy in mounting space as the flat relay requires but one-half to two-thirds that of the customary round relay.
- (2) The large variety of spring combinations which are uniform in design permit of greater flexibility in equipment layouts.
- (3) The relay parts as well as the mountings are punch press product which insures interchangeability of all parts.
- (4) Ease of adjustment is obtained due to the uniform design of the various spring arrangements and stability due to the method of assembly.
- (5) The flat relay operates and releases faster than the customary round core relays. This is of advantage in automatic systems as pointed out in the first part of this article.

Other designs of punched or flat type relays used extensively in the telephone plant are the line and cut-off relays, the supervisory relays and the alternating current relays which operate on ringing currents.

Relays which are used for supervisory relays and alternating current relays are generally constructed from silicon steel instead of the customary Norway or magnetic iron. The silicon steel is very satisfactory for these relays because of its comparatively high permeability, low coercive force and small hysteresis. The high permeability is advantageous for relays that are required to operate on a very small energy input and the low coercive force is very

effective for obtaining a quick and positive release of the relay armature, particularly where a leak current exists due to a faulty line insulation.

A recent development in flat type relays for use on alternating currents of ringing frequencies is shown in Figure No. 6. The armature of this relay is attracted to the bifurcated extension of the core "B". One of these core extensions

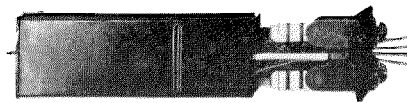
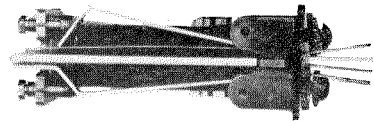
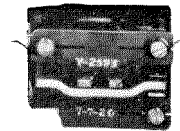

FIGURE 6

is completely surrounded by a part of the copper spool head "C". This arrangement is known as pole "shading" or phase splitting and is used to produce a steady pull on the armature, when the relay is energized by alternating currents.

Referring to Figure No. 7 the theory of operation is shown by considering the vector diagram in connection with the schematic drawing of the relay core and armature. When an alternating current is applied to the winding we can assume that an alternating flux  $2\phi_m$  is generated in the core. This flux, of course, divides into two approximately equal parts in the two respective bifurcated extensions of the core. If these two respective fluxes can be displaced in time phase

it is evident that the armature will be attracted by one of the bifurcated extensions of the core while the flux, and consequently the attraction of the other, is passing through zero. This may be explained by the vector diagram in which  $E_z$  represents the induced voltage in the

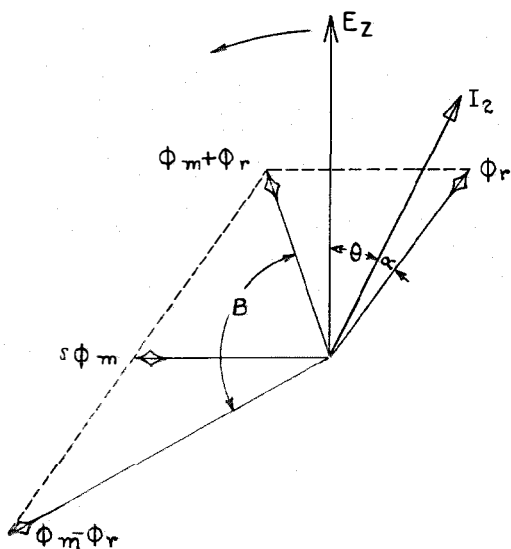
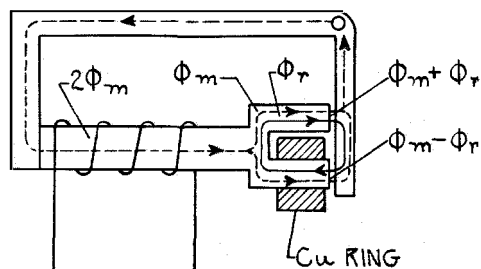

FIGURE 7

short circuited copper ring due to alternating flux  $\phi_m$ . The current in the copper ring  $I_2$  lags behind the voltage  $E_z$  as shown and the flux due to this current is  $\phi_r$ . This flux  $\phi_r$  has a magnetic path through the bifurcated pole pieces and armature as shown by the arrows. Following out the arrows it will be seen that this flux adds to the flux  $\phi_m$  in the upper part and subtracts in the lower part of the two core extensions. The vector addition and subtraction of these two fluxes results in the two

vectors  $\phi_m + \phi_r$  and  $\phi_m - \phi_r$ , each of which represents a flux that crosses the air gap to attract the armature. These two fluxes differ in time phase as represented by the angle "B" so that a substantially constant attraction results on the armature. The operation of the relay under these conditions is very much the same as that of a D. C. relay as there occurs no vibration or chatter of the armature or contacts. The minimum A. C. effective ampere turns required for operation are 70 to 100 ampere turns as compared with 30 to 50 ampere turns for D. C. operation.

Such a relay, of course, operates on direct current as well as on alternating current and in fact the flat type supervisory relays are quite similar to these relays in mechanical design; the difference being simply in the omission of the copper shading feature and the bifurcated pole piece.

Figure No. 8 shows the mechanical design features for both the supervisory and alternating current relays. In this figure the winding has been omitted so as to show clearly the unusually small core construction. This core design is especially efficient in repeating coil cord circuits where the relay receives a very small amount of energy for operation on long subscribers' loops, and must also release reliably against a leak current after operation on the comparatively large amount of current received on short subscribers' loops. The small core, of course, saturates magnetically on a relatively small current or energy so that the excessive current received on short subscribers' loops does not store up additional magnetism which would be detrimental to the release of the relay. Where supervisory relays of this general mechanical design are used in bridge of a cord circuit the core section is made much larger and also built up on each side with a number of silicon steel laminations. This construction affords sufficient impedance to alternating currents of high frequencies to prevent appreciable shunting of voice currents.

Referring further to the figure, micrometer screws "A" and "B" are used to adjust the back and front contacts respectively and to fix both the unoperated and operated positions of the armature. The screw "C" is used to control an armature restoring spring which is in the form of a flat spring riveted to the armature.



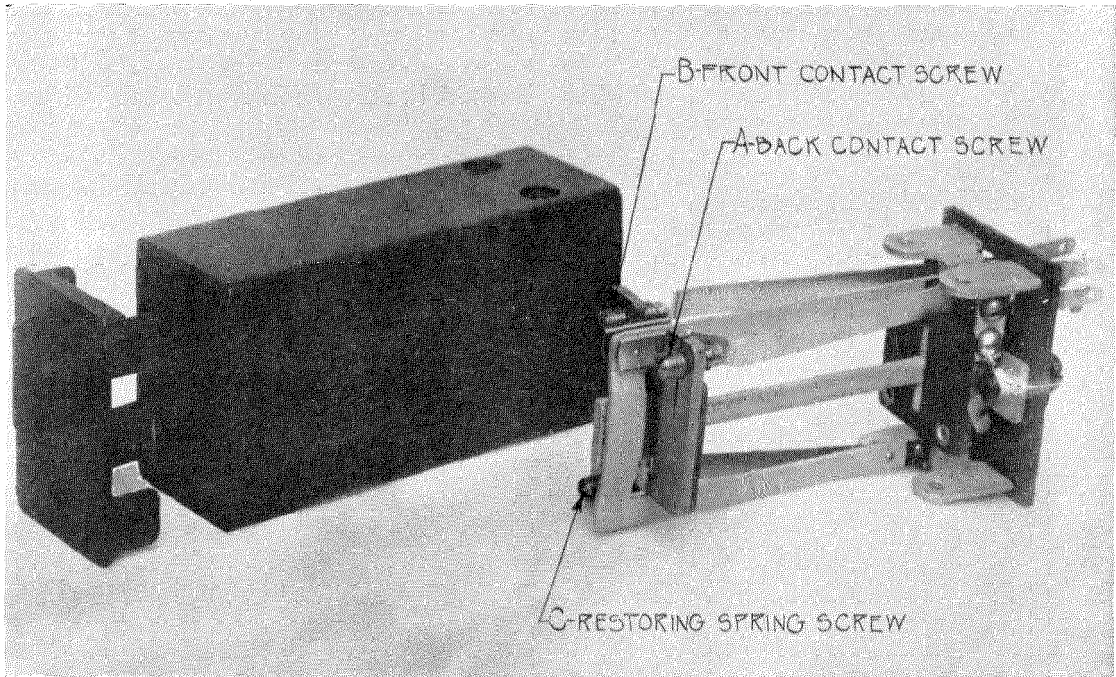

FIGURE 8

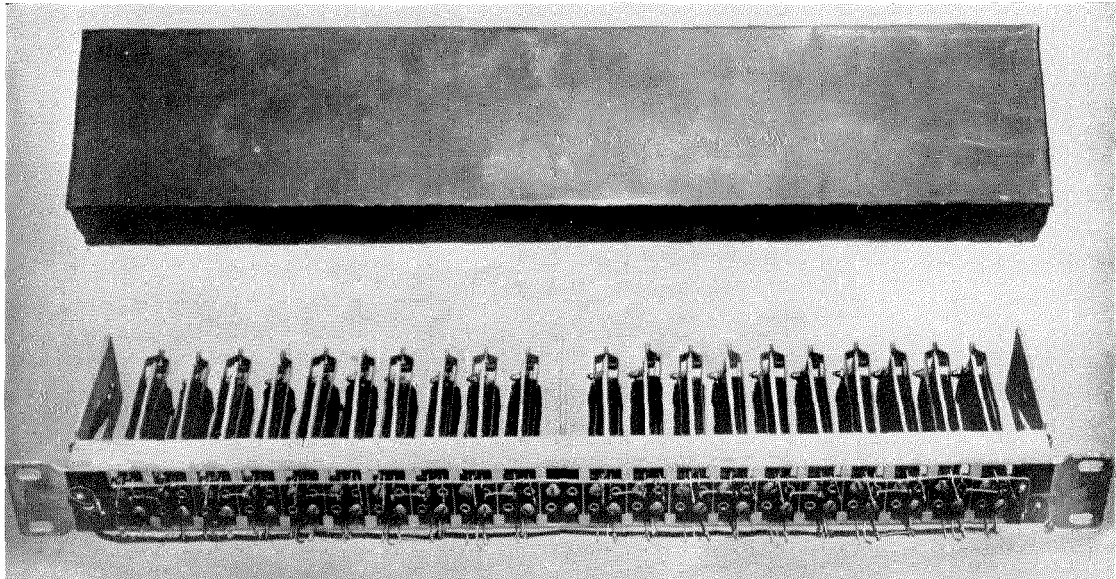

FIGURE 9

These relays are generally provided with individual covers which are effective in preventing cross-talk when the relays are used as supervisory relays in cord circuits. The insulating materials used throughout are of the same high grade as previously described in other flat type relays.

A punched mounting plate equipped with line and cut-off relays is shown in Figure No. 9. These relays are somewhat similar to the flat types that are used for various switching purposes, but due to the large and continued annual demand these designs have been carefully worked out to perform most efficiently the specific functions of line and cut-off relays. Thus the springs and terminals at the rear of the mounting plate have been designed to permit of simple and economical strapping and cabling. The iron parts are somewhat lighter than the flat relays which are required to control a great

variety of springs, since the heaviest work encountered is the operation of the two sets of springs and contacts of the cut-off unit. The insulation, contacts, springs and coil construction are similar to the flat relays previously described.

The winding of the line relay and also the cut-off unit may be varied of course to suit the voltage, line and cord circuit conditions of different systems. The maximum power for operating the line relay is obtained by making the resistance of the line relay equal to the line resistance, but as a general rule this gives more than the required power to operate these flat type line relays. This fact, of course, allows of considerable flexibility in the design of windings to suit specific conditions and also allows the use of additional springs and contacts on the line unit when they are required in automatic systems.

# Specializing Transportation Equipment in Order to Adapt it Most Economically to Telephone Construction and Maintenance Work

By J. N. KIRK

*Outside Plant Engineer, Department of Operation and Engineering, American Telephone and Telegraph Company.*

## INTRODUCTION

IN this paper is described in a general way the interesting application of motor vehicles and their associated apparatus in connection with outside plant construction and maintenance work, outlining through the successive stages of development what has been accomplished in this respect up to the present time. In order to present a comprehensive picture covering this field of activity, the more primitive types of equipment, together with the manual methods of doing work, are shown in comparison with representative instances of higher development during the past few years in which this phase of the work has been given particular consideration.

The telephone system is different from most public utilities in that it is responsible for a universal service throughout the United States. Wherever the highways and byways may lead, and in many instances where no traveled way could well exist, will be found the familiar and indispensable telephone, with the wire and cable on pole line and in underground conduit. Irrespective of the remoteness of the territory, of the subsurface or the climatic conditions involved, there must always be found a way to construct and maintain the telephone plant. To install this widely distributed plant and continuously safeguard the service in response to the ever increasing public demands, it is essential that facilities be provided for the prompt and safe transportation of quantities of heavy, bulky materials and gangs of men to any point in the telephone system during emergencies as well as under normal conditions, and that provision also be made to supplement the necessary manual operations in every way possible by the proper adaptation of mechanical apparatus.

It might be helpful in this consideration to compare the construction problems of the Tele-

phone Companies with the production problems of any large manufacturing concern. The transportation of raw materials, of the products during manufacture, and of the finished products, together with the application of labor saving machinery in this connection, unquestionably constitute a very real problem to the manufacturer. In this case, however, all of the activities are so completely concentrated and under his control to such an extent as to greatly simplify the efficient and economical operation of all units involved. Let us consider this large, self-contained manufacturing plant completely dismembered, with the various machines and manufacturing processes widely scattered over distances of many miles instead of a few feet, and we have a very fair comparative picture of the relative importance of the Telephone Companies' transportation and construction apparatus problems in providing and maintaining efficient service. Because of this fundamental condition which obtains in the telephone industry, all outside plant machinery units must be portable, of comparatively small capacity and yet of high efficiency.

To meet these exacting requirements the Bell System is ever on the alert to avail itself of every possible advantage in the development, adaptation and application of transportation equipment, machinery and methods. By means of this mechanical equipment the heavy units of material are handled with ease, safety and dispatch by the gangs, leaving them fresh for the lighter detail work requiring dexterity but practically no heavy, straining effort.

When one speaks of automotive and construction apparatus or machinery developments as applied to the telephone business, such developments must naturally appeal to many as being foreign to and rather difficult to closely associate with the furnishing of telephone service. We are, however, in the midst of a truly mechanical age and the more we study and experiment

with the adaptation of mechanical equipment to the new lines of telephone activity, the broader seem to be the fields of applicability and the more evident becomes the necessity of closely coordinating the various phases of adapting commercial equipment and developing new types of apparatus for telephone use.

It is the intention in the following to outline a number of the more important developments associated with the adaptation of mechanical methods to outside plant construction and maintenance work. In presenting the picture contrasting the construction methods of today with the earlier practices, one cannot but note the remarkable developments and improvements which have come about.

#### TRANSPORTATION EQUIPMENT

It is reported that some forty years ago, after deliberating for an entire day the directors of one of the now large Associated Companies decided that the volume and nature of the company's business warranted the purchase of a horse and buggy.



FIG. 1—Horse-Drawn Vehicle in Telephone Service—Courtesy *Telephone Review*

Figure 1 represents such an outfit as was probably purchased and which, in connection with the telephone business of today, is about as rare as the motor vehicle is common-place.

As representative of some fifteen years later we have illustrated in figure 2 the one-horse, light construction wagon, the predecessor of the three-quarter and one ton motor vehicles

which now handle light construction, certain classes of station installation work, section line

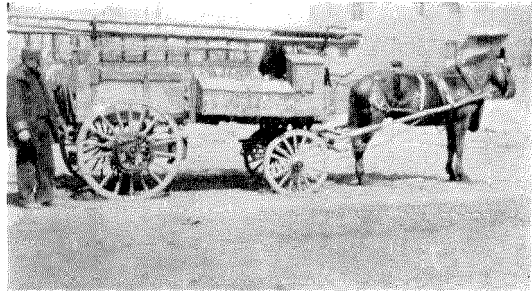

FIG. 2—Light Construction Truck of about 1896

work, etc. It is interesting to note the improvised reel on the rear wheel of the wagon and also the warning "BE CAREFUL OF ACCIDENTS" which is printed on the side of the body. These features are indicative of the fact that the labor saving equipment and "safety first" movements which have now reached such broad proportions in the Telephone System were germinating at least as far back as 1896.

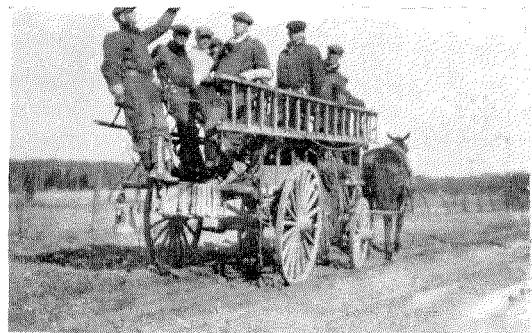

FIG. 3—Heavy Construction Truck Carrying Gang, Tools and Materials, 1896

The heavy construction gang unit of 1896 shown in Figure 3, brings to mind the original method of employing large gangs which, with practically no labor saving equipment available, necessarily had to handle the heavy features of outside construction work by "main strength".

In the interval between the advent of the horse-drawn vehicle and that of the motor vehicle into the telephone business, bicycles were used to some extent. These comparatively slow, energy consuming vehicles, however, soon were superseded by the motorcycles which for

a few years, principally during the period between 1914 and 1920, were considered a very necessary factor and played an important part in connection with the maintenance and, to a lesser extent, the construction of the telephone plant.

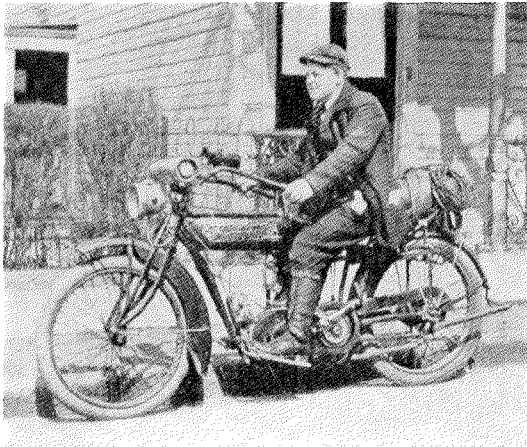

FIG. 4—Motorcycle which was Used for Maintenance Work—Courtesy *Telephone Review*

Several hundred machines of these types were at one time used by the various companies, but experience has indicated that their use results in high maintenance, that they present many features hazardous to the employees and general public, and that they are more or less detrimental to the health of those who use them to any great extent.

While the motorcycles have the advantage that they can generally worm their way through

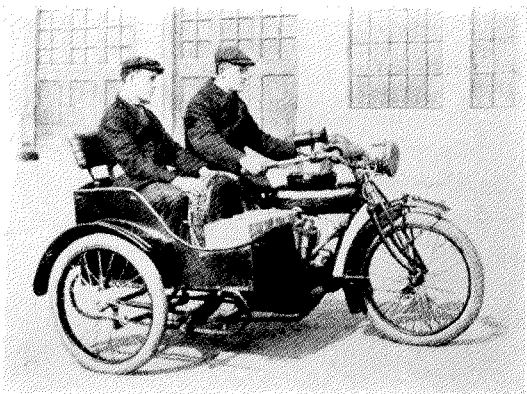

FIG. 5—Motorcycle with Sidecar Used for Instrument Installation Work—Courtesy *Telephone Review*

traffic more readily than an automobile, this advantage is completely overbalanced by the universal tendency to speed in riding motorcycles, by the many serious accidents from skidding on wet pavements, the difficulty in riding over roads having deep wheel tracks, the entire lack of weather protection for the rider, and the instability of the sidecar outfits when turning corners. The use of motorcycles by the Telephone Companies is now practically, if not entirely, obsolete.

The many adaptations of the Ford car have proven in over the motorcycle by a large margin

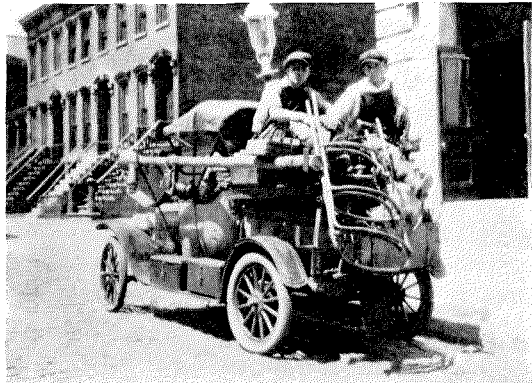

FIG. 6—A Seriously Overloaded Ford Carrying Splicers and Their Supplies

from practically every viewpoint. There are now more than 5,000 Fords in the service of the Associated Companies. This group of cars is often referred to in telephone parlance as the "mosquito fleet" and it is interesting to note that the building up of this fleet had its inception as late as about 1914.

Approximately 80 per cent of these Fords are equipped with various types of boxes and specially designed bodies which permit the carrying of light loads of materials and tools. On account of their large numbers, low operating costs and remarkable ability to negotiate almost impassable roads, they go far toward coordinating the operation of the widely scattered units of the Telephone System.

In telephone work the Ford runabouts average approximately 9,000 miles per car per year. Normally, their net loads vary from 150 pounds to 750 pounds, although in emergencies they are sometimes seriously overloaded.

Fig. 6 shows a telephone company Ford seriously overloaded while transporting splicers'

equipment. In fact, the net load carried by this particular car, including the four men, was about 1,300 pounds. This illustrates a case where the service for which the vehicle was originally supplied, has outgrown the load-carrying and space capacity of the unit. Of course, if this practice were permitted to continue or become general, it would be expensive, both from a motor vehicle operating and gang service viewpoint, not to mention the hazard presented in carrying two of the men in such a precarious position.

It is apparent that in order to find a particular item of tools or material on this car it might be necessary to completely unload. As regards the effect upon the car, the tires frequently blow out, the front construction requires constant attention to keep it tight, the springs depress to the extent that the fenders are permitted to ride upon the tires, the steering is difficult, etc.

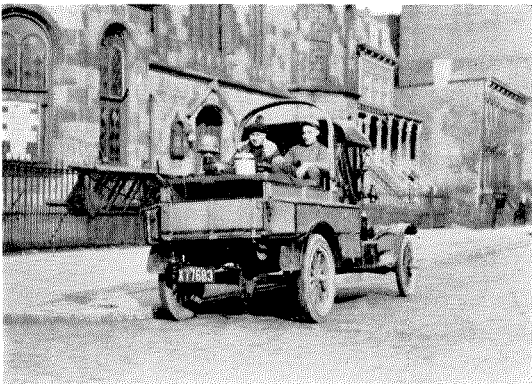

FIG. 7—Ford Truck Equipped with Modern Side Box Body

As soon as it was recognized that this particular service was outgrowing the transportation unit, a special side box body upon a high speed one-ton Ford truck was developed and is now undergoing service trials in order to properly provide a unit having ample space and load-carrying capacity. Fig. 7 shows some of the latest ideas in the design of such an outfit. Note the ample kerosene tank slung under the rear end of the body with a convenient filler pipe on the rear end of the left side box and a faucet under the tank with hose connection for filling the splicers' furnaces with kerosene.

As an illustration of a Ford runabout especially adapted for the work of serving an installer

and helper in placing telephone sets together with the inside wiring and the drop wires from pole to house, Fig. 8 is presented.



FIG. 8—Ford Runabout of the Latest Type in Installation Service

It will be noted that in this design the body extension back of the seat is limited in order that only a small weight over-hang back of the rear axle is possible. This is important in order not to overstrain the rear spring. The body design is made as light in weight as practicable in order to provide ample net load carrying capacity.

There are now on the market innumerable Ford accessories which are claimed to correct all of the ills to which the Ford is subject. Careful studies and field trials, however, indicate that by far the greater portion of these devices are of no advantage and many are actually detrimental to the efficiency and safety of operation. However, through careful selection and in some cases modification of certain of these accessories to meet specific telephone service requirements it now seems probable that somewhat more efficient, economical and safer operation will be realized.

About 1910, carefully prepared studies indicated the practicability and economy of utilizing gasoline driven motor trucks for the transportation of men, supplies and construction equipment of various kinds.

The first automobile trucks were proven in over horse drawn vehicles on the basis of using the trucks as purely transportation units. However, it soon developed that there were many possible economical applications of the motor

truck in connection with the placing, moving and removal of pole lines, aerial cables, underground cables, wires, etc., bringing into use the many accessory devices such as winches, der-

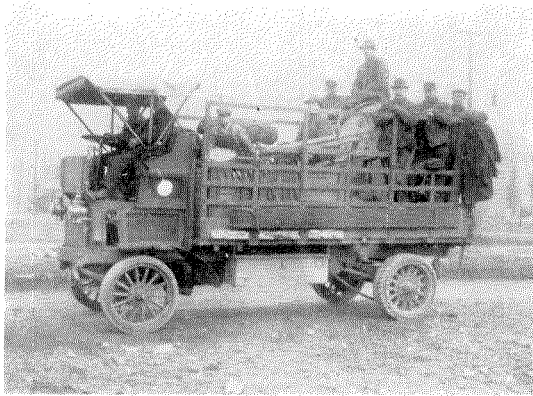

FIG. 9—Heavy Construction Gang Truck, 1910.  
One of the First in Telephone Service

ricks, earth boring machines, various types of trailers, pumps and other safety and labor saving apparatus. The importance of some of these devices in telephone construction work will later be described.

The motorizing of the Bell System has been very rapid since 1910. Because of the widely scattered distribution of outside telephone plant it is necessary, in transporting the workmen, together with their tools and materials, to employ in the Bell System approximately 3,000 trucks and tractor-trucks of from  $\frac{1}{2}$  ton to 15 tons capacity. These together with the "Mosquito Fleet" and the relatively small number of supervisory passenger cars of a better class, make a total motor vehicle strength of over 8,000 units in the Bell System. In addition to this Company owned equipment, there are employed annually by the Associated Companies several hundred hired motor vehicles.

In the neighborhood of 25,000 employees depend upon the System's transportation equipment as an indispensable part of their daily work, that is, in its capacity of labor saving machinery as well as in moving the men, together with their tools and materials, from their bases of operation to the job and back, and also between jobs. The annual cost of providing this transportation service for the Bell System is in the neighborhood of twelve to fourteen million dollars. Although this total is a sizable amount,

it is actually small when compared with the service rendered and when considered upon the basis of slightly less than \$6 average cost per car per day used, including all units from 750 to 30,000 pounds net carrying capacities.

Studies are constantly being made in connection with the opportunities presented along the line of increasing the mechanical efficiencies and lowering the maintenance costs of the various units. As the result of this work much is being accomplished in conserving the working time and energy of the men by employing proper labor saving facilities with the motor vehicles in order to do practically all of the slow, heavy work by proper application of power from the motor vehicle engines. The continuation of this field of study should tend toward offsetting the constantly increasing construction costs.

The realization of the most important savings in the motor vehicle field, that is by making the truck units serve the gangs as labor saving machines in addition to their use as transportation equipment, involves the use of winches driven from the truck engines, derricks for all kinds of pole work, for handling loading pots, etc., suitable trailers for transporting poles, reels of cable and other materials, the use of quick acting safe drawbars for trailing loads behind the trucks, the use of the truck equipment for pulling the proper tension into aerial cable strand and for pulling in the aerial cable, the use of the power equipment with suitable accessory appliances for pulling in or removing underground cable, of power driven collapsible reels for quickly pulling down and coiling up open wire, employing improved methods with the assistance of the power equipment for the handling of all heavy loads (such as reels of cable on and off trucks), and for numerous other uses. In addition to these savings, important economies can be realized by equipping the construction units with suitable bodies to meet the various construction requirements.

In reviewing the progress in the use of motor vehicles it is interesting to note that in the first few years it became apparent that in order to properly utilize the units it would be necessary to equip them with special side box bodies, winches, derricks, etc. Designs for these various items of equipment were prepared in accordance with the best information at hand and the resulting units of about 1914-1916 were so heavy

and bulky that some of the 3-ton trucks carrying this equipment were loaded practically to capacity exclusive of their complement of material, tools and men. This led to the introduction of 5-ton truck units in heavy construction work. Figure 10 shows an old type of body equipment in which the arrangement and

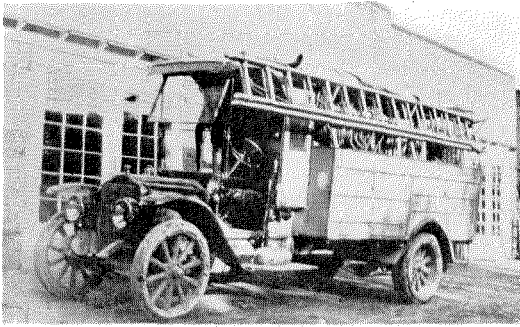

FIG. 10—An Old Type of Side Box Body Construction

size of the side box compartments was such that practically no free load capacity was available. A rear view of this outfit would more clearly indicate the absolute lack of space for carrying materials such as reels of strand and cable, etc.

In the past few years and at the present time, the developments are toward lighter weight, more efficient bodies and labor saving equipment as is illustrated in Fig. 11 and later in this paper under the discussion of winches.

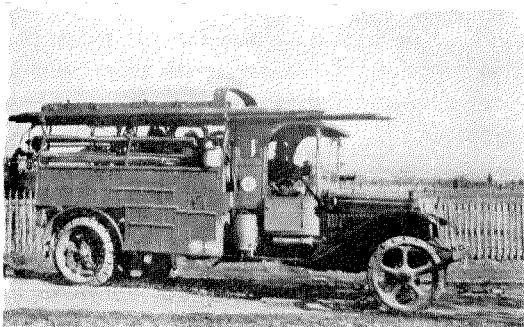

FIG. 11—Latest Type 2-Ton Heavy Construction Unit

The use of this equipment is permitting a material reduction in gang sizes which in itself further reduces the weight to be carried on the truck. The net result is that instead of a 3 or 5-ton unit weighing loaded 18,000 or 25,000 pounds, it is possible to handle the work more

satisfactorily with 2 or 2½-ton units weighing in the neighborhood of 12,000 pounds.

The advantages gained by this reduction in truck size are large. Not only is the initial and operating cost of the equipment much less but the more important feature is that these 2-ton trucks can penetrate and economically operate in territories where a heavier unit could not negotiate the roads. Many country bridges will not carry more than 6 tons. Also, on

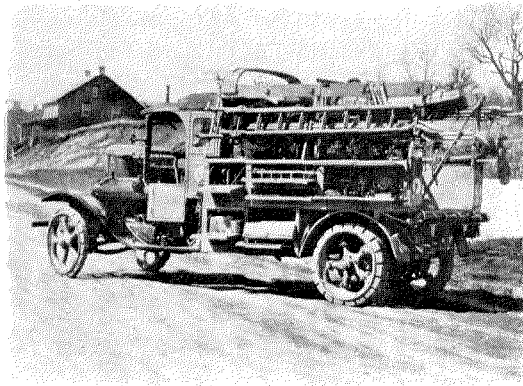

FIG. 12—Latest Type 2-Ton Heavy Construction Unit Showing Tool, Material and Locker Compartments Open

narrow country roads, the comparatively shorter wheel base of the 2-ton truck permits easier turning around or maneuvering.

Figs. 11, 12, 13 and 18 present illustrations of some of the latest developments in line construction truck design and associated equipment. The particular type of body shown has been selected as an example from the various types employed by the Telephone Companies because of its broad use and because it so well illustrates the general development which is taking place. The outfits shown, except in Fig. 13, are of 2 to 2½-ton capacity and perhaps the most outstanding feature is that of the rugged and compact body arrangement, each detail of which has been specially designed to meet a particular construction need. The tool and machinery equipment is applicable to the most exacting requirements of the average outside construction job. The arrangement is such that all necessary tools and materials can be carried in a safe and orderly manner, and the truck power plant, through the introduction of suitable winch equipment, is available for the



heaviest duty, slow speed work, as well as the lightest duty, high speed work which may be encountered.

A more complete description of some of the principal features embodied in this combination material distributing, tool and gang delivering unit, power plant and general work shop, may be of interest.

With regard first to some of the more important points incorporated in the body: Every construction crew must carry a large number of different comparatively small materials and tools. The old method of piling the mixed tools and materials in large boxes carried in the truck body led to much lost time on the job in looking for particular items as required in the course of the day's work. The foreman could never be quite sure as to just what he had on his truck, which resulted in two unsatisfactory and uneconomical conditions: First—otherwise unnecessary extra trips were made between the job and the storeroom to secure materials thought to be on the truck but which could not be located when needed. Second—due to the lack of orderly arrangement, much more material was generally carried than was actually needed, which resulted in excessive loads upon the trucks and in the aggregate an unnecessarily large material supply balance for the company.

The new type of body is the result of careful field study. In this particular one, of the several designs necessary to meet the requirements of the subdivisions into which the construction work naturally divides itself, it will be noted that side boxes are provided of such sizes as to satisfactorily house in an orderly manner the small tools and materials, suitable hangers and racks are arranged to carry the larger tools and materials, space is available for chauffeur's chains, tools, grease, etc., and compartments are also provided for the extra clothing and lunches of the men. Safe and readily accessible locations are provided for the heavier equipment, such as members of the pole derrick, digging bars, shovels, ladders, etc. Fig. 13 shows a close up view of the orderly and readily accessible arrangement of tools and materials.

It should be particularly noted in this connection that the truck body arrangement is such that with its full complement of tools and

materials there is available a maximum of free load space.

With the further thought of conserving the health of the crew when operating in sections where suitable drinking water cannot be ob-

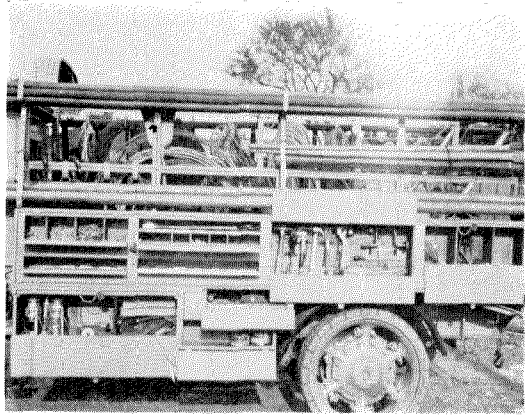

FIG. 13—Side Boxes Opened Showing Arrangement of Tools and Materials

tained, a sanitary keg is provided for carrying an ample supply of pure water. Paper drinking cups are used.

A safe, clean, dry, convenient location for the "Safety First" kit is built into the top of the cab.

A small vise for the use of the gang and chauffeur is attached to one of the running boards.

The cab also incorporates every possible feature of safety and protection to the driver, and a tarpaulin is so arranged as to provide maximum protection for the men in case of bad weather.

As may be noted, in Fig. 12 a spindle and sheave have been provided which can be mounted across the top body rails either at the rear end or the middle of the truck in order to permit the use of the winch rope for loading and unloading cable reels or reels of strand without the use of skids.

Fig. 14 shows the old manual method of loading a reel of cable on a horse-drawn truck. This operation involves the slow and laborious method of rolling a two or three-ton load up an inclined plane by means of a hand winch. It should be noted that six men are engaged in handling this reel and that at least two of them must of necessity occupy positions which present

more or less hazard in the event that the winch rope should break or some part of the mechanism otherwise fail to hold the suspended load. This

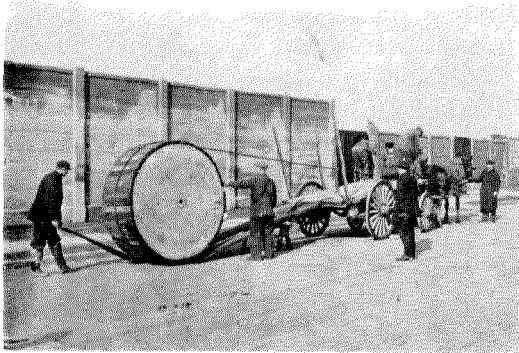

FIG. 14--Loading Cable Reel on Horse-Drawn Truck by Means of Two-Man Power Hand Winch

familiar method of winch operation by means of a manila rope laboriously wound upon a ratchet stop drum by two men, was limited entirely to loading and unloading heavy items of material from the truck platform. For this purpose it was, however, a great improvement upon former methods even though it was very slow and not entirely free from danger.

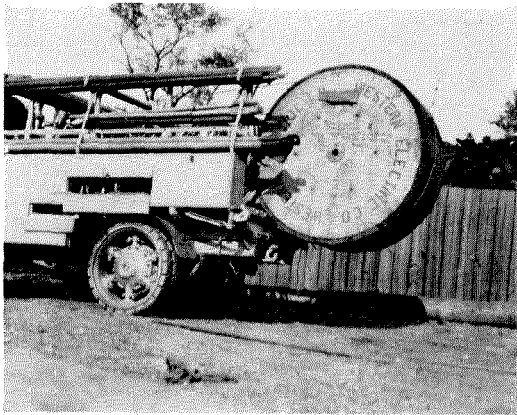

FIG. 15--Loading Cable Reel, by Use of Sheave and Spindle with Rope Sling, Without Skids

In Fig. 15 a similar reel of cable is being loaded on a motor truck by means of the engine operated winch in conjunction with the sheave and spindle feature previously mentioned. In this case the possibility of hazard to the workman is completely removed. The reel is loaded in a fraction of the time required by the old manual

method and the entire operation, after adjusting the winch line, is completed by the chauffeur from his position in the cab. In the event that the winch rope or other parts of the mechanism should fail, the result would be a vertical drop of the reel of cable, perhaps slightly damaging the reel, but the employes are not required to take positions where they are in any danger.

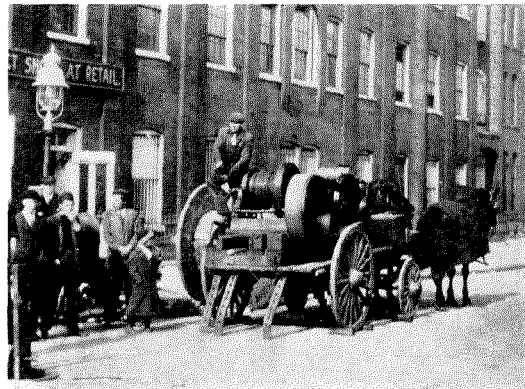

FIG. 16--Old Type Gasoline Engine Driven Winch on Horse-Drawn Truck

Fig. 16 shows the first type of power winch application to telephone construction work. This unit consisted of a slow speed, heavy duty, single cylinder, gasoline engine unit permanently mounted on a horse-drawn truck. It was used principally for pulling in underground cable and was a great improvement over the former method of pulling by means of horses. It will be noted that on this winch steel rope was used.

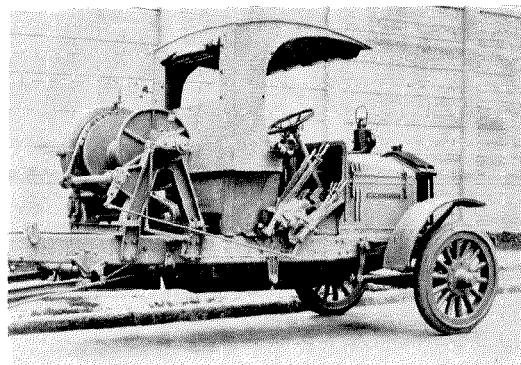

FIG. 17--Old Type Heavy Winch on 5-Ton Truck Chassis

With the engine propelled truck came the possibility of utilizing the truck power through

a special power take-off to drive a winch which would not only be more powerful, but also much more rapid in action and distinctly superior with regard to the important feature of control.

Fig. 17 illustrates one of the original types of power winch on a 5-ton truck chassis. This was an adaptation of one of the best hoisting winches then available and some ingenious controls

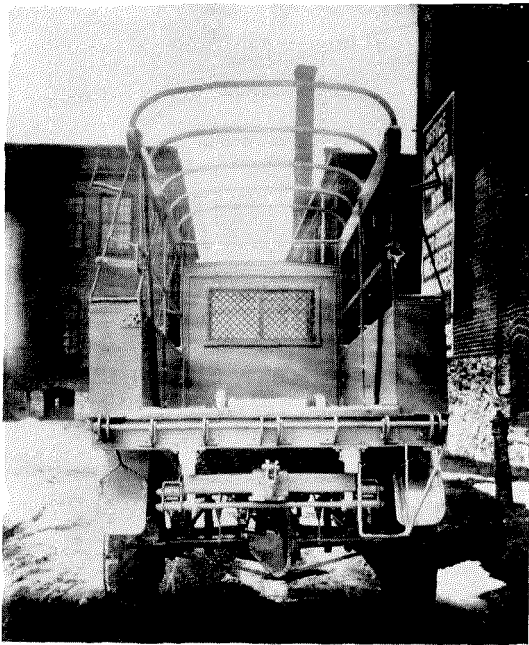

FIG. 18—Rear View of Latest Type 2-Ton Construction Truck Showing Winch Below Cab Window. Generous Clear Body Platform Space is Evident

were developed at the time in order to facilitate or in fact, even permit of its operation on the trucks.

While this unit was a wonderful labor saving device and opened up the possibilities of the broad field of usefulness for truck operated winches, its size and weight were such that it could not well be used on trucks of less than 5-tons capacity. It will be noted that the winch extends well up to the cab window and would practically fill the front end of the body. Its net weight exclusive of the truck power take-off was 2,300 pounds.

The desirability and in fact the indispensable need of using winches on the smaller trucks has led to the development of a very compact light weight unit which will handle about 900 feet

of 7/16" steel rope and withstand a pull of 10,000 pounds on a single line. Experience indicates, that this winch is capable of meeting the maximum requirements generally encountered in construction work.

The compactness of this winch is illustrated by Fig. 18 which shows it below the cab window with only the upper half of the drum projecting above the floor line in order to give the rope proper clearance in winding and unwinding. This winch weighs slightly less than 500 pounds.

In closing this discussion of motor vehicle application to telephone work it might be of interest to examine the curve in Fig. 19, which shows the rate of growth of the motor vehicle fleet in the Bell System.

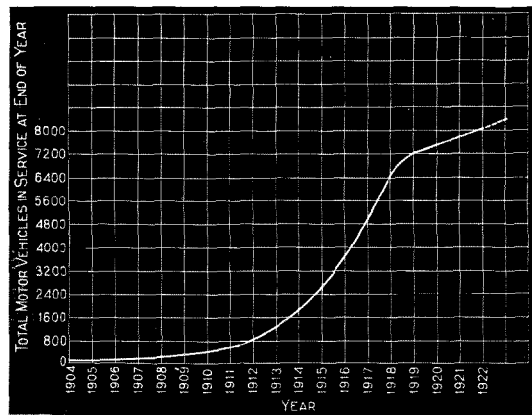

FIG. 19—Curve Showing Growth of Motor Vehicle Fleet in Bell System

This curve prepared from such information as now available presents a reasonably accurate picture of the motor vehicle development which began in the Bell System as early as 1904.

As explanatory of this curve it may be noted that previous to 1910 very few cars and no trucks were purchased. From 1910 to 1913 various types of equipment were placed in service largely upon an experimental basis. The results of these experimental installations were so favorable that from 1913 to 1919 the growth was very rapid due to superseding the large number of horse-drawn trucks with motor vehicles as well as providing additional motor vehicles to keep pace with the growth of the telephone industry. From 1919 to 1922 the slope of the curve indicates a slow, steady growth which corresponds with the growth in

requirements of the telephone construction and maintenance organizations in handling their steadily increasing activities.

From the foregoing it will be noted that a period of 40 years has witnessed a striking development in transportation and associated equipment as applied to telephone construction

work, and studies now under way indicate that there is yet much to be accomplished.

In a future issue will be discussed the adaptation to telephone work of the more important items of labor saving machinery such as pole derricks, trailers of various types, earthboring machines, air compressors and compressed air tools, etc.

# Telephone and Telegraph Statistics of the World

By S. L. ANDREW

*Chief Statistician, American Telephone and Telegraph Company*

IN the following tables are summarized the results of a compilation of the world's telephone and telegraph statistics as of January 1, 1921, recently completed by the Chief Statistician's Division of the American Telephone & Telegraph Company. Owing to the war, which interrupted our lines of communication with many foreign countries on statistical matters, this compilation constitutes the first complete summary of its kind which has been made since that for January 1, 1914. Upon the termination of the war, communication was gradually reestablished with officials of foreign telephone and telegraph systems, both Government and private, and it is upon data obtained through the courteous cooperation of such officials that the present compilation is based.

Despite the disturbed conditions which have prevailed in many parts of the world, accurate official information was received for almost all countries, including the new European states created as a result of the peace treaties. In the case of those countries for which it was impossible to secure wholly authoritative figures for January 1, 1921, estimates were, of course, necessary; but practically without exception it was possible to base these estimates upon official data for earlier years, and accordingly the margin of error to which they are subject is undoubtedly very small. In the table on "Telephone Development of the World, by Countries," it was not considered practicable to show data separately for each individual country; for purposes of condensation the less important countries and political divisions in each of the major continental divisions have been grouped under the designation "Other Places." In the case of Europe, "Other Places" include Albania, Armenia, Azerbaijan, Azores, Canary Islands, Dantzic, Esthonia, Faroe Islands, Fiume, Georgia, Gibraltar, Iceland, Latvia, Lithuania, Luxembourg, Madeira, Malta, Monaco and Turkey; and the fact that official data were secured for nearly all of these places in which there were any telephones at all is an indication of the completeness of the figures. In the preparation of

the compilation, statistics on revenues and investment were secured, but as a result of the inflated condition of many foreign currencies, these statistics have little comparative significance and consequently have not been published.

By comparison of the statistics for the year beginning January 1, 1921, with those for the year beginning January 1, 1914, and with particular reference to the telephone situation, certain outstanding developments may be noted.

In the United States, the number of telephones increased by about 3,800,000, representing an increase of 40% over 1914. This increase is almost equal to the total number of telephones in all of Europe on January 1, 1914. In Austria and Hungary, loss of territory substantially reduced the total number of telephones, but as the lost territories were the least developed telephonically, the telephones per 100 population have increased in both countries. Of the new states created as a result of the war, Czecho-Slovakia leads with 77,195 telephones, closely followed by Poland with 72,450 telephones. In the neutral countries telephone growth has naturally been more rapid than in the belligerent nations, the number of telephones in Denmark nearly doubling during the seven years' period, while increases in The Netherlands, Norway, Sweden, Spain and Switzerland have been relatively large. Recovery in Belgium since the war has been rapid and the 1921 total nearly equals that for 1914. In France, Great Britain and Italy, telephone growth was practically halted during the war, but substantial increases were recorded in the years 1919 and 1920. The increase in France has been augmented by the acquisition of Alsace-Lorraine and the purchase of the telephone system of the American Expeditionary Forces. In Germany the number of telephones increased slightly throughout most of the war period. In South America, Asia, Africa and Oceania a steady extension of telephone service is indicated in almost every country.

DISTRIBUTION OF THE WORLD'S TELEPHONES

→ January 1, 1921 ←

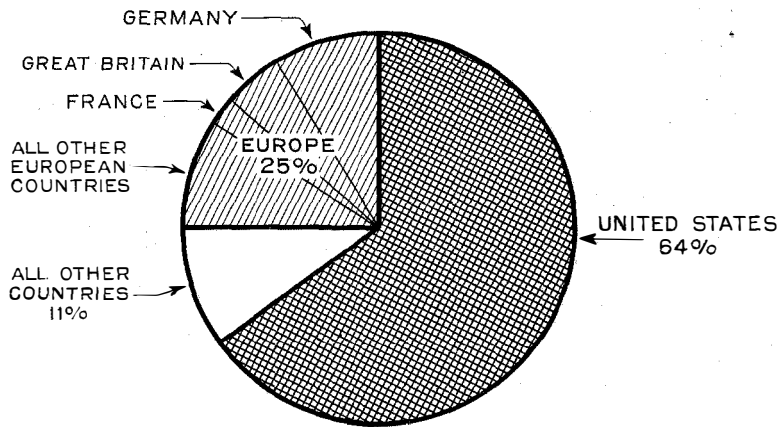

TELEPHONES PER 100 POPULATION

→ January 1, 1921 ←

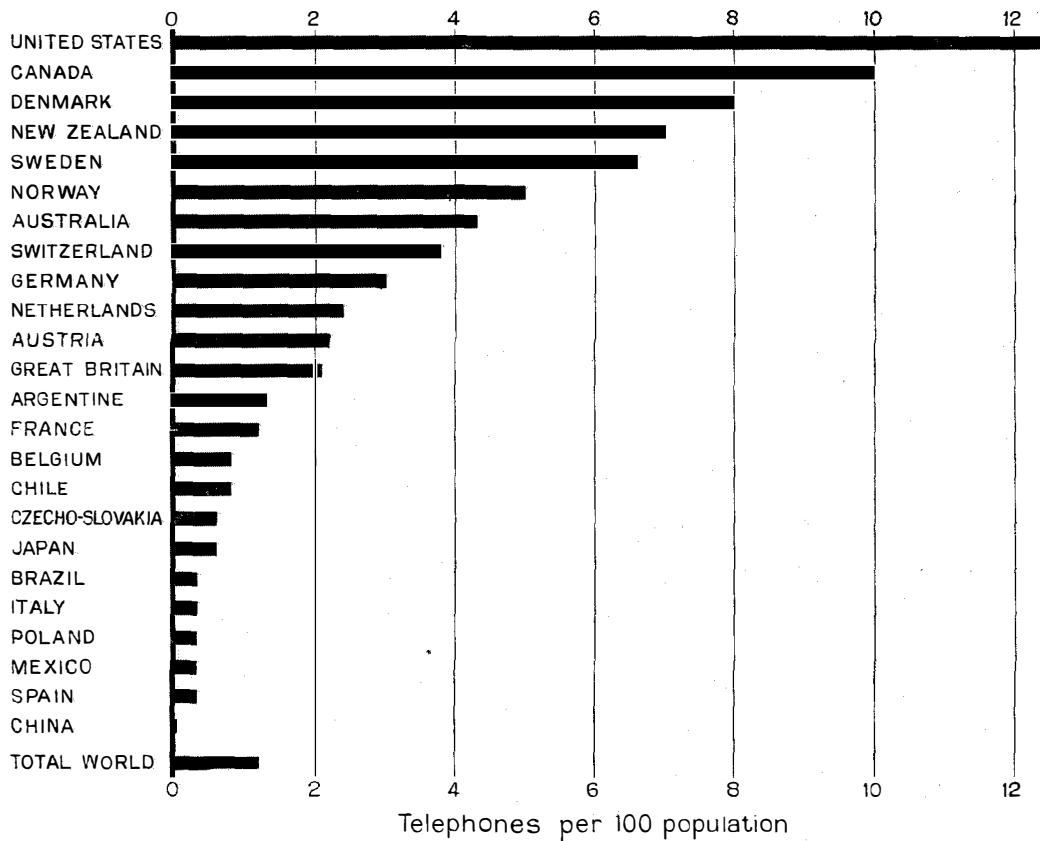

## TELEPHONE DEVELOPMENT OF THE WORLD, BY COUNTRIES

JANUARY 1, 1921

|                                    | Number of Telephones |                   |                   | Per Cent of Total World | Telephones per 100 Population | Per Cent Increase in Telephones since Jan. 1, 1914† |
|------------------------------------|----------------------|-------------------|-------------------|-------------------------|-------------------------------|---|
|                                    | Government Systems   | Private Companies | Total             |                         |                               |   |
| <b>NORTH AMERICA:</b>              |                      |                   |                   |                         |                               |   |
| United States .....                | —                    | 13,329,379        | 13,329,379        | 63.92%                  | 12.4                          | 39.7%   |
| Canada .....                       | 181,930              | 674,336           | 856,266           | 4.11%                   | 9.8                           | 71.4%   |
| Central America .....              | 6,337                | 9,613             | 15,950            | .08%                    | 0.3                           | 102.4%  |
| Mexico .....                       | 1,860                | 42,924            | 44,784            | .21%                    | 0.3                           | 7.0%  |
| West Indies:                       |                      |                   |                   |                         |                               |   |
| Cuba .....                         | 464                  | 33,912            | 34,376            | .16%                    | 1.1                           | 113.5%  |
| Porto Rico .....                   | 555                  | 7,415             | 7,970             | .04%                    | 0.6                           | 81.5%   |
| Other W. I. Places* .....          | 2,958                | 7,180             | 10,138            | .05%                    | 0.2                           | 53.5%   |
| Other No. Am. Places* .....        | 40                   | 3,160             | 3,200             | .02%                    | 0.8                           | 37.0%   |
| Total .....                        | 194,144              | 14,107,919        | 14,302,063        | 68.59%                  | 9.8                           | 41.3%   |
| <b>SOUTH AMERICA:</b>              |                      |                   |                   |                         |                               |   |
| Argentina .....                    | —                    | 116,553           | 116,553           | .56%                    | 1.3                           | 56.8%   |
| Bolivia (Jan. 1, 1920) .....       | —                    | 2,517             | 2,517             | .01%                    | 0.1                           | 0.7%  |
| Brazil .....                       | 1,247                | 83,844            | 85,091            | .41%                    | 0.3                           | 117.2%  |
| Chile .....                        | —                    | 29,867            | 29,867            | .14%                    | 0.8                           | 51.6%   |
| Colombia .....                     | —                    | 6,843             | 6,843             | .03%                    | 0.1                           | 115.3%  |
| Ecuador .....                      | 1,425                | 2,521             | 3,946             | .02%                    | 0.2                           | 34.9%   |
| Paraguay .....                     | 138                  | 268               | 406               | .01%                    | 0.04                          | -18.6%  |
| Peru .....                         | 2                    | 8,550             | 8,552             | .04%                    | 0.2                           | 113.6%  |
| Uruguay .....                      | —                    | 22,381            | 22,381            | .11%                    | 1.5                           | 64.7%   |
| Venezuela .....                    | 663                  | 8,233             | 8,896             | .04%                    | 0.3                           | 76.9%   |
| Other Places (Jan. 1, 1920) .....  | 1,898                | —                 | 1,898             | .01%                    | 0.4                           | 34.3%   |
| Total .....                        | 5,373                | 281,577           | 286,950           | 1.38%                   | 0.4                           | 72.4%   |
| <b>EUROPE:</b>                     |                      |                   |                   |                         |                               |   |
| Austria .....                      | 133,480              | —                 | 133,480           | .64%                    | 2.2                           | -22.5%  |
| Belgium .....                      | 62,867               | —                 | 62,867            | .30%                    | 0.8                           | -3.3%   |
| Bulgaria* .....                    | 5,000                | —                 | 5,000             | .02%                    | 0.1                           | 38.6%   |
| Czecho-Slovakia .....              | 77,195               | —                 | 77,195            | .37%                    | 0.6                           | xx  |
| Denmark (March 31, 1921) .....     | 7,230                | 245,091           | 252,321           | 1.21%                   | 7.7                           | 95.4%   |
| Finland* .....                     | —                    | 45,000            | 45,000            | .22%                    | 1.3                           | 12.5%   |
| France .....                       | 473,212              | —                 | 473,212           | 2.27%                   | 1.2                           | 43.3%   |
| Germany .....                      | 1,809,574            | —                 | 1,809,574         | 8.68%                   | 3.0                           | 27.4%   |
| Great Britain .....                | 985,964              | —                 | 985,964           | 4.73%                   | 2.1                           | 26.3%   |
| Greece .....                       | 4,700                | —                 | 4,700             | .02%                    | 0.1                           | 46.9%   |
| Hungary .....                      | 57,009               | —                 | 57,009            | .27%                    | 0.7                           | -32.1%  |
| Italy (June 30, 1920) .....        | 79,934               | 35,043            | 114,977           | .55%                    | 0.3                           | 25.2%   |
| Jugo-Slavia .....                  | 16,439               | —                 | 16,439            | .08%                    | 0.1                           | xx  |
| Netherlands .....                  | 160,733              | 1,200*            | 161,933           | .78%                    | 2.4                           | 87.3%   |
| Norway* (June 30, 1920) .....      | 73,372               | 62,000            | 135,372           | .65%                    | 5.                            | 64.0%   |
| Poland* .....                      | 47,450               | 25,000            | 72,450            | .35%                    | 0.3                           | xx  |
| Portugal* .....                    | 1,800                | 13,621            | 15,421            | .07%                    | 0.2                           | 74.2%   |
| Roumania (March 31, 1921) .....    | 24,701               | —                 | 24,701            | .12%                    | 0.1                           | 23.5%   |
| Russia* .....                      | 200,000              | —                 | 200,000           | .96%                    | 0.2                           | xx  |
| Spain* .....                       | 5,000                | 65,000            | 70,000            | .34%                    | 0.3                           | 105.9%  |
| Sweden .....                       | 386,341              | 1,789             | 388,130           | 1.86%                   | 6.6                           | 66.6%   |
| Switzerland .....                  | 152,336              | —                 | 152,336           | .73%                    | 3.8                           | 57.7%   |
| Other Places in Europe* .....      | 30,365               | 1,160             | 31,525            | .15%                    | 0.2                           | xx  |
| Total .....                        | 4,794,702            | 494,904           | 5,289,606         | 25.37%                  | 1.2                           | 31.9%   |
| <b>ASIA:</b>                       |                      |                   |                   |                         |                               |   |
| British India .....                | 13,000*              | 21,268            | 34,268            | .16%                    | 0.01                          | 93.6%   |
| China* .....                       | 52,500               | 21,960            | 74,460            | .36%                    | 0.02                          | xx  |
| Japan .....                        | 330,597              | —                 | 330,597           | 1.59%                   | 0.6                           | 50.7%   |
| Other Places in Asia* .....        | 49,473               | 4,847             | 54,320            | .26%                    | 0.04                          | 115.1%  |
| Total .....                        | 445,570              | 48,075            | 493,645           | 2.37%                   | 0.1                           | 61.3%   |
| <b>AFRICA:</b>                     |                      |                   |                   |                         |                               |   |
| Egypt (March 31, 1920) .....       | 22,280               | —                 | 22,280            | .11%                    | 0.2                           | 29.1%   |
| Union of South Africa .....        | 51,402               | —                 | 51,402            | .24%                    | 0.7                           | 77.8%   |
| Other Places in Africa* .....      | 27,076               | 1,448             | 28,524            | .14%                    | 0.02                          | 50.5%   |
| Total .....                        | 100,758              | 1,448             | 102,206           | .49%                    | 0.1                           | 57.0%   |
| <b>OCEANIA:</b>                    |                      |                   |                   |                         |                               |   |
| Australia (June 30, 1920) .....    | 224,000              | —                 | 224,000           | 1.08%                   | 4.3                           | 62.8%   |
| Dutch East Indies .....            | 33,225               | 1,279             | 34,504            | .16%                    | 0.1                           | 132.5%  |
| Hawaii .....                       | —                    | 14,376            | 14,376            | .07%                    | 5.6                           | 97.4%   |
| New Zealand (March 31, 1921) ..... | 88,439               | —                 | 88,439            | .42%                    | 7.0                           | 79.0%   |
| Philippine Islands .....           | 1,955                | 10,496            | 12,451            | .06%                    | 0.1                           | 84.3%   |
| Other Places in Oceania* .....     | 2,073                | 237               | 2,310             | .01%                    | 0.1                           | 44.7%   |
| Total .....                        | 349,692              | 26,388            | 376,080           | 1.80%                   | 0.6                           | 73.0%   |
| <b>TOTAL WORLD</b> .....           | <b>5,890,239</b>     | <b>14,960,311</b> | <b>20,850,550</b> | <b>100.00%</b>          | <b>1.2</b>                    | <b>40.0%</b>  |

\* Partly estimated.

† No allowance has been made in these figures for any change in territory since January 1, 1914. Minus sign preceding a figure denotes decrease.

# TELEPHONE DEVELOPMENT OF IMPORTANT CITIES

JANUARY 1, 1921

| Country and City (or Exchange Area) | Estimated Population (City or Exchange Area) | Number of Telephones | Telephones per 100 Population | Country and City (or Exchange Area)                          | Estimated Population (City or Exchange Area) | Number of Telephones | Telephones per 100 Population |
|-------------------------------------|--|----------------------|-------------------------------|--|--|----------------------|-------------------------------|
| <b>ARGENTINE:</b>                   |  |                      |                               | <b>HUNGARY:</b>  |  |                      |                               |
| Buenos Aires                        | 1,700,000                                    | 65,383               | 3.8                           | Budapest   | 926,000                                      | 24,205               | 2.6                           |
| <b>AUSTRALIA:*</b>                  |  |                      |                               | <b>ITALY:</b>  |  |                      |                               |
| Adelaide                            | 255,000                                      | 16,067               | 6.3                           | Milan  | 718,000                                      | 15,000†              | 2.1                           |
| Brisbane                            | 210,000                                      | 12,664               | 6.0                           | Naples   | 780,000                                      | 6,800†               | 0.9                           |
| Melbourne                           | 767,000                                      | 48,461               | 6.3                           | Rome   | 689,000                                      | 13,000†              | 1.9                           |
| Sydney                              | 899,000                                      | 58,594               | 6.5                           | Turin  | 517,000                                      | 7,500†               | 1.5                           |
| <b>AUSTRIA:</b>                     |  |                      |                               | <b>JAPAN:</b>  |  |                      |                               |
| Vienna                              | 1,842,000                                    | 98,000               | 5.3                           | Kobe   | 609,000                                      | 9,869                | 1.6                           |
| <b>BELGIUM:</b>                     |  |                      |                               | Kyoto  | 591,000                                      | 13,281               | 2.2                           |
| Antwerp                             | 502,000                                      | 10,028               | 2.0                           | Nagoya   | 430,000                                      | 10,505               | 2.4                           |
| Brussels                            | 885,000                                      | 23,809               | 2.7                           | Osaka  | 1,253,000                                    | 33,004               | 2.6                           |
| <b>BRAZIL:</b>                      |  |                      |                               | Tokio  | 2,173,000                                    | 64,564               | 3.0                           |
| Rio de Janeiro                      | 1,130,000                                    | 30,522               | 2.7                           | Yokohama   | 423,000                                      | 7,617                | 1.8                           |
| <b>CHILE:</b>                       |  |                      |                               | <b>MEXICO:</b>   |  |                      |                               |
| Santiago                            | 507,000                                      | 7,900                | 1.6                           | Mexico City  | 600,000                                      | 23,503               | 3.9                           |
| <b>CUBA:</b>                        |  |                      |                               | <b>NETHERLANDS:</b>  |  |                      |                               |
| Havana                              | 400,000                                      | 24,936               | 6.2                           | Amsterdam  | 642,000                                      | 31,392               | 4.9                           |
| <b>DENMARK:</b>                     |  |                      |                               | The Hague  | 353,000                                      | 22,393               | 6.3                           |
| Copenhagen                          | 666,000                                      | 96,008               | 14.4                          | Rotterdam  | 510,000                                      | 24,848               | 4.9                           |
| <b>FRANCE:</b>                      |  |                      |                               | <b>NEW ZEALAND:*</b>   |  |                      |                               |
| Bordeaux                            | 267,000                                      | 7,394                | 2.8                           | Auckland   | 158,000                                      | 9,791                | 6.2                           |
| Lyons                               | 562,000                                      | 10,986               | 2.0                           | Christchurch   | 105,000                                      | 7,880                | 7.5                           |
| Marseilles                          | 586,000                                      | 11,859               | 2.0                           | Wellington   | 107,000                                      | 10,375               | 9.7                           |
| Paris                               | 2,906,000                                    | 159,692              | 5.5                           | <b>NORWAY: †</b>   |  |                      |                               |
| <b>GERMANY:</b>                     |  |                      |                               | Christiania  | 256,000                                      | 29,802               | 11.6                          |
| Berlin                              | 2,170,000                                    | 199,555              | 9.2                           | Bergen   | 97,000                                       | 6,970                | 7.2                           |
| Breslau                             | 528,000                                      | 26,198               | 5.0                           | <b>PORTUGAL:</b>   |  |                      |                               |
| Cologne                             | 634,000                                      | 35,514               | 5.6                           | Lisbon   | 820,000                                      | 9,939                | 1.2                           |
| Dresden                             | 529,000                                      | 33,150               | 6.3                           | <b>SWEDEN:</b>   |  |                      |                               |
| Düsseldorf                          | 407,000                                      | 25,194               | 6.2                           | Göteborg   | 202,000                                      | 23,778               | 11.8                          |
| Essen                               | 439,000                                      | 14,763               | 3.4                           | Malmö  | 114,000                                      | 11,708               | 10.3                          |
| Frankfort                           | 433,000                                      | 35,576               | 8.2                           | Stockholm  | 376,000                                      | 118,180°             | 31.4°                         |
| Hamburg-Altona                      | 1,155,000                                    | 85,748               | 7.4                           | <b>SWITZERLAND:</b>  |  |                      |                               |
| Hanover                             | 310,000                                      | 20,928               | 6.8                           | Basel  | 137,000                                      | 11,619               | 8.5                           |
| Leipzig                             | 604,000                                      | 38,830               | 6.4                           | Berne  | 112,000                                      | 10,016               | 8.9                           |
| Munich                              | 631,000                                      | 42,174               | 6.7                           | Geneva   | 136,000                                      | 13,714               | 10.1                          |
| Nuremberg                           | 353,000                                      | 18,005               | 5.1                           | Zurich   | 211,000                                      | 20,023               | 9.5                           |
| Stuttgart                           | 309,000                                      | 25,494               | 8.3                           | <b>UNITED STATES:</b>  |  |                      |                               |
| <b>GREAT BRITAIN:*</b>              |  |                      |                               | New York   | 5,708,000                                    | 892,198              | 15.6                          |
| Belfast                             | 410,000                                      | 8,637                | 2.1                           | Chicago  | 2,755,000                                    | 575,840              | 20.9                          |
| Birmingham                          | 1,273,000                                    | 26,477               | 2.1                           | Total of the 30 cities in U. S. with over 250,000 population | 25,176,000                                   | 4,201,614            | 16.7                          |
| Bradford                            | 375,000                                      | 11,604               | 3.1                           | <b>URUGUAY:</b>  |  |                      |                               |
| Bristol                             | 405,000                                      | 10,154               | 2.5                           | Montevideo   | 363,000                                      | 13,420               | 3.7                           |
| Dublin                              | 387,000                                      | 11,213               | 2.9                           |  |  |                      |                               |
| Edinburgh                           | 420,000                                      | 16,561               | 3.9                           |  |  |                      |                               |
| Glasgow                             | 1,260,000                                    | 43,263               | 3.4                           |  |  |                      |                               |
| Hull                                | 328,000                                      | 13,209               | 4.0                           |  |  |                      |                               |
| Leeds                               | 536,000                                      | 12,999               | 2.4                           |  |  |                      |                               |
| Liverpool                           | 1,190,000                                    | 38,475               | 3.2                           |  |  |                      |                               |
| London                              | 7,069,000                                    | 330,002              | 4.7                           |  |  |                      |                               |
| Manchester                          | 1,591,000                                    | 46,313               | 2.9                           |  |  |                      |                               |
| Newcastle                           | 597,000                                      | 13,571               | 2.3                           |  |  |                      |                               |
| Sheffield                           | 505,000                                      | 11,916               | 2.4                           |  |  |                      |                               |

\* Statistics as of March 31, 1921.

† Statistics as of June 30, 1920.

‡ Number of subscribers.

° The greater part of this development was secured by a private company which was purchased by the Government in 1918. On January 1, 1921 the process of merging the company's plant with the Government's local system was not fully completed and the total number of telephones still included a certain number of duplicates.



## TELEPHONE AND TELEGRAPH WIRE OF THE WORLD, BY COUNTRIES

JANUARY 1, 1921

|                                     | Service Operated by<br>(See Note) | Miles of Telephone Wire |                         |                    | Miles of Telegraph Wire (See Note) |                         |                    |
|-------------------------------------|-----------------------------------|-------------------------|-------------------------|--------------------|------------------------------------|-------------------------|--------------------|
|                                     |                                   | Number of Miles         | Per Cent of Total World | Per 100 Population | Number of Miles                    | Per Cent of Total World | Per 100 Population |
| <b>NORTH AMERICA:</b>               |                                   |                         |                         |                    |                                    |                         |                    |
| United States.....                  | P.                                | 32,000,000              | 60.77%                  | 29.8               | 1,725,000                          | 28.51%                  | 1.6                |
| Canada.....                         | P. G.                             | 2,105,101               | 4.00%                   | 24.0               | 238,866                            | 3.95%                   | 2.7                |
| Central America.....                | P. G.                             | 31,904                  | .06%                    | 0.5                | 21,171                             | .35%                    | 0.4                |
| Mexico.....                         | P. G.                             | 111,797                 | .21%                    | 0.8                | 74,540                             | 1.23%                   | 0.5                |
| West Indies:                        |                                   |                         |                         |                    |                                    |                         |                    |
| Cuba.....                           | P. G.                             | 94,495                  | .18%                    | 3.0                | 17,698                             | .29%                    | 0.6                |
| Porto Rico.....                     | P. G.                             | 11,870                  | .02%                    | 0.9                | 1,295†                             | .02%                    | 0.1                |
| Other W. I. Places*.....            | P. G.                             | 20,234                  | .04%                    | 0.4                | 4,749                              | .08%                    | 0.1                |
| Other No. Am. Places*.....          | P. G.                             | 6,080                   | .01%                    | 1.6                | 8,570                              | .14%                    | 2.3                |
| Total.....                          |                                   | 34,381,481              | 65.29%                  | 23.5               | 2,091,889                          | 34.57%                  | 1.4                |
| <b>SOUTH AMERICA:</b>               |                                   |                         |                         |                    |                                    |                         |                    |
| Argentine.....                      | P.                                | 370,723                 | .69%                    | 4.1                | 168,826                            | 2.79%                   | 1.9                |
| Bolivia (Jan. 1, 1920).....         | P.                                | 2,435                   | .01%                    | 0.1                | 6,957                              | .11%                    | 0.2                |
| Brazil.....                         | P. G.                             | 226,463                 | .42%                    | 0.7                | 88,385                             | 1.46%                   | 0.3                |
| Chile.....                          | P.                                | 51,118                  | .10%                    | 1.3                | 34,826†                            | .58%                    | 0.9                |
| Colombia.....                       | P.                                | 8,502                   | .02%                    | 0.1                | 13,382                             | .22%                    | 0.2                |
| Ecuador.....                        | P. G.                             | 5,048                   | .01%                    | 0.3                | 4,622                              | .08%                    | 0.2                |
| Paraguay.....                       | P. G.                             | 144                     | .01%                    | 0.01               | 1,703                              | .03%                    | 0.2                |
| Peru.....                           | P. G.                             | 30,822                  | .06%                    | 0.6                | 10,178                             | .17%                    | 0.2                |
| Uruguay.....                        | P.                                | 43,440                  | .08%                    | 2.9                | 5,124                              | .08%                    | 0.3                |
| Venezuela.....                      | P. G.                             | 22,494                  | .04%                    | 0.8                | 6,420                              | .11%                    | 0.2                |
| Other Places (Jan. 1, 1920).....    | G.                                | 3,325                   | .01%                    | 0.7                | 758                                | .01%                    | 0.2                |
| Total.....                          |                                   | 764,514                 | 1.43%                   | 1.2                | 341,181                            | 5.64%                   | 0.5                |
| <b>EUROPE:</b>                      |                                   |                         |                         |                    |                                    |                         |                    |
| Austria.....                        | G.                                | 295,037                 | .56%                    | 4.8                | 50,400                             | .83%                    | 0.8                |
| Belgium.....                        | G.                                | 291,483                 | .55%                    | 3.8                | 20,611                             | .34%                    | 0.3                |
| Bulgaria*.....                      | G.                                | 11,550                  | .02%                    | 0.2                | 12,000                             | .20%                    | 0.2                |
| Czecho-Slovakia.....                | G.                                | 132,190                 | .25%                    | 1.0                | 42,183                             | .70%                    | 0.3                |
| Denmark (March 31, 1921).....       | P. G.                             | 521,818                 | .99%                    | 16.0               | 8,756                              | .14%                    | 0.3                |
| Finland.....                        | P.                                | 85,500*                 | .16%                    | 2.5                | 10,413                             | .17%                    | 0.3                |
| France.....                         | G.                                | 1,290,484               | 2.45%                   | 3.4                | 715,524                            | 11.82%                  | 1.9                |
| Germany.....                        | G.                                | 5,325,686               | 10.12%                  | 8.7                | 492,745                            | 8.14%                   | 0.8                |
| Great Britain (March 31, 1920)..... | G.                                | 3,493,783               | 6.63%                   | 7.4                | 284,223                            | 4.70%                   | 0.6                |
| Greece.....                         | G.                                | 8,460*                  | .02%                    | 0.2                | 20,173                             | .33%                    | 0.4                |
| Hungary.....                        | G.                                | 177,757                 | .34%                    | 2.3                | 49,932                             | .83%                    | 0.6                |
| Italy (June 30, 1920).....          | P. G.                             | 326,603                 | .62%                    | 0.9                | 150,000*                           | 2.48%                   | 0.4                |
| Jugo-Slavia.....                    | G.                                | 50,000*                 | .09%                    | 0.4                | 44,418                             | .73%                    | 0.4                |
| Netherlands.....                    | P. G.                             | 329,236                 | .63%                    | 4.8                | 29,257                             | .48%                    | 0.4                |
| Norway* (June 30, 1920).....        | P. G.                             | 282,376                 | .54%                    | 10.5               | 16,453                             | .27%                    | 0.6                |
| Poland.....                         | P. G.                             | 213,897*                | .41%                    | 0.8                | 95,523                             | 1.58%                   | 0.3                |
| Portugal*.....                      | P. G.                             | 44,620                  | .08%                    | 0.7                | 17,500                             | .29%                    | 0.3                |
| Roumania (March 31, 1921).....      | G.                                | 63,754                  | .12%                    | 0.4                | 45,444                             | .75%                    | 0.3                |
| Russia*.....                        | G.                                | 400,000                 | .76%                    | 0.4                | 300,000                            | 4.96%                   | 0.3                |
| Spain.....                          | P. G.                             | 140,000*                | .27%                    | 0.7                | 73,202                             | 1.21%                   | 0.3                |
| Sweden.....                         | P. G.                             | 816,505                 | 1.55%                   | 13.8               | 51,150                             | .85%                    | 0.9                |
| Switzerland.....                    | G.                                | 349,534                 | .64%                    | 8.8                | 20,844                             | .34%                    | 0.5                |
| Other Places in Europe*.....        | P. G.                             | 80,000                  | .15%                    | 0.5                | 28,160                             | .47%                    | 0.2                |
| Total.....                          |                                   | 14,730,273              | 27.97%                  | 3.2                | 2,578,911                          | 42.61%                  | 0.6                |
| <b>ASIA:</b>                        |                                   |                         |                         |                    |                                    |                         |                    |
| British India.....                  | P. G.                             | 145,000*                | .28%                    | 0.05               | 322,568                            | 5.33%                   | 0.1                |
| China.....                          | P. G.                             | 76,000*                 | .14%                    | 0.02               | 75,678                             | 1.25%                   | 0.02               |
| Japan.....                          | G.                                | 923,072                 | 1.75%                   | 1.6                | 135,547                            | 2.24%                   | 0.2                |
| Other Places in Asia*.....          | P. G.                             | 146,000                 | .28%                    | 0.1                | 140,000                            | 2.31%                   | 0.1                |
| Total.....                          |                                   | 1,290,072               | 2.45%                   | 0.2                | 673,793                            | 11.13%                  | 0.1                |
| <b>AFRICA:</b>                      |                                   |                         |                         |                    |                                    |                         |                    |
| Egypt (March 31, 1920).....         | G.                                | 92,982                  | .18%                    | 0.7                | 21,118                             | .35%                    | 0.2                |
| Union of South Africa.....          | G.                                | 138,507                 | .26%                    | 1.9                | 46,411                             | .77%                    | 0.6                |
| Other Places in Africa*.....        | P. G.                             | 51,069                  | .10%                    | 0.04               | 126,000                            | 2.08%                   | 0.1                |
| Total.....                          |                                   | 282,558                 | .54%                    | 0.2                | 193,529                            | 3.20%                   | 0.1                |
| <b>OCEANIA:</b>                     |                                   |                         |                         |                    |                                    |                         |                    |
| Australia (June 30, 1920).....      | G.                                | 823,576                 | 1.56%                   | 15.9               | 94,476                             | 1.56%                   | 1.8                |
| Dutch East Indies.....              | P. G.                             | 111,725*                | .21%                    | 0.2                | 18,773                             | .31%                    | 0.04               |
| Hawaii.....                         | P.                                | 47,010                  | .09%                    | 18.4               | 0                                  | 0.00%                   | 0.0                |
| New Zealand (March 31, 1921).....   | G.                                | 203,093                 | .39%                    | 16.0               | 51,228                             | .85%                    | 4.0                |
| Philippine Islands.....             | P. G.                             | 23,660                  | .04%                    | 0.2                | 6,407                              | .11%                    | 0.1                |
| Other Places in Oceania*.....       | P. G.                             | 4,210                   | .01%                    | 0.2                | 1,290                              | .02%                    | 0.1                |
| Total.....                          |                                   | 1,213,274               | 2.30%                   | 1.8                | 172,174                            | 2.85%                   | 0.3                |
| <b>TOTAL WORLD</b> .....            |                                   | 52,662,172              | 100.00%                 | 3.1                | 6,051,477                          | 100.00%                 | 0.4                |

Note: Telegraph service is operated by Governments, except in the United States and Canada. In connection with telephone wire, P. indicates telephone service operated by private companies, G. by the Government, and P. G. by both private companies and the Government.

\* Partly estimated.

† January 1, 1920.

---

---

# *International Western Electric Company*

INCORPORATED

195 BROADWAY

NEW YORK, U. S. A.

## *Affiliated Companies*

Western Electric Company, Limited. . . . . *London, W. C. 2, England*  
Branches: Birmingham, Cardiff, Glasgow, Leeds, Manchester, Newcastle-on-Tyne, Johannesburg, Singapore.

Bell Telephone Manufacturing Company. . . . . *Antwerp, Belgium*  
Branches: Berne, The Hague, Barcelona.

Le Materiel Telephonique. . . . . *Paris, France*

Western Electric Italiana. . . . . *Milan, Italy*

Western Electric Norsk Aktieselskap. . . . . *Christiania, Norway*

Vereinigte Telephon und Telegraphen Fabrik. . . . . *Vienna, Austria*

United Incandescent Lamps and Electrical Company, Limited  
*Budapest (Ujpest), Hungary*

Western Electric Company (Australia) Limited. . . . . *Sydney, Australia*

Nippon Denki Kabushiki Kaisha. . . . . *Tokyo, Japan*  
Branches: Osaka, Dalny (Manchuria), Seoul (Chosen)

Sumitomo Electric Wire & Cable Works, Ltd. . . . . *Osaka, Japan*

China Electric Company, Limited. . . . . *Peking, China*  
Branches: Shanghai, Tientsin

Northern Electric Company, Limited. . . . . *Montreal, Canada*  
Branches: Quebec, Halifax, Toronto, London (Ontario),  
Hamilton, Windsor, Winnipeg, Calgary, Regina, Vancouver

Compania Western Electric Argentina. . . . . *Buenos Aires, Argentina*

International Western Electric Company. . . . . *Rio de Janeiro, Brazil*

Sales Offices and Agencies Throughout the World

To those interested in better communication the International Western Electric Company and its Affiliated Companies offer the facilities of their consulting engineering departments to aid in the solution of problems in Telephony, Telegraphy and Radio.